



Harvey Cushing / John Hay Whitney  
Medical Library

HISTORICAL LIBRARY



Yale University

Emily H. Preston, 1916

Eleanor Seale '17 - 1911

Paul M. Graves, '17





Digitized by the Internet Archive  
in 2012 with funding from  
Open Knowledge Commons and Yale University, Cushing/Whitney Medical Library



A TEXT-BOOK  
OF  
PHYSIOLOGY

FOR  
MEDICAL STUDENTS AND PHYSICIANS

BY  
WILLIAM H. HOWELL, PH. D., M. D., SC. D., LL.D.  
PROFESSOR OF PHYSIOLOGY IN THE JOHNS HOPKINS UNIVERSITY, BALTIMORE

---

---

Sixth Edition, Thoroughly Revised

---

---

PHILADELPHIA AND LONDON  
W. B. SAUNDERS COMPANY  
1916

Copyright, 1905, by W. B. Saunders and Company. Reprinted February, 1906, September, 1906, and January, 1907. Revised, reprinted, and recopyrighted August, 1907. Reprinted January, 1908, and October, 1908. Revised, reprinted, and recopyrighted August, 1909. Reprinted January, 1910, and July, 1910. Revised, reprinted, and recopyrighted August, 1911. Reprinted January, 1912, and October, 1912. Revised, reprinted, and recopyrighted September, 1913. Reprinted August, 1914. Revised, reprinted and recopyrighted September, 1915

---

Copyright, 1915, by W. B. Saunders Company

---

Registered at Stationers' Hall, London, England

---

Reprinted March, 1916

---

PRINTED IN AMERICA

PRESS OF  
W. B. SAUNDERS COMPANY  
PHILADELPHIA

H15T  
Q P34  
H68  
1916



## PREFACE TO THE SIXTH EDITION.

---

IN the preparation of the sixth edition of this text-book the author, as in previous editions, has made an earnest effort to keep up with the progress of physiological science. Those who are familiar with the complexity of the current literature dealing with physiological problems will appreciate the difficulties involved in such an undertaking. The great volume of experimental work appearing in our scientific and medical journals makes it well-nigh impossible for a single worker to keep in intimate touch with the shifting points of view in regard to the many problems considered in a general book of this character.

The author has done as well as he could, and he must beg the generous indulgence of other workers if at any point he has failed to reflect accurately the existing trend of belief. Most of the important alterations in the text will be found in the section upon Nutrition and Internal Secretions. A large part of the latter subject has been rewritten. Unfortunately, it is a subject whose intricacies have increased rather than diminished with the progress of investigative work, and it is more rather than less difficult now than it was a decade ago to present a fair summary of the numerous facts, speculations, and hypotheses bearing upon this topic.

W. H. HOWELL.



## PREFACE.

---

In the preparation of this book the author has endeavored to keep in mind two guiding principles: first, the importance of simplicity and lucidity in the presentation of facts and theories; and, second, the need of a judicious limitation of the material selected. In regard to the second point every specialist is aware of the bewildering number of researches that have been and are being published in physiology and the closely related sciences, and the difficulty of justly estimating the value of conflicting results. He who seeks for the truth in any matter under discussion is oftentimes forced to be satisfied with a suspension of judgment, and the writer who attempts to formulate our present knowledge upon almost any part of the subject is in many instances obliged to present the literature as it exists and let the reader make his own deductions. This latter method is doubtless the most satisfactory and the most suitable for large treatises prepared for the use of the specialist or advanced student, but for beginners it is absolutely necessary to follow a different plan. The amount of material and the discussion of details of controversies must be brought within reasonable limits. The author must assume the responsibility of sifting the evidence and emphasizing those conclusions that seem to be most justified by experiment and observation. As far as material is concerned, it is evident that the selection of what to give and what to omit is a matter of judgment and experience upon the part of the writer, but the present author is convinced that the necessary reduction in material should be made by a process of elimination rather than by condensation. The latter method is suitable for the specialist with his background of knowledge and experience, but it is entirely unfitted for the elementary student. For the purposes of the latter brief, comprehensive statements are oftentimes misleading, or fail at least to make a clear impression. Those subjects that are presented to him must be given with a certain degree of fullness if he is expected to obtain a serviceable conception of the facts, and it follows that a treatment of the wide subject of physiology is possible, when undertaken with this intention, only by the adoption of a system of selection and elimination.

The fundamental facts of physiology, its principles and modes

of reasoning are not difficult to understand. The obstacle that is most frequently encountered by the student lies in the complexity of the subject,—the large number of more or less disconnected facts and theories which must be considered in a discussion of the structure, physics, and chemistry of such an intricate organism as the human body. But once a selection has been made of those facts and principles which it is most desirable that the student should know, there is no intrinsic difficulty to prevent them from being stated so clearly that they may be comprehended by anyone who possesses an elementary knowledge of anatomy, physics, and chemistry. It is doubtless the art of presentation that makes a text-book successful or unsuccessful. It must be admitted, however, that certain parts of physiology, at this particular period in its development, offer peculiar difficulties to the writers of text-books. During recent years chemical work in the fields of digestion and nutrition has been very full, and as a result theories hitherto generally accepted have been subjected to criticism and alteration, particularly as the important advances in theoretical chemistry and physics have greatly modified the attitude and point of view of the investigators in physiology. Some former views have been unsettled and much information has been collected which at present it is difficult to formulate and apply to the explanation of the normal processes of the animal body. It would seem that in some of the fundamental problems of metabolism physiological investigation has pushed its experimental results to a point at which, for further progress, a deeper knowledge of the chemistry of the body is especially needed. Certainly the amount of work of a chemical character that bears directly or indirectly on the problems of physiology has shown a remarkable increase within the last decade. Amid the conflicting results of this literature it is difficult or impossible to follow always the true trend of development. The best that the text-book can hope to accomplish in such cases is to give as clear a picture as possible of the tendencies of the time.

Some critics have contended that only those facts or conclusions about which there is no difference of opinion should be presented to medical students. Those who are acquainted with the subject, however, understand that books written from this standpoint contain much that represents the uncertain compromises of past generations, and that the need of revision is felt as frequently for such books as for those constructed on more liberal principles. There does not seem to be any sound reason why a text-book for medical students should aim to present only those conclusions that have crystallized out of the controversies of other times, and ignore entirely the live issues of the day which are

of so much interest and importance not only to physiology, but to all branches of medicine. With this idea in mind the author has endeavored to make the student realize that physiology is a growing subject, continually widening its knowledge and readjusting its theories. It is important that the student should grasp this conception, because, in the first place, it is true; and, in the second place, it may save him later from disappointment and distrust in science if he recognizes that many of our conclusions are not the final truth, but provisional only, representing the best that can be done with the knowledge at our command. To emphasize this fact as well as to add somewhat to the interest of the reader short historical *résumés* have been introduced from time to time, although the question of space alone, not to mention other considerations, has prevented any extensive use of such material. It is a feature, however, that a teacher might develop with profit. Some knowledge of the gradual evolution of our present beliefs is useful in demonstrating the enduring value of experimental work as compared with mere theorizing, and also in engendering a certain appreciation and respect for knowledge that has been gained so slowly by the exertions of successive generations of able investigators.

A word may be said regarding the references to literature inserted in the book. It is perfectly obvious that a complete or approximately complete bibliography is neither appropriate nor useful, however agreeable it may be to give every worker full recognition of the results of his labors. But for the sake of those who may for any reason wish to follow any particular subject more in detail some references have been given, and these have been selected usually with the idea of citing those works which themselves contain a more or less extensive discussion and literature. Occasionally also references have been made to works of historical importance or to separate papers that contain the experimental evidence for some special view.



# TABLE OF CONTENTS.

## SECTION I.

### THE PHYSIOLOGY OF MUSCLE AND NERVE.

	PAGE
CHAPTER I.—THE PHENOMENON OF CONTRACTION . . . . .	17
The Histological Structure of the Muscle Fiber, 18.—Its Appearance by Polarized Light, 19.—The Extensibility and Elasticity of Muscular Tissue, 20.—The Independent Irritability of Muscle, 23.—Definition and Enumeration of Artificial Stimuli, 24.—The Duration of the Simple Muscle Contraction, 26.—The Curve of a Simple Muscle Contraction, 26.—The Latent Period, 27.—The Phases of Shortening and Relaxation, 27.—Isotonic and Isometric Contractions, 28.—Maximal and Submaximal Contractions, 28.—Effect of Temperature upon the Simple Contraction, 29.—Effect of Veratrin on the Simple Contraction, 31.—Contraction, 32.—Fatigue, the Treppe, and Effect of Rapidly Repeated Stimulation, 34.—The Wave of Contraction and Means of Measuring, 35.—Idiomuscular Contractions, 36.—The Energy Liberated during a Muscular Contraction, 36.—The Proportional Amount of this Energy Utilized in Work, 38.—The Curve of Work and the Absolute Power of a Muscle, 39.—Definition of Tetanus or Compound Contraction, 41.—The Summation of Contractions, 43.—Discontinuity of the Processes of Contraction in Tetanus, 44.—The Muscle-tone, 44.—The Rate of Stimulation Necessary for Complete Tetanus, 45.—The Tetanic Nature of Voluntary Contractions, 45.—The Ergograph, 47.—Results of Ergographic Experiments, 49.—Sense of Fatigue, 50.—Muscle Tonus, 51.—Rigor Mortis and Rigor Caloris, 52.—The Occurrence and Structure of Plain Muscle Tissue, 55.—Distinctive Properties of Plain Muscle, 56.—The General Properties of Cardiac Muscular Tissue, 58.—The Contractility of Cilia and Their General Properties, 58.	
CHAPTER II.—THE CHEMICAL COMPOSITION OF MUSCLE AND THE CHEMICAL CHANGES OF CONTRACTION AND OF RIGOR MORTIS . . . . .	61
The Composition of Muscle Plasma, 61.—The Proteins of Muscle, 61.—The Carbohydrates of Muscle, 63.—Lactic Acid in Muscle, 64.—The Nitrogenous Extractives of Muscle, 64.—Pigments of Muscle, 65.—Enzymes of Muscle, 65.—Inorganic Constituents of Muscle, 65.—The Chemical Changes in Muscle during Contraction, 66.—The Chemical Changes during Rigor Mortis, 69.—The Relation of the Waste Products to Fatigue, the Chemical Theory of Fatigue, 70.—Theories of the Mechanism of the Contraction of Muscle, 72.	
CHAPTER III.—THE PHENOMENON OF CONDUCTION. PROPERTIES OF THE NERVE FIBER . . . . .	75
General Statement Regarding Property of Conductivity, 75.—Structure of the Nerve Fiber, 75.—Function of the Myelin Sheath, 76.—Chemistry of the Nerve Fiber, 77.—The Nerve Trunk an Anatomical Unit Only, 77.—Definition of Afferent and Efferent Nerve Fibers, 79.—Classification of Nerve Fibers, 80.—The Bell-Magendie Law of the Composition of the Anterior and the Posterior Roots of the Spinal Nerves, 81.—Cells of Origin of the Anterior and Posterior Root Fibers, 83.—Origin of the Afferent and Efferent Fibers in the Cranial Nerves, 83.—Independent Irritability of Nerve Fibers, Artificial Nerve Stimuli, 84.—Du Bois-Reymond's Law of Stimulation by the Galvanic Current, 86.—Electrotonus, 87.—Pflüger's Law of Stimulation, 88.—The Opening and the Closing Tetanus, 90.—Mode of Stimulating Nerves in Man, 90.—Motor Points of Muscles, 91.—Physical and Physiological Poles, 93.	
CHAPTER IV.—THE ELECTRICAL PHENOMENA SHOWN BY NERVE AND MUSCLE . . . . .	95
The Demarcation Current, 95.—Construction of the Galvanometer, 97.—Construction of the Capillary Electrometer, 100.—Non-polarizable Electrodes, 100.—Action Current or Negative Variation, 102.—Monophasic and Diphasic Action Currents, 103.—The Rheoscopic Frog Preparation, 104.—Relation of Action Current to the Contraction Wave and Nerve Impulse, 105.—The Electrotonic Currents, 107.—The Core-model, 108.	

	PAGE
CHAPTER V.—THE NATURE OF THE NERVE IMPULSE AND THE NUTRITIVE RELATIONS OF NERVE FIBER AND NERVE CELL . . . . .	110
Historical, 110.—Velocity of the Nerve Impulse, 111.—Relation of the Nerve Impulse to the Wave of Negativity, 113.—Direction of Conduction in the Nerve, 114.—Effect of Various Influences on the Nerve Impulse, 115.—The Refractory Period, 117.—The Fatigue of Nerve Fibers, 117.—The Metabolism of the Nerve Fiber During Functional Activity, 119.—Theories of the Nerve Impulse, 120.—Qualitative Differences in Nerve Impulses, 122.—Doctrine of Specific Nerve Energies, 122.—Nutritive Relations of Nerve Fibers and Nerve Cells, 123.—Nerve Degeneration and Regeneration, 125.—Degenerative Changes in the Central End of the Neuron, 127.	
<b>SECTION II.</b>	
<b>THE PHYSIOLOGY OF THE CENTRAL NERVOUS SYSTEM.</b>	
CHAPTER VI.—STRUCTURE AND GENERAL PROPERTIES OF THE NERVE CELL . . . . .	129
The Neuron Doctrine, 129.—The Varieties of Neurons, 131.—Internal Structure of the Nerve Cell, 134.—General Physiology of the Nerve Cell, 135.—Summation of Stimuli in Nerve Cell, 138.—Response of the Nerve Cell to Varying Rates of Stimulation, 138.—The Refractory Period of the Nerve Cell, 139.	
CHAPTER VII.—REFLEX ACTIONS . . . . .	140
Definition and Historical, 140.—The Reflex Arc, 140.—The Reflex Frog, 142.—Spinal Reflex Movements, 142.—Theory of Co-ordinated Reflexes, 144.—Spinal Reflexes in Mammals, 145.—Dependence of Co-ordinated Reflexes upon the Excitation of the Sensory Endings, 145.—Reflex Time, 146.—Inhibition of Reflexes, 147.—Influence of the Condition of the Cord on Its Reflex Activities, 149.—Reflexes from Other Parts of the Nervous System, 149.—Reflexes Through Peripheral Ganglia, Axon Reflexes, 150.—The Tonic Activity of the Spinal Cord, 152.—Effects of the Removal of the Spinal Cord, 153.—Knee-jerk, 155.—Reinforcement of the Knee-jerk, 155.—Is the Knee-jerk a Reflex Act? 157.—Conditions Influencing the Extent of the Knee-jerk, 159.—The Knee-jerk and Spinal Reflexes as Diagnostic Signs, 160.—Other Spinal Reflexes, 160.	
CHAPTER VIII.—THE SPINAL CORD AS A PATH OF CONDUCTION . . . . .	162
Arrangement and Classification of the Nerve Cells in the Cord, 162.—General Relations of the Gray and White Matter in the Cord, 164.—The Methods of Determining the Tracts of the Cord, 164.—General Classification of the Tracts of the Cord, 165.—The Names and Locations of the Long Tracts, 167.—The Termination in the Cord of the Fibers of the Posterior Root, 168.—Ascending or Afferent Paths in the Posterior Funiculi, 169.—Ascending or Afferent Paths in the Lateral Funiculi, 172.—The Spinal Paths for the Cutaneous Senses (Touch, Pain, Temperature), 174.—The Homolateral or Contralateral Conduction of the Cutaneous Impulses, 176.—The Descending or Efferent Paths in the Anterolateral Funiculi (Pyramidal System), 178.—Less Well-known Tracts in the Cord, 180.	
CHAPTER IX.—THE GENERAL PHYSIOLOGY OF THE CEREBRUM AND ITS MOTOR FUNCTIONS . . . . .	182
The Histology of the Cortex, 183.—The Classification of the Systems of Fibers in the Cerebrum (Projection, Association, and Commissural), 184.—Physiological Deductions from the Histology of the Cortex, 186.—The Phenomenon of Conditioned Reflexes, 189.—Extirpation of the Cerebrum, 190.—Localization of Functions in the Cerebrum, Historical, 192.—The Motor Areas of the Cortex, 196.—Differences in Paralysis from Injury to the Spinal Neuron and the Pyramidal Neuron, 198.—Voluntary Motor Paths Other than the Pyramidal Tract, 198.—The Crossed Control of the Muscles and Bilateral Motor Representation in the Cortex, 199.—Are the Motor Areas Exclusively Motor? 200.	
CHAPTER X.—THE SENSE AREAS AND THE ASSOCIATION AREAS IN THE CORTEX . . . . .	202
The Body-sense Area, 203.—The Course of the Lemniscus, 205.—The Center for Vision, 207.—Histological Evidence of the Course of the Optic Fibers, 208.—The Decussation in the Chiasm, 209.—The Projection of the Retina on the Occipital Cortex, 210.—The Function of the Lower Visual Centers, 212.—The Auditory Center, 212.—Course of the Cochlear Nerve, 214.—The Physiological Significance of the Lower Auditory Centers, 215.—Motor Responses from the Auditory Cortex, 216.—The Olfactory Center, 216.—The Olfactory Bulb and its Connections, 217.—The Cortical Center for Smell, 218.—The Cortical Center for Taste, 218.—Aphasia, 219.—Sensory Aphasia, 221.—The Association Areas, 223.—Subdivision of the Association Areas, 225.—The Development of the Cortical Areas, 226.—Histological Differentiation in Cortical Structure, 229.—Physiology of the Corpus Callosum, 230.—Physiology of the Corpora Striata and Thalami, 231.	



	PAGE
<b>CHAPTER XI.—THE FUNCTIONS OF THE CEREBELLUM, THE PONS, AND THE MEDULLA</b> . . . . .	233
<p>Anatomical Structure and Relations of the Cerebellum, 233.—General Statement of Theories Regarding the Cerebellum, 237.—Experiments upon Ablation of the Cerebellum, 239.—Interpretation of the Experimental and Clinical Results, 240.—Conclusions as to the General Functions of the Cerebellum, 241.—The Psychological Functions of the Cerebellum, 243.—Localization of Function in the Cerebellum, 243.—The Functions of the Medulla Oblongata, 245.—The Nuclei of Origin and the Functions of the Cranial Nerves, 246.</p>	
<b>CHAPTER XII.—THE SYMPATHETIC OR AUTONOMIC NERVOUS SYSTEM</b> . . . . .	251
<p>General Statements, 251.—Autonomic Nervous System, 252.—The Use of the Nicotin Method, 253.—General Course of the Autonomic Fibers Arising from the Cord, 254.—General Course of the Fibers Arising from the Brain, 255.—General Course of the Fibers Arising from the Sacral Cord, 256.—Normal Mode of Stimulation of Autonomic Nerve Fibers, 257.</p>	
<b>CHAPTER XIII.—THE PHYSIOLOGY OF SLEEP</b> . . . . .	258
<p>General Statements, 258.—Physiological Relations during Sleep, 258.—The Intensity of Sleep, 259.—Changes in the Circulation during Sleep, 261.—Effect of Sensory Stimulation, 264.—Theories of Sleep, 265.—Hypnotic Sleep, 269</p>	

SECTION III.

THE SPECIAL SENSES.

<b>CHAPTER XIV.—CLASSIFICATION OF THE SENSES AND GENERAL STATEMENTS</b> . . . . .	271
<p>Classification of the Senses, 271.—The Doctrine of Specific Nerve Energies, 273.—The Weber-Fechner Psychophysical Law, 275.</p>	
<b>CHAPTER XV.—CUTANEOUS AND INTERNAL SENSATIONS</b> . . . . .	278
<p>General Classification, 278.—Protopathic, Epicritic, and Deep Sensibility, 278.—The Punctiform Distribution of the Cutaneous Senses, 280.—Specific Nerve Energies of the Cutaneous Nerves, 281.—The Temperature Senses, 282.—The Sense of Pressure, 283.—The Threshold Stimulus and the Localizing Power, 283.—The Pain Sense, 286.—Localization or Projection of Pain Sensations, 286.—Reflected or Misreferred Pains, 287.—Muscular or Deep Sensibility, 287.—The Quality of the Muscular Sensibility, 289.—Sensations of Hunger and Thirst, 290.—The Sense of Thirst, 290.</p>	
<b>CHAPTER XVI.—SENSATIONS OF TASTE AND SMELL</b> . . . . .	294
<p>The Nerves of Taste, 294.—The End-organ of the Taste Fibers, 296.—Classification of Taste Sensations, 296.—Distribution and Specific Energy of the Fundamental Taste Sensations, 297.—Method of Sapid Stimulation, 298.—The Threshold Stimulus for Taste, 299.—The Olfactory Organ, 299.—The Mechanism of Smelling, 300.—Nature of the Olfactory Stimulus, 301.—The Qualities of the Olfactory Sensations, 301.—Fatigue of the Olfactory Apparatus, 303.—Delicacy of the Olfactory Sense, 303.—Conflict of Olfactory Sensations, 305.—Olfactory Associations, 305.</p>	
<b>CHAPTER XVII.—THE EYE AS AN OPTICAL INSTRUMENT. DIOPTRICS OF THE EYE</b> . . . . .	306
<p>Formation of an Image by a Biconvex Lens, 306.—Formation of an Image in the Eye, 309.—The Inversion of the Image on the Retina, 311.—The Size of the Retinal Image, 312.—Accommodation of the Eye, 313.—Limit of the Power of Accommodation and Near Point of Distinct Vision, 316.—Far Point of Distinct Vision, 316.—The Refractive Power of the Surfaces in the Eye, 317.—Optical Defects of the Normal Eye, 319.—Spherical Aberration, 319.—Abnormalities in the Refraction of the Eye, Ametropia, 319.—Myopia, 320.—Hypermetropia, 321.—Presbyopia, 321.—Astigmatism, 322.—Innervation and Control of the Ciliary Muscle and the Muscles of the Iris, 324.—The Accommodation Reflex and the Light Reflex, 326.—Action of Drugs upon the Iris, 328.—The Antagonism of the Sphincter and Dilator Muscles of the Iris, 329.—Intra-ocular Pressure, 330.—The Ophthalmoscope, 331.—Retinoscope, 333.—Ophthalmometer, 334.</p>	
<b>CHAPTER XVIII.—THE PROPERTIES OF THE RETINA. VISUAL STIMULI AND VISUAL SENSATIONS</b> . . . . .	336
<p>The Portion of the Retina Stimulated by Light, 336.—The Action Current Caused by Stimulation of the Retina, 337.—The Visual Purple, Rhodopsin, 338.—Extent of the Visual Field, Perimetry, 340.—Central and Peripheral Fields of Vision, 342.—Visual Acuity, 343.—Relation Between Stimulus and Sensation, Thresh-</p>	

old Stimulus, 345.—The Light Adapted and the Dark Adapted Eye, 346.—Luminosity or Brightness, 347.—Qualities of Visual Sensations. 349.—The Achromatic Series, 349.—The Chromatic Series, 350.—Color Saturation and Color Fusion, 350.—The Fundamental Colors, 351.—The Complementary Colors, 351.—After Images, Positive and Negative, 352.—Color Contrasts, 353.—Color Blindness, 354.—Dichromatic Vision, 355.—Tests for Color Blindness, 356.—Achromatic Vision, 357.—Distribution of Color Sense in the Retina, 357.—Functions of the Rods and Cones, 358.—Theories of Color Vision, 360.—Entoptic Phenomena, 366.—Shadows of Corpuscles and Blood-vessels, 366.—Shadows from Lens and Vitreous Humor, 367.

CHAPTER XIX.—BINOCULAR VISION. . . . . 368

Movements of the Eyeballs, 368.—Co-ordination of the Eye Muscles, Muscular Insufficiency and Strabismus, 370.—The Binocular Field of Vision, 372.—Corresponding or Identical Points, 372.—Physiological Diplopia, 373.—The Horopter, 375.—Suppression of Visual Images, 375.—Struggle of the Visual Fields, 375.—Judgments of Solidity, 376.—Monocular Perspective, 376.—Binocular Perspective, 378.—Stereoscopic Vision, 378.—Explanation of Binocular Perspective, 380.—Judgments of Distance and Size, 381.—Optical Deceptions, 382.

CHAPTER XX.—THE EAR AS AN ORGAN FOR SOUND SENSATIONS. . . . . 385

The Pinna or Auricle, 386.—The Tympanic Membrane, 386.—The Ear Bones, 387.—Mode of Action of the Ear Bones, 388.—Muscles of the Middle Ear, 390.—The Eustachian Tube, 391.—Projection of the Auditory Sensations, 391.—Sensory Epithelium of the Cochlea, 392.—Nature and Action of the Sound Waves, 393.—Classification and Properties of Musical Sounds, 394.—Upper Harmonics or Overtones, 396.—Sympathetic Vibrations and Resonance, 398.—Functions of the Cochlea, 398.—Sensations of Harmony and Discord, 402.—Limits of Hearing, 402.

CHAPTER XXI.—FUNCTIONS OF THE SEMICIRCULAR CANALS AND THE VESTIBULE. . . . . 404

Position and Structure of the Semicircular Canals, 404.—Flouren's Experiments upon the Semicircular Canals, 405.—Temporary and Permanent Effects of the Operations, 406.—Effect of Direct Stimulation of the Canals, 407.—Effect of Section of the Ampullary or the Acoustic Nerve, 408.—Is the Effect of Section of the Canals due to Stimulation? 408.—Theories of the Functions of the Semicircular Canals, 408.—Summary of the Views upon the Function of the Semicircular Canals, 410.—Functions of the Utriculus and Sacculus, 412.

SECTION IV.

BLOOD AND LYMPH.

CHAPTER XXII.—GENERAL PROPERTIES OF BLOOD. PHYSIOLOGY OF THE CORPUSCLES. . . . . 415

Histological Structure of Blood, 415.—Reaction of the Blood, 416.—Specific Gravity of the Blood, 419.—The Red Corpuscles, 420.—Condition of the Hemoglobin in the Corpuscles, 420.—Hemolysis, 421.—Hemolysis Due to Variations in Osmotic Pressure, 422.—Hemolysis Due to Action of Hemolysins, 423.—Nature and Amount of Hemoglobin, 426.—Compounds of Hemoglobin with Oxygen and Other Gases, 428.—The Iron in the Hemoglobin, 429.—Crystals of Hemoglobin, 430.—Absorption Spectra Hemoglobin and Oxyhemoglobin, 431.—Derivative Compounds of Hemoglobin, 435.—Origin and Fate of the Red Corpuscles, 437.—Variations in the Number of Red Corpuscles, 439.—Physiology of the Blood Leucocytes, 442.—Variations in Number of the Leucocytes, 443.—Functions of the Leucocytes, 443.—Physiology of the Blood Plates, 444.

CHAPTER XXIII.—CHEMICAL COMPOSITION OF THE BLOOD PLASMA; COAGULATION; QUANTITY OF BLOOD; REGENERATION AFTER HEMORRHAGE. . . . . 447

Composition of the Plasma and Corpuscles, 447.—Proteins of the Blood Plasma, 449.—Serum Albumin, 449.—Paraglobulin (Serum Globulin), 450.—Fibrinogen, 450.—Less Well-known Proteins of the Blood, 452.—Coagulation of Blood, 452.—Time of Clotting, 454.—Preparation of Solutions of Fibrinogen, 455.—Preparation of Thrombin, 456.—The Action of Thrombin on Fibrinogen, 458.—The Influence of Calcium, 459.—The Influence of Tissue-extracts, 459.—Theory of Coagulation, 461.—Why Blood Does Not Clot Within the Vessels, 462.—Metathrombin, 464.—Intravascular Clotting, 464.—Means of Hastening or of Retarding Coagulation, 465.—Total Quantity of Blood in the Body, 468.—Regeneration of the Blood after Hemorrhage, 469.—Blood Transfusion, 471.

CHAPTER XXIV.—COMPOSITION AND FORMATION OF LYMPH. . . . . 472

General Statements, 472.—Formation of Lymph, 474.—Lymphagogues of the First Class, 475.—Lymphagogues of the Second Class, 476.—Summary of the Factors Controlling the Flow of Lymph, 478.

SECTION V.

PHYSIOLOGY OF THE ORGANS OF CIRCULATION OF THE BLOOD AND LYMPH.

	PAGE
CHAPTER XXV.—THE VELOCITY AND PRESSURE OF THE BLOOD FLOW . . .	481
The Circulation as Seen Under the Microscope, 481.—The Velocity of the Blood Flow, 482.—Mean Velocity in the Arteries, Veins, and Capillaries, 485.—Cause of the Variations in Velocity, 487.—Variations of Velocity with the Heart Beat or Changes in the Blood-vessels, 487.—Time Necessary for a Complete Circulation of the Blood, 488.—The Pressure Relations in the Vascular System, 489.—Methods of Recording Blood-pressure, 489.—Systolic, Diastolic, and Mean Arterial Pressure, 493.—Method of Measuring Systolic and Diastolic Pressure in Animals, 495.—Data as to the Mean Pressure in Arteries, Veins, and Capillaries, 496.—Methods of Determining Blood-pressure in the Large Arteries of Man, 500.—Normal Arterial Pressure in Man and its Variations, 505.—The Method of Determining Venous Pressures and Capillary Pressures in Man, 507.	
CHAPTER XXVI.—THE PHYSICAL FACTORS CONCERNED IN THE PRODUCTION OF BLOOD-PRESSURE AND BLOOD-VELOCITY . . . . .	510
Side Pressure and Velocity Pressure, 510.—The Factors Concerned in Producing Normal Pressure and Velocity, 513.—General Conditions Influencing Blood-pressure and Blood-velocity, 514.—The Hydrostatic Effect, 515.—Accessory Factors Aiding the Circulation, 517.—The Conditions of Pressure and Velocity in the Pulmonary Circulation, 518.—Variations of Pressure in the Pulmonary Circuit, 519.	
CHAPTER XXVII.—THE PULSE . . . . .	520
General Statement, 520.—Velocity of the Pulse Wave, 521.—Form of the Pulse Wave, Sphygmography, 523.—Explanation of the Catacrotic Waves, 525.—Anacrotic Waves, 526.—The Kinds of Pulse in Health and Disease, 527.—Venous Pulse, 528.	
CHAPTER XXVIII.—THE HEART BEAT . . . . .	533
General Statement, 533.—Musculature of the Auricles and Ventricles, 533.—The Auriculoventricular Bundle, 536.—Contraction Wave of the Heart, 540.—The Electrical Variation, 541.—Change of Form during Systole, 544.—The Apex Beat, 544.—Cardiogram, 546.—Intraventricular Pressure during Systole, 547.—The Volume Curve and the Ventricular Output, 549.—The Heart Sounds, 552.—The Third Heart Sound, 555.—Events Occurring during a Cardiac Cycle, 556.—Time Relations of Systole and Diastole, 557.—Normal Capacity of Ventricle and Work Done by the Heart, 557.—Coronary Circulation during the Heart Beat, 559.—Suction-pump Action of the Heart, 560.—Occlusion of the Coronary Vessels, 562.—Fibrillar Contractions of Heart Muscles, 563.	
CHAPTER XXIX.—THE CAUSE AND THE SEQUENCE OF THE HEART BEAT. PROPERTIES OF THE HEART MUSCLE . . . . .	564
General Statement, 564.—The Neurogenic Theory of the Heart Beat, 566.—Myogenic Theory, 567.—Automaticity of the Heart, 569.—Action of Calcium, Potassium, and Sodium Ions on the Heart, 570.—Connection of Inorganic Salts with the Causation of the Beat, 572.—Maximal Contractions of the Heart, 573.—Refractory Period of the Heart Beat, 575.—The Compensatory Pause, 576.—Normal Sequence of the Heart Beat, 576.—Tonicity of the Heart Muscle, 579.	
CHAPTER XXX.—THE CARDIAC NERVES AND THEIR PHYSIOLOGICAL ACTION . . . . .	581
Course of the Cardiac Nerves, 581.—Action of the Inhibitory Fibers, 581.—Analysis of the Inhibitory Action, 583.—Effect of Vagus on the Auricle and the Ventricle, 585.—Escape from Inhibition, 585.—Reflex Inhibition of the Heart Beat, the Cardio-inhibitory Center, 586.—The Tonic Activity of the Cardio-inhibitory Center, 587.—The Action of Drugs on the Inhibitory Apparatus, 589.—The Nature of Inhibition, 589.—Course of the Accelerator Fibers, 591.—Action of the Accelerator Fibers, 593.—Tonicity of the Accelerators and Reflex Acceleration, 593.—The Accelerator Center, 595.	
CHAPTER XXXI.—THE RATE OF THE HEART BEAT AND ITS VARIATIONS UNDER NORMAL CONDITIONS . . . . .	596
Variations in Rate with Sex, Size, and Age, 596.—Variations through the Extrinsic Cardiac Nerves, 597.—Variations with Blood-pressure, 597.—With Muscular Exercise, 598.—With the Gases of the Blood, 599.—With Temperature of the Blood, 599.	

	PAGE
CHAPTER XXXII.—THE VASOMOTOR NERVES AND THEIR PHYSIOLOGICAL ACTIVITY . . . . .	602
<p>Historical, 602.—Methods Used to Determine Vasomotor Action, 603.—The Plethysmograph, 604.—General Distribution and Course of the Vasoconstrictor Nerve Fibers, 606.—Tonic Activity of the Vasoconstrictors, 609.—The Vasoconstrictor Center, 609.—Vasoconstrictor Reflexes, Pressor and Depressor Fibers, 611.—Depressor Nerve of the Heart, 614.—Vasoconstrictor Centers in the Spinal Cord, 615.—Rhythmical Activity of the Vasoconstrictor Center, 615.—Course and Distribution of the Dilator Fibers, 616.—General Properties of Vasodilator Fibers, 617.—Vasodilator Center and Reflexes, 618.—Vasodilatation Due to Afferent Fibers, 619.—Regulation of the Blood-supply by Chemical and Mechanical Stimuli, 620.</p>	
CHAPTER XXXIII.—THE VASOMOTOR SUPPLY OF THE DIFFERENT ORGANS . . . . .	622
<p>Vasomotors of the Heart, 622.—Vasomotors of the Pulmonary Arteries, 623.—Circulation in the Brain and Its Regulation, 624.—Arterial Supply, 624.—Venous Supply, 625.—The Meningeal Spaces, 626.—Intracranial Pressure, 628.—Effect of Changes in Arterial Pressure upon the Blood Flow through the Brain, 630.—The Regulation of the Brain Circulation, 632.—Vasomotor Nerves of the Head Region, 634.—Of the Trunk and the Limbs, 635.—Of the Abdominal Organs, 636.—Of the Genital Organs, 636.—Of the Skeletal Muscles, 637.—The Vasomotor Nerves to the Veins, 638.—The Circulation of the Lymph, 638.</p>	
SECTION VI.	
PHYSIOLOGY OF RESPIRATION.	
CHAPTER XXXIV.—HISTORICAL STATEMENT. THE ORGANS OF EXTERNAL RESPIRATION AND THE RESPIRATORY MOVEMENTS . . . . .	640
<p>Historical, 640.—Anatomy of Organs of Respiration, 644.—Thorax as a Closed Cavity, 644.—Normal Position of the Thorax, 645.—Inspiration by Contraction of the Diaphragm, 646.—Inspiration by Elevation of the Ribs, 647.—The Muscles of Inspiration, 648.—Muscles of Expiration, 648.—Quiet and Forced Respiratory Movements, Eupnea and Dyspnea, 649.—Costal and Abdominal Types of Respiration, 650.—Accessory Respiratory Movements, 651.—Registration of the Respiratory Movements, 651.—Volumes of Air Respired, Vital Capacity, Tidal Air, Complementary Air, Supplemental Air, Residual Air, Minimal Air, 653.—Size of the Bronchial Tree, 655.—Artificial Respiration, 655.</p>	
CHAPTER XXXV.—THE PRESSURE CONDITIONS IN THE LUNGS AND THORAX AND THEIR INFLUENCE UPON THE CIRCULATION . . . . .	657
<p>The Intrapulmonic Pressure and Its Variations, 657.—Intrathoracic Pressure, 658.—Variations of, with Forced and Unusual Respirations, 659.—Origin of the Negative Pressure in the Thorax, 660.—Pneumothorax, 661.—Aspiratory Action of the Thorax, 661.—Respiratory Waves of Blood-pressure, 662.</p>	
CHAPTER XXXVI.—THE CHEMICAL AND PHYSICAL CHANGES IN THE AIR AND THE BLOOD CAUSED BY RESPIRATION . . . . .	665
<p>The Inspired and Expired Air, 665.—Physical Changes in the Expired Air, 666.—Injurious Action of Expired Air, 666.—Ventilation, 668.—The Gases of the Blood, 669.—The Pressure of Gases, 673.—Absorption of Gases in Liquids, 673.—The Tension of Gases in Solution, 674.—The Condition of Nitrogen in the Blood, 676.—Condition of Oxygen in the Blood, 676.—Condition of Carbon Dioxid in the Blood, 679.—The Physical Theory of Respiration, 680.—Gaseous Exchanges in the Lungs, 681.—Exchange of Gases in the Tissues, 683.—Secretory Activity of Lungs, 684.</p>	
CHAPTER XXXVII.—INNERVATION OF THE RESPIRATORY MOVEMENTS . . . . .	685
<p>The Respiratory Center, 685.—Spinal Respiratory Centers, 686.—Automatic Activity of the Respiratory Center, 687.—Reflex Stimulation of the Center, 688.—Afferent Relations of the Vagus to the Center, 689.—The Inspiratory and Inhibitory Fibers of the Vagus, 691.—Respiratory Reflexes from the Larynx, Pharynx, and Nose, 693.—Voluntary Control of the Respiratory Movements, 693.—Nature of the Respiratory Center, 694.—Respiratory Centers in the Mid-brain, 695.—Automatic Stimulus to the Respiratory Center, 695.—Cause of the First Respiratory Movements, 699.—Dyspnea, Hyperpnea, and Apnea, 699.—Innervation of the Bronchial Musculature, 702.</p>	
CHAPTER XXXVIII.—THE INFLUENCE OF VARIOUS CONDITIONS UPON THE RESPIRATION . . . . .	704
<p>Effect of Muscular Work on the Respiratory Movements, 704.—Effect of Variations in the Composition of the Air, 705.—High and Low Barometric Pressures, Mountain Sickness, Caisson Disease, 706.—The Respiratory Quotient and Its Variations, 708.—Modified Respiratory Movements, 710.</p>	

## SECTION VII.

## PHYSIOLOGY OF DIGESTION AND SECRETION.

	PAGE
CHAPTER XXXIX.—MOVEMENTS OF THE ALIMENTARY CANAL . . . . .	713
Mastication, 713.—Deglutition, 713.—Nervous Control of Deglutition, 716.—Cardiac Sphincter, 718.—Anatomy of the Stomach, 719.—Musculature of the Stomach, 720.—Movements of the Stomach, 720.—Effect of the Nerves on the Movements of the Stomach, 724.—Hunger Contractions, 725.—Movements of the Intestines, 725.—Peristaltic and Pendular Movements of the Intestines, 727.—Movements of the Intestinal Villi, 729.—Nervous Control of the Intestinal Movements, 730.—Effect of Various Conditions on the Intestinal Movements, 730.—Movements of the Large Intestines, 731.—Defecation, 733.—Vomiting, 735.—Nervous Mechanism of Vomiting, 736.	
CHAPTER XL.—GENERAL CONSIDERATION OF THE COMPOSITION OF THE FOOD AND THE ACTION OF ENZYMES . . . . .	738
Foods and Food-stuffs, 738.—Accessory Articles of Diet, 741.—Enzymes, Historical, 741.—Reversible Reactions, 744.—Specificity of Enzymes, 745.—Definition and Classification of Enzymes, 746.—General Properties of Enzymes, 748.—Partial List of Enzymes, 750.—Chemical Composition of the Enzymes, 751.	
CHAPTER XLI.—THE SALIVARY GLANDS AND THEIR DIGESTIVE ACTION	752
Anatomy of the Salivary Glands, 752.—Histological Structure, 754.—Composition of the Secretion, 755.—The Secretory Nerves, 755.—Trophic and Secretory Nerve Fibers, 758.—Histological Changes during Activity, 759.—Action of Drugs upon the Secretory Nerves, 762.—Paralytic Secretion, 763.—Normal Mechanism of Salivary Secretion, 763.—Electrical Changes in Glands, 765.—Digestive Action of Saliva, Ptyalin, 765.—Conditions Influencing the Action of Ptyalin, 766.—Functions of the Saliva, 767.	
CHAPTER XLII.—DIGESTION AND ABSORPTION IN THE STOMACH . . . . .	768
Structure of the Gastric Glands, 768.—Histological Changes during Secretion, 769.—Method of Obtaining the Gastric Secretion and Its Normal Composition, 770.—The Acid of Gastric Juice, 772.—Origin of HCl, 773.—Secretory Nerves of the Gastric Glands, 774.—Normal Mechanism of the Secretion of the Gastric Juice, 775.—Nature and Properties of Pepsin, 778.—Artificial Gastric Juice, 779.—Pepsin-hydrochloric Digestion, 780.—The Rennin Enzyme, 782.—Digestive Changes in the Stomach, 784.—Absorption in the Stomach, 785.	
CHAPTER XLIII.—DIGESTION AND ABSORPTION IN THE INTESTINES . . . . .	787
Structure of the Pancreas, 787.—Composition of the Secretion, 788.—Secretory Nerve Fibers to the Pancreas, 788.—The Curve of Secretion, 789.—Normal Mechanism of Pancreatic Secretion, 790.—Secretin, 790.—Enterokinase, 791.—Digestive Action of Pancreatic Juice, 792.—The Amino-acids, 793.—Significance of Tryptic Digestion, 795.—Action of the Diastatic Enzyme (Amylase), 796.—Action of the Lipolytic Enzyme (Lipase, Steapsin), 797.—The Intestinal Secretion (Succus Entericus), 798.—Absorption in the Small Intestine, 800.—Absorption of Carbohydrates, 802.—Absorption of Fats, 803.—Absorption of Proteins, 805.—Digestion and Absorption in the Large Intestine, 806.—Bacterial Action in the Small Intestine, 807.—Bacterial Action in the Large Intestine, 808.—Physiological Importance of Intestinal Putrefaction, 809.—Composition of the Feces, 810.	
CHAPTER XLIV.—PHYSIOLOGY OF THE LIVER AND SPLEEN . . . . .	812
Structure of the Liver, 812.—Composition of Bile, 813.—The Bile Pigments, 814.—The Bile Acids, 815.—Cholesterin, 817.—Lecithin, Fats, and Nucleo-albumins, 818.—Secretion of the Bile, 818.—Ejection of the Bile—Function of the Gall-bladder, 820.—Occlusion of the Bile-ducts, 821.—Physiological Importance of Bile, 822.—Occurrence of Glycogen, 823.—Origin of Glycogen, 824.—Function of Glycogen, Glycogenic Theory, 826.—Glycogen in the Muscles and Other Tissue, 828.—Conditions Affecting the Supply of Glycogen, 828.—Formation of Urea in the Liver, 829.—Physiology of the Spleen, 830.	
CHAPTER XLV.—THE KIDNEY AND SKIN AS EXCRETORY ORGANS . . . . .	833
Structure of the Kidney, 833.—The Secretion of Urine, 834.—Function of the Glomerulus, 836.—Function of the Convoluted Tubule, 838.—Action of Diuretics, 840.—The Blood Flow Through the Kidneys, 841.—Hormone Stimulation, 843.—The Composition of Urine, 844.—The Nitrogenous Excreta in the Urine, 845.—Origin and Significance of Urea, 847.—Origin and Significance of the Purin Bodies (Uric Acid, Xanthin, Hypoxanthin), 850.—Origin and Significance of the Creatinin and Creatin, 852.—Hippuric Acid, 854.—The Conjugated Sulphates and the Sulphur Excretion, 855.—Secretion of the Water and Inorganic Salts, 856.—Micturition, 856.—Contractions of the Bladder, 857.—Nervous Mechanism of Micturition, 859.—Excretory Functions of the Skin, 860.—Composition of Sweat, 861.—Secretory Fibers of Sweat Glands, 862.—Sweat Centers, 864.—Sebaceous Secretion, 864.—Excretion of Carbon Dioxid through the Skin, 865.	

	PAGE
CHAPTER XLVI.—SECRETION OF THE DUCTLESS GLANDS—INTERNAL SECRETION . . . . .	866
Internal Secretion of Liver, 867.—Internal Secretion of the Thyroid Tissues, 867.—Extirpation of Thyroids and Parathyroids, 868.—Function of the Parathyroids, 869.—Function of the Thyroid, 871.—Function of Thymus, 872.—Structure and Properties of Adrenal Bodies, 874.—Physiology of the Medulla, 875.—Epinephrin, 875.—The Chromaffin Tissues, 875.—Secretory Nerves of the Adrenal Gland, 878.—Functional Significance of the Medullary Tissue, 878.—Functional Significance of Cortical Tissue, 879.—Pituitary Body, 880.—The Pineal Body, 884.—Internal Secretion of Testis and Ovary, 884.—Internal Secretion of Pancreas, 887.	
<b>SECTION VIII.</b>	
<b>NUTRITION OF HEAT PRODUCTION AND REGULATION.</b>	
CHAPTER XLVII.—GENERAL METHODS. HISTORY OF THE PROTEIN FOOD . . . . .	891
General Statement, 891.—Nitrogen Equilibrium, 891.—Carbon Equilibrium and Body Equilibrium, 893.—Balance Experiments, 893.—Respiration Chamber, 893.—Effect of Non-protein Food on Nitrogen Equilibrium, 894.—Nutritive History of the Protein Food, 895.—Tissue Protein and Circulating Protein, 896.—Amount of Protein Necessary in Normal Nutrition, 898.—Nutritive Value of Different Proteins, 901.—Vitamines and Other Special Substances, 904.—Specific Dynamic Action of Proteins, 905.	
CHAPTER XLVIII.—NUTRITIVE HISTORY OF CARBOHYDRATES AND FATS. . . . .	906
The Carbohydrate Supply of the Body, 906.—Intermediary Metabolism of the Carbohydrate in the Body, 907.—Regulation of the Sugar Supply of the Body, 909.—Diabetes, 910.—Functions of the Carbohydrate Food, 913.—Nutritive Value of Fats, 914.—Intermediary Metabolism of Fats, 915.—Origin of Body Fat, 916.—Origin of Body Fat from Food Fat, 917.—Origin of Body Fat from Carbohydrates, 918.—Source of Fat in Ordinary Diets, 919.—Cause of the Formation of Fat, Obesity, 919.	
CHAPTER XLIX.—NUTRITIVE VALUE OF THE INORGANIC SALTS AND THE ACCESSORY ARTICLES OF DIET. . . . .	921
The Inorganic Salts of the Body, 921.—Effect of Ash-free and Ash-poor Diets, 922.—Special Importance of Sodium Chlorid, Calcium, and Iron Salts, 922.—The Condiments, Flavors, and Stimulants, 925.—Physiological Effects of Alcohol, 926.	
CHAPTER L.—EFFECT OF MUSCULAR WORK AND TEMPERATURE ON BODY METABOLISM; HEAT ENERGY OF FOODS; DIETETICS. . . . .	930
The Effect of Muscular Work, 930.—Effect of Sleep, 933.—Effect of Variations in Temperature, 933.—Effect of Starvation, 934.—The Potential Energy of Food, 935.—Dietetics, 939.	
CHAPTER LI.—THE PRODUCTION OF HEAT IN THE BODY; ITS MEASUREMENT AND REGULATION; BODY TEMPERATURE; CALORIMETRY; PHYSIOLOGICAL OXIDATIONS. . . . .	944
Historical Account of Theories of Animal Heat, 944.—Body Temperature in Man, 945.—Calorimetry, 947.—Respiration Calorimeter, 950.—Heat Regulation, 953.—Regulation of Heat Loss, 953.—Regulation of Heat Production, 955.—Existence of Heat Centers and Heat Nerves, 957.—Theories of Physiological Oxidations, 959.	
<b>SECTION IX.</b>	
<b>PHYSIOLOGY OF REPRODUCTION.</b>	
CHAPTER LII.—PHYSIOLOGY OF THE FEMALE REPRODUCTIVE ORGANS. . . . .	965
General Statement, 965.—The Graafian Follicle and the Corpus Luteum, 965.—Menstruation and Puberty, 967.—Structural Changes in the Uterus during Menstruation, 968.—The Phenomenon of Heat in Lower Animals, 968.—The Relation of the Ovaries to Menstruation, 969.—Physiological Significance of Menstruation, 971.—Effect of the Menstrual Cycle on Other Functions, 972.—Passage of the Ovum into the Uterus, 973.—Maturation of the Ovum, 974.—Fertilization of the Ovum, 976.—Implantation of the Ovum, 978.—Nutrition of the Ovum—Physiology of the Placenta, 979.—Changes in the Maternal Organism during Pregnancy, 981.—Parturition, 982.—The Mammary Glands, 983.—Connection between the Uterus and the Mammary Glands, 983.—Composition of Milk, 985.	

TABLE OF CONTENTS.

15

	PAGE
CHAPTER LIII.—PHYSIOLOGY OF THE MALE REPRODUCTIVE ORGANS. . . .	987
Sexual Life of Male, 987.—Properties of the Spermatozoa, 988.—Chemistry of the Spermatozoa, 990.—The Act of Erection, 991.—Reflex Apparatus of Erection and Ejaculation, 992.	
CHAPTER LIV.—HEREDITY; DETERMINATION OF SEX; GROWTH AND SENESCENCE. . . . .	994
Definition of Heredity, 994.—Evolution and Epigenesis, 994.—Theory of Mutations, 996.—The Mendelian Law, 997.—Determination of Sex, 999.—Growth and Senescence, 1001.	

---

APPENDIX.

I.—PROTEINS AND THEIR CLASSIFICATION. . . . .	1009
Definition and General Structure of Proteins, 1009.—Reactions of Proteins, 1011.—Classification of Proteins, 1013.—The Albumins, 1013.—The Globulins, 1014.—The Glutelins, 1014.—Alcohol-soluble Proteins (Prolamins), 1014.—Albuminoids, 1014.—Protamins and Histons, 1014.—The Conjugated Proteins, 1015.—The Derived Proteins, 1016.	
II.—DIFFUSION AND OSMOSIS. . . . .	1016
Diffusion, Dialysis, and Osmosis, 1016.—Osmotic Pressure, 1017.—Electrolytes, 1018.—Gran-molecular Solutions, 1018.—Calculation of Osmotic Pressure in Solutions, 1019.—Determination of Osmotic Pressure by the Freezing Point, 1019.—Application to Physiological Processes, 1020.—Osmotic Pressure of Proteins, 1020.—Isotonic, Hypertonic, and Hypotonic Solutions, 1020.—Diffusion or Dialysis of Soluble Constituents, 1021.—Diffusion of Proteins, 1021.	
INDEX. . . . .	1023





# A TEXT-BOOK OF PHYSIOLOGY.

---

## SECTION I.

### THE PHYSIOLOGY OF MUSCLE AND NERVE.

---

#### CHAPTER I.

##### THE PHENOMENON OF CONTRACTION.

The tissues in the mammalian body in which the property of contractility has been developed to a notable extent are the muscular and the ciliated epithelial cells. The functional value of the muscles and the cilia to the body as an organism depends, in fact, upon the special development of this property. The muscular tissues of the body fall into three large groups, considered from either a histological or a functional standpoint,—namely, the striated skeletal muscle, the striated cardiac muscle, and the plain muscle. These tissues exhibit certain marked differences in properties which are described farther on. In each group, moreover, there are certain minor differences in structure which are associated with differences in properties; thus, skeletal muscle from different regions of the same animal may show variations in rapidity of contraction, and this variation goes hand in hand with an obvious difference in histological structure. Similar, perhaps more marked, differences are observed in the plain muscular tissue of various organs. The muscular tissues from animals belonging to different classes exhibit naturally even wider variations in properties, and these differences in some cases are not associated with visible variations in structure.

**The Structure of Skeletal Muscle.**—This tissue makes up the essential part of the skeletal muscles by means of which our

voluntary movements are effected. What we call a muscle is an organ composed of many thousands of muscle fibers, bound together by connective tissue, and surrounded by a sheath of the same tissue. Each fiber is a minute cylindrical or prismatic thread, whose diameter varies perhaps between 0.1 and 0.01 mm., and whose length does not exceed 36 mm. It constitutes the unit of structure of the muscle, and the shortening of the muscle, as a whole, is the expression of the combined effect of the contractions of the constituent fibers. In considering the physiology of the muscle as a contracting mechanism it is convenient to discuss the phenomenon as it occurs in a single fiber. As a matter of fact, each fiber is a complex structure, consisting of several distinct parts. It is developed from a single cell, and since it contains a number of nuclei, we may regard it histologically as a sort of a multinuclear giant cell of elongated form. Each fiber is enclosed within a thin, structureless, elastic membrane, the sarcolemma. The material of the fiber inside the sarcolemmal bag shows the characteristic cross-striation, and is supposed to be of a semi-liquid or viscous consistency when living. This material, as a whole, is designated as the muscle plasma.

There is on record an interesting observation by Kühne\* which seems to demonstrate the fluid nature of the living muscle substance. He happened, on one occasion, to find a frog's muscle fiber containing a nematode worm within the sarcolemma. The animal swam readily from one end of the fiber to the other, pushing aside the cross bands, which fell into place

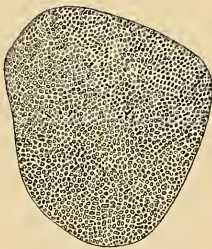

Fig. 1.—A cross-section of muscle fiber of rabbit. The bundles of fibrils are dark; the intervening small amount of sarcoplasm is represented by the clear spaces.—(Kölliker.)



Fig. 2.—Cross-section of two muscle fibers of the fly: *Ms*, The columns of fibrils; *Sp*, the sarcoplasm.—(Schiefferdecker.)

again after the animal had passed. At one end, where the fiber had been injured, the worm was unable to force its way. The muscle substance at this point was dead and apparently had passed into a solid condition. The fact that the cross bands were displaced only temporarily by the movement and fell back into their normal position would indicate that they may have a more solid structure.

\* Kühne, "Archiv für pathologische Anatomie," 26, 222, 1863.

Disregarding the nuclei, the muscle plasma consists of two different structures: the fibrils, which are long and thread-like and run the length of the fiber, and the intervening sarcoplasm. The fibrils consist of alternating dim and light discs or segments, which, falling together in the different fibrils, give the cross-striation that is characteristic. In mammalian muscles the fibrils are grouped more or less distinctly into bundles or columns (sarcostyles), between which lies the scanty sarcoplasm. The relative amount of sarcoplasm to fibrillar substance varies greatly in the striped muscles of different animals, as is indicated in the accompanying illustrations. The evidence from comparative physiology indicates that the fibrils are the contractile element of the fiber, while the sarcoplasm, it may be assumed, possesses a general nutritive function. Among mammals there are certain muscles in which the amount of sarcoplasm within each fiber is relatively large, and this sarcoplasm, having the granular structure common to undifferentiated protoplasm, interferes with the clearness of striation of the fibers. Fibers of this latter sort are usually of a deeper color than those in which the sarcoplasm is less abundant, and the two varieties have been designated as the red (more abundant sarcoplasm) and the pale fibers. Muscles containing chiefly the less clearly striated red fibers, for example, the diaphragm and the heart, are characterized physiologically by a slower rate of contraction and by a relatively small susceptibility to fatigue. The so-called red and pale fibers may occur in the same muscle. The separate fibrils, like the entire fiber, show two kinds of substance, the alternating dim and light bands, and these two materials are obviously different in physical structure as seen by ordinary light. When examined by polarized light, this difference becomes more evident, for the dim substance possesses the property of double refraction. When the muscle fiber is placed between crossed Nicol prisms the dim bands

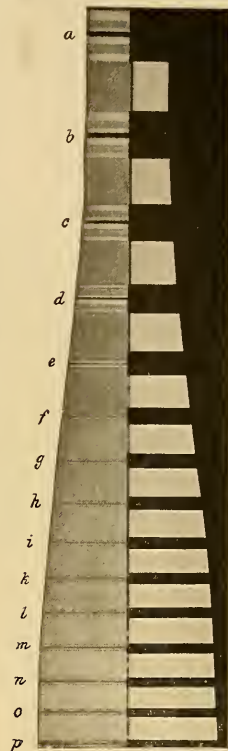

Fig. 3.—To show the appearance of the dim (anisotropic) and light (isotropic) bands at rest and in contraction, as seen by ordinary and by polarized light. The figure represents a muscle fibril (beetle) in which the lower portion has been fixed in a condition of contraction. On the left the relations of the dim and light bands are shown as they appear in ordinary light, in the relaxed (upper part), and the contracted (lower part) state. On the right the relations of the bands are shown as they appear when placed between crossed Nicol prisms. The white spaces represent the dim bands.

appear bright, while the light bands remain dark, as is shown in Fig. 3. From this standpoint the material of the light bands in the normal fibrils is spoken of as isotropous, and that in the dim bands as anisotropous. The anisotropic material of the dim bands consists of doubly refracting positive uniaxial particles, and Engelmann has claimed that such particles may be discovered in all contractile tissues.\* The inference made by him is that this anisotropic substance is the contractile material in the protoplasm, the machinery, so to speak, through which its shortening is accomplished. Engelmann supports this conclusion by the statement that during contraction the size of the dim bands increases at the expense of the material in the light bands.† This theory is indicated in the schema given in Fig. 3. The relative changes in appearance of the anisotropic and isotropic bands during the phase of contraction, which are shown in the figure, may be explained on the assumption that the anisotropic substance absorbs or imbibes water from the isotropic layer. Engelmann has used such an assumption as the basis for a theory of the shortening of the muscle (p. 72). Unfortunately, the histological changes indicated in Fig. 3 have not been wholly corroborated by later observers. Hürthle‡ states that during contraction the anisotropic band may shrink to less than one-half its width, while the isotropic layer shows no change. He finds in this appearance a confirmation of the view that the anisotropic substance constitutes the active contractile material of the muscle, but there is no evidence, he thinks, to support the assumption that the change in the anisotropic layer is due to imbibition of water from the isotropic layer.

**The Extensibility and Elasticity of Muscular Tissue.**—Muscular tissue, when acted upon by a weight, extends quite readily, and when the weight is removed, it regains its original form by virtue of its elasticity. In our bodies the muscles stretched from bone to bone are, in fact, in a state of elastic tension. If a muscle is severed by an incision across its belly the ends retract. The extensibility and elasticity of the muscles add to the effectiveness of the muscular-skeletal machinery. A muscle that is in a state of elastic tension contracts more promptly and more effectively for a given stimulus than one which is entirely relaxed. Moreover, in our joints the arrangement of antagonists—flexors and extensors—is such that the contraction of one moves the bone against the pull of the extensible and elastic antagonist.

\*This claim has been denied, see Ellis, "American Journal of Physiology," 31, 370, 1913.

† Biedermann, "Electro-physiology," vol. i, translated by Welby, and Engelmann, "Archiv für die gesammte Physiologie," 18, 1.

‡ Hürthle, "Archiv f. d. ges. Physiologie," 126, 1, 1909.

It would seem that the movements of the skeleton must gain much in smoothness and delicacy by this arrangement. The physical advantages of the extensibility and elasticity of muscular tissue are evident not only in the contractions of our voluntary muscles, but, as we shall see, in a striking way also in the circulation, in which the force of the heart beat is stored and economically distributed by the elastic tension of the distended arteries. The extensibility of muscular tissue has been studied in comparison with the extensibility of dead elastic bodies. With

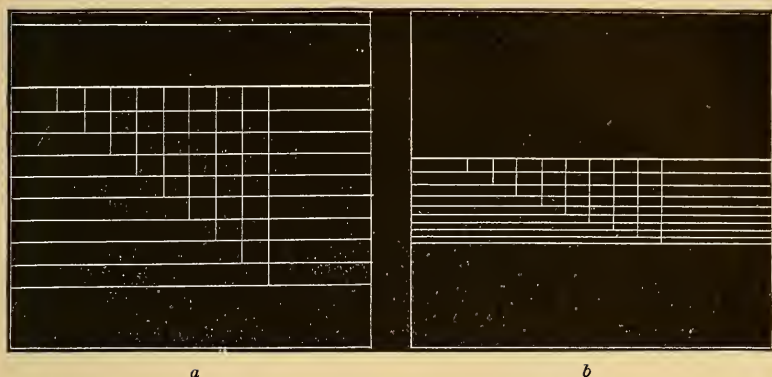

Fig. 4.—*a*, Curve of extension of a rubber band, to show the equal extensions for equal increments of weight. The band had an initial load of 17 gms., and this was increased by increments of 3 gms. in each of the nine extensions, the final load being 44 gms. The line joining the ends of the ordinates is a straight line. *b*, Curve of extension of a frog's muscle (gastrocnemius). The initial load and the increment of weight were the same as with the rubber. The curve shows a decreasing extension for equal increments. The line joining the ends of the ordinates is curved.

regard to the latter it is known that the strain that the body undergoes is proportional, within the limits of elasticity, to the stress put upon it. If, for instance, weights are attached to a rubber band suspended at one end, the amount of extension of the band will be directly proportional to the weights used. If the extensions are measured the relationship may be represented as shown in Fig. 4, the equal increments in weight being indicated by laying off equal distances on the abscissa, and the resulting extensions by the height of the ordinates dropped from each point. If the ends of the ordinates are joined, the result is a straight line. When a similar experiment is made with a living muscle it is found that the extension is not proportional to the weight used. The amount of extension is greatest in the beginning and decreases proportionately with new increments of weight. If the results of such an experiment are plotted, as above, representing the equal increments of weight by equal distances along the abscissa and the resulting extensions by ordinates dropped from these points, then upon joining the ends of

the ordinates we obtain a curve concave to the abscissa. At first the muscle shows a relatively large extension, but the effect becomes less and less with each new increment of weight, the curve at the end approaching slowly to a horizontal. If the weight is increased until it is sufficient to overcome the elasticity

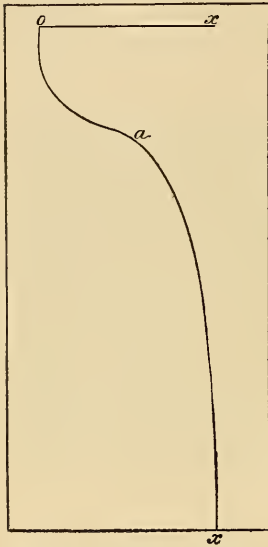

Fig. 5.—Curve given by Marey to show the effect upon the extension of muscle caused by increasing the load regularly to the point of rupture: From *o* to *a* the extension of the muscle decreases as the weight increases, giving a curve concave to the abscissa; at *a* the limit of elasticity is passed and the muscle lengthens by increasing extensions for equal increments; at *x* rupture (750 gms. for frog's gastrocnemius).

of the muscle the curve is altered—it becomes convex to the abscissa, or, in other words, the amount of extension increases with increasing increments of weight up to the point of rupture, as shown in the accompanying curve\* (Fig. 5). Haycraft† calls attention to the fact that under normal conditions the physiological extension of the frog's muscles in the body is equal to that produced by a weight of 10 to 15 gms., and that when the excised muscle is extended by weights below this limit it follows the law of dead elastic bodies, giving equal extensions for equal increments of weight. It is only after passing this limit that the law stated above holds good. It should be added also that the amount of deformation exhibited by a muscle or other living tissue placed under a stress varies with the time that the stress is allowed to act. The muscle is composed of viscous material, and yields slowly to the force acting upon it. In experiments of this kind, therefore, the weights should be allowed to act for equal intervals of time. It has been shown

that the extensibility of a muscle is greater in the contracted than in the resting state.

The curve of extension described above for skeletal muscle holds also for so-called plain muscle. This latter tissue forms a portion of the walls of the various viscera, the stomach, bladder, uterus, blood-vessels, etc., and the facts shown by the above curve enter frequently into the explanation of the physical phenomena exhibited by the viscera. For instance, it follows from this curve that the force of the heart beat will cause less expansion in an artery already distended by a high blood-pressure than in one in which the blood-pressure is lower.

\* See Marey, "Du mouvement dans les fonctions de la vie," 1868, p. 284

† Haycraft, "Journal of Physiology," 31, 392, 1904.

**The Irritability and Contractility of Muscle.**—Under normal conditions in the body a muscle is made to contract by a stimulus received from the central nervous system through its motor nerve. If the latter is severed the muscle is paralyzed. We owe to Haller, the great physiologist of the eighteenth century, the proof that a muscle thus isolated can still be made to contract by an artificial stimulus—*e. g.*, an electrical shock—applied directly to it. This significant discovery removed from physiology the old and harmful idea of animal spirits, which were supposed to be generated in the central nervous system and to cause the swelling of a muscle during contraction by flowing to it along the connecting nerve. But to remove a muscle from the body and make it contract by an artificial stimulus does not prove that the muscle substance itself is capable of being acted upon by the stimulus, since in such an experiment the endings of the nerve in the muscle are still intact, and it may be that the stimulus acts only on them and thus affects the muscle indirectly. In a number of ways, however, physiologists have found that the muscle substance can be made to contract by a stimulus applied directly to it, and therefore exhibits what is known as independent irritability. The term irritability, according to modern usage, means that a tissue can be made to exhibit its peculiar form of functional activity when stimulated,—*e. g.*, a muscle cell will contract, a gland cell will secrete, etc.,—and independent irritability in the case under consideration means simply that the muscle gives its reaction of contraction when artificial stimuli are applied directly to its substance. This conception of irritability was first introduced by Francis Glisson (1597-1677), a celebrated English physician.\* Subsequent writers frequently used the term as synonymous with contractility and as applicable only to the muscle. But it is now used for all living tissues in the sense here indicated. A simple proof of the independent irritability of a striated muscle is obtained by cutting the motor nerve going to it and stimulating the muscle after several days. We know now that in the course of several days the severed nerve fibers degenerate completely down to their terminations in the muscle fibers, and the muscle, thus freed from its nerve fibers by the process of degeneration, can still be made to contract by an artificial stimulus. The classical proof of the independent irritability of muscle fibers was given by Claude Bernard, the great French physiologist of the nineteenth century. He made use of the so-called arrow poison of the South American Indians. This substance or mixture of substances is known generally under the name curare; it is prepared from the juices of several plants (*strychnos*) (Thorpe). The poisonous part of the material is soluble

\* See Foster's "History of Physiology," p. 287.

in water, and Bernard showed that when such an extract is injected into the blood or hypodermically it paralyzes the motor nerves at their peripheral end, so that direct stimulation of these nerves is ineffective. Direct stimulation of the muscle substance, on the contrary, causes a contraction.\* We are justified, therefore, in saying that skeletal muscle possesses the properties of independent contractility (Haller) and independent irritability (Bernard). By the former term we mean that the shortening of the muscle is due to active processes developed in its own tissue, by the latter we mean that the muscular tissue may be made to enter into contraction by artificial stimuli applied directly to its own substance. This latter property cannot be said to hold for all the tissues. Whether a nerve cell or a gland cell may be made to enter into its specific form of activity by the direct application of an artificial stimulus is still a debatable question.

**Artificial Stimuli.**—If we designate the stimulus that the muscle receives normally from its nerve as its normal stimulus, all other forms of energy which may be used to start its contraction may be grouped under the designation artificial stimuli. Experiments have shown that a contraction may be aroused by mechani-

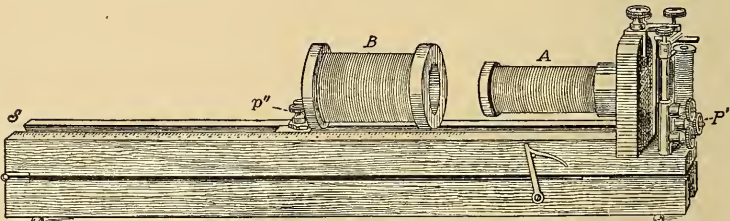

Fig. 6.—The induction coil as used for physiological purposes (du Bois-Reymond pattern): A, The primary coil; B, the secondary coil; P', binding posts to which are attached the wires from the battery, they connect with the ends of coil A; P'', binding posts connecting with ends of coil B, through which the induction current is led off; S, the slide, with scale, in which coil B is moved to alter its distance from A.

cal stimuli,—for instance, by a sharp blow applied to the muscle; by thermal stimuli,—that is, by a sudden change in temperature; by chemical stimuli,—for example, by the action of concentrated solutions of salts, and finally by electrical stimuli. In practice, however, only the last form of stimulus is found to be convenient. The mechanical and thermal stimuli cannot be well applied without at the same time injuring the muscle substance, and the same is probably true of chemical stimuli, which possess the disadvantage, moreover, of not exciting simultaneously the different fibers of which the muscle is composed. Electrical stimuli, on the contrary, are

\* "Leçons sur les effets des substances toxiques et médicamenteuses," 1857, pp. 238 *et seq.*



applied easily, are readily controlled as regards their intensity, and affect all the fibers simultaneously, thus giving a co-ordinated contraction of the entire bundle, as is the case with the normal stimulus. For electrical stimulation we may use the galvanic current taken directly from the battery, or the induced or so-called faradic current obtained from an induction coil. Under most conditions the latter is more convenient, since it gives brief shocks, the strength and number of which can be controlled readily. The form in which this instrument is used in experimental work in physiology we owe to du Bois-Reymond; hence it is frequently known as the du Bois-Reymond induction coil. Experimental physiology owes a great deal to this simple and serviceable in-

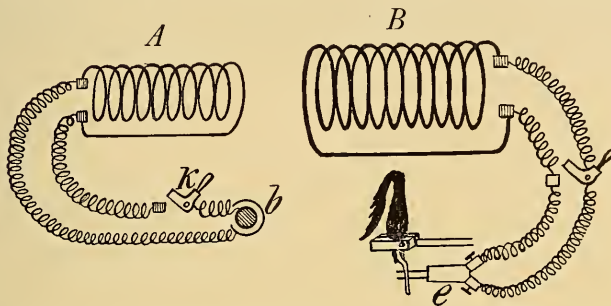

Fig. 7.—Schema of induction apparatus.—(Lombard.) *b* represents the galvanic battery connected by wires to the primary coil, *A*. On the course of one of these wires is a key (*k*) to make and break the current. *B* shows the principle of the secondary coil, and the connection of its two ends with the nerve of a nerve-muscle preparation. When the battery current is closed or made in *A*, a brief current of high intensity is induced in *B*. This is known as the making or closing shock. When the battery current is broken in *A*, a second brief induction current is aroused in *B*. This is known as the breaking or opening shock.

strument. A figure and brief description of the apparatus are appended (Figs. 6 and 7).

**Simple Contraction of Muscle.**—Experiments may be made upon the muscles of various animals, but ordinarily in physiological laboratories one of the muscles (gastrocnemius) of the hind leg of the frog is employed. If such a muscle is isolated and connected with the terminals from an induction coil it may be stimulated by a single shock or by a series of rapidly repeated shocks. The contraction that results from a single stimulus is designated as a simple contraction. In the frog's muscle it is very brief, lasting for 0.1 second or less; but in this, as in other respects, cross-striated muscular tissue varies in different animals,\* as is shown by the accompanying table, which gives a general idea of the range of rapidity of contraction:

\* Cash, "Archiv f. Anat. u. Physiol.," 1880, suppl. volume, p. 147.

## DURATION OF A SIMPLE MUSCULAR CONTRACTION.

Insect.....	0.003 sec.
Rabbit (Marey).....	0.070 "
Frog .....	0.100 "
Terrapin.....	1.000 "

The series may be continued by the figures obtained from the plain muscle, thus:

The involuntary muscle (mammal) .....	10.00
Foot muscle of slug* (Ariolimax).....	20.00

The duration of the simple contraction varies considerably in the muscles of different parts of the same animal. Thus, according to Cash, the hyoglossal muscle in the frog requires 0.205 to 0.3 second, while the gastrocnemius takes 0.12 second; in the tortoise the pectoralis major requires 1.8 seconds, the omohyoid only 0.55 second; in the rabbit the soleus (a red muscle) requires 1 second, the gastrocnemius (a pale muscle) 0.25 second. On examining into these differences it may be shown that the variations bear a relation to the special functions of the muscles. Where rapid movements are requisite or advantageous the muscle shows the property of quick contraction and relaxation, while in other places, in which maintenance of contraction is the more important feature, the properties of the muscle have been developed so as to adapt them to this kind of contraction. The skeletal and the plain muscles exhibit the extreme examples in this form of adaptation.

**The Curve of Contraction.**—When a contracting muscle is attached to a lever this lever may be made to write upon a smoked surface and thus record the movement, more or less magnified according to the leverage chosen. If the recording surface is stationary the record obtained is a straight line and indicates only the extent of the shortening. If, however, the recording surface is in movement during the contraction the record will be in the form of a curve, which, making use of the system of right-angled co-ordinates, will indicate not only the full extent of the shortening, but also the amount of shortening or subsequent relaxation at any moment during the entire period. To obtain such records from the rapidly contracting frog's muscle it is evident that the recording surface must move with considerable rapidity and with a uniform velocity. A curve of this kind is represented in Fig. 8. *C* represents the axis of abscissas and gives the factor of time. A vertical ordinate erected at any point on *C* gives the extent of shortening at that moment. Below the curve of the muscle is the record of the vibrations of a tuning fork giving 100 double vibrations per second; that is, the distance from crest to crest represents an

\* Carlson, "American Journal of Physiology," 10, 418, 1904.

interval of  $\frac{1}{100}$  of a second. Three principal facts are brought out by an analysis of the curve: I. The latent period. By this is meant that the muscle does not begin to shorten until a certain time after the stimulus is applied. On the curve the stimulus

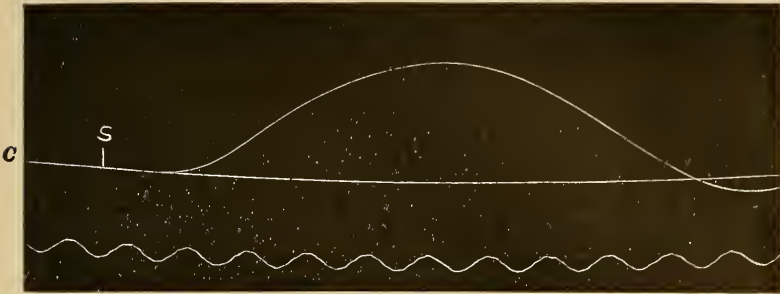

Fig. 8.—Curve of simple muscular contraction.

enters the muscle at *S*, and the distance between this point and the beginning of the rise of the curve, interpreted in time, is the latent period. II. The phase of shortening, which has a definite course and at its end immediately passes into III., the phase of relaxation.

**The Latent Period.**—In the contraction of the isolated frog's muscles as usually recorded the latent period amounts to 0.01 sec., but it is generally assumed that this period is exaggerated by the method of recording used, since the elasticity of the muscle itself prevents the immediate registration of the movement. By improvements in methods of technique the latent period for a fresh muscle may be reduced to as little as 0.005 or even 0.004 sec. Under the conditions in the body, however, the muscle contracts against a load, as when lifting a lever; hence, we may assume that normally there is a lost time of at least 0.01 sec. after the stimulus enters the muscle. In addition to the latent period due to the elasticity of the muscle it is certain that a brief amount of time actually elapses after the stimulus enters the muscle before the act of shortening begins; some time is taken up in the chemical changes and the effect of these changes in putting the mechanism of contraction into play (see below on the Theory of Muscle Contractions). The latent period varies greatly in muscles of different kinds, and in the same muscle varies with its conditions as regards temperature, fatigue, load to be raised, etc.

**The Phases of Shortening and of Relaxation.**—In the normal frog's muscle the phase of shortening for a simple contraction occupies about 0.04 second, while the relaxation may be a trifle longer, 0.05 sec. In muscles whose duration of contraction differs from that of the frog the time values for the shortening and the relaxation

exhibit corresponding differences. As we have seen, the appearance of the muscle fiber when viewed by polarized light indicates that during the phase of shortening the most marked physical change occurs in the anisotropic band. Whatever may be the nature of this change, it is evidently a reversible one. After reaching its maximum it proceeds in the opposite direction, the particles return to their original position, and a relaxation occurs. Many conditions, some of which will be described below, alter the time necessary for these processes, that is, the duration of the simple contraction. It is noteworthy that it is the phase of relaxation which may be most easily prolonged or shortened by varying conditions.

**Isotonic and Isometric Contractions.**—In the method of recording the shortening of the muscle that is described above the muscle is supposed to contract against a constant load which it can lift. Such a contraction is spoken of as an isotonic contraction. If the muscle is allowed to contract against a tension too great for it to overcome—a stiff spring, for instance—it is practically prevented from shortening, and a contraction of this kind, in which the length of the muscle remains unchanged, is spoken of as an isometric contraction. A curve of such a contraction may be obtained by magnifying greatly, by means of levers, the slight change in the stiff spring against which the muscle is contracting. Such a curve gives a picture of the liberation of energy within the muscle during contraction.

The usual oval form of dynamometer employed to record the grip of the flexors of the fingers gives an isometric record of the energy of contraction of these muscles.

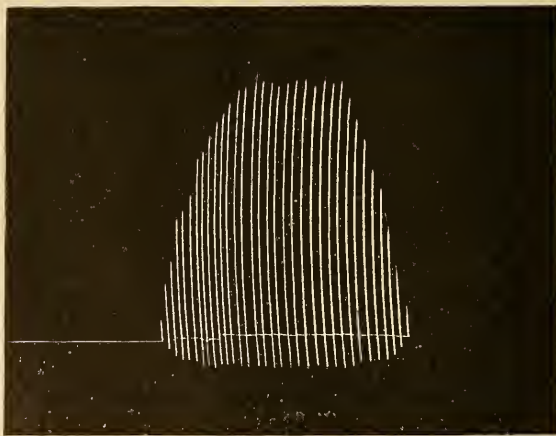

Fig. 9.—Effect of varying the strength of stimulus. The figure shows the effect upon the gastrocnemius muscle of a frog of gradually increasing the stimulus (breaking induction shock) until maximum contractions were obtained. The stimuli were then decreased in strength and the contractions fell off through a series of gradually decreasing submaximal contractions. The series up and down is not absolutely regular owing to the difficulty of obtaining a regular increase or decrease in the stimulus. (The prolongations of the curves below the base line are due to the elastic extension of the muscle by the weight during relaxation.)

### Effect of Strength of Stimulus upon the Simple Contraction.

—The strength of electrical stimuli can be varied conveniently and

with great accuracy. When the stimulus is of such a strength as to produce a just visible contraction it is spoken of as a minimal stimulus and the resulting contraction as a minimal contraction. Stimuli of less strength than the minimal are designated as sub-minimal. If one increases gradually the intensity of the electrical current used as a stimulus without altering its duration, beginning with a stimulus sufficient to cause a minimal contraction, the resulting contractions increase proportionally up to a certain maximum beyond which further increase of stimulus, other conditions remaining the same, causes no greater extent of shortening. Contractions between the minimal and the maximal are designated as submaximal.\* (See Fig. 9.)

**Effect of Temperature upon the Simple Contraction.**—Variations in temperature affect both the extent and the duration of the contraction. The relationship is, however, not a simple one in the case of the frog's muscle upon which it has been studied most frequently. If we pay attention to the extent of the contraction alone it will be found that at a certain temperature,  $0^{\circ}\text{C}$ ., or slightly below,

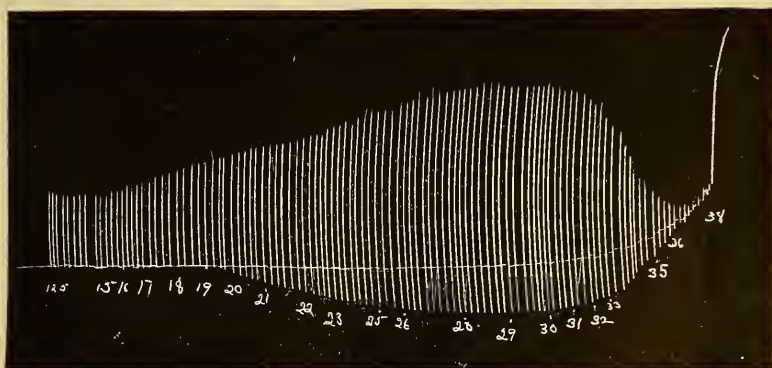

Fig. 10.—Curve showing the effect of temperature. The temperatures at which the contractions were obtained are indicated on the figure. In this experiment a large resistance was introduced into the secondary circuit so that changes in the resistance of the muscle itself due to heating could not affect the strength of the stimulus.

the muscle loses its irritability entirely. As its temperature is raised a given stimulus, chosen of such a strength as to be maximal for the muscle at room temperatures, causes greater and greater contractions up to a certain maximum, which is reached at about  $5^{\circ}$  to  $9^{\circ}\text{C}$ . As the temperature rises beyond this point the contractions decrease somewhat to a minimum that is reached at about  $15^{\circ}$  to  $18^{\circ}\text{C}$ . Beyond this the contractions again increase in

\* Fick, "Untersuchungen über elektrische Nervenreizung," Braunschweig, 1864.

extent to a second maximum at about  $26^{\circ}$  to  $30^{\circ}$  C., this maximum being in some cases greater, and in others less than the first maximum. Beyond the second maximum the contractions again decrease rather rapidly as the temperature rises until at a certain temperature,  $37^{\circ}$  C., irritability is entirely lost (Fig. 10). If the temperature is raised somewhat beyond this latter point heat rigor makes its appearance, and the muscle may be considered as dead. The relationship between temperature and extent of contraction, therefore, may be expressed by a curve such as is represented in Fig. 11, in which there are two maxima and two points at which irritability is lost. The second maximum indicates a fact of general physiological interest,—namely, that in all of the tissues of the body there is a certain high temperature at which optimum activity is exhibited, and if the temperature is raised beyond this point functional activity becomes

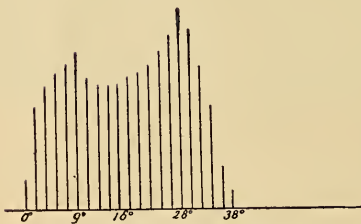

Fig. 11.—Curve to show the effect of a rise of temperature from  $0^{\circ}$  C. to  $38^{\circ}$  C. upon the height of contraction of frog's muscle. The first maximum at  $9^{\circ}$  C., the second at  $28^{\circ}$  C. Beyond  $38^{\circ}$  C. the muscle lost its irritability and went into rigor mortis.

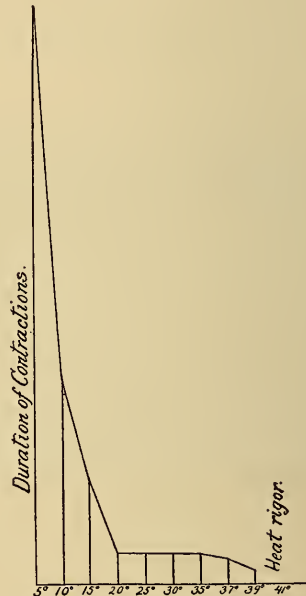

Fig. 12.—Curve to show the effect of a rise of temperature from  $5^{\circ}$  C. to  $39^{\circ}$  C. upon the duration of contraction of frog's muscle. The relative durations at the different temperatures are represented by the height of the corresponding ordinates.

more and more depressed. The point of optimum effect is not identical for the different tissues of the same animal, much less so for those of different animals, but the fact may be emphasized that in no case do protoplasmic tissues withstand a very high temperature.

Functional activity is lost usually at 45° C. or below. The duration of the contraction shows usually in frogs' muscles a simple relationship to the changes of temperature. At low temperatures, 4 or 5° C., the contractions are enormously prolonged, particularly in the phase of relaxation; but as the temperature is raised the duration of the contractions diminishes, at first rapidly, then more slowly, to a certain point—about 18° to 20° C., beyond which it remains more or less constant in spite of the changes in extent of shortening. The relationship between duration of contraction and temperature may therefore be expressed by such a curve as is shown in Fig. 12, in which the heights of the ordinates represent the relative durations of the contractions. Muscles from different frogs show considerable minor variations in their reactions to changes in temperature, and we may suppose that these variations depend upon differences in nutritive condition. In this, as in many other respects, the reactions obtained from so-called winter frogs after they have prepared for hibernation are more regular and typical than those obtained in the spring or summer.

**Effect of Veratrin.**—The alkaloid veratrin exhibits a peculiar and interesting effect upon the contraction of muscle. A muscle taken from a veratrinized animal and stimulated in the usual way by a single stimulus gives a contraction such as is exhibited in the accompanying curve (Fig. 13). Two peculiarities are shown by the curve: (1) The phase of shortening is not altered, but the phase of relaxation is greatly prolonged. (2) The curve shows two summits,—that is, after the first shortening there is a brief relaxation followed by a second, slower contraction. The cause of this second shortening is not known. Biedemann has suggested that it is due to the presence in the muscle of the two kinds of fibers—red and pale—which were spoken of on p. 19, and that



Fig. 13.—Curve showing the effect of veratrin.

the veratrin dissociates their action, but this explanation, according to Carvallo and Weiss,\* is disproved by the fact that muscles composed entirely of white or red fibers show a similar result from the action of veratrin. It would seem more probable,

\* "Journal de la physiol. et de la path. générale," 1899.

therefore, that two different contraction processes are initiated by the stimulus, one much more rapid than the other. Many other facts in physiology speak for this general view that a muscle may, according to conditions, give either a quick contraction (twitch) or a more slowly developing contraction, with a prolonged phase of relaxation (tone contraction). This latter feature constitutes the characteristic peculiarity of the curve of a veratrin contraction. A somewhat similar effect is produced by the action of glycerin, nicotine, etc. We have in such substances reagents that affect one phase of the contraction process without materially influencing the other. As regards the veratrin effect, it becomes less and less marked if the muscle is made to give repeated contractions, but reappears after a suitable period of rest. The peculiar action of the veratrin is, therefore, antagonized seemingly by the chemical products formed during contraction.

**Contracture.**—The prolonged relaxation that is so characteristic of the veratrinized muscles may be observed in frog's muscle under other circumstances, and is described usually as a condition of contracture. By contracture we mean a state of maintained contraction or, looking at it from the other point of view, a state of retarded relaxation.

This condition is often exhibited in a most interesting way when a muscle is repeatedly stimulated. In some cases it develops at the beginning of a series of contractions, as is represented in Fig. 14, which pictures the phenomenon as it was first described.\* In other cases it appears later on in the curve, preceding or following the development of the state of fatigue. Whenever it occurs the effect is to hold the muscle in a state of maintained contraction or tone, on which is superposed the series of quick contractions and relaxations due to the separate stimuli. When the condition develops early in the functional activity of the muscle (Fig. 14) further activity usually causes it to disappear, and the condition of the muscle as a mechanism for prompt shortening and relaxation is improved. We have in this fact apparently an indication of one way in which the "warming up" exercise before athletic contests may be of value. When the contraction appears late in the series of contractions it is usually permanent, that is to say, it wears off only as the muscle relaxes slowly from fatigue. Toward the end of such a series the muscle is often practically in a state of continuous contraction, a condition which would nullify its ordinary use in locomotion. It seems possible that certain conditions of tonic spasm or cramps which occur during life may involve this process, for example, the temporary cramp that sometimes attacks a player in athletic games, or the curious spasmodic condition known as intermittent claudication, in which the muscles on exercise are thrown into a state of tonic contraction. From the physiological standpoint the phenomenon of contracture when compared with that of the simple contraction indicates the possibility that two different contraction processes may take place in muscle, one involving the state of tone and, therefore, the length and hardness of the muscle, the other controlling the movements proper. This suggestion has been made by a number of authors† on various grounds. It has been sug-

\* Tiegel, "Pflüger's Archiv für die gesammte Physiologie," etc., 13, 71, 1876.

† See especially Uexküll, "Zentralblatt f. Physiologie," 1908, 22, 33; also Guenther, "American Journal of Physiology," 1905, 14, 73.



gested by some that there are two different contractile substances in muscle, one giving the usual quick contraction, known as a "twitch," the other the slower contraction, which exhibits itself as tone or contracture.\*

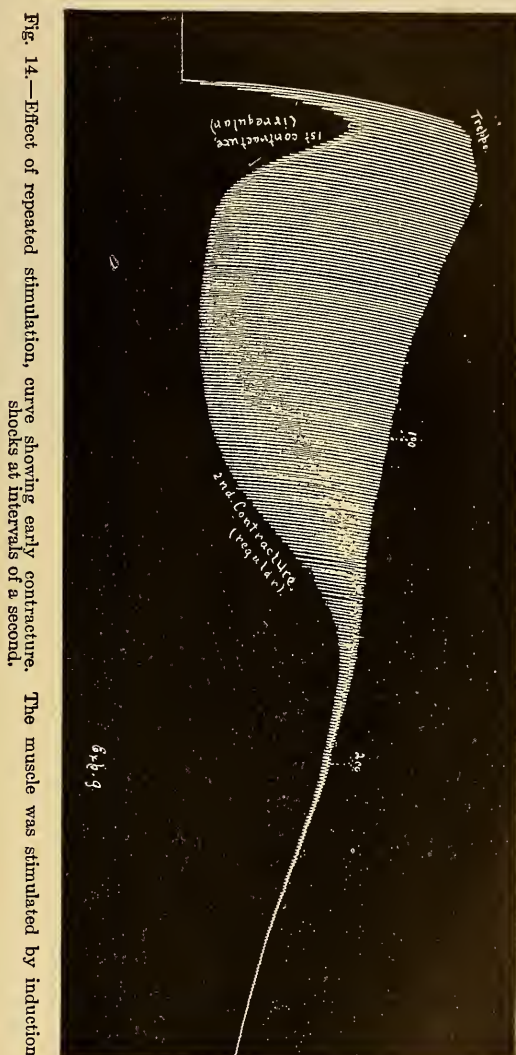

**The Effect of Rapidly Repeated Contractions.**—When a muscle is stimulated repeatedly by stimuli of equal strength that

\* Ioteyko, "Travaux du laboratoire de Physiologie," Institut Solvay, 1902, 5, 229.

fall into the muscle at equal intervals the contractions show certain features that, in a general way, are constant, although the precise degree in which they are exhibited varies curiously in different animals. Such curves are exhibited in Figs. 14, 15, and 16, and the features worthy of note may be specified briefly as follows:



Fig. 15.—Effect of repeated stimulation; complete curve, showing late contracture. The muscle was stimulated by induction shocks at the rate of 50 per minute. The separate contractions are so close together that they can not be distinguished.

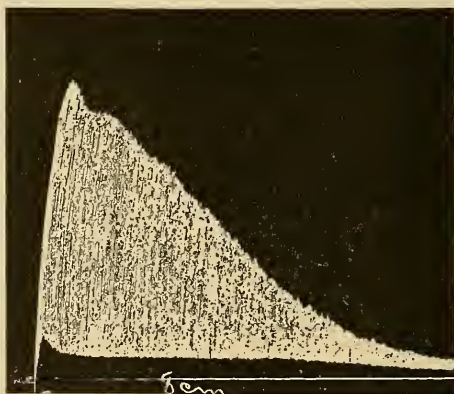

Fig. 16.—Effect of repeated stimulation, curve showing no contracture or very little. The muscle was stimulated by induction shocks at the rate of 50 per minute. A very slight contracture is shown in the beginning, but subsequently the contractions show only a diminished extent, the rate of relaxation remaining apparently unchanged.

1. *The Introductory Contractions.*—The first three or four contractions decrease slightly in extent, showing that the muscle at first loses a little in irritability on account of previous contractions. This phenomenon is frequently absent.

2. *The Staircase or "Treppe."*—After the first slight fall in height has passed off the contractions increase in extent with great

regularity and often for a surprisingly large number of contractions. This gradual increase in extent of shortening, with a constant stimulus, was first noticed by Bowditch upon the heart muscle, and was by him named the phenomenon of "treppe," the German word for staircase. It indicates that the effect of activity is in the beginning beneficial to the muscle in that its irritability steadily increases, and the fact that the same result has been obtained from heart muscle, plain muscle, and nerve fibers indicates that it may be a general physiological law that functional activity leads at first to a heightened irritability. According to Lee,\* the "treppe" in muscle is due to an initial increase of irritability set up by the chemical products formed during contraction.

3. *Contracture*.—This phenomenon of maintained contraction has been described above. In frogs' muscles stimulated repeatedly it makes its appearance, as a rule, sooner or later in the series of contractions; but there is a curious amount of variation in the muscles of different individuals in this respect.

4. *Fatigue*.—After the period of the "treppe" has passed, the contractions diminish steadily in height, until at last the muscle fails entirely to respond to the stimulus. This progressive loss of irritability in the muscle caused by repeated activity is designated as fatigue. It will be considered more in detail under the head of Compound Muscular Contractions and in Chapter II. The curve obtained in an experiment of this kind illustrates in a striking way one of the general characteristics of living matter, namely, that every effective stimulus applied to it leaves a record, so to speak. The muscle in this case is in a changed condition after each stimulus, as is indicated by the difference in its response to the succeeding stimulus. While it cannot be said that a similar effect has been shown in all tissues, still the evidence in general points that way, and some of the complicated phenomena exhibited by living matter, such as memory, habits, immunity, etc., are referable in the long run to this underlying peculiarity.

Lee has discovered the interesting fact that while in frog's muscle, as a rule, fatigue is accompanied by a prolongation of the curve, especially of the phase of relaxation, this does not hold for mammalian muscle. In the latter muscle the successive contractions become smaller as fatigue sets in, but their duration is not increased.

**The Contraction Wave**.—Under ordinary conditions the fibers of a muscle when stimulated contract simultaneously or nearly so, and the whole extent of the muscle is practically in the same phase of contraction at a given instant. It is comparatively easy to show, however, that the process of contraction spreads over the fibers, from the point stimulated, in the form of a wave which moves

\* See "American Journal of Physiology," 1907, 18, 267.

with a definite velocity. In a long muscle with parallel bundles of fibers one may prove, by proper recording apparatus, that if the muscle is stimulated at one end a point near this end enters into contraction before a point farther off. Knowing the difference in time between the appearance of the contraction at the two points and the distance apart of the latter, we have the data for determining the velocity of its propagation. In frog's muscles this velocity is found to be equal to 3 or 4 meters per second, while in human muscle, at the body temperature, it is estimated at 10 to 13 meters per second. Knowing the time it takes this wave to pass a given point ( $d$ ) and its velocity ( $v$ ), its entire length is given by the formula  $l=vd$ . In the frog's muscle, therefore, with a velocity of 3000 mm. per second, and a duration of, say, 0.1 second, the product ( $3000 \times 0.1 = 300$  mms.) gives the length of the wave or the length of muscle which is in some phase of contraction at any given instant. Under normal conditions the muscle fibers are stimulated through their motor plates, which are situated toward the middle of the fiber, or perhaps one muscle fiber may have two or more motor plates, giving two or more points of stimulation. It follows, therefore, from this anatomical arrangement and the great velocity of the wave that all parts of the fibers are in contraction at the same instant and, indeed, in nearly the same phase of contraction. Under abnormal conditions muscles may exhibit fibrillar contractions; that is, separate fibers or bundles of fibers contract and relax at different times, giving a flickering, trembling movement to the muscle.

**Idiomuscular Contractions.**—In a fatigued or moribund muscle mechanical stimulation may give a localized contraction which does not spread or spreads very slowly, showing that the abnormal changes in the muscle prevent the excitation from traveling at its normal velocity. A localized contraction of this kind was designated by Schiff as an idiomuscular contraction. It may be produced in the muscle of a dying or recently dead animal by localized mechanical stimulation, as by drawing a blunt instrument—*e. g.*, the handle of a scalpel—across the belly of the muscle. The point thus stimulated stands out as a wheal, owing to the idiomuscular contraction.

**The Energy Liberated in the Contraction.**—When a muscle contracts, energy is, as we say, liberated in several forms, and can be measured quantitatively. First, there is a production of heat, which is indicated by a rise in temperature of the muscle.\* According to Heidenhain, the temperature of the frog's muscle is increased in a single contraction by  $0.001^{\circ}$  C. to  $0.005^{\circ}$  C. Larger muscles, such as those of the thigh of the dog, when repeatedly stimulated may cause a rise of temperature of from  $1^{\circ}$  to  $2^{\circ}$  C. The thermometer does not, of course, measure the amount of heat

\* For general discussion, see Tigerstedt in Winterstein's "Handbuch d. Vergleich. Physiologie."

produced, but only the temperature of the muscle. Heat is estimated quantitatively in terms of calories. By a calorie is meant the quantity of heat necessary to raise 1 gm. of water  $1^{\circ}$  C. Knowing the specific heat and weight of muscle, we can readily calculate the number of calories produced. Thus, if a frog's muscle weighing 2 gms. shows a rise of temperature of  $0.005^{\circ}$  C. from a single contraction the production of heat in calories is given by multiplying the weight of the muscle by its specific heat, 0.83, to reduce it to an equivalent weight of water, and this product by the rise in temperature:  $2 \times 0.83 \times 0.005 = 0.0083$  calorie. The fact that muscular exercise increases the production of heat in the body is a matter of general observation. Making use of a very sensitive thermo-couple, Hill\* has been able to register the production of heat in an excised frog's muscle. In the case of a simple contraction or twitch, the production of the heat is practically instantaneous, indicating an underlying chemical change of explosive suddenness. Analyses of the galvanometric records obtained in these experiments show that there is also a delayed heat production which occurs after the contraction is over. We may say, in fact, that the result of a stimulus causing a contraction is to set up two processes, each of which leads to the development of heat. The heat produced in the first process is detectible during the contraction, while that caused by the second process is subsequent to the act of shortening and, therefore, is not directly connected with the changes leading to contraction. The significance of this delayed heat production will be referred to in connection with the chemical changes of contraction and the theories of muscle contraction. Second. Some electrical energy is developed during the contraction. The means of detecting and measuring this energy will be described in a subsequent chapter. Considered quantitatively, the amount is small. Third. Work is done if the muscle is allowed to shorten during the contraction. By work is meant external or useful work—that is, the muscle lifts a weight or overcomes an opposing resistance. If a muscle contracts against a weight too heavy to be lifted, or a resistance too strong to be overcome, it does no external work, although, of course, much energy is liberated as heat or, as it is sometimes called, internal work. The work done by a muscle during contraction is measured in the usual mechanical units, by the product of the load into the lift. That is, if a muscle lifts a weight of 40 grams to a height of 10 millimeters, the work done is  $40 \times 10 = 400$  gram-millimeters, or 0.4 grammeter. We can in calculations convert external work into heat or internal work by making use of the ascertained mechanical equivalent of heat, according to

\* Hill, "Journal of Physiology," 40, 389, 1910; 46, 28, 1913.

which 1 calorie = 426.5 grammeters of work. The work, 0.4 grammeter, supposed to be done in the above experiment, would be equivalent, therefore, to  $0.4 \div 426$ , or about 0.001 of a calorie.

**The Efficiency of the Muscle as a Work Machine.**—In any engine constructed to perform external work it is desirable to know what efficiency the engine exhibits, that is to say, what per cent. of the total energy given to the engine or developed in the engine may be obtained as external or mechanical work. If we represent by  $Q$  the total energy developed and by  $W$  the energy, expressed in the same unit, obtained as work, then the efficiency  $E$  is given by the formula

$$E = \frac{W}{Q}.$$

Numerous experiments to determine this value have been made upon the isolated muscles of frogs. These muscles can be taken from the body, be made to contract under different loads by artificial stimuli, and the work done and the heat developed can both be measured with considerable accuracy. The earlier experiments of this kind indicated that the frog's muscle under optimum conditions may exhibit an efficiency as high as 25 to 30 per cent., as is shown by the following example taken from Fick's investigations:\*

<i>Load.</i>	<i>Heat Developed.</i>	<i>Mechanical Work.</i>	<i>Thermal Equivalent of Work.</i>	<i>Efficiency.</i>
200 gm.	25.6 microcalories.	2905 gm.-mm.	6.83 microcalories.	$\frac{6.83}{25.6} = 26 + \%$

Experiments have shown that the efficiency of different muscles in the same animal varies or may vary, and likewise the efficiency of the same muscle under different nutritive conditions. Many observations of a similar character have been carried out upon man when doing muscular work of various sorts, such as mountain climbing, bicycle riding, etc. In such experiments the total energy given off during the work may be estimated by the methods of direct or of indirect calorimetry (p. 947). In the former case the heat produced in the body is determined directly, in the latter case it is estimated on the basis of the amount of material consumed. The body at rest produces constantly a certain amount of heat which can be measured. In determining the efficiency of the human muscles in work the heat production during rest is subtracted from the heat production during work, the difference giving the new energy developed in the muscles during work. Thus, for example, in experiments made at the Nutrition Laboratory of the Carnegie Institution results of this kind were obtained:†

\* Fick, "Pflüger's Archiv," 16, 58, 1878.

† Benedict and Cathcart, "Muscular Work—The Efficiency of the Human Body as a Machine," Carnegie Institution, 1913.

HEAT-EQUIVALENT OF MUSCULAR WORK.	HEAT PRODUCED.	HEAT PRODUCED OVER RESTING METABOLISM.	NET EFFICIENCY.
Calories.	Calories.	Calories.	Per cent.
569	3959	2619	21.7
601	4139	2799	21.5
538	3834	2494	21.6
657	4309	2969	22.1
563	4056	2716	20.7
587	4131	2791	21.0

The average results of such experiments show an efficiency of about 21 per cent., which compares favorably with the figures obtained for mechanical engines, such as the steam engine (15 to 25 per cent.). It must not be assumed, however, from this comparison of the muscle with a steam engine that in the former, as in the latter, there is a conversion of part of the heat to mechanical work. This view was held formerly in physiology, but considerations, which are referred to below (p. 73), have convinced most physiologists that the muscle is not a heat engine. The energy that is expressed as work is derived in some other as yet undetermined way. Nevertheless, heat is evolved by chemical changes and material is consumed in muscular contraction as an apparently necessary part of the process, and the work performed bears to this energy liberated as heat the proportion indicated.

#### The Curve of Work and the Absolute Power of a Muscle.—

The statements in the preceding paragraph prove that the muscle, judged from the standpoint of a machine to do work, compares most favorably in its efficiency with machinery of human construction. But it should be borne in mind that in this as in other respects the properties of cross-striated muscular tissues vary greatly. In some animals or individuals it is a much more efficient machine than in others. This fact is indicated by our general experience regarding variations in muscular strength in different individuals, and is proved more precisely by direct experiments on single muscles. A frog's muscle may be isolated and the extent of its contractions and the work done may be estimated directly. Under such conditions it will be found that, while the height of the successive contractions diminishes as the load increases (see Fig. 17), the work done—that is, the product of the load into the lift—first increases and then decreases. For example:

<i>Load in Grams.</i>	<i>Lift in Millimeters.</i>	<i>Work Done in Gram-millimeters Load × Lift.</i>
5	27.6	138.0
15	25.1	376.5
25	11.45	286.25
35	6.3	220.5

A series of experiments of this kind furnishes data for constructing a curve of work by plotting off along the abscissa at equal

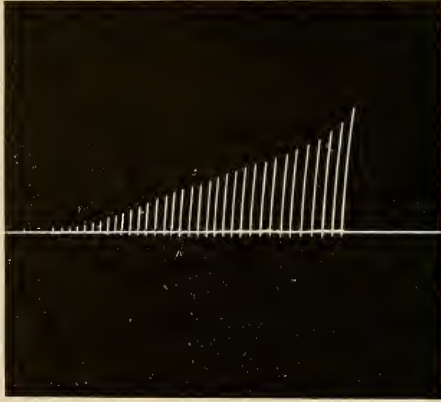

Fig. 17.—To show the decrease in extent of contraction of the gastrocnemius muscle of a frog with increase in load. In the first contraction, to the right, the load was 14.2 gms. At each successive contraction the load was increased by 5.3 gms. With a load of 182 gms. the lever gave only the slightest indication of a shortening, and this may have been due to some lateral movement.

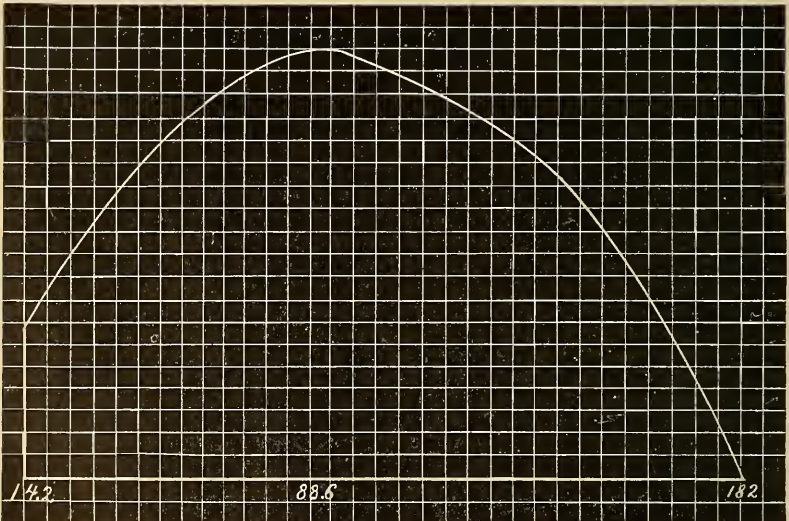

Fig. 18.—The curve of work obtained by plotting the results shown in Fig. 17. The initial contraction was made with a load of 14.2 gms., and the work done in gram-millimeters is represented by the ordinate erected at this point. The maximum work was done with a load of 88.6 gms., and the absolute power of this particular muscle was found to be equal to 182 gms.

intervals the equal increments in load and erecting over each load an ordinate showing the proportional amount of work done. The



curve has the general form indicated in Fig. 18. Three facts are expressed by this curve: First, that if the muscle lifts no weight no work will be done; this follows theoretically from the formula  $W = LH$ , in which  $W$  represents the work done,  $L$  the load, and  $H$  the lift. If either  $L$  or  $H$  is equal to zero the product, of course, is zero; that is, no external work is done; the chemical energy liberated in the contraction takes the form of heat. Second. There is an optimum load for each muscle with which the greatest proportion of work can be obtained. Third. When the load is just sufficient to counteract the contraction of the muscle no work is done,  $H$  in the above formula being zero. This amount of load measures what Weber called the absolute power of the muscle. As will be seen from the above curve, it is measured by the weight which the muscle cannot lift and which, on the other hand, cannot cause any extension of the muscle while contracting. Or, in more general terms (Hermann), the absolute power of a muscle is the maximum of tension which it can reach without alteration of its natural length. This absolute power can be measured for the muscles of different animals and for convenience of comparison can then be expressed in terms of the cross-area of the muscle given in square centimeters. Weber has shown that the absolute power of a muscle varies with the cross-area, since this depends upon the number of constituent fibers whose united contraction makes the contraction of the muscle. Expressed in this way, it is found that the absolute power of human muscle is, size for size, much greater than that of frog's muscle. For instance, the absolute power of a frog's muscle of 1 square centimeter cross-area is estimated at from 0.7 kilogram to 3 kilograms, while that of a human muscle of the same size is estimated by Hermann at 6.24 kilograms. Taken as a whole, the human muscle is a better machine for work, but it seems possible, although exact figures are lacking, that the absolute power of the muscles of some insects reckoned for the same unit of cross-area would be much greater than in human muscle.

#### COMPOUND OR TETANIC CONTRACTIONS.

**Definition of Tetanus** —When a muscle receives a series of rapidly repeated stimuli it remains in a condition of contraction as long as the stimuli are sent in or until it loses its irritability from the effect of fatigue. A contraction of this character is described as a compound contraction or tetanus. If the stimuli follow each other with sufficient rapidity the muscle shows no external sign of relaxation in the intervals between stimuli, and if its contractions are recorded upon a kymographion by means of an attached lever a curve is obtained such as is shown at 5 in Fig. 19. A con-

traction of this character is described as a complete tetanus. If, however, the rate of stimulation is not sufficiently rapid the muscle will relax more or less after each stimulus and its recorded

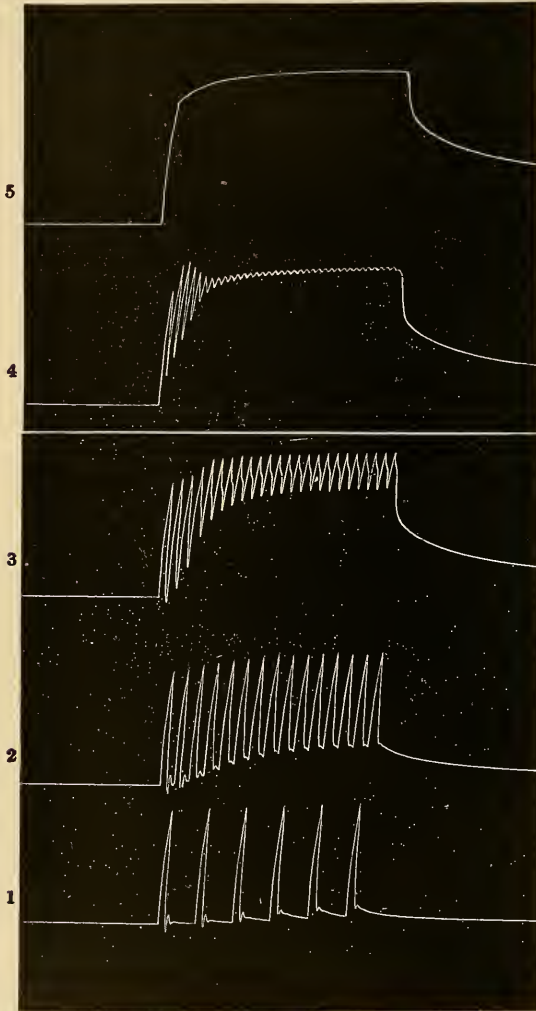

Fig. 19.—Analysis of tetanus. Experiment made upon the gastrocnemius muscle of a frog to show that by increasing the rate of stimulation the contractions, at first separate (1), fuse more and more through a series of incomplete tetani (2, 3, 4) into a complete tetanus (5) in which there is no indication, so far as the record goes, of a separate effect for each stimulus.

curve, therefore, will present the appearance shown in 1, 2, 3, and 4 of Fig. 19. A tetanus of this character is described as an incomplete tetanus. It is obvious that according to the rate of stimu-

lation there may be numerous degrees of incomplete tetanus, as shown in Fig. 19, extending from a series of separate single contractions, on the one hand, to a perfect fusion of the contractions, a complete tetanus, on the other. Tetanic contractions present two peculiarities in addition to the mere matter of duration, which is governed, of course, by the duration of the stimulation: First, the more or less complete fusion of the contractions due to the separate stimuli. This, as stated above, is the distinctive sign of a tetanus. Second, the phenomenon of summation in consequence of which the total shortening of the muscle in tetanus may be considerably greater than that caused by a maximal simple contraction.

**Summation.**—The facts of summation may be shown most readily by employing a device to send into the muscle two successive

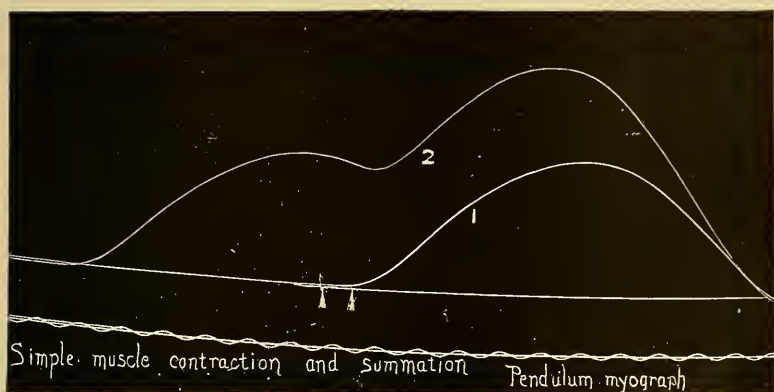

Fig. 20.—Summation of two successive contractions. Curve 1 shows a simple contraction due to a single stimulus, the latent period being indicated at the beginning of the contraction. Curve 2 shows the summation due to two succeeding stimuli.

stimuli at varying intervals. If the second stimulus falls into the muscle at the apex of the contraction caused by the first stimulus, then, even if the first contraction is maximal, the muscle will shorten still farther; the first and second contractions are summated, giving a total shortening greater than can be obtained by a single stimulus (see Fig. 20). The extent of the summation in such cases varies with a number of conditions, such as the intervals between the stimuli, the relative strengths of the stimuli, the load carried by the muscle, etc. Taking the simplest conditions of a moderately loaded muscle and two maximal stimuli, it is found that the greatest summation occurs when the stimuli are so spaced that the second contraction begins at the apex of the first. If the stimuli are closer together, so that, for instance, the second contraction follows shortly after

the first has begun, the total shortening is less, and the same is true to an increasing extent as the second contraction falls later and later in the period of relaxation after the first contraction.\* If instead of two we use three successive stimuli, falling into the muscle at proper intervals, a still further summation occurs. In this way the total extent of shortening in a muscle completely tetanized may be several times as great as that of a single maximal contraction.

**The Discontinuous Character of the Tetanic Contraction—The Muscle-tone.**—In complete tetanus the muscle seems to be in a condition of continuous uniform contraction; the recorded curve shows no sign of relaxation between stimuli and no external indication, in fact, that the separate stimuli do more than maintain a state of uniform contraction. It can be shown, however, that in reality each stimulus has its own effect, and that the chemical changes underlying the phenomenon of contraction form an interrupted series corresponding, within limits, to the series of stimuli sent in. The clearest proof for this belief is found in the electrical changes that result from each stimulus, and the facts relating to this side of the question will be stated subsequently in the chapter on The Electrical Phenomena of Muscle and Nerve. Another proof is found in the phenomenon of the muscle-tone. When a muscle is stimulated directly or through its motor nerve a musical note may be heard by applying the ear or a stethoscope to the muscle. The note that is heard corresponds in pitch, up to a certain point, with the number of stimuli sent in,—that is, the muscle vibrates, as it were, in unison with the number of stimuli, and, although the vibrations are not sufficient to affect the recording lever, they can be heard as a musical note. This fact, therefore, may be taken as a proof that during complete tetanus there is a discontinuous series of changes in the muscle the rate of which corresponds with that of the stimulation. The series of electrical changes corresponding with the series of stimuli sent in may be made audible by applying a telephone to the muscle. Making use of this method, Wedenski† has shown that the ability of the muscle to respond isorhythmically to the rate of stimulation is limited. In frog's muscle the pitch of the musical tone may correspond with the rate of stimulation up to about 200 stimuli per second. In the muscle of the warm-blooded animal the correspondence may extend to about 1000 stimuli per second. If the rate of stimulation is increased beyond these limits the musical note heard does not correspond, but falls to a lower pitch, indicating that some of the stimuli under these

\* Von Kries, "Archiv für Physiologie," 1888, p. 537.

† Wedenski, "Du rythme musculaire dans la contraction normale," "Archives de physiologie," 1891, p. 58.

conditions become ineffective. It should be added that the high figures given above for the correspondence between the stimuli and the muscle-tone hold good only for entirely fresh preparations. The lability of the muscle quickly becomes less as it is fatigued; so that in the frog, for instance, the correspondence in long-continued contractions is accurate only when the rate of stimulation does not exceed 30 per second.

**The Number of Stimuli Necessary for Complete Tetanus.—**

The number of stimuli necessary to produce complete tetanus varies, as we should expect, with the kind of muscle used and in accordance with the rapidity of the process of relaxation shown by these muscles in simple contractions. The series that may be arranged to demonstrate this variation is quite large, extending from a supposed rate of 300 per second for insect muscle to a low limit of one stimulus in 5 to 7 seconds for plain muscle. The frog's muscle goes into complete tetanus with a rate of stimulation of from 20 to 30 per second. Inasmuch as the rapidity of relaxation of the muscle is much retarded by certain influences, such as a low temperature or fatigue, it follows that these same influences affect in a corresponding way the rate of stimulation necessary to give complete tetanus. A frog's muscle stimulated at the rate of 10 stimuli per second may record an incomplete tetanus, but if the stimulus is maintained for some time the tetanus finally becomes complete in consequence of the slowing of the phase of relaxation, or, another way of looking at the matter, in consequence of the development of that condition of maintained contraction which has been spoken of above as contracture.

**Voluntary Contractions.**—After ascertaining that muscles may give either simple or tetanic contractions one asks naturally whether in our voluntary movements we can also obtain both sorts of contractions. In the first place, it is obvious that most of our voluntary movements are too long continued to be simple contractions. The time element alone would place them in the group of tetanic contractions, and this is the usual conclusion regarding them. In voluntary movements a neuromuscular mechanism comes into play. This mechanism consists, on the motor side, of at least two nerve units or neurons and the muscle, as indicated in the accompanying diagram (Fig. 21). If in ordinary voluntary movements the muscular contractions are tetanic, we must suppose that the motor nerve cells discharge a series of nerve impulses through the motor nerve into the muscle. The contraction of voluntary muscle has been investigated, therefore, in various ways to ascertain whether there is any objective indication of the number of separate contractions that are fused together to make this normal tetanus. Various methods have been em-

ployed. The contractions of the muscle have been recorded by means of levers or tambours, so as to give a curve which can be analyzed; the vibrations of the muscle have been estimated on the principle of sympathetic resonance, and the musical tone emitted

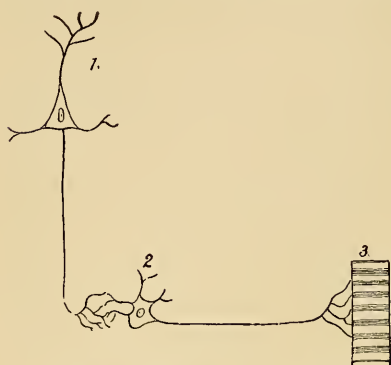

Fig. 21.—Schema to show the innervation of the skeletal (voluntary) muscles: 1, the intercentral (pyramidal) neuron; 2, the spinal neuron; 3, the muscle.

by the muscle during contraction has been determined. The estimates arrived at by these several methods all indicated a relatively slow rhythm of stimulation approximating a rate of 20 stimuli per second. The whole subject has been reinvestigated more recently by employing the "string galvanometer" (see p. 99) to record the number of electrical variations occurring during a voluntary contraction. Since each separate stimulus to a muscle causes a distinct electrical variation, it is evident

that if we can record the number of such variations per second we shall have almost conclusive evidence as regards the number of simple contractions which enter into the production of voluntary

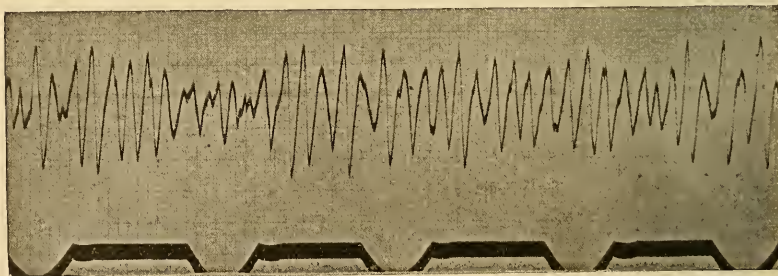

Fig. 22.—The upper curve shows the vibrations of the "string" of the string galvanometer during voluntary contraction of the flexor of the fingers. Each vibration is due to an electrical oscillation in the muscle (action current). These oscillations occur at the rate of 50 per second, as may be seen by reference to the lower curve, the breaks in which indicate fifths of a second. This fact would indicate, therefore, that in the voluntary contraction we have a tetanus composed of single contractions following at the rate of 50 per second.—(From Piper.)

tetanus. The string galvanometer lends itself to this purpose better than any form of electrometer yet devised, and Piper,\* by the use of this instrument, finds that in voluntary contractions of the flexor

\* Piper, Pflüger's "Archiv f. d. ges Physiologie," 1907, 119, 301; "Zeitschrift f. Biologie," 1908, 50, 393, and 504; "Archiv für Physiologie," 1914, 345.

muscles of the arms or fingers the series of electrical variations follows at the rate of 47 to 50 per second. Increase in strength of contraction in these muscles causes no change in rate, although a corresponding variation in the intensity of the electrical changes is observed. When different muscles are studied by this method, quite a marked difference in rate is obtained. Piper reports such observations as the following: *M. deltoideus*, 58 to 62; *M. gastrocnemius* and *M. tibialis anterior*, 42 to 44; *M. quadriceps femoris*, 38 to 41; *M. masseter*, 88 to 100, and *M. temporalis*, 80 to 86. Assuming that these figures represent the rate of discharge of nerve impulses per second by the nerve cells from which arise the motor fibers to the muscles named, it is evident that the various spinal and cranial motor centers may possess quite widely different rhythms, although for each particular center the rate is more or less fixed. Among the motor centers thus far studied it will be noted that the cells of the *N. trigeminus* possess the highest rate of discharge. There has been much discussion as to whether or not we can obtain simple as well as compound contractions by voluntary stimulation of our muscles. It has been pointed out that in very rapid contractions, such as occur in the trilling movements of the fingers in playing the piano, the duration of the separate contractions is so brief as to suggest that they may be of the order of simple contractions. Direct investigation of such movements by the older method of recording with levers (von Kries) or by the newer method of photographing the electrical oscillations shows, on the contrary, that even the shortest possible voluntary contractions are brief tetani made up of a short lasting series of contractions fused together. In all probability, therefore, our motor centers, whenever they are stimulated by a so-called act of the will, discharge rhythmically a series of nerve impulses. As we shall see later, it is possible that certain of these centers, when stimulated reflexly, may discharge a single nerve impulse and thus arouse a simple muscular contraction (see Knee-kick).

**The Ergograph.**—Voluntary contractions in man may be recorded in a great many ways, but Mosso has devised a special instrument for this purpose, known as the ergograph. It has been much used in quantitative investigations upon muscular work and the conditions influencing it. The apparatus is shown and described in Fig. 23. The person experimented upon makes a series of short contractions of the flexor muscle of the middle finger, thereby lifting a known weight to a definite height which is recorded upon a drum. In a set of experiments the rate of the series of contractions—that is, the interval of rest between the contractions—is kept constant, as also is the load lifted.

Under these conditions the contractions become less and less extensive as fatigue comes on, and finally, with the strongest voluntary

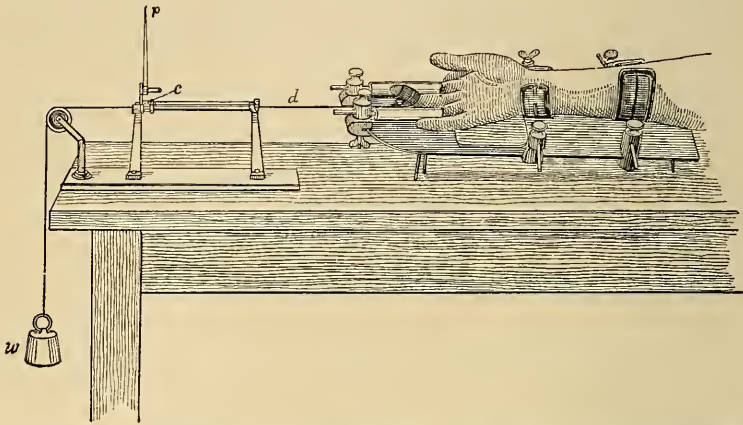

Fig. 23.—Mosso's ergograph: *c* is the carriage moving to and fro on runners by means of the cord *d*, which passes from the carriage to a holder attached to the last two phalanges of the middle finger (the adjoining fingers are held in place by clamps); *p*, the writing point of the carriage, *c*, which makes the record of its movements on the kymographion; *w*, the weight to be lifted.

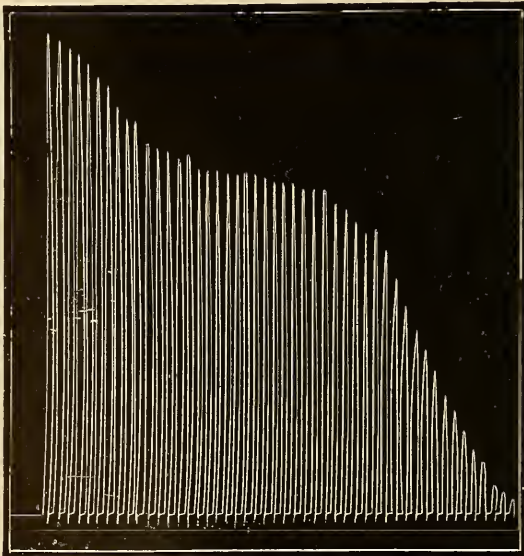

Fig. 24.—Normal fatigue curve of the flexors of the middle finger of right hand. Weight 3 kilograms, contractions at intervals of two seconds.—(Maggiara.)

effort, the contraction of the muscles is insufficient to lift the weight. In this way a record is obtained such as is shown in Fig. 24.



In such a record we can easily calculate the total work done by obtaining the product of the load into the lift for each contraction and adding these products together. By this means the capacity for work of the muscle used can be studied objectively under varying conditions, and many suggestive results have been obtained, some of which will be referred to specifically.\* It should be borne in mind, however, that the ergograph in this form does not enable us to compute the total work that the muscle is capable of performing. It is obvious that when the point of complete fatigue is reached, as illustrated in the record, Fig. 24, the muscle is still capable of doing work, that is external work, if we replace the heavy load by a lighter one. For this reason some investigators have substituted a spring in place of the load,† giving thus a spring ergograph instead of a weight ergograph. Although with the spring ergograph every muscular contraction is recorded and the entire work done may be calculated, it also possesses certain theoretical and practical disadvantages, for a discussion of which reference must be made to the authors quoted.

The weight ergograph has, so far at least, given us the most suggestive results. Among these the following may be mentioned: (1) If a sufficient interval is allowed between contractions no fatigue is apparent. With a load of 6 kilograms, for instance, the flexor muscle (*M. flexor digitorum sublimis*) showed no fatigue when a rest of 10 seconds was given between contractions. (2) After complete fatigue with a given load a very long interval (two hours) is necessary for the muscle to make a complete recovery and give a second record as extensive as the first. (3) After complete fatigue efforts to still further contract the muscle greatly prolong this period of complete recovery,—a fact that demonstrates the injurious effect of straining a fatigued muscle. (4) The power of a muscle to do work is diminished by conditions that depress the general nutritive state of the body or the local nutrition of the muscle used; for instance, by loss of sleep, hunger, mental activity, anemia of the muscle, etc. (5) On the contrary, improved circulation in the muscle—produced by massage, for example—increases the power to do work. Food also has the same effect, and some particularly interesting experiments show that sugar, as a soluble and easily absorbed foodstuff, quickly increases the amount of muscular work that can be performed. (6) The total amount of work that can be obtained from a muscle is greater with small than with large loads,

\* Mosso, "Archives italiennes de biologie," 13, 187, 189; also Maggiora, 1890, p. 191, 342. Lombard, "Journal of Physiology," 13, 1, 1892.

† Franz, "American Journal of Physiology," 4, 348, 1900; also Hough, *ibid.*, 5, 240, 1901.

since fatigue sets in more rapidly with the larger loads. (7) Marked activity in one set of muscles—the use of the leg muscles in long walks, for example—will diminish the amount of work obtainable from other muscles, such as those of the arm. It is very evident that the instrument may be used to advantage in the investigation of many problems connected with gymnastics, dietetics, stimulants,\* medicines, etc.

A point of general physiological interest that has been brought out in connection with the use of the ergograph calls for a few words of special mention. Mosso found that if a muscle—*e. g.*, the flexor digitorum sublimis—is stimulated directly by the electrical current and its contractions are recorded by the ergograph, it will give a curve similar to that figured above for the voluntary contractions, except that the contractions are not so extensive. Under these conditions the muscle, when completely fatigued to electrical stimulation, will respond to voluntary stimulation from the nerve centers. It seems likely, as suggested by Hough, that this result is due mainly to the fact that the electrical current cannot be applied to a muscle in its normal position so as to excite uniformly all the constituent muscle fibers, although it is also possible that what we call the normal or voluntary stimulus is more effective or, to use a physiological term, more adequate to the muscle fibers than the electrical shock. On the other hand, after fatigue from a series of voluntary contractions it has been observed that the muscle will still give contractions if stimulated directly by electricity. This fact has been interpreted to mean that, in the neuromuscular complex involved in a muscular contraction—namely, motor nerve cell, motor nerve fiber, and muscle fiber—the ordinary fatigue curve obtained from the ergograph does not represent pure muscle fatigue, but fatigue of the neuromuscular apparatus as a whole. Wedenski has called attention to the fact that in the neuromuscular apparatus the motor end-plate is a sensitive link in the chain, and that, when the nerve is stimulated strongly with artificial stimuli at least, this structure falls into a condition in which it fails to conduct the nerve impulse to the muscle. It may be, therefore, that in sustained voluntary contractions the end-plate or the specialized receptive substance in which the nerve fibers terminate fails first, and is directly responsible for the failure of the apparatus to perform further work.† That the fatigue in ordinary voluntary contractions affects the muscles before the motor nerve centers is indicated by the experiments of Storey.‡ Making use of a weight ergograph and experimenting upon the abductor indicis, he found that after fatiguing this muscle to voluntary contractions with a certain weight, removal of the weight enabled the individual to make contractions as high and as rapid as before the fatigue. On the other hand, if, after removing the weight, the muscle was stimulated electrically, the contractions were lower and slower than before the fatigue. So far as our knowledge goes, therefore, fatigue as it appears in sustained voluntary contractions is due probably primarily to a loss of irritability in the muscle and in the receptive apparatus between nerve and muscle. The motor nerve fibers do not fatigue, and as regards the motor nerve centers, it is not possible as yet to say what may be their relative susceptibility to fatigue. A significant fact, reported by Piper, is that the motor nerve centers when fatigued discharge their impulses at a rate of perhaps one-half the normal.

**Sense of Fatigue.**—It should be noted in passing that in continued voluntary contractions we are conscious of a sense of fatigue

\* Schumberg, "Archiv f. physiol.," 1899, suppl. volume, p. 289, and Palmen, "Skandinavisches Archiv für Physiologie," 1910, 24, 168, 197.

† For further evidence, see Burridge, "Journal of Physiology," 1911, 41, 285.

‡ Story, "American Journal of Physiology," 1903, 8, 355.

which eventually leads us, if possible, to discontinue our efforts. This sensation must arise from a stimulation of sensory nerve fibers within the muscle or its tendons, and it may be regarded as an important regulation whereby we are prevented from pushing our muscular exertions to the point of "straining."

**Muscle Tonus.**—In addition to the conditions of contraction and of relaxation the living muscle exhibits the phenomenon of "tone." By muscle tone we mean a state of continuous shortening or contraction which under normal conditions is slight in extent and varies from time to time. This condition is dependent upon the connection of the muscle with the nerve centers, and we may assume that under normal circumstances the motor centers are continually discharging subminimal nerve impulses into the muscles which cause chemical changes similar in kind to those set up by an ordinary voluntary effort but less in amount, the result being that the muscles enter into a state of contraction which, while slight in extent, is more or less continuous. According to this view, the whole neuromuscular apparatus is in a condition of tonic activity, and this state may be referred in the long run to the continual inflow of sensory impulses into the central nervous system. That is, the tonus of the skeletal muscles is not only dependent on the nerve centers (neurogenic), but is in reality an example of reflex stimulation of these centers. The tone of any particular muscle or group of muscles may be destroyed, therefore, by cutting its motor nerve, or less completely by severing the sensory paths from the same region. If, for instance, one severs in a dog the posterior roots of the spinal nerves innervating the leg, there will be a distinct loss of muscular tone, although the motor nerves remain intact. The underlying cause of tone is poorly understood. It may be, as implied above, simply a condition of subdued tetanus due to a constantly acting series of sub-minimal stimuli, or it may be an order of contraction quite different from the usual visible movements; that is to say, the shortening in the case of tonus may be due to a substance or mechanism in the muscle-fibers different from that which subserves the ordinary quick movements which we designate as contractions. However this may be, the fact of muscle tone is important in a number of ways. It is of value, without doubt, for the normal nutrition of the muscle, and, as is explained in the chapter on Animal Heat, it plays a very important part in controlling the production of heat in the body. The extent of muscle tone varies with many conditions, the most important of which, perhaps, are external temperature and mental activity. With regard to the first, it is known that, as the external temperature falls and the skin becomes chilled, the sensory stimulation thus

produced acts upon the nerve centers and leads to an increased discharge along the motor paths to the muscle. The tone of the muscles increases and may pass into the visible movements of shivering. By this means the production of heat within the body is increased automatically. Similarly, an increase in mental activity, so-called mental concentration, whether of an emotional or an intellectual kind, leads, by its effect on the spinal motor centers, to a state of greater muscle tonus, the increased muscular tension being, indeed, visible to our eyes.

**The Condition of Rigor.**—When the muscle substance dies it becomes rigid, or goes into a condition of rigor: it passes from a viscous to a solid state. The rigor that appears in the muscles after somatic death is designated usually as rigor mortis, and its occurrence explains the death stiffening in the cadaver. It is characterized by several features: the muscles become rigid, they shorten, they develop an acid reaction, and they lose their irritability to stimuli. Whether all of these features are necessary parts of the condition of rigor mortis it is difficult to say; the matter will be discussed briefly below. Some of the facts which have been observed regarding rigor mortis are as follows: After the death of an individual the muscles enter into rigor mortis at different times. Usually there is a certain sequence, the order given being the jaws neck, trunk, upper limbs, lower limbs, the rigor taking, therefore, a descending course. The actual time of the appearance of the rigidity varies greatly, however; it may come on within a few minutes or a number of hours may elapse before it can be detected, the chief determining factor in this respect being the condition of the muscle itself. Death after great muscular exertion, as in the case of hunted animals or soldiers killed in battle, is usually followed quickly by muscle rigor; indeed, in extreme cases it may develop almost immediately. Death after wasting diseases is also followed by an early rigor, which in this case is of a more feeble character and shorter duration. The development of rigor is very much hastened by many drugs that bring about the rapid death of the muscle substance, such as veratrin, hydrocyanic acid, caffein, and chloroform. A frog's muscle exposed to chloroform vapor goes into rigor at once and shortens to a remarkable extent. Rigor is said also to occur more rapidly in a muscle still connected with the central nervous system than in one whose motor nerve has been severed. After a certain interval, which also varies greatly,—from one to six days in human beings,—the rigidity passes off, the muscles again become soft and flexible; this phenomenon is known as the release from rigor. In the cold-blooded animals the development of rigor is very much slower than in warm-blooded animals. Upon an isolated frog's muscle the most striking fact regarding rigor mortis is the shortening

that the muscle undergoes. This shortening or contraction comes on slowly, as is shown in the accompanying figure, but in extent it exceeds the simple contraction obtainable from the living muscle by means of a maximal stimulus. This part of the phenomenon is, however, much less marked apparently in mammalian muscle. The usual explanation that is given of rigor is that it is due to a coagulation of the fluid substance, the muscle plasma, of which the fibers are constituted. During life the proteins exist in a liquid or viscous condition; after death they coagulate into a solid form. This view is referred to again in the chapter dealing with the chemistry of muscle and nerve; it has received much support from the investigations of Kühne,\* who proved that the muscle plasma is really coagulable. After first freezing and mincing



Fig. 25 — Curve of normal rigor mortis, gastrocnemius muscle of frog. The curve was obtained upon a kymograph making one revolution in eight days. The marks on the line below the curve indicate interval of six hours. It will be seen that the shortening required eighteen hours, the relaxation about seventy-two hours.

the muscles he succeeded in squeezing out the plasma from the living fibers and showed that it subsequently clotted. While the coagulation theory of rigor explains the greater rigidity of the muscle, it does not furnish in itself a satisfactory explanation of the shortening, and the fact, as stated above, that the rigidity may occur without the shortening indicates that this latter process may possibly be due to changes that precede the appearance of rigidity. In addition to the rigor mortis that occurs after death at ordinary temperatures, a condition of rigor may be induced rapidly by raising the temperature of the muscle to a certain point. Rigor induced in this way is designated as heat rigor or rigor caloris. Much uncertainty has prevailed as to whether heat rigor is different essentially from death rigor. According to some physiologists, the processes may be regarded as the same, the heat rigor being simply

\* Kühne, "Archiv f. Physiologie," 1859, p. 788.

a death rigor that is rapidly developed by the high temperature, this latter condition accelerating the chemical changes leading to rigor, as is the case, for instance, in the action of chloroform. This view is supported by a study of the chemical changes that take place under the two conditions, as will be described later, and by the fact that some of the conditions that influence one phenomenon have a parallel effect upon the other. For instance, death rigor is accelerated by previous use of the muscle, and the same is true for heat rigor. While a resting frog's muscle begins to go into heat rigor, as judged by the shortening, at 37° to 40° C.; a muscle that has been greatly fatigued shows the same phenomenon at 25° to 27° C.\* According to other observers, heat rigor is due to an ordinary heat coagulation of the proteins present in the muscle fiber, and it has been claimed that a separate contraction may be obtained on heating for each of the proteins said to exist in the muscle fiber.† More recent observations‡ seem to show that when a frog's muscle is gradually heated, only two really distinct contractions are obtained, one at 39° C. (38° to 40°) or slightly lower, and one at 50° C. (49° to 51°). Mammalian muscle gives also two contractions when heated, one at 47° C. (46° to 50°) and one at 62° C. (61° to 64°). In each of these cases the second contraction is due to the action of heat on the connective-tissue elements of the muscle. The first contraction is, therefore, the one that is characteristic of the muscular substance proper and the one that marks the occurrence of heat rigor. At the temperatures stated, 39° C. for frog's muscle and 47° C. for mammalian muscle, the viscous material within the sarcolemma coagulates. It does not follow necessarily that this coagulation is the direct cause of the shortening. Meigs§ states that plain muscle heated to 50° C. lengthens instead of shortening, although at that temperature much of its contained protein is coagulated. In striated muscle, on the other hand, coagulation may be produced by alcohol without any noticeable shortening. It may be, therefore, that coagulation and shortening are separate results following upon the chemical changes preceding the death of the muscle substance. The coagulation produced in heat rigor is apparently more complete and resistant than that of death rigor, for ordinary death rigor passes off after a certain interval, even if putrefactive processes are excluded; the rigor from heat or from chloroform, on the contrary, shows no release. With regard to the

\* Latimer, "American Journal of Physiology," 2, 29, 1899.

† Brodie and Richardson, "Philosophical Trans., Roy. Soc.," London, 1899, 191, p. 127; also Inagaki, "Zeitschrift f. Biol.," 1906, 48, 313.

‡ Vrooman, "Bio-chemical Journal," 1907, 2, 363.

§ Meigs, "American Journal of Physiology," 24, 1 and 178, 1909.

specific cause of the contraction and coagulation of death rigor nothing final can be said. The interesting researches of Fletcher and Hopkins\* indicate that during the survival period between the loss of the normal circulation and the appearance of rigor chemical changes are going on in the living substance which result in the formation and accumulation of lactic acid. When the process of production of the lactic acid ceases, the muscle has lost its irritability, and then soon enters into the stage of rigor. If during this survival period the muscle is kept well supplied with oxygen, no lactic acid accumulates in the muscle, and when the muscle finally loses its irritability, no rigor occurs. These facts would seem to implicate the lactic acid in some way in the process of clotting and of rigor. One specific theory† that is based on the occurrence of lactic acid assumes that the shortening in death rigor, as in normal contraction (p. 74), is due to an imbibition of water by the fibrils in consequence of the action of the acid. Later the acid causes a coagulation or precipitation of the protein, and this process initiates the release from rigor because coagulated protein has less power of imbibition. The fibrils lose water and return to their original length.

#### PLAIN OR SMOOTH MUSCULAR TISSUE.

**Occurrence and Innervation.**—Plain or long striated muscular tissue occurs in the walls of all the so-called hollow viscera of the body, such as the arteries and veins, the alimentary canal, the genital and urinary organs, the bronchi, etc., and in other special localities, such as the intrinsic muscles of the eyeball, the muscles attached to the hair follicles, etc. In structure it differs fundamentally from cross-striated muscle, in that it occurs in the form of relatively minute cells, each with a single nucleus, which are united to form, in most cases, muscular membranes constituting a part of the walls of the hollow viscera. Each muscle-cell is spindle shaped, contains a single elongated nucleus, and the cytoplasm is traversed by fine fibrils (myofibrillæ) which are said to continue from one cell to another. As in the case of the striated muscle, these fibrils are supposed to constitute the contractile element. The muscle-cells are supplied with nerve-fibers belonging to the autonomic system (p. 251), which originate directly from so-called sympathetic nerve-cells, and only indirectly, therefore, from the central nervous system.

Speaking generally, the contractions of this tissue are removed from the direct control of the will, being regulated by reflex and usually unconscious stimulations from the central nervous system.

\* Fletcher and Hopkins, "Journal of Physiology," 1907, 35, 247.

† Von Fürth and Lenk, "Biochemische Zeitschrift," 33, 341, 1911.

All the important movements of the internal organs, or, as they are sometimes called, the organs of vegetative life, are effected through the activity of this contractile tissue. From this standpoint their function may be regarded as more important than that of the mass of the voluntary musculature, since so far as the mere maintenance of the life of the organism is concerned, the proper action and co-ordination of the movements of the visceral organs is at all times essential.

**Distinctive Properties.**—The phenomena of contraction shown by plain muscles are, in general, closely similar to those already studied for striated muscle, the one great difference being the much greater sluggishness of the changes. Plain muscles differ

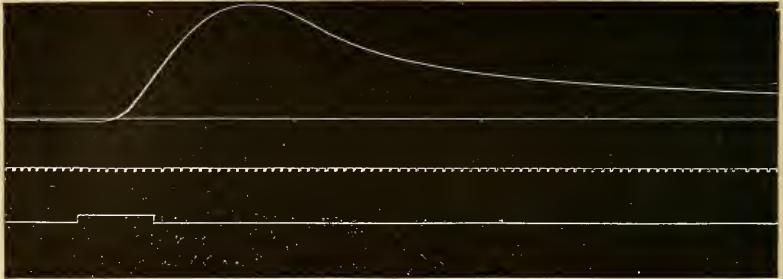

Fig. 26.—Curve of simple contraction of plain muscle. The middle line is the time record, marking intervals of a second. The lowermost line indicates at the break the moment of stimulation (short-lasting, tetanizing current). It will be seen that the latent period between beginning of stimulation and beginning of contraction is equal to about three seconds.

among themselves, of course, as do the striated muscles, but, speaking generally, the simple contractions of plain muscle have a very long latent period that may be a hundred or five hundred times as long as that of cross-striated muscle, and the phases of shortening and of relaxation are also similarly prolonged; so that the whole movement of contraction is relatively slow and gentle (see Fig. 26). Plain muscle responds to artificial stimuli, but the electrical current is obviously a less adequate—that is, a less normal—stimulus for this tissue than for the striped muscle. The amount of current necessary to make it contract is far greater. The amount of contraction varies with the strength of stimulus,—that is, the tissue gives submaximal and maximal contractions. Two successive stimuli properly spaced will cause a larger or summated contraction, and a series of stimuli will give a fused or tetanic contraction. The rate of stimulation necessary to produce tetanus is, of course, much slower than for cross-striped muscle. The stomach muscle of the frog, for instance, requires only one stimulus at each five sec-



onds to cause tetanus.\* A distinguishing and important characteristic of the plain muscle is its power to remain in tone,—that is, to remain for long periods in a condition of greater or less contraction. Doubtless this tonic contraction under normal relations is usually dependent upon stimulation received through the nervous system (neurogenic tonus), but the muscle, when completely isolated from the central nervous system, whether in or out of the body, continues to exhibit the phenomenon of tone to a remarkable degree. In most of the organs in which plain muscle occurs there are present also numerous nerve cells, and it is therefore still a question as to whether the tonic changes shown by this tissue, after separation of its extrinsic nerves, depend upon a property of the muscle itself (myogenic tonus) or upon their intrinsic nerve cells. Most observers adopt the former view. The importance of this property of tone in the plain muscle tissues will be made fully apparent in the description of the physiology of the organs of circulation and digestion. We shall find that constantly throughout life the walls of the small arteries resist a high internal pressure, and that in other visceral organs pressures of varying amounts are supported by the tonicity of the plain muscle in their walls. Many interesting observations in late years tend to show that the tension developed in plain muscle in a state of tone is accompanied by little or no production of heat and by little evidence of chemical changes of an oxidative nature.† In some very economical way, so far as the consumption of material and energy is concerned, the condition of the muscle may be changed from a state of little tone to one of greater tone. Plain muscle may exhibit also the phenomenon of rhythmical activity—that is, under proper conditions it may contract and relax rhythmically like heart tissue.‡ Such movements have been observed and studied upon the plain muscle of the ureter, the bladder, the esophagus, stomach, and other portions of the alimentary canal, the spleen, the blood-vessels, etc. This property seems to be very unequally distributed among the different kinds of plain muscle found in the same or different animals, but this fact serves only to illustrate the point already sufficiently emphasized, that grouping one kind of tissue—*e. g.*, plain muscle—into a common class does not signify that the properties of all the members of the group are identical. The question as to how far the phe-

\* Schultz, "Zur Physiologie der längsgestreiften (glatten) Muskeln," "Archiv f. Physiologie," suppl. volume, 1903, p. 1. See also Stewart, "American Journal of Physiology," 4, 185, 1900. For finer histology see M'Gill, "American Journal of Anatomy," ix, 1909.

† Snyder, "American Journal of Physiology," 35, 340, 1914.

‡ Engelmann, "Archiv f. d. ges. Physiologie," 2, 243, 1869. Stiles, "Amer. Jour. of Physiology," 5, 338, 1901.

nomenon of rhythmical contraction is entirely muscular and how far it depends upon intrinsic nerve cells is a complex one; the answer will probably vary for different organs, and the subject will therefore be considered in the organs as they are treated.

**Cardiac Muscular Tissue.**—As the muscle cells of cardiac tissue are somewhat intermediate in structure between the striated fibers of voluntary muscle and the cells of plain muscles, so their physiological properties to some extent stand between these two extremes. The rate of contraction, for instance, while slower than that of the fibers of skeletal muscles, is more rapid than that of plain muscle. The most striking peculiarity of heart muscle is, however, its power of rhythmical contractility, and this, as well as its other properties, is so directly concerned with its functions as an organ of circulation that it may be discussed more profitably in that connection.

**Ciliated Cells.**—In the mammalian body the phenomenon of contractility is exhibited not only by the well-defined muscular tissue, but also by the leucocytes and especially by the cilia of the ciliated epithelium. Epithelial cells with motile cilia are found lining the mucous membrane of the air-passages in the trachea, larynx, bronchi, and nose, in the lacrimal duct and sac, in the genital passages, uterus and Fallopian tubes and the tubules of the epididymis, and in the Eustachian tube and part of the middle ear. Similar cells are found lining the ventricles of the brain and the central canal of the cord. The cilia in this latter position have been demonstrated to be motile in the frog, and according to an old observation by Purkinje\* the same is true for the mammalian (sheep) embryo. So also in the neck of the uriniferous tubule ciliated cells are said to occur, but whether they are motile or not has not been demonstrated. In the internal ear and the olfactory mucous membrane the so-called sense cells are also ciliated, but here at least the cilia are probably not motile. Ordinarily each ciliated epithelial cell carries a bunch of cilia, all of which contract together, but motile protoplasmic prolongations of the cell may occur singly, as is illustrated in the spermatozoa, for instance, and in many of the protozoa and plant cells. In the lower forms of life cilia play obviously a very important rôle in locomotion, the capture of food, and respiration, and their form and manner of movement vary greatly. The form of movement or manner of contraction was formerly described under four heads,—the hook form, the pendular, the undulatory or wave-like, and the funnel form or infundibular. With the exception of the spermatozoa, the cilia found in mammals show the first form of contraction. The little processes are

\* Purkinje, "Müller's Archiv," 1836.

contracted quickly in one direction, so as to take a hook shape, and then relax more slowly, the relaxation taking several times as long as the contraction. The whole movement is rhythmical and very rapid. The cilia of the epithelium of the frog's pharynx and esophagus, which have been the most frequently studied in the higher animals, contract, according to Engelmann, at the rate of 12 times per second. When a field of epithelium is observed under the microscope the contractions pass over it in a definite direction, but so rapidly that the eye is not able to analyze them; one obtains the impression simply of a swiftly flowing current. As the cilia begin to die, their movements become less rapid, and the nature of the contractions and their progress from cell to cell can be satisfactorily observed. In the mammalia the function of the ciliated epithelium is supposed to be entirely mechanical,—that is, the cilia move substances lying upon them. In the oviducts they move or help to move the ovum toward the uterus, and in this latter organ their motion is supposed to guide the spermatozoa from the uterus toward the oviducts,—that is, the resistance offered to the motile spermatozoa guides their movements. So in the respiratory passages foreign particles of various sorts, together with the secretion of the mucous glands, are moved toward the mouth, the effect being to protect the air-passages from obstruction. The contraction and relaxation of the cilia are assumed to be phenomena of essentially the same order as those exhibited by the muscle tissue. A theory that will adequately explain one will doubtless be applicable to the other. Many interesting facts have been established regarding ciliary movements. The contractions of the cilia in any given field—the trachea, for instance—follow in a definite sequence and are coordinated. The waves of contraction progress in a definite direction. This fact increases greatly the effectiveness of the cilia in performing work. Thus, in spite of their extremely minute size, it is estimated that an area of a square centimeter is capable of moving a load of 336 gms. The contractions are automatic,—that is, the stimulus causing them is not dependent upon a connection with the nervous system, but upon processes arising within the cell itself; the cilia of a single completely isolated cell may continue to contract vigorously. The movement may continue for several days after the death of the individual, thus again showing the physiological independence of the structure. The ciliated cells may conduct a stimulus or impulse to other cells even after its own cilia have lost their contractility. This fact is particularly significant in general physiology, as it aids in showing that the property of conductivity which is exhibited in such high degree by nerve fibers is possessed to a lower degree by other tissues.

The ciliary movement is affected by variations in temperature, and if the temperature passes beyond an optimum point the cilia fall into a condition resembling heat rigor in the muscle. Their movements are affected also by the reaction of the medium, being at first accelerated and then slowed or destroyed by a slight degree of acidity and favored by a very slight degree of alkalinity.\*

\* References for physiology of ciliary movement: Verworn, "General Physiology," English translation by Lee; Pütter, "Ergebnisse der Physiologie," 1902, vol. ii, part II; Engelmann, article, "Cils vibratils," in Richet's "Dictionnaire de Physiologie," vol. iii, 1898.

## CHAPTER II.

### THE CHEMICAL COMPOSITION OF MUSCLE AND THE CHEMICAL CHANGES OF CONTRACTION AND OF RIGOR MORTIS.

**Muscle Plasma.**—The beginning of our present knowledge of the chemical composition of muscle is found in some interesting experiments made by Kühne upon frog's muscle. Kühne froze the living muscle to a hard mass, cut it into fine shavings with cold knives, and ground the pieces thoroughly in a cold mortar. The fine muscle snow thus obtained was put under high pressure and a liquid expressed which was assumed to represent the fluid living substance in the normal fiber. This muscle plasma clotted on standing, much as blood does, the muscle clot shrinking and squeezing out a muscle serum. Similar experiments have since been performed by Halliburton\* on mammalian muscle.

*Composition of the Muscle Plasma.*—Using the term muscle plasma to designate the entire contents of the muscle fiber within the sarcolemma, it is obvious that this material should contain all the constituents that properly belong to the muscle, in contradistinction to the substances found in the connective tissue binding the muscle fibers together.

The constituents in addition to water that are known to occur in muscle are very numerous indeed, and difficult to classify. They may be grouped under the following heads: (1) Proteins. (2) Carbohydrates and fats. (3) Nitrogenous extractives (creatin, urea, etc.). (4) Non-nitrogenous extractives (lactic acid, inosite, etc.). (5) Pigments. (6) Ferments. (7) Inorganic salts. Very little that is positive can be stated regarding the physiological rôle of most of these constituents, the interest that attaches to them at present being largely on the chemical side.

**The Muscle Proteins.** †—The proteins of the muscle have been investigated by a number of observers, but unfortunately the terminology employed has not been uniform, and the facts so far

\* Halliburton, "Journal of Physiology," 8, 133, 1888.

† Von Fürth, "Archiv f. exper. Path. u. Pharmakol.," 36, 231, 1895, and "Handbuch der Biochemie," 1909, vol. 2, p. 244; Halliburton, "Journal of Physiology," 8, 133, 1888; Stewart and Sollman, *ibid.*, 24, 427, 1899.

as they are known to us seem to be obviously incomplete. According to von Fürth, two proteins may be obtained from mammalian muscle by extracting it with dilute saline solutions,—namely, myosin and myogen, the latter existing to three or four times the amount of the former. Myosin belongs to the globulin group of proteins (see appendix); it is coagulated by heat at 44° to 50° C., it is precipitated by dialysis or by weak acids, it is easily precipitated from its solutions by adding an excess of neutral salts, such as sodium chlorid, magnesium or ammonium sulphate. With the last salt it is completely precipitated when the salt is added to one-half saturation or less. Its most interesting property, however, is that on standing at ordinary temperatures it passes over into an insoluble modification which separates out as a sort of clot. Following the terminology used for the blood, this insoluble modification is called myosin fibrin. Myogen, the other protein, seems to fall into the group of albumins rather than globulins. It is not precipitated by dialysis and requires more than half saturation with ammonium sulphate for its complete precipitation. It is coagulated by heat at a temperature of 55° to 65° C. Solutions of myogen on standing also undergo a species of clotting, the insoluble protein that is formed in this case being called myogen fibrin. It appears, however, that in changing to myogen fibrin the myogen passes through an intermediate stage, designated as soluble myogen fibrin, in which its temperature of heat coagulation is as low as 30° to 40° C.—the lowest temperature recorded for any protein. As was stated in the paragraph on muscle rigor, it is known that frog's muscle goes into heat rigor at about 37° to 40° C., and in accordance with this fact it is stated that a protein, soluble myogen fibrin, which is not present in mammalian muscle, occurs normally in the muscle of the frog and also of the fishes.

It may be doubted whether these proteins exist as such in the living muscle. Extracts must of necessity be made after the muscle plasma is dead and probably coagulated. Myogen is said not to occur in the muscles of the invertebrates. It should be added that after the most complete extraction with saline solutions the muscle fiber still retains much protein material, and its structural appearance, so far as cross-striation is concerned, remains unaltered. The portion of protein material thus left in the muscle fiber as a sort of skeleton framework is designated as the muscle stroma; it is not soluble in solutions of neutral salts, but dissolves readily in solutions of dilute alkalies. In striped muscle this so-called stroma forms about 9 per cent. of the weight of the muscle; while in the heart muscle it makes about 56 per cent., and in the smooth muscle, 72 per cent. It is at present uncertain whether the myosin and

myogen represent the protein constituents of the contractile elements of the muscle fibers or of the undifferentiated portion, the sarcoplasm. The proteins of plain muscle tissue and of cardiac muscle have not received so much attention as those of voluntary muscle. It is stated, however, that the proteins extracted from these tissues by salt solutions are coagulable on standing, as in the case of the extracts of voluntary muscle. In plain muscle two proteins, in addition to some nucleoprotein, are described, one belonging to the albumin and one to the globulin class, but the identity or relationship of these proteins to those above described has not been established. In heart muscle, myosin and myogen occur in practically the same proportions as in voluntary muscle, but the amount of stroma left undissolved after treatment with saline solutions is, as stated above, much greater than in skeletal muscle.\*

**The Carbohydrates of Muscle.**—Muscle contains a certain amount of sugar (dextrose or dextrose and isomaltose), and also under normal conditions a considerable quantity of glycogen, or so-called animal starch. The formation and the consumption of glycogen in the body constitute one of the most interesting chapters in the physiology of nutrition, and the relations of glycogen will be treated more fully under that head. It may be stated here, however, that the muscular tissue has the power of converting the sugar brought to it by the blood into glycogen. It is a synthetic reaction in which the simple molecule of the monosaccharide (dextrose) is converted by dehydration and condensation to the larger molecule of the polysaccharide (glycogen). It is represented in principle by the reaction

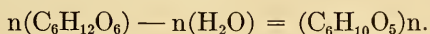

The glycogen thus formed is stored in the muscle and forms a constant constituent of well-nourished muscle in the resting condition, the amount varying between 0.5 and 0.9 per cent. of the weight of the muscle. The glycogen thus stored in the muscle is consumed by the tissue during its activity, and it is assumed that before it is thus consumed it is converted back into sugar by the action of an amyolytic enzyme contained in the muscle. The glycogen, therefore, itself represents a local deposit of carbohydrate nutritive material. The sugar and the glycogen must be considered as one from the standpoint of the nutrition of the muscle. During muscular activity the store of glycogen is used up, and if the activity is sufficiently prolonged it may be made to disap-

\* Vincent and Lewis, "Journal of Physiology," 26, 445, 1901; also "Zeitschrift f. physiolog. Chemie," 34, 417, 1901-2; Stewart and Sollman, *loc. cit.*; von Fürth, "General Review, Handbuch der Biochemie," vol. 2, part 2, p. 244.

pear entirely. Among the many uncertain and contradictory statements regarding the chemical changes in active muscle, this fact stands out in pleasant contrast as one that is satisfactorily demonstrated.

**Lactic Acid** ( $C_3H_6O_3$ ).—Lactic acid is found in varying amounts in the extracts of muscle. The acid that is obtained is the so-called ethidene lactic acid or  $\alpha$ -hydroxypropionic acid ( $CH_3CHOHCOOH$ ), and differs from the lactic acid found in sour milk in that it rotates the plane of polarized light to the right. The lactic acid in sour milk is produced by bacterial fermentation, and is inactive to polarized light, because it exists in racemic form; that is, it consists of equal amounts of the right-handed form which turns the plane of polarization to the right and of the left-handed form which turns it to the left. In the muscle the right-handed form is found mainly or only, and this form, therefore, is frequently designated as sarcolactic (or paralactic) acid. Recent work indicates that in the perfectly resting muscle lactic acid is present only in traces. The amount is greatly increased during contraction or in the processes leading to rigor. This substance may be considered, therefore, as an intermediary product formed in the course of the chemical reactions constituting the normal metabolism of the muscle. Its origin is considered in more detail below.

**The Nitrogenous Extractives (Nitrogenous Wastes).**—Muscle extracts contain numerous crystallizable nitrogenous substances which are regarded as the end-products of the disassimilation or catabolism of the living protein material of the muscle. The number of these substances that have been found in traces or weighable quantities is rather large. They have aroused great interest because their structure throws some light on the nature of protein catabolism. The one that occurs in largest amount is creatin,  $C_4H_9N_3O_2$ , or methyl-guanidin-acetic acid,  $NHCNH_2-NCH_3CH_2COOH$ . Creatin is present in amounts equal to 0.4 to 0.5 per cent. of the weight of the muscle. The relations of this substance to the creatinin ( $C_4H_7N_3O$ ) found in the urine are discussed on p. 852. Another nitrogenous body with basic properties which occurs in amounts about equal to the creatin is carnosin,  $C_9H_{14}N_4O_3$ .\* It is probably a derivative of histidin, since on hydrolysis it yields histidin and alanin (Gulewitsch). Nothing is known of its physiological significance. In addition there is a group of bodies supposed to represent the end-products of the breaking up of the nucleins of the muscle, all of which belong to the so-called purin bases. These are: Uric acid ( $C_5H_4N_4O_3$ ),

\* Von Fürth and Schwarz, "Biochemische Zeitschrift," 1911, 30, 413.



xanthin ( $C_5H_4N_4O_2$ ), hypoxanthin ( $C_5H_4N_4O$ ), guanin ( $C_5H_5N_5O$ ), adenin ( $C_5H_5N_5$ ), and carnin ( $C_7H_8N_4O_3$ ). They will be referred to more fully in the section on Nutrition. Several other nitrogenous extractives have been isolated and named, but there is perhaps some doubt as to their chemical individuality. These nitrogenous products are found in the various meat extracts and meat juices used in dietetics. While they possess no direct nutritive value, it seems probable (see chapter on Gastric Digestion) that they may have a stimulating action upon the secretion of the gastric glands.

• **Pigments.**—The red color of many muscles is believed to be due to the presence of a special pigment which resembles in its structure and its properties the hemoglobin of the red blood corpuscles, and perhaps is identical with it. This pigment is known as myohematin or myochrome. It belongs presumably to the group of so-called respiratory pigments, which have the property of holding oxygen in loose combination, and by virtue of this property it takes part in the absorption of oxygen by the muscular tissue.

**Enzymes.**—Very active chemical changes take place in muscle during contraction as well as during rest. These metabolic changes involve processes of hydrolysis, of oxidation, of reduction, and of synthesis, and, in most cases, they are supposed to be effected through the agency of enzymes. In accordance with this general statement very many different kinds of enzymes have been shown to occur in muscular tissue: proteolytic, amylolytic, and lipolytic enzymes, oxidases or peroxidases, reductases, an enzyme capable of splitting off urea from arginin (arginase), probably deaminases that split off ammonia from the amino-acids, etc. Most of these enzymes will be referred to more or less specifically in the section on Nutrition.

**The Inorganic Constituents.**—Muscle tissue contains a number of salts, chiefly in the form of the chlorids, sulphates, and phosphates of sodium, potassium, calcium, magnesium, and iron. As in other tissues, the potassium salts predominate in the tissue itself. In frog's muscle the entire ash constitutes about 0.88 per cent. of the dry material of the muscle, and of this ash the potassium and the phosphoric acid together make up more than 80 per cent. (Urano). These inorganic constituents are most important to the normal activity of the muscle, and, indeed, in two ways: first, in that they maintain a normal osmotic pressure within the substance of the fibers and thus control the exchange of water with the surrounding lymph and blood; second, in that they are necessary to the normal structure and irritability of the living muscular tissue. Serious variations

in the relative amounts of these salts cause marked changes in the properties of the tissues, as is explained in the section on Nutrition, in which the general nutritive importance of the salts is discussed, and also in the section dealing with the cause of the rhythmical activity of the heart.

**Chemical Changes in the Muscle during Contraction and Rigor.**—The chemical changes known to occur in muscle as a result of contraction under normal conditions are the following: (1) Production of carbon dioxid. (2) Production of lactic acid. (3) Disappearance of glycogen. A complete theory of contraction would include, of course, an explanation of the relation of these changes to one another and to the processes of contraction and relaxation. We do not at present possess such a theory, and consequently the significance of the facts known can only be guessed at or stated in a provisional way.

*Production of Carbon Dioxid.*—After increased muscular activity it may be shown that an animal gives off a larger amount of carbon dioxid in its expired air. In such cases the carbon dioxid produced in the muscles is given off to the blood, carried to the lungs, and then exhaled in the expired air. Pettenkofer and Voit, for instance, found that during a day in which much muscular work was done a man expired nearly twice as much  $\text{CO}_2$  as during a resting day. The same fact can be shown directly upon an isolated muscle of a frog made to contract by electrical stimulation. The carbon dioxid in this case diffuses out of the muscle in part to the surrounding air, and in part remains in solution, or in chemical combination as carbonates, in the liquids of the tissue. It has been shown by Hermann\* and others that a muscle that has been tetanized gives off more carbon dioxid than a resting muscle when their contained gases are extracted by a gas pump. This  $\text{CO}_2$  arises from the oxidation of the carbon of some of the constituents of the muscle, and its existence is an indication that in their final stages the changes in the muscle are equivalent to those of ordinary combustion at high temperatures, the burning of wood or fats, for instance. Moreover, the formation of the  $\text{CO}_2$  in the muscle is accompanied by the production of heat, as in combustion; and for the same amount of  $\text{CO}_2$  produced in the two cases the same amount of heat is liberated. Fletcher† has discovered the significant fact that the increased elimination of  $\text{CO}_2$  following upon contraction is clearly shown only when the muscle is well supplied with oxygen. In the absence of oxygen contraction may cause no increase in the  $\text{CO}_2$  given off. This fact seems to

\* Hermann, "Untersuchungen über den Stoffwechsel der Muskeln, etc.," Berlin, 1867.

† Fletcher, "Journal of Physiology," 1902, 28, 474.

be in accord with prevalent ideas regarding the nature of the muscular metabolism, according to which the chemical processes take place in two stages. In the first the complex energy-yielding material, sugar, for example, undergoes a splitting process which results in the formation of intermediary products, such as lactic acid. In the second stage these intermediary products or some of them are oxidized, provided, as Fletcher points out, there is an adequate supply of oxygen. Under normal conditions a sufficient amount of oxygen is furnished by the circulating blood, but under pathological conditions and in the excised muscle, especially when air is excluded, the supply may not be adequate, and as a result the intermediary products are not oxidized completely. Under such conditions less heat is produced in the muscle, and the intermediary products accumulate in the tissue.

The general views here stated are in accord with the facts regarding heat production in muscle during contraction, as stated on p. 37. The so-called delayed heat production that occurs after the mechanical process of shortening is past is probably caused by the oxidation of the intermediary products, the lactic acid perhaps, and Hill\* has shown that when oxygen is excluded, this second phase in heat production drops out.

*Disappearance of the Glycogen.*—An equally positive chemical change in the muscle during contraction is the disappearance of its contained glycogen. Satisfactory proof has been furnished that the amount of glycogen in a muscle disappears more or less in proportion to the extent and duration of the contractions, and that after prolonged muscular activity, especially in the starving animal, the supply may be exhausted entirely. In what way the glycogen is consumed is not completely known; the matter is discussed in the next paragraph and in the section on Nutrition. It is, perhaps, the general belief in physiology to-day that under normal conditions the glycogen of the muscle, after being changed to sugar, undergoes a conversion to lactic acid as a result of the stimulus that induces contraction, and that this formation of lactic acid is directly or indirectly connected with the process of shortening.

*The Formation of Lactic Acid.*—The lactic acid that is present in the muscle is believed to be increased in quantity by muscular activity. Attention was first called to this point by du Bois-Reymond, who showed that the reaction of the tetanized muscle is distinctly acid, while that of the resting muscle is neutral or slightly alkaline. This fact can be demonstrated by the use of

\* Hill, "Journal of Physiology," 46, 2S, 1913.

litmus paper, but perhaps more strikingly by the use of acid fuchsin.\* If a solution of acid fuchsin is injected under the skin of a frog it is gradually absorbed and distributed to the body without injuring the tissues. In the normal media of the body this solution remains colorless or nearly so. If now one of the legs is tetanized the muscles take on a red color, showing that an acid is produced locally. The supposition generally made is that the acidity during activity is due to an increased production of sarcolactic acid. Experiments have been made by a number of observers to determine quantitatively the amount of lactic acid in the resting and the worked muscle respectively. Several have stated that the amount is actually less in the worked muscle; others have found an increase. The balance of evidence seems to show that there is an increased production, but that this increase may be obscured in the living animal by the fact that the acid is removed by oxidation or by the circulating blood. This conclusion has been confirmed in a satisfactory way by the striking experiments of Fletcher and Hopkins.† These observers have shown in the first place that injury to a muscle causes a production of lactic acid, and that, therefore, the usual method of determining the amount of this substance in supposedly resting muscle has given fallacious results owing to the injury inflicted during the process of extraction. By the adoption of a new method they have avoided this error, and they find that in resting muscle lactic acid exists in traces only (0.03 per cent.) or perhaps is absent altogether. An appreciable amount is formed when the excised muscle is well tetanized (0.22 per cent.), also after injury, and especially in the development of rigor. In heat-rigor a maximum yield of 0.3 to 0.5 per cent. is obtained in the frog's muscle. In a muscle removed from the body and deprived, therefore, of its supply of oxygen, lactic acid develops rapidly, reaching finally an amount equal to that observed in heat-rigor. As long as such a surviving muscle shows irritability toward artificial stimulation, lactic acid continues to form. When irritability is lost, no further production of acid can be detected and the muscle soon goes into death-rigor. On the contrary, if the muscle is supplied abundantly with oxygen, no accumulation of lactic acid can be detected. It is evident from these observations that lactic acid is formed in the muscle as a result of the chemical changes underlying contraction, and also of the changes that occur during dying. The interpretation of this fact and also

\* Dreser, "Centralblatt für Physiologie," 1, 195, 1887.

† Fletcher and Hopkins, "Journal of Physiology," 1907, 35, 247; also 1911, 12, 43, 286, and Embden, et. al., "Biochemische Zeitschrift," 1912, 45, 45.

of the further fact that the lactic acid does not appear when oxygen is freely supplied to the muscle is surrounded with difficulties owing to our lack of knowledge of the chemical reactions that take place. The simplest explanation at present is that the lactic acid is an intermediary product formed from the sugar by enzyme action, and that it subsequently, in the presence of oxygen, undergoes oxidation under the influence of other enzymes; but another possible explanation is that the lactic acid, after causing in some way the process of contraction, is again reconstructed by synthesis into the precursor from which it was derived. A synthesis of this kind would require energy, and it has been suggested\* that the oxidation that occurs in the muscle at this point yields the energy necessary for this work. Much uncertainty, however, prevails in regard both to the immediate origin and the fate of the lactic acid. Some evidence, as yet incomplete, has been furnished to show that there is present in muscle a compound containing a carbohydrate-phosphoric acid group.† When the juice of a muscle is expressed under great pressure and is kept at body temperature, both lactic acid and phosphoric acid are formed in the mixture and in approximately equimolecular amounts. It is suggested, therefore, that the sugar in the muscle may first be synthesized with phosphoric acid (and perhaps other constituents) to form this complex compound, for which the name *lactacidogen* has been proposed. It is in the breaking down of this substance that the lactic acid is produced from the carbohydrate group. A further discussion of the chemical relations of the lactic acid to sugar will be found on p. 907.

**Chemical Changes During Rigor Mortis.**—The chemical changes during rigor have been referred to above, but may be summarized here in brief form:

1. There is a coagulation of the protein material of the muscle plasma, which at present may be explained by supposing that the contained myosin and myogen, spontaneously, or under the action of acid products of metabolism, pass into their insoluble forms,—namely, myosin fibrin and myogen fibrin.

2. There is an increased acidity, due doubtless to a production of lactic acid.

3. There is a production of  $\text{CO}_2$ . Much importance was attributed formerly to this product on the belief that it indicated the occurrence of a metabolic reaction, a catabolic or oxidative change similar to that taking place in contraction. Fletcher

\* Hill, *loc. cit.*, and Fletcher and Brown, "Journal of Physiology," 48, 177, 1914.

† Embden et al, "Zeitschrift f. physiol. Chemie," 93, 1, 1914.

and Brown\* give proof, however, so far at least as heat rigor and chloroform rigor are concerned, that the  $\text{CO}_2$  formed does not arise from a metabolic breakdown of organic material, but is simply an indirect result of the production of acid. This acid as it accumulates acts upon the carbonates in the muscle and thus leads to a liberation of the  $\text{CO}_2$ . From this standpoint the  $\text{CO}_2$  production in rigor has no physiological significance.

4. The consumption of glycogen. According to some observers, glycogen disappears during rigor as it does during contraction; but others find that the amount is not changed during this process.

**The Relation of the Chemical Changes during Contraction to Fatigue; Chemical Theory of Fatigue.**—As we have seen, a muscle kept in continuous contraction soon shows fatigue; it relaxes more and more until, in spite of constant stimulation, it becomes completely unirritable. We may define fatigue, therefore, as a more or less complete loss of irritability and contractility brought on by functional activity. But even when the fatigue is complete and the muscle fails to respond at all to maximal stimulation, a very short interval of rest is sufficient to bring about some return of irritability. For a complete restoration to its normal condition a long interval of time may be necessary. If the muscle is isolated from the body and is thus deprived of its circulation and its proper supply of oxygen, fatigue appears more rapidly and is recovered from less completely. Ranke,† to whom we owe the first thorough investigation of this subject, was led to believe that as a result of the chemical changes occurring in the muscle during contraction certain substances are formed which depress or inhibit the power of contraction. In support of this view he found that extracts made from the fatigued muscles of one frog when injected into the circulation of another fresh frog would bring on the appearance of fatigue in the latter. Control experiments made with extracts of unfatigued muscles gave no such result. He designated these inhibitory products as fatigue substances and made experiments to prove that they consist of the known products of muscular metabolism, namely, lactic acid (or the lactates), carbon dioxide, and possibly also acid potassium phosphate ( $\text{KH}_2\text{PO}_4$ ). These results have been confirmed by other observers,‡ and we may accept, therefore, the view that the products of muscular activity, if they are allowed to accumulate in the muscle, serve to diminish or suppress its contractility. We know that when muscular ac-

\* Fletcher and Brown, "Journal of Physiology," 48, 177, 1914.

† Ranke, "Tetanus," Leipzig, 1865.

‡ Lee, "American Journal of Physiology," 1907, 20, 170, and BurrIDGE, "Journal of Physiology," 1911, 41, 285.

tivity is prolonged, or is carried out under conditions which imply a lessened supply of oxygen, an accumulation of some of these products does actually occur. It is possible, of course, that other intermediary substances are formed which may have a similar effect. Thus Weichardt\* has stated that muscular contractions give rise to a definite toxin, derived from the protein material of the muscle, which, in his opinion, is the chief agent in causing fatigue. He claims to have isolated this fatigue toxin (kenotoxin) to the extent at least of having freed it from the above-mentioned fatigue substances of Ranke. When injected into the circulation of a fresh animal, it brings on fatigue or even death. Moreover, by injecting it in suitable doses, the body may form an antitoxin, and this latter substance, when given to a fresh animal, may confer upon it an unusual capacity for performing muscular work. It is not advisable, however, to accept these statements until the facts have been corroborated by other observers and further experiments. At present we are justified only in laying emphasis upon the known products of muscular metabolism, particularly the lactic acid. When this substance accumulates in the muscle it may be carried off in the blood and thus influence other organs. On such a supposition we may explain the fact, brought out by ergographic experiments, that marked exercise of one set of muscles, for example, those of the legs in walking or climbing, may diminish the amount of work obtainable from other unused muscles, such as those of the arms. So also the effect of muscular exercise upon the rate of the respiratory movements and upon the heart-rate is explained, as we shall see, in a similar way. It should be added that Lee,† confirming an older observation by Ranke, has published experiments which indicate that the first effect of the so-called fatigue substances is to increase the irritability of the muscle, while the later effect is to diminish the irritability or to suppress it altogether. In this initial favoring influence Lee finds an explanation of the phenomenon of Treppe (see p. 35). After the appearance of complete fatigue a muscle shows usually some return of irritability if given a short rest. But even in the case of a muscle in the body, with its circulation intact, an interval of some hours is required before it regains entirely its power to perform a normal amount of work. It seems probable that the loss of power to do work is referable in part to a using up of the supply of energy-yielding material, but the accumulation of the

\* Weichardt, "Archiv f. Anat. u. Physiol. (physiol. Abth.)," 1905, 219; also "Münchener med. Wochenschrift," 1904, 1905, 1906.

† For discussion and experiments, see Lee, Harvey Lectures, 1905-06, Philadelphia, 1906; also "Journal of the American Medical Association," May 19, 1906, "American Journal of Physiology," 18, 267, 1907.

so-called fatigue-substances is doubtless the immediate cause of the loss of irritability which we usually designate as fatigue.

**Theories of Muscle Contraction.**—It is generally admitted that no theory of muscle contraction yet proposed is satisfactory. Such a theory

should explain the mechanism by means of which the shortening of the muscle is produced, the nature of the energy which is thus transformed into mechanical work, and the relation of this energy to the chemical reaction that takes place in the stimulated muscle. The measurable manifestations of energy which are observed in the contracting muscle are the change in electric potential, the increased production of heat, and the mechanical work. The electrical change is a fleeting phenomenon which passes rapidly over the muscle, starting from the point stimulated. Whether this electrical change is simultaneous with the chemical reaction or precedes it cannot be stated definitely, although simultaneous records indicate that the electrical change begins at least before either the mechanical or the thermal changes can be recorded. The usual point of view in physiology has been that the chemical change caused by the stimulus or the products formed from this change give origin to all the forms of energy, electrical, mechanical, and thermal, which are exhibited by the contracting muscle. The older view was to compare the muscle to a heat engine in which the potential chemical energy of the fuel is first converted to heat by combustion

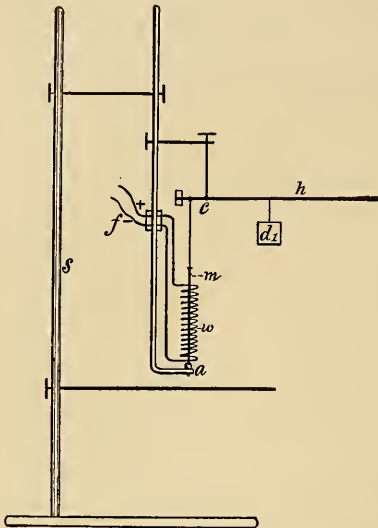

Fig. 27.—Engelmann's artificial muscle. The artificial muscle is represented by the catgut string, *m*. This is surrounded by a coil of platinum wire, *w*, through which an electrical current may be sent. The catgut is attached to a lever, *h*, whose fulcrum is at *c*. The catgut is immersed in a beaker of water at 50° to 55° C., and "stimulated" by the sudden increase in temperature caused by the passage of a current through the coil.—(After Engelmann.)

tion, and then by appropriate mechanisms a portion of this heat energy is utilized to perform mechanical work. Engelmann\* has furnished a specific hypothesis of this character. He assumes that the chemical energy set free in the muscle takes the form of heat, which then acts upon the doubly refractive particles in the dim bands of the muscular fibrillæ and causes them to imbibe water from the adjoining light bands. If the doubly refractive particles are supposed to have a linear shape, then, by imbibition, they would tend to assume a spherical form, and thus there would occur a shortening along one diameter and an increase along the diameter at right angles, such as occurs in the contracting muscle. As the muscle cools down the water passes back into the light bands and the phase of relaxation takes place. He has supported this hypothesis by microscopical observations upon the relations of the dim and light bands in the contracted and relaxed fibrils (p. 20), and, moreover, has constructed an artificial muscle from a string of catgut which, working on this principle, contracts when heated and relaxes when cooled. When the heating occurs suddenly this model gives curves of contraction identical with those obtained

\* Engelmann, "Ueber den Ursprung der Muskelkraft," Leipzig, 1893; also Pflüger's "Archiv," 1873, 7, 155.



from plain muscle. The apparatus is illustrated and described in Fig. 27, and the curve of contraction obtained from it is shown in Fig. 28. The underlying principle of this hypothesis has met with much criticism. Fick\* has shown apparently that when applied quantitatively to the work done by muscle it leads to an impossible conclusion. If, in a reversible process, at a temperature  $T_0$ , a certain quantity of heat,  $Q_0$ , is converted to mechanical work, it necessitates, according to the second law of Thermodynamics, the passage of heat,  $Q$ , from a higher temperature,  $T_1$  to a lower temperature,  $T_2$ , in accordance with the equation,  $\frac{Q_0}{T_0} = Q \left( \frac{1}{T_2} - \frac{1}{T_1} \right)$ .

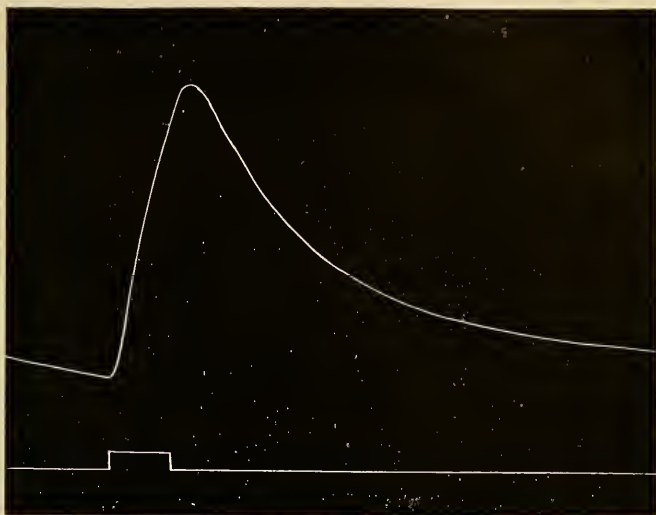

Fig. 28.—Curve of simple contraction obtained from an artificial muscle. The duration of the stimulus (heating effect caused by the current) is shown by the break in the line beneath the curve.

We may assume, in accordance with experimental results, that the efficiency of muscle is equal to 25 per cent. of the total energy, or that  $Q_0 = \frac{1}{4}Q$ , and that  $T_2$  is the temperature of the body,  $37^\circ\text{C}$ ., or expressed in the absolute scale,  $37^\circ + 273^\circ = 310^\circ\text{C}$ .  $T_0$  is the same as  $T_1$ . If, now, in the equation we substitute  $\frac{1}{4}Q$  for  $Q_0$  and  $310^\circ\text{C}$ . for  $T_2$  and solve the equation for  $T_1$  it gives a value of  $387^\circ\text{C}$ ., or, expressed in centigrade units,  $387^\circ - 273^\circ = 114^\circ\text{C}$ . That is to say, to perform the work indicated the muscle must show a fall in temperature from  $114^\circ$  to  $37^\circ\text{C}$ ., and it seems clearly impossible to suppose that the muscle in contracting attains any such temperature as  $114^\circ\text{C}$ .

This criticism has been accepted by most authors as demonstrating that the muscle cannot work as a heat engine by transforming a part of the heat of the chemical reaction to work. A difference in temperature is necessary that is not possible in the case of muscle. Other theories have been proposed, according to which the chemical energy is supposed to be converted into work either directly (Fick) or through a change in surface tension. The muscle is supposed to act in such theories as a chemical or chemodynamic engine. The various forms which the theories employing the conception of surface tension have taken make it difficult to describe them in general terms. According to one presentation (Macallum†) the sarcous elements (dim bands) may be considered

\* Fick-Pflüger's "Archiv," 1893, 53, 606.

† Macallum, "Surface Tension and Vital Phenomena," University of Toronto Studies, Physiological Series, No. 8, 1912.

as having interfaces with the sarcoplasm along the lateral planes and with the isotropic substance (light bands) at their ends, at which surface tension exists. If the results of the chemical changes within the elements are such as to cause a diminution in surface tension along the lateral walls, or an increase in this energy at the end surfaces, the elements would tend to change from a cylinder with straight to one with curved lateral walls, and this change, when multiplied by the total number of sarcous elements in the muscle, would account for the shortening. The theory is deficient in not explaining how the surface energy is changed, and also in failing to give an approximate quantitative determination of the total amount of mechanical energy that might be obtained in this way from the muscle. According to calculations made by Bernstein,\* the work energy exhibited by a contracting muscle is greater than can be accounted for by probable changes in surface tension.

Another theory has been adopted in recent years by an increasing number of workers, and has been supported by many suggestive experiments. This theory holds that the shortening of muscle in contraction is essentially a phenomenon of imbibition. The instrument by which the shortening is effected is the fibril, which is regarded as a coherent gel structure embedded in a more liquid material, the sarcoplasm. When the muscle is stimulated, lactic acid is formed in the fibril or in the sarcoplasm around it, and the effect of this acid is to increase the power of imbibition of the fibril or of certain structures in it, for example, the anisotropic discs. The swelling thus produced causes the shortening of the muscle, and the subsequent relaxation is explained as due to the removal of the acid by diffusion or by oxidation. The heat developed in the muscle after the phase of shortening is past has been connected with this latter process, namely, the oxidative destruction of the lactic acid, although some authors contend that the lactic acid is not removed by oxidation to  $\text{CO}_2$  and  $\text{H}_2\text{O}$ , but is resynthesized to the sugar or the sugar-complex from which it was derived. The theory has many variations as regards details, but the central point is that the lactic acid is the agent which causes the contraction by its action on the imbibition-properties of the fibril. The shortening in rigor mortis is explicable in the same way as an acid effect.†

\* Bernstein-Pflüger's "Archiv," 85, 271, 1901. See also Berg, "Biochemical Bulletin," 2, 101, 1912.

† For various expressions of this theory, consult McDougall, "Journal of Anatomy and Physiology," 31, 410, 1897, and 32, 187, 1898. Meigs, "American Journal of Physiology," 26, 191, 1910, and 22, 477, 1908. Fletcher and Brown, "Journal of Physiology," 48, 177, 1914. Hill, *ibid.*, 46, 28, 1913. Pauli, "Kolloid-chemie der Muskelkontraktion," 1912.

## CHAPTER III.

### THE PHENOMENON OF CONDUCTION—PROPERTIES OF THE NERVE FIBER.

**Conduction.**—When living matter is excited or stimulated in any way the excitation is not localized to the point acted upon, but is or may be propagated throughout its substance. This property of conducting a change that has been initiated by a stimulus applied locally is a general property of protoplasm, and is exhibited in a striking way by many of the simplest forms of life. A light touch, for instance, applied to a vorticella will cause a retraction of its vibrating cilia and a shortening of its stalk. In the most specialized animals, such as the mammalia, this property of conduction finds its greatest development in the nervous tissue, and indeed, especially in the axis cylinder processes of the nerve cells, the so-called nerve fibers. But the property is exhibited also to a greater or less extent by other tissues. When a muscular mass is stimulated at one point the excitation set up may be propagated not only through the substance of the cells or fibers directly affected, but from cell to cell for a considerable distance. In the heart tissue and in plain muscle it has been shown that a change of this sort may be conducted independently of the phenomenon of visible contraction. A stimulus applied to the venous end of a frog's heart, for instance, may, under certain conditions, be conducted through the auricular tissue without causing in it a visible change, and yet arouse a contraction in the ventricular muscle (Engelmann). Similarly, it can be shown that ciliary cells can convey a stimulus from cell to cell. A stimulus applied to one point of a field of ciliary epithelium may set up a change that is conveyed as a ciliary impulse to distant cells. The universality of this property of conduction in the simpler, less differentiated forms of life, and its presence in some degree in many of the tissues of the higher forms would justify the assumption that the underlying change is essentially the same in all cases. But in nerve fibers this property has become specialized to the highest degree, and in this tissue it may be studied, therefore, with the greatest success and profit.

**Structure of the Nerve Fiber.**—The peripheral nerve fiber, as we find it in the nerve trunks and nerve plexuses of the body, may be either medullated or non-medullated. All the nerve fibers that arise histologically from the nerve-cells of the central nervous

system proper—the brain and cord and the outlying sensory ganglia of the cranial nerves and the posterior spinal roots—are medullated. These fibers contain a central core, the axis cylinder, which is usually regarded as an enormously elongated process of the nerve cell with which it is connected. The axis cylinder shows a differentiation into fibrils (neurofibrils) and interfibrillar substance (neuroplasm). All of our evidence goes to show that the axis cylinder is the essential part of the nerve fiber so far as its property of conduction is concerned. It is further assumed that the neurofibrils in the axis cylinder form the conducting mechanism rather than the interfibrillar substance. Surrounding the axis cylinder we have the medullary or myelin sheath, varying much in thickness in different fibers. This sheath is composed of peculiar material and is interrupted or divided into segments at certain intervals, the so-called nodes of Ranvier. Outside the myelin there is a delicate elastic sheath comparable to the sarcolemma of the muscle fiber and designated as the neurilemma. Lying under the neurilemma are found nuclei, one for each internodal segment of the myelin, surrounded by a small amount of granular protoplasm. The non-medullated fibers have no myelin sheath. They are to be considered as an axis cylinder process from a nerve cell, surrounded by or inclosed in a neurilemmal sheath. These fibers arise histologically from the nerve cells found in the outlying ganglia of the body, the ganglia of the sympathetic system and its appendages.

**The Function of the Myelin Sheath.**—The myelin sheath of the cerebrospinal nerve fibers is a structure that is interesting and peculiar, both as regards its origin and its composition. Much speculation has been indulged in with regard to its function, but practically nothing that is certain can be said upon this point. It has been supposed by some to act as a sort of insulator, preventing contact between neighboring axis cylinders and thus insuring better conduction. But against this view it may be urged that we have no proof that the non-medullated fibers do not conduct equally as well. The view has some probability to it, however, for we must remember that the non-medullated fibers do not run in large nerve trunks that supply a number of different organs, and therefore in them a provision for isolated conduction is not so necessary. Moreover, in the medullated fibers the myelin sheath is lost toward its peripheral end after the nerve has entered the tissue to which it is to be distributed, indicating that its function is then no longer necessary. According to the older conceptions of the process of conduction in nerve fibers, not only anatomical but also physiological continuity is necessary. Mere contact of living axis cylinders would not enable the nerve impulse to pass from one to the other. The newer views, included in the so-called

neuron theory, assume that mere contact of living, entirely normal nerve substance does permit an excitatory change to pass from one to the other, so that it is not impossible that the myelin sheath may serve to prevent one axis cylinder from influencing the neighboring axis cylinders in a nerve trunk.

As some evidence for this view, attention has been called to the fact that in the condition known as multiple or insular sclerosis of the brain and cord the axis cylinders of the areas affected remain intact, while the myelin sheaths are destroyed. The disturbances of co-ordination accompanying this condition may be an expression, therefore, of a loss of isolated conduction.

Others have supposed that the myelin sheath serves as a source of nutrition to the inclosed axis cylinder, or as a regulator in some way of its metabolism. No fact is reported that would make this suggestion seem probable, except, perhaps, the statement that stimulation of a nerve, even for a brief period, causes a change in the appearance of the neurokeratin framework found in the myelin sheath. The change consists in a widening of the meshes (Stübel\*). In general, it is found that the myelin sheath is larger in those fibers that have the longest course; the size of the sheath, in fact, increases with that of the axis cylinder. It is known also that the medullated fibers in general are more irritable to artificial stimuli than the non-medullated ones, and that when induction shocks are employed, the non-medullated fibers lose their irritability more rapidly at the point stimulated. None of these facts are sufficient, however, to indicate the probable function of the myelin. The embryological development of the sheath also fails to throw light on its physiological significance. For, while it is usually supposed that the axis cylinder itself is simply an outgrowth from the nerve cell, and the myelin sheath arises from separate mesoblastic cells which surround the axis cylinder, this view, so far as the myelin is concerned, is not beyond question, and the study of the process of regeneration of nerve fibers indicates that the actual production of myelin is controlled in some way by the functional axis cylinder. The axis cylinder outgrowths from the sympathetic nerve cells found in the ganglia of the sympathetic chain and in the peripheral ganglia generally of the body are usually non-medullated, although apparently this is not an invariable rule. In the birds all such fibers, on the contrary, are medullated (Langley†). Nothing is known as to the conditions that determine whether a nerve-fiber process shall or shall not be surrounded by a myelin sheath.

**Chemistry of the Nerve Fiber.**—Our knowledge of the chemistry of the nerve fibers is very incomplete. The myelin sheath is composed largely of bodies to which the general name of "lipoids" has been applied. This term is used as a generic name for

\* Stübel, "Pflüger's Archiv," 1912, 149, 1.

† Langley, "Journal of Physiology," 30, 221, 1903; 20, 55, 1890.

those constituents of living cells which can be extracted by ether or similar solvents. It is a biological rather than a chemical term. By extraction of myelin with hot alcohol a complex phosphorus-containing substance known as protagon may be obtained in crystalline form. This substance is, however, believed now to be a mixture rather than a definite chemical individual. The most important substances isolated from the myelin are lecithin (phosphatids), cholesterin, and the cerebrosides.

*Lecithin* ( $C_{44}H_{90}NPO_9$ ) is a waxy hygroscopic yellowish substance containing about 4 per cent. of phosphorus. When decomposed by the action of alkalis it yields as split products glycerophosphoric acid, a nitrogenous base, cholin ( $C_5H_{15}NO_2$ ), and some of the higher fatty acids, such as oleic, palmitic, or stearic. It is probable that there are a number of different lecithins varying somewhat in their composition, for instance, in the character of the fatty acid contained in the molecule. The lecithins constitute one member of a larger group known as phosphatids, which are characterized by the presence of both phosphorus and nitrogen. They are widely distributed in the tissues and liquids of the body, but are especially characteristic of the white matter of the nervous system. They combine easily with other substances, such as proteins, glucosides, etc., and it is probable that lecithin exists in some such combination in the myelin. The decomposition of the lecithin referred to above occurs in the body when nerves undergo degeneration. The presence of the fatty acid liberated under such circumstances is demonstrated by the well-known reaction with osmic acid used to detect degenerated nerve fibers, while the existence of cholin has been shown by Halliburton\* in the liquids of the body, not only after nerve-degeneration produced by experimental lesions, but in the case of degenerative diseases of the nervous system.

*Cholesterin* or *cholesterol* ( $C_{27}H_{46}O$ ) is a white crystalline substance containing, as its formula shows, neither nitrogen nor phosphorus. It is widely distributed among the tissues of the body, and in an isomeric form, phytocholesterin, occurs also in plants. In the animal body it is especially abundant in the white matter of the nerves. The chemical nature of cholesterin has long been a matter of uncertainty, but recent work indicates that it belongs to the group of "terpenes" heretofore supposed to be confined to the plant kingdom. It is given the formula—

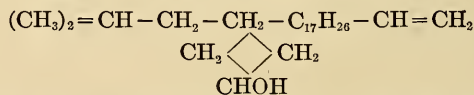

\* Halliburton, "British Medical Journal," 1907, May 4 and 11. Also "Folia Neuro-Biologica," 1907, i., 38, and "Biochemistry of Muscle and Nerve," Philadelphia, 1904.

The fact that lecithin and cholesterin usually occur together has suggested that they have some physiological connection. It has been supposed, for example, that they act as a check upon each other. Lecithin under certain conditions favors hemolysis of red corpuscles, or the action of lipase on fat, while cholesterin inhibits both of these activities. No application of this antagonistic relationship is possible at present in the case of the myelin sheath.

*Cerebrosides or Cerebrogalactosides.*—This name is given to a group of bodies containing nitrogen, but no phosphorus. In the myelin they are found in connection with and possibly in combination with the lecithin. They belong to the group of glucosides, that is, on hydrolytic decomposition they give rise to a carbohydrate group, in this case galactose. Fatty acids and a nitrogenous base also result from this decomposition. The cerebroside material obtained from the white matter has been named specifically *cerebrin* or *phrenosin*, but little is known of its exact structure.

**Union of Nerve Fibers into Nerves or Nerve Trunks.**—The assembling of nerve fibers into larger or smaller nerve trunks resembles histologically the combination of muscle fibers to form a muscle. Physiologically, however, there is no similarity. The various fibers in a muscle act together in a co-ordinated way as a physiological unit. On the other hand, the hundreds or thousands of nerve fibers found in a nerve may form groups which are entirely independent in their physiological activity. In the vagus nerve, for instance, we have nerve fibers running side by side, some of which supply the heart, some the muscles of the larynx, some the muscles of the stomach or intestines, some the glands of the stomach or pancreas, and so on. Nerves are, therefore, anatomical units simply, containing groups of fibers which have very different activities and which may function entirely independently of one another. As a nerve-trunk is constituted it consists chiefly of the connective tissue binding the fibers together. It is estimated (Ellison) that in the median nerve the connective tissue forms 63 per cent. of the whole trunk, while myelin sheaths make up 28 per cent., and the axis cylinders only 9 per cent.

**Afferent and Efferent Nerve Fibers.**—The older physiologists believed that one and the same nerve or nerve fiber might conduct sensory impulses toward the central nervous system or motor impulses from the central nervous system to the periphery. Bell and Magendie succeeded in establishing the great truth that a nerve fiber cannot be both motor and sensory. Since their time it has been recognized that we must divide the nerve fibers connected with the central nervous system into two great groups: the efferent fibers, which carry impulses outwardly from the nervous system

to the peripheral tissues, and the afferent fibers, which carry their impulses inwardly,—that is, from the peripheral tissues to the nerve centers. Under normal conditions the afferent fibers are stimulated only at their endings in the peripheral tissues, in the skin, the mucous membranes, the sense organs, etc., while the efferent fibers are stimulated only at their central origin,—that is, through the nerve cells from which they spring. The difference in the direction of conduction depends, therefore, on the anatomical fact that the efferent fibers have a stimulating mechanism at their central ends only, while the afferent fibers are adapted only for stimulation at their peripheral ends.

**Classification of Nerve Fibers.**—In addition to this fundamental separation we may subdivide peripheral nerve fibers into smaller groups, making use of either anatomical or physiological differences upon which to base a classification. For the purpose here in view a classification that is physiological as far as possible seems preferable. In the first place, experimental physiology has shown that the effect of the impulse conveyed by nerve fibers may be either exciting or inhibiting. That is, the tissue or the cell to which the impulse is carried may be thereby stimulated to activity, in which case the effect is excitatory, or, on the contrary, it may, if already in activity, be reduced to a condition of rest or lessened activity; the effect in this case is inhibitory. Many physiologists believe that one and the same nerve fiber may carry excitatory or inhibitory impulses, but in some cases at least we have positive proof that these functions are discharged by separate fibers. We may subdivide both the afferent and the efferent systems into excitatory and inhibitory fibers. Each of these subgroups again falls into smaller divisions according to the kind of activity it excites or inhibits. In the efferent system, for instance, the excitatory fibers may cause contraction or motion if they terminate in muscular tissue, or secretion if they terminate in glandular tissue. For convenience of description each of the groups in turn may be further classified according to the kind of muscle in which it ends or the kind of glandular tissue. In the motor group we speak of vasomotor fibers in reference to those that end in the plain muscle of the walls of the blood-vessels; visceromotor fibers, those ending in the muscular tissue of the abdominal and thoracic viscera; pilomotor fibers, those ending in the muscles attached to the hair follicles. The classification that is suggested in tabular form below depends, therefore, on three principles: first, the direction in which the impulse travels normally; second, whether this impulse excites or inhibits; third, the kind of action excited or inhibited, which in turn depends upon the kind of tissue in which the fibers end.



Efferent	Excitatory	Motor	{	Motor.		
		Secretory		Vasomotor.		
	Inhibitory	Inhibito-motor	{	Cardiomotor.		
		Inhibito-secretory		Visceromotor.		
Afferent	Excitatory	{	{	Pilomotor.		
				Sensory	Salivary.	
				Reflex	Gastric.	
	Inhibitory	{	{	{	Pancreatic.	
					Inhibito-motor	Sweat.
						Inhibito-secretory
Excitatory	{	{	Subdivisions corresponding to the varieties of secretory fibers above.			
			Inhibitory	Visual.		
				Inhibito-reflex	Auditory.	
Excitatory	{	{	Olfactory.			
			Inhibitory	Gustatory.		
Excitatory	{	{		Pressure.		
			Inhibitory	Temperature.		
Excitatory	{	{		Pain.		
			Inhibitory	Hunger.		
Excitatory	{	{		Thirst, etc.		
			Inhibitory	According to the efferent fibers affected.		
Excitatory	{	{		Inhibitory effects upon the conscious sensations are not demonstrated.		
			Inhibitory	The reflex fibers that cause unconscious reflexes are known to be inhibited in some cases at least.		

That the final action of a peripheral nerve fiber is determined by the tissue in which it ends rather than by the nature of the nerve fiber itself or the nature of the impulse that it carries is indicated strongly by the regeneration experiments made by Langley.\* For instance, the chorda tympani nerve contains fibers which cause a dilatation in the blood-vessels of the submaxillary gland, while the cervical sympathetic contains fibers which cause a constriction of the vessels in the same gland. If the lingual nerve (containing the chorda tympani fibers) is divided and the central end is sutured to the peripheral end of the severed cervical sympathetic, the chorda fibers will grow along the paths of the old constrictor fibers of the sympathetic. If time is given for regeneration to take place, stimulation of the chorda now causes a constriction in the vessels. The experiment can also be reversed. That is, by suturing the central end of the cervical sympathetic to the peripheral end of the divided lingual the fibers of the former grow along the paths of the old dilator fibers, and after regeneration has taken place stimulation of the sympathetic causes dilatation of the blood-vessels in the gland. These results are particularly instructive, as vasoconstriction is an example of the excitatory effect of the nerve impulse, being the result of a contraction of the circular muscles in the vessels, while vasodilatation is an example of inhibitory action, being due to an inhibition of the contraction of the same muscles. Yet obviously these two opposite effects are determined not by the nature of the nerve fibers, but by their place or mode of ending in the gland.

**Separation of the Afferent and Efferent Fibers in the Roots of the Spinal Nerves.**—According to the Bell-Magendie discovery,

\* Langley, "Journal of Physiology," 23, 240, 1898; *ibid.*, 30, 439, 1904; "Proceedings Royal Society," 73, 1904.

the motor fibers to the voluntary muscles emerge from the spinal cord in the anterior roots, while the fibers that give rise to sensations enter the cord through the posterior roots. These facts have been demonstrated beyond all doubt. Magendie discovered an apparent exception in the phenomenon of recurrent sensibility. When the anterior root is severed and its peripheral end is stimulated only motor effects should be obtained. Magendie observed, however, upon dogs that in certain cases the animals showed signs of pain. This apparent exception to the general rule was afterward explained satisfactorily. It was shown that the fibers in question do not really belong to the anterior root,—that is, they do not emerge from the cord with the root fibers; they are, in fact, sensory fibers for the meningeal membranes of the cord which are on their way to the posterior roots and which enter the cord with the fibers of the latter. Since the work of Bell and Magendie it has been a question whether their law applies to all afferent and efferent fibers and not simply to the motor and sensory fibers proper. The experimental evidence upon this point, as far as the mammals are concerned, has accumulated slowly. Various authors have shown that stimulation of the anterior roots of certain spinal nerves may cause a constriction of the blood-vessels, an erection of the hairs (stimulation of the pilomotor fibers), a secretion of sweat, and so on, while stimulation of the posterior roots in the same regions is without effect upon these peripheral tissues. One apparent exception, however, has been noted. A number of observers have found that stimulation of the peripheral end of the divided posterior roots (fifth lumbar to first sacral) causes a vascular dilatation in the hind limb. The matter has been particularly investigated by Bayliss,\* who gives undoubted proof of the general fact. At the same time he shows that the fibers in question are not efferent fibers from the cord passing out by the posterior instead of the anterior roots. This is shown by the fact that they do not degenerate when the root is cut between the ganglion and the cord, as they should do if they originated from cells in the cord. Bayliss's own explanation of this curious fact is that the fibers in question are ordinary afferent fibers, but that they are capable of a double action: they can convey sensory impulses from the blood-vessels to the cord according to the usual type of sensory fibers, but they can also convey efferent impulses, antidromic impulses as he designates them, to the muscles of the blood-vessels. In other words, for this special set of fibers he attempts to re-establish the view held by physiologists before the time of Bell,—namely, that one and the same fiber transmits normally both afferent and efferent impulses. An exception so peculiar as this to an otherwise general rule cannot be accepted without hesitation. Some facts are given

\* Bayliss, "Journal of Physiology," 26, 173, 1901, and 28, 276, 1902.

on p. 152 that suggest an explanation less opposed to current views than that offered by Bayliss.

**Cells of Origin of the Anterior and Posterior Root Fibers.**—

The efferent fibers of the anterior root arise as axons or axis cylinder processes from nerve cells in the gray matter of the cord at or near the exit of the root. The motor fibers to the voluntary muscles arise from the large cells of the anterior horn of gray matter; the fibers to the plain muscle and glands, autonomic fibers according to Langley's nomenclature, take their origin from spindle-shaped nerve cells lying in the so-called lateral horn of the gray matter.\* According to the accepted belief regarding the nutrition of nerve fibers, any section or lesion involving these portions of the gray matter or the anterior root will be followed by a complete degeneration of the efferent fibers. In the case of the fibers to the voluntary muscles this degeneration will extend to the muscles and include the end-plates. In the case of the autonomic fibers the degeneration will extend to the peripheral ganglia in which they terminate, involving, therefore, the whole extent of what is called the pre-ganglionic fiber (see the chapter on the autonomic nerves and the sympathetic system). The posterior root fibers have their origin in the nerve cells contained in the posterior root ganglia. These cells are unipolar, the single process given off being an axis cylinder process or axon. It divides into two branches, one passing into the cord by way of the posterior root, the other toward the peripheral tissues in the corresponding spinal nerve in which they form the peripheral sensory nerve fibers. It follows that a section or lesion of the posterior root will result in a degeneration of the branch entering the cord, this branch having been cut off from its nutritive relationship with its cells of origin. The degeneration will involve the entire length of the branch and its collaterals to their terminations among the dendrites of other spinal or bulbar neurons (see the chapter on the spinal cord). After a lesion of this sort the stump of the posterior root that remains in connection with the posterior root ganglion maintains its normal structure. On the other hand, a section or lesion involving the spinal nerve will be followed by a degeneration of all the fibers, efferent and afferent, lying to the peripheral side of the lesion, since these fibers are cut off from connection with their cells of origin, while the fibers in the central stump of the divided nerve will retain their normal structure.

**Afferent and Efferent Fibers in the Cranial Nerves.**—The first and second cranial nerves, the olfactory and the optic, contain only afferent fibers, which arise in the former nerve from the olfactory epithelium in the nasal cavity, in the latter from the nerve cells in the retina. The third, fourth, and sixth nerves contain only efferent fibers which arise from the nerve cells constituting

\* Herring, "Journal of Physiology," 29, 282, 1903.

their nuclei of origin in the midbrain and pons. The fifth nerve resembles the spinal nerves in that it has two roots, one containing afferent and the other efferent fibers. The efferent fibers, constituting the small root, arise from nerve cells in the pons and midbrain, the afferent fibers arise from the nerve cells in the Gasserian ganglion. This ganglion, being a sensory ganglion, is constituted like the posterior root ganglia. Its nerve cells give off a single process which divides in T, one branch passing into the brain by way of the large root, while the other passes to the peripheral tissues as a sensory fiber of the fifth nerve. The seventh nerve may also be homologized with a spinal nerve. The facial nerve proper consists of only efferent fibers, which arise from nerve cells constituting its nucleus of origin in the pons. The geniculate ganglion, attached to this nerve shortly after its emergence, is similar in structure to the Gasserian or a posterior root ganglion. Its nerve cells send off processes which divide in T and constitute afferent fibers in the so-called *nervus intermedius* or nerve of Wrisberg. The eighth nerve consists only of afferent fibers which arise from the nerve cells in the spiral ganglion of the cochlea, cochlear branch, and from those constituting the vestibular or Scarpa's ganglion, the vestibular branch. Both of these ganglia are sensory, resembling the posterior root ganglia in structure. The ninth nerve is also mixed, the efferent fibers arising from the motor nucleus in the medulla, while the sensory fibers arise in the superior and petrosal ganglia found on the nerve at its emergence from the skull. The tenth is a mixed nerve, its efferent fibers arising in motor nuclei in the medulla, the afferent fibers in the nerve cells of the ganglia lying upon the trunk of the nerve at its exit from the skull (*ganglion jugulare* and *nodosum*). The eleventh and twelfth cranial nerves contain only efferent fibers that arise from motor nuclei in the medulla.

It will be seen from these brief statements that in all the nerve trunks of the central nervous system—that is, the spinal and the cranial nerves—the cells of origin of the efferent fibers lie within the gray matter of the brain or cord, while the cells of origin of the afferent fibers lie in sensory ganglia outside the central nervous system,—namely, in the posterior root ganglia for the spinal nerves, in the *ganglion semilunare* (Gasseri), the *g. geniculi*, the *g. spirale*, the *g. vestibulare*, the *g. superius* and *g. petrosum* of the glossopharyngeal, and the *g. jugulare* and *g. nodosum* of the vagus. These various sensory ganglia attached to the cranial nerves correspond essentially in their structure and physiology with the posterior root ganglia of the spinal nerves.

**Independent Irritability of Nerve Fibers.**—Although the nerve fibers under normal conditions are stimulated only at their ends, the efferent fibers at the central end, the afferent at the peripheral end, yet any nerve fiber may be stimulated by artificial

means at any point in its course. Artificial stimuli capable of affecting the nerve fiber—that is, capable of generating in it a nerve impulse which then propagates itself along the fiber—may be divided into the following groups:

1. *Chemical stimuli.* Various chemical reagents, when applied directly to a nerve trunk, excite the nerve fibers. Such reagents are concentrated solutions of the neutral salts of the alkalis, acids, alkalis, glycerin, etc. This method of stimulation is not, however, of much practical value in experimental work, since it is difficult or impossible to control the reaction.

2. *Mechanical stimuli.* A blow or pressure or a mechanical injury of any kind applied to a nerve trunk also excites the fibers. This method of stimulating the fibers is also difficult to control and has had, therefore, a limited application in experimental work. The mechanical stimulus is essentially a pressure stimulus, and the difficulty lies in controlling this pressure so that it shall not actually destroy the nerve fiber by rupturing the delicate axis cylinder. Various instruments have been devised by means of which light blows may be given to the nerve, sufficient to arouse an impulse, but insufficient to permanently injure the fibers. The results obtained by this method have been very valuable in physiology as controls for the experiments made by the usual method of electrical stimulation. It may be mentioned also that under certain conditions—for instance, at one stage in the regeneration of injured nerve fibers mechanical stimuli may be more effective than electrical, that is, may stimulate the nerve fiber when electrical stimuli totally fail to do so.

3. *Thermal stimuli.* A sudden change in temperature may stimulate the nerve fibers. This method of stimulation is very ineffective for motor fibers, only very extreme and sudden changes, such as may be obtained by applying a heated wire directly to the nerve trunk, are capable of so stimulating them as to produce a muscular contraction. On the other hand, the sensory nerve fibers are quite sensitive to changes of temperature. If a nerve trunk in a man or animal is suddenly cooled, or especially if it is suddenly heated to 60° to 70° C., violent pain results from the stimulation of the sensory fibers in the trunk, while the motor fibers are apparently not acted upon. We have in this fact one of several differences in reaction between motor and sensory fibers which have been noted from time to time, and which seem to indicate that there is some difference in structure or irritability between them.

4. *Electrical stimuli.* Some form of the electrical current is beyond question the most effective and convenient means of stimulating nerve fibers. We may employ either the galvanic current—that is, the current taken directly from a battery—or the induced current

from the secondary coil of an induction apparatus or the so-called static electricity from a Leyden jar or other source. In most experimental work the induced current is used. The terminal wires from the secondary coil are connected usually with platinum wires imbedded in hard rubber, forming what is known as a stimulating electrode. (See Fig. 29.) By this means the platinum ends which now



Fig. 29.—Stimulating (catheter) electrodes for nerves: *b*, Binding posts for attachment of wires from the secondary coil; *s*, insulating sheath of hard rubber; *p*, platinum points laid upon the nerve.

form the electrodes, anode and cathode, can be placed close together upon the nerve trunk, and the induced current passing from one to the other through a short stretch of the nerve sets up at that point nerve impulses which then propagate themselves along the nerve fibers. The induction current is convenient because of its intensity, which overcomes the great resistance offered by the moist tissue; because of its very brief duration, in consequence of which it acts as a sharp, quick, single stimulus or shock, and because of the great ease with which it may be varied as to rate and as to intensity. On account of the very brief duration of the induced current it is difficult to distinguish between the effects of its opening and closing.

#### The Stimulation of the Nerve by the Galvanic Current.—

When however, we employ the galvanic current, taken directly from a battery, as a stimulus, we can, of course, allow the current to pass through the nerve as long as we please and can thus study the effect of the closing of the current as distinguished from that of the opening, or the effect of duration or direction of the current, etc.

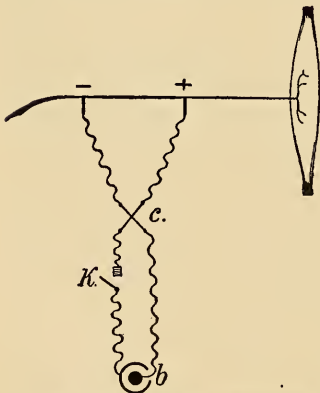

Fig. 30.—Schema of the arrangement of apparatus for stimulating the nerve by a galvanic current: *b*, The battery; *k*, the key for opening and closing the circuit; *c*, the commutator for reversing the direction of the current; + the anode or positive pole; — the cathode or negative pole.

*Du Bois-Reymond's Law of Stimulation.*—When a galvanic current is led into a motor nerve it is found, as a rule, that with all moderate strengths of currents there is a stimulus to the nerve at the moment it is closed, the making or closing stimulus, and another when the current is broken, the breaking or opening stimulus, while during

the passage of the current through the nerve no stimulation takes

place: the muscle remains relaxed. We may express this fact by saying that the motor nerve fibers are stimulated by the making and the breaking of the current or by any sudden change in its intensity, but remain unstimulated during the passage of currents whose intensity does not vary.

*The Anodal and Cathodal Stimuli.*—It has been shown quite conclusively that the nerve impulse started by the making of the current arises at the cathode, while that at the breaking of the current begins at the anode, or, in other words, the making shock or stimulus is cathodal, while the breaking stimulus is anodal. This fact is true for muscle as well as nerve, and possibly for all irritable tissues capable of stimulation by the galvanic current. This important generalization may be demonstrated for motor nerves by separating the anode and cathode as far as possible and recording the latent period for the contractions caused respectively by the making and the breaking of the current in the nerve. If the cathode is nearer to the muscle the latent period of the making contraction of the muscle will be shorter than that of the breaking contraction by a time equal to that necessary for a nerve impulse to travel the distance between anode and cathode. If the position of the electrodes is reversed the latent period of the making contraction will be correspondingly longer than that of the breaking contraction. It is very evident from these facts that when a current is passed into a nerve or muscle the changes at the two poles are different, as shown by the differences in reactions and properties of the nerve at these points. Bethe has shown that a difference may be demonstrated even by histological means. After the passage of a current through a nerve for some time the axis cylinders stain more deeply than normal at the cathode with certain dyes (toluidin blue), while at the anode they stain less deeply.

*Electrotonus.*—The altered physiological condition of the nerve at the poles during the passage of the galvanic current is designated as electrotonus, the condition round the anode being known as anelectrotonus, that round the cathode as catelectrotonus. Electrotonus expresses itself as a change in the electrical condition of the nerve which gives rise to currents known as the electrotonic currents,—a brief description of these currents will be given in the next chapter,—and also by a change in irritability and conductivity. The latter changes were first carefully investigated by Pflüger, who showed that when the galvanic current, or, as it is usually called in this connection, the polarizing current, is not too strong there is an increase in irritability and conductivity in the neighborhood of the cathode, the so-called catelectrotonic increase of irritability, while in the region of the anode there is an anelectrotonic decrease in irritability and conductivity. These opposite variations in the state of the nerve are represented in the accom-

panying diagram. Between the two poles—that is, in the intrapolar region—there is, of course, an indifferent point, on one side of which the irritability of the nerve is above normal and on the other side below normal. The position of this indifferent point shifts toward the cathode as the strength of the polarizing current is increased. In other words, as the current increases the anelectrotonus spreads more rapidly and becomes more intense, and the conductivity in this region soon becomes so depressed as to block entirely the passage of a nerve impulse through it. The changes on the cathodal side are not so constant nor so distinct. It has been shown,\* in fact, that if the polarizing current is continued for some time, the heightened irritability at the cathode soon diminishes and sinks below normal, so that in fact at the cathode as well as at the anode the irritability may be lost entirely. If the polarizing current is very strong this depressed irritability at the cathode comes on practically at once. Moreover, when a strong current that has been passing through a nerve is broken the condition of depressed irritability at the cathode persists for some time after the opening of the current.

*Pflüger's Law of Stimulation.*—It was said above that when a galvanic current is passed into a nerve there is a stimulus (cathodal) at the making of the current and another stimulus (anodal)

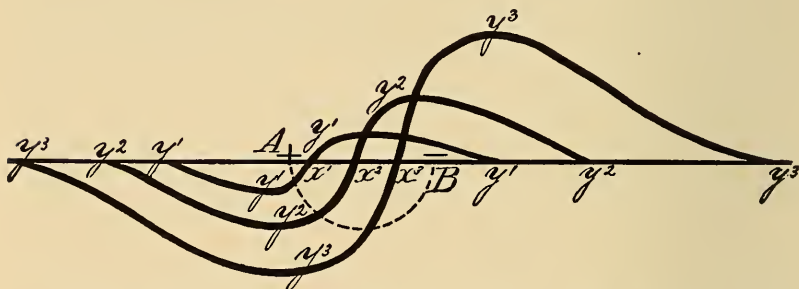

Fig. 31.—Electrotonic alterations of irritability caused by weak, medium, and strong battery currents: *A* and *B* indicate the points of application of the electrodes to the nerve, *A* being the anode, *B* the cathode. The horizontal line represents the nerve at normal irritability; the curved lines illustrate how the irritability is altered at different parts of the nerve with currents of different strengths. Curve  $v^1$  shows the effect of a weak current, the part below the line indicating decreased, and that above the line increased irritability; at  $x^1$  the curve crosses the line, this being the indifferent point at which the catelectrotonic effects are compensated for by anelectrotonic effects;  $v^2$  gives the effect of a stronger current, and  $v^3$ , of a still stronger current. As the strength of the current is increased the effect becomes greater and extends farther into the extrapolar regions. In the intrapolar region the indifferent point is seen to advance, with increasing strengths of current, from the anode toward the cathode.—(*Lombard.*)

at the breaking of the current. This statement is true, however, only for a certain range of currents. Of the two stimuli, the making or cathodal stimulus is the stronger, and it follows, therefore,

\* Werigo, "Pflüger's Archiv," 84, 547, 1901. See Biedermann, "Electrophysiology," translated by Welby, vol. ii, p. 140.



that when the strength of the current is diminished there will come a certain point at which the anodal stimulus will drop out. With weak currents there is then a stimulus only at the make. On the other hand, when very strong currents are used the stimuli that act at the two poles set up nerve impulses whose passage to the muscle may be blocked by the depressed conductivity caused by the electrotonic changes. Whether or not the stimulus will be effective in causing a contraction in the attached muscle will depend naturally on the relative positions of the electrodes,—that is, on the direction of the current in the nerve. In describing the effect of these strong currents we must distinguish between what are called ascending and descending currents. Ascending currents are those in which the direction of the current in the nerve is away from the muscle, a position of the poles, therefore, in which the anode is closer to the muscle. In descending currents the positions are reversed. Pflüger's law of contraction or of stimulation takes account of the effect of extreme variations in the strength of the current and is usually expressed in tabular form as follows: The letter C indicates that the nerve is stimulated and causes a contraction in the attached muscle, and O indicates a failure in the stimulation (weak currents) or a failure in the nerve impulse to reach the muscle owing to blocking (strong currents).

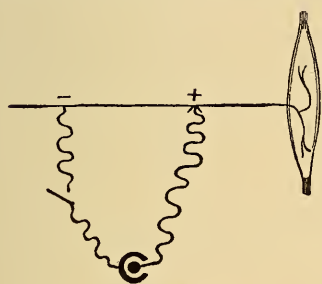

Fig. 32.

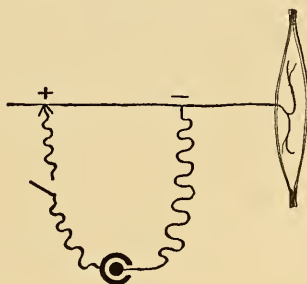

Fig. 33.

Figs. 32 and 33.—Schema to show the arrangement of apparatus for an ascending and a descending current: Fig. 32, ascending; Fig. 33, descending.

	ASCENDING CURRENT.		DESCENDING CURRENT.	
	Making.	Breaking.	Making.	Breaking.
Very weak currents ..	C	O	C	O
Moderate " ....	C	C	C	C
Very strong " ....	O	C	C	O

The effects obtained with the strong currents are readily understood if we bear in mind the facts stated above regarding electrotonus. When the current is ascending the stimulus on making starts from the cathode, but cannot reach the muscle because it is blocked by a region of anelectrotonus in which the conduc-

tivity is depressed. The stimulus on breaking takes place at the anode and the impulse encounters no resistance in its passage to the muscle. With the descending current the cathode lies next to the muscle and the making or cathodal stimulus of course causes a contraction. On breaking, however, the impulse that is started from the anode is blocked by the depressed irritability in the cathodal region, which, as has been said, comes on promptly with strong currents and persists for a time after the current is broken.

**The Opening and the Closing Tetanus.**—While the du Bois-Reymond law stated above expresses the facts as usually observed upon a nerve-muscle preparation, there are a number of observations which indicate that the excitation at the anode and the cathode during the passage of a current may give rise to a series of stimuli instead of a single stimulus. Thus with sensory nerves it is well known that the stimulation, as judged by the sensations aroused, continues while the current is passing instead of being limited to the moment of making or of breaking of the current. In this respect, as in stimulation by high temperatures, the sensory fibers differ apparently from the motor. When a galvanic current is passed through the ulnar nerve at the elbow sensations are felt during the entire time of passage of the current. But in an ordinary nerve-muscle preparation it is also frequently observed that at the moment of opening the current a tetanic contraction, persisting for some time, is obtained instead of a single twitch. This phenomenon is known as the opening tetanus or Ritter's tetanus, and Pflüger has shown that the continuous excitation proceeds from the anode, since in the case of a descending current division of the nerve in the intrapolar region brings the muscle to rest. In the same way it frequently happens that upon closing the current through a nerve the muscle, instead of giving a twitch, goes into a persistent tetanic contraction. The tetanus in this case is designated as the closing or Pflüger's tetanus. Both of these phenomena are observed, especially, when the irritability of the nerve is for any reason greater than normal. It should be added that the opening and the closing tetanus may be observed also in a muscle when the galvanic current is passed through it.

**Stimulation of the Nerves in Man.**—For therapeutic as well as diagnostic and experimental purposes it often becomes desirable to stimulate the nerves, particularly the motor nerves, in man. We may use for this purpose either the induced (faradic, alternating) current or the direct battery current (galvanic or continuous current). In such cases the electrodes cannot be applied, of course, directly to the nerve; it becomes necessary to stimulate through the skin, and the so-called unipolar method is employed. The unipolar method consists in placing one electrode, the active or stimulating electrode, over the nerve at the point which it is desired to stimulate, while the other electrode, the inactive or indifferent electrode, is applied to the skin at some more or less remote part, usually at the back of the neck. The indifferent electrode is made large enough to cover several square centimeters of the skin, and one may conceive the threads of current as passing from it into the moist tissues of the body, and thence to the active electrode. As the threads of current condense to this latter electrode they pass through the motor nerve which lies under it, and if sufficiently in-

tense, will stimulate the nerve. The arrangement is represented in the accompanying schema (Fig. 34), showing the disposition of the electrodes for stimulating the median nerve. At the indifferent electrode the sensory nerves of the skin are of course stimulated, but no motor response is obtained, as no motor nerve lies immediately under the skin. Moreover, the large size of this electrode tends to diffuse the current and thus reduce its effectiveness in stimulating. The active or stimulating electrode is small in size, particularly when induction currents are employed, so that the current may be condensed and thus gain in effectiveness. The dry surface of the skin is a poor conductor of the electrical current, and to reduce the resistance at the points at which the electrodes come in contact

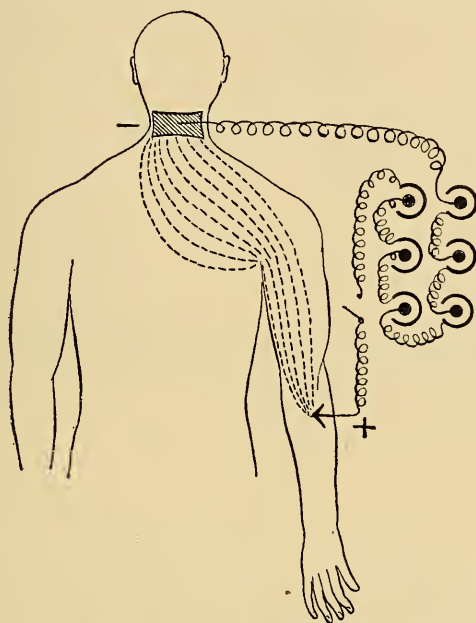

Fig. 34.—Schema to show the unipolar method of stimulation in man. The anode, +, is represented as the stimulating pole, applied over the median nerve. The cathode, —, is the indifferent pole.

with the skin each is covered with cotton or chamois skin kept moistened with a dilute saline solution.

**Motor Points.**—By means of the unipolar method nearly every voluntary muscle of the body may be stimulated separately. All that is necessary, when the induced current is used, is to bring the active electrode as nearly as possible over the spot at which the muscle receives its motor branch. A diagram showing these motor points for the arm is given in Fig. 35. In the same way the

nerves of the brachial plexus and other nerve trunks may be stimulated very readily through the skin. When the induction current is used no distinction is made between the cathodic and anodic effects. When, however, the battery current is employed

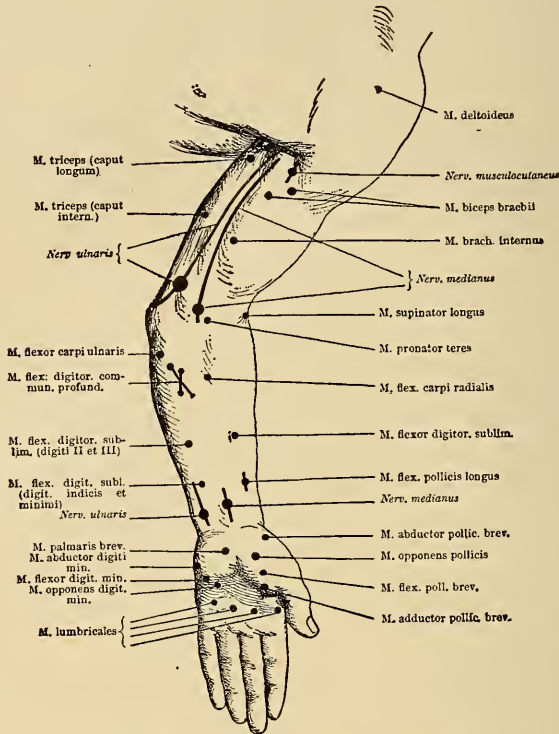

Fig. 35.—Motor points in upper extremity.

one may make the stimulating electrode either anode or cathode, and under these circumstances a marked difference is observed in the strength of the current that it is necessary to use to get a response. With the battery or galvanic current, in fact, one may distinguish four stimuli, the closing and the opening shock when the stimulating electrode is cathode and the closing and the opening shock when it is anode. The contractions resulting from these four stimuli are designated usually as follows: The cathodal closing contraction, C C C; the cathodal opening contraction, C O C; the anodal closing contraction, A C C; and the anodal opening contraction, A O C. If the minimal amount of current necessary to give each of these contractions is measured in milliamperes by means of a suitable ammeter,

it will be found that the four stimuli are of different efficiencies. The usual relationship is expressed by the sequence  $C C C > A C C > A O C > C O C$ , although this sequence is subject to some individual variation. Pathological or traumatic lesions that cause the degeneration of the nerves may be revealed by the use of these methods of stimulation. The nerve trunk under such circumstances fails to respond to either form of stimulus, induced or galvanic. The muscle, on the other hand, while it may fail to respond to induction shocks, is stimulated by the galvanic current, and, indeed, may show an increased irritability toward this form of stimulus, although the contractions are more sluggish in character than in a muscle with a normal nerve supply. Certain qualitative changes in the reaction of the muscle to the galvanic current may also be noticed, for instance, the  $A C C$  is sometimes obtained with less current than the  $C C C$ . This qualitative and quantitative change in reaction to the galvanic current, and the loss of irritability to the induced current, constitute what is known as the reaction of degeneration.

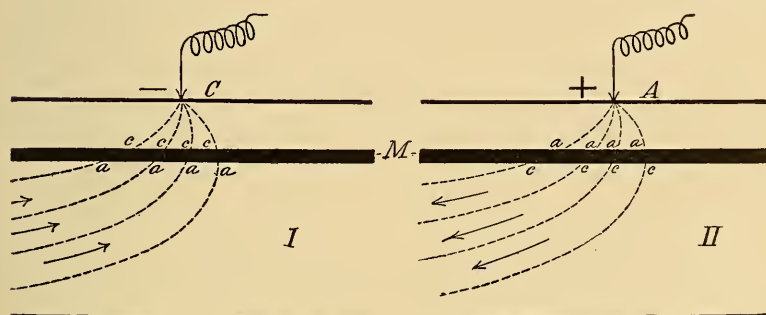

Fig. 36.—Two schemata to show the relation between the physical and the physiological electrodes or poles. Each schema represents the forearm with the median nerve, *M*. In *I* the stimulating electrode is the cathode; the threads of current which have started from the anode (the indifferent electrode) placed elsewhere, converge to this pole. Where these threads enter the nerve we have a series of physiological anodes, *a*; where they leave, a series of physiological cathodes, *c*. In *II* the stimulating electrode is the anode. The threads of current leave this pole to traverse the body toward the indifferent electrode (cathode). Where they enter and leave the nerve we have, as in the first case, physiological anodes and cathodes, now, however, on the opposite sides of the nerve.

**Distinction between Physical and Physiological Poles.**—The facts stated above seem to show, at first sight, that by the unipolar method we may obtain both an opening and a closing shock at either the cathode or anode,—a result which is in apparent contradiction to the general law that the making or closing stimulus occurs only at the cathode and the breaking or opening stimulus only at the anode. This apparent contradiction is readily explained when we remember that in the

unipolar method the active electrode rests upon the skin over the nerve, and that the threads of current radiating from this point enter the nerve at one point and leave it at another. Evidently, therefore, so far as the nerve is concerned, there will be an anode where the current is considered as entering the nerve and a cathode where it leaves it, so that under the active electrode, whether this is physically an anode or cathode, there will be, as regards the nerve, a series of what may be called physiological cathodes and anodes. The closing shock arises at these cathodes, the opening shock at the anodes. The position of the series of anodes and cathodes will vary according as the active electrode is an anode or cathode, as is indicated in the accompanying diagram (Fig. 36).

## CHAPTER IV.

### THE ELECTRICAL PHENOMENA SHOWN BY NERVE AND MUSCLE.

**The Demarcation Current.**—Our definite knowledge of the electrical properties of living tissue began with the celebrated investigations of du Bois-Reymond\* (1843). When a muscle or nerve is removed from the body, and, in the case of the muscle, when one tendinous end is cut off, it is found that the cut end has an electrical potential differing from that of the uninjured longitudinal surface of the preparation. Following the usual nomenclature, the cut end is electronegative, the longitudinal surface is electropositive. If, therefore, the longitudinal surface is connected by a conductor with the cut surface a current will flow from the former to the latter, as is indicated in the accompanying diagram.

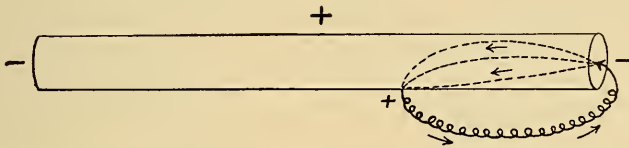

Fig. 37.—Schema showing the course of the demarcation current in an excised nerve, when a point on the longitudinal and one on the cut surface are united by a conductor.

While the direction of the current through the conductor connecting the two points is from the longitudinal to the cut surface the current may be considered as being completed in the opposite direction within the substance of the muscle or nerve, as shown in the diagram. We may, in fact, consider an excised nerve or muscle as a battery, the cut end representing the zinc plate and the longitudinal surface the copper plate. Within the battery the direction of the current is from zinc to copper, from cut end to longitudinal surface; outside the battery the direction is from copper to zinc, from longitudinal to cut surface. If two wires are connected with the muscle or nerve the end of the one attached to the longitudinal surface will represent the positive pole or anode, the end of the one attached to the cut end will represent the cathode

\* "Untersuchungen über thierische Elektrizität," du Bois-Reymond, 1848-1860.

or negative pole. On joining the ends of the wires a current will pass from positive to negative pole.

A current of this character from an excised nerve or muscle is, of course, small in amount and to detect it one must make use of a delicate electrometer of some sort (see below). Du Bois-Reymond considered that the difference in electrical potential which gives rise to this current exists normally in the muscle, although masked by an opposite condition in the tendinous ends, and he therefore spoke of the currents as the natural muscle or natural nerve currents. It has since been shown by Hermann that this view is incorrect; that the perfectly normal uninjured muscle or nerve has the same electrical potential throughout and will therefore give no current when any two points are connected by a conductor. Moreover, the completely dead muscle or nerve shows no current. The difference in potential that is found in the excised nerve or muscle is due, according to Hermann, to the fact that at the cut end the nerve or muscle is injured. The chemical changes that take place as a result of the injury make the tissue electronegative as regards the unchanged living substance elsewhere. For this reason Hermann described the current as a demarcation current; others have called it the current of injury.

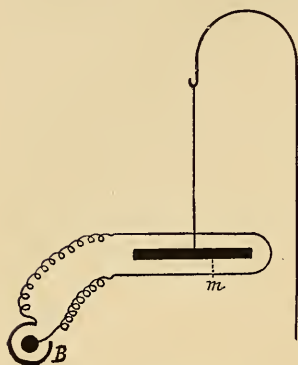

Fig. 38. — Schema showing the principle of construction of the galvanometer: *M*, The magnet suspended by a thread; *B*, the battery, with the wires leading off the current encircling the magnet.

The nature of the changes at the injured end are not known. It is interesting to note that Bernstein\* has shown that the electromotive force of the muscle current increases with the temperature, a fact which leads him to conclude that the difference in potential between the longitudinal and cut surface of the muscle depends upon a difference in concentration of the electrolytes. The muscle, in fact, acts after the manner of a "concentration cell." Such a difference in concentration may pre-exist in the normal muscle, or, according to the view adopted above, is developed as the result of injuring one end of the muscle. It may be supposed that the injury causes changes which result in the formation of new organic or inorganic electrolytes and thus increases the concentration at that point. From what is known of the chemical changes in muscle it is safe to assert that there is an increased production of lactic acid at the injured end, and it is probable that other electrolytes may be liberated in diffusible form. With this increased concentration at the injured area a development of electric potential might be expected, owing to the probability that the cations (H, K, Na, Mg, Ca) will diffuse off more rapidly and thus leave the injured end with a negative charge. Experiments made by Urano and von Frey on muscle juice squeezed out of the muscle fibers under high pressure have shown that when it is diffused against sugar solutions it loses its K and Mg more rapidly than the  $\text{PO}_4$  and  $\text{SO}_4$ .

\* "Pflüger's Archiv," 1902, 92, 521.



**Means of Demonstrating the Muscle Current.**—The demarcation current and other electrical conditions to be described require especial apparatus for their study. To detect the existence of a current physiologists use either a galvanometer or a capillary electrometer. The galvanometers employed are of several types, the Kelvin reflecting galvanometer, the d'Arsonval form, and more recently the "string-galvanometer" of Einthoven. The principle of the galvanometer lies in the fact that a magnetic needle is deflected when an electrical current passes through a wire in its vicinity. If a magnetic needle is swung by a delicate thread so as to move easily, it will come to rest in the magnetic meridian with its north pole pointing north. If now a wire is curved round it, as shown in the accompanying diagram (Fig. 38), and a battery current is sent through this wire, the needle will be deflected to the right if the current passes in one direction and to the left if it passes in the opposite direction. The movement of the needle is an indication of the presence and direction of the electrical current in the wire. The extent of deflection of the needle may be used to measure the strength of the current by ascertaining

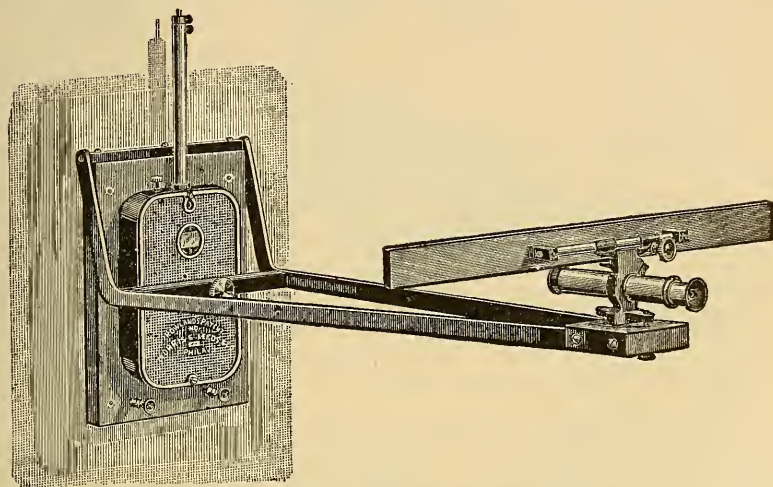

Fig. 39.—D'Arsonval galvanometer as modified by Rowland.

the amount of deflection caused by a standard battery. The effect of the current upon the needle increases with the number of turns of wire, so that delicate galvanometers constructed upon this principle are spoken of as high resistance galvanometers, the great length of wire used making, of course, a high resistance. Instead of having the coil through which the current passes kept in a fixed position and the magnet delicately swung or poised, the reverse arrangement may be used—that is, the coil may be swung between the poles of a fixed magnet. Under these circumstances, if a current is sent through the coil, this latter will move with reference to the magnet. A galvanometer constructed on this principle is designated as a d'Arsonval galvanometer, after the physiologist who first employed this arrangement. In the d'Arsonval form the magnet is fixed while the coil of wire through which the current passes is swung by a very delicate thread of quartz, silk fiber, or phosphor-bronze. The principle of the arrangement is shown in the accompanying diagram (Fig. 40) and one form of a complete instrument in Fig. 39. A large horseshoe magnet (*n, s*) is fixed permanently and between the poles is swung a coil (*c*) of delicate wire, the two ends of the wire being connected with binding posts in the frame of the instrument. The coil is held in place below by a delicate spiral. In Fig. 40 it will be seen that the delicate thread suspending

the coil carries just above the coil a small mirror, *m*, and a plate of thin mica or aluminum. The mirror is deflected with the coil, and when viewed through the telescope pictured in Fig. 39 the image of the scale above the telescope is reflected in this mirror. As the coil and mirror are twisted by the action of the current passing through the former the reflection of the scale in the mirror is displaced. By means of a cross hair in the telescope the angle of deflection may be read upon the reflected scale. The aluminum vane back of the mirror makes the system dead-beat, so that when a deflection is obtained

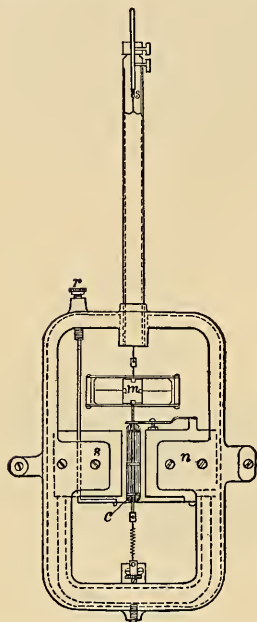

Fig. 40.—Diagram of structure of the d'Arsonval galvanometer. *c* is the coil of fine wire through which the current is passed. It is swung by a fine thread of phosphor-bronze so as to lie between and close to the poles—(*n*) north pole, and (*s*) south pole—of the magnet. Just above the magnet the thread carries a mica or aluminum vane to which is attached a small mirror. The scale of the instrument is reflected in this mirror and is observed through the telescope shown in Fig. 38.

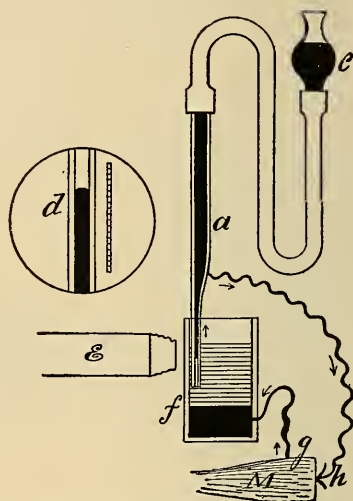

Fig. 41.—Schema of capillary electrometer arranged to show the demarcation current in muscle (*Lombard*): *a*, The glass tube containing mercury and drawn to a fine capillary below; *c*, the receptacle containing mercury by raising which the mercury can be driven into the capillary of *a*; *f*, a vessel with glass sides containing mercury below, and above dilute sulphuric acid into which the capillary of *a* dips; *E*, the microscope for observing the mercury thread in the capillary; *m*, the muscle; *g* and *h*, the wires touching the longitudinal and cut surfaces of the muscle. The current flows as indicated by the small arrows; *d*, the capillary thread of mercury as seen under the microscope.

the system comes quickly to rest with few or no oscillations. If the coil of wire contains sufficient turns, enough to give a total resistance of two to three thousand ohms, and the poles of the magnet are brought very close to the coil, the instrument may be given a delicacy sufficient to study accurately the muscle and nerve currents. In such an instrument the effect of the earth's magnetism may be neglected and the galvanometer may be hung upon any support without reference to the magnetic meridian.

The movable system of this galvanometer possesses considerable inertia, so that it will not indicate accurately the presence or extent of very brief electrical currents such as have to be studied in physiology in some cases.

For purposes of this kind the string-galvanometer or the instrument known as the capillary electrometer is employed.

**The String-galvanometer.**—In this instrument a very delicate thread of silvered quartz or of platinum is stretched between the poles of a strong magnet, as is represented in the diagrams given in Figs. 42 and 43. The

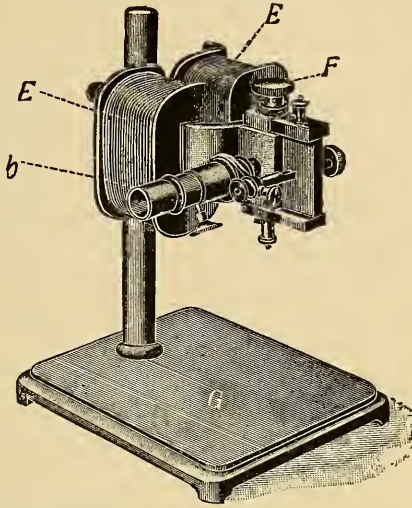

Fig. 42.—One form of the string-galvanometer: *E*, The electromagnet; *b*, the projection microscope; *F*, a screw for varying the tension of the thread.—(Edelmann's Catalogue.)

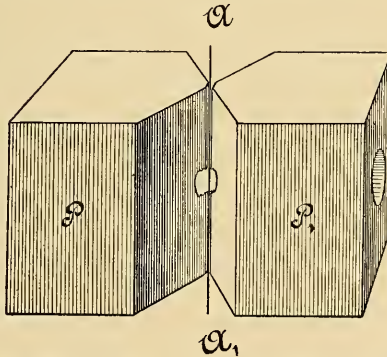

Fig. 43.—Schema to show the relation of the thread to the magnets in the string-galvanometer: *AA*, The delicate thread of silvered quartz or of platinum, stretched between the polar pieces (*PP*) of an electromagnet. When a current passes through *AA*, the thread shows a movement. The ends of the magnets are pierced by holes, seen in *P*<sub>1</sub>, through which the movements of the thread may be watched by means of a microscope or be projected upon a photographic plate.—(After *Eindhoven*.)

metal poles of the magnet are pierced by holes, so that the thread may be illuminated by an electric light (arc light) from one side, and on the other the shadow of the thread may be thrown upon a screen after being magnified by a microscope (see Fig. 42). With this arrangement the thread shows a

lateral movement whenever a current is passed through it. The instrument may be made of great delicacy so as to detect very minute currents, and, moreover, it has the very great advantage of responding accurately to rapid changes in potential. If the shadow of the thread is allowed to fall upon sensitized paper properly adjusted upon a rotating surface, its movements may be photographed and a permanent record be thus obtained (see Fig. 22 for an example of such a photographic record showing the electrical changes in a contracting muscle).

**The Capillary Electrometer.**—The principle of the construction of the capillary electrometer is illustrated in Fig. 41. A glass tube, *a*, is drawn out at one end into a very fine capillary, the end of which dips into some diluted sulphuric acid contained in the vessel (*f*). At the bottom of this vessel is a layer of mercury connecting with a wire, *g*, fused into the glass vessel. The tube *a* is partially filled with redistilled mercury, which penetrates for a short distance into the capillary. By means of pressure applied from above *c*, the mercury can be forced through the capillary. Then by diminishing the pressure the mercury can be brought back into the capillary

a certain distance, drawing after it some of the dilute sulphuric acid. The mercury in tube *a* is connected with the other pole of the battery by a wire fused into its wall and dipping into the mercury. By regulating the pressure on the mercury the point of contact between the thread of mercury and the sulphuric acid in the capillary, *d*, can be brought to any desired position. An equilibrium is then established which will remain constant as long as the conditions are not changed. If now the circuit from a battery or other source of electricity—for example, the excised nerve or muscle—is closed, the current entering by wire *g*, if this represents the anode, traverses the sulphuric acid and mercury in the capillary and returns by the wire *h*. At the moment of the establishment of the current the equilibrium of forces that holds the mercury at a certain point in the capillary is disturbed, the end of the mercury thread moves upward with the current for a certain distance, depending on the strength of the current and the delicacy of the capillary. If the current be passed in the opposite direction the mercury will move downward a certain distance. The meniscus of contact moves up or down with the direction of the current, owing, it is supposed, to a change in the surface tension at this point. The capillary tube as used for physiological purposes is too small for the movements of the mercury to be detected with the eye. It is necessary to magnify it either with a microscope or a projection lantern. Ordinarily the electrometer is so made that it can be placed upon the stage of the microscope and the capillary be brought into focus at the meniscus, as shown in *d*, Fig. 41. By means of proper apparatus the movement can be photographed and thus a permanent record be obtained of the direction and extent of movement of the mercury.

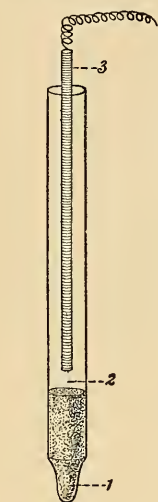
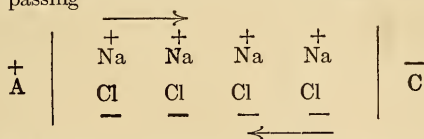

Fig. 44.—To show the structure of a non-polarizable electrode: 1, The pad of kaolin or filter paper moistened with physiological saline (NaCl, 0.7 per cent.) (this is placed on the tissue); 2, the saturated solution of zinc sulphate; (3) the bar of amalgamated zinc.

**Non-polarizable Electrodes.**—In connecting a muscle or nerve to an electrometer or galvanometer it is necessary that the leading off electrodes—that is, the point of contact between the wires and the muscle or nerve—shall be iso-electric and non-polarizable. By iso-electric is meant that the two electrodes have the same electrical potential, and it is obvious that the leading off electrodes must fulfil this condition approximately at least, since otherwise the current obtained from the muscle or nerve could not be attributed to differences in potential in the tissue itself; it would be shown by any other moist conductor connecting the two electrodes. Two clean platinum electrodes would fulfil this condition. A more serious difficulty is found in

the polarization of metallic electrodes. Whenever a metal conductor and a liquid conductor come into contact there is apt to be polarization. What takes place may be represented by the following diagram, in which a current is supposed to be passing



between the poles *A* and *C* through a solution of sodium chlorid. During the passage of the current the cations, Na, with their positive charges move toward the cathode; at the cathode the free sodium ion acts upon the water, HHO, forming NaOH and liberating hydrogen, which accumulates upon the cathode in the form of gas. The anions, Cl, with their negative charges move toward the anode; there the chlorine acts upon the water, forming HCl and liberating oxygen. In consequence of this accumulation of gases upon the poles a gas battery is formed, in which the direction of current is against that of the main current, that is, from *C* to *A*. It is obvious that in quantitative studies of the electrical currents of animal tissues polarization will destroy the accuracy of the results; the demarcation current will show a diminution due not to changes in the nerve, but to physico-chemical changes at the leading-off electrodes. To prevent polarization du Bois-Reymond devised the non-polarizable electrodes consisting of zinc terminals immersed in zinc sulphate. Theoretically any metal in a solution of one of its salts may be used, but experience shows that the zinc-zinc sulphate electrode is most nearly perfect. Each electrode where it comes into contact with the tissue is made of one of these combinations. Various devices have been used. For instance, the electrode may be constructed as shown in the diagram (Fig. 44). A short glass tube of a bore of about 4 mms. is well cleaned—one end, which is to come into contact with the nerve—is filled, as shown, by a plug of kaolin made into a stiff putty with physiological saline solution of NaCl (0.7 per cent.). The kaolin should have a neutral reaction and unless good kaolin is obtainable it is better to use a plug made of clean filter paper macerated in physiological saline and packed tightly into the end of the tube. Above this plug the tube is filled in for a part of its length with a saturated solution of zinc sulphate into which is immersed a bar of amalgamated zinc with a copper wire soldered to its end. With a pair of such electrodes the conduction of the current through the nerve or muscle to the metallic part of the circuit may be represented as follows:

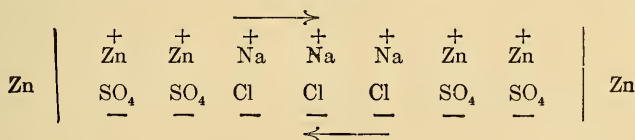

The liquid part of the circuit comes into contact with the metallic part at the junction of Zn and ZnSO<sub>4</sub>. At the cathode it may be supposed that the Zn cation instead of acting upon the water and liberating hydrogen, deposits itself upon the zinc electrode; at the anode the sulphion (SO<sub>4</sub>) attacks the zinc instead of the water, forming ZnSO<sub>4</sub>. In this way polarization is prevented, and by the construction of the electrode the living tissue is brought into contact only with the plug of kaolin moistened with physiological saline. Such electrodes are indispensable in studying the electrical phenomena of living tissues, and also in all investigations bearing upon the polar effects during the passage of an electrical current from a battery. Ordinarily, however, when it is only desired to stimulate a nerve or muscle, metal (platinum) electrodes are employed.

**The Action Current or Negative Variation.**—Du Bois-Reymond proved that when the excised muscle or nerve is stimulated its demarcation current suffers a diminution or negative variation. If, for instance, the excised nerve gives a demarcation current sufficient to cause a deflection in the galvanometer of 50 mms., then if the nerve is stimulated by a series of induction shocks the galvanometer will show a lessened deflection, say, one of 40 mms. The negative variation in this case is equal to 10 mms., on the scale of the galvanometer used. It has been shown that this negative variation is due to a current in the opposite direction whose strength, in the example given, relative to that of the demarcation current is as 10 to 50. Frequently the phenomenon of the negative variation is known also as the action current. The explanation given for this action current is that the nerve or muscle when excited takes on an electrical condition which is negative as regards any unexcited or less excited portion of the nerve. The effect upon the demarcation current is illustrated in the accompanying diagram.

The demarcation current in a nerve is led off to a galvanometer by electrodes placed at *b* and *c*. When the nerve is stimulated at *a* the excitation set up passes along the nerve, and wherever it may be that portion of the nerve is thrown into an electronegative condition. When this condition reaches a point at which it can influence the galvanometer—that is, when it reaches *b*, it will diminish the difference in potential that exists between *b* and *c*, and therefore

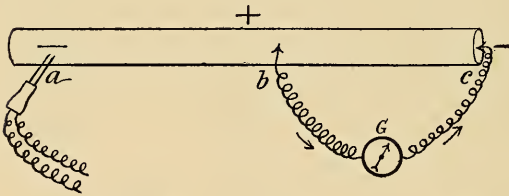

Fig. 45.—Schema to indicate the method of detecting the action current in a stimulated excised nerve: *b* and *c*, the leading off electrodes, one on the longitudinal, one on the cut surface; the demarcation current passes through the galvanometer, *g*, in the direction of the arrows; *a*, stimulating electrodes from induction coil; the stimulus causes a negative condition,—which passes along the nerve; when this reaches *b* it causes a partial reversal of the demarcation current, giving the negative variation or action current.

reduce the current flowing from *b* to *c*. Bernstein\* has shown that this negative condition moves in the form of a wave. That is, at any point the negativity grows to a maximum and then diminishes. Moreover, it travels at a definite velocity which is easily measured. Accord-

ing to his experiments, the velocity of this wave in the frog's motor nerve is from 25 to 28 meters per second, and the length of the wave is about 18 mms. Hermann, on the contrary, believes that, in the excised nerve at least, the length of the wave may be greater, reaching perhaps 140 mms.

\* Bernstein, "Untersuchungen über den Erregungsvorgang im Nerven und Muskelsysteme," Heidelberg 1871.

These figures will vary naturally for the nerves of different animals or for different nerves in the same animal, for it must always be remembered that nerve fibers, whose functions in general are so similar, differ much in obvious microscopical structure and probably more widely in their chemical composition. Using an analogy that is familiar, we may say that when a stimulus acts upon a living nerve a wave of electronegativity spreads from the stimulated spot and travels in wave form with a definite velocity, just as water waves radiate from the spot at which a stone is thrown into a quiet pool. A similar phenomenon occurs in muscle fibers when stimulated, but the negative condition travels over the muscle fiber at a slower speed, 3 to 4 meters per second in frog's muscle, and with a wave length, according to Bernstein, of only 10 mms. This wave of negativity in the muscle begins during the latent period and, therefore, precedes the actual shortening at any point.

This phenomenon of a negative electrical condition traveling over the nerve or muscle and giving us an action current when led off through a galvanometer is of the greatest physiological importance, particularly in the study of nerves. It has been shown that in the nerve this wave of negativity marks the progress of the wave of excitation, and, since we can study its progress by means of the galvanometer or capillary electrometer, we can thus study the excitability and conductivity in nerves when removed from connection with their end-organs. That the negative wave, or the action current that it gives rise to, is an invariable sign of the passage of an excitation or nerve impulse is shown by the facts that it is absent in the dead nerve, and that in the living nerve it is produced by mechanical,\* chemical,† and reflex‡ stimulations, as well as by the more usual method of electrical stimulation.

**Monophasic and Diphasic Action Currents.**—According to the conception of the action current given above, it is evident that it should be obtained upon stimulation when a living normal nerve is connected at any two points of its course with a galvanometer or capillary electrometer. The detection of the current under such conditions offers more difficulties, because it is diaphasic, as will be seen from the accompanying diagram (Fig. 46). The figure represents a normal nerve led off to the galvanometer from two points, *b* and *c*, of its longitudinal surface. As these points in the uninjured nerve have the same potential, no current is shown by the galvanometer. If the nerve is stimulated at *a* by a single stimulus, a negative condition or charge passes along the nerve. When it reaches the point *b*, there will be a momentary current

\* Steinach, "Pflüger's Archiv," 55, 487, 1894.

† Grützner, "Pflüger's Archiv," 25, 255, 1881.

‡ Boruttau, "Pflüger's Archiv," 84, and 90, 1901-1902.

through the galvanometer from *c* to *b*; as the charge passes on to *c*, this point in turn will become negative to *b*, and there will be a momentary current through the galvanometer in the other direction. The diphasic current that occurs under these conditions cannot be detected by the ordinary galvanometer, even when a series of stimuli is sent into the nerve at *a*, since the movable system in this instrument has too much inertia to respond to such quick changes in opposite directions. With the more mobile string-galvanometer or capillary electrometer the diphasic currents have been demonstrated successfully. In laboratory investigations one of the leading off electrodes, *c*, is usually placed on the cut end of the nerve. Under this condition the action current becomes monophasic and shows itself as a negative variation of the demarcation current. This difference is due to the fact that the negative condition accompanying or constituting the wave of excitation undergoes a decrement as it enters a region in which a negative condition already prevails. Therefore, when the leading-off electrodes are placed so that one is on the longitudinal and one on the cut surface, the change of potential accompanying the excitation will affect only the first electrode (*b*) and give a monophasic variation, which can now be shown by the usual galvanometer, provided a series of stimuli is thrown in at *a*.

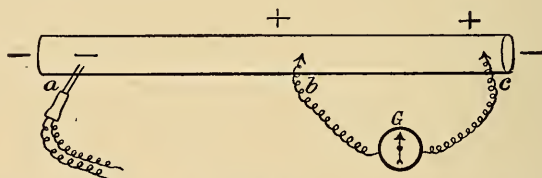

Fig. 46.—Schema to show the arrangement for obtaining a diphasic action current. The arrangement differs from that in Fig. 42 only in that both leading off electrodes, *b* and *c*, are placed on the longitudinal surface. No demarcation current is indicated. When the nerve is stimulated at *a* the negative charge reaches *b* first, causing a current through the galvanometer from *c* to *b*. Subsequently it reaches *c* and causes a second current in the opposite direction from *b* to *c*.

*The Positive Variation.*—It happens not infrequently that when one electrode is placed upon the cut end, the nerve upon stimulation with a series of induction shocks gives a positive instead of a negative variation of the demarcation current. This result is usually explained as being due to a predominance of the anelectrotonic currents (see below). When this phenomenon occurs it can usually be avoided by making a fresh section at the end of the nerve.

**Detection of the Action Currents by the Rheoscopic Frog Preparation or by the Telephone.**—The motor nerve of a nerve-muscle preparation from a frog is so extremely irritable to electrical currents that it may be used instead of a galvanometer to detect



the action currents in a stimulated muscle. A nerve-muscle preparation used for this purpose is known as a rheoscopic preparation. The way in which it is used is indicated in the accompanying diagram. *b* represents the rheoscopic preparation, its nerve being laid upon the muscle whose currents are being investigated, *a*, so as to touch the cut end (*x*) and the longitudinal surface (*g*). When *a* is stimulated, either directly or through its nerve, as represented in the diagram, the negative changes that pass along the muscle fibers of *a* with each stimulus cause action currents that will be led off through the nerve of *b* from *x* to *g*. If the nerve is in a sensitive condition it will be stimulated by the action currents and thus a series of excitations will be sent into *b* corresponding exactly in rate with the artificial stimuli given to the nerve of *a*. The rheoscopic preparation may be used very beautifully to demonstrate the action current in the contracting heart muscle. If the nerve of *b* is laid upon the exposed beating heart of an animal, the muscle of *b* will give a single twitch for each beat of the ventricle. Another interesting method of detecting the action currents, particularly in nerves, is by means of the telephone. Wedenski has made especial use of this method, the telephone being connected with

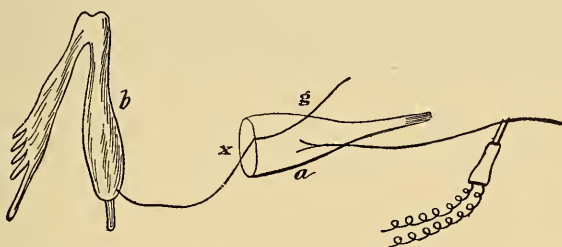

Fig. 47.—Schema to show the arrangement of a rheoscopic muscle-nerve preparation: *b*, The rheoscopic muscle-nerve preparation, the nerve being arranged to touch the cut surface and the longitudinal surface of the muscle, *a*, whose action currents are to be detected. When the nerve of *a* is stimulated each contraction of this muscle is followed by a contraction of *b*, since each contraction of *a* is accompanied by an action current which passes through the nerve of *b* and stimulates it.

the nerve in place of the galvanometer. The method has obvious advantages in the fact that it may be used with a nerve to which the muscle is also attached, so that the excitation processes in the nerve and their effect upon the muscle may be studied simultaneously.

**Relation of the Action Current to the Contraction Wave in Muscle and to the Excitation Wave (Nerve Impulse) in Nerve.**—The action current or, to be more accurate, the moving negative potential, which gives rise to an action current when two points of the muscle are led off to a galvanometer, has been shown

by Bernstein to precede the wave of contraction in muscle; that is, in a stimulated muscle fiber the electrical change at any point precedes the mechanical process of shortening. This relationship is shown in the accompanying illustration (Fig. 48), in which the mechanical contraction (movement of the lever) is photographed simultaneously with the movement of the string of the string-galvanometer which indicates the electrical change. As the figure shows the electrical change is diphasic, owing to the opposite effects on the galvanometer of the change of potential at

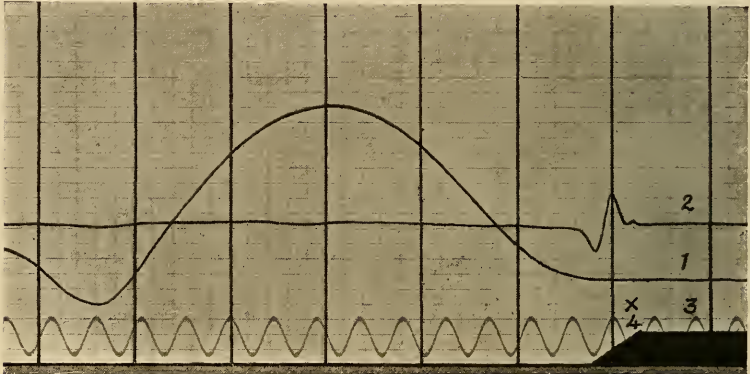

Fig. 48.—Simultaneous record of the mechanical and electrical change in a contracting muscle: 1, Mechanical curve of contraction, photograph of the lever; 2, movement of the string of the string-galvanometer (owing to its faintness it was necessary to retouch this curve); movement upward indicates an increase of negative potential at the upper end of the muscle; 3, time record in hundredths of a second; 4, the stimulating lever; the break in the line indicates the moment of stimulation; on the curve of contraction (1) this moment is indicated by *x*; on the curve showing the movement of the string (2) the same instant is marked by the small nick in the curve preceding the large wave caused by the electrical change. The curve was obtained from the gastrocnemius muscle of a frog, stimulated through its nerve by a single induction shock, contraction isotonic. The leading-off electrodes were placed at the ends of the muscle; galvanometer string under tension. The electric curve is diphasic, and both phases are completed within the latent period of contraction (*Snyder*).

the two points lead off to the galvanometer, but the first phase, which begins almost immediately on stimulation, is completed before the muscle begins to shorten. We may suppose that the electrical change is an indication of the excitation, or possibly constitutes the excitation that sets up the chemical change of contraction, or else that the change in electrical potential is caused by the chemical change of contraction and precedes the mechanical result of shortening, since the latter process will have a certain latent period. It has been shown, indeed, by Demoor that a completely fatigued muscle may still conduct an excitation (muscle impulse), although unable to contract, and the same fact has been demonstrated by Engelmann

for the heart muscle. In the nerve the action current, or the negative change causing it, has been considered as simultaneous with or possibly identical with the nerve impulse. The velocity of the two is identical; the action current is given whenever the nerve is stimulated, and, so far as experiments have gone, the nerve cannot enter into activity without showing an action current,—that is, without showing a moving electrical change. Whether this electrical change constitutes the nerve impulse or is simply an accompanying phenomenon will be discussed briefly in the paragraph upon the nature of the nerve impulse in the following chapter.

**The Electrotonic Currents.**—In speaking of the effect of passing a galvanic current through a nerve attention was called to the fact that the condition of the nerve is altered at each pole. At the anode there is a condition of decreased irritability and conductivity known as anelectrotonus; at the cathode, in the beginning, at least, a condition of increased irritability known as catelectrotonus. In addition

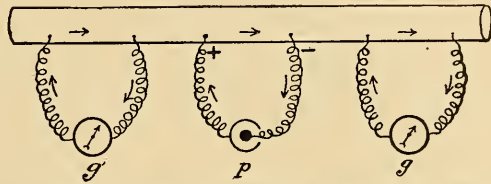

Fig. 49.—Schema to show the direction of the electrotonic currents in an excised nerve: *P*, The battery for the polarizing current sent into the nerve at +, the anode, and emerging at —, the cathode; *g*, galvanometer arranged with leading off electrodes to detect the anelectrotonic current, the direction of which is indicated by the arrows (in the nerve it is the same as that of the polarizing current); *g*, galvanometer similarly arranged to detect the catelectrotonic current. The anelectrotonic and catelectrotonic currents continue as long as the polarizing current is maintained.

to these changes in the physiological properties of the nerve there is a change also in its electrical condition at each pole, of such a character that if the nerve is led off from two points on the anode side a current will be indicated. The current can be obtained at a considerable distance from the anode, and is known as the anelectrotonic current, while the electrical condition in the nerve that makes it possible is designated as anelectrotonus. A similar current can be led off from the nerve on the cathode side for a considerable distance beyond the cathode; this is known as the catelectrotonic current, and the electrical condition leading to its production as catelectrotonus. Within the nerve these electrotonic currents have the same direction as the battery or polarizing current, as is shown in the diagram (Fig. 49). The terms anelectrotonus and catelectrotonus are used, therefore, in physiology to designate both the physiological and the electrical changes around the poles when a battery current is led

into a nerve. Whether the physiological and the electrical changes have a causal connection or are two independent phenomena is at present undecided.

Bethe\* has shown that during the passage of the polarizing current the neurofibrils in the axis cylinder lose at the anode their power of staining with certain basic dyes (*e. g.*, methylene blue), while at the cathode the affinity for these dyes is increased. He assumes, that in the neurofibrils there is an acid substance—fibril acid—and that at the anode the combination with this body and the neurofibrils is loosened; hence the loss of staining power. At the cathode the reverse change takes place. He assumes further-

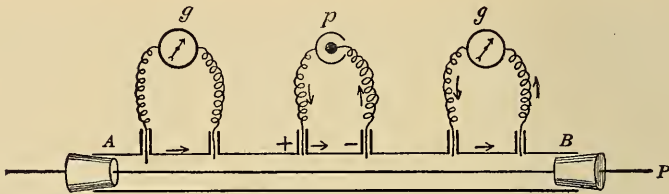

Fig. 50.—To show the action of the core-model: *p*, The polarizing current; *g'* and *g*, the galvanometers with leading off electrodes to detect the anelectrotonic and catelectrotonic currents, respectively.

more, that when the affinity between neurofibril and fibril acid is increased at the cathode an electronegative ion is liberated (anion), while at the anode at the time that the combination between fibril and fibril acid is dissociated an electropositive ion (cation) is liberated. In this way he constructs an hypothesis of a complex of neurofibril, fibril acid, and electrolyte which is capable of accounting for the electrotonus, both as regards the electrical and the physiological phenomena, and which refers both phenomena to a single reaction in the nerve.

Another explanation of the electrotonic currents which has been much discussed is that first developed by Hermann.† This author constructed a model consisting of a conductor surrounded by a less conductive liquid sheath, and showed that such a model is capable of giving the electrotonic currents. This model may be made as represented in the accompanying diagram, of a glass tube A-B, through the middle of which is stretched a platinum wire, P, the rest of the tube being filled with a saturated solution of zinc sulphate. The glass tube is provided with vertical branches by means of which a polarizing current, *p*, can be sent into the solution of zinc sulphate and the electrotonic currents be led off to galvanometers, *g'*, *g*, on each side. Under these conditions a current similar to the anelectrotonic current can be detected on the side of the anode (*g'*) and one equivalent to the catelectrotonic current on the side of the cathode (*g*). The explanation given to these currents is that as the threads of current pass into the platinum core there is a polarization at the surface between the core and the zinc sulphate solution which extends to a considerable distance on each side of the electrodes and causes diffusion currents from sheath to core. It is these threads of current that may be led off as electrotonic currents. Hermann suggested that in the nerve we have a structure essentially similar to that of the core model. He thought that the axis cylinder might be considered as representing the core and the myelin the less conductive sheath corresponding to the zinc sulphate solution. Others (Boruttan) have suggested that

\* Bethe, "Allgemeine Anatomie u. Physiol. des Nervensystems," Leipzig, 1903.

† Hermann, "Handbuch der Physiologie," vol. ii, p. 174.

the neurofibrils in the axis cylinder may represent the core or cores and the surrounding neuroplasm the sheath, thus providing for the possibility of electrotonic currents in non-medullated fibers. As a matter of fact, the non-medullated fibers in mammals give very slight electrotonic currents compared with the medullated fibers.\*

According to the "core-model" explanation, the electrotonic currents represent a purely physical phenomenon, which is dependent, however, upon a certain structure of the nerve. That is, a completely dead nerve will not show these currents, although an anesthetized nerve, in the mammal (Waller) at least, continues to show them, and, according to Sosnowsky, excised rabbits' nerves kept in a moist atmosphere may show them for several days. While the core-model hypothesis has led to much investigation in physiology and has been made the basis for a purely physical explanation of the nerve impulse, it is still very uncertain whether it furnishes any positive information concerning the processes that actually take place in the living nerve when submitted to the action of electrical currents or other artificial stimuli.

\* Alcock, "Proceedings Royal Society," 1904, 73, p. 166.

## CHAPTER V.

### THE NATURE OF THE NERVE IMPULSE AND THE NUTRITIVE RELATIONS OF NERVE FIBER AND NERVE CELL.

The question of the nature of the nerve impulse has always aroused the deepest interest among physiologists. It has constituted, indeed, a central question around which have revolved various hypotheses concerning the nature of living matter. The importance of the nerves as conductors of motion and sensation was apparent to the old physiologists, and the nature of the conduction or the thing conducted was the subject of many hypotheses and many different names. For many years the prevalent view was that the nerves are essentially tubes through which flows an exceedingly fine matter, of the nature of air or gas, known as the animal spirits. Others conceived this fluid to be of a grosser structure like water and described it as the nerve juice. With Galvani's discovery of electricity the nerve principle, as it was called, became identified with electricity, and, indeed, this view, as will be explained, occurs in modified form to-day. Du Bois-Reymond, after discovering the demarcation current and action current in muscle and nerve, formulated an hypothesis according to which the nerve fibers contain a series of electromotive particles, and by this hypothesis and the facts upon which it was based he thought that he had established that "hundred-year-old dream" of physicists and physiologists of the identity of the nerve principle and electricity. His theory to-day has fallen into disrepute, but the facts upon which it was based remain, as before, of the deepest importance. In the middle of the nineteenth century those who were not convinced of the identity of the nerve principle with electricity believed, nevertheless, that the process of conduction in the nerve is a phenomenon of an order comparable to the transmission of light or electricity, with a velocity so great as to defy measurement. But in this same period a simple but complete experiment by Helmholtz demonstrated that its velocity is, as compared with light or with electrical conduction through the air or through metals, exceedingly slow,—27 meters per second. Modern views have taken divergent directions; the movement or excitation that is conducted along the fiber has been named

the nerve principle, the nerve energy, the nerve force, the nerve impulse. As the latter term is less specific regarding the nature of the movement, and emphasizes the fact of the conduction of an isolated disturbance or pulse, it seems preferable to employ it until a more satisfactory solution of its nature has been reached.

**The Velocity of the Nerve Impulse.**—The determination of the velocity of the nerve impulse was first made by Helmholtz\* upon the motor nerves of frogs. His experiment consisted in stimulating the sciatic nerve, first, near its ending in the muscle

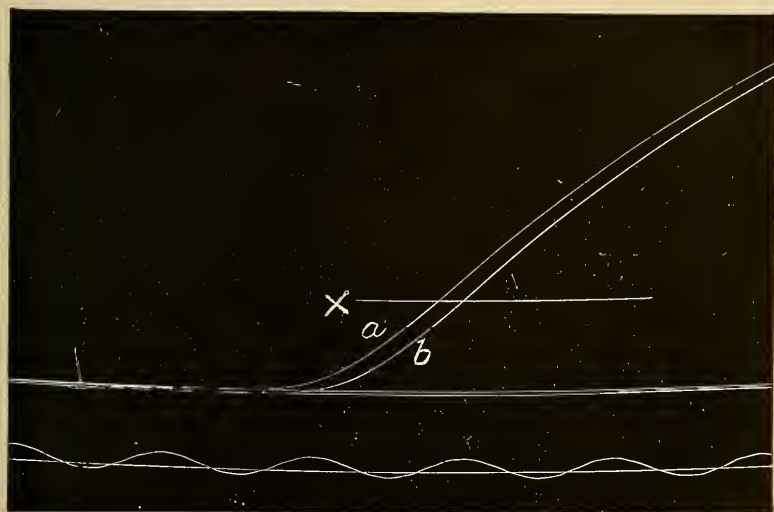

Fig. 51.—Record to show the method of estimating the velocity of the nerve impulse in a motor nerve. The experiment was made upon a nerve-muscle preparation from the frog, the contractions being recorded upon the rapidly moving plate of a pendulum myograph. Two contractions were obtained, the first (*a*) when the nerve was stimulated near the muscle, the second (*b*) when the nerve was stimulated as far as possible from the muscle. The latent period of the second contraction was longer, as shown by the distance between the curves measured on the line *x*. The value of this distance in time is obtained by reference to the record of a tuning fork vibrating 100 times per second, which is given on the lower line. In the experiment the length of a tuning fork wave (0.01 sec.) was 21 mms., the distance between the two muscular contractions was 3.35 mms., and the distance between the points stimulated upon the nerve was 49 mms. Hence the velocity of the nerve impulse in this experiment was 49 divided by  $(\frac{3.35}{2100} \times \frac{1}{100})$  or 30716 mms. (30.716 m.) per second.

and, second, near its origin from the cord, and measuring the time that elapsed in each case between the moment of stimulation and the moment of the muscular response. It was found that when the nerve was stimulated at its far end this time interval was longer, and since all other conditions remained the same this difference in time could only be due to the interval required for the nerve impulse to travel the longer stretch of nerve. In the accom-

\* Helmholtz, "Müller's Archiv f. Anat. u. Physiol.," 1852, p. 199.

panying figure the record of a laboratory experiment of this kind is reproduced. Knowing the difference in time and also the length of nerve between the points stimulated, the data are at hand to calculate the velocity of the impulse. The velocity varies with the temperature. According to Helmholtz, this variation lies between 24.6 and 38.4 m. per second for a range of temperature between 11° and 21° C. For average room temperatures we may say that in the motor nerves of the frog the impulse travels with a velocity of 28 to 30 meters per second. Similar experiments have been made upon man and other mammals. Helmholtz stimulated the median nerve in man at two different points and recorded the resulting contractions of the muscles of the thumb. By this means he obtained an average velocity of 34 m. per second, but others, making use of the same method, have reported varying results. Piper\* has applied the string-galvanometer to the investigation of this point. Using the unipolar method, he stimulated the median nerve with induction shocks, the active electrode being applied at the elbow and at the axilla at a distance apart of from 160 to 170 mm. The muscular response was recorded not by registering the contraction, but by means of its action current. When the stimulus was applied at the elbow the interval between the stimulation and the electrical response averaged 0.00442 second; at the axilla the interval was 0.00578 second. The difference, namely, 0.00136 second, gave the time necessary for the impulse to travel over 160 to 170 mm. of nerve, and indicated a velocity of 117 to 125 m. per second.

It is interesting to recall that only six years before Helmholtz's first publication Johannes Müller had stated that we should never find a means of determining the velocity of the nerve impulse, since it would be impossible to compare points at great distances apart, as in the case of the movement of light. "The time," said he, "required for the transmission of a sensation from the periphery to the brain and the return reflex movements of the muscles is infinitely small and unmeasurable." The mode of reasoning by which Helmholtz was led to doubt the validity of this assertion is interesting. He says ("Müller's Archiv," 1852, 330): "As long as physiologists thought it necessary to refer nerve actions to the movement of an imponderable or psychical principle, it must have appeared incredible that the velocity of this movement could be measured within the short distances of the animal body. At present we know from the researches of du Bois-Reymond upon the electro-motive properties of nerves that those activities by means of which the conduction of an excitation is accomplished are in reality actually conditioned by, or at least closely connected with an altered arrangement of their material particles. Therefore conduction in nerves must belong to the series of self-propagating reactions of ponderable bodies, such, for example, as the conduction of sound in the air or elastic structures, or the combustions in a tube filled with an explosive mixture." One of the first fruits, therefore, of the scientific investigation of the electrical properties of the nerve fiber was the discovery of the important fact of the velocity of the nerve impulse.

\* Piper, "Archiv f. d. ges. Physiologie," 1908, 124, 591.



Numerous efforts have been made to determine the velocity of the nerve impulse in medullated sensory fibers. The results have not been entirely satisfactory. The end-organ in this case is the cortex of the cerebrum, and its reaction consists in arousing a sensation, or a reflex action. Neither end-reaction can be measured directly. Attempts have been made to determine it indirectly by noting the time of a voluntary muscle response for sensory stimuli applied to the skin at different distances from the spinal axis. In such cases the sensory impulse travels to the cord, thence to the brain, and the return motor impulse travels from brain to cord and then by the motor nerves to the muscle used for the response. The results of this method have been discordant, owing probably to the fact that the central paths from two different points on the skin are not identical. It is usually assumed—without, however, very convincing proof—that the velocity of the impulse in the medullated afferent nerve fibers is the same as in the efferent fibers. A large number of observations are on record which show that the velocity varies greatly in the nerves of different animals. In the mammal, according to Chauveau, the velocity for the non-medullated fibers is only 8 meters per second; in the lobster it is 6 meters per second; in the octopus, 2 meters; in the olfactory (sensory) nerve of the pike,  $\frac{1}{5}$  meter, and in the anodon, only  $\frac{1}{100}$  meter per second.

**Relation of the Nerve Impulse to the Wave of Negativity.**—A fact of great significance is that the velocity of the impulse in the motor nerves of the frog corresponds exactly to the velocity of the wave of negativity as measured by Bernstein. Evidently the two phenomena are coincident in their progress along the fiber, and physiologists generally have accepted the existence of an action current as a proof of the passage of a nerve impulse. This belief is strengthened by the fact that, as stated above, the negative wave accompanies the nerve impulse not only when the nerve is stimulated by electrical currents, but also after mechanical, chemical, or reflex stimulation. The question has been raised as to whether this electrical phenomenon accompanies the normal nerve impulse,—that is, the nerve impulse that originates in the nerve centers, in the case of motor nerves, or in the peripheral sense organs in the case of sensory nerves. In regard to the latter relation we have positive evidence that when light falls upon the living retina an electrical disturbance is produced by the visible rays of the spectrum,\* and there is every reason to believe that the passage of visual impulses along the optic nerve is accompanied by an electrical change. With regard to normal motor impulses, the evidence is also positive that motor discharges from the central nervous system are accompanied

\* See Einthoven and Jolly, "Quarterly Journal of Experimental Physiology," 1, 373, 1908.

by a wave of electrical potential. This fact may be shown by stimulating the motor areas in the cerebral cortex and testing the efferent nerves, such as the sciatic, for an action current; or by stimulating a posterior root on one side in the lumbar region and testing the sciatic nerve on the other side with a galvanometer.\* Moreover, all influences that alter the velocity or strength of the nerve impulse affect the intensity of the action current in the same manner. It is believed generally, therefore, that the electrical change is an invariable accompaniment of the excitatory wave, and the demonstration of an action current in a nerve is tantamount to a proof of the passage of a nerve impulse.†

**Direction of Conduction in the Nerve.**—The fact that under normal conditions the motor fibers conduct impulses only in one direction—*i. e.*, toward the periphery—and the sensory fibers in the opposite direction—that is, toward the nerve center—suggests, of course, the question as to whether the direction of conduction is conditioned by a fundamental difference in structure in the two kinds of fibers. No such difference in structure has been revealed by the microscope. It is the accepted belief in physiology that any nerve fiber may conduct an impulse in both directions, and does so conduct its impulses when the fiber is stimulated in the middle of its course. An entirely satisfactory proof for this belief is difficult to furnish unless the conclusion in the preceding

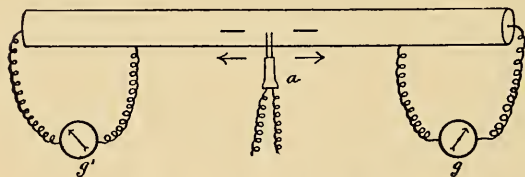

Fig. 52.—Schema to show the arrangement for proving the propagation of the negative charge in both directions: *a*, The stimulating electrodes; *g* and *g'*, galvanometers with leading off electrodes arranged to show the negative variation on each side.

paragraph is admitted—the conclusion, namely, that the electrical change is a necessary and invariable accompaniment of the nerve impulse. It is not difficult to show by means of a galvanometer that when a nerve trunk is stimulated the wave of negativity spreads in both directions from the point stimulated and gives an action current on either side, as indicated in the accompanying diagram. This fact holds true for motor or for sensory fibers. The older physiologists attempted to settle this question in a more direct way, but by methods which later experiments have proved to be insufficient. They attempted, for instance, to

\* Gotch and Horsley, "Phil. Trans., Royal Soc.," London, 1891, vol. 182 (B), and Boruttai, "Pflüger's Archiv," 1901.

† For a more extended discussion, see Keith-Lucas, Croonian Lecture, "Proceedings of the Royal Society," B, 85, 582, 1912.

unite a motor and sensory trunk directly, to cut the hypoglossal (motor) and the lingual (sensory) and suture, say, the central stump of the lingual to the peripheral stump of the hypoglossal. If stimulation of this latter trunk, after union had been established, gave signs of sensation it was considered as proof that the efferent hypoglossal fibers were now conducting afferently. We now know that in such a case the old hypoglossal fibers degenerate completely, and the new ones that are eventually formed in their place are outgrowths from the lingual stump, or at least are not the old efferent fibers, and hence experiments of this kind are not so conclusive as they seemed to be at the time when it was supposed that severed nerve fibers can unite immediately, by first intention, without previous degeneration. A similar objection applies to Paul Bert's often quoted experiment. Bert implanted the tip of a rat's tail into the skin of its back. After union had taken place the tail was severed at the base, and the stump now attached to the back was tested from time to time as to its sensibility. Sensation returned slowly. At first it was indefinite, but by the end of a year was apparently normal.

**Modification of the Nerve Impulse by Various Influences—Narcosis—Temperature.**—The strength of the impulse and its velocity may be modified in various ways: by the action of temperature, narcotics, pressure, etc. Variations of temperature, as stated before, change the velocity of propagation of the impulse, the velocity increasing with a rise of temperature up to a certain point. So also the irritability as well as the conductivity of the nerve fiber is influenced markedly by temperature. If a small area of a nerve trunk be cooled or heated, the nerve impulse as it passes through this area may be increased or decreased in strength or may be blocked entirely. Different fibers show somewhat different reactions in this respect; but, speaking generally, the limits of conductivity in relation to temperature lie between  $0^{\circ}$  C. and  $50^{\circ}$  C. Cooling a nerve to  $0^{\circ}$  C. will in most cases suspend the conductivity, but this function returns promptly upon warming.\* By this means we can block the nerve impulses in a nerve trunk for any desired length of time. The exact relationship between the temperature of the nerve and the velocity of the impulse has been studied carefully with the object of determining the *temperature coefficient*. It has been shown by van't Hoff that the velocity of chemical reactions is increased twofold or more for each rise of 10 degrees in temperature, that is, the temperature coefficient for chemical reactions lies between 2 and 3. On the other hand, with most physical processes the temperature coefficient for the

\* Howell, Budgett, and Leonard, "Journal of Physiology," 16, 298, 1894.

same range of temperature lies around 1 or between 1 and 2. Snyder\* finds, on comparing the velocities of the impulse at different temperatures, that they follow van't Hoff's law for chemical reactions, that is, the velocity is approximately doubled by a rise of  $10^{\circ}$  C. in temperature within physiological limits, or, expressed in more general terms,  $\frac{\text{velocity at } T_n + 10}{\text{velocity at } T_n} = 2$ . This effect of temperature on the velocity of the impulse is shown graphically in Fig. 53. Anesthetics and narcotics,† such as ether,

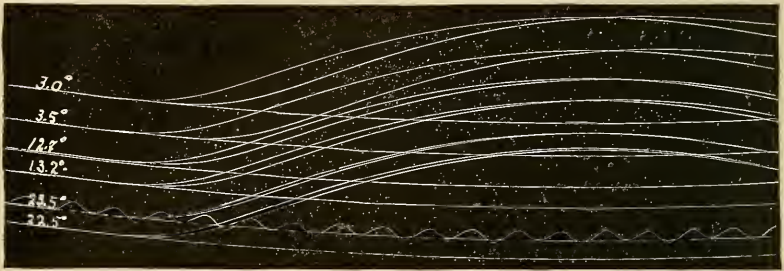

Fig. 53.—Figure to show the effect of temperature on the velocity of the nerve impulse. At each temperature two contractions of the gastrocnemius were recorded, one when the nerve was stimulated close to the muscle, one when it was stimulated further away (44 mm.). The horizontal distance between the curves as they rise can be expressed in time by reference to the tuning-fork vibrations (200 per second) given below. For intervals of  $10^{\circ}$  C. it will be seen that the velocity, as indicated by the reciprocals of the distances between the pairs of curves, indicates a coefficient of two.—(Snyder.)

chloroform, cocain, chloral, phenol, alcohol, etc., may be applied locally to a nerve trunk, and if the application is made with care the conductivity and irritability may be lessened or suspended entirely at that point, to be restored again when the narcotic is removed. It is an interesting fact that the conductivity of the nerve may be suspended also by deprivation of oxygen,‡—that is, by local suffocation or asphyxia. A nerve fiber surrounded by an oxygen-free atmosphere will slowly lose its conductivity, and this property will be restored promptly upon the admission of oxygen. Compression of a nerve will also suspend its conductivity without permanently injuring the fibers, provided the pressure is properly graduated. Lastly, as was explained in a preceding chapter, the conductivity of the nerve may be increased or decreased or suspended entirely by the action of a galvanic (polarizing) current. This method of suspending conductivity temporarily has been frequently employed

\* Snyder, "American Journal of Physiology," 22, 179, 1908.

† Fröhlich, "Zeitschrift f. allgemeine Physiol.," 3, 75, 1903.

‡ Baeyers, *ibid.*, 2, 169, 1903.

for experimental purposes, the arrangement being as represented in Fig. 54.

**The Refractory Period.**—In the case of the heart, the nerve cell, and the muscle it has been shown that for a short period after the tissue enters into a condition of functional activity it is non-irritable toward a second stimulus. This condition of loss of excitability following upon or accompanying functional activity is designated as the *refractory period*. It is interesting to find that a tissue so irritable as a nerve fiber exhibits the same phenomenon. For a very brief period (0.002 to 0.006 of a second), after it enters into action, as indicated by the electrical response, a second stimulus throw in will be found to be ineffective. As the electrical change passes off, that is, as the state of activity subsides, the nerve regains its normal irritability. The refractory period of the nerve fiber may be much prolonged by conditions which slow the processes underlying activity, for example, by low temperatures, or by the action of certain drugs, such as yohimbine (Tait).

**The Question of Fatigue of Nerve Fibers.**—An important question in connection with the nature of the nerve impulse has

been that of the susceptibility of the nerve fibers to fatigue. The obvious fatigue of muscles and of nerve centers has been referred to the accumulation of the products of metabolism of their tissues or to the actual consumption of the energy-yielding material in them. Functional activity in these tissues implies the breaking down

of complex organic material (catabolism) and the setting free of the so-called chemical energy. The internal energy of the compound is liberated as kinetic energy of heat, etc. It has been accepted, therefore, that if the nerve fiber could be demonstrated to show fatigue as a result of functional activity, this fact would be probable proof that the conduction of the impulse is associated with a chemical change of a catabolic nature in the substance of the fiber. Experimental work, however, has shown that under normal conditions the nerve fiber shows no fatigue. The experiments made upon this point have been numerous and varied. The general idea underlying all of them has been to stimulate the nerve continuously, but to interpose a block

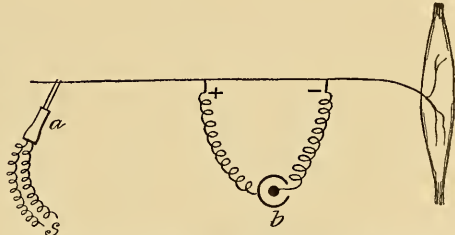

Fig. 54.—Schema to show the method of blocking the nerve impulse by means of a polarizing current: *a*, The stimulating electrodes; *b*, the battery, the current of which is led into the nerve. The depressed irritability at both anode, +, and cathode, —, prevents the nerve impulse started at *a* from reaching the muscle.

somewhere along the course of the nerve so that the impulses should not reach the end-organ. This precaution is necessary because the end-organ—muscle, gland, etc.—is subject to fatigue, and must therefore be protected from constant activity. From time to time or at the end of a long period of stimulation the block is removed and it is noted whether or not the end-organ—for instance, the muscle—gives signs of a stimulation. The removable block has been obtained by the action of a polarizing current, by cold, by narcotics, by curare, etc. Using curare, for instance, Bowditch\* found that the sciatic nerve might be stimulated continuously by induction shocks for several (four to five) hours without complete fatigue, since as the curare effect wore off the muscle whose contractions were being recorded (*M. tibialis ant.*) began to respond, at first with single and finally with tetanic contractions. The curare in this case may be supposed to have blocked the nerve impulse at the motor end-plate and thus protected the muscle from responding until the lapse of several hours, although the nerve was under stimulation during this entire time. This experiment has since been repeated by Durig,† who has made use of the fact that the effects of curare can be removed within a few minutes by the salicylate of physostigmin. Durig stimulated the nerve for as much as ten hours and then upon removing the curare block found from the contraction of the muscle that the nerve was still conducting. Edes‡ and others have shown that the same result is obtained when the nerve is tested by a capillary electrometer instead of by the response of an end-organ. Under such conditions the nerve exhibits an undiminished action current, although constantly stimulated by tetanizing shocks from an induction apparatus. Brodie and Halliburton§ have found that the non-medullated fibers in the splenic nerve can also be stimulated for many hours without losing their power of conduction,—that is, without showing fatigue. Many other observers have obtained similar results, which have confirmed physiologists in the belief that the nerve fibers may conduct impulses indefinitely, or, in other words, that their normal functional activity may be carried on continuously without fatigue. If this belief is entirely correct it would place the nerve fibers in a class by themselves, since all other tissues that have been studied show evidence of fatigue when kept in continuous functional activity. Moreover, if this belief is entirely correct it would imply that the conduction of an impulse in the nerve fiber is not associated with a consumption of material,

\* Bowditch, "Journal of Physiology," 6, 133, 1885.

† Durig, "Centralblatt f. Physiol.," 15, 751, 1902.

‡ Edes, "Journal of Physiology," 13, 431, 1892.

§ Brodie and Halliburton, "Journal of Physiology," 28, 181, 1902.

a metabolism, and in this respect also the functional activity of the nerve would be placed in contrast with that of other organs. It must be remembered, however, that, although the above experiments demonstrate the practical "unfatigueableness" of nerve fibers under ordinary conditions of stimulation, there are some reasons to make us hesitate in supposing that in these structures functional activity is entirely without a depressing effect upon irritability. Garten has shown that one nerve, the olfactory of the pike, when stimulated by induction shocks, with an interval between the stimuli of as much as 0.27 sec., gives evidence of fatigue, since its action current, as measured by the capillary electrometer, diminishes in extent quite rapidly, and recovers after a short rest.\* So also it has been found that while a nerve deprived of oxygen, by keeping it in an atmosphere of nitrogen, loses its irritability after a certain time, this event occurs much more rapidly if the nerve is stimulated constantly.† This fact would suggest that some oxygen is consumed during functional activity, and that the ability of the nerve under normal circumstances to escape the results of fatigue may be due possibly to the fact that the supply of oxygen is sufficiently abundant to oxidize promptly the fatigue substances formed during activity.

**Does the Nerve Fiber Show Any Evidence of Metabolism During Functional Activity?**—The functional part of a nerve fiber in conduction is the axis cylinder, and, indeed, probably the neurofibrils in the axis cylinder. The mass of this material, even in a large nerve trunk, is small (about 9 per cent.), and its chemistry is but little known. The efforts that have been made to prove a metabolism in the nerve fiber during activity have been directed along the lines indicated by what is known of muscle metabolism. In a muscle during contraction heat is produced, the substance of the muscle shows an acid reaction, and carbon dioxide is formed. Efforts to show similar reactions in stimulated nerves have been only partially successful. Rolleston‡ investigated the question of heat production with the aid of a delicate bolometer capable of indicating a difference of temperature of  $\frac{1}{100000}$ ° C. The frog's sciatic was used, but no increase in temperature during stimulation could be demonstrated. Making use of a more sensitive instrument, Hill has obtained the same negative result. If any heat is produced by the transmission of a nerve impulse it must be less, according to his measurements, than a hundred-millionth

\* Quoted from Biedermann, "Ergebnisse der Physiologie," vol. ii, part ii, p. 129.

† Thörner, "Zeitschrift f. allg. Physiologie," 8, 530, 1908.

‡ Rolleston, "Journal of Physiology," 11, 208, 1890.

of a degree centigrade.\* On the other hand, Tashiro† reports that, by means of a new method which is capable of detecting as little as 0.0000001 gm. of carbon dioxid, he has been able to show that the resting nerve produces carbon dioxid and that this production is increased about two and a half times when the nerve is stimulated. Additional evidence for the occurrence of a nerve metabolism during activity is found in the fact, already alluded to, that oxygen plays a part in maintaining the irritability of nerves. An excised frog's nerve loses its irritability in an atmosphere deprived of oxygen, and regains it promptly when oxygen is again supplied. When stimulated in an atmosphere free from oxygen the nerve shows signs of fatigue, while in the presence of oxygen activity is maintained, one may say indefinitely, under continuous stimulation. These facts warrant the belief that oxygen is used by the nerve during activity, and presumably it is used in this as in the other tissues to produce physiological oxidations. Another fact which points in the same direction is the high value of the temperature coefficient for nerve conduction, which has been referred to above. Bearing these two general considerations in mind, we can hardly escape the conviction that the functional activity of the nerve fiber is connected with a chemical reaction of some kind, most probably a reaction in which some material in the nerve undergoes oxidation.

**Views as to the Nature of the Nerve Impulse.**—The older conceptions of the nerve principle, while they varied in detail, were based upon the general idea that the nervous system contains a matter of a finer sort than that visible to our senses. This matter was pictured at first as a spirit (animal spirits), and later as a material comparable to the luminiferous ether or to electricity. Since the discovery that the nerve impulse travels with a relatively slow velocity and is accompanied by a demonstrable change in the electrical condition of the nerve, many different views regarding its nature have been proposed. In discussing the matter it is evident that two perhaps different phenomena have to be considered, namely, the act of excitation by natural or artificial stimuli and the act of propagation or conduction. Formerly, it was held in a general way that the nerve impulse depends upon the breaking down of some unstable substance within the axis cylinder. It was assumed that this sensitive and unstable material is upset by the energy of the stimulus at the point stimulated, and that the energy thus liberated acts upon contiguous particles, and so the disturbance is propagated along the nerve as a progressive chemical

\* Hill, "Journal of Physiology," 43, 433, 1911-12.

† Tashiro, "American Journal of Physiology," "Proc. of Am. Physiological Soc.," 31, 22, 1913.



change which in a very general way may be compared to the passage of a spark along a line of gunpowder. A fundamental objection to such a view is the uncertainty of the proof regarding the consumption of material in a nerve during activity, as has been explained in the preceding sections. Quite the opposite point of view has also been held, namely, the idea that the nerve impulse is a purely physical process, which involves no chemical change and no using up of material. Various suggestions have been offered as to the character of this physical change, but the one that is perhaps most worthy of consideration identifies the nerve impulse with the negative electrical change that is known to pass along the fiber. It is assumed that this electrical change constitutes the nerve impulse, and to explain its occurrence and propagation from a physical standpoint it has been supposed that the nerve fiber has a structure essentially similar to the "core conductor" (see p. 108), in that it contains a central thread surrounded by a liquid sheath of less conductive material. The central thread may be supposed to be the axis cylinder and the less conductive sheath the surrounding myelin, or, perhaps, to follow another suggestion that fits the non-medullated as well as the medullated fibers, the central threads are represented by the neurofibrils within the axis cylinder and the surrounding sheath by the perifibrillar substance. That the axis cylinder is a better conductor than the myelin sheath has been indicated by the microchemical researches of Macallum. This observer has shown that in the axis cylinder the chlorids exist in greater concentration than in the surrounding sheath.\* The point of importance is that, with a core model (see Fig. 50), consisting of a glass tube with a core of platinum wire and a sheath of solution of sodium chlorid, 0.6 per cent., electrical phenomena can be obtained similar to those shown by the stimulated nerve. If an induction current, serving as a stimulus, is sent into one end of such an artificial nerve and from the other end two leading off electrodes are connected with a galvanometer, then we can demonstrate by means of the galvanometer that an electrical charge is propagated along the model at each application of the stimulus. And, as such a moving electrical disturbance is the only objective phenomenon known to occur in the stimulated nerve, it has been assumed that it constitutes the nerve impulse. When this electrical disturbance reaches the end-organ,—the muscle, for instance,—it initiates the chemical changes that characterize the activity of the organ. This kind of theory makes the nerve impulse an electrical phenomenon, and assumes that the nerve fibers have become differentiated to form a specific kind of

\* Macallum, "Proceedings of the Royal Society," 1906, B. lxxvii., 165.

conductor, the efficiency of which depends upon its having a structure similar to that of a "core conductor." Other theories of a physico-chemical character have been proposed especially to explain the initial excitation caused by a stimulus and the electrical phenomena responsible for the action current. Nernst has supposed that the electrolytes contained in the axis cylinder lie within membranous partitions which are impermeable to the passage of certain ions. When an electrical current is passed through a nerve, it is conveyed of course by the dissociated electrolytes, and in consequence of the impermeable character of the septa, there will be a concentration of positively charged ions at one face of the membranes and of negatively charged ions at the other. When the concentration of the ions reaches a certain point, excitation occurs. The nature of the excitation under such circumstances has been further imagined by Hill, who suggests that some sensitive substance, presumably a colloid, exists in the nerve in combination with certain ions. This combination is in an unstable or critical state, and when, in consequence of a stimulus of any kind, the concentration of ions in combination with it is increased, it breaks down and this act constitutes the excitation, which is then propagated along the nerve. This author has treated his assumption mathematically to ascertain how far it accords with the known facts of the stimulation of nerves with electrical currents. It should be added that these and, indeed, all specific theories of the nature of the nerve impulse are, at present, matters for discussion and experiment among specialists. We are far from having an explanation of the nerve impulse resting upon such an experimental basis as to command general acceptance.\*

**Qualitative Differences in Nerve Impulses and Doctrine of Specific Nerve Energies.**—Whether or not the nerve impulses in various nerve fibers differ in kind is a question of great interest in physiology. The usually accepted view is that they are identical in character in all fibers and vary only in intensity. According to this view, a sensory nerve—the auditory nerve, for instance—carries impulses similar in character to those passing along a motor nerve, and the reason that in one case we get a sensation of hearing and in the other a contraction of a muscle is found in the manner of ending of the nerve, one terminating in a special part of the cortex

\* For a summary of the literature upon the nature of the nerve impulse consult Boruttau, "Zeit. f. allg. Physiologie," 1, 1, Sammelreferate, 1902; Biedermann, "Ergebnisse der Physiologie," vol. ii, part ii, 1903; Hering, "Zur Theorie der Nerventhätigkeit," 1899; Hill, "Journal of Physiology," 40, 190, 1910; Lucas, *ibid.*, p. 224; and Croonian Lecture, "Proceedings Royal Society," B. 85, 582, 1912; Tashiro, "Proceedings of the National Academy of Sciences," 1, 110, 1915.

of the cerebrum, the other in a muscle. From this standpoint the nerve fibers may be compared to electrical wires. The current conducted by the wires is similar in all cases, but may give rise to very different effects according to the way in which the wires terminate, whether in an explosive mixture, an arc light, or solutions of electrolytes of various kinds. We have in physiology what is known as the doctrine of specific nerve energies, first formulated by Johannes Müller. This doctrine expresses the fact that nerve fibers when stimulated give only one kind of reaction, whether motor or sensory, no matter in what way they may be stimulated. The optic nerve, for instance, gives us a sensation of light, usually because light waves fall on the retina and thus stimulate the optic nerve. But if we apply other forms of stimulation to the nerve they will also, if effective, give a sensation of light. Cutting the optic nerve or stimulating it with electrical currents gives visual sensations. On the identity theory of the nerve impulses the specific energies of the various nerves—that is, the fact that each gives only one kind of response—is referred entirely to the characteristics of the tissue in which the fibers end. If, as has been said, one could successfully attach the optic nerve to the ear and the auditory nerve to the retina then we should see the thunder and hear the lightning.

The alternative theory supposes that nerve impulses are not identical in different fibers, but vary in quality as well as intensity, and that the specific energies of the various fibers depend in part at least on the character of the impulses that they transmit. On this theory one might speak of visual impulses in the optic nerves as something different in kind from the auditory impulses in the auditory fibers. With our present methods of investigation the question is one that can not be definitely decided by experimental investigation; most of the discussion turns upon the applicability of the doctrine to the explanation of various conscious reactions of the sensory nerves.

So far as experimental work has been carried out on efferent nerves, it is undoubtedly in favor of the identity theory. The action current is similar in all nerves examined; the reactions to artificial stimuli are essentially similar. Moreover, nerves of one kind may be sutured to nerves of another kind, and, after regeneration has taken place, the reactions are found to be determined solely by the place of ending (see p. 81).

#### **The Nutritive Relations of the Nerve Fiber and Nerve Cell.**

—In recent times in accordance with the so-called neuron doctrine (see p. 129) every axis cylinder has been considered as a process of a nerve cell, and therefore as a part, morphologically speaking, of that cell. However this may be, there is excellent experimental

evidence to show that the physiological integrity of the axis cylinder depends upon its connection with its corresponding nerve cell. This view dates from the interesting work of Waller,\* who showed that if a nerve be severed the peripheral stump, containing the axis cylinders that are cut off from the cells, will degenerate in a few days. The process of degeneration brought about in this way is known as secondary or Wallerian degeneration. The central stump, on the contrary, remains intact, except for a short region immediately contiguous to the wound, for a relatively long period, extending perhaps over years. Waller, therefore, spoke of the nerve cells as forming the nutritive centers for the nerve fibers, and this belief is generally accepted. In what way the cell regulates the nutrition of the nerve fiber throughout its whole length is unknown. Some of the cells in the lumbar spinal cord, for instance, give rise to fibers of the sciatic nerve which may extend as far as the foot, and yet throughout their whole length the nutritive processes in these fibers are dependent on influences of an unknown kind, emanating from the nerve cells to which they are joined. These influences may consist simply in the effect of constant activity; that is, in the conduction of nerve impulses, or there may be some kind of an actual transferal of material. This latter idea is supported by the interesting fact, which we owe to Meyer, that tetanus and diphtheria toxins may be transmitted to the central nervous system by way of the axis cylinders of the nerve fibers. By means of his method Waller investigated the location of the nutritive centers for the motor and sensory fibers of the spinal nerves. If an anterior root is cut the peripheral ends of the motor fibers degenerate throughout the length of the nerve, while the fibers in the stump attached to the cord remain intact; hence the nutritive centers for the motor fibers must lie in the cord itself. Subsequent histological work has corroborated this conclusion and shown that the motor fibers of the spinal nerves take their origin from nerve cells lying in the anterior horn of gray matter in the cord, the so-called motor or anterior root cells. If the posterior root is cut between the ganglion and the cord, the stump attached to the cord degenerates; that attached to the ganglion remains intact, and there is no degeneration in the nerve peripheral to the ganglion (Fig. 55). If, however, this root is severed peripherally to the ganglion degeneration takes place only in the spinal nerve beyond the ganglion. The nutritive center, therefore, for the sensory fibers must lie in the posterior root ganglion, and not in the cord. This conclusion has also been abundantly corroborated by histological work. It is known that the sensory fibers arise from the nerve cells in these ganglia.

\* Waller, "Müller's Archiv," 1852, p. 392; and "Comptes rendus de l'Acad. de la Science," vol. xxxiv., 1852.

By the same means it has been shown that the motor fibers in the cranial nerves arise from nerve cells (nuclei of origin) situated in the brain, while the sensory fibers of the same nerves, with the exception of the olfactory and optic nerves which form special cases, arise from sensory ganglia lying outside the nervous axis, such, for

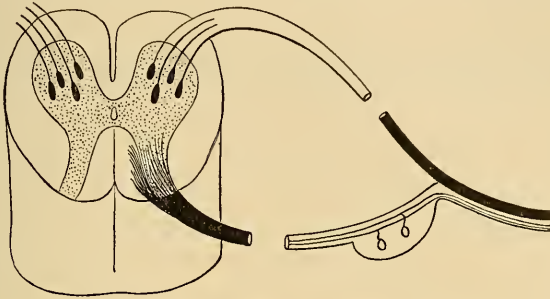

Fig. 55.—Diagram to show the direction of degeneration on section of the anterior and the posterior root, respectively. The degenerated portion is represented in black.

instance, as the spiral ganglion of the cochlear nerve, or the ganglion semilunare (Gasserian ganglion) of the fifth cranial nerve.

**Nerve Degeneration and Regeneration.**—When a nerve trunk is cut or is killed at any point by crushing, heating, or other means all the fibers peripheral to the point of injury undergo degeneration. This is an incontestable fact, and it is important to bear in mind the fact that the definite changes included under the term degeneration are exhibited only by living fibers. A dead nerve or the nerves in a dead animal show no such changes.\* The older physiologists thought that if the severed ends of the nerves were brought together by sutures they might unite by first intention without degeneration in the peripheral end. We know now that this degeneration is inevitable once the living continuity of the fibers has been interrupted in any way. Any functional union that may occur is a slow process involving an act of regeneration of the fibers in the peripheral stump. The time required for the degeneration differs somewhat for the different kinds of fibers found in the animal body. In the dog and in other mammalia the degeneration begins in a few (four) days; in the frog it may require from thirty to one hundred and forty days, depending upon the season of the year, although if the frog is kept at a high temperature (30° C.) degeneration may proceed as rapidly as in the mammal. In the dog it proceeds so quickly that the process seems to be simultaneous throughout the whole peripheral stump, while in the frog, and, according to Bethe,

\* See Van Gehuchten, "Le Névraie," 1905, vii., 203.

in the rabbit, it can be seen clearly that the degenerative changes begin at the wound and progress peripherally. The fibers break up into ellipsoidal segments of myelin, each containing a piece of the axis cylinder, and these segments in turn fragment very irregularly into smaller pieces which eventually are absorbed\* (Fig. 56). The central stump whose fibers are still connected with the nerve cells undergoes a similar degeneration in the area immediately contiguous to the wound, but the degenerative processes extend for only a short distance over an area covering a few internodal segments. Although the central ends of the fibers remain substantially intact, it is interesting to find that the nerve cells from which they originate undergo distinct changes, which show that they are profoundly affected by the interruption of their normal connections (see p. 127). In the peripheral end the process of regeneration begins almost simultaneously with the degenerative changes, the two proceeding, as it were, hand in hand. The regeneration is due to the activity of the nuclei of the neurilemmal sheath. These nuclei begin to multiply and to form around them a layer of protoplasm, so that as the fragments of the old fiber disappear their place is taken by numerous nuclei and their surrounding cytoplasm. Eventually there is formed in this way a continuous strand of protoplasm with many nuclei, and the fiber thus produced, which has no resemblance in structure to a normal nerve fiber, is described by some authors as an "embryonic fiber"; by others as a "band fiber" (Fig. 57). In the adult animal the process of regeneration stops at this point unless an anatomical connection is established with the central stump, and, indeed, such a connection is usually established unless special means are taken to prevent it. The central and peripheral stumps find each other in a way that is often remarkable, the union being guided doubtless by intervening connective tissue.

Forsmanns† has emphasized this peculiar attraction, as it were, between the peripheral and the central ends, giving some reason to believe that it is a case of chemotaxis or chemotropism. When the ends of the nerves were given very unusual positions by means of collodium tubes into which they were inserted they managed to "find" each other. Moreover, he states that a central stump, if given an equal opportunity to grow into two collodium tubes, one containing liver and the other brain tissue, will chose the latter, a fact which would indicate some underlying chemical attraction or affinity in nerve tissue for nerve tissue. A directive influence of this kind depending upon some property connected with chemical relationship is designated as "chemotaxis."

If the central and peripheral stumps are brought together by

\* See Howell and Huber, "Journal of Physiology," 13, 335, 1892; also Mott and Halliburton, "Proceedings Royal Society," 1906, B. lxxviii., 259, and Cajal, "Trabajos del laboratorio de investigaciones biologicas (Univ. of Madrid)," vol. 4, 119, 1906.

† Forsmanns, "Zeigler's Beiträge," 27, 216, 1902.



Fig. 56.—Histology of a degenerating nerve fiber.

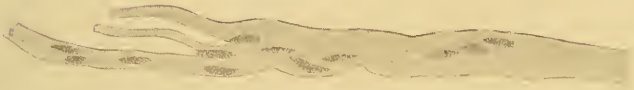

Fig. 57.—Embryonic fibers in a regenerating nerve.



Fig. 58.—A newly developed fiber in a regenerating nerve fiber.





suture or grow together in any way, then, under the influence of the central end, the "band fiber" gradually becomes transformed into a normal nerve fiber, with myelin sheath and axis cylinder (Fig. 58). It is possible that this result is due to local processes in the band fiber stimulated by nutritive influences of some kind from the central stump, but more probably there is an actual down-growth of the axis cylinders from the central ends. In support of this latter view, it may be said that the outgrowth of the new axis cylinders from the old ones present in the fibers of the central stump has been followed more or less successfully by a number of histologists.

Bethe\* has thrown some doubt upon this view, for he has shown apparently that in young mammals (eight days to eight weeks) the regeneration of the fibers in the peripheral stump does not stop at the stage of "band fibers," but progresses until perfectly normal nerve fibers are produced, even though no connection is made with the central stump. It should be added, however, that the fibers so formed do not persist indefinitely unless they become connected with the central stump. If this connection fails to take place, the newly formed fibers will degenerate after an interval of some months. Still, the fact, if true, that in the young fiber the regeneration is complete seems to indicate that the axis cylinder may arise independently of the fibers in the central stump.

Whether or not Bethe's observations upon the autoregeneration of the axis cylinders in the severed nerves of young animals can be accepted is doubtful, the balance of evidence at present seems to indicate that what he took for autoregenerated fibers were really fibers which grew into the degenerated trunk from the surrounding tissue.

**Degenerative Changes in the Neuron on the Central Side of the Lesion.**—According to the Wallerian law of degeneration, as originally stated, the nerve fiber on the central side of the injury and the nerve cell itself do not undergo any change. As a matter of fact, the central stump immediately contiguous to the lesion undergoes typical degeneration and regeneration similar to that described for the fibers of the peripheral stump. The immediate degenerative changes in the fibers in the central stump were supposed to extend back only to the first node of Ranvier,—to affect, therefore, only the internodal segment actually injured. Later it was found that the degeneration may extend back over a distance of several internodal segments. This limited degeneration on the central side must be considered as traumatic,—that is, it involves only those portions directly injured by the lesion. The central end of the fiber in general was supposed to remain intact as long as its cell of origin was normal. It was thought at first that after simple section of a nerve trunk, in amputation, for instance, the nerve cells and central stumps remain normal throughout the life

\* Bethe, "Allgemeine Anat. u. Physiologie des Nervensystems," 1903.

of the individual. Dickinson, however, in 1869\* showed that in amputations of long standing the motor cells in the anterior horn of the cord decrease in number and the fibers in the central stump become atrophied. This observation has been corroborated by other observers, and it is now believed that after section of a nerve chronic degenerative changes ensue in the course of time in the central fibers and their cells, resulting in their permanent atrophy. We have, in such cases, what has been called an atrophy from disuse. A fact that has been discovered more recently and that is perhaps of more importance is that the nerve cells do undergo certain definite although usually temporary changes immediately after the section of the nerve fibers arising from them. It has been shown that when a nerve is cut the corresponding cells of origin may show distinct histological changes within the first twenty-four hours. These changes consist in a circumscribed destruction of the chromatin material in the cells (chromatolysis), which in a short time extends over the whole cell, so that the primary staining power of the cell is lost (condition of achromatosis) (see Fig. 63). The cell also becomes swollen and the nucleus may assume an excentric position. These retrogressive changes continue for a certain period (about eighteen days). After reaching their maximum of intensity the cells usually undergo a process of restitution and regain their normal appearance, although in some cases the degeneration is permanent. According to other observers a number of the cells in the spinal cord and spinal ganglia undergo simple atrophy after section of their corresponding nerves, and some of the nerve fibers in the central stumps may also show atrophy, while others undergo a genuine degeneration, which, however, comes on much later than in the peripheral stumps. It seems evident that the behavior of the cells and fibers on the central side of the section is not uniform; atrophy rather than degeneration is the change that is prominent, and this atrophy in some neurons occurs early, while in others it is apparent only after a long interval of time. An explanation of this variation in the reaction of the nerve cells and their disconnected central stumps cannot yet be given. On the peripheral side of the section, as stated above, the degenerative changes are complete and affect all of the fibers.†

\* "Journal of Anatomy and Physiology," 3, 176, 1869.

† Nissl, "Allgemeine Zeitschrift f. Psychiatrie," 48, 197, 1892. Also Bethe, *loc. cit.*, and Ranson, "Retrograde Degeneration in the Spinal Nerves," The Journal of Comparative Neurology and Psychology, 1906, xvi., 265.

## SECTION II.

# THE PHYSIOLOGY OF THE CENTRAL NERVOUS SYSTEM.

---

## CHAPTER VI.

### STRUCTURE AND GENERAL PROPERTIES OF THE NERVE CELL.

**The Neuron Doctrine.**—Since the last decade of the nineteenth century the physiology of the nervous system has been treated from the standpoint of the neuron. According to this point of view, the entire nervous system is made up of a series of units, the neurons, which are not anatomically continuous with each other, but communicate by contact only. It has been taught also that each neuron represents from an anatomical and physiological standpoint a single nerve cell. The typical neuron consists of a cell body with short, branching processes, the dendrites, and a single axis cylinder process, the axon or axite, which becomes a nerve fiber, acquiring its myelin sheath at some distance from the cell. According to this view, the peripheral nerve fibers are simply long processes from nerve cells. Within the central nervous system each neuron connects with others according to a certain schema. The axon of each neuron ends in a more or less branched "terminal arborization," forming a sort of end-plate which lies in contact with the dendrites of another neuron, or in some cases with the body of the cell itself, the essentially modern point of view being that where the terminal arborization of the axon meets the dendrites or body of another neuron the communication is by contact, the neurons being anatomically independent units. It is usually accepted also as a part of the neuron doctrine that the conduction of a nerve impulse through a neuron is always in one direction, that the dendrites are receiving organs, so to speak, receiving a stimulus or impulse from the axon of another unit and conveying this impulse toward the cell body, while the axon is a discharging

process through which an impulse is sent out from the cell to reach another neuron or a cell of some other tissue. The neuron, so far as conduction is concerned, shows a definite polarity, the conduction in the dendrites being cellulipetal, in the axons, cellulifugal.

The neuron doctrine, so far as the name at least is concerned, dates from a general paper by Waldeyer,\* in which the newer work up to that time was summarized. The main facts upon which the conception rests were furnished by His (1886), to whom we owe the generally accepted belief that the nerve fiber (axis cylinder) is an outgrowth from the cell, and secondly by Golgi, Cajal, and a host of other workers, who, by means of the new method of Golgi, demonstrated the wealth of branches of the nerve cells, particularly of the dendrites, and the mode of connection of one nerve unit with another. The view that these units are anatomically independent and on the embryological



Fig. 59.—Motor cell, anterior horn of gray matter of cord. From human fetus (*Lenhossek*): \* marks the axon; the other branches are dendrites.

side are derived each from a single epiblastic cell (neuroblast) has proved acceptable and most helpful; but the validity of this hypothesis has been called into question from time to time. As was stated on p. 127, Bethe has claimed that in young animals the nuclei of the neurilemmal sheath may regenerate a new nerve fiber containing axis cylinder and myelin sheath, and this fact, if true, at once brings into question the hitherto accepted belief

\* "Deut. med. Wochenschrift," 1891, p. 59.

that the axis cylinder can be formed only as an outgrowth from a nerve cell. Some histologists—Apáthy, Bethe, Nissl—have also attacked the most fundamental feature of the neuron doctrine—the view, namely, that each neuron represents an independent anatomical element. These authors contend that the neurofibrils of the axis cylinder pass through the nerve cells and enter by way of a network into direct connection with the neurofibrils of other neurons (see Fig. 64). The neurofibrils form a continuum through which nerve impulses pass without a break from neuron to neuron. According to this conception, the ganglion cells play no direct part in the conduction of the impulse from one part of the nervous system to another; the neurofibrils alone, and the intracellular and pericellular networks with which they connect, form the conducting paths that are everywhere in continuity. In the explanation given below of the activities of the nervous system, the author, following the usual custom, makes use of the neuron doctrine.

**The Varieties of Neurons.**—The neurons differ greatly in size, shape, and internal structure, and it is impossible to classify them with entire success from either a physiological or an anatomical standpoint. Neglecting the unusual forms whose occurrence is limited and whose structure is perhaps incompletely known, there are three distinct types whose form and structure throw some light on their functional significance:

I. The bipolar cells. This cell is found in the dorsal root ganglia of the spinal nerves and in the ganglia attached to the sensory fibers of the cranial nerves, the ganglion semilunare (Gasserian) for the fifth cranial, the g. geniculi for the seventh, the g. vestibulare and g. spirale for the eighth, the g. superius and g. petrosum for the ninth, the g. jugulare and g. nodosum for the tenth.

The typical cell of this group is found in the dorsal root ganglia. In the adult the two processes arise as one, so that the cell seems to be unipolar, but at some distance from the cell this process divides in T, one branch passing into the spinal cord via the posterior root, the other entering the spinal nerve as a sensory nerve fiber to be distributed to some sensory surface. Both processes become medullated and form typical nerve fibers. That these apparently unipolar cells are really bipolar is shown not only by this division into two distinct fibers, but also by a study of their development in the embryo. In early embryonic life the two processes arise from different poles of the cell, and later become fused into an apparently simple process (Fig. 60). The striking characteristics of this cell, therefore, are that it gives rise to two nerve fibers, and that it possesses no dendritic processes. On the physiological side these cells might be designated as sensory cells, since they appear to be associated always with sensory nerve fibers.

The nerve cells found in the sensory ganglia exhibit, as a matter of fact, a number of different types, some of which possess short dendritic processes. These histological variations cannot as yet be given a physiological significance, but their occurrence certainly seems to indicate a possibility that the sensory ganglia may have a much more varied physiological activity

than has been attributed to them heretofore. For a description of these ganglia and a classification of their cells under eight different types consult Cajal in "Ergebnisse der Anat. u. Entwicklungsgeschichte," vol. xvi., 1906, and Dogiel, "Bau der Spinalganglien, etc.," Jena, 1908.

So far as the sensory fibers of the spinal and cranial nerves are concerned, it is worth noting also that all of them arise from cells lying outside the main axis of the central nervous system. It has been a question whether the sensory impulses brought to the ganglion cells through the peripheral process (sensory



Fig. 60.—Bipolar cells in the posterior root ganglion. Section through spinal ganglion of newborn mouse (*Lenhossek*): *a*, The spinal ganglion; *b*, the spinal cord; *c*, the posterior, *d*, the anterior root.

fiber) pass into the body of the cell before going on to the cord or brain, or whether at the junction of the two processes they simply pass on directly to the cord. According to the histological structure there is no apparent reason why an impulse should not pass directly from the peripheral to the central process at the junction, but whether or not this really occurs and the relation of the ganglion cell to the conducting path are questions that must be left unsettled at present.

II. The multipolar cells. The processes of these cells fall into two groups: the short and branching dendrites with an inner structure resembling that of the cell body, and the axon or axis cylinder process (Fig. 59). According to the structure of this last process, this type may be classified under two heads: Golgi cells of the first and the second type. The cells of the first type are characterized by the fact that the axon leaves the central gray matter and becomes a nerve fiber. This nerve fiber within the central nervous system may give off numerous collaterals, each of which ends in a

terminal arborization. By this means the neurons of this type may be brought into physiological connection with a number of other neurons. This kind of nerve cell is frequently described as the typical nerve cell. Golgi supposed that it represents the motor type of cell, and this view is, in a measure, borne out by subsequent investigation. The distinctly motor cells of the central nervous system—such, for instance, as the pyramidal cells of the cerebral cortex, the anterior horn cells of the spinal cord, the Purkinje cells of the cerebellum—all belong to this



Fig. 61.—Golgi cell (second type). The axon, *a*, divides into a number of fine branches.—(From Obersteiner, after Andriezen.)

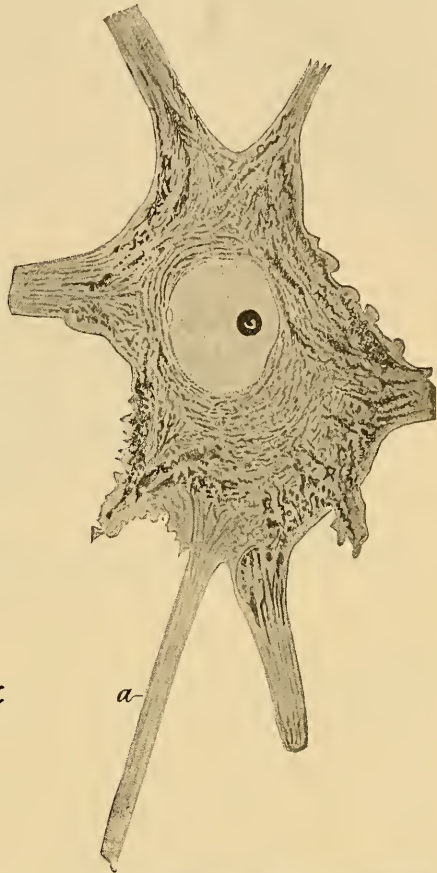

Fig. 62.—Normal anterior horn cell (Warrington), showing the Nissl granules in the cell and dendrites: *a*, The axon.

type. But within the nerve axis most of the conduction from neuron to neuron, along sensory as well as motor paths, is made with the aid of such structures, the dendrites being the receptive or sensory organ and the axon the motor apparatus.

The Golgi cells of the second type (Fig. 61) are relatively less numerous and important. They are characterized by the fact that the axon process instead of forming a nerve fiber splits into a great number of branches within the gray matter. Assuming

that in such cells the distinction between the axon and the dendrites is well made and that as in the other type the dendrites form the receiving and the axon the discharging apparatus, these cells would seem to have a distributive function. The impulse that they receive may be transmitted to one or many neurons. They are sometimes spoken of as intermediate or association cells.

**Internal Structure of the Nerve Cell.**—Within the body of the nerve cell itself the striking features of physiological significance are, first, the arrangement of the neurofibrils, and, second, the

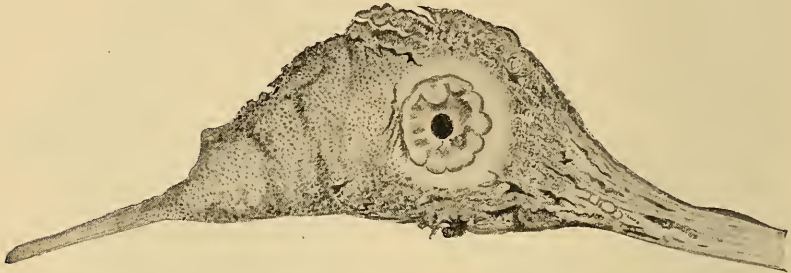

Fig. 63.—Anterior horn cell fourteen days after section of the anterior root (*Warrington*): To show the change in the nucleus and the Nissl granules, beginning chromatolysis.

presence of a material in the form of granules, rods, or masses which stains readily with the basic anilin dyes, such as methylene blue, thionin, or toluidin blue. This latter substance is spoken of as the “chromophile substance,” tigroid, or more frequently as Nissl’s granules, after the histologist who first studied it successfully. These masses or granules are found in the dendrites as well as in the cell, but are absent from the axon (see Fig. 62). Little is known of their composition or significance, but their presence or absence is in many cases characteristic of the physiological condition of the cell. After lesions or injuries of the neuron the material may become dissolved and diffused through the cell or may decrease in amount or disappear, and it seems probable, therefore, that it represents a store of nutritive material (Fig. 63). The non-staining material of the cell, according to most recent observers, contains neurofibrils which are continued out into the processes, dendrites as well as axons. These fibrils may be regarded as the conducting structure along which passes the nerve impulse. The arrangement of these fibrils within the cell is not completely known, the results obtained varying with the methods employed. A matter of far-reaching importance on the physiological side is the question of



the existence of an extracellular nervous network. Most recent histologists agree in the belief that there is a delicate network surrounding the cells and their protoplasmic processes. This pericellular net or Golgi's net is claimed by some to be a nervous structure connecting with the neurofibrils inside the cell and forming not only a bond of union between the neurons, but possibly also an important intercellular nervous structure that may play an important rôle in the functions of the nerve centers. This view is represented schematically in Fig. 64. According to others, this network around and outside the cells is a supporting tissue simply that takes no part in the activity of the nerve units.

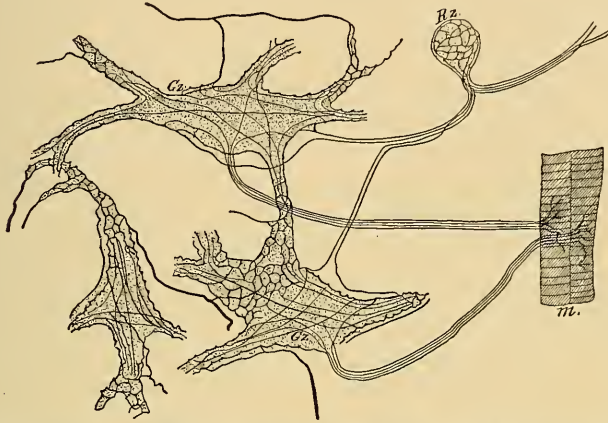

Fig. 64.—Bethe's schema to indicate the connections of the pericellular network: *Rz*, A sensory cell in the posterior root ganglion; the fibrils in the branch that runs to the cord are indicated as connecting directly with the pericellular network of the motor cells, *Gz*.

**General Physiology of the Nerve Cell.**—Modern physiologists have considered the cell body of the neuron, including the dendrites, as the source of the energy displayed by the nervous system, and it has been assumed that this energy arises from chemical changes in the nerve cell, as the energy liberated by the muscle arises from or is dependent upon the chemical changes in its substance. It would follow from this standpoint that evidences of chemical activity should be obtained from the cells and that these elements should exhibit the phenomenon of fatigue. Regarding this latter point, it is believed in physiology that the nerve cells do show fatigue. The nerve centers fatigue as the result of continuous activity, as is evident from our personal experience in prolonged intellectual or emotional activity and as is implied in the necessity of sleep for recuperation and by the rapidity with which functional

activity is lost on withdrawal of the blood supply. Objectively, also, it has been shown in the ergographic experiments (see p. 50) that the well-known fatigue of the neuromuscular apparatus possibly affects the nerve centers as well as the muscle. Assuming that the nerve cells are the effective agent in the nerve centers, such facts indicate that they are susceptible to fatigue under what may be designated as the normal conditions of activity. But we have no very direct proof that this property is possessed universally by the nerve cells nor any indication of the probable differences in this regard shown by nerve cells in different parts of the central nervous system. It seems probable that under normal conditions—that is, under the influence of what we may call minimal stimuli—some portions of the nerve centers remain in more or less constant activity during the day without showing a marked degree of fatigue, just as our muscles remain in a more or less continuous state of tonic contraction throughout the waking period at least. Doubtless when the stimulation is stronger the fatigue is more marked, because the processes of repair in the nerve centers can not then keep pace with the processes of consumption of material. In general, it may be held that every tissue exhibits a certain balance between the processes of consumption of material associated with activity and the processes of repair. If a proper interval of rest is allowed, the tissue will function without exhibiting fatigue, as is the case with the heart and the respiratory center. If, however, the stimulation is too strong or is repeated at too brief an interval, then the processes of repair do not keep pace with those of consumption, or the products of functional activity are not completely removed, and in either case we have the phenomenon of fatigue, that is to say, a depression of normal irritability. The point of importance is to determine the differences in this respect between the different tissues. Our actual knowledge on this point as regards nerve cells is quite incomplete. Evidence of a probable chemical change in the nerve cells during activity is found in the readiness with which the gray matter of the nervous system takes on an acid reaction.\* In the fresh resting state it is probably alkaline or neutral, but after death it quickly shows an acid reaction, due, it is said, to the production of lactic acid. Its resemblance to the muscle in this respect leads to the inference that in functional activity acid is also produced. Mosso states that in the brain increased mental activity is accompanied by a rise in the temperature of the brain.† His experiments were made upon individuals with an opening in the skull through which a

\* Langendorff, "Centralbl. f. d. med. Wiss.," 1886. See also Halliburton, "The Croonian Lectures on The Chemical Side of Nervous Activity," 1901.

† Mosso, "Die Temperatur des Gehirns," 1894.

delicate thermometer could be inserted so as to lie in contact with brain. So also the facts briefly mentioned in regard to the Nissl granules give some corroborative evidence that the activity of the nervous system is accompanied by and probably caused by a chemical change within the cells, since the excessive activity of the nerve cells seems to be accompanied by some change in these granules, and in abnormal conditions associated with loss of functional activity the granules undergo chromatolysis,—that is, they are disintegrated and dissolved. Obvious histological changes which imply, of course, a change in chemical structure, have been observed by a number of investigators.\* All seem to agree that activity of the tissue, whether normal or induced by artificial stimulation, may cause visible changes in the appearance of the cell and its

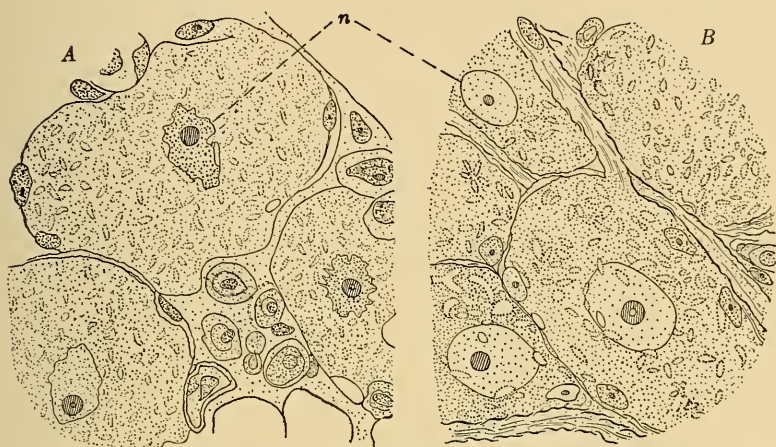

Fig. 65.—Spinal ganglion cells from English sparrows, to show the daily variation in the appearance of the cells due to normal activity: *A*, Appearance of cells at the end of an active day; *B*, appearance of cells in the morning after a night's rest. The cytoplasm is filled with clear, lenticular masses, which are much more evident in the rested cells than in those fatigued.—(Hodge.)

nucleus. Activity within normal limits may cause an increase in the size of the cell together with a diminution in the stainable (Nissl) substance, and excessive activity a diminution in size of the cell and the nucleus, the formation of vacuoles in the cell body, and a marked effect upon the stainable material. Hodge has shown that in birds, for instance, the spinal ganglion cells of a swallow killed at nightfall after a day of activity exhibit a marked loss of substance as compared with similar cells from an animal killed in the early morning (Fig. 65). Dolley† also states that in

\* See especially Hodge, "Journal of Morphology," 7, 95, 1892, and 9, 1, 1894.

† Dolley, "American Journal of Physiology," 25, 151, 1909.

the dog the cerebellar cells exhibit a definite series of changes in the chromatic substance, both that within the nucleus and that within the cytoplasm (Nissl's granules) following upon prolonged muscular activity or after such conditions as shock or anemia. If these conditions are extreme, the chromatin material may be entirely removed from the cells, and this he interprets as an indication of a functionally exhausted cell.

It must be remembered, however, that our knowledge of the nature of the chemical changes that occur in the cell during activity is very meager. Presumably carbon dioxide and lactic acid are formed as in muscle, and we know that oxygen is consumed. Enough is known perhaps to justify the general view that the energy exhibited by the nervous system is derived, in the long run, from a metabolism of material in the nerve cells, a metabolism which consists essentially in the splitting and oxidation of the complex substances in the protoplasm of the cell.

**Summation of the Effects of Stimuli.**—In a muscle a series of stimuli will cause a greater amount of shortening than can be obtained from a single stimulus of the same strength. In this case the effects of the stimuli are summated, one contraction taking place on top of another, or to put it in another way, the muscle while in a condition of contraction from one stimulus is made to contract still more by the following stimulus. In the nerve fiber such a phenomenon has not been demonstrated. In the nerve cell it is usually taught that the power of summation is a characteristic property. It is pointed out that, while a single stimulus applied to a sensory nerve may be ineffective in producing a reflex response from the central nervous system, a series of such stimuli will call forth a reaction. In this case it is assumed that the effects of the succeeding stimuli are summated within the nerve cells through which the reflex takes place, and, generally speaking, it is assumed in physiology that the nerve centers are adapted by their power of summation to respond to a series of stimuli or to continuous stimulation. The best examples of this kind of action are obtained perhaps from sensory nerves, in which case we judge of the intensity of the cell activity by the concomitant sensation, or by a reflex response.

**Response of the Nerve Cell to Varying Rates of Stimulation.**—The various parts of the neuromuscular apparatus—namely, the nerve cell, the nerve fiber, and the muscle fiber—have different degrees of responsiveness to repeated stimuli, and this responsiveness varies, moreover, for the different kinds of muscles and of nerve fibers, and, probably for the different kinds of nerve cells. The motor cells of the brain and cord discharge their impulses under normal stimulation at a certain rhythm

which was formerly supposed to average about 10 per second, but is now estimated as varying between certain wide limits, perhaps from 40 to 100 per second (p. 46). For any particular group of these motor cells the evidence indicates that it has a practically constant rate whatever may be the intensity of the stimulus—and, indeed, when artificial stimulation is used and the rate is varied, the evidence that we have so far appears to show that the nerve cells do not discharge in a one to one correspondence with the rate of stimulation, as is the case, within limits, for muscle and nerve fibers. On the contrary, under such circumstances the discharge from the nerve cells takes place in a rhythm characteristic of the cells and independent of that of the stimulation.\* From this point of view we must look upon these nerve cells as possessing fundamentally a rhythmic activity, as in the case of the heart. There is no doubt, however, that some at least of the motor cells of the spinal cord can be stimulated by a single stimulus so as to respond with a single discharge instead of a rhythmical series of discharges. As will be described below, the knee-kick is a simple muscular contraction, not a tetanus, which is aroused by reflex stimulation of the corresponding motor cells in the spinal cord.

**The Refractory Period of the Nerve Cell.**—It will be recalled that the nerve fiber exhibits what is called a refractory period for a brief interval (0.002 to 0.006 sec.) after it is stimulated. During this period it is not irritable to a second stimulus. The same phenomenon is exhibited to a marked degree by the heart muscle and likewise by many nerve cells. In the motor nerve cell which shows the property of discharging a series of impulses with rhythmic regularity it may be supposed that the refractory period is marked, and indeed is connected probably with the rhythmic character of the cell's activity. But in this as in other properties it is certain that there are great differences in the many varieties of nerve cells found in the central nervous system. While those that act rhythmically have probably a relatively long refractory period, others may exhibit a period of unirritability but little longer than that shown by the nerve fibers. In the case of the reflex motor centers in the lumbar spinal cord of the frog it is stated (Langendorff) that a second stimulus falling at an interval of 0.04 sec. after the first is effective. The refractory period of these cells is less, therefore, than this interval.

\* Horsley and Schäfer, "Journal of Physiology," 7, 96, 1886.

## CHAPTER VII.

### REFLEX ACTIONS.

**Definition and Historical.**—By a reflex action we mean the involuntary production of activity in some peripheral tissue in consequence of a stimulation of afferent nerve fibers. The conversion of the sensory or afferent impulse into a motor or efferent impulse is effected in the nerve centers, and may be totally unconscious as well as involuntary,—for instance, the emptying of the gall-bladder during digestion, or it may be accompanied by consciousness of the act, as, for example, in the winking reflex when the eye is touched. The application of the term reflex to such acts seems to have been made first by Descartes\* (1649), on the analogy of the reflection of light, the sensory effect in these cases being reflected back, so to speak, as a motor effect. The attention of the early physiologists was directed to these involuntary movements and many instances were collected, both in man and the lower animals. Their involuntary character was emphasized by the discovery that similar movements are given by decapitated animals,—frogs, eels, etc.

Some of the earlier physiologists thought that the reflex might occur in the anastomoses of the nerve trunks, but a convincing proof that the central nervous system is the place of reflection or turning-point was given by Whytt (1751). He showed that in a decapitated frog the reflex movements are abolished if the spinal cord is destroyed. Modern interest in the subject was excited by the numerous works of Marshall Hall (1832–57), who contributed a number of new facts with regard to such acts, and formulated a view, not now accepted, that these reflexes are mediated by a special set of fibers—the excitomotor fibers.

In describing reflexes the older physiologists had in mind only reflex movements, but at the present time we recognize that the reflex act may affect not only the muscles,—voluntary, involuntary, and cardiac,—but also the glands. We have to deal with reflex secretions as well as reflex movements.

**The Reflex Arc.**—It is implied in the definition of a reflex that both sensory and motor paths are concerned in the act. Ac-

\* See Eckhard, "Geschichte der Entwicklung der Lehre von den Reflexerscheinungen," "Beiträge zur Anatomie u. Physiologie," Giessen, 1881, vol. ix

According to the neuron theory, therefore, the simplest reflex arc must consist of two neurons: the sensory neuron, whose cell body lies in the sensory ganglia of the posterior roots or of the cranial nerves, and a motor neuron, whose nerve cell lies in the anterior horn of gray matter of the cord or in the motor nucleus of a cranial nerve. The reflex arc for the spinal cord is represented in Fig. 66. The arc may, however, be more complex. The sensory fibers entering through the posterior roots may pass upward through the entire length of the cord to end in the medulla, and on the way give off a number of collaterals as is represented in Fig. 67, or they may make connections with intermediate cells which, in turn, are connected with one or more motor neurons (Fig. 68). According

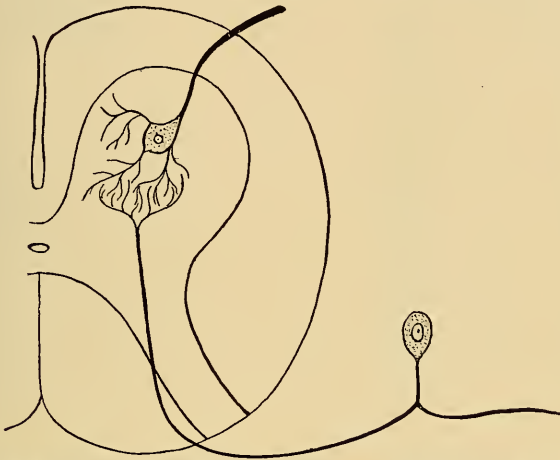

Fig. 66.—Schema to show the connection between the neuron of the posterior root and the neuron of the anterior root,—the reflex arc.

to these schemata, one sensory fiber may establish reflex connections with a number of different motor fibers, or, a fact which must be borne in mind in studying some of the well-known reflex activities of the cord and medulla especially, a sensory fiber carrying an impulse which eventually reaches the cortex of the cerebrum and gives rise to a conscious sensation may, by means of its collaterals, connect with motor nuclei in the cord or medulla and thus at the same time give origin to involuntary and even unconscious reflexes. Painful stimulation of the skin, for example, may give us a conscious sensation of pain and at the same time reflexly stimulate the vasomotor center and cause a constriction of the small arteries. The fact that in this case two distinct events occur does not necessitate the assumption that the impulses from the skin are carried to the cord by two different varieties of fibers.

It may well be that one variety of sensory neuron, the so-called pain fibers, effects both results, because of the opportunities in the cord for connections with different groups of nerve cells.

**The Reflex Frog.**—The motor reflexes from the spinal cord can be studied most successfully upon a frog in which the brain has been destroyed or whose head has been cut off. After such an operation the animal may for a time suffer from shock, but a vigorous animal will usually recover and after some hours will

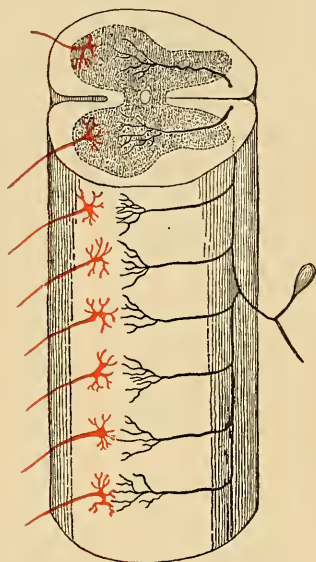

Fig. 67.—Kölliker's schema to show the direct reflex arc. It shows the posterior root fiber (black) entering the cord, dividing in Y, and connecting with motor cells (red) by means of collaterals.

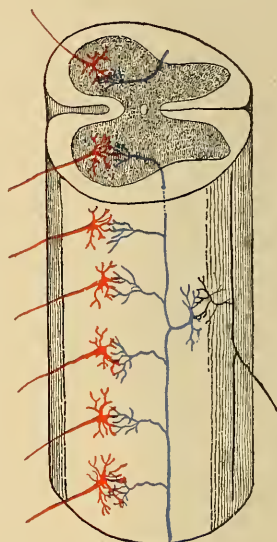

Fig. 68.—Kölliker's schema to show the reflex arc with intercalated tract cells. Posterior root fiber, black; intercalated tract cell, blue; motor cells, red.

exhibit reflex movements that are most interesting. The fundamental characteristics of reflex movements in their relations to the place, intensity, and quality of the stimulus can be studied with more ease upon an animal whose cord is thus severed from the brain than upon a normal animal. In the latter case the connections in the nervous system are more complex and the reactions are therefore less simple and less easily kept constant.

**Spinal Reflex Movements.**—The reflex movements obtained from the spinal cord or from other parts of the central nervous system may be divided into three groups by characteristics that are physiologically significant. These classes are: (1) Simple reflexes, or those in which a single muscle is affected. The best example of



this group is perhaps the winking reflex, in which only the orbicularis palpebrarum is concerned. (2) Co-ordinated reflexes, in which a number of muscles react with their contractions so graduated as to time and extent as to produce an orderly and useful movement. (3) Convulsive reflexes, such as are seen in spasms, in which a number of muscles—perhaps all the muscles—are contracted convulsively, without co-ordination and with the production of disorderly and useless movements. Of these groups, the co-ordinated reflexes are by far the most interesting. They can be obtained to perfection from the reflex frog. In such an animal no spontaneous movements occur if the sensory surfaces are entirely protected from stimulation. A sudden stimulus, however, of sufficient strength applied to any part of the skin will give a definite and practically invariable response in a movement which has the appearance of an intentional effort to escape from or remove the stimulus. If the toe is pinched the foot is withdrawn—in a gentle manner if the stimulus is light, more rapidly and violently, but still in a co-ordinated fashion, if the stimulus is strong. If the animal is suspended and various spots on its skin are stimulated by the application of bits of paper moistened with dilute acetic acid the animal will make a neat and skillful movement of the corresponding leg to remove the stimulating body. The reactions may be varied in a number of ways, and in all cases the striking features of the reflex response are, first, the seemingly purposeful character of the movement, and, second, the almost mechanical exactness with which a definite stimulus will give a definite response. This definite relationship holds only for sensory stimulation of the external integument, the skin and its organs. It is obvious, in fact, that a muscular response can be effective only for stimuli originating from the external surface. Stimuli from the interior of the body exert their reactions, for the most part, upon the plain musculature and the glands. The convulsive reflexes may be produced by two different means: (1) By very intense sensory stimulation. The reflex response in this case overflows, as it were, into all the motor paths. A variation of this method is seen in the well-known convulsive reaction that follows tickling. In this case the stimulus, although not intense from an objective standpoint, is obviously violent from the standpoint of its effectiveness in sending into the central nervous system a series of maximal sensory impulses. (2) By heightening the irritability of the central nervous system. Upon the reflex frog this effect is obtained most readily by the use of strychnin. A little strychnin injected under the skin is soon absorbed and its effect is shown at first by a greater sensitiveness to cutaneous stimulation, the slightest touch to the foot causing its withdrawal. Soon, however, the response, instead of being orderly and adapted to a useful end, becomes

convulsive. A mere touch of the skin or a current of air will throw every muscle into contraction, and the extensors being stronger than the flexors the animal's body becomes rigid in extension at every stimulation. The explanation usually given for this result is that the strychnin, acting upon some part of the nerve cells, increases greatly their irritability, so that when a stimulus is sent into the central nervous system along any sensory path from the skin it apparently radiates throughout the cord and acts upon all the motor cells. This latter supposition leads to the interesting conclusion that all the various motor neurons of the cord must be in physiological connection, either direct or indirect, with all the neurons supplying the cutaneous surface. The further fact that under normal conditions the effect of a given sensory stimulus is manifested only on a limited and practically constant number of the motor neurons seems to imply, therefore, that normally the paths to these neurons are more direct and the resistance, if we may use a somewhat figurative term, is less than that offered by other possible paths. Muscular spasms are observed under a number of pathological conditions,—for instance, in hydrophobia. We are at liberty to assume in such cases that the toxins produced by the disease affect the irritability of the cells in much the same way as the strychnin.

**Theory of Co-ordinated Reflexes.**—The purposeful character of the co-ordinated reflexes in the frog gives the impression to the observer of a conscious choice of movements on the part of the brainless animal. Most physiologists, however, are content to see in these reactions only an expression of the automatic activity of a mechanism. It is assumed that the sensory impulses from any part of the skin find, on reaching the cord, that the paths to a certain group of motor neurons are more direct and offer less resistance than any others. It is along these paths that the reflex will take place, and we may further assume that these paths of least resistance, as they have been called, are in part preformed and in part are laid down by the repeated experiences of the individual. That is, in each animal a definite structure may be supposed to exist in the cord; each sensory neuron is connected with a group of motor neurons, to some of them more directly than to others, and we may imagine, therefore, a system of reflex apparatuses or mechanisms which when properly stimulated will react always in the same way. And, indeed, in spite of the adapted character of the reflexes under consideration their automaton-like regularity is an indication that their production is due to a fixed mechanical arrangement. Whether or not the reactions of the nervous system in such cases are accompanied by any degree of consciousness can not be proved or disproved, but the assumption of such an accompaniment does not seem necessary to explain the reaction.

*Spinal Reflexes in the Mammals.*—Experiments upon the lower mammals show that co-ordinated reflex movements may be obtained from the cord after severance of its connections with the brain. Sherrington\* has described a simple operation by which the head may be removed from an anesthetized cat and the animal be kept alive for a number of hours. Stimulation of the skin in such an animal calls forth numerous definite reflexes, such as flexion or extension of the legs, the scratching movements of the hind legs, stretching movements, etc. Or the spinal cord may be severed in the thoracic region, below the origin of the phrenic nerves, and the animal, with care, can be kept alive for months or years. In such an animal reflex movements of the hind legs or tail may be obtained readily from slight sensory stimulation of the skin. The knee-jerk and similar so-called deep reflexes are also retained. But it is evident that these movements are not so complete nor so distinctly adapted to a useful end as in the frog. The muscles of the body supplied by the isolated part of the cord retain, however, a normal irritability and exhibit no wasting. In man, on the contrary, it is stated that after complete section of the cord the deep reflexes, such as the knee-jerk, as well as the skin reflexes, are very quickly lost. The muscles undergo wasting and soon lose their irritability.† The monkeys exhibit in this respect a condition that is somewhat intermediate between that of the dog and man. It seems evident from these facts that in the lower animals, like the frog, a much greater degree of independent activity is exhibited by the cord than in the more highly developed animals. According to the degree of development, the control of the muscles is assumed more and more by the higher portions of the nervous system, and the spinal cord becomes less important as a series of reflex centers, its functions being more dependent upon its connections with the higher centers.

**Dependence of Co-ordinated Reflexes upon the Excitation of the Normal Sensory Endings.**—It is an interesting fact that when a nerve trunk is stimulated directly in a reflex frog—the sciatic nerve, for instance—the reflex movements are disorderly and quite unlike those obtained by stimulating the skin. It is said that if the skin be loosened and the nerve twigs arising from it be stimulated, an operation that is quite possible in the frog, the response is again a disorderly reflex, whereas the same fibers stimulated through the skin give an orderly, co-ordinated movement. The difference in response in these cases is probably not due to any peculiarity in the nature of the sensory impulses originating in the nerve endings of the skin, but more likely to a difference in their strength and arrangement. When one stimulates a sensory nerve

\* Sherrington, "Journal of Physiology," 38, 375, 1909.

† See Collier, "Brain," 1904, p. 38.

trunk directly,—the ulnar nerve at the elbow in ourselves, for instance,—the resulting sensations are markedly different from those obtained by stimulating the skin areas supplied by the same nerve; we have little or no sensations of touch or temperature, only pain and a peculiar tingling in the fingers. In such an experiment the stimulus applied to the trunk affects more or less equally all the contained fibers, whereas in stimulation of the skin itself the effect upon the cutaneous fibers of pressure, temperature, or pain predominates and presumably it is these fibers that normally are connected in an efficient way with the reflex machinery in the nerve centers.

**Reflex Time.**—Since nerve centers are involved in a reflex movement, a determination of the total time between the application of the stimulus and the beginning of the response gives a means of ascertaining the time needed for the processes within the nerve cells. Helmholtz, who first made experiments of this kind, stated that the time required within the nerve centers might be as much as twelve times as great as that estimated for the conduction along the motor and sensory nerves involved in the reflex. Most observers state that the time within the center varies with the strength of the stimulus, being less, the stronger the stimulus. It varies also with the condition of the nerve centers, being lengthened by fatigue and other conditions that depress the irritability of the nerve cells. By reflex time or reduced reflex time we may designate the time required for the processes in the center,—that is, the total time less that required for transmission of the impulse along the motor and sensory fibers and the latent period of the muscle contraction. For the frog this is estimated as varying between 0.008 and 0.015 sec. In man the reflex time usually quoted is that given by Exner for the winking of the eye. He stimulated one lid electrically and recorded the reflex movement of the lid of the other eye. The total time for the reflex was, on an average, from 0.0578 sec. to 0.0662 sec. He estimated that the time for transmission of the impulse along the sensory and motor paths, together with the latent period of the muscle, amounted to 0.0107 sec. So that the true reflex time from his determinations varied between 0.0471 and 0.0555 sec. Mayhew,\* using a more elaborate method, obtained for the total time a mean figure equal to 0.0420 sec. If Exner's correction is applied then the true reflex time according to this determination is equal to 0.0313 sec. In a series of experiments made upon frogs, in which the efferent response to stimulation of the afferent fibers of the sciatic nerve was measured by the electrical variation in the muscle involved, Buchanan finds that the delay in the cord, when the reflex was on the same side, was

\* Mayhew, "Journal of Exp. Medicine," 2, 35, 1897.

equal to 0.01 to 0.02 sec. If the reflex was on the crossed side about double this time was consumed in the cord. This delay of the velocity of transmission of an impulse in the nerve centers is a factor which must vary somewhat in different parts of the nervous system. It has been shown that, in certain cases at least, when strong stimuli are used the latent period of a reflex is not greater than would be accounted for by transmission through the nerve fibers and by the latency of the muscular contraction. Thus François Frank, in an experiment in which the gastrocnemius muscle of one side was made to contract reflexly by stimulation of the afferent root of a lumbar nerve on the other side, records a latent period of only 0.017 sec. Evidently in such a case there was no perceptible delay in passing through the nerve centers of the lumbar cord.

**Inhibition of Reflexes.**—One of the most fundamental facts regarding spinal reflexes is the demonstration that they can be depressed or suppressed entirely—that is, inhibited—by other impulses reaching the same part of the spinal cord. The most significant experiment in this connection is that made by Setschenow.\* If in a frog the entire brain or the cerebral hemispheres are removed, then stimulation of the exposed cut surface—for instance, by crystals of sodium chlorid—will depress greatly or perhaps inhibit entirely the usual spinal reflexes that may be obtained by cutaneous stimulation. On removal of the stimulating substance from the cut surface by washing with a stream of physiological saline (solution of sodium chlorid, 0.7 per cent.) the reflex activities of the cord are again exhibited in a normal way. This experiment accords with many facts which indicate that the brain may inhibit the activities of the spinal centers. In the reflex from tickling, for instance, we know that by a voluntary act we can repress the muscular movements up to a certain point; so also the limited control of the action of the centers of respiration and micturition is a phenomenon of the same character. To explain such acts we may assume the existence of a definite set of inhibitory fibers, arising in parts of the brain and distributed to the spinal cord, whose function is that of controlling the activities of the spinal centers. In view of the fact, however, that there is no independent proof of the existence of a separate set of inhibitory fibers within the central nervous system—that is, a set of fibers whose specific energy is that of inhibition—it is preferable to speak simply of the inhibitory influence of the brain upon the cord, leaving undecided the question as to whether this influence is exerted through a special set of fibers, or is brought about by some variation in

\* Setschenow, "Physiologische Studien über d. Hemmungs-Mechanismen f. d. Reflexthätigkeit im Gehirn d. Frosches," Berlin, 1863.

the time relations, intensity, or quality of the nerve impulses. Regarding the fact, however, there can be no question, and it constitutes a most important factor in the interaction of the different parts of the nervous system. It is probable that this factor explains why a normal frog gives reflexes that are so much less constant and less predictable than one with its brain removed. A similar inhibition of spinal reflexes may be obtained by simultaneous stimulation of two different parts of the skin. The usual reflex from pinching the toe of one leg may be inhibited in part or completely by simultaneous stimulation of the other leg or by direct electrical stimulation of an exposed nerve trunk. A similar interference is illustrated, perhaps, in the well-known device of inhibiting an act of sneezing by a strong sensory stimulation from some part of the skin—for instance, by pressing upon the upper lip. The importance of the process of inhibition in the normal movements of the body is illustrated strikingly by the phenomenon known as *reciprocal innervation*, which has been investigated chiefly by Sherrington.\* This observer has found that when a flexor muscle is stimulated reflexly there is at the same time a relaxation or loss of tone in its antagonistic extensor, which is explained as being due to an inhibition of the motor cells of the extensor in the cord. Reflex stimulation of the extensor is accompanied similarly by an inhibition of the tone of the antagonistic flexor. This phenomenon has been demonstrated not only for reflex stimulation of the cord but also for voluntary movements (Athanasieu) and for electrical stimulation of the cortical centers. The motor centers of the muscles surrounding the joints are apparently so connected in pairs that when one is excited the center of the corresponding antagonist is inhibited. This reciprocating mechanism disappears under conditions, such as strychnine-poisoning, in which, according to the usual belief, the irritability of the centers is greatly increased. A relationship quite comparable to the reciprocal innervation, although working in only one direction, is exhibited by the peripheral nerve plexuses in the intestinal canal in the so-called law of the intestines (see p. 726). A brief statement of the more or less unsatisfactory theories of inhibition is given in connection with the inhibitory action of the vagus nerve on the heart beat (see p. 589). It should be added, however, in this connection, that stimulation of the cord, and probably of other parts of the nervous system, from two different sources may result not only in an inhibition of the reflex normally occurring from one of the stimuli, but under some circumstances

\* Sherrington, "The Integrative Action of the Nervous System," 1906, p. 84.

may give an augmentation or reinforcement of the reflex. A striking example of this augmenting effect is given below in the paragraph upon the knee-kick.

**Influence of the Condition of the Cord on its Reflex Activities.**—The time and extent of the reflex responses may be altered greatly by various influences, particularly by the action of drugs. The effect in such cases is usually upon the nerve centers,—that is, upon the cells themselves or upon the synapses, that is to say, the connections between the terminal arborization and the dendrites—the process of conduction within the sensory and motor fibers being less easily affected. A convenient method of studying such influences is that employed by Türk. In this method the reflex frog is suspended, and the tip of the longest toe is immersed to a definite point in a solution of sulphuric acid of a strength of 0.1 to 0.2 per cent. If the time between the immersion and the reflex withdrawal of the foot is noted by a metronome, or by a record upon a kymograph, it will be found to be quite constant, provided the conditions are kept uniform. If the average time for this reflex is obtained from a series of observations it is possible to inject various substances—such as strychnin, chloroform, potassium bromid, quinin, etc.—under the skin, and after absorption has taken place to determine the effect by a new series of observations. So far as drugs are concerned the results of such experiments belong rather to pharmacology than to physiology. The method in some cases brings out an interesting difference in the effects of various kinds of stimulation. Strychnin, for instance, as was stated above, increases greatly the delicacy of the reaction to pressure stimulation. At one stage in its action before the convulsive responses are obtained the threshold stimulus is greatly lowered,—mere contact with the toes causes a rapid retraction of the leg; whereas in the normal reflex frog a relatively large pressure is necessary to obtain a similar response. At this stage in the action of the strychnin the effect of the acid stimulus, on the contrary, may be markedly weakened so far as the time element is concerned. If the action of the strychnin is not too rapid, it is usually possible to find a point at which the time for the reflex is diminished, but this effect quickly disappears and the period between stimulus and response becomes markedly lengthened at a time when the slightest mechanical stimulation gives a rapid reflex movement. This paradoxical result may depend possibly upon the variety of nerve fiber stimulated by the two kinds of stimuli or may be connected with the fact that the acid stimuli may bring about inhibitory as well as excitatory processes in the cord.

**Reflexes from Other Parts of the Nervous System.**—Numerous typical reflexes are known to occur in the brain. The

reflex effects upon the important centers in the medulla, such as the vasomotor center, the respiratory center, and the cardio-inhibitory center, the winking of the eye, sneezing, the light reflex upon the sphincter muscle of the iris, and many other similar cases might be enumerated. All of these reactions will be described and discussed in their proper places. The conscious reactions of the brain are not included among the reflexes by virtue of the definition which lays stress upon the involuntary characteristic of the reflex response, but it should be remembered that, so far as the nervous mechanism is concerned, these conscious reactions do not differ from the true reflexes. When we voluntarily move a limb the movement is guided and controlled by sensory impulses from the muscles put into action. The fibers of muscle sense from these muscles convey sensory impulses through a chain of neurons to the cortex of the brain and there the impulses doubtless affect and set into action the motor neurons through which the movement is effected. So far as we know, the discharges from the efferent neurons of the brain do not arise independently within these cells, they are conditioned or originated by stimuli from other neurons; so that the activities of the brain are carried on by a mechanism of one neuron acting on another, just as in the case of the reflex arc. The added feature of a psychical factor, a reaction in consciousness, enables us to draw a line of distinction between these activities and those of so-called pure reflexes; but the distinction is perhaps one of convenience only, for, although the extremes may be far enough apart to suit the definition, many intermediate instances may be found which are difficult to classify. All skilled movements, for instance, such as walking, singing, dancing, bicycle riding, and the like,—although in the beginning obviously effected by voluntary co-ordination, nevertheless in the end, in proportion to the skill obtained, become more or less entirely reflex,—that is, involuntary. In learning such movements one must, as the saying goes, establish his reflexes, and the result can hardly be understood otherwise than by supposing that the continual adjustment of certain sensory impulses to certain co-ordinated movements results in the formation of a more or less complex reflex arc, a set of paths of least resistance.

**Reflexes through Peripheral Ganglia—Axon Reflexes.**—Many attempts have been made by physiologists to ascertain whether or not reflexes can occur through the peripheral nerve ganglia, lying outside the central nervous system. With regard to the posterior root ganglia, it has usually been supposed that they cannot exhibit reflexes. When the posterior root connecting such a ganglion to the cord is severed, then, according to our usual conception, the cells in the ganglia are cut off from all connections with the peripheral tissues by efferent



paths. This usual view may not, however, be correct. On the physiological side we have the fact (see p. 82) that stimulation of certain of the posterior root ganglia under such circumstances does give peripheral effects on the blood-vessels, causing a vascular dilatation in a certain region. On the histological side Cajal\* and others have shown that some of these cells are provided with a pericellular nerve network, which is an afferent path so far as the cell is concerned, while the axon of the cell constitutes an efferent path. Whether these cells form a special group of efferent cells lying within the sensory ganglion, or whether they are sensory cells discharging into the cord and stimulated reflexly through the nerve network as well as through the peripheral process of the axon, cannot be said. The subject is one full of interest to physiology. In the ganglia of the sympathetic nerve and its appendages and in the similar ganglia contained in many of the organs the nerve cells have dendritic processes, and, so far as their histology is concerned, it would seem possible that in any ganglion of this type there might be sensory and motor neurons so connected as to make the ganglion an independent reflex center. Numerous experiments have been made to determine experimentally whether reflexes can be obtained through such ganglia. Perhaps the most successful of these experiments have been made upon the inferior mesenteric ganglion.

This ganglion may be isolated from all connections with the central nervous system and left attached to the bladder through the two hypogastric nerves (see Fig. 287). If now one of these nerves is cut and the central stump is stimulated, a contraction of the bladder follows. Obviously in this case the impulse has traveled to the ganglion and down the other hypogastric nerve; the reaction has every appearance of being a true reflex. Nevertheless, Langley and Anderson,† who have studied the matter with especial care, are convinced that in this



Fig. 69.—Schema to show idea of an axon reflex: The preganglionic fiber, *a*, sends branches to two postganglionic fibers, *b*, *c*. If stimulated at *x* the impulse passes backward in a direction the reverse of normal and falling into *b* and *c* gives a pseudoreflex effect.

experimentally whether reflexes can be obtained through such ganglia. Perhaps the most successful of these experiments have been made upon the inferior mesenteric ganglion.

\* Cajal, "Ergebnisse der Anat. u. Entwicklungsgeschichte," vol. xvi., 1906; Dogiel, "Bau der Spinalganglien, etc.," 1908.

† Langley and Anderson, "Journal of Physiology," 16, 410, 1894.

and similar cases we have to do with what they call pseudo-reflexes or axon reflexes. The idea underlying this term may be explained in this way: Every sympathetic ganglion is connected with the central nervous system, brain and cord, by efferent spinal fibers, preganglionic fibers, which terminate by arborization around the dendrites of the sympathetic cells. The efferent fibers arising from the latter may be designated as post-ganglionic fibers. These authors give reasons to believe that any one preganglionic fiber, *a*, Fig. 69, may connect by collaterals with several sympathetic cells. If such a fiber were stimulated at *x*, then the impulse passing back along the axon in a direction the reverse of normal would stimulate cells *b* and *c*, giving effects that are apparently reflex, but which differ from true reflexes in that the stimulating axon belongs to a motor neuron. Under normal circumstances it is not probable that an effect of this kind can be produced, but there are some interesting observations on record

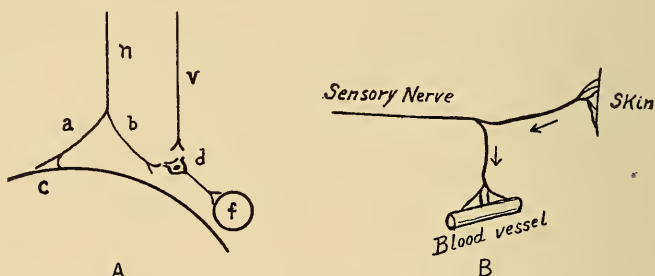

Fig. 69a.—Schemata of axon-reflex producing local vascular dilatation from the application of an irritant—A, Bardy's schema: *n*, the sensory fiber; *c*, the conjunctiva; *d*, the peripheral sympathetic ganglion; *f*, the blood-vessel. The reflex runs from *c* over *a b* and *d* to *f*; *v*, a vaso-constrictor fiber. B, Bruce's schema (modified): The arrows indicate the course of the axon-reflex.

which indicate that axon-reflexes may play an important rôle in the control of the blood-supply to certain areas. When a membrane or the skin is inflamed by an irritant, it becomes congested and painful, exhibiting, in fact, the four classical symptoms, rubor, turgor, calor, and dolor. Two observers\* have found that the local vasodilatation caused by such an irritant as mustard oil applied to the conjunctiva is greatly diminished if the sensory nerve-fibers of the region are paralyzed by a local anesthetic or if the same fibers are destroyed by degeneration after section. In other words, the effect of the irritant in causing local dilatation of the blood-vessels is not due to its direct action on the walls of the blood-vessels, but is of the nature of a reflex effect through the nerve supply. Further experiments indicate that the effect is not due to a reflex of the

\* Ninian Bruce, "Quarterly Journal of Exp. Physiol.," 6, 339, 1913; Bardy, "Skandinavisches Archiv. f. Physiol.," 32, 198, 1914.

ordinary kind through the central nervous system or the posterior root ganglion or the superior cervical ganglion, and it is probably, therefore, a peripheral reflex of the nature of an axon-reflex taking place wholly through the sensory nerve-fibers or through such fibers in connection with the small peripheral sympathetic ganglia distributed along the course of the blood-vessels. The apparatus that may be involved is represented in the two accompanying schemata (Fig. 69a).

**The Tonic Activity of the Spinal Cord.**—In addition to the definite reflex activities of the cord, each traceable to a distinct sensory stimulus, there is evidence to show that many of its motor neurons are in that state of more or less continuous activity which we designate as tonic activity or tonus. There is abundant reason for this belief in regard to many of the special centers of the cord and brain, such as the vasomotor center, the center for the sphincter muscle of the iris, the centers for the sphincter muscles of the bladder, the anus, etc. But the evidence includes the motor neurons to the voluntary as well as the involuntary musculature. In a decapitated frog the muscles take a definite position, and Brondgeest showed that if such an animal is suspended, after cutting the sciatic plexus in one leg, the leg on the uninjured side takes a more flexed position. The explanation offered for this result is that the muscles on the sound side are being innervated by the motor neurons of the cord. Inasmuch as a result of this kind cannot be obtained from a frog whose skin has been removed, or in one in which the posterior roots have been severed it seems evident that this tonic discharge from the motor neurons is due to a constant inflow of impulses along the sensory paths. The muscle tonus, in other words, is really a reflex tonus, which differs from ordinary reflex movements only in the absence of a sudden, visible contraction and in the more or less continuous character of the innervation. In the section on animal heat the importance of this constant innervation of the muscles as a source of heat is further emphasized. The idea of a more or less continuous but varying activity of the centers in the brain and cord in consequence of the continuous inflow of impulses along the sensory paths fits in very well with many facts observed in the peripheral organs,—facts that will be referred to from time to time as the physiology of these organs is considered.

**Effects of Removal of the Spinal Cord.**—Numerous investigators have sectioned the cord partly or completely at various levels. The general results of these experiments as regards loss of sensation or voluntary movement are described in the next section treating of the cord as a path of conduction to and from the brain. But attention may be called here to some of the gen-

eral results obtained by Goltz\* in some remarkable experiments in which the entire cord was removed with the exception of the cervical region and a small portion of the upper thoracic. In making this experiment it was necessary to perform the operation in several steps. That is, the cord was first sectioned in the upper thoracic region and then in successive operations the lower thoracic, lumbar, and sacral regions were removed completely. Very great care was necessary in the treatment of the animals after these operations, but some survived and lived for long periods, the digestive, circulatory, and excretory organs performing their functions in a normal manner. The muscles of the hind limbs and trunk, however, underwent complete atrophy, owing to the destruction of their motor nerves. The blood-vessels also were paralyzed after the first operations, but gradually their musculature again recovered tone, showing that, although under normal conditions the tonic contraction of the vessels is under the influence of nerves arising from the cord, this tone may be re-established in time after the severance of all spinal connections. Some of the specific results of these experiments, bearing upon the reflexes of defecation, micturition, and parturition, will be described later. Attention may be called here to the general results illustrating the general functions of the cord.

In the first place, there was, of course, a total paralysis of voluntary movement in the muscles innervated normally through the parts of the cord removed, and a complete loss of sensation in the same regions, particularly of cutaneous and muscular sensibility. In the second place, the visceral organs, including the blood-vessels, were shown to be much more independent of the direct control of the central nervous system. While these organs in the experiments under consideration were still in connection with the sympathetic ganglia and in part with the brain through the vagi, still their connections with the central nervous system, particularly as regards their sensory paths and the innervation of the blood-vessels, were in largest part destroyed. The immediate effect of this destruction would have been the death of the animal if the care of the observer had not replaced, in the beginning, the normal control exercised by the nervous system through the spinal nerves; but later this careful nursing was not required. While these organs, therefore, are capable of a certain amount of independent activity and co-ordination, they are normally controlled through the various reflex activities of the brain and cord. In the third place, it is noteworthy that the adaptability of the cordless portion of the animal was distinctly less than normal. Its power of preserving a

\* Goltz and Ewald, "Pflüger's Archiv für die gesammte Physiologie," 63, 362, 1896.

constant body temperature was more limited than in the normal animal, and the susceptibility to inflammatory disturbances in the visceral organs was greatly increased. It seems evident, from these facts, that, although the animal was living, its power of adaptation to marked changes in the external or internal environment was greatly lessened, and this fact illustrates well the great general importance of the spinal cord and brain as reflex centers controlling the nutrition and co-ordinated activities of the body tissues and organs. This control is necessary under normal conditions for the successful combination of the activities of the various organs. A large part of this control is doubtless dependent upon the regulation of the blood supply to the various organs. The mechanism by which this is effected and the parts played by the cord and the brain (medulla oblongata), respectively, will be described in the section on Circulation.

**Knee-jerk.**—Knee-jerk or knee-kick is the name commonly given to the jerk of the foot when a light blow is struck upon the patellar ligament just below the knee. The jerk of the foot is due to a contraction of the quadriceps femoris muscle. According to Sherrington, the parts of this muscular mass chiefly concerned are the *m. vastus medialis* and *m. vastus intermedius*. In order to obtain the muscular response it is usually necessary to put the quadriceps under some tension by flexion of the leg. This end is achieved most readily by crossing the knees or by allowing the leg to hang freely when sitting on the edge of a bench or table. Under such circumstances the jerk is obtained in the great majority of normal persons, and this fact has made it an important diagnostic sign in many diseases of the spinal cord. The importance of the reaction for such purposes was first brought out by the work of Erb and Westphal\* in 1875.

**Reinforcement of the Knee-jerk.**—It was first shown by Jendrassik (1883) that the extent of the jerk may be greatly augmented if, at the time the blow is struck upon the tendon, a strong voluntary movement is made by the individual, such as squeezing the hands together tightly or clenching the jaws. This phenomenon was studied carefully in this country by Mitchell and Lewis,† who ascertained that a similar augmentation may be produced by giving the individual a simultaneous sensory stimulation. They designated the phenomenon as a reinforcement, and this name is generally employed by English writers, although occasionally the term "Bahnung," introduced by Exner to describe a similar phenomenon, is also used. It is found that by a reinforcement the knee-

\* Erb and Westphal, "Archiv f. Psychiatrie," 1875, vol. v.

† Mitchell and Lewis, "American Journal of Med. Sciences," 92, 363, 1886.

jerk may be demonstrated in some individuals in whom the ordinary blow upon the tendon fails to elicit a response. Bowditch and Warren\* studied the phenomenon of reinforcement and brought out a fact of very great interest. They studied especially the time interval between the blow upon the tendon and the reinforcing act and found that if the latter preceded the blow by too great an interval then, instead of an augmentation of the jerk, there was a diminution which they designated as negative reinforcement or inhibition. This inhibiting effect began to appear when the reinforcing act (hand-squeeze) preceded the blow by an interval of from 0.22 to 0.6 sec., and the maximum inhibiting effect was obtained at an

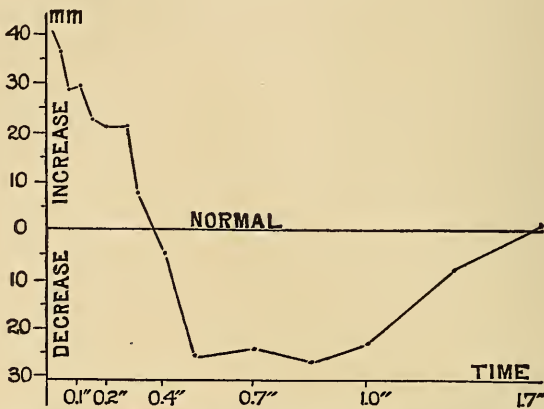

Fig. 70.—Showing in millimeters the amount by which the “reinforced” knee-kick varied from the normal, the level of which is represented by the horizontal line at 0, “normal.” The time intervals elapsing between the clenching of the hands (which constituted the reinforcement) and the tap on the tendon are marked below. The reinforcement is greatest when the two events are nearly simultaneous. At an interval of 0.4 sec. it amounts to nothing; during the next 0.6 sec. the height of the kick is actually diminished, while after an interval of 1 sec. the negative reinforcement tends to disappear; and when 1.7 sec. is allowed to elapse the height of the kick ceases to be affected by the clenching of the hands.—(Bowditch and Warren.)

interval of from 0.6 to 0.9 sec. Beyond this point the effect became less noticeable, and at an interval of 1.7 to 2.5 sec. the reinforcing act had no influence at all upon the jerk. These relations are shown in the accompanying curve (Fig. 70). These authors confirmed also the fact that a sensory stimulus, such as a gentle blast of air on the conjunctiva or the knee, may reinforce the jerk. The physiological explanation of the reinforcement, negative and positive, is a matter of inference only, but the view usually held is that it is due to “overflow.” That is, many facts, such as strychnin tetanus, indicate that the neuromuscular machinery of the entire central nervous system is more or less directly connected and that

\* Bowditch and Warren, “Journal of Physiology,” 2, 25, 1890.

functional activity at one part may influence the irritability of the remainder, either in the direction of reinforcement or inhibition. We may conceive, therefore, that when the hands are squeezed, the motor impulses sent down from the cortex of the brain to the upper portion of the cord overflow to some extent, sufficient at least to alter the irritability of the other motor neurons in the cord. Experimental stimulation of the cortex has given similar results. Exner\* found that when the motor center for the foot in the cortex of a rabbit was stimulated, the stimulation, even if too weak to be effective itself, caused an increase in the contraction brought about reflexly by a simultaneous stimulation of the skin of the paw, and furthermore if these stimuli were so reduced in strength that each was ineffective, then when applied together a contraction was obtained. In this case an ineffective stimulus from the cortex reaching the spinal cord increased the irritability of the motor centers there so that a simultaneous reflex stimulus from the foot, ineffective in itself, became effective.

**Is the Knee-jerk a Reflex?**—The most interesting question in this connection is whether the jerk is a true reflex act or is due to a direct mechanical stimulation of the muscle. Opinions have been divided upon this point. Those who believe that the jerk is a reflex lay emphasis upon the undoubted fact that the integrity of the reflex arc is absolutely essential to the response. The quadriceps receives its motor and sensory fibers through the femoral nerve, and pathological lesions upon man as well as direct experimental investigation upon monkeys prove that if either the posterior or anterior roots of the third and fourth lumbar spinal nerves are destroyed the knee-jerk disappears entirely. The opponents of the reflex view explain this fact by the theory that in order for the quadriceps to respond it must be in a condition of tonus. This tonus depends upon the reflex arc, the sensory impulses from the muscle serving to keep it in that condition of subdued contraction known as tone. On this view destruction of the reflex arc renders the muscle less irritable, so that it will not respond by a contraction to the sudden mechanical extension or pull caused by the blow on the tendon. The adherents of this view lay emphasis upon two facts: First, the knee-jerk is a simple contraction, and not a tetanus, and, generally speaking, the motor centers of the cord discharge a series of impulses when stimulated. In answer to this objection it may be said that while muscular contractions produced reflexly are usually tetanic, it does not follow that this is invariably the case. Sherrington† has shown, for instance, that an undoubted reflex

\* Exner, "Archiv f. die gesammte Physiologie," 27, 412, 1882.

† Sherrington, "The Integrative Action of the Nervous System," 1906.

designated by him as the "extensor thrust," which also involves the extensor muscles of the hind leg, is very short lasting, requiring perhaps only  $\frac{1}{5}$  sec., and judged by this standard is as much of a simple contraction as the knee-jerk. The "extensor thrust" is a sharp contraction of the extensor muscles of the hind leg aroused by pressure upon the plantar surface of the hind foot. On the frog also a single stimulus applied to the central end of the divided sciatic nerve will call forth a reflex contraction, which is a twitch, and not a tetanus. Second, the time for the jerk—that is, the interval between the stimulus and the response—is too short for a reflex. The determination of this time has been attempted by many observers for the purpose of deciding the controversy, but unfortunately the results have been lacking in uniformity, although the best results from man indicate a latency between stimulus and response of 0.023 sec. after deducting the latent period of the muscle itself. Applegarth, making use of a dog with a severed spinal cord, obtained for the time of the knee-jerk an interval of 0.014 to 0.02 sec.; Waller and Gotch, using the rabbit, found the time to be only 0.008 to 0.005 sec. Other figures would appear to indicate that the latent period is shorter the smaller the animal, a fact which in itself would imply that some factor other than the latency of the muscle itself enters into the time required. And if we accept the newer figures in regard to the velocity of the nerve impulse in mammalian nerves at the body temperature (see p. 112), there would seem to be sufficient time in all cases for the impulse to get to the cord and back. Several observers\* have attempted to determine the time intervening between stimulus and response by using the string galvanometer to indicate the electrical response in the muscle, instead of attempting to record the contraction itself. According to Snyder, the time interval lies between 0.0113 and 0.015 sec., while Hoffmann's results give an interval of 0.019 to 0.024 sec. The calculations of both observers indicate that the time is sufficient for a reflex, and much too long for a direct excitation. In the case of the Achilles jerk, Hoffmann finds that it may be liberated by electrical stimulation of the n. tibialis and that under these circumstances there is first a deflection of the galvanometer, due to direct stimulation of the gastrocnemius through its motor nerve, and this is followed later by a second deflection, due to reflex stimulation. This latter accords in time interval with the Achilles jerk, and gives a new proof that the phenomenon is a genuine reflex. In view of these facts it would seem to be safe to conclude that the knee-kick and similar phenomena are reflexes

\* Snyder, "American Journal of Physiology," 26, 474, 1910. Hoffmann, "Archiv f. Physiologie," 1910, 223.



but reflexes in which a single nerve impulse is sent out from the cord, causing a simple contraction in the muscle affected.

**Conditions Influencing the Extent of the Knee-jerk.**—The effect of various normal conditions upon the knee-jerk has been studied by a number of observers, particularly by Lombard.\* The results are most interesting in that they indicate very clearly that the irritability of the spinal cord varies with almost every marked change in mental activity. During sleep the jerk disappears and in mental conditions of a restful character its extent is relatively small. In conditions of mental excitement or irritation, on the contrary, the jerk becomes markedly increased. Lombard observed also, in his own case, a daily rhythm, which is represented in the chart given in Fig. 71. It would seem from his experiments

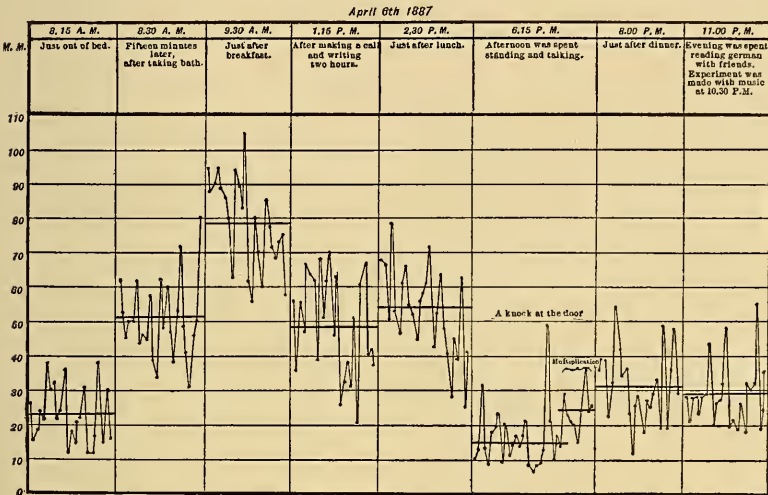

Fig. 71.—Lombard's figure to indicate the daily rhythm in the extent of the knee-jerk and the effect of mental stimuli. The ordinates (0–110) represent the extent of the kick in millimeters. Each dot represents a separate kick, while the heavy horizontal line gives the average extent for the period indicated.

that the extent of the knee-jerk is a sensitive indicator of the relative state of irritability of the nervous system: "The knee-jerk is increased and diminished by whatever increases and diminishes the activity of the central nervous system as a whole." This general fact is supported, especially as regards mental activity, by observations on other similar mechanisms,—such, for instance, as the condition of the nervous centers controlling the bladder.

\* Lombard, "The American Journal of Psychology," 1887, p. 1. See also article "Knee-jerk" (Warren), "Wood's Ref. Handbook of Med. Sciences."

**Use of the Knee-jerk and Spinal Reflexes as Diagnostic Signs.**—The fact that the knee-jerk depends on the integrity of the reflex arc in the lumbar cord has made it useful as a diagnostic indication in lesions of the cord, particularly, of course, for the lumbar region. It is mainly on account of its practical value and the ease with which it is ordinarily obtained that the phenomenon has been studied so extensively. In the disease known as progressive locomotor ataxia the posterior root fibers in the posterior columns in the lumbar region are affected, and, as a consequence, the jerk is diminished or abolished altogether according to the stage of the disease. So also lesions affecting the anterior horns of the gray matter will destroy the reflex by cutting off the motor path, while in other cases lesions in the brain or the lateral columns of the cord affecting the pyramidal system of fibers may be accompanied by an exaggeration of this and similar reflexes. This latter fact agrees with the experimental results (see p. 147) upon ablation of the brain. After such operations in the frog and lower mammals at least the spinal reflexes may show a marked increase. Interruption of the descending connections between brain and cord at any point, therefore, may be accompanied by a striking increase in sensitiveness of the spinal reflexes. The explanation usually given is that the inhibitory influences of the brain centers upon the cord are thereby weakened or destroyed.

**Other Spinal Reflexes.**—Various other distinctive reflexes through the spinal cord may be obtained readily, and since the motor cells concerned lie at different levels in the cord the presence, absence, or modified character of these reflexes has been used frequently for diagnostic purposes. In the first place there are a number of so-called deep reflexes which may be aroused by sensory stimulation of parts beneath the skin, such as the tendons, ligaments, and periosteum. Almost any tendon if stimulated mechanically may give a jerk of the corresponding muscle, just as in the case of the knee-kick. Such reactions have been described and used in the case of the wrist-jerk, the jaw-jerk, the Achilles-jerk, etc. The last named is obtained by putting the foot into a position of dorsiflexion and then tapping the tendo calcaneus (Achillis). The result is a contraction of the gastrocnemius, causing plantar flexion of the foot. A variation of this reflex is the phenomenon known as ankle clonus. This is obtained by giving a quick forcible dorsiflexion to the foot thus putting the tendon and muscle under a sudden mechanical strain. In some cases there results a rhythmical series of contractions of the gastrocnemius. A second group of reflexes may be obtained by stimulation of special points on the skin, the cutaneous reflexes. For example,



Fig. 72.—Diagrammatic representation of the lower portion of the human bulb and spinal cord.

The cord is divided into its four regions: 1, Medulla cervicalis; 2, medulla dorsalis; 3, medulla lumbalis; 4, medulla sacralis. Within each region the spinal segments bear Roman numbers. On the left side of the diagram the locality supplied by the sensory (afferent) neurons is indicated by one or more words, and these latter are connected with the bulb or the segments of the cord at the levels at which the nerves enter. The afferent character is indicated by the arrow tip on the lines of reference.

On the right-hand side the names of muscles or groups of muscles are given, and to them are drawn reference lines which start from the segments of the cord in which the cell-bodies of origin have been located.

Within the cord itself, the designations for several reflex centers are inscribed in the segment where the mechanism is localized. For example, Reflexus scapularis, Centrum cilio-spinale, Reflexus epigastricus, Reflexus abdominalis, Reflexus cremastericus, Reflexus patellaris, Reflexus tendo Achillis, Centrum vesicale, Centrum anale (the last two on the left side of the diagram). (Donaldson, "Amer. Text-book of Physiology," from "Icones Neurologicae," *Strümpell and Jakob*.)

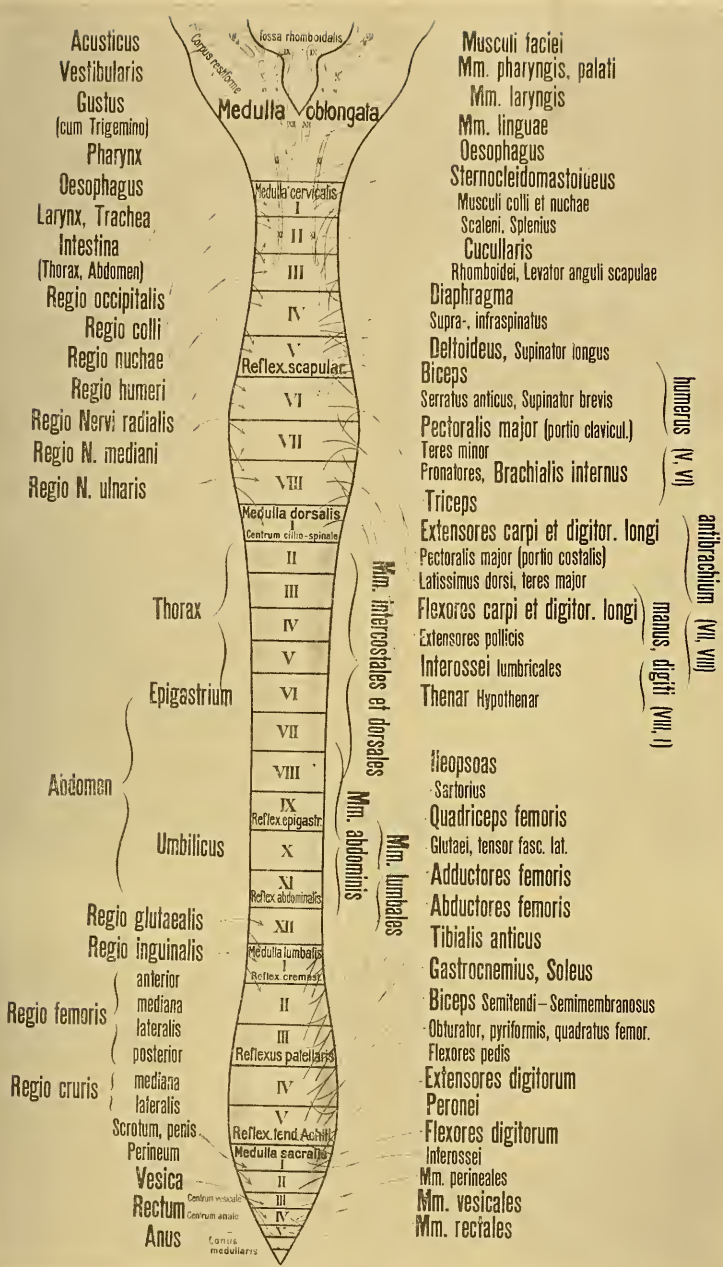

Fig. 72.



the plantar reflex, which consists in a flexion of the toes when the sole of the foot is stimulated by tactile or painful stimuli. Under pathological conditions which involve a lesion of the pyramidal tracts in the cord this reflex is altered, the great toe being extended instead of flexed (Babinski's phenomenon). The cremasteric reflex consists in a contraction of the cremasteric muscle which raises the testis. It follows from stimulation of the skin on the inner side of the thigh at the level of the scrotum. The location of the motor centers of these and other similar reflexes is shown in the accompanying illustration (Fig. 72).

## CHAPTER VIII.

### THE SPINAL CORD AS A PATH OF CONDUCTION.

In addition to the varied and important functions performed by the cord as a system of reflex centers controlling the activities of numerous glands and visceral organs as well as the so-called voluntary muscles, it is physiologically most important as a pathway to and from the brain. All the fibers, numbering more than half a million, that enter the cord through the posterior roots of the spinal nerves bring in afferent impulses, which may be continued upward by definite tracts that end eventually in the cortex of the cerebrum, the cerebellum, or some other portion of the brain. On the other hand, many of the efferent impulses originating reflexly or otherwise in different parts of the brain are conducted downward into the cord to emerge at one or another of the anterior roots of the spinal nerves. The location and extent of these ascending and descending paths form a part of the inner structure of the cord, which is most important practically in medical diagnosis and which has been the subject of a vast amount of experimental inquiry in physiology, anatomy, pathology, and clinical medicine. In working out this inner architecture the neuron conception has been of the greatest value, and the results are usually presented in terms of these interconnecting units.

**The Arrangement and Classification of the Nerve Cells in the Gray Matter of the Cord.**—Nerve cells are scattered throughout the gray matter of the cord, but are arranged more or less distinctly in groups or, considering the longitudinal aspect of the cord, in columns the character of which varies somewhat in the different regions. From the standpoint of physiological anatomy these cells may be grouped into four classes: (1) The anterior root cells, clustered in the anterior column of gray matter (1, Fig. 73). The axons of these cells pass out of the cord almost at once to form the anterior or motor roots of the spinal nerves. (2) The tract cells, so called because their axons instead of leaving the cord by the spinal roots enter the white matter and, passing upward or downward, help to form the tracts into which this white matter may be divided (2 and 3 of Fig. 73). These tract cells are found throughout the gray matter, and, according to the side on which the axon enters into a tract, they may be divided into three subgroups: (a) Those whose axons enter the white matter on the same side of



the cord, the tautomeric tract cells of Van Gehuchten. (b) Those whose axons pass through the anterior white commissure and thus reach the tracts in the white matter of the other side. These are known as commissural cells or the heteromeric tract cells of Van Gehuchten. They form one obvious means for crossed conduction in the cord. (c) Those whose axons divide into two, one passing into the white matter of the same side, the other passing by way of the anterior commissure to reach the white matter of the opposite side—the hecateromeric tract cells of Van Gehuchten. (3) The Golgi cells of the second type—that is, cells whose

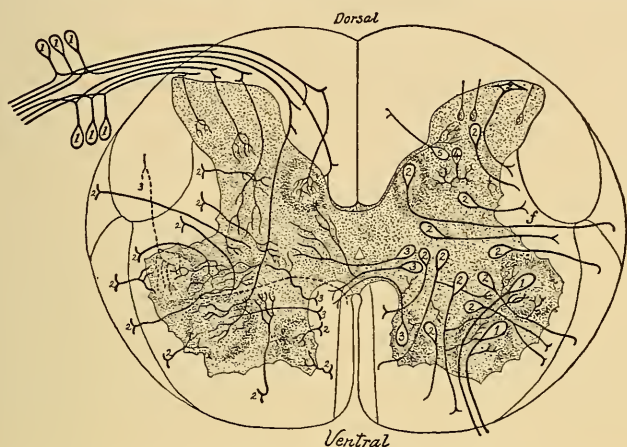

Fig. 73.—Schema of the structure of the cord.—After *Lenhossek*.) On the right the nerve cells; on the left the entering nerve fibers. Right side: 1, Motor cells, anterior column, giving rise to the fibers of the anterior root; 2, tract cells whose axons pass into the white matter of the anterior and lateral funiculi; 2, commissural cells whose axons pass chiefly through the anterior commissure to reach the anterior funiculi of the other side; 4, Golgi cells (second type), whose axons do not leave the gray matter; 5, tract cells whose axons pass into the white matter of the posterior funiculi. Left side: 1, Entering fibers of the posterior root, ending, from within outward, as follows: Clarke's column, posterior column of opposite side, anterior column same side (reflex arc), lateral column of same side, posterior column of same side; 2, collaterals from fibers in the anterior and lateral funiculi, 3, collaterals of descending pyramidal fibers ending around motor cells in anterior column.

axons divide into a number of small branches like those of a dendrite. The axons of these cells, therefore, do not become medullated nerve fibers; they take no part in the formation of the spinal roots or the tracts of white matter in the cord, but terminate diffusely within the gray matter itself. (4) The posterior root cells lying toward the base of the anterior columns. These cells have been demonstrated in some of the lower vertebrates (petromyzon—chick embryo), but their existence in the mammal is still a question in some doubt; their axons pass out from the cord by the posterior root and they form the anatomical evidence for the view that the posterior roots may contain some efferent fibers. Some of the groups of tract cells have been given special names—such, for instance, as the dorsal nucleus (Clarke's

column). This group of cells lies at the inner angle of the posterior column of gray matter (5, Fig. 76), and forms a column usually described as extending from the middle lumbar to the upper dorsal region. The axons from these cells pass to the dorsal margin of the lateral funiculi on the same side to constitute an ascending tract of fibers known as the tract of Flechsig, or the fasciculus cerebellospinalis.

**General Relations of the Gray and White Matter in the Cord.**—Cross-sections of the cord at different levels show that the relative amounts of gray and white matter differ considerably at different levels, so that it is quite possible to recognize easily from what region any given section is taken. At the cervical and the lumbar enlargements the amounts of both gray and white matter—that is, the total cross-area of the cord—show a sudden

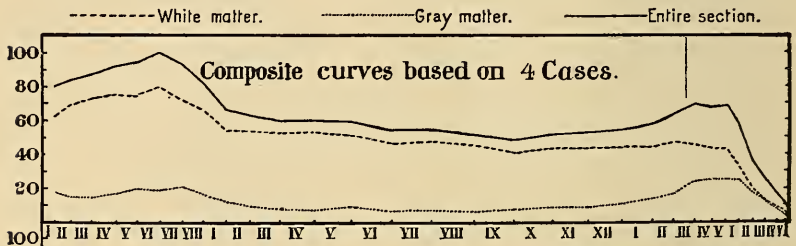

Fig. 74.—Curves to show the relative areas of the gray and white matter of the spinal cord at different levels.—(Donaldson and Davis.) The Roman numerals along the abscissa represent the origin of the different spinal nerves.

increase owing to the larger number of fibers arising at these levels. The white matter, and therefore the total cross-area, shows also a constant increase from below upward, due to the fact that in the upper regions many fibers exist that have come into the cord at a lower level or from the brain, those from the latter region being gradually distributed to the spinal nerves as we proceed downward. In the accompanying figure a curve is presented showing the cross-area of the cord and the relative amounts of gray and white matter at each segment.

**Tracts in the White Matter of the Cord, Methods of Determining.**—The separation of the medullated fibers of the cord into distinct tracts of fibers possessing different functions has been accomplished in part by the combined results of investigations in anatomy, physiology, and pathology. The two methods that have been employed most frequently and to the best advantage are the method of secondary degeneration (Wallerian degeneration) and the method of myelinization. The method of secondary degeneration depends upon the fact that, when a fiber is cut off from its cell of origin, the peripheral end degenerates in a few days. If, therefore, a lesion, experimental or pathological, is made

in the cord at any level, those fibers that are affected undergo degeneration: those with their cells below the lesion degenerate upward, and those with their cells above the lesion degenerate downward. According to the law of polarity of conduction in the neuron a descending degeneration in the cord indicates motor or efferent paths as regards the brain, and ascending degeneration indicates sensory or afferent paths. It is obvious that localized lesions can be used in this way to trace definite groups of fibers through the cord. If, for instance, one exposes and cuts the posterior roots in one or more of the lumbar nerves, the portions of the fibers entering the cord will degenerate, and the path of some of these fibers may be traced in this way upward to the medulla. The degenerated fibers may be revealed histologically by the staining methods of Weigert or of Marchi. The latter method (preservation in Müller's fluid, staining in osmic acid and Müller's fluid) has proved to be especially useful; the degenerated fibers during a certain period give a black color with this liquid, owing probably to the splitting up of the lecithin in the myelin and the liberation of the fat from its combination with the other portions of the molecule.\* The myelinization method was introduced by Flechsig. It depends upon the fact that in the embryo the nerve fibers as first formed have no myelin sheath, and that this easily detected structure is in the central nervous system assumed at about the same time by those bundles or tracts of fibers that have a common course and function. By this means the origin and termination of certain tracts may be worked out in the embryo or shortly after birth. The well-known system of pyramidal fibers, for instance, is clearly differentiated in the embryo late in intra-uterine life or at birth, owing to the fact that the fibers composing it have not at that time acquired their myelin sheaths. Flechsig assumes that the development of the myelin marks the completed structure of the nerve fiber and indicates, therefore, the time of its entrance into full functional activity.

**General Classification of the Tracts.**—The tracts that have been worked out in the white matter of the cord have been classified in several ways. We have, in the first place, the division into ascending and descending tracts. This division rests upon the fact that the axon conducts its impulses away from the cell of origin, and consequently those neurons whose axons extend upward toward the higher parts of the cord or brain are designated as ascending, since normally the impulses conducted by them take this direction. They constitute the afferent or sensory paths, and in case of injury to the fiber or cell the secondary degeneration also extends upward. The reverse, of course, holds true for the descending or motor paths.

\* See Halliburton, "The Chemical Side of Nervous Activity," London, 1901; "Croonian Lectures."

The tracts may be divided also into long and short (or segmental) tracts. The latter group comprises those tracts or fibers which have only a short course in the white matter, extending over a distance of one or more spinal segments. Histologically the fibers of these tracts take their origin from the tract cells in the gray matter of the cord and after running in the white matter for a distance of one or more segments they again enter the gray matter to terminate around the dendritic processes of another neuron. These short tracts may be ascending or descending, and the impulses that they conduct are conveyed up or down the cord by a series of neurons, each of whose axons runs only a short distance in the white matter, and then conveys its impulse to another neuron whose axon in turn extends for a segment or two in the white matter, and so on. These tracts are sometimes described as association or short association tracts, because they form the mechanism by which the activities of different segments of the cord are brought into association. This method of conduction by segmental relays involving the participation of a series of neurons may be regarded as the primitive method. It indicates the original structure of the cord as a series of segments, each more or less independent physiologically. The short tracts in the mammalian cord lie close to the gray matter, forming the bulk of what is known as the anterior and lateral proper fasciculi. The long tracts, on the contrary, are composed of those fibers, ascending or descending, which run a long distance, and, in fact, extend from the cord to some part of the brain. It is known, however, that, although the tracts as tracts extend from brain to cord, many of their constituent fibers may begin and end in the cord or in the brain, as the case may be. Some of the fibers of the long tracts are, therefore, so far as the cord is concerned, simply long association tracts which connect different regions—*e. g.*, cervical and lumbar—of the cord by a single neuron, as the short association tracts connect different segments of the same region. It is said that in these long tracts those fibers that have the shortest course lie to the inside—that is, nearest to the gray matter.\* From the results of comparative studies of the different vertebrates we may conclude that the long tracts are a relatively late development in their phylogenetic history, and that in the most highly developed animals, man and the anthropoid apes, these long tracts are more conspicuous and form a larger percentage of the total area of the cord. A physiological corollary of this conclusion should be that in man the independent activity of the cord is less marked than in the lower vertebrates, and this deduction is borne out by facts (see p. 145).

\* Sherrington and Laslett, "Journal of Physiology," 29, 188, 1903; and Sherrington, *ibid.*, 14, 255.

**Specific Designation of the Spinal Tracts.**—The tracts that are most satisfactorily determined for the human spinal cord are indicated schematically in Fig. 75.

They are named as follows: In the posterior funiculus,

1. The fasciculus gracilis (column of Goll).
2. The fasciculus cuneatus (column of Burdach).

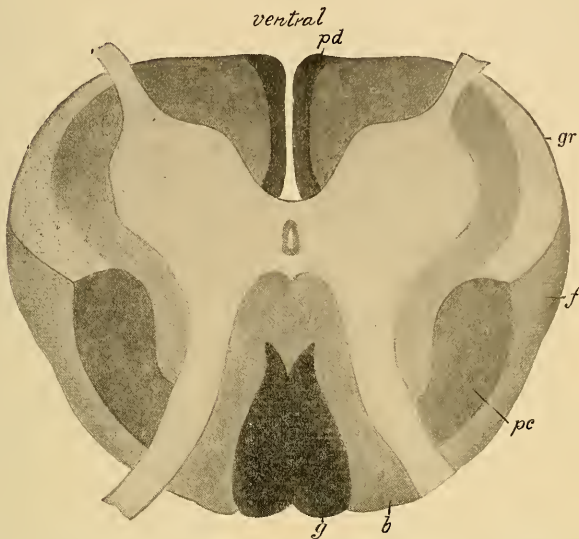

Fig. 75.—Schema of the tracts in the spinal cord (Kolliker): *g*, Fasciculus gracilis; *b*, fasciculus cuneatus; *pc*, fasciculus cerebrospinalis lateralis; *pd*, fasciculus cerebrospinalis anterior; *f*, fasciculus cerebellospinalis; *gr*, fasciculus anterolateralis superficialis.

In the lateral funiculus,

1. The fasciculus cerebrospinalis lateralis, known also as the lateral or crossed pyramidal tract.
2. The fasciculus cerebellospinalis, known also as Flechsig's tract.
3. The fasciculus anterolateralis superficialis, known also as Gowers tract.

4. The lateral ground bundle (fasciculus lateralis proprius), made up chiefly of short association fibers.

In the anterior funiculus,

1. The fasciculus cerebrospinalis anterior, known also as the direct or anterior pyramidal tract.
2. The anterior ground bundle (fasciculus anterior proprius).

Of these tracts, the fasciculus gracilis, fasciculus cuneatus, fasciculus cerebellospinalis, and fasciculus anterolateralis superficialis represent ascending or sensory paths, while the lateral and anterior cerebrospinal or pyramidal fasciculi form a related descending or motor path. The anterior and lateral ground

bundles are composed of mixed ascending and descending fibers which have not yet been separated satisfactorily into specific tracts, although some attempts in this direction have been made, as is described briefly below. At the apex of the posterior horn, or column of gray matter, there is found a small group of fibers known as the tract of Lissauer, which is composed apparently chiefly of ascending fibers.

**The Termination in the Cord of the Fibers of the Posterior Root.**—All fibers conveying afferent impulses from the skin of the limbs and trunk, from the muscles and joints, and from the vis-

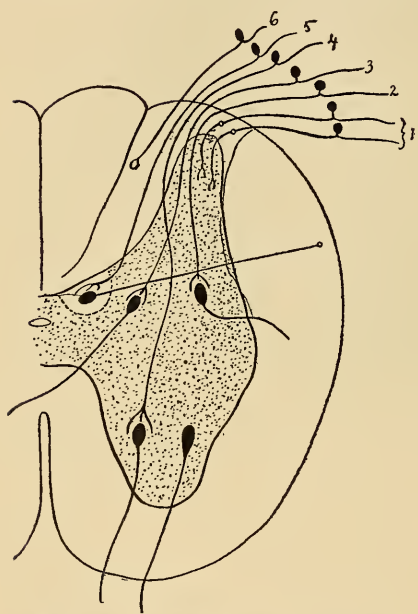

Fig. 76.—Schema to show the terminations of the entering fibers of the posterior root: 1, Fibers entering zone of Lissauer and terminating in posterior column; 2, fiber terminating around a tract cell whose axon passes into white matter of same side; 3, fiber terminating around a tract cell whose axon passes to opposite side (commissural cell); 4, fiber terminating around motor cell of anterior column (reflex arc); 5, fiber terminating in tract cell of dorsal nucleus; 6, fiber (exogenous) passing upward in posterior funiculus to terminate in the medulla oblongata.

cera and internal membranes enter the cord through the posterior roots. Inasmuch as these roots are superficially connected with the posterior funiculi, the older observers naturally supposed that this portion of the white matter of the cord forms the pathway for sensory impulses passing to the brain. That this supposition is not entirely correct was proved by experimental physiology. Section of the posterior funiculi causes little or no obvious loss of sensations in the parts below the lesion. Histological investigation has since shown that only a portion of the fibers entering through the posterior root continue up the cord in the posterior funiculi; some and indeed a large proportion of the whole number enter into the gray matter and end

around tract cells, whence the path is continued upward by the axons of these latter cells, mainly in the lateral or anterolateral funiculi. The several ways in which the posterior root fibers may end in the cord are indicated in Fig. 76.

The posterior roots contain fibers of different diameters, and those of smallest size (1) are found collected into an area known

as the tract of Lissauer, lying between the periphery of the cord and the *substantia gelatinosa* of the posterior column. These fibers, partly medullated and partly non-medullated, terminate chiefly round the small cells found in the *substantia gelatinosa*.\* The larger fibers of the root lying to the median side fall into two groups: Those lying laterally (2, 3, 4) enter the gray matter of the posterior column and end in tract cells (2) whose axons are distributed to the same side of the cord, or in tract cells whose axons (3) pass to the other side through the anterior white commissure, or (4) in the motor cells of the anterior column, thus making a typical reflex arc. Some of the fibers of this group may also pass through the posterior commissure, to end in the gray matter of the opposite side. The larger fibers lying nearest to the median line enter the fasciculus cuneatus and run forward in the cord, some of them (6) continuing upward to the medulla, and some of them (5), after a shorter course, turning into the gray matter to end in the cells of the dorsal nucleus. The axons of the cells in the dorsal nucleus in turn pass out of the gray matter to constitute the ascending path in the lateral funiculus, known as the cerebello-spinal fasciculus.

This general outline of the mode of ending in the cord of the fibers of the posterior root is complicated further by the fact that these fibers are supposed to give off collaterals after entering the cord. The course of the typical fiber in the posterior root is represented in Fig. 67. According to this diagram, the root fiber, after entering the cord, makes a Y or T division, one branch passing downward or posteriorly for a short distance, the other, longer division, passing upward or anteriorly. Each of these main stems may give off one or more lateral branches, sensory collaterals. A main stem, therefore, which runs upward in the fasciculus cuneatus (6) to terminate in the medulla oblongata may give off collaterals at various levels which terminate in the gray matter of the cord, either around tract cells or around the anterior root cells, forming in the latter case a simple reflex arc. The existence of collaterals upon the root fibers within the cord has been demonstrated in the human embryo, but we have little exact information concerning their numerical value in the adult. The schema given in Fig. 76 must, therefore, be accepted as an entirely diagrammatic representation of the chief possibilities of the mode of ending of the fibers of the posterior root by way of their collaterals as well as by way of the main stems.

**Ascending (Afferent or Sensory) Paths in the Posterior Funiculi.**—The posterior funiculi are composed partly of fibers derived directly from the posterior roots (6 in schema) and arising, therefore, from the cells in the posterior root ganglia, and partly

\* Ranson, "The American Journal of Anatomy," 16, 97, 1914.

from fibers that arise from tract cells in the gray matter of the cord itself. It is convenient to speak of the former group as exogenous fibers, using this term to designate nerve fibers which arise from cells placed outside the cord; and the latter group as endogenous fibers—that is, fibers that have their cells of origin in the gray matter of the cord. If we omit a consideration of their collaterals the course of the exogenous fibers is easily understood.

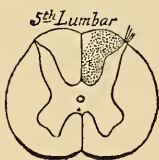
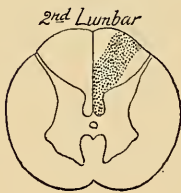
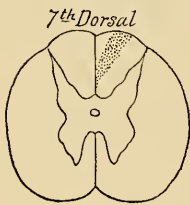
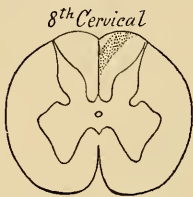
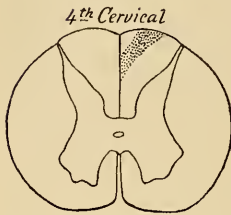

Fig. 77.—Diagrams to show course of upward degeneration of fibers of posterior funiculi after section of a number of posterior roots of the nerves forming the lumbosacral plexus.—(Mott.) It will be noted that in the cervical regions the degenerated area is confined to the fasciculus gracilis.

They come into the cord at every posterior root, enter into the fasciculus cuneatus, and pass upward. The fibers of this kind that enter at the lower regions, sacral and lumbar, are, however, gradually pushed toward the median line by the exogenous fibers entering at higher levels, so that in the upper thoracic or cervical regions the fasciculus gracilis is composed mainly of exogenous fibers that have entered the cord in the lumbar or sacral region. These fibers continue upward to end in two groups of cells that lie on the dorsal side of the medulla oblongata, and are known, respectively, as the nucleus of the fasciculus gracilis (or nucleus of Goll) and the nucleus of the fasciculus cuneatus (or nucleus of Burdach). Their path forward from the medulla is continued by new neurons arising in these nuclei, and will be described later. The course of these fibers in the cord may be shown beautifully by the method of secondary degeneration. If one or more of the posterior roots of the lumbar spinal nerves are cut or, better still, if the posterior funiculi are severed in this region, the degeneration will affect the exogenous fibers throughout their course to the medulla, and it will be seen that in the cervical region the degenerated fibers are grouped in the area of the fasciculus gracilis (see Fig. 77). The



endogenous fibers, so far as they are ascending, represent afferent paths in which two or more neurons are concerned. The posterior root fibers concerned in these paths end in the gray matter of the cord, and thence the conduction is continued by one or more tract cells. The conduction by this set of fibers may be on the same side of the cord as that on which the root fibers entered; or it may be crossed, or, using a convenient terminology, it may be homolateral or contralateral. The endogenous fibers are not a conspicuous feature of the posterior funiculi and little is known of their physiological significance. The physiological value of the exogenous or root fibers in the posterior funiculi has been investigated by a large number of observers. The physiologists have employed the direct method of cutting the funiculi in the thoracic or lumbar region and observing the effect upon the sensations of the parts below the lesion. The positive results of these experiments have been difficult to define. Most of the older observers found that there was no detectable change in the sensations of the parts below, but they paid attention only to cutaneous sensations, and, indeed, chiefly to the sense of pain. Later observers\* have differed also in their description of the effects of this operation; but most of them state that the animal shows an awkwardness or lack of skill in the movements of the hind limbs, especially in the finer movements, and this effect is interpreted to mean that there is some loss of muscle sense. This conclusion is strengthened by the results of pathological anatomy. In the disease known as *tabes dorsalis* the posterior funiculi of the cord in the lumbar region are affected and the striking symptom of this condition is an interference with the power of co-ordinating properly the movements of the lower limbs, particularly in the act of maintaining body equilibrium in standing and walking,—a condition known as *locomotor ataxia*. So far as the cutaneous sensations are concerned,—that is, the sensations of touch (pressure), pain, and temperature,—all observers agree that the two latter are not affected by section of the funiculi, while regarding touch, opinions have differed radically. Schiff contended that touch sensations are detectable as long as these funiculi are intact, and are seriously interfered with when they are sectioned; but most of the results, pathological and experimental, indicate that when the continuity of these fibers is destroyed, the sense of touch is still present in the parts supplied by the cord below the lesion. An explanation of the confusion in the reported results may be found perhaps in the fact reported below (see p. 175) that fibers conveying the impulses necessary to tactile discrimination pass upward in these funiculi, while other touch (pressure) impulses

\* Borchert, "Archiv f. Physiologie," 1902, 389. See also Sherrington, "Journal of Physiology," 14, 255, 1893.

cross in the cord and pass upward in the anterior funiculi. To summarize, therefore, we may say that the evidence at hand proves that the ascending fibers of the posterior funiculi do not convey impulses of pain or temperature, that if they convey any cutaneous touch (pressure) impulses, they certainly do not form the only path of conduction for this sense, and that most probably their chief function is the conduction of impulses of muscle sense,—that is, they consist of those deep sensory fibers from the voluntary muscles, the tendons, and the joints, through which we obtain an idea of the position of the limbs and the state of contraction of the muscles. The sensations thus aroused in the higher parts of the brain are necessary to the proper co-ordination of the movements of the muscles. Injury to these funiculi, therefore, while it does not cause paralysis, is followed by disorderly—that is, ataxic—movements. On the histological side it has been shown, as stated above, that these fibers end in nuclei of the medulla, and thence are continued forward by the great sensory tract known as the “lemniscus,” to end eventually in that part of the cortex of the cerebrum designated as the area of the body senses.

**Ascending (Afferent or Sensory) Paths in the Lateral Funiculi.**—The two best known ascending tracts in these funiculi are those of the cerebellospinal and the superficial anterolateral fasciculi. Both of these tracts are composed of endogenous fibers. The former takes its origin in the lower thoracic region, and is composed of

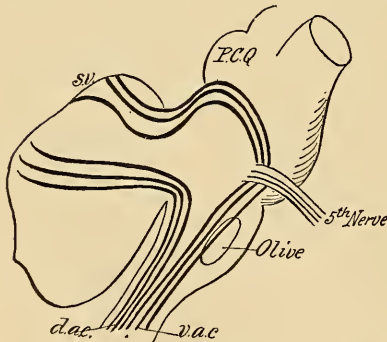

Fig. 78.—To show the course of the fibers of the cerebellar tracts of the cord (*Mott*): *v.a.c.*, Ventral tract (superficial anterolateral); *d.a.c.*, dorsal tract (cerebellospinal); *s.v.*, superior vermis; *P.C.Q.*, inferior colliculus.

axons connected with the tract cells of the dorsal nucleus. The impulses which its fibers convey are brought into the cord through those fibers of the posterior root that end around the cells of the dorsal nucleus. A number of the fibers in this funiculus end doubtless in the gray matter of the upper regions of the cord, but most of them continue upward on the same side, enter the inferior peduncle of the cerebellum (restiform body), and terminate in the posterior and median portions

of the vermiform lobe, mainly on the same side, but partly also on the opposite side. The superficial anterolateral fasciculus, situated ventrally to the cerebellospinal fasciculus (*gr*, Fig. 75), may extend forward into the anterior funiculi along the periphery of the cord. The two bundles may be more or less intermingled

at the points of contact. This tract begins in the lumbar region, its fibers arising on the same side from tract cells situated in the intermediate portions of the gray matter, or, according to Bruce,\* in the lower cells of the column of Clarke. This author states also that fibers belonging to this tract in the lower thoracic region may pass over into the tract of Flechsig at higher levels. Many of the fibers in this tract possibly terminate in the cord itself, since the bundle does not increase regularly in size as it passes up the cord. Most of the bundle continues forward, however, along the ventral side of the pons, gradually shifts more to the dorsal side, and at the level of the superior peduncles of the cerebellum turns backward, for the most part, at least, and passes to the cerebellum by way of the superior peduncle (*brachium conjunctivum*) and the anterior medullary velum, to end in the vermiform lobe chiefly on the same side, but to some extent on the opposite side† (Fig. 78). The area of distribution of these fibers lies anterior or headward of those arising in the dorsal cerebellospinal tract (Flechsig). Where this tract separates from the cerebellospinal fasciculus it is stated‡ that it gives off a number of fibers which enter the restiform body with the cerebellospinal fasciculus to end in the cerebellum. This and other facts indicate that the two tracts constitute a common system. Regarding the physiology of these two tracts there is little experimental and not much clinical evidence. Some observers have cut the cerebellospinal fasciculus in animals, but with no very obvious effect except again a slight degree of ataxia in the movements below the lesion and some loss of muscular tone.§ This result, together with the fact that the bundle ends in the cerebellum, gives reason for believing that the fibers convey afferent impulses from the muscles. As we shall see, much evidence of various kinds connects the cerebellum with the co-ordination of the muscles of the body in the complex movements of standing and locomotion. This power of co-ordination in turn depends upon the afferent impulses from the muscles and the joints and other so-called deep sensory parts, and since the fibers of the cerebellospinal fasciculus end in the cerebellum, and since experimental lesion of them gives no loss of cutaneous sensibility, but some degree of ataxia, it seems justifiable to conclude that these fibers are physiologically muscle-sense fibers. The similar fibers in the posterior funiculi end eventually in the cortex of the cerebrum, and may be supposed, therefore, to mediate our conscious muscular sensa-

\* Bruce, "Quarterly Journal of Exp. Physiology," 3, 391, 1910.

† For the literature upon these tracts see Van Gehuchten, "Le Névrate," 3, 157, 1901; Horsley and Macnalty, "Brain," 1909, 237, and Bruce, loc. cit.

‡ Schäfer and Bruce, "Journal of Physiology," 1907 ("Proc. Physiol. Soc.,").

§ Bing, "Archiv für Physiologie," 1906, 250; also Horsley and Macnalty, loc. cit.

tions, but these fibers in the cerebellospinal tract end in the cerebellum, an organ which, so far as we know, gives rise to no conscious sensations. To speak of them, therefore, as muscle-sense fibers may be somewhat misleading, and it may be better to follow the plan of designating them as the non-sensory afferent fibers arising from tissues beneath the skin, such as the muscles, the tendons, and the ligaments round the joints. The superficial anterolateral fasciculus has been the subject of some experimental study from the physiological side, but the results have been negative. Clinically, the tract may be involved in pathological or traumatic lesions of the lateral funiculi. Gowers\* gives a history of some such cases, which lead him to believe that this tract constitutes a pathway for pain impulses, and this view or the view that it conducts the impulses of both pain and temperature has been more or less generally accepted. Entire confidence, however, cannot be placed in this conclusion, since the lesions in question were not strictly confined to the fasciculus in question, although clinical evidence indicates that the fibers conveying impulses of pain or of pain and temperature lie in the ground bundles in the neighborhood of this tract. The only positive indication that we have concerning the physiological value of this specific tract of fibers is given by their histology in the fact that they end, for the most part, in the cerebellum. The cerebellum, we know, may be removed in dogs and monkeys without loss of the sensation of pain, temperature, or touch, and this fact speaks strongly against the view that either the cerebellospinal or the superficial anterolateral fasciculus is concerned in the conduction of these cutaneous sensations. From a physiological standpoint we should be inclined to believe that both of these tracts conduct non-sensory afferent impulses from the tissues lying under the skin, particularly from the muscles, tendons, and joints. It would seem, therefore, that all the long ascending tracts in the posterior and lateral funiculi of the cord may be made up of fibers of muscular sensibility, using this term in a wise sense to include the deep sensibility of the joints, tendons, and muscles. The immense importance of muscular control in the maintenance of life and in defense against enemies may explain, upon the doctrine of the struggle for existence, why the long paths should have been developed first in connection with this sense.

**The Spinal Paths for the Cutaneous Senses (Touch, Pain, and Temperature).**—From the facts stated in the last two paragraphs it would seem probable that the spinal paths for touch, pain, and temperature must be along the short association tracts of the proper fasciculi of the lateral and anterior funiculi. There is evidence from the clinical side that the paths of con-

\* Gowers, "Lancet," 1886.

duction for these senses are separate. In the pathological condition known as syringomyelia, cavities are formed in the cord affecting chiefly the central gray matter and the contiguous portions of the white. In these cases a frequent symptom is what is known as the dissociation of sensations; the patient loses, in certain regions, the sensations of pain and temperature (analgesia and thermo-anesthesia), but preserves that of pressure (touch). Facts of this kind indicate that the paths of conduction for touch are separate from those for pain and temperature, but little that is positive is known regarding the exact location of these paths. The fibers of pain and temperature probably end in the gray matter of the cord (posterior column) soon after their entrance, and the path is continued upward by tract cells whose axons enter the proper fasciculi in the anterolateral funiculi,\* but the number of such neurons concerned in the conduction as far as the medulla is not known. Regarding the path for the touch impulses a singular amount of uncertainty has prevailed. This sense is not lost or, at least, is rarely lost in cases of syringomyelia in which the other cutaneous senses are affected. On the other hand, the posterior funiculi, as we have seen, may be completely sectioned in lower animals without destroying the sense of touch and in the case of man extensive pathological lesions of the same funiculi are reported in which the sense of touch was not lost. Some authors, therefore, have been led to believe that the touch impulses may be conveyed up the cord by several paths: by the long association fibers of the posterior funiculi, and by the short association fibers of the lateral funiculi. Such a view receives little support from the experimental work on the lower mammals. In these animals the evidence tends to show that the conduction is by way of the lateral or anterolateral funiculi, by means of tract cells and short association tracts. The fact that in man the clinical evidence seems to point to the posterior funiculi as a possible or, indeed, probable path for these fibers may serve to exemplify the fact that in these matters the various mammalia differ more or less according to the degree of their development. It seems possible that, so far as man is concerned, an explanation of the difference of opinion regarding the spinal paths of the sense of touch is found in the distinction made by Head and Thompson † between tactile discrimination and cutaneous sensibility to touch. By the former is meant the ability to discriminate between two stimuli applied simultaneously to the skin at a certain distance apart, by the latter, the ability to perceive and locate accurately a light pressure stimulus applied to the skin. These two forms of

\* For discussion, see Bertholet, "Le Névrose," 1906, vii., 283, for the lower animals; Head and Thompson, "Brain," 1906, p. 537, and Thompson, "Lancet," 1909, for man.

† Head and Thompson, "Brain," 1906; also Saunders, "Brain," 36, 166, 1913.

cutaneous touch sensations are mediated according to these authors by separate systems of fibers. As the result of a spinal lesion the power of discrimination may be lost over a given area of skin which otherwise is completely sensitive to all cutaneous stimuli. They find that the fibers of tactile discrimination travel up the cord uncrossed in the posterior funiculi, together with the fibers of muscle sense—that is, the fibers which give us a sense of position and movement of the limbs. The fibers of cutaneous touch sensations in general, on the contrary, cross to the other side before reaching the medulla, and pass upward in the anterolateral ground-bundles.

**Homolateral and Contralateral Conduction of the Cutaneous Impulses.**—Great interest, from the medical side, has been shown in the question of the crossed or uncrossed conduction of the cutaneous impulses in the cord. The matter is naturally one of importance in diagnosis. In human beings it was pointed out by Brown-Séguard\* that unilateral lesions of the cord are followed by muscular paralysis below on the same side, and loss of cutaneous sensibility on the opposite side. This syndrome has been held clinically to establish the diagnosis of a unilateral lesion, and has led to the view that, while the conduction of motor impulses in the cord is homolateral, that of the cutaneous sensory impulses is contralateral. Experimental work on lower animals, on the contrary, has not supported this view. While results in this direction have varied, as would be expected from the intrinsic difficulties connected with the interpretation of the sensations of an animal, the general outcome has been to show that the sensory conduction is bilateral, but mainly on the same side. That is, if the cord is cut on one side only (hemisection) in the thoracic region, the cutaneous sensibility of the parts below the lesion is impaired upon the same side, but not completely abolished, showing that some crossing has taken place.† In fact, it is stated that pain sensations in the lower animals are not abolished by a double hemisection,‡ that is to say, by a hemisection below, in the thoracic cord for example, on one side, and a hemisection above, cervical cord, on the other side. That the pain impulses get through to the brain under this condition would seem to imply that they are conveyed either diffusely through the central gray matter, or that they cross a number of times from one side to the other. In man the evidence from the clinical side, as far as it goes, indicates that the paths for touch, pain, and temperature are more specialized than in the lower mammals, so that the results obtained from experiments upon the latter must be used

\* Brown-Séguard, "Journal de Physiologie," 6, 124, 232, 581, 1863.

† Mott, "Brain," 1895, 1, and Bertholet, "Le Névraque," 1906, vii., 283.

‡ Karplus and Kreidl, "Pflüger's Archiv," 158, 275, 1914.

with caution in the diagnosis of human lesions. Head and Thompson, in the paper previously referred to, conclude, upon the basis of extensive clinical studies, that in man all the fibers of cutaneous sense cross in the cord except those mediating tactile discrimination. As stated above, these latter pass upward in the posterior funiculi together with some of the fibers of muscle sense, and do not cross

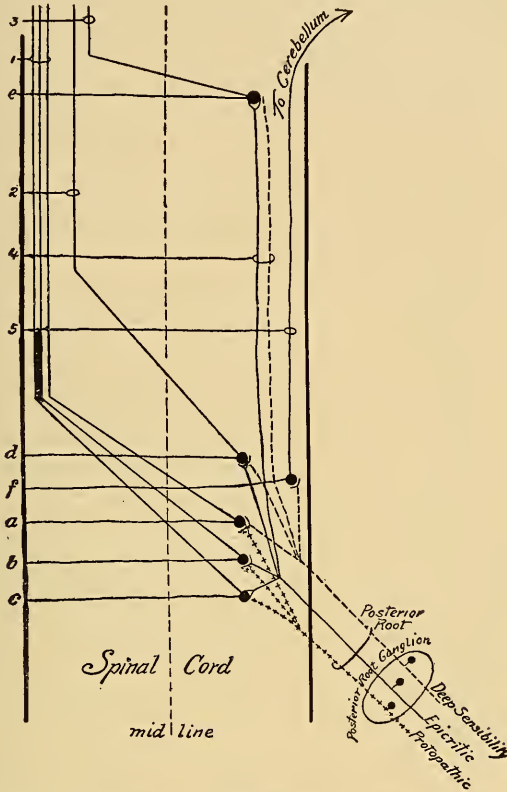

Fig. 79.—Diagram of the afferent nerve-fibers and their course in the spinal cord: *a*, Specific receptor for painful impulses; *b*, specific receptor for heat impulses; *c*, specific receptor for cold impulses; *d*, specific receptor for tactile impulses; *e*, specific receptor for impulses of passive position and tactile discrimination; *f*, specific receptor for non-sensory afferent impulses; 1, sensory fibers of the second order for pain, heat, and cold; 2, sensory fibers of the second order for touch; 3, sensory fibers of the second order for passive position and tactile discrimination; 4, long fibers (uncrossed) in the posterior column of the cord; 5, spinocerebellar tracts (lateral columns) for non-sensory afferent impulses (from Thompson, slightly modified).

until after they reach the medulla. These authors in studying the sensory paths in the spinal cord make a distinction, in the first place, between cutaneous sensibility and deep sensibility. By the latter term they designate the senses of pressure, of pain, and of position resident in the muscles, tendons, and other parts beneath the skin. Cutaneous sensibility they divide further into epicritic sensibility

(touch, cold, heat) and protopathic sensibility (cold, heat, pain), see p.278. The fibers of these three general varieties are regrouped in the cord in such a way that the epicritic and protopathic temperature fibers are brought together into a common tract, which is contralateral; the deep and cutaneous pain fibers are likewise united into a common tract, which is contralateral, and cutaneous pressure fibers, except those mediating tactile discrimination, unite with the deep pressure fibers to form a common tract which crosses the mid-line less promptly. This conception is indicated in the accompanying schema (Fig. 79). According to their interpretation, a complete unilateral lesion of the

cord in the cervical region would be followed by a homolateral loss of motion in the parts below, and also of tactile discrimination and muscle sense, using the latter term to cover the deep sensibility in regard to position and movements of the limbs. On the contralateral side there would be a loss of pain, temperature, and pressure.

**The Descending (Efferent or Motor) Paths in the Antero-lateral Funiculi.**—The main descending path in the cord is the pyramidal or cerebrospinal system of fibers. In man, as shown in Fig. 75, there are two fasciculi belonging to this system—the anterior and the lateral pyramidal tracts. Both tracts arise from the anterior pyramids on the ventral face of the medulla, whence the name of the pyramidal system. At the junction of the medulla and cord the fibers of the pyramids decussate in part, forming a conspicuous feature of the internal structure at this point, known as the pyramidal decussation. According to the general schema of this decussation (see Fig. 80), the larger number of the fibers in the pyramid of one side pass over to form the lateral pyramidal

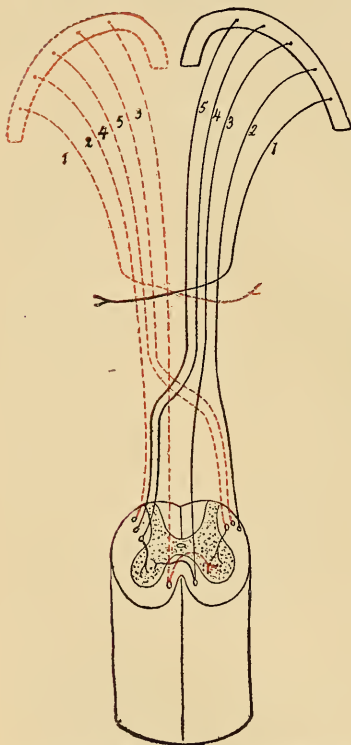

Fig. 80.—Schema representing the course of the fibers of the pyramidal or cerebrospinal system: 1, Fibers to the nuclei of the cranial nerve; 2, uncrossed fibers to the lateral pyramidal fasciculus; 3, fibers to the anterior pyramidal fasciculus crossing in the cord; 4 and 5, fibers that cross in the pyramidal decussation to make the lateral pyramidal fasciculus of the opposite side.

fasciculus of the other side of the cord (4, 5), while a smaller part (3) continues down on the same side to form the anterior pyra-



midal fasciculus. Eventually, however, these latter fibers also cross the mid-line in the anterior white commissure, not, however, all at once, as at the pyramidal decussation, but some at the level of each spinal nerve. These pyramidal fibers have their origin in the cortex of the cerebral hemispheres in large pyramidal cells; some of them cross the mid-line before reaching the medulla to end around the cells of origin of the cranial nerves, but the greater number continue into the cord and, after crossing the mid-line in the pyramidal decussation or in the anterior white commissure, terminate around the motor cells of the anterior columns which give rise to the motor roots of the spinal nerves. Both fasciculi, the lateral and the anterior, continue throughout the length of the cord, diminishing in area on the way as some of their fibers terminate in each segment. This system of fibers is supposed to represent the mechanism for effecting voluntary movements, and according to the general schema the voluntary motor path from cerebrum to muscle comprises two neurons,—the pyramidal or cerebrospinal neuron and the spinal or the cranial neuron. Moreover, as represented in the schema, the innervation is crossed, the right side of the brain controlling the musculature of the left side of the body and *vice versa*. As we shall see, however, when we come to study the motor areas of the brain, this rule has important exceptions, and histologically there is proof that some of the fibers in each pyramid (2 in Fig. 80). continue into and terminate in the cord on the same side. The pyramidal system varies, among the different vertebrates, in an interesting way, in the extent of its development and in its location in the cord.\* It reaches its highest development in man and the anthropoid apes. In the other mammalia it is relatively less important and the anterior fasciculus may be lacking altogether. In the birds what represents the same system is found in the anterior funiculus (Sandmeyer), while in the frog the system does not exist at all.

The relative importance of the system in the different mammalia is indicated in the accompanying table, taken from Lenhossek, † in which the area of the pyramidal system is given in percentage of the total cross-area of the cord:

Mouse.....	1.14 per cent.
Guinea pig.....	3.0 “
Rabbit.....	5.3 “
Cat.....	7.76 “
Man.....	11.87 “

Evidently, therefore, the importance of the pyramidal system varies in different animals, and it is necessary to bear this fact

\* Simpson, “Quarterly Journal of Exp. Physiology,” 8, 79, 1914.

† Lenhossek, “Bau des Nervensystems,” second edition, 1895.

in mind in applying the results of experiments on the lower animals to man. In the lowest vertebrates there are undoubtedly motor paths between the brain and cord through which so-called voluntary movements are effected, but these are probably short paths involving a number of neurons. The higher the position of the animal in the phylogenetic scale, the more complete is the development of the long pyramidal system; but even in the higher mammals it is probable that motor paths, other than the pyramidal system, connect the cortex and subcortical centers with the motor nuclei in the cord. In the dog, for example, section of the pyramids is not followed by complete paralysis, and, indeed, after such sections stimulation of the motor areas of the cortex still causes definite muscular movements.\* One such indirect motor path is referred to below in connection with the rubrospinal tract (Monakow's bundle).

**Less Well-Known Tracts in the Cord.**—In addition to the tracts just described there are a number of others—mainly, descending tracts—concerning which our anatomical knowledge is less complete, and the physiological value of which is entirely unknown or at best is a matter of inference from the anatomical relations.†

*Descending Tracts in the Posterior Funiculus*—Comma Tract; Oval Field.—In the posterior funiculi several tracts of descending fibers have been described. The comma tract of Schultze is found in the cervical and the upper thoracic cord. The bundle lies at the border-line between the fasciculus gracilis and the fasciculus cuneatus. In the lower regions of the cord, lumbar and sacral, similar small areas of descending fibers are found—oval field (Flechsig), median triangle (Gombault and Philippe)—which represent possibly different systems. These fibers have been explained as descending association tracts connecting distant parts of the gray matter of the cord, but recent work‡ indicates that they may represent simply the descending limb of entering posterior root fibers. When the latter enter the cord they divide in T, one branch passing upward, the other downward for a short distance. On this interpretation the fibers in question do not constitute a descending tract, physiologically speaking, in spite of their descending degeneration.

*Descending Tracts in the Anterolateral Funiculus.*—The prepyramidal tract, known also as Monakow's bundle, the fasciculus intermediolateralis, or the rubrospinal tract, is a conspicuous

\* Rothmann, "Zeitschrift f. klin. Med.," vol. xlviii., 1903; Schäfer, "Quarterly Journal of Exp. Physiology," 3, 355, 1910.

† Collier and Buzzard, "Brain," 1901, 177; Fraser, "Journal of Physiology," 28, 366, 1902. For summary and literature consult Van Gehuchten, "Anatomie du système nerveux de l'homme."

‡ "Brain," vol. xxxvi., 1913.

bundle forming a wedge-shaped or triangular area in the lateral columns between the lateral pyramidal fasciculus and the superficial anterolateral fasciculus (Gower's), or, perhaps, more correctly speaking, forming the anterior portion of the lateral pyramidal fasciculus; the two systems being more or less intermingled. The fibers composing this bundle are descending fibers that take their origin in the midbrain in the cells of the red nucleus. Shortly after their origin they cross to the opposite side and, passing through the pons and medulla, enter the spinal cord in the lateral funiculi, in which they may be detected as far as the sacral region. These fibers terminate around cells lying in the posterior part of the anterior column of gray matter, whose axons, in turn, probably emerge through the anterior roots. This tract, therefore, constitutes a crossed motor path from midbrain to the anterior roots, and, since the red nucleus, in turn, is connected with the cerebrum, either directly or by way of the cerebellum, it represents a cerebrospinal motor path in addition to that offered by the pyramidal system.

The vestibulospinal fibers lie anterior to the preceding tract in the anterolateral funiculus; they may extend into the anterior funiculus as far as the anterior pyramidal fasciculus. It is stated that they arise in cells of the nucleus of Deiters and the nucleus of Bechterew, and similar cells lying in the region of the pons. In the cord these fibers end around cells in the anterior column. Since the Deiters nucleus forms a termination for the sensory fibers of the vestibular branch of the eighth cranial nerve, and since these fibers are believed to give us a sense of the position of the body and to be concerned in the reflex adjustment of the muscles in the movements used to maintain equilibrium, their connection in Deiters' nucleus with a spinal motor path becomes very significant as furnishing a reflex arc through which sensory impressions from the vestibular apparatus in the ear may automatically control the musculature of the body. A number of other descending paths in the anterior and lateral funiculi have been described, such as Helweg's bundle or the olivospinal tract, lying on the margin of the cord at the junction of the anterior and the lateral funiculi and supposed to arise in the olivary bodies; the anterior and the lateral reticulospinal tracts arising from cells in the reticular formation of medulla, pons, and midbrain; and the continuation into the cord of the important medial longitudinal fasciculus (post. long. bundle), which extends from the midbrain through to the cord and connects the motor nuclei of the cranial nerves with the motor centers of the cord. Concerning these and similar tracts our physiological knowledge is scanty, and it is not possible at present to employ them with certainty in explaining the activity of the neuromuscular apparatus.

## CHAPTER IX.

### THE GENERAL PHYSIOLOGY OF THE CEREBRUM AND ITS MOTOR FUNCTIONS.

From the time of Galen in the second century of the Christian era the cerebrum has been recognized as the organ of intelligence and conscious sensations. Galen established this view not only by anatomical dissections, confirming the older work of the Alexandrian school (third century B.C.) in regard to the origin from the brain of the cranial nerves, but also by numerous vivisection experiments upon lower animals. All modern work has confirmed this belief and has tended to show that in the cerebral hemispheres and, indeed, in the cortex of gray matter lies the seat of consciousness. It is perhaps still an open question as to the existence of a conscious or psychical factor in the activities of other parts of the nervous system, but there is no doubt that the highest development of psychical activity in man is associated with the cortical matter of the cerebrum. In the young infant the dawn of its mental powers is connected with and dependent on the development of the normal cortical structure, while in extreme age the failure in the mental faculties goes hand in hand with an atrophy of the elements of the cortex. If this cortex were removed all the intelligence, sensation, and thought that we recognize as characterizing the highest psychical life of man would be destroyed, and abnormalities in the structure of this cortical material are accepted as the probable causal factor of those perversions in reasoning and in character which are exhibited by the insane or the degenerate. The cortical gray matter, therefore, is the chief organ of the psychical life, the tissue through whose activity the objective changes in the external world, so far as they affect our sense organs, are converted into the subjective changes of consciousness. The nature of this reaction constitutes the most difficult problem of physiology and psychology, a problem which perhaps is beyond the possibility of a satisfactory scientific explanation. For it is held that the methods of science are applicable only to the investigation of the objective—that is, the physical and chemical—changes within the nervous matter, while the psychical reaction is of a nature that cannot be approached through the conceptions or methods of physical science. In other words, there is a physicochemical mechanism in the brain matter which is capable of giving us a

reaction in consciousness. The methods of physiology are adapted to the investigation of the nature of this mechanism, but the reaction in consciousness deals with a something which so far as we know is not matter or energy, and which, therefore, is not within the scope of physiological or, indeed, scientific explanation. In what follows, therefore, attention is called only to the mechanical side,—the facts that have been discovered regarding the anatomical structure and the physical and chemical properties of the nervous mechanism.

**The Histology of the Cortex.**—The finer structure of the different regions of the cortex has been the subject of much investigation, but in this connection it is only necessary to recall the elementary facts so far as they are useful in physiological explanations. Leaving aside differences in the shape and stratification of the cells, it is an interesting fact that the cortex everywhere has a similar structure. It consists of four or five layers more or less clearly distinguishable (see Fig. 81).

1. The superficial, plexiform, or molecular layer, lying immediately beneath the pia mater, and having a thickness of about 0.25 mm. In this layer, in addition to the supporting neuroglia, there are found a number of very small nerve cells of several types lying with their processes parallel to the surface of the brain. The axons and dendrites of these small cells terminate within the layer, so that they take no direct part in the formation of the white matter of the brain, but have, probably, a distributive or associative function. In this layer, also, end many of the dendrites of the larger nerve cells of the deeper layers and the terminal arborization of entering nerve fibers (axons) from other regions.

2. The layer of pyramidal cells. This layer is characterized by the presence of numerous pyramidal cells (see D, Fig. 84), which in general increase in size in passing from the upper to the lower strata. The apices of these cells are directed toward the external surface. The dendrites from the apical process terminate in the molecular layer, while the axon arising from the basal side of the cell passes inwardly to constitute one of the nerve fibers of the medullary portion of the cerebrum. This thick lamina of cells is sometimes subdivided into three layers of small, medium, and large pyramidal cells.

3. The granular or stellate layer composed of many small cells, some of which are pyramidal and some stellate in form, with short branching axons. These latter belong to Golgi's second type of nerve cell.

4. The deep pyramidal layer or layer of large or medium-sized pyramidal cells, similar in form to those in layer two, and the axons of which pass into the medulla or white matter of the cerebrum as nerve fibers.



5. The layer of fusiform or polymorphic nerve cells. A layer of cells whose form is more irregular than that of the pyramidal cells, but whose axons also pass into the medullary portion of the cerebrum, while their dendrites stretch externally into the layers of pyramidal cells. In this layer are found also some cells belonging to the second type of Golgi (Martinotti cells).

2 The medulla of the cerebrum. The white matter of the cerebrum begins immediately below the last-named layer, and consists (1) of nerve fibers which originate from the pyramidal and polymorphic cells immediately exterior to it, and which carry outgoing impulses from that part of the cortex, and (2) of fibers arising elsewhere in the cortex or in the lower portions of the brain, which terminate in the cortex and carry the incoming impulses—impulses which are afferent as regards that part of the cortex.

3 fibers in this white matter may be classified under three heads: First, the *projection system* (*A, B, C, D, and E* of Fig. 82), comprising those fibers, afferent and efferent, which connect the cortex with underlying parts of the central nervous system,—the spinal cord, medulla, pons, midbrain, or thalamus.

5 This great projection system emerges, for the most part, through the internal capsule and the peduncles of the cerebrum. Second, the *association system*. Certain parts of the cortex are seemingly lacking in a projection system; the fibers arising from these parts do not enter the capsule to make connection with the motor and sensory paths below, but pass to other parts of the cortex, forming a part of the system of association fibers. This sys-

Fig. 81.—Section through the cortex of the third frontal convolution (Broca's convolution) to show the stratification of the nerve cells: 1, The plexiform or molecular layer; 2, the outer layer of pyramidal cells; 3, the granular layer; 4, the deep or inner pyramidal layer; 5, the fusiform or polymorphic layer (from a camera lucida drawing by Mellus).

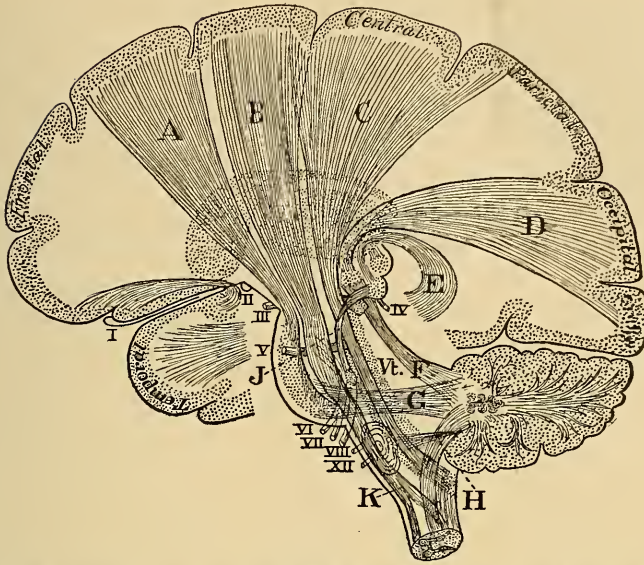

Fig. 82.—Schema of the projection fibers of the cerebrum and of the peduncles of the cerebellum; lateral view of the internal capsule: *A*, Tract from the frontal gyri to the pons nuclei, and so to the cerebellum (frontal cerebro-cortico-pontal tract); *B*, the motor (pyramidal) tract; *C*, the sensory (lemniscus) tract; *D*, the visual tract; *E*, the auditory tract; *F*, the fibers of the superior peduncle of the cerebellum; *G*, fibers of the middle peduncle uniting with *A* in the pons; *H*, fibers of the inferior peduncle of the cerebellum; *J*, fibers between the auditory nucleus and the inferior colliculus; *K*, motor (pyramidal) decussation in the bulb; *Vt*, fourth ventricle. The numerals refer to the cranial nerves.—(Modified from *Starr*.)

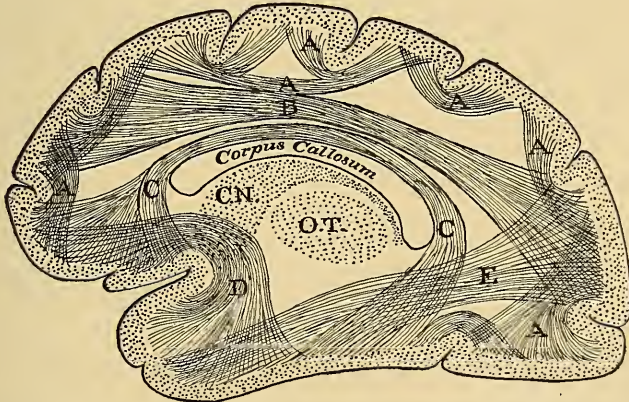

Fig. 83.—Lateral view of a human hemisphere, showing the bundles of association fibers (*Starr*): *A*, *A*, Between adjacent gyri; *B*, between frontal and occipital areas; *C*, between frontal and temporal areas, cingulum; *D*, between frontal and temporal areas, fasciculus uncinatus; *E*, between occipital and temporal areas, fasciculus longitudinalis inferior; *C.N.*, caudate nucleus; *O.T.*, thalamus.

tem may be defined as comprising those fibers which connect one part of the cortex with another (Fig. 83). There are short associ-

ation tracts (*A, A*) connecting neighboring convolutions and long tracts passing from one lobe to another. Third, the *commissural system*, consisting of association fibers that cross the mid-line and connect portions of one cerebral hemisphere with the cortex of the other. These fibers make up the commissural bands, known in gross anatomy as the corpus callosum, anterior white commissure, fornix, etc.

**Physiological Deductions from the Histology of the Cortex.**  
—Cajal\* especially lays stress upon some anatomical features which seem to justify certain generalizations of a physiological nature. In the first place, every part of the cortex receives incoming impulses and gives rise to outgoing impulses. Every part of the cortex is, therefore, both a termination of some afferent path and the beginning of some efferent path; it is, in other words, a reflex arc of a greater or less degree of complexity. We may suppose that every efferent discharge from any part of the cortex is occasioned by afferent impressions reaching that point from some other part of the nervous system. Whether or not there is such a thing as absolutely spontaneous mental activity cannot be determined by physiology, but on the anatomical side at least all the structures exhibit connections that fit them for reflex stimulation, and many of our apparently spontaneous acts must be of this character. Secondly, all parts of the cortex exhibit an essentially similar structure. Modern physiology has taught that different parts of the cerebrum have different functions, but the differentiation in structure which usually accompanies a specialization in function is not at first very evident. Definite differences in the thickness of the layers, in the size or shape of the cells, or in the character of the fibrillation, have been pointed out (see p. 229), but it is perhaps something of a disappointment to find so little of an anatomical distinction between structures whose reaction in consciousness may be separated so widely. Numerous special studies made upon the lamination of different parts of the human cortex (see p. 229), and comparative observations upon the cerebral cortex in different vertebrates, have served to give an anatomical foundation for various interesting speculations which subsequent work may or may not confirm. † It is pointed out that if we omit the outer or molecular layer the other cells of the cortex fall into three groups, namely, the *granular layer* (3 in Fig. 81), the *supra-granular layer* (2), comprising the pyramidal cells external to the

\* Cajal, "Les nouvelles idées sur la structure du système nerveux, etc.," Paris, 1894.

† For a summary of these views consult Bolton, "Brain," 1910 and 1912, or "Further Advances in Physiology," Hill, London and New York, 1909; Van Valkenburg, "Folia neurobiologica," 1910, 4, 335.



granular layer, and the *infragranular layer* (4 and 5), comprising the pyramidal and fusiform cells internal to the granular layer. Comparison of the cerebral cortex in the brains of the different vertebrates indicates that the supragranular cells have appeared relatively late in the phylogeny of the vertebrates, and have reached their greatest development in the human brain. The suggestion occurs, therefore, that these cells have a different functional significance from those in the infragranular layer. It has been supposed that the supragranular cells mediate the so-called



Fig. 84.—A-D, Showing the phylogenetic development of mature nerve cells in a series of vertebrates; a-e, the ontogenetic development of growing cells in a typical mammal (in both cases only pyramidal cells from the cerebrum are shown); A, frog; B, lizard; C, rat; D, man; a, neuroblast without dendrites; b, commencing dendrites; c, dendrites further developed; d, first appearance of collateral branches; e, further development of collaterals and dendrites.—(From Ramón y Cajal.)

higher psychical processes, which characterize man and the related mammalia as compared with the lower vertebrates. The infragranular cells, on the other hand, constitute a primitive layer which has obvious connections, through projection fibers, with the underlying parts of the brain and of the body at large. These cells form, therefore, a mechanism through which the brain is connected directly with the rest of the body, and through which the older

instinctive reactions are controlled. In the matter of lamination and distinct variations in size and appearance of the strata of cells and fibers the human cortex shows a greater differentiation than in the lower animals, and it is especially characterized by a large development of what are known as associational areas (p. 223), particularly in the frontal lobe. In the third place, the central nervous system throughout the vertebrates is constructed upon the same lines, a mechanism of interconnecting neurons. There is a vast difference in the men-

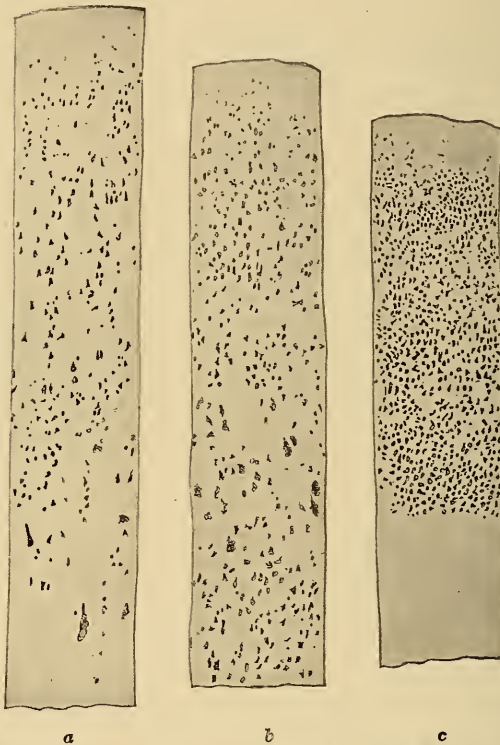

Fig. 85.—Sections through corresponding parts of the cortex in: *a*, Man; *b*, dog; and *c*, mole, to show the greater separation of the nerve cells in the higher animals.—(Bethe, after Nissl.)

tal activity of a frog and a man, but the cortex of the cerebrum shows a fundamental similarity in structure in the two cases. In addition to the variations in stratification or lamination referred to above one general distinction that comparative anatomy is able to make is that in the higher animals the greater mental development is associated with a greater complexity and richness in the con-

nections of the neurons. As shown in Figs. 84 and 85, the number of processes, particularly the dendritic processes, is much greater in the cortical cells of the higher animals; or, to put this fact in another way, the number of cells in the cortex of the higher animals is much less for an area of the same size than in lower animals. The amount of in-between substance or the richness of the network of processes is increased. This anatomical fact would indicate that the greater mental activity in the higher animals is dependent, in part, upon the richer interconnection of the nerve cells, or, expressed physiologically, our mental processes are characterized by their more numerous and complex associations. A visual or auditory stimulus that, in the frog, for instance, may call forth a comparatively simple motor response, may in man, on account of the numerous associations with the memory records of past experiences, lead to psychical and motor responses of a much more intricate and indirect character. From a physiological standpoint these responses are of the order of reflex actions. They must be investigated and, if possible, explained from this point of view. The problem is difficult and complex. The methods that have been employed for its solution are described and illustrated in the summary of results given in the following pages, but it is obvious that new methods of approach are much needed. One such attempt that is now being made is known under the term of "conditioned reflexes."

**The Phenomenon of Conditioned Reflexes.**—The usual reflexes effected through the spinal cord and the lower centers of the brain are of a fixed nature. Light thrown on the retina causes always a constriction of the pupil; a touch applied to the cornea causes a winking movement; acid in the mouth is followed by a secretion of saliva. These and similar reflexes are essentially invariable responses to appropriate stimuli, and the mechanism involved, the reflex arc, is an inherited structure already elaborated for use. Pawlow designates such acts as *unconditioned reflexes*. In contrast to them he describes a class of reflexes obtained through the cortex of the cerebrum which he calls *conditioned reflexes*, because they may be elaborated under certain conditions. They may be brought into existence by a process of training or education, and they are subject to various forms of inhibition, internal and external. He has made a special study of these reflexes in connection with the salivary glands. If a certain sensory stimulus is given, for example, a note of 800 vibrations per second, it has no effect on the flow of saliva. But if repeatedly the salivary gland is stimulated by acid or food simultaneously with the sounding of the note a conditioned reflex will be established, and the note, when given alone, will cause a flow of saliva. When this conditioned

reflex is first established it may be obtained also with neighboring tones, but with training the reflex becomes more and more specialized, so that finally as small an interval as one-eighth of a tone may be differentiated—a sound of 800 vibrations causes a flow of saliva while a sound of 812 vibrations is ineffective. The process of differentiation is explained as being due to an internal inhibition, as shown by the following experiment. If a tone of 812 vibrations is sounded no saliva is obtained, and if immediately afterward the effective tone, 800 vibrations, is sounded no effect follows. Only after a wait of fifteen to twenty minutes does the tone of 800 again cause a flow of saliva. He argues from this that the tone of 812 vibrations is accompanied by a process of inhibition, whose effect passes off only after some minutes. By these objective methods Pawlow\* has brought to light some interesting peculiarities in the action of the cortex, and has established a method by means of which it may be possible to study the nature and development of the mechanisms elaborated in the plastic cortical centers by education and experience during the life of the individual.

**Extirpation of the Cerebrum.**—One of the methods used in physiology to determine the general functional value of the cerebral hemispheres has been to remove them completely, by surgical operation, and to study the effect upon the psychical responses of the animal. Upon the cold-blooded animals and the birds the operation may be performed with ease, but in these animals the positive results are not striking and the experiments are valuable chiefly for their negative results. If the cerebral hemispheres are removed from the frog, for example, the animal after recovering from the immediate effects of the operation—that is, the effects of the anesthetic and the shock—shows surprisingly little difference from the normal animal. It maintains a normal posture and shows no loss at all in its power of equilibration. When placed on its back it quickly regains its usual position. If thrown into water it swims to a solid support and crawls out like a normal animal. It jumps when stimulated and is careful to avoid obstacles placed in its way, showing that its visual reflexes are not impaired. It is said, however, that the more complicated reactions that depend upon the memory of past experiences or the instincts are absent or imperfect. This latter peculiarity is manifested most impressively in birds (pigeons) after removal of a part or all of the cerebrum. As a result of such an operation, the nervous, active animal is changed at once to a stupid, lethargic creature which reacts only when

\* Pawlow, "Livre jubilaire du Professeur Ch. Richet," 1912, p. 325. See also Morgulis, "The Journal of Animal Behavior," 4, 362, 1914.

stimulated. It sits in a drowsy attitude, with its head drawn in to the shoulders, its eyes closed, and its feathers slightly erected; occasionally it will open its eyes, stretch the neck, gape, preen its feathers perhaps, and then sink back into its somnolent attitude. The animal in this condition maintains its equilibrium perfectly, flies well if thrown into the air and perches comfortably upon a narrow support. It may be kept alive apparently indefinitely by appropriate feeding and so long as it is well fed retains its stupid and impassive appearance. If allowed to starve for a while it becomes restless from the effects of hunger, may walk to and fro, and peck aimlessly at the ground. If surrounded by grain it may peck at the separate grains, but never actually seizes one in its beak and swallows it. The striking defect in these animals is the loss of those responses that depend upon memory of past or inherited experiences. Its motor reactions are all of a simple kind. If placed upon a hot plate it will, for a time, lift first one foot, then the other, and finally squat, but never flies away. When dosing a loud noise awakens it, but it exhibits no signs of fear, and quickly relapses into somnolence when the auditory stimulus ceases. The one positive conclusion that we may draw from the behavior of these animals is that in them the cerebrum is the organ in which the memory associations are mediated, and that when it is removed the actions of the animal become much more direct and predictable, since the stimulus awakens no associations with past experiences. The complete removal of the cerebrum in mammals is attended with more difficulty. When taken out at once by a single operation, the animal survives but a short time and the permanent effects of the operation cannot be detected. Goltz,\* however, has succeeded, in dogs, in removing by a peculiar operation all of the cerebral cortex. The operation was performed in several successive stages with an interval of several months between. In the most successful experiment the animal was kept alive for a year and a half and the postmortem examination showed that all of the cortex had been removed except a small portion of the tip of the temporal lobe, and this latter, since its connection with the other parts of the brain had been destroyed, was, of course, functionless. In addition, a large part of the corpora striata and the thalami and a small portion of the midbrain had been removed. The behavior of this animal was studied carefully. After the immediate effects of the operation—paralysis, etc.—had disappeared the animal moved easily; in fact, showed a tendency to keep moving continually. There was no permanent paralysis of the so-called voluntary movements. He answered to sensory stimuli of

\* Goltz, "Archiv f. die gesammte Physiologie," 51, 570, 1892.

various kinds, but not in an intelligent way. If, for instance, a painful stimulus was applied to the skin, he would growl or bark, and turn his head toward the place stimulated; but did not attempt to bite. No caressing could arouse signs of pleasure, and no threatening signs of fear or anger. Like the pigeon, the most conspicuous defect in the animal was a lack of intelligent response,—that is, the responses to sensory stimuli were simple, and evidently did not involve complex associations with past experiences. His memory records, for the most part, had been destroyed. Goltz records that when starved he showed signs of hunger, and that eventually he learned to feed himself when his nose was brought into contact with the food, although he was not able to recognize food placed near him. He would reject food with a disagreeable taste. When sleeping he gave no signs of dreaming, differing in this respect from normal dogs. On human beings observations of a similar character have been made on children born without the brain. In one interesting case\* of this kind, in which autopsy revealed a total destruction of the cerebral hemispheres, the child lived for nearly four years. During that time no signs of intelligence could be detected. The child never showed any recognition of its mother and lay for the most part in a somnolent condition without movement, the arms and legs showing also a condition of contracture. No cutaneous or general sensibility could be determined.

**Localization of Functions in the Cerebrum.**—When the belief was established that the cerebrum is the organ of the higher psychical activities there arose naturally the question whether different parts of the cortex have different functions corresponding to the various faculties of the mind, or whether the cerebrum is functionally equivalent throughout, in the same sense, for instance, as the liver. This question of the localization of functions in the brain (cerebrum) has been much debated, but the most interesting and important discussions upon the subject belong to the nineteenth century. About the beginning of the century Franz Joseph Gall, at that time a physician in Vienna, began to teach publicly his well-known system of cranioscopy or, as it was later designated by his chief disciple (Spurzheim), system of phrenology. † Gall, from his early youth, was possessed with the idea that the different faculties of the mind are mediated through different parts of the brain, that in it we have to deal not with a single, but with a plurality of organs. This belief was in opposition to the current ideas of his

\* Edinger and Fischer, "Pflüger's Archiv," 152, 535, 1913.

† Gall (and Spurzheim), "Recherches sur la système nerveux en général et sur celui du cerveau en particulier," 1810-19.

times and Gall devoted his entire life to an earnest effort to establish and popularize his views. He and his disciples contributed many very important facts to our knowledge of the finer anatomy of the brain; but, so far as the view of separate organs in the cerebrum is concerned, the methods that he employed, although perhaps the only ones that he could make use of at that time, have since been demonstrated to be fallacious when used as he used them. He conceived that the more developed any given mental quality is the larger will be the organ representing it in the cerebrum, and since the cranium fits closely to the cerebrum the relative prominence of the parts of the cerebrum may be judged by a study of the exterior of the skull. This method of study constituted the essential feature of cranioscopy or phrenology, and by observation upon people with particularly marked mental qualities Gall and his disciples supposed that they had located the organs for thirty-five different faculties. While the general idea of this method may be defended, it is obvious that the application of it scientifically, so that positive and demonstrable results can be obtained, is practically impossible. The system of phrenology and its methods quickly fell into disrepute, since they were exploited by frauds and charlatans. Gall's ideas in the beginning excited the greatest interest, but it seems that he was never able to convince the majority of the scientific men of his day of the conclusiveness of his results. At the time that he was teaching his doctrines in Paris, where he spent the later years of his life, Flourens began his celebrated experimental work upon the functions of the brain,—work which was mainly instrumental in convincing physiologists that the cerebrum is a single organ, functionally equivalent in all of its parts.\* Flourens' chief experiments were made upon pigeons, and in these animals he found that successive ablations of parts of the cerebrum from before backward or from side to side were not followed by a corresponding series of defects in the animals' psychical life. On the contrary, when the quantity of brain substance removed was sufficiently large, all these qualities went at once. The choice of animals for these experiments was an unfortunate one, but the results were corroborated in part by a number of instances in which human beings by accident or wounds in battle had lost a part of the brain without any apparent defect in their mental powers. Therefore toward the middle of the nineteenth century the prevalent view in physiology was that the cerebrum is functionally equivalent in all of its parts. One fact was known in medicine at that time

\* Flourens, "Recherches expérimentales sur les propriétés et les fonctions du système nerveux dans les animaux vertébrés," 1824.

which distinctly contradicted this belief,—namely, that an injury to the region of the third frontal convolution in man, on the left side, causes a loss of articulate speech (motor aphasia). But this fact, so significant to us now, was not properly valued at the time. The beginning of our modern views of cerebral localization is found in the work of Fritsch and Hitzig\* (1870), in which they exposed and stimulated electrically the cortex cerebri in dogs. They observed that stimulation of certain definite areas, particularly in the sigmoid gyrus, gave distinct and constant movements in the limbs, face, etc. (see Fig. 86). This work was followed quickly by experiments of a similar kind made by numerous observers, in which the cerebrum was stimulated in various animals and finally in man. In addition, the method of ablation of these areas was employed with subsequent study of the animal in regard to the motor or sensory defects resulting therefrom, and the results obtained were further extended by careful autopsies upon human beings in whom paralyses of various kinds and sensory defects were associated with more or less definite lesions of the cerebrum. The first outcome of this work was to lead to an extreme view of localization of function in the brain, in which the different motor and sensory areas were definitely circumscribed and separated one from the other, making the cerebrum a plurality of organs, to use Gall's term. The more recent work has tended to modify these extreme views of localization and to emphasize the fact that histologically and physiologically the entire cerebrum is connected so intimately, part to part, that, although the different regions mediate different functions, nevertheless an injury or defect in one part may influence to some extent the functional value of all other regions in the organ. The general idea of a localization of function has been accepted, but the modern view is that the cerebrum is composed of a plurality of organs, not completely separated one from the other, as taught by Gall, but intimately associated and to a certain extent dependent one on another for their full functional importance. The functional interrelation of different parts of the cortex is shown by the fact that a cortical lesion at one point may involve not only the activity primarily connected with that region, but may influence also the functional performance of far distant uninjured parts of the cortex or even of the underlying portions of the central nervous system, the medulla, and the spinal cord. Monakow states, for example, that in lesions of the pyramidal system we may observe among the temporary symp-

\* Fritsch and Hitzig, "Archiv f. Anatomie und Physiologie und wissenschaftliche Medizin," 1870, 300.



toms accompanying the hemiplegia a disturbance of the swallowing reflex or a diminution in the spinal reflexes. The nuclei in the medulla and the cord suffer a diminution in irritability, although not directly involved in the lesion. Monakow designates this result or condition under the term *diaschisis*,\* which he defines as a diminution in irritability within the whole connected functional complex without anatomical lesion. It must also be borne in mind in this connection that most of the efforts made hitherto to localize the functional activities of the brain have had reference chiefly to planes of separation vertical to the cortex. As indicated on p. 187,

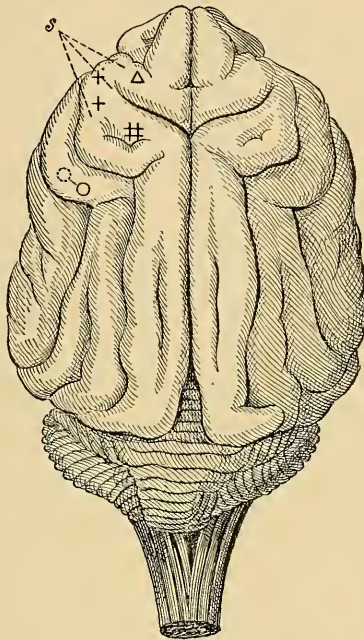

Fig. 86.—To show the motor areas in the dog's brain as originally determined by Fritsch and Hitzig: *s*, Sigmoid gyrus; Δ, center for the neck muscles; +, center for the extensors and adductors of the forelimb; +, center for the flexors and rotation of forelimb; #, center for the hind limb; ⊙—⊙, center for the muscles innervated by the facial.

recent investigations have indicated that it will be necessary to consider also the separation of function along horizontal planes (von Valkenburg). That is to say, it seems quite possible that the several strata in the cortex, such as the granular, the infragranular, and the supragranular layers may mediate different activities of the brain, or even different psychical functions.

\* von Monakow, "Ergebnisse der Physiologie," vol. xiii., 1913.

**The Motor Area.**—The first experiments of Fritsch and Hitzig disclosed the location of a cortical region in the dog which upon stimulation gave definite movements. The later experiments of Ferrier, Schäfer, Horsley, and Beevor, particularly upon the apes, gave reason for believing that this motor area surrounds the central sulcus of Rolando and extends inward upon the mesial surface of the cerebrum. Its exact boundaries marked out by

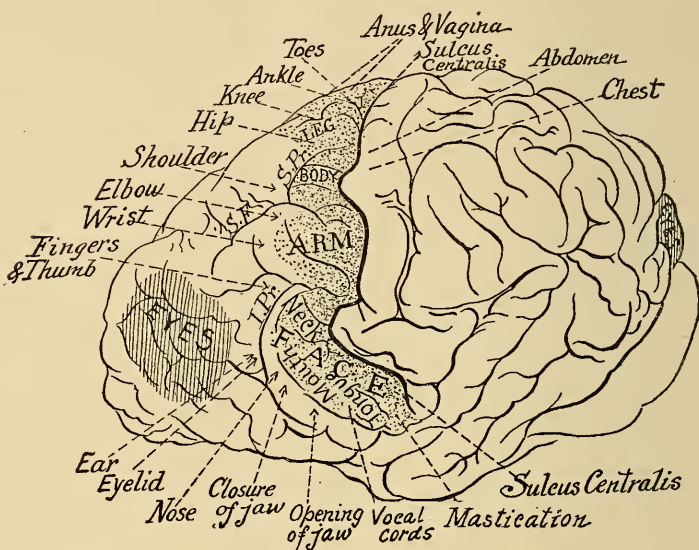

Fig. 87.—Location of motor areas in brain of chimpanzee.—(Sherrington and Greenbaum.) The extent of the motor areas is indicated by stippling; it lies entirely in front of the fissure of Rolando (sulcus centralis). Much of the motor area is hidden in the sulci. The regions marked eyes indicate the areas whose stimulation gives conjugate movements of the eyeballs. It is doubtful, however, whether these represent motor areas proper.

careful stimulation of the region in monkeys was more or less verified upon man, since in operations upon the brain it was often necessary to stimulate the cortex in order to localize a given motor area. By these means charts have been made showing the cortical area for the musculature of each part of the body. It was found that in general the distribution of the areas lies along the central sulcus of Rolando and follows the order of the cranial and spinal nerves. Within each area smaller centers may be located by careful stimulation; thus, the hand and arm area may be subdivided into centers for the wrist, fingers, thumb, etc. Sherrington and Greenbaum,\* making

\* "Reports of the Thompson-Yates and Johnson Laboratories," 4, 351, 1902; 5, 55, 1903.

use of electrical stimulation, unipolar method, have explored carefully the motor areas in the monkey. They state that these areas do not extend back of the central sulcus, but lie chiefly along the anterior central convolution, as represented in Figs. 87 and 88, and extend for only a small distance on to the mesial surface of the cerebrum. The area thus delimited by physiological experiments is the region from which arises the pyramidal system of fibers, and clinical experience has

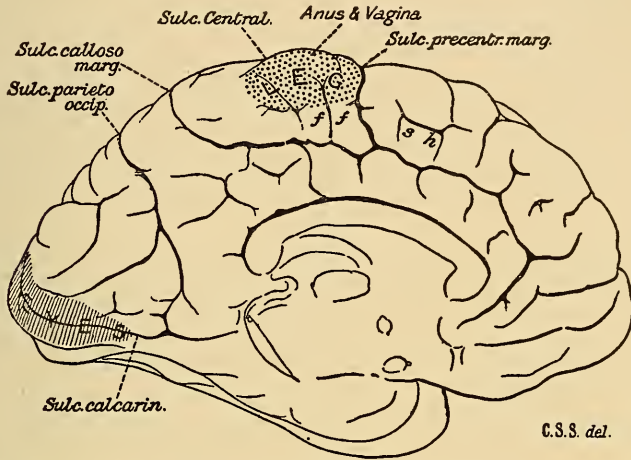

Fig. 88.—To show extension of motor areas on to the mesial surface, brain of chimpanzee.—(Sherrington and Greenbaum). Mesial surface of left hemisphere: Stippled region marked L E G gives the motor area for lower limb; *f*, *s*, and *h* indicate regions from which movements were obtained occasionally with strong stimuli; *f*, foot and leg; *s*, shoulder and chest; *h*, thumb and fingers. The shaded area marked E Y E S indicates a region stimulation of which gives conjugate movements of the eyes.

shown that lesions in this part of the cortex are accompanied by a paralysis of the muscles on the other side, particularly in the limbs. Pathological or experimental lesions here, moreover, are followed by a degeneration of the pyramidal neurons, —a degeneration which extends to the termination of the neurons in the cord. With these data we can construct a fairly complete account of the mechanism of voluntary movements. The initial outgoing or efferent impulses arise in the large pyramidal cells of the motor areas, and proceed along the axons of their neurons to the motor nuclei of the cranial or spinal nerves. The neurons of the pyramidal tract constitute the motor tract for voluntary movements; a lesion anywhere along this tract causes paralysis, more or less complete, and on the other side of the body in general, if the lesion is anterior to the decussation. The path of the motor fibers is represented in the schema given in Fig. 89. Arising in the cortex, they take the following route (see also Fig. 82, B):

1. Corona radiata.
2. Internal capsule.
3. Peduncle of cerebrum.
4. Pons Varolii, in which they are broken into a number of smaller bundles by the fibers of the middle peduncle of the cerebellum (brachium pontis). In this region, also, some of the fibers cross the mid-line, to end in the motor nuclei of the cranial nerves: Third, fourth, fifth, sixth, and seventh.
5. Anterior pyramids.
6. Pyramidal decussation.
7. Anterior and lateral pyramidal fasciculi in the cord.

After ending in the motor nuclei of the cranial or spinal nerves the path is continued by a second neuron from these nuclei to the muscles. The entire path involves, therefore, at a minimum, two neurons, and injury to either will cause paralysis of the corresponding muscles.

**Difference in the Paralysis from Injury to the Spinal and the Pyramidal Neuron.**—With regard to the musculature of the limbs especially a difference has been observed in the paralysis caused by injury to the spinal and pyramidal (cerebrospinal) neurons, respectively. Lesions of the anterior root cells in the cord or of the axons arising from them cause complete paralysis of the corresponding muscles, since these muscles are then removed not only from voluntary control, but also from reflex effects. The muscles are entirely relaxed and in time exhibit a more or less complete atrophy. When the pyramidal neurons are affected, as in the familiar condition of hemiplegia resulting from a unilateral lesion of the motor cortex, there is paralysis as regards voluntary control, but, the spinal neuron being intact, the muscles are still subject to reflex stimulation through the cord, especially to the so-called tonic impulses. Under these conditions, especially if the lesion is in the cord, it is frequently noticed that the paralyzed muscles are thrown into a state of continuous contraction, contracture, in which they exhibit a spastic rigidity. This fact, therefore, may be used in diagnosing the general location of the lesion. A satisfactory explanation of the cause of the tonic contraction has not been furnished. It may be due to uncontrolled reflex excitation of the spinal neurons, or, as suggested by Van Gehuchten, to the action of the indirect motor path by way of the rubrospinal tract (fasciculus intermediolateralis).

**Is the Pyramidal System the Only Means of Voluntary (Cortical) Control of the Muscles?**—Much discussion has arisen regarding this question. It is, in fact, one of those questions of nervous mechanism in which experiments upon lower animals

must be applied with caution to the conditions in man. As we have seen, the entire cerebral cortex may be removed from the frog, the pigeon, and the dog without causing permanent paralysis, although in the animal last named there is at first a more or less marked loss of voluntary control. But in man and the higher types of the monkey the pyramidal system is more completely developed, and corresponding with this fact it is found that the paralysis from lesion of the motor cortex is more permanent. In fact, observations upon men in whom it has been necessary to remove parts of the motor area by surgical operation indicate that the voluntary control of the muscle is lost or impaired permanently. It would seem, therefore, that even in an animal as high in the scale as the dog voluntary control of the muscles can be maintained through fibers other than those belonging to the pyramidal system. A system such as that found in the rubrospinal tract (p. 180) may be considered as adequate to fulfil such a function. In man, however, along with the more complete development of the pyramidal system, the efficacy of the phylogenetically older motor systems is correspondingly reduced.

#### The Crossed Control of the Muscles and Bilateral Representation in the Cortex.—

It has been known from very ancient times that an injury to the brain on one side is accompanied by a paralysis of voluntary movement on the other side of the body, a condition known as hemiplegia. The facts given above regarding the origin and course of the pyramidal system of fibers explain the crossed character of the paralysis quite satisfactorily. The schema thus presented to us is, however, not entirely without exception. In cases of hemiplegia in which the whole motor area of one side is included it is known that the paralysis on the other side

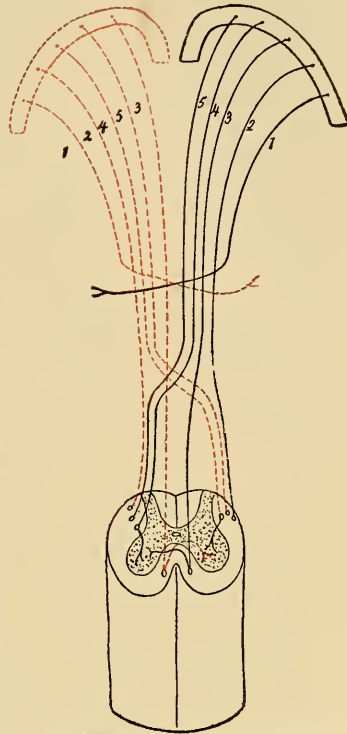

Fig. 89.—Schema representing the course of the fibers of the pyramidal system: 1, Fibers to the nuclei of the cranial nerve; 2, uncrossed fibers to the lateral pyramidal fasciculus; 3, fibers to the anterior pyramidal fasciculus crossing in the cord; 4 and 5, fibers that cross in the pyramidal decussation to make the lateral pyramidal tract of the opposite side.

does not involve all the muscles, and, in the second place, it is said that there is some muscular weakness on the same side. The paralysis in hemiplegia affects but little, if at all, those muscles of the trunk which are accustomed to act in unison,—the muscles of inspiration, for instance, the diaphragm, abdominal and intercostal muscles, and the muscles of the larynx. It would appear that these muscles are bilaterally represented in the cortex; so that if one side of the brain is intact the muscles of both sides are still under voluntary control. The mechanism of this bilateral representation is not definitely known; one may conceive several possibilities. The motor area on each side may send down a double set of pyramidal fibers, one of which crosses and the other remains on the same side, or the fibers may bifurcate. Or it is possible that the bilateral control is due to commissural connections between the lower centers in the cord. Some evidence in favor of the former view is found in the undoubted histological fact brought out by Mellus and others, that small unilateral lesions in the motor area—the center of the great toe in the monkey, for instance—are followed by degeneration in the lateral pyramidal fasciculus in the cord on both sides, showing that some portions of the motor area send fibers to both sides of the body. In cases of hemiplegia it may be added that the muscles of the limbs are not all equally affected.

**Are the Motor Areas Only Motor in Function?**—The great number of nerve cells in the cortex in addition to the large pyramidal cells that give origin to the fibers of the pyramidal system makes it possible histologically that other functions may be mediated in the same region. This possibility has been kept in view since the early experiments of Munk, in which he showed that lesions in the Rolandic region are followed by disturbances in what are designated as the body sensations, that is, in muscular and cutaneous sensibility, but especially the former. It was suggested, therefore, at one time that one and the same spot in the cortex might serve as the origin of the motor impulses to a given muscle and as the cortical termination of the sensory impulses coming from the same muscle, the reaction in consciousness, the muscular sensations, being mediated perhaps through cells other than those giving rise to the pyramidal fibers. Recent physiological and clinical work has, however, not tended to support this view. The motor areas appear to be confined to the region in front of the central sulcus of Rolando, while the cortical area, in which the afferent fibers mediating body sensibility (muscular-cutaneous) make their final termination extends back of this sulcus in the posterior central convolution. Whether, on the other hand, the sense areas for the body (cutaneous and

muscular) extend forward into the cortex of the frontal lobe is not clearly shown by experimental or clinical evidence. Flechsig, from his studies upon the time of myelinization of the afferent fibers in the embryo brain, concludes that this is the case, and that, therefore, the motor and sensory areas overlap for a part at least of their extent (see p. 226 and Fig. 98). On the contrary, in an interesting report by Cushing\* of two cases in which the anterior central convolution was stimulated in conscious patients, it is stated that there was no sensation other than that arising from the change in position of the muscles which were thrown into contraction. In the motor area there are numerous connections by association tracts with other parts of the brain. By this means the motor area, without doubt, is brought into relation with many other parts of the cortex, and the sensations or perceptions aroused elsewhere may react upon the motor paths. A voluntary movement, however simple it may be, is a psychological act of some complexity, that is to say, every movement is preceded or accompanied by certain sensations and perceptions which depend upon sensory stimulations occurring at that time, or upon experiences derived from conditions of excitation that have occurred at some previous period—every action is part of a train of conscious or subconscious processes whose neural mechanism extends over wide regions of the cortex. The mental processes, the associations that lead to and originate the motor discharge, the mental image of the movement to be effected, cannot be definitely located in the cortex, and it is possible that the so-called motor area itself participates in these psychical antecedents. But what may be said with confidence is that the immediate origin of the outgoing motor impulse lies in the area along the anterior margin of the central sulcus of Rolando, which contains the foci, so to speak, into which all accessory processes are gathered, so far as they affect our muscular acts, and from which emerge the actual efferent stimuli to the different muscles.

\* Cushing, "American Journal of Physiology," 1909 ("Proc. Amer. Physiol. Soc.").

## CHAPTER X.

### THE SENSE AREAS AND THE ASSOCIATION AREAS OF THE CORTEX.

The delimitation of the sensory areas in the cortex is a matter of very considerable difficulty, owing partly to the fact that the determination of the presence or absence of certain states of consciousness in the animal or person under observation cannot be made except by indirect means, and partly no doubt to the fact that the organization of the sensory mechanism in the brain is more complex and diffuse than in the case of the motor apparatus. Moreover, the distinction between what we may call simple sensations and the more complex psychical representations and judgments of which these sensations form a necessary constituent cannot be made clearly, even by the individual in whom the reactions occur. We recognize in ourselves different stages in the degree of consciousness aroused by sensory reactions. Our visual and auditory sensations are clearly differentiated; but many of the lower senses escape recognition in the individual himself, since the state of consciousness accompanying them is of a lower order. Our muscular sensations, for instance, are so indefinite as to be practically subconscious. They are most important to us in every act of our lives, yet the uninformed person is unconscious of the existence of such a sensation, and if deprived of it would recognize the defect only in the consequent loss of control of the voluntary muscular movements. In the attempts to determine in what part of the brain the various sensations are mediated every possible method of inquiry has been used: the anatomical course of the sensory paths, physiological experiments of stimulation and ablation, and observations upon individuals with pathological or traumatic lesions in the brain. The results of these investigations are presented briefly in the following pages. It may be helpful in considering these results to bear in mind the fundamental physiological conception that each specialized sense is supposed to have its own set of nerve fibers. These fibers after entering the cord in the spinal nerves, or the brain in the cranial nerves, are assumed to follow different intercentral paths, which eventually terminate in the cortex of the cerebrum. The attempts made to localize these senses in the cortex reduce themselves practically to a consideration of the location of the termini of the several tracts. Investi-



gations made so far indicate that these termini are located in different regions, and that destruction of any terminus has, of course, the same effect upon the corresponding sense as destruction of the tract in any part of its course. If we go beyond this point, and endeavor to say what part of the complex mental activity associated with each kind of sensory reaction is mediated by the cells located in these termini, we are met at once with difficulties which, at present, cannot be overcome. Each terminus is connected by association fibers with various other parts of the cortex, and this whole complex of neurons is concerned no doubt in the psychical reactions aroused.

**The Body-sense Area.**—In his early experiments Munk insisted that lesions of the cortex involving the area around the central sulcus are accompanied by a state of anesthesia on the other side of the body, hemianesthesia, particularly as regards the tactile and muscular sensations. It is not necessary, perhaps, to go into the details of the long controversy that arose in connection with this point. Both the clinical and the experimental evidence has been contradictory in the hands of different observers, but the tendency of recent studies has been to show, as stated above, that, whereas the motor areas lie anterior to the central sulcus, the sensory areas concerned with the cutaneous and muscular sensations extend posterior to this sulcus.\* Positive cases are recorded in which lesions involving the anterior central convolutions were accompanied by paralysis on the other side, hemiplegia, without any detectable disturbance of sensibility, and, on the other hand, lesions have been described in the posterior central and neighboring parietal convolutions in which there was a hemianesthesia more or less distinctly marked without any paralysis. As stated above, Cushing,† in his report upon the stimulation of the cortex in two conscious patients, states that no sensations were aroused by stimuli applied to the anterior central convolution, while stimulation of the posterior convolution aroused distinct sensations of numbness and of touch. Such cases tend to support the view that the motor and body sense areas, although contiguous, do not overlap. Regarding the sensory defects associated with lesions of the parietal lobe posterior to the central sulcus (posterior central convolution, supramarginal, superior, and possibly inferior parietal convolutions), it seems probable that they involve chiefly the muscular sense, pressure and temperature sense, and the judgments or perceptions based upon these sensations, while the sense of pain is affected but little, if at all. Monakow gives the order in which sensory defects manifest

\* Consult von Monakow, "Ergebnisse der Physiol.," 1902, vol. i, part i, p. 621.

† Cushing, loc. cit.

themselves after such lesions, as follows: The localizing and muscle senses are chiefly affected, in fact, almost lost on the opposite side; the temperature and pressure sense may be affected, while the pain sense is retained or but slightly affected. The clinicians have observed that the most positive and invariable symptom of lesions in this region is a condition of astereognosis, that is, a diminution in what may be called the stereognostic perceptions. By stereognostic perception is meant the power to judge concerning the form and consistency of external objects when handled, and it must be regarded as a perception based upon localized sensations of touch,

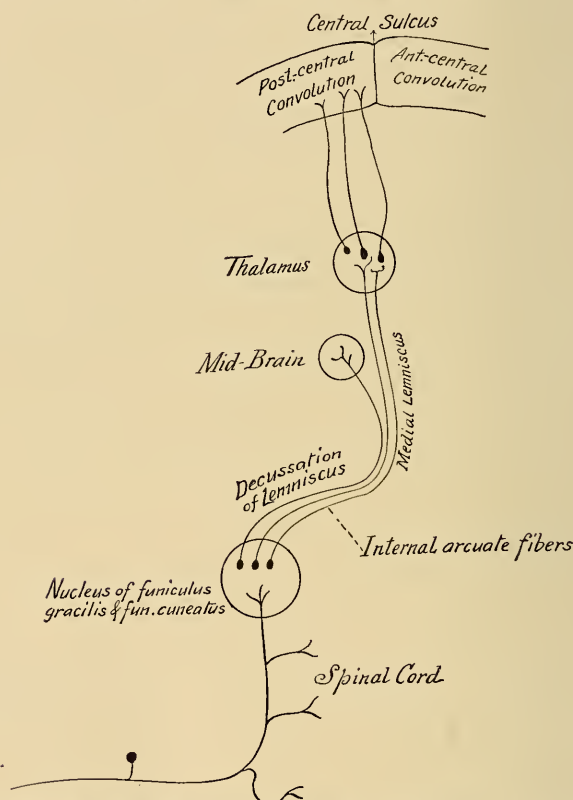

Fig. 90.—Schema representing the origin and course of the fibers of the median fillet,—the intercentral paths of the fibers of body sense.

together perhaps with those of temperature and muscular sensibility. On the whole, therefore, we must infer that the cortex in this postcentral area is concerned with the sensations of pressure, temperature, and muscular conditions, and especially the higher type of these sensations, which we can project or localize accurately. This conclusion is strengthened by the fact that, as described in

the next paragraph, the fibers of the lemniscus terminate in this same region. Secondly, in this region there are mediated also possibly some of the syntheses and associations of these sensations, which we designate as perceptions or judgments, and it is possible that injuries or defects here may be followed by an impairment of these higher perceptive reactions, without any definite loss of sensibility in the skin. Such a defect falls under the general head of agnosia, and is illustrated by the condition of astereognosis referred to above, which might be defined as chiefly a tactile agnosia. The part of the cortex, if any, in which the tract of pain fibers makes its final terminus has not been definitely localized.

**The Histological Evidence.—Course of the "Lemniscus."**—On the histological side there is very strong corroborative evidence for the view that cortical centers for the sensory fibers of the skin and muscles lie in the parietal lobe in the region indicated above. This evidence is connected with the path taken

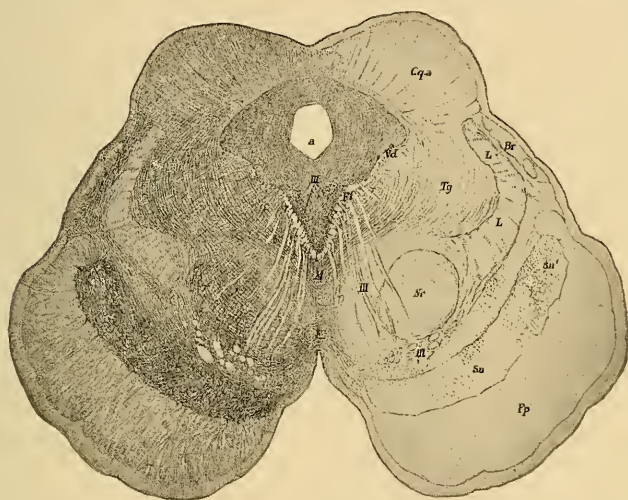

Fig. 91.—Cross-section through midbrain (Kolliker) to show the position of the lemniscus (L, L): Nr, The red nucleus; Sn, the substantia nigra; Pp, the peduncle.

by the sensory fibers in the cord, especially those of the posterior funiculi, after ending in the nucleus of the funiculus gracilis and the nucleus of the funiculus cuneatus of the medulla. This path is represented in a schematic way in the accompanying diagram (Fig. 90). The second sensory neurons arise in the nuclei mentioned. For the most part, at least, these new neurons run ventrally, as internal arcuate fibers, cross the mid-line, and then pass forward or anteriorly. The crossing occurs mainly just in front of—that is, cephalad to—the pyramidal decussation, forming thus a sensory decussation (decussation of the

lemniscus), which explains the crossed sensory control, as the pyramidal decussation explains the crossed motor control of the cerebrum in relation to the body. After this decussation the sensory fibers form a longitudinal bundle on each side known as the median fillet or lemniscus, which in the pons lies just dorsal to the pyramidal system of fibers.

The lemniscus fibers may be traced forward (see Fig. 91) as far as the superior colliculus of the corpora quadrigemina and the thalamus, the important termination being in the thalamus (ventral or lateral nucleus). Those neurons that end in the thalamus are continued forward by a third set of neurons, which end in the parietal lobe of the cerebrum (see Fig. 82, C). On its way through the medulla and pons the lemniscus is believed to receive accessions of sensory fibers from the sensory nuclei of the cranial nerves of the opposite side. The course of the lemniscus has been traced by various means, but especially by the method of myelination during embryonic life and by degeneration consequent upon long-standing disuse. As was stated in the section upon Nerve Degeneration, injury to an axon is followed quickly by degeneration of the peripheral end, and much more slowly by a degeneration of the central end and the nerve cell itself, when the path is not again established. Certain long-standing cystic lesions (porencephaly) in the parietal cortex have resulted in an atrophic degeneration of the lemniscus fibers, thus adding materially to the evidence that this sensory tract ends eventually in the region indicated.\* Further evidence of the same character is found in the observations made by Campbell† upon cases of tabes dorsalis. The lesion in such cases is in the posterior funiculi of the spinal cord, but eventually the whole upward path is affected and degenerative changes are found in the cells of the posterior central convolution.

From the connections of the lemniscus with the tracts of the posterior funiculi of the cord it is evident that it forms one pathway at least for the fibers of muscle sense. Whether or not the fibers of pressure, pain, and temperature take the same route is not known, but it seems probable, at least, from the known connections of the lemniscus with the sensory nuclei of the cranial nerves and with the sensory tracts of the lateral as well as the posterior funiculi of the cord. The lemniscus ends chiefly in the thalamus, before passing on to the cortex, and here, as in other similar cases, we have the possibility that the lower centers, in addition to the reflex connections which they make, may mediate also some form of conscious reaction. While the general tendency has been to confine the conscious

\* Hösel, "Archiv f. Psychiatrie," 24, 452, 1892.

† Campbell, "Histological Studies on Localisation of Cerebral Functions," Cambridge, 1905.

quality of the central reactions to the cortex, there is no proof that the lower centers are entirely lacking in this property. In Goltz's dog without cerebral cortex, for instance, the animal responded to various sensory stimuli, and when hungry gave evidence, so far as his actions were concerned, of experiencing the sensations of hunger; but whether or not these actions were associated with conscious sensations is hidden from us, and we can hope to arrive at positive conclusions upon this point only by observations upon man himself.

**The Center for Vision.**—The location in the cortex of the general area for vision has been established by anatomical, physiological, and clinical evidence. The physiologists have experimented chiefly by the method of ablation. Munk, Ferrier, and later observers have found that removal of both occipital lobes is followed by defects in vision. According to Munk, removal of both occipital lobes is followed by complete loss of visual sensations, or, as he expresses it, by cortical blindness. Goltz, however, contends that in the dog at least removal of the entire cerebral cortex leaves the animal with some degree of vision, since he will close his eyes if a strong light is thrown upon them. All the experiments upon the higher mammals (monkeys) and clinical experience upon man tend, however, to support the view of Munk. Complete removal of the occipital lobes is followed by apparently total blindness. If any degree of vision remains it is not sufficient for recognition of familiar objects or for directing the movements. In an animal in this condition the pupil is constricted when light is thrown upon the eye; but this reaction we may regard as a reflex through the midbrain, and there is no reason to believe that it is accompanied by a visual sensation. When the injury to the occipital cortex is unilateral the blindness affects symmetrical halves of the two eyes, a condition known as hemiopia. Destruction of the right occipital lobe causes blindness in the two right halves of the eyes, or, in accordance with the law of projection of retinal stimuli, in the two left halves of the normal visual field when the eyes are fixed upon any object. Destruction of the left occipital lobe is followed by blindness in the two left halves of the retinas or the right halves of the visual field. This result of physiological experiments is borne out by clinical experience. Any unilateral injury to the occipital lobes is followed by a condition of hemiopia more or less complete according to the extent of the lesion. Observation, however, has shown that this general symmetrical relation has one interesting and peculiar exception. The most important part of the retina in vision is the region of the fovea centralis, whose projection into the visual field constitutes the field of direct or central vision. It is said that the hemiopia caused by unilateral lesions of the cortex does not involve this part of the retina.

*The Histological Evidence.*—The histological results supplement in a very satisfactory way the findings from physiology and pathology. The retina itself, considered from an embryological standpoint, is an outgrowth from the brain vesicles, and is therefore an outlying portion of the central nervous system. The optic fibers, in terms of the neuron doctrine, must be considered as axons of the nerve cells in the retina. If, therefore, an eye is enucleated or an optic nerve is cut the fibers connected with the brain undergo secondary degeneration and their course can be traced microscopically to the brain. By this means it has been shown that in man and the mammalia there is a partial decussation of the optic fibers in the chiasma. The fibers from the inner side of each retina cross at this point to the opposite optic tract; those from the outer side of the retina do not decussate,

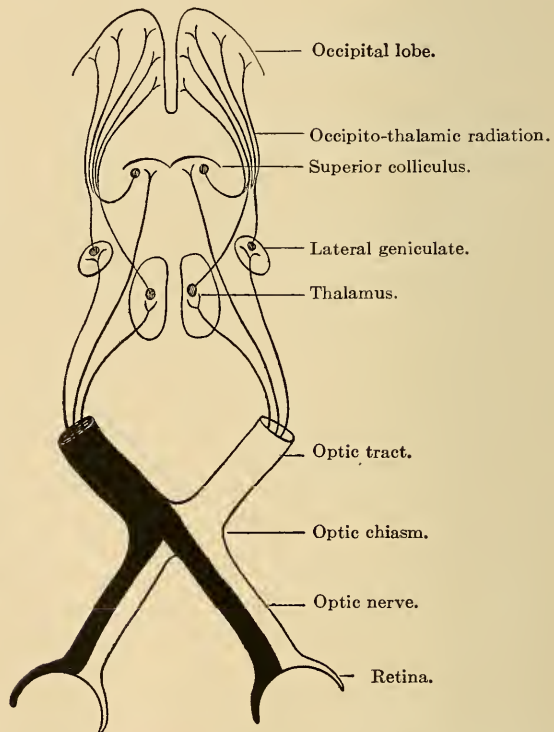

Fig. 92.—Diagram to indicate the general course of the fibers of the optic nerves and the bilateral connection between cortex and retina.

but pass into the optic tract of the same side. The fibers of the optic tract end mainly in the gray matter of the lateral geniculate body, but some pass also to the thalamus (pulvinar) and some to the superior colliculus of the corpora quadrigemina.

These locations, therefore, particularly the lateral geniculates, must be considered as the primary optic centers. From these points the path is continued toward the cortex by new neurons whose axons constitute a special bundle, the occipitohalamic radiation, lying in the occipital part of the internal capsule (see Fig. 82, *D*). A schema representing this course of the optic fibers is given in the accompanying diagram (Fig. 92). According to this schema, the general relations of each occipital lobe to the retinas of the two eyes is such that the right occipital cortex represents the cortical center for the two right halves of the retinas, while the left occipital lobe is the center for the two left halves of each retina,—a relation that agrees completely with the results of experimental physiology and clinical studies.

In addition to the fibers described, which may be regarded as the visual fibers proper, there are other fibers in the optic tracts and optic nerves whose physiological value is not entirely clear. The fibers of this kind that have been described are: (1) Inferior or Gudden's commissure. Fibers that pass from one optic tract to the other along the posterior border of the chiasma. These fibers form a commissural band connecting the two internal (or median) geniculate bodies, and possibly also the inferior colliculi. It seems probable that they belong to the central auditory path rather than to the visual system. (2) Fibers passing from the chiasma into the floor of the third ventricle. The further course of these fibers is not clearly known, but it is possible that they make connections with the nuclei of the third nerve. They will be referred to in the section on Vision in connection with the light reflex of the iris. (3) A superior commissure. Several observers have claimed that there is a commissural band along the anterior margin of the chiasma which connects one optic nerve or retina with the other.

There are many points in connection with the course of the optic fibers and the physiology of the different parts of the occipital cortex which are unknown and require further investigation. Some of these points may be referred to briefly.

**The Amount of Decussation in the Chiasma.**—According to the schema given above, half of the fibers in each optic nerve decussate in the chiasma. There is, however, no positive proof that the division of the fibers is so symmetrically made. In the lower vertebrates,—fishes, amphibia, reptiles, and most birds—the crossing is said to be complete, while in the mammalia a certain proportion of the fibers remain in the optic tract of the same side. In a general way, it would appear that the higher the animal is in the scale of development the larger is the number of fibers that do not cross in the chiasma. At least it is true that a larger num-

ber remain uncrossed in man than in any of the mammalia, and it is also possible or probable that the extent of decussation in man shows individual differences. There seems to be no acceptable suggestion regarding the physiological value of this partial decussation other than that of a probable relation to binocular vision. It has been used to explain the physiological fact that simultaneous stimulation of symmetrical points in the two retinas gives us a single visual sensation.

**The Projection or Localization of the Retina on the Occipital Cortex.**—It would seem most probable that the paths from each spot in the retina terminate in a definite region of the occipital cortex, and attempts have been made by various methods to determine this relation. According to Henschen,\* the

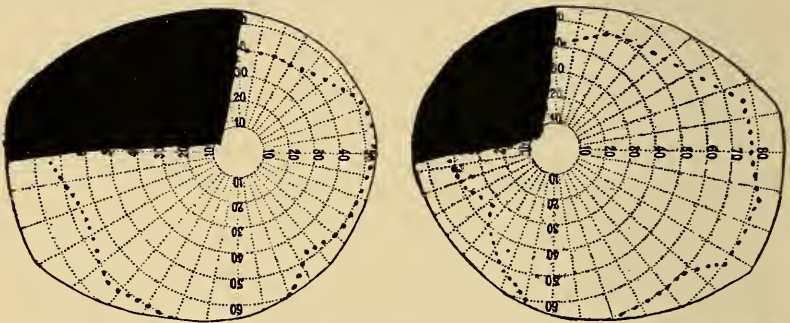

Fig. 93.—Perimeter fields in quadrant hemianopia. The outline of the visual fields is given by the dotted lines. Blindness in the left upper quadrants; cortical lesion in and below the calcarine fissure (taken from Beevor and Collier).

visual paths in man end around the calcarine fissure on the mesial surface of the brain, and this portion of the occipital lobe should be regarded as the true cortical terminus of the optic fibers. There seems to be much evidence, indeed, that the immediate ending of the optic paths lies in this region. Thus, Donaldson† found, upon examination of the brain of Laura Bridgman, the blind deaf-mute, that the cuneus especially showed marked atrophy, and Flechsig,‡ by means of the myelinization method, arrived at the conclusion that the optic fibers end chiefly along the margin of the calcarine fissure. Clinical cases are frequently quoted in which lesions of the region of the calcarine fissure were followed by a more or less complete hemiopia. When, as seems to be the most common occurrence, such lesions occur above the fissure, in the cuneus, or below the fissure, in the gyrus lingualis, the resulting hemiopia is confined to corresponding

\* Henschen, "Brain," 1893, 170.

† Donaldson, "American Journal of Physiology," 1892, 4.

‡ Flechsig, "Localisation der geistigen Vorgänge," Leipzig, 1896.



quadrants of the retina, and is designated frequently as quadrant hemiopia (see Fig. 93). It has been assumed that the fibers from the fovea end perhaps in the fissure itself—according to some authors (Henschen), along the anterior third of the fissure, according to others (Schmid and Laqueur\*) along the posterior portion of the fissure. Moreover, since unilateral lesions in this region, however extensive, do not cause complete blindness in the fovea, it has been supposed that this important part of the retina is bilaterally represented in the cortex, so that complete foveal blindness—that is, blindness of the centers of the visual fields—can only occur when both occipital lobes are injured in the region of the calcarine fissure. While the general opinion seems to be that this last-named region is the main cortical ending of the retinal fibers, especially of those arising from the foveal area, other observers contend that the entire occipital cortex, lateral as well as mesial surfaces, must be regarded as the cortical termination of the visual paths, and that even the foveal portion of the retina is connected with a wide area in this lobe. Those who hold this view explain the known fact that lesions in the region of the calcarine fissure give the most permanent condition of hemiopia, on the view that these lesions involve the underlying fibers of the occipitohalamic radiation. Monakow,† for instance, points out that while extensive lesions of the occipital cortex on both sides leave, with a few exceptions, some degree of central vision, no cases are reported of cortical lesions involving only or mainly the vision in the macular region. He, therefore, argues that while the paths from the retina to the lower visual centers (lateral geniculate) may be isolated, the further connections with the cortex must be widespread. The cortical center for distinct vision according to this view is not limited to a narrow area, but must involve a large region in the occipital cortex. It is difficult to reconcile this view with the ideas of isolated conduction and specific function of each part of the cortex. Some additional facts of interest have been obtained from experiments involving the stimulation of the occipital cortex. Stimulation of this kind causes movements of the eyes, and the movements vary with the place stimulated.‡ Stimulation of the upper border of the lobe causes movements of the eyes downward, stimulation of the lower border movements upward, and of intermediate regions movements to the side. Assuming that the direction of the movement is toward that part of the visual field from which a normal visual stimulus would come, it is evident that movements of the

\* Schmid and Laqueur, "Virchow's Archiv," 158, 1900.

† Monakow, loc. cit., also "Ergebnisse d. Physiologie," 1907.

‡ Schäfer, "Brain," 11, 1, 1889, and 13, 165, 1890.

eyes downward would imply stimulation of the upper half of the retina, since objects in the lower part of the visual field form their image on the upper half of the retina. This fact, that stimulation of the occipital cortex causes definite movements of the eyeballs, seems to imply that there are efferent fibers in the occipitohalamic radiation running from the occipital cortex to the midbrain, where they make connections with the motor nuclei of the third, fourth, and sixth cranial nerves.

**The Function of the Lower Visual Centers.**—The first ending of the optic fibers lies in the lateral geniculate and to a lesser extent in the thalamus and superior colliculus. It is conceivable, of course, that some degree of visual sensation may be mediated through these centers. Goltz observed that in dogs with the cerebrum removed the animals showed a constriction of the pupils when a bright light was thrown upon the eyes or even closed the eyes. It is the general belief that reactions of this kind are mechanical or unconditional reflexes accompanied by no higher psychological reaction than in the case of spinal reflexes. The existence in the midbrain of the motor nuclei of the third nerve, and of the medial longitudinal fasciculus through which connections are established with the motor nuclei of other cranial nerves, furnishes us with a possible reflex arc through which the visual impulses brought into the lower optic centers, especially the superior colliculus, may cause co-ordinated movements of the eyes or of the head. Usually it is assumed that conscious visual sensations, and especially visual associations and memories, are aroused only after the impulses reach the occipital cortex. In the fishes the midbrain forms the final ending of the optic fibers, and in these animals, therefore, whatever psychological activity accompanies the visual processes must be mediated through this portion of the brain. In the higher animals, however, the development of a cerebral cortex is followed by the evolution of the occipitohalamic radiation, and as the connections of the occipital cortex increase in importance, those of the midbrain (with the optic fibers) dwindle correspondingly. Here, as in other cases, the psychological activity is concentrated in the portions of the brain lying most anteriorly, and doubtless the degree of consciousness is greatly intensified in the higher animals in correspondence with the development of the cerebral cortex, whose striking characteristic is its capacity to evoke a psychological reaction.

**The Auditory Center.**—The location of the auditory area has been investigated along lines similar to those used for the visual center. The experimental physiological work has yielded varying results in the hands of different observers. Munk and Ferrier placed the cortical center for hearing in the temporal lobe, and

in spite of negative results by Schäfer and others this localization has been shown to be substantially correct. Entire ablation of both temporal lobes is followed by complete deafness. Ablation on one side, however, is followed only by impairment of hearing, and in the light of the results from histology and from the clinical side it seems probable that the connections of the auditory cortex with the ear follow the general schema of the optical system rather than that of the body senses. That is, it is probable that the

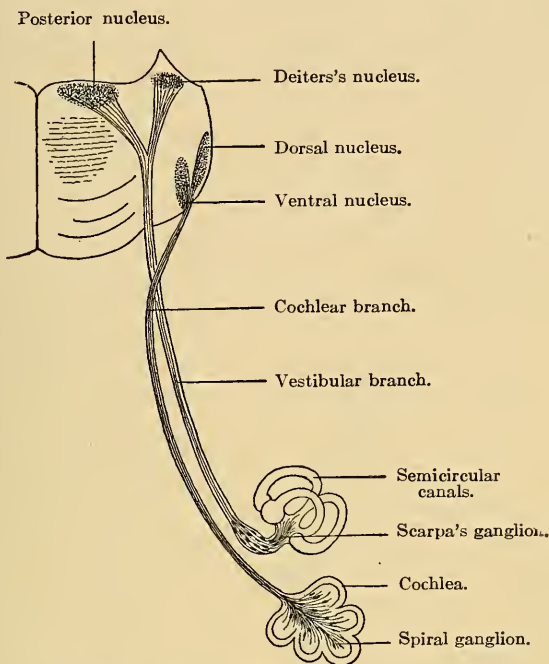

Fig. 94.—The medullary nuclei of the eighth nerve.—(From *Poireer and Charpy.*)

auditory fibers from each ear end partly on the same side and partly or mainly on the opposite side of the cerebrum. The exact portion of the temporal lobe that serves as the cortical terminus of the auditory tract of fibers cannot be determined with certainty, but it seems probable that it lies mainly in the superior temporal gyrus and the transverse gyri extending from this into the lateral fissure of the cerebrum (fissure of Sylvius).

*The Histological Evidences.*—On the histological side the paths of the auditory fibers have been followed with a large measure of success, although in many details the opinions of the different investigators vary considerably. The eighth cranial nerve

springs from the bulb by two roots: the external and the internal. The former has been shown to supply, mainly at least, the cochlear portion of the internal ear, and is, therefore, the auditory nerve proper. This division is spoken of as the cochlear branch. The internal root supplies mainly the vestibular branch of the internal ear, and is, therefore, spoken of as the vestibular branch (see Fig. 94). It seems certain that the latter is not an auditory nerve, but is concerned with peculiar sensations from the semicircular canals and vestibule that have an important influence on muscular activity, especially in complex movements. The central course of these two roots is quite as distinct as their peripheral distribution,—a fact that bears out the supposition that they mediate different functions. The vestibular branch ends in the nucleus of Deiters, the nucleus of Bechterew, and the nucleus fastigii of the cerebellum. Through these nuclei reflex connections are made with the motor centers of the cord and midbrain, and probably also with the cerebellum. The path is not known to be continued forward to the cerebrum. The central course of the cochlear branch is indicated schematically

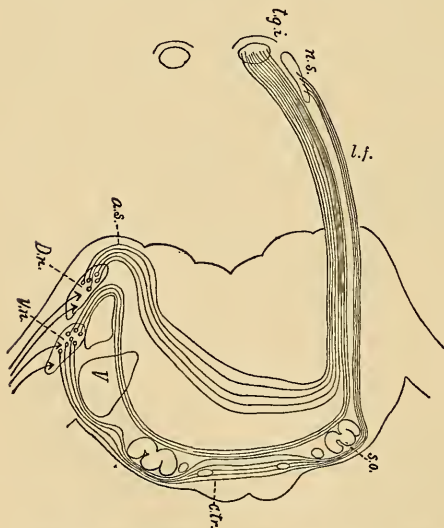

Fig. 95.—Diagram to show central course of auditory fibers (modified from *Van Gehuchten*): *D.n.*, Dorsal nucleus giving rise to the fibers that form the medullary stria (*a.s.*); *V.n.*, the ventral nucleus, giving origin to the fibers of the corpus trapezoideum (*c.tr.*); *s.o.*, superior olivary nucleus; *l.f.*, lateral lemniscus; *n.s.*, nucleus of the lateral lemniscus; *t.g.i.*, the inferior colliculus.

in Figs. 94 and 95. The fibers constituting this branch arise from nerve cells in the modiolus of the cochlea,—the spiral ganglion. These cells, like those in the posterior root ganglia, are bipolar. One axon passes peripherally to end around the sense cells of the cochlea, at which point the sound waves arouse the nerve impulses. The other axon passes toward the pons, forming one of the fibers of the cochlear branch. On entering the pons these cochlear branches end in two nuclei, one lying ventral to the restiform body and known as the ventral or accessory nucleus (*V.n.*, Fig.

95), and one dorsally, known as the dorsal nucleus or the tuberculum acusticum (*D.n.*). From these nuclei the path is continued

by secondary sensory neurons, and its further course toward the brain is still a matter of much uncertainty in regard to many of the details.\* The general course of the fibers, however, is known. Those axons that arise from the accessory nucleus pass mainly to the opposite side by slightly different routes (Fig. 95). Some strike directly across toward the ventral side of the pons, forming a conspicuous band of transverse fibers that has long been known as the corpus trapezoideum; others pass dorsally around the restiform body and then course downward through the tegmental region to enter the corpus trapezoideum. The fibers of this cross band end, according to some observers, in certain nuclei of gray matter on the opposite side of the pons, especially in the superior olivary body and the trapezoidal nucleus, and thence the path forward is continued by a third neuron. Certainly from the level of the superior olivary body the auditory fibers enter a distinct tract long known to the anatomist and designated as the lateral fillet or lateral lemniscus. Authors differ as to whether the auditory fibers of this tract arise from nerve cells in the superior olivary and neighboring nuclei, or are the fibers from the accessory nucleus which pass by the superior olivary body without ending and then bend to run forward in a longitudinal direction. This last view is represented in the schema (Fig. 95). The secondary sensory fibers that arise in the tuberculum acusticum pass dorsally and then transversely, forming a band of fibers that comes so near to the surface of the floor of the fourth ventricle as to form a structure visible to the eye and known as the medullary or auditory striæ. The fibers of this system dip inward at the raphé, cross the mid-line, and a part of them at least eventually reach the lateral lemniscus of the other side either with or without ending first around the cells of the superior olivary nucleus. According to the description of some authors, the fibers from the accessory nucleus and tuberculum acusticum do not all cross the mid-line to reach the lateral lemniscus of the other side; some of them pass into the lateral lemniscus of the same side; so that the relations of the fibers of the cochlear nerves to the lateral lemniscus resemble, in the matter of crossing, the relations of the optic fibers to the optic tract. After entering the lateral lemniscus the auditory fibers pass forward toward the midbrain and end in part in the gray matter of the inferior colliculus and in part in the median or internal geniculate, and, according to Van Gehuchten, partly also in a small mass of nerve cells in the midbrain known

\* For literature, see Van Gehuchten, "Le Névrate," 4, 253, 1903, and 8, 127, 1906.

as the superior nucleus of the lemniscus. From this second or third termination another set of fibers, the auditory radiation, continues forward through the inferior extremity of the internal capsule to end in the superior temporal gyrus (see Fig. 82, *E*). According to Flechsig,\* who has studied the course of these fibers in the embryo by the myelinization method, the main group passes from the median geniculates to the transverse gyri of the temporal lobe within the lateral fissure of the cerebrum (fissure of Sylvius). The median geniculates, in man at least, have, therefore, the function of a subordinate auditory center, as the lateral geniculates have the function of a subordinate visual center. The median geniculates are connected with the inferior colliculus, and also, it will be remembered, with each other, by commissural fibers (Gudden's commissure) that pass along the optic tracts and the inferior margin of the chiasma. The auditory path, therefore, involves the following structures: The spiral ganglion, the cochlear nerve, accessory nucleus and tuberculum acusticum, corpus trapezoideum, medullary striæ, superior olivary, lateral lemniscus, inferior colliculus, median geniculate, Gudden's commissure, auditory radiation, and temporal cortex.

**The Motor Responses from the Auditory Cortex.**—According to Ferrier, stimulation of the cortex of the temporal lobe (inferior convolution) causes definite movements, such as pricking of the ears and turning of the head and eyes to the opposite side. As in the case of the visual area, therefore, we must suppose that distinct motor paths originate in the auditory region, and it is natural to suppose that these paths give a means for cortical reflex movements following upon auditory stimulation.

**The Olfactory Center.**—The olfactory sense is quite unequally developed in different mammals. Broca divided them from this standpoint into two classes: the osmatic and the anosmatic group, the latter including the cetacea (whale, porpoise, dolphin). The osmatic group in turn has been divided into the microsmatic and macrosmatic animals, the latter class including those animals in which the sense of smell is highly developed, such as the dog and rabbit, while the former includes those animals, such as man, in which this sense is relatively rudimentary.† The peripheral end-organ of smell consists of the olfactory epithelium in the upper portion of the nasal chambers. The physiology of this organ will be considered in the section on special senses. The epithelial cells of which it consists are comparable to bipolar ganglion cells. The processes or hairs that project into the nasal chamber

\* Flechsig, "Localisation der geistigen Vorgänge," Leipzig, 1896.

† See Barker, "The Nervous System," 1899, for references to literature.

are acted upon by the olfactory stimuli, and the impulses thus aroused are conveyed by the basal processes of the cells, the olfactory fibers, through the cribriform plate of the ethmoid bone into the olfactory bulb.

**The Olfactory Bulb and its Connections.**—The olfactory bulbs are outgrowths from and portions of the cerebral hemispheres. Each bulb is connected with the cerebral hemispheres by its olfactory tract. The connections established by the fibers

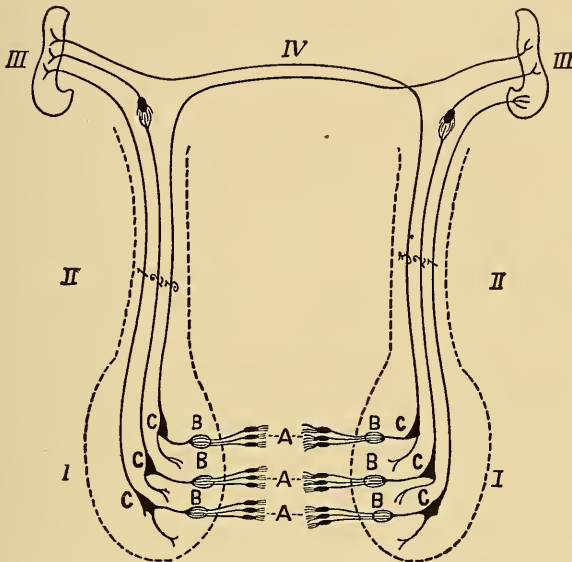

Fig. 96.—Diagram of the central course of the olfactory fibers: *I*, Olfactory bulb; *II*, olfactory tract; *III*, cortex of the hippocampal lobe (gyrus uncinatus); *IV*, anterior commissure, olfactory portion; *A*, olfactory epithelial cells of nose (their fibers, olfactory nerve fibers, terminate in the glomeruli of the bulb); *B*, glomeruli of olfactory bulb where the olfactory fibers come in contact with the dendrites of the mitral cells; *C*, mitral and brush cells; 1, 2, 3, axons from the mitral cells constituting the fibers of the olfactory tract. Fibers 3, which enter the commissure, arise, according to some observers, from cells in the olfactory lobe near the base of the tract.

of this tract are widespread, complicated, and in part incompletely known. All those portions of the brain connected with the sense of smell are sometimes grouped together as the rhinencephalon. According to von Kölliker, the parts included under this designation are, in addition to the olfactory bulb and tract, Ammon's horn, the fascia dentata, the hippocampal lobe, the fornix, the septum pellucidum, and the anterior commissure. The schematic connections of the olfactory fibers are as follows (Fig. 96): After entering the olfactory lobe the fibers terminate in certain globular bodies, the glomeruli olfactorii (*B*), whose diameter varies from 0.1 to 0.3 mm. Here connections are made by contact with the dendrites

of nerve cells of the olfactory lobe, the mitral and brush cells (C). The axons of these cells pass toward the brain in the olfactory tract. Three bundles of these fibers are distinguished: (1) The precommissural bundle, the fibers of which terminate in part in nerve cells situated in the tract itself, but, for the most part, enter the anterior commissure and pass to the same or the opposite side, to end in the hippocampal lobes or other gray matter belonging to the rhinencephalon. (2) The mesial bundle, the fibers of which terminate in the gray matter adjacent to the base of the olfactory tract, the tuberculum olfactorium, whence the path is probably continued by other neurons to the region of the hippocampal lobe. (3) The lateral tract, whose fibers seem to pass to the hippocampal lobe of the same side. According to Van Gehuchten,\* none of the fibers of the anterior commissure arise from the nerve cells in the olfactory bulb. He considers that the fibers in the olfactory portion of this commissure constitute an association system connecting the olfactory lobe of one side with the olfactory bulb of the other side.

**The Cortical Center for Smell.**—So far as the histological evidence goes, it tends to show that the chief cortical termination of the olfactory paths is found in the hippocampal convolution, especially its distal portion, the uncus. The experimental evidence from the side of physiology points in the same direction. Ferrier states that electrical stimulation in this region is followed by a torsion of the lips and nostrils of the same side, muscular movements that accompany usually strong olfactory sensations. On the other hand, ablations of these regions are followed by defects in the sense of smell. The experimental evidence is not very satisfactory, owing to the technical difficulties in operating upon these portions of the brain without at the same time involving neighboring regions. There is some clinical evidence also that lesions in this region involve the sense of smell. Thus Carbonieri records that a tumor in this portion of the temporal lobe occasioned epileptic attacks which were accompanied by nauseating odors.

**The Cortical Center for Taste Sensations.**—Practically nothing definite is known concerning the central paths and cortical termination of the taste fibers. The course of these fibers in the peripheral nerves has been much investigated and the facts are mentioned in the section upon "special senses." It is usually assumed, although without much decisive proof, that the cortical center lies also in the hippocampal convolution posterior to the area of olfaction. Experimental lesions in this region, according to Ferrier, are accompanied by disturbances of the sense of taste. On embryological grounds Flechsig supposes that the cortical

\* Van Gehuchten, "Le Névraie," 6, 191, 1904.



center may lie in the posterior portion of the gyrus fornicatus (6, Fig. 99).

**Aphasia.**—The term aphasia means literally the loss of the power of speech. It was used originally to indicate the condition of those who from accident or disease affecting the brain had lost in part or entirely the power of expressing themselves in spoken words, but the term as a general expression is now extended to include also those who are unable to understand spoken or written language—that is, those who are word-blind or word-deaf. It is usual, therefore, to distinguish sensory aphasia from motor aphasia. By the latter term is meant the condition of those who are unable to speak, although there is no paralysis of the muscles of articulation, and by sensory aphasia, those who are unable to understand the written, printed, or spoken symbols of words, although there is no loss of the sense of vision or of hearing.

**Motor Aphasia.**—A condition of motor aphasia not infrequently results from injuries to the head or from hemorrhage in the region of the middle cerebral artery. The first exact statement of the portion of the brain involved seems to have been made by Bouillaud (1825), who, as the result of numerous autopsies, attributed the defect to lesions of the frontal lobe.

(It is a curious fact that Bouillaud's observations were inspired by the work of Gall. Gall having observed, as he thought, that individuals who are fluent speakers or who have retentive memories are characterized by projecting eyes, concluded that this peculiarity is due to the larger size of the lower part of the frontal lobe, and he therefore located the faculty of speech in this region of the brain. In spite of the vagaries into which he was led by his false methods Gall made many most important contributions to our knowledge of the anatomy of the brain and the cord. The discovery of the location of the center of speech, however, cannot be rightly placed to his credit, since his reasons for its location were, so far as we know, entirely unjustified. It cannot be reckoned as more than a coincidence that in this particular his phrenological localization was afterward in a measure justified by facts.)

The essential truth of Bouillaud's observations was established by other observers, and Broca located the part of the brain involved in these lesions in the posterior part of the third or inferior frontal convolution. He described conditions of pure motor aphasia, designated by him as *aphemia*, which he thought were due to lesions in this gyrus. This region is, therefore, frequently known as Broca's convolution or Broca's center. Subsequent observations have tended to confirm this localization, and what is designated as the "speech center" has been placed in the inferior frontal convolution in the gyrus surrounding the anterior or ascending limb of the lateral fissure (fissure of Sylvius, *S*, Fig. 97). Many authors insist that this localization is too limited, and that defects in the power of speech may result not only from injuries to this region, but also from lesions of contiguous areas,

including the anterior portion of the island and the opercular portion of the central convolution. Autopsies have shown that in right-handed persons the speech center is placed or is functional usually in the left cerebral hemisphere, while, on the other hand, it is stated, although hardly demonstrated, that in the case of left-handed individuals aphasia is produced by lesions involving the right side of the brain. This region is not the direct cortical motor center for the muscles of speech. It is possible that aphasia may exist without paralysis of these latter muscles. It is rather the memory center of the motor innervations necessary to form the appropriate sounds or words with which we have learned to express certain concepts. The child is taught to express certain ideas by definite words, and the memory apparatus through which these associations are transmitted to the motor apparatus may be conceived as located in the speech center. Lesions of any kind affecting this area will, therefore, destroy more or less the ability to use appropriately spoken words, and clinical experience shows that motor aphasia may be exhibited in all degrees of completeness and in many curious varieties. The individual may retain the power to use a limited number of words, with which he expresses his whole range of ideas, as, for instance, in the case described by Broca,\* in which the individual retained for the expression of numbers only the word "three," and was obliged to make this word do duty for all numerical concepts. Other cases are recorded in which the patient had lost only the power to use names—that is, nouns ("Marie")—or could remember only the initial letters. Others still, in which words could be used only when associated with musical memories, as in singing; or in which the words were misused or employed in wrong combinations (paraphasia). Motor aphasias have been classified in various ways to suit the different schemata which have been invented to explain the cerebral mechanism of speech, but the whole subject is in reality so complex that most of these classifications must be received with caution. There seems to be no doubt, however, that a condition of what may be called pure motor aphasia may result from localized injuries to the brain. In this condition there is loss of the power of articulate speech, without paralysis of the muscles of articulation, and with the preservation of what has been called internal language, that is, the power to conceive the ideas for which the appropriate verbal expressions are missing. Most authors conclude that this condition is due to an injury or lesion in Broca's convolution, but others contend that the evidence for

\* Exner, "Hermann's Handbuch der Physiologie," vol. iii, part II, p. 342. Consult for older literature.

this localization is at present unsatisfactory.\* It does not seem to be certain whether or not, in the case of complete lesion of the center on one side, the ability to speak can be again acquired by education of new centers.† Some recorded cases seem to indicate that this re-education is possible in the young, while in the old it is more difficult or impossible. We express our thoughts not only in spoken, but also in written, symbols. As this latter form of expression involves a different set of muscles and a different educational experience, it is natural to assume that the complex associations concerned or, to use a convenient expression, the memory centers, should involve a different part of the cortex. It is, in fact, observed that in some aphasics the loss of the power of writing, a condition designated as *agraphia*, is the characteristic defect, rather than the loss of the ability to use articulate language. There may be also, as a result of cerebral injury, a loss of the power to make various kinds of purposive movements or combinations of movements other than those used in speaking or writing, and for this general condition the term "*apraxia*" has been employed. Using this term in its widest sense, pure motor aphasia (*aphemia*) might be defined as an *apraxia* limited to the muscles of articulation, and *agraphia* as an *apraxia* involving the movements of writing. The general evidence seems to show that these conditions of *apraxia*, other than the *aphemia*, are associated with lesions in the first and second frontal convolutions anterior to the motor area.

*Sensory Aphasia.*—In sensory aphasia‡ the individual suffers from an inability to understand spoken or written language. Conditions of this kind have been referred to lesions in the cortex of the temporal or temporo-parietal region (*H* and *V*, Fig. 96), and, as in the case of motor aphasia, the lesion is usually on the left side. Since the cortical centers for hearing and seeing are situated in distinct parts of the brain, we should expect that the mechanism for the association, in one case of visual memories of verbal symbols with certain concepts, and in the other case, of auditory memories, should also be located in separate regions. Inability to understand spoken language, or word-deafness, is, in fact, usually attributed to a lesion involving the superior or middle temporal convolution contiguous to the cortical sense of hearing (*H*, Fig. 97), while loss of power to understand written or printed language, word-blindness (*alexia*), is traced to lesions involving the

\* For these opposing views and the work of Marie see Moutier, "*L'Aphasia de Broca*," Paris, 1908.

† See Mills, "*Journal of the Amer. Med. Assoc.*," 1904, xliii.

‡ Consult Starr, "*Aphasia*," "*Transactions of the Congress of American Physicians and Surgeons*," vol. 1, p. 329, 1888; also Monakow, "*Gehirn-pathologie*," 1906; Collier, "*Brain*," 1908.

inferior parietal convolution, the gyrus angularis, contiguous to the occipital visual center (*V*, Fig. 97). These two conditions may occur together, but cases are recorded in which they existed independently. It may be imagined that the individual suffering from word-blindness alone is essentially in the condition of one who attempts to read a foreign language. The power of vision exists, but the verbal symbols have no associations, therefore no meaning. So one who is word-deaf alone may be compared to the normal individual who is spoken to in a foreign tongue. The words

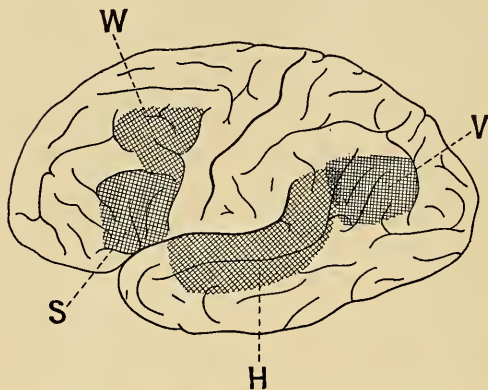

Fig. 97.—Lateral view of a human hemisphere; cortical area *V*, damage to which produces "mind-blindness" (word-blindness); cortical area *H*, damage to which produces "mind-deafness" (word-deafness); cortical area *S*, damage to which causes the loss of articulate speech; cortical area *W*, damage to which abolishes the power of writing.—(Donaldson.)

are heard, but they have no associations with past experience. Sensory aphasia may be complete or incomplete. In the complete form there is word-deafness as well as word-blindness, and there may be difficulties as well in the power of articulate speech. In the incomplete type these symptoms are exhibited in milder and varying form. One may imagine that our ability to recognize external objects through the senses

might be affected in other ways than a failure to comprehend the visual or auditory symbols, and some writers, therefore, employ the wider term agnosia to indicate any failure in the intellectual recognition of external objects. From this point of view word-blindness might be designated as visual agnosia, word-deafness as auditory agnosia, and astereognosis as chiefly a tactile agnosia. The exact localization in the cortex of the areas involved in the auditory and visual associations and perceptions connected with speech has not been established definitely. The question is a complex and difficult one, and those who have had the most experience are perhaps the most cautious in referring word-blindness or word-deafness to the lesion of circumscribed areas of the cortex.\* It may be said, however, with some certainty, that the phenomena of sensory aphasia in general are connected with lesions involving the area

\* For a general review see Monakow, "Ergebnisse der Physiologie," 1907, p. 334.

along the margins of the posterior portion of the lateral fissure (fissure of Sylvius), and extending into the parietal lobe as far as the angular gyrus, and with the cortex within the fissure including the cortex of the island.

The general facts regarding aphasia illustrate very well the theory or idea usually held among physiologists in regard to the distribution or localization of mental activity in the cerebral cortex. The understanding and the use of spoken or written language is, so to speak, a mental whole, both from the standpoint of education and of use. To understand or to express certain conceptions implies the use of definite words, and our visual, auditory, and motor experiences are combined in these symbols. Each phase of this complex may be cultivated more or less separately; in the case of the unlettered man, for instance, the written or printed symbols form no part in the associations connected with his verbal concepts. Corresponding to these facts we have, on the anatomical side, a portion of the brain in which the auditory memories are organized,—that is, they are connected in some way with a definite arrangement of nerve cells and their processes, another part in which the visual memories are organized, and other parts in which the motor memories as regards speaking or writing are laid down in some definite form. Each part is a distinct center, but their combined use in intellectual life would imply that they are connected by association fibers, so that, although fundamentally distinct, they are practically combined in their activity. Corresponding with this conception it is found from clinical experience that sensory aphasics suffer a deterioration, more or less pronounced, of their general intellectual capacity according to the extent of the area involved. We may believe that the varying gifts of individuals, in the matter of the use of language, rest partly on the amount of training received and partly on the inborn character and completeness of the nervous machinery in the different centers.

**The Association Areas.**—According to the views presented above, it will be seen that the motor and sense areas occupy only a small portion of the cortex, forming islands, as has been said, surrounded by much larger areas. Flechsig\* has designated these latter areas as association areas, and has advocated the view that they are the portions of the cortex in which the higher and more complex mental activities are mediated, the true organs of thought. His views as to the relations and physiological significance of these areas have been based chiefly on the study of the embryo brain with reference to the time of acquisition of the myelin sheaths.

\* Flechsig, "Gehirn und Seele," Leipzig, 1896; also, "Archives de Neurologie," vol. ii, 1900.

Thus he finds that the fibers to the sense areas acquire their myelin, and therefore according to his view become fully functional before those distributed to the association areas. Moreover, in the embryo, at least, these latter areas are not supplied with projection fibers,—that is, they are not connected directly with the underlying parts of the nervous systems. Their connections are with each other and with the various sense centers and motor centers of the cortex.

The association areas may be regarded therefore as the regions in which the different sense impressions are synthesized into complex perceptions or concepts. The foundations of all knowledge are to be found in the sensations aroused through the various sense organs; through these avenues alone can our consciousness come into relation with the external or the internal (somatic) world, and the union of these sense impressions into organized knowledge is, according to Flechsig, the general function of the association areas. This function of the association areas is indicated by the anatomical fact that they are connected with the various sense centers by tracts of association fibers, suggesting thus a mechanism by which the sense qualities from these separate sense centers may be combined in consciousness to form a mental image of a complex nature. The sequence of phenomena in the external world is orderly, and, corresponding to this fact, the reflection of these phenomena in the sequence and combinations of sensations is also orderly. In the association areas our memory records of past experiences and their connections are laid down in some, as yet unknown, material change in the network of nerve cells and fibers. Here, as elsewhere in the nervous system, it may be supposed that the efficiency of the nervous machinery is conditioned partly by the completeness and character of training, but largely also by the inborn character of the machinery itself. The very marked differences among intelligent and cultivated persons—for instance, in the matter of musical memory and the power of appreciating and reproducing musical harmonies—cannot be attributed to differences in training alone. The gifted person in this respect is one who is born with a certain portion of his brain more highly organized than that of most of his fellow-men. This general conception that the special capacities of talented individuals rest chiefly upon inborn differences in structure or organization of the brain may be regarded as one outcome of the modern doctrine of localization of functions in this organ. In the beginning of the nineteenth century it seems to have been the general view that those who had a high degree of mental capacity might direct their activity with equal success in any direction according to the training received. A man who could walk fifty miles to the north, it was said, could just as

easily walk fifty miles to the south, and a man whose training made him an eminent mathematician might with different training have made an equally eminent soldier or statesman. In our day, however, with our ideas of the organization of the brain cortex, and our belief that different parts of this cortex may give different reactions in consciousness, it seems to follow that special talents are due to differences in organization of special parts of the cortex.

**Subdivision of the Association Areas.**—On anatomical grounds Flechsig distinguishes three (or four) association areas: The frontal or anterior 35, Fig. 100), which lies in front of the motor area; the median or insular,—that is, the cortex of the island of Reil; and the posterior, which lies back of the body feeling area, extending to the occipital lobe and also laterally into the temporal lobe. This area Flechsig suggests may be subdivided into a parietal area, 34, Fig. 100, and a temporal area, 36, Fig. 100. The greater relative development of these areas is one of the features distinguishing the human brain from those of the lower mammals. In accordance with the general conception of localization of functions Flechsig suggests that these areas have different functions,—that is, take different parts in the complex of mental activity. Basing his views upon the nature of the association tracts connecting them with the sense centers, he suggests that the posterior area is concerned particularly in the organization of the experiences founded upon visual and auditory sensations, and shows especial development in cases of talents, such as those of the musician, which rest upon these experiences. The anterior area, being in closer connection with the body sense area, may possibly be especially concerned in the organization of experiences based upon the internal sensations (bodily appetites and desires), and in alterations or defective development of this portion of the brain may lie the physical explanation of mental and moral degeneracy. This general idea is borne out in a measure by histological studies of the brains of those who are mentally deficient (amentia) or mentally deranged (dementia). It is stated\* that the brain in such cases shows a distinct thinning of the cortex and that the maximum focus of this change is found in the prefrontal lobes (anterior association area). In the case of the idiotic this area is distinctly undeveloped and in the insane the atrophy is marked in proportion to the degree of dementia. Regarding the peculiar functions of the cortex of the island of Reil there are no facts sufficiently distinct to warrant a positive statement, although, as stated above, the data from pathological anatomy

\* Bolton, "Brain," 1903, p. 215, and 1910, p. 26.

would seem to indicate that this portion of the cortex may form a part of the speech area both on the motor and the sensory side. The area is much more developed in man than in the lower mammals, and its connections with other parts of the cortex by means of association tracts are such as to lead to the supposition that its general functions are of the higher synthetic character attributed to the association areas in general.

By way of caution it should be stated that the general ideas developed above in accordance with]Flechsig's views do not meet with universal acceptance. Some of the most experienced observers are unwilling to admit that such a degree of localization of the psychical activities really exists. They contend that the whole cortex may be concerned in mediating the highest mental processes, and quote post-mortem examinations of carefully studied cases in support of this view. Even in the primary sense centers or motor centers the character of the lamination of the cortex indicates the possibility that the higher synthetic functions may be mediated there in addition to the reception of sensory impulses or the generation of motor impulses. We must recognize, in fact, that the schemata designed to show the distribution of the higher psychical activities in the cortex represent at present only hypotheses which need confirmation before they can be finally accepted. We may feel considerable confidence in the localizations of the motor areas, and of some, at least, of the sensory areas, but in the matter of the more complex mental acts, failure in which expresses itself in the conditions of aphasia, dementia, perversions, etc., our knowledge is incomplete, both as regards analysis of the symptoms and the localities affected in the brain.

**The Development of the Cortical Area.**—Flechsig\* has published the results of an extensive study of the time of myelination of the fibers in the cerebrum of man from the fourth month of intra-uterine to the fourth month of extra-uterine life. The first areas to develop in the cortex are the primary sense centers (smell, cutaneous and muscle sense, sight, hearing, and touch), and later in connection with these centers systems of motor fibers appear. There are thus formed seven primary zones, sensory and motor, to which he gives the name of *projection areas*. The location of these areas is shown in part in Figs. 98 and 99, 2 (*2<sup>b</sup>*, *2<sup>c</sup>*), 5, 6, 7 (*7<sup>b</sup>*), 8, 15. Two areas connected with the olfactory sense are not shown in these figures; they appear in the anterior perforate lamina on the base of the brain and in the uncinat gyrus. Later there is developed around these primary zones areas that Flechsig calls marginal or border zones, which have no projection fibers, but which are connected by short association fibers with one or more of the primary projection zones, 14, 16 to 33, in Figs. 100 and 101. Later still the great association areas—34, 35, 36, Figs. 100 and 101—acquire their myelinated fibers. These latter centers, as indicated above, may be considered as association areas

\* Flechsig, "Berichte der mathematisch-physischen Klasse der königl. Sachs. Gesellschaft der Wissenschaften zu Leipzig," 1904. For a summary of the results of this work see Sabin, "The Johns Hopkins Hospital Bulletin," February, 1905.





Fig. 98.—Lateral surface of the brain, showing the primordial areas, both sensory and automatic, in dotted zones.—(Flechsig.)



Fig. 99.—Same zones on the mesial surface of the brain.—(Flechsig.)

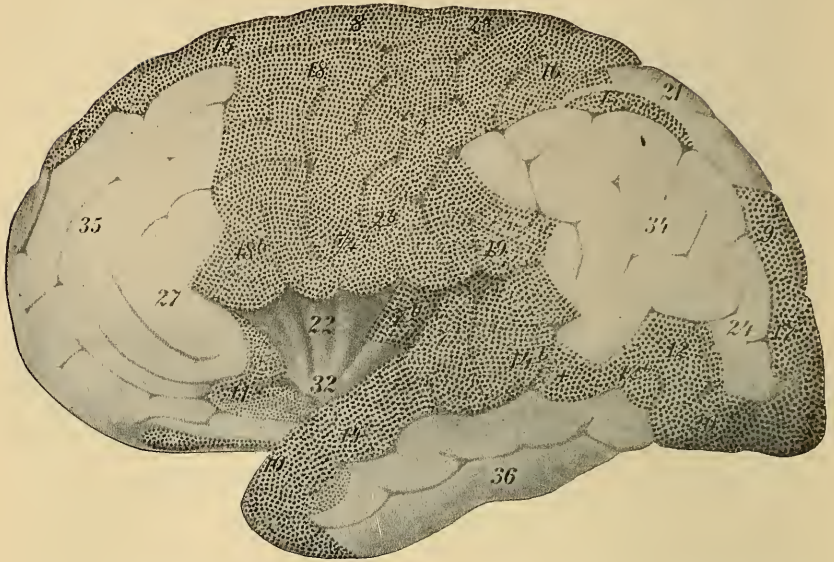

Fig. 100.—Lateral surfaces of the brain, showing the primordial and marginal zones.  
—(Flechsig.)

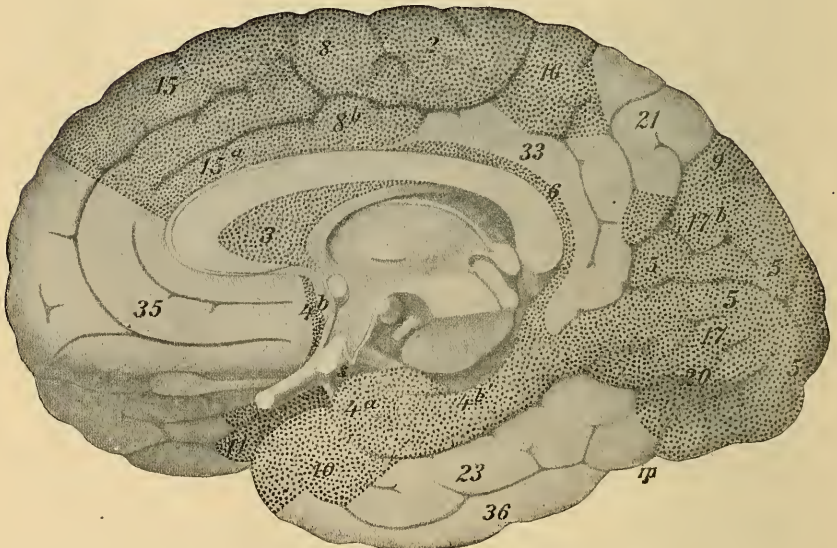

Fig. 101.—Same areas on the mesial surface.—(Flechsig.)

with more complex connections, and they serve to mediate, possibly, the higher psychical activities. Flechsig, in his report, designates these areas from an anatomical point of view as terminal or central zones. As the result of his histological work, as far as it has progressed, he distinguishes thirty-six areas in the cortex in which the myelinization of the fibers occurs separately, and in which, therefore, by inference different physiological activities are mediated. These thirty-six areas are subdivided as follows:

**I. Primary areas.**

**I<sup>a</sup>.** Primary projection areas (1, 2, 4, 5, 6, 7, 8 (15), seven or eight in number, and provided with projection fibers—sensory and motor.

**I<sup>b</sup>.** Primary areas without projection fibers (3, 9, 10, 11, 12, 13) and apparently without association fibers. Functions uncertain.

**II. Association areas.**

**II<sup>a</sup>.** Intermediate or border areas, 14, 16-33, provided with short association fibers.

**II<sup>b</sup>.** Terminal or central areas, 34, 35, 36, provided with long association fibers.

**Histological Differentiation in Cortical Structure.**—While the general structure of the cortex is everywhere similar, detailed examination has shown differences in the shape of the cells, the thickness and number of the strata or laminæ, the calibre of the fibers, etc., which are said to be constant for any given region. By this means it is possible to divide the cerebral cortex into a number of areas whose structures are sufficiently distinct to be recognized with some certainty. Reasoning from analogy, we should infer that a differentiation in structure implies a subdivision of physiological activity, and to this extent this recent histological work supports the view of a localized distribution of function in the cortex. Campbell,\* in a very thorough investigation of this kind, has succeeded in separating some fifteen or sixteen different areas, and the results obtained by him support in a general way the localizations described in the preceding pages. Thus the cortex in the postcentral convolution (body-sense area) has a structure distinctly different from that of the precentral convolution (motor area), the latter being characterized among other things by the presence of giant pyramidal cells (Betz cells), and a marked diminution in the width of the granular layer of cells. In the occipital lobes the region round the calcarine fissure has a structure different from that of the contiguous cortex, and a similar difference is claimed for the auditory region. Campbell believes that the extreme end of the frontal lobe (prefrontal region) has a compara-

\* Campbell, "Histological Studies on Localisation of Cerebral Functions," Cambridge, 1905; See also Brodmann, "Journal f. Psychol. u. Neurol.," 1902, 7.

tively undeveloped structure, but Bolton,\* on the contrary, states that it has a typical structure and believes that it plays a part of the greatest importance in the higher or general processes of association. It is the last region of the cortex to be evolved. In mental decadence or dementia it is, according to this author, the first region to undergo dissolution, and in conditions of amentia it is undeveloped.

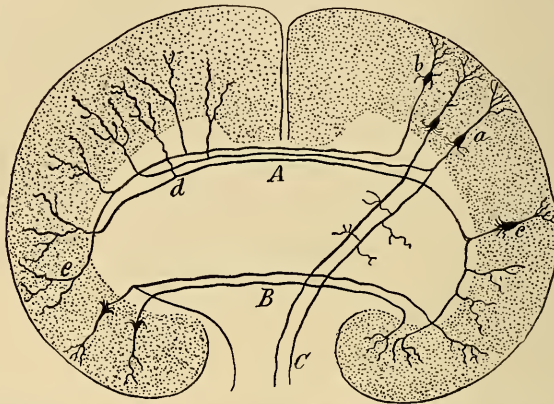

Fig. 102.—Diagram to show the composition of the corpus callosum as a system of commissural fibers, without projection fibers.—(Cajal.)

**The Corpus Callosum.**—The corpus callosum is the most conspicuous of the bands of commissural fibers that connect one cerebral hemisphere with the other. Similar tracts of the same general nature are the anterior commissure and the fornix. The position and great development of the corpus callosum has made it the object of experimental as well as anatomical investigation. When the corpus is divided by a section along the longitudinal fissure (v. Koranyi) no perceptible effect of either a motor or sensory nature is observed in the animal. When it is stimulated electrically (Mott and Schäfer) from above, symmetrical movements on the two sides of the body may be obtained. If the motor cortex on one side is removed, stimulation in the longitudinal fissure causes movements only on the side controlled by the uninjured cortex. These facts are in harmony with the results of histological studies, which indicate that the fibers of the corpus callosum do not enter directly into the internal capsules, to be distributed to underlying portions of the brain, but are truly commissural and connect portions of the cortex of one hemisphere with the cortex of the other side. This relation is indicated in the

\* Bolton, "Brain," 1910, p. 26.

accompanying diagram (Fig. 102). So far as the motor regions are concerned, there is some evidence that the connection thus established is between symmetrical parts of the cortex (Muratoff),—that is, between parts having similar functions,—and we may regard the corpus as a means by which the functional activities of the two sides of the cerebrum are associated. On the human side, study of cases of lesions of the corpus callosum has yielded an important suggestion in line with the conclusion just stated. Liepmann\* has reported cases of this kind in which there were apraxic symptoms (dyspraxia) in the movements of the left side of the body, although the right cortex was uninjured. He draws the conclusion that in movement complexes in general the left hemisphere leads or initiates, as in the case of articulate speech, and that through the commissural fibers of the corpus callosum a stimulus is conveyed to the right cortex when the movement affects the musculature of the left side.

**The Corpora Striata and Thalami.**—The numerous masses of gray matter found in the cerebrum beneath the cortex, in the thalamencephalon, and in the midbrain have each, of course, specific functions, but, in general, it may be said that they are intercalated on the afferent or efferent paths to or from the cortex. Their physiology is included, therefore, in the description of the functions mediated by these paths. For instance, the lateral geniculate bodies form part of the optic path. In addition, however, these masses of cells contain in many cases reflex arcs of a more or less complicated kind, through which afferent impulses are converted into efferent impulses that affect the musculature or the glandular tissues of the body. The large nuclei constituting the corpora striata (nucleus caudatus and n. lenticularis) and the thalami have been frequently studied experimentally to ascertain whether they have specific functions independently of their relations to the cortex. These efforts have given uncertain results. Older experiments (Nothnagel), in which the attempt was made to destroy these nuclei by the localized injection of chromic acid, are probably unreliable, as the destruction involved also the projection fibers passing to the cortex. Lesions of the nucleus caudatus are said to be accompanied always by a rise in body temperature and an increase in heat production, and stimulation of the same nucleus gives a very marked rise in blood-pressure. These facts indicate a possible connection of this nucleus with heat and vasomotor regulation. Other observers have supposed that these nuclei are especially concerned in the co-ordination of the muscles employed in involuntary or unconscious movements. While the nucleus

\* Liepmann, "Med. Klin.," 1907, 725.

lenticularis is connected with the posterior Rolandic region of the cortex, the n. caudatus seems to be independent in this regard, and to be provided with its own system of projection fibers. With regard to the various nuclei of the thalamus, it is known that they form abundant connections with the sensory areas of the cortex cerebri, and from this standpoint they may be regarded as consisting of subcenters, with a probability, however, that reflexes may occur through them (subcortical reflexes) independently of the cortex. Numerous fibers have been traced from the thalamus to the body sense area (Flechsig). Sachs\* states that the thalamus may be considered as being composed of two practically independent parts: an inner division, which has relation with the nucleus caudatus and the rhinencephalon, and an outer division, which, on the one hand, serves as a terminus for the fibers of the lemniscus and of the superior cerebellar peduncle, and, on the other hand, is connected by afferent and efferent paths with the cortex of the Rolandic region. It is evident, from these relations and from the proximity of the internal capsule, that lesions in the thalamus may occasion symptoms of a very diverse character. Among these symptoms, we should expect to find hemianesthesia on the opposite side, owing to the fact that the thalamus serves as a substation for the fibers of the lemniscus.

\* Sachs, "Brain," 1, 1909.

## CHAPTER XI.

### THE FUNCTIONS OF THE CEREBELLUM, THE PONS, AND THE MEDULLA.

The functions of the cerebellum are, in some respects, less satisfactorily known than those of any other part of the central nervous system. Many theories have been held. Most of these views have been attempts to assign to the organ a single function of a definite character, but latterly the insufficiency of the theories proposed has led observers to attribute to the cerebellum general properties the nature of which can not be expressed satisfactorily in a single phrase. Before attempting to give a summary of existing views it will be helpful to recall briefly the important facts regarding its structure and relations, so far as they are known and can be used to explain its functional value.

**Anatomical Structure and Relations of the Cerebellum.**—The finer histology of the cerebellar cortex is represented in Fig. 103. Three layers may be distinguished. The external molecular layer (*A*), the middle granular layer (*B*), and the internal medullary layer consisting of the white matter or medullated nerve fibers, afferent and efferent (*C*). Between the molecular and granular layers lie the large and characteristic Purkinje cells (*a*). The dendrites of these cells branch profusely in the molecular layer; their axons pass into the medullary layer. From the standpoint of the neuron doctrine these cells, so far as the cerebellum is concerned, are efferent. They form, indeed, the sole efferent system of the cerebellar cortex. The afferent fibers of the cerebellum end in both the granular and the molecular layers. Those that terminate in the granular layer—designated by Cajal as moss fibers, have at their terminations and points of branching curious clumps of small processes; they probably connect with the dendrites of the nerve cells in this layer. Those that pass deeper into the molecular layer come into connection with the dendrites of the Purkinje cells, around which, indeed, they seem to twine, so that Cajal designated them as climbing fibers. The granular layer (*B*) contains numerous granules (*g*) or small nerve cells. These cells are spherical, and have a relatively large nucleus and a small amount of cytoplasm. Their dendrites are few and short; their axons run into the molecular layer, divide in **T**, and the two branches then run parallel to the surface and doubtless make connections with the den-

drites of the Purkinje cells as well as with the cells of the molecular layer. A few larger nerve cells of Golgi's second type (*f*) are found also in the granular layer. In the molecular layer are found two types of cells: the larger basket cells (*b*) whose axons terminate in a group of small branches that inclose the body of the Purkinje cells, and a number of smaller cells (*e*), situated more superficially, whose axons pass longitudinally in the molecular layer and terminate in arborizations or baskets that doubtless make connections with the dendrites of the Purkinje cells.

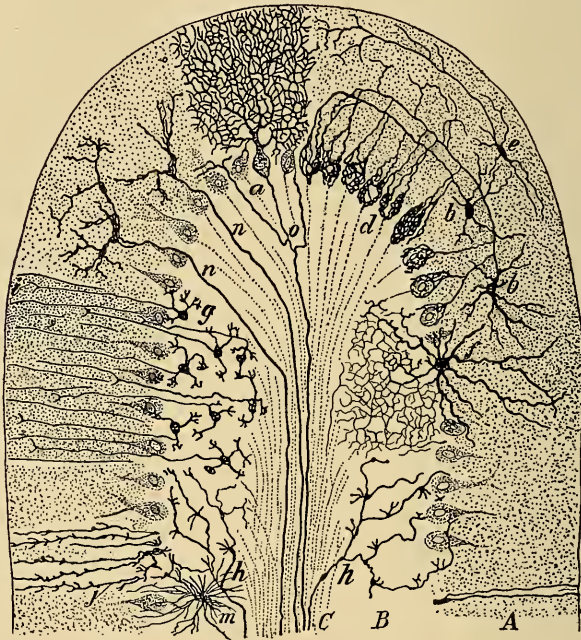

Fig. 103.—Histology of the cerebellum.—(From Obersteiner.)

A consideration of this peculiar and intricate structure enables us to comprehend that the cerebellar cortex presents a reflex arc of a very considerable degree of complexity. The incoming impulses through the moss and climbing fibers may pass at once to the Purkinje cells and lead to efferent discharges, or they may end in the cells of the granular or molecular layer and thus be distributed to the Purkinje cells in a more indirect way. In addition to the cortex the cerebellum contains several masses of gray matter in its interior: the large dentate nucleus in the center of each hemisphere and the group of nuclei lying in or near the middle of the medullary substance of the vermiciform lobe (nucleus fastigii, *n. globosi*, and the *n. emboliformis*). The axons of the Purkinje



cells of the cortex terminate in these subcortical nuclei, and the efferent path from the cerebellum is then continued by new neurons. Thus, the fibers of the superior peduncles (brachium conjunctivum) of the cerebellum arise chiefly from the dentate nuclei, and only indirectly from the cortex. The anatomical connections, afferent and efferent, between the cerebellum and other parts of the nervous system are very complex and not yet entirely known. Without attempting to recall all of these connections, which will be found described in works upon anatomy or neurology, emphasis may be laid upon those which are at present helpful in discussing the physiology of the organ.

1. *Connections with the Afferent Paths of the Cord.*—Through the inferior peduncles (restiform bodies) the cerebellum receives afferent fibers from the spinal cord and the medulla. The cerebello-spinal fasciculus undoubtedly terminates in the cerebellum, and according to some observers the fibers of the posterior funiculi after ending in the n. gracilis and n. cuneatus are also continued in part to the cerebellum by nerve fibers passing by way of the inferior peduncles. This latter view has, however, not found confirmation in recent work, most authors believing that the afferent fibers of the posterior funiculi all enter the lemniscus, after decussating, and pass forward to the thalamus. Ascending fibers arising in the reticular formation of the medulla and the olivary nucleus may take this path to the cerebellum, and, on the other hand, may make connections with the sensory tracts of the cord or the sensory nuclei of the medulla. Another afferent tract of the cord, that of Gowers (fasciculus anterolateralis superficialis), ends in the cerebellum, in large part at least, forming a part, in fact, of the cerebellospinal system. The nature of the sensory impulses conveyed in this way to the cerebellum is not entirely understood, but it seems certain that some of them, at least, arise in the deeper tissues, the muscles and joints. This tract and the similar tract of Flechsig, by forming an afferent connection between the deep tissues and the cerebellum, present a mechanism which may be used to explain the influence exercised by the cerebellum upon muscular activity.

2. *Connections with the Vestibular Branch of the Eighth Cranial Nerve.*—This branch, arising in the semicircular canals and utriculus and sacculus, ends in the pons in several nuclei (Deiters', Bechterew's) and also in the n. fastigii of the cerebellum. These nuclei, in turn, are connected with other parts of the central nervous system, but the details are not yet completely known. The connections that have been most clearly established are those made with the motor centers. Through the medial longitudinal fasciculus these nuclei are connected with the motor nuclei of the cranial nerves and with descending paths in the spinal

cord (vestibulospinal), which end in the motor centers for the spinal nerves. In how far the vestibular nuclei may make afferent connections with the cerebellum is undecided, but it seems probable

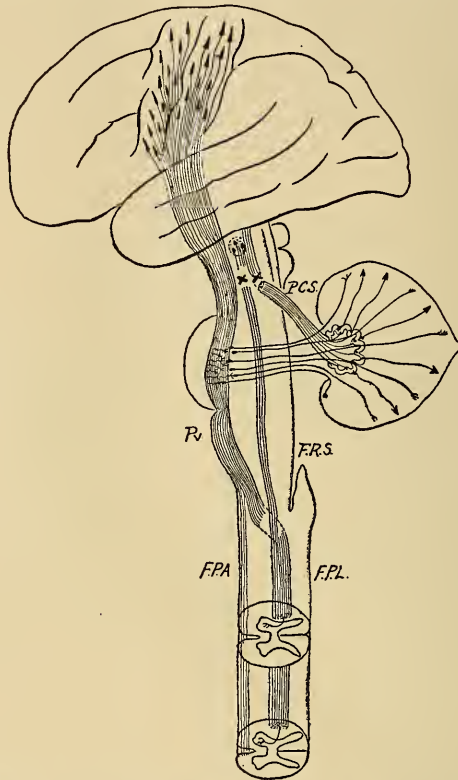

Fig. 104.—Diagram to indicate a possible descending path from cerebrum to cord in addition to the pyramidal system, namely, the secondary or cerebellar motor path (Van Gehuchten). The path is indirect and comprises the following units: 1. The cortico-ponto-cerebellar path, represented as arising in the motor area of the cerebrum and passing down with the pyramidal system to end in the pons, thence continued through the middle peduncles to the cerebellar cortex of opposite side. 2. The path from the cerebellar cortex to the dentate nucleus. 3. The path from the dentate nucleus to the red nucleus passing by way of the superior peduncles, brachium conjunctivum. 4. The path from the red nucleus to the motor cells of the spinal cord (rubro-spinal tract).

that such tracts exist, in view of the fact that destruction of the semicircular canals and severe lesions of the cerebellum cause motor disturbances that are strikingly similar.

3. *Connections with Other Sensory Nuclei.*—In addition to the special sensory connections just described, it is stated by various neurologists that the sensory nuclei of the vagus, the trigeminal and the auditory nerves, send afferent paths into the cerebellum, and that similar paths extend from the primary end stations of the optic fibers.\*

\* See Edinger, "Brain," 29, 483, 1906.

4. *Connections with the Cortex of the Cerebrum.*—The cerebellar cortex is connected with the cerebral cortex by the large system known as the cortico-ponto-cerebellar tract (see Fig. 82, A). The fibers of this tract arise in the motor area of the cerebrum or in the frontal cortex anterior to the motor area, descend in the internal capsule and cerebral peduncle, and end in the gray matter of the pons. Thence new axons continue the path across the mid-line and to the cerebellar cortex by way of the middle peduncle (brachium pontis). The tract would seem to convey efferent impulses from the cerebral cortex (motor region) of one side to the cerebellar cortex of the opposite side. A second possible connection with the cerebrum is made by way of the thalamus. Fibers arising in the dentate nucleus emerge by way of the brachium conjunctivum and connect with the red nucleus in the subthalamic region and perhaps also with the thalamus. The latter fibers may be continued forward to the cortex of the cerebrum and thus constitute an afferent path from cerebellum to cerebrum. Those fibers, on the contrary, which end in the red nucleus are brought into reflex connection with the motor bundle (rubrospinal tract), extending from the red nucleus to the motor centers in the spinal cord. Making use of the connections described above, Van Gehuchten pictures an indirect motor path from the cortex of the cerebrum to the motor nerves by way of the cerebellum (see Fig. 104). The motor impulses descend by way of the cortico-ponto-cerebellar path to the cerebellar cortex, thence to the dentate nucleus, thence to the red nucleus, and then, by way of the rubrospinal tract, to the motor nuclei of the spinal nerves.

**Theories Concerning the Functions of the Cerebellum.**—Modern views concerning the functions of the cerebellum may be classified under three general heads: First, those that consider it a general co-ordinating center or organ for the muscular movements and especially for those concerned in equilibrium and locomotion. This view, first proposed essentially by Flourens (1824), has been adopted by many, perhaps by most, writers since his time. The manner in which the organ serves to co-ordinate these movements has been explained in various ways. According to the older observers, it was supposed so to arrange or group the various motor impulses that they reached the lower motor centers in the cord in the necessary combination for co-ordinated contractions. According to more recent observers, this synergetic action is exercised not directly on the motor side of the reflex but on the sensory side. The numerous sensory paths connected with the organ, especially those of the muscular sense, and those from the vestibular nerve, suggest the view that in the complex cortex of the cerebellum these afferent impulses act upon nervous combinations whose

discharges in turn are conveyed to the motor centers in a definite and orderly sequence. Either point of view assumes that there are in the cerebellum certain distinct mechanisms—that is, combinations of neurons that are essentially reflex centers, and that in all of our more complex bodily movements these mechanisms intervene. The second general set of theories regarding the cerebellum assumes that this organ is essentially the center or a center for the muscle sense. This view is connected usually with the name of Lussana,\* but has been supported since in one sense or another by many observers.† It is, in fact, not essentially different perhaps from the second phase of the first group of theories. Those who have expressed their idea of the physiology of the cerebellum by saying that it is a center of the muscle sense have, in recent times at least, recognized that this sense has a cortical center also in the cerebrum. The view can not assume, therefore, a conscious muscle sense mediated by the cerebellum, but only that fibers of deep sensibility have a cortical termination therein, and that the cerebellar activity thus aroused is in some way necessary to the orderly adjustment of complex voluntary movements. Some authors have assumed that the reflex effect thus exerted on the musculature of the limbs and trunk is not concerned directly in elaborating the proper co-ordination of the muscles, but consists essentially in the production of a state of tonus of a variable or adaptive character, which serves as a foundation, so to speak, for the voluntary control of the muscles. It would seem to be evident that on any theory of this kind the results of cerebellar activity must be exerted through some efferent channel upon the muscles concerned in equilibrium and body-movements. No direct efferent path between the cerebellar cortex and the motor centers of the cord has been established satisfactorily, but it may be that the indirect path through the superior peduncles to the red nucleus and thence to the cord through the rubrospinal tract subserves this function. According to another point of view, the cerebellum is a great augmenting organ for the neuromuscular system. It is added on, as it were, to the cerebrospinal motor system, and serves not to co-ordinate the motor discharges, but to increase their strength or effectiveness. This general view, first proposed by Weir Mitchell (1869), has been supported by Luys, and especially, although with important modifications, by Luciani.‡ Some of the details of the work of the latter observer are given below.

\* Lussana. See "Journal de la physiologie de l'homme," 5, 418, 1862.

† See Lewandowsky, "Archiv f. Physiologie," 1903, 129.

‡ For the literature of the cerebellum, see Luciani, "Il cervello," Florence, 1891; German translation, "Das Kleinhirn," 1893. Also Luciani, article "Das Kleinhirn," in "Ergebnisse der Physiologie," vol. iii, part ii, p. 259, 1904, and van Rynberk, *ibid.*, 653, 1908.

**Experimental Work Upon the Cerebellum.**—Rolando, and particularly Flourens, gave the direction to modern experimentation in this subject. The latter observer made numerous observations, especially on pigeons, in regard to the effect of removing all or a part of the cerebellum. He describes in detail the striking results of such an operation. When all or a large part of the organ is removed the animal shows a most distressing inability to stand or move. There seems to be no muscular paralysis, but, at first, a total lack of power to co-ordinate properly the contractions of the various muscles involved in maintaining equilibrium. The animal takes a most abnormal position, with the head retracted and twisted, and any attempt to move is followed by violent disorderly contractions that may result in a series of involuntary somersaults. The animal is totally unable to fly. When the injury to the cerebellum is less the effect upon the movements is either too slight to be noticed or is shown in a greater or less uncertainty in its movements. When it attempts to walk, for instance, it exhibits a staggering, drunken gait, a condition designated as cerebellar ataxia. Similar operations on mammals give in general the same results. If the operation is unilateral,—that is, affects only one hemisphere,—the animal (dog) exhibits forced movements, such as a tendency to roll around the long axis of his body toward the injured side and subsequently movements in a circle toward the same side. In man there are several cases on record in which the organ was shown by autopsy to be largely or completely atrophied, and numerous cases of tumors affecting the cerebellum have also been reported. In the latter group of cases there may be certain marked subjective symptoms, such as headache, and especially vertigo, but on the objective side the neurologists emphasize the fact that in cerebellar disorders the lack of accurate co-ordination or asynergy is the fundamental symptom. This condition may be manifested by an ataxic gait, by muscular tremors, and, especially, by lack of skill in performing certain definite movements which require the associated activity of several muscles—for example, the placing of the finger to the nose or the rapid alternation in the contraction of antagonistic muscles, abduction and adduction, or pronation and supination.\* So also in the cases of atrophy, in which probably the condition develops slowly through a number of years, a degree of ataxia is exhibited, especially when the movements are rapid and forced. In the ataxic condition resulting from tabetic lesions of the posterior funiculi the effect upon the movements is increased by covering up the eyes (Romberg's symptom), the individual

\* Mills and Weisenburg, "Journal of the American Medical Association," November 21, 1914.

being then deprived of his visual stimuli as well as those coming by way of the muscular and cutaneous nerves. In cerebellar ataxia, however, the effect is not increased by closure of the eyes, a result which is probably explained by the fact that the individual still possesses his paths of muscular and cutaneous sensibility to the cerebrum, and these senses may be used in the reflex adjustments of voluntary movements.

**Interpretation of the Experimental and Clinical Results.—**

Flourens was led by the striking results of his operations on pigeons to suggest the view that the cerebellum is an organ for the co-ordination of the movements of equilibrium and locomotion. Objections were raised to this view. Some observers (Dalton, Weir Mitchell) found that if the pigeons from which the cerebellum had been removed were kept long enough the effects first observed gradually disappeared, so that finally the animals were able to move or fly with no marked difference from the normal animal except that fatigue was shown much more quickly. Hence the view advocated by Mitchell that the essential function of the cerebellum is that of an augmenting apparatus for the voluntary movements. With regard to this view it may be remarked in passing that pigeons with the cerebral hemispheres removed exhibit apparently as a permanent symptom the same tendency to rapid fatigue after sustained muscular effort. By the same logical process therefore one might conclude that one function of the cerebrum is that of an augmenting organ to the motor discharges from the cerebellum or midbrain. So also the cases of complete or nearly complete atrophy of the cerebellum in human beings in which no evil result follows other than a slight degree of cerebellar ataxia have been used as an argument against the view that this organ is necessary to the co-ordination of the complex voluntary movements. The view that the cerebellum has essentially a direct co-ordinating function has been criticized most seriously by Luciani. This observer made a series of long-continued and most careful observations upon dogs and monkeys in which the entire cerebellum or certain definite parts had been removed. He lays stress upon the fact that the violent disturbance of movement is temporary and is slowly recovered from in time. He was led, therefore, to view these disturbances as due primarily not to the loss of the normal functional activity of the organ, but to irritations resulting from the operation. When this stage of irritation is passed the real defects which indicate the true function of the cerebellum become apparent. These defects exhibit themselves as a loss of power in the neuromuscular apparatus of the complex voluntary movements, and he analyzes these results under three heads: First, a loss of force in the muscular contractions,—a condition of asthenia;

second, a loss of tone in the muscles of the limbs and trunk, particularly in the hind limbs,—a condition of atonia; and, third, a loss of steadiness in the muscular contractions,—a condition of astasia. The astasia manifests itself in a tremor of the muscles when voluntarily contracted, especially in movements requiring much exertion. Luciani supposes that this tremor is due to an alteration—that is, a slowing—of the rhythm of discharges of the impulses from the motor centers. The functions of the cerebellum on his theory are expressed, therefore, by saying that it is an augmenting organ for the activity of the neuromuscular apparatus; and that, so far as this augmenting or strengthening activity can be analyzed, it consists in an increase in the energy of the motor discharges (sthenic action), an increase in the tension or tone of the motor centers and their connected muscles (tonic action), and an increase in the rhythm of the motor impulses (static action) so that normally the muscular contractions are of the nature of complete tetani. Luciani believes that this action of the cerebellum is continuous, although varying in intensity, and that it affects all of the musculature of the body, and not simply the muscles concerned in body equilibrium. This constant motor activity is in turn dependent upon a constant inflow of sensory impulses into the cerebellum along its afferent connections, particularly upon the impulses from the vestibular portion of the internal ear, and those from the muscle sense fibers and similar fibers of so-called deep sensibility. The constant augmenting activity of the cerebellum is, therefore, a species of reflex effect,—a reflex tonus which affects all the musculature. Whether the cerebellar mechanism is especially arranged to co-ordinate its effect upon the neuromuscular apparatus—that is, in some way to adapt the movements to a definite end—Luciani leaves an open question. He does not believe that a lack of co-ordination (cerebellar ataxia) is necessarily present in cerebellar lesions; but admits that, if this symptom is an invariable one, it would be necessary to add to the general augmenting activity of the cerebellum also a general adaptive or co-ordinating activity. It is precisely this latter feature which stands out in the minds of most physiologists as the characteristic function of the cerebellum, while Luciani considers that it is not demonstrated by clinical or experimental facts, and that even if demonstrated it would have to be considered as a part—perhaps a subordinate part—of the functional influence of this organ.

**Conclusions as to the General Functions of the Cerebellum.**—It is evident that an authoritative statement of the function or functions of the cerebellum is impossible. It seems quite clear, however, that the organ exerts a regulating influence of some kind

upon the neuromuscular apparatus of our so-called voluntary movements. The precise nature of the regulating influence is in dispute, and one who reads the literature finds it difficult at times to separate clearly the different theories proposed, since some authors are content with general statements and others attempt a more specific analysis. On the whole, it seems desirable at present to hold to the general idea, introduced by Flourens, that the cerebellum is a central organ for co-ordination of voluntary movements, particularly the more complex movements necessary in equilibrium and locomotion. Instead, however, of assuming with Flourens that the cerebellum contains a co-ordinating principle, an expression that means nothing at present, we may assume that it exerts its co-ordinating influence by virtue of the definite nervous mechanisms contained in it—that is, by nervous complexes which, on the afferent side, are connected with the peripheral sensory nerves to the vestibule of the ear, the muscles, joints, etc., and on the efferent side are in direct or indirect relations with the motor centers of the cord. Co-ordinated movements requiring the combined and sustained activity of a number of muscles depend in some way upon a combination of the activity of these mechanisms with the discharging mechanisms farther forward in the brain (cerebrum). Whether this co-activity consists in the addition of a tonic element to the impulses proceeding from the cerebrum, as would be implied by the results of Luciani's experiments, or whether the cerebellum participates, through some form of representation of these movements,\* based upon the afferent impulses received through the paths already described, cannot be settled at present. Luciani's conception has the recommendation of being based upon a large amount of experimental work, and it may be included or utilized in a general theory of a co-ordinating function of the cerebellum, if we assume that the effect of this organ on muscular tonicity is adaptive, that is to say, varies in a definite way in the different muscles according to the character of the afferent impulses received from the muscles, joints, labyrinth, etc. That an adaptive tonicity of the muscles actually occurs is demonstrated by experiments (see p. 410), and we can understand that a regulated tonicity of this kind may constitute the foundation upon which the normal co-ordination of the muscles is effected. The fact that in birds as well as in higher forms the animal eventually learns to co-ordinate such movements after the loss of the cerebellum does not invalidate this conclusion. In the first place, the recovery in such cases is not entirely complete, since some ataxia is still manifested in vigorous or hurried movements, and the amount of restoration of normal activity which is obtained may

\* See Horsley, "Brain," 1906, 446.



be referred to a possible adaptation or training in the cerebral portion of the mechanism. The relative parts taken by the cerebellum and the cerebrum in such movements vary probably in different animals and in different movements in the same animal. Removal of the cerebrum from a pigeon leaves an animal with almost perfect power of controlling its equilibrium. In the dog a similar operation is followed by a longer period of inability to control perfectly the movements of locomotion, and it is probable that in man after such an operation the power of locomotion would be acquired more slowly, if at all. On the other hand, the violent effect upon such movements caused by the removal of the cerebellum in the pigeon is less evident in the dog, and, if we may judge from the incomplete data of clinical neurology, very much less evident in man. In man the motor control of the voluntary muscular system through the cerebrum is more highly developed than in the lower animals.

Lewandowsky's\* suggestion that normally in man the finer, more conscious movements of the body are controlled directly from the cerebrum, while the subconscious or dimly conscious movements of locomotion and equilibrium, which are of a more sustained or tonic character, are regulated through the cerebellar centers seems to be in accord with the facts known.

**The Psychological Functions of the Cerebellum.**—In the cerebellum, as in the other nerve centers below the cerebrum, we have to consider the possibility of a psychical or conscious side to the activity of the organ. It seems clear, however, that the degree of consciousness, if any, exhibited by the cerebellum is of a much lower order than that shown by the cerebrum. All observers agree that there is no apparent loss of sensations after removal of the cerebellum, but Luciani, Russell, and others state their belief that in some indefinable way the mentality of the animal is affected by such operations. Whatever functions of this kind are present we can define only by the unsatisfactory term of subconscious rather than unconscious. As far as can be determined, this effect is felt mainly upon the muscular sense and the sense of position and of direction.

**Localization of Function in the Cerebellum.**—All observers agree that so far as the influence of the cerebellum on the musculature of the body is concerned, it is homolateral,—that is, each half of the cerebellum is connected with its own half of the body. The connection with the motor areas of the brain is the reverse, the right half of the cerebrum being in relation with the left half of the cerebellum. These relations are, in the main, borne out by the anatomical course of the motor and sensory

\* Lewandowsky, "Archiv f. Physiologie," 1903, 129; see also Kohnstamm, "Archiv f. d. gesammte Physiologie," 89, 240, 1902.

paths described above. There arises, however, the question whether or not there is a localization of function in the cerebellum, that is, whether definite parts of the cerebellar cortex are in specific relations with separate muscles or groups of muscles. The possibility of a localization of function was suggested years ago by experiments made by Ferrier, in which electrical stimulation of the cortex gave definite movements of the head, limbs, and especially of the eyes, the movements varying somewhat according to the part stimulated. These results were not wholly confirmed by later observers. Horsley and Clarke\* state that such strong stimuli are required to obtain a decisive effect from the cortex of the cerebellum that it may be questioned whether in positive cases the result is due to excitation of the cortex itself or to an escape of stimulus to the underlying nuclei. Direct stimulation of the dentate nucleus gave them conjugate movements of the two eyes. These indications

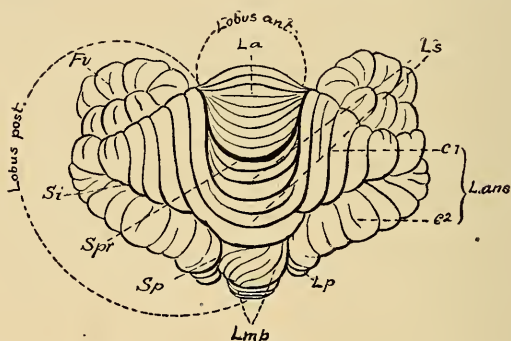

Fig. 105.—Schema of dog's cerebellum to show Bolk's nomenclature for the lobes and sulci. Dorsal view: *La*, lobus anterior (this lobe is separated from the larger posterior lobe by the deep primary fissure, *Spr*); *Ls*, lobulus simplex; *Lans*, lobulus ansiformis; *Lp*, lobulus paramedianus; *Lmp*, lobulus medianus posterior; *Fv*, formata vermicularis (pars tonsillarlis); *C<sup>1</sup>*, crus primum; *C<sup>2</sup>*, crus secundum; *Spr*, sulcus primarius; *Sp*, sulcus paramedianus; *Si*, sulcus intercruralis.—(After van Rynberk.)

of a localization have been strengthened by the results of comparative anatomy, and especially by the effects of ablation of definite parts of the cortex. Earlier experimenters, using the method of ablation, obtained quite negative results from the standpoint of localization, but this seems to have been due to the fact that a faulty anatomical schema was used; a whole hemisphere, or the entire vermiform lobe, etc., was removed. Later experimenters† have adopted the newer anatomical schemata,

\* Horsley and Clark, "Brain," 28, 13, 1905.

† Van Rynberk, "General Review in Ergebnisse der Physiologie," 7, 653, 1908, and 12, 533, 1912.

which take account of the true genetic relations of the various lobes and lobules of the cerebellum, and they have been rewarded by obtaining results of a positive character. The newer anatomical nomenclature is illustrated in Fig. 105, which gives a schematic representation of the arrangement of the lobules of the cerebellum of the dog, according to Bolk. Following this schema van Rynberk reports that excision of the lobulus simplex is followed by movements of the head (head nystagmus), which indicate an abnormal innervation of the neck muscles. Injury on one side of the crus primum of the ansiform lobule is followed by abnormal movements of the forefoot of the same side, while similar injuries to the crus secundum result in abnormal movements localized to the hind foot. Extirpation of a lobulus paramedianus causes rolling movements round the long axis of the body or bending of the body to one side (pleurothotonus). These experimental results have been confirmed in part by observations on clinical cases in which the asynergy following cerebellar lesions showed some indication of a localization to one or another part of the body.

**The Medulla Oblongata.**—In the medulla oblongata we must recognize a region of special physiological importance in that it is the seat of certain centers which control the activity of the circulatory and respiratory organs. If the medulla is severed from the portion of the brain lying anterior to it the animal continues to live for a considerable period. The respiratory movements are performed rhythmically, and the blood-vessels retain their tone so as to maintain an approximately normal blood-pressure. On the contrary, destruction of the medulla, or severance of its connections with the underlying parts, is followed by a cessation of respiration and a loss of tone in the arteries, either of which results in the rapid death of the organism as a whole. The portions of the medulla which exercise these important functions are designated, respectively, as the respiratory and the vasomotor or vasoconstrictor centers. Their location and to some extent their connections have been determined by physiological experiments, but so far it has not been possible to mark out histologically the exact groups of cells concerned. The position and physiological properties of these centers are described in the sections on respiration and circulation. These centers are of especial importance because of their wide connections with the body, their essentially independent activity in reference to the higher parts of the brain, and the absolutely necessary character of the regulations they effect. In the development of the brain the functions originally mediated by the lower parts have been transferred more and more to the higher parts, especially in regard to conscious sensation and motion, and

the so-called higher psychical activities. But the unconscious and involuntary regulation of the organs of circulation and respiration and to a certain extent of the other visceral organs has been centralized, as it were, in the medulla. In addition to the control of the respiration and circulation other important reflex activities are effected through the medulla by means of the vagus nerve, which has its nucleus of origin in this part of the brain. Such, for instance, are the reflex control of the heart through the cardio-inhibitory center and of the motions and secretions of the alimentary canal.

**The Nuclei of Origin and the Functions of the Cranial Nerves.**—The origin, course, anatomical and physiological relations of the first or olfactory, second or optic, and eighth or auditory nerves have been referred to in the preceding pages. For the sake of completeness the origin and functions of the other cranial nerves may be summarized briefly in this connection.

*The Third Cranial Nerve (N. Oculomotorius).*—This nerve arises from the base of the brain on the median side of the corresponding pedunculus cerebri. It is, so far as is known, only a motor nerve, supplying fibers to four of the extrinsic muscles of the eyeballs—namely, the internal rectus, the superior rectus, the inferior rectus, and the inferior oblique—and to the levator palpebræ. It innervates also two important intrinsic muscles of the eyeball, the ciliary muscle used in accommodating the eye in near vision, and the sphincter of the iris, which controls in part the size of the pupil. These two latter muscles belong to the type of plain muscle, and the fibers of the third nerve which innervate them terminate in the ciliary ganglion, whence the path is continued by sympathetic nerve fibers (postganglionic fibers) to the muscles. In the interior of the brain the fibers of the third nerve arise from a conspicuous nucleus or collection of nuclei situated in the central gray matter of the midbrain at the level of the superior colliculus. The fibers for the ciliary muscle and sphincter pupillæ arise more anteriorly than those for the extrinsic muscles. Histologically three parts at least may be distinguished, as shown in Fig. 107,—namely, the lateral (or principal) nucleus, which gives origin chiefly to the fibers innervating the extrinsic muscles; the median nucleus; and the nucleus of Edinger-Westphal. According to Bernheimer\* the large median nucleus gives rise to the fibers that innervate the ciliary muscles, while the Edinger-Westphal nuclei (accessory nuclei) control the movements of the sphincter muscle of the iris. Some of the fibers, particularly those from the lateral nucleus to the inferior rectus, the internal rectus, and

\* Bernheimer, in "Graefe-Saemisch's Handbuch der ges. Augenheilkunde," 2d ed., I, 41.

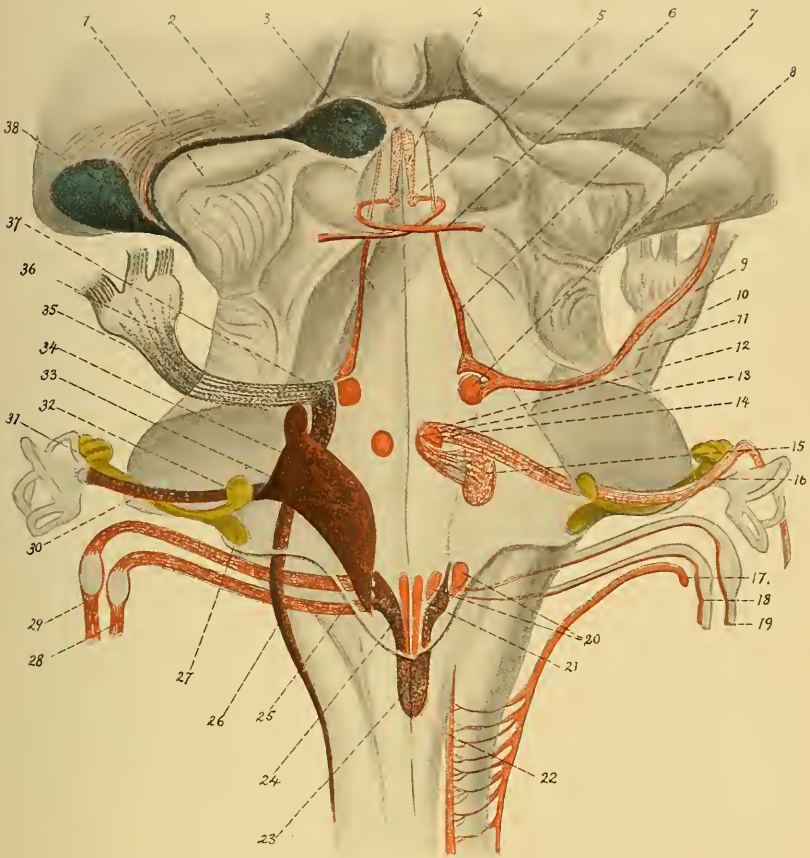

Fig. 106.—Nuclei of origin of motor and primary terminal sensory nuclei of cerebral nerves (*Held*): Schematically represented in a supposedly transparent brain stem viewed from behind. (Nuclei and roots of motor nerves in light red, of sensory nerves in purple. Cochlear nerve in yellow.) 4, nucleus of the third nerve (n. oculomotorii); 5, nucleus of the fourth nerve (n. trochlearis); 6, the fourth nerve; 7, the descending (motor) root of the fifth nerve; 8, the principal motor nucleus of the fifth nerve; 9, the semilunar ganglion (g. Gasseri); 26, the ascending (sensory) root of the fifth nerve; 14, nucleus of the sixth cranial nerve; 15, nucleus of the facial (seventh) nerve; 16, the facial nerve; 34, 33, nucleus of the vestibular branch of the eighth cranial nerve; 32, ventral nucleus of the cochlear branch of the eighth nerve; 27, dorsal nucleus of the cochlear branch of the eighth nerve; 19, 29, the glossopharyngeal nerve; 18, 28, the vagus nerve; 20, motor nuclei of vagus and glossopharyngeal (nucleus ambiguus and nucleus dorsalis); 23, 24, nucleus of the *alæ cinereæ*, the solitary bundle and its nucleus; 17, the eleventh or spinal accessory nerve; 22, nucleus of the spinal accessory; 21, nucleus of the hypoglossal nerve.—(From *Spalteholz*, "Human Anatomy.")



the inferior oblique, cross the mid-line and emerge in the nerve of the opposite side.

*The Fourth Cranial Nerve (N. Trochlearis).*—This nerve emerges from the brain in the anterior medullary velum (valve of Vieussens) just posterior to the inferior colliculus. It curves around the pedunculus cerebri to reach the base of the brain. It is a motor nerve, and supplies fibers to the superior oblique muscle of the eyeball. In the interior of the brain the fibers arise from a nucleus in the central gray matter just posterior to that of the third nerve (Fig. 107). The fibers pass dorsalward toward the velum and make a complete decussation before emerging.

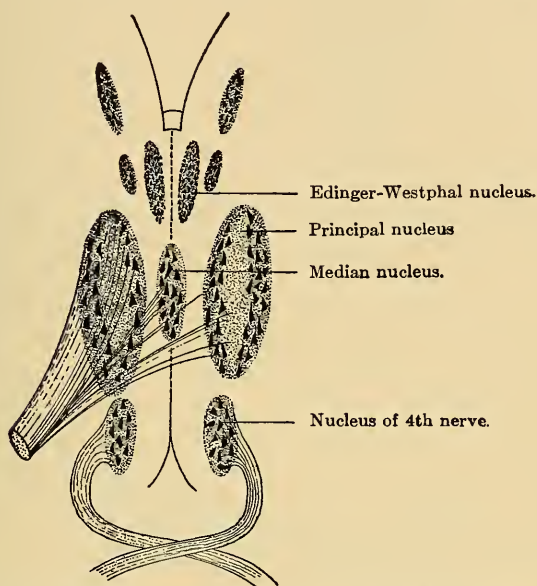

Fig. 107.—Nuclei of origin of the third and fourth nerves.—(From Poirier and Charpy.)

*The Fifth Cranial Nerve (N. Trigeminus).*—This nerve arises from the side of the pons by two roots, a small motor root, portio minor, and a large sensory root, portio major. It is, therefore, a mixed motor and sensory nerve, supplying motor fibers to the muscles of mastication and sensory fibers of pressure, pain, and temperature to the face, the forepart of the scalp, the eye, nose, portions of the ear, mouth, and tongue, and to the dura mater (Fig. 108). In the interior of the brain the motor portion, portio minor, arises partly from a small nucleus in the pons and partly from a long column of cells extending along the lower margin of the central gray matter throughout the midbrain. This column and the fibers arising from it constitute the descending motor root of the

fifth nerve (see Fig. 109). The sensory fibers originate from the nerve cells in the Gasserian ganglion (g. semilunare). The branch

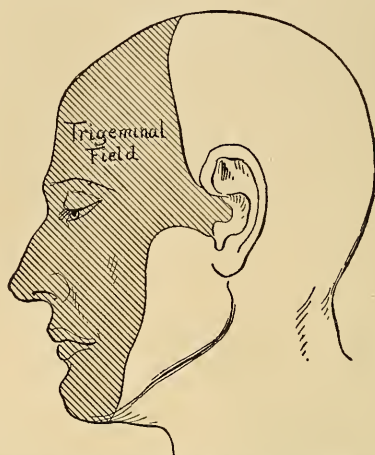

Fig. 108.—Diagram showing the average area of distribution of the sensory fibers of the trigeminal nerve.—(Cushing.)

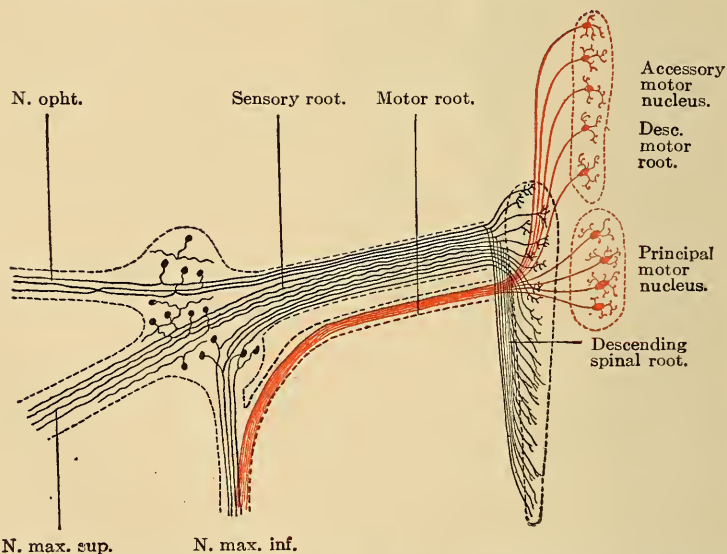

Fig. 109.—Nuclei of origin of the fifth cranial nerve.—(From Poirier and Charpy, after Van Gehuchten.)

that enters the brain ends partly in a collection of cells in the pons, the so-called sensory nucleus, and partly in a column of cells extending posteriorly throughout the length of the medulla. These cells



and the fibers ending in them constitute the descending spinal root of the fifth nerve (see Fig. 106).

*The Sixth Cranial Nerve (N. Abducens).*—This nerve arises from the base of the brain at the posterior edge of the pons. It is a motor nerve, and supplies fibers to the external rectus muscle of the eye-ball. In the interior of the brain its fibers originate in a small spherical nucleus lying beneath the floor of the fourth ventricle. Connections have been traced between this nucleus and the pyramidal tract of the opposite side (Fig. 106).

*The Seventh Cranial Nerve (N. Facialis).*—This nerve appears on the base of the brain at the inferior margin of the pons, lateral and somewhat posterior to the emergence of the sixth nerve. It is mainly a motor nerve, but carries some sensory fibers (fibers of taste and general sensibility) received through the n. intermedius of Wrisberg. The motor fibers of the nerve supply the muscles of the face, part of the scalp, and the ear, including its intrinsic muscles, and in addition secretory fibers are supplied to the submaxillary and sublingual glands. Within the brain these fibers arise from a conspicuous nucleus in the tegmental region of the pons lying ventral to the nucleus of the sixth, beneath the middle of the fourth ventricle (Fig. 106). The sensory fibers of the nerve of Wrisberg originate in the nerve cells of the geniculate ganglion.

*The Ninth Cranial Nerve (N. Glossopharyngeus)* arises from the side of the medulla,—the restiform body. It is a mixed nerve, supplying motor fibers to the muscles of the pharynx and the base of the tongue and secretory fibers to the parotid gland. Within the brain these fibers arise from two motor nuclei common to this and the tenth nerve,—namely, a dorsal nucleus below the floor of the fourth ventricle and a smaller ventral nucleus, n. ambiguus, in the reticular substance of the tegmentum (Fig. 106). The sensory fibers supply in part the mucous membrane of the tongue and pharynx, the tympanic cavity, and the Eustachian tube. These fibers arise from cells in the two ganglia on the trunk of the nerve, the ganglion superius and g. petrosum. The branches from these cells that pass into the medulla terminate in the nucleus of the ala cinerea.

*The Tenth Cranial Nerve (N. Vagus or Pneumogastricus).*—This nerve arises from the side of the medulla posterior to the origin of the glossopharyngeal nerve. It is also a mixed nerve, with an extensive distribution to the respiratory and digestive organs and the heart. Its efferent or motor fibers arise within the brain from the same masses of cells that give rise to the motor fibers of the glossopharyngeal. These fibers supply the intrinsic muscles of the larynx, esophagus, stomach, small intestine, and part of the large intestine. Inhibitory fibers are carried to the heart and secretory

fibers to the gastric and pancreatic glands. Its sensory or afferent fibers are distributed to the mucous membrane of the larynx, trachea, and lungs, and to the mucous membrane of the esophagus, stomach, intestines, and gall-bladder and ducts. These fibers arise from cells in the ganglia on the trunk of the nerve, the ganglion jugulare and g. nodosum. The branches from these cells that pass into the medulla terminate in the gray matter of the ala cinerea.

*The Eleventh Cranial Nerve (N. Accessorius).*—This nerve is usually described as arising by upper roots from the medulla, and by a series of lower roots from the spinal cord as low as the fifth to the seventh cervical segment. It is a motor nerve, supplying fibers to the sternomastoid and trapezius muscles. The medullary branches arise from the posterior portion of the dorsal motor nucleus which gives origin to the vagus, while the spinal branches originate from cells in the anterior horn of the gray matter of the cord (Fig. 106).

*The Twelfth Cranial Nerve (N. Hypoglossus).*—This nerve arises from the medulla in the furrow between the anterior pyramid and the olivary body. It is a motor nerve, supplying the muscles of the tongue and the extrinsic muscles of the larynx and hyoid bone. Within the brain these fibers originate from a distinct nucleus lying in the floor of the fourth ventricle near the mid-line (Fig. 106).

## CHAPTER XII.

### THE SYMPATHETIC OR AUTONOMIC NERVOUS SYSTEM.

The chain of nerve ganglia extending on each side of the spinal column to the coccyx is known as the sympathetic nervous system. This name was given to the structure under the misapprehension that it constitutes a nerve pathway through which so-called sympathetic—or, as we now designate them, reflex actions of distant organs are effected. It was supposed to arise from the brain by branches connected with the fifth and sixth cranial nerves.\* We now know that this system consists of a series of ganglia or collections of nerve cells connected with each other and connected also with the spinal nerves. Strictly speaking, the term sympathetic system is applicable only to the chain of ganglia which begins with the superior cervical ganglion at the base of the skull and ends with the ganglion coecygeum. There are, however, other outlying nerve ganglia with or without specific names which from a physiological and indeed from an anatomical standpoint belong to the same group. In the abdomen we have the so-called prevertebral ganglia, the celiac ganglion, from which arises the celiac plexus, the superior mesenteric, and the inferior mesenteric ganglion giving rise to the hypogastric nerve. These ganglia lie ventral to the sympathetic trunk, but are in direct connection with it. In the head region the ciliary, sphenopalatine, and otic ganglia are also of the same type. More peripherally are numerous other ganglia lying in or around the various visceral organs, such as the submaxillary ganglion near the duct from the corresponding gland, the cardiac ganglia in the heart, and the extensive system of nerve cells in the walls of the alimentary canal known as the plexuses of Meissner and Auerbach. With the exception, perhaps, of this last system, whose histological structure and connections are not satisfactorily known, all of these ganglia are frequently designated as sympathetic, and from a physiological as well as an anatomical standpoint may be considered with the ganglia of the sympathetic trunk or chain. Langley, who has contributed greatly to our knowledge of the finer anatomy and the physiology of this system, has proposed a different classification. †

\* Charles Bell, "The Nervous System of the Human Body," third edition, London, 1844, p. 9.

† Schäfer's "Text-book of Physiology," 1900, vol. ii; "Ergebnisse der Physiologie," 1903, vol. ii, part ii, p. 823; also "Brain," 1903, vol. xxvi, and "Zentralblatt f. Physiologie," 27, 149, 1913.

**Autonomic Nervous System.**—According to Langley, the efferent fibers from the nerve cells of the sympathetic and related

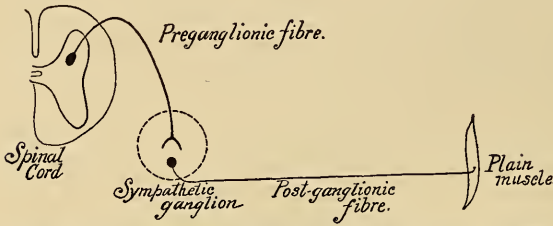

Fig. 110.—Schema to show the general relation between the preganglionic and postganglionic fibers of the autonomic paths.

ganglia supply the plain muscle tissues, the cardiac muscles, and the glands,—that is, the organs of the involuntary or, according to an old nomenclature, the vegetative processes of the body. He proposes for this entire system of efferent fibers the term “autonomic,” to indicate that they possess a certain independence of the central nervous system. The autonomic path consists of two neurons: one belonging to the central nervous system, whose axon emerges in one of the spinal or cranial nerves and ends around the dendrites of a sympathetic cell; and one occurring in some one of the numerous sympathetic ganglia, whose axon passes to the peripheral tissue. The first axon is spoken of as the preganglionic fiber, the second as the post-ganglionic fiber. Their connections are represented in the accompanying schema (Fig. 110).

Physiological and anatomical investigations have shown that autonomic nerve-fibers arise from four regions in the central nervous system (Fig. 111): First, from the midbrain, emerging in the third cranial nerve and passing via the ciliary ganglion; second, from the bulbar region, emerging in the seventh, ninth, and tenth cranial nerves; third, from the thoracic spinal nerves (first thoracic to fourth or fifth lumbar) and passing in general via the ganglia of the sympathetic chain; fourth, from the sacral region by way of the so-called nervus erigens supplying the descending colon, rectum, anus, and genital organs. The autonomic fibers at



Fig. 111.—Illustrating the central origin of the autonomic fibers.—(Langley.)

their origin in the central nervous system—that is, while pre-ganglionic fibers—are all possessed of a small medullated sheath, having a diameter of 1.8 to 4  $\mu$ . The postganglionic fiber is in most cases non-medullated, but this is by no means an invariable rule. In many cases the axons from sympathetic cells possess distinct, although small, myelin sheaths. The autonomic fibers arising from the midbrain, bulb, and sacral cord are distributed to limited parts of the body, while those from the thoracic part of the cord, the great sympathetic system, innervate practically all regions of the body. In their physiological and pharmacological reactions the two groups offer certain contrasts, which have been much emphasized in recent years. For this and other reasons, Langley has suggested a comprehensive classification based on anatomical grounds which is illustrated in the following schema:

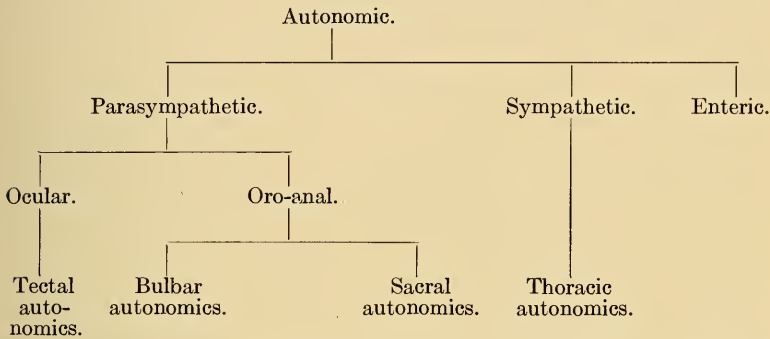

The enteric group comprises the system forming the extensive plexuses of Auerbach and Meissner. We know but little in regard to the anatomical connections of these plexuses with the central nervous system, or the peculiarities of their functional activity; therefore, provisionally, they are set aside as a separate group. The grouping of the remaining autonomic fibers into two great classes—sympathetic and parasympathetic—may or may not come into general use, but the division of the entire system, with the exception of the enteric fibers, into the four varieties of autonomies, tectal, bulbar, thoracic, and sacral, according to their point of emergence from the central nervous system, affords a useful basis for physiological description. Unfortunately, in pharmacological and medical literature a variation in this nomenclature has been adopted by some writers, who use the word autonomic in a narrower sense to designate the fibers grouped under the term “parasympathetic” in the above schema.

**The Nicotin Method.**—The course of the autonomic fibers has been traced in many cases to their corresponding sympathetic

nerve cells partly by the method of secondary degeneration and partly by the use of nicotin, as first described by Langley and Dickinson.\* These authors have shown that after the use of nicotin, either injected into the circulation or painted upon the ganglion, stimulation of the preganglionic fiber in any part of its course fails to give any response, while stimulation of the postganglionic fiber, on the contrary, is still effective. It would seem, therefore, that the nicotin paralyzes the connection (the synapse) of the preganglionic fiber with the sympathetic nerve cell, and by means of the local application of the drug it is possible in many cases to pick out the ganglion in which the preganglionic fiber really ends. For it often happens that in the sympathetic trunk a preganglionic fiber will pass through several ganglia before making final connections with a sympathetic cell. So far, the course of these fibers has been traced most successfully in the case of the nerves supplying the sweat-glands, blood-vessels, and especially the erector muscles of the hairs, the so-called pilomotor nerve-fibers. The visible result of stimulation in the last case gives a ready means of determining the presence of the fibers.

**General Course of the Autonomic Fibers Arising from the Spinal Cord—Thoracic Autonomics.**—It has long been known that the spinal nerves are connected with many of the ganglia of the sympathetic chain by fine branches known as the rami communicantes. In the thoracic and lumbar regions (first thoracic to second or fourth lumbar) these rami consist of two parts, a white and a gray ramus, the difference in color being due to the fact that the white rami are composed almost entirely of medullated fibers, while the gray rami are largely non-medullated. In the cervical, lower lumbar, and sacral regions the rami consist only of the gray part. Physiological experiments show that the white rami consist of preganglionic fibers that arise from nerve cells in the spinal cord, pass out by way of the anterior roots, enter the white ramus, and thus reach the sympathetic chain. On entering this latter the fiber may not end at once in the ganglion at which it enters, but may pass up or down in the chain for some distance. Eventually, however, it ends around a sympathetic nerve cell and the path is then continued by the axon from this cell as the postganglionic fiber. The gray rami consist of these latter fibers, which return from the sympathetic chain to the spinal nerves and are then distributed to the areas supplied by these nerves, particularly the cutaneous areas, since the skin branches are the ones that supply the sweat glands, the blood-vessels, and the erector muscles of the hairs. It will be noted that the fibers that pass from a given spinal nerve—say, the twelfth thoracic—by a white ramus to enter the sympathetic chain

\* "Proceedings, Royal Society," 1889, 46, 423.

do not return as postganglionic fibers by the gray ramus to the same spinal nerve. On the contrary, the gray ramus of the twelfth thoracic may consist of the postganglionic portion of autonomic fibers that enter the sympathetic through a white ramus of one of the higher thoracic nerves. In general, we may say that there is a great outflow of autonomic fibers, including vasomotor, sweat, and pilomotor fibers, in the white rami communicantes from the first or second thoracic to the second or fourth lumbar nerves. Those of these fibers that are to be distributed to the skin areas of the body—head, limbs, and trunk—return by way of the gray rami to the various spinal nerves and are distributed with these nerves, the distribution being somewhat different in different animals and for the several varieties of fibers. Those fibers that are distributed eventually to the blood-vessels, glands, and walls of the viscera have a different course from those supplying the glands, blood-vessels, and plain muscle of the head region. For the head region the fibers after entering the sympathetic chain pass upward along the cervical sympathetic to end in the superior cervical ganglion; thence the path is continued by postganglionic fibers which emerge by the various plexuses that arise from this ganglion. For the abdominal and pelvic viscera the fibers (particularly the rich supply of vasoconstrictor fibers), after entering the sympathetic chain, emerge, still as preganglionic fibers, by the splanchnic nerves that run to the celiac ganglion or in the branches connecting with the inferior mesenteric ganglia, and then become postganglionic fibers (see Fig. 112). The details of the course of the vasomotor, sweat, visceromotor fibers to the different regions, the cardiac fibers, etc., will be given in the appropriate sections.

**General Course of the Autonomic Fibers Arising from the Brain—Tectal and Bulbar Autonomics.**—These fibers leave the brain in the third, seventh, ninth, tenth, and eleventh cranial nerves. Those that emerge in the third nerve end, as preganglionic fibers, in the ciliary ganglion. Their postganglionic fibers leave this ganglion in the short ciliary nerves and innervate the plain muscle of the sphincter of the iris and the ciliary muscle. The fibers that emerge in the seventh and ninth nerves probably supply the glands and blood-vessels (vasodilator fibers) of the mucous membrane of the nose and mouth. Some of these fibers reach the fifth nerve by way of anastomosing branches and are distributed with it. Their preganglionic portion terminates in some of the ganglia belonging to the sympathetic type which are found in this region, such as the sphenopalatine and otic ganglia, and the submaxillary and sublingual ganglia for the fibers distributed to the glands of the same name. The autonomic fibers that arise with the tenth (and the eleventh) nerves are distributed through the

vagus. Physiologically these fibers consist of motor fibers (viscero-

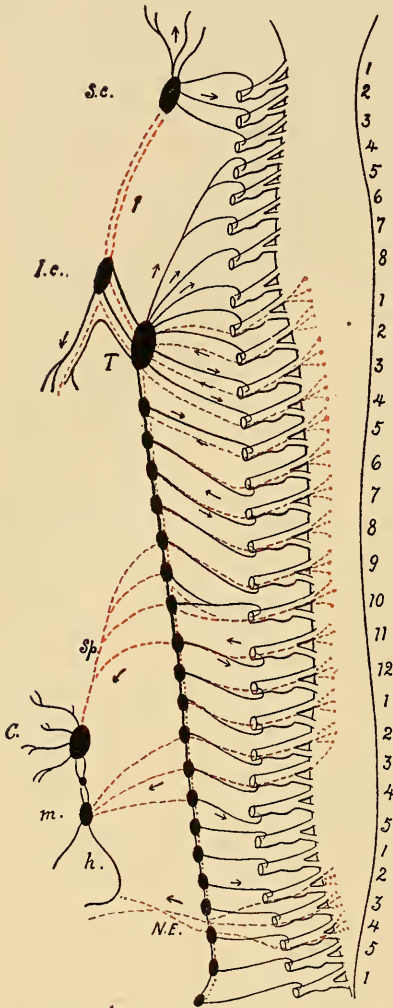

Fig. 112.—Diagram giving a schematic representation of the course of the autonomic (sympathetic) fibers arising from the thoracic and sacral regions of the cord. The preganglionic fiber is represented in red, the postganglionic in black lines. The arrows indicate the normal direction of the nerve impulses or nerve conduction. *S.c.*, Superior cervical ganglion; *I.c.*, inferior cervical ganglion; *T.*, the first thoracic ganglion; *Sp.*, the splanchnic nerve; *C.*, the semilunar or celiac ganglion; *m.*, the inferior mesenteric ganglion; *h.*, the hypogastric nerves; *N.E.*, the nervus erigens. The numerals indicate the corresponding spinal nerves.

motor fibers) to the musculature of the esophagus, stomach, small intestine, and large intestine as far as the descending colon, motor fibers to the bronchial musculature, inhibitory fibers to the heart, and secretory fibers to the gastric and pancreatic glands. The ganglia in which the preganglionic portions end have not been definitely located, but probably they comprise the small and, for the most part, unnamed local ganglia found in or near the organs innervated.

**General Course of the Autonomic Fibers Arising from the Sacral Cord—Sacral Autonomics.**—The autonomic fibers of this region emerge from the cord in the anterior roots of the sacral nerves,—second to fourth. The branches from these roots unite to form the so-called nervus erigens (pelvic nerve), which loses itself in the pelvic plexus without making connections with the sympathetic chain of ganglia. The pelvic plexus is formed in part also from the hypogastric nerve arising from the inferior mesenteric ganglion. Through this latter path thoracic autonomic fibers from the upper lumbar region enter the plexus (Fig. 112). The autonomic fibers of the nervus erigens supply vasodilator fibers to the external genital organs, and in the male constitute the nervous part of the physiological mechanism for erection, whence the



name. They supply, also, vasodilator fibers to rectum and anus and motor fibers to the plain muscles of the colon descendens, rectum, and anus. The preganglionic parts of these fibers end in small sympathetic ganglia in the pelvic plexus or in the neighborhood of the organs supplied.

#### **Normal Mode of Stimulation of the Autonomic Nerve Fibers.**

—In distinction from the nerve fibers innervating the skeletal muscles practically the whole set of autonomic fibers is removed from the control of the will. An apparent exception to this general statement is found in the fact that the ciliary muscle of the eye is seemingly under voluntary control. We must suppose that under normal conditions the autonomic fibers are always excited reflexly, and the course of the afferent fibers concerned in these reflexes and the nature of the effective sensory stimulus in each case are important in the consideration of each of the physiological mechanisms involved. Most of these mechanisms, as we shall find, work reflexly—that is, without voluntary initiation—and, for the most part, unconsciously, for instance, the movements of the intestines, the secretion of the digestive glands, and the contraction and dilatation of the arteries. The autonomic nerve-fibers control, therefore, the unconscious co-ordinated actions, the so-called vegetative processes, of the body. There is no apparent reason in the anatomical arrangements why these fibers should be free from voluntary control. Their distinguishing characteristic in comparison with the nerves for the voluntary movements is the fact that they all terminate first in sympathetic nerve cells; but this fact gives no explanation of the absence of conscious control by the will. We are justified in saying that nerve paths that pass through sympathetic nerve cells cannot be excited voluntarily; but the immediate reason for this fact is probably to be found in the ultimate point of origin of these paths in the central nervous system. What we designate as voluntary motor paths arise in a definite region of the cortex,—the motor area in the frontal lobe. Our motor conceptions or ideas can affect the efferent paths arising in this region, but not those, apparently, which originate in other parts of the brain.

## CHAPTER XIII.

### THE PHYSIOLOGY OF SLEEP.

The state of more or less complete unconsciousness which we designate as sleep forms a part of the physiology of the brain which naturally has attracted much attention, and the theoretical explanations that have been advanced at one time or another are exceedingly numerous. The same condition occurs in many, if not all, of the other mammalia, and, indeed, in all living things there occur periods of rest alternating with periods of activity. Whether these periods of rest are essentially similar in nature to sleep in man is a question in general physiology that can be solved only when we know more of the chemistry of living matter. Within the human body there are other tissues that exhibit periods of rest alternating with periods of activity,—the gland cells, for example. The secreting cells of the pancreas have a period of activity in which the destructive processes exceed the constructive, and a period of rest in which these relations are reversed. We may compare this condition in the gland cells with that in the brain. Sleep, from this standpoint, is a period of comparative rest or inactivity, during which the constructive or anabolic processes are in excess of the disassimilatory changes. The period of sleep is a period of recuperation, and doubtless all tissues have these alternating phases. To explain sleep fundamentally, therefore, it would be necessary to understand the chemical changes of anabolism and catabolism, and an explanation of the sleep of the brain tissues would doubtless explain the similar phenomenon in other tissues. But what the physiologists desire first, and have attempted to determine, is an explanation of why this condition comes on with a certain periodical regularity,—an explanation, in other words, of the mechanism of sleep, the change or changes in the brain or the body which reduce the metabolism of the brain tissue to such an extent that it falls below the level necessary to cause consciousness.

**Physiological Relations during Sleep.**—The central and most important fact of sleep is the partial or complete loss of consciousness, and this phenomenon may be referred directly to a lessened metabolic activity in the brain tissue, presumably in the cortex cerebri. During sleep the following changes have been recorded:

The respirations become slower and deeper and the costal respiration (respiration by elevation of the ribs) predominates over the abdominal or diaphragmatic respiration as compared with the waking condition. The respiratory movements also show frequently a tendency to become periodic,—that is, to increase and decrease regularly in groups after the manner of the Cheyne-Stokes type of breathing. The expiration is frequently shorter and more audible than in the respirations of the waking hours. The eyeballs roll upward and outward and the pupil is constricted. According to Lombard's observations, the knee-kick decreases or disappears entirely during sleep. Some of the constant secretions are diminished in amount,—as, for instance, the urine, the tears, and the secretion of the mucous glands in the nasal or pharyngeal membrane. One of the familiar signs of a sleepy condition is the dryness of the surface of the eyes, a condition that leads to the rubbing of the eyes. It is sometimes stated that the digestive secretions are diminished during sleep, but the statement does not seem to rest upon satisfactory observations, and may be doubted. The pulse-rate decreases during sleep, the blood-pressure falls somewhat, and there are certain significant changes in the distribution of blood in the body. These latter changes will be referred to more in detail below. The physiological oxidations are also decreased, as shown by the diminished output of carbon dioxide. On the whole, however, the physiological activities of the body go on much as in the waking condition. Those changes in activity that do occur are, in the main, an indirect result of the partial or complete cessation of activity in the cerebrum. One might say that while the cortex of the brain sleeps—that is, is inactive—most of the other organs of the body may be awake and maintain their normal activity. Another fact of interest is that the entire cortex does not fall asleep at the same instant nor always to the same extent. Ordinarily as sleep sets in the power to make conscious movements is lost first and the auditory sensibility last, and on awakening the reverse relation holds. The individual may be conscious of sound sensations before he is sufficiently awake to make voluntary movements.

**The Intensity of Sleep.**—The intensity of sleep—that is, the depth of unconsciousness—has been studied by the simple device of ascertaining the intensity of the sensory stimulus necessary to awaken the sleeper. Kohlschütter\* used for this purpose a pendulum falling against a sounding plate. At intervals of a half-hour during the period of sleep the auditory stimuli thus produced were increased in intensity until waking was caused. His results are expressed in the curve shown in Fig. 113, in which the intensity

\* Kohlschütter, "Zeitschrift f. rationelle Medicin," 1863.

of the sleep is represented by the height of the ordinates. According to this curve, the greatest intensity is reached about an hour after the beginning, and from the second to the third hour onward the depth of sleep is very slight; the activities of the brain lie just below the threshold of consciousness. It appears also from this curve that the recuperative effect of sleep is not proportional to its intensity. The long period from the third to the eighth hour, in which the depth of sleep is so slight is presumably as important in restoring the brain to its normal waking irritability as the deeper

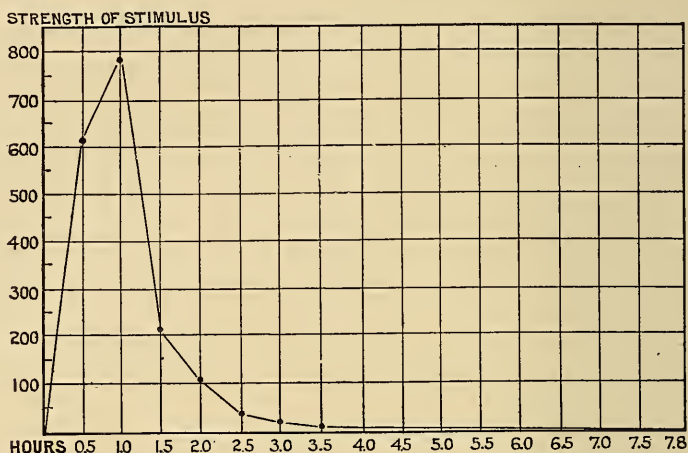

Fig. 113.—Curve illustrating the strength of an auditory stimulus (a ball falling from a height) necessary to awaken a sleeping person. The hours marked below. The tests were made at half-hour intervals. The curve indicates that the distance through which it was necessary to drop the ball increased during the first hour, and then diminished, at first very rapidly, then slowly.—(Kohlschütter.)

period up to the third hour. That this is the case is perhaps sufficiently demonstrated by the experience of every one, but Weygandt has attempted to prove the point by direct experiments. He found that for simple mental acts, such as the addition of pairs of figures, a short sleep was as effective as a longer one, but for more difficult mental work, such as memorizing groups of ten figures, efficiency was distinctly improved in proportion to the length of sleep. It is probable that the curve of intensity of sleep varies somewhat with the individual and also with surrounding conditions. That individual variations occur is indicated by the results obtained by two other observers, Mönninghoff and Piesbergen,\* who used the same general method as was employed by Kohlschütter. The sleeper was awakened by auditory stimuli produced by dropping a lead

\* Mönninghoff and Piesbergen, "Zeitschrift f. Biologie," 19, 1, 1883.

ball from varying heights upon a lead plate. Only two experiments were made each night, and the curves constructed represent, therefore, composites from several periods of sleep. One of the curves obtained is represented in Fig. 114. According to this curve the maximum intensity is reached between the first and second hours, and between the fourth and the fifth hour there is a second slight increase in intensity, giving a second maximum in the curve. This latter feature of a second increase in intensity toward morning is very apparent also in some interesting curves obtained by Czerny from children of different ages. His method of awakening the sleeper was to use induction shocks of varying intensities. In children of four years with a normal period of sleep of about twelve hours the curve shows a very marked increase in intensity toward morning, as shown in Fig. 115. Curves made by similar experimental methods are reported by Howell and by Michelson.\* The striking feature about all the curves is the sharp increase in intensity shortly after falling asleep; in most cases the maximum is reached at the first or second hour of slumber, but Michelson believes that there are two classes of individuals in this respect, those with morning dispositions in whom the maximum of mental efficiency occurs early in the day and who upon going to sleep show a maximum of intensity within an hour, and those with evening dispositions whose maximum efficiency comes later in the day and whose curve of sleep reaches its maximum of intensity with relative slowness ( $1\frac{3}{4}$  to  $3\frac{1}{2}$  hrs.).

**Changes in the Circulation during Sleep.**—That the circulation undergoes distinct and characteristic changes during sleep has been shown upon man by phlethysmographic observations and upon the lower animals by direct kymographic experiments. Using very young dogs, Tarchanoff† has been able to measure their blood-pressure while sleeping. He finds that the pressure in the aorta falls by an amount equal to twenty to fifty millimeters of mercury during sleep, and that the same general fact is true for man is shown by the sphygmomanometric observations reported by Brush and Fayerweather.‡ Making use of patients with a trephine hole in the skull, Mosso§ found that during sleep the volume of the brain diminishes, while that of the arm or foot increases. The apparent explanation of this fact is that the blood-vessels in the body dilate, and receive, therefore, more

\* Howell, "Journal of Experimental Medicine," 2, 313, 1897. Michelson, "Dissertation," Dorpat, 1891.

† Tarchanoff, "Archives italiennes de biologie," 21, 318, 1894.

‡ Brush and Fayerweather, "American Journal of Physiology," 5, 199, 1901.

§ Mosso, "Ueber den Kreislauf des Blutes im menschlichen Gehirn," 1881.

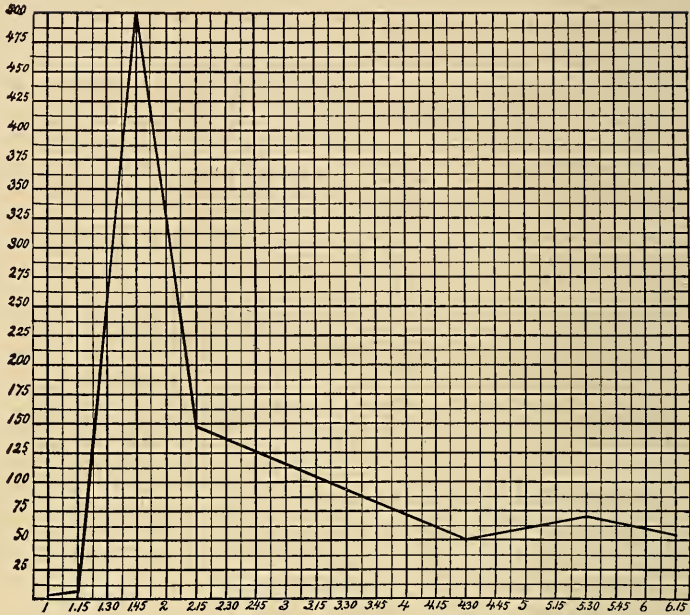

Fig. 114.—Curve of intensity of sleep according to Mönninghoff and Piesbergen. The figures along the abscissa represent time in hours from the beginning of sleep; those along the ordinate the relative intensity of sleep measured in milligram-millimeters, expressing the intensity of sound of a falling body necessary to awaken the sleeper.

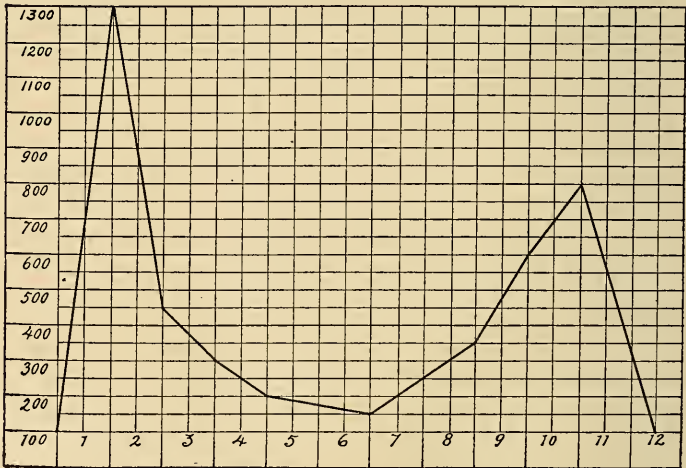
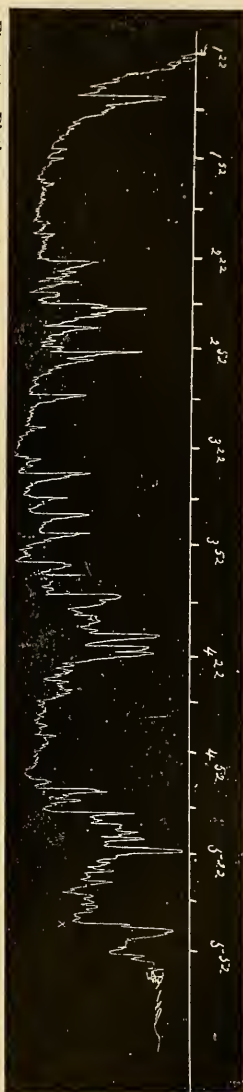

Fig. 115.—Curve of intensity of sleep in a child of three years and eight months, as determined by Czerny.

blood, while a smaller amount flows to the brain. The volume of the foot or hand was measured in these experiments by incising it in a plethysmograph (see section on Circulation). Unfortunately, this result has been contradicted by other observers,\* who claim that during sleep there is a vascular dilatation in the brain as well as in the limbs. In view of this contradiction in results between experimenters making use of similar methods of work, it is evident that theories, such as are described below, which are based upon a diminution in blood-flow through the brain, are brought into question. More extensive observations upon individuals with an opening in the skull-wall are greatly needed to determine this point. The author† has extended Mosso's observations so as to obtain a plethysmographic record of the volume of the hand and part of the forearm during a period of normal sleep. One of the records thus obtained is given in Fig. 116. The amount of dilatation is given by the ordinates below the base line. Granting that the increase in volume of the hand and arm is caused by an increase in the volume of blood contained in their blood-vessels, the curve shows that during and after the onset of sleep the blood-vessels in the arm slowly dilate until between one and two hours after the beginning of sleep. After this maximum is reached the arm remains more or less of the same volume for a certain period or else diminishes in volume very gradually. Shortly before waking, however, the arm begins to diminish more rapidly in size, owing, doubtless, to the contraction of its blood-vessels; so that at the time of awaking it has practically the same volume as at the beginning of sleep. If, on the basis of Mosso's experiments,

Fig. 116.—Plethysmographic curve of hand during sleep. The duration of the experiment was from 1.22 A. M. to 5.52 A. M.



\* Shepard, "American Journal of Physiology," 23, 1909 ("Proc. Amer. Physiol. Soc."); Brodmann, "Journal f. Psychologie u. Neurologie," 1, 10, 1902.

† Howell, *loc. cit.*

we assume that the blood-flow in the brain stands in a reciprocal relation to that in the arm, this curve may be taken to indicate that before and after the onset of sleep the blood-flow through the brain diminishes rapidly to a certain point and that before awaking the blood-flow begins to increase again until it reaches normal proportions.

**Effect of Sensory Stimulation.**—That sensory stimuli of various kinds affect a sleeping individual without entirely awaking him is shown by the movements that may be caused in this way, and also by the nature of the dreams which may be provoked. It is very interesting to find from plethysmographic observations that all kinds of sensory stimulations from without and from within are liable to affect the circulation of the blood during sleep. As shown by the plethysmograph, the volume of

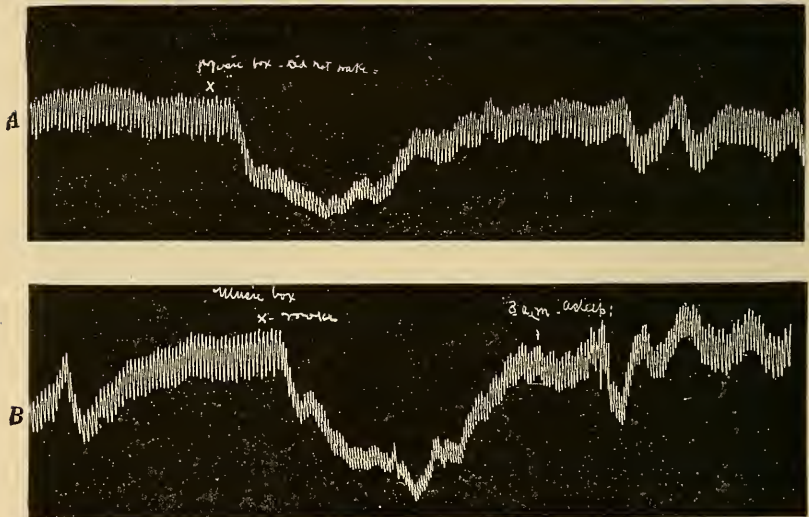

Fig. 117.—Sleep: A, effect of external impression (music box), insufficient to awaken sleeper,—a marked diminution in volume of the arm; B, effect of external impression (music box) sufficient to awaken sleeper; a stronger diminution in volume followed by dilatation as the subject again fell asleep.

the arm diminishes more or less in proportion to the intensity of the stimulus, and the probable interpretation of this fact is that the sensory stimulus acts reflexly upon the vasomotor center in the medulla and causes through it a contraction of the blood-vessels. In the curve shown in Fig. 116 most of the irregularities were traceable to causes of this kind,—noises in the building or street or other sensory stimuli. The same fact is exhibited in a striking way by the curves given in Fig. 117. In these experiments the recorder attached to the plethys-



mograph to register the changes in volume was of a different kind (tambour) and the record reads in a reverse way to that shown in Fig. 116,—that is, a dilatation is recorded by a rise in the curve and a constriction by a fall. The recorder being more sensitive, the volume changes in the arm due to the heart beat are clearly indicated. The legends attached to the illustration explain the results of the experiments.

**Theories of Sleep.**—Many hypotheses have been advanced to explain the nature and causation of sleep.\* Confining ourselves to the more recent hypotheses that attempt to explain the immediate cause of the production of the condition, the following brief description will suffice to show the nature of the theories proposed:

1. *The Accumulation of Acid Waste Products.*—Preyer† and also Obersteiner have suggested that the accumulation of acid waste products in the blood brings on a gradually increasing loss of irritability or fatigue in the brain cells which results finally in a depression of their activity sufficient to cause unconsciousness. It is known that functional activity in the muscle is accompanied by the formation of acid waste products, especially sarcolactic acid, and that if not removed as quickly as formed these products cause a diminution and finally a loss of irritability. The central nerve tissues in activity show also an acid reaction. Moreover, if lactic acid or its sodium salt is injected into the blood it brings on a condition of fatigue and finally a state of unconsciousness. The theory, therefore, supposes that during the waking hours the constant activity of the muscles and nervous system results in a gradual accumulation of these waste products, since their oxidation and removal does not keep pace with their production. The end-result is a diminishing irritability of the central nervous system, especially perhaps of the cortex, which results finally in involuntary sleep, although normally the accumulation is not carried to this extreme, since it is our habit to induce sleep, when the sensations of sleepiness become apparent, by withdrawing ourselves from excitations, mental or sensory. No experimental confirmation of this theory has been furnished.

2. *Consumption of the Intramolecular Oxygen.*—Pflüger‡ suggests that the cause of sleep lies essentially in the fact that the brain cells during the waking hours use up their store of oxygen more rapidly than it can be replaced by the absorption of oxygen from the blood. The result is a gradual reduction in irritability; so that when external stimuli are withdrawn the oxidations in the cells sink

\* For a very complete statement of the theories of sleep and for the literature in general, see the excellent book by Piéron, "Le problème physiologique du sommeil," Paris, 1913.

† Preyer, "Centralblatt f. d. med. Wiss.," 13, 577, 1875; and Obersteiner, "Allgemeine Zeitschrift f. Psychiatrie," 29, 224, 1872-73.

‡ Pflüger, "Archiv f. d. gesammte Physiologie," 10, 468, 1875.

below the level necessary to arouse consciousness. During sleep the store of intramolecular oxygen—that is, the oxygen synthetically combined by anabolic processes to form the irritable living matter—is again replenished. The fundamental conception on which this theory rests, the idea, namely, of a storage of intramolecular oxygen, has been practically abandoned.

3. *Toxin Theories.*—Quite a number of writers have assumed that some special toxin, which might be called a hypnotoxin, is formed during the waking hours, and finally accumulates in sufficient quantity to inhibit the activity of the cortical cells. A specific view of this kind has been proposed by Piéron, and to a certain extent has been supported by experiments. It has been shown that very young dogs, when deprived completely of sleep, will die within four to six days. Piéron, making use of the method of experimental insomnia, states that dogs kept awake for periods of thirty to three hundred hours show evidence of an intoxication, not only in the extreme somnolence manifested, but, microscopically, in that the cortical cells in the frontal region are distinctly altered. When the blood or cerebrospinal liquid of such animals is injected into the brain-ventricles (fourth ventricle) of another animal, the latter is thrown into a condition of somnolence, and exhibits changes in his cerebral cortex similar to those in the dog suffering from insomnia. This assumed hypnotoxin is precipitated by alcohol and is destroyed by a temperature of 65° C. In his complete theory the author supposes that the toxin acts directly to arouse somnolence, but that the sudden advent of deep sleep is due to the fact that the toxin sets into action some unknown nervous inhibitory mechanism.

4. *The Neuron Theory.*—Duval,\* Cajal, and others have applied the neuron doctrine to explain the occurrence of sleep. According to the neuron conception, the connection between the cells in the cortex and the incoming impulses along the afferent paths is made by the contact of the terminal arborizations of the afferent fibers with the dendrites of the cell. Assuming that these latter processes are contractile, Duval supposes that sleep is caused mechanically by their retraction, which results in breaking the connections and thus withdrawing the brain cells from the possibility of external stimulation. Conductivity is re-established upon awaking by the elongation and intermingling of the processes again re-establishing physiological connections. The numerous efforts made to demonstrate the fact of a retraction of the dendritic processes by histological examinations of brains during sleep or narcosis have, however, not been successful.

\* Duval, "Comptes rendus de la soc. de biol.," February, 1895; and Cajal, "Archiv f. Anat. (u. Physiol.)," 375, 1895.

5. *Inhibitory Theories.*—Some authors regard the condition of sleep as caused by a process of inhibition (Pawlow), although the mechanism by which this inhibition is exerted and the cause of its periodic recurrence are not explained. Shepard\* defines sleep as a dominance in attention of a group of fatigue sensations which inhibit the motor processes and the sensations aroused through the usual avenues of sense.

6. *Anemia Theories of Sleep.*—It is known that experimental interference with the supply of blood to the brain brings on unconsciousness practically immediately. Quite naturally, therefore, it has been suggested that the alternation between sleeping and waking may be connected with a rhythmical variation in the blood-flow through the cortex. Numerous facts in physiology have made it probable that during sleep there is a diminished flow of blood through the brain, a condition of cerebral anemia. In animals with the brain exposed or with a glass window in the skull it has been observed directly that the flow of blood to the cortex is diminished during sleep. Mosso's plethysmographic experiments mentioned above have been given a similar interpretation, and Tarchanoff's observations upon sleeping dogs, as well as direct determinations upon man by Brush and Fayerweather, show that the arterial pressure falls during sleep. Hooker† has shown that the venous pressure also falls during sleep, and that the cutaneous veins of the hand may exhibit a pulse, indicating a dilatation of the cutaneous arteries. Inasmuch as the lessened pressure in the arteries is accompanied by a dilatation of the vessels of the skin, as shown by the plethysmograph, it is probable, when the facts previously mentioned are taken into consideration, that the diminished pressure in the arteries forces less blood through the brain and more through the dilated vessels of the skin. In fact, as is explained in the section on circulation, it is probable that the blood-flow through the brain is normally regulated indirectly by the circulation in other parts of the body. Constriction of blood-vessels elsewhere increases arterial pressure and shunts more blood through the brain, and *vice versa*. This general view is in accord with the fact that sensory stimuli and increased mental activity are accompanied by a constriction of the blood-vessels (of the skin) and a rise of arterial pressure, while, on the other hand, mental inactivity and especially sleep are accompanied by a dilatation of the blood-vessels of the body (skin vessels) and a fall of arterial pressure. Many facts, therefore, point to an anemic condi-

\* Shepard, "The Circulation and Sleep" ("Univ. of Michigan Studies," Scientific Series, vol. i, 1914).

† Hooker, "American Journal of Physiology," 35, 73, 1914.

tion of the brain during sleep, and some physiologists have believed that this condition precedes and causes the state of sleep, while others take the opposite view that it follows and is merely one result of sleep. On the basis of the plethysmographic experiments mentioned above the author\* has proposed a theory of sleep in which the diminished flow of blood to the brain is explained and is assumed to be the chief factor in bringing on sleep. The theory assumes that the periodicity of sleep is dependent mainly upon a rhythmical loss of tone in the vasomotor center in the medulla in consequence of fatigue from continued activity during the waking hours. That is, the vasomotor center is in constant action during this period; the continued flow of sensory stimuli and the constant activity of the brain act reflexly on this center and through it cause a constriction of the blood-vessels of the body, particularly of the skin, by means of which the blood-flow through the brain is maintained with an adequate velocity. In consequence of this varying but constant activity the center undergoes fatigue; stronger and stronger stimulation is necessary to maintain its normal tone, and eventually its effect on the blood-pressure becomes insufficient to maintain an adequate flow through the brain and unconsciousness or sleep results, even against one's desires, as is shown by the experience of those who have attempted to keep awake much beyond the habitual period. Ordinarily, however, this fatigue of the vasomotor center and its resulting tendency to a cessation of activity is favored by our voluntary withdrawal of stimulation. Our preparations for sleep, closure of eyes, darkened and if possible quiet room, cessation from disturbing thoughts, result in a diminution of the sensory and mental stimuli that normally play upon the vasomotor center. The cessation of such stimuli may, indeed, at any time be all that is necessary to bring about a partial loss of activity in this center, a lessened flow of blood through the brain, and a period of sleep which, however, is usually short. If, however, the vasomotor center has been previously fatigued, as may be supposed to be the case at the end of the day, the withdrawal of these stimuli permits it to fall into a more complete state of inactivity, and the diminution of blood-flow to the brain and the state of unconsciousness is longer lasting,—lasts indeed, according to the curves of which an example is given in Fig. 116, until the gradual resumption of activity in the vasomotor center brings about a constriction of the blood-vessels of the body and thus drives enough blood through the brain to cause spontaneous awakening. A third factor which must aid in the production of unconsciousness as a result of the lessened flow of blood, and in the return of consciousness in connection with

\* Howell, "Journal of Experimental Medicine," 2, 313, 1897.

the increased flow of blood, is the greater or less fatigue of the cortical cells themselves after a day's activity, and their greater irritability after a night's rest. Many factors, therefore, co-operate in the development of the normal state of sleep lasting for six to eight hours out of twenty-four, but the central factor which explains its rapid onset, involving nearly simultaneously all the conscious areas of the brain, whether previously fatigued or not, and the equally sudden restoration to consciousness of the entire cortex, is to be found in the amount of blood-flow to the brain. Under normal conditions this is the factor that stands in most immediate relation to that appearance and disappearance of full consciousness which mark for us the limits of sleep. A similar view is advocated by Hill,\* who believes, however, that the regulation of the blood-flow through the brain is effected through the vasomotor control of the splanchnic area, whereas the author's view is that the regulation is effected mainly through variations in the cutaneous circulation,—that is, for the normal occurrence of sleep. The drowsiness that follows a heavy meal is probably due mainly to the mechanical effect of a dilatation of the blood-vessels of the viscera and the consequent diminution in the blood-flow through the brain; but the sleep that occurs at the end of the day is associated with a dilatation of the blood-vessels of the skin of the trunk and extremities. What the condition in the visceral organs may be at such times we have at present no means of knowing. It should be stated that in opposition to these veins regarding an anemic condition of the brain during sleep, Shepard † reports, as the result of an extensive series of plethysmographic observations made upon two individuals with defects in the skull, that during sleep the volume of the brain is increased. He believes, therefore, that during this period there is a vascular dilatation in the brain and an increased circulation, that the brain, in fact, receives its greatest supply of blood during its period of least activity. This conclusion is at variance with what we should expect from observations on the blood-flow in other organs during their periods of maximum and minimum functional activity. The author concludes also from his observations that the brain must possess an efficient supply of vasomotor nerves, which during the waking hours are in tonic activity, but in sleep suffer a diminution in tone that leads to a local dilatation. Evidence from other sources (p. 632), on the contrary, makes it rather improbable that the brain possesses an efficient vasomotor system.

**Hypnotic Sleep.**—The sleep that can be produced by so-called

\* Hill, The "Physiology and Pathology of the Cerebral Circulation," London, 1896.

† Shepard, *loc. cit.*

suggestion, the sleep of hypnotism, has been studied by means of the plethysmographic method.\* The result, so far as the volume of the arm and hand is concerned, shows that in this condition, unlike normal sleep, there is a marked diminution in volume, and, therefore, we may believe, an increased constriction of the blood-vessels of the skin. This observation accords with the blanched appearance of the skin of the extremities, and with the statement that in deep hypnotic sleep the skin does not bleed readily when pricked with a needle. In view of our limited knowledge, however, it would be hazardous to base any comparison between normal and hypnotic sleep upon this single fact. Some authors, † in fact, doubt whether there is a true hypnotic sleep. They incline to the view that the immobilization or diminished excitability produced by hypnotic suggestion or manipulation simply passes into a condition of natural sleep.

\* Walden, "American Journal of Physiology," 4, 124, 1900-01.

† Piéron, *loc. cit.*

### SECTION III.

## THE SPECIAL SENSES.

---

### CHAPTER XIV.

#### CLASSIFICATION OF THE SENSES AND GENERAL STATEMENTS.

Under the general term sense organ we may include not only the peripheral organ on which the stimulus acts, but also the sensory path through which the impulses are conveyed to the central nervous system and the cortical center by means of which the reaction in consciousness is mediated.

**Classification of the Senses.**—In general, we attempt to distinguish the various sense organs by the differences in their end reaction in consciousness. Each sense organ gives a different kind of response, the nature and distinctive features of which are recognized subjectively. The conscious sensations are said to differ in quality or modality. The qualitative difference in some cases is very distinct,—the difference between sensations of sound and of vision, for instance,—and on this subjective difference we base our efforts to give specific names to the sense organs concerned. This means of classification is not, however, applicable in all cases. While many of our sensations are so distinct in quality that we can recognize them and name them without difficulty, others are of a more obscure character. In addition to our sensations of vision, hearing, smell, taste, pressure, temperature, and pain, there are doubtless many other sensations whose conscious reaction is less distinct in quality and for which our subjective means of recognition and classification are less satisfactory or entirely inadequate. Such, for instance, are the sensations from the muscles, from the semicircular canals and the vestibular sacs of the ear, and from many of the visceral organs. For the recognition and classification of these senses and sense organs it is necessary to fall back upon the methods of anatomical and physiological analysis, methods which in many respects are uncertain. So also within the limits of any sensation of a given quality or modality, we distinguish certain subqualities. In vision we have many dif-

ferent qualities which we designate by special names,—the series of different colors, for example. In sound sensations we distinguish different tones and different qualities of tones. But here, again, the subjective mark is often so indistinct in consciousness that it cannot be used satisfactorily for purposes of classification. In the odor sensations we distinguish many different qualities, each recognizable at the time that it is experienced, but their characteristics are so fugitive that so far it has not been possible to name them or group them in any satisfactory way. In studying the qualities of the various sensations, so far as they are recognizable, the effort of physiology has been to connect them with some definite anatomical or physiological peculiarity in the sense organs concerned. The final explanation of the differences in quality involves a study of the nature and properties of consciousness itself,—a subject which as yet has not been undertaken by physiology. At present we accept the fact of consciousness and the fact that there are different kinds or qualities of consciousness, and our investigations are directed only toward ascertaining the anatomical, physical, and chemical properties of the organs involved in the production of these subjective changes.

In former times it was customary to divide the sensations into two different groups,—the special and the common senses,—the former including the so-called five senses of man,—namely, sight, hearing, touch, taste, and smell,—while under the latter were grouped all other sensations of less distinctive qualities. In physiology the belief that man has only five special senses has, however, long been abandoned. The sense of touch as ordinarily understood has been shown to consist of three or more distinct senses, namely, pressure (in its several varieties), heat and cold; and the sense of pain exhibited by the skin is in all essential respects as special and characteristic as those just named. There is, however, no certain standard as to what shall constitute a special in contradistinction to a common sense; so that a classification based on this nomenclature is unsatisfactory. In one respect, however, our senses show a difference which may be used as a basis for dividing them into two general groups. This difference lies in the manner of projection. We may assume that all of our sensations are aroused directly in the brain. In that organ take place the final changes which react in consciousness. But in no case are we conscious that this is the case. On the contrary, we project our sensations either to the exterior of the body or to some peripheral organ in the body, the effort being apparently to project them to the place where experience has taught us that the acting stimulus arises. We may divide the senses, therefore, into two great groups: (1) The



external or rather the exterior senses, or those in which the sensations are projected to the exterior of the body, and which form, therefore, the means through which we become acquainted with the outside world. The exterior senses include sight, hearing, taste, smell, pressure, and temperature (heat and cold). (2) The internal or interior senses, or those in which the sensations are projected to the interior of the body. It is through these senses that we acquire a knowledge of the condition of our body and perhaps also a knowledge of ourselves as an existence or organism distinct from the external world. Among the interior senses we must include pain, muscle sense, the sensations from the semicircular canals and vestibule of the internal ear, hunger, thirst, sexual sense, fatigue, and in addition perhaps other less definite sensations from the visceral organs. This line of demarcation, although it holds so well in most cases, is not absolutely distinctive. The temperature sense, for instance, is, so to speak, on the border line between the two groups; we may project this sensation either to the exterior or to the interior according to circumstances. When the temperature nerves are excited simultaneously with the pressure nerves, we project the sensation to the exterior, to the stimulating body. If the skin is touched by a hot or cold solid object we speak of the object as being hot or cold. If, however, the same nerves are stimulated by warm gases or even liquids under conditions that do not involve the pressure sense we refer the change to ourselves,—we are hot or cold, as the case may be. So also when the skin is heated by the blood the resulting sensation is projected to the skin. It would seem that the habit of projection is acquired by experience, and that those senses whose organs are habitually affected by objects from without we learn to project to the object giving rise to the stimulus.

**The Doctrine of Specific Nerve Energies.**—The term specific nerve energy we owe to Johannes Müller (1801–1858). The term is in some respects unfortunate, as at present in the physical sciences the word energy is used to designate certain specific properties of matter. The phrase specific nerve energy in physiology, however, is intended to designate the fact that each sensory unit arouses or mediates its own specific quality of sensation, the specific energy of the optic apparatus being visual sensations, of the auditory apparatus sound sensations, etc., and each sensory nerve or apparatus can give no other than its own quality of sensation. Whether this specificity in the reaction of each sensory nerve is due to some peculiarity in the nerve itself or its peripheral end-organ, or to a peculiarity of the part of the brain in which it terminates Müller left an open question, although he called attention to the fact that the central ending is capable of giving its specific effect in con-

consciousness independently of the conducting nerve fibers. With regard to this latter question the opinions of physiologists still differ. Most physiologists, perhaps, adopt the view that the specific reaction in consciousness is due to the central ending,—that, in other words, the different sensory parts of the cortex give different kinds or qualities of consciousness, while the sensory nerve fibers are simply conductors of nerve impulses, which, however much they may differ in intensity, are qualitatively the same in all nerve fibers. According to this view, it would result, as du Bois-Reymond expressed it, that, if the auditory nerve fibers were attached to the visual center and the optic fibers to the auditory center, we would see the thunder and hear the lightning. Each typical sense-organ from this standpoint consists of three essential parts: the central ending, which determines the quality of the sensation; the peripheral end-organ, retina, cochlea, etc., which determines whether or not any given form of stimulus shall be effective and which in most cases is constructed so as to be responsive to a special form of stimulus designated as its adequate stimulus; and of connecting neurons whose only function is to conduct the nerve impulses originating in the end-organ. The fact, therefore, that the light waves can stimulate the rods and cones of the retina, but are an inadequate stimulus probably to the hair cells of the cochlea or the taste buds of the tongue, is due to a peculiarity in structure of the rods and cones; but the fact that the impulses conducted by the optic fibers arouse a peculiar modality of sensation is not due to any peculiarity in structure in these fibers or in the rods and cones, but to a characteristic structure of the optic centers. The positive experimental evidence for the correctness of this view is not conclusive, but, on the whole, is impressive. Such facts as the following may be noted:

1. When sensory nerve fibers are stimulated otherwise than through their end-organs each reacts, if it reacts at all, according to its specific energy,—that is, it produces its own quality of sensation. When the optic nerve is cut, for instance, the mechanical stimulus causes a flash of light; when the chorda tympani is stimulated in the tympanic cavity by mechanical, electrical, or chemical stimuli sensations of taste are aroused.

2. Mechanical pressure upon the peripheral nerves distributed to the skin may cause a loss of some of the cutaneous senses in certain areas of the skin with a retention of others. Thus the senses of pressure and temperature may be lost and that of pain retained, or pain may be lost and pressure retained. A similar dissociation of the sensations of the skin in definite regions may be observed after localized lesions of the spinal cord, or during the process of regeneration that follows suture of a severed nerve. Such facts agree with the view that each sense has its own set

of nerve-fibers; those that mediate pain cannot by a mere modification of the stimulus give also a sense of pressure.

3. The only objective manifestation of a nerve impulse that we can study in the nerve itself is the electrical change that accompanies it or perhaps constitutes its essence. This electrical change is qualitatively the same in all kinds of nerve fibers, and this fact agrees with the view that the nerve impulse is qualitatively the same in all fibers.

So far as the sensory nerve fibers are concerned, the chief objection to this view of the doctrine of specific nerve energies is found perhaps in the difficulty or impossibility of applying it to the explanation of color vision. According to the strict interpretation of the view, each fundamental color sense, being distinct in quality, should be mediated by its own set of nerve fibers. When Helmholtz first formulated his theory of color vision he spoke, therefore, of three kinds of nerve fibers,—the red, the green, and the violet,—each when stimulated alone giving its own specific sensation and not capable of giving any other. The facts accumulated regarding color vision, however, seem to show that this view will not hold. One and the same cone, with its connecting fiber, may give rise to any or all of the primary color sensations, and, unless we choose to further subdivide the nerve unit and assume that the separate nerve fibrils of which the axis cylinder is composed constitute the separate conductors for the primary sense qualities, it would seem to be impossible to apply the doctrine of specific energies to this case. Not too much weight should be given perhaps to this objection. For it must be remembered that all of our present theories of color vision are unsatisfactory, and possibly when we attain to the right point of view the facts may not be so difficult to interpret in terms of this theory of specific energies.

The alternative view proposed in place of the doctrine of specific nerve energies assumes that the nerve impulses may vary in quality as well as in intensity, and that therefore one and the same nerve fiber may arouse different qualities of sensation and have different end effects according to the character of the impulse conveyed. This point of view is not capable of much discussion, since there are no positive facts that support it. It is logically satisfactory in meeting the cases in which the former view seems to be unsatisfactory. It is difficult, however, in our ignorance of the nature of the nerve impulse to imagine in what respects it may possibly differ in character.

**The Weber-Fechner (Psychophysical) Law.**—One difficulty that has been encountered in the physiological study of sensory nerves is that the end reaction cannot be measured with exactness. With efferent nerves the end reaction is a contraction or secretion

that can be estimated quantitatively in terms of our physical and chemical units of measurement. But the end reaction of a sensory nerve is a state of consciousness for which we have no standard of measurement. Weber, in studying the relation between the strength of the stimulus and the amount of the resulting sensation, availed himself of the method of the least detectible change in sensation; that is, he determined the increase in stimulus at different levels necessary to cause a just perceptible increase in the sensation. By means of this method he arrived at the significant result that the increase in stimulus necessary to cause this change is, within physiological limits, a definite fractional increment of the acting stimulus. If, for instance, with a weight of 30 gms. upon the finger it requires an increment of  $\frac{1}{30}$ —that is, one additional gram—to make a just perceptible difference in the pressure sensa-

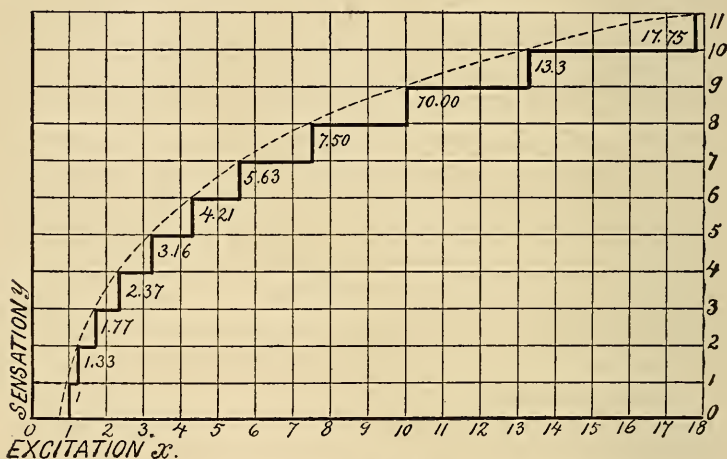

Fig. 118.—Curve to indicate the Weber-Fechner law of a logarithmical relation between excitation and sensation.—(From *Waller*.) The excitations are indicated along the abscissas, the sensations along the ordinates. The increase in sensation is represented as taking place in equal steps, "the minimal perceptible difference," while the corresponding excitations require an increasing increment of  $\frac{1}{3}$  at each step, namely 1, 1.33, 1.77, 2.37, etc. That is, for equal increments of sensation increasing increments of stimulation are necessary.

tion, then, with a weight of 60 gms. upon the finger the addition of another gram would not be perceived; it would require again an increment of  $\frac{1}{30}$ —that is, 2 gms.—to make a just perceptible difference in sensation. This relationship is known as Weber's law. While its exactness has often been disputed, it seems to be generally admitted that for a median range of stimulation the law expresses the approximate relation between the two variables considered. Fechner attempted to give this law a more quantitative and extensive application by assuming that just perceptible differences

in sensation represent actually equal amounts of sensation. Accepting this assumption, we can express the relationship between stimulus and sensation as determined by Weber's experiments by saying that for the sensation to increase by equal amounts,—that is, by arithmetical progression,—the stimulus must vary according to a certain factor,—that is, by geometrical progression. The sensation may be regarded as a geometrical function of the stimulus. If the relation between stimulus and sensation is represented as a curve in which the ordinates express the sensation increasing by equal amounts, and the abscissas the corresponding stimuli increasing at each interval by  $\frac{1}{3}$ , a result is obtained such as is represented in the accompanying figure (Fig. 118). A curve of this kind is a logarithmical curve, and Fechner expressed the relationship between stimulus and sensation in what has been called the psychophysical law,—namely, that the sensation varies as the logarithm of the stimulus.

## CHAPTER XV.

### CUTANEOUS AND INTERNAL SENSATIONS.

**General Classification.**—According to the older views, the sensory nerves of the skin give sensations of touch. Modern physiology has shown, however, that these nerves mediate at least four different qualities of sensation—namely, pressure, warmth, cold, and pain. Our so-called touch sensations are usually compound, consisting of a pressure and a temperature component and also very frequently an element of muscle sense when muscular efforts are involved, as, for instance, in measuring weights or resistances. The four sensory qualities enumerated constitute the cutaneous senses, and they are present, or, to speak more accurately, the nerves through which these senses are mediated are present not only over the general cutaneous surface but also in those membranes—such as the mucous membrane of the mouth and the rectum (stomodeum and proctodeum)—which embryologically are formed from the epiblast. The surfaces in the interior of the body, on the contrary—such as the membranes of the alimentary canal, muscles, fasciæ, etc.—have only nerves of pain, but no sense of touch or temperature. Of these cutaneous senses, three—pressure, warmth, and cold—may be grouped with the exterior senses, the sensations being projected to the exterior of the body, into the substance causing the stimulation; although, as was mentioned above, the temperature sensations under conditions—fever, vascular dilatation, etc.—may be projected to parts of the skin itself and be felt as changes in ourselves. The temperature sensations are, in fact, projected to the exterior whenever they are combined with pressure sensations, the latter serving, as it were, as the dominant sense. The pain sense, on the other hand, belongs to the group of interior senses, the sensations being always projected into our own body and being felt as changes in ourselves.

**Protopathic, Epicritic, and Deep Sensibility.**—In the matter of the classification of the cutaneous senses and, indeed, the body senses in general, a new point of view has been suggested by Head and Rivers.\* These authors made a careful study of the loss of sensations after division of the cutaneous nerves, and of the subsequent gradual and separate return of these sensations following upon suture of the divided ends. They find that in skin areas made completely

\* Head and Rivers, "Brain," 1905, 99, and 1908, 323.

anesthetic there is present a deep or subcutaneous sensibility to pressure and movements, a sensibility which must be mediated through sensory fibers contained in the nerves to the muscles. In the skin itself there are present two systems of sensory fibers which regenerate at different times in a nerve that has been severed, and may be studied separately by this means. One system conveys sensations of pain and of extreme changes in temperature, but the sensations are imperfectly localized and the sensibility is low, or, to express the same idea in another way, the threshold is high. This kind of sensation is found in the viscera also, and it may be considered from the functional standpoint as a defensive agency toward pathological changes in the tissues; it is designated as *protopathic* sensibility. It is stated that the glans penis possesses only this kind of sensibility. Protopathic sensibility comprises three qualities of sensation and presumably three sets of nerve-fibers, namely—for pain, for heat (not stimulated below 37° C.), and for cold (not stimulated above 26° C.). The second system of fibers responds to stimulations by light pressures and small differences in temperature between 26° and 37° C., the range of temperature to which the temperature nerves of the protopathic system are insensitive. These fibers regenerate after lesions much more slowly than the protopathic variety, and since the sensations mediated by them are localized very exactly, they furnish us the means for making fine discriminations of touch and temperature. For this reason they are described as an *epicritic* system, and the corresponding sensations are designated as epicritic sensibility. This system of fibers is not found in the other organs, and it constitutes, therefore, the special characteristic of the skin area. In this system there are included separate fibers for heat, for cold, for light pressures, and for tactile discrimination. It is through the sensations mediated by these fibers that we recognize the shape and size of objects. According to this classification we may assume that the posterior roots of the spinal nerves carry into the spinal cord the following varieties of afferent fibers:

- |                                     |   |             |   |   |
|-------------------------------------|---|-------------|---|---|
| Cutaneous sensory fibers            | { | Epicritic   | { | Heat (small differences).<br>Cold (small differences).<br>Touch (light pressures).<br>Tactile discrimination. |
|                                     | { | Protopathic | { | Heat (extremes).<br>Cold (extremes).<br>Pain.   |
| Subcutaneous or deep sensory fibers | { |             | { | Pressure.<br>Pain.<br>Muscular (position).  |
| Non-sensory afferent fibers         | { |             | { | From muscles, joints, etc.<br>(Ending in cerebellum).   |

The paths taken by these fibers after entering the cord are described on p. 174.

**The Punctiform Distribution of the Cutaneous Senses.—**

A most interesting fact in regard to the cutaneous senses is that they are not distributed uniformly over the whole skin, but are present in discrete points or spots. This fact was first clearly established by Blix,\* although it was discovered independently by Goldscheider and in this country by Donaldson. These observers paid attention chiefly to the warm and cold spots. The existence of these spots may be demonstrated easily by anyone upon himself by moving a metallic point gently over the skin. If the point has a temperature below that of the skin it will be noticed that at certain spots it arouses simply a feeling of contact or pressure, while at other spots it gives a distinct sensation of coldness. If, on the other hand, the point is warmer than the skin it will at certain spots give a sensation of warmth. On marking the cold and warm spots thus obtained it is found that they

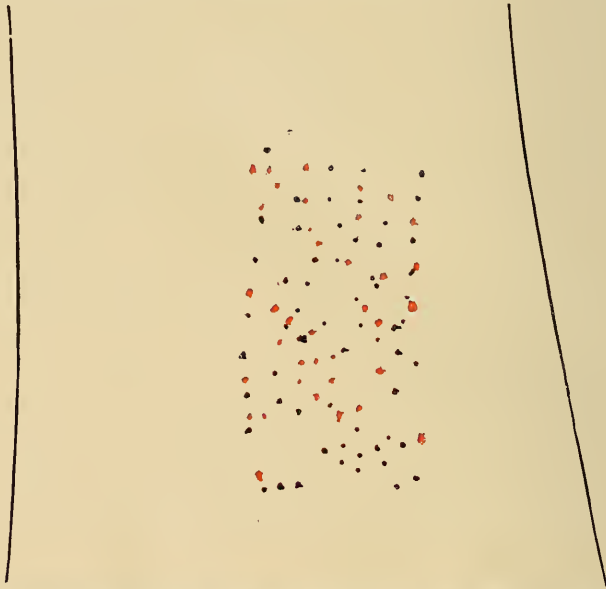

Fig. 119.—Representation of the distribution of cold and warm spots on the volar surface of forearm in a space 2 cms. by 4 cms. The red dots represent the cold spots as tested at a temperature of 10° C. The black dots represent the warm spots as tested at a temperature of 41° to 48° C.

occupy different positions on the skin. Elaborate charts have been made of the warm and cold spots on different regions of the skin, the apparatus usually employed being a metal tube through which water of any desired temperature may be circulated. The temperature of the skin, whatever it may be,

\* Blix, "Zeitschrift f. Biologie," 20, 141, 1884; Donaldson, "Mind," 39, 1, 1885. See also Goldscheider, "Archiv f. Physiologie," 1885, suppl. volume.



forms the zero line; any object of a higher temperature stimulates only the warm spots, while one of a lower temperature acts upon the cold spots. The pressure or tactile sense and the pain sense are also distributed in a punctiform manner; they have been studied most carefully by von Frey.\* To determine the location of the pressure points he used fine hairs of different diameters fastened to a wooden handle. The cross-areas of these hairs are determined by measurements under the microscope, and the pressure exerted by each is measured by pressing it upon the scale pan of a balance. The quotient of the pressure exerted divided by the cross-area of the hair in square millimeters,  $\frac{\text{gm.}}{\text{mm}^2}$ , reduces the pressure to a uniform unit of area. For the pain points fine needles may be employed or stiff hairs similar to those used for the pressure points. From the experiments made there seems to be no doubt that each of the four cutaneous senses has its own spots of distribution in the skin, those for pain being most numerous and those for warmth the least numerous. There is some reason for believing also that the nerve endings mediating the pain sense lie most superficially in the skin and those for the warm sense the deepest.

**Specific Nerve Energies of the Cutaneous Nerves.**—Many attempts have been made to determine whether the doctrine of specific nerve energies applies to these cutaneous senses; that is, whether each sense has its own nerve fibers capable of giving only its own quality of sensation. The evidence, on the whole, is favorable to this view. According to some observers, electrical or mechanical stimulation of the different points calls forth for each its characteristic reaction. Donaldson has found that cocain applied to the eye or throat destroys the senses of pain and pressure, but leaves those of heat and cold, which again supports the view of separate fibers for each sense. In addition there are a number of interesting pathological cases which point in the same direction. In some lesions of the cord—syringomyelia, for instance—the senses in the skin of the parts below are dissociated,—that is, there may be loss of pain and temperature in a certain area with a retention of the pressure sense,—a fact which indicates that these senses have separate paths and therefore separate nerve-fibers.† Still more interesting cases of dissociation are reported as the result of the compression of peripheral nerve trunks. Thus, Barker‡ describes his own case, in which, as the result of the pressure of a cervical rib upon some of the cords of the brachial plexus, there was a region in the arm lacking in the pressure and temperature senses, but retain-

\* Von Frey, "Königl. Sächsischen Gesellschaft der Wissenschaften, Math.-phys. Klasse," 1894-95-96.

† For many interesting cases of dissociation due to spinal lesions see Head, "Brain," 1906, 537.

‡ Barker, "Journal of Experimental Medicine," 1, 348, 1896.

ing the sense of pain. He quotes other cases in which the reverse dissociation occurred, pressure sense alone remaining. The simplest explanation of these facts is the view that each pressure, pain, warm, and cold spot is supplied by its own nerve fiber, and that each, when stimulated, reacts, if it reacts at all, only with its own peculiar quality of sensation. According to this view, artificial stimulation, if properly controlled, of the trunks of the nerves supplying the skin should be capable of bringing out these different sense qualities. Experiments made with this point in view have not, however, been very successful. Mechanical or electrical stimulation of the ulnar nerve, for instance, gives usually only pain sensations, although if the stimulus is feeble contact sensations are aroused. The method, however, is probably at fault. In the case of amputated fingers or limbs a more decisive result is obtained. As is well known, individuals after such operations may for many years have sensations of their lost fingers or limbs. In such cases the pressure in the stump of the wound acting upon the central ends of the sensory fibers arouses sensations which are projected in the usual way, and give the feeling that would be experienced if the lost parts were still there and were stimulated in the normal manner.

**The Temperature Senses.**—The main facts regarding the distribution of heat and cold spots have been determined, but in most of the experiments on record no distinction was made between protopathic temperature sensations and those mediated by the epicritic temperature nerves. It is difficult to adapt the older descriptions to this newer terminology, but when not otherwise specifically stated it may be assumed that the epicritic system is referred to. In general, the cold spots are more numerous than the warm spots, and react more promptly to their adequate stimulus. The threshold stimulus varies in different parts of the skin, the tip of the tongue requiring the smallest stimulus to arouse a sensation, and the eyelids, forehead, cheeks, lips, limbs, and trunk following in the order named. According to Goldscheider, the spots on most portions of the skin form chains that have a somewhat radiate arrangement with reference to the hair follicles. The temperature points possess each its adequate stimulus, that for the cold spot being temperatures lower than the skin or of the terminal organ of the cold nerves, that for the heat spots temperatures higher than their own. From the standpoint of specific nerve energies it is most interesting to find that these points, particularly the cold spots, may be stimulated by other than their adequate stimuli. Mechanical and electrical stimulation has, in the hands of several observers, been efficient in causing a sensation of cold upon a cold spot and of heat upon a warm spot. Some chemical stimuli are also effective. Menthol applied to the skin gives a cold sensa-

tion, while, on the other hand, if the arm be plunged into a jar of carbon-dioxid gas a distinct warm sensation will be experienced. A curious effect of this kind is what is known as the paradoxical cold reaction. It is produced by applying a very warm object, with a temperature of  $40^{\circ}$  to  $60^{\circ}$  C., to a cold spot. According to Head and Rivers this reaction is rather characteristic of the protopathic temperature fibers. It can be obtained, for example, from the glans penis, which possesses only protopathic sensibility, or during the course of regeneration of a severed cutaneous nerve. In this latter condition hot objects applied to a cold spot give a vivid sensation of cold. The same result may be felt sometimes at the instant of entering a hot bath. Many efforts have been made to determine whether there is a specific kind of end-organ for each of these senses. Numerous observers have cut out the skin from cold or hot spots and examined the removed part carefully by histological methods. The general result has been that no distinctive end-organs have been found. Von Frey, however, believes that, although the heat spots are supplied simply by a terminal end plexus, the cold spots in some places at least have as a special end-organ the end-bulbs of Krause. This conclusion is based upon the fact that these end-bulbs are found in places, such as the glans penis and conjunctiva, where the cold sense is especially prominent or exclusively present.

**The (Epicritic) Sense of Pressure or Touch.**—The cutaneous pressure points are smaller and more numerous than the cold or warm spots. Von Frey has shown that in those portions of the body that are supplied with hairs the pressure points lie over the hair follicles. The pressure nerve-fibers, in fact, terminate in a ring surrounding the hair follicle, this form of termination serving as an end-organ. On account of their position they are stimulated by any pressure exerted upon the hair. The hair, indeed, acts like a lever and transmits any pressure applied to it with increased intensity, acting, therefore, as regards the pressure organ somewhat like the ear-bones in the case of the endings of the auditory nerve. In parts of the body not furnished with hairs the tactile or Meissner corpuscles are found and these structures doubtless function as pressure end-organs. They are particularly abundant in the parts of the hand and feet in which a delicate sense of pressure is present in spite of a much thickened epidermis. It has been estimated that for the entire surface of the body, excluding the head region, there are about 500,000 of these pressure points. These points are close together on those parts, such as the tongue and fingers, which have a delicate tactile sense and more widely scattered where the sense is less developed.

**The Threshold Stimulus and the Localizing Power.**—The

delicacy of the sense of pressure may be measured by determining the minimal pressure necessary to arouse a sensation,—that is, the threshold stimulus,—or it may be estimated in terms of the power of discriminating two contiguous stimuli,—that is, the minimal distance that two points must be apart in order for the sensations to be recognized as distinct. The two methods of measurement do not coincide. As determined by the threshold stimulus, the greatest delicacy is exhibited by the skin of the face, the forehead, and temples. According to the older methods of measurement, the forehead will perceive a pressure of 2 mgs., while the skin of the tips of the fingers needs a pressure of from 5 to 15 mgs. to arouse a perceptible sensation. The back of the hand or the arm is more sensitive from this standpoint than the tips of the fingers. When measured by the power of discriminating two points—that is, the localizing sense—the tips of the fingers are far more sensitive than the skin of the face or of the arm. This latter property, in fact, stands in relation to the closeness of the pressure points to one another. The localizing sense may be determined by Weber's method of using a pair of compasses with blunt points. For any given area of the skin the power of discrimination or localization is expressed in terms of the number of millimeters between the two points at which they are just distinguished as two separate sensations when applied simultaneously to the skin. Instruments made for this purpose are designated as esthesiometers. They carry two points the distance of which apart can be readily adjusted and read off on a scale. The most satisfactory form of esthesiometer is that devised by von Frey. The two points in this case are made by long, rather stiff hairs whose pressure can be made quite uniform. According to the older measurements, the discriminating sense of different parts of the skin varies greatly, as is shown by the accompanying table:

Tip of the tongue.....	1.1 mms.
Tip of finger, palmar surface.....	2.3 “
Second phalanx finger, palmar surface.....	4.5 “
First phalanx finger, palmar surface.....	5.5 “
Third phalanx finger, dorsal surface.....	6.8 “
Middle of palm.....	8 to 9 “
Second phalanx finger, dorsal surface.....	11.3 “
Forehead.....	22.6 “
Back of the hand.....	31.6 “
Forearm.....	40.6 “
Sternum.....	45 “
Along the spine.....	54 “
Middle of neck or back.....	67.7 “

The tips of the tongue and the fingers are, therefore, the most delicate surfaces, and that the tongue surpasses the fingers in this respect is easily within the experience of everyone who will recall the ease with which small objects between the teeth are detected by

the tongue as compared with the fingers. From the above data it is evident also that the whole skin may be imagined as composed of a mosaic of areas of different sizes, the sensory circles of Weber, in each of which two or more simultaneous stimulations of the pressure nerves give only one pressure sensation. The size of these areas, particularly where they are large, may be reduced by practice, as is shown by the increased tactile sensibility of the blind. The fact that we can recognize two simultaneous pressure stimuli of the skin as two distinct sensations implies that the two sensations have some recognizable difference in consciousness. This difference is spoken of as the local sign. We may believe that every sensitive point upon the skin has its own distinctive local sign or quality, and that by experience we have learned to project each local sign more or less accurately to its proper place on the skin surface. Two points on this surface that are a great distance apart are easily recognized as different; but as we bring the points closer together the difference becomes less marked and finally disappears when the distance corresponds to the area of the sensory circle for the part of the skin investigated, for instance, 1 mm. for the tongue, 22 mms. for the forehead, etc. The ultimate limit of the power of discrimination was assumed by Weber to depend upon the area of distribution of a single nerve fiber. Assuming that each nerve fiber at its termination spreads over a certain skin area, it was suggested that the size of this area forms a limit to the power of discrimination, since two stimuli within it would affect a single fiber and therefore would give a single sensation.

This view, however, has not been supposed to accord with the facts even when the additional supposition was made that the local signs of two adjacent fibers may not be distinct enough for us to recognize them as separate and that practically there must be a number of intervening unstimulated areas, the number varying according to the sensitiveness of the area. Von Frey has, however, given a new method of testing the localizing sense of the skin, the results of which seem to accord with this anatomical explanation. If instead of applying the two points simultaneously they are applied in succession, at an interval of one second, the individual can distinguish the difference when two neighboring pressure points are stimulated. Each pressure point in the skin, therefore, has a local sign, which enables us to distinguish it from all others, and by this method the ultimate sensory circles on the skin become much smaller than when measured by the usual method of Weber. The center of each is a pressure point and the area is determined by the distance from this center at which an isolated stimulation of this point can be obtained. It seems probable, moreover, that each of these pressure points is connected to the brain by a separate nerve path, possibly a single fiber, and that this anatomical arrangement

determines the limitation of the localizing sense for different regions of the skin.

In the newer work of Head and Rivers, which has been referred to several times, it will be recalled that they distinguish first of all between cutaneous sensibility to pressure and a deep sense of pressure. When the cutaneous fibers of a given area are all destroyed by degeneration, the area is still sensitive to pressure applied so as to deform the skin inward. The spot so stimulated can be localized accurately. This deep sense of pressure is mediated by the deep nerve fibers which supply the muscles. According to these authors the cutaneous pressure sensibility is mediated by two sets of fibers, those which give us the power of tactile discrimination when the compass points are applied simultaneously to the skin, and those which give us the power of recognizing simply light pressures. In lesions of the spinal cord one of these sensibilities may be lost and the other retained over a given skin area (Head and Thompson, "Brain," 1906). In fact, the fibers of tactile discrimination are stated to pass up the cord (uncrossed) in the posterior funiculi, while those of light pressures ascend in the lateral or anterolateral funiculi and cross before reaching the medulla.

**The Pain Sense.**—Pain is probably the sense that is most widely distributed in the body. It is present throughout the skin, and under certain conditions may be aroused by stimulation of sensory nerves in the various visceral organs, and indeed in all of the membranes of the body. Our knowledge of the physiological properties of the end-organs and nerves mediating this sense is chiefly limited to the skin, and for cutaneous pain at least the evidence, as stated above, is very strongly in favor of the view that there exists a special set of fibers which have a specific energy for pain. All recent observers agree that the pain sense has a punctiform distribution in the skin, the pain points being even more numerous than the pressure points. The threshold stimulus of these points in various regions may be determined by von Frey's stimulating hairs, and experiments of this kind show, as we should expect, that it varies greatly. The cornea, for instance, gives sensations of pain with much weaker stimuli than in the case of the finger tips. In general, however, the threshold stimulus is much higher for the pain than for the pressure points. Histological examination of the pain points indicates that there is no special end-organ, the stimulus taking effect upon the free endings of the nerve fibers. Any of the usual forms of artificial nerve stimuli may affect these endings if of sufficient intensity, and, as is well known, stimuli applied to sensory nerve trunks affect these fibers with especial ease. A temperature of 50° to 70° C. applied to an afferent nerve will cause violent pain sensations, but has no effect upon the motor nerve fibers in the same trunk. Mechanical stimulation gives usually only pain sensations, and the results of inflammatory changes, as in neuritis or neuralgia, are equally marked.

*Localization or Projection of Pain Sensations.*—Under normal conditions cutaneous pains are projected with accuracy to the point stimulated, and it is possible that this result is due in part at least to the training acquired in connection with concomitant (epieritic)

pressure sensations, the latter acting as a guide or aid in the projection. Thus in the cases referred to above, in which a portion of the skin had lost the sense of pressure and temperature, but retained that of pain, it was found that the localization was very incomplete. Pain arising in the internal organs, on the contrary, is located very inaccurately. The pain from a severe toothache, for example, may be projected quite diffusely to the side of the face. A very interesting fact in this connection is that such pains are often referred to points on the skin and may be accompanied by skin areas of tenderness. Pains of this kind that are misreferred to the surface of the body are designated as reflected pains. It has been shown by Head\* and others that the different visceral organs have, in this respect, a more or less definite relation to certain areas of the skin. Pains arising from stimuli acting upon the intestines are located in the skin of the back, loins, and abdomen in the area supplied by the ninth, tenth, and eleventh dorsal spinal nerves; pains from irritations in the stomach are located in the skin over the ensiform cartilage; those from the heart in the scapular region, and so on. The explanation offered for this misreference is that the pain is referred to the skin region that is supplied from the spinal segment from which the organ in question receives its sensory fibers, the misreference being due to a diffusion in the nerve centers. As Head expresses it, "when a painful stimulus is applied to a part of low sensibility in close central connection with a part of much greater sensibility the pain produced is felt in the part of higher sensibility rather than in the part of lower sensibility to which the stimulus was actually applied." It is interesting that affections of the serous cavities—*e. g.*, the peritoneum—do not cause reflected pains or cutaneous tenderness as in the case of the viscera. Another notable fact in this connection is the occurrence of the condition known as *allochiria*. When from any cause one or other of the cutaneous senses is depressed in a given area stimulation in this region may give sensations which are referred to the symmetrical area on the other side of the body, or, if this also is involved, it may be referred to the area next above or below in the spinal order. The above law, according to which projection is made to the area of high sensibility most closely connected with the area of low sensibility, seems to hold in this case also.

**Muscular or Deep Sensibility.**—The existence of a special set of sensory nerve-fibers distributed to the muscles was clearly recognized by some of the older physiologists. Charles Bell, † for example, says: "Between the brain and the muscles

\* Head, "Brain," 16, 1, 1893, and 24, 345, 1901.

† Bell, "The Nervous System of the Human Body," third edition, London, 1844, p. 200.

there is a circle of nerves; one nerve conveys the influence from the brain to the muscle; another gives the sense of the condition of the muscle to the brain." The conclusive proof of the existence of such fibers, however, has only been furnished within recent years. It has been demonstrated that there are special sensory endings in the muscles, the so-called muscle spindles, and in the attached tendons, the tendon spindles or tendon organs of Golgi. The muscle spindles are found most frequently in the neighborhood of the tendons, at tendinous intersections or under aponeuroses. Sherrington\* has shown that the nerve fibers in them do not degenerate after section of the anterior roots of the corresponding spinal nerves and are therefore derived from the posterior roots. In the muscles of the limbs he estimates that from one-half to one-third of the fibers in the muscular nerve branches are sensory, and that most of these sensory fibers end in the muscle spindles. On the physiological and clinical side facts of various kinds have accumulated that make clear the existence of this group of sensory fibers and emphasize their essential importance in the co-ordination of our muscular movements. It has been shown that stimulation of the nerves distributed to the muscles or mechanical stimulation of the muscles themselves causes a depressor effect upon blood-pressure, thus demonstrating the presence of afferent fibers in the muscles. As described in the section upon the central nervous system, the numerous experiments upon the effect of section of the posterior and lateral funiculi of the cord, and observations upon the results of pathological lesions of the posterior funiculi (tabes dorsalis) give results which are interpreted to mean that fibers of muscular sensibility form the most important group in the posterior funiculi and constitute, as well, perhaps, the long, ascending fibers in the cerebellospinal fasciculus in the lateral funiculi. It is believed, therefore, that our so-called voluntary muscles are richly supplied with afferent fibers and that the impulses carried by these fibers to the brain are necessary for the proper contraction of the muscles, and particularly for the adequate combination of the contractions of groups of muscles in the co-ordinated movements of equilibrium. Indeed, section of the posterior roots of the spinal nerves supplying a given region is followed by a loss of control of the muscles in this region hardly less complete than the paralysis produced by direct section of the anterior roots; the muscles not only lose their tonicity in consequence of the dropping out of the reflex sensory stimuli from the skin and muscles of the region, but they are apparently withdrawn from voluntary control in spite of the maintenance of their normal motor connections. Within the central nervous system the afferent nerve-fibers of the muscles end

\* Sherrington, "Journal of Physiology," 17, 237, 1894.



in part in the cerebellum and in part pass forward, by way of the median fillet, to end in the cerebrum. In the cerebrum they end in the cortex of the parietal lobe in the region of the posterior central convolution. There is reason to believe that this cortical sense area of the muscle sense is connected by association fibers with the motor areas lying anterior to the central fissure of Rolando, and we have thus a reflex arc—or, as Bell expressed it, a circle of nerves between the muscles and the brain. It is probable that a similar arc or circle is formed by the connections through the cerebellum, and still a third one of a lower order by the connections in the spinal cord. In the higher animals the impulses received in the cerebellum through the fibers of muscle sense, in connection with those received from the semicircular canals and vestibular sacs of the ear, furnish the afferent element in the reflex cerebellar control of muscular movements, particularly of the synergetic combinations necessary in locomotion. Through the circle or arc in the cortex of the cerebrum it may be supposed that our characteristic voluntary movements are affected, and it may be doubted whether a so-called voluntary contraction can be made when this circle is broken on the sensory side. Whether or not this latter suggestion is true, it seems to be beyond doubt that adequately controlled voluntary movements depend for their adaptation upon the inflow of afferent impulses along the fibers of muscle sense. We have a certain consciousness of the condition of our muscles at all times, and if we were deprived of this knowledge we should be unable to control them properly, perhaps unable to use them voluntarily.

**The Quality of the Muscular Sensibility.**—Under the term muscular sensibility in its wide sense we must understand the sensibility mediated by the afferent fibers from the muscles, the tendons, ligaments, and joints. The quality of these deep sensations is of several kinds—we have first of all the deep pressure sensibility (see p. 286), which gives a definite conscious reaction that is well localized. It is usually projected to the exterior and is not consciously separated from the tactile or pressure sensations of the skin. We probably make much use of this sensibility in judging the weight and resistance of bodies. Muscular sensibility proper is that ill-defined consciousness which we possess of the condition and position of our muscles or of the joints or limbs moved by them. It includes also the sense of passive position, and the sense of effort and of the spatial relations of the limbs in motion or at rest. When the afferent fibers from the muscles and joints are traced into the central nervous system, some of them, it will be remembered, enter the tracts of Flechsig and Gower and end in the cerebellum, while

others pass up the cord in the posterior funiculi, enter the lemniscus, and terminate eventually in the cerebral cortex in the post-Rolandic region. Our conscious muscular sensations are mediated presumably by this latter group. The untrained person scarcely recognizes the existence of these sensations, but they are evident enough upon analysis, and it is most certain that they take a fundamental part in regulating our movements. In our estimations of the extent of the muscular contractions they form the chief sensory basis, and in this way they may indirectly furnish us with data for perceptions and judgments of various kinds. Doubtless, also, this sense takes an essential part in the primitive formation of our conceptions of space, since it may be assumed that the continual movements of the extremities furnish in connection with our visual and tactile impressions essential data upon which we build our perceptions of distance and size, our judgments of spatial relations. As is explained in the chapter on the Physiology of the Ear, the sensations from the semi-circular canals and vestibular sacs co-operate in giving data for these fundamental conceptions, and it is not possible for us to disentangle the parts taken by these senses separately in building up our knowledge of the external world.

**Sensations of Hunger and Thirst.**—Hunger and thirst are typical interior (or common) sensations. We feel them as changes in ourselves, although the sensations are of such a vague character that it is difficult to analyze them successfully by methods of introspection. The feeling that we designate commonly as hunger or appetite occurs normally at a certain time after meals, and it is referred or projected more or less definitely to the region of the stomach. When the sensation is not satisfied by the ingestion of food, it increases in intensity and the individual experiences the pangs of hunger. The testimony of those who have starved for long periods, as well as the experience of professional fasters, indicates that these pangs after a few days diminish in strength and may finally disappear, so that prolonged starvation is not accompanied necessarily by physical suffering. The older observers made a distinction between a hunger supposed to be due to conditions in the stomach and a hunger due to insufficient nutrition in the body at large. Whether or not sensations of this quality can arise from impoverished nutrition of the tissues in general has been a matter of some dispute. There are some facts which indicate that a general or somatic hunger may exist, for example, the continued hunger, in spite of ample food, which may be present in a condition such as diabetes, or such a case as that described by Hertz,\* in which a patient with an intestinal fistula through which most of the food escaped complained of constant hunger, although his stomach

\* Hertz, "The Sensibility of the Alimentary Canal," London, 1911.

was filled with food. It is possible, of course, that in such cases the sensations of hunger are not produced by general changes in the tissues, but are due to some chemical change in the blood that affects the hunger apparatus of the stomach. What we usually mean by hunger is a sensation that is referable to changes in the stomach and disappears normally when the stomach is supplied with food. Cannon and Washburn\* have shown that when the stomach is empty the hunger sensations may appear and disappear at certain intervals, and they have demonstrated experimentally that the appearance of a hunger pain is simultaneous with a contraction of the musculature of the stomach. They propose the theory that hunger sensations or hunger pains are caused by contractions of the stomach, the contractions affecting presumably some as yet undescribed sensory apparatus. Carlson † has reported observations upon a man with a permanent gastric fistula, which corroborate the results of Cannon and Washburn. As soon as the stomach is empty these hunger contractions make their appearance, but mechanical or chemical stimulation of the mucous membrane of the mouth, esophagus, or stomach causes them to disappear through a reflex inhibition. The efferent fibers concerned in this inhibition run in the splanchnic nerves. Since the hunger contractions occur after section of both vagi and splanchnics, it is evident that the essential mechanism concerned is wholly intrinsic, involving, probably, the local nerve plexuses in the walls of the stomach. The vagi exert a tonic influence on the apparatus, while, as just stated, its activity is readily inhibited through the splanchnic paths. Since the hunger pains and the hunger contractions disappear when food is eaten, and while the stomach is in active digestion, it seems evident that the ordinary movements of the stomach during digestion are of a different order from those contractions that cause hunger pains. It is suggested that the latter involve mainly the fundus or body of the stomach. Some confusion has existed in regard to the significance of the terms "hunger" and "appetite." Most writers have been inclined to use these terms to indicate different degrees of activity of the same sensory apparatus, appetite being employed to describe the milder forms of hunger as contrasted with the stronger and more disagreeable sensations designated as hunger pains or hunger pangs. Other authors consider that hunger and appetite constitute two different sensations mediated presumably by two different physiological mechanisms. Thus, Cannon and Washburn define appetite as a kind of pleasurable

\* Cannon and Washburn, "American Journal of Physiology," 29, 441, 1912.

† Carlson, *ibid.*, 31, 151, 1912, and 31, 175, and 212, 1913; also vols. 32, 33, 34, and 36.

mental state connected with stimulation of the nerves of taste or odor and dependent upon past associations of an agreeable character. Carlson\* also separates sharply the two sensations. The sensory apparatus for hunger lies in the walls of the stomach, probably in the muscular coats, and is stimulated by the contractions of the musculature. The sensations aroused are more or less disagreeable. Appetite, on the contrary, is an entirely pleasant sensation aroused in part through the sensory nerves of taste and smell, but also by sensory fibers in the gastric mucosa. This gastric component of the appetite-sense explains the increased appetite observed sometimes at the beginning of a meal after partaking of some palatable food. Under ordinary conditions of life the regulation of the amount and quality of the food necessary to the proper nutrition of the body and the maintenance of body equilibrium is effected through the sense of hunger or of hunger and appetite. Its striking influence upon the body at large is well illustrated in the case of animals (pigeons, dogs) deprived of their cerebrum. During the period of fasting these animals show all the external signs of hunger, and keep in continual, restless movement that seems to imply a constantly acting sensory stimulus. The complexity of the nervous apparatus that controls the appetite is shown by many facts from the experiences of life and from the results of laboratory investigations. For example, it is found that large amounts of gelatin in the diet, although at first accepted willingly, soon provoke a feeling of dislike and aversion to this particular foodstuff which cannot be overcome. An animal will starve rather than use the gelatin, although all of our direct physiological evidence would indicate that this substance is an efficient food, playing much the same part as the fats or carbohydrates. A fact of this kind indicates that the sensory apparatus of the appetite is influenced in some specific way by the metabolism of this particular material. So also the feeling of satiety and aversion for food that follows overfeeding indicates something more than a simple removal of the sensations of hunger; it implies an active state, due possibly to the excitation of sensory fibers of a different character.

**The Sense of Thirst.**—Our sensations of thirst are projected more or less accurately to the pharynx, and the facts that we know would seem to indicate that the sensory nerves of this region have the important function of mediating this sense. The water contents of the body are subject to great changes. Through the lungs, the skin, and the kidneys water is lost continually in amounts that vary with the conditions of life. This loss affects the blood directly, but is doubtless made good, so far as this tissue is concerned, by a

\* Carlson and Braafadt, "American Journal of Physiology," 36, 153, 1914.

call upon the great mass of water contained in the storehouse of the tissues. To restore the body tissues to their normal equilibrium in water we ingest large quantities, and the control of this regulation is effected through the sense of thirst. We know little or nothing about the nervous apparatus involved; but it may be assumed that when the water content falls below a certain amount the nerve fibers in the pharyngeal membrane (fibers of the glossopharyngeal nerve) are stimulated and give us the sensation of thirst. That we have in this membrane a special end-organ of thirst is indicated, moreover, by the fact that local drying in this region, from dry or salty food, or dry and dusty air, produces a sensation of thirst that may be appeased by moistening the membrane with a small amount of water not in itself sufficient to relieve a genuine water need of the body. Our normal thirst sensations might be designated, therefore, as pharyngeal thirst, to indicate the probable origin of the sensory stimuli. Prolonged deprivation of water, however, must affect the water content of all the tissues, and under these conditions sensations are experienced whose quality is not that of simple thirst alone, but of pain or suffering. All accounts agree that complete deprivation of water for long periods induces intense discomfort, anguish, and possibly mental troubles, and we may suppose that under these conditions sensory nerves are stimulated in many tissues, and that the metabolism in the nervous system in addition is directly affected by the loss of water.\* It is interesting to note that while in diseases due to a general infection, loss of appetite, anorexia, is a frequent symptom, there is no corresponding loss of the sense of thirst. Even in hydrophobia the patient experiences the sensations of thirst, although unable to drink water.

\* According to an interesting account of death from voluntary starvation, quoted by Hertz (*loc. cit.*), there comes a time at which neither thirst nor hunger causes any distress.

## CHAPTER XVI.

### SENSATIONS OF TASTE AND SMELL.

The sense of taste is mediated by nerve fibers distributed to parts of the buccal cavity and particularly to parts of the tongue. The most sensitive regions are the tip, the borders, and the posterior portion of the dorsum of the tongue in the region of the circumvallate papillæ. Taste buds and a sense of taste are described also for the soft palate, the epiglottis, and even for the larynx. The sense is not present uniformly over the entire dorsum of the tongue. On the contrary, it has an irregular, punctiform distribution over most of this region with the exception of the parts mentioned above.

**The Nerves of Taste.**—The anterior two-thirds of the tongue are supplied with sensory fibers from the lingual nerve, a branch of the inferior maxillary division of the fifth nerve, and the posterior third from the glossopharyngeal. The taste fibers for these regions, therefore, are supplied immediately through these nerves. It has been shown, moreover, that the taste fibers carried in the lingual are brought to it through the chorda tympani nerve, which arises from the seventh cranial nerve and joins the lingual soon after emerging from the tympanic cavity of the ear. There has been much discussion as to the origin of these taste fibers from the brain. At first sight it would seem that the fibers for the posterior third of the tongue must have their origin from the brain in the glossopharyngeal and those for the anterior two-thirds in the sensory portion of the facial. Many surgeons have reported, however, that complete extirpation of the semilunar ganglion of the fifth nerve is followed by complete loss of taste in the corresponding side of the tongue, and others have described a loss of taste for the anterior two-thirds following a similar operation. Some authors have asserted, therefore, that all the taste fibers originate or rather end in the sensory nucleus of the fifth, while others believe that the fibers running in the chorda tympani, at least, take their origin in the fifth nerve. It is supposed by these authors that the fibers reach the semilunar ganglion by a circuitous route, as is indicated in the diagram given in Fig. 120. Those that run in the lingual and chorda tympani nerves are assumed to pass to the ganglion by way of the great superficial petrosal and Vidian nerves and the sphenopalatine ganglion, while those that are contained in the glossopharyngeal reach

the same ganglion through the tympanic nerve, the small superficial petrosal, and the otic ganglion. A report by Cushing\* of the results of removal of the Gasserian ganglion in thirteen cases throws much doubt upon these views. This author made careful examinations of the sense of taste, not only immediately after the operation, but for a long period subsequently. He states that in no case was there any effect upon the sense of taste in the posterior third of the tongue. We may believe, therefore, that the taste fibers of this part arise immediately from the ganglion-cells in the petrosal ganglion and enter the brain with the roots of the nerve to terminate in its sensory nucleus in the medulla.

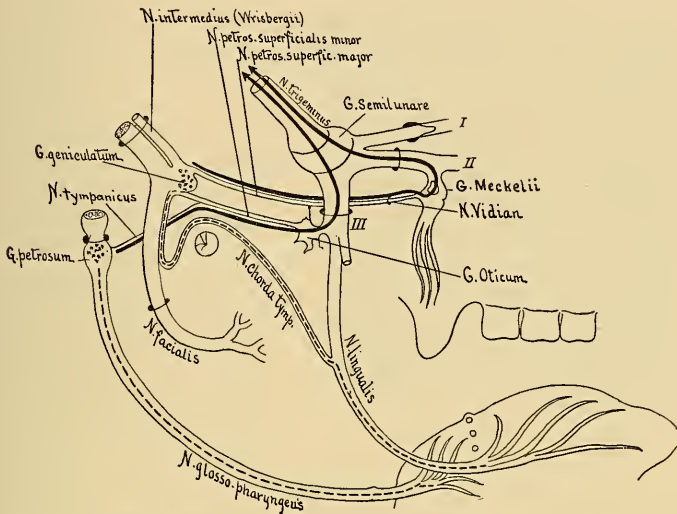

Fig. 120.—Schema to show the course of the taste fibers from tongue to brain.—(Cushing.) The dotted lines represent the course as indicated by Cushing's observations. The full black lines indicate the paths by which some authors have supposed that these fibers enter the brain in the trigeminal nerve.

Regarding the anterior two-thirds of the tongue, the lingual region, it was found that in some cases there was at first a loss of acuity of taste or even an entire disappearance of the sense, but subsequently it returned. It would seem, therefore, that the loss of taste described after removal of the Gasserian ganglion is an incidental result the cause of which is not entirely clear. Cushing attributes it to a postoperative degeneration and swelling in the fibers of the lingual nerve, which affect the conductivity of the intermingled fibers of the chorda tympani. Since, however, there is no perma-

\* Cushing, "Bulletin of the Johns Hopkins Hospital," 14, 71, 1903. Gives also the surgical literature.

ment loss of taste in this region, it follows that the taste fibers do not pass through the Gasserian ganglion. We may assume, therefore, that they originate directly in the nerve cells of the geniculate ganglion and enter the brain with the fibers of the intermediate nerve (n. intermedius Wrisbergii).

**The End-organ of the Taste Fibers.**—In the circumvallate papillæ, in some of the fungiform papillæ, and in certain portions of the fauces, palate, epiglottis, or even the vocal cords there are found the organs known as taste buds which are believed to act as peripheral organs of taste. These curious structures are represented in Fig. 121. They are oval bodies with an external layer of tegmental or cortical cells, and they contain in the interior a

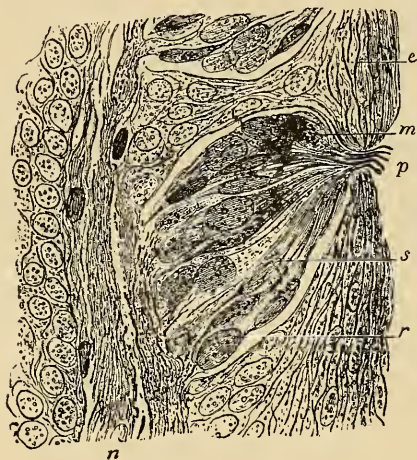

Fig. 121.—Section through one of the taste buds of the papilla foliata of the rabbit (from *Quain*, after *Ranvier*), highly magnified: *p*, Gustatory pore; *s*, gustatory cell; *r*, sustentacular cell; *m*, leucocyte containing granules; *e*, superficial epithelial cells; *n*, nerve fibers.

number of elongated cells each of which ends in a hair-like process which projects through the central taste pore of the organ. These latter cells may be considered as the true sense cells; the hair-like process constitutes probably the part that is stimulated directly by sapid substances. The impulse thus aroused is communicated through the body of the cell to the endings of the taste fibers which terminate around these cells by terminal arborizations of the same general type as in the case of the hair cells in the cochlea.

**Classification of Taste Sensations.**—Our taste sensations are very numerous, but it has been shown that there are four primary or fundamental sensations,—namely, sweet, bitter, acid, and salty, and that all other tastes are combinations of these primary sensations, or combinations of one or more of them with sensations of odor or with sensations derived from stimulation of the so-called nerves of common sensibility in the tongue. Thus, the taste of pepper may be resolved into a slight odor sensation and a sensation due to stimulation of the fibers of general sensibility,—that is, it gives no taste sensation proper. The taste of alum may be considered as a combination of a salty taste with common sensibility. Combinations of sweet and acid tastes, sweet



and bitter tastes, etc., form a part of our daily experience, and in the fused or compound sensation that results from such combinations one may usually recognize without difficulty the constituent parts. The seemingly great variety of our taste sensations is largely due to the fact that we confuse them or combine them with simultaneous odor sensations. Thus, the flavors in fruits and the bouquet of wines are due to odor sensations which we designate ordinarily as tastes, since they are experienced at the time these objects are ingested. If care is taken to shut off the nasal cavities during the act of ingestion even imperfectly, as by holding the nose, the so-called taste disappears in large measure. Very disagreeable tastes are usually, as a matter of fact, due to unpleasant odor sensations. On the other hand, some volatile substances which enter the mouth through the nostrils and stimulate the taste organs are interpreted by us as odors. The odor of chloroform, for instance, is largely due to stimulation of the sweet taste in the tongue.

**Distribution and Specific Energy of the Fundamental Taste Sensations.**—Regarding the distribution of the fundamental taste sensations over the tongue and palate there seem to be many individual differences. In general, however, it may be said that the bitter taste is more developed at the back of the tongue and the adjacent or posterior regions; at the tip of the tongue the bitter sense is less marked or in cases may be absent altogether. On the contrary, in this latter region the sweet taste is well developed. On this account it may happen that substances which when first taken into the mouth give a not unpleasant sweet taste subsequently when swallowed cause disagreeably bitter sensations, like the little book of the evangelist, which in the mouth was "sweet as honey, and as soon as I had eaten it, my belly was bitter." Oehrwall\* has made an interesting series of experiments in which he stimulated separately a number of fungiform papillæ on the surface of the tongue. Each papilla was stimulated separately for its fundamental taste senses of sweet, bitter, and acid, by using drops of solutions of sugar, quinin, and tartaric acid. Of the 125 papillæ thus examined, 27 gave no reaction at all, although sensitive to pressure and temperature. In the 98 papillæ that reacted to the sapid stimulation it was found that 60 gave taste sensations of all three qualities, 4 gave only sweet and bitter, 7 only bitter and acid, 12 only sweet and acid, 12 only acid, and 3 only sweet. None was found to give only a bitter sensation. These facts bear directly upon the question of the specific energy of the taste fibers. It is possible that the four fundamental taste qualities may be mediated by four different end-organs and four separate

\* Oehrwall, "Skandinavisches Archiv f. Physiologie," 2, 1, 1890.

sets of nerve fibers, each giving, when stimulated, only its own quality of sensation. On the other hand, it is possible that one and the same nerve fiber might give different qualities of sensation according to the nature and mode of action of the sapid substances. The fact, as shown by Oehrwall's experiments, that there are sensory spots upon the tongue which will not react to some kinds of sapid substance, but do react to others, and perhaps only to one particular kind, speaks strongly in favor of the view that there are different end-organs and nerve fibers for each fundamental taste. This view is still further supported by the fact that certain chemically pure substances give different tastes according to the part of the tongue upon which they are placed. Thus, sodium sulphate (Guyot) may taste salty upon the tip of the tongue and bitter when placed upon the posterior part. A better instance still is given by solutions of a bromin substitution product of saccharin, the chemical name for which is parabrom-benzoic sulphinid:  $C_6H_3Br \left\{ \begin{array}{l} CO \\ SO_2 \end{array} \right\} NH$ .

When this substance is placed upon the tip of the tongue it gives a sweet sensation, while upon the posterior region it gives only a bitter taste together with a sensation of astringency (Howell and Kastle). Extracts of the leaves of a tropical plant, *Gymnema silvestre*, applied to the tongue, destroy the sense of taste for sweet and bitter substances (Shore), and this fact may be explained most satisfactorily by assuming that this substance exercises a selective action upon taste terminals in the tongue, paralyzing those for the bitter and the sweet substances. Finally, the fact that electrical, mechanical, or chemical stimulation of the chorda tympani, where it passes through the tympanic cavity, may arouse taste sensations is proof that the taste sensation in general is not due to a peculiar kind of impulse that can be aroused only by the action of sapid bodies upon the terminals in the tongue, but, on the contrary, that it is a specific energy of these fibers, and depends for its quality, therefore, upon the specific reaction of the terminations in the brain.

**Method of Sapid Stimulation.**—In order that sapid substances may react upon the taste terminals it is necessary, in the first place, that they shall be in solution. It is impossible to taste with a dry tongue. We may assume, therefore, that the stimulation consists essentially in a chemical reaction between the sapid substance and the terminal of the taste fiber,—for instance, the hair process of the sense cells in the taste buds,—and the question naturally arises whether the distinctive reactions corresponding to the separate taste qualities can be referred to a definite chemical structure in the sapid bodies. Are there certain chemical groups which possess the property of reacting specifically with the end-organs? Experience shows that substances of very different chemical constitution may

excite the same taste. Thus, sugar, saccharin, and sugar of lead (lead acetate) all give a sweet taste, while, on the other hand, starch (soluble starch), which stands so close in structure to the sugars, has no effect upon the taste terminals. It is interesting to remember that the taste nerves may be stimulated by sapid substances dissolved in the blood as well as when applied to the exterior of the tongue. A sweet taste may be experienced in diabetes from the sugar in the blood, or a bitter taste in jaundice from the bile.

**The Threshold Stimulus.**—The determination of the threshold stimulus for different sapid substances is made by ascertaining the minimal concentration of the solution which is capable of arousing a taste sensation. The delicacy of the sense of taste is influenced, however, by certain accessory conditions which must be taken into account. Thus, the temperature of the solution is an important condition. Very cold or very hot solutions do not react,—that is, the extremes of temperature seem to diminish or destroy the sensitiveness of the end-organ. A temperature between  $10^{\circ}$  and  $30^{\circ}$  C. gives the optimum reaction. So also the delicacy of the sense of taste is increased by rubbing the sapid solution against the tongue. Doubtless this mechanical action facilitates the penetration of the sapid body into the mucous membrane, but it seems also to increase the irritability of the end-organ. It is our habit in tasting bodies with the tongue to rub this organ against the hard palate. With regard to the threshold stimulus such results as the following are reported:

Salty (sodium chlorid).	0.25 gm. in	100 c.c. H <sub>2</sub> O—	detectible	on tip of tongue.
Sweet (sugar)	.....0.50	“ “ “ “	detectible	on tip of tongue.
Acid (HCl)	.....0.007	“ “ “ “	detectible	on border of tongue.
Bitter (quinin)	.....0.00005	“ “ “ “	detectible	on root of tongue.

The very great sensitiveness of the tongue to bitter substances is evident from this table.

**The Olfactory Organ.**—The end-organ for the olfactory sense lies in the upper part of the nose, and consists of elongated, epithelial-like cells, each of which bears on its free end a tuft of six to eight hair-like processes, while at its basal end it is continued into a nerve fiber that passes through the cribriform plate of the ethmoid bone and ends in the olfactory bulb. These olfactory sense cells lie among supporting epithelial cells of a columnar shape (Fig. 122). At the free edge of the cells there is a limiting membrane through which the olfactory hairs project. The olfactory sense

cells are essentially nerve cells, and in this respect resemble the sense cells in the retina, the rods and cones, rather than those of the ear or of the organs of taste. The distribution of the olfactory cells, according to v. Brunn, is confined to the nasal septum and a portion of the upper turbinate bone. The area covered in each nostril corresponds to about 250 square millimeters. The epithelium of the lower and middle turbinates and the floor of the nostrils is composed of the usual ciliated cells found in the respiratory passages, while the so-called vestibular region of the nose, the part roofed in

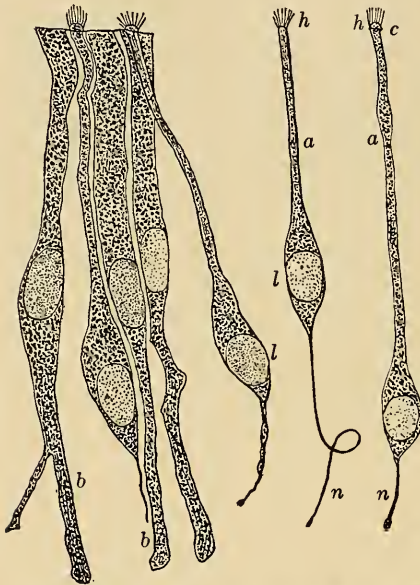

Fig. 122.—Cells of the olfactory region (after v. Brunn): *a, a*, Olfactory cells; *b, b*, epithelial cells; *n, n*, central process prolonged as an olfactory nerve fibril; *l, l*, nucleus; *c*, knob-like clear termination of peripheral process; *h, h*, bunch of olfactory hairs.

by the cartilage, is covered by a stratified pavement epithelium corresponding in structure with that of the skin. These latter portions of the nose are supplied with sensory fibers derived from the fifth or trigeminal nerve. We must consider the 500 sq. mm. of olfactory epithelium as the olfactory sense organ comparable physiologically and perhaps anatomically to the rod and cone layer of the retina. The connections of these cells with the central nervous system have already been described (p. 217). It will be remembered that the fine, non-medullated fibers springing from the basal end of the sense cells enter the olfactory bulb and end in terminal arborizations in the olfactory glomeruli, where they make connections by contact with the dendrites of the mitral cells of the bulb. Through the axons of these mitral cells the impulses are conducted along the olfactory tract to their various terminations in the olfactory lobe itself, either of the same or of the opposite side, and eventually also in the cortical region, the uncinate gyrus of the hippocampal lobe. As regards the olfactory sense cells, the nerve cells in the olfactory bulb might be compared with the nerve ganglion layer of the retina, and the nerve fibers of the olfactory tract with the fibers of the optic nerve.

**The Mechanism of Smelling.**—Odoriferous substances to

**The Mechanism of Smelling.**—Odoriferous substances to

affect the olfactory cells must, of course, penetrate into the upper part of the nasal chamber. This end is attained during inspiration, either by simple diffusion or by currents produced by the act of sniffing. It may also happen by way of the posterior nares. In fact, the flavors of many foods, fruits, wine, etc., are olfactory rather than gustatory sensations. When such food is swallowed the posterior nares are shut off from the pharynx by the soft palate, but in the expiration succeeding the swallow the odor of the food is conveyed to the olfactory end-organ. Flavors are perceived, therefore, not during the act of swallowing, but subsequently, and if the nostrils are blocked, as in coryza, foods lose much of their flavor. Simply holding the nose will destroy much of the so-called taste of fruits or the bouquet of wines.\*

**Nature of the Olfactory Stimulus.**—The fact that smells are transmitted through space like light and sound has suggested the possibility that they may depend upon a vibratory movement of some medium. This view, although occasionally defended in modern times, is apparently entirely incompatible with the facts. The usual view is that odoriferous bodies emit particles which, as a rule at least, are in gaseous form. These particles are conveyed to the olfactory epithelium by currents in the air or by simple gaseous diffusion, and after solution in the moisture of the membrane act chemically upon the sensitive hairs of the sense cells. All vapors or gases are, however, not capable of acting as stimuli to these cells; so that evidently the odoriferous character depends upon some peculiarity of structure. It is assumed that there are certain groups, "odoriphore groups," which are characteristic of all odoriferous substances and by virtue of which these substances react with the special form of protoplasm found in the hair cells. Haycraft† has formulated certain fundamental conceptions bearing upon the relation between chemical structure and odoriferous stimulation. He has shown that the power to cause smell, like other physical properties, is a periodic function of the atomic weight—that in the periodic system, according to Mendelejeff, the elements in certain groups are characterized by their odoriferous properties; for instance, the second, fourth, and sixth members—sulphur, selenium, and tellurium—of the sixth group. Moreover, in organic compounds belonging to an homologous series the smell gradually changes and, indeed, increases in the higher members of the series,—that is, in those having a more complex molecular structure.

**The Qualities of the Olfactory Sensations.**—While we dis-

\* For many interesting facts concerning smelling and the literature to 1895 see Zwaardemaker, "Die Physiologie des Geruchs," Leipzig, 1895.

† Haycraft, "Brain," 1888, p. 166.

tinguish a great many different kinds of odors, it has been found difficult, indeed impossible, to classify them very satisfactorily into groups. That is, it is not possible to pick out what might be called the fundamental odor sensations. This sense was doubtless used by primitive man chiefly in detecting and testing food, in protecting himself from noxious surroundings, and perhaps also in controlling his social relations. The olfactory sensations, in accordance with this use, and with the fact, revealed by comparative anatomy, that this sense is the oldest phylogenetically, give either pleasant or unpleasant sensations in a more marked and universal way than in the case of vision or hearing, approaching, in this respect, rather the purely sensual characteristics of the lower senses, the bodily appetites. Mankind has been content to classify odors as agreeable and disagreeable, and to designate the many different qualities of odors by the names of the substances which in his individual experience usually give rise to them. A number of observers have proposed classifications more or less complete in character. One of the latest, and perhaps the best, is that suggested by Zwaardemaker on the basis of the nomenclatures introduced by previous observers. Adopting first the general grouping into pure odors, odors mixed with sensations of common sensibility from the mucous membrane of the nose, and odors mixed or confused with tastes, he separates the pure odors or odors proper into nine classes, as follows:

- I. *Odores ætherei* or ethereal odors, such as are given by the fruits, which depend upon the presence of ethereal substances or esters.
- II. *Odores aromatici* or aromatic odors, which are typified by camphor and citron, bitter almond and the resinous bodies. This class is divided into five subgroups.
- III. *Odores fragrantes*, the fragrant or balsamic odors, comprising the various flower odors or perfumes. The class falls into three subgroups.
- IV. *Odores ambrosiaci*, the ambrosial odors, typified by amber and musk. This odor is present in the flesh, blood, or excrement of some animals, being referable in the last instance to the bile.
- V. *Odores alliacei* or garlic odors, such as are found in the onion, garlic, sulphur, selenium and tellurium compounds. They fall into three subgroups.
- VI. *Odores empyreumatici* or the burning odors, the odors given by roasted coffee, baked bread, tobacco smoke, etc. The odors of benzol, phenol, and the products of dry distillation of wood come into this class.
- VII. *Odores hircini* or goat odors. The odor of this animal arises from the caproic and caprylic acid contained in the sweat; cheese, sweat, spermatic and vaginal secretions give odors of a similar quality.
- VIII. *Odores tetri* or repulsive odors, such as are given by many of the narcotic plants and *acanthus*.
- IX. *Odores nauseosi* or nauseating or fetid odors, such as are given by feces and certain plants and the products of putrefaction.

While the classification serves to emphasize a number of marked resemblances or relations that exist among the odors, it does not rest wholly upon a subjective kinship,—that is, the different odors brought together in one class do not in all cases arouse in us sensa-

tions that seem to be of related quality. It is not impossible, however, that further analysis may succeed in showing that there are certain fundamental qualities in our numerous odor sensations. Our position regarding the odors is similar to that which formerly prevailed in the case of the taste sensations. It was thought to be impossible to classify these latter satisfactorily on the basis of a few fundamental sensations, but it is now universally accepted that all of our true gustatory sensations show one or more of four primary taste qualities. As was said above, our odor sensations are classified in ordinary life as agreeable or disagreeable, and, indeed, Haller, the great physiologist of the eighteenth century, divided odors along this line into three classes: (1) the agreeable or ambrosial, (2) the disagreeable or fetid, and (3) the mixed odors. In many cases, no doubt, the agreeableness or disagreeableness of an odor depends solely upon the associations connected with it. If the associative memories aroused are unpleasant the odor is disagreeable. Thus, the odor of musk, so pleasant to most persons, produces most disagreeable sensations in others, on account of past associations. It is possible, however, that there is some fundamental difference in physiological reaction between such odors as those of putrefaction and of a violet which may be considered as the cause of the difference in psychical effect. It has been suggested, for instance, that they may affect the circulation in the brain in opposite ways, one producing an increased, the other a decreased flow. This improbable supposition has been shown to be devoid of foundation by the observations of Shields.\* In his experiments the vascular supply to the skin of the arm was determined by plethysmographic methods, and it was found that both pleasant (heliotrope perfume) and unpleasant (putrefactive) odors give a similar vascular reaction. Each class, if it acts at all, causes, as a rule, a constriction of the skin vessels, such as is obtained normally from increased mental activity,—a reaction usually interpreted to mean a greater flow of blood to the brain.

**Fatigue of the Olfactory Apparatus.**—It is a matter of common observation that many odors, such as the perfumes of flowers, quickly cease to give a noticeable sensation when the stimulation is continued. This result is usually attributed to fatigue of the sense cells in the end-organ and it is noticeable chiefly with faint odors. One who sits in an ill-ventilated room occupied by many persons may be quite unconscious of the unpleasant odor from the vitiated air, while to a newcomer it is most distinct.

**Threshold Stimulus—Delicacy of the Olfactory Sense.**—The extraordinary delicacy of the sense of smell in some of the lower animals is seemingly beyond the power of objective measurement or

\* Shields, "Journal of Experimental Medicine," 1, 1896.

expression. The ability of a dog, for instance, to follow the trail of a given person depends undoubtedly upon the recognition of the individual odor, and the actual amount of olfactory material left upon the ground which serves as the stimulus must be infinitesimally small. Even in ourselves the actual amount of olfactory material which suffices to give a distinct sensation is often beyond our means of determination except by the aid of calculation. It is recognized in chemical work, for instance, that traces of known substances too small to give the ordinary chemical reactions may be detected easily by the sense of smell. By taking known amounts

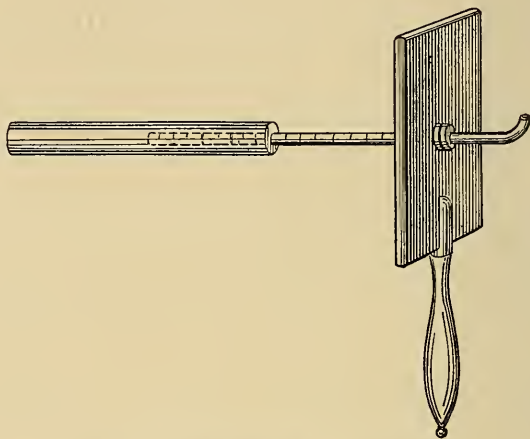

Fig. 123.—Zwaardemaker's olfactometer.

of odoriferous substances and diluting them to known extents it is possible to express in weights the minimal amount of each substance that can cause a sensation. By this method such figures as the following are obtained: Camphor is perceived in a dilution of 1 part to 400,000; musk, 1 part to 8,000,000; vanillin, 1 part to 10,000,000; while, according to the experiments of Fischer and Penzoldt, mercaptan may be detected in a dilution of  $\frac{1}{23000000}$  of a milligram in 1 liter of air or  $\frac{1}{46000000}$  of a milligram in 50 c.c. of air. Various methods have been proposed to determine the relative delicacy of the olfactory sense in different persons, and these methods have some application in the clinical diagnosis of certain cases. Zwaardemaker has devised a simple apparatus, the olfactometer, the principle of which is illustrated in Fig. 123. It consists of an outside cylinder—the olfactory cylinder, whose inner surface is of porous material which can be filled with a known strength of olfactory solution—and an inside tube, smelling tube. This latter is applied to the nose and where it runs inside the cylinder it is gradu-



ated in centimeters. It is evident that the further out the inner tube is pulled the greater will be the amount of olfactory substance which will be exposed to the incoming air of an inspiration.

**Conflict of Olfactory Sensations.**—When different odors are inhaled simultaneously through the two nostrils they may give rise to the phenomenon of a conflict of the olfactory fields similar to that described for the visual fields. That is, we perceive first one then the other without obtaining a fused or compound sensation. The result depends largely on the odors selected. In some cases one odor may predominate in consciousness to the entire suppression of the other,—a phenomenon which also has an analogy in binocular sensations. It is well known, also, that certain odors antagonize or neutralize others. It is said, for instance, that the odor of iodoform, usually so persistent and so disagreeable, may be neutralized by the addition of Peru balsam, and that the odor of carbolic acid may destroy that of putrefactive processes. Whether the neutralization is of a chemical nature or is physiological does not seem to have been definitely ascertained.

**Olfactory Associations.**—Personal experience shows clearly that olfactory sensations arouse numerous associations—our olfactory memories are good. On the anatomical side the cortical center in the hippocampal lobe is known to be widely connected with other parts of the cerebrum, and we have in this fact a basis for the extensive associations connected with odors. In animals like the dog, with highly developed olfactory organs, it is evident that this sense must play a correspondingly large part in the psychical life. In such animals as well as among the invertebrates it is intimately connected with the sexual reflexes, and some remnant of this relationship is obvious among human beings. Among the so-called special senses that of smell is perhaps the one most closely connected with the bodily appetites, and overgratification or over-indulgence of this sense, according to historical evidence, has at least been associated with periods of marked decadence of virtue among civilized nations.

## PHYSIOLOGY OF THE EYE.

The eye is the peripheral organ of vision. By means of its peculiar physical structure rays of light from external objects are focused upon the retina and there set up nerve impulses that are transmitted by the fibers of the optic nerve and optic tract to the visual center in the cortex of the brain. In this last organ is aroused that reaction in consciousness which we designate as a visual sensation. In studying the physiology of vision we may consider the eye, first, as an optical instrument physically adapted to form an image on the retina and provided with certain physiological mechanisms for its regulation; secondly, we may study the properties of the retina in relation to its reactions to light, and lastly, the visual sensations themselves, or the physiology of the visual center in the brain.

---

### CHAPTER XVII.

#### THE EYE AS AN OPTICAL INSTRUMENT—DIOPTRICS OF THE EYE.

**Formation of an Image by a Biconvex Lens.**—That the refractive surfaces of the eye form an image of external objects upon the retinal surface is a necessary conclusion from its physical structure. The fact may be demonstrated directly, however, by observation upon the excised eye of an albino rabbit. The thin coats of such an eye are semitransparent, and if the eye is placed in a tube of blackened paper and held in front of one's own eyes it can be seen readily that a small, inverted image of external objects is formed upon the retinal surface, just as an inverted image of the exterior is formed upon the ground glass plate of a photographic camera. This image is formed in the eye by virtue of the refractive surfaces of the cornea and the lens. The curved surfaces of these transparent bodies act substantially like a convex glass lens, and the physics of the formation of an image by such a lens may be used to explain the refractive processes in the eye. To understand the formation of an image by a biconvex lens the following physical facts must be

borne in mind. Parallel rays of light falling upon one surface of the lens are brought to a point or focus ( $F$ ) behind the other surface (Fig. 124). This focus for parallel rays is the *principal focus* and the distance of this point from the lens is the *principal focal distance*. This distance depends upon the curvature of the lens and its refractive power, as measured by the refractive index of the material of which it is composed. Parallel rays are given theoretically by a source of light at an infinite distance in front of the lens, but practically objects not nearer than about twenty feet give rays so little divergent that they may be considered as par-

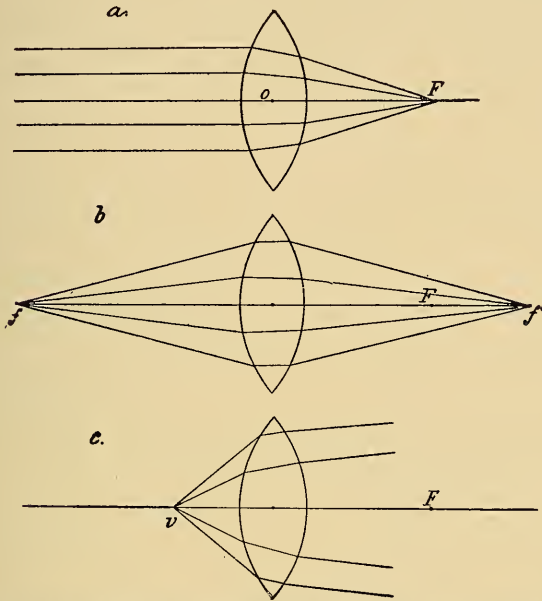

Fig. 124.—Diagrams to illustrate the refraction of light by a convex lens: a., Refraction of parallel rays; b., refraction of divergent rays; c., refraction of divergent rays from a luminous point nearer than the principal focal distance.

allel, so far as the optical apparatus of the eye is concerned. On the other hand, if a luminous object is placed at  $F$  the rays from it that strike upon the lens will emerge from the other surface as parallel rays of light. If a luminous point ( $f$ , Fig. 124) is placed in front of such a lens at a distance greater than the principal focal distance, but not so far as to give practically parallel rays, the cone of diverging rays from it that impinges upon the surface of the lens will be brought to a focus ( $f'$ ) further away than the principal focus. Conversely, the rays from a luminous point at  $f'$  will be brought to a focus at  $f$ . These points,  $f$  and  $f'$ , are, therefore, spoken of as conjugate foci. All luminous

points within the limits specified will have their corresponding conjugate foci, at which their images will be formed by the lens. Lastly, if a luminous point is placed at  $v$ , Fig. 124, nearer to the lens than the principal focal distance, the cone of strongly divergent rays that falls upon the lens, although refracted, is still divergent after leaving the lens on the other side and consequently is not focused and forms no real image of the point. For every lens there is a point known as the optical center, and for biconvex lenses this point lies within the lens,  $o$ . The line joining this center and the principal focus is the *principal axis* of the lens ( $o-F$ , Fig. 124). All other straight lines passing through the optical center are known as *secondary axes*. Rays of light that are coincident with any of these secondary axes suffer no angular deviation in passing through the lens; they emerge parallel to their line of entrance and practically unchanged in direction. Moreover, any luminous point not on the

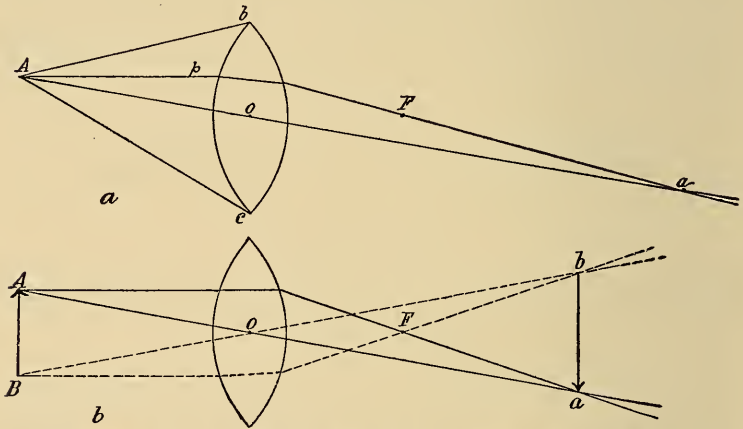

Fig. 125.—Diagrams to illustrate the formation of an image by a biconvex lens: *a*, Formation of the image of a point; *b*, formation of the images of a series of points.

principal axis will have its image (conjugate focus) formed somewhere upon the secondary axis drawn from this point through the optical center. The exact position of the image of such a point can be determined by the following construction (Fig. 125): Let  $A$  represent the luminous point in question. It will throw a cone of rays upon the lens, the limiting rays of which may be represented by  $A-b$  and  $A-c$ . One of these rays,  $A-p$ , will be parallel to the principal axis, and will therefore pass through the principal focus,  $F$ . If this distance is determined and is indicated properly in the construction, the line  $A-p$  may be drawn, as indicated, so as to pass through  $F$  after leaving the lens. The point at which the prolongation of this line cuts the secondary axis,  $A-o$ , marks the

conjugate focus of  $A$  and gives the position at which all of the rays will be focused to form the image,  $a$ . In calculating the position of the image of any object in front of the lens the same method may be followed, the construction being drawn to determine the images for two or more limiting points, as shown in Fig. 125. Let  $A-B$  be an arrow in front of the lens. The image of  $A$  will be formed at  $a$  on the secondary axis  $A-o$ , and the image of  $B$  at  $b$  along the secondary axis  $B-o$ . The images of the intervening points will, of course, lie between  $a$  and  $b$ ; so that the image of the entire object will be that of an inverted arrow. This image may be caught on a screen at the distance indicated by the construction if the latter is drawn to scale. The principal focus of a convex lens may be determined experimentally or it may be calculated from the formula  $\frac{1}{p} + \frac{1}{p^1} = \frac{1}{f}$ , in which  $f$  represents the principal focal distance and  $p$  and  $p^1$ , the conjugate foci for an object farther away than the principal focal distance. That is, if the distance of the object from the lens,  $p$ , is known, and the distance of its image,  $p^1$ , is determined experimentally, the principal focal distance of the lens,  $f$ , may be determined by the formula. The principal focus of a lens may be calculated also from the radius of curvature, according to the formula,  $F = \frac{R}{n-1}$ , in which  $F$  = the principal focus,  $R$  = the radius, and  $n$  = the refractive index of the material. Since in glass,  $n$  = approximately 1.5, the formula for this material works out  $F = 2 R$ .

**Formation of an Image by the Eye.**—As stated above, the refractive surfaces of the eye act essentially like a convex lens. As a matter of fact, these refractive surfaces are more complex than in the case of the biconvex lens. In the latter the rays of light suffer refraction at two points only. Where they enter the lens they pass from a rarer to a denser medium and where they leave the lens they pass from a denser to a rarer medium. At these two points, therefore, they are refracted. In the eye there is a larger series of refractive surfaces. The light is refracted at the anterior surface of the cornea, where it passes from the air into the denser medium of the cornea; at the anterior surface of the lens, where it again enters a denser medium; and at the posterior surface of the lens, where it enters the less dense vitreous humor. The relative refractive powers of these different media have been determined and are expressed in terms of their refractive indices, that of air being taken as unity.\*

\* The term index of refraction expresses the constant ratio between the angles of incidence and of refraction, or specifically between the sine of the angle of incidence and the sine of the angle of refraction:  $\frac{\text{sine } i}{\text{sine } r} = \text{index of refraction}$ .

Index of refraction for air.....	= 1
Index of refraction for cornea and aqueous humor.....	= 1.3365
Index of refraction for crystalline lens.....	= 1.4371
Index of refraction for vitreous humor.....	= 1.3365

The three points at which the light is refracted are indicated in the accompanying schema (Fig. 126). The refractive surfaces of the eye may be considered as being composed of a concavo-convex lens, the cornea and aqueous humor, and a biconvex lens, the crystalline lens. In a system of this kind, composed of several refractive media, it has been shown that to construct geometrically

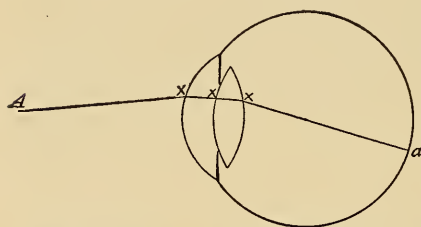

Fig. 126.—Diagram to illustrate the surfaces in the eye at which the rays of light are chiefly refracted.

the path of the rays it is necessary to know six points; these are the six cardinal points or optical constants of Gauss,—namely, the anterior and the posterior focal distance, the two nodal points, and the two principal points. So far as the eye is concerned, it has been shown that the path of the rays of light

may be represented with sufficient accuracy by employing what is known as the reduced schematic eye of Listing, in which the refraction is supposed to take place at a single convex surface separating two media, the air on one side and the humor of the eye on the other, the latter having a refractive index of 1.33 (see Fig. 127). In this reduced eye the position of the ideal refracting surface  $c'$  lies in the aqueous humor, at a distance of 2.1 mms. from the anterior surface of the cornea, and the position of the nodal point or optical center—that is, the center of curvature of the ideal refracting surface, lies in the crystalline lens at  $n$ , a distance of 7.3 mms. from the anterior surface of the cornea. The principal focal distance for this refracting surface lies at a distance of 20.7 mms., which would be equivalent to 22.8 mms. (20.7 + 2.1)

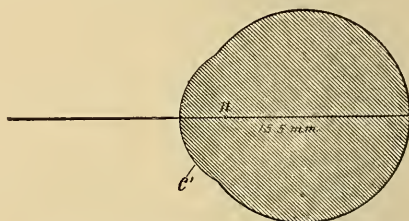

Fig. 127.—Diagram to illustrate the reduced or schematic eye with a single refracting surface separating two media of different densities:  $c'$ , the ideal refracting surface situated 2.1 mms. behind the anterior surface of real cornea;  $n$ , the nodal point, or center of curvature of the surface  $c'$ , and 15.5 mms. in front of retina. The eyeball is supposed to be filled with a uniform substance having a refractive index of 1.33, equal to that of the vitreous humor.

from the actual surface of the cornea and 15.5 mms. (22.8 — 7.3) from the nodal point. In the eye at rest this principal focal

distance coincides with the retina, since the refracting surfaces in the normal resting eye are so formed that parallel rays (rays from distant objects) are brought to a focus on the retina. To show the formation of the image of an external object on the retina it suffices, therefore, to use a construction such as is represented in Fig. 128. Secondary axes are drawn from the limiting points of the object—*A* and *B*—through the nodal point. Where these axes cut the retina the retinal image of the object will be formed. That is, all the rays of light proceeding from *A* that penetrate the eye will be focused at *a*, and all proceeding from *B* at *b*. The image on the retina will therefore be inverted and will be smaller than the object. The angle formed at the nodal point by the lines *A*-*n* and *B*-*n* is known as the *visual angle*; it varies inversely with the distance of the object from the eye.

**The Inversion of the Image on the Retina.**—Although the images of external objects on the retina are inverted, we see them erect. This fact is easily understood when we remember that our actual visual sensations take place in the brain and that the projection of these sensations to the exterior is a secondary act that has been learned from experience. Experience has taught us to project the visual sensation arising from the stimulation of any given point on the retina to that part of the external world from which the stimulus arises—that is, to the luminous point giving origin to the light rays. According to the physical principles described above, the image of such a point must be formed on the retina where the secondary axis from that point through the nodal point touches the retina. In projecting this retinal stimulus outward to its source, therefore, we have learned to project it back, as it were, along the line of its secondary axis. In Fig. 128 the retinal stimulus at *a* is projected outward along the line *a*-*n*-*A*, and to such a distance as, from other sources, we estimate the object *A* to be. This law of projection is fixed by experience, but it implies, as will be noted, that we are conscious of the differences in sensation aroused by stimulation of different parts of the retina. Considering the retina as a sensory surface, —like the skin, for instance,—each point, speaking in general terms, may be assumed to be connected with a definite portion of the cortex, and the sensation aroused by the stimulation of these different points must differ to some extent in consciousness, each has

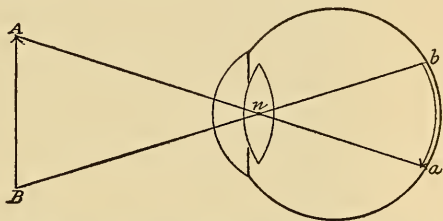

Fig. 128.—Diagram to illustrate the construction necessary to determine the location and size of the retinal image.

its local sign. The sensations arising from each of these points we have learned to project outward into the external world along the line from it to the nodal point of the eye, because under the normal conditions of life this point is stimulated only by external objects situated on this line. This law of projection is so firmly fixed that if a given point in the retina is stimulated in some unusual way we still project the resulting sensation outward according to the law, and thus make a false projection and interpretation. For instance, if the little finger is inserted into the inner and lower angle of the eye and is pressed upon the eyeball the edge of the retina is stimulated mechanically. One experiences, in consequence, a visual sensation, known as a phosphene, consisting of a dark-blue spot surrounded by a light halo. This sensation, however, is projected out toward the upper and outer angle of the eye, according to the law of projection, since normally this part of the retina is only stimulated by light coming from such a direction. A similar error in projection is obtained by holding objects so close to the eye that a physical inverted image cannot be formed, but only an erect shadow image. This experiment may be performed as follows: Hold the head of a pin close to the eye, and, in order that a sharp shadow may be thrown, allow the light to fall on this pin through a pinhole in a card held somewhat farther from the eye. By this means an erect shadow of the pin, lying in the circle of light from the hole, will be thrown on the eye. This shadow image will be projected outward according to the usual law, and consequently will appear inverted.

**The Size of the Retinal Image.**—The size of the image of an object on the retina may be reckoned easily, provided the size of the object and its distance from the eye is known. As will be seen from the construction given in Fig. 128, the triangles  $A-n-B$  and  $a-n-b$  are symmetrical; consequently we have the ratio:

$$A-B : a-b :: A-n : a-n \quad \text{or}$$

$$\frac{A-B}{a-b} = \frac{A-n}{a-n}; \text{ that is}$$

$$\frac{\text{Size of object}}{\text{Size of image}} = \frac{\text{Distance of object from nodal point.}}{\text{Distance of image from nodal point.}}$$

As was stated above, the distance of the image from the nodal point—that is, the distance of the retina from the nodal point—may be placed at 15.5 or 15 mms. Consequently, three of the factors in the above equation being known, it is easily solved for the unknown factor—namely, the size of the image on the retina. To take a concrete example; suppose it is desired to know the size on the retina of the image made by an object 120 feet high at a distance of one mile (5280 feet). If we designate the size of the image as  $x$  and substitute the known values for the other terms of the equation.



we have  $\frac{120}{x} = \frac{5280}{15}$ , or  $x = 0.341$  mm., which is about the diameter of the fovea centralis. The retinal image of the object in this case would be, in round numbers, about  $\frac{1}{1000} \frac{1}{1000}$  of the actual height of the object.

**Accommodation of the Eye for Objects at Different Distances.**—The normal or, as it is sometimes named, the emmetropic eye, is arranged to focus parallel rays more or less accurately upon the retina. That is, the refractive media have such curvatures and densities that parallel, or substantially parallel rays are brought to a focus upon the retinal surface. When objects are brought closer to the eye, however, the rays proceeding from them become more and more divergent. If the eye remains unchanged the refracted rays cut the retina before coming to a focus—so that each luminous point in the object, instead of forming a point upon the

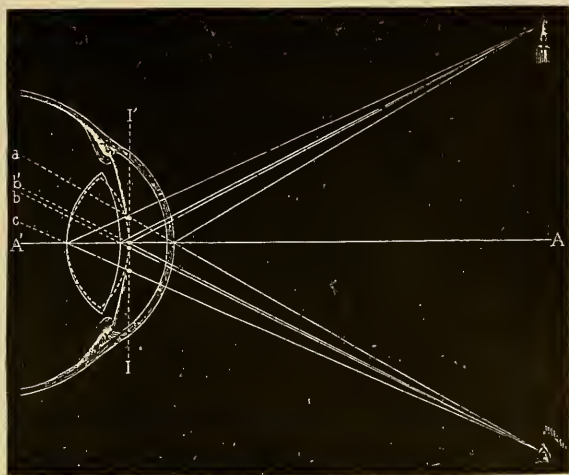

Fig. 129.—Diagram explaining the change in the position of the image reflected from the anterior surface of the crystalline lens.—(Williams, after Donders.)

retina, forms a circle, known as a *diffusion circle*. As this is true for each point of the object, the retinal image as a whole is blurred. We know, however, that up to a certain point at least this blurring does not occur when the object is brought closer to the eyes. The eye, in fact, accommodates itself to the nearer object so as to obtain a clear focus. In a photographic camera this accommodation or focusing is effected by moving the ground glass plate farther away as the object is brought closer to the lens. In the eye the same result is obtained by increasing the curvature and therefore the refractive power of the lens. That a change in the lens is the essential factor in accommodation for near objects is demonstrated by a simple and conclusive experiment devised by

Helmholtz with the aid of what are known as the images of Purkinje. The principle of this experiment is represented by the diagram given in Fig. 129. The eye to be observed is relaxed; that is, gazes into the distance. A lighted candle is held to one side as represented, and the observer places his eye so as to catch the light of the candle when reflected from the observed eye. With a little practice and under the right conditions of illumination the observer will be able to see three images of the candle re-



Fig. 130.—Reflected images of a candle flame as seen in the pupil of an eye at rest and accommodated for near objects.—(Williams.)

flected from the observed eye as from a mirror: one, the brightest, is reflected from the convex surface of the cornea (*a*, Fig. 130, *A*); one much dimmer and of larger size is reflected from the convex surface of the lens (*b*, Fig. 130, *A*). This image is larger and fainter because the reflecting surface is less curved. The third image (*c*, Fig. 130, *A*) is inverted and is smaller and brighter than the second. This image is reflected from the posterior surface of the lens, which acts, in this instance, like a concave mirror. If now the observed eye gazes at a near object, it will be noted (Fig. 130, *B*) that the first image does not change at all, the third image also remains practically the same, but the middle image (*b*) becomes smaller and approaches nearer to the first (*a*). This result can only mean that in the act of accommodation the anterior surface of the lens becomes more convex. In this way its refractive power is increased and the more divergent rays from the near object are focused on the retina. Helmholtz has shown that the curvature of the posterior surface of the lens is also increased slightly; but the change is so slight that the increased refractive power is referred chiefly to the change in the anterior surface. The means by which the change is effected was first explained satisfactorily by Helmholtz.\* He attributed it to the contraction of the ciliary muscle. This small muscle, composed of plain muscle fibers, is found within the eyeball, lying between the choroid and the sclerotic coat at the point at which the sclerotic passes into the cornea and the choroid falls into the ciliary

\* Helmholtz, "Handbuch der physiologischen Optik," second edition, 1896.

processes. Some of its fibers take a more or less circular direction around the eyeball, resembling thus a sphincter muscle, while others take a radial direction in the planes of the meridians of the eye and have their insertion in the choroid coat (Fig. 131). When this muscle contracts the radial fibers especially will pull forward the choroid coat. The effect of this change in the choroid is to loosen the pull of the suspensory ligament (zonula Zinnii) on the lens and this organ then bulges forward by its own elasticity. The theory assumes that in a condition of rest the suspensory ligament, which runs from the ciliary processes to the capsule of the lens, exerts a

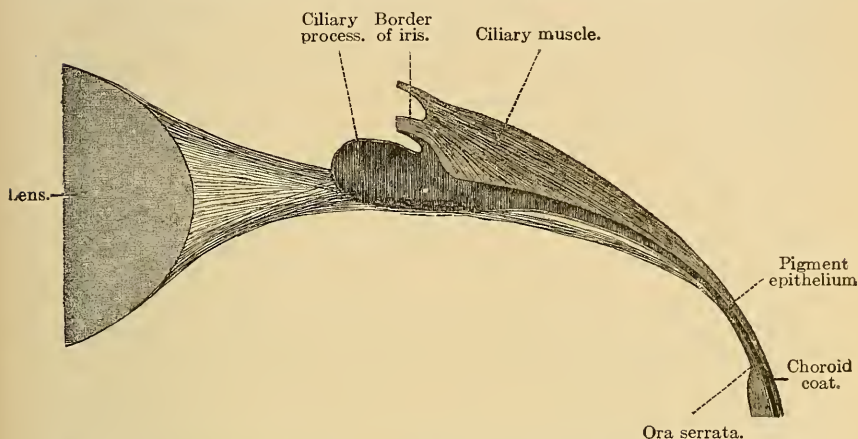

Fig. 131.—Meridional section of eyeball after removal of sclerotic coat, cornea, and iris, to show the position of the ciliary muscle.—(Schultze.)

tension upon the lens which keeps it flattened, particularly along its anterior surface, since the ligament is attached more to this side. When this tension is relieved indirectly by the contraction of the ciliary muscle the elasticity of the lens, or rather of the capsule of the lens, causes it to assume a more spherical shape along its anterior surface, and the amount of this change is proportional to the extent of contraction of the muscle. Other theories have been proposed to explain the way in which the contraction of the ciliary muscle effects a change in the curvature of the lens,\* but none is so simple and, on the whole, so satisfactory as the one suggested by Helmholtz.

It is interesting to note that in fishes accommodation is effected in a different way, namely, by movements of the lens forward and backward. In these animals the eye when at rest is accommodated for near vision, and to see objects at a distance the refractive power of the eye is diminished by the contraction of a special muscle, *retractor lentis*, which pulls the lens toward the retina.†

\* See Tscherning, "Optique physiologique," Paris, 1898; and Schoen, "Archiv f. die gesammte Physiologie," 59, 427, 1895.

† See Beer, "Wiener klinische Wochenschrift," 1898, No. 12.

**Limit of the Power of Accommodation—Near Point of Distinct Vision.**—When an object is brought closer and closer to the eye a point will be reached at which it is impossible by the strongest contraction of the ciliary muscle to obtain a clear image of the object. The rays from it are so divergent that the refractive surfaces are unable to bring them to a focus on the retina. Each luminous point makes a diffusion circle on the retina, and the whole image is indistinct. The distance at which the eye is just able to accommodate and within which distinct vision is impossible is called the *near point*. Observation shows that this near point varies steadily with age and becomes rapidly greater in distance between the fortieth and the fiftieth year. In the case of the normal eye the recession of the near point varies so regularly with age that its determination may be used to estimate the age of the individual. Figures of this kind are given (see also p. 318):

AGE.	NEAR POINT.	
10.....	7	cm. or 2.76 in.
20.....	10	“ “ 3.94 “
30.....	14	“ “ 5.61 “
40.....	22	“ “ 8.66 “
50.....	40	“ “ 15.75 “
60.....	100	“ “ 39.37 “

This gradual lengthening of the near point is explained usually by the supposition that the lens loses its elasticity, so that contraction of the ciliary muscle has less and less effect in causing an increase in its curvature. The process starts very early in life, and is one of the many facts which show that senescence begins practically with birth. The change in near point in early life is so slight as to escape notice, but after it reaches a distance of about 25 cm. (about 10 inches) the fact obtrudes itself upon us in the use of our eyes for near objects,—**reading**, for example. The condition is then designated as **old-sightedness** or *presbyopia*. Most normal eyes become so distinctly presbyopic between the fortieth and the fiftieth year as to require the use of glasses in reading. If no other defect exists in the eye, this deficiency of the lens is readily overcome by using suitable convex glasses to aid the eye in focusing the rays. It is obvious that in such cases the glasses need not be used except for near work.

**Far Point of Distinct Vision.**—The normal eye is so adjusted that parallel rays are brought to a focus on the retina. The far point is therefore theoretically at infinity. Objects at a great distance are seen distinctly, as far as their size permits, without accommodation,—that is, with the eye at rest. Practically it is found that objects at a distance of 6 to 10 meters (20 to 30 feet) send rays that are sufficiently parallel to focus on the retina without muscular effort on the part of the eyes, and this distance, therefore, measures the practical far point, *punctum remotum*, of the normal

eye. The rays at this distance are, in reality, somewhat divergent, and that they produce a distinct image without an act of accommodation may be due to the fact that the rods and cones, the really sensitive part of the retina, do not form a mathematical plane, but have a certain thickness or depth. In the fovea centralis, for instance, the cones have a length estimated (Greeff) at  $85 \mu$  (0.085 mm.), and since the displacement of the focus of an object moved from an infinite distance (parallel rays) to 6 or 10 meters from the eye is less than this amount, the focused image would continue to fall on some part of the cones without the aid of the mechanism of accommodation.

**The Refractive Power of the Eye and the Range of Accommodation.**—The refractive power of lenses is expressed usually in terms of their principal focal distance. A lens with a distance of one meter is taken as the unit and is designated as having a refractive power of one diopter, 1 D. Compared with this unit, the refractive power of lenses is expressed in terms of the reciprocal of their principal focal distance measured in meters; thus, a lens with a principal focal distance of  $\frac{1}{10}$  meter is a lens of 10 diopters, 10 D., and one with a focal distance of 10 meters is  $\frac{1}{10}$  diopter (0.1 D.). In expressions of this kind it is assumed that the lens is surrounded by air on both sides. In the case of the eye, in which there is air on one side and liquid (humor) on the other, it is necessary to distinguish between an anterior and a posterior focal distance, according as the rays of light are conceived as passing from the air into the eye and forming their focus in the vitreous humor (posterior principal focus), or as passing in the opposite direction and forming their focus in the air (anterior principal focus). The posterior principal focal distance (reduced eye) may be given as 20 + mm., while the anterior focal distance is equal to 15 mm. (13 mm. in front of cornea). Compared with a glass lens in air, the equivalent refractive power of the eye is equal to 50 D ( $\frac{1000}{20}$ ), reckoned for the posterior focal distance, or 66 D ( $\frac{1000}{15}$ ), reckoned for the anterior focal distance. In the combined system of cornea and lens the action of the cornea is more important than that of the lens. Removal of the lens, as in cataract operations, does not lessen the refractive power of the eye so much as when the action of the cornea is destroyed, as happens for the most part when the head is immersed in water. The total refractive power of the eye is increased by the act of accommodation, on account of the greater curvature of the lens. As stated in a preceding paragraph, the extent of accommodation varies with age. At ten years the range is from infinity, when the eye is at rest, to 7cm. when the maximum accommodation is used. In other words, the increased curvature of the front of the crystalline lens in maximal accommodation adds to the refractive power

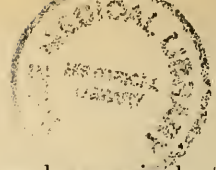

of the eye an amount which may be expressed as equivalent to  $14 + D \left(\frac{1000}{70}\right)$ . It is as though the eye were left at rest and a glass lens of  $14 + D$  were placed against the cornea. The decreasing range of accommodation as age increases is expressed conveniently in the number of diopters which may be added to the refractive power of the eye by the action of the ciliary muscle.

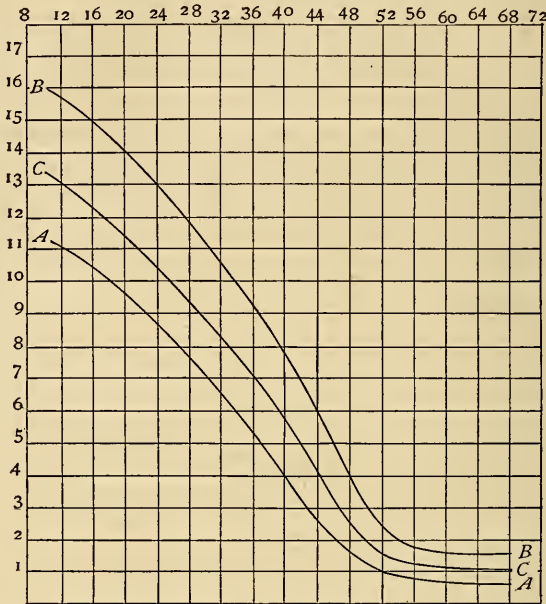

Fig. 131a.—Curves showing the variation in the range of accommodation with age. Figures along the abscissa represent years; figures along the ordinate represent diopters of accommodation: C C, Represents the mean or average of over 1000 cases, while A A and B B gives the extremes noted in their cases. It should be stated that the maximum accommodation or near point was reckoned from the anterior principal focus (13 mm. in front of the cornea) instead of from the anterior surface of the cornea (Duane).

The following table illustrates the usual range of accommodation for different ages. (Somewhat different results are expressed in the curve\* represented in Fig. 131a):

Years.	Range of accommodation in diopters.
10	14
15	12
20	10
25	8.5
30	7
35	5.5
40	4.5
45	3.5
50	2.5
55	1.75
60	1
65	0.75
70	0.25

\* Duane, "The Ophthalmoscope," Sept., 1912.

**Optical Defects of the Normal Eye.**—The refractive surfaces of the eye exhibit some of the optical defects commonly noticed in lenses, particularly those defects known as chromatic and spherical aberration. White light is composed of ether waves of different lengths and different rapidities of vibration, the shortest waves being those at the violet end of the spectrum and the longest those at the red end. In passing through a prism or lens these waves are refracted unequally and are therefore more or less dispersed according to the character of the refracting medium. The short, rapid waves at the violet end are refracted the most and are brought to a focus before the longer, red waves, so that the image shows fringes of color instead of being pure white. This phenomenon is known as chromatic aberration. Lenses used for scientific purposes are corrected for this defect or made achromatic by a combination of lenses of crown and flint glass so placed that the dispersive power of one neutralizes that of the other. The eye exhibits this defect, but not to such an extent as to be noticeable in ordinary vision. If, however, an object is in focus when viewed by red light it can be shown that the focus must be changed if the same object is illuminated by violet light. Helmholtz estimates that if the media of the eye possess the same dispersive power as water the rays of violet light must be brought to a focus at about 0.434 mm. in front of that of the red rays.

*Spherical aberration* depends upon the fact that the rays near the circumference of a lens are refracted more and therefore are brought to a focus sooner than those entering nearest the center. This defect may be noticed in an uncorrected lens by the fact that when the center of the image is in exact focus its margins are slightly out of focus and *vice versa*. The defect is usually corrected, as in photography, by use of a diaphragm to cut off the rays from the periphery of the lens. In the eye both spherical and chromatic aberrations are remedied to a large extent by a similar device. The iris constitutes an adjustable diaphragm, which reflexly narrows as the light increases in intensity and thus cuts off the rays that would go through the periphery of the lens. The interesting physiological control of the movements of the iris is described below. In the eye the defect of spherical aberration is counteracted also by the peculiar structure of the crystalline lens. This organ is composed of concentric layers whose density increases toward the center. The result of this arrangement is that the center of the lens is more refractive than the periphery, and the tendency of the latter portion to refract more strongly is more or less neutralized.

**Abnormalities in the Refraction of the Eye—Ametropia.**—The eye that is normal and in which parallel rays focus on the retina when the eye is at rest is designated as emmetropic. Any

abnormality in the refractive surfaces or the shape of the eyeball prevents this exact focusing of parallel rays and makes the eye ametropic. The most common refractive troubles of the eye are due to short-sightedness or myopia, far-sightedness or hypermetropia, astigmatism, and old-sightedness or presbyopia. Some description of these conditions is useful to emphasize by contrast the mode of action of the dioptric mechanism in the normal eye, but for a full description of the extent and complexity of these defects reference must be made to special treatises upon the errors of refraction in the eye.

In *myopia* or near-sightedness parallel rays of light are brought to a focus before reaching the retina. Consequently when the rays fall upon the retina each point forms a diffusion circle and the image is indistinct. This defect may be due to an abnormally great curvature of the refractive surfaces, the cornea or the lens, or to an abnormal length of the eyeball in its anteroposterior diameter. The latter cause is the more common. The defect may be congenital, but usually it is acquired, and in the latter case its cause is generally attributed to a weakness in the coats of the eyeball. The interior of the eye is under some pressure, intra-ocular tension, which is estimated to be equal to the pressure of a column of mercury 25 to 30 mms. in height. This tension is increased by strong convergence of the eyeballs in looking at near objects. If the coats of the eye are weak or become so from disease or malnutrition they may yield somewhat to this pressure and the eyeball become lengthened in the anteroposterior diameter. The condition as regards refraction of parallel rays is represented then by the diagram *B*, in Fig. 132. The retina is farther away than the principal focal distance of the refractive surfaces, and if the defect is excessive even diverging rays may not be focused. The obvious remedy for such a condition is to use concave lenses before the eyes for distant vision. By this means, if the lenses are properly chosen, the rays will be given such an amount of divergence that the focus will be thrown back to the retina. As compared with the normal or emmetropic eye, the myopic eye has its far point of distinct vision—that is, the farthest point that can be seen distinctly without an effort of accommodation—less than twenty feet from the eye, the exact distance depending upon the extent of the myopia. On the contrary, the near point of distinct vision—that is, the nearest point at which distinct vision can be obtained with the aid of the muscles of accommodation—is closer than in the normal eye. Much of the prevalent myopia in the young is attributed by oculists to bad methods in reading, such as insufficient lighting, small print, and a faulty position of the book. Such conditions lead to an excessive muscular effort and thus aggravate any tendency that exists toward the development of a near-sighted condition.



In *hypermetropia* the conditions are the opposite of those in myopia. Parallel rays of light after refraction in the eye cut the retina before they come to a focus. The principal focal distance, in other words, is behind the retina. In this case, also, each point of a distant object will make upon the retina, when the eye is not accommodated, a diffusion circle, and the image consequently is blurred. This defect may be caused by a lessened curvature or refractive power in the cornea or lens, but in the majority of cases it is referable to a diminution in the anteroposterior diameter of the eyeball. This condition is usually congenital:

the eyeball from birth is smaller than the normal. The path of the parallel rays in this case is represented in the diagram *C*, Fig. 132. When such an eye looks at a distant object a clear image may be obtained only by using the ciliary muscle, and to prevent this constant strain upon the muscle of accommodation convex glasses must be worn. Glasses of this kind converge the rays and if properly chosen will bring parallel rays to a focus without the constant aid of accommodation. It is obvious that in the hypermetropic eye there is no far point of distinct vision when the eye is at rest, since some accommodation must be used to bring even parallel rays to a focus. The near point of distinct vision will be farther away than in the normal eye, since accommodation begins when the rays are parallel and its limits are reached with a less degree of divergence; hence the name of far-sightedness.

*Presbyopia* or old-sightedness has been referred to above. It is due to a gradual failure in the effectiveness of accommodation with increasing age, and is attributed usually to a progressive increase of rigidity in the lens. The near point of distinct vision

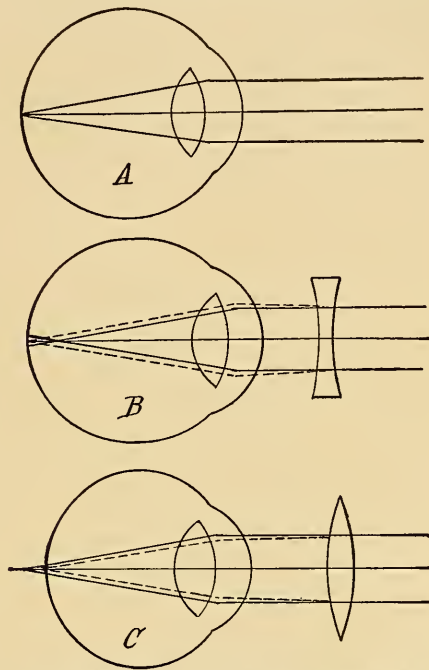

Fig. 132.—Diagram showing the difference between normal (*A*), myopic (*B*), and hypermetropic (*C*) eyes. In *B* and *C* the dotted lines represent the path of the rays after correction by glasses.—(Bowditch.)

recedes farther and farther from the eye, and consequently in close work convex glasses must be worn to aid the accommodation. It is obvious that this effect of old age will be less noticeable in the myopic than in the emmetropic eye, since in the former the greater length of the eyeball requires less accommodation in near vision and the failure of the lens to refract is therefore not felt so soon. What is known as second-sight in the old may be brought about by the late development of a myopic condition,—that is, by a change in the length of the eyeball or by a swelling of the crystalline lens,—and in such a case convex glasses for near work may be dispensed with.

*Astigmatism.*—In a perfectly normal or ideal eye the refractive surfaces, cornea, anterior and posterior surfaces of the lens, are sections of true spheres, and, all the meridians being of equal curvature, the refraction along these different meridians is equal. Such an eye will bring the cone of rays proceeding from a luminous point to a focal point on the retina, barring the disturbing influence of chromatic and spherical aberration. If, however, one or all of the refractive surfaces have unequal curvatures along different meridians, then it is obvious that the rays from a luminous point can not be brought to a focal point, since the rays along the meridian of greater curvature will be brought to a focus first and begin to diverge before the rays along the lesser curvature are focused. Such a condition is designated as astigmatism (from *a*, not, and *στίγμα*, point). The effect may be illustrated by the diagram in Fig. 133, which represents the refraction of the rays from a luminous point by a lens whose curvature along the vertical meridian is greater than along the horizontal meridian.

The rays along the vertical meridian are brought to a focus first at *G*, but those from the horizontal meridian are still converging; so that a screen placed at this point will give the image of a horizontal line (*a-a'*). The rays along the horizontal meridian are brought to a focus at *B*, but those from focus *G* have by this time spread out in a vertical plane, so that a screen placed at this point will give the image of a vertical line (*b-c*). In between the images will be elliptical or circular, as represented in the diagram. In the eye astigmatism may be due to an inequality in curvature of either the cornea or the lens, and may be either regular or irregular. By regular astigmatism is meant that condition in which while the curvature along each individual meridian is equal throughout its course, the curvatures of the different meridians vary regularly from a maximum to a minimum, and in such a way that the meridians of greatest and least curvature are at right angles to each other or approximately so. In other words, the curvature of the refractive surfaces of the eye is such as would be obtained by adding a cylindrical to a spherical lens. Ordinary astig-

matism is of the regular variety, and is usually attributed to a defect in the curvature of the cornea. If the astigmatism is such that the vertical meridian has the greatest curvature it is termed "with the rule," since usually this meridian is slightly more curved than the horizontal one. If, on the contrary, the curvature along the horizontal meridian is greater, the astigmatism is "against the rule." The meridians of greatest and least curvature may not lie in the vertical and horizontal planes, but in some of the oblique planes; but so long as they are at right angles the astigmatism is regular. It is evident that such a condition may be corrected by the use of cylindrical lenses, so chosen as to increase the refraction along the meridian in which the cornea has the least curvature, in which case a convex or plus cylinder is used, or, on the other hand, to diminish appropriately the refraction along the meridian of greatest curvature, in which case a concave or minus cylinder is used. An eye that suffers from a marked

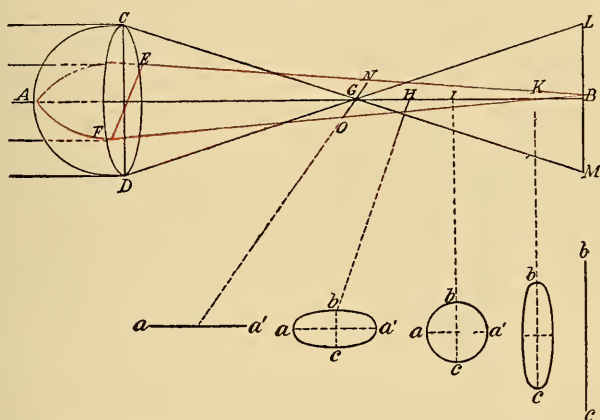

Fig. 133.—Schema to illustrate the paths of the rays of light in a cornea showing regular astigmatism.—(McKendrick.) The lower line of figures represents the section of the cone of light, or the images obtained at different distances. The image varies from a horizontal to a vertical line, but at no place can a point be obtained at which rays along all meridians are focused.

degree of astigmatism cannot focus distinctly at the same time lines that are at right angles to each other; hence, the use of a series of lines whose images are formed along the different meridians of the eye, as shown in Fig. 134, may be used to reveal this defect if it exists. If one looks at such a chart through a convex lens, *e. g.*, a lens of 5 or 10 diopters, and, starting from a distance at which the lines are all blurred, brings it gradually nearer to the eye, it will be observed, if the eye is astigmatic, that the lines do not all come into focus at once. If one meridian, for example, that of 90°, comes into focus first, then at that distance the meridian at right angles, 180°, will appear most blurred. A normal

eye can be thrown into an astigmatic condition by approximating the eyelids closely. In this position the tears make a concave cylindrical lens, which alters the curvature along the vertical meridian. What is known as irregular astigmatism is due to the fact that the meridians of greatest and least curvature are not at approximately right angles, or, as is more commonly the case, it is due to an irregularity in the curvature along some one meridian, such as may be produced by a scar upon the cornea. This condition may be produced from a variety of causes affecting either the cornea or the lens, and practically it cannot be corrected by the use of lenses. As Helmholtz has shown,

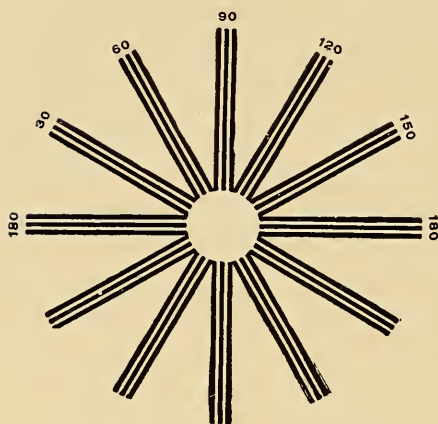

Fig. 134.—Astigmatic chart.

a small degree of irregular astigmatism is present normally, owing to a certain asymmetry in the curvature of the lens. This defect is made apparent in the visual sensations caused by a point of light, such as is furnished, for instance, by a fixed star. The retinal image in these cases, instead of being a symmetrical point, is a radiate figure the exact form of which may vary in different eyes. For this reason the fixed stars give us the well-known star-shaped image instead of a clearly defined point.

**Innervation and Physiological Control of the Ciliary Muscle and the Muscles of the Iris.**—From an optical point of view the iris plays the part of a diaphragm. It is, moreover, an adjustable diaphragm the aperture of which—that is, the size of the pupil—is varied reflexly according to the conditions of illumination. Its adjustments are made possible by the fact that it contains within its substance two bands of muscular tissue, one, the sphincter muscle, forming a circular ring whose contraction diminishes the aperture of the pupil, and the other a dilator muscle whose contraction widens the pupil. Each of these muscles possesses its own nerve fibers that arise ultimately from the brain, and through these fibers reflex movements of great delicacy are effected. The sphincter pupillæ is a well-defined band of plain muscle whose width varies, according to the state of contraction, from 0.6 to 1.2 mms.; it forms a ring lying just on the margin of the pupil, and it is imbedded in the stroma of the iris. The histological differentiation

of the dilator pupillæ is much less distinct. For a long time its existence was the subject of controversy, but it is now conceded that such a muscle is present in the form of a layer of elongated spindle-like cells which lie close to the pigment layer of the iris and form radial bundles stretching from the ciliary border of the iris toward the pupillary orifice.\* Both of these muscles are supplied by autonomic nerve fibers—that is, the motor nerve path comprises a preganglionic fiber, arising from the central nervous system, and a postganglionic fiber, arising from a sympathetic ganglion. Anatomically it can be shown that the sphincter muscle is supplied by the short ciliary nerves arising from the ciliary ganglion, which supply also the

muscle of accommodation, the ciliary muscle; while the dilator muscle is supplied by the long ciliary nerves that arise from the ophthalmic branch of the fifth cranial nerve, as represented in Fig. 135. The entire course of the motor paths, preganglionic and postganglionic fibers, is represented diagrammatically in Fig. 136. The motor fibers to the ciliary muscle and sphincter pupillæ arise in the mid-brain in the nucleus of origin of the third cranial nerve, and indeed in a special part of this nucleus lying most anteriorly. They leave the third nerve in the orbit and end within the substance of the ciliary ganglion, whence the path is continued by sympathetic (postganglionic) fibers emerging from the ganglion in the short ciliary nerves. The fibers to the dilator

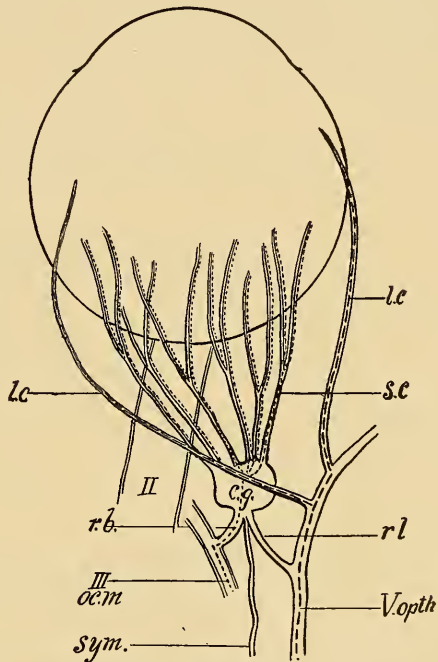

Course of constrictor nerve fibers,.....  
 Course of dilator nerve fibers,-----

Fig. 135.—Diagrammatic representation of the nerves governing the pupil (after Foster): II, Optic nerve; c.g., ciliary ganglion; r.b., its short root from III, motor oculi nerve; sym., its sympathetic root; rl, its long root from V, ophthalmic branch of ophthalmic division of fifth nerve; s.c., short ciliary nerves; l.c., long ciliary nerves.

\* For a physiological proof and the literature of the controversy see Langley and Anderson, "Journal of Physiology," 13, 554, 1892. For the histological proof, Grunert, "Archives of Ophthalmology," 30, 377, 1901.

muscle have a very different path. They arise also in the brain, most probably in the midbrain, although their exact origin has not been determined satisfactorily, and pass down the spinal cord to terminate in the lower cervical region. From this point the path is continued by spinal neurons which leave the cord in the eighth cervical and the first and second thoracic spinal nerves and pass by way of the corresponding rami communicantes into the sympathetic chain at the level of the first thoracic ganglion. From this point the fibers pass upward in the cervical sympathetic without terminating until they reach the superior cervical ganglion near the base of the skull. From this ganglion the path is continued by sympathetic (postganglionic) fibers which pass to the Gasserian ganglion and unite with its ophthalmic branch. Subsequently they leave the ophthalmic nerve in the long ciliary branches. These fibers under normal conditions are in constant (tonic) activity, so that if the path is interrupted at any point—by section of the cervi-

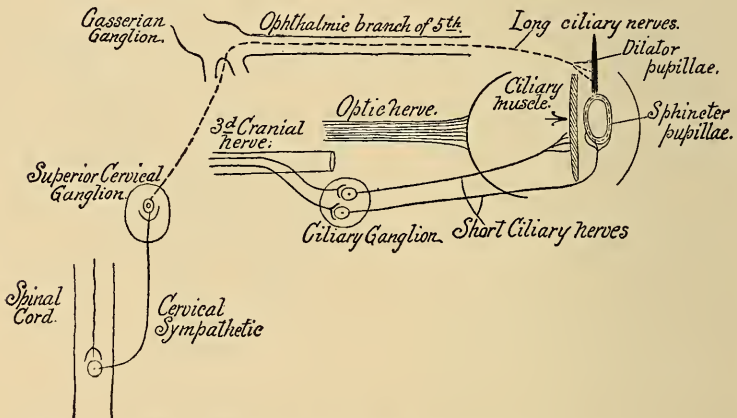

Fig. 136.—Schema showing the path of the preganglionic and postganglionic fibers to the ciliary muscle and to the sphincter and dilator muscles of the iris.—(Modified from Schultz.) The course of the long ciliary nerves is represented very diagrammatically.

cal sympathetic, for instance—the pupil is seen to contract. This constant activity may be referred directly to the activity of the spinal neurons whose cells lie in the spinal cord in the lower cervical and upper thoracic region. The cells in question constitute what is sometimes called the lower ciliospinal center of Budge.

**The Accommodation Reflex and the Light Reflex of the Sphincter Muscle.**—When the eye is accommodated for a near object by the contraction of the ciliary muscle there is always a simultaneous contraction of the sphincter pupillæ whereby the pupil is narrowed. The act is one of obvious value in vision, since by diaphragming down the lens the focus is improved and more exact vision, such as is needed in close work, is obtained. The act

is usually spoken of as the *accommodation reflex*, but in reality it is rather what is known as an associated movement. The act of accommodation carries with it the constriction of the pupil, because, in all probability, the efferent discharge from the cells in the midbrain controlling the ciliary muscle affects likewise the neighboring center for the sphincter muscle. An example of a similar associated action is seen in the effect of the respiratory movements on the rate of heart beat, the inspiratory discharge from the respiratory center being accompanied by an associated effect upon the cardio-inhibitory center whereby the heart rate is quickened. In the particular case that we are dealing with three muscular acts, in fact, are usually associated, for every act of accommodation under normal circumstances is accompanied not only by a constriction of the pupil, but also by a convergence of the eyeballs, due to a contraction of the internal rectus muscle in each eye.

The *light reflex* is observed when light is thrown into the eye. As is well known, the pupil dilates in darkness or dim lights and contracts to a pin-point upon strong illumination of the retina. The value of this reflex is also obvious. In the dim light the total illumination and therefore the visual power of the retina is aided by an enlarged pupil, but in strong lights the illumination may be diminished with advantage by diaphragming, since the optical image on the retina is thereby improved on account of the diminution in spherical aberration. The reflex arc involved in this act is known in part. The afferent path is along the optic nerve; the efferent path back to the sphincter is through the third nerve and ciliary ganglion; injury to either of these paths diminishes or destroys the reflex. The reflex is also lost in some cases in which neither of these paths seems to be involved. In *tabes dorsalis* (locomotor ataxia) and general paresis, for instance, the pupil of the eye is constricted and does not give the light reflex, but still shows the accommodation reflex. Such a condition is known as the *Argyll Robertson pupil*. Some question exists, therefore, as to the nature of the connections in the brain between the afferent impulses and the motor center in the nucleus of the third nerve. According to some authors, the afferent light reflex fibers are a set of fibers distinct from the visual fibers proper. They arise in the retina and pass backward in the optic nerve, but leave the optic tracts at the chiasma to enter the walls of the third ventricle and thus reach the nucleus of the third nerve. This view, however, finds no support in the histological structure of the retina. In the foveal region at least we must suppose that stimulation of the cones gives rise to both the visual sensation and the pupil reflex, but it is said that in some cases\* (*amaurosis*)

\* Behr, "Archiv f. Ophthalmologie," 86, 468, 1913.

the pupil reflex may be obtained without accompanying visual sensations. Under normal conditions the light reflex is bilateral,—that is, light thrown upon one retina only will cause constriction of the pupil in both eyes. In the lower animals, whose optic nerves cross completely in the chiasma, the light reflex, on the contrary, is unilateral, affecting only the eye that is stimulated.\* We may conclude, therefore, that the bilaterality of the reflex in the higher animals is dependent upon the partial decussation of the optic fibers in the chiasma, a sensory stimulus upon one retina giving rise to impulses which are conveyed to the two sides of the brain. It is possible, however, that in addition commissural connections may exist between the central connections,—the motor centers in the midbrain. It is usually stated that the effect of the light upon the sphincter muscle is greatest when the retina is stimulated at or near the fovea and that it varies directly with the intensity of the light and the area illuminated.†

**The Action of Drugs upon the Iris.**—The condition of constriction of the pupil is frequently designated as miosis (mi-o'-sis) and the condition of dilatation as mydriasis (myd-ri'-as-is). Many drugs are known which, when applied directly to the absorptive surfaces of the eye or when injected into the circulation, affect the muscles of the iris and therefore vary the size of the pupil. Those drugs that cause miosis are spoken of as miotics, and those that produce mydriasis as mydriatics. Atropin, the active principle of belladonna, homatropin, and cocain are well-known mydriatics, while physostigmin (eserin) and muscarin or pilocarpin are examples of the miotics. There has been much question as to the precise action of these drugs. For an adequate discussion of this question the student is referred to works on pharmacology; but it may be said that the evidence from the physiological side‡ indicates that atropin causes mydriasis by paralyzing the endings of the constrictor nerve fibers in the sphincter muscle, while physostigmin and muscarin cause miosis by stimulation of the endings of these same fibers.§ In the case of cocain it is probable that the drug first stimulates mainly the endings of the dilator fibers in the dilator muscles, and in stronger doses causes additional mydriasis by paralyzing the constrictor fibers. The stronger mydriatics paralyze not only the sphincter pupillæ, but also the similarly innervated ciliary muscle, thus destroying the power of accommodation. When atropin is applied to the eye the individual is

\* Steinach, "Archiv f. d. gesammte Physiologie," 47, 313, 1890.

† See Abelsdorff and Feilchenfell, "Zeitschrift f. Psychologie und Physiologie des Sinnesorgane," 34, 111, 1904.

‡ Schultz, "Archiv f. Physiologie," 1898, 47.

§ According to Langley, "Journal of Physiology," 39, 235, 1909, the stimulating or paralyzing effect of such drugs is due to an action not on the nerve terminals, but on a special receptive substance in the muscle-fibers.



unable to use his eyes for near work—reading, for example—until the effect of the drug has worn off. In ophthalmological literature this condition of paralysis of the ciliary muscle is spoken of as cycloplegia, and most of the mydriatic drugs are also cycloplegics. On the contrary, the stronger miotics stimulate the ciliary muscle, and therefore during their period of action throw the eye into a condition of forced accommodation.

**The Balanced Action of the Sphincter and Dilator Muscles of the Iris.**—It would seem that under normal conditions both the sphincter and the dilator muscle are kept more or less in tonic activity by impulses received through their respective motor fibers. They thus balance each other, to speak figuratively, and a mechanism of this kind in which two opposing actions are in play is in a condition to respond promptly and smoothly to an excess of stimulation from either side. The two muscles, in fact, act as antagonists in the same manner as the flexor and extensor muscles around a joint. At the same time this relation adds some difficulties to the explanation of specific reactions, since it is evident that a dilatation of the pupil may be caused either by a contraction of the dilator muscle or a loss of tone (inhibition) in the sphincter, while in constriction of the pupil the effect may result either from a contraction of the sphincter or an inhibition of the dilator; or, lastly, the contraction of one muscle may always be accompanied by an inhibition of its antagonist, as is supposed to be the case with the flexor and extensor muscles of the limbs (law of reciprocal innervation). Anderson\* has given some evidence to show that the dilatation of the pupil in cats is due to a double action of this sort, the pupillodilator muscle contracting first and subsequently the tone of the constrictors suffering an inhibition. Alterations in the size of the pupil take place not only under the conditions described above—namely, the light and the accommodation reflex and the action of drugs—but also under many other circumstances, normal and pathological. In sleep, for instance, the eyes roll upward and outward and the pupils are constricted. The miosis in this case may be due to a cessation in tonic activity on the part of the dilator muscle, or to an increased tonus of the sphincter muscle. The latter explanation is strengthened by the fact that experiments indicate that during the waking period the tonus of the cranial center controlling the sphincter is kept under inhibition by the inflow of sensory impulses. During sleep this central inhibition diminishes or disappears. Emotional states also affect the size of the pupil and thus aid in giving the facial expressions characteristic of these conditions. Writers speak of the eyes dilating with terror or darkening with emotions of deep pleasure. This pupillary accompaniment of the emotional states may

\* "Journal of Physiology," 30, 15, 1903.

occur even when it is a matter of memory rather than immediate experience. The explanation of this mydriasis can hardly be obtained by experiment. So far as the physiological mechanisms are concerned, it may be explained either by a stimulation of the dilator muscle or by an inhibition of the tonus of the constrictor muscle. In favor of the latter explanation we have the fact that stimulation of the cortex cerebri causes dilatation when the dilator paths are severed.

**Intraocular Pressure.**—The liquids in the interior of the eye are normally under a pressure, the average value of which may be estimated at 25 mms. of mercury. In consequence of this internal pressure the eyeball is tense and its external surface, including the cornea, shows a regular curvature. It is obvious that folds or creases in the cornea would entirely destroy its usefulness, so far as the formation of an image is concerned. The amount of the intraocular pressure may be measured by thrusting a tubular needle, properly connected with a manometer, into the anterior chamber of the eye. The liquid in the interior of the eyeball may be considered as tissue lymph, and like the lymph elsewhere it is derived from the blood-plasma. Investigation has shown that the lymph is formed in the ciliary processes, but in this as in other cases there is a difference of opinion as to whether the production is due to so-called secretory or to mechanical causes, such as filtration.\* We may suppose that the liquid filters into the eye through the vessels in the ciliary processes, and, on the other hand, drains off or is absorbed at the angle of the anterior chamber through the vein known as the canal of Schlemm. The intraocular pressure rises until, under its influence, the outflow just balances the inflow. It is evident from this point of view that intraocular pressure will be increased by any change that will augment the production of the liquid at the ciliary processes, such as a rise of blood-pressure, or by any interference with the outflow, such as might arise from a blocking of the canal of Schlemm. Certain pathological conditions (glaucoma) are characterized by an abnormally high intraocular tension, the difference from the normal being such that it is easily recognized by pressure with the fingers.

**Methods of Determining the Refraction of the Eye.**—The condition of the eye as regards its refraction may be determined by the use of suitable charts and a series of spherical and cylindrical lenses. The results by such a method depend largely upon the statements of the patient, that is to say, they are largely subjective. A number of instruments have been devised, however, by means of which the refraction of the eye may be studied

\* For discussion and literature, see Henderson and Starling, "Proceedings Royal Society," 1906, B. vol. 77; Hill and Flack, *ibid.*, vol. 85, 1912, and Henderson, "Glaucoma," London, 1910.

in a purely objective way, so far as the patient is concerned. The most important of these instruments are the ophthalmoscope, the retinoscope or skiascope, and the ophthalmometer. A brief description is given of each of these instruments, but for the numerous practical details necessary to their successful use reference must be made to special manuals.

**The Ophthalmoscope.**—The light that falls into the eye is partly absorbed by the black pigment of the choroid coat, and is partly reflected back to the exterior. This latter portion is reflected back in the direction in which it entered. Merely holding a light near the eye does not, therefore, enable us to

see the interior more clearly, since in order to catch the returning rays in our own eye it would be necessary to interpose the head between the source of light and the observed eye. If, however, we could arrange the light to enter the observed eye as though it proceeded from our own eye, then the returning rays would be perceived, and with sufficient illumination the bottom or fundus of the observed eye might be seen. Arguing in this way Helmholtz constructed his first form of the ophthalmoscope in 1851. The value of the ophthalmoscope is twofold: It enables the observer to examine the interior of the eye and thus recognize diseased conditions of the retina; it is also useful in detecting abnormalities in the refractive surfaces of the eye. The principle of the instrument is well represented in the original form devised by Helmholtz, as shown schematically in Fig. 138, *A*. *I* represents the observed eye and *II* the eye of the observer. Between the two eyes is placed a piece of glass inclined at an angle. Light from the candle falling upon this glass is in part reflected from the surface to enter eye *I*, and these rays on emerging from the eye along the same line pass through the glass in part and enter eye *II*. In place of the plane unsilvered glass it is now customary to use a concave mirror with a small hole through the center, the observer's eye being placed directly behind this hole. Such an instrument is shown in Fig. 137. The instrument is used in two ways, known as the direct and the indirect method. In the direct method the mirror is held very close to the observed eye, and the paths of the rays of light into and out of the eye are represented schematically in Fig. 138, *B*. The light from a lamp or from an electrical bulb placed within the handle of the ophthalmoscope (Fig. 137) is caught upon the mirror and is thrown into the eye, the rays coming to a focus and then spreading out so as to give a diffuse illumination of the fundus. This latter surface may now be considered as a luminous object sending out rays of light.

Taking any three objects on the retina, *A*, *B*, *C*, it is apparent that if eye *I* is an emmetropic eye, these points are at the principal focal distance, and the rays sent from each after emerging from the eye are in parallel bundles. These rays penetrate the hole in the mirror and fall into the observer's eye as though they came from distant objects. If the observer's eye is also emmetropic, or is made so by suitable glasses, these bundles of rays will be focused on his retina without an act of accommodation. He must, in fact, in looking through the mirror, gaze, not at the eye before him, but, relaxing his accommodation, gaze through the eye, as it were, into the distance. In this way he will see the portion of the retina illuminated, the image of the

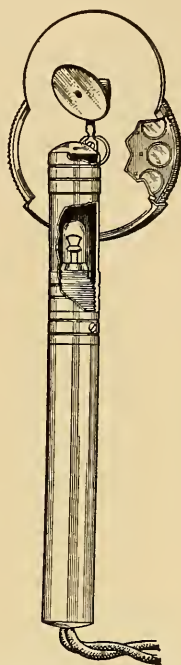

Fig. 137.—De Zeng electric ophthalmoscope. The electric light is contained in the handle of the instrument and its light is concentrated on the mirror by a lens seen at the top of the handle. Back of the mirror is a rotating disc with plus and minus lenses of different powers.

objects seen being inverted on his own retina and therefore projected or seen erect. If the observed eye is myopic its retina is farther back than the principal focus of its refracting surfaces; consequently the rays sent out from the illuminated retina emerge in converging bundles and cannot be focused on the retina of the observer's eye. By inserting a concave lens of proper power between his eye and the mirror the observer can render the rays parallel and thus bring out the image. From the power of the lens used the degree of myopia may be estimated. Just the reverse happens if the observed eye is hypermetropic. In such an eye the retina is nearer than the principal focal

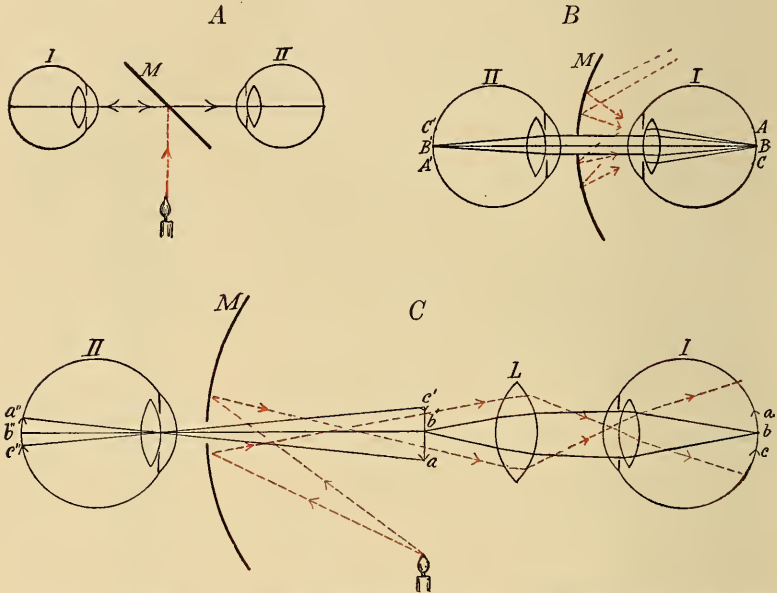

Fig. 138.—Diagrams to represent the principle of the ophthalmoscope: A, The original form of ophthalmoscope, consisting of a piece of glass, *M*, inclined at a suitable angle. The rays from the source of light are reflected into the observed eye, *I*, and thence return along the same lines passing through *M* to reach the observer's eye, *II*. B, The direct method with the ophthalmoscopic mirror. The rays of light illuminate the fundus of the observed eye, *I*, and thence pass out in parallel rays, if the eye is emmetropic, to reach the observer's eye, *II*. C, The indirect method with ophthalmoscopic mirror and intercalated lens. The rays of light-red lines are brought to a focus within the anterior chamber of the eye and thence diverge to give a general illumination of the interior of the eyeball. The returning rays of light are indicated for a single point, *b*. At *a'*, *b'*, *c'*, a real inverted image of a portion of the retina is formed in the air, which in turn is focused on the retina of the observer's eye.

distance of the refractive surface; consequently the light emitted from the retina emerges in bundles of diverging rays which cannot be brought to a focus on the retina of the observer unless he exerts his own power of accommodation or interposes a convex lens between his eye and the mirror.

The indirect method of using the ophthalmoscope is represented in Fig. 138, C. The mirror is held at some distance, at arm's length, from the observed eye, *I*, while just before this eye a biconvex lens of short focus is placed. As shown in the diagram by the red lines, the reflected light from the mirror comes to a focus and then diverging falls upon the biconvex lens. This lens brings the rays to a focus at or near the eye, whence they again diverge and light up the retina with a diffuse illumination. The light from

this retina is in turn sent back toward the mirror, its path being indicated for the point  $b$  by the black lines. If the eye is emmetropic the rays from this point emerge parallel, and, falling upon the biconvex lens, are brought to a focus at  $b'$ . Similarly the rays from  $a$  will be brought to a focus at  $a'$  and from  $c$  at  $c'$ . Consequently there will be formed in the air an inverted image, and it is at this image that the eye of the observer gazes through the hole in the mirror. This image forms its image on the retina of the observer's eye, as represented in the diagram at  $a''$ ,  $b''$ ,  $c''$ , and is projected outward or seen inverted as regards the original position of the points in the retina of eye  $I$ . The indirect method gives a larger field than the direct method, although the objects seen are of smaller size.

**The Retinoscope or Skiascope.**—When one reflects a spot of light upon a wall, any movement of the reflecting (plane) mirror is followed by a movement of the reflected spot in the same direction. So if the fundus of the eye is illuminated by a plane mirror provided with a peep-hole, the observer looking through this hole may see a spot of light reflected from the retina and can determine whether the spot moves in the same direction as the mirror or against it. If the eye under observation is normal (emmetropic), then the rays of light starting from the retina will emerge in parallel bundles, since the retina lies at the principal focal distance, and as the mirror is tilted from side to side the illuminated spot moves in the same direction. By placing a convex lens of suitable focus in front of the observed eye we can cause the emerging parallel rays to come to a focus and cross before reaching the observer's eye. In such a case the movements of the spot of light upon the retina will be against those of the mirror. For example, let us suppose that the observing eye is placed just 1 meter away from the eye observed, then if we put in front of the latter a convex lens of 1.25 D. the emerging rays will be focused at a point 25 cm. in front of the observer's eye and the movements of the spot of light will be against the mirror. A lens of less than 1 D. placed in front of the observed eye would not bring the rays to a focus in front of the observer's retina, consequently the movements of the spot would be with the mirror. Assuming that we are dealing with an emmetropic eye, it can be shown that at the distance mentioned (1 meter) any lens of less than 1 D. placed in front of the eye leaves the movements with the mirror, while any lens of more than 1 D. gives movements against the mirror. Consequently a lens of just 1 D. would mark the exact "point of reversal." With a lens of this power the focus would fall theoretically just on the observer's retina. In such a case any movement of the mirror would be followed by the appearance or disappearance of the spot, but no direction of movement would be perceived. The movements of the spot of light formed upon the retina by the retinoscopic mirror may be used to determine all the various abnormalities of refraction of the eye according to the following general schema: The observer sits at a fixed distance, say 1 meter, from the patient, and determines whether the reflected spot from the illuminated fundus moves with or against the mirror. If the movement is with the mirror, then the eye under observation is either normal or hyperopic (or if myopic the myopia is less than 1 D.). By placing convex lenses in front of the eye the observer seeks for the point of reversal. If this point is given by a lens of + 1 D., then the eye under examination is emmetropic; if a stronger lens is required the eye is hyperopic, that is, the emerging rays are divergent and require a stronger lens to bring them to a focus before reaching the observer's eye. In the latter case the amount of hyperopia is obtained by ascertaining the strength in diopters of the lens required to just reverse the movement and subtracting 1 D. from it, since the latter amount is required, at a distance of 1 meter, to get reversal with the normal eye. If the reversal is given by a convex lens of less than 1 D., then the eye is myopic to an extent less than 1 D. When the movements of the spot of light are against the mirror from the beginning, then the observer is dealing with a myopic eye (the myopia being greater than 1 D.). To reverse the movement it is now necessary to place concave lenses in front of the observed eye until the point of reversal is obtained, that is, until the focus of the emerging rays falls behind the

retina of the observer. The concave lens necessary to give this result, plus 1 D. for distance, gives the extent of the myopia in diopters. With astigmatic eyes the point of reversal may be determined for the different meridians of the eye, the movements of the mirror being in the same meridian. By the character of the reflected spot and the points of reversal it is possible with the retinoscope to determine the principal meridians, and the difference in refraction between them, that is, the degree and the axis of the astigmatism.

**The Ophthalmometer.**—The ophthalmometer is an instrument for measuring the curvature of the refracting surfaces of the eye. As actually applied in practise it is arranged especially for measuring the curvatures of the cornea along its different meridians. The point for which the instrument is designed is to obtain the size of the image reflected from the convex surface of the cornea. Any luminous object placed in front of the eye will give a reflected image from the cornea as from the surface of a convex mirror. If the size of the object and its distance from the cornea are known and the size of the corneal image is determined, then the radius of curvature of the cornea is given by the equation  $r = \frac{2pi}{0-2i}$ , in which  $p$  represents the distance of

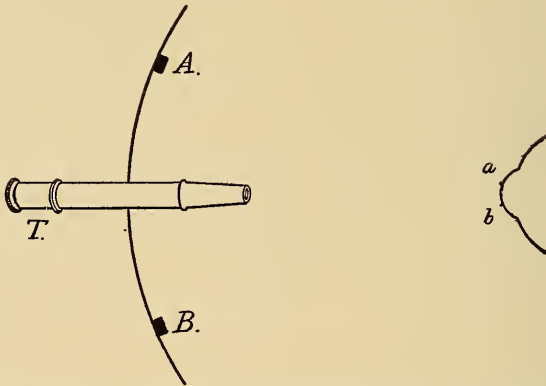

Fig. 139.—Schema to indicate the general principle of the ophthalmometer: *T*, Telescope to observe the reflected images from the cornea; *A* and *B*, the targets or mires in the shield at a known distance apart whose images are reflected from the cornea; *a* and *b*, the reflected images of *A* and *B* on the cornea. The distance *a-b* has to be determined.

the object from the cornea,  $i$ , the size of the corneal image, and  $o$ , the size of the object. For example, let *A* and *B* in Fig. 139 be two luminous areas arranged on the arc of a circle. If placed in front of the cornea *C* each will give a reflected image *a* and *b*, which may be observed by means of the telescope *T*. The distance between *A* and *B* represents the size of the object and the distance between *a* and *b* the size of the image. This latter factor is determined by means of the telescope. A scale, for instance, might be placed in the eye-piece of the telescope and the distance *a-b* be determined in terms of its graduation. This valuation might then be converted into millimeters by substituting a scale for the cornea and measuring off upon it the observed distance in the eye-piece scale. If the arc carrying *AB* is arranged so that it may be rotated it is obvious that the size of the corneal images may be measured for the different meridians and thus enable one to compare their curvatures. In modern instruments, such as is represented in Fig. 140, the luminous areas, known as targets or mires, are placed in a spherical shield which may be rotated around the axis of the telescope. The shield has a radius of curvature of 0.35 meters and its center of rotation is approximately coincident with that of the cornea when the eye is in its proper position. The reflected images of the mires from the surface of the

cornea are each doubled, when viewed through the telescope, by means of a double vision prism of Iceland spar and the displacement produced in this way is a definite amount for the distance chosen. Four images of the mires are thus seen, and when the mires are properly adjusted for a cornea of average curvature the two inner images are in contact with each other. A variation from this average is indicated by an overlapping of the images,

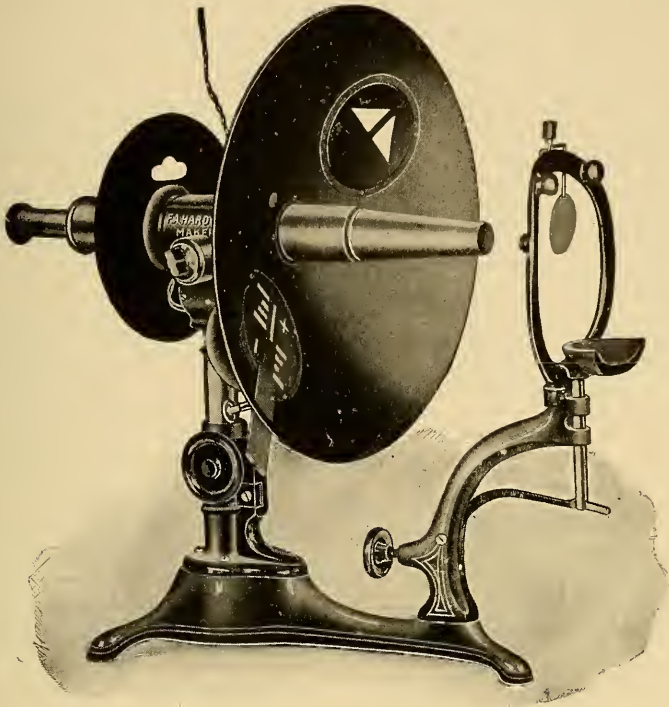

Fig. 140.—Ophthalmometer (Hardy).

the value of which in diopters or in radii of curvature is read off upon the instrument. The instrument, therefore, when once calibrated enables one to read off at once the radii of curvature for the different meridians and thus determine the axis and degree of astigmatism. It should be added that the instrument gives only the curvatures and degree of astigmatism, if any exists, of the cornea, and is therefore of no immediate service in determining the total astigmatism, that is, the astigmatism of cornea and lens acting together.

## CHAPTER XVIII.

### THE PROPERTIES OF THE RETINA—VISUAL STIMULI AND VISUAL SENSATIONS.

**The Portion of the Retina Stimulated by Light.**—The normal stimulus to the sensory cells in the retina is found in the vibrations of the ether, the waves of light. When sunlight is passed through a prism the waves of different lengths are dispersed, and those capable of stimulating the retina form the visible spectrum extending from red to violet. The limits of the spectrum are, on the one hand, the extreme red rays with a wave length of 7600, measured in Angström units ( $1 \text{ \AA} = \frac{1}{10,000,000} \text{ mm.}$ ), and, on the other, the extreme violet, having a wave length of about 3900. The part of the retina stimulated by these vibrations is supposed to be the layer of rods and cones. To reach these structures the light must pass

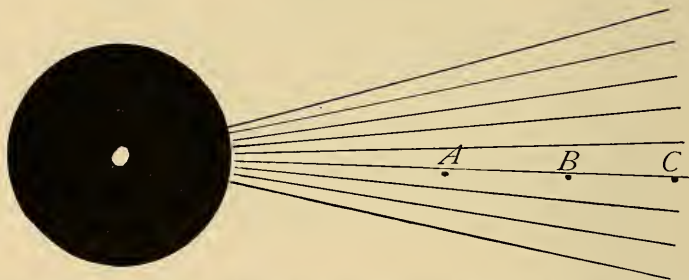

Fig. 141.—Demonstration of blind spot, left eye (Stifel's figure): Hold the black circle in front of the left eye at a distance of about 10 inches. Close the right eye. Place a pencil point at *A* and draw it slowly along the line *ABC*, keeping the left eye on the pencil point. At a certain distance beyond *A*, for example, at *B*, the white spot in the black circle will disappear (falls on the blind spot), but will reappear when the pencil point is moved further outward, at *C* for example. By marking the points at which the white spot disappears and reappears the diameter of the spot is given for that meridian and distance of projection. In the same way the diameter may be marked for the other meridians and the form of the blind spot be obtained.

through the other layers of the retina. That the rods and cones are the structures that react to the light stimulation is indicated by their structure and their connections and by such facts as the following: Under certain conditions, which are described below, the shadows of the retinal vessels and the contained corpuscles may be seen, a fact which indicates that the perceiving structures lie externally to these vessels. In the fovea centralis, in which vision is most perfect, the layers of the retina are thinned out until practically only the rods and cones remain to be acted upon. That the optic



nerve fibers themselves are not acted upon by light waves is proved by the existence of the blind spot. The termination of the optic nerve within the eyeball, the optic disc, lies about 15 degrees to the nasal side of the fovea and has a diameter of about 1.5 mms. From this point the nerve-fibers spread out over the rest of the optic cup to form the internal layer of the retina. But the optic disc itself has no retinal structure, and light that falls upon it is not perceived. The presence of this blind spot in our visual field is easily demonstrated by the experiment illustrated and described in Fig. 141. In the visual field for each eye, therefore, there is a gap representing the projection of the area of the optic disc to the exterior, the size of the gap increasing with the distance from the eye. We do not notice this deficiency, inasmuch as it exists in our indirect field of vision (see below), in which our perception of form is poorly developed; so that any disturbance in outline that might result in the retinal image of external objects is unperceived. Moreover, the portion of the external world that falls on the blind spot of one eye may fall on the retinal field of the other, and be perceived in binocular vision. It is to be borne in mind, also, that the projection of the blind spot does not appear in the visual field as a dark area; it is simply an absent area, so that no gap exists in our consciousness of the spatial relations of the visual field; the margins, so to speak, of the hole come into contact so far as our consciousness is concerned.

#### **The Action Current Caused by Stimulation of the Retina.—**

The effect of light waves falling upon the retina is to set up a series of nerve impulses in the optic nerve fibers. It is interesting to find that these impulses aroused in a sensory nerve by a normal stimulus are attended by electrical changes similar to those observed in motor fibers when stimulated normally or artificially. The fact strengthens the view that the electrical change is an invariable accompaniment of the nerve impulse, if not the nerve impulse itself. If the eye is excised and connected with a galvanometer or capillary electrometer by two non-polarizable electrodes, one placed upon the cut end of the optic nerve and the other on the cornea, the usual demarcation current is obtained due to the injury to the optic nerve. If the preparation is kept in the dark and arrangements are made to throw a light through the pupil upon the retina the galvanometer indicates an electrical change or current whenever the light is admitted.\* The direction of the current in the eyeball is from the fundus to the cornea, and as regards the pre-existing demarcation current it is in the same direction and forms, therefore, a so-called positive variation. When the electrodes are placed on the longitudinal and the cut surface of the optic nerve, then, according to Kühne, the electrical response to light is a negative variation similar

\* Dewar and McKendrick, "Transactions, Royal Society, Edinburgh," 27, 1873; Gotch, "Journal of Physiology," 29, 388, 1903, and 31, 1, 1904.

to that described for stimulation of nerves in general (p. 102). Not only is there a "light response" each time that the retina is stimulated by light, but there is a similar electrical change, a "dark response," when the light is suddenly withdrawn. This last interesting fact would seem to indicate a stimulation process of some kind in the retina due to darkness—that is, withdrawal of the objective stimulus. Einthoven and Jolly\* have applied the sensitive string galvanometer to the study of this phenomenon. They find that the electrical response of the illuminated eye, when photographed, presents a curve of much complexity, and they conclude that its complexity is due to the fact that several different processes occur together in the stimulated retina. They offer some evidence to indicate that three different processes depending on the reaction of three different substances may be distinguished. These substances react with different velocities and with different changes in electric potential to flashes of light and "flashes of darkness." What physiological effects may be connected with these three processes cannot yet be stated. The electrical reaction is a very sensitive one, lights so weak as to be near the threshold for the human eye give a distinct electrical change in the frog's retina, and an eye that has been kept in the dark for some time (dark-adapted eye) shows an increased sensitiveness. It is very interesting, also, to find that the frog's retina responds to a range of light vibrations that corresponds with the limits of the visible spectrum as seen by the human eye. If the electrical response is a true indication of functional activity, it would appear that the frog's vision has about the same extent as our own as regards the ether waves of different periods of vibration.

**The Visual Purple—Rhodopsin.**—The change that takes place in the rods and cones whereby the vibratory energy of the ether waves is converted into nerve impulses is unknown. It has been assumed by some observers that the light waves act mechanically, the wave movements setting into vibration portions of the external segments of the rods or cones, and that this mechanical movement forms the direct excitant of the nerve impulses.† The general view, however, is that the process is photochemical,—that is, the impact of the ether waves sets up chemical changes in the rods or cones which in turn give rise to nerve impulses that are transmitted to the brain. We have an analogy for this action in the known change produced by light upon sensitized photographic films. In the retina itself some basis for such a view is found in the existence of a red pigment which is bleached by light. This interesting dis-

\* Einthoven and Jolly, "Quarterly Journal of Experimental Physiology," 1, 373, 1908.

† Zenker, "Archiv f. mik. Anatomie," 3, 248, 1867.

covery was made by Boll,\* and the facts were afterward carefully investigated by Kühne.† The red pigment, known usually as visual purple or rhodopsin, is found only in the external segments of the rods; the cones do not contain it. In the fovea, therefore, which has only cones, the pigment is entirely absent. The existence of the visual purple may be demonstrated very easily. A frog is kept for some time in the dark; it is then killed and an eye removed and bisected equatorially. If the vitreous is removed from the posterior half the retina may be detached by means of a pair of forceps. When the operation is performed in red or yellow light, as in photographic work, the detached retina on examination by daylight is found to be a deep-red color; but after a short exposure it fades rapidly, finally becoming colorless. If the frogs before operation were exposed to strong daylight, the retina is found to be colorless. A similar pigment is found in the eyes of man and the other mammalia. It has been shown, moreover, that a photograph may be made upon the surface of the retina by means of this purple. If the head of a rabbit or frog that has been kept in the dark for some time is exposed with proper precautions to the light of a window, for instance, the part of the retina on which the image of the window-lights falls will be bleached, while the parts upon which the image of the window-bars falls and the surrounding areas of the retina will retain their red color. A figure of such a retinal photograph or optogram, as it is called, is represented in the accompanying illustration (Fig. 142). The visual purple has been extracted

from the rods by solutions of bile salts, this substance having the power to discharge the pigment from its combination in the rods in the same way as it discharges hemoglobin from its combination in the red corpuscles. The solutions thus obtained are also bleached upon ex-

posure to light. We have in the visual purple, therefore, an unstable substance readily decomposed or altered by the mechanical effect of the ether waves, and also, it may be said, by gross mechanical reactions, such as compression; and there can be little doubt that the substance plays an important part in the functional

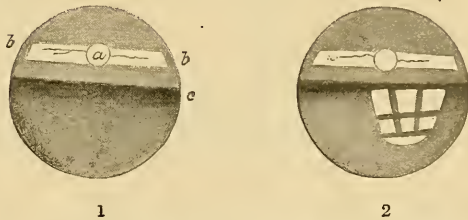

Fig. 142.—Optogram in eye of rabbit: 1, The normal appearance of the retina in the rabbit's eye; *a*, The entrance of the optic nerve; *b, b*, a colorless strip of medullated nerve fibers; *c*, a strip of deeper color separating the lighter upper from the more heavily pigmented lower portion. 2 shows the optogram of a window.

\* Boll, "Archiv f. Physiologie," 1877, 4.

† Kühne, "Untersuch. a. d. physiol. Inst. d. Univ. Heidelberg," vol. i, 1878. Also "The Photochemistry of the Retina," etc., translated by Foster, London, 1878.

response of the rod elements. It has been shown that provision exists in the retina for the constant regeneration of this red pigment. It will be remembered that the external segments of the rods impinge upon the heavily pigmented epithelial cells that lie between the rods and the choroid coat. From experiments upon frogs' eyes it appears that a portion of the retina detached from the pigment cells and bleached by the action of light is not able to regenerate its visual purple until again laid back upon the choroid coat. This regenerating influence of the black pigmented cells may be connected with another interesting relation that they exhibit. Under normal conditions delicate processes extend from these cells and penetrate between the rods and cones. When the eye is exposed to light the black pigment migrates along these processes as far even as the external limiting membrane, and it is possible that this arrangement may be useful in obviating diffuse radiation of light from one rod to another. When the eye is kept in the dark, however, the pigment moves outwardly and collects around the external segments, where the process of regeneration of the visual purple is taking place. Further evidence that the visual purple is connected with the irritability of the rods toward light stimulation is shown by the fact that when it is exposed to the different rays of the spectrum the absorption of light is greatest in that part of the spectrum (green) which appears the brightest in vision when carried out under such conditions as may be supposed to involve the activity chiefly of the rods (see below for these conditions). It is, however, perfectly obvious that visual purple is not essential to vision. The fact that it is absent from the fovea centralis is alone sufficient proof of this statement. Moreover, it seems to be absent entirely in the eyes of some animals; for instance, the pigeon, hen, some reptiles, and some bats. The most attractive view of the function of the visual purple is that it serves to increase the delicacy of response or irritability of the rods in dim lights,—a view that is explained in more detail in the paragraph below, dealing with the supposed difference in function between the rods and cones.

**The Extent of the Visual Field—Perimetry.**—By the visual field of each eye is meant the entire extent of the external world which when the eye is fixed forms an image upon or is projected upon the retina of that eye. From what has been said previously regarding the dioptrics of the eye it is obvious that the visual field is inverted upon the retina, and that, therefore, objects in the upper visual field fall upon the lower half of the retina, and objects in the right half of the visual field fall upon the left half of the retina. Assuming that the retina is sensitive to light up to the ora serrata, it is evident that if the eye were protruded sufficiently from its orbit its projected visual field when represented upon a flat surface would have the form of a circle, the center of which would correspond to

the fovea centralis. As a matter of fact, the configuration of the face is such as to cut off a considerable part of this field, in any fixed position of the eyes, and to give to the field as it actually exists an irregular outline. The bridge of the nose, the projecting eyebrows, and cheek bones serve to thus limit the field; and, in addition, the sensitivity of the peripheral portion of the retina

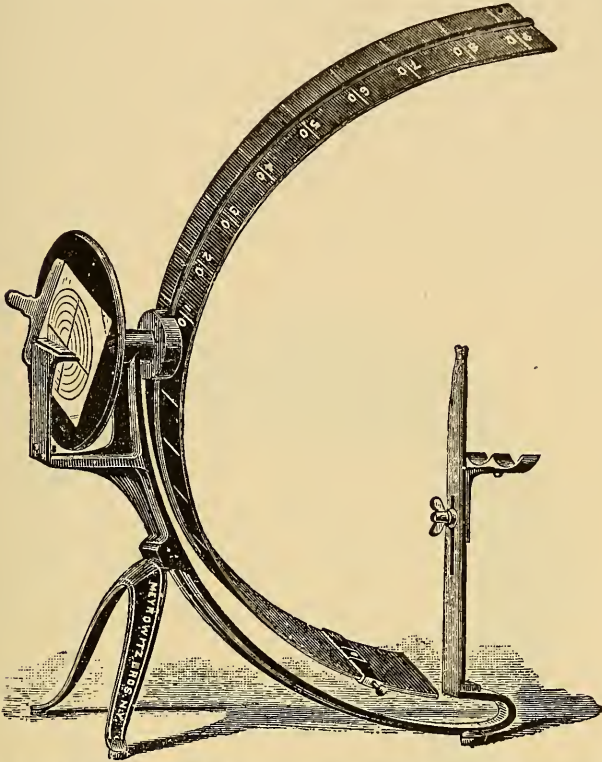

Fig. 143.—Perimeter. The semicircular bar may be placed in any meridian. A given object is then moved along the bar from without in until it is just perceived. The angular distance at which this occurs is marked off on the corresponding meridian on the chart seen at the left of the figure. The eye examined gazes over the top of the vertical rod at the right at a fixed point in the middle of the semicircular bar.

may not extend equally far toward the ora serrata in different eyes or in different meridians of the same eye. To obtain the exact outline and extent of the visual field in any given case it is only necessary to keep the eye fixed and then to move a small object in the different meridians and at the same distance from the eye. The limits of vision may be obtained in this way along each meridian and the results combined upon an appropriate chart. An instrument, the perimeter, has been devised to facilitate the process of charting the visual field. It has been given a number of different forms, one of which is illustrated in Fig 143. The shape

of the visual fields in the normal eye is represented in Fig. 144. The determination of the visual fields is of especial importance in cases of brain lesions involving the visual area in the occipital lobe. The extent and portion of the retina affected may be used to aid in locating the seat of the lesion. For physiological and for clinical purposes it is necessary to distinguish between the *central* (or direct) and the *peripheral* (or indirect) fields of vision. The former term is meant to refer to that portion of the field which falls upon the fovea centralis; in other words, it is the projection, in any fixed position of the eye, of the fovea into the external world. The peripheral field refers to the rest of the visual field which is projected upon the retina outside the fovea. As a matter of fact, all of our distinct and most useful vision, in the daytime at least, is effected through the fovea. When the eye is kept fixed, the small portion of the external world that falls upon the fovea is seen distinctly. All the rest is seen more or less indistinctly in proportion

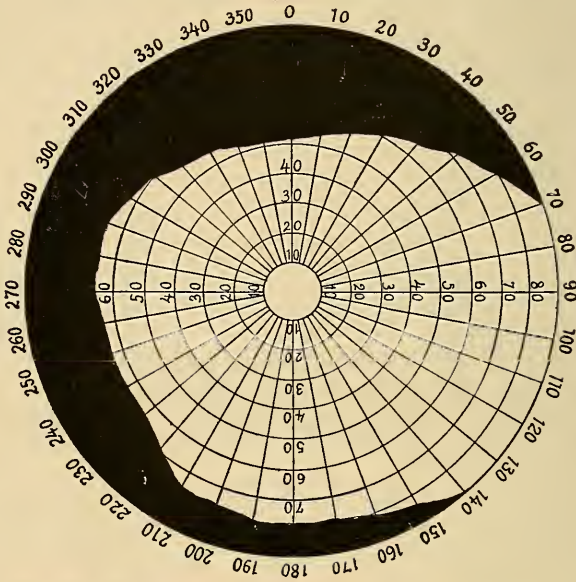

Fig. 144.—Perimeter chart to show the field of vision for a right eye when kept in a fixed position.

to the distance of its retinal image from the fovea. In using our eyes, therefore, we keep them continually in motion so as to bring each object, as we pay especial attention to it, into the field of central vision. The line from the fovea to the point looked at is designated as the *line of sight* or *visual axis*. The area of the fovea is quite small. The measurements given by different observers vary somewhat, especially as in some cases the measurements are

estimated for the bottom of the depression, the fundus, and in others for the diameter from edge to edge. The average diameter is usually given as lying between 0.3 and 0.4 mm. Lines drawn from the ends of this diameter to the nodal point of the eye subtend an angle of 1 degree to 1.5 degrees; and, therefore, all objects in the external world around the line of sight which lie within this visual angle are comprised in the central field of vision, and their retinal images fall upon the fovea. Unilateral lesions of one occipital lobe cause half-blindness (hemianopia) in the retinas on the same side,—that is, lesions in the right occipital lobe cause blindness of the right halves of the retinas, while injuries to the left occipital lobes are accompanied by loss of vision on the left sides of the retinas (see p. 207); but such unilateral lesions, it is stated, do not involve the central field of vision—only the peripheral portion of the field is affected. In connection with its special functions in vision the fovea centralis possesses a peculiar structure. It forms a shallow depression in the center of the retina described by some authors as elliptical, by others as circular in outline. In the center of the fovea lies a smaller, very shallow depression spoken of as the foveola. The diameter of the fovea, as stated above, is estimated differently by different authors. While measurements on preserved specimens give the diameter as 0.2 to 0.4 mm., ophthalmoscopic examination seems to indicate that in the fresh state it may be larger. According to Fritsch,\* the fundus, reckoned from the point at which the depression begins, has a diameter of 0.5 to 0.75 mm. Within the fovea cones only are present, and these cones are longer and more slender (diameter, 0.002 mm.) than in the rest of the retina. Moreover, the thickness of the retina is much reduced in the fovea, whence arises the depression. At this point the cones are practically exposed directly to the light, whereas in other parts the light must penetrate the other layers before reaching the rods and cones. Lying around the fovea is an area about 6 mm. in diameter, of a yellowish color, and hence known as the macula lutea. The portion of the visual field falling upon this area, in a fixed position of the eye, is sometimes called the macular field. According to some observers† the yellow color of the macula is due to post-mortem changes.

**Visual Acuity.**—The distinctness of vision or the resolving power of the eye varies greatly in different parts of the retina. It may be measured for the fovea by bringing two fine lines closer and closer together until the eye is unable to see them as two distinct objects. Measured in this way, it is usually stated that when the distance between the lines subtends an angle of 1 minute (60 seconds) at the eye, the limit of resolvability is reached. This

\* Fritsch, "Sitzungsberichte d. könig. Akad. d. Wiss.," Berlin, 1900.

† Sivén, "Skandinavisches Archiv f. Physiol.," 1905, 17, 306.

angle on the retina comprises an area of about 0.004 mm. in diameter, sufficient to cover two cones in the fovea. A simpler method to ascertain the size of a just perceptible image on the retina is to use a black spot upon a white background. At a sufficient distance this object will be invisible, the white margins separated by the diameter of the black spot fuse together, but if brought closer to the eye, the spot will be just distinguishable at a certain distance. The diameter of the spot being known, and its distance from the eye, the size of the retinal image may be calculated. Using this method, Guillery\* estimated the diameter of the just perceptible retinal image, or, as it has been appropriately called, *the physiological point*, at 0.0035 mm. These estimates apply only to the fovea, and, indeed, to the central part of the fovea, the foveola. Numerous authors have called attention to the fact that

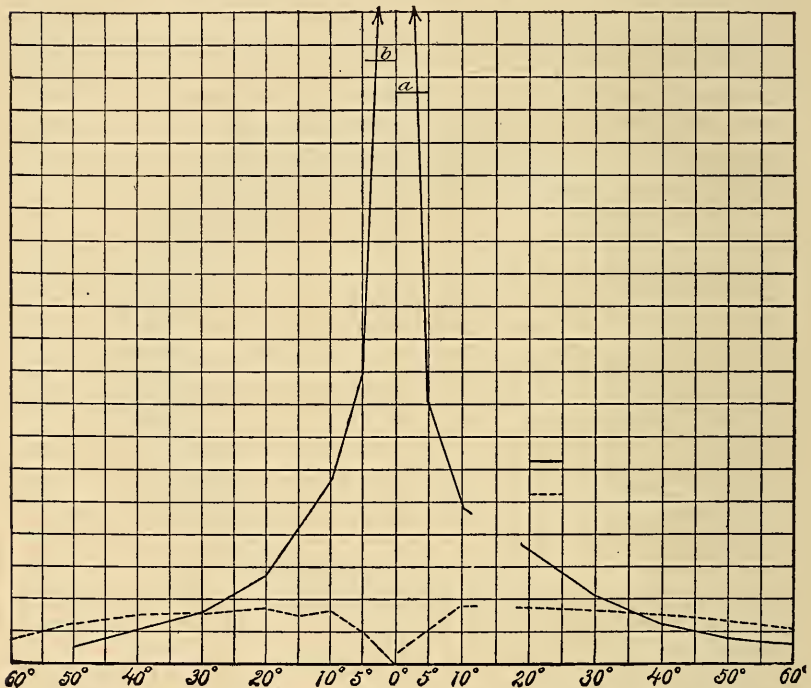

Fig. 145.—Curve to show the relative acuity of vision in the central and peripheral fields and in the light-adapted and the dark-adapted eye.—(Koester.) The full line represents the relative acuteness of vision in the eye exposed to usual illumination. From the center of the fovea, 0°, the acuity of vision falls rapidly at first and then more slowly as one passes outward into the peripheral field. The dotted line represents the acuity of vision in dim lights. The fovea, under this latter condition, is less sensitive than the parts of the retina at an angular distance of 10° or even 60°.

visual acuity, as measured by the least distance at which two objects may be seen separately, varies with the intensity of illumina-

\* Guillery, "Zeitschrift f. Psychologie u. Physiol. d. Sinnesorgane," 12, 243, 1896.



tion. The estimates given are for ordinary room light. Out-of-doors, and especially in the case of persons who live habitually an outdoor life, visual acuity or the power of visual discrimination is increased. We may believe that under the most favorable conditions of illumination and contrast we can resolve two objects whose images on the fovea are separated by a distance about equal to the diameter (0.002 mm.) of a single cone. The acuity of vision does not vary greatly throughout the fovea; any object whose retinal image falls well within the fovea can be seen quite distinctly in all of its parts when the eye is fixed for the center of the object. This is the case, for instance, with the moon. Nevertheless, in looking at such an object as the moon the eye, to make out details, will fixate one point after another, showing that for most distinct vision we use probably only the center of the fovea. As we pass out from the fovea into the peripheral field of vision the acuity of vision diminishes very rapidly, so that at 20 degrees, for instance, from the center of the fovea the retinal images must be separated by a distance of 0.035 mm. in order to be recognized as distinct; a distance ten times as great as is necessary in the fovea. On this account our vision in the peripheral field is very indistinct,—details of form cannot be clearly perceived. The rapidity with which visual acuity diminishes as we pass outward from the fovea is indicated by the curve given in Fig. 145. In all close work, therefore, we keep our eyes moving continually so as to bring one point after another into the center of the fovea, as is well illustrated by the act of reading. If the eye is kept fixed upon the central letter of a long word, only one or two letters on each side can be made out distinctly in spite of the fact that with such familiar objects we can guess the letter even when the image is not entirely distinct. In ophthalmological practice the acuity of vision (central vision) is measured usually by test letters whose size is such that at the distance at which they are read—say, 6 meters (20 feet), the practical far point at which no accommodation is needed—each subtends at the eye an angle of 5 minutes. An eye that can distinguish the letters at this distance is said to be normal; one that can distinguish them only at a smaller distance or at the given distance requires letters of larger size has a subnormal acuity of vision. If, for instance, an individual at 20 feet can read only those letters that the normal eye can distinguish at 100 feet his visual acuity,  $V$ , is equal to  $\frac{20}{100}$ .

**Relation between the Amount of Sensation and the Intensity of the Stimulus—Threshold Stimulus.**—With the sensory as with the motor nerves we may distinguish between various degrees of sub-maximal stimulation. The stronger the stimulus, the stronger the reaction,—that is, in the case of the optic nerve, the visual sensation.

The end reaction of the activity of a sensory nerve is a state of consciousness. The variations in magnitude of this state can not be measured with objective exactness, they must be judged subjectively by the individual concerned. A stimulus too weak to give a response with a motor nerve is usually designated in physiology as subminimal; a similar stimulus with sensory nerves is frequently expressed by the equivalent term subliminal,—that is, below the threshold. So a stimulus just strong enough to provoke a perceptible reaction is the minimal stimulus for efferent nerves and the threshold stimulus for sensory nerves. Inasmuch as the variations in the intensity of consciousness can not be adequately measured, it is customary, in studying the relations of the strength of stimulus to the conscious response, to pay attention to the strength of stimulus under any given condition which is sufficient to arouse a just perceptible difference in the conscious reaction. Proceeding upon this method, it is found in the case of the visual sensations and the optic nerve, as with other sensations and their corresponding nerves, that the increase of stimulus necessary to cause a just perceptible change in consciousness varies with the amount of stimulus already acting. If, for instance, the retina is being stimulated by a light of 1 candle power an increase of illumination to 1.1 candle power may make a perceptible difference in sensation. But if the retina is being illuminated by a light of 10 candle power an increase to 10.1 candle power would probably make no perceptible difference. For a certain range of stimulation, in fact, it has been stated that the increase in stimulus must be a constant fractional part of the stimulus already acting. That is, in the hypothetical case given, if, with 1 candle power, an increase to 1.1 candle power makes a just perceptible difference in consciousness, then with 10 candle power an increase of  $\frac{1}{10}$  of the acting stimulus, namely—1 candle power—will be necessary to cause a perceptible difference. The relation as expressed in this form is known as Weber's law; but it seems probable that, while the general fact is true, this exact expression of it holds only approximately for an intermediate range of stimulation. In this matter of a threshold stimulus the sensitiveness of the retina shows also certain interesting differences in the foveal as compared with the peripheral field. The difference is especially marked when the reaction of the retina in strong lights is compared with its reaction in dim lights.

**The Light-adapted and the Dark-adapted Eye.**—The condition of the retina changes when after exposure to light it is submitted to darkness, the change being most marked in the peripheral field. When one passes from daylight into a dark room vision at first is very imperfect, but after some minutes it rapidly improves, "as the eye becomes accustomed to the dark." The

change is known as an adaptation, and in this respect the retina differs from the sensitive photographic plate. Comparison of the threshold stimulus for different parts of the retina, in an eye exposed alternately to darkness and to light, has shown that in the dark the sensitiveness in the peripheral field increases greatly during an hour or so, while that of the foveal field is apparently unchanged. With such a dark-adapted eye, therefore, there will be a certain dim light which will be seen by the peripheral parts of the retina, but perhaps will cause no reaction upon the fovea. For such a degree of light, therefore, the fovea would be blind. This general fact has, indeed, long been known. Anyone may notice in late twilight, when the stars are beginning to appear, that a very faint star may disappear when looked at,—that is, when its image is brought upon the fovea; to see it one must direct his eyes a little to the side, so as to bring its image into the peripheral field. This greater sensitiveness of the dark-adapted eye in the peripheral field where the rods predominate over the cones seems to be associated with the movement of the pigment in the pigment epithelium (see above) and the resulting regeneration of the visual purple in the external segments of the rods. The increase in the visual purple in the dark may, indeed, account for the increased sensitiveness to light in the rod-region and explain why a similar increase fails to occur in the fovea, where only cones are present. The curve given in Fig. 145 shows that in the dark-adapted eye the threshold of vision in the peripheral field may be lower than in the fovea. In accordance with these facts von Kries\* has suggested that the rods, the peripheral field of the retina, are especially adapted for vision in dim lights, night vision, while the cones are especially adapted for vision in strong lights, day vision. This general fact will perhaps accord with the experience of anyone who attempts to estimate the value of his peripheral vision in dim nightlight as compared with daylight. Other interesting differences in the reaction of the light-adapted and the dark-adapted eye are referred to below in connection with color blindness.

#### CHARACTERISTICS OF THE VISUAL SENSATIONS.

In addition to the spatial attributes connected with our visual sensations—that is, the perception of form—they are characterized by two properties which may be described in general as variations in intensity and in quality.

**Luminosity or Brightness.**—That characteristic which we describe as the luminosity or brightness of a visual sensation has

\* Von Kries, "Zeitschrift f. Psychologie u. Physiologie d. Sinnesorgane," 9, 81, 1895.

been defined differently by various writers. We may consider it, however, as the expression of the intensity of the acting stimulus. Sensations of the same quality are easily compared as regards their brightness. We can tell as between two whites or two greens which is the brighter of the two, but when two different qualities—a red and a green sensation, for instance—are compared our subjective determination of the relative brightness is, for most persons, difficult or impossible to make. To a lesser degree the difficulty is similar to that of the comparison of sight and sound. According to the conception adopted here, however, that the brightness is an expression of the intensity of the stimulus, an objective standard of comparison might be obtained by measuring the resulting action currents in the optic nerve fibers. When the spectral colors are examined it is obvious that some of the colors are brighter than others, the extreme red and extreme violet, for instance, possessing little luminosity as compared with the yellow. The relative brightness

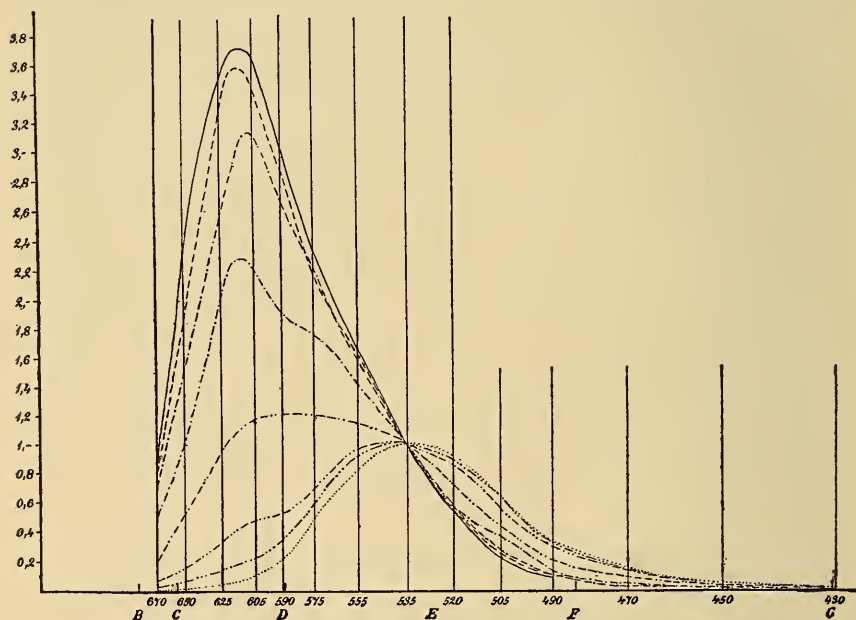

Fig. 146.—Diagram showing the distribution of the intensity of the spectrum as dependent upon the degree of illumination. The spectrum is represented along the abscissa, the numerals giving the wave lengths from red, 670, to violet, 430. The ordinates give the luminosity of the different colors. Eight curves are given to show the changes in distribution of relative brightness with changes in degree of illumination. With the greatest illumination the maximum brightness is in the yellow (605-625); with weaker illumination it shifts to the green (535).—(*König*.)

of the different spectral colors is found to vary with the amount of illumination, as shown in the curves given in Fig. 146. With a

brilliant spectrum the maximum brightness is in the yellow, but with a feeble illumination it shifts to the green. This fact accords with what is known as the "Purkinje phenomenon,"—namely, the changing luminosity and color value of colors in dim lights. As the light becomes more feeble the colors toward the red end of the spectrum lose their quality, the blue colors being perceived last of all, just as in late twilight it may be noticed that the sky remains distinctly blue after the colors of the landscape become indistinguishable. It should be added that the "Purkinje phenomenon" is true only for the parts of the retina lying outside the fovea, that is, for the peripheral field. As the light grows dimmer the perception of blue is lost first in the fovea, so that with a certain feebleness of illumination the central field becomes blue-blind. With a very feeble illumination the dark-adapted eye becomes practically totally color blind.

**Qualities of Visual Sensations.**—The different qualities of our color sensations may be arranged in two series: an achromatic series, consisting of white and black and the intermediate grays, and a chromatic series, comprising the various spectral colors, together with the purples made by combination of the two ends of the spectrum, red and blue, and the colors obtained by fusion of the spectral colors with white or with black, such, for instance, as the olives and browns.

*The Achromatic Series.*—Our standard white sensation is that caused by sunlight. Objects reflecting to our eye all the visible rays of the sunlight give us a white sensation. This sensation, therefore, is due primarily to the combined action of all the visible rays of the spectrum, each of which, taken separately, would give us a color sensation. White or gray may be produced also by the combined action of certain pairs of colors,—complementary colors,—as is described below. Black, on the contrary, is the sensation caused by withdrawal of light. It must be emphasized that in order to see black a retina must be present. It is probable that a person with both eyes enucleated has no sensation of darkness. That black is a sensation referable to a condition of the retina is made probable also by the interesting observations recorded by Gotch,\*—namely, that when an eye that has been exposed to light is suddenly cut off from the light there is an electrical change in the retina, a dark response, similar to that caused by throwing light on a retina previously kept in the dark. Blackness, therefore, is a sensation produced by withdrawing light from the retina, and a black object is one that reflects no light to the eye. Black may be combined with white to produce the series of grays, and when combined with the spectral colors it gives a series of modified color tones,

\* Gotch, "Journal of Physiology," 29, 388, 1903.

thus the olives of different shades may be considered as combinations of green and black in varying proportions.

The *chromatic series* consists of those qualities to which we give the name of colors, and, as stated above, they comprise the spectral colors, and the extraspectral color, purple, together with the light-weak and light-strong hues obtained by combining the colors with white or black. In the spectrum many different colors may be detected,—some observers record as many as one hundred and sixty,—but in general we give specific names only to those that stand sufficiently far apart to represent quite distinct sensations,—namely, the red, orange, yellow, green, blue, and violet. When light is taken from a definite limited portion of the spectrum we have a monochromatic light that gives us a distinct color sensation varying with the wave length of the portion chosen.

**Color Saturation and Color Fusion.**—The term saturation as applied to colors is meant to define their freedom from accompanying white sensation. A perfectly saturated color would be one entirely free from mixture with white. On the objective side it is easy to select a monochromatic bundle of rays from the spectrum without admixture of white light, but on the physiological side it is not probable that the color sensation thus produced is entirely free from white sensation, since the monochromatic rays may initiate in the retina not only the specific processes underlying the production of its special color, but at the same time give rise in some degree to the processes causing white sensations. Even the spectral colors are therefore not entirely saturated, but they come as near to giving us this condition as we can get without changing the state of the retina itself by previous stimulation.

*Color Fusion.*—By color fusion we mean the combination of two or more color processes in the retina, this end being obtained by superposing upon the same portion of the retina the rays giving rise to these color processes. It must be borne in mind that color fusion upon the retina is quite a different thing from color mixture as practised by the artist. A blue pigment, such as Prussian blue, for instance, owes its blue color to the fact that when sunlight falls upon it the red-yellow rays are absorbed and only the blue, with some of the green, rays are reflected to the eye. So a yellow pigment, chrome yellow, absorbs the blue, violet, and red rays and reflects to the eye only the yellow with some of the green rays. A mixture of the two upon the palette will absorb all the rays except the green and will therefore appear green to the eye. If, however, by means of a suitable device, we throw simultaneously upon the retina a blue and a yellow light, the result of the retinal fusion is a sensation of white. Many different methods have been employed to throw colors simultaneously upon the retina, the most perfect

being a system of lenses or mirrors by which different portions of a spectrum can be superposed. The usual device employed in laboratory experiments is that of rotation of discs of colored paper. Each disc has a slit in it from center to periphery so that two discs can be fitted together to expose more or less of each color. If a combination of this kind is attached to a small electrical motor it can be rotated so rapidly that the impressions of the two colors upon the retina follow at such a short interval of time as to be practically simultaneous.

**The Fundamental Colors.**—By the methods of color fusion it can be shown that three colors may be selected from the spectrum whose combinations in different proportions will give white, or any of the intermediate color shades, or purple. Considered purely objectively, a set of three such colors may be designated as the fundamental colors, and red, yellow, and blue, or red, green, and violet have been the three colors selected. On the physiological side, however, it has been assumed that there are certain more or less independent color processes—photochemical processes—in the retina which give us our fundamental color sensations, and that all other color sensations are combinations of these processes in varying proportions with each other or with the processes causing white and black. Referring only to the colors proper, the fundamental color sensations according to some views are red, green, and blue or violet; according to others, they are red, yellow, green, and blue. (See paragraph on Theories of Color Vision.)

Helmholtz calls attention to the fact that the names used for these fundamental color sensations are obviously of ancient origin, thus indicating that the difference in quality of the sensations has been long recognized. Red is from the Sanskrit *rudhira*, blood; blue from the same root as blow, and refers to the color of the air; green from the same root as grow, referring to the color of vegetation. Yellow seems to be derived from the same root as gold, which typified the color. The other less distinct qualities have names of recent application, such as orange, violet, indigo blue, etc.

**Complementary Colors.**—It has been found by the methods of color fusion that certain pairs of colors when combined give a white (gray) sensation. It may be said, in fact, that for any given color there exists a complement such that the fusion of the two in suitable proportions gives white. If we confine ourselves to the spectral colors we recognize such complementary pairs as the following:

- Red and greenish blue.
- Orange and cyan blue.
- Yellow and indigo blue.
- Greenish yellow and violet.

The complementary color for green is the extraspectral purple. Colors that are closer together in the spectral series than the

complementaries give on fusion some intermediate color which is more saturated—that is, less mixed with white sensation—the nearer the colors are together. Thus, red and yellow, when fused, give orange. Colors farther apart than the distance of the complementaries give some shade of purple. On the physical side, therefore, we can produce a sensation of white in two ways: Either by the combined action of all the visible rays of the spectrum (sunlight) or by the combined action of pairs of colors whose wave lengths vary by a certain interval. It is probable that in the retina the processes induced by these two methods are qualitatively the same, the wave-lengths represented by the complementary colors setting up by their combined action the same photochemical processes that normally are induced by the sunlight.

**After-images.**—As the name implies, this term refers to images that remain in consciousness after the objective stimulus has ceased to act upon the retina. They are due doubtless to the fact that the changes set up in the retina by the visual stimulus continue, with or without modification, after the stimulus is withdrawn. After-images are of two kinds: positive and negative. In the positive after-images the visual sensation retains its normal colors. If one looks at an incandescent electric light for a few seconds and then closes his eyes he continues to see the luminous object for a considerable time in its normal colors. Objects of much less intensity of illumination may give positive after-images, especially when the eyes have been kept closed for some time, as, for instance, upon waking in the morning. In negative after-images the colors are all reversed—that is, they take on the complementary qualities (see Fig. 147). White becomes black, red, a bluish green, and *vice versa*. Negative after-images are produced very easily by fixing the eyes steadily upon a given object for an interval of twenty seconds or more and then closing them. In the case of colored objects the after-image is shown better, perhaps, by turning the eyes upon a white surface after the period of fixation is over. After-images produced in this way often appear and disappear a number of times before ceasing entirely, and, although the color at first is the complementary of that of the object looked at, it may change before its final disappearance. Anyone who has gazed for even a brief interval at the setting sun will remember the number of colored and changing after-images seen for a time when the eye is turned to another portion of the sky. That several different after-images are seen in this case is due to the fact that the eyes are not kept fixed under the dazzling light of the sun, and a number of different images are formed, therefore, upon the retina.





Fig. 147.—Colored figure to illustrate negative after images. Look fixedly at the middle of the cross for twenty to thirty seconds. Then either close the eyes or look at a white surface. A cross will be seen in which the colors are reversed, the long limb being red and the short one green. If the image is obtained on a white surface its size will depend on its distance from the eyes,—that is, the distance of projection.



Fig. 148.—Mayer's experiment to show color contrast. The figure shows a gray strip on a green background. If the figure is covered with a sheet of tissue paper the gray strip takes on a reddish tint. If the tissue paper is not of quite the right thickness to produce the illusion, this latter may be brought out by moving the sheet somewhat away from the figure.



After-images may be used in a very instructive way to show that our estimates of the size of a retinal image vary with the distance to which we project it,—that is, with the distance at which we suppose we see it. Once the image is, so to speak, branded on the retina, its actual size, of course, does not vary, but our judgment of its size may be made to vary rapidly by projecting the image upon screens at different distances. If, for instance, in obtaining the after-image of the strips shown in Fig. 147 one moves the white paper used to catch the image toward and away from the eye, the apparent size varies proportionally to its distance.

**Color Contrasts.**—By color contrast is meant the influence that one color field has upon a contiguous one. If, for instance, a piece of blue paper is laid upon a larger yellow square, the color of each of them is heightened by contrast. A piece of blue paper on a blue background does not appear so saturated as when placed against a yellow background. The influences of contrast may be shown in a great variety of ways.\* For instance, if a disc like that in the illustration, Fig. 149A, is rotated rapidly, it should give circles of gray, the darkest at the middle; but each circle should be uniform as it is made by the fusion of a definite amount of white and black. On the contrary, the appearance obtained is that repre-

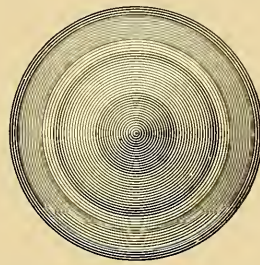
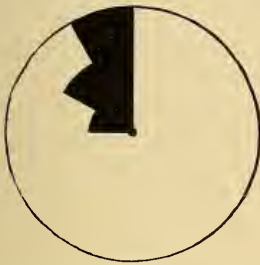

Fig. 149A.—Black and white disc for experiment on contrast.—(Rood.)

Fig. 149B.—Showing the result when the disc A is set into rapid rotation.—(Rood.)

sented in Fig. 149B. Each circle appears darker on its outer edge where it borders on a lighter circle, and lighter on its inner edge where it borders on a darker circle. Similar contrasts may be obtained from comparing shadows cast by yellow and white light. If a rod be arranged in a dark room so as to cast a shadow from an opening admitting daylight and one also from a lighted candle, either shadow taken separately appears black, but if the two are cast side by side one will appear blue, the other yellow. The shadow cast by the daylight, being illuminated by the yellow candle-light, will appear yellow, and the other shadow, that from the candle-light, will by

\* Rood, "Modern Chromatics," "International Scientific Series."

contrast seem quite blue. A striking instance of the effect of contrast is given, also, by the simple experiment of Mayer, illustrated in Fig. 148. The gray square on the green background suffers no apparent change from contrast, but if the figure is covered by a sheet of white tissue paper the gray square at once takes on a reddish hue. It is evident that in all artistic and ornamental employment of colors this influence must be considered, and empirical rules are established which indicate for the normal eye the beneficial or the killing effect of different colors when brought into juxtaposition.

**Color Blindness.**—The fact that some eyes do not possess normal color vision does not seem to have attracted the attention of scientific observers until it was studied with some care by Dalton, the distinguished English chemist, at the end of the eighteenth century. Dalton himself suffered from color blindness, and the particular variety exhibited by him was for some time described as Daltonism, but is now usually designated as red blindness. The subject was given practical importance by later observers, especially by the Swedish physiologist Holmgren,\* who emphasized its relations to possible accidents by rail or at sea in connection with colored signals. It is now the practice in all civilized countries to require tests for color blindness in the case of those who in railways or upon vessels may be responsible for the interpretation of signals. The numerous statistics that have been gathered show that the defect is fairly prevalent, especially among men. It is said that on the average from 2 to 4 per cent. are color blind among males, while among women the proportion is much smaller,—0.01 to 1 per cent. Among the poorly educated classes the defect is said to be more common than among educated persons. Color blindness may exist in different degrees of completeness, from a total loss to a simple imperfection or febleness of the color sense, and it is usually congenital. Among those persons who possess a trichromatic color sense differences may be observed in regard to the proportions of different colors which must be combined to make a match with a given standard. This condition has been shown to exist particularly for the combinations of red and green required to match a homogeneous yellow. Individuals who differ sensibly from the normal in the amounts of red and green selected to make such a match have been described as having an “anomalous trichromatic vision.”† Those who are completely color blind as regards some or all of the fundamental

\* Holmgren, “Color Blindness in its Relations to Accidents by Rail and Sea,” *Smithsonian Institution Reports*, Washington, 1878. See also Jeffries, “Color Blindness, its Danger and its Detection,” Boston.

† Consult von Kries in Nagel’s *Handbuch der Physiologie*, vol. 3, p. 124.

colors fall into two groups: the dichromatic, whose color vision may be represented by two fundamental colors and their combinations with white or black, and the achromatic, or totally color blind, who see only the white-gray-black series.

*Dichromatic Vision.*—The color-blind who belong to this class fall into two or three groups, which have been designated, under the influence of the Young-Helmholtz theory of color vision, the red-blind, the green-blind, and the violet-blind. As the terms red-blind and green-blind imply a more specific condition of vision than is found to be the case on careful examination, von Kries has suggested as a substitute the names protanopia and deuteranopia, as indicating a defect in a first or second constituent necessary for color vision. According to the same nomenclature, so-called violet-blindness would be designated as tritanopia. From this standpoint genuine color blindness may be regarded as a reduction form of normal trichromatic vision of such a character that all the color sensations may be conceived as depending upon the existence of only two fundamental color processes. The most common by far of these groups is that of so-called red-blindness (protanopia); it constitutes the usual form of color blindness. As a matter of fact, persons so affected are in reality red-green blind. In what may be called the most typical cases they distinguish in the spectrum only yellows and blues. The red, orange, yellow, and green appear as yellow of different shades, the green-blue as gray, and the blue-violet and purple as blue. The red end of the spectrum is distinctly shortened, especially if the illumination is poor, and the maximum luminosity, instead of being in the yellow, as in normal eyes, is in the green. When the spectrum is examined by such persons a neutral gray band is seen at the junction of the blue and green. In some cases, however, this neutral band is not seen, the yellow passing with but little change into the blue. As a matter of fact, in red-blindness the most characteristic defect is a failure to see or to appreciate the green. This color is confused with the grays and with dull shades of red. When such persons are examined for their negative after-images for different colors, it will be noted that they describe some of their after-images as red, the after-image of indigo-blue, for example, but that they describe none as green. The after-image of purple, for instance, which to the normal eye is bright green, is described by them as gray blue or pale blue. From the descriptions given it is probable that the color vision of the so-called red-blind is not by any means the same in all cases, but exhibits many individual differences. The green-blind are also, according to recent descriptions, red-green blind; they also

confuse reds and greens and in the spectrum are conscious of only two color qualities, namely, yellow and blue. They differ from the red-blind in that the red end of the spectrum is not shortened, and the maximum luminosity, as with the normal eye, is placed in the yellow. In the matching and combination of colors they show distinct differences from the red-blind, so that though resembling the latter in general features, they differ obviously in some details. As compared with the protanopes, it may be said that their retinas are more sensitive to the long waves in the spectrum. Violet blindness (tritanopia) seems to be so rare as a congenital and permanent condition that no very exact study of it has been made. In cases of acquired tritanopia resulting from pathological changes it is reported that the violet end of the spectrum is colorless (neutral) and that a neutral band appears also in the yellow-green region of the spectrum.\* By the ingestion of santonin it is said that a condition of this kind may be produced temporarily. The violet end of the spectrum is shortened and white objects take on a yellowish hue. The conditions produced by santonin are evidently more complex than can be explained by simply assuming that the violet color sense is lost. Recent observers † state that the drug produces a condition of yellow vision, outside the fovea, in the daylight, and a condition of violet vision with yellow-blindness, but no red- or green-blindness, in dim lights.

*Tests for Color Blindness.*—Although the vision of the red and the green blind is deficient as regards green and red colors, it will be found in many cases that they recognize these colors and name them correctly, having adopted the usual nomenclature and adapted it to their own standards. In order to detect the deficiency they must be examined by some test which will compel them to match certain colors. Under these circumstances it will be found that along with correct matches they will make others which to the normal eye are entirely erroneous. A great number of methods have been proposed and used to detect color blindness. The simplest perhaps is that of Holmgren.‡ A number of skeins of wool are used and three test colors are chosen,—namely, (I) a pale pure green skein, which must not incline toward yellow green; (II) a medium purple (magenta) skein; and (III) a vivid red skein. The person under investigation is given skein I and is asked to select from the pile of assorted colored skeins those that have a similar color value. He is not to make an exact match, but to select those that appear

\* Collins and Nagel, "Zeitschrift f. Psychol. u. Physiol. d. Sinnesorgane," 1906, xli., 74.

† Sivén and Wendt, "Skandinavisches Archiv f. Physiologie," 14, 196, 1903, and 1905, 17, 306.

‡ For details see the works of Holmgren and of Jeffries, already quoted.

to have the same color. Those who are red or green blind will see the test skein as a gray with some yellow or blue shade and will select, therefore, not only the green skeins, but the grays or grayish yellow and blue skeins. To ascertain whether the individual is red or green blind tests II and III may then be employed.

With test II, medium purple, the red blind will select, in addition to other purples, only blues or violets; the green blind will select as "confusion colors" only greens and grays.

With test III, red, the red blind will select as confusion colors greens, grays, or browns less luminous than the test color, while the green blind will select greens, grays, or browns of a greater brightness than the test.

*Achromatic Vision.*—A number of cases of total color blindness have been carefully examined.\* It would seem that in such individuals there is an entire loss of color sense,—they possess only achromatic vision. The external world appears to them only in shades of gray. In the majority of these cases ( $\frac{2}{3}$ ) there is a region of blindness in the fovea (central scotoma), and an unusual sensitiveness to light and nystagmus (rolling movement of the eyeballs) are also characteristic. Since the peripheral field of vision is nearly normal as regards sensitiveness to light, while the central field is frequently blind or amblyopic, it has been assumed that this condition is one of loss of function in the cones.

**Distribution of the Color Sense in the Retina.**—What has been said above in regard to color blindness refers especially to the central field of vision. When we examine the peripheral field in the normal eye it is found that on the extreme periphery the retina is totally color blind, perceiving only light and darkness,—that is, the shades of gray. As we pass in toward the center the color sense develops gradually, the blue colors being perceived first and the greens last,—that is, nearest to the center,—so that in a certain zone the normal eye is red-green blind. The distribution of the color sense may be studied conveniently by means of the perimeter (see p. 341). It will be found to vary with each individual, so much so that it is possible that a test of this character might be used for the identification of individuals. Exceptionally it is found that the entire retina possesses a nearly normal color sense. Usually for the colors red, green, and blue, the blue has the most extensive field and the green the least, as is indicated in the perimeter chart given in Fig. 150. If the green chosen is blue green (490  $\mu\mu$ )—that is, the complementary of the red—it is stated that their fields are co-extensive.† From this standpoint the retina presents three

\* Grunert, "Archiv für Ophthalmologie," 56, 132, 1903.

† Baird, "The Color Sensitivity of the Peripheral Retina," Carnegie Publication, No. 29, 1905.

concentric zones: an extreme peripheral zone devoid of color vision, an intermediate zone in which yellow and blue are perceived, and a central zone sensitive to red and green.\* The outlines of

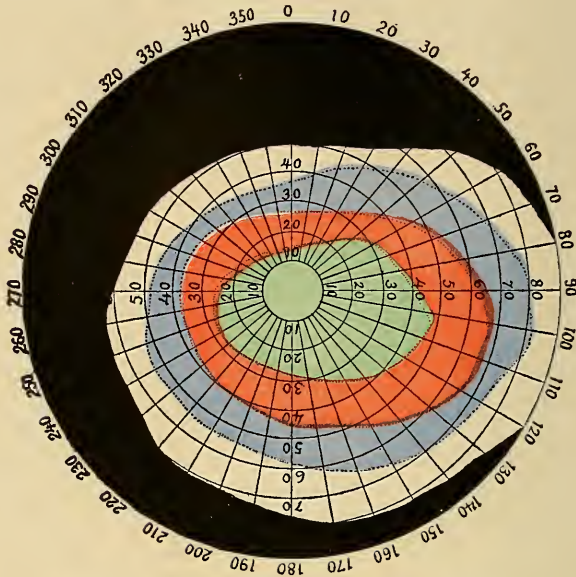

Fig. 150.—Perimeter chart indicating the average fields of vision for blue, red, and green compared with white (gray). Right eye: The outlines of the color fields are represented as smooth since the chart is an average from many determinations. As a matter of fact, in each individual the outline is highly irregular. Normally green (bright green) is the smallest field, green objects outside the limit appearing yellow and farther out colorless (gray).

the different fields usually show many irregularities, and in some cases it will be found that bright green is perceived over a larger area than the red. The fields are not identical in the two eyes, and in each eye it is, as a rule, more extensive upon the nasal than upon the temporal side of the retina. In the red-green blind the peripheral fields of color vision, judged by the individual's own standards, may be markedly constricted as compared with the normal retina (see Fig. 151).

**Functions of the Rods and Cones.**—Many facts unite in making it probable that the rods and cones are different in function. They differ in structure and especially in their connections. As is shown in the diagram given in Fig. 152, the cones terminate in the external nuclear layer in arborizations which connect with the bipolar ganglion cells, and in the fovea at least this connection is such

\* It is interesting to find (Haycraft) that around the blind spot there is a small zone which, like the periphery of the retina, is completely color-blind, that is, perceives only gray, and external to this the color sense is developed in zones whose order is similar to that on the periphery of the retina.



that each cone connects with a single nerve cell and eventually perhaps with a single optic nerve fiber. The rods, on the contrary, end in a single knob-like swelling, and a number of them make connections with the same nerve cell. Histologically, therefore, the

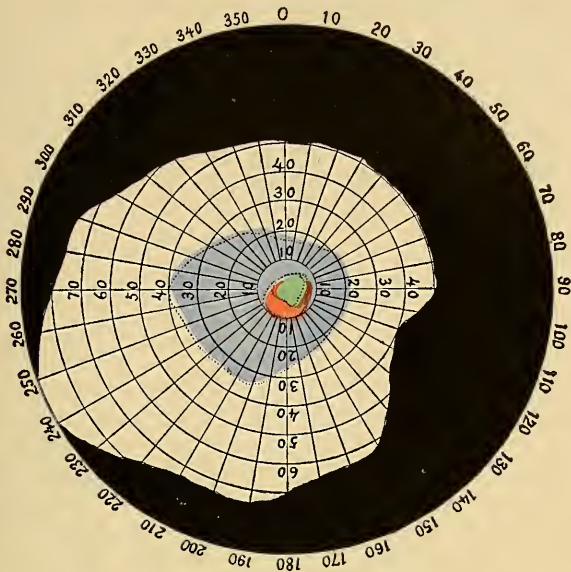

Fig. 151.—Perimeter chart showing the highly restricted color fields in the left eye of a typical case of so-called red-green color blindness. The ability to distinguish red and green, by whatever characteristics of intensity or color they possessed extended for a very short distance outside the fovea. It is interesting that the ability to distinguish blue was in this case limited as compared with a normal eye.

conduction paths for the cones seem to be more direct than in the case of the rods. These latter elements, moreover, possess the visual purple, which is lacking in the cones. Lastly, in the eye of the totally color blind, in the dark-adapted eye in dim lights, in the color-blind peripheral area of the normal eye, and in the eyes of most distinctly night-seeing animals, such as the mole and the owl, vision seems to be effected solely by the rods. These facts find their simplest explanation perhaps in the view advocated by Parinaud, Franklin, von Kries,\* and others, according to which the perception of color is a function of the cones alone, while the rods are sensitive only to light and darkness, and by virtue of their power of adaptation in the dark through the regeneration of their visual purple, they form also the special apparatus for vision in dim

\* Von Kries, "Zeitschrift f. Psychologie u. Physiol. d. Sinnesorgane," 9, 81, 1895.

lights (night vision). Color blindness, therefore, whether total or partial, may be regarded as an affection or lack of normal development of the cones. On the other hand, those interesting cases in

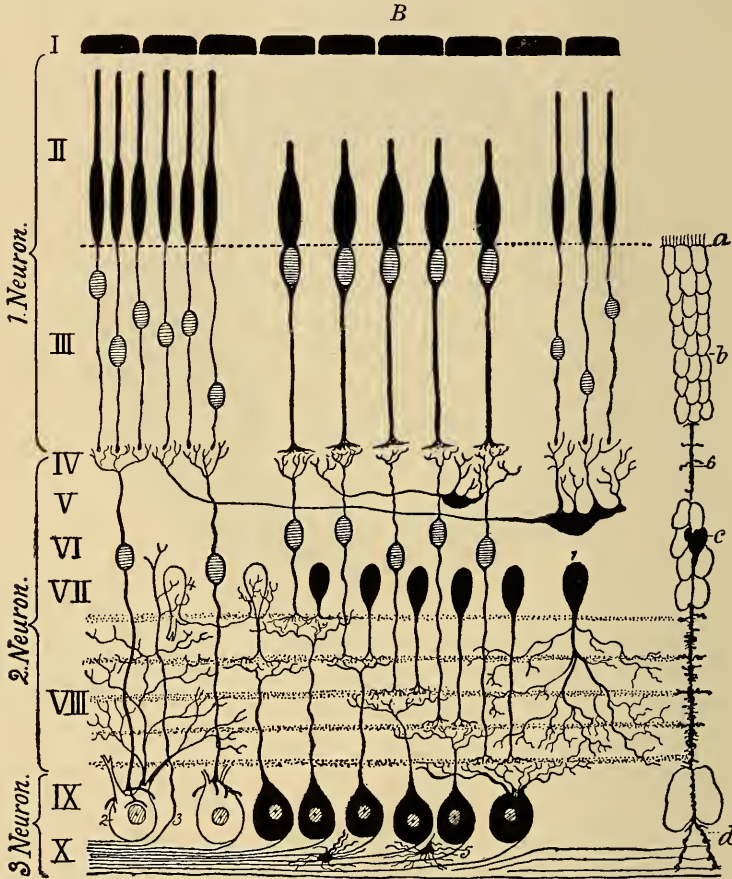

Fig. 152.—Schema of the structure of the human retina (Greeff): I, Pigment layer; II, rod and cone layer; III, outer nuclear layer; IV, external plexiform layer; V, layer of horizontal cells; VI, layer of bipolar cells (inner nuclear); VII, layer of amacrine cells (without axons); VIII, inner plexiform layer; IX, ganglion cell layer; X, nerve fiber layer; 6, fiber of Müller.

which the vision, while good in daylight, is faulty or lacking in dim lights (night blindness, hemeralopia) may be referred to a defective functional activity of the rods, probably from lack of formation of visual purple.

**Theories of Color Vision.**—A number of theories have been proposed to explain the facts of color vision. None of them has been entirely successful in the sense that the explanations it affords

have been submitted to satisfactory experimental verification. The immediate stimuli that give rise to the visual impulses are assumed to be of a chemical nature, and it seems probable that in this case as in that of many other problems of physiology, we must await the development of a more complete knowledge of the chemical processes involved. The theories proposed at present, while all tested by experimental inquiries, are in a large measure hypotheses constructed to fit more or less completely the facts that are known. Three of these theories may be described briefly as examples of the modes of reasoning employed:

*I. The Young-Helmholtz Theory.*—This theory, proposed essentially by Thomas Young (1807) and afterward modified and expanded by Helmholtz,\* rests upon the assumption that there are three fundamental color sensations,—red, green, and violet—and corresponding with these there are three photochemical substances in the retina. By the decomposition of each of these substances corresponding nerve fibers are stimulated and impulses are conducted to a special system of nerve cells in the visual center of the cerebrum. The theory, therefore, assumes special nerve fibers and nerve centers corresponding respectively to the red, green, and violet photochemical substances, and the peculiar quality of the resulting sensations are referred, in the original theory, to the different reactions in consciousness in the three corresponding centers in the brain. When these three substances are equally excited a sensation of white results, of greater or less intensity according to the extent of the excitation. White, therefore, on this theory, is a compound sensation produced by the combination or fusion in consciousness of the three equal fundamental color sensations. The sensation of black, on the other hand, results from the absence of stimulation, from the condition of rest in the retina and in the corresponding nerve fibers and nerve centers. All other color sensations—yellow, for instance—are compound sensations produced by the combined stimulation of the three photochemical substances in different proportions. It is assumed, furthermore, that each of the photochemical substances is acted upon more or less by all of the visible rays of the spectrum, but that the rays of long wave lengths at the red end of the spectrum affect chiefly the red substance, those corresponding to the green of the spectrum chiefly the green substance, and the rays of shortest wave length chiefly the violet substance. These relationships are expressed in the diagram given in Fig. 153) The figure also indicates that it is impossible to stimulate any one of these substances entirely alone,—that is, we cannot obtain a perfectly saturated color sensation. Even the extreme red or the extreme violet

\* Helmholtz, "Handbuch der physiologischen Optik," second edition, 1896, I, 344.

rays act more or less on all of the substances, and the resulting red or violet sensation, is, therefore, mixed to some extent with white,—that is, is not entirely saturated. The theory, as stated by Helmholtz, held strictly to the doctrine of specific nerve energy, in assuming that each photochemical substance serves simply as a means for the excitation of a nerve fiber, and that the quality of the sensation aroused depends on the ending of this fiber in the brain. The phenomenon of negative after-images finds a simple explanation in terms of this theory. If we look fixedly at a green object, for example, the corresponding photochemical substance is chiefly acted upon, and if subsequently the same part of the retina is exposed to white light, the red and violet substances, having been previously less acted upon, now respond in greater proportions to the white light, and

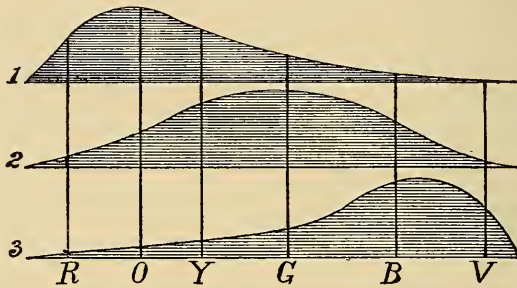

Fig. 153.—Schema to illustrate the Young-Helmholtz theory of color vision.—(Helmholtz.) The spectral colors are arranged in their natural order,—red to violet. The curves represent the intensity of stimulation of the three color substances: 1, The red perceiving substance; 2, the green perceiving; 3, the violet perceiving. Verticals drawn at any point of the spectrum indicate the relative amount of stimulation of the three substances for that wave length of the spectrum.

the after-image takes a red-violet—that is, purple—color. Many objections have been raised to the Young-Helmholtz theory. It has been urged, for instance, that we are not conscious that white or yellow sensations are blends or compounded color sensations; we perceive in them none of the supposed component elements as we do in such undoubted mixtures as the blue-greens or the purples. The theory explains poorly or not at all the fact that on the periphery of the retina we are color blind and yet can perceive white or gray, and it breaks down also in the face of the facts of partial and complete color blindness. The explanation given for black is also unsatisfactory in that it assumes an active state of consciousness associated with a condition of rest in the visual mechanism.

II. *Hering's Theory of Color Vision.*—This theory also assumes the existence in the retina of three photochemical substances, but of such a nature as to give us six different qualities of sensation. There is a white-black substance which when acted upon by the

visible rays of light undergoes disassimilation and sets up nerve impulses that arouse in the brain the sensation of white. On the other hand, when not acted upon by light this same substance undergoes assimilatory processes that in turn set up nerve impulses which in the brain give us a sensation of black. There are in the retina also a red-green and a yellow-blue substance. The former when acted upon by the longer rays undergoes disassimilation and gives a sensation of red, while the shorter waves cause assimilation and produce a sensation of green. A similar assumption is made for the yellow-blue substance. The essence of the theory may be stated, therefore, in tabular form, as follows\*:

PHOTOCHEMICAL SUBSTANCE.	RETINAL PROCESS.	SENSATION.
Red-green.....	Disassimilation	= red
	Assimilation	= green
Yellow-blue.....	Disassimilation	= yellow
	Assimilation	= blue
White-black.....	Disassimilation	= white
	Assimilation	= black

It will be observed that the theory gives an independent objective cause for the sensations of white, black, and yellow, and in

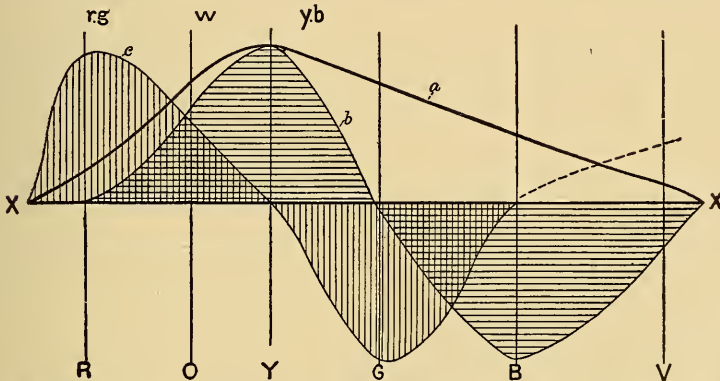

Fig. 154.—Schema to illustrate the Hering theory of color vision.—(Foster.) The curves indicate the relative intensities of stimulation of the three color substances by different parts of the spectrum. Ordinates above the axis, X-X, indicate catabolic changes (disassimilation), those below anabolic changes (assimilation). Curve a represents the conditions for the black-white substance. It is stimulated by all the rays of the visible spectrum with maximum intensity in the yellow. Curve c represents the red-green substance, the longer wave lengths causing disassimilation (red), the shorter ones assimilation (green). Curve b gives the conditions for the yellow-blue substance.

this respect satisfies the objections made on this score to the Young-Helmholtz theory. It fits better, also, the facts of partial and total color blindness. In the latter condition one may assume, in terms of

\* For discussion of color theories see Calkins, "Archiv f. Physiologie," 1902, suppl. volume, p. 244; also Greenwood in Hill's "Further Advances in Physiology," p. 378, 1909.

this theory, that only the white-black substance is present, while red and green blindness—both of them, it will be recalled, really forms of red-green blindness—are explained on the view that in such persons the red-green substance is deficient or lacking. On this theory, complementary colors—red and blue-green, yellow and blue—are, in reality, antagonistic colors. When thrown on the

retina simultaneously their effects neutralize each other, and there remains over only the disassimilatory effect on the white substance which is exerted by all the visible rays. The effect of the various visible rays of the spectrum on the three photochemical substances is illustrated by the chart given in Fig. 154. Ordinates above the abscissa representing disassimilatory effects; those below, assimilatory.

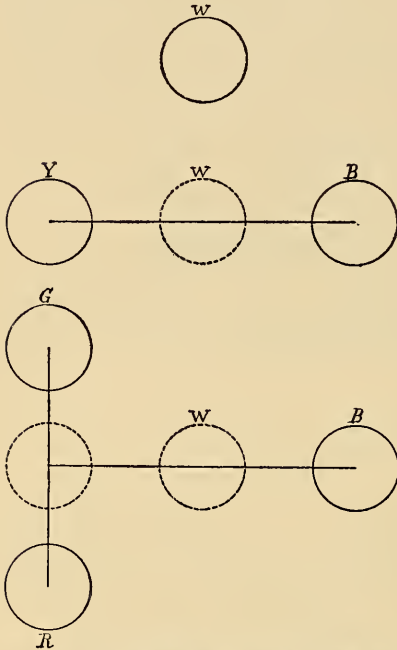

Fig. 155.—Schema to illustrate the Franklin theory of color vision (*Franklin*): *W*, The molecule of the primitive visual (gray-perceiving) substance; *Y* and *B*, the first step in the differentiation into a yellow- and a blue-perceiving substance, whose combined dissociation gives the same effect as that of the original substance, *W*; *G* and *R*, the second step in the differentiation of the yellow-perceiving substance, the combined dissociation of the two giving the same effect as that of the yellow-perceiving substance alone. The complete development of color vision as it exists in the central part of the retina consists in the existence of three substances, which, taken separately, give red, green, and blue color sensations.

### III. The Franklin Theory of Color Vision (*Molecular Dissociation Theory*).

—This theory, proposed by Mrs. C. L. Franklin,\* takes into account the fact of a gradual evolution of the color sense of the retina from a primitive condition of colorless vision such as still exists in the periphery of the retina and in the eyes of the totally color blind. It assumes that the colorless sensations—white, gray, black—are occasioned by the reactions of a photochemical material which for convenience may be designated as the gray

substance. This substance in the normal eye exists in both rods and cones; in the latter, however, in a differentiated condition capable of giving color sensations. When the molecules of this substance are completely dissociated by the action of light, gray

\* Franklin, "Zeitschrift f. Psychologie und Phys. d. Sinnesorgane," 1892, iv; also "Mind," 2, 473, 1893, and "Psychological Review," 1894, 1896, 1899.

sensations result, and as this is the only reaction possible in the rods these elements can furnish us only sensations of this quality.

The molecules of gray substance in the cones, on the other hand, have undergone a development such that certain portions only of the molecule may become dissociated by the action of light of certain periods of vibration. This development may be supposed to have taken place in two stages: first, the formation of two groupings within the molecule, one of which is dissociated by the longer waves and gives a sensation of yellow, and one of which is dissociated by the shorter waves and gives the sensation of blue. This stage remains still on portions of the periphery of the retina, and is the condition present in the fovea also in the eyes of the red-green blind. The second stage consists in the division of the yellow component into two additional groupings in one of which the internal movements are of such a period as to be affected by the longest visible waves, the red of the spectrum, while the other is dissociated by rays corresponding to the green of the spectrum and gives rise to the sensation of green. If the red and green groupings are dissociated together the resulting effect is the same as follows from the dissociation of the entire yellow component, while the complete dissociation of the red, green, and blue groupings gives the stimulus obtained originally from the dissociation of the whole molecule, and causes gray sensations. The idea of this subdivision or differentiation in structure of the original gray substance is indicated diagrammatically in Fig. 155. The theory accounts admirably for many phenomena in vision, and is perhaps especially adapted to explain the facts of color blindness and the variations in quality of our visual sensations in the peripheral areas of the retina. An extension and modification of this theory has been published by Schenck.\* He assumes that each of the three-color perceiving substances is composed of two parts. One part which acts as a receiver for the stimulus, a sort of an optical resonator, in fact, and a second part which is set into activity by the receiver and gives rise to the corresponding color sensation. The theory is very elastic in its adaptability to the various kinds of color blindness.

The two latter theories seem to imply that a number of different kinds of impulses may be transmitted along the optic fibers. Hering's theory requires apparently the possibility of six qualitatively different impulses,—namely, white, black, red, green, yellow, and blue,—while the Franklin theory assumes impulses corresponding to white (gray), red, green, yellow, and blue. Black is not specifically accounted for except as a part of the gray series. At present in physiology there is no proof that nerve impulses can differ qualitatively from each other, although it may be urged, perhaps with equal force, that there is no proof that they can not so differ. The doctrine of specific nerve energy assumes that nerve impulses are, as regards quality, always

\* Schenck, "Archiv f. d. gesammte Physiologie," 118, 129, 1907.

the same, and differ from one another only in intensity, the qualitative differences that exist among sensations being referred to a difference in reaction in the end-organ in the brain.

**Entoptic Phenomena.**—Under the term entoptic phenomena is included a number of visual sensations due to the shadows of various objects within the eyeball itself. Ordinarily these shadows are imperceptible, owing to the diffuse illumination of the interior of the eye through the relatively wide opening of the pupil. By means of various devices the illumination of the eye may be so controlled as to make these shadows more distinct and thus bring the retinal images into consciousness. Some of these entoptic appearances are described briefly, but for a detailed description the reader is referred to the classical work of Helmholtz.\*

*The Blood-corpuses.*—The entoptic images that are most easily recognized perhaps are those of the moving corpuscles in the capillaries of the retina. If one looks off into the blue sky he will have no difficulty in recognizing a number of minute clear and dark specks that move in front of the eye in definite paths. The character of the movement leaves no doubt that these sensations are due to the shadows of the blood-corpuses. In fact, the shadows often show a rhythmic acceleration in velocity synchronous with the heart-beats, a pulse movement. By projecting the moving images upon a screen at a known distance from the eye the velocity of the capillary circulation has been estimated in man.

*The Retinal Blood-vessels.*—The blood-vessels of the retina lie in front of the rods and cones and must necessarily throw their shadows upon these sensitive end-organs. The shadows may be made more distinct and a visual picture of the vessels obtained by a number of methods. For instance, if a card with a pin hole through it is moved slowly in front of the eye the images of the blood-vessels stand out in the field of vision with more or less distinctness. The card should be given a circular movement. If it is kept in one position the images quickly disappear, since the retina apparently fatigues very quickly for such faint impressions. A more impressive picture may be obtained by the method of Purkinje. In a dark room one holds a candle toward the side of the head in such a position as to give the sensation of a glare in the corresponding eye. If the eye is directed toward the opposite side of the room and the candle is kept in continual circular movement the blood-vessels appear in the field of vision magnified in proportion to the distance of projection; the picture makes the impression of a thicket of interlacing branches. In this experiment the light from the candle strikes the nasal side of the

\* Helmholtz, "Handbuch der physiologischen Optik," second edition, I, 184.



retina at an oblique angle and is reflected toward the other side of the globe. The blood-vessels are in this way illuminated from an unusual direction and their shadows are thrown upon a portion of the retina not usually affected and for that reason perhaps more sensitive to the impression.

*Imperfections in the Vitreous Humor and the Lens.*—Small fragments of the cells from which the vitreous humor was constructed

in the embryo and similar relatively opaque objects in the lens may throw shadows on the retinal bottom. These shadows take different forms, but usually are described as small spheres or beads, single or in groups, that move with the eyes and are designated, therefore, as the *muscæ volitantes* (flitting flies or floating flies). To

bring out these shadows it is convenient to make the source of illumination small and to bring it at or nearer than the anterior focal distance of the eye (15 to 16 mms.). The method employed for this purpose by Helmholtz is illustrated in Fig. 156. In this figure *b* is a candle flame, and *a* a lens of short focus which makes an image of the flame at the small opening shown in the dark screen, *c*. The eye is placed just behind this opening and is illuminated by the rays from the small, bright image of the flame at that spot. The shadows are seen projected upon the illuminated surface of the glass lens.

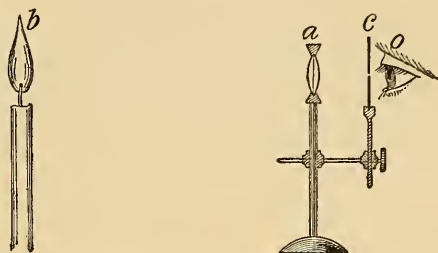

Fig. 156.—Helmholtz's method of showing entoptic phenomena due to imperfections in the lens and vitreous (*Helmholtz*): *c*, a screen with pinhole; *a*, lens with short focus.

## CHAPTER XIX.

### BINOCULAR VISION.

Vision with two eyes differs from monocular vision chiefly in the varied combinations of movements of the two eyeballs and the aid thereby afforded in the determination of distance and size, in the enlarged field of vision, and, above all, in the more exact perception of solidity or perspective, especially for near objects.

**The Movements of the Eyeballs.**—Each eyeball is moved by six extrinsic muscles which are innervated through three cranial nerves. The third or oculomotor nerve controls the internal rectus, the superior rectus, the inferior rectus, and the inferior oblique; the fourth cranial nerve (n. patheticus) innervates the superior oblique alone; and the sixth cranial (n. abducens) the external rectus alone. By means of these muscles the eyeballs may be given various movements, all of which may be considered as rotations of the ball around various axes. The common point of intersection of these axes is designated as the rotation point or center of rotation of the eyeball; it lies about 13.5 mms. back of the cornea in the emmetropic eye. The various axes of rotation all pass through this point, and we may classify them under four heads: (1) The horizontal or sagittal axis, which is the line passing through the rotation point and the object looked at,—the fixation point. This axis corresponds practically with the line of sight,—that is, the line drawn from the object looked at to the middle of the fovea, and it may therefore, without serious error, be spoken of as the visual axis. Rotations around this axis give a wheel movement or torsion to the eyeballs. (2) The transverse axis, the line passing through the rotation points of the two eyes and perpendicular to 1. Rotations around this axis move the eyeballs straight up or down. (3) The vertical axis, the vertical line passing through the rotation point and perpendicular at this point to the horizontal and transverse axes. Rotations around this axis move the eyeball to the right or the left. (4) The oblique axes, under which are included all the axes of rotation passing through the rotation point at oblique angles to the horizontal axis. These axes all lie in the equatorial plane of the eye, and rotations around any of them move the eyeball obliquely upward or downward. These definitions all have reference to what is known as the primary position of the

eyes,—that is, that position taken by the eyes when we look straight before us toward the horizon,—a position, therefore, in which the plane of the horizontal axes is parallel to the ground; all other positions of the eyes are spoken of as secondary.

With regard to the movements of the eyes about its axes of rotation the following general statements are made: Starting from the primary position, rotations of the eyes about the vertical axis—that is, movements directly to right or left—may be made by the contraction of the internal or the external rectus as the case may be. Rotations around the transverse axis—that is, movements directly up or down—require in each case the co-operation of two muscles. In movements upward the superior rectus, acting alone, would in

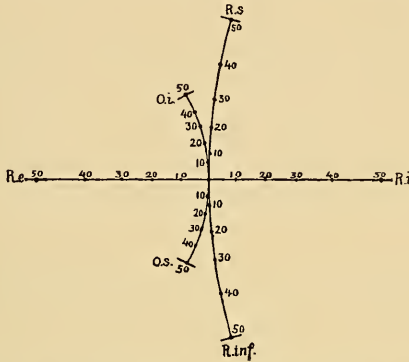

Fig. 157.—“Diagram showing for the left eye the paths of the line of sight caused by the action of the different eye-muscles (Hering). The horizontal line indicates movements out or in to various degrees as caused by the contraction of the internal or external rectus. The curved lines show the amount of torsion given the eyeball by the superior and inferior rectus and the superior and inferior oblique when contracting separately. The short heavier line at the end of the paths indicates the position of the horizontal meridian at the end of the movement.” R. e., the external rectus; R. i., the internal rectus; R. S., the superior rectus; R. inf., the inferior rectus; O. i., the inferior oblique; O. S., the superior oblique.

rotating the eyeball upward also give it a slight torsion so as to turn the upper part of the vertical meridian inward. To obtain a movement directly upward (rotation around the transverse axis) the superior rectus and inferior oblique must act together. For a similar reason rotation directly downward requires the combined action of the inferior rectus and superior oblique. These facts are expressed clearly in Hering’s diagram, reproduced in Fig. 157, which indicates the paths traversed by the line of sight when the eyeball is moved by the different muscles acting separately. Rotation of the eyeballs around oblique axes require the co-operation of three of the muscles: movements upward and outward—the superior rectus, inferior oblique, and external rectus; movements upward and inward—superior rectus, inferior

oblique, and internal rectus; movements downward and outward—inferior rectus, superior oblique, and external rectus; movements downward and inward—inferior rectus, superior oblique, and internal rectus. Most of the movements of the eyes are of the latter kind,—namely, rotations around an oblique axis,—and the position of the axis for each definite movement of this character may be determined by Listing's law, which may be stated as follows: When the eye passes from a primary to a secondary position it may be considered as having rotated around an axis perpendicular to the lines of sight in the two positions. It will be noted readily from observations upon the movements of one's own eyes that they ordinarily make only such movements as will keep the lines of sight of the two eyes parallel or will converge them upon a common point. In movements of convergence the internal recti of the two eyes are associated, while in symmetrical lateral movements the internal rectus of one eye acts with the external rectus of the other. Under normal conditions it is impossible for us to diverge the visual axes,—that is, to associate the action of the external recti. A movement of this kind would produce useless double vision (diplopia), and it is, therefore, a kind of movement which all of our experience has trained us to avoid.

**The Co-ordination of the Eye Muscles—Muscular Insufficiency—Strabismus.**—In order that the eyeballs may move with the minute accuracy necessary in binocular vision, a beautifully balanced or co-ordinated action of the opposing muscles is necessary. The object of these movements is to bring the point looked at in the fovea of each eye and thus prevent double vision, diplopia (see following paragraphs). This object is attained when the eyeballs are so moved that the lines of sight unite upon the object or point looked at. In viewing an object or in reading we keep readjusting the eyes continually to bring point after point at the junction of the lines of sight. When we look before us at a distant object the muscles in each eye should be so adjusted that without any contraction the antagonistic muscles will just balance each other—that is, when the eye muscles are entirely relaxed, except for their normal tone, the visual axes should be parallel. If this balance does not exist, we have a condition designated as heterophoria. In this condition a constant contraction of one or more muscles is required, even in far vision, to prevent diplopia. When the eye at rest shows a tendency to drift toward the temporal side, owing to the fact that the pull of the external rectus overbalances that of the internal rectus, the condition is known as exophoria. If, for the opposite reason, there is a tendency to drift to the nasal side, the

condition is described as esophoria. A tendency to drift up or down is called hyperphoria, and this is further specified as right or left hyperphoria according to the eye whose axis deviates upward. A lack of resting balance of this kind may make itself felt also in near work, particularly in reading, sewing, etc., since it will require a constantly greater innervation of the muscle whose antagonist overbalances it. Under some conditions the resulting muscular strain causes much uneasiness or distress. The heterophorias are easily detected and measured by the use of prisms, but they do not show the same constancy as the refractive errors of the eye, owing probably to the fact that they involve the variable factor of muscular tonus.

The principle used in detecting heterophoria is to produce a condition of diplopia by placing prisms in front of the eyes. If, for example, a prism ( $5^\circ$ ) is placed in front of the right eye with its base up, the image of any object looked at, a candle-flame, for instance, at a distance of 6 meters, will be displaced on the retina above the fovea and will be projected, therefore, into the lower half of the visual field. The left eye receives its image on the fovea and two flames are seen one above the other, a condition of vertical diplopia. As the images cannot be united by movements of the eyeballs the eyes come to rest in their position of equilibrium. If the two flames lie in a vertical line the eyes are in balance for distant vision. If the image belonging to the right eye (in this case the lower image) is displaced toward the left hand as compared with the other, exophoria is indicated. The pull of the external rectus has thrown the front of the eye toward the right and its fovea in the opposite direction, hence the image has fallen to the right of the fovea and is displaced in the visual field toward the left. A deviation in the other direction would indicate esophoria, and the amount in each case is expressed by the degree of prism necessary to bring the objects into a vertical line (for esophoria the correcting prism is placed base out, for exophoria, base in). In a similar way hyperphoria is detected by producing in the beginning a condition of lateral diplopia, by placing a suitable prism before the eye with its base in. Several systems of notation have been proposed for prisms. The one commonly used expresses in degrees the angle (refracting angle) at the edge of the prism.

The defect may be remedied by surgical operations upon the muscles, or by the use of proper prisms with their bases so adjusted as to help the weaker muscle. In exophoria, for example, the greater pull of the external rectus rotates the front of the eye outward, while the back of the eye with the fovea is moved inward toward the nose. A prism of the proper strength placed before the eye with its base in toward the nose will throw the image of an external object on the fovea, without necessitating a contraction of the internal rectus to bring the fovea back into its normal position. When the lack of balance between the opposing muscles is so great that the visual axes cannot by muscular effort be brought to bear upon the same points, we have the condition of squint or strabismus. Such a condition may result from a deficiency in strength or in actual paralysis of one or more of the

muscles, or from an overaction in some of the muscles as contrasted with their antagonists.

**The Binocular Field of Vision.**—When the two eyes are fixed upon a given point, placed, let us say, in front of us in the median plane, each eye has its own visual field that may be charted by means of the perimeter. But the two fields overlap for a portion of their extent, and this overlapping area constitutes the field of binocular vision (see Fig. 158). Every point in the binocular field forms an image upon the two retinas. The most interesting fact about the binocular field is that some of the objects

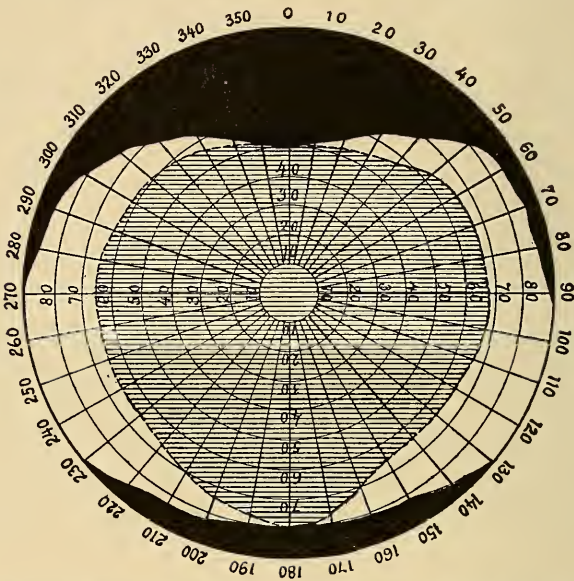

Fig. 158.—Perimeter chart to show the extent of the binocular visual field (shaded area) when the eyes are fixed upon a median point in the horizontal plane.

contained in it are seen single in spite of the fact that there are two retinal images, while others are seen or may be seen double when one's attention is directed to the fact. Whether any given object is seen single or double depends upon whether its image does or does not fall upon corresponding points in the two retinas.

**Corresponding or Identical Points.**—By definition corresponding or identical points in the two retinas are those which when simultaneously stimulated by the same luminous object give us a single sensation, while non-corresponding points are those which when so stimulated give us two visual sensations. It is evident, from our experience, that the foveæ form corresponding points or areas. When we look at any object we so move our eyes that the

images of the point observed shall fall upon symmetrical parts of the two foveæ; the lines of sight of the two eyes converge upon and meet in the point looked at. If, while observing an object, we press gently upon one eyeball with the end of the finger, two images are seen at once, and they diverge farther and farther from each other as the pressure upon the eyeball is increased. Experiment shows, also, that, in a general way, portions of the retina symmetrically placed to the right side of the foveæ in the two eyes are corresponding, and the same is true for the two left halves and the two upper and lower halves. The right half of the retina in one eye is non-corresponding to the left half of the other retina, and *vice versa*; and the same relation is true of the upper and lower halves, respectively. If we imagine one retina to be lifted without turning and laid over the other so that the foveæ and vertical and horizontal meridians coincide, then the corresponding points will be superposed throughout those portions of the retina that represent the binocular field. This statement, however, is theoretical only; an exact point to point correspondence has not been determined experimentally. Experiments have shown, however, that the corresponding points in the upper halves of the retinas along the vertical mid-line do not cover each other, that is, they do not lie in the actual anatomical vertical meridian, but form two meridians which diverge symmetrically from the mid-line so as to make an angle of about 2 degrees (physiological incongruence of the retinas). Within the limits of our powers of observation for ordinary objects we may adopt Tscherning's rule,—namely, that when the images of an object on the two retinas are projected to the same side of the point of fixation they are seen single, their retinal images in this case falling on the retina to the same side of the lines of sight; when, however, the retinal images fall on opposite sides of the lines of sight and are projected to opposite sides of the point of fixation, they are seen double. The doubling of objects that do not fall on corresponding points (physiological diplopia) is most readily demonstrated for objects that lie between the lines of sight, either closer or farther away than the object looked at. If, for instance, one holds the two forefingers in front of the face, in the median plane, one hand being at about the near point of distinct vision and the other as far away as possible, it will be noticed that when the eyes are fixed on the far finger the near one is seen double and *vice versa*. In this, as in other experiments in which the eyes are accommodated for one object while the attention is directed to another, some difficulty may be experienced at first in dissociating these two acts which normally go together, but a little practice will soon enable one to distinguish clearly the doubling of the point upon which the lines of sight are not converged.

If a long stick is held horizontally in front of the eyes the end near the face will be doubled when the eyes are directed to the far end and *vice versa*. Moreover, by a simple experiment it may be shown that objects nearer the eyes than the point looked at are doubled heteronymously,—that is, the right-hand image belongs to the left eye and the left-hand one to the right eye. This is easily demonstrated by closing the eyes alternately and noting which of the images disappears. The reason for the cross-projection of the images is made apparent by the construction in Fig. 159, *I*, bearing in mind the essential fact that in projecting our retinal images we always project to the plane of the object upon which the eyes are focused. In the figure the eyes are converged on *A*; the images of point *B* fall to opposite sides of the line of sight and are seen double and are projected to the plane of *A*, the image on the right eye being projected to *b'* on the left of *A* and that on the left eye to *b* on the right of *A*. In a similar way it may be shown that objects farther away from the eye than the point looked at are doubled homonymously,—that is, the right-hand image belongs to the right eye, and the left-hand one to the left eye. The fact is explained by the construction in Fig. 159, *II*, in which *A* is the point converged upon and *B* the more distant object. In all binocular vision, therefore, the series of objects between the eye and the point looked at are

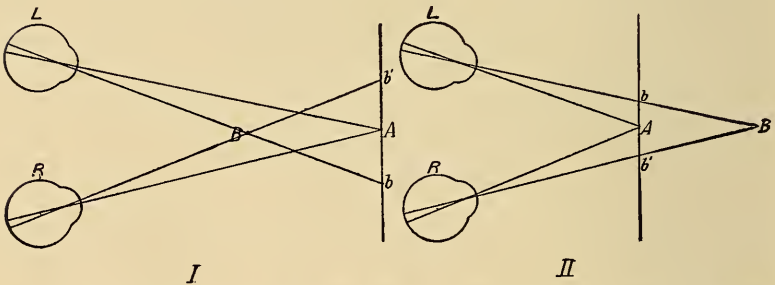

Fig. 159.—Diagrams to show homonymous and heteronymous diplopia: In *I* the eyes are focused on *A*; the images of *B* fall on non-corresponding points,—that is, to different sides of the foveæ,—and are seen double, being projected to the plane of *A*, giving heteronymous diplopia. In *II* the eyes are focused on the nearer point, *A*, and the farther point, *B*, forms images on non-corresponding points and is seen double,—homonymous diplopia,—the images being projected to the focal plane *A*.

doubled heteronymously, and those extending beyond the point in the same line are doubled homonymously. Normally we take no conscious notice of this fact, our attention being absorbed by the object upon which the lines of sight are directed. Some physiologists, however, have assumed that the knowledge plays an important part subconsciously in giving us an idea of depth or perspective,—an immediate perception, as it were, of the distinction



between foreground and background. It is usually assumed that the explanation of corresponding points is to be found in the anatomical arrangement of the optic nerve fibers. Those from the right halves of the two retinas, which are corresponding halves, unite in the right optic tract and are distributed to the right side of the brain, while the fibers from the left halves go to the left side of the brain. The basis of the single sensation from two visual images is to be found probably in the fact that the cerebral terminations through which the final psychological act is mediated lie close together or possibly unite.

**The Horopter.**—In every fixed position of the eyes there are a certain number of points in the binocular field which fall upon corresponding points in the two retinas and are therefore seen single. The sum of these points is designated as the horopter for that position of the eyes. It may be a straight or curved line, or a plane or curved surface. Helmholtz calls attention to the fact that, when standing with our eyes in the primary position,—that is, directed toward the horizon,—the horopter is a plane coinciding with the ground, and this fact may possibly be of service to us in walking.

**Suppression of Visual Images.**—It happens not infrequently that when an image of an object falls upon non-corresponding points in the two retinas the mind ignores or suppresses one of the images. This peculiarity is exhibited especially in the case of persons suffering from “squint” (strabismus). In this condition the individual, for one reason or another, is unable to adjust the contractions of his eye muscles so as to unite his lines of sight upon the object looked at. The image of the object falls upon non-corresponding points and should give double vision, diplopia. This would undoubtedly be the case if the condition came on suddenly; just as double vision results when we dislocate one eyeball by pressing slightly upon it. But in cases of long standing one of the images, that from the abnormal eye, is usually suppressed. The act of suppression seems to be a case of a stronger stimulus prevailing over a weaker one in consciousness, just as a painful sensation from stimulation of one part of the skin may be suppressed by a stronger pain from some other region.

**Struggle of the Visual Fields.**—When the images of two dissimilar objects are thrown, one on each retina, the mind is presented, so to speak, simultaneously with two different sensations. Under such circumstances what is known as the struggle of the visual fields ensues. If the image on one eye consists of vertical lines and on the other of horizontal lines we see only one field at a time, first one then the other, or the field is broken, vertical lines in part and horizontal lines in part; there is no genuine fusion into a con-

tinuous, constant picture. The struggle of the two fields is better illustrated when different colors are thrown on the two retinas. When red and yellow are superposed on one retina we obtain a compound sensation of orange; if they are thrown one on one retina, one on the other, no such fusion takes place. We see the field alternately red or yellow or a mixture of part red and part yellow, or at times one color, as it were, through the other. If, however, one field is white and the other black a peculiar sensation of glitter is obtained, quite unlike the uniform gray that would result if the two fields were superposed on one retina.

**Judgments of Solidity.**—Our vision gives us knowledge not only of the surface area of objects, but also of their depth or solidity,—that is, from our visual sensations we obtain conceptions of the three dimensions of space. The visual sensations upon which this conception is built are of several different kinds, partly monocular,—that is, such as are perceived by one eye alone,—partly binocular. If we close one eye and look at a bit of landscape or a solid object we are conscious of the perspective, of the right relations of foreground and background, and those individuals who have the misfortune to lose one eye are still capable, under most circumstances, of correct visual judgments concerning three dimensional space. Nevertheless it is true that with binocular vision our judgments of perspective are more perfect, and that under certain circumstances data are obtained from vision with two eyes which give us an idea of solidity far more real than can be obtained with one eye alone. This difference is shown especially in the combination of stereoscopic pictures, and in ordinary vision when the light is dim, as in twilight, or in exact judgments of perspective in the case of objects close at hand. If, for example, we close one eye and attempt to thread a needle, light a pipe, or make any similar co-ordinated movement that depends upon an exact judgment of the distance of the object away from us, it will be found that the resulting movement is far less perfectly performed than when two eyes are used. The sensation elements upon which our judgments of depth or perspective are founded may be classified as follows:\*

*The Monocular Elements.*—That is, those that are experienced in vision with one eye. (a) *Aerial perspective.* The air is not entirely transparent, and, therefore, in viewing landscapes the more distant objects are less distinctly seen, as is illustrated, for instance, by the haze covering distant mountains. This experience leads us sometimes to make erroneous judgments when the conditions are unusual. An object seen suddenly in a fog looms large, as the expression goes, since the feeling that hazy objects are at a great

\* See Le Conte, "Sight," vol. 31 of "The International Scientific Series," 1881.

distance leads us to give a proportional overvaluation to the relatively large visual image made by the near object.

(b) *Mathematical perspective.* The outlines of objects before us are projected upon the surface of the eye in two dimensions only, just as they are represented in a drawing. The lines that indicate depth are therefore foreshortened, and lines really parallel tend to converge more and more to a vanishing point in proportion to their distance away from us. When one stands between the tracks of a railway, for instance, this convergence of the parallel lines is distinctly apparent. We have learned to interpret this mathematical perspective correctly and with great accuracy. The use of this perspective in drawings is, in fact, one of the chief means employed by the artist to produce an impression of depth or solidity. For distant objects at least this factor is probably the most potent of those that can be appreciated by monocular vision.

The importance of the mathematical perspective for our visual judgments may be illustrated very strikingly by a simple experiment. If one takes a biconvex lens of short focus and standing at a window that looks out upon a long street holds the lens in front of the eyes at arm's length he will be able to see, by focusing on the inverted image formed by the lens, that not only are objects inverted as regards their surface features, but, for most persons at least, the perspective is also inverted. Objects actually in the foreground will appear in the background, and one may have the curious sensations of watching persons who, as they walk, seem to recede farther and farther into the distance in spite of the fact that they continue to increase in size. The inverted or pseudoscopic vision thus produced is due undoubtedly to the inversion of the lines of perspective. Parallel lines which, without the lens, would have on the retina a projection of this kind  $\wedge$  are with the lens projected inverted  $\nabla$ , and our visual judgments are controlled by this factor in spite of the opposing evidence from the size of the retinal images. In order for the experiment to succeed it is necessary that the objects viewed shall be far enough away so that a flat picture may be given by the lens,—that is, a picture in which the foci for the near points shall not differ practically from those of more distant points, otherwise the muscular movements of accommodation interfere with the delusion. The relative importance of this last factor (see succeeding paragraph) is well illustrated by varying the experiment in this way: Place two objects upon a well-lighted table, one at the near end and one at the far end. Then standing close to the table view these objects through the lens as before. They will be seen in their right relations to each other. If, however, one backs away from the table while watching the images there will come a distance at which the near object will be seen to shift around to the rear of the far object.

(c) *The Muscle Sense (Focal Adjustment).*—For objects near enough to require accommodation it is obvious that the nearer object will need a stronger contraction of the ciliary muscle, and also of the internal rectus in order to bring the line of sight to bear correctly. By means of the fibers of muscle sense we have a very exact conception of the degree of contraction of these muscles, and this sensation is perhaps the most important factor used in making our monocular judgments of depth for objects at a short distance

In binocular vision the same factor is doubtless of increased efficiency by reason of the sensations obtained from the two eyes.

While there is experimental evidence (Sherrington) that this factor plays a rôle, it is a fact that the origin of the afferent fibers assumed to exist has not been determined. Apparently, they do not come from the fifth nerve.

(d) *The disposition of lights and shades and the size of familiar objects.* It may be assumed that in distant vision of complex fields the varying lights and shades exhibited by objects according as they stand in front of or behind each other also aid our judgment. The actual size also of the retinal images of familiar objects—such as animals, trees, etc.—gives us an accessory fact which contributes to the impression derived from the sources mentioned above. These factors are employed with effect by the artist in strengthening the general impression which he wishes to give of the difference between the foreground and the background.

*The Binocular Perspective.*—In binocular vision there is an additional element which contributes greatly to our judgment of depth. This element consists in the fact that the retinal images of external objects, particularly near objects, are different in the two eyes. Inasmuch as the eyes are separated by some distance the projection of any solid object upon one retina is different from the projection on the other. If a truncated pyramid is held in front of the eyes, the right eye sees more of the right side, the left more of the left side. The projection of the same object upon the two retinas may, in fact, be represented by the drawings given in Fig. 160. Whenever this condition prevails, whenever what we may call a right-eyed image of an object is thrown on the right eye and simultaneously a left-eyed image on the left eye, whether in nature or by an artifice, we at once perceive depth or solidity in the object. This fact is made use of in all devices employed to produce stereoscopic vision.

**Stereoscopic Vision.**—Stereoscopic pictures may be obtained

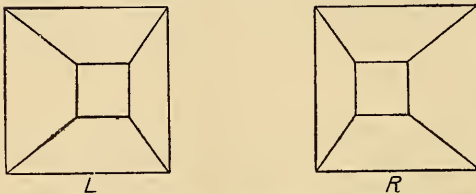

Fig. 160.—Right- and left-eyed images of truncated pyramid. May be combined to produce solid image by relaxing the accommodation,—that is, gazing to a distance through the book.

by photographing the same object or collection of objects from slightly different points so as to get a right-eyed and a left-eyed picture; or for simple outline pictures, such as geometrical figures, they may be made by draw-

ings of the object as seen by the two eyes, respectively (see Figs. 160 and 162). Any optical device that will enable us to throw the

right-eyed picture on the right eye and the left-eyed picture on the left eye constitutes a stereoscope. Many different forms of stereoscope have been devised; the one that is most frequently used is the *Brewster stereoscope* represented in principle in Fig. 161. Each eye views its corresponding picture through a curved prism. The sight of the left-eyed picture is cut off from the right eye, and *vice versa*, by a partition extending for some distance in the median plane. The prisms are placed with their bases outward and the rays of light from the pictures are refracted, as shown in the diagram, so as to aid the eyes in converging their lines of sight upon the same object. The prisms also magnify the pictures somewhat. Stereoscopic pictures are mounted usually for this instrument so that the distance between the same

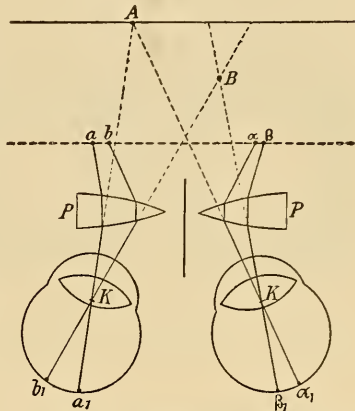

Fig. 161.—Diagram to illustrate the principle of the Brewster stereoscope (*Landois*):  $P$  and  $P'$ , the prisms.  $a, b$ , and  $a', b'$ , the left- and right-eyed pictures, respectively,  $b, \beta$ , being a point in the foreground and  $a, \alpha$ , a point in the background. The eyes are converged and focused separately for each point as in viewing naturally an object of three dimensions.

object in the two pictures is about 80 mms.—greater, therefore, than the interocular distance. A simple form of stereoscope that is very effective and interesting is sold under the name of the *anaglyph*. The two pictures in this case are approximately superposed, but the outlines of one are in blue and the other in red. When looked at, therefore, the picture gives an ordinary flat view with confused red-blue outlines. If, however, one holds a piece of red glass in front of the left eye and a piece of blue glass in front of the right eye, or more conveniently uses the pair of spectacles provided which have blue glass on one side, red on the other, then the picture stands out at once in solid relief with surprising distinctness—and as a black and white object only. The red and blue glasses in this case simply serve to throw the right-eyed image on the right eye and the left-eyed image on the left eye. Assuming that the right-eyed image is outlined in red, then the blue glass should be in front of the right eye. This glass will absorb the red rays completely so that the red outlines in the picture will seem black and a distinct right-eyed picture is thrown on the right eye, distinct enough to make us overlook the much fainter image in blue, which is also transmitted through the blue glass. The red glass before the left

eye cuts out, in the same way, the right-eyed image and presents in dark outline the left-eyed image. By simply reversing the spectacles the right-eyed image may be thrown upon the left eye and *vice versa*. Under these conditions the picture for most persons may be seen in inverted



Fig. 162.—Stereoscopic picture of an octahedral crystal. May be combined stereoscopically by relaxing the accommodation by the method of heteronymous diplopia. Hold the object at a distance of a foot or more and gaze beyond.

relief (pseudoscopic vision), objects in the foreground receding into the background. This inversion of the relief when the projection upon the retinas is reversed is a striking indication of the potency of the normal projection as a factor in our judgments of solid objects. It will be observed, moreover, that those pictures that show least

mathematical perspective are the most readily inverted, and that the ability to invert the picture varies in different individuals; in some, what we have called the binocular perspective, founded upon the dissimilar images, prevails over the mathematical perspective more readily than in others.

Stereoscopic pictures may also be combined very successfully without the use of a stereoscope by virtue of the phenomenon of physiological diplopia. If, for instance, two stereoscopic drawings, such as are represented in Fig. 162, are held before the eyes and one relaxes his accommodation so as to look through the pictures, as it were, to a point beyond, then, in accordance with what was stated on p. 373, each picture gives a double image, since it falls on non-corresponding parts of the two retinas. Four pictures, therefore will be seen, all out of focus. With a little practice one can so converge his eyes as to make the two middle images come together, and since one of these is an image of the right-eyed picture and is falling on the right eye, and the other is a left-eyed picture falling on the left eye, the combination of the two fulfills the necessary conditions for binocular perspective. The figure stands out in bold relief.

**Explanation of Binocular Perspective.**—Our perception of solidity or relief is a secondary psychological act, and, so far as the binocular element is concerned, it is based upon the fact that the images are slightly different on the two retinas; but why this dissimilarity should produce an inference of this kind is not entirely understood. Certain facts have been pointed out as having a probable bearing upon the mental process. In the first place, in stereoscopic pictures,

as in nature, we do not see the whole field at once. To see the objects in the foreground the eyeballs must be converged by the eye muscles so that the lines of sight may meet in the object regarded. When attention is paid to objects in the background less convergence is necessary (see Fig. 161). The point of fixation for the lines of sight is kept continually moving to and fro, and the sensation of this muscular movement possibly plays an important part in giving us the idea of depth or solidity. For persons not practised in the matter of observing stereoscopic pictures the full idea of relief comes out only after this muscular activity has been called upon. But for the practised eye this play of the muscles is not absolutely necessary. The stereoscopic picture stands out in relief even when illuminated momentarily by the light of an electric spark. The perception of solidity in this case is instantaneous, and it has been suggested that this result may depend upon the immediate recognition of physiological diplopia,—that is, the fact that objects nearer than the point of fixation are doubled heteronymously, while those farther away are doubled homonymously (see p. 374). Such an effect can only be produced distinctly by objects having depth and possibly in the case of the trained eye it alone is sufficient to give the immediate inference of solidity or relief, while the untrained eye requires the accessory sensations aroused by focal adjustment, mathematical perspective, etc.

**Judgments of Distance and Size.**—Judgments of distance and size are closely related. Our judgments regarding size are based primarily upon the size of the retinal image, the amount of the visual angle. This datum, however, is sufficient in itself only for objects at the same distance from us. If they are at different distances or we suppose that such is the case, our judgment of the distance controls our judgment of size. This fact is beautifully shown in the case of after-images (see p. 352). When an after-image of any object is obtained on the retina our judgment of its size depends altogether on the distance to which we project it. If we look at a surface near at hand, it seems small; if we gaze at a wall many feet away it is at once greatly enlarged. The familiar instance of the variation in the size of the full moon according as it is seen at the horizon or at the zenith depends upon the same fact. The distance to the horizon as viewed along the surface of the earth seems greater than to the zenith; we picture the heavens above us as an arched dome flattened at the top, and hence the same size of retinal image is interpreted as larger when we suppose that we see it at a greater distance. Our judgments of distance, on the other hand, depend primarily upon the data already enumerated in speaking of the perception of solidity or depth in the visual field.

For objects within the limit of accommodation we depend chiefly on the muscle sense aroused by the act of focusing the eyes,—that is, the contractions of the ciliary and of the extrinsic muscles. For objects outside the limit of accommodation we are influenced by binocular perspective, mathematical perspective, aerial perspective, etc. But here again our judgment of distance is greatly influenced in the case of familiar objects by the size of the retinal image. A striking instance of the latter fact is obtained by the use of field glasses or opera glasses. When we look through them properly the size of the retinal image is enlarged, and the objects, therefore, seem to be nearer to us. If we reverse the glasses and look through the large end the size of the retinal image is reduced and the objects, therefore, seem to be much farther away, since under normal conditions such small images of familiar objects are formed only when they are at a great distance from us.

**Optical Deceptions.**—Wrong judgments as regards distance and size are frequently made and the fact may be illustrated in a number of interesting ways. Thus, in Fig. 163 the lines *A* and *B* are of the same length, but *B* seems to be distinctly the longer. So in Fig. 164 the vertical lines, although exactly parallel, seem, on the contrary, to run obliquely with reference to one another. Both of these deceptions depend apparently upon our inability to estimate angles exactly; we undervalue the acute angles and overvalue those



Fig. 163.—Müller-Lyer figures to show illusion in space perception. The lines *A* and *B* are of the same length.

that are obtuse. A very remarkable delusion is given by Fig. 165. If the book is held flat at the level of the chin and six or eight inches from the face and the eyes are focused on the point of intersection of any two of the lines, a third line will be seen perpendicular to the plane of the other two, and projecting vertically from the surface of the page. A row of these vertical lines will be seen if the distance is properly chosen. As one bends the head from side to side the lines sway in the same direction. It forms a very striking instance of the fact that we may see most distinctly a thing that has no real existence,—a case, therefore, in which we can not trust our senses. The delusion seems to be due to the fact that the two lines, in the position indicated, form a projection on the retina such as would be made by an actual vertical rod placed at the point at which we see one. Fig. 166 gives an interesting illustration of the way in which our judg-



ment of solidity may vary with our interpretation of mathematical perspective and shading when these factors are arranged



Fig. 164.—Zöllner's lines.

to give more than one choice. If the figure is looked at steadily it may assume several different appearances; two are especially prominent. We may see two cubes resting upon a third one,

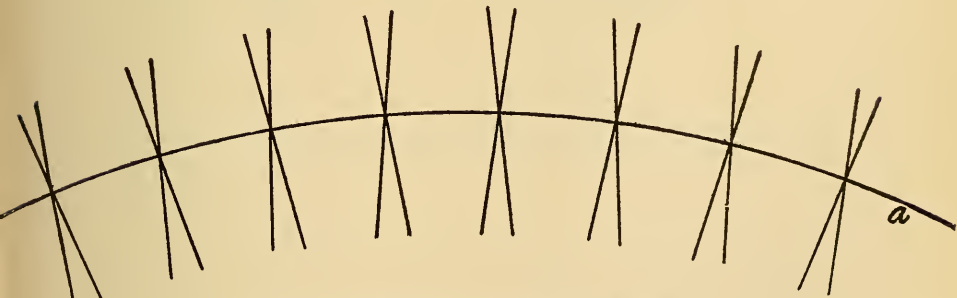

Fig. 165.—Optical illusion in projection.—(Franklin.)

each with the black side undermost, or we may see one cube resting on two under ones, each with its black side uppermost. Our

judgment in the matter changes from one interpretation to the other without any apparent cause. That the act of accommodation plays a part in the changes is shown by the fact that if one

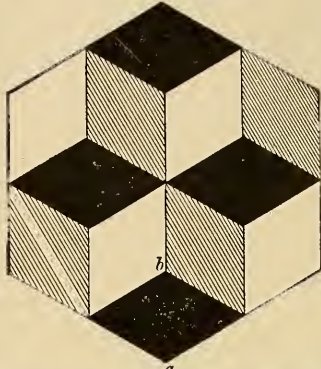

Fig. 166.—Figure to illustrate binocular<sup>a</sup> deceptions depending upon different interpretations of the mathematical perspective and the lights and shades. On gazing fixedly the image will change from a single cube with black top resting on two others with black tops, to one of two cubes with black bottoms resting upon a single cube with black bottom. Still other figures may appear from time to time.

focuses for the point *a*, this point may be held in the foreground and the second of the above appearances be seen. While if the eyes are accommodated strongly for point *b*, it will be brought forward and the first of the two appearances described is brought into view.

# PHYSIOLOGY OF THE EAR.

## CHAPTER XX.

### THE EAR AS AN ORGAN FOR SOUND SENSATIONS.

In discussing the physiology of the ear it is necessary to consider the functional importance of its various parts, the external ear consisting of the lobe or pinna, the external auditory meatus, and the tympanic membrane; the middle ear, with its chain of ossicles, its muscles and ligaments, and the Eustachian tube; and the internal ear, with its cochlea, vestibule (utricle and saccule), and semi-circular canals. The eighth cranial or so-called auditory nerve is

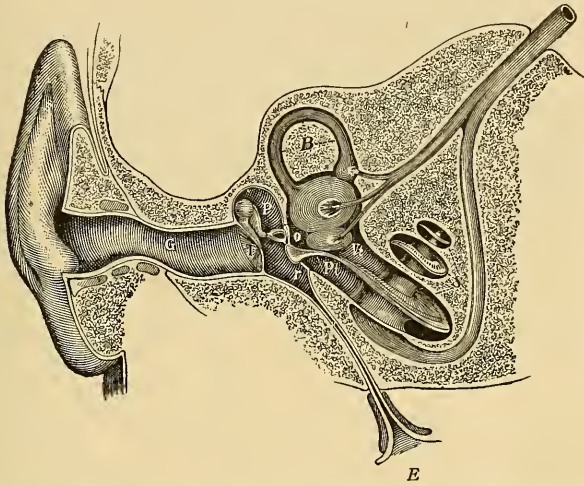

Fig. 167.—Semidiagrammatic section through the right ear (*Czermak*): *G*, External auditory meatus; *T*, membrana tympani; *P*, tympanic cavity; *o*, fenestra ovalis; *r*, fenestra rotunda; *B*, semicircular canal; *S*, cochlea; *Vt*, scala vestibuli; *Pt*, scala tympani; *E*, Eustachian tube.

distributed entirely within the internal ear; the fibers of the cochlear branch, which alone perhaps are concerned with hearing, end among the sensory nerve cells of the cochlea, while the vestibular branch supplies similar sense cells situated in the utricle, saccule, and the ampullæ of the semicircular canals. We may consider first the functions of the ear in respect to the sensations of sound. The somewhat complicated anatomy of the parts concerned should

be obtained from the special works on anatomy or histology. For the purposes of a physiological presentation the schematic figure employed by Czermak and reproduced in Fig. 167 will suffice to exhibit the general anatomical relations of the parts concerned in the transmission of the sound waves from the exterior to the cochlea.

**The Pinna or Auricle.**—The pinna opens into the external meatus by means of a cone-shaped depression, the concha. The whole organ, and especially the concha, may be considered as fulfilling more or less perfectly the function of collecting the sound waves and reflecting them into the meatus. In the lower animals the concave shape of the ear and its motility probably make it much more useful in this respect than in the case of the human ear. But even in man the pinna is valuable to some extent in intensifying the appreciation of sounds and

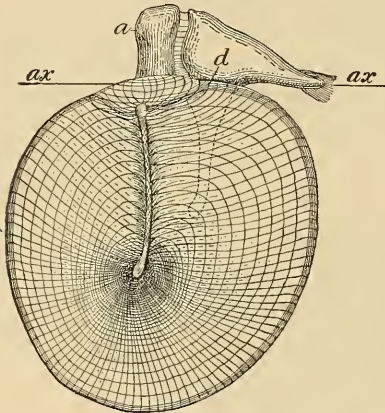

Fig. 168.—To show the structure of the tympanic membrane, looked at from the side of the meatus (*Hensen*): *ax*, The axis of rotation of the ear bones; *d*, the incus; *a*, the head of the malleus.

also in enabling us to determine their direction. The external auditory meatus has a length of about 21 to 26 mms., and a capacity of something over one cubic centimeter. Its course is not straight, but passes first somewhat backward and upward, and then turns forward and inward to end against the tympanic membrane. All sound waves that affect the drum of the ear must, of course, pass through this canal.

**The Tympanic Membrane.**—The tympanic membrane closes the inner end of

the meatus and lies obliquely to the axis of the canal, its plane making an angle, opening downward, of 150 degrees. The membrane, although not more than 0.1 mm. thick, consists of three coats: a layer of skin on the external surface, a layer of mucous membrane on the side toward the middle ear, and in between a layer of fibrous connective tissue. The middle layer gives to the membrane its peculiar structure and properties. In form the membrane has the shape of a shallow funnel with the apex, or umbilicus, as it is called, somewhat below the center. The fibers of the fibrous layer are arranged partly circularly and partly in lines radiating from the umbilicus to the peripheral margin (Fig. 168). The walls of the funnel are slightly convex outwardly; so that each radiating fiber forms an arch. On the inner side of the membrane the chain of ear ossicles is attached, so that the vibrations

of the membrane are transmitted directly to these bones. The peculiar form of the membrane, its funnel shape, its arched sides, and its unsymmetrical division by the umbo are supposed to contribute to its value as a transmitter of the sound vibrations of the air. In the first place, the membrane shows little tendency to after-vibrations, —that is, when set in motion by an air wave it shows little or no tendency to continue vibrating after the acting

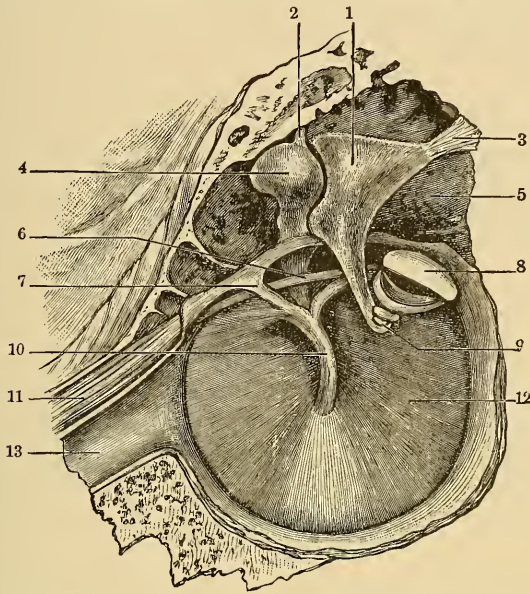

Fig. 169.—Tympanum of right side with ossicles in place, viewed from within (after Morris): 1, Body of incus; 2, suspensory ligament of malleus; 3, ligament of incus; 4, head of malleus; 5, epitympanic cavity; 6, chorda tympani nerve; 7, tendon of tensor tympani muscle; 8, foot-piece of stirrup; 9, os orbiculare; 10, manubrium; 11, tensor tympani muscle; 12, membrana tympani; 13, Eustachian tube.

force has ceased. It is obvious that such a property is valuable in rendering hearing more distinct, and the peculiarity of the membrane in this respect is attributed partly to its special form and partly to the damping action of the bones attached to it. In the second place, the arched sides of the funnel act as a lever, so that the movements at these parts are transmitted to the umbo with a diminution in amplitude, but an intensification in force. It is at the umbo that the movement is communicated to the ear bones.

**The Ear Bones.**—The three ear bones—the malleus, the incus, and the stapes—taken together form a chain connecting the tympanic membrane with the membrane of the fenestra ovalis. By this means the vibrations of the tympanic membrane are communicated to the membrane of the fenestra ovalis and thus to the perilymph filling the cavity of the internal ear. The bones consist

of spongy material with a compact surface layer. Their general shape and connections are illustrated in Figs. 169 and 170. To understand the manner in which the chain of bones acts in conveying the vibrations from one membrane to the other some points in their structure and connections may be recalled. *The malleus* is about 8 to 9 mm. long, and has an average weight of 23 milligrams. Its long handle is imbedded in the tympanic membrane, the tip reaching to the umbo. The large, rounded head projects above the upper edge of the tympanic membrane and forms a true

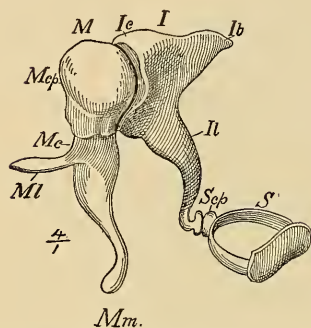

Fig. 170.—The bones of the middle ear in natural connections (*Helmholtz*): *M*, The malleus; *Mcp*, the head; *Mc*, the neck; *MI*, the processus gracilis; *Mm*, the manubrium; *Ic*, body of the incus; *Ib*, short process; *Il*, long process; *S*, the stapes.

joint of a peculiar nature with the incus. It has two processes in addition to the manubrium: a short one, processus brevis, that presses against the upper edge of the tympanic membrane, and a longer one, the processus gracilis or processus Folianus, which projects forward and is continued by a ligament, the anterior ligament, through which the malleus is attached to the bony wall of the tympanic cavity. Three other ligaments are attached to the malleus, the external ligament, binding it to the external face of the cavity, the posterior ligament, and the superior ligament, the latter attaching the upper part of the head

to the roof of the tympanic cavity. By means of these ligaments the bone is held steadily in position even after its connections with the incus are loosened. The *incus* is somewhat more massive than the malleus, weighing about 25 milligrams. Its thicker portion articulates with the head of the malleus, and it has two processes nearly at right angles to each other. The shorter process extends posteriorly and is attached by a ligament to the posterior wall of the tympanic cavity; the long process passes downward parallel with the handle of the malleus, but turns in at the tip to form the rounded os orbiculare, which articulates with the head of the stapes. This latter bone is extremely light, weighing about 3 milligrams, its oval base being attached to the margins of the fenestra ovalis by a short, stiff membrane.

**The Mode of Action of the Ear Bones.**—The movements of the tympanic membrane are communicated to the tip of the handle of the manubrium. As the handle moves in, the chain of bones makes a rotary movement around an axis which may be defined as the line passing through the attachment of the short process of the incus and the anterior ligament of the malleus. The general posi-

tion of this axis is represented by the line  $a-b$  in Fig. 171. This line passes through the neck of the malleus; so that as the handle moves in the head of the malleus and the upper part of the incus move in the opposite direction,—while the long process of the incus together with the stapes, being below the axis, moves in the same direction as the handle (see Fig. 171A). The chain of bones, therefore, acts like a bent lever whose fulcrum is at  $a$ , the power arm being repre-

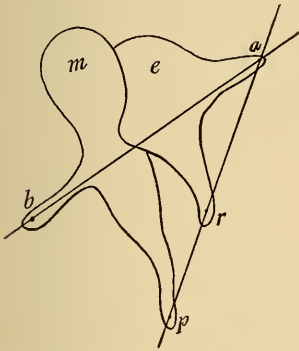

Fig. 171.—To illustrate the lever action of the ear bones (*McKendrick*):  $M$ , The malleus;  $e$ , the incus;  $a-b$ , the axis of rotation;  $a$ , short process of incus abutting against the tympanic wall;  $a-p$ , the power arm;  $a-r$ , the load arm of the lever.

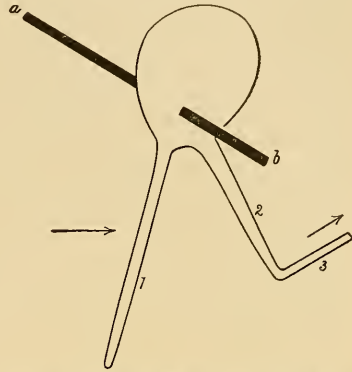

Fig. 171A.—Schema to illustrate the way in which the ear ossicles act together as a bent lever in transmitting the movements of the tympanic membrane to the membrane of the fenestra ovalis. 1, The handle of the malleus; 2, the long process of the incus; 3, the stapes;  $a-b$ , the axis of rotation. The arrows indicate a movement inward of the tympanic membrane.

sented by the line  $p-a$  and the load arm by the line  $r-a$ . According to Helmholtz,\* the distance  $p-a$  is equal to 9.5 mms., while  $r-a$  is 6.3 mms. The movement at  $r$ , therefore, or the movement of the stapes, will have only two-thirds of the amplitude of the movement at  $p$ , but will have a correspondingly greater force (one and one-half times). The mechanisms of the tympanic membrane and the ear bones combine, therefore, to convert the vibratory movements of the tympanic membrane into smaller but more intense movements of the membrane of the fenestra ovalis. It should be borne in mind, however, that the amplitude of these movements under normal conditions is very minute. That of the base of the stirrup is estimated at about 0.04 mm., while the amplitude at the tip of the manubrium, though relatively much larger, is still less than a millimeter (0.2 to 0.7 mm.). The minute but relatively intense movements of the stapes set into vibration the perilymph in the internal ear, and through these movements the sensory nerve cells in the cochlea

\* Helmholtz, "Die Lehre von den Tonempfindungen, etc.," fifth edition, 1896. See also English translation by Ellis.

are stimulated, and nerve impulses are thereby aroused in the fibers of the cochlear nerve. Ankylosis of the ear bones impedes their movements and impairs the delicacy of hearing, and if the ankylosis affects the base of the stapes at its insertion into the fenestra ovalis practically complete deafness ensues. The articulation of the head of the malleus with the body of the incus is a peculiar saddle-shaped joint, which, according to the description given by Helmholtz, acts like a cogged or ratchet movement. When the tympanic membrane moves in and the head of the malleus, therefore, moves outward, the joint locks, so that the incus follows the malleus. If, however, from any unusual cause the tympanic membrane is moved outward from its resting position, as may result, for instance, from a marked fall in air pressure, then the malleus-incus\* joint unlocks and the incus fails to follow completely the movement of the malleus, thereby protecting the structures in the internal ear.

**Muscles of the Middle Ear.**—Two small muscles are present in the middle ear: the tensor tympani and the stapedius. The former arises in a groove just above the Eustachian tube and its long tendon is inserted into the neck of the malleus just below the axis of rotation. The muscle is innervated by a branch of the fifth nerve. It is obvious that when this muscle contracts it must pull the tympanic membrane inward and put it under greater tension. It has been shown that in some persons this muscle can be contracted voluntarily, the tympanic membrane being pulled inward. † The stapedius muscle arises from the inner wall of the tympanic cavity and its tendon is inserted into the neck of the stapes. This muscle is innervated through a branch of the facial. When it contracts it tends to pull the stapes laterally, and thus probably places the membrane attached to its base under greater tension. The functions fulfilled by these muscles have been the subject of much controversy. According to a view first proposed by Johannes Müller, they act as a protective mechanism to the membranes of the middle ear. By increasing the tension of the membranes they limit the amplitude of their vibrations and thus protect the membranes from injury or possible rupture in the case of the violent movements resulting from loud, explosive noises. Or possibly by their reflex contraction they protect us from intense, disagreeable noises, by limiting the responsiveness of the vibrating membranes. A more probable view, however, and one supported to some extent by experimental evidence, was suggested by Mach. According to this observer, the contractions of the muscles adjust the membranes to the better

\* Some doubt has been thrown upon this interesting hypothesis regarding the nature of the malleus-incus articulation. According to Frey ("Pflüger's Archiv, 1911, 139, 548"), the two bones are not united by a true joint, but are ankylosed more or less rigidly, so that movement between them is not probable.

† Mangold, "Pflüger's Archiv," 149, 539, 1913.



reception of sound vibrations and are used, therefore, in attentive listening. They form, in fact, a mechanism of accommodation similar in its general functions to the ciliary muscle of the eye. Hensen\* has shown that both muscles contract reflexly to sounds, and that the contractions of the tensor tympani are stronger, the higher the pitch of the sound. This contraction seems to take place at the beginning of the sound, but is not maintained for a long period. The reaction is apparently a reflex movement the sensory path of which lies in the acoustic nerve and the reflex center in the medulla oblongata. That a similar reflex adjustment takes place in man is indicated by the following experiment described by Hensen. If while listening to a tuning-fork (400 to 1000 v. d.) a metronome is set going at a rate of 40 to 60 beats per minute, the tone of the tuning-fork becomes obviously strengthened. The stimulus of the noise caused by the metronome may be supposed to excite the reflex contractions of the muscles of the ear and thus increase its responsiveness to the vibrations of the tuning-fork. According to this view, therefore, the ear muscles are kept constantly in play by sounds or sudden variations in the intensity of sounds, and perhaps the obvious effort experienced in listening intently to a sound is also due to a contraction of these muscles.

**The Eustachian Tube.**—Through the Eustachian tube a communication is established between the tympanic cavity and the pharynx, and through this latter with the exterior. The obvious advantage of this arrangement is that it keeps the air within the tympanum under the same pressure as the outside air,—that is, the pressure on the two sides of the tympanic membrane is kept the same. The pharyngeal opening of the tube is normally closed, but it may be opened by raising or lowering the pressure in the pharynx. This happens, for instance, in the act of swallowing, and we perform this act, therefore, whenever our sensations from the tympanic membrane warn us of an inequality in pressure upon the two sides. When, for instance, one enters a caisson in which the external pressure is increased over the normal atmospheric pressure the tympanic membrane would be driven inward by the excess of external pressure were it not for the existence of the Eustachian tube. Under these conditions swallowing movements will open the pharyngeal end of the tube and thus bring the tympanic cavity under a barometric pressure equal to that on the outside. In nasal catarrh the tube may be occluded so as to prevent this equalization, and under such conditions, as is well known, the delicacy of hearing is much impaired, until by raising the pressure in the pharynx or by other means the tube is opened.

**The Projection of the Auditory Sensations.**—Auditory sensations are projected to the exterior and, indeed, to the supposed

\* Hensen, "Archiv f. d. gesammte Physiologie," 87, 355, 1901.

origin of the sound. The projection, however, is nothing like so perfect as in the case of visual stimuli. Our judgments of the distance and direction of sounds are manifestly less exact than in the case of objects seen by the eye. As an example, one may refer to the difficulty of locating exactly such sounds as the note of a cricket. In the ear the sensitive elements in the cochlea are not arranged so that sounds coming from different directions can affect different nerve fibers. All sound stimuli come to this part of the ear by one path,—namely, the tympanic membrane and its accessory structures. In judging the direction and distance of sounds we must rely, therefore, upon the relative distinctness of the sounds in the two ears, the variations in distinctness observed by varying the position of the head, the accessory information obtained from vision, etc. It is stated (Brown) that when the two ears are used, the localization is more exact than when only one ear is open. The two ears act somewhat like the two eyes in giving a spatial or perspective element to the projection. The general sensibility of the tympanic membrane also plays a part. When a vibrating body—a tuning-fork, for example—is held between the teeth, the vibrations are transmitted to the internal ear, in part at least, through the bones of the head, and the sound in this case is referred or projected into the head itself instead of to the tuning-fork, so that in hearing by the usual method the sensations of the vibrating tympanic membrane must form part of the data by means of which we project the sensation to the exterior.

**The Sensory Epithelium of the Cochlea.**—The fibers of the cochlear branch of the auditory nerve arise in the nerve cells of the spiral ganglion situated in the central pillar, the modiolus, of the cochlea. This ganglion resembles in structure the posterior root ganglion of the spinal nerves. Each cell is bipolar, sending one fiber toward the brain in the acoustic nerve, and one fiber to end in terminal arborizations around the sensory cells or hair cells of the organ of Corti in the cochlea. We have every reason to believe, therefore, that these hair cells form the apparatus which is affected by sound and by means of which nerve impulses are generated and transmitted to the acoustic fibers. The general arrangement and the relations of these cells are indicated in Fig. 172. They consist of short more or less cylindrical cells (*E*, 6, 6', 6'', Fig. 172), whose lower portion does not reach to the basilar membrane, but is supported by the intervening Deiters cells. The upper ends of the cells project through the openings in the reticulate membrane and end in a number—according to Retzius,\* about twenty—short, stiff hairs. The hair cells are arranged in four to six rows, one row on the inner side of the inner rods of Corti and three to five

\* The most complete details of the structure of the ear will be found in the great work of Retzius, "De Gehörorgan der Wirbelthiere," vol. ii, 1884, Stockholm.

rows, according to the part of the cochlea examined on the outer side of the rods of Corti. Their total number has been estimated differently by different observers; but, accepting the lower figures given, it may be said that there are at least 3500 inner hair cells and 13,000 outer ones, giving a total of 16,500 or more. The theory usually proposed to account for the mechanism by which the vibrations of the perilymph affect these cells, and especially the explanation of the means by which different sounds affect different cells, is that there is contained in the cochlea a mechanism which acts by sympathetic resonance. To make this theory clear a short

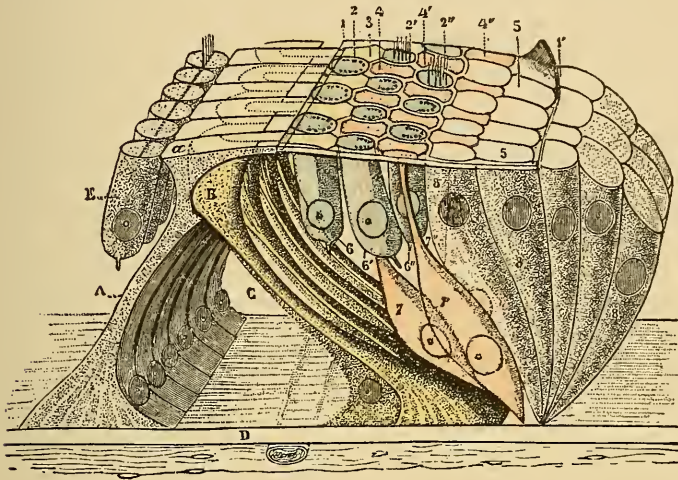

Fig. 172.—Diagrammatic view of the organ of Corti, the sense cells, and the accessory structures of the membranous cochlea (*Testut*): A, Inner rods of Corti; B, outer rods of Corti; C, tunnel of Corti; D, basilar membrane; E, single row of inner hair (sense) cells; 6, 6', 6'', rows of outer hair (sense) cells; 7, 7', supporting cells of Deiters. The ends of the inner hair cells are seen projecting through the openings of the reticulate membrane. The terminal arborizations of the cochlear nerve fibers end around the inner and outer hair cells.

description must be given of the nature of sound waves and the physical facts in regard to sympathetic resonance.

**The Nature and Action of Sound Waves.**—Sound waves in air consist of longitudinal vibrations of the air molecules, alternate phases of rarefaction and condensation. For convenience' sake, these waves are usually represented graphically after the manner of water waves, by a curved line rising above and falling below a median zero line, the ordinates above the zero line representing the phase of condensation, and those below the phase of rarefaction. These waves are produced by the vibrations of the sounding body, and may vary greatly in length, in amplitude, and in form. For musical sounds within the range of hearing the length of the waves may vary from forty to seventy feet, at the one extreme, to a frac-

tion of an inch at the other. They travel through the air with an average velocity of 1100 to 1200 feet per second, the exact rate varying with the temperature. When these waves, whatever may be their form, follow each other with regularity—that is, with a definite period or rhythm—a musical sound is perceived provided the rhythm is maintained for a number of vibrations. So that regularity or periodicity of the sound waves may be considered as the underlying physical cause of musical sounds. Non-musical sounds or noises, which constitute the vast majority of our auditory sensations, are referred, on the contrary, to non-periodical vibrations. Waves of this kind may be due to the nature of the impulse given to the air by the sounding body,—single pulses, for instance, or a series of such pulses or shocks following at a slow or irregular rhythm, or as is more frequently the case, they may result from a mixture of very short and different rhythmical vibrations. As the case of musical sounds is far the simpler, the theory of the action of the cochlea has been based chiefly upon the results obtained from a study of these forms of waves.

**Classification and Properties of Musical Sounds.**—Musical sounds exhibit three fundamental properties, each of which may be referred to a difference in the physical stimulus. They vary, in the first place, in pitch, and this difference finds its explanation in the rapidity of vibration of the sounding body and the sound waves produced by it. The more rapid the rate, the shorter will be the waves and the higher will be the pitch of the musical note. Notes of the same pitch may, however, vary in loudness or intensity, and

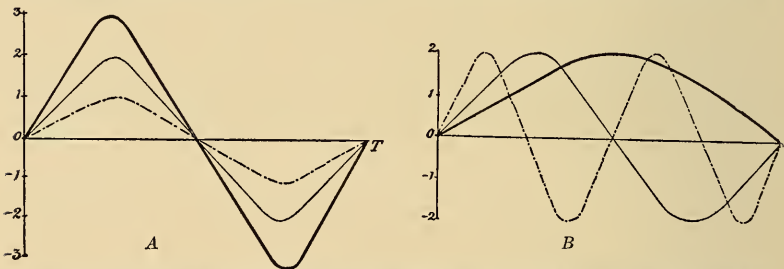

Fig. 173.—To illustrate the conception of differences in pitch and in amplitude or intensity: In *A* three pendular or sinus curves of the same period or pitch, but with different amplitudes. In *B* three pendular or sinus curves of the same amplitude, but with different periods (after Auerbach).

this difference is referable to the amplitude of the vibrations (see Fig. 173). A given tuning-fork emits always a note of the same pitch, but the loudness of the note may vary according to the amplitude of the vibrations. The vibrations of the tympanic membrane and of the perilymph in the internal ear vary in rate and intensity with the sounding body; so that we may say that the stimulation of the hair-cells in the cochlea gives us auditory sensations.

that vary in pitch with the rate of excitation and in intensity with the amplitude of the vibratory movement. A third property of musical sounds is their variations in quality or timbre. The same note of the same amplitude, when given by different musical instruments, varies in quality, so that we have no difficulty in recognizing the note of a piano from the same note when given by a violin or the human voice. The underlying physical cause of variations in timbre is found in the form of the sound waves produced, and immediately, therefore, in the form of vibratory movement communicated to the perilymph. Examination of the forms of sound waves produced by different musical instruments shows that they may be divided into two great groups: (1) The simple or pendular form; (2) the compound or non-pendular form. The *simple* or *pendular* form of wave is given, for instance, by tuning forks. A graphic representation of this wave form may be obtained by attaching a bristle to the end of the fork and allowing it to write upon a piece of blackened paper moving with uniform velocity,—the blackened surface, for instance, of a kymographion. The form of the wave obtained is represented in Fig. 174. The vibrating body swings symmetrically to each side of the line of rest, and, inasmuch as this is also the form of movement that would be traced by a swinging pendulum, this form of wave is designated frequently as pendular. It is sometimes called also the sinusoidal wave, since the distance of the vibrating point to each side of the line of rest is equal to the sine of an arc increasing proportionally for the time of the phase. A *compound* (or non-pendular or non-sinusoidal) *wave* may have a very great variety of forms. The different phases follow periodically, but the movement of the vibrating body to each side of the line of rest is not

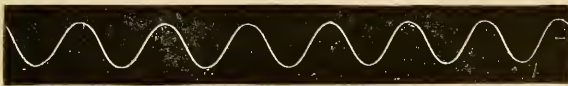

Fig. 174.—Form of wave made by tuning fork.

perfectly symmetrical. Fourier has shown that any periodical vibratory movement, whatever may be its form, may be considered as being composed of a series of simple or pendular movements whose periods of vibrations are 1, 2, 3, 4, etc., times as great as the vibration period of the given movement. That is, every so-called compound wave form may be considered as being caused by the fusion of a number of simple waves. Representing the wave movement of the air graphically as water waves, this composition of simple waves into compound ones is illustrated by the curves given in Fig. 175. In this figure *A* and *B* represent two simple vibrations such as would be given by two tuning-forks, the vibrations in *B* being double those of *A*. If these two waves are communicated to the air

at the same time the actual movement of the molecules will be a resultant of the forces acting upon them at any given instant, and will be indicated, therefore, by the algebraical sum of the ordinates above and below the lines of rest. If the movements are so timed that  $e$  in curve  $B$  is synchronous with  $d^o$  in curve  $A$ , then the resulting compound wave form is illustrated by  $C$ . If, however, curve  $B$  is supposed to be in a different phase, so that  $e$  is synchronous with  $d^i$ , then a form of wave illustrated by  $D$  will be obtained. In this way a great variety of forms of compound waves may be supposed to be produced by the union of a series of simple waves of different periods of vibration. That compound waves differ from simple ones in being composed of several series of vibrations is indicated directly by our sensations. When we listen to the note of a tuning-fork we hear only a single tone; when two or more tuning-forks are sounded together the trained ear can detect the tone due to each fork, and similarly when a single note is sounded by the human voice, a violin, or any other instrument that has a characteristic quality the trained ear can detect a series of higher tones,

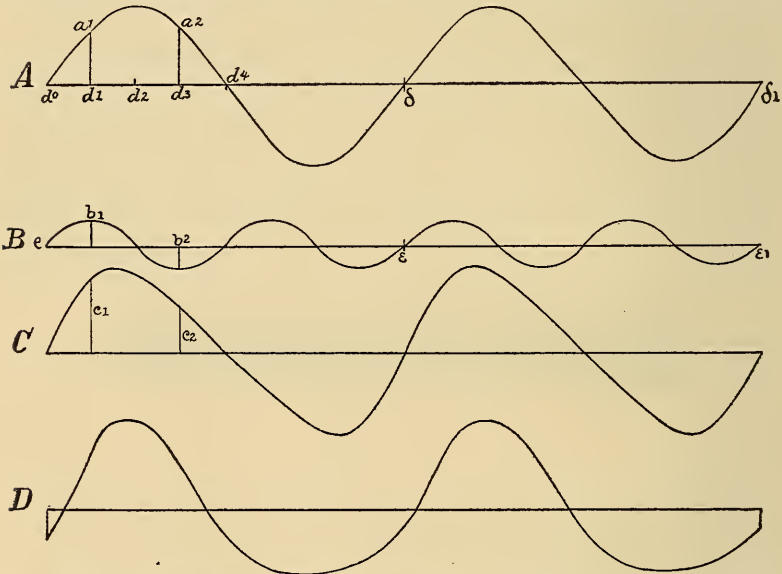

Fig. 175.—Schema by Helmholtz to illustrate the formation of a compound wave from two pendular waves:  $A$  and  $B$ , pendular vibrations,  $B$  being the octave of  $A$ . If superposed so that  $e$  coincides with  $d^o$  and the ordinates are added algebraically, the non-pendular curve  $C$  is produced. If superposed so that  $e$  coincides with  $d^i$  the non-pendular curve  $D$  is produced.

the upper partial tones, or harmonics, or overtones, which indicate that the note is really compound, and not simple. The formation of these overtones is due to the fact that the sounding body may be considered as vibrating not only as a whole, but also in its aliquot

parts, as is represented in Fig. 176, illustrating the vibrations of a string. When the string is plucked, it vibrates as a whole (*a*), giving large waves which produce what is called the fundamental tone, but at the same time each half (*b*), third (*c*), fourth (*d*), etc., may vibrate, giving each its own simple tone. The combination of all of these simple waves forms a compound wave whose form or, at least, whose composition, determines the quality of the tone heard. As many as ten or sixteen of these overtones may be detected from the vibrating strings of a violin or guitar. When the period of vibration of these overtones bears a simple ratio to that of the fundamental, a ratio that can be expressed by the simple num-

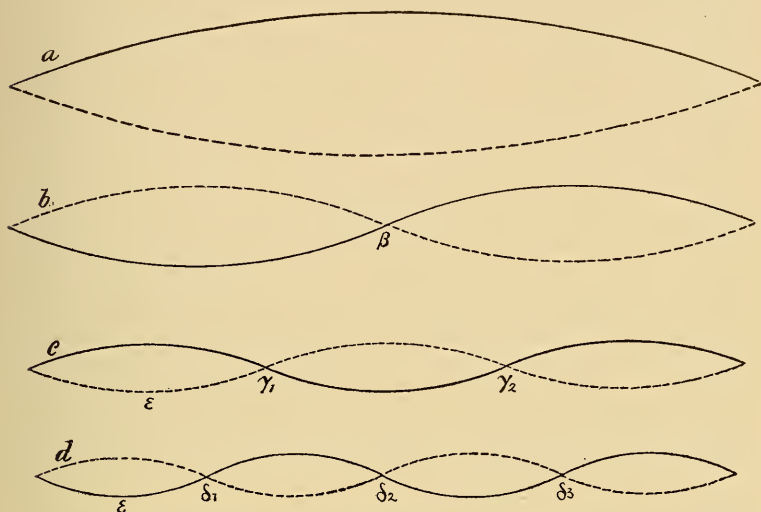

Fig. 176.—To illustrate the mechanism of the formation of overtones.—(Helmholtz.) In *a* the string vibrates as a whole, giving its fundamental tone; in *b*, *c*, and *d*, its halves, thirds, and fourths are vibrating independently. When a string is struck, plucked, or bowed these movements may happen simultaneously and the fundamental note due to the vibrations of the whole string is combined with the notes due to the vibrations of aliquot parts, the overtones. The combination gives a compound wave whose form and musical quality vary with the number and relative strength of the overtones.

bers 1, 2, 3, 4, 5, they harmonize with it and form the harmonic overtones. It should be borne in mind that, so far as the tympanic membrane is concerned, it does not respond separately to the single tones which constitute the compound wave, but swings in unison with the movement of the compound wave. Nevertheless, the internal ear, according to the law of Ohm, is capable of analyzing the compound wave form into the series of simple or pendular wave forms of which it is composed, and of distinguishing the series of corresponding tones. While this analysis cannot be made consciously except by the trained musician, it is made unconsciously, as it were, by every normal ear, and in consequence of this analysis

we recognize the variations in quality of different compound tones. The principle upon which the cochlea acts in thus separating the compound tones into their elements is not explained with entire satisfaction. According to the view so admirably presented by Helmholtz,\* the analysis depends upon the existence in the ear of a mechanism for sympathetic vibrations or resonance.

**Sympathetic Vibrations or Resonance.**—By sympathetic vibration is meant the fact that an elastic body is easily set into vibration by movements of the surrounding medium when these movements correspond with its own period of vibration. A string whose period of vibration is 128 per second will be little affected by vibrations of the surrounding air unless they have the same periodicity. If, however, a note of this period is sounded by the voice, for instance, the string will be set into vibration with relative ease. By means of this principle the untrained ear can readily pick out the more prominent of the upper harmonics of any given note of a musical instrument. It is only necessary to select a series of resonators corresponding to the series of overtones. Each resonator is set into vibration by its corresponding overtone and so emphasizes this particular tone that it may be easily recognized. If one stands in front of a piano with the strings exposed and sings a given note it may be shown that a series of the piano strings is set into vibration corresponding, in the first place, to the rate of vibration of the fundamental tone, and secondly to the more prominent of the harmonic overtones. In this case the compound wave strikes upon the collection of strings of the piano, and is analyzed into its component simple tones by the sympathetic vibrations of the corresponding strings. Helmholtz assumes that the cochlea analyzes compound musical waves by an essentially similar method.

**The Functions of the Cochlea.**—The vibratory movement, whatever may be its form, in the air of the external meatus imparts to the tympanic membrane a similar form of movement, and this, in turn, through the ear bones and the membrane of the fenestra ovalis sets the perilymph into vibrations of the same form. That the perilymph can swing or vibrate under the influence of the movements of the stapes is explained by the existence of the second opening, the fenestra rotunda, between the middle and the internal ear (see Fig. 167). As the membrane of the fenestra ovalis is pushed in, that of the fenestra rotunda is pushed out, and *vice versa*, and the wave movement is transmitted along the perilymph of the cochlea in a manner illustrated by the schema represented in Fig. 177. These vibratory movements of the perilymph affect the membranous cochlea, which may be regarded as being suspended in the perilymph, and, according to the resonance theory,

\* Helmholtz, *loc. cit.*



certain structures within the membranous cochlea are set into sympathetic vibrations corresponding to the simple waves of which the compound wave is constituted. Helmholtz first suggested that the peculiar rods of Corti form the resonating apparatus, and by sympathetic vibrations are capable of analyzing the compound

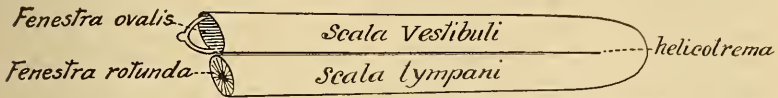

Fig. 177.—Schematic figure from Auerbach to show the relative positions of the membranes of the oval and round fenestras and the course of the wave movement through the cochlea from one to the other.

movement. Later, however, this suggestion was abandoned, since the number of the rods is not sufficiently great perhaps to answer the requirements of this theory. According to Retzius, the inner rods number 5600 and the outer ones 3850. Moreover, these structures are absent from the bird's cochlea, and we must assume that these animals are capable of appreciating musical sounds. Helmholtz then adopted a suggestion of Hensen's, that the basilar membrane constitutes the resonating apparatus. This membrane forms the floor of the membranous cochlea, stretching from the limbus to the opposite side of the bony cochlea (Fig. 172). Its middle layer consists of fibers, running radially, which, though united to one another, are sufficiently independent to be regarded as separate strings. These fibers in the portion covered by the rods of Corti, the inner zone or zona tecta, are finer and more difficult to separate than in the portion exterior to the outer rods, the outer zone or zona pectinata. From the base to the apex of the cochlea the membrane increases in width, the length of the strings in the outer zone varying, according to Retzius, from  $135 \mu$  in the basal portion to  $220 \mu$  in the middle spiral and to  $234 \mu$  at the apex. The whole structure is estimated to contain about 24,000 strings varying gradually in length, as stated, and resembling in general arrangement the strings of the piano. Assuming that each of these fibers has its own period of vibration, we may imagine that the entire collection forms an apparatus for sympathetic vibration which is capable of analyzing each compound wave motion into its constituent simple waves, each string being set into strongest vibrations by the wave of the corresponding period. Moreover, it is implied or assumed in this theory that the vibrations of each string are communicated to a corresponding nerve fiber of the cochlear nerve, through which the stimulus is conveyed to the brain as a nerve impulse. We should be capable of perceiving, theoretically, as many distinct musical tones as there are fibers in the basilar membrane, while a compound wave, by setting a number of these mechanisms into action, gives a series of sensations which are more or less fused in consciousness. The

peculiar quality or timbre of the tone of each instrument is referable, therefore, immediately to the number and relative intensities of the simple tone sensations that it arouses. The fusion of these elementary tone sensations into compound ones of different qualities is comparable, in a general way, to the fusion of simple color sensations, with this exception, however, that in the compound tone sensations we are capable of distinguishing more clearly the fact that they are composed of simpler elements; the constituent tones may be recognized by the trained ear at least. The mechanism by which the vibrations of the strings of the basilar membrane are conveyed to the hair cells and through them to the nerve fibers is a matter of speculation only, as are also the functions of the remaining parts of the organ of Corti. It may be suggested, perhaps, that the rods of Corti and Deiters's cells, together with the reticulate membrane, with which they are both connected, form not only a supporting apparatus for the hair cells, but also a mechanism by which the vibrations of the strings are communicated to the hairs of the hair cells; but the suggestion is unsatisfactory, as the anatomical arrangement does not suffice to explain how the vibrations of individual strings are transmitted to the separate hair cells. The assumption has also been made that the tectorial membrane acts as a damper to the vibrating hair cells or the reticulate membrane. Its position as a pad lying over the rods of Corti and the reticulate membrane justifies perhaps such an assumption. Many physiologists, while accepting the general principle that the cochlea analyzes the sound waves by a mechanism for sympathetic vibrations, have been unwilling to admit that the basilar membrane constitutes such a mechanism. They point to the improbability or impossibility of fibers of only 0.36 mm. (or 0.5 mm. at the best) in length acting as efficient resonators, especially as they are not entirely free and are surrounded by liquid. Attempts have been made, therefore, to select other structures in the cochlea as more likely to be affected by sympathetic vibrations. Attention has been directed mainly to the tectorial membrane or membrane of Corti. Thus, Ayers\* believes that this structure as seen in the usual microscopical preparations, is simply an artefact. Under normal conditions he believes that it is a band of very long and delicate hairs projecting from the hair cells and lying free in the endolymph. According to his view, it is these hairs that take up the vibrations and transmit their impulses directly to the hair cells. The histological statement upon which this view is based has not, however, been verified. More recently v. Ebner,† reviving an older view of Hasse, has suggested

\* Ayers, "Journal of Morphology," 6, 1, 1892.

† Kölliker, "Handbuch d. Gewebelehre," sixth edition, vol. iii, pt. II, p. 958, 1902; also Hardesty, "American Journal of Anatomy," 8, 109, 1908.

that the tectorial membrane, especially its free end, serves as the mechanism for sympathetic vibration. This membrane increases in width from the base to the apex of the cochlea and varies in thickness in its radial diameter, so that it might be conceived to respond to different periods of vibrations in its different parts, its movements being communicated directly to the hair cells upon which it rests. Unfortunately we have no direct experimental evidence in favor of any of these views. Several observers, however, have demonstrated apparently that, whatever may be the mechanism for sympathetic vibration, it is so arranged that at the base of the cochlea the higher notes are received and at the apex the notes of the lowest pitch. Thus, Munk, in experiments upon dogs, in which by an operation through the fenestra rotunda he had destroyed the basal portion of the cochlea, found that the animals, after a temporary deafness of some days, could hear apparently only low tones and noises. Baginsky,\* in a later series of experiments, opened the bulla ossea on each side, destroyed the cochlea on one side entirely so as to render that ear deaf, while on the other he injured it in certain areas only. He found that when the apex of the cochlea was destroyed the animal appeared to perceive only the high tones,  $c'''$ ,  $c''''$ ,  $c'''''$ .

The fundamental principle of the theory of the function of the cochlea as developed by Helmholtz has been subjected to some criticism. The theory of a series of resonators each responding to a definite note does not explain with entire satisfaction some of the known acoustic phenomena. Thus, it is known that when two notes are sounded together combinational tones may be heard, either a low difference tone whose pitch is equal to that of the difference between the rates of the two notes, or a summation tone whose pitch is equal to the sum of the vibrations of the two notes. It is difficult to conceive that these combinational tones have an objective existence, as vibrations, and the means by which they are perceived by the cochlea is not explained satisfactorily by the theory of resonators. Other theories of the function of the cochlea have been proposed to avoid such difficulties. Thus, Ewald † suggests a view according to which the basilar membrane vibrates throughout its length for each note. He has shown that a rubber membrane of the dimensions of the basilar membrane will be set into such vibrations throughout its length and when examined under the microscope presents such a picture as is represented in Fig. 178, in which the crests of the waves are at a fixed interval for each tone. If at these intervals the corresponding hair cells and nerve fibers are supposed to be stimulated, then our consciousness would recognize each note by its appropriate interval. For the application of this theory to musical harmony—combinational tones and beats—reference must be made to the original.

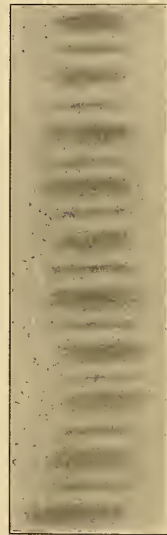

Fig. 178.—To illustrate the idea of a fixed sound wave.—(Ewald.) The illustration shows a fundamental note and its first overtone.

\* Baginsky, "Virchow's Archiv f. pathol. Anat.," 94, 65, 1883.

† Ewald, "Archiv f. d. gesammte Physiologie," 76, 147, 1899.

**Sensations of Harmony and Discord.**—The combination of notes to produce various harmonies or intentional discords is a part of the theory of music, but attention may be called briefly to the physiological explanation offered by Helmholtz to account for the fact that certain notes when combined give us a disagreeable sensation, appear rough and unpleasant; while others, on the contrary, produce pleasant sensations. Discord or dissonance is due, according to Helmholtz, to the beats produced when two dissonant notes are sounded together. On the physical side the beat,—that is, a rhythmical variation in the intensity of the sound,—is due to the phenomenon of interference. If the rates of vibration of two notes are such that at certain intervals the crests of the waves fall together and again the crest of one coincides with the hollow of the other, the sound sensations will be periodically increased and decreased. While there is no fundamental explanation for the fact that a regularly varying intensity of sound is disagreeable, it is a well-known phenomenon and it finds analogies in the other sensations,—for instance, in the very disagreeable effect of a flickering light. When two notes are sounded together the number of beats varies with the difference between the rates of vibration; thus, two notes, one of 128 vibrations and the other of 136 vibrations, give 8 beats per second. When the number of beats rises to 33 per second the discord is most disagreeable; if, however, the rate of interference is more rapid, the unpleasant sensation becomes less perceptible, and beyond 132 per second is not noticeable. When the rates of vibrations of two tones are such that neither the fundamentals nor any of the overtones give beats, the effect is that of harmony, the vibrations of one note strengthening those of the other. The most perfect harmony is that of a note sounded simultaneously with another of the same rate, ratio 1: 1, or with its octave, ratio 1: 2. The various intervals which in music have been found to be perfectly consonant or which vary so little from it as to be usable in harmonies are those whose vibrations bear a simple ratio to each other. Thus, the octave of any note has the ratio of 1: 2, the double octave 1: 4, the twelfth 1: 3. These three intervals give absolutely consonant sounds. Other intervals—such as the fifth, 2: 3, or the major third, 4: 5—give a less perfect consonance. Three or more notes bearing such relations to each other constitute a chord, the vibrations in the major chord being, for instance, in the ratios 4: 5: 6,— $c'$  (128),  $e'$  (160),  $g'$  (192).

**The Limits of Hearing.**—The rates of vibration that can be perceived by the ear as musical tones lie between fairly well-defined limits, although in this organ, as in the case of the eye, there are individual variations,—variations, indeed, which are more marked in the case of the ear, since its range of appreciation

is larger. The lowest rate of vibration that can cause a musical sensation is usually placed at 24 to 30 per second, although some ears can still respond to an octave lower—about 16 per second. To most ears vibrations below 16 per second are felt, if perceived at all, as single pulses that stimulate the sensory nerves of the tympanic membrane itself, giving pressure sensations rather than auditory sensations. It may happen, however, that vibrations too slow to be perceived by the ear as an auditory sensation will give overtones of a higher pitch and of sufficient strength to be recognized. The high limit of audibility, on the other hand, is usually placed at 40,000 double vibrations per second, although the various estimates published vary so widely that in this respect there must be great individual differences. The shrill notes of insects are said to be inaudible to some ears. König, making use of Kundt's method of light powders, succeeded in tuning a series of forks to an estimated rate of 90,000 double vibrations per second. It was found that those between  $c_7$  and  $c_9$  (8192 to 32,768) were generally audible, while the  $c_{10}$  (65,536) was inaudible. The limit, therefore, lay between  $c_9$  and  $c_{10}$ . Notes near this high limit are not, however, usable in ordinary music; the sensations produced have a disagreeable, if not actually painful, shrillness. The range of vibrations employed in music is illustrated by the seven octaves of the piano, the notes varying from the lowest  $c$  of 32 vibrations to  $c_6$  of 4096 vibrations. The intervening series is divided into tones whose serial relations to each other are expressed by the ratios  $\frac{9}{8}$  or  $\frac{10}{9}$  and semitones of the ratio  $\frac{16}{15}$  or  $\frac{25}{24}$ ; thus,  $c'' = 256$  vibrations and the  $d''$  of the same octave corresponds to  $256 \times \frac{9}{8} = 288$  vibrations.\*

\* See Helmholtz, Popular Scientific Lectures, "Ueber die physiologischen Ursachen des musikalischen Harmonie," Bonn, 1857.

## CHAPTER XXI.

### THE FUNCTIONS OF THE SEMICIRCULAR CANALS AND THE VESTIBULE.

**Position and Structure.**—The membranous semicircular canals lie within the bony semicircular canals, the space between being filled with perilymph which communicates freely with that in the rest of the labyrinth. Within the membranous canals is the endolymph, which communicates through the five openings with the endolymph in the utriculus. The canals lie in three planes that are, approximately at least, at right angles to one another (Fig. 179). The horizontal or external canals lie in a horizontal plane at right

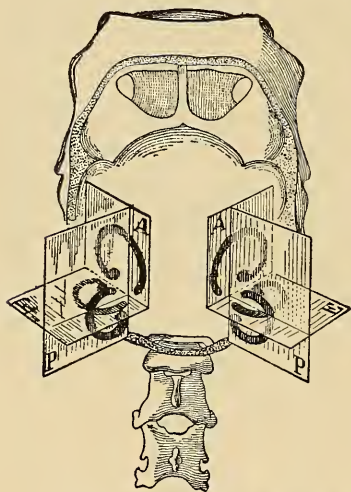

Fig. 179.—Diagram to show the position of the semicircular canals in the head of the bird. On each side it will be seen that the three canals lie in planes at right angles to one another. The external or horizontal canals (E) of the two sides lie in the same plane. The anterior canal of one side (A) lies in a plane parallel to that of the posterior canal (P) of the other side (Ewald).

angles to the mesial or sagittal plane of the body, and the vertical canals on each side make an angle of about 45 degrees with this mesial plane. The plane of each of the anterior canals is parallel to that of the posterior or inferior vertical canal of the opposite side, as represented in the figure. At one end of each canal, near its junction with the utriculus, is the swelling known as the ampulla, and within the ampulla lies the crista acustica, containing the hair cells with which the nerve fibers communicate, and which, therefore, are considered as the sense cells of the organ. The hair cells are cylindrical and each gives off a long hair, consisting perhaps of a bundle of finer hairs, which projects into the interior of the canal for a distance of at least  $28\mu$ . The nerve fibers distributed to these hair cells are given off by the vestibular branch of the eighth nerve, or more properly the vestibular nerve, one branch of which (ramus utriculo-ampullaris) supplies the utriculus and the ampulla of the superior and horizontal canals, while the other (ramus sacculo-ampullaris) furnishes fibers to the sacculus and the posterior ampulla.

**Flourens's Experiments upon the Semicircular Canals.**—Modern experiments and theories concerning the functions of the semicircular canal date from the classical researches of Flourens\* (1824). This investigator laid bare the canals in birds and mammals and studied the effects of sections of one or more of them. The experiments have since been repeated by numerous observers,



Fig. 180.—Dissection to show the position of the three semicircular canals in the pigeon and the relations of their ampullary ends (from preparation made by Dr. Esther Rosenkrantz).

and the results obtained have been described in great detail, for an account of which reference must be made to original sources.† In general, it may be said that injuries to the canals are followed by certain more or less definite movements of the head, eyes, and body, and by a disturbance in the power of the animal to co-ordinate normally the muscles used in standing, locomotion, or flying. The character and extent of these results vary with the number of canals injured, and, indeed, show a more or less definite relationship

\* Flourens, "Recherches expérimentales sur les propriétés et les fonctions du système nerveux," second edition, 1842.

† The literature of the semicircular canals and the vestibule is very extensive. The complete bibliography may be obtained from the following sources: "Die Lehren von den Funktionen der einzelnen Theile des Ohrlabyrinths," by von Stein, 1894; Richet's "Dictionnaire de Physiologie," article by Cyon, on "Espace," 1900. Ewald, "Physiolog. Untersuchungen u. d. Endorgan des nervus octavus," 1892.

to the several canals. When the horizontal canal is cut on one side in pigeons the animal makes movements of the head in the plane of that canal, and if the similar canal on the other side is also sectioned these movements are more pronounced. The animal may also in moving show an inability to walk normally and a tendency, especially when excited, to make abnormal forced movements of rotation of the whole body. After such an operation the pigeon will not fly voluntarily and if thrown into the air is not able to guide its flight with accuracy and soon descends. Similar operations on the anterior or the posterior canals cause movements of the head in the corresponding planes and a tendency in walking or flying to make forced movements—somersaults—forward or backward. When all three canals are cut on one or both sides the animal shows a distressing inability to maintain a normal position. The head is twisted, it is not able to stand unless supported, and any attempt at walking or flying results in violent forced and inco-ordinated movements. The animal makes continual somersaults at each attempt to stand or walk and the head is kept in spasmodic, forceful movements, which may produce injury or death. To preserve the animal from injury after such an extensive operation it is necessary to keep it wrapped in bandages. It should be added that results of this character are obtained only when the membranous canals are injured. If the bony canal alone is cut and even if the perilymph is removed by suction no such effects are obtained. At most slight and relatively transient movements of the head are observed. If the exposed membranous canal is pricked with a needle more violent movements result, and if sectioned these movements are maintained for a longer period and are accompanied by the other results described. Similar effects have been obtained from operations on mammals and other animals, but the results are more pronounced in some animals than in others, varying apparently with the delicacy of the co-ordination necessary to the movements (Ewald). Thus, the movements of walking or flying in the pigeon may be assumed to require a nicer adjustment of the muscles used than is necessary in the swimming movements of the fish, and in correspondence with this idea it is found that operations on the canals of fishes are not followed by conspicuous effects upon the movements of the animals.

**Temporary and Permanent Effects of the Operation.**—The general effects of operations on the semicircular canals, so far as disturbances of equilibrium and occurrence of forced movements are concerned, resemble those resulting from operations upon the cerebellum, and, as in the case of the last mentioned organ, it is found by most observers that if the animal is properly cared for the severity of the first effects passes off to a greater or less



extent. Flourens states that his pigeons, with two or more canals cut, continued to show the effects of the operation almost with the same intensity for nearly a year. Some unpublished experiments made in the author's laboratory have given different results.\* Pigeons with only one canal cut recover practically completely within ten or more days. Those with two canals cut recover nearly completely within a month, so far as walking is concerned, although they exhibit an unwillingness to fly. Those with three or more canals cut never recover completely, but their final condition is very different from that exhibited shortly after the operation. Even when all six canals have been cut the animal, if well cared for in the beginning, is able finally to stand and walk and feed itself. It is not able, however, to fly, and in walking its progress is uncertain; there is a tendency to walk zigzag or in circles, first to one side, then to the other. If hurried or excited some return of the violent movements of the head and inco-ordination of the movements of locomotion may be seen. If, instead of cutting the canals, the ampullæ are destroyed, the initial effects of the operation seem to be less violent, owing possibly to the fact that in the former case the irritative effects of the lesion still have the end organs in the ampullæ to act upon. Pigeons with all six ampullæ destroyed may make eventually an excellent recovery. Within a few months they walk and perch with little difficulty when not frightened. In the matter of flying they do not recover their former skill, but this may be due to lack of practice, since in the experiments quoted (Rosencrantz) no provision was made for exercise in flying. The very marked degree of recovery noted, even after loss of all six ampullæ, seems to be due to the fact that the animal learns to use his other sensory data in co-ordinating his muscles. If after a nearly complete degree of recovery has taken place a new operation is performed in which the canals are cut, the resulting disturbance to motion is relatively small and soon passes off. That there is any effect at all from the second operation may be due to the emptying of the endolymph and the consequent effect upon the remaining ampullæ, or, if these had all been previously destroyed, to the effect upon the sense organs of the vestibular sacs.

**Effect of Direct Stimulation of the Canals.**—The membranous canals or their ampullary enlargements have been stimulated by many observers and by many different methods—electrical, chemical, and mechanical. The results of electrical stimulation are not constant nor striking, but chemical and especially mechanical stimulation in the hands of many observers has called forth definite movements of head or eyes similar in a general

\* Experiments lasting over two years made by Dr. E. Rosencrantz.

way to those caused by section of the canal, but lasting, of course, for a short time only. In the dog-fish, Lee\* finds that pressure upon an ampulla causes movements of the eyes and fins such as would occur normally if the animal's body were rotated in the plane of the canal stimulated.

**Effect of Section of the Ampullary or the Acoustic Nerve.**—

Many of the older and newer observers have cut one or both of the acoustic nerves or destroyed the entire labyrinth on one or both sides. The effects described vary somewhat with the animals used, but, in general, section of the nerve on one side is followed by forced movements, especially by rolling movements around the long axis of the body. When the nerves are cut on both sides disturbances in the power to maintain equilibrium perfectly are more or less distinctly marked. In fishes (dog-fish) the animal may swim or come to rest in unusual positions,—on the back or side, for instance.

**Is the Effect of Section of the Canals Due to Stimulation?**—

The movements that result from section of one or more of the canals have been attributed by some authors to stimulations set up by the injury caused by the operation, and by others have been considered as a result of the falling out of the stimuli normally and constantly proceeding from the canals. This fundamental question has not been decided. On the one hand, the movements observed are similar to those caused by excitation, which would indicate that a stimulation is set up by the operation. On the other hand, the effects are so long lasting as to make it improbable that they are entirely due to the irritation of the operation. Moreover, Gaglio † states that when the spot operated upon is cocainized the same effects follow. Indeed, cocainizing the membranous canals gives the same results as cutting them. It is possible, of course, that both processes take place, an irritative stimulation and a falling out of normal impulses, the effects of the latter being longer lasting.

**Theories of the Functions of the Semicircular Canals.**—As indicated briefly above, the facts regarding injury to and stimulation of the semicircular canals are very numerous and, on the whole, fairly concordant. Their interpretation, however, has offered great difficulties, and many views have been proposed; almost every investigator, in fact, has, to some extent, varied in his interpretation of the precise functional significance of these organs.‡ These views may be classified, although imperfectly, under the following heads:

1. The old view, first proposed by Autenrieth (1802), that the

\* Lee, "Journal of Physiology," 15, 328, 1903.

† Gaglio, "Archives ital. de biologie," 31, 377, 1899.

‡ For a detailed and complete account of these views to 1892, see Stein, "Die Lehren von den Funktionen der einzelnen Theile des Ohrlabyrinths," Jena, 1894.

canals or their sense cells are stimulated by sound waves and give us the means of determining the direction of sound in accordance with their position in three planes at right angles to one another. This view has been revived from time to time by recent writers.

2. Flourens himself believed that the impulses normally proceeding from these organs serve to moderate, or, as we should say now, to inhibit the movements of the head. As soon as the canals are cut the movements that have been kept under control by their influence are unrestrained. On this view the semicircular canals are organs which reflexly inhibit or restrain the voluntary movements, and thus take an essential part in the proper co-ordination of such movements. He did not attempt to define the physiology of the organs in terms of the sensations aroused.

3. The view that the stimulus to the hair-cells is to be found in the varying pressure of the endolymph. As first proposed by Goltz (1870), it was assumed that the endolymph exerts a hydrostatic pressure upon the hair cells which in any given position varies in the different ampullas and varies with different positions of the head. The sensory impulses thus aroused give us a knowledge of the position of the head and enable us, therefore, to control its movements and also those of the body. On this view these organs act as sense organs in maintaining body equilibrium and may be designated as peripheral sense organs of equilibrium. Later observers (Mach, Breuer, Brown, *et al.*) modified this view by the assumption that the hair cells are stimulated not so much by the hydrostatic pressure of the endolymph as by the pressure changes developed during movements of the head, making the organs, therefore, a means of appreciating especially the movements of the head, a dynamic rather than a hydrostatic organ of equilibrium. It was assumed that rotation movements of the head in the plane of a canal set up a movement or pressure of the endolymph in the opposite direction, just as, to use a rough comparison, when one twirls a pail of water in one direction the water lags behind and exerts a pressure in the opposite direction. According to this hypothesis, which in some form or other is the view usually taught, the hair cells in each ampulla are stimulated chiefly by movements in the plane of that canal toward the ampulla, the pressure of the endolymph being in the opposite direction,—that is, from utriculus toward the canal. Moreover, the vertical canals act in pairs (see Fig. 179), the superior or anterior vertical of one side acting with the posterior or inferior vertical of the other side, the two canals lying in parallel planes. Movements in this plane forward would stimulate the anterior ampulla on one side chiefly, movements in the same plane backward, the posterior ampulla of the opposite side. The horizontal canals also act together, being stimulated chiefly by rotational

movements in the horizontal plane, the hair cells in one responding chiefly to movements in one direction, the other to movements in the same plane, but in the opposite direction. Rotational movements in other planes—sagittal, oblique, etc.—would affect two or more of the pairs of canals in proportion to the degree that each is involved in the movement on the principle of the parallelogram of forces.\* By a mechanism of this sort it may be supposed that we are informed regarding the plane, direction, and extent of the movements of the head and are thereby enabled to control these movements. The canals function especially as a dynamic organ of equilibrium, but may also give us guiding sensations when the movements are progressive rather than rotational, and also when the head is at rest, although, as is explained below, this last function is by some relegated to the hair cells of the utriculus and sacculus. According to this view, the loss of the power of maintaining exact equilibrium after injuries to the canals or section of the nerves may be explained by supposing that false sensations are experienced and false compensatory movements are made. So, also, the vertigo experienced after continued rotation may be attributed to abnormal stimulation of these sense organs,—a view that finds some support in the fact that many deaf-mutes, whose internal ear is supposed to be deficient, do not experience vertigo after rotation, and in animals with the labyrinth destroyed rotational movements fail to give the symptoms of vertigo.

4. Ewald, while accepting the general view that the sense cells are stimulated by the pressure of the endolymph, lays stress upon the fact that the nerve impulses thus aroused have, as their main result, a reflex effect upon the tonicity of the voluntary musculature. The constant flow of impulses from these organs serves to maintain the muscles in a normal condition of tone. In animals with the labyrinth destroyed on both sides the body musculature is flabby and lacking in tonicity. This view has received considerable support from the experiments of Magnus and Klijn.† These authors made use of cats thrown into the condition of exaggerated tonus, known as decerebrate rigidity, which follows upon removal of the cerebrum (section of the cerebral peduncles). With the animal in this condition they showed that different positions of the head in space caused definite changes in the posture of the extremities, and they demonstrated that these changes were due to labyrinthine reflexes, since they disappeared upon destruction of both labyrinths.

**Summary.**—The sensations, if any, aroused through the semi-

\* Consult Lee, *loc. cit.*

† Magnus and Klijn, "Pflüger's Archiv," 1912, 145, 455.

circular canals, are too indistinct to be recognized and named by an appeal to consciousness, and it would seem to be wiser to designate them after the analogy of the muscle sensations simply as semicircular canal or labyrinthine sensations. Our perceptions or ideas of space and direction are possibly founded in part upon these reactions and in part upon the muscular, visual, and tactile sensations. Our reasoning with regard to the semicircular canal sensations would be more satisfactory if it could be shown that the vestibular nerve, after ending in the pons, was continued forward by sensory paths to the cortex of the cerebrum. As a matter of fact, such paths have not been demonstrated, and if we assume that conscious sensations are mediated only through the cortex of the cerebrum we have no anatomical proof that the semicircular canals give us any reaction in consciousness. The vestibular nerve fibers end in the nucleus of Deiters and the nucleus of Bechterew, through which reflex connections are established with the motor centers of the spinal and possibly the cranial nerves. There is a connection also with the nucleus fastigii of the cerebellum and through this possibly with the cerebellar cortex, although this latter connection has not been actually demonstrated. With regard to the influence of the nerve impulses from the semicircular canals upon movements, all the facts known seem to indicate that they play an important part in the regulation or co-ordination of the movements of equilibrium and locomotion. Inasmuch as this general co-ordination or control seems to rest normally in the nervous mechanisms of the cerebellum and inasmuch as the vestibular nerves probably make connections with the cerebellum, we may assume that the cerebellum forms the brain center through which the semicircular canal impulses exert their influence upon co-ordinated muscular contractions—the cerebellum forms the nerve center for the semicircular canals, or the semicircular canals form a peripheral sense organ to the cerebellum. Some such hypothesis seems to be necessary to account for the general similarity between the effects of lesions of the canals and of the cerebellum. Whether the impulses from the canals are excitatory or inhibitory or both, as regards their effect upon muscular contractions, is not clearly apparent from the experimental evidence so far furnished, but Ewald's suggestion that they serve to maintain reflexly the tonus of the body musculature is perhaps the most acceptable view, especially when it is remembered that this tonicity may vary in an adaptive way in different muscles according to the strength of the stimuli coming from one or another of the canals. In regard to the means by which these nerves are normally stimulated there is also much room for conjecture, but provisionally

at least it seems permissible to adopt the view that variations in the pressure of the endolymph upon the hairs of the hair cells, especially in movements of rotation, constitute the immediate cause of their excitation. Granting that changes in position or movement of the head may cause such variations in pressure the theory offers a simple and satisfactory explanation of the mode of excitation and the means by which the excitation may vary appropriately under different conditions. While the endolymph theory may be criticized easily, no other equally satisfactory theory has been suggested to take its place.

**Functions of the Utriculus and Sacculus.**—These small sacs contain sensory hair cells similar in general structure to those found in the cristæ of the ampullary sacs. Each collection of hair cells, together with the supporting cells, is designated as a macula. One of these is found in the utriculus, the macula utriculi, and another in the sacculus, the macula sacculi. Lying among the hairs of the hair cell are found masses of small crystals of calcium carbonate, the otoliths or otoconia. In this respect the structure of the macula differs strikingly from that of the crista. The position and connections of the utriculus and sacculus lead at first naturally to the supposition that they are stimulated by the sound waves of the perilymph, and are, therefore, concerned in the function of hearing. The accepted views regarding the functions of the cochlea in hearing make this organ sufficient for all auditory purposes, and there is no specific part of this process that need be attributed to the vestibular sacs. It was, indeed, at one time suggested that their structure adapts them to respond especially to short and irregular vibrations, but no cogent reasons or facts have been advanced to support this view. The fact that the sacs are so closely connected with the semicircular canals suggests rather that the functions of these organs are similar and that like the canals, therefore, they influence the contractions of the muscles and function as organs of equilibrium. In recent years the view that has been most discussed is that advanced by Breuer,—namely, that these organs give us information regarding the position of the head when at rest and when making progressive—that is, non-rotary—movements, supplementing, therefore, the functions of the semicircular canals on the supposition that these latter act especially in movements of rotation. Or, as it is sometimes expressed, the sacs form a static and the canals a dynamic organ of equilibrium. According to this view, the otoliths act as a means of mechanical stimulation of the hairs. Being heavier than the endolymph, they press upon the hairs with a force varying with the position of the head and thus give rise to sensations or reflexes which are adapted to the maintenance of equilibrium. Since the planes of the two sacs are different, they may be differ-

ently affected by the same position or movement. So also in progressive movements forward the weight of the otoliths may be imagined to exercise a stress of some sort upon the hairs. This theory has been the subject of much investigation, numerous experiments having been made chiefly upon fishes and invertebrates.\* According to some observers destruction of these sacs or section of their nerves is accompanied by a distinct interference with the fish's normal equilibrium: the animal swims at times upon its back or side and apparently loses its normal means of judging correctly its position. In many invertebrates there is present a sac, known as the otocyst, containing hair cells and otoliths. Its structure resembles that of the vestibular sacs of the mammalian ear, and it has been assumed that it has a similar function. Experiments by numerous observers have indicated that when the otoliths are removed the animal shows disturbances in equilibrium, particularly in the matter of the compensatory movements exhibited during rotation. Others, however, deny these facts and state that invertebrates without otocysts make compensatory movements when rotated and that in those with otocysts compensatory movements and maintenance of normal equilibrium persist after destruction of the sacs. A very ingenious experiment reported by Kreidl seems to show that the otoliths may affect the hairs by their weight. When the palæmon, a crustacean, molts it casts off the inner lining of the otocyst, together with the otoliths. The otocysts in these animals lie at the base of the antennules and open freely to the exterior. After molting the animal by means of its claws places fine grains of sand in the otocyst to act as otoliths. Taking advantage of this peculiarity, Kreidl placed the animal, after molting, upon finely powdered iron, with the result that some of the iron granules were deposited in the otocyst in place of the usual grains of sand. When now a magnet was brought near to the animal reactions were obtained which showed that the pressure of the iron upon the hairs influenced its position. The position taken by the animal under these conditions was such as would be expected as a resultant of the forces of magnetism and gravity, and the experiment, therefore, justifies the hypothesis that under normal conditions gravity affects the otoliths and through them the muscular co-ordination of the animal. These experiments have been confirmed by Prentiss.† This author has shown, moreover, that if larval lobsters (4th stage) are prevented from obtaining otoliths after moulting by placing them in filtered seawater, their movements, like those of larvæ deprived of their otocysts, show a distinct instability and lack of normal orientation.

\* Consult the following papers: Sewall, "Journal of Physiology," 4, 339, 1884; Lee, *ibid.*, 15, 311, 1893, and "American Journal of Physiology," 1, 128, 1898; Lyon, "American Journal of Psychology," 3, 86, 1900.

† Prentiss, "Bulletin of Museum of Comparative Zoology," Harvard, 1901, xxxvi., No. 7.

Some interesting results reported] by Streeter,\* from experiments made upon tadpoles, demonstrate in a striking way the importance of the labyrinth to the power or property of equilibration. Up to the sixth day after fertilization the tadpole shows no evidence of a power of equilibrium, and is not capable of swimming freely in the water. When the auditory vesicles appear, after the sixth day, the animal exhibits evidence of a sense of equilibrium and swims freely in the water out of contact with solid substances. If at or before the beginning of this stage one of the auditory vesicles is removed, the tadpole shows evident, although temporary, signs of a defective power of equilibration. If both vesicles are removed the animal seems to lose permanently its power of swimming, and when at rest lies in any position, as though it were lacking in a sense of equilibrium.

\* Streeter, "Journal of Exp. Zoölogy," 3, 543, 1906; also vols. 4 and 16.



SECTION IV.  
BLOOD AND LYMPH.

---

CHAPTER XXII.

GENERAL PROPERTIES: PHYSIOLOGY OF THE  
CORPUSCLES.

The blood of the body is contained in a practically closed system of tubes, the blood-vessels, within which it is kept circulating by the force of the heart beat. It is usually spoken of as the nutritive liquid of the body, but its functions may be stated more explicitly, although still in quite general terms, by saying that it carries to the tissues foodstuffs after they have been properly prepared by the digestive organs; that it transports to the tissues oxygen absorbed from the air in the lungs; that it carries off from the tissues various waste products formed in the processes of disassimilation; that it is the medium for the transmission of the internal secretion of certain glands; and that it aids in equalizing the temperature and water contents of the body. It is quite obvious, from these statements, that a complete consideration of the physiological relations of the blood would involve substantially a treatment of the whole subject of physiology. It is proposed, therefore, in this section to treat the blood in a restricted way,—to consider it, in fact, as a tissue in itself, and to study its composition and properties without special reference to its nutritive relationship to other parts of the body.

**Histological Structure.**—The blood is composed of a liquid part, the *plasma*, in which float a vast number of microscopical bodies, the *blood corpuscles*. There are at least three different kinds of corpuscles, known respectively as the *red corpuscles* or erythrocytes; the *white corpuscles* or leucocytes, of which in turn there are a number of different kinds; and the *blood plates*. Blood-plasma, when obtained free from corpuscles, is perfectly colorless in thin layers—for example, in microscopical preparations; when seen in large quantities it has in man a yellow or greenish color, although in some other animals (dog, cat) it is as clear as water. The red color of blood is not due, therefore, to coloration of the blood-plasma, but is caused by the mass of red corpuscles held in suspension in this liquid. The proportion by bulk of plasma to corpuscles is usually given, roughly, as two to one.

*Blood-serum and Defibrinated Blood.*—In connection with the explanation of the term “blood-plasma” just given it will be convenient to define briefly the terms “blood-serum” and “defibrinated blood.” Blood, after it escapes from the vessels, usually clots or coagulates; the nature of this process is discussed in detail on page 452. The clot, as it forms, gradually shrinks and squeezes out a clear liquid to which the name *blood-serum* is given. Serum resembles the plasma of normal blood in general appearance, but differs from it in composition, as will be explained later. At present we may say, by way of a preliminary definition, that blood-serum is the liquid part of blood after coagulation has taken place, as blood-plasma is the liquid part of blood before coagulation has taken place. If shed blood is whipped vigorously with a rod or some similar object while it is clotting, the essential part of the clot—namely, the fibrin—forms differently from what it does when the blood is allowed to coagulate quietly; it is deposited in shreds on the whipper. Blood that has been treated in this way is known as *defibrinated blood*. It consists of blood-serum plus the red and white corpuscles, and as far as appearances go it resembles exactly normal blood; it has lost, however, the power of clotting. A more complete definition of these terms will be given after the subject of coagulation has been treated.

**Reaction of the Blood.**—When the blood is tested with litmus paper it gives a distinct alkaline reaction, and if titrated with a weak acid a considerable amount of the acid may be added before the reaction, as tested by litmus, becomes neutral. On account of these facts it was formerly believed that the liquid of the blood, the blood-plasma, is markedly alkaline, owing to the presence in it of sodium carbonate. It is now realized that this view was founded on a wrong conception of the cause of changes in reaction. A liquid is acid when the hydrogen ions ( $\text{H}^+$ ) in solution are in excess of the hydroxyl ions ( $\text{OH}^-$ ) and it is alkaline when the hydroxyl ions are in excess. Complete neutrality is obtained when the concentration in hydrogen ions is equal to that of the hydroxyl ions. Acids are defined as compounds which, in aqueous solution, undergo dissociation more or less completely with the formation of hydrogen ions.  $\text{HCl}$  dissociates, for example, into  $\text{H}^+$  and  $\text{Cl}^-$ , and the strength of the acid is proportional to the number of hydrogen ions present in the solution. Alkalies, on the other hand, are compounds which on dissociation yield hydroxyl ions either directly or indirectly.  $\text{NaOH}$  on dissociation yields  $\text{Na}^+$  and  $\text{OH}^-$ . Sodium carbonate also gives an alkaline solution, owing to a secondary reaction.  $\text{Na}_2\text{CO}_3$  dissociates into  $\text{Na}^+$ ,  $\text{Na}^+$ , and  $\text{CO}_3^{2-}$ , but the acid ion  $\text{CO}_3^{2-}$  then reacts with water to form

$\text{HCO}_3$  and  $\text{OH}$ . In accordance with these facts, it is evident that to determine whether the blood is neutral, acid, or alkaline it is necessary to ascertain its concentration in hydrogen and hydroxyl ions. As a matter of fact, it is sufficient to determine the concentration in either hydrogen or hydroxyl ions since the product of the two forms a constant:

$$\text{H} \times \text{OH} = \text{Constant.}$$

For technical reasons it has proved to be more convenient to determine the concentration in hydrogen ions, and the reaction of the blood is usually expressed in terms of the hydrogen-ion concentration. Two methods are employed in making these determinations.\* One, the electrical method, makes use of platinum electrodes covered with hydrogen gas, and measures the difference in electric potential between this electrode and the blood, and the other is the method of selected indicators. A series of indicators may be selected which undergo a change in color at certain concentrations of hydrogen ions, and under suitable precautions the color change given to these indicators by the blood may be interpreted in terms of the hydrogen-ion concentration. In the first determinations of the reaction of the blood made by the electrical method slightly erroneous figures were obtained, owing to the fact that precautions were not taken to examine the blood under its normal carbon-dioxid tension. In the body the blood is surrounded by a medium containing carbon dioxid under a certain pressure, for venous blood about 5 per cent. of an atmosphere, or 40 mm. The carbon dioxid gives the blood an acid reaction, hence if the blood is taken out of the body and exposed to an atmosphere practically free from  $\text{CO}_2$ , it will tend to give off some of this gas and take on a slightly more alkaline reaction. In making the most accurate determinations of the normal reaction of the blood it is necessary, therefore, to examine it at the temperature of the body, and in an atmosphere containing as much  $\text{CO}_2$  as is present normally in the tissues of the body. The results of the measurements of the reaction of the blood made with these precautions are as follows: In a neutral liquid, pure water for example, the hydrogen-ion concentration is equal to  $1 \times 10^{-7}$  (normal), or 0.0000001 gm. hydrogen per liter. Blood under the normal conditions in the body has a hydrogen-ion concentration, varying from  $0.35 \times 10^{-7}$  to  $0.49 \times 10^{-7}$ , that is, from 0.000000035 to 0.000000049. It is evident, therefore, that the blood possesses a hydrogen-ion concentration less than that of a neutral liquid, and it is therefore slightly alkaline, the arterial

\* See Henderson, "American Journal of Physiology," 21, 427, 1908; also "Science," March 14, 1913. Consult also Hasselbach, "Biochemische Zeitschrift," 30, 317, 1911, and Michaelis and Davidoff, *ibid.*, 46, 131, 1912.

blood being a trifle more alkaline than the venous blood owing to the fact that the latter contains more  $\text{CO}_2$ . It is becoming customary in physiological and medical literature to express the hydrogen-ion concentration of the body liquids under normal and pathological conditions in terms of the logarithms of the figures giving the concentration, an expression which is known as the *hydrogen exponent*, and is indicated by the symbol pH. These logarithms are all negative, but the minus sign is omitted (see p. 844). In this nomenclature the reaction of a neutral liquid is expressed by the exponent 7. The reaction of blood for the limits indicated above:

$$\text{Concentration } 0.35 \times 10^{-7} = 7.45$$

$$\text{Concentration } 0.49 \times 10^{-7} = 7.31$$

or the higher the exponent the greater the alkalinity of the blood. Determinations of the reaction of the blood under normal and abnormal conditions show that its range of variation in reaction is very limited. Yet we know that in the metabolism of the body acids and bases are being formed constantly and given to the blood, and in our foods also we may ingest acids or alkalies, which are absorbed into the blood and which, it might be supposed, would change its reaction. Since the reaction remains remarkably constant, it is evident that regulatory mechanisms must be present to provide for the elimination or neutralization of an excess of either acid or alkali. A general regulation of this kind is provided in the activity of the lungs and the kidneys. The concentration of  $\text{CO}_2$  in the body is kept within certain normal limits by the reflex regulation of the respiratory movements. When the amount of  $\text{CO}_2$  tends to rise, as in muscular exercise, for example, the corresponding increase in the ventilation of the lungs provides a method of eliminating the excess. So also the kidneys furnish an abundant secretion by which any excess of acids or bases is prevented from accumulating in the blood. In addition to the regulatory methods of this kind it has been shown that the composition of the blood itself is such that considerable amounts of acids or alkalies may be added to it directly without altering distinctly its reaction. This peculiarity is due to the presence in the blood of salts of carbonic and phosphoric acid. We find in the blood a mixture of monosodium phosphate and disodium phosphate, sodium bicarbonate and carbonic acid, and it has been shown, by Henderson especially, that such a mixture is peculiarly adapted to preserve its neutrality within relatively wide limits when acids or alkalies are added to it. A mixture of this kind constitutes what is frequently called a buffer solution. Monosodium phosphate is weakly acid, the disodium phosphate is weakly alkaline, but a mixture of the two salts gives a neutral solution, and addition of acid causes no change in the neutral

reaction since it acts simply to change some of the disodium phosphate to monosodium phosphate.



The concentration of bicarbonate of sodium and carbonic acid in the blood is especially important in preserving the weak alkalinity characteristic of the blood. Addition of acid or alkali within limits does not alter the reaction, since the acid reacts with the bicarbonate and disodium phosphate, while the alkali reacts with the carbonic acid or, perhaps, is neutralized by combination with the proteins. This characteristic of the blood as a buffer solution together with the regulating action of the lungs upon the carbonic acid and of the kidney in secreting excess of fixed acids combine, therefore, to maintain a nearly constant reaction of the blood under widely varying conditions of metabolism in health and disease. In the older methods of determining the alkalinity of the blood it was customary to add a dilute acid until a neutral reaction was obtained with litmus. In this procedure the acid displaces the sodium from its combination with carbonic and phosphoric acid, and the amount of acid necessary for this purpose furnishes no indication of the real reaction of the blood; it determines simply the amount of base combined with these weak acids. This method of titrating the blood is still used to some extent, and the figures obtained give what is known as the "titration alkalinity" of the blood as distinguished from the true alkalinity, that is to say, the excess of hydroxyl over the hydrogen ions.

**Specific Gravity.**—The specific gravity of human blood in the adult male may vary from 1.041 to 1.067, the average being about 1.055. The most satisfactory method of determining this factor is, of course, to compare the weight of a known volume of blood with that of an equal volume of water, but for observations upon human beings such small quantities of blood must be used that recourse must be had usually to a more indirect method. Perhaps the simplest of the methods suggested is that devised by Hammerschlag.\* In this method a mixture is made of chloroform (sp. gr., 1.526) and benzol (sp. gr., 0.889). The mixture is made in such proportions as to have a specific gravity of about 1.055. A drop of blood from the finger is shaken into this mixture; if the drop sinks to the bottom it is evident that the specific gravity of the blood is higher than that of the mixture, and the reverse is true if the drop rises. By adding more of the chloroform or of the benzol, as the case may be, the specific gravity of the mixture may be quickly altered so as to be equal to that of the drop of blood, which will then float in the liquid without a distinct tendency to rise or fall. The specific gravity of the mixture, which is also that of the blood, is then determined by a

\* Hammerschlag, "Zeitschrift f. klin. Med.," 20, 444, 1892.

suitable hydrometer. By the use of such methods it has been found\* that the specific gravity varies with age and with sex; that it is diminished after eating and is increased after exercise; that it has a diurnal variation, falling gradually during the day and rising slowly during the night; and that it varies greatly in individuals, so that a specific gravity which is normal for one may be a sign of disease in another. The specific gravity of the corpuscles is slightly greater than that of the plasma. For this reason the corpuscles in shed blood, when its coagulation is prevented or retarded, tend to settle to the bottom of the containing utensil, leaving a more or less clear layer of supernatant plasma. Among themselves, also, the corpuscles differ slightly in specific gravity, the red corpuscles being heaviest.

**Red Corpuscles.**—The red corpuscles in man and in all the mammalia, with the exception of the camel and other members of the group *Camelidæ*, are biconcave circular discs or, according to some authors, bell-shaped corpuscles without nuclei; in the *Camelidæ* they have an elliptical form. Their average diameter in man is given as  $7.7 \mu$  ( $1 \mu = 0.001 \text{ mm.}$ ); their number, which is usually reckoned as so many in a cubic millimeter, varies greatly under different conditions of health and disease. The average number is given as 5,000,000 per c.mm. for males and 4,500,000 for females. The red color of the corpuscles is due to the presence in them of a pigment known as "hemoglobin." Owing to the minute size of the corpuscles, their color when seen singly under the microscope is a faint yellowish red, but when seen in mass they exhibit the well-known blood-red color, which varies from scarlet in arterial blood to purplish red in venous blood, this variation in color being dependent upon the amount of oxygen contained in the blood in combination with the hemoglobin. Speaking generally, the function of the red corpuscles is to carry oxygen from the lungs to the tissues. This function is entirely dependent upon the presence of hemoglobin, which has the power of combining easily with oxygen gas. The physiology of the red corpuscles, therefore, is largely contained in a description of the properties of hemoglobin.

*Condition of the Hemoglobin in the Corpuscle.*—The finer structure of the red corpuscle is not completely known. It is usually stated that the corpuscle is composed of two substances, stroma and hemoglobin, together with a certain amount of water and salts and also a certain amount of lecithin and cholesterin. The stroma is a delicate, extensible, colorless substance that gives shape to the corpuscles; it forms a meshwork or spongy mass in which the hemoglobin is deposited. This latter substance forms the chief constituent of the corpuscle, since it makes about 32 per cent. of the weight of the normal corpuscle, and when dry from 90 to 95 per cent. of the total solid material. According to another view the

\* See Jones, "Journal of Physiology," 12, 299, 1891.

corpuscles are vesicles with an external envelope or pellicle in which lecithin and cholesterin are found, while the hemoglobin is contained within.\* Whichever view may be correct, great interest attaches to the presence of the lecithin and cholesterin, whether these substances are found in an external membrane or in a stroma permeating the corpuscle. According to Pascucci the lecithin and cholesterin constitute as much as 30 per cent. of the dry weight of the stroma, that is, of the portion of the corpuscle left after removal of the hemoglobin. Such a large proportion of these two substances is not found elsewhere in the body except in the myelin sheath of the nerve fibers. It is believed that they play an important rôle in maintaining the integrity of the corpuscles and particularly in giving to the peripheral layer or membrane surrounding the corpuscles certain characteristic properties of permeability. Under normal conditions this external layer is easily permeable to water and to certain substances in solution, such as urea, alcohol, and ether, but it is said to be impermeable to the neutral salts; the concentration of sodium chloride, for example, is much greater in the plasma than in the red corpuscles. The condition in which the hemoglobin exists within the corpuscle is not fully understood. It is evidently not in solution, since the amount present is too great to be held in solution in the corpuscle, and, moreover, even a thin layer of corpuscles is far from being transparent. Nor is it deposited in the form of crystals. It is assumed, therefore, that it is present in an amorphous form. In various ways, however, the relations of the hemoglobin within the corpuscle may be disturbed; so that it escapes and enters into solution in the plasma. Blood in which this has happened suffers a change in color, becoming a dark crimson, and is, therefore, known as "laked blood." Laked blood in thin layers is quite transparent compared with the normal blood with its opaque corpuscles.

**Hemolysis.**—The act of discharging the hemoglobin from the corpuscles so that it becomes dissolved in the plasma is designated as hemolysis, and substances that cause this action are spoken of as hemolytic agents. A number of such agents are known; but, although the results of their action are the same, so far as the hemoglobin is concerned, the way in which they bring about this result must vary greatly. Some of the known methods of producing hemolysis, or rendering the blood "laky," are as follows: (1) By the addition of water to the blood or by diminishing in any way the concentration or osmotic pressure of the plasma. (2) By adding ether or chloroform. (3) By the addition of soaps or of the higher fatty acids, especially the unsaturated acids. (4) By

\* For recent discussions upon the histological structure of the corpuscles see Weidenreich, "Anatom. Anzeiger," 1905, xxvii., and Schilling-Torgau, "Folia Haematologica," Pt I, 1912, 14, 95.

adding bile or solutions of the bile-salts. (5) By adding amyloalcohol. (6) By adding the serum from the blood of certain animals. (7) By adding saponin or sapotoxin. (8) By the addition of an excess of alkali. (9) By various toxins found in snake venom or in the serum of other animals or among the products of bacterial activity (natural hemolysins), or by similar organic substances produced within the body by the process of immunizing. Some of these hemolytic agents, such as ether, bile salts, and soaps, probably effect their action by their power of uniting with the lipid elements (lecithin, cholesterin) in the stroma of the corpuscles. The framework of the corpuscles is thus altered so that the hemoglobin is set free. The action of the hemolysins and of agents which lower the osmotic pressure of the plasma demands a more detailed description, as processes of great practical importance are involved in these changes.

*Hemolysis Caused by Lowering the Osmotic Pressure of the Plasma.*

—The blood corpuscles contain a certain amount of water (57 to 64 per cent.), an amount insufficient to discharge the hemoglobin. We may imagine that the osmotic pressure within the corpuscle is such, compared with the osmotic pressure exerted by the salts in the plasma, that a water equilibrium is established, and that, although water molecules diffuse into and out of the corpuscle, the exchange is equal in the two directions. If, however, the outside plasma is diluted by the addition of water to any considerable extent, then the osmotic pressure outside the corpuscles is correspondingly reduced, while that within the corpuscles is unchanged. Consequently an increased amount of water will pass into the corpuscles, sufficient, in fact, to rupture the corpuscles and thus discharge the hemoglobin. It is evident, therefore, that in injecting liquids into the circulation or in diluting blood outside the body care must be taken not to use solutions whose osmotic pressure is markedly less than that of blood-plasma, otherwise many of the red corpuscles may be destroyed. Solutions whose osmotic pressure is the same as that of the plasma are said to be isosmotic or isotonic with the blood, those whose pressure is lower are designated as hypotonic, and those whose pressure is higher as hypertonic.\* The salt that is contained in the plasma in largest amounts is sodium chlorid. In mammalian serum it exists to an amount equal to 0.56 per cent. and is probably responsible for the greater part (60 per cent.) of the osmotic pressure shown by this liquid. In making isotonic solutions this salt is, therefore, generally employed. A solution containing nine-tenths of 1 per cent. of sodium chlorid (NaCl, 0.9 per cent.) gives the same osmotic

\* For a full consideration of osmotic pressure in its relations to physiological processes, see Hamburger, "Osmotischer Druck und Ionenlehre," Wiesbaden, 1902.



pressure as plasma as determined by the effect of each on the lowering of the freezing-point (see Appendix, Diffusion, Osmosis, and Osmotic Pressure). Such a solution mixed with blood should not and does not alter the water contents of the corpuscles. One may, in fact, use a 0.7 per cent. solution of sodium chlorid without causing any noticeable hemolysis, and this strength of solution is frequently employed in infusions and experimental work; it constitutes what is known in the laboratories as normal saline or physiological saline. If, however, one uses a lower concentration, some of the corpuscles are hemolyzed, and the number of corpuscles destroyed and the rapidity of the hemolysis increase rapidly with the lowering of the osmotic pressure.\* While a 0.9 per cent. solution of sodium chlorid suffices in most cases for infusions and for diluting blood, it does not entirely replace the normal plasma or serum, since these liquids, in addition to the sodium salts, contain salts of calcium, potassium, magnesium, etc., each of which has doubtless a certain specific importance. In diluting blood outside the body, when the dilution is large, better results are obtained by using what is known as Ringer's mixture, which consists of the physiological saline solution plus small amounts of potassium and calcium chlorid. One formula for Ringer's solution is:

Sodium chlorid . . . . .	0.9	per cent.
Calcium chlorid . . . . .	0.026	" "
Potassium chlorid . . . . .	0.03	" "

*Hemolysis Caused by the Action of Hemolysins.*—It has long been known that the serum of one animal may destroy the red corpuscles of another animal. Thus, rabbits' blood corpuscles added to the clear serum of a dog, cat, or man are quickly destroyed, with the liberation of their hemoglobin. This action was formerly described under the term "globulicidal action of serum," and was compared to the similar destructive (bactericidal) action, exhibited by serum toward some bacteria. In more recent literature the term hemolysis has replaced that of "globulicidal action," and the hemolytic effect that a serum may exert upon foreign corpuscles is attributed to the presence in it of certain substances which in general are classed as hemolysins. This hemolytic action is not due to a simple difference in osmotic pressure. The serums of the different mammalia have all approximately the same osmotic pressure; the differences are too slight to explain the effects observed. Moreover, if the

\* According to Brachmachari ("Studies in Hemolysis," Calcutta, 1913) the red corpuscles in human blood begin to hemolyze in  $\frac{n}{20}$  solutions of sodium chlorid, and the hemolysis increases rapidly between this concentration and  $\frac{n}{30}$  solutions. Some corpuscles, however, retain hemoglobin even when the blood is diluted with nine times its volume of distilled water.

serum used is heated to 55° C. its hemolytic action is destroyed, although no noticeable change occurs in the osmotic pressure. In addition to the hemolysins found normally in the blood of different animals it was shown first by Bordet \* that they may be produced artificially. The serum of guinea pigs has little or no effect normally on the red corpuscles of rabbits' blood. If, however, one injects some rabbits' blood beneath the skin of a guinea-pig and, if necessary, repeats the process it will be found that the blood of this particular guinea pig has now a strong hemolytic action toward the red corpuscles of rabbits. This method of producing specific hemolysins by means of subcutaneous or intraperitoneal injections of foreign red corpuscles is designated as a process of immunizing, and the serum of the animal in which a specific hemolysin has been thus produced is frequently called, for convenience, an immune serum. These terms are employed on account of the essential similarity of the processes involved to those underlying the development of immunity toward special diseases. When the body is invaded by pathogenic bacteria the toxic substances produced by these organisms stimulate the tissues to form specific antitoxins which are capable of neutralizing the action of the bacterial toxins. The body is thus rendered immune toward special bacteria, and that the blood of the immunized animal actually contains a definite antitoxin may be shown in some cases by the fact that when injected into another individual the latter also acquires the specific immunity. So in regard to the hemolysins. The presence of the foreign red corpuscles causes the development of a specific antibody capable of destroying the special form of red corpuscle injected. The substance in the red corpuscles which stimulates the tissue to form an antibody is designated in general, according to the nomenclature of the day, as an antigen. Experiments indicate that the antigen in the red corpuscles is not the hemoglobin, but rather some constituent of the stroma. This interesting reaction may be obtained with other cells than the red corpuscles and bacteria. By injecting spermatozoa, an antibody may be produced in the blood which destroys this particular form of cell, and the same fact holds good for epithelial cells, etc. Moreover, solutions of foreign proteins injected in the same way give rise to the formation of definite antibodies capable of coagulating or precipitating the special proteins used. In this last case the antisubstance is designated as a precipitin on account of its precipitating effect on the solution of protein (see Appendix, p. 1011). This wonderful protective adaptation of the body toward the invasion of foreign cells or proteins is at bottom doubtless a chemical reaction dependent upon the properties of the living cells, but the nature of the processes involved is not at all understood, and the phenomenon is,

\* Bordet, "Annales de l'Inst. Pasteur." 1895.

therefore, designated provisionally as a biological reaction. The specific hemolysins produced by immunization have been studied by Bordet, Ehrlich, and others.\* It has been shown that they are in reality composed of two substances whose combined action is necessary for the hemolysis. There is, first, a new and specific substance that is produced by the body as a consequence of the injection of the foreign blood corpuscles. This substance has been given different names, but is known most frequently (Ehrlich) as the *immune body* (or *amboceptor*). It is not destroyed by moderate heating. The immune body is enabled to act upon the corpuscles by the co-operation of certain substances which are normally present in the serum and are therefore not produced by the process of immunization. These substances are known usually as complements, and it is they that are destroyed by heating to 55° C. If the immune serum of a guinea pig is heated to 55° C. its hemolytic action upon rabbits' corpuscles is destroyed. The action may be restored, however, by adding a little of the rabbit's own serum, since in terms of the above hypothesis the complements are present in normal serum. That is to say, an experiment of the following kind may be performed. Washed blood corpuscles of a rabbit plus immune serum from a guinea pig show hemolysis. Washed blood corpuscles of a rabbit plus immune serum which has been made inactive by heating show no hemolysis. Addition of normal rabbits' serum to this latter mixture again activates the immune serum and causes hemolysis. The rabbits' serum in this case supplies the needed complement.

These facts, it should be stated, are interpreted somewhat differently by Bordet.† The immune substance he designates as a "*substance sensibilatrice*" and the complement as *alexin*. The latter forms the protective substance of the blood, but is unable to act upon the foreign cells until these latter have been changed in some way, that is, sensitized by the specific immune substance developed during the process of immunizing.

In the case of some of the natural hemolysins referred to above it has also been shown that the solution of the corpuscles depends upon the combined action of two substances. This point has been made clear particularly in regard to the snake-poisons, such as cobra venom. In these venoms there is present a substance analogous to the immune body or amboceptor, but in order for it to affect the red corpuscles it must be activated by a complement of some sort, present in the plasma or the red corpuscle itself. Kyes‡ has given some interesting facts to prove that lecithin is an effective complement for these venoms,

\* See Wassermann, "Immune Sera, Hemolysins, Cytotoxins, and Precipitins," translated by Bolduan, New York, 1904. Ehrlich "Collected Studies on Immunity," translated by Bolduan, New York, 1906. Simon, "Infection and Immunity," Philadelphia, 1912.

† Bordet, "Studies in Immunity," translated by Gay, New York, 1909.

‡ Kyes, "Berl. klin. Wochenschrift," 1902 and 1903.

and that probably it is this definite substance which is furnished by the blood in activating the venom toxin.

Speaking in general terms, the serum of any animal is more or less hemolytic in relation to the blood-corpuscles of an animal of another species; but great differences are shown in this respect. The blood-serum of the horse shows but little hemolytic action upon the red corpuscles of the rabbit when compared with the effect of the serum of the dog or cat. Eels' serum has a remarkably strong hemolytic action upon the red corpuscles of most mammals; a very minute quantity of this serum (0.04 c.c.) injected into the veins of a rabbit will cause hemolysis of the corpuscles and, as a consequence, the appearance of bloody urine (hemoglobinuria). It should be added that this curious toxic or lytic effect of foreign serums is not confined to the red corpuscles. They contain cytotoxins that affect also other tissue elements, especially those of the central nervous system, and may therefore cause death. As little as 0.04 c.c. of eels' serum injected into a small rabbit will cause the death of the animal, the fatal effect being due apparently to an action on the vasomotor and respiratory centers in the medulla. The hemolytic and generally toxic effect of foreign sera has been known for a long time. It was discovered practically in the numerous attempts made in former years to transfuse the blood of one animal into the veins of another. It has been found that this process of transfusion as a means of combatting severe hemorrhage is dangerous unless the blood is taken from an animal of the same or a nearly related species.

**Nature and Amount of Hemoglobin.**—Hemoglobin is a very complex substance belonging to the group of conjugated proteins. Under the influence of heat, acids, alkalis, etc., it may be broken up, with the formation of a simple protein, globin, belonging to the group of histons (see appendix) and a pigment, hematin. The globin forms, according to different estimates, from 86 to 94 per cent. of the molecule, and the hematin about 4 per cent. Other substances of an undetermined character result from the decomposition.\* When the decomposition takes place in the absence of oxygen, the products formed are globin and hemochromogen, instead of globin and hematin. Hemochromogen in the presence of oxygen quickly undergoes oxidation to the more stable hematin. Hoppe-Seyler has shown that hemochromogen possesses the chemical grouping which gives to hemoglobin its power of combining readily with oxygen and its distinctive absorption spectrum. On the basis of facts such as these, hemoglobin may be defined as a compound of a protein body with hematin. It seems, then, that, although the hemochromogen or hematin portion is the essential constituent, giving to the

\* Schulz, "Zeitschrift f. physiologische Chemie," 24; also Lauraw, *ibid.*, 26.

molecule of hemoglobin its valuable physiological properties as a respiratory pigment, yet in the blood corpuscles this substance is incorporated into the much larger and more unstable molecule of hemoglobin, whose behavior toward oxygen is different from that of the hematin itself, the difference lying mainly in the fact that the hemoglobin as it exists in the corpuscles forms with oxygen a comparatively feeble combination that may be broken up readily with liberation of the gas.

Hemoglobin is widely distributed throughout the animal kingdom, being found in the blood corpuscles of mammalia, birds, reptiles, amphibia, and fishes, and in the blood or blood corpuscles of many of the invertebrates. The composition of its molecule is found to vary somewhat in different animals; so that, strictly speaking, there are probably a number of different forms of hemoglobin—all, however, closely related in chemical and physiological properties. Elementary analysis of dogs' hemoglobin shows the following percentage composition (Jaquet): C, 53.91; H, 6.62; N, 15.98; S, 0.542; Fe, 0.333; O, 22.62. Its molecular formula is given as  $C_{758}H_{1203}N_{195}S_3FeO_{218}$ , which would make the molecular weight 16,669. Other estimates are given of the molecular formula, but they agree at least in showing that the molecule is of enormous size. The hematin that is split off from the hemoglobin is a pigment whose constitution is relatively simple, as is indicated by its percentage formula,  $C_{34}H_{34}N_4FeO_5$  (Küster). It contains all of the iron of the original hemoglobin molecule. Gamgee has called attention to two facts which seem to indicate that the globin and hematin do not exist as such in the hemoglobin molecule. Thus, hematin is magnetic,—that is, is attracted by a magnet,—while hemoglobin, on the contrary, is diamagnetic. Globin alone rotates the plane of polarized light to the left, levorotatory, while hemoglobin solutions are dextrorotatory. The exact amount of hemoglobin in human blood varies naturally with the individual and with different conditions of life. According to Preyer,\* the average amount for the adult male is 14 grams of hemoglobin to each 100 grams of blood. It is estimated that in the blood of a man weighing 68 kilograms there are contained about 500 to 700 grams of hemoglobin, which is distributed among some 25,000,000,000,000 of corpuscles, giving a total superficial area of about 3200 square meters. Practically all of this large surface of hemoglobin is available for the absorption of oxygen from the air in the lungs, for, owing to the great number and the minute size of the capillaries, the blood, in passing through a capillary area, becomes subdivided to such an extent that the red corpuscles stream through the capillaries, one may say, in single file. In circulating through the lungs, therefore, each corpuscle becomes

\* "Die Blutkrystalle," Jena, 1871.

exposed more or less completely to the action of the air, and the utilization of the entire quantity of hemoglobin must be nearly perfect. Instruments known as hemometers or hemoglobinometers have been devised for clinical use in determining the amount of hemoglobin in the blood of patients. A number of different forms of this instrument are in use. In all of them, however, the determination is made with a drop or two of blood, such as can be obtained without difficulty by pricking the skin. The amount of hemoglobin in the withdrawn blood is determined usually by a colorimetric method,—that is, its color, which is due to the hemoglobin, is compared with a series of standard solutions containing known amounts of hemoglobin, or with a wedge of colored glass whose color value in terms of hemoglobin has been determined beforehand. For details of the structure of the several instruments employed and the precautions to be observed in their use reference must be made to the laboratory guides.\*

**Compounds with Oxygen and Other Gases.**—Hemoglobin has the property of uniting with oxygen gas in certain definite proportions, forming a true chemical compound. This compound is known as *oxyhemoglobin*; it is formed whenever blood or hemoglobin solutions are exposed to air or are otherwise brought into contact with oxygen. According to a determination by Hüfner,† one gram of hemoglobin combines with 1.36 c.c. of oxygen. These figures would indicate the probability that each molecule of hemoglobin unites with a molecule of oxygen, since 1.36 c.c. of oxygen weighs approximately 0.0019 + gram, and the ratio of 1 gram of hemoglobin to 0.0019 gram of oxygen is that of the molecular weight of hemoglobin to the molecular weight of oxygen, that is, 16669:32 :: 1:0.0019. It should be stated that some observers‡ find that the maximum oxygen capacity of the blood may show individual variations within narrow limits, and that, therefore, what we designate as hemoglobin may not be a single chemical substance, but a mixture of closely related compounds. Oxyhemoglobin is not a very firm compound. If placed in an atmosphere containing no oxygen it is dissociated, giving off free oxygen and leaving behind hemoglobin or, as it is often called by way of distinction, "*reduced hemoglobin*." This power of combining with oxygen to form a loose chemical compound, which in turn can be dissociated easily when the oxygen pressure is lowered, makes possible the function of hemoglobin in the blood as the carrier of oxygen from the lungs to the tissues. The details of this process are described in the section on Respiration. Hemoglobin forms with carbon monoxid gas (CO) a compound, similar to oxyhemoglobin, which is known

\* See Simon, "A Manual of Clinical Diagnosis," Philadelphia.

† "Archiv. f. Physiologie," 1894, p. 130.

‡ See Bohr, in Nagel's "Handbuch der Physiologie," vol. i, pt. 1., 1905.

as *carbon monoxid hemoglobin*. In this compound also the union takes place in the proportion of one molecule of hemoglobin to one molecule of the gas. The compound formed differs, however, from oxyhemoglobin in being much more stable, and it is for this reason that the breathing of carbon monoxid gas is liable to prove fatal. The CO unites with the hemoglobin, forming a firm compound; the tissues of the body are thereby prevented from obtaining their necessary oxygen, and death results from suffocation or asphyxia. Carbon monoxid forms one of the constituents of coal-gas. The well-known fatal effect of breathing coal-gas for some time, as in the case of individuals sleeping in a room in which gas is escaping, is traceable directly to the carbon monoxid. Nitric oxid (NO) forms also with hemoglobin a definite compound that is even more stable than the CO hemoglobin; if, therefore, this gas were brought into contact with the blood, it would cause death in the same way as the CO.

Oxyhemoglobin, carbon monoxid hemoglobin, and nitric oxid hemoglobin are similar compounds. Each is formed, apparently, by a definite combination of the gas with the hematic portion of the hemoglobin molecule, and a given weight of hemoglobin unites presumably with an equal volume of each gas. In marked contrast to these facts, Bohr\* has shown that hemoglobin forms a compound with carbon dioxid gas, *carbohemoglobin*, in which the quantitative relationship of the gas to the hemoglobin differs from that shown by oxygen. In a mixture of O and CO<sub>2</sub> the latter gas is absorbed by hemoglobin solutions independently of the oxygen, so that a solution of hemoglobin nearly saturated with oxygen will take up CO<sub>2</sub> as though it held no oxygen in combination. Bohr suggests, therefore, that the O and the CO<sub>2</sub> must unite with different portions of the hemoglobin—the oxygen with the pigment portion and the CO<sub>2</sub> possibly with the protein portion. Although the amount of CO<sub>2</sub> taken up by the hemoglobin is not influenced by the amount of O already in combination, the reverse relationship does not hold in all cases. It is found that the presence of the CO<sub>2</sub> loosens, as it were, the combination between the hemoglobin and the oxygen so that the oxyhemoglobin dissociates more readily than would otherwise be the case. This is observed at least when the oxygen is under a low pressure, such as occurs, for instance, in the capillaries of the tissues. The importance of this fact in regard to the oxygen supply to the tissues is referred to more explicitly in the section on Respiration.

**Presence of Iron in the Molecule.**—It is probable that iron is quite generally present in the animal tissues in connection with nuclein compounds, but its existence in hemoglobin is noteworthy because it has long been known, and because the important property of combining with oxygen seems to be connected with the presence

\* "Skandinavisches Archiv f. Physiologie," 3, 47, 1892, and 16, 402, 1904.

of this element. According to recent analyses, the proportion of iron in hemoglobin is constant, lying between 0.33 and 0.34 per cent.\* The amount of hemoglobin in blood may be determined, therefore, by making a quantitative determination of the iron. The amount of oxygen with which hemoglobin will combine may be expressed by saying that one molecule of oxygen will be fixed for each atom of iron in the hemoglobin molecule. In the decomposition of hemoglobin into globin and hematin, which has been spoken of above, the iron is retained in the hematin.

**Crystals.**—Hemoglobin may be obtained readily in the form of crystals (Fig. 181). As usually prepared, these crystals are really

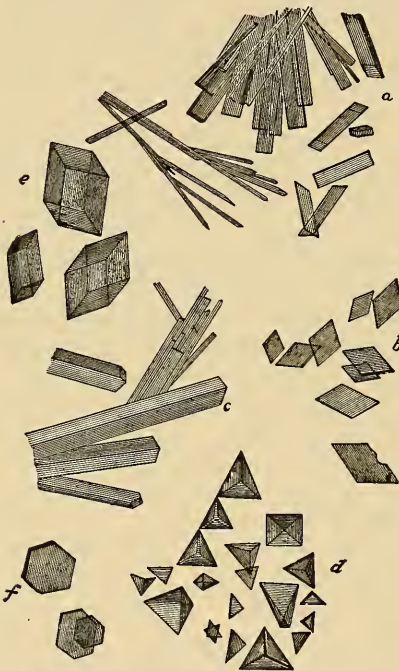

Fig. 181.—Crystallized hemoglobin (after *Frey*): *a, b*, Crystals from venous blood of man; *c*, from the blood of a cat; *d*, from the blood of a guinea pig; *e*, from the blood of a hamster; *f*, from the blood of a squirrel.

oxyhemoglobin, but it has been shown that reduced hemoglobin also crystallizes, although with more difficulty. Hemoglobin from the blood of different animals varies to a marked degree in respect to the power of crystallization and the form of the crystals, but in the various species of any one genus the crystals belong to one crystallographic group. From the blood of the rat, dog, cat, guinea-pig, and horse crystals are readily obtained, while hemoglobin from the blood of man and of most of the vertebrates crystallizes much less easily. Methods for preparing and purifying these crystals will be found in works on physiological chemistry. To obtain specimens quickly for examination under the microscope, one of the most certain

methods is to take some blood from one of the animals whose hemoglobin crystallizes easily, place it in a test-tube, add to it a few drops of ether, shake the tube thoroughly until the blood becomes laky,—that is, until the hemoglobin is discharged into the plasma,—and then place the tube on ice until the crystals are deposited. Small portions of the crystalline sediment may then be removed to a glass

\* Butterfield, "Zeit. f. physiol. Chemie," 62, 173, 1909.



slide for examination. According to Reichert, the deposition of the crystals is hastened by adding ammonium oxalate to the blood in quantities sufficient to make from 1 to 5 per cent. of the mixture. In man and in most of the mammalia hemoglobin is deposited in the form of rhombic prisms; in the guinea-pig it crystallizes in tetrahedra (*d*, Fig. 181); in the rat in the form of elongated six-sided plates, and in the squirrel in hexagonal plates. In an elaborate and careful study of the crystallographic characters of hemoglobin from a large number of animals Reichert and Brown\* have shown that differences exist between the crystals of various species of such a character that they may be used to determine whether or not animals belong to the same genus. This difference in crystalline form implies some difference in molecular structure, and taken together with other known variations in property shown by hemoglobin from different animals leads us to believe that the huge molecule has a labile structure, and that it may differ somewhat in its molecular composition or atomic arrangement without losing its physiological property of an oxygen-carrier. In this connection it is interesting to state that the hemoglobin of horses' blood, which crystallizes ordinarily in large rhombic prisms, may be made to give hexagonal crystals by allowing it to undergo putrefaction, and that the form of the crystals may then be changed from hexagons to rhombs by varying the temperature of the solutions.† The crystals are readily soluble in water, and by repeated crystallization the hemoglobin may be obtained perfectly pure. As in the case of other soluble protein-like bodies, solutions of hemoglobin are precipitated by alcohol, by mineral acids, by salts of the heavy metals, by boiling, etc. Notwithstanding the fact that hemoglobin crystallizes so readily, it is not easily dialyzable, behaving in this respect like non-crystallizable colloidal bodies. The compounds which hemoglobin forms with carbon monoxid (CO) and nitric oxid (NO) are also crystallizable, the crystals being isomorphous with those of oxyhemoglobin.

**Absorption Spectra.**—Solutions of hemoglobin and its derivative compounds, when examined with a spectroscope, give distinctive absorption bands.

Light, when made to pass through a glass prism, is broken up into its constituent rays, giving the play of rainbow colors known as the *spectrum*. A spectroscope is an apparatus for producing and observing a spectrum. A simple form, which illustrates sufficiently well the construction of the apparatus, is shown in Fig. 182, *P* being the glass prism giving the spectrum. Light falls upon this prism through the tube (*A*) to the left, known as the "collimator tube." A slit at the end of this tube (*S*) admits a narrow slice of light—lamplight or sunlight—which then, by means of a convex lens at the other end of the tube, is made to fall upon the prism (*P*) with its rays parallel. In

\* Reichert and Brown, "The Crystallography of Hemoglobins," Carnegie Institution of Washington, No. 116, 1909.

† Uhlik, "Archiv f. d. gesammte Physiologie," 104, 64, 1904.

passing through the prism the rays are dispersed by unequal refraction, giving a spectrum. The spectrum thus produced is examined by the observer with the aid of the telescope (*B*). When the telescope is properly focused for the rays entering it from the prism (*P*), a clear picture of the spectrum is seen. The length of the spectrum will depend upon the nature and the number of the prisms through which the light is made to pass. For ordinary purposes a short spectrum is preferable for hemoglobin bands, and a spectroscope with one prism is generally used. If the source of light is a lamp flame of some kind,

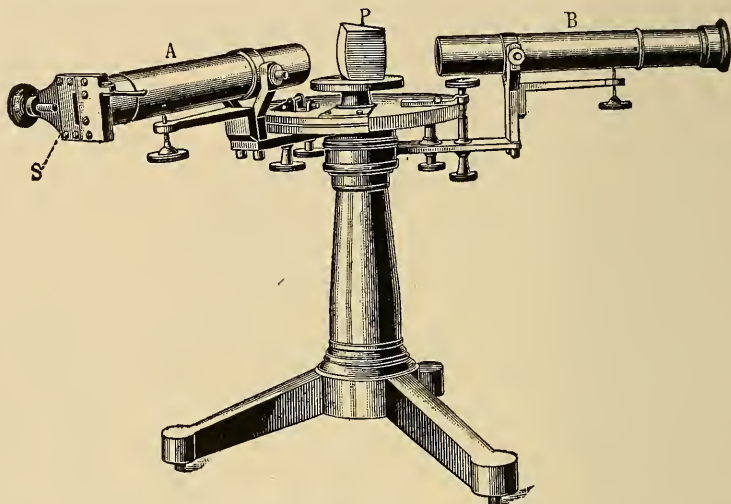

Fig. 182.—Spectroscope: *P*, The glass prism; *A*, the collimator tube, showing the slit, *S*, through which the light is admitted; *B*, the telescope for observing the spectrum.

the spectrum is continuous, the colors gradually merging one into another from red to violet. If sunlight is used, the spectrum will be crossed by a number of narrow dark lines known as the "Fraunhofer lines." The position of these lines in the solar spectrum is fixed, and the more distinct ones are designated by letters of the alphabet, *A*, *B*, *C*, *D*, *E*, etc., as shown in the charts below. If while using solar light or an artificial light a solution of any substance which gives absorption bands is so placed in front of the slit that the light is obliged to traverse it, the spectrum as observed through the telescope will show one or more narrow or broad black bands that are characteristic of the substance used and constitute its absorption spectrum. The positions of these bands may be designated by describing their relations to the Fraunhofer lines, or more directly by stating the wave lengths of the portions of the spectrum between which absorption takes place. Some spectroscopes are provided with a scale of wave lengths superposed on the spectrum, and when properly adjusted this scale enables one to read off directly the wave lengths of any part of the spectrum.

When very dilute solutions of oxyhemoglobin are examined with the spectroscope, two absorption bands appear, both occurring in the portion of the spectrum included between the Fraunhofer lines *D* and *E*. The band nearer the red end of the spectrum is known as the " $\alpha$ -band"; it is narrower, darker, and more clearly defined than the other, the " $\beta$ -band" (Fig. 183). The width and distinctness of the bands vary naturally with the concentration of the solution

used (see Fig. 184) or, if the concentration remains the same, with the width of the stratum of liquid through which the light passes. With a certain minimal percentage of oxyhemoglobin (less than 0.01 per cent.) the  $\beta$ -band is lost and the  $\alpha$ -band is very faint in layers 1 centimeter thick. With stronger solutions the bands become darker and wider and finally fuse, while some of the extreme red end and a great deal of the violet end of the spectrum are also absorbed. The variations in the absorption spectrum, with differences in concentration, are clearly shown in the accompanying illustration from Rollett \* (Fig. 184); the thickness of the layer of liquid is supposed to be one centimeter. The numbers on the right indicate the percentage strength of the oxyhemoglobin solutions. It will be noticed that the absorption which takes

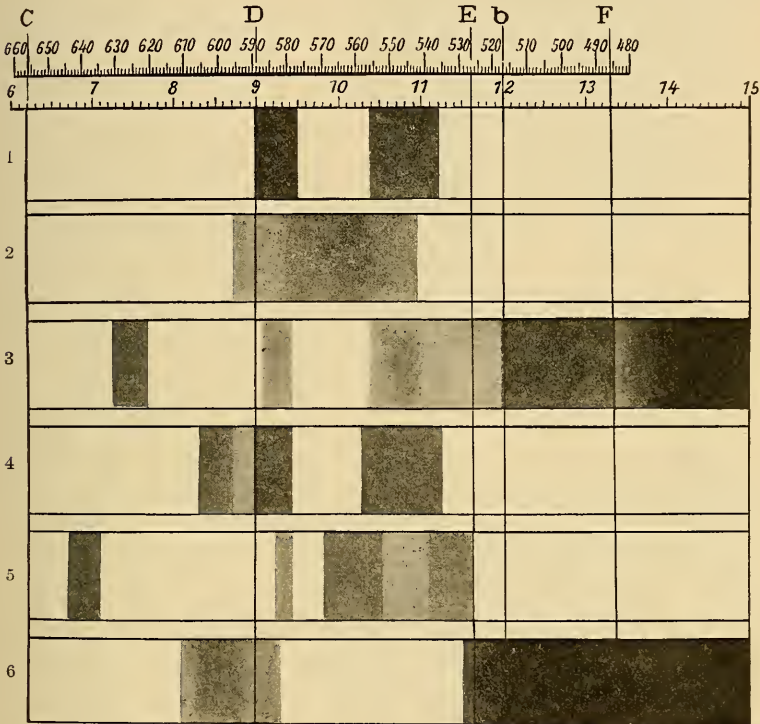

Fig. 183.—Table of absorption spectra (*Ziemke and Müller*): 1, Absorption spectrum of oxyhemoglobin, dilute solution; 2, absorption spectrum of reduced hemoglobin; 3, absorption spectrum of methemoglobin, neutral solution; 4, absorption spectrum of methemoglobin, alkaline solution; 5, absorption spectrum of hematin, acid solution; 6, absorption spectrum of hematin, alkaline solution.

place as the concentration of the solution increases affects the red-orange end of the spectrum last of all.

\* Hermann's "Handbuch der Physiologie," vol. iv., 1880.

Solutions of reduced hemoglobin examined with the spectroscopie show only one absorption band, known sometimes as the " $\gamma$ -band." This band lies also in the portion of the spectrum included between the lines *D* and *E*; its relations to these lines and the bands of oxyhemoglobin are shown in Fig. 183. The  $\gamma$ -band is much more diffuse than the oxyhemoglobin bands, and its limits, therefore, especially in weak solutions, are not well defined. The width and distinctness of this band vary also with the concentration of the solution. This variation is sufficiently well shown in the accompanying illustration (Fig. 185), which is a companion figure to the one given for oxyhemoglobin (Fig. 184). It will be noticed that

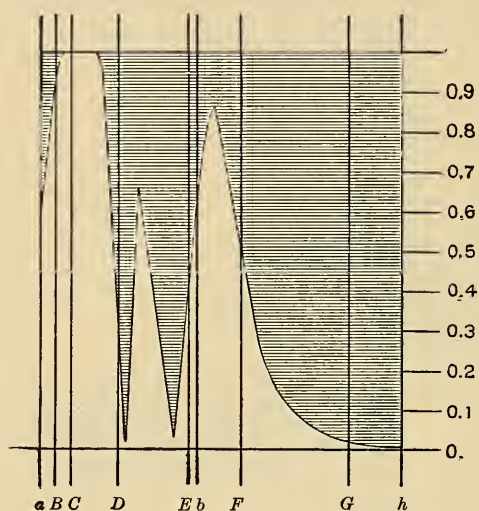

Fig. 184.—Diagram to show the variations in the absorption spectrum of oxyhemoglobin with varying concentrations of the solution.—(After Rollett.) The numbers to the right give the strength of the oxyhemoglobin solution in percentages; the letters give the positions of the Fraunhofer lines. To ascertain the amount of absorption for any given concentration up to 1 per cent., draw a horizontal line across the diagram at the level corresponding to the concentration. Where this line passes through the shaded part of the diagram absorption takes place, and the width of the absorption bands is seen at once. The diagram shows clearly that the amount of absorption increases as the solutions become more concentrated, especially the absorption of the blue end of the spectrum. It will be noticed that with concentrations between 0.6 and 0.7 per cent. the two bands between *D* and *E* fuse into one.

the last light to be absorbed in this case is partly in the red end and partly in the blue, thus explaining the purplish color of hemoglobin solutions and of venous blood. Oxyhemoglobin solutions can be converted to hemoglobin solutions, with a corresponding change in the spectrum bands, by placing the former in a vacuum or, more conveniently, by adding reducing solutions. The solutions most commonly used for this purpose are ammonium sulphid and Stokes's reagent.\* If a solution of reduced hemoglobin is shaken with air, it quickly changes to oxyhemoglobin and gives two bands instead of one when examined by the spectroscopie. Any given solution may be changed in this way from oxyhemoglobin to hemoglobin, and the reverse, a great number of

\* Stokes's reagent is an ammoniacal solution of a ferrous salt. It is made by dissolving 2 parts (by weight) of ferrous sulphate, adding 3 parts of tartaric acid, and then ammonia to distinct alkaline reaction. A permanent precipitate should not be obtained.

times, thus demonstrating the facility with which hemoglobin takes up and surrenders oxygen.

Solutions of carbon monoxid hemoglobin also give a spectrum with two absorption bands closely resembling in position and appearance those of oxyhemoglobin. They are distinguished from the oxyhemoglobin bands by being slightly nearer the blue end of the spectrum, as may be demonstrated by observing the wave lengths or, more conveniently, by superposing the two spectra. Moreover, solutions of carbon monoxid hemoglobin are not reduced to hemoglobin by adding Stokes's liquid, two bands being still seen after such treatment. A solution of carbon monoxid hemoglobin suitable for spectroscopic examination may be prepared easily by passing ordinary coal-gas through a dilute oxyhemoglobin solution for a few minutes and then filtering.

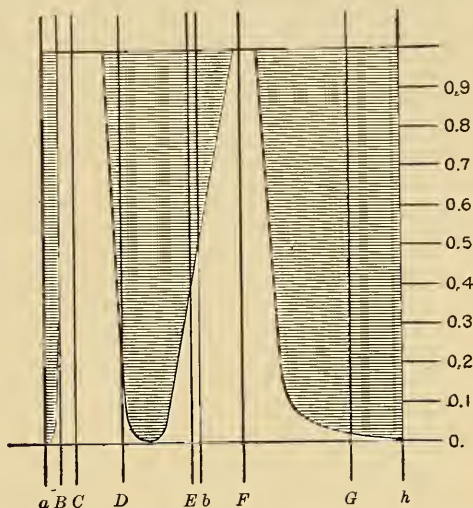

Fig. 185.—Diagram to show the variations in the absorption spectrum of reduced hemoglobin with varying concentrations of the solution (after *Rollett*). The numbers to the right give the strength of the hemoglobin solution in percentages; the letters give the positions of the Fraunhofer lines. For further directions as to the use of the diagram, see the description of Fig. 184.

**Derivative Compounds of Hemoglobin.**—There are a number of pigmentary bodies which are formed directly from hemoglobin by decompositions or chemical reactions of various kinds. Some of these derivative substances occur normally in the body. The best known are as follows\*:

*Methemoglobin.*—When blood or a solution of oxyhemoglobin is allowed to stand for a long time exposed to the air it undergoes a change in color, taking on a brownish tint. This change is due to the formation of methemoglobin, and it is said that to some extent the transition occurs very soon after the blood is exposed to the air, and that, therefore, determinations of the quantity of hemoglobin by the ordinary colorimetric methods should be made promptly to

\* For more detailed information concerning the chemistry and literature of these compounds, see Hammarsten, "Physiological Chemistry," translated by Mandel; Abderhalden, "Lehrbuch d. physiolog. Chemie," 1914.

avoid a deterioration in color value. Methemoglobin may be obtained rapidly by the action of various reagents on the blood, some of them oxidizing substances, such as permanganate of potash or ferricyanid of potash, some of them reducing substances. Indeed, it is known that the change may occur within the blood-vessels by the action of such bodies as the nitrites, antifebrin, acetanilid, etc. According to most observers, methemoglobin contains the same amount of oxygen as hemoglobin; it is combined differently, however, forming a more stable compound, which can not be dissociated by the action of a vacuum. On this account, therefore, methemoglobin is not capable of acting as a respiratory pigment, and to the extent that it is formed in the blood this tissue suffers a loss of its functional value as a carrier of oxygen. By the stronger action of reducing solutions—such as ammonium sulphid—the oxygen may be removed from the methemoglobin and reduced hemoglobin be obtained. Methemoglobin crystallizes in needles, and its solutions give an absorption spectrum which varies according as the solution is neutral or has an alkaline reaction. In neutral solutions the characteristic band is one in the orange, as indicated in Fig. 183. In alkaline solution the absorption spectrum has three bands, two of which are nearly identical with those of oxyhemoglobin.

*Hematin* ( $C_{33}H_{33}N_4FeO_5$ ) is obtained when hemoglobin is decomposed by the action of acids or alkalies in the presence of oxygen. It may occur in the feces if the diet contains hemoglobin or hematin, or in case of hemorrhage in the stomach or small intestine, since both the pancreatic and the gastric secretion break up hemoglobin, with the formation of hematin. It is an amorphous substance, of a dark-brown color, easily soluble in alkalies or in acid alcoholic solutions. These solutions give a characteristic absorption spectrum which is represented in Fig. 183. The chemical structure of hematin has not been established satisfactorily, but it is probable that the molecule contains four pyrrol groups:

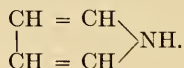

Two of the amino-acid derivatives of proteins, tryptophan and prolin (see p. 795), contain this same grouping, and it is possible, therefore, that these amino-acids may serve as material from which the body constructs its hematin.

*Hemin* ( $C_{33}H_{32}O_4N_4FeCl$ ) is a derivative of hematin, obtained by the action of hydrochloric acid or chlorids, in which an hydroxyl group is replaced by chlorin. The compound is obtained in the form of crystals, which under the microscope appear usually as small, rhombic plates of a dark-brown color. These crystals

may be obtained from small quantities of blood stains, etc., no matter how old, and they have been relied upon, therefore, as a sure and easy test for the existence of blood,—that is, hemoglobin. The test is one that has been much used in medicolegal cases, and may be carried out as follows: A bit of dried blood is powdered with a few crystals of NaCl. Some of the powder is placed upon a glass slide and covered with a cover-slip. By means of a pipette a drop or two of glacial acetic acid is run under the slip, and then by drawing the slide repeatedly through a flame the acid is evaporated to dryness, taking care not to heat the acid so high as to cause it to boil. After the evaporation of the acid water is run under the slip and the specimen is ready for examination with the microscope.

*Hemochromogen* is obtained when hemoglobin is decomposed by acids or alkalis in the absence of free oxygen. By oxidation it is converted to hematin. Hemochromogen is crystalline, and gives a characteristic absorption spectrum.

*Hematoporphyrin* ( $C_{33}H_{33}N_4O_6$ ) differs from the preceding derivatives of hemoglobin in that it contains no iron. It may be obtained from hematin by the action of strong acids, and is of much physiological interest because of its relationship to the bile pigments, which, like it, are iron-free derivatives of the hemoglobin. In old blood-clots or extravasations it has long been known that a colored crystalline product may be formed. This product was designated as hematoidin by Virchow and later was stated, on the one hand, to be identical with the bile pigment, bilirubin, and, on the other hand, to be isomeric with hematoporphyrin. It is also of interest to recall that the green coloring matter of the plants, chlorophyl, appears to contain pyrrol groupings, and some of its derivatives show close relationship to derivatives of the hematin.

*Histohematin*s.—This name is a general term that has been given to the coloring matter found in the tissues, so far as it has the property of taking up oxygen. The red coloring matter in some muscles is an example of such a compound and has been designated specifically as myohematin. According to most observers, myohematin is identical with hemoglobin,—that is, the muscle substance contains some hemoglobin,—and we may suppose that its presence in the tissue furnishes a further means for the transportation of oxygen to the muscle protoplasm.

*Bile Pigments and Urinary Pigments*.—These pigments are referred to in the description of the composition of bile and urine. In this connection the fact may be emphasized that each of them is supposed to be derived from hemoglobin, and each constitutes, so to speak, a form of excretion of hemoglobin.

**Origin and Fate of the Red Corpuscles**.—The mammalian red corpuscle is a cell that has lost its nucleus. It is not probable, therefore, that any given corpuscle lives for a great while in the circulation.

This is made more certain by the fact that hemoglobin is the mother substance from which the bile pigments are made, and, as these pigments are being excreted continually, it is fair to suppose that red corpuscles are as steadily undergoing disintegration in the blood-stream.

The number of red corpuscles destroyed daily in the body has never been determined with any accuracy, but it may be quite large, as would appear from the following approximate calculation based upon our incomplete knowledge of the amount of bile-pigment secreted daily. From observations made upon cases of biliary fistulas in man it is estimated that the daily flow of bile amounts to about 15 gms. per kilogram of body weight. If we assume in accordance with the figures given by some authors that the bile contains as much as 0.2 per cent. of pigment, then 1.95 gms. of pigment will be secreted per day ( $65 \times 15 \times .002$ ). This pigment is formed from approximately the same weight of hematin and for its formation would require the destruction of 48 gms. of hemoglobin, since hematin forms 4 per cent. of the molecule of hemoglobin ( $1.95 \div .04 = 48$ ). Abderhalden gives a much more moderate estimate on the assumption that the daily excretion of pigment in the bile amounts only to 0.5 gm. This amount of pigment would be obtained from 12.5 gms. of hemoglobin. In order to furnish even as much as 12.5 gms. of hemoglobin, it is evident that an enormous number of red corpuscles, approximately 450,000,000,000, would have to be destroyed daily.

Just when and how the corpuscles go to pieces is not definitely known. It has been suggested that their destruction takes place in the spleen or lymph-glands or in the liver. Certain large cells (macrophages) have been described in the spleen which, at times, contain red blood-corpuscles or fragments of them in their cytoplasm. In the bird and some other animals Kyes\* has been able to demonstrate that the so-called Kupffer cells of the liver actually ingest red corpuscles, and subsequently digest them so as to liberate the iron of the hemoglobin in a form that can be detected by microchemical reactions. These Kupffer cells are modified or specialized endothelial cells of the venous capillaries of the liver, and the cells in the spleen which have the same property seem to be of the same type. Kyes proposes for them the name *hemophags*. The large number of these cells present in the liver, and their action in destroying the red corpuscles and liberating the iron falls in with the known function of the liver in producing an iron-free bile-pigment from the hematin. Whether or not all red corpuscles meet their fate in this way cannot be determined at present. It would seem probable that some undergo hemolysis while in the blood-stream, but the facts given above are the most definite information obtained upon this interesting question. The continual destruction of red corpuscles implies, of course, a continual formation of new ones. It has been shown satisfactorily that in the adult the organ for the production of red corpuscles is the red marrow of bones. In this tissue *hematopoiesis*, as the process of formation of red corpuscles is termed, goes on continually, the process being much increased after hemorrhages and in certain

\* Kyes, "Internationalen Monatsschrift f. Anat. u. Physiol.," 31, 543, 1914.



pathological conditions. The details of the histological changes will be found in the text-books of histology. It is sufficient here to state simply that groups of nucleated, colorless cells, erythroblasts, are found in the red marrow. These cells multiply by karyokinesis and the daughter-cells eventually produce hemoglobin in their cytoplasm, thus forming nucleated red corpuscles. The nuclei are subsequently lost, either by disintegration or by extrusion, and the newly formed non-nucleated red corpuscles (erythrocytes) are forced into the blood-stream, owing to a gradual change in their position during development caused by the growing hematopoietic tissue. When the process is greatly accelerated, as after severe hemorrhages or in certain pathological conditions, red corpuscles still retaining their nuclei (normoblasts) may be found in the circulating blood, having been forced out prematurely. Such corpuscles may subsequently lose their nuclei while in the blood-stream. In the embryo, hematopoietic tissue is found in parts of the body other than the marrow, notably in the liver and spleen, which at that time serve as organs for the production of new red corpuscles. In the blood of the young embryo nucleated red corpuscles are at first abundant, but they become less numerous as the fetus grows older.\* It is interesting to note that in the adult after severe anemias—*e. g.*, pernicious anemia—and in rabbits after the injection of saponin the spleen may again take on its hematopoietic function. The venous sinuses become crowded with cells of the marrow type.†

**Variations in the Number of Red Corpuscles.**—The average number of red corpuscles for the adult male, as has been stated already, is usually given as 5,000,000 per c.mm. The number is found to vary greatly, however. Outside pathological conditions, in which the diminution in number may be extreme, differences have been observed in human beings under such conditions as the following: The number is less in females (4,500,000); it varies in individuals with the constitution, nutrition, and manner of life; it varies with age, being greatest in the fetus and in the new-born child; it varies with the time of the day, showing a distinct diminution after meals; in the female it varies somewhat in menstruation and in pregnancy, being slightly increased in the former and diminished in the latter condition.

*Variation with Altitude.*—Perhaps the most interesting of the conditions that may influence the number of the blood corpuscles is a change in altitude. Attention was first directed to this point by Bert,‡ who believed that the diminished supply of oxygen in high

\* Howell, "Life History of the Blood Corpuscles," etc., "Journal of Morphology," 1890, vol. iv.; Bunting, "Univ. of Pennsylvania Medical Bulletin," 1903, xvi., 200.

† See Bunting, "The Journal of Experimental Medicine," 1906, viii., 625.

‡ Bert, "La pression barométrique," 1878, p. 1108.

altitudes may be compensated by an increased amount of hemoglobin, and subsequently Viault\* demonstrated that living for a short time at very high altitudes (4000 meters) causes a marked increase in the number of red corpuscles,—an increase, for instance, from 5,000,000 per c.mm. to 7,000,000 or even 8,000,000. This fact has since been investigated with great care by a large number of observers and under a great variety of conditions. The observation has been abundantly confirmed, and indeed it would seem that the reaction takes place very quickly. Within twenty-four hours, according to some observers, and in less time, according to others who have experimented during balloon ascensions (Gaule, Hallion, and Tissot), the increase in the number of corpuscles may be detected, although the maximum increase comes on more gradually. According to Kemp,† the number of blood plates is also greatly increased by high altitudes, while the leucocytes are not affected. There has, however, been much difference of opinion as to whether this increase in number of the red corpuscles is relative or absolute,—that is, whether the total number of red corpuscles in the blood, and therefore probably the total amount of hemoglobin, is increased, or whether it is simply an apparent increase due, for instance, to a diminution in the water of the blood and a consequent concentration as regards the number of corpuscles, or to a variation in the distribution of the corpuscles between the vessels of the skin and those of the internal organs. The results published upon these questions have been conflicting. According to one set of observers there is an absolute increase in the total number of red corpuscles, and therefore in the total amount of hemoglobin. There seems to be little doubt that such a change occurs in cases of long residence in high altitudes, and we may assume that the diminished amount of oxygen in the air or some other condition peculiar to these altitudes acts as a stimulus to the blood-forming tissues (red marrow) and augments the output of corpuscles and hemoglobin. The increase in number of corpuscles and percentage of hemoglobin occurs slowly upon changing from a low to a high altitude, and their inverse change upon returning to a low altitude also occurs gradually. An illustration of the relationship between altitude and amount of hemoglobin is given in Fig. 185*a*. According to another set of observers, the increase in the number of red corpuscles is due to a concentration of the blood. The blood-plasma is reduced in quantity, perhaps by transudation of water into the tissues, and, therefore, the number of red corpuscles and the amount of hemoglobin become greater for each cubic millimeter. If we assume that this smaller bulk of blood, more concentrated in corpuscles and hemoglobin, circulates

\* Viault, "Comptes rendus de l'académie des sciences," 1890 and 1891.

† Kemp, "American Journal of Physiology," 10, 34, 1904.

more rapidly, then also the oxygen-carrying capacity of the blood is increased. In favor of this view, Abderhalden, for instance, has claimed that if animals of the same species and same litter are bled to death and the total quantity of hemoglobin is estimated, the average figures obtained for the animals at low

*Haemoglobin.*

Fig. 185 a.—To show the relationship between altitude and the percentage of hemoglobin in the blood. Figures along the bottom give the atmospheric pressure; along the ordinate to the right the altitude in feet, and along the ordinate to the left the percentage of hemoglobin.—(Fitzgerald.)

levels are the same as for those at the high altitudes. Zuntz has, however, called attention to the fact that when Abderhalden's figures are estimated per kilogram of weight they show an increase in total hemoglobin in the high altitudes, and he and other observers have obtained similar results. It seems certain, there-

fore, that high altitudes cause eventually a marked increase in the production of red corpuscles, but the very sudden changes of this kind reported by some authors as happening within a few hours must be considered as apparent rather than real, and are to be explained by some change in the water contents or in the distribution of the blood.\*

**Physiology of the Blood Leucocytes.**—The function of the blood leucocytes has been the subject of numerous investigations, particularly in connection with the pathology of blood diseases. Although many hypotheses have been made as the result of this work, it cannot be said that we possess much positive information as to the normal function of these cells in the body. It must be borne in mind, in the first place, that the blood leucocytes are not all the same histologically, and it may be that their functions are as diverse as their morphology. Various classifications have been made, based upon one or another difference in microscopical structure and reaction, but at present the terminology most used in medical literature is that adopted by Ehrlich.† According to this nomenclature, the white corpuscles fall into two main groups,—the lymphocytes and the leucocytes,—and each of these into two or more subgroups. Thus:

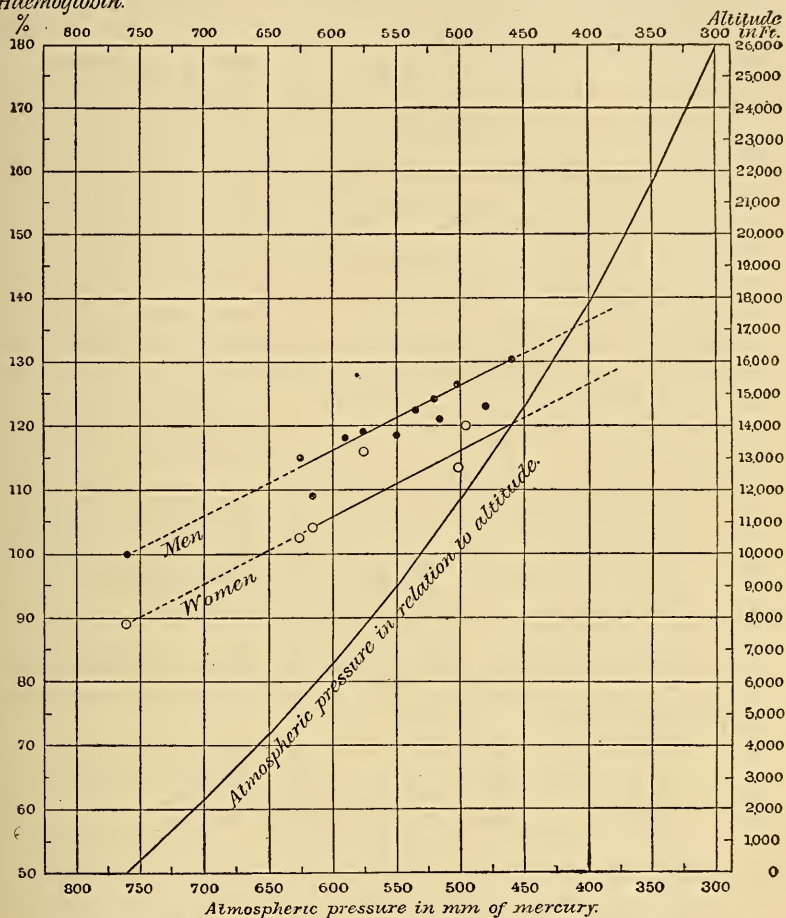
- I. **LYMPHOCYTES.** No granules in the cell substance, and, though capable of ameboid changes of form, this property is not characteristic and probably not sufficient to cause locomotion.
  - (a) *Small lymphocytes* are about the size of the red corpuscles; the nucleus is large, symmetrically placed, stains homogeneously, and the cytoplasm is reduced to a very small amount. They form from 20 to 25 per cent. of all the white corpuscles.
  - (b) *Large lymphocytes.* Two to three times as large as the preceding. Nucleus somewhat eccentric; the cytoplasm is relatively more abundant than in *a*, but non-granular. These forms exist only in small numbers, forming 1 per cent. or less of the white corpuscles.
- II. **LEUCOCYTES.** Granules of different sorts found in the cytoplasm. Cells characteristically ameboid.
  - (a) *Transition forms* (uninuclear leucocytes). Single large nucleus, more or less lobulated; cytoplasm abundant and faintly granulated. The granules stain with neutral dyes and are therefore designated as neutrophile granules. The name, transition form, implies that these leucocytes represent an intermediate stage between the large lymphocytes and the following variety, but this belief is vigorously denied by many competent hematologists. This form exists in small numbers—2 to 10 per cent. of the total number of white corpuscles.
  - (b) *Polynuclear or polymorphonuclear leucocytes.* The nucleus is segmented into lobes connected by narrow strands. The cytoplasm is especially ameboid and is granular. The granules in most cases are neutrophilic and small in size. The typical cells of this kind form the bulk of the white corpuscles of the blood,—60 to 75 per

\* For the extensive literature see Van Voornveld, "Das Blut im Hochgebirge," "Pflüger's Archiv," 92, 1, 1902; Zuntz et al., "Höhenklima und Bergwanderungen in ihrer Wirkung auf den Menschen," 1906. Douglas et al., "Philosophical Transactions, Royal Society of London," B. vol. 203, p. 185, 1913.

† Ehrlich, "Die Anaemie," 1898; see also Seemann, "Ergebnisse der Physiologie," 3, part 1, 1904.

cent. *Eosinophilic leucocytes* form a subgroup of this variety. They have a similar segmented nucleus, but the cytoplasm contains numerous coarse granules that stain in acid dyes, such as eosin, whence the name.

- (c) *Mast cells*. These peculiar cells exist in very small numbers under normal conditions,—less than 1 per cent. of the total number of white corpuscles. They have a polymorphic nucleus like the preceding group, but differ in the fact that the granules in the cytoplasm are strongly basophilic,—that is, will stain only with basic dyes, such as thionin.

Current opinions vary greatly in regard to the origin and relations of these different forms of white blood-corpuseles, almost every writer proposing some special hypothesis to indicate his particular point of view.\* In general, however, it may be said that the divergent views fall under two heads. First, the so-called dualistic theory, according to which there are two sources of origin for these cells, namely, the *lymphoblasts* of the lymph nodes which give rise to the small lymphocytes and the *myeloblasts* of the bone-marrow, which give rise to the granular leucocytes of the blood and probably also serve as the parent form for the large mononuclear leucocytes and transitional forms. Second, the unitarian or monophyletic theory, according to which all the white blood-corpuseles arise from a single form or variety of parent cells that has the characteristics of a large or small lymphocyte. Most authors perhaps believe that the various forms as they exist in the blood are from an anatomical standpoint permanently differentiated. Such a view implies, on the physiological side, that each form has some special functional activity of its own. Little or no progress has been made, however, in discovering the specific physiology of the various leucocytes.

**Variations in Number.**—Under normal conditions the total number of leucocytes may show considerable variation; the average number in health varies usually between 5000 and 7000 per cubic millimeter. A distinct increase in number is designated as a condition of *leucocytosis*, a marked diminution as a condition of *leucopenia*. Leucocytosis occurs under various normal conditions, such as digestion, exercise or cold baths, pregnancy, etc. The variations, relative or absolute, under pathological conditions, have been studied with exhaustive care as an aid to diagnosis and classification.

**Functions of the Leucocytes.**—Perhaps the most striking property of the leucocytes as a class is their power of making ameboid movements,—a characteristic which has gained for them the sobriquet of “wandering” cells. By virtue of this property some of them are able to migrate through the walls of blood capillaries into the surrounding tissues. This process of migration takes

\* See Weidenreich for summary, “Ergebnisse der Anatomie und Entwicklungsgeschichte,” vol. 19, part II (1909), 1911.

place normally, but is vastly accelerated under pathological conditions. As to the function or functions fulfilled by the leucocytes, numerous suggestions have been made, some of which may be stated in brief form as follows: (1) They protect the body from pathogenic bacteria and other foreign cells or organisms. In explanation of this action it has been suggested that they may either ingest bacteria, and thus destroy them directly, or they may form certain substances, bacteriolysins, that destroy the bacteria. The wonderful protective adaptation of the body designated by the term "biological reaction" has already been referred to (p. 424). The formation of immune substances in the blood is attributed, in part at least, to the leucocytes. Leucocytes that act by ingesting the bacteria are spoken of as "phagocytes" (*φάγειν*, to eat; *κύτος*, cell). This theory of their function is usually designated as the "phagocytosis theory of Metchnikoff"; it is founded upon the fact that the ameboid leucocytes are known to ingest foreign particles, including bacteria, with which they come in contact. The leucocytes which seem especially adapted to attack bacteria are the polymorphonuclear variety, designated by Metchnikoff as microphags. This power of the leucocytes to ingest bacteria depends, according to Wright, upon the presence in the plasma of certain substances designated as *opsonins* (from *opso'no*, I prepare food for), which sensitize or in some way prepare the bacteria so that they are attacked by the leucocytes. These opsonins, like the cytotoxins, belong to the group of antibodies, and may be called into existence or increased in amount by the injection into the body of suitable bacteria or their products.\* (2) They aid in the absorption of fats from the intestine. (3) They aid in the absorption of peptones from the intestine. (4) They take part in the process of blood coagulation. (5) They help to maintain the normal composition of the blood-plasma in proteins. The blood proteins are peculiar, and they are not formed directly from the digested food. It is possible that the leucocytes, which are the only typical cells in the blood, aid in keeping up the normal supply of proteins. From this standpoint they might be regarded in fact as unicellular glands, the products of their metabolism serving to maintain the normal composition of the blood-plasma. The formation of granules within the substance of the eosinophiles offers a suggestive analogy to the accumulation of zymogen granules in glandular cells.

**Physiology of the Blood Plates.**—The blood plates are disc-shaped bodies which appear as short rods or as circular or elliptic plates, according as they are seen on edge or on the flat face. They vary in diameter on the flat face, but are in all cases much

\* For a brief general discussion of opsonins, see Hektoen, "Science," Feb. 12, 1909.

smaller than the red corpuscles. When removed from the circulating blood they are known to disintegrate very rapidly. This peculiarity, in fact, prevented them from being discovered for a long time after the blood had been studied microscopically. It has been shown that they are *formed* elements, and not simply precipitates from the plasma, as was suggested at one time. The theory of Hayem, their real discoverer, that they develop into red corpuscles may also be considered as erroneous. There is considerable evidence to show that in shed blood they take part in the process of coagulation. The nature of this evidence will be described later.

On account of their small size the structure of the blood plates is not satisfactorily known. Deetjen\* has demonstrated that they are capable of ameboid movements. When removed from the blood-vessels to a glass slide they usually agglutinate into larger or smaller masses, swell, and disintegrate, but if received upon a surface of agar-agar which has been made up with physiological saline, together with some sodium metaphosphate ( $\text{NaPO}_3$ ), they flatten out, show a central granular portion and a peripheral clear layer, and may make quite active ameboid movements. Deetjen claims also that they possess a distinct nucleus. This latter statement is perhaps doubtful, as other observers report that the material which stains like a nucleus is present as separate granules in the interior of the plate. These granules, though possibly of nuclear material, do not have the morphological appearance of a cell nucleus. It remains, therefore, uncertain whether the blood plates are to be considered as independent cells or as fragments of cells. The origin or histogenesis of the plates has been studied by many observers. Numerous hypotheses have been suggested; that they originate from the nuclei of the polynuclear leucocytes; that they are extruded remnants of the nuclei of the young red blood-corpuscles; that they are detached pieces of the cytoplasm of the giant cells (megakaryocytes) of the bone-marrow, etc., but no one of the hypotheses proposed has found general acceptance. The origin, fate and function of these interesting bodies are still open questions in spite of the great amount of investigation devoted to the subject. The normal number of the plates in the circulating blood is large, but the estimates made vary somewhat with the method used.† When the blood is shed the plates

\* "Virchow's Archiv f. path. Anat. u. Physiol.," 164, 239, 1901, also Zeitschrift f. physiol. chemie, 63, 1, 1909.

† For a summary of the literature and methods, consult Kemp, "Journal of the American Medical Association," April 7 and 14, 1906; Pratt, *ibid.*, Dec. 30, 1905, and Wright and Kinnicutt, "Transactions of Assoc. of Am. Physicians," May, 1901. The preservative solution recommended by Pratt consists of sodium metaphosphate, 2 grams; sodium chlorid, 0.9 gram; water, 100 c.c. That preferred by Kemp is, formalin (40 per cent. aqueous solution of formaldehyd), 10 c.c.; sodium chlorid (1 per cent. solution), 150 c.c., while Wright employs a solution of cresyl blue and potassium cyanid.

agglutinate quickly into masses which soon disintegrate more or less completely, and it is necessary therefore in counting them to mix the blood with a fixing solution which will coagulate the plates and keep them from adhering together. Solutions that precipitate the calcium of the blood-plasma, such as sodium oxalate, have the effect of fixing the plates. The average number of plates may be given as 300,000 per cubic millimeter. The extremes reported vary from 200,000 or 250,000 to 778,000. Under certain pathological conditions, especially in pernicious anemia and lymphatic leucemia, their number is greatly reduced, while in the acute infectious diseases there is said to be a diminution in number during the period of fever, followed by a marked increase beyond the normal during the period of convalescence. A number of observers have stated that in hemorrhagic diseases in which there is delayed coagulation and tendency to bleed there may be a great reduction in the number of platelets. Duke\* states that in such cases transfusion of blood from a normal person removes the hemorrhagic tendency, while increasing markedly the number of platelets. But in three days the number of platelets again falls to a low level, and simultaneously there is again a tendency to spontaneous bleeding. The observation is of interest as indicating that the life history of the platelets in the circulation is probably very brief.

\* Duke, "Journal of the Amer. Med. Assoc.," 55, p. 1185, 1910.



## CHAPTER XXIII.

### CHEMICAL COMPOSITION OF THE BLOOD-PLASMA; COAGULATION; QUANTITY OF BLOOD; REGENERATION AFTER HEMORRHAGE.

**Composition of the Plasma and Corpuscles.**—Blood (plasma and corpuscles) contains a great variety of substances, as might be inferred from its double relations to the tissues as a source of nutrition and as a means of removing the waste products of their functional activity. The constituents that may be present in normal blood-plasma are in part definitely known and in part entirely unknown from a chemical standpoint. Some idea of the complexity of the composition may be obtained from the following table:

#### COMPOSITION OF THE BLOOD-PLASMA.

WATER, OXYGEN, CARBON DIOXID, NITROGEN.

<i>Proteins</i> . . . . .	{	Fibrinogen. Paraglobulin { Euglobulin. { Pseudoglobulin. Serum-albumin. Fats. Sugar. Urea. Uric acid. Creatin. Creatinin. Jecorin. Glucuronic acid. Lecithin. Cholesterin. Lactic acid.	}	
<i>Extractives</i> —that is, substances other than proteins that may be extracted from the dried residue by water, alcohol, or ether.	{	Chlorids Carbonates Sulphates Phosphates	} of {	Sodium. Potassium. Calcium. Magnesium. Iron.
<i>Salts</i> . . . . .	{	Internal secretions. Enzymes { Lipase. { Glycolase, etc. Prothrombin. Antithrombin. Epinephrin. Immune bodies (Amboceptors). Complements. Opsonins.	}	
<i>Enzymes and special substances</i> . . . . .	{		}	

A number of detailed chemical analyses of the blood of different animals, so far as its constituents can be determined by analytical

methods, have been reported at different times. The following table, taken from Abderhalden,\* and showing the composition of dogs' blood, may serve as an example:

	1000 PARTS, BY WEIGHT, OF BLOOD CONTAIN	1000 PARTS, BY WEIGHT, OF SE- RUM CONTAIN	1000 PARTS, BY WEIGHT, OF CORPUS- CLES CONTAIN
Water .....	810.05	923.98	644.26
Solids .....	189.95	76.02	355.75
Hemoglobin.....	133.4	.....	327.52
Protein.....	39.68	60.14	9.918
Sugar .....	1.09	1.82	
Cholesterin .....	1.298	0.709	2.155
Lecithin .....	2.052	1.699	2.568
Fat .....	0.631	1.051	
Fatty acids .....	0.759	1.221	0.088
Phosphoric acid:			
as nuclein .....	0.054	0.016	0.110
Na <sub>2</sub> O .....	3.675	4.263	2.821
K <sub>2</sub> O .....	0.251	0.226	0.289
Fe <sub>2</sub> O <sub>3</sub> .....	0.641	.....	1.573
CaO .....	0.062	0.113	
MgO .....	0.052	0.040	0.071
Cl .....	2.935	4.023	1.352
P <sub>2</sub> O <sub>5</sub> .....	0.809	0.242	1.635
Inorganic:			
P <sub>2</sub> O <sub>5</sub> .....	0.576	0.080	1.298

The same constituents in much the same proportions are found in the blood of all the mammalia examined. The amount of protein in the serum is greater in some cases than in others,—in the dog, for instance, according to Abderhalden's analyses, the protein amounts to only 6 per cent., while in the horse it may be 7 or 8 per cent. So also there are small variations in the amount of cholesterin, sugar, and other constituents, but, on the whole, the composition of the liquid part of the blood, blood-serum or blood-plasma, is remarkably uniform so far as chemical analyses go. We know, however, that the physiological properties of mammalian serum may be very different indeed; that the serum of a dog, for instance, will kill a rabbit when injected into its vessels. Such physiological differences as this, however, depend upon constituents which can not be determined at present by chemical means. The chemical composition of the blood-serum differs from that of the red corpuscles in a number of respects in addition to the presence of hemoglobin in the latter. The corpuscles contain no sugar nor fat, a larger amount of cholesterin, lecithin, phosphoric acid, and potassium, and less sodium and chlorin. The red corpuscles of different mammalia show a remarkable variation in the amount of potassium salts contained. Thus, according to Brandenburg, 1000 parts by weight of the red corpuscles contain the following amounts of K<sub>2</sub>O in different mammalia: Cat, 0.258; dog, 0.257; man, 4.294; horse, 4.957; rabbit, 5.229.

\* "Zeitschrift f. physiologische Chemie," 25, 88, 1898.

**Proteins of the Blood-plasma.**—The general properties and reactions of proteins and the related compounds, as well as a classification of those occurring in the animal body, are described briefly in the Appendix. This description should be read before attempting to study the proteins of the plasma and the part they take in coagulation. Three proteins are usually described as existing in the plasma of circulating blood,—namely, fibrinogen, paraglobulin, or, as it is sometimes called, “serum-globulin,” and serum-albumin. The first two of these proteins, fibrinogen and paraglobulin, belong to the group of globulins, and hence have many properties in common. Serum-albumin belongs to the group of albumins, of which egg-albumin constitutes another member.

*Serum-albumin.*—This substance is a typical protein. It can be obtained readily in crystalline form from the horse's blood. Its percentage composition, according to Michel, is as follows: C, 53.08; H, 7.10; N, 15.93; S, 1.90; O, 21.96.

Its molecular composition, according to Schmiedeberg,\* may be represented by  $C_{78}H_{122}N_{20}SO_{24}$  or some multiple of this formula. Serum-albumin shows the general reactions of the native albumins. One of its most useful reactions is its behavior toward magnesium sulphate and ammonium sulphate. Serum-albumin usually occurs in the body-liquids together with the globulins, as is the case in blood. If such a liquid is thoroughly saturated with solid magnesium sulphate or half saturated with ammonium sulphate, the globulins are precipitated completely, while the albumin is not affected. So far as the blood and similar liquids are concerned, a definition of serum-albumin might be given by saying that it comprises all the proteins not precipitated by saturation with magnesium sulphate or by half saturation with ammonium sulphate. When its solutions have a neutral or an acid reaction, serum-albumin is precipitated in an insoluble form by heating the solution above a certain degree. Precipitates produced in this way by heating solutions of proteins are spoken of as coagulations—heat coagulations—and the exact temperature at which coagulation occurs is to a certain extent characteristic for each protein. The temperature of coagulation of serum-albumin is usually given at from 70° to 75° C., but it varies greatly with the conditions,—for instance, with the reaction of the solution, its concentration in salts, or with the nature of the salts present. It has been asserted, in fact, that careful heating under proper conditions gives separate coagulations at three different temperatures,—namely, 73°, 77°, and 84° C.—indicating the possibility that what is called “serum-albumin” may be a mixture of three proteins. Serum-albumin occurs in blood-plasma and blood-serum, in lymph, and in the different normal and pathological exudations found in the body,

\* “Archiv f. exper. Pathol. u. Pharmakol.,” 39, 1, 1897.

such as pericardial liquid, hydrocele fluid, etc. The amount of serum-albumin in the blood varies in different animals, ranging among the mammalia from 2.67 per cent. in the horse to 4.52 per cent. in man. In some of the cold-blooded animals it occurs in surprisingly small quantities,—0.36 to 0.69 per cent.

*Paraglobulin*, which belongs to the group of globulins, exhibits the general reactions characteristic of the group. As stated above, it is completely precipitated from its solutions by saturation with magnesium sulphate or by half saturation with ammonium sulphate. It is incompletely precipitated by saturation with common salt (NaCl). In neutral or feebly acid solutions it coagulates upon heating to 75° C. Hammarsten gives its percentage composition as: C, 52.71; H, 7.01; N, 15.85; S, 1.11; O, 23.32. Schmiedeberg gives it a molecular composition corresponding to the formula  $C_{117}H_{182}N_{30}SO_{38} + \frac{1}{2}H_2O$ . Paraglobulin occurs in blood, in lymph, and in the normal and pathological exudations. The amount of paraglobulin present in blood varies in different animals. Among the mammalia the amount ranges from 1.78 per cent. in rabbits to 4.56 per cent. in the horse. In human blood it is given at 3.10 per cent., being less in amount, therefore, than the serum-albumin. It is usually stated that more of this protein is found in the serum than in the plasma. This fact is explained by supposing that during coagulation some of the leucocytes disintegrate and part of their substance passes into solution as a globulin identical with or closely resembling paraglobulin. Paraglobulin as obtained from blood-serum by half saturation with ammonium sulphate or full saturation with magnesium sulphate does not behave like a chemical individual. Portions of it, for instance, are precipitated by CO<sub>2</sub> or by dialysis, and portions are not so precipitated. Recently, therefore, it has been assumed that paraglobulin is in reality a mixture of two or possibly three different, although related, proteins. The separation usually given is into euglobulin and pseudoglobulin, euglobulin being the portion precipitated by ammonium sulphate when added to one-third saturation (28 to 33 per cent.), and pseudoglobulin the portion precipitated only by one-half saturation (34 to 50 per cent.). The latter portion shows properties more nearly related to the albumins.\* The whole basis of classification is, however, unsatisfactory and provisional (see appendix).

*Fibrinogen* is a protein belonging to the globulin class and exhibiting all the general reactions of this group. It is distinguished from paraglobulin by a number of special reactions; for example,

\* Porges and Spiro, "Beiträge zur chem. Physiol. u. Pathol.," 3, 277 1903; and Freund and Joachim, "Zeitschrift f. physiologische Chemie," 36, 407, 1902.

its temperature of heat coagulation is much lower ( $56^{\circ}$  to  $60^{\circ}$  C.), and it is completely thrown down from its solutions by saturation with sodium chlorid as well as with magnesium sulphate. Its most important and distinctive reaction is, however, that under proper conditions it gives rise to an insoluble protein, fibrin, whose formation is the essential phenomenon in the coagulation of blood. Fibrinogen has a percentage composition, according to Hammarsten, of: C, 52.93; H, 6.90; N, 16.66; S, 1.25; O, 22.26; while its molecular composition, according to Schmiedeberg, is indicated by the formula  $C_{108}H_{162}N_{30}SO_{34}$ .

Fibrinogen is found in blood-plasma, lymph, and in some cases, though not always, in the normal and pathological exudations. It is absent from blood-serum, being used up during the process of clotting. It occurs in very small quantities in blood, compared with the other proteins. Estimates of the amount of fibrin, which cannot differ very much from the fibrinogen, show that in human blood it varies from 0.22 to 0.4 per cent.; in horse's blood it may be more abundant,—0.65 per cent. There is some evidence to indicate that the fibrinogen is produced in the liver, or at any rate that this organ is concerned in some way in its production. Thus it is stated that extirpation of the liver in the dog, after establishing an Eck fistula, is followed by a rapid disappearance of the fibrinogen of the blood.\* In phosphorus poisoning, and particularly in chloroform poisoning, which is attended by an extensive necrosis of the central portions of the liver lobules, the amount of fibrinogen in the blood is rapidly reduced,† and simultaneously, as we should expect, the blood loses more or less completely its power of clotting. Finally it has been noted that if the blood of a dog is withdrawn in separate portions, defibrinated and reinjected into the circulation, the missing fibrinogen is quickly regenerated in a normal animal, while in one with its liver thrown out of function this regeneration does not take place‡

The following table § gives some results of analyses of blood which indicate the average amounts of the different proteins in the blood-plasma of several animals. The figures give the weight of the protein in grams for 100 c.c. of plasma.

	TOTAL PROTEINS.	SERUM- ALBUMIN.	PARAGLOBULIN.	FIBRINOGEN.
Man . . . . .	7.26	4.01	2.83	0.42
Dog . . . . .	6.03	3.17	2.26	0.60
Sheep . . . . .	7.29	3.83	3.00	0.46
Horse . . . . .	8.04	2.80	4.79	0.45
Pig . . . . .	8.05	4.42	2.98	0.65

\* See Doyon, "C. r. Soc. Biol.," 56, 612, 1904, and Nolf, "Arch. internat. de physiol.," 3, 1, 1905; "Archivio di Fisiologia," 7, 1909.

† Whipple, "Journal of Exp. Medicine," 13, 136, 1911, and 15, 246, 1912.

‡ Meek, "American Journal of Physiology," 30 161, 1912.

§ Lewinski, "Pflüger's Archiv," 100, 611, 1903.

*Other Proteins of the Blood-serum or Blood-plasma.*—From time to time other protein bodies have been described in the serum or plasma of the blood. In the serum after coagulation Hammarsten has obtained a globulin body, *fibrin-globulin*, which he supposes may be split off from the fibrinogen during the act of clotting. Faust describes an albuminoid substance, *glutolin*, which is present in the blood and is usually precipitated together with the paraglobulin. A number of observers have noted the existence in blood of a protein not coagulated by heat. By some authors this has been described as a peptone or an albumose (Langstein), by others as an ovomucoid (Zanetti), and by others still (Chabrié) as a peculiar protein for which the name *albumon* has been proposed. By others still, this non-coagulable protein obtained from serum or plasma has been explained as an artificial product arising from the globulins of the blood during the process of removing the coagulable proteins by heating. So, too, nucleoprotein substances have been described in the blood-serum by several observers, most recently by Freund and Joachim. It is quite possible, however, that the substance described as nucleoprotein is in reality a mixture or combination of lecithin and protein. Most of the protein when precipitated from the blood carries down with it some lecithin, and will therefore show a reaction for phosphorus. It can be shown that the phosphorus present is, in most cases at least, removable by boiling with alcohol, and there is at present no entirely satisfactory proof that nucleoprotein exists in the blood.

**Coagulation of Blood.**—One of the most striking properties of blood is its power of clotting or coagulating shortly after it escapes from the blood-vessels. The general changes in the blood during this process are easily followed. At first perfectly fluid, in a few minutes it becomes viscous and then sets into a soft jelly which quickly becomes firmer, so that the vessel containing it may be inverted without spilling the blood. The clot continues to grow more compact and gradually shrinks in volume, pressing out a smaller or larger quantity of a clear, faintly yellow liquid to which the name *blood-serum* is given. The essential part of the clot is the fibrin. Fibrin is an insoluble protein not found in normal blood. In shed blood, and under certain conditions in blood while still in the blood-vessels, this fibrin is formed from the soluble fibrinogen. The deposition of the fibrin is peculiar. As seen in ordinary microscopical preparations, the fibrin forms very delicate threads which are united to make a fine reticulum. When the process is observed with the aid of the ultramicroscope it can be seen that the fibrin is deposited in the form of very fine needles, which have the appearance of acicular crystals.\* When the process of clotting is very slow the needles may remain separate for a long time until their number is greatly increased, but in normal clotting the process, once it has started, is completed quite rapidly, the final result being a dense network or meshwork of the fibrin needles (Fig. 186). This form of precipitation of a colloid solution, or the formation of a hydrogel from a hydrosol, is unique so far as our knowledge goes. Solutions of fibrinogen may be precipitated,

\* See Stübel, "Pflüger's Archiv f. d. ges. Physiologie," 156, 361, 1914; and Howell, "American Journal of Physiology," 35, 143, 1914.

like solutions of other proteins, in a great variety of ways, by heat, by acids, by neutral salts, etc., but in these cases the colloidal particles of the solution are simply aggregated into larger clumps or masses. The deposition of the fibrinogen in the form of needles takes place only under the influence of thrombin, the substance which causes normal clotting, as will be described further on. When the clot is formed it shrinks or contracts rapidly in all directions, especially if freed from contact with the walls of the containing vessel. If the blood has not been disturbed during the act of clotting, the red corpuscles are caught in the fine fibrin meshwork, and as the clot shrinks these corpuscles are held more firmly, only the clear liquid of the blood

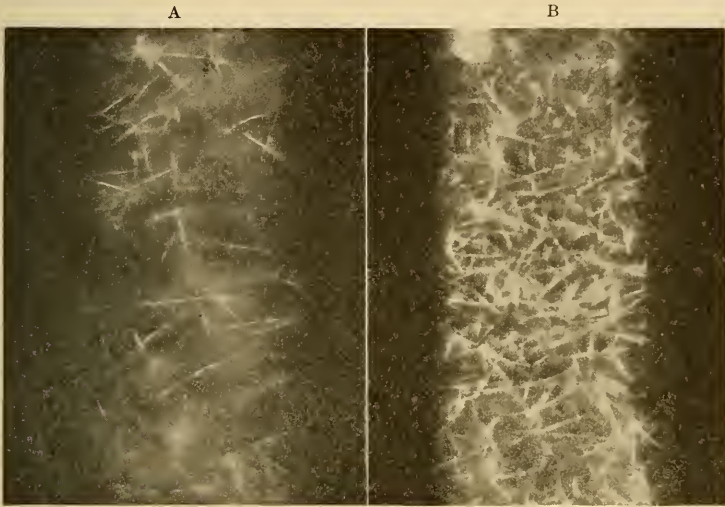

Fig. 186.—The fibrin needles formed in the clotting of blood. Plasma of oxalated dog's blood clotted by thrombin. The photographs show the needles as seen with the ultramicroscope. A, photographed by sun-light; B, by arc-light. Only the needles lying in the focal plane are seen distinctly.

being squeezed out, so that it is possible to get specimens of serum containing few or no red corpuscles. The leucocytes, on the contrary, although they are also caught at first in the forming meshwork of fibrin, may readily pass out into the serum in the later stages of clotting, on account of their power of making ameboid movements. If the blood has been agitated during the process of clotting, the delicate mesh will be broken in places and the serum will be more or less bloody—that is, it will contain numerous red corpuscles. If during the time of clotting the blood is vigorously whipped with a bundle of fine rods, all the fibrin is deposited as a stringy mass upon the whip, and the remaining liquid part con-

sists of serum plus the blood corpuscles. Blood that has been whipped in this way is known as "defibrinated blood." It resembles normal blood in appearance, but is different in its composition; it cannot clot again. The physiological value of clotting is that it stops hemorrhages by closing the openings of the wounded blood-vessels.

*Time of Clotting.*—In human blood the time necessary for clotting varies greatly, according to the conditions to which the blood is subjected after shedding. Blood allowed to flow from a wound into a receiving vessel may clot within a few (3 to 10) minutes according to the amount of blood drawn, the extent of surface with which it comes into contact, the condition of the receiving vessel, etc. The same blood taken from a vein into a clean syringe, by the operation of venepuncture, and emptied into a perfectly clean vessel, may require from 30 to 40 minutes before it jellies throughout. If the surfaces with which the shed blood comes into contact are coated with oil or vaseline, clotting may be delayed for even a longer time. These differences may be understood when we remember that clotting is a complicated process which involves a series of preliminary changes or reactions in the blood. These latter reactions may be accelerated or retarded according to the conditions under which the blood is placed. For clinical purposes various simple methods have been devised to determine the clotting time with a drop or two of blood, such as may be obtained by pricking the ear or the finger.\* In using such methods to compare normal with pathological bloods, it is necessary to employ always the same method and to keep the conditions as uniform as possible. Pathological conditions are known in which the coagulation time of the blood is greatly prolonged. This is notably the case in the class of persons known as bleeders (hemophilics), whose blood clots so slowly that even small wounds often cause a fatal hemorrhage. True congenital hemophilia is transmissible by heredity, and exhibits the interesting peculiarity that, as a rule, it affects only the male, but is transmitted only through the female. That is to say, a man who is hemophilic does not transmit the defect to his sons or his daughters, but the latter may carry the defect in a latent form and transmit it actively to their sons. The mortality from this condition is very high. On the other hand, cases are known in which the coagulability of the blood is so much augmented that spontaneous clotting occurs at places within the veins or arteries (thrombosis), leading to serious complications or even to death. To throw light on these cases it is

\* For clinical methods of determining the coagulation time with a drop or two of blood, reference may be made to the manuals of clinical diagnosis. See Addis, "Quarterly Journal of Exp. Physiology," 1908, I, 305.



desirable, of course, to understand the process of clotting as fully as possible. The problem has proved to be a difficult and complex one.

**General Statement of Problem.**—The clotting of blood is such a prominent phenomenon that it has attracted attention at all times, and as a result numerous theories to account for it have been advanced. Most of these theories have now simply an historical interest. In recent years much experimental work has been done upon the subject, the result of which has been to increase greatly our knowledge of the process; but no complete explanation has yet been reached. It is generally admitted that the essential constituent of the clot—namely, the fibrin—is formed from the fibrinogen normally present in the plasma, and that without this fibrinogen clotting is impossible. If, for instance, blood is heated to 60° C., a temperature sufficient to precipitate the fibrinogen as a heat coagulum, its power of clotting is lost. Clotting, therefore, is essentially a process of the blood-plasma, as was shown indeed by the old experimenters (Hewson). Moreover, it is also admitted that the conversion of the soluble fibrinogen to the insoluble fibrin is accomplished by the agency of a substance, known as thrombin or fibrin ferment, which is not present, in its active form at least, in the blood while in the blood-vessels, but is formed after the blood is shed or under certain abnormal conditions within the blood-vessels. These two important facts we owe mainly to the investigations of Alexander Schmidt,\* whose work completed the older observations of Hewson, Buchanan, Denis, and Brücke.

**Preparation of Solutions of Fibrinogen.**—Fibrinogen may be obtained readily in solution free from other proteins by the general method first described by Hammarsten. One may use the plasma of horse's blood which has been kept from clotting by prompt cooling, and in which the corpuscles have been thrown down by centrifugalizing or by long standing at low temperature, but it is more convenient, perhaps, to use blood which has been kept from clotting by allowing the blood, as it escapes from the vessels, to run into a solution of sodium oxalate, using an amount such that the final mixture contains 0.1 per cent. of the oxalate. This mixture is centrifugalized, the clear plasma is removed, and the fibrinogen in it is precipitated by adding an equal part of a saturated solution of sodium chlorid.

The method in some detail is as follows: After adding to the clear plasma an equal bulk of a saturated solution of sodium chlorid the resulting pre-

\* "Archiv f. Anat., Physiologie, u. wiss. Medicin," Reichert u. du Bois-Reymond, 1864, pp. 545, 675, and 1862, pp. 428, 533; "Pflüger's Archiv. f. d. gesammte Physiol.," 6, 413, 1872; "Zur Blutlehre," Leipzig, 1892 and 1895.

cipitate of fibrinogen is centrifugalized, the supernatant liquid is poured off, the precipitate is washed with a little of a half-saturated solution of sodium chlorid, and then dissolved with stirring in a 2 per cent. solution of sodium chlorid and filtered. This solution is again precipitated by half-saturation with sodium chlorid, centrifugalized, washed, and dissolved as before in a 2 per cent. solution of sodium chlorid. The process may be repeated a third time, and the washed precipitate is finally dissolved in a 1 per cent. solution of sodium chlorid. It frequently happens that the third precipitate will not dissolve in the dilute sodium chlorid, and in that case a drop or two of a 0.5 per cent. solution of sodium bicarbonate may be added to carry it into solution. If care is taken in washing the centrifugalized precipitate, two precipitations usually suffice to give a fibrinogen solution, which will not clot spontaneously nor after the addition of calcium salts, but clots promptly with thrombin.

A solution of fibrinogen prepared as above clots readily upon the addition of blood-serum or of other solutions containing thrombin, and if the preparation has been entirely successful, a genuine clot, that is, the precipitation of the fibrinogen in gelatinous form, cannot be obtained from it by any other means. As a matter of fact, solutions of fibrinogen prepared as described sometimes clot, although much more slowly, when instead of a thrombin solution one adds a little calcium chlorid or a solution containing calcium chlorid and sodium bicarbonate in about the proportion found in a Ringer's mixture. This latter fact indicates that the fibrinogen solution in such cases contains a trace of some material from which thrombin may be produced. In all probability this material is the antecedent form of thrombin, that is, so-called prothrombin, which, as we shall see, is converted to thrombin by the action of calcium salts.

**Preparation and Properties of Thrombin.**—Thrombin, or so-called fibrin ferment, is prepared readily by the method first described by Schmidt. Blood is allowed to clot, and the serum is then precipitated by the addition of a large excess of alcohol (usually twenty volumes). After standing some days or weeks the precipitate is drained off and dried, and is then ground up and extracted with water. The aqueous extract contains proteins, salts, and other things in addition to the thrombin. A solution made in this way causes a prompt coagulation when added to a solution of pure fibrinogen. That the thrombin thus obtained is not present as such in normal blood, but is formed after shedding, is indicated by the fact that if the animal's blood is allowed to flow directly from the artery into a large bulk of alcohol, due care being taken in the process, the precipitate thus obtained when subsequently dried and extracted with water yields little or no thrombin.

Another, perhaps simpler, method of obtaining a strong preparation of thrombin is to treat fibrin with an 8 per cent. solution of sodium chlorid (Buchanan-Gamgee). Fibrin obtained from a

slaughter-house is washed thoroughly in running water until the hemoglobin is removed, and is then minced and extracted at a low temperature with the strong salt solution for several days. The filtered extract is rich in thrombin, but contains also large amounts of dissolved protein. Starting with such an extract the author\* has shown that by repeated shakings with chloroform the coagulable proteins present in the extract may be removed completely and the thrombin, in diminished quantities, be left behind in apparently pure condition.

A simpler method of obtaining relatively pure preparations of thrombin in permanent form for experimental work and demonstrations may be described briefly as follows:

1. Fibrin obtained from the slaughter-house is washed thoroughly to remove all hemoglobin. The mass is squeezed to remove excess of water, is then cut into fine pieces with scissors, and covered with an 8 per cent. solution of sodium chlorid. The mixture is left for forty-eight hours in a refrigerator, with occasional stirring.

2. The salt solution is drained off through cheese-cloth.

3. The filtrate is precipitated by the addition of an equal volume of acetone, and this mixture is filtered as quickly as possible through a number of small filters, not using more than 50 c.c. to a filter. After the liquid has run through the filters are opened, and the precipitate is spread as thin as possible with a spatula. The filters are then dried rapidly in a current of cold air before an electric fan.

4. The dried filters may be kept indefinitely in a desiccator, and when thrombin is needed may be extracted with a little water, or the thrombin may be extracted from the whole mass by covering the filters with water, allowing to stand for one or two hours, and then filtering without squeezing the filters. The clear solution of fibrin thus obtained may be distributed in watch glasses, 1 or 2 c.c. to a glass, and be dried in front of an electric fan. These dried preparations may be kept indefinitely in a desiccator. When needed the contents of each glass are dissolved in 2 or 3 c.c. of water or normal saline. This preparation contains a little coagulable protein in addition to thrombin. If desired this impurity may be removed by dialyzing and shaking with chloroform, or by reprecipitation with acetone.

Observations made upon preparations of thrombin purified as just described show that it has the following properties: it is very easily soluble in water, it is not coagulated by boiling, it is precipitated with difficulty by alcohol in excess, it is precipitated uninjured by half-saturation with ammonium sulphate, it responds to a number of the ordinary protein tests, such as the biuret, the Millon's, and especially the tryptophan (Adamkiewicz) reaction. We may conclude, therefore, that in all probability thrombin is a protein substance. The evidence at hand indicates that thrombin as such does not exist in the circulating blood, but is present probably in an antecedent or inactive form known as *prothrombin* or *thrombogen*. So far as is known this prothrombin is furnished only by the blood-platelets. When the blood is shed, or under certain abnormal conditions while circulating in the vessels, the pro-

\* Howell, "American Journal of Physiology," 26, 453, 1910.

thrombin is changed or activated to thrombin. The nature of this change is discussed below. Once the thrombin exists in active condition it exhibits the remarkable property of precipitating the fibrinogen in the form of a gelatinous clot, the essential part of the clot being a mesh of fibrin needles.

**Nature of the Action of the Thrombin on Fibrinogen.**—Solutions of fibrinogen may be precipitated readily in a number of ways, but, so far as known, only thrombin is capable of precipitating it in the peculiar way necessary to form a gelatinous clot. The nature of this reaction is obscure. The usual view in physiology is that first suggested by Schmidt, namely, that the thrombin is an enzyme or ferment, fibrin ferment. If this view is correct, then, in accordance with our idea of the way in which ferments act, the thrombin should not be used up in the reaction, but should act over and over again, converting new fibrinogen to fibrin. Moreover, the fibrin on this view should be formed entirely from the fibrinogen, since the thrombin, if a ferment, does not constitute a part of the final product. Several specific hypotheses have been proposed to explain the nature of the change undergone by the fibrinogen in its conversion to fibrin. It has been suggested that the fibrinogen undergoes a hydrolytic cleavage, with the formation of the insoluble fibrin, on the one hand, and a soluble "fibrin globulin," on the other; or that the molecular state of the fibrinogen undergoes a change similar perhaps to that caused by heating, whereby an insoluble product is formed. These and similar hypotheses have not been supported by experimental evidence, and, indeed, a number of observers from time to time have questioned the fundamental part of such theories, namely, the belief that thrombin acts like a ferment. Experiments indicate that, unlike the ferments in general, thrombin under certain conditions (absence of salts) withstands the temperature of boiling water, and, again, unlike the ferments, a small amount of thrombin allowed to act upon fibrinogen produces a fixed amount of fibrin which does not increase with the time during which the thrombin is allowed to act. It has been suggested, therefore, as an alternative hypothesis that the thrombin and fibrinogen form a combination of a physical or physico-chemical character which results in their mutual precipitation as fibrin (Nolf). Such a theory is in accord with the fact that freshly formed fibrin when subjected to prolonged washing with water gives off little or no thrombin, but when subsequently treated with solutions of sodium chlorid (8 per cent.) a portion of it goes into solution and this solution is rich in thrombin.

**The Influence of Calcium Salts in Coagulation.**—Many observers have called attention to the fact that calcium salts in certain concentrations influence favorably the coagulation of blood.

We owe to Arthus and Pagès, however, the proof that calcium salts are essential to the process of normal coagulation. These observers showed that freshly drawn blood allowed to flow into an oxalate solution, in amounts such that the final concentration in oxalate is not less than 0.1 per cent., will remain unclotted indefinitely, but may be made to clot at any time by the addition of a suitable amount of calcium salt. That this effect is not due to an excess of the added oxalate is proved by the fact that the oxalated blood or the plasma obtained from it by centrifugalization may be dialyzed against a large bulk of solution of sodium chlorid, 0.9 per cent., until the excess of oxalate is removed. This dialyzed plasma will remain unclotted indefinitely, but coagulates promptly upon the addition of small amounts of calcium chlorid. It has been shown quite conclusively by Hammarsten that the calcium is not directly concerned in the conversion of the fibrinogen to fibrin; the thrombin is able to effect this change in the absence of calcium. The dialyzed oxalated plasma spoken of above is readily clotted if some thrombin solution free from calcium salts is added to it. The rôle of the calcium lies in the part that it takes in the conversion of the prothrombin to thrombin. According to the terminology used at present, we may say that calcium is necessary for the activation of the thrombin. In the oxalated plasma fibrinogen and prothrombin or inactive thrombin are present, and the addition of calcium salts serves simply to convert the prothrombin to thrombin. We may believe that this reaction occurs always in the initial stages of normal clotting.

**Influence of Tissue Extracts Upon Coagulation.**—Another important consideration in the normal clotting of blood is the influence of extracts of tissues upon the rapidity of the process. Many observers have shown that certain substances are contained in the tissues in general, including the blood-corpuscles, which tend to accelerate the process of clotting. Arthus, for example, found that blood taken directly from the artery of a mammal through a clean tube will clot within a certain time, while if allowed to flow first over the wounded surface, as happens under normal conditions, the time of clotting is much accelerated. This influence of the tissues is shown in an extreme way when we consider the blood of the lower vertebrates, the birds, reptiles, and fishes. If blood is drawn from an artery of one of these animals through a clean tube it clots with great slowness. If such a specimen of blood is centrifugalized promptly the supernatant plasma, when pipetted off, may remain unclotted for many hours or fail to clot at all. If, however, the drawn blood or the centrifugalized plasma is mixed with an extract from the animal's tissues, the muscles,

for example, it will clot within a few minutes. This is, of course, what happens in such animals when wounded. The escaping blood oozes over the cut surface and clotting occurs promptly. Mammalian blood differs from that of the lower vertebrates in that it clots within a relatively short time, even if kept from coming in contact with the injured tissues, and this difference may be explained on the view that the accelerating substance furnished by the tissues in the lower vertebrates is supplied in the case of the mammal by the corpuscles in its own blood, most probably by the platelets which, as is well known, disintegrate very rapidly when the blood is shed. The mammalian blood (dog) may, however, be brought into the condition of the bird's blood very easily by the so-called process of peptonization, that is to say, by injecting rapidly into the circulation a certain amount of a solution of Witte's peptone (see below, Antithrombin). If the injection is successful, the blood when drawn remains fluid for many hours, and, if promptly centrifugalized, the plasma may fail entirely to clot. In such cases the addition of tissue extracts may cause clotting within a few minutes, as in the case of the bird's blood. The substance or substances in the tissues which exhibit this accelerating influence upon clotting have received various names from different observers in accordance with the special theory of coagulation advocated. They have been called zymoplastic substances, thromboplastic substances, coagulins, cytozyms, thrombo-kinase, etc. It is perhaps most convenient to speak of them in general as *thromboplastic substances*, since this term does not commit us to the manner of their action, but simply implies that they are of importance in the formation of the clot. It has long been known that thromboplastic substance may be extracted from the tissues by the action of ether, or of alcohol and ether, and the author\* has shown that the active substance in the ether extracts is one of the phosphatids, corresponding apparently to the fraction which has been designated as *kephalin*. The closely related lecithin has no thromboplastic power. In aqueous extracts of the tissues the kephalin is held in solution in combination with a protein which is precipitated at a temperature of 60° C. It is probable that this kephalin-protein constitutes the active thromboplastic substance of the tissues. As regards the manner in which it participates in the process of clotting several views have been proposed. According to the theory of Morawitz (see next paragraph) it is concerned, together with the calcium, in activating the prothrombin to thrombin, and, indeed, is necessary to this reaction. According to Howell its function lies in neutralizing the action of antithrombin, hence its effectiveness in causing the clotting of

\* Howell, "American Journal of Physiology," 31, 1, 1912, and 32, 264, 1913.

peptone-plasma or bird's plasma, both of which owe their relative incoagulability to the presence of an excess of antithrombin.

**Theory of Coagulation.**—Modern theories of coagulation, with some exceptions (Wooldridge, Nolf), accept as their starting-point the fact that fibrin is formed eventually by the action of thrombin upon fibrinogen. The various theories proposed differ from one another largely in their explanation of the origin of the thrombin and of the parts taken by the calcium and the thromboplastic substances in the process of clotting. The simplest of these theories assumes that the prothrombin in the blood arises from the blood-plates (and leucocytes ?) and is activated to thrombin by the calcium, the thrombin then reacting with the fibrinogen. The theory which seems to be most generally accepted at present is that proposed independently by Morawitz\* and by Fuld and Spiro † Using the terminology of Morawitz, this theory assumes that the thrombin is present in the blood in an inactive form which he designates as thrombogen. To convert this thrombogen (prothrombin) to thrombin requires the action both of calcium salts and of an organic thromboplastic substance which he designates as a kinase or thrombokinase. Thrombokinase is furnished by the tissue-cells in general, especially by those rich in nuclein, and is furnished also by the cellular elements of the blood. In the circulating blood calcium salts and thrombogen are present, but no kinase. When the blood is shed the disintegration of the platelets and leucocytes, in mammalian blood, or of the cells of the wounded tissues in the blood of the lower vertebrates, liberates thrombokinase, which then, in combination with the calcium, converts the thrombogen to thrombin. The theory may be expressed in diagrammatic form as follows:

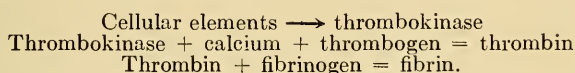

The theory explains very well many of the most significant facts known in regard to clotting, but it may be said that the central feature of the theory, the existence of an organic kinase, has not been supported by direct experimental evidence. The author has been led by his own work ‡ to adopt a different point of view, which may be expressed briefly, as follows: Prothrombin may be converted to active thrombin by the action of calcium alone. This activation does not occur in the circulating blood because an

\* Morawitz, Hofmeister's "Beiträge," 5, 133, 1904, and "Arch. f. klin. Med.," 79, 1.

† Fuld and Spiro, "Hofmeister's Beiträge," 5, 174, 1904.

‡ Howell, *loc. cit.* and "American Journal of Physiology," 29, 187, 1911.

antithrombin is present in amounts sufficient to prevent the reaction. In shed blood the tissue-cells or the cells of the blood (plates) furnish a thromboplastic substance (kephalin-protein) which neutralizes the action of the antithrombin and thus permits the calcium to react with the prothrombin to form thrombin, which in turn reacts with the fibrinogen to form fibrin. Both theories assume that the process of clotting in shed blood is initiated by the production of a new substance, the thromboplastic substance, furnished by the cells or blood-corpuseles (plates), but on one view this substance acts as a kinase which participates directly in the conversion of prothrombin to thrombin, while on the other view the substance permits this conversion to occur indirectly by neutralizing the opposing antithrombin.

Several other theories of coagulation are proposed, but they are difficult to explain in a few words. Two of the most recent of these theories may be referred to briefly. According to Nolf\* the essential factors of coagulation are three colloids, fibrinogen and thrombogen furnished by the liver and thrombozym derived from the leucocytes. These colloids unite to form fibrin, but in order for the reaction to take place calcium must be present, as also thromboplastic substance. Bordet and Delange† explain the formation of thrombin as due to a reaction between substances designated as cytozym and serozym. The cytozym is furnished by the platelets (and tissues). It is not destroyed by boiling. The serozym is a substance not present in blood, but formed in some way after the blood is shed. It is destroyed by heating to 55° C. The reaction between cytozym and serozym requires the presence of calcium salts.

**Why Blood Does Not Clot Within the Blood-vessels.—Anti-thrombin.**—The specific explanation of the fluidity of the blood within the vessels must vary, of course, with the theory of coagulation that is adopted. In general, it may be stated with confidence that the circulating blood contains no active thrombin, or at least not enough to clot the blood, and the real difficulty we have to explain is how the prothrombin is kept in an inactive state throughout life. According to Morawitz, everything turns on the fact that thrombokinese is absent. The fibrinogen, prothrombin, and calcium are in solution in the blood-plasma, but according to his theory the kinase is essential to aid the calcium in activating the prothrombin. Cellular elements, platelets, leucocytes, erythrocytes doubtless are constantly undergoing disintegration in the circulation and thereby furnish some kinase, but under normal conditions this does not occur in mass, as is the case in shed blood. The explanation is logically satisfactory, if we accept the theory of a kinase, although it does not accord very well with the fact that large amounts of tissue extracts, containing the kinase, may be injected into the circulation without producing intravascular

\* "Archives internationales de physiol.," 6, 115, 1908.

† "Annales de l'institut Pasteur," 26, 657 and 737, 1912.



clotting. Another point of view is that the prothrombin is kept inactive and the normal fluidity of the blood is maintained by the constant presence of an *antithrombin*. That such a substance does exist in the blood may be demonstrated by direct experiments. It has long been known that extracts of the leech's head yield a soluble protein which has, to a marked degree, the property of preventing the clotting of blood. This substance is made in quantity for experimental work, and is sold under the name of hirudin.\* It has been shown that this substance prevents thrombin from acting upon fibrinogen, and in this sense, therefore, it is an antithrombin. Moreover, the incoagulability of the blood of a so-called peptonized dog is due to the presence in the blood of the same or of a similar substance, which, according to the evidence at hand, is secreted by the liver. When peptonized plasma is added to a mixture of thrombin and fibrinogen, the normal action of the thrombin is prevented, but if the peptonized plasma is first heated to 80° and filtered from the heat coagulum formed, the filtrate no longer has a restraining influence upon the action of thrombin. Evidently the so-called peptonized plasma contains a something which antagonizes the action of thrombin, and the antagonistic reaction is of a quantitative kind, that is to say, a fixed amount of the peptone plasma will antagonize the action of a definite amount of thrombin. This substance in the peptonized plasma behaves exactly like the hirudin of the leech extract, and it is probable, therefore, that it is a definite antithrombin. Moreover, by similar experiments with the incoagulable plasma of the bird or with the oxalated plasma of the mammal it can be shown that these bloods also contain antithrombin. In the bird's blood this substance is present in larger amounts than in the mammalian blood, but the evidence at hand indicates that circulating blood contains constantly some antithrombin and that this amount may be increased under certain conditions, for example, by the injection of solutions of Witte's peptone into the blood-vessels. As regards the antithrombin present in normal human blood it is important to bear in mind the fact that its action in antagonizing the thrombin is very much greater at body temperatures than at room temperatures. At about the body temperature its activity is greatly augmented. In circulating blood, fibrinogen, prothrombin, calcium, and antithrombin are present. The presence of the antithrombin prevents the activation of the prothrombin, or if any is activated, prevents it from reacting with the fibrinogen. When blood is shed there is a general breaking down and disintegration of the platelets, which results in adding two things to the blood: first, more prothrombin; and, second, some thromboplastic substance which tends to neu-

\* Franz, "Archiv. f. exper. Path. u. Pharmak.," 49, 342, 1903.

tralize the antithrombin. If the shed blood comes into contact with the tissues, additional thromboplastic material is added which accelerates the process of thrombin formation. From this point of view, therefore, antithrombin plays the important rôle of protecting the blood from clotting within the vessels. Observations on human blood under normal and pathological conditions show that this substance is constantly present, and in amounts that seem to vary within narrow limits. Regarding the seat of formation of the antithrombin, Delezenne, Nolf, and others have published experiments which indicate that it is formed in the liver, and there is evidence that it is produced normally in the uterus at the time of menstruation.\*

**Metathrombin.**—In the serum of blood after clotting ready-formed thrombin exists. On standing the amount of this thrombin diminishes sometimes quite rapidly, so that after a certain time the serum shows little or no power to cause the clotting of a fibrinogen solution. In either a fresh or an old serum, if not kept too long, the thrombic power can be very greatly increased if it is treated with an equal volume of a decinormal solution of sodium hydroxid for a few minutes and then neutralized with acid (Fuld and Spiro and Morawitz). The same result may be obtained with fresh serum by adding a little tissue extract, or a solution of the active substance in such extracts (kephalin). It has been suggested, therefore, that at the time of clotting a portion of the prothrombin in the blood-plasma is converted into an inactive form known as *metathrombin*, which may be activated to thrombin by either of the methods mentioned above. A simpler explanation is that this so-called metathrombin represents a combination of thrombin and antithrombin, from which the thrombin is liberated either by the alkali activation or in the case of fresh serum by the action of kephalin. †

**Intravascular Clotting.**—As is well known, clots may form within the blood-vessels in consequence of the introduction of foreign material of any kind. Air, for instance, that has gotten into the veins, if not absorbed, may act as a foreign substance and cause the same chain of events as when the blood is shed,—namely, the disintegration of formed elements, formation of thrombin, and clotting. So also when the internal coat of a blood-vessel is injured, as, for instance, by a ligature, the altered endothelial cells act as a foreign substance. If the circulatory conditions are favorable—for instance, if the ligated artery causes a stasis of blood at

\* See Doyon, "C. r. de la soc. de Biologie," 1911–1912; Schickele, "Biochemische Zeitschrift," 38, 169, 1912; also Howell, "American Journal of Physiology," 29, 187, 1911.

† Weymouth, "American Journal of Physiology," 32, 266, 1913.

that point—there may be an agglutination of the blood plates, starting at the injured surface, and the subsequent formation of a clot. Intravascular clotting may also be produced by the injection of various substances. From our knowledge of the factors concerned in coagulation we should suppose that the normal balance of the blood might be overthrown in one of two general ways, by injecting active thrombin or by injecting extracts of the tissues (thromboplastic substance). As a matter of fact, intravascular clotting may be produced by either of these methods, but experiments have developed the somewhat unexpected result that the blood or the body can protect itself within wide limits from the effects of such injections. Solutions of pure thrombin, or serum or defibrinated blood containing active thrombin, may be introduced into the circulation in quantities that outside would suffice to clot the whole mass, and yet no harm be done. The explanation of this negative result, according to the author's experiments, is that the excess of thrombin within the living animal causes the formation of a compensatory amount of antithrombin, probably by a protective reflex secretion. Tissue extracts or solutions of the precipitated thromboplastic substance (Woodridge) cause clotting more readily, but here again injections of this kind, instead of hastening the clotting of blood, may at times have just the opposite effect, giving what older observers called the "negative phase of the injection." On the other hand, when the coagulability of the blood is diminished experimentally by injecting antithrombin (hirudin) directly, or by causing the body to produce an excess of antithrombin within itself (injection of Witte's peptone) the effect soon passes off; the excess of antithrombin is removed by some procedure which is not yet understood. It may be pointed out that these attempts to devise methods by means of which the coagulability of the blood may be controlled have a practical bearing in their application to pathological conditions in which the balance is already disturbed in the direction of an increased or decreased coagulability.

**Means of Hastening or of Retarding Coagulation.**—Blood coagulates normally within a few minutes, but the process may be hastened by increasing the extent of foreign surface with which it comes in contact. Thus, agitating the liquid when in quantity, or the application of a sponge or a handkerchief to a wound, hastens the onset of clotting. This is easily understood when it is remembered that the breaking down of leucocytes and blood-plates is hastened by contact with foreign surfaces. It has been proposed also to hasten clotting in case of hemorrhage by the use of thrombin solutions or of tissue extracts containing some thromboplastic substance. Hot sponges or cloths applied to a wound hasten

clotting, probably by accelerating the formation of thrombin and the chemical changes of clotting. Coagulation may be retarded or be prevented altogether by a variety of means, of which the following are the most important:

1. *By Cooling.*—This method succeeds well only in blood that clots slowly—for example, the blood of the horse, bird, or terrapin. Blood from these animals received into narrow vessels surrounded by crushed ice may be kept fluid for an indefinite time. The blood corpuscles soon sink, so that by this means one may readily obtain pure blood-plasma. The cooling probably prevents clotting by keeping the corpuscles intact.

2. *By the Use of Oiled or Paraffined Vessels.*—If blood, when withdrawn from the vessels, is allowed to come into contact only with oiled or paraffined surfaces its clotting is very much delayed. Under ordinary conditions blood brought into contact with foreign surfaces clots rapidly, because the platelets quickly agglutinate and dissolve, yielding to the plasma a supply of prothrombin and thromboplastic substance. An oiled or paraffined surface is one which the liquid of the blood cannot wet, and under these conditions the platelets do not undergo the rapid change in surface properties that causes them to break down. The cannula used for drawing the blood and the vessel for receiving it may be paraffined conveniently by filling with a dilute solution of paraffin in ether, then pouring off the solution and allowing to dry for a few minutes. In this way the glass surface is coated with a thin, uniform layer of paraffin.

3. *By the Action of Neutral Salts.*—Blood received at once from the blood-vessels into a solution of such neutral salts as sodium sulphate or magnesium sulphate, and well mixed, does not clot. In this case also the corpuscles settle slowly, or they may be centrifugalized, and specimens of plasma be obtained. For this purpose horses' or cats' blood is to be preferred. Such plasma is known as "salted plasma"; it is frequently used in experiments in coagulation—for example, in testing the efficacy of a given thrombin solution. The best salt to use is magnesium sulphate in solutions of 27 per cent.: 1 part by volume of this solution is usually mixed with 4 parts of blood; if cats' blood is used, a smaller amount may be taken—1 part of the solution to 9 of blood. Salted plasma or salted blood again clots when diluted sufficiently with water or when thrombin solutions are added to it. Since the action of thrombin on fibrinogen is not prevented by neutral salts in these concentrations, while an oxalated plasma which clots readily on the addition of calcium is prevented from so clotting when sodium chlorid or magnesium sulphate is added previously to a concentration of 4 or 5 per cent.,

it follows that in all probability the neutral salts exert a restraining effect on the process of clotting because they prevent or retard the activation of the prothrombin by the calcium.

4. *By the Action of Oxalate Solutions.*—If blood as it flows from the vessels is mixed with solutions of potassium or sodium oxalate in proportion sufficient to make a total strength of 0.1 per cent. or more of these salts, coagulation is prevented entirely. Addition of an excess of water does not produce clotting in this case, but solutions of any soluble calcium salt quickly start the process. The explanation of the action of the oxalate solutions is simple; they are supposed to precipitate the calcium as insoluble calcium oxalate.

5. *By the Action of Sodium Fluorid.*—Blood drawn directly into a solution of sodium fluorid does not clot. It is best to use a 3 per cent. solution of the fluorid, and to take 1 part of the solution to 9 parts of blood. Addition of thrombin to this fluorid blood causes clotting, while calcium salts are usually stated to be without effect. As a matter of fact, calcium salts cause a precipitate of a portion of the protein, and if added cautiously in excess they induce clotting, as in the case of the oxalated blood. The fluorid plasma may be made to clot also by dialysis. We may believe that the fluorid, like the oxalate, prevents clotting by removing the calcium. The calcium is not precipitated, but is held bound as a fluorid in combination with a portion of the protein (Rettger). Coagulation is prevented in a similar way by solutions of sodium citrate or sodium metaphosphate. In the case of the citrate use a 2 per cent. solution and take 1 part to 4 of the blood.

6. *By the Injection of Certain Organic Substances.*—There are a number of substances which when injected into the blood retard or prevent its coagulation. For instance, solutions of ordinary preparations of pepsin, trypsin, peptone, snake venom, leech extracts, etc. Snake venom may be wonderfully potent in this particular; it is stated that so little as 0.00001 gm. to each kilogram of animal suffices to destroy the coagulability of the blood. Of these various bodies solutions of peptone have received the most attention from investigators. Peptone, as usually obtained by digestion experiments, is in reality a mixture of proteoses and peptones. When injected into the circulation in the proportion of 0.3 gm. to each kilogram of animal the coagulability of the blood is very greatly diminished for a brief period of half an hour or more. When, however, such solutions are added to freshly drawn blood they exercise no influence upon the coagulation. Evidently, therefore, when injected into the blood they provoke a reaction of some sort, the products of which prevent coagulation. There is

evidence to show that this reaction takes place in the liver, and in accordance with this view it is found that much smaller quantities of the peptone solution suffice to give a delayed coagulation when injected directly into the portal vein. As stated in the preceding paragraphs, the blood of the peptonized animal shows upon examination the presence of an increased amount of antithrombin, and doubtless the loss or diminution in the coagulability of the blood is due to the excess of this substance. We may believe, therefore, that the peptone solution has in some way, directly or indirectly, stimulated the body to produce antithrombin. Pick and Spiro\* have shown that this action of peptone solutions is not due to the peptone or the albumoses contained in it. When obtained in purified form these substances have no such effect. They attribute the action to a substance, derived probably from the tissues used in the preparation of the peptone, and for which they suggest the name of *peptozym*.

In obtaining so-called peptone plasma by injecting solutions of Witte's peptone, of the strength named, into the arteries of a dog it happens sometimes that a negative result is obtained. Some specimens of Witte's peptone are effective and some are not. This fact accords with the results of the investigation made by Pick and Spiro in indicating that the reaction is not due to the peptones or proteoses, but to some unknown constituent present which may be regarded as an impurity.

Leech extracts differ from solutions containing peptozym in that they prevent the clotting of the blood when added to it outside the body. They evidently contain already formed a substance whose action prevents coagulation. This substance is secreted by the salivary glands of the leech. It has been prepared from the glands in a more or less pure form, and is designated as *hirudin*. It is a body belonging apparently to the groups of albumoses and is supposed to antagonize the action of thrombin. As stated above, hirudin is probably identical with or similar to the antithrombin which occurs normally in circulating blood.

**Total Quantity of Blood in the Body.**—The total quantity of blood in the body has been determined approximately for man and a number of the lower animals. The method (Welcker) used in such determinations consists essentially in first bleeding the animal as thoroughly as possible and weighing the quantity of blood thus obtained, and afterward washing out the blood-vessels with water and estimating the amount of hemoglobin in the washings.

Gréhant ("Journal de l'Anat. et de Physiol.," 1882, 564) has devised another method which may be used upon the living animal, as follows: A specimen of blood is taken from the animal and the volume per cent. of oxygen is determined by extraction with a gas-pump. The animal is then

\* "Zeitschrift f. physiol. Chemie," 31, 235, 1900.

made to breathe a known volume of carbon monoxid for a certain time, and the total amount of this carbon monoxid that is absorbed is ascertained by analysis. A second specimen of blood is then taken and its volume per cent. in oxygen is again determined. The difference between this volume per cent. of oxygen and that obtained before the administration of the carbon monoxid gives the volume per cent. of carbon monoxid in the blood, since the latter gas displaces an equal volume of oxygen. If the total amount of carbon monoxid absorbed by the blood is indicated by  $V$  and the volume per cent., that is, the number of c.c. to each 100 c.c. of blood, is indicated by  $v$ , then the total quantity of the blood will be given by the formula  $\frac{V}{v} \times 100$ .

The average results obtained from numerous experiments are as follows: The ratio of weight of blood to weight of body is, in the dog, 7.7 per cent.; rabbit and cat, 5 per cent.; birds, 10 per cent. On man we have upon record two determinations on guillotined criminals made by Bischoff, which gave 7.7 and 7.2 per cent. Haldane and Smith,\* however, have devised a modification of Gréhan's carbon monoxid method, which they have applied to living men. The results of some 74 experiments gave them an average value of only 5 per cent. for man. The distribution of this blood in the tissues of the body at any time has been estimated by Ranke,† from experiments on freshly killed rabbits, as follows :

Spleen .....	0.23 per cent.
Brain and cord .....	1.24 " "
Kidneys .....	1.63 " "
Skin .....	2.10 " "
Intestines .....	6.30 " "
Bones .....	8.24 " "
Heart, lungs, and great blood-vessels .....	22.76 " "
Resting muscles .....	29.20 " "
Liver .....	29.30 " "

It will be seen from inspection of this table that in the rabbit the blood of the body is distributed at any one time about as follows: One-fourth to the heart, lungs, and great blood-vessels; one-fourth to the liver; one-fourth to the resting muscles; and one-fourth to the remaining organs.

**Regeneration of the Blood after Hemorrhage.**—A large portion of the entire quantity of blood in the body may be lost suddenly by hemorrhage without producing a fatal result. The extent of hemorrhage that may be recovered from safely has been investigated upon a number of animals. Although the results show more or less individual variation, it may be said that in dogs a hemorrhage of from 2 to 3 per cent. of the body-weight‡ is re-

\* Haldane and Smith, "Journal of Physiology," 25, 331, 1900; also Zuntz and Pletsch, "Biochemische Zeitschrift," 47, 1908.

† Taken from Vierordt's "Anatomische, physiologische, und physikalische Daten und Tabellen," Jena, 1893.

‡ Frederic, "Travaux du Laboratoire" (Université de Liège), 1, 189, 1885.

covered from easily, while a loss of 4.5 per cent., more than half the entire blood, will probably prove fatal. In cats a hemorrhage of from 2 to 3 per cent. of the body-weight is not usually followed by a fatal result. Just what percentage of loss may be borne by the human being has not been determined, but it is probable that a healthy individual may recover without serious difficulty from the loss of a quantity of blood amounting to as much as 3 per cent. of

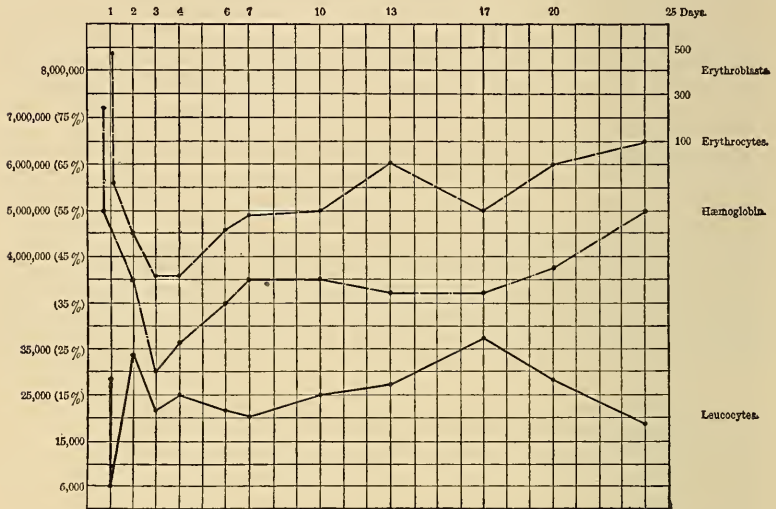

Fig. 187.—To show the effect of hemorrhage upon the number of red and white corpuscles and the amount of hemoglobin.—(Dawson.) The ordinates express the numbers of corpuscles and also the percentages of hemoglobin as stated in the figures to the left. The abscissas give the days after hemorrhage. The experiment was made upon a dog of 8.1 kgms. The hemorrhage, which lasted 2.3 minutes, was equal to 4.3 per cent. of the body-weight. An equal amount of physiological saline (NaCl, 0.8 per cent.) was injected immediately.

the body-weight. It is known that if liquids that are isotonic to the blood, such as physiological saline (NaCl, 0.7 to 0.9 per cent.) or Ringer's solution, are injected into the veins immediately after a severe hemorrhage, recovery is more certain; in fact, it is possible by this means to restore persons after a hemorrhage that would otherwise have been fatal. By an infusion of this kind, particularly if at or somewhat above the body temperature, the heart beat is increased, the volume of the circulating liquid is brought to an amount sufficient to maintain approximately normal conditions of pressure and velocity, and the red corpuscles that still remain are kept in more rapid circulation and are thus utilized more completely as oxygen carriers. If a hemorrhage has not been fatal, experiments on lower animals show that the plasma of the blood is regenerated with some rapidity, the blood regaining its normal vol-



ume within a few hours in slight hemorrhages, and in from twenty-four to forty-eight hours if the loss of blood has been severe; but the number of red corpuscles and the hemoglobin are restored more slowly, getting back to normal only after a number of days or after several weeks. The accompanying curves illustrate the results of a severe hemorrhage (4.3 per cent. of the body-weight) followed by transfusion of an equal volume of physiological saline. So far as the red corpuscles and the amount of hemoglobin are concerned, it will be noticed that the large sudden fall from the hemorrhage, first day, is followed by a slower drop in both factors during the second and third days. This latter phenomenon constitutes what is known as the posthemorrhagic fall.\*

**Blood-transfusion.**—Shortly after the discovery of the circulation of the blood (Harvey, 1628), the operation was introduced of transfusing blood from one individual to another or from some of the lower animals to man. Extravagant hopes were held as to the value of such transfusion not only as a means of replacing the blood lost by hemorrhage, but also as a cure for various infirmities and diseases. Then and subsequently fatal as well as successful results followed the operation. So far as the use of the blood of another animal is concerned, it is now known to be a dangerous undertaking, mainly because the serum of one animal may be toxic to another or cause a destruction of its blood corpuscles. Owing to this hemolytic and toxic action, which has previously been referred to (p. 423), the injection of foreign blood is likely to be directly injurious instead of beneficial. In human surgery modern technic (Carrel) has overcome some of the difficulties formerly encountered in the transfusion of blood from one human being to another. Anastomoses may be made between the blood-vessels of the "donor" and the "recipient," so that the blood passes from one to the other without coming into contact with a foreign surface and, therefore, without danger of coagulation or the formation of thrombin. Other simpler methods are used successfully for the same purpose. For example, the blood may be taken from the vein of a "donor" with a syringe and immediately introduced into the vein of the "recipient." Such methods of transfusion are used very frequently at the present time and often with good results. In cases of loss of blood from severe hemorrhage it is simpler and usually quite sufficient to inject a neutral liquid, such as the so-called "physiological salt solution"—a solution of sodium chlorid of such a strength (0.7 to 0.9) as will suffice to prevent hemolysis of the red corpuscles.

\* Dawson, "American Journal of Physiology," 4, 1, 1900.

## CHAPTER XXIV.

### COMPOSITION AND FORMATION OF LYMPH.

Lymph is a colorless liquid found in the lymph-vessels as well as in the extravascular spaces of the body. All the tissue elements, in fact, may be regarded as being bathed in lymph. To understand its occurrence in the body one has only to bear in mind its method of origin from the blood. Throughout the entire body there is a rich supply of blood-vessels penetrating every tissue with the exception of the epidermis and some epidermal structures, as the nails and the hair. The plasma of the blood, by the action of physical or chemical processes, the details of which are not yet entirely understood, makes its way through the thin walls of the capillaries, and is thus brought into immediate contact with the tissues, to which it brings the nourishment and oxygen of the blood and from which it removes the waste products of metabolism. This extravascular lymph is collected into small capillary spaces which in turn open into definite lymphatic vessels. It is still a question among the histologists whether the lymph-vessels form a closed system or are in direct anatomical connection with the tissue spaces. Modern work\* supports the view that the lymph capillaries are closed vessels similar in structure to the blood capillaries. They end in the tissues generally, but are not in open communication with the spaces between the cellular elements or with the larger serous cavities between the folds of the peritoneum, pleura, etc., or with the spaces between the meningeal membranes surrounding the central nervous system. From the physiological standpoint, however, the liquid in these latter cavities, the cerebrospinal liquid and the liquid bathing the tissue elements, must be regarded as a part of the general supply of lymph and as being in communication with the liquid contained in the lymph-vessels. That is to say, the water and the dissolved substances contained in the tissue spaces interchange more or less freely with the lymph proper found in the formed lymph-vessels. The lymph-vessels unite to form larger and larger trunks, making eventually one main trunk, the thoracic or left lymphatic duct,

\* See Sabin, "American Journal of Anatomy," 1, 367, 1902, and 3, 183, 1904; also "General and Special Anatomy of the Lymphatics," from Poirier and Charpy, translated by Leaf, 1904.

and a second smaller right lymphatic duct, which open into the blood-vessels, each on its own side, at the junction of the subclavian and internal jugular veins. While the supply of lymph in the lymph-vessels may be considered as being derived ultimately entirely from the blood-plasma, it is well to bear in mind that at any given moment this supply may be altered by direct interchange with the plasma on one side and the extravascular lymph permeating the tissue elements on the other. The intravascular lymph may be augmented, for example, by a flow of water from the blood-plasma into the lymph-spaces, and thence into the lymph-vessels, or by a flow from the tissue elements into the lymph-spaces that surround them. The lymph movement is from the tissues to the veins, and the flow is maintained chiefly by the difference in pressure between the lymph at its origin in the tissues and in the large lymphatic vessels. The continual formation of lymph in the tissues leads to the development of a relatively high pressure in the lymph capillaries, and as a result of this the lymph is forced toward the point of lowest pressure—namely, the points of junction of the large lymph-ducts with the venous system. A brief discussion of the factors concerned in the movement of lymph will be found in the section on Circulation. As would be inferred from its origin, the composition of the intravascular lymph is essentially the same as that of blood-plasma. It contains the three blood proteins, the extractives (urea, fat, lecithin, cholesterin, sugar), and inorganic salts. The salts are found in the same proportions as in the plasma; the proteins are usually stated to be less in amount. Histological examination shows that the lymph contains many leucocytes almost all of which belong to the group of small lymphocytes. Red corpuscles are frequently found, especially when the flow of lymph has been stimulated by artificial means. It is believed usually that these red corpuscles are not a normal or constant element of the lymph, but represent, so to speak, an accidental constituent. When red corpuscles for any reason get through the capillary walls into the tissue-spaces they are gathered up in the lymph-stream. Blood-platelets seem to be entirely lacking. Lymph, like blood, coagulates when removed from the lymph-vessels. Ordinarily the clotting is slower than with blood, and the clot is not so firm. If, however, tissue extract is added to the lymph, it clots rapidly and firmly. Chemical examination shows that, like the blood, the lymph contains fibrinogen, prothrombin, antithrombin, and calcium salts. When collected without contamination with tissue-juice, its slower and feebler clotting as compared with the blood may be explained by the absence of the blood-platelets. The composition of the exuda-

tive liquids of the body, such as the pericardial liquid, the synovial liquid, the aqueous humor, the cerebrospinal liquid, etc., which are sometimes classed under the general term "lymph," may vary greatly; thus, the cerebrospinal liquid possesses no morphological elements, contains no fibrinogen, and, therefore, does not clot, and, indeed, has only minute traces of protein of any kind.

**Formation of Lymph.**—The careful researches of Ludwig and his pupils were formerly believed to prove that the lymph is derived directly from the plasma of the blood mainly by filtration through the capillary walls. Emphasis was laid on the undoubted fact that the blood within the capillaries is under a pressure higher than that prevailing in the tissues outside, and it was supposed that this excess of pressure is sufficient to squeeze the plasma of the blood through the very thin capillary walls. Various conditions that alter the pressure of the blood were shown to influence the amount of lymph formed in accordance with the demands of a theory of filtration. Moreover, the composition of lymph as usually given seems to support such a theory, inasmuch as the inorganic salts contained in it are in the same concentration, approximately, as in blood-plasma, while the proteins are in less concentration, following the well-known law that in the filtration of colloids through animal membranes the filtrate is more dilute than the original solution. This simple and apparently satisfactory theory has been subjected to critical examination within recent years, and it has been shown that filtration alone does not suffice to explain the composition of the lymph under all circumstances. At present two divergent views are held upon the subject. According to some physiologists, all the facts known with regard to the composition of lymph may be satisfactorily explained if we suppose that this liquid is formed from blood-plasma by the combined action of the physical processes of filtration, diffusion, and osmosis. According to others, it is believed that, in addition to filtration and diffusion, it is necessary to assume an active secretory process on the part of the endothelial cells composing the capillary walls. The actual condition of our knowledge of the subject can be presented most easily by briefly stating some of the objections that have been raised by Heidenhain\* to a pure filtration-and-diffusion theory, and indicating how these objections have been met.

1. Heidenhain showed by simple calculations that an impossible formation of lymph would be required, upon the filtration theory, to supply the chemical needs of the organs in various organic and inorganic constituents. Thus, to take an illustration that has been much discussed, one kilogram of cows' milk contains 1.7 gms. CaO and the entire milk of twenty-four hours would contain, in round

\* "Archiv f. die gesammte Physiologie," 49, 209, 1891.

numbers, 42.5 gms. CaO. Since the lymph contains normally about 0.18 part of CaO per thousand, it would require 236 liters of lymph per day to supply the necessary CaO to the mammary glands. Heidenhain himself suggests that the difficulty in this case may be met by assuming active diffusion processes in connection with filtration. If, for instance, in the case cited, we suppose that the calcium of the lymph is quickly combined by the tissues of the mammary gland, then the diffusion tension of calcium salts in the tissue will be kept at zero, and an active diffusion of calcium into the lymph will occur so long as the gland is secreting. In other words, the gland will receive its calcium by much the same process as it receives its oxygen, and will get its daily supply from a comparatively small bulk of lymph. Strictly speaking, therefore, the difficulty we are dealing with here shows only the insufficiency of a pure filtration theory. It seems possible that filtration and diffusion together would suffice to supply the organs, so far at least as the diffusible substances are concerned.

2. Heidenhain found that occlusion of the inferior vena cava causes not only an increase in the flow of lymph—as might be expected, on the filtration theory, from the consequent rise of pressure in the capillary regions—but also an increased concentration in the percentage of protein in the lymph. This latter fact has been satisfactorily explained by the experiments of Starling.\* According to this observer, the lymph formed in the liver is normally more concentrated than that of the rest of the body. The occlusion of the vena cava causes a marked rise in the capillary pressure in the liver, and most of the increased lymph-flow under these circumstances comes from the liver; hence the greater concentration. The results of this experiment, therefore, do not antagonize the filtration-and-diffusion theory.

3. Heidenhain discovered that extracts of various substances, which he designated as “lymphagogues of the first class,” cause a marked increase in the flow of lymph from the thoracic duct, the lymph being more concentrated than normal, and the increased flow continuing for a long period. Nevertheless, these substances cause little, if any, increase in general arterial pressure; in fact, if injected in sufficient quantity they produce usually a fall of arterial pressure. The substances belonging to this class comprise such things as peptone, egg-albumin, extracts of liver and intestine, and especially extracts of the muscles of crabs, crayfish, mussels, and leeches. Heidenhain supposed that these extracts contain an organic substance which acts as a specific stimulus to the endothelial cells of the capillaries and increases their secretory action. The results of the action of these substances has been differently explained by

\* “Journal of Physiology,” 16, 234, 1894.

those who are unwilling to believe in the secretion theory. Starling\* finds experimentally that the increased flow of lymph in this case, as after obstruction of the vena cava, comes mainly from the liver. There is at the same time in the portal area an increased pressure that may account in part for the greater flow of lymph; but, since this effect upon the portal pressure lasts but a short time, while the greater flow of lymph may continue for one or two hours, it is obvious that this factor alone does not suffice to explain the result of the injections. Starling suggests, therefore, that these extracts act pathologically upon the blood capillaries, particularly those of the liver, and render them more permeable, so that a greater quantity of concentrated lymph flows through them. Starling's explanation is supported by the experiments of Popoff.† According to this observer, if the lymph is collected simultaneously from the lower portion of the thoracic duct, which conveys the lymph from the abdominal organs, and from the upper part, which contains the lymph from the head, neck, etc., it is found that injection of peptone increases the flow only from the abdominal organs. Popoff finds also that the peptone causes a dilatation in the intestinal circulation and a marked rise in the portal pressure. At the same time there is some evidence of injury to the walls of the blood-vessels from the occurrence of extravasations in the intestine. As far, therefore, as the action of the lymphagogues of the first class is concerned, it may be said that the advocates of the filtration-and-diffusion theory have suggested a plausible explanation in accord with their theory. The facts emphasized by Heidenhain with regard to this class of substances do not compel us to assume a secretory function for the endothelial cells.

4. Injection of certain crystalline substances—such as sugar, sodium chlorid and other neutral salts—causes a marked increase in the flow of lymph from the thoracic duct. The lymph in these cases is more dilute than normal, and the blood-plasma also becomes more watery, thus indicating that the increase in water comes from the tissues themselves. Heidenhain designated these bodies as "lymphagogues of the second class." His explanation of their action is that the crystalloid materials introduced into the blood are eliminated by the secretory activity of the endothelial cells, and that they then attract water from the tissue liquid, thus augmenting the flow of lymph. These substances cause but little change in arterial blood-pressure; hence Heidenhain thought that the greater flow of lymph can not be explained by an increased filtration. Starling‡ has shown, however, that, although these bodies may not

\* "Journal of Physiology," 17, 30, 1894.

† "Centralblatt f. Physiologie," 9, No. 2, 1895.

‡ *Loc. cit.*

seriously alter general arterial pressure, they may greatly augment intracapillary pressure, particularly in the abdominal organs. His explanation of the greater flow of lymph in these cases is as follows: "On their injection into the blood the osmotic pressure of the circulating fluid is largely increased. In consequence of this increase water is attracted from lymph and tissues into the blood by a process of osmosis, until the osmotic pressure of the circulating fluid is restored to normal. A condition of hydremic plethora is thereby produced, attended with a rise of pressure in the capillaries generally, especially in those of the abdominal viscera. This rise of pressure will be proportional to the increase in the volume of the blood, and therefore to the osmotic pressure of the solutions injected. The rise of capillary pressure causes great increase in the transudation of fluid from the capillaries, and therefore in the lymph-flow from the thoracic duct." This explanation is well supported by experiments, and seems to obviate the necessity of assuming a secretory action on the part of the capillary walls.

5. Numerous other experiments have been devised by Heidenhain and his followers to show that the physical laws of filtration, diffusion, and osmosis do not suffice to explain the production of lymph; but in all these cases possible explanations have been suggested in terms of the physical laws, so that it may be said that the facts do not compel us to assume a secretory activity on the part of the endothelial cells of the capillaries. Asher\* and his co-workers have brought forward many facts to show that the lymph is controlled as to its amount by the activity of the tissue elements and may be considered as a product of the activity of the tissues, as a secretion, in fact, of the working cells. When the salivary glands, the liver, etc., are in greater functional activity the flow of lymph from them is increased beyond doubt, so that the activity of the organs does influence most markedly the production of lymph. Most physiologists, however, prefer to explain this relationship on the view suggested by Koranyi, Starling, and others,—namely, that in the metabolic changes of functional activity the large molecules of protein, fat, etc., are broken down to a number of simpler ones, the number of particles in solution is increased and therefore the osmotic pressure is increased. According to most observers the molecular concentration of the lymph in the thoracic duct, and, therefore, the osmotic pressure, is greater than that of the blood. Thus Botazzi,† in one experiment, reports that the lowering of the freezing-point of the blood-serum was  $\Delta = 0.595^{\circ}$  C., while that of the lymph from the thoracic duct of the same

\* "Zeitschrift f. Biologie," vols. xxxvi-xl, 1897 to 1900.

† Quoted from Magnus, "Handbuch der Biochemie," 1908, vol. ii.<sup>2</sup> (Formation of Lymph).

animal was  $\Delta = 0.615^{\circ}$  C. Back in the tissues, where physiological oxidations are going on, this difference is probably greater, and greater in proportion to the activity of the tissues. We can understand that in this way functional activity of an organ may result in attracting more water from the blood-capillaries into the tissue spaces and may thus cause an augmented flow of lymph. It is to be borne in mind that the liquid of the tissues may be drained off not only through the lymph-vessels but also through the blood-vessels. That liquids injected directly into the tissues or special substances dissolved in such liquids may be absorbed directly by the blood has long been known. Magendie, for example, proved that when a poison was injected into an organ which was connected with the rest of the body only by its blood-vessels, the animal quickly showed the symptoms of a corresponding intoxication. Ordinary hypodermic injections are absorbed much more quickly into the general circulation than would be the case if they were obliged to traverse the lymph-vessels and enter the blood through the thoracic duct. Meltzer has shown that this absorption by the blood from the tissue spaces takes place with especial promptness if the injection is made into a mass of muscular tissue.

The liquid in the extravascular tissue spaces is, in fact, subject to a play of influences from several sides, and it is the balance among these competing influences which determines at any time the amount and composition of this tissue lymph. Thus, the supply of this liquid is furnished, on the one hand, by water and dissolved substances coming to it from the blood in the capillaries, on the other hand, by water and dissolved substances derived from the great reservoir contained in the tissue cells. The amount of the tissue lymph is continually depleted on the other side by water and dissolved substances passing back into the capillaries, or into the tissue elements, or, finally, into the lymph capillaries. The amount that passes by this latter route varies greatly in the different tissues, and in the same tissue may be influenced greatly by pathological as well as normal changes in conditions.

**Summary of the Factors Controlling the Flow of Lymph.—**

We may adopt, provisionally at least, the so-called mechanical theory of the origin of lymph. Upon this theory the forces in activity are, first, the intracapillary pressure tending to filter the plasma through the endothelial cells composing the walls of the capillaries, and second, that form of molecular energy which gives rise to the phenomena of diffusion and osmotic pressure. By the action of this force, the flow of water from one place to another is influenced in accordance with the difference in concen-



tration of the dissolved substances. These two forces acting everywhere control primarily the amount and composition of the lymph; but still another factor must be considered; for when we come to examine the flow of lymph in different parts of the body striking differences are found. It has been shown, for instance, that in the limbs, under normal conditions, the flow is extremely scanty, while from the liver and the intestinal area it is relatively abundant. In fact, the lymph of the thoracic duct may be considered as being derived almost entirely from the latter two regions. Moreover, the lymph from the liver is characterized by a greater percentage of proteins. To account for these differences Starling suggests the plausible explanation of a variation in permeability in the capillary walls. This factor is evidently one of great importance, although it is not possible to state the character of the changes supposed to occur. One helpful suggestion that rests upon experimental evidence is that the concentration of bases, especially of the calcium, contained in the substance of the vessel-walls, affects greatly their physical properties and permeability. It is evident that constituents of this kind may vary with the character of the food, or in general with the composition of the blood. The idea that the permeability of the capillaries may vary under different conditions has long been used in pathology to explain the production of that excess of lymph which gives rise to the condition of dropsy or edema. The theories and experiments made in connection with this pathological condition have, in fact, a direct bearing upon the theories of lymph formation.\* Under normal conditions the lymph is drained off as it is formed, while under pathological conditions it may accumulate in the tissues owing either to an excessive formation of lymph or to some interruption in its circulation.

The scanty flow of lymph from the limbs has been referred by Magnus† to another possible cause, namely, to the great capacity of the muscular tissue to imbibe water (and salts). According to this author the tissues, particularly the muscular tissues, constitute great reservoirs in which excess of water and salts may be stored. If, for example, a hypotonic solution of sodium chloride is injected into the circulation, most of the water added will be removed from the circulation by imbibition into the muscular tissues. In the limbs, with their large supply of muscular tissue, it may be that lymph is formed as elsewhere from the blood plasma, but it is held back from the lymph-vessels by absorption into the muscular mass.

\* Consult Meltzer, "Edema" ("Harrington Lectures"), "American Medicine," 8, Nos. 1, 2, 4, and 5, 1904.

† Magnus, *Loc cit.*

From the foregoing considerations it is evident that changes in capillary pressure, however produced, may alter the flow of lymph from the blood-vessels to the tissues, by increasing or decreasing, as the case may be, the amount of filtration; changes in the composition of the blood, such as follow periods of digestion, will cause diffusion and osmotic streams tending to equalize the composition of blood and lymph; and changes in the tissues themselves following upon physiological or pathological activity will also disturb the equilibrium of composition, and, therefore, set up diffusion and osmotic currents. In this way a continual interchange is taking place by means of which the nutrition of the tissues is effected, each according to its needs. The details of this interchange must of necessity be very complex when we consider the possibilities of local effects in different parts of the body. The total effects of general changes, such as may be produced experimentally, are simpler, and, as we have seen, are explained satisfactorily by the physical and chemical factors enumerated.

## SECTION V.

### PHYSIOLOGY OF THE ORGANS OF CIRCULATION OF THE BLOOD AND LYMPH.

The heart and the blood-vessels form a closed vascular system containing a certain amount of blood. This blood is kept in endless circulation mainly by the force of the muscular contractions of the heart. But the bed through which it flows varies greatly in width at different parts of the circuit, and the resistance offered to the moving blood is very much greater in the capillaries than in the large vessels. It follows from the irregularities in size of the channels through which it flows that the blood-stream is not uniform in character throughout the entire circuit; indeed, just the opposite is true. From point to point in the branching system of vessels the blood varies in regard to its velocity, its head of pressure, etc. These variations are connected in part with the fixed structure of the system and in part are dependent upon the changing properties of the living matter of which the system is composed. It is convenient to consider the subject under three general heads: (1) The purely physical factors of the circulation,—that is, the mechanics and hydrodynamics of the flow of a definite quantity of blood through a set of fixed tubes of varying caliber under certain fixed conditions. (2) The general physiology of the heart and the blood-vessels,—that is, mainly the special properties of the heart muscle and the plain muscle of the blood-vessels. (3) The innervation of the heart and the blood-vessels,—that is, the variations in the circulation produced by the action of the nervous system.

---

## CHAPTER XXV.

### THE VELOCITY AND PRESSURE OF THE BLOOD-FLOW.

**The Circulation as Seen Under the Microscope.**—It is a comparatively easy matter to arrange a thin membrane in a living animal so that the flowing blood may be observed with the aid of a microscope. For such a purpose one generally employs the web between the toes of a frog, or better still the mesentery, lungs, or bladder of the same animal. With a good preparation many

important peculiarities in the blood-flow may be observed directly. If the field is properly chosen one may see at the same time the flow in arteries, capillaries, and veins. It will be noticed that in the arteries the flow is very rapid and somewhat intermittent,—that is, there is a slight acceleration of velocity, a pulse, with each heart beat. In the capillaries, on the contrary, the flow is relatively very slow; the change from the rushing arterial stream to the deliberate current in the capillaries takes place, indeed, with some suddenness. The capillary flow, as a rule, shows no pulses corresponding with the heart beats, but it may be more or less irregular,—that is, the flow may nearly cease at times in some capillaries, while again it becomes distinct and uniform. In the veins the flow increases markedly in rapidity, and, indeed, it may be observed that the larger the vein, the more rapid is the flow. There is not, however, as a rule, any indication of an intermittence or pulse in this flow—the velocity is entirely uniform. In both arteries and veins it will be noticed that the red corpuscles form a solid column or core in the middle of the vessel, and that between them and the inner wall there is a layer of plasma containing only, under normal conditions, an occasional leucocyte. The accumulation of corpuscles in the middle of the stream makes what is known as the *axial stream*, while the clear layer of plasma is designated as the *inert layer*. The phenomenon is readily explained by physical causes. As the blood flows rapidly through the small vessels the layers nearer the wall are slowed by adhesion, so that the greatest velocity is attained in the middle or axis of the vessel. The corpuscles, being heavier than the plasma, are drawn into this rapid part of the current. It has been shown by physical experiments that, when particles of different specific gravities are present in a liquid flowing rapidly through tubes, the heavier particles will be found in the axis and the lighter ones toward the periphery. In accordance with this fact, leucocytes, which are lighter than the red corpuscles, may be found in the inert layer. When the conditions become slightly abnormal (incipient inflammation) the leucocytes increase in number in the inert layer sometimes to a very great extent, owing apparently to some alteration in the endothelial walls whereby the leucocytes are rendered more adhesive. The agglutination of the leucocytes and their migration through the walls into the surrounding tissues are described in works on Pathology.

**The Velocity and Volume of the Blood-flow.**—The microscopical observations described above show that the velocity of the blood-current varies widely, being rapid in the arteries and veins and slow in the capillaries. To ascertain the actual velocity in the larger vessels and the variations in vessels of different sizes experimental determinations are necessary. While the general principle involved

in these determinations is simple, their actual execution in an experiment is attended with some difficulties, and various devices have been adopted. The most direct method perhaps is that used in the instrument devised by Ludwig,—namely, the *stromuhr*. The principle used is to cut an artery or vein of a known size and determine how much blood flows out in a given time. We may define the velocity of the blood at any point as the length of the column of blood flowing by that point in a second. If we cut the artery there a cylindrical column of blood of a definite length and with a cross-area equal to that of the lumen of the artery will flow out in a second. The volume of the outflow can be determined directly by catching the blood. Knowing this volume and the cross-area of the artery, we can determine the length of the column—that is, the velocity of the flow—since in a cylinder the volume,  $V$ , is equal to the product of the length into the cross-area.

$$V = \text{length} \times \text{cross-area, or} \\ \text{length} = \frac{V}{\text{cross-area}}$$

We cannot, of course, make the experiment in this simple way upon a living animal; the loss of so much blood would at once change the physical and physiological conditions of the circulation, and would give us a set of conditions at the end of the experiment different from those at the beginning. By means of the *stromuhr*, however, this experiment can be made, with this important

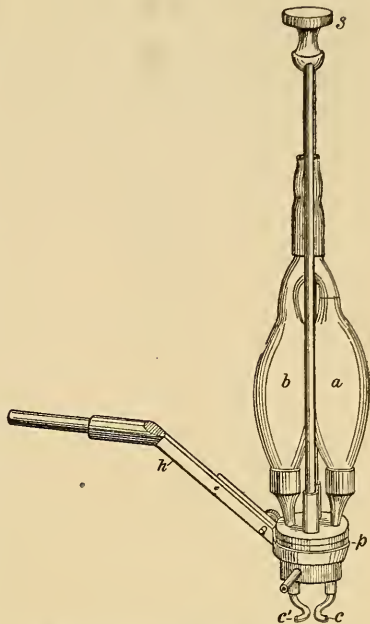

Fig. 188.—Ludwig's *stromuhr*:  $a$  and  $b$ , The glass bulbs;  $a$  is filled with oil to the mark (5 c.c.), while  $b$  and the neck are filled with salt solution or defibrinated blood;  $p$ , the movable plate by means of which the bulbs may be turned through 180 degrees;  $c, c'$ , for the cannulas inserted into the artery;  $s$ , the thumb screw for turning the bulbs;  $h$ , the holder. When in place the clamps on the arteries are removed, blood flows through  $c$  into  $a$ , driving out the oil and forcing the salt solution in  $b$  into the head end of the artery through  $c'$ . When the blood entering  $a$  reaches the mark, the bulbs are turned through 180 degrees so that  $b$  lies over  $c$ . The blood flows into  $b$  and drives the oil back into  $a$ . When it just fills this bulb, they are again rotated through 180 degrees, and so on. The oil is driven out of and into  $a$  a given number of times, each movement being equal to an outflow of 5 c.c. of blood. When the instrument has been turned, say, ten times, 50 c.c. of blood have flowed out. Knowing the time and the caliber of the artery, the calculation is made as described in the text. Several modifications of the form of this instrument have been devised.\*

\* A modification by Tigerstedt is described in the "Skandinavisches Archiv f. Physiol.," 3, 152, 1891. One by Burton-Opitz in the "Arch. f. d. ges. Physiologie," 121, 151, 1908.

variation, that the blood that flows from the central end of the cut artery is returned to the peripheral end of the same artery, so that the circulation is not blocked nor deprived of its normal volume of liquid. The instrument, as is explained in the legend of Fig. 188, measures the volume of blood that flows out of the cut end of an artery in a definite time. The calculation for velocity is made as

follows: Suppose that the capacity of the bulb is 5 c.c., and that in the experiment it has been filled 10 times in 50 seconds,—*i. e.*, the bulbs have been reversed 10 times; then obviously  $10 \times 5$  or 50 c.c. have flowed out of the artery in this time, or 1 c.c. in 1 second. The diameter of the vessel can be measured, and if found equal, say, to 2 mms., then its cross-area is  $\pi r^2 = 3.15 \times 1 = 3.15$ . Since 1 c.c. equals 1000 c.mm., the length of our cylinder of blood would be given by the quotient of  $\frac{1000}{3.15} = 317$  mms. So that the blood in this case was moving with the velocity of 317 mms. per second. Another instrument that has been employed for the same purpose is the *dromograph* or *hemodromograph* of Chauveau.

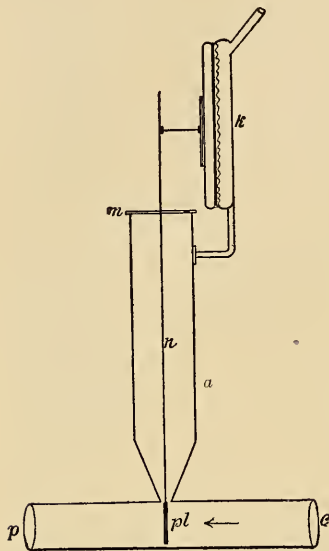

Fig. 189.—Chauveau's hemodromograph (after Langendorff). The tube, *p-c*, is placed in the course of an artery, the blood after removal of clamps flowing in the direction shown by the arrow. The current strikes the plate, *pl*, and forces it to an angle varying with the velocity. The movement of *pl* is transmitted through the stem, *n*, which moves in a rubber membrane as a fulcrum, *m*. The angular movement of the projecting end of *n* may be measured directly or may be made to act upon a tambour, as shown in the figure, and thus be transmitted to a recording drum.

plate lying in the tube (*pl*). When the instrument is in place and the blood is allowed to stream through the tube, it deflects the needle, which turns on its insertion through the rubber as a fulcrum. The angle of deflection of the free end of the needle may be measured directly upon a scale or it may be transmitted through tambours and recorded upon a kymographion. The instrument must, of course, be graduated by passing through it currents of known velocity, so that the angle of deflection may be expressed in terms of absolute velocities. It possesses a great advantage over the stromuhr in that it gives not simply the average

velocity during a given time, but also the variations in velocity coincident with the heart beat or other changes that may occur during the period of observation. By means of instruments of this kind it is possible to determine not only the velocity in any large artery or vein at a given moment, but also the total volume of flow into or out of an organ during a given period of time. Data of the latter kind give us an idea of the relative quantity of blood supplied to each organ and the differences in this respect between the several organs. Burton-Opitz\* on the basis of experiments made by himself and others gives the following figures, which express the blood-supply per minute for each 100 grams of organ:

Posterior extremity . . . . .	5 c.c.	Spleen . . . . .	58 c.c.
Skeletal muscle . . . . .	12 c.c.	Liver (venous) . . . . .	59 c.c.
Head . . . . .	20 c.c.	Liver (total) . . . . .	84 c.c.
Stomach . . . . .	21 c.c.	Brain . . . . .	136 c.c.
Liver (arterial) . . . . .	25 c.c.	Kidney . . . . .	150 c.c.
Intestines . . . . .	31 c.c.	Thyroid Gland . . . . .	560 c.c.

**Mean Velocity of the Blood-flow in the Arteries, Veins, and Capillaries.**—Actual determinations of the average velocity in the large arteries and veins give such results as the following: Carotid of horse (Volkman), 300 mms. per second; (Chauveau) 297 mms. Carotid of the dog (Vierordt), 260 mms.

The flow in the carotid, as in the other large arteries, is not, however, uniform; there is a marked acceleration or pulse at each systole of the heart during which the velocity is greatly augmented. Thus, in the carotid of the horse it has been shown by the hemodromograph that during the systole the velocity may reach 520 mms. and may fall to 150 mms. during the diastole. It is found, also, that this difference between the systolic velocity and the diastolic velocity tends to disappear as the arteries become smaller, and, as was said above, disappears altogether in the capillaries, in which the pulse caused by the heart beat is lacking. The smaller the artery, therefore, the more uniform is the movement of the blood.

The flow in the large veins is uniform or approximately uniform and increases as one approaches the heart, although the velocity in the large veins near the heart is somewhat slower than in the large arteries of the same region, owing to the fact that the total area of the venous bed is larger than that of the arterial bed. Burton-Opitz† gives the following average figures obtained from experiments upon anesthetized dogs. Jugular, 147 mms.; femoral, 61.6 mms.; renal, 63 mms.; mesenteric vein, 84.9 mms. In the capillaries, however, the velocity is relatively very small. From direct observations made by means of the microscope and from indirect observations in the case of man,

\* Burton-Opitz, "Quarterly Jour. of Experimental Physiology," 4, 117, 1911.

† Burton-Opitz, "Am. Journal of Physiology," vols. 7 and 9, and "Pflüger's Archiv," vols. 123 and 124, 1908.

the capillary velocity is estimated as lying between 0.5 mm. and 0.9 mm. per sec.

Vierordt reports some interesting calculations upon the velocity of the blood, in the capillaries of his own eye. Under suitable conditions,\* the movements of the corpuscles in the retina may be perceived in consequence of the shadows that they throw upon the rods and cones. The visual images thus produced may be projected upon a surface at a known distance from the eye and the space traversed in a given time may be observed. The distance actually covered upon the retina may then be calculated by the following construction, in which  $A-B$  = the distance traveled by the projected image;  $A-n$ , the distance of the surface from the eye; and  $a-n$ , the distance of the retina from the nodal point of the eye. We have then the proportion  $ab : an :: AB : An$ , or  $ab = \frac{AB \times an}{An}$ . According to this method, Vierordt calculated that the velocity of the blood in the human capillaries is equal to about 0.6 to 0.9 mm. per second.

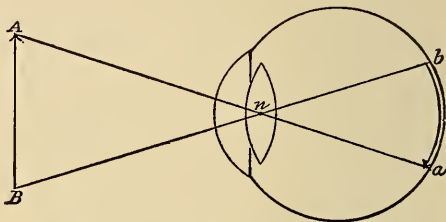

Fig. 190.—Diagram of the eye to show the construction used to determine the size of the retinal image when the size of the external object is known:  $n$ , The nodal point of the eye. See text.

In the arteries, moreover, it may be observed that the average velocity diminishes the farther one goes from the heart,—that is, the smaller the artery,—and reaches its minimum when the arteries pass into the capillaries. Thus, Volkmann reports for the horse the following figures: Carotid, 300 mms.; maxillary, 232; metatarsal, 56 mms. In the veins also the same fact holds. The smaller the vein—that is, the nearer it is to the capillary region—the smaller is its velocity, the maxi-

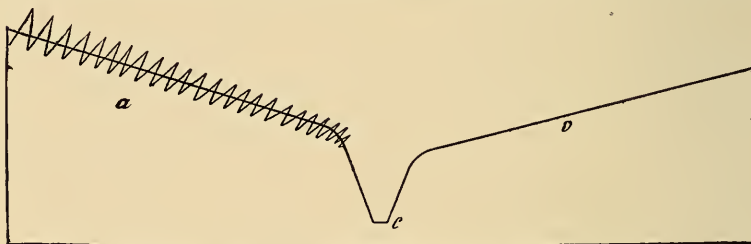

Fig. 191.—Schematic representation of the relative velocities of the blood-current in different parts of the vascular system:  $a$ , The arterial side, indicating the changes with each heart beat and the fall of mean velocity as the arterial bed widens;  $c$ , the capillary region—the great diminution in velocity corresponds with the great widening of the bed;  $v$ , the venous side, showing the gradual increase toward the heart, and represented as entirely uniform, although, as a matter of fact, the velocity in the large veins is affected by the respirations and to a small extent by the heart beat, owing to the phenomenon known as the venous pulse (p. 528).

imum velocity being found in the vena cava. The general relations of the velocity of the blood in the arteries, capillaries, and

\* "Archiv f. physiologische Heilkunde," 15, 255, 1856.



veins may be expressed, therefore, by a curve such as is shown in Fig. 191.

**Explanation of the Variations in Velocity.**—The general relationship between the velocities in the different parts of the vascular system is explained by the difference in the width of the bed in which the blood flows. In the systemic circulation the main stem, the aorta, branches into arteries which, taken individually, are smaller and smaller as we approach the capillaries. But each time that an artery branches the sum of the areas of the two branches is greater than that of the main stem. The arterial system may be compared, in fact, to a tree, the sum of the cross-areas of all the twigs is greater than that of the main trunk. It follows, therefore, that the blood as it passes to the capillaries flows in a bed or is distributed in a bed which becomes wider and wider, and as it returns to the heart in the veins it is collected into a bed that becomes smaller as we approach the heart. Vierordt estimates that the combined calibers of all the capillaries in the systemic circulation would make a tube with a cross-area about 800 times as large as the aorta. If the circulation is proceeding uniformly it follows that for any given unit of time the same volume of blood must pass through any given cross-section of the system,—that is, at a given point in the aorta or vena cava as much blood must flow by in a second as passes through the capillary region—and that consequently where the cross-section or bed is widest the velocity is correspondingly diminished. If the capillary bed is 800 times that of the aorta, then the velocity in the capillaries is  $\frac{1}{800}$  of that in the aorta,—say,  $\frac{1}{800}$  of 320 mms. or 0.4 mm. Just as a stream of water flowing under a constant head reaches its greatest velocity where its bed is narrowest and flows more slowly where the bed widens to the dimensions of a pool or lake.

**Variations in Velocity with Changes in the Heart-beat or the Size of the Vessels.**—While the above statement holds true as an explanation of the general relationship between the velocities in the arteries, veins, and capillaries at any given moment, the absolute velocities in the different parts of the system will, of course, vary whenever any of the conditions acting upon the blood-flow vary. In the large arteries, as has been said, there are extreme fluctuations in velocity at each heart beat; but if we consider only the average velocities it may be said that these will vary throughout the system with the force and rate of the heart beat, or with the variations in size of the small arteries and the resulting changes in blood-pressure in the arteries. Marey\* gives the two following laws: (1) Whatever increases or diminishes the force with which the blood is driven from the heart toward the periphery will cause the velocity of the blood and the pressure in the arteries to vary in

\* "La Circulation du Sang," Paris, 1881, p. 321.

the same sense. (2) Whatever increases or diminishes the resistance offered to the blood in passing from the arteries (to the veins) will cause the velocity and the arterial pressure to vary in an inverse sense as regards each other. That is, an increased resistance diminishes the velocity in the arteries while increasing the pressure, and *vice versa*.

**The Time Necessary for a Complete Circulation of the Blood.**—It is a matter of interest in connection with many physiological questions to have an approximate idea of the time necessary for the blood to make a complete circuit of the vascular system,—that is, starting from any one point to determine how long it will take for a particle of blood to arrive again at the same spot. In considering such a question it must be borne in mind that many different paths are open to the blood, and that the time for a complete circulation will vary somewhat with the circuit actually followed. For example, blood leaving the left ventricle may pass through the coronary system to the right heart and thence through the pulmonary system to the left heart again, or it may pass to the extremities of the toes before getting to the right heart, or it may pass through the intestines, in which case it will have to traverse three capillary areas before completing the circuit. It is obvious, therefore, that any figures obtained can only be regarded as averages more or less exact. The experiments that have been made, however, are valuable in indicating how very rapidly any substance that enters the blood may be distributed over the body. The method first employed by Hering (1829) was to inject into the jugular vein of one side a solution of potassium ferrocyanid, and then from time to time specimens of blood were taken from the jugular vein of the opposite side. The first specimen in which the ferrocyanid could be detected by its reaction with iron salts gave the least time necessary for a complete circuit. The method was subsequently improved in its technical details by Vierordt, and such results as the following were obtained: Dog, 16.32 seconds; horse, 28.8 seconds; rabbit, 7.46 seconds; man (calculated), 23 seconds. The time required is less in the small than in the large animals, and Hering and Vierordt concluded that in general it requires from 26 to 28 beats of the heart to effect a complete circulation. Stewart has devised a simpler and better method,\* based upon the electrical conductivity of the blood. If a solution of a neutral salt, such as sodium chlorid, more concentrated than the blood, is injected into the circulation, the conductivity of the blood is increased. If the injection is made at a given moment and a portion of the vessel to be examined is properly connected with a galvanometer so as to measure the electrical conductivity through it, then the instant that the solution of salt reaches this latter vessel the fact will be indicated by a deflection

\* "Journal of Physiology," 15, 1, 1894.

of the galvanometer. Using this method, Stewart was able to show that in the lesser circulation (the pulmonary circuit) the velocity is very great compared with that of the systemic circulation—only about one-fifth of the time required for a complete circuit is spent in the lesser circulation. Attention may also be called to the fact that the important part of the circulation, as regards the nutritive activity of the blood, is the capillary path. It is while flowing through the capillaries that the chief exchange of gases and food material takes place. The average length of a capillary is estimated at 0.5 mm.; so that with a velocity of 0.5 mm. per second the average duration of the flow of any particle of blood through the capillary area is only about 1 sec.

**The Pressure Relations in the Vascular System.**—That the blood is under different pressures in the several parts of the vascular system has long been known and is easily demonstrated. When an artery is cut the blood flows out in a forcible stream and with spurts corresponding to the heart beats. When a large vein is wounded, on the contrary, although the blood flows out rapidly, the stream has little force. Exact measurements of the hydrostatic pressure under which the blood exists in the large arteries and veins were first published by Rev. Dr. Stephen Hales, an English clergyman, in his famous book entitled "Statical Essays, containing Hæmostaticks," 1733.\* This observer measured the static pressure of the blood in the arteries and veins by the simplest direct method possible. After tying the femoral artery in a horse he connected it to a glass tube 9 feet in length. On opening the vessel the blood mounted in the tube to a height of 8 feet 3 inches, showing that normally in the closed artery the blood is under a tension or pressure sufficient to support the weight of a column of blood of this height. A similar experiment made upon the vein showed a rise of only 12 inches.

**Methods of Recording Blood-pressure.**—Since Hales's work the chief improvements in method which have marked and caused the development of this part of the subject have been the application of the mercury manometer by Poiseuille† (1828), the invention of the recording manometer and kymographion by Ludwig‡ (1847), and the later numerous improvements by many physiologists, and latterly the development of methods for measuring blood-pressures directly in man. The Hales method of measuring arterial pressure directly in terms of a column of blood is inconvenient on account of the great height, large fluctuations, and rapid clotting. The two former disadvantages are overcome by using a column of mercury. Since this metal is 13.5 times as heavy as blood, the column

\* For an account of the life and works of this physiologist see Dawson, "The Johns Hopkins Hospital Bulletin," vol. xv, Nos. 159 to 161, 1904.

† Poiseuille, "Recherches sur la force du cœur aortique." Paris, 1828.

‡ Ludwig, "Müller's Archiv f. Anatomie, Physiologie, etc.," 1847, p. 242

which will be supported by the blood will be correspondingly shorter and all the fluctuations will be similarly reduced. Poiseuille placed the mercury in a U tube of the general form shown in Fig. 192, *M*. One leg was connected with the interior of an artery by appropriate tubing filled with liquid and when the clamp was removed from the vessel its pressure displaced the mercury in the limbs by a certain amount. The difference in height between the levels of the mercury in the two limbs in each experiment gives the blood pressure, which is therefore usually expressed as being equal to so many millimeters of mercury. By this expression it is meant that the pressure within the artery is able to support a column

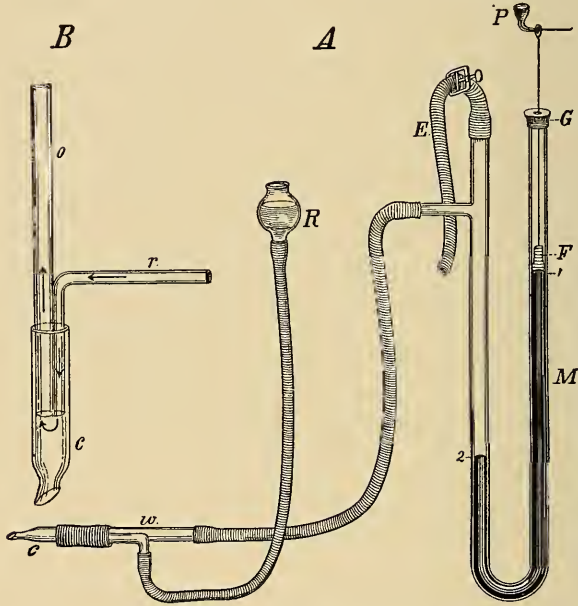

Fig. 192.—*A*, Schema to show the recording mercury manometer and its connection with the artery: *M*, The manometer with the position of the mercury represented in black (the pressure is given by the distance in millimeters between the levels 1 and 2; one-half of this distance is recorded on the kymographion by the pen, *P*); *F*, the float resting upon the surface of the mercury; *G*, the cap through which the stem carrying the pen moves; *E*, offset for driving air out of the manometer and for filling or washing out the tube to the artery; *R*, the receptacle containing the solution of sodium carbonate; *c*, the cannula for insertion into the artery; *w*, the washout arrangement shown in detail in *B*.

*B*, The washout cannula: *c*, the glass cannula inserted into the artery; *r*, the stem connected with the reservoir of carbonate solution; *o*, the stem connected with the manometer. The arrows show the current of carbonate solution during the process of washing out, the artery at that time being closed by a clamp.

of mercury that many millimeters in height, and by multiplying this value by 13.5 the pressure can be obtained, when desirable, in terms of a column of blood or water. For continuous observations and permanent records the height of the column of mercury and its variations during an experiment are recorded by the device represented in Fig. 192.

The distal limb of the U tube in which the mercury rises carries a float of hard rubber, aluminum, or some other substance lighter than the mercury. The float in turn bears an upright steel wire which at the end of the glass tube plays through a small opening in a metal or glass cap. At its free end it bears a pen to trace the record. If smoked paper is used the pen is simply a smooth-pointed glass or metal arm, while if white paper is employed the wire carries a small glass pen with a capillary tube, which writes the record in ink. The tube connecting the proximal end of the manometer to the artery of the animal must be filled with a solution that retards the coagulation of blood. For this purpose one employs ordinarily a saturated solution of sodium carbonate and bicarbonate or a 5 per cent. solution of sodium citrate. This tube is connected also by a T piece to a reservoir containing the carbonate solution, and by varying the height of this latter the pressure in the tube and the manometer may be adjusted beforehand to the pressure that is supposed or known to exist in the artery under experiment. By this means the blood, when connections are made with the manometer, does not penetrate far into the tube, and clotting is thereby delayed. In long observations it is most convenient to use what is known as a *washout cannula*, the structure of which is represented in Fig. 192, B. When this instrument is attached to the cannula inserted into the blood-vessel one can, after first clamping off the artery, wash out the connections between the artery and the manometer with fresh carbonate solution as often as desired. By such means continuous records of arterial pressure may be obtained during many hours. Determinations of the pressure in the veins may be made with a similar apparatus, but owing to the low values that prevail on this side of the circulation it is more convenient to use some form of water manometer and thus record the venous pressures in terms of the height of the water column supported. It should be added also that when it is necessary to know the pressure in any special artery or vein the connections of the manometer are made usually to a side branch opening more or less at right angles into the vessel under investigation, or if this is not possible then a T tube is inserted and the manometer is connected with the side branch. The reason for this procedure is that if the artery itself is ligated and the manometer is connected with its central stump, the flow in it and its dependent system of capillaries and veins is cut off; the stump of the artery constitutes simply a continuation of the tube from the manometer and serves as a side connection to the intact artery from which it arises. Thus, when a manometer is inserted into the carotid artery the pressure that is measured is the side-pressure in the innominate or aorta from which it arises, while a cannula in the central stump of a femoral artery measures the pressure in the iliac. A specimen of what is known as a blood-pressure record is shown in Fig. 193. The exact pressure at any instant, in millimeters of mercury, is obtained by measuring the distance between the base line and the record and multiplying by 2. The base line represents the position of the recording pen when it is at its zero position for the conditions of the experiment. It is necessary to multiply the distance between the base line and the record by 2, because, as is seen in Fig. 191, the recording apparatus measures only the rise of the mercury in one limb of the manometer; there is, of course, an equal fall in the other limb.

The blood-pressure record (Fig. 193) shows usually large rhythmic variations corresponding to the respiratory movements and in addition smaller waves caused by the heart beat. The causes of the respiratory waves of pressure are discussed in the section on respiration. Regarding the heart waves or pulse waves the usual record obtained by means of a mercury manometer gives an entirely false picture of the extent of the variations in pressure caused by the heart beat. The mass of mercury possesses considerable weight and inertia, which unfits it for following accurately very rapid changes in pressure. When the pressure changes are slow, as in the case of

the long respiratory waves seen in the record, the manometer undoubtedly indicates their extent with entire accuracy. But when these changes are very rapid, as in the beat of a dog's or rabbit's heart, the mercury does not register either extreme in the variation, but tends to record the mean or average pressure. The full extent of the variations in arterial pressure caused by the heart beat can be

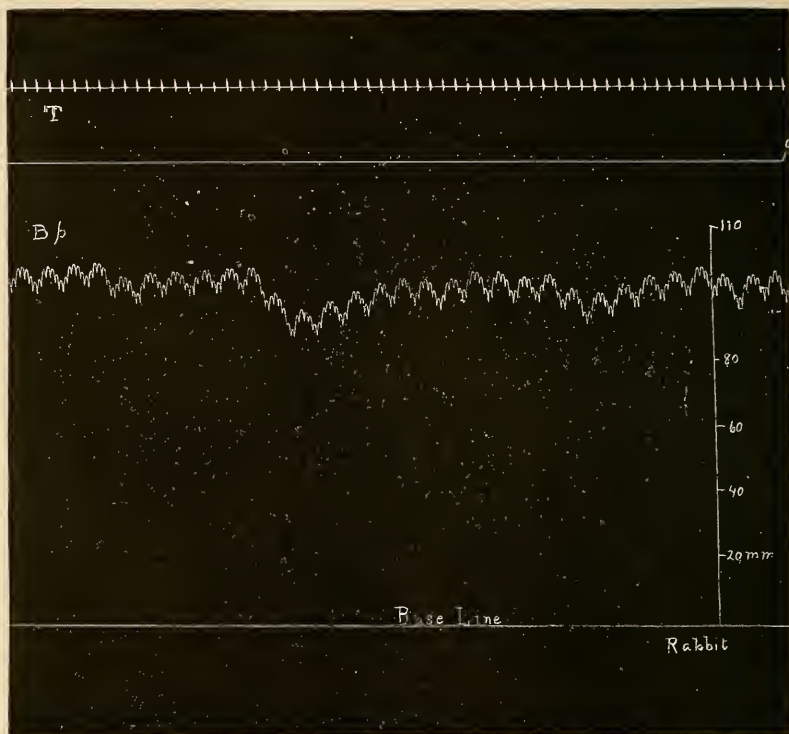

Fig. 193.—Typical blood pressure record with mercury manometer: *Bp*, The record showing the heart beats and the larger curves due to the respirations (respiratory waves of blood-pressure) and still longer waves due to vasomotor changes; *T*, the time line, giving the time in seconds. The actual arterial pressure at any moment is the distance from the base line—that is, the line of zero pressure—to the blood-pressure line, multiplied by two. These values are indicated in the vertical line drawn to the right, which shows that the average pressure at the time of the experiment was 100 mms. Hg. The small size of the variations in pressure due to each heart beat is altogether a false picture due to the inertia of the mercury, its inability to follow completely the quick change. Each heart beat, instead of being lower, should be higher than the respiratory waves.

determined by other means (see below), and, if the knowledge thus obtained is applied to the correction of the record of the mercury manometer, the tracing given in Fig. 193 should have, so far as the heart beats are concerned, somewhat the appearance shown in Fig. 194. This latter figure gives a more accurate mental picture of the actual conditions of pressure in the large arteries, as influenced by

the heart beat. These arteries are, in fact, subject to very rapid and very extensive changes in pressure at each beat of the heart, and these changes are naturally more pronounced when the force of the heart beat is increased,—for instance, by muscular exercise.

**Systolic, Diastolic, and Mean Arterial Pressure.**—As stated in the last paragraph, the arterial pressure in the larger arteries undergoes extensive variations with each heart beat. The maximum pressure caused by the systole of the heart, the apex of the pulse wave, is spoken of as *systolic pressure*; the minimum pressure in the artery—that is, the pressure at the end of the diastole of the heart, or the bottom of the pulse-wave, is known as the *diastolic pressure*. In a dog under ordinary conditions of experimentation the systolic (lateral) pressure in the aorta may be as much as 168 mms., while the diastolic pressure is only 100 mms. In man the

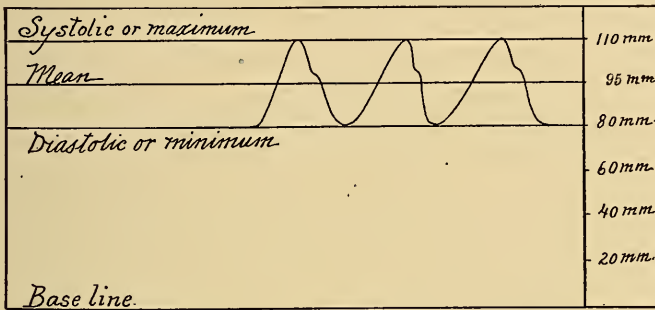

Fig. 194.—Schematic representation of the pressure change caused by each heart beat. The schema represents three heart beats supposed to be recorded on a rapidly moving surface by a manometer delicate enough to follow the pressure changes accurately. The top of the pulse wave measures the systolic pressure; the bottom the diastolic pressure.

systolic pressure as measured in the brachial artery may be taken in round numbers as equal to 110 to 116 mms., while the diastolic pressure is only 65 to 75 mms. The difference between the systolic and the diastolic pressure has been designated conveniently as the *pulse pressure*. It measures, of course, the variation in pressure in any given artery caused by the heart beat, and so far as that artery is concerned it gives the force of the heart beat except for the small component used to accelerate the movement of the blood. From the figures given above it will be seen that the pulse pressure in the brachial artery of man averages 45 mms. Hg. Each systole of the heart distends this artery, therefore, by a sudden increase in pressure equal to the weight of a column of mercury 45 mms. high. As we go outward in the arterial tree the pulse pressure becomes less and less, the oscillations in pressure with each heart beat are less marked, until, finally, in the smallest arteries and

capillaries and in the veins there is no pulse wave, and no difference between systolic and diastolic pressure. In speaking of the pressure in the blood-vessels we refer usually to what is called the mean pressure. It is obvious that, so far as the larger arteries are concerned, the mean pressure is only a convenient expression for the average pressure during a certain period. If, by the methods described below, we determine the systolic and diastolic pressures in the artery of a man, and assume that there has been no general variation between the two observations, we can estimate the mean pressure with approximate accuracy by taking the arithmetical mean of the two figures, or by adding to the diastolic pressure one-half of the pulse pressure.

The arithmetical mean of systolic and diastolic pressures during any given heart-beat does not give the true mean pressure, owing to the form of the pulse wave (see Fig. 214). If the rise from diastolic to systolic pressure and the succeeding fall took place uniformly, so that the pulse curve constituted

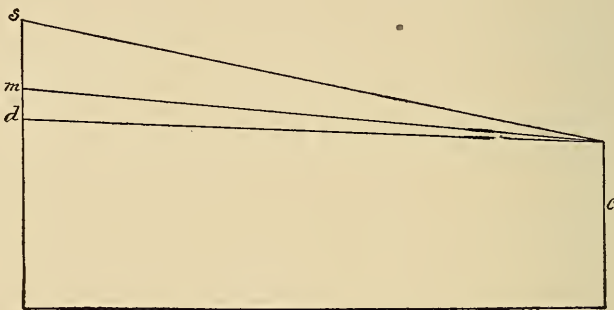

Fig. 195.—Schema to indicate the general relations of systolic, mean, and diastolic pressures throughout the arterial system: *s*, Systolic; *m*, mean; *d*, diastolic; *c*, pressure at beginning of the capillaries. The distance from *s* to *d* represents the pulse pressure at different parts of the arterial system.

a true triangle, the true mean pressure would be given by the arithmetical mean of the two pressures. As a matter of fact, the descending limb of the pulse curve is not a straight but a curved line, and it is broken, moreover, by secondary waves. The position of the mean pressure during any given heart-beat will vary, therefore, with the form of the pulse curve. Generally speaking, it lies nearer to the diastolic than to the systolic level.\*

In physiological observations, as a rule, no attempt is made to estimate the mean pressure for any given time with mathematical accuracy. In the ordinary tracing as given by the mercury manometer (Fig. 193) the mean pressure for any given period during which the variations have been symmetrical and not extreme is estimated as the arithmetical mean of the highest and lowest points reached. When desirable, the mean pressure may be recorded by introducing a resistance (narrowing the tube by means of a stopcock) between the artery and the manometer. The latter

\* See Dawson, "British Medical Journal," 1906, 996.



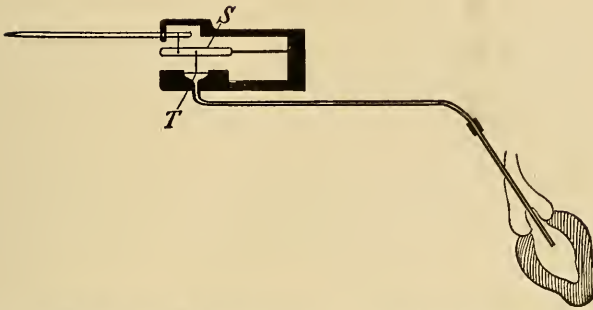

Fig. 196.—Diagram showing construction of Hürthle's manometer.—(After Curtis.) The interior of the heart or the artery is connected by rigid tubing to a very small tambour, *T*. The tubing and the tambour are filled with liquid. The movements of the rubber dam covering the tambour are greatly magnified by a compound lever, *S*. The tendency of this lever to "fling" may be prevented by an arrangement not shown in the diagram. The essential principles of the recorder are, first, liquid conduction from heart to tambour; second, a very small tambour and membrane so that a minimal volume of liquid escapes from the heart into the tambour.

will then record mean pressure and show no variations with the heart-beat. A general idea of the variations in systolic, diastolic, and mean pressures, throughout the arterial system, may be obtained from the schema given in Fig. 195.

**Method of Measuring Systolic and Diastolic Pressure in Animals.**—In animals a manometer may be connected directly with the artery and systolic and diastolic pressures may be obtained in one of two general ways: (1) By using some form of pressure recorder or manometer sufficiently mobile to follow very quick changes of

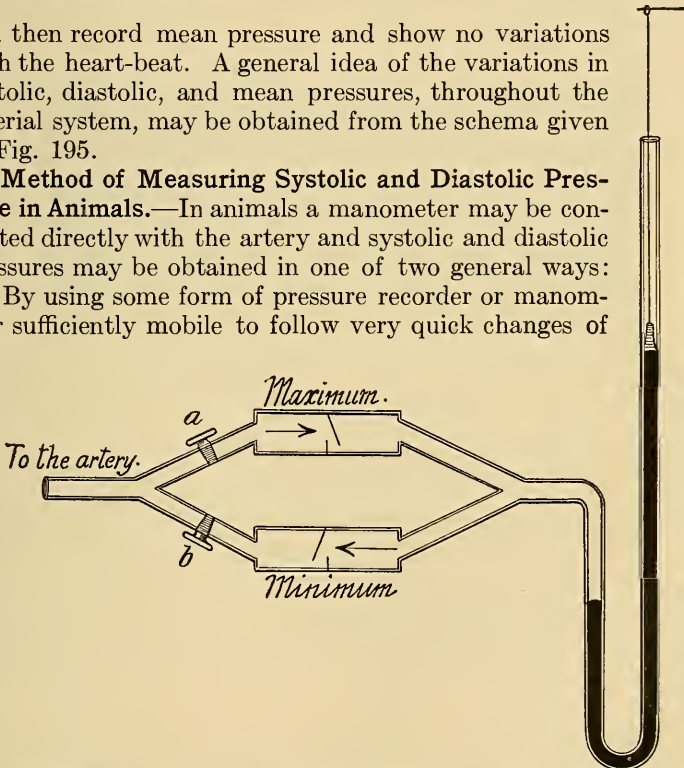

Fig. 197.—Schema to illustrate the use of valves in determining maximum (systolic) and minimum (diastolic) blood-pressure. When stopcock *a* is open the heart beats are transmitted through the maximum valve and the mercury in the manometer is prevented from falling between beats. The manometer will record the highest pressure reached during the period of observation. The reverse occurs when valve *b* alone is open.

pressure. (2) By using a mercury manometer provided with maximum and minimum valves. Of the manometers that have been devised to register accurately the quick changes in pressure due to the heart beat, the one that has been most frequently used is the membrane manometer of Hürthle.\*

The principle made use of in the Hürthle manometer is illustrated by the diagram in Fig. 196. The instrument consists essentially of a small box or tambour of very limited capacity; the top of the tambour is covered with thin rubber dam and the cavity is filled with liquid and connected by rigid tubing, also filled with liquid, with the interior of the artery or heart. Variations in pressure in the artery are transmitted through the column of liquid to the rubber membrane of the tambour, and the movements of this latter are greatly magnified by a sensitive lever attached to it. The liquid conduction and the small size of the tambour, which prevents any noticeable outflow of liquid, combine to make a sensitive and very prompt recorder of pressure changes. It is necessary to calibrate this instrument whenever used in order to give absolute values to the records obtained. A specimen of a blood-pressure record obtained with this instrument is shown in Fig. 198. It will be noticed that the size of the heart-beat, relative to the distance from the base line, is much greater than in the record obtained with the mercury manometer, Fig. 193.

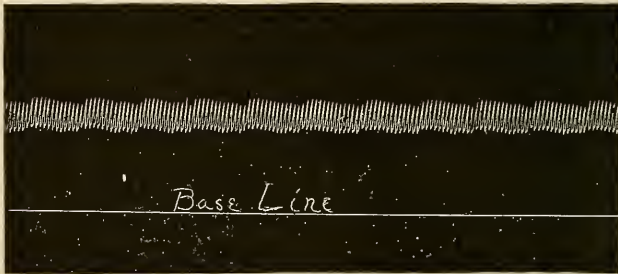

Fig. 198.—Blood-pressure record from a dog with a Hürthle manometer. The size of the heart beats is relatively much greater than with a mercury manometer. In this case the systolic pressure is about 150 mms. Hg; the diastolic, 100 mms.; and the heart beat or pulse pressure, 50 mms.

The method that depends upon the use of maximum and minimum valves may be understood by reference to Fig. 197. On the path between the artery and the manometer one may place a maximum and a minimum valve so arranged that the blood-pressure and heart beat may be transmitted through either valve. As is shown by the figure, if the connection is maintained through the maximum valve for a certain time the highest pressure reached during that period will be recorded, while, when the minimum valve is used the lowest pressure reached will be indicated.

Such valves, of course, act slowly and can not be used to determine the maximum and minimum pressure in the artery during a single heart beat; they record the highest and lowest point reached during a certain given interval.

**Actual Data as to the Mean Pressure in Arteries, Veins, and Capillaries.**—The mean value of the pressure in the aorta has been determined for many mammals. It is found that the actual

\* *Archiv. f. d. gesammte Physiologie*, 49, 45, 1891.

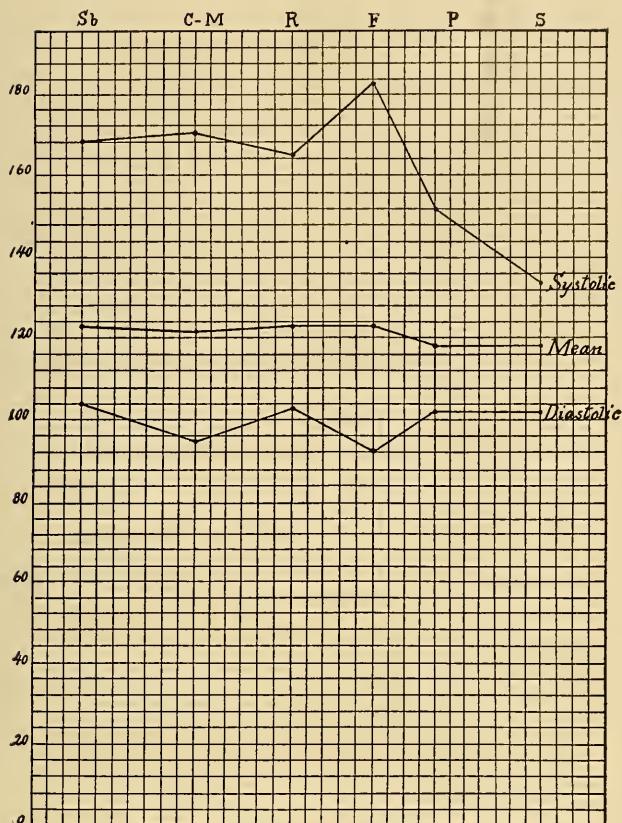

Fig. 199.—Curve showing the results of actual measurement of systolic, diastolic, and mean pressure (lateral pressures) along the aorta and femoral of the dog. The branches through which the lateral pressures were obtained are indicated as follows: *Sb*, Left subclavian; *C-M*, celiac and superior mesenteric; *R*, left renal; *F*, left femoral (Ellenberger and Baum), external iliac; *P*, profunda branch of femoral; *S*, saphena. The pressure in millimeters is given along the ordinates to the left. It will be noted that the mean and the diastolic pressures remain practically the same throughout the descending aorta and into the femoral. The systolic pressure shows a marked increase at the lower end of the aorta and then falls off rapidly. The pulse pressure at the inferior end of the descending aorta is much larger than at the arch.—(Dawson.)

figures vary with the conditions under which the results have been obtained. Such values as the following may be quoted:\*

Horse . . . . .	321	mm.	to	150	mm.	Hg.
Dog . . . . .	172	"	"	104	"	"
Sheep . . . . .	206	"	"	156	"	"
Cat . . . . .	150	"	"		"	"
Rabbit . . . . .	108	"	"	90	"	"
Man (probable, Tigerstedt) . . . . .	150	"			"	"

\* See Volkmann, "Die Haemodynamik," 1850.

It appears from these figures that there is no proportion between the size of an animal and the amount of mean arterial pressure. It is probable that there may be a general relationship between the size of the animal—that is, the size of the heart—and the amount of pulse pressure or the oscillation of pressure with each heart beat, but sufficient data are not at hand to determine this point. As we pass from the aorta to the smaller arteries the mean pressure decreases somewhat, although not very rapidly, while the pulse pressure decreases also and to a more noticeable extent.

This fact is illustrated in Fig. 199, which gives a graphic representation of a number of experimental determinations\* of systolic and diastolic pressures in the large arteries of the dog.

If we turn to the other end of the vascular system, the veins, we find that the lowest pressure is in the venæ cavæ and that it increases gradually as we go toward the capillary area. According to one observer,† the fall in pressure from periphery toward the heart is at the rate of 1 mm. Hg for every 35 mms. of distance. We have such figures as the following:

DOG (OPITZ).	SHEEP.
Superior vena cava (near auricle) . . . . . = -2.96 mms. Hg.	Jugular vein . . . . . 0.2 mm. Hg.
Superior vena cava more distal . . . . . = -1.38 " "	Facial vein . . . . . 3.0 mms. "
External jugular (left) . . . = 0.52 mm. "	Branch of brachial . . . . 9.0 " "
Right brachial . . . . . = 3.90 mms. "	Crural . . . . . 11.4 " "
Left facial . . . . . = 5.12 " "	
Left femoral . . . . . = 5.39 " "	
Left saphenous . . . . . = 7.42 " "	

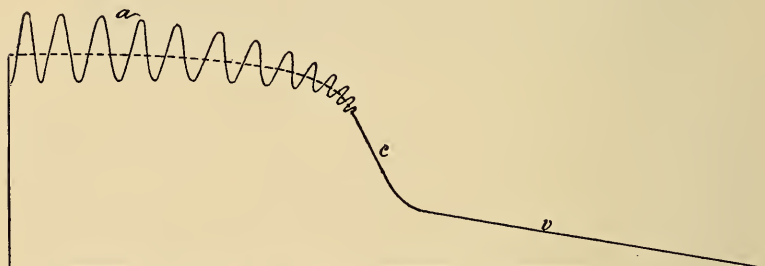

Fig. 200.—Schematic representation of the general relations of blood-pressure (side pressure) in different parts of the vascular system: *a*, The arteries; *c*, the capillaries; *v*, the veins. The mean and diastolic pressures remain nearly constant in the arterial system, as far as they can be measured accurately. The pressures in the veins are represented as uniform at any one point. In the large veins near the heart there are variations of pressure with each respiration and with each heart beat (Venous Pulse, p. 529).

At the heart, therefore, the pressure of the blood upon the walls of the veins is very small, and, indeed, owing to the circumstance that the large veins lie in the thoracic cavity, in which the pressure is below that of the atmosphere, the pressure of the blood in

\* Dawson, "American Journal of Physiology," 15, 244, 1906.

† Burton-Opitz, "American Journal of Physiology," 9, 198, 1903.

them may also be below atmospheric pressure, although doubtless at this point (vena cava) the pressure within the vein is greater than the pressure on its exterior (intrathoracic pressure). Taking into account the negative intrathoracic pressure (p. 658) it may be estimated that the difference in pressure between the blood in the veins of the neck and that in the superior vena cava is equal to 4 or 5 mms. Hg., and this difference is sufficient to drive the blood into the heart and to fill and distend it rapidly during diastole\*. To complete the general conception of the pressure relations in the vascular system it is necessary to know the pressure of the blood in the smallest arteries and veins and in the capillaries. It is not possible—in the cases of the capillaries, for instance—to connect a manometer directly with the vessels, and recourse has been had to a less direct and certain method. The pressure in the capillaries in different regions of the skin has been estimated by determining the pressure necessary to obliterate them—that is, to blanch the skin. A glass plate is laid upon the skin or mucous membrane and weights are added until a distinct change in the color of the skin is noted† Knowing the necessary weight to produce this effect and the area submitted to compression, the pressure may be expressed in terms of millimeters of mercury or blood.

The following example may be used to illustrate this method. Suppose that the glass plate has an area of 4 sq.mms., and that to blanch the skin under it a weight of 1 gm. is necessary; 1 gm. of water = 1 c.c. or 1000 c.mms. Therefore to blanch this area would require a column of water containing 1000 c.mms. with a cross-area of 4 sq.mms. The height of this column would therefore be equal to  $\frac{1000}{4}$  or 250 mms. of water,—that is, 18.5 mms. Hg.

The results obtained by this method are not very constant and can only be considered as approximate. It would appear, however, that the pressure lies somewhere between 20 and 40 mms. of mercury. Thus, upon the gums of a rabbit von Kries found a capillary pressure of 33 mms. Hg.

By means of a more adjustable instrument von Recklinghausen‡ estimates that in man the pressure within the capillaries of the finger-tips or, to be more accurate, within the small arteries supplying these capillaries, is equal to 55 mms. Hg. (See p. 507.)

The general relations of the pressures in arteries, veins, and capillaries may be expressed in a curve such as is shown in Fig. 200.

It should be added that in this curve and in all the figures so far quoted in regard to the actual pressure within the different

\* Henderson and Barringer, "Amer. Journal of Physiology," 31, 352, 1913.

† V. Kries, "Berichte d. Sächs. Gesellschaft d. Wiss. Math.-phys. Classe," 1875, p. 148.

— ‡ Von Recklinghausen, "Archiv f. exp. Path. u. Pharmak.," 55, 375, 1907.

arteries and veins, it is assumed that the animal is in a recumbent posture. In an animal standing upon his feet, especially in an upright animal like man, it is obvious that the effect of gravity will modify greatly the actual figures of pressure. Upon the arteries and veins of the feet, for example, there will be exerted a hydrostatic pressure equal to the height of the column of liquid between the feet and the heart, which adds itself to the pressure resulting from the circulation as caused by the heart. When the animal is in a recumbent position the hydrostatic factor practically disappears. (See p. 515.)

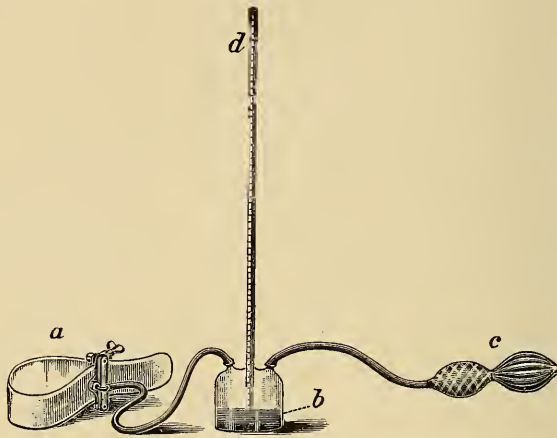

Fig. 201.—Figure of the Riva-Rocci apparatus (*Sahlb*): *a*, The leather collar with inside rubber bag to go on the arm; *c*, the bulb for blowing up the rubber bag and thus compressing the artery; *d*, the manometer dipping into the reservoir of mercury, *b*, to measure the amount of pressure.

**The Method of Determining Blood-pressure in the Large Arteries of Man.**—It is a matter of interest and practical importance to ascertain even approximately the arterial pressure in man and its variations in health and disease. The first practical method for determining this point upon man was suggested by von Basch (1887), who devised an instrument for this purpose, the sphygmomanometer. Since that time a number of different instruments have been described, but attention may be called to two only, which illustrate sufficiently well the principles involved. In the first place, it must be clearly recognized that the arterial pressure in the large arteries of man shows marked variations with the heart beat; the pressure during the beat of the heart rises suddenly to a much higher level than during the diastole. The relation of the systolic (or maximum) and diastolic (or minimum) pressures is indicated by the diagram in Fig. 195. The instruments that have been invented for determining human blood-pressure are in

reality adapted, more or less accurately, to determine one or the other or both of these pressures. No instrument has been devised for determining the mean pressure, and as a matter of fact such a thing as mean pressure does not exist in the large arteries, it is simply an abstraction. What really occurs in these arteries is a rapid swing of pressure with each heart-beat from the diastolic to the systolic level, and to interpret fully our records it is important to determine each of these values. The methods that have been proposed for this purpose have undergone a gradual evolution and improvement. The determinations of systolic pressure were first made, according to the principle suggested by von Basch, by ascertaining the pressure that is just sufficient to occlude an artery, so that a pulse wave cannot pass through. The simplest form of apparatus for this purpose is the one proposed by Riva-Rocci and represented in Fig. 201. Instruments of this kind are known as sphygmomanometers.

The leather or canvas band, *a*, is buckled snugly around the arm. On the inner surface of this band there is a rubber bag which communicates with the mercury manometer, *d*, and the pressure bulb, *c*. When the band is in place rhythmical compressions of *c* will force air into the rubber bag surrounding the arm. This bag is blown up and exerts pressure upon the arm and through the arm tissue upon the brachial artery. The amount of pressure that is being exerted upon the arm is indicated at any moment by the mercury manometer. The moment of obliteration of the artery is determined by feeling (or recording) the pulse in the radial artery. The moment that this pulse disappears, as the pressure upon the brachial is raised, indicates the maximum or systolic pressure in the brachial artery. As the pressure is lowered again the pulse reappears. Among other sources of error involved in this method it is to be remembered that the tactile sensibility is not sufficiently delicate to detect a minimal pulse in the artery. Other methods of determining the systolic pressure (see below) indicate, as a matter of fact, that the pulse continues some time after an individual of average tactile sensibility is unable to detect it.

For practical purposes, a great improvement was made by Korotkoff in the introduction of the auscultation method by means of which both systolic and diastolic pressures may be determined rapidly with approximate accuracy. In this method the cuff with its pneumatic bag (*a*) is placed round the arm above the elbow, and by means of a bulb (*c*) or pump the pressure within the pneumatic bag is raised until the brachial artery is completely obliterated. A stethoscope is now applied to the location of the brachial artery just below the lower edge of the cuff, and by means of a needle valve the pressure on the artery is allowed to drop slowly. The moment that the pressure falls to a point at which a pulse wave can break through the constricted area a distinct sound will be heard in the stethoscope. If the mercury manometer is read at this point, it will give the value for the systolic pressure. As the outside pressure continues to fall the sound becomes fuller,

and at a certain point disappears entirely. The pressure, as recorded by the manometer, at which the arterial sound disappears marks the diastolic pressure, approximately at least. Ac-

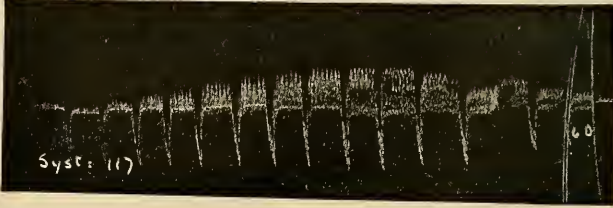

Fig. 202.—Record (Erlanger) to show the maximum size of the recorded pulse wave when the outside or extravascular pressure is equal to the internal diastolic pressure. The artery is compressed first with a pressure above systolic, sufficient to obliterate the lumen. As this pressure is lowered in steps of 5 mms. the recorded pulse wave increases in size to a maximum and then again becomes smaller. The outside pressure with which the maximum pulse is obtained measures the amount of the internal diastolic pressure (Marey's principle).

ording to some observers, the diastolic pressure is indicated more accurately by a change in the character of the sound, from sharp to dull, which takes place just before it disappears.\* If,

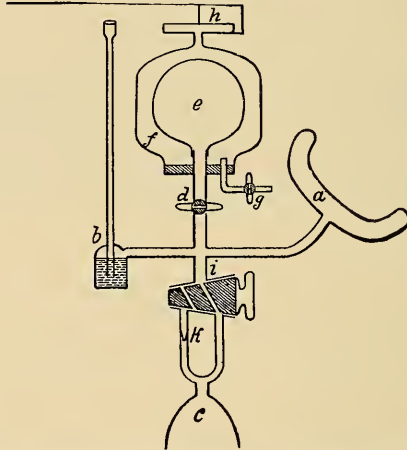

Fig. 203.—Schema showing the construction of the Erlanger apparatus: *a*, Rubber bag of the arm piece; *c*, bulb for blowing up this bag and putting pressure on the arm; *b*, the manometer for measuring the pressure; *i*, two-way stopcock (when turned so as to communicate with the capillary opening, *k*, it allows the pressure in *a* to fall slowly); *e*, a rubber bag in a glass chamber, *f*; *e* communicates with *a* when stopcock *d* is open and the pulse waves from *a* are transmitted to *e*; the pulsations of *e* in turn are transmitted to the delicate tambour, *h*, and are thus recorded.

however, for any reason it is desirable to obtain a record of the systolic and diastolic pressures, some form of sphygmomanometer

\* Taussig and Cook, "The Archives of Internal Medicine," 11, 542, 1913; also Hooker and Southworth, *ibid.*, 13, 384, 1914.



must be employed in which the pulse from the artery under the cuff is recorded upon the smoked surface of a kymographion. Several instruments of this kind have been described, but the one devised by Erlanger\* is probably the most complete. This instrument is illustrated in Figs. 203 and 204, and is described in some detail below. When the pressure in the cuff is raised above

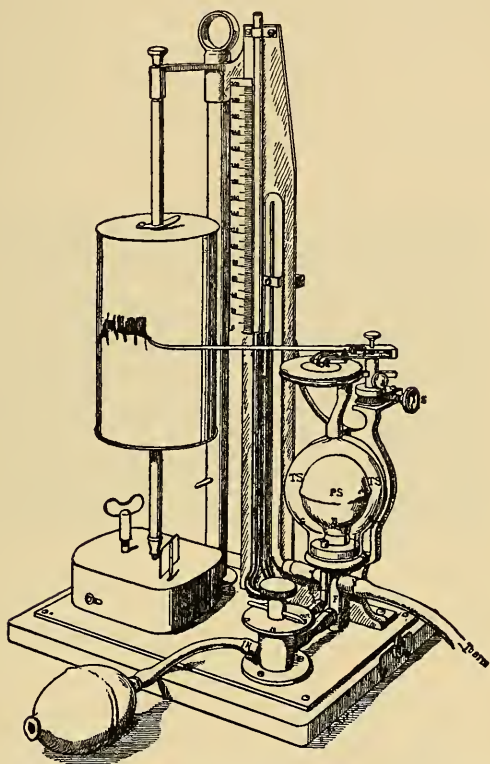

Fig. 204.—Erlanger apparatus. The collar for the arm is not shown. The parts may be understood by reference to the schema given in Fig. 203.

the systolic level the brachial artery is completely closed, but the pulsations of the stump above the closed area are recorded through the tambour system connected with the cuff. By means of a suitable stop-cock the pressure in the cuff is dropped, 5 mms. at a time, and a record of the pulse is taken at each level. The point of systolic pressure is indicated either by a sudden increase in the

\* "American Journal of Physiology," "Proceedings of the American Physiological Society," 6, xxii., 1902; and "Johns Hopkins Hospital Reports," 12, 53, 1904.

size of the pulse or by a sudden spreading of the limbs of the pulse wave. As the pressure is dropped in steps below this point the size of the pulse wave increases to a maximum, and then again declines (Fig. 202). The pressure at which the maximum pulse waves are obtained indicates diastolic pressure, according to the principle first suggested by Marey. This principle assumes that when the pressure on the outside of an artery is just equal to the diastolic pressure on the inside, that is to say, to the pressure in between the pulse beats, the arterial wall is in a position in which it will give the widest excursion for any given force of heart beat. The correctness of this principle has been demonstrated upon the exposed artery. In the living person a certain amount of soft compressible tissue intervenes between the cuff and the

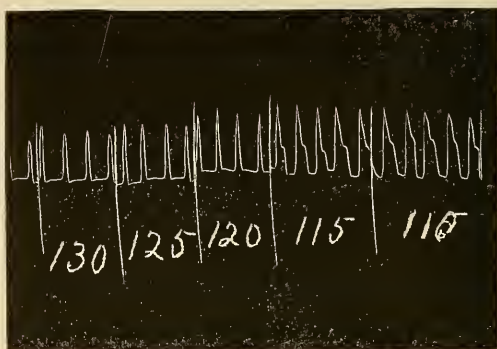

Fig. 205.—To show the method of detecting the systolic pressure upon the tracing given by the Erlanger sphygmomanometer. The pressure upon the arm is raised above systolic pressure and is then dropped 5 mm. at a time, a short record being taken after each drop. Records are shown for 130, 125, 120, 115, and 110 mm. At 115 mm. it will be seen that the limbs of the pulse-wave show the separation or spreading which indicates the first pulse-wave to get through the occluded artery, and therefore the systolic pressure.

brachial artery, and a portion of the external pressure is used in overcoming the resistance of this tissue. The readings as made are, therefore, probably somewhat above the actual diastolic pressure by an amount that has been estimated at from 6 to 10 mms. of mercury. As these instruments are usually employed, measurements are made upon the brachial artery at the level of the heart, and consequently no correction need be made for a hydrostatic factor, such as would be necessary, for example, if the determinations were made on an artery in the leg in a person standing erect.

The way in which the Erlanger apparatus is used may be understood from the schematic Fig. 203. *a* is the rubber bag, which is buckled upon the arm by a leather strap. This bag communicates with the mercury manometer, *b*, with a pressure bag, *c*, through the two-way stopcock, *i*, and through the stopcock *d* with a rubber bag, *e*, contained in a glass chamber, *f*. This glass

chamber communicates above with a sensitive tambour, *h*, and by means of the stopcock *g* can be placed in communication with the outside air. The systolic pressure may be determined in two ways: By one method only the mercury manometer is necessary, the instrument corresponding with the Riva-Rocci apparatus described above. By means of the pressure bag, *c*, the bag, *a*, up the arm is blown up until the pressure is above the systolic pressure and the radial pulse below disappears. By turning stopcock *i* properly the system is allowed to communicate with the air through a capillary opening, *k*. Consequently the pressure upon the artery in the arm falls slowly, and by palpating the radial artery one can determine the pressure, as measured by the mercury manometer, at which the pulse just gets through. This pressure will measure approximately the systolic pressure. The second method (method of v. Recklinghausen) gives higher and doubtless more accurate results. In this method the pressure is at first raised above systolic pressure with stopcocks *d* and *g* open. *a*, *e*, and *b* are under the same pressure. If stopcock *g* is now turned off, the pulsations in *a* are transmitted to *e* and through it to the tambour, *h*, and the lever of the tambour writes these pulsations on a kymographion. It should be explained that pulsations are obtained even when the pressure on the arm is much more than sufficient to completely obliterate the brachial artery. The reason for this is that the pulsations of the central stump of the closed artery will be communicated to bag *a*. When the pressure is suprasystolic these pulsations are small. If now the pressure in the system is diminished slowly by turning stopcock *i* so as to communicate with the capillary opening, *k*, it will be found that at a certain point the pulsations suddenly increase in height (Fig. 205). This point marks the moment when the pulse wave is first able to break through the brachial artery, and it gives, therefore, the systolic pressure. In many cases this method of determining the point of systolic pressure is not satisfactory, since the pulse waves increase gradually in amplitude without a sudden break, or perhaps there is more than one place at which a sudden increase occurs. A more reliable method according to Erlanger is to note the point at which the ascending and descending limbs of the pulse wave show a noticeable separation (Fig. 205). "At the moment the pressure on the artery falls below systolic, blood succeeds in making its way beneath the cuff. This must be squeezed out before the lever can return to the base line, whereas at higher pressures the lever is raised only through the hydraulic-ram action of the pulse wave upon the upper edge of the cuff." After finding the systolic pressure the diastolic pressure is obtained by allowing the pressure to drop still further. The pulsations increase in height to a maximum size and then decrease. The pressure at which the maximum pulse wave is obtained marks the diastolic pressure. It is better perhaps in dropping the pressure for this last purpose to manipulate stopcock *i* so as to drop the pressure 5 mms. at a time, recording the pulse wave at each pressure. In this way a record is obtained such as is given in Fig. 202. It should be added, also, that in order to keep the lever of the tambour horizontal while the pressure in the system is being lowered there is a minute pinhole in the metal bottom of the tambour. Through this pinhole the pressure in the tambour and chamber, *f*, is kept atmospheric throughout, except during the quick changes caused by the pulse waves. By means of this instrument one can determine within a minute or so the amount of the systolic and diastolic pressure in the brachial artery, and also, of course, the difference between the two, the pulse pressure, which may be taken as an indication of the force of the heart-beat.

#### The Normal Arterial Pressure in Man and Its Variations.—

By means of one or other of the instruments devised for the purpose, numerous results have been obtained regarding the blood-pressure in man at different ages and under varying normal and abnormal conditions. Unfortunately, the methods used have not always been complete. Some authors give only systolic pressures, for example. In such experiments also a troublesome

factor is always the psychical element. The mental interest that the individual experimented upon takes in the procedure almost always causes a rise of pressure and perhaps a changed heart rate. Results, as a rule, upon any individual show lower values after the novelty of the procedure has worn off, and the patient submits to the process as an uninteresting routine. Under normal conditions, Potain\* estimated the systolic pressure in the radial of the adult at about 170 mms. of mercury and the variations for different ages he expressed in the following figures:

Age.....	6-10	15	20	25	30	40	50	60	80
Pressure (systolic).	89	135	150	170	180	190	200	210	220

Without the other side of the picture—that is, the diastolic pressure and the force of the heart beat (pulse pressure)—it is difficult to interpret these figures. The rapid increase up to maturity probably represents chiefly the larger output of blood from the heart; the slower and more regular increase from maturity to old age is due possibly to the gradual hardening of the arteries, since the less elastic the arteries become, the greater will be the systolic rise with each heart beat. Owing to the method Potain used these figures are all undoubtedly too high, but the relative values are probably correct. With his more complete apparatus Erlanger reports that in the adult (20 to 25), when the psychical factor is excluded, the average pressure in the brachial is 110 mms., systolic, and 65 mms., diastolic,—figures much lower than those given by Potain. Von Recklinghausen's figures for the same artery are, systolic pressure 116 mms. Hg, diastolic pressure 73 mms. Hg.

Erlanger and Hooker report observations upon the effect of meals, of baths, of posture, the diurnal rhythm, etc.†

The effect of meals is particularly instructive in that it illustrates admirably the play of the compensatory mechanisms of the circulation by means of which the heart and the blood-vessels are adjusted to each other's activity. During a meal there is a dilatation of the blood-vessels in the abdominal area, or, as it is frequently called in physiology, the splanchnic area, since it receives its vasomotor fibers through the splanchnic nerve. The natural effect of this dilatation, if the other factors of the circulation remained constant, would be a fall of pressure in the aorta and a diminution in blood-flow to other organs, such as the skin and the brain. This tendency seems to be compensated, however, by an increased output of blood from the heart. Observations with the sphygmomanometer show that after full meals there is a marked

\* "La pression arterielle de l'homme," Paris, 1902.

† Erlanger and Hooker, "The Johns Hopkins Hospital Report," vol. xii., 1904.

increase in the pulse pressure, indicating a more effective beat of the heart. So far as the effect on the heart is concerned, the result of a meal is similar to that of muscular exercise, and this reaction may account for the fact, not infrequently observed, that in elderly people whose arteries are rigid an apoplectic stroke may follow a heavy meal.

**The Method of Determining Venous Pressures and Capillary Pressures in Man.**—A number of methods have been proposed for determining venous pressures in man, the simplest being that described by Gaertner.\* It consists simply in raising slowly the arm of the patient until the veins on the back of the hand just disappear. The height above the heart at which this occurs gives the venous pressure in the right auricle, since the vein may be considered as a manometer tube ending in the auricle. In this and in other methods of measuring venous

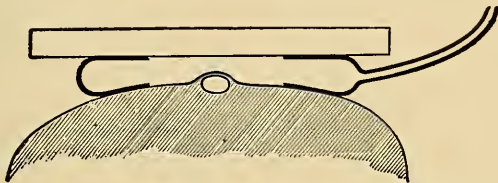

Fig. 206.—To illustrate the method of measuring venous pressure: *H*, The back of the hand in which a single vein is represented; *B*, the circular rubber bag with central opening, and with a tube, *T*, which leads to the pump and the manometer; *G*, glass plate held over the rubber bag. The bag, *B*, is blown up by pressure through the tube *T* until the vein is collapsed. The pressure at which this occurs, or the pressure at which the vein reappears as the bag is allowed to empty, gives the pressure within the vein.—(von Recklinghausen.)

pressures, and the same is true, of course, of arterial and capillary pressures, there must be some agreement as to what constitutes the heart-level, since the highest and lowest points of the heart when the individual is standing or sitting may differ by as much as 15 centimeters. von Recklinghausen proposes the level made by a dorsoventral line drawn from the bottom of the sternum (costal angle) to the spinal column. This author† has devised a simple apparatus for determining venous and capillary pressures, the principle of which is shown by the schema represented in Fig. 206.

A circular bag of thin rubber with a diameter of about 5½ cm. is provided with a central opening of 2 cm. The bag is connected with a pump so that it can be blown up, and the degree of pressure exerted is measured by an attached manometer. This bag, moistened with glycerine, is laid upon a vein, as represented in the diagram. It is covered by a glass plate held firmly in position and the bag is then blown up until the vein disappears; the pressure at which this happens is shown by the manometer and marks the pressure

\* "Muench. mediz. Wochenschrift," 1903, 1904.

† Von Recklinghausen, "Archiv f. exper. Pathol. u. Pharmacol.," 55, 470, 1906.

within the vein. A convenient modification of this apparatus, which has been described by Hooker,\* is shown in Fig. 207. A small glass chamber is fastened on the hand over a vein by means of a film of collodion solution. The interior of the chamber is connected by rubber tubing with a water manometer and a pressure bulb. By means of the latter the air pressure on the vein may be raised until the vein is just obliterated and the pressure used is indicated on the manometer in centimeters of water.

With instruments of this kind the degree of pressure necessary to obliterate a given vein in the arm, hand, or foot can

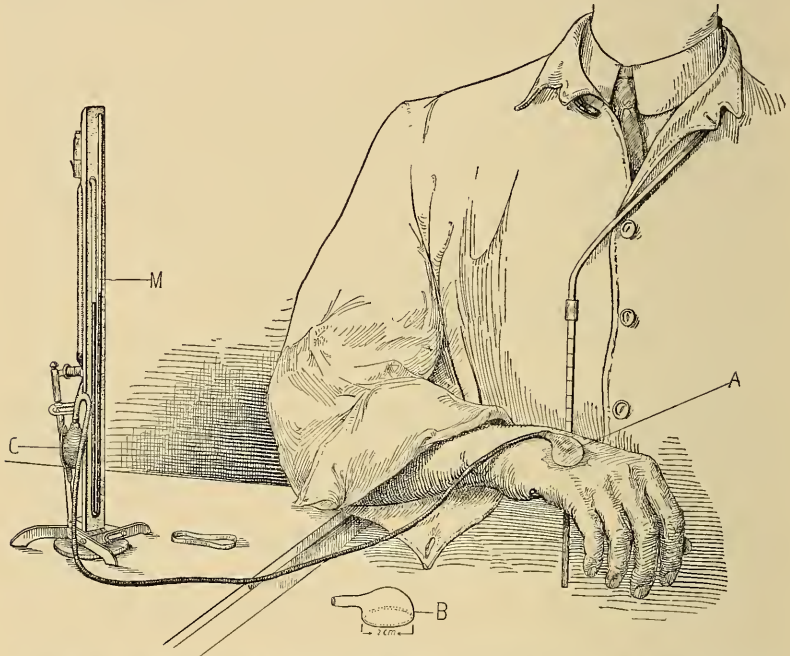

Fig. 207.—Hooker's venous pressure apparatus. A glass capsule, *A*, is fastened to the skin over a vein by means of a solution of collodion. This capsule is connected by rubber tubing with a pressure-bulb, *C*, and a water manometer, *M*. By means of the bulb the pressure is raised in *A* until the vein is obliterated. The pressure at which this occurs is shown by the level of the liquid in the manometer. This pressure, expressed in centimeters of water, is corrected by subtracting the distance between the vein and the costal angle, as indicated on the metal rod supporting the hand. *B* gives an enlarged view of the glass capsule.

be determined readily in terms of a column of water, but it is obvious that for any given vein this pressure will vary with the position of the vein. When the hand hangs pendent at the side the pressure within its veins will be greater than when the hand is raised to the heart-level. The pressure actually measured for any given position of the hand or foot must,

\* Hooker, "American Journal of Physiology," 35, 73, 1914; also Eyster and Hooker, "Johns Hopkins Hospital Bulletin," 274, 1908.

therefore, be corrected for the heart-level by determining the vertical distance between the vein and the heart (costal angle), and subtracting this distance, expressed in centimeters, from the pressure, also expressed in centimeters, which was found necessary to obliterate the vein. Measurements made by this method and corrected for the heart-level show that in the normal person the pressure within the small veins of the hand or arm may vary between 10 and 20 cm. of water. The average pressure during the day is about 15 cm., but at night, when asleep, it may fall as low as 7 to 8 cm. Unusual or pathological conditions which cause a congestion in the venous side of the heart will raise the venous pressure correspondingly.\*

When the venous pressure is measured in the small veins of the feet in a person while standing we should suppose that after a reduction to the heart level it would be about the same as that noted for the veins of the hands, since the vessels are of about the same order with reference to their distance from the capillary bed. In a series of observations of this kind, reported by von Recklinghausen, it was found, on the contrary, that after subtracting the distance between the foot and the heart, the pressure within the veins was negative by as much as 40 cm. The author explains this unexpected result by supposing that the flow through the foot got up only enough pressure in the veins to lift the blood to the level of the pelvis, and that the complete closure of the venous valves at this level protected the veins from the full pressure of the column of blood. Eventually, no doubt, the pressure in the veins would have risen sufficiently to lift the blood to the heart-level, but it seems probable that under the ordinary conditions of life this result is effected by the coöperation of the muscles of the legs and the respiratory movements of the thorax (see p. 517). The contractions of these muscles, aided by the venous valves, squeeze the blood upward to the heart. The fact that in standing quietly the flow through the feet may be suspended or impeded, for a time at least, throws some light, as von Recklinghausen suggests, upon the fact that it is so difficult to stand for any length of time without moving.

The apparatus described above may be used for determining capillary as well as venous pressures, according to the principle described on p. 499. For this purpose the pressure box is laid upon a given skin area and the pressure is raised until the skin beneath is blanched. The pressure is then lowered slowly until the skin again reddens, showing the reëstablishment of the capillary flow. The pressure thus obtained is corrected as described for the level of the heart.†

\* For a description of some pathological cases, see Eyster and Hooker, *loc. cit.*

† For some technical details, see von Recklinghausen, *loc. cit.*

## CHAPTER XXVI.

### THE PHYSICAL FACTORS CONCERNED IN THE PRODUCTION OF BLOOD-PRESSURE AND BLOOD-VELOCITY.

In the preceding pages some of the essential facts have been stated regarding the pressure and the velocity of the blood in the different parts of the vascular system. We may now consider the physical factors that are concerned in the production and maintenance of these peculiarities. The problem as it actually exists in the circulation, with its elastic vessels varying in size from the aorta, with an internal diameter of nearly 20 mms., to the capillaries, with a diameter of 0.009 mm., is extremely complex, but the general static and dynamic principles involved are simple and easily understood.

**Side Pressure and Velocity Pressure.**—When water flows through a tube under, let us say, a constant head of pressure it encounters a resistance due to the friction between the walls of the vessel and the particles of water. This resistance will be greater, the narrower the tube. A part of the head of pressure used to drive the liquid along the tube will be used in overcoming this resistance to its movement, and the volume of the outflow will be correspondingly diminished. If we use an apparatus such as is represented in Fig. 208, consisting of a reservoir, *H*, and a long outflow tube, 1, 2, 3, 4, 5, the outflow from the end and the pressure along the tube may be measured directly. We must suppose that the head of pressure—that is, the height of the water in *H*—is kept constant by some means. The resistance or tension due to the friction in the tube may be measured at any point by inserting a side-tube or gauge (piezometer) at that point. The liquid will rise in this tube to a level corresponding to the pressure or resistance offered to the movement of the liquid at that point—that is, the weight of the column of liquid will measure the pressure at that point upon a surface corresponding to the cross-area of the tube. The pressure or tension at any point may be spoken of as the *side pressure* or *lateral pressure*, and it expresses the amount of resistance offered to the flow of the liquid because of the friction exerted upon the water by the walls of the tube between that point and the exit. This side pressure increases in a straight line from the point of exit



to the reservoir, and this in general is the picture presented by the circulation. The reservoir, the head of pressure, is represented by the aorta, the exit for the outflow by the opening of the venæ cavæ into the right auricle, and the side pressure or internal tension of the blood due to friction against the walls of the vessels increases from the venæ cavæ back to the aorta. If from aorta to vena cava the vessels were of the same diameter the increase would be in a straight line, as in the case of the model. In this model it will be noticed that the straight line showing the side pressure does not strike the top of the column of liquid in the reservoir, but corresponds to a certain height,  $h'$ . This expresses the fact that, of the total head of pressure in the reservoir, which we may designate as  $H$ , a certain portion only, but a large portion,  $h'$ , is used in over-

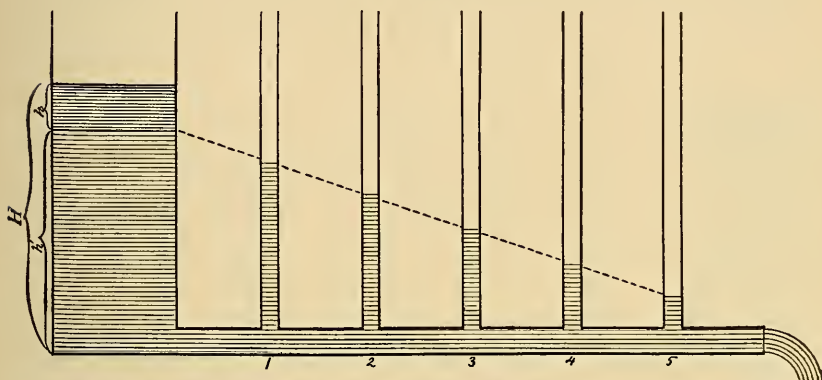

Fig. 208.—Schema to illustrate the side pressure due to resistance, and the velocity pressure (*Tigerstedt*):  $H$ , A reservoir containing water; 1, 2, 3, 4, 5, the outflow tube with gauges set at right angles to measure the side pressure;  $h'$ , the portion of the total pressure used in overcoming the resistance to the flow;  $h$ , the portion of the total pressure used in moving the column of liquid—the velocity pressure.

coming the resistance along the tube. What is left—that is,  $H-h'$ , represents the force that is employed in driving the liquid through the tube with a certain velocity; this portion of the pressure we may speak of as the *velocity pressure*,  $h$ . If in measuring the side pressure at any point the gauge were prolonged into the tube and bent so as to face the stream, this velocity pressure would add itself to the side pressure at that point and the water would rise to a higher level in this particular tube. There are two important differences between the circulation as it exists in the body and that represented by the model. In the body, in the first place, we have the area of capillaries, small arteries, and veins, intercalated between the large arteries on one side and the veins on the other; and, in the second place, the vessels, especially the arteries, are extensible and elastic. The effect caused by the first of these

factors—namely, a great resistance placed in the middle of the course—may be illustrated by the model shown in Fig. 209, which differs from that in Fig. 208 in having a stopcock in the outflow tube, which, when partly turned off, makes a narrow opening and a relatively great resistance. When the stopcock is open the pressure falls equally throughout the tube, provided the bore of the stopcock is equal to that of the tube. If, however, it is partially turned the side pressure is much increased between it and the reservoir on what we may term the arterial side of the schema, and it is correspondingly diminished between the stopcock and the exit, on the venous side of the schema. Substantially this condition prevails in the body. The capillary region, including the smallest arterioles and veins, offers a great resistance to the flow of blood, and this resistance is spoken of in physiology as the *peripheral resistance*. Its effect is to

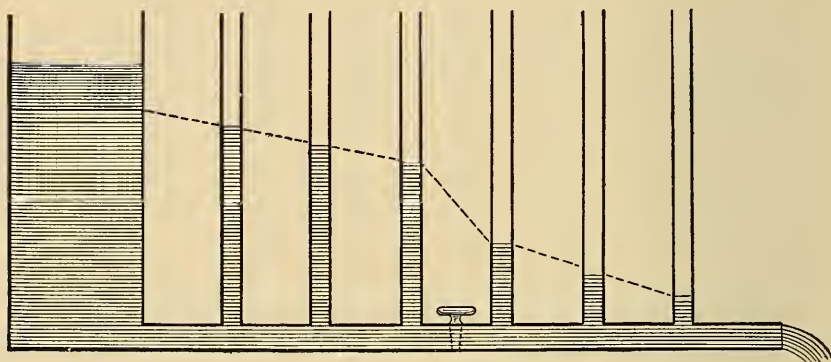

Fig. 209.—Schema like the preceding except that a stopcock is inserted at the middle of the outflow to imitate the peripheral resistance of the capillary area. The relations of the internal pressure on the arterial and venous sides of this special resistance is shown by the height of the water in the gauges.

raise the pressure on the arterial side and lower it on the venous side. When other conditions in the circulation remain constant it is found that an increase in peripheral resistance, caused usually by a constriction of the arterioles, is followed by a rise of arterial pressures and a fall of venous pressures. On the contrary, a dilatation of the arterioles in any organ is followed by a fall of pressure in its artery or arteries and a rise of pressure in its veins. The effect of the elasticity of the arteries is of importance in connection with the fact that in reality the circulation is charged with blood not from a constant reservoir as in the models, Figs. 208 and 209, but by the rhythmical beats of the heart. If the vascular system were perfectly rigid each rhythmical charge into the aorta would be followed by an equal discharge from the venæ cavæ, the pressure throughout the system would rise to a high point during systole and fall to a low point dur-

ing the diastole. The elasticity of the arteries, in connection with the peripheral resistance, makes an important difference. As the heart discharges into the aorta the pressure rises, but the walls of the arterial system are distended by the increased pressure, and during the following diastole the recoil of these distended walls maintains a flow of blood through the capillaries into the veins. With a certain rapidity of heart beat the distention of the arterial walls is increased to such a point that the outflow through the capillaries into the veins is as great during diastole as during systole; the rhythmical flow in the arteries becomes converted by the elastic tension of the overfilled arterial system into a continuous flow in the capillaries and veins. This effect may be illustrated by a simple schema such as is represented in Fig. 210. A syringe bulb (*a*), representing the heart, is connected by a short piece of rubber tubing to a glass tube (*b*), and also by a piece of distensible band tubing (*e*) with

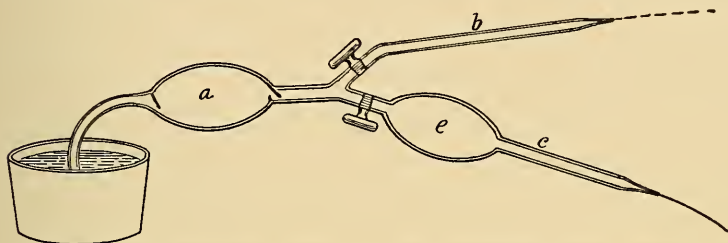

Fig. 210.—Simple schema to illustrate the factors producing a constant head of pressure in the arterial system: *a*, A syringe bulb with valves, representing the heart; *b*, glass tube with fine point representing a path with resistance alone, but no extensibility (the outflow is in spurts synchronous with the strokes of the pump); *c*, outflow with resistance and also extensible and elastic walls represented by the large rubber bag, *e*; the outflow is a steady stream due to the elastic recoil of the distended bag, *e*.

a similar glass tube drawn to a fine point (*c*). In the latter case the distensible, elastic tubing represents the arterial system, and the fine pointed glass tube the peripheral resistance of the capillary area. If the syringe bulb is put into rhythmical play and the flow is directed through tube *b* the discharges are in rhythmical spurts, but if directed through tube *c* the discharge is a continuous stream, since the force of the separate beats becomes stored as elastic tension in the walls of the band tubing, and it is this constant force which drives a steady stream through the capillary point. In a general way, this schema gives us a true picture of the conditions in the circulation. The rhythmical force of the heart beat is stored as elastic tension in the walls of the arteries, and it is the squeeze of these distended walls which gives the continuous driving force that is responsible for the constant flow in the capillaries and veins.

**Enumeration of the Factors Concerned in Producing Normal Pressure and Velocity.**—In the normal circulation we may

say that four chief factors co-operate in producing the conditions of pressure and velocity as we find them. These factors are: (1) The heart beat. (2) The resistance to the flow of blood through the vessels, and especially the *peripheral resistance* in the region of the small arteries, capillaries, and small veins. (3) The elasticity of the arteries. (4) The quantity of blood in the system. The way in which these factors act may be pictured as follows: Suppose the system at rest with the definite quantity of blood distributed equally throughout the vascular system. The internal or side pressure throughout the system will be everywhere the same,—probably zero (atmospheric) pressure, since the capacity of the vascular system is sufficient to hold the entire quantity of blood without distension of its walls. If, now, the heart begins to beat with a definite rhythm and discharges a definite quantity of blood at each beat the whole mass will be set into motion. The arteries receive the blood more rapidly than it can escape through the capillaries into the veins, and consequently it accumulates upon the arterial side until an equilibrium is reached,—that is, a point at which the elastic recoil of the whole arterial tree suffices to force through the capillaries in a unit of time as much blood as is received from the heart during the same time. In this condition of equilibrium the flow in capillaries and veins is constant, and the side pressure in the veins increases from the right auricle back to the capillaries. In the arteries there is a large side pressure throughout, owing to the resistance between them and the veins and especially to the great resistance offered by the narrow capillaries. This pressure rises and falls with each discharge from the heart, and the pulse waves, both as regards pressure and velocity, are most marked in the aorta and diminish farther out in the arterial tree, failing completely in the last small arterioles, since if taken together these arterioles constitute a large and distensible tube of much greater capacity than the aorta.

**General Conditions Influencing Blood-pressure and Blood-velocity.**—Alterations in any of the four chief factors mentioned above must, of course, cause a change in pressure and velocity.

I. An increase in the rate or force of the heart beat will increase the velocity of the flow throughout the system, although, of course, that general difference in velocity in the arteries, capillaries, and veins which depends upon the variations in width of bed will remain. Such a change will also cause a rise of pressures throughout the system. The energy exhibited in the vascular system as side pressure, velocity pressure, etc., comes, in the long run, mainly from the force of contraction of the heart muscle. This force is what is represented in the model, Fig. 208, as the total head of pressure ( $H$ ). An increase in rate or force of heart-beat is equivalent, therefore,

to an increase in this head of pressure, and along with the increase in velocity thus caused there is an increased friction or resistance.

II. An increase or decrease in the width of the vessels will influence both the resistance to the flow and the velocity. Under normal conditions it is the small arteries that are constricted or dilated (vasoconstriction and vasodilatation). A constriction of these arteries causes an increase in arterial pressures and a decrease in venous pressure. The velocity of the blood-flow is decreased. A dilatation has the opposite effects. Numerous instances of this relation will be referred to in describing the physiology of the vaso-motor nerves.

III. A diminution in elasticity of the arteries will tend to interfere with the constancy of the flow from the arteries into the capillaries, and in the arteries themselves the swings of pressure from systolic to diastolic during the heart beat will be more extensive. This latter fact can be shown upon elderly individuals whose arteries are becoming rigid, but whether a change of this character is ever so advanced in human beings as to seriously modify the capillary circulation does not appear to have been investigated.

IV. A loss of blood, other conditions remaining the same, will also cause a fall in blood-pressures and velocity. As a matter of fact, however, a considerable amount of blood may be lost without any marked permanent change in arterial blood-pressure. The reason for this result is found in the adjustability or adaptability of the vascular system. It is in such respects that the system differs greatly from a rigid schema such as we use for our models. When blood is withdrawn from the vessels the loss may be offset by an increased action of the heart and by a contraction of the arterioles, the two effects combining to give a normal or approximately normal arterial pressure. To carry out the analogy with the model (Fig. 208) if by chance some of the store of water was lost we might substitute a narrower reservoir, so that with a diminished supply we could still maintain the same level of pressure. In the body, moreover, a loss of blood by hemorrhage may be compensated in part, so far as the bulk of the liquid is concerned, by a flow of liquid from the tissues into the blood-vessels.

**The Hydrostatic Effect.**—In the living animal, especially in those, like ourselves, that walk upright, the actual pressure in the arteries of the various tissues must vary much also with the position. For instance, in standing erect the small arteries in the hands or feet are, in addition to other conditions noted above, exposed to the weight of the column of arterial blood standing over them. In the pendent arm the skin of the fingers is congested; if, however, the arm is raised above the head the skin may become blanched because now the column of blood from fingers to shoulder exercises

a hydrostatic pressure in the opposite direction. In determinations of blood-pressure in the brachial artery of man care should be taken to keep the arm in the same position in a series of observations in order to equalize the effect of the hydrostatic factor. The importance of this gravity effect is most evident in the case of the abdominal (splanchnic) circulation. When an animal accustomed to go on all fours is held in a vertical position the great vascular area of the abdomen is placed under an increased pressure due to gravity, and, unless there is a compensatory contraction of the arterioles or of the abdominal wall, so much blood may accumulate in this portion of the system that the arterial pressure in the aorta will fall markedly or the circulation may stop entirely.\* In most cases the compensation takes place and no serious change in the circulation results. In rabbits, however, which have lax abdominal walls, it is said that the animal may be killed by simply holding it in the erect position for some time. For the same reason an erect posture in man may be dangerous when the compensatory nervous reflexes controlling the arteries and the tone of the abdominal wall are thrown out of action, as, for instance, in a faint or in a condition of anesthesia. In such conditions the recumbent position favors the maintenance of the normal circulation. Indeed, under ordinary conditions some individuals are quite sensitive to the effects of a vertical position, especially if unaccompanied by muscular or mental activity, and may suffer from giddiness and a sense of faintness in consequence of a fall in general blood-pressure. It seems probable that in these cases the gravity effect has drafted off an undue amount of blood into the splanchnic area. Individuals who have been kept in bed for long periods by sickness, accident, or other causes suffer from giddiness and unsteadiness when they first attempt to stand or walk. It seems quite possible that in such cases the effect is caused by a fall in arterial pressure brought about by the dilatation in the splanchnic area. The added weight of blood thrown on these vessels by the effect of gravity is not compensated by a vasoconstriction of the arterioles or an increased tone in the abdominal walls. While certain general deductions of the kind given above may be made from our knowledge of the hydrodynamics and hydrostatics of the circulation, it is evident that in particular cases, whether affecting special organs or the organism as a whole, it is necessary to obtain directly, if possible, the facts, not only for the arterial pressure and velocity but also for the venous pressure and velocity, in order to draw safe conclusions as to the changes in the circulation. In all observations made upon man it is especially important to standardize the results by reducing

\* Hill and Barnard, "Journal of Physiology," 21, 321, 1897.

them to a common level, that is, to the level of the heart at the costal angle (p. 507).

**Accessory Factors Aiding the Circulation.**—The force of the heart beat is the main factor concerned in the movement of the blood, but certain other muscular movements aid more or less in maintaining the circulation as it actually exists in the living animal, particularly in their effect upon the flow of blood in the veins. The most important of these accessory factors are the respiratory movements and the contractions of the muscles of the limbs and viscera. At each inspiratory movement the pressure relations are altered in the thorax and abdomen, and reverse changes occur during expiration. These effects influence the flow of blood to the heart, and alter the velocity and pressure of the blood in a way that is described in the section on Respiration under the title of The Respiratory Waves of Blood-pressure. In brief, it may be said that the main effect of the respiratory movements is to force or to suck blood from the large veins of the abdomen and neck into the large thoracic veins, and, therefore, into the right side of the heart. Keith\* has called attention to the fact that the system of large veins in the thorax and abdomen, namely, the superior and inferior venæ cavæ, the innominate, iliac, hepatic, and renal veins constitute what he calls a *venous cistern*, whose capacity may be reckoned as about 400 to 500 c.c. This cistern is shut off below from the veins of the lower extremity by the valves in the femoral veins at their entrance into the pelvis; it is shut off from the veins of the upper extremity by valves in the subclavian veins, and from the veins of the neck and head by the jugular valves. When an inspiration is made, the lowered pressure in the thoracic cavity aspirates blood from the veins in the neck and upper extremities into the superior cava, and on the return to the expiratory position blood cannot be forced back owing to the jugular and subclavian valves. In the same way the lessened intrathoracic pressure during inspiration must tend to aspirate blood from the abdominal portion of the inferior vena cava into the thoracic portion, and this movement of blood into the thorax is probably aided by the rise in pressure in the abdomen caused by the descent of the diaphragm, since an increase of pressure in the abdomen would be prevented from driving blood toward the legs by the presence of the femoral valves. The play of the respiratory movements must, therefore, constitute a constant factor tending to empty the venous cistern into the right heart, and in this way promoting the circulation on the venous side. Contractions of the skeletal muscles must also influence the blood-flow. The thickening of the fibers in contraction squeezes upon the capillaries and small vessels and tends

\* Keith, "Journal of Anatomy and Physiology," 42, 1, 1908.

to empty them. On account of the valves in the veins the blood is forced mainly toward the venous side of the heart, so that rhythmical contractions of the muscles may accelerate the circulation. This pumping effect of our muscular movements is probably quite an important factor in returning the blood from the lower extremities. In this portion of the body the venous flow to the heart has to overcome the hydrostatic pressure of the column of blood, and it has been shown that when one is standing quite still, the venous pressure alone may be insufficient to overcome this resistance, so that the blood-flow from the feet may be much retarded. Under these circumstances movements of the legs, as in walking, aided by the valves in the veins, probably help to "milk" the blood into the pelvic veins. The contractions of the smooth muscles, especially in the stomach and intestines, during digestion have a similar effect. The musculature of the spleen also is supposed to aid the circulation through that organ by its rhythmical contractions.

**The Conditions of Pressure and Velocity in the Pulmonary Circulation.**—The general plan of the smaller circulation from right ventricle to left auricle is the same as in the major or systemic circulation, and the same general principles hold. The right ventricle pumps its blood into the pulmonary artery, and, on account of the peripheral resistance in the lung capillaries, the side pressure in the artery is higher than in the capillaries, and higher in these than in the pulmonary veins. The velocity of movement is least, on the other hand, in the extensive capillary area and greatest in the pulmonary artery and veins, on account of the variations in width of the bed. So also in the pulmonary artery the pressure and velocity must fluctuate between a systolic and diastolic level at each heart beat, while in the pulmonary veins they are more or less uniform. An interesting difference between the two circulations consists in the fact that the peripheral resistance is evidently much less in the pulmonary circuit, and consequently the pressure in the pulmonary arteries is much less than in the aortic system. The velocity of the flow, as already stated (p. 489), is also greater in the lung capillaries than in the systemic capillaries. Exact determinations of the pressure in the pulmonary artery are made with difficulty on account of the position of the vessel.\* The results obtained by various observers give such values as the following:

	MEAN PRESSURE. MMS. HG.	EXTREME VARIATIONS. MMS. HG.
Dog .....	20	10 to 33
Cat.....	18	7.5 " 24.7
Rabbit .....	12	6 " 35

\* For a discussion of the special physiology of the pulmonary circulator and for references to literature, see Tigerstedt, "Ergebnisse der Physiologie," vol. ii., part ii., p. 528, 1903.



It will be seen, therefore, that the mean pressure is not more than one-seventh to one-eighth of that prevailing in the aorta. The thinner walls and smaller muscular power of the right ventricle as compared with the left are an indication of the fact that less force is necessary to keep up the circulation through the pulmonary circuit.

**The Variations in Pressure in the Pulmonary Circuit.**—Experimental results indicate that the pressures in the pulmonary circuit do not undergo as marked changes as in the systemic circulation; the flow is characterized by a greater steadiness. With a systemic pressure, as taken in the carotid, varying from 144 to 222 mms., that in the pulmonary artery changes correspondingly only from 20 to 26 mms., and extreme variations of pressure in the pulmonary artery probably do not exceed, as a rule, 15 to 20 mms. The regulations of the pressure and flow of blood in the small circulation do not seem to be so direct or complex as in the aortic system. The part taken by the vasomotor nerves is referred to in the chapter upon the innervation of the blood-vessels, and attention may be called here only to the mechanical factors, which, indeed, for this circulation are probably the most important. The output from the right ventricle, and therefore the amount of flow and the pressure in the pulmonary artery, depend mainly on the amount of blood received through the venæ cavæ by the right auricle. If one of the venæ cavæ is closed the pulmonary pressure sinks; pressure upon the abdomen, on the other hand, by squeezing more blood toward the right heart may raise the pressure in the pulmonary artery. By such means, therefore, the variations in blood-flow in the systemic circulation indirectly influence and control the pressure relations in the pulmonary circuit. But the changes in the systemic circulation may affect the blood-flow through the lungs in still another way,—namely, by a back effect through the left auricle. When for any reason the blood-pressure in the aorta is driven much above the normal level the left ventricle may not be able to empty itself sufficiently, and if this happens the pressure in the left auricle will rise and the flow through the lungs from right ventricle to left auricle will be more or less impeded. On the whole, it would seem that the pulmonary circulation is subject to less changes than in the case of the organs supplied by the aorta. The mechanical conditions, especially in the capillary region, are such that the blood is sent through the lungs with a relatively high velocity, although under small actual pressure. The special effects of the respiratory movements and of variations in intrathoracic pressure upon the pulmonary circulation are referred to in connection with respiration.

## CHAPTER XXVII.

### THE PULSE.

**General Statement.**—When the ventricular systole discharges a new quantity of blood into the arteries the pressure within these vessels is increased temporarily. If the arteries, capillaries, and veins were perfectly rigid tubes it is evident that this pressure would be transmitted practically instantaneously throughout the system, and that a quantity of blood would be displaced from the venæ cavæ into the auricles equal to the quantity forced into the aorta by the ventricle. The flow of blood throughout the vascular system would take place in a series of spurts or pulses, the pressure rising suddenly during systole and falling rapidly during diastole. Since the blood is incompressible and the walls of the vessels if rigid would be inextensible, the rise of pressure, the pulse, would be simultaneous in all parts of the system. The fact, however, that the walls of the vessels are extensible and elastic modifies the transmission of the pulse wave in several important particulars: It explains why it is that the pulse dies out in or at the beginning of the capillaries and why it occurs at different times in different arteries—that is, why the wave of pressure takes a perceptible time to travel over the arteries. The result that follows from the elasticity of the arteries may be pictured as follows: Under the normal conditions of the circulation when the heart contracts and forces a new quantity of blood into the aorta room must be made for this blood either by moving the whole mass of the blood forward—that is, by discharging an equal amount at the other end into the auricle—or by the enlargement of the arteries. This latter alternative is what really happens, as it takes less pressure to distend the aorta than to move forward the entire mass of blood under the conditions that exist in the body. So soon, therefore, as the semi-lunar valves open and the new column of blood begins to enter the aorta, the walls of that vessel begin to expand and during the time that the blood is flowing out of the heart—that is, in round numbers, about 0.3 sec.—the extension of the walls passes from point to point along the arterial system. At the end of the outflow from the heart all the arteries are beginning to enlarge, the maximum extension being in the aorta, and room is thus made for the new quantity of blood. The new blood that is actually discharged from the heart

lies somewhere in the aorta, but the pressure that has been transmitted along the system and has caused it to expand has made room for the blood forced out of the aorta by the new blood. With the cessation of the heart beat and the closure of the semilunar valves, the sharp recoil of the distended aorta drives forward the column of blood, and as the aorta sinks back to its normal diastolic diameter the more distal portions of the arterial system are at first distended to a certain point and then return to their diastolic size as the excess of blood streams through the capillaries into the veins. At the time that the aorta has reached its diastolic size the walls of the most distant arterioles have passed their maximum extension and are beginning to collapse. The distension caused by the pulse, therefore, spreads through the arterial system in the form of a wave. At any given point the distension of the walls increases to a maximum and then declines, and when this change in size is recorded in the large arteries, by methods described below, it is found that the expansion of the artery is much more sudden than the subsequent collapse. This difference is understood when we remember that the heart throws its load of blood into the arteries with suddenness and force, causing a sharp rise of pressure, while the collapse of the arteries is due to their own elasticity. The disappearance of the pulse before reaching the capillary area is readily comprehended when one remembers that the arterial tree constantly increases in size as one passes out from the aortic trunk. Many facts, such as those of pressure and velocity already described, indicate that the increase in capacity of the arterial system is somewhat gradual until the region of the smallest arterioles and capillaries is reached and that at this point there is a sudden widening out or increase in capacity of the whole system, although the individual vessels diminish in diameter. It is in this region that the pulse, under ordinary conditions, becomes imperceptible.\* When the arterioles in any organ are dilated the pulse may spread through the capillary regions and be visible in the veins. A venous pulse produced in this way may be observed, for example, in the veins of the hand during sleep (Hooker).

**Velocity of the Pulse Wave.**—From the above considerations it is evident that in a system such as is presented by our blood-vessels the velocity of the pulse wave must vary with the rigidity of the tubes. If perfectly rigid the pressure would be transmitted practically instantaneously; if the walls were very extensible the propagation would be relatively slow. For our blood-vessels as they exist at any given moment the velocity of the pulse wave may be estimated by a simple method: Two arteries may be selected at

\* For a satisfactory discussion of the pulse and for literature consult von Frey, "Die Untersuchung des Pulses." Berlin, 1892. For a description of the variations in disease consult Mackenzie, "The Study of the Pulse, etc." New York, 1902.

different distances from the heart and the pulse wave as it passes by a given point in each artery may be recorded by some convenient apparatus, such as can be devised in any laboratory. If the waves are recorded on a rapidly revolving kymographion whose rate of movement can be determined, then the difference in time in the arrival of the pulse wave at the two points is easily ascertained. That there is a perceptible difference in time one can easily demonstrate to himself by feeling simultaneously the pulse of the radial and the carotid arteries. If this difference in time is determined for two arteries—for instance, the femoral and the tibialis anterior—and the distance between the two points is recorded, we have evidently the necessary data for obtaining the velocity of the pulse wave in the arteries of that region. A record of this kind is shown in Fig. 211.

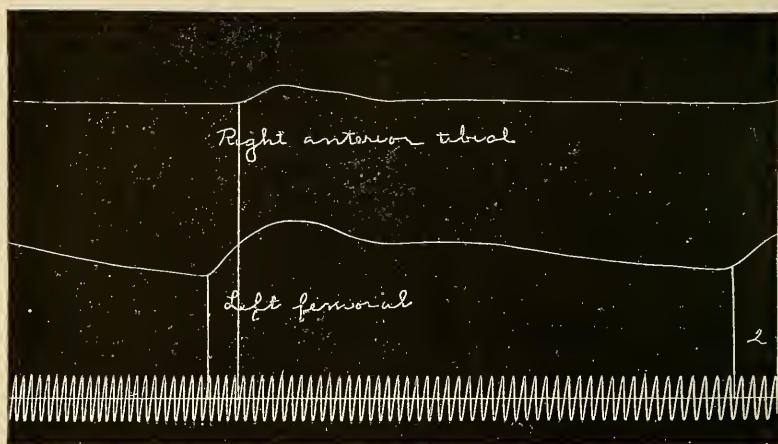

Fig. 211.—To illustrate the method of determining the velocity of the pulse wave in man. Shows record of the pulse at two points on the leg at a known distance apart. The difference in time is given by the verticals dropped from the beginning of these waves to the time curve. This last is made by the vibrations of a tuning fork giving 50 vibrations per second. The difference in this case was equal to 0.07 sec.

The results obtained by various authors indicate that the velocity varies somewhere between 6 and 9 meters per second for adults. The figures published by later observers show also that the velocity is somewhat greater in the upper extremities (7.5 m. for carotid-radial estimation) than in the descending aorta (6.5 m. for carotid-femoral estimation).\* The average of thirty determinations made in the author's laboratory upon medical students shows that the velocity in the leg (femoral-anterior tibial) is 6.1 m. when the records are made upon the same leg, and 7.4 m. when the record for the femoral is taken from one leg and that for the anterior tibial

\* Edgren, "Skandinavisches Archiv f. Physiol.," 1, 96, 1889.

from the other. The latter condition would seem to be more normal, since the blood-flow and normal tension of the walls are probably less disturbed. An increase in rigidity of the arteries causes the velocity to rise; in elderly people, therefore, the velocity is distinctly greater. In arterial sclerosis with hypertrophy of the heart the velocity may increase to as much as 11 or 13 m. Any marked dilatation of the arteries—such as occurs, for instance, in aneurysms,—retards the pulse wave markedly; so that the existence of an aneurysm may be detected in some cases by this fact. If we know the velocity of the wave and the time that it takes to pass any given point the length of the wave is given by the formula  $l=vt$ . In an adult the duration of the wave ( $t$ ) at the radial may be taken as 0.5 to 0.7 sec.; so that if the velocity of the wave were uniform throughout the arteries the length of the wave would be from 3.25 to 4.5 m. We can conclude, therefore, that before

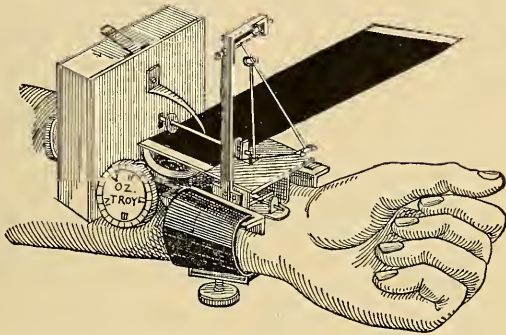

Fig. 212.—The Dudgeon sphygmograph in position.

the wave has disappeared at the root of the aorta it has reached the most distant arteries.

**The Form of the Pulse Wave—Sphygmography.**—The pulse wave may be felt upon any superficial artery in consequence of the distension of the vessel. By the tactile sense alone the experienced physician may distinguish some of the characters of the wave, its frequency, its force, etc. The details of the form of the wave, however, were made evident only when the variations in size of the artery were recorded graphically by placing a lever upon it. Any instrument suitable for this purpose is designated as a *sphygmograph*, and very numerous forms have been devised. The movement of the artery is very small and to obtain a distinct record it is necessary to magnify this movement greatly by a properly constructed lever.

The form of lever that is perhaps most frequently employed is shown in the accompanying figures. The instrument is strapped upon the arm so that the

button of the metallic spring rests over the radial artery. The movements of the artery are transmitted to this spring and this latter in turn acts upon the bent lever, and the magnified movement is recorded by the writing point, upon a strip of blackened paper which is moved under the point by clockwork contained in the case. To obtain a satisfactory record or *sphygmogram*, two details are of special importance: First, the button of the lever must be pressed upon the artery with the proper force. Theoretically this pressure should be about equal to the diastolic pressure within the artery. All sphygmographs are provided with means to regulate the pressure, and practically one must learn so to place the button and to arrange the pressure as to obtain the largest tracing. A second detail of importance is that the weight of the lever when set suddenly into motion causes a movement, due to the inertia of the mass, which may alter the true form of the wave.

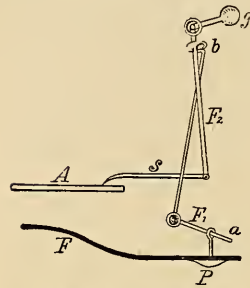

Fig. 213.—The lever of the Dudgeon sphygmograph: *P*, The button of the spring *F*, to be placed upon the artery. The movement is transmitted to the lever, *F*<sub>1</sub>, and thence to the bent lever, *F*<sub>2</sub>, whose movement is effected through the weight, *g*. The writing point *s*, of this lever makes the record on the smoked surface, *A*.

To overcome this defect the lever should be as light as possible, or the spring upon which the artery plays should have considerable resistance. In those sphygmographs in which the inertia factor is practically eliminated the difficulty of obtaining a tracing, especially from a weak pulse, is correspondingly increased, and in the sphygmographs most commonly employed, such as the Dudgeon, facility in application is obtained at the expense of incomplete correction of the error of inertia.

The pulse wave obtained from the radial artery is represented in Fig. 214. It will be seen from this figure that the artery dilates rapidly and then falls more slowly, but it must be borne in mind that the very pointed apex of the wave recorded by this form of sphygmograph is due to the instrumental error referred to above, namely, the "fling" of the lever caused by the sudden expansion

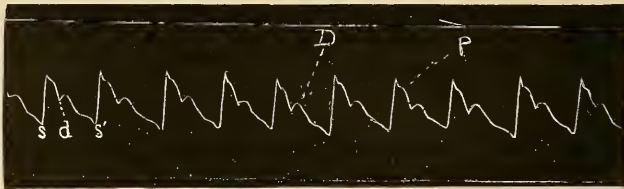

Fig. 214.—Sphygmogram from the radial artery, Dudgeon sphygmograph: *D*, The dirotic wave; *P*, the predicrotic wave.

of the artery. The ascending portion of the wave is spoken of as the *anacrotic limb*, the descending, as the *catacrotic limb*. Under usual conditions the anacrotic limb is smooth,—that is, shows no secondary waves,—while the catacrotic limb shows one or more secondary waves, which are spoken of in general as the *catacrotic waves*. The most constant of these latter waves occurs usually

approximately at the middle of the descent (*D*) and is designated as the *dicrotic* wave. A less conspicuous wave between it and the apex of the pulse wave is known usually as the *predicrotic* wave, *P*, while the wave or waves following the dicrotic are designated as *postdicrotic*. These catacrotic waves are too small, under normal conditions, to be felt by the finger. Under certain abnormal conditions, however, which cause a low blood-pressure without marked diminution in the heart beat, the dicrotic wave is emphasized and may be detected by the finger. A pulse of this kind is known as a dicrotic pulse. In each pulse wave we may distinguish a systolic and a diastolic phase; the former, making due allowance for transmission, corresponds with the time during which the aortic valves are open, and blood is streaming from the heart to the aorta, the latter represents the period during which the aortic valves are closed and the arteries are shut off from the heart. In Fig. 214 the systolic phase extends from *s* to *d*, the diastolic from *d* to *s'*.

**Explanation of the Catacrotic Waves.**—It has been found difficult to give an entirely satisfactory explanation of the catacrotic waves or, to speak more accurately, it is difficult to decide between the different explanations that have been proposed. Concerning the dicrotic wave, it may be said that tracings from different arteries show that, like the main pulse wave, it has a centrifugal course,—that is, it starts in the aorta and runs peripherally with the same velocity as the main wave upon which it is superposed. Moreover, simultaneous tracings of the pressure changes in the heart and in the aorta show that the closure of the semilunar valves is synchronous with the small depression or negative wave (*d*, Fig. 214) which immediately precedes the dicrotic wave. The general belief, therefore, is that the dicrotic wave results from the closure of the semilunar valves. When the distended aorta begins to contract by virtue of the elasticity of its walls, it drives the column of blood in both directions. Owing to the position of the semilunar valves the flow to the ventricle is prevented; but the interposition of this sudden block causes a reflected wave which passes centrifugally over the arterial system. The dicrotic wave is preceded by a small negative wave or notch in the curve which marks the time of closure or just follows the closure of the semilunar valves. The sequence of events as pictured by Mackenzie\* is as follows: "As soon as the aortic pressure rises above the ventricular the valves close. At the moment this happens the valves are supported by the hard, contracted ventricular walls. The withdrawal of the support by the sudden relaxation of these walls will tend to produce a negative pressure wave in the arterial system. But this negative

\* Mackenzie, "The Study of the Pulse and the Movements of the Heart." 1902.

wave is stopped by the sudden stretching of the aortic valves, which, on losing their firm support, have now themselves to bear the resistance of the arterial pressure. This sudden checking of the negative wave starts a second positive wave, which is propagated through the arterial system as the dicrotic wave." The smaller waves, such as the predicrotic, have been explained simply as reflected waves, or as instrumental errors, due to fling of the lever. According to some authors,\* an important—perhaps the chief—factor in the production of the secondary waves is the reflection that occurs from the periphery. Where each arterial stem breaks up into its smaller vessels the main pulse wave suffers a reflection, a wave running backward toward the heart. It is probable that such reflected waves from different areas—for instance, from the coronary system, the subclavian system, the mesenteric system, etc.—meet in the aorta and may in part summate to larger waves, which again pass peripherally. The catacrotic waves, according to this view, probably differ in character in the different arteries, and tracings indicate that this is the case. The radial pulse differs, for instance, from the carotid pulse in the character of its waves. Between these

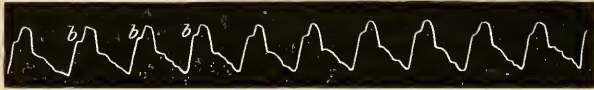

Fig. 215.—Anacrotic pulse from a case of aortic stenosis (*Mackenzie*): *b*, The anacrotic wave.

opposite views it is not possible to decide, but it is perhaps permissible to believe that while the dicrotic wave is due primarily to the impulse following upon the closure of the semilunar valves, nevertheless the actual form of this and the other secondary waves is variously modified in different parts of the system by the reflected waves from different peripheral regions.†

*Anacrotic Waves.*—As was said above, the anacrotic limb under normal conditions shows no secondary waves. Under pathological conditions, however, a secondary wave more or less clearly marked may appear, as is shown, for instance, in the tracing given in Fig. 215. Such waves are recorded in cases of stiff arteries or stenosis of the semilunar valves. In the normal individual an anacrotic pulse in the radial may be obtained, according to von Kries,‡ by raising the arm. He believes that in this position the reflection of the pulse wave from the periph-

\* See von Frey, *loc. cit.*

† For a general discussion, see Tigerstedt, "Ergebnisse d. Physiologie," vol. viii., 1909.

‡ Von Kries, "Studien zur Pulslehre," 1892.



ery is favored, and that the anacrotic wave is simply a quickly reflected wave. An opposite interpretation, however, is given by von Recklinghausen, who states that conditions which lead to a diminution in vascular tone and a dilation of the arteries produce "weak reflection" and an anacrotic pulse. Constriction of the small arteries in any system favors quick reflection in the artery supplying the system and produces a pulse with a sharp-pointed apex.

**Characteristics of the Pulse in Health and in Disease.**—

By mere palpation the physician obtains from the pulse valuable indications concerning the heart and the circulation. The frequency of the heart beat is at once made evident, so far at least as the ventricle is concerned. One may determine readily whether the frequency is above or below the normal, whether the rhythm is regular or irregular. By the same means one can determine

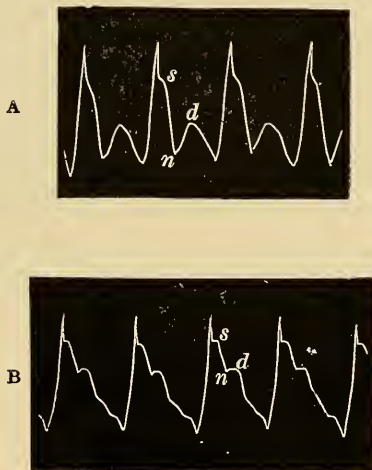

Fig. 216.—Sphygmograms illustrating the effect of variations in blood-pressure, particularly upon the position of the diastolic wave and notch: *n*, The diastolic notch; *d*, the diastolic wave. A, Sphygmogram while blood-pressure was relatively low. B, Sphygmogram with higher blood-pressure. (*Mackenzie.*)

whether the pulse is large (*pulsus magnus*) or small (*pulsus parvus*), whether the wave rises and falls rapidly (*pulsus celer*) as happens in the case of insufficiency of the aortic valves, or whether in one phase or the other it is more prolonged than normal (*pulsus tardus*). It seems obvious, however, that a more satisfactory conclusion may be reached in all such cases by obtaining a sphygmographic record. In the works devoted to clinical methods numerous such sphygmograms are described. By mere pressure upon the artery one can determine also approximately whether the blood-pressure is high

or low by estimating the force with which the wave presses upon the fingers, or the pressure necessary to occlude the artery. A similar inference may be drawn from the character of the sphygmogram, and especially from the relative size and position of the dicrotic wave. When this latter wave falls at or near the base line of the curve it indicates a low arterial pressure, since under these circumstances the artery collapses readily after its first systolic expansion (see Fig. 216). Since the introduction of the sphygmomanometer (p. 501), however, it seems evident that this instrument must be appealed to whenever the determination of blood-pressure is a matter of importance.

**Venous Pulse.**—Under usual conditions the pulse wave is lost before entering the capillary regions, but as a result of dilatation in the arteries of an organ the pulse may carry through and appear in the veins, in which it may be shown, for instance, by the rhythmical flow of blood from an opened vein. The term venous pulse, however, as generally used applies to an entirely different phenomenon,—namely, to a pulse observed especially in the large veins (jugular) near the heart. The pulse in this case is not due to a pressure wave transmitted through the capillaries, but to pressure changes of both a positive and negative character occurring in the heart and transmitted backward into the veins. The venous pulse that has this origin may usually be seen and recorded in the external (or internal) jugular. Under pathological conditions, especially when the flow through the right heart is more or less impeded, it may be plainly apparent at a further distance from the heart and may cause a noticeable pulsation of the liver, which is designated as a liver pulse. The venous pulse curve has been much studied in recent years.\* It is somewhat complicated and an explanation of some of its details has not been agreed upon, but there can be no doubt that when properly interpreted it will throw much light upon the pressure changes in the heart, and will afford a valuable means of diagnosis in cases of valvular lesions and other pathological conditions of the heart. It is evident also that the venous pulse gives a ready means of determining the rate of beat of the auricles, just as the arterial pulse enables us to count the beats of the ventricles, and in this way records of the venous pulse are important in the interpretation of irregularities in the beat of the heart (arrhythmia).

As usually recorded the venous pulse shows three positive waves, designated commonly as the *a*, *c*, and *v* waves, and three negative waves. Of the three positive waves, the *a* wave marks,

\* See Mackenzie, "The Study of the Pulse," 1902; also Lewis, in Hill's "Further Advances in Physiology," New York, 1909.

undoubtedly, the contraction of the auricle, but in order to locate this wave or, indeed, to interpret at all the complicated venous pulse, it is necessary to have a simultaneous tracing of the arterial pulse, preferably the carotid, or of the apex beat of the heart. Either of these latter tracings enables one to mark upon the venous pulse the point at which the ventricular systole begins, and the wave immediately preceding this point must be due to the auricular contraction, the *a* wave (Figs. 217 and 218). Following the rise of the *a* wave there is a fall, the first negative wave, which is due to the auricular relaxation. The interpretation of the other two positive and negative waves has been the subject of much discussion. Mackenzie, one of whose tracings is reproduced in Fig. 217), believed that the

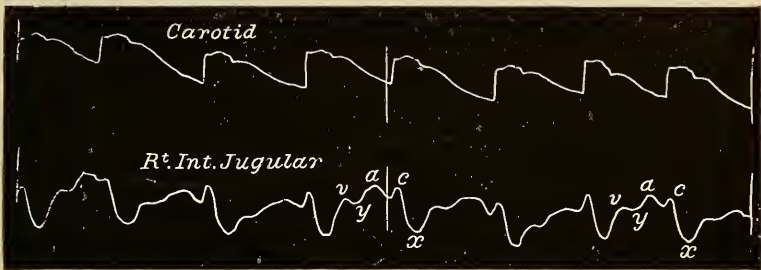

Fig. 217.—Simultaneous tracings of the carotid and venous pulses. In the venous tracing (internal jugular) *a* indicates the auricular wave due to the contraction of the auricle; *c* is the carotid wave due (Mackenzie) to an impulse from the neighboring carotid artery; *v* is the ventricular wave due to the checking or stagnation of the flow into the auricle as this chamber fills during the period of closure of the auriculoventricular valves; *x*, dilatation due to auricular relaxation; *y*, the period of ventricular diastole. (Mackenzie.)

*c* wave is due simply to the pulse in the neighboring carotid artery, and that, therefore, it has no significance in regard to changes within the heart itself. Careful records made by other observers show, however, that this explanation is insufficient. The *c* wave begins in the jugular before the arterial pulse wave reaches the carotid, hence this wave cannot be due wholly to the carotid pulse. As is shown in the tracing given in Fig. 218, the *c* wave begins, in fact, at the very moment of ventricular systole. The explanation of it which meets with most acceptance is that it is due to a sharp protrusion of the auriculoventricular valves into the cavity of the auricle. At the beginning of the ventricular systole these latter valves are in position for closure, while the semilunar valves at the opening to the pulmonary artery are tightly closed. For a short period the ventricular muscle contracts upon a closed cavity, and the pressure upon the contents rises rapidly. It is at the beginning of this brief period that the auriculoventricular valves are protruded

somewhat into the auricle and thus cause a positive wave in the venous blood which is propagated back into the large veins. Immediately upon the opening of the semilunar valves blood streams out of the ventricle into the pulmonary artery, and the ventricle diminishes rapidly in size—especially in the diameter from base to apex. This sudden descent of the base of the ventricle pulls downward the floor of the auricle and causes a sudden enlargement of the auricular cavity, which in turn produces a temporary negative pressure in the auricle and

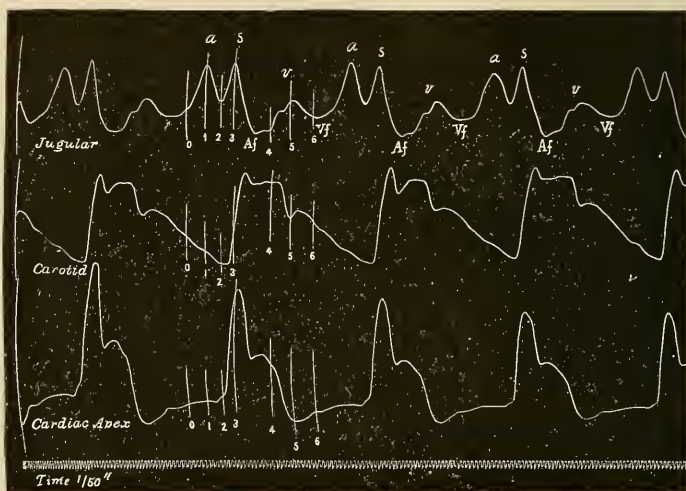

Fig. 218.—Simultaneous tracings of the jugular pulse, the carotid pulse, and the apex beat. (*Bachmann*.) At the bottom of the tracing the time is given in fiftieths of a second. The vertical lines 0, 1, 2, 3, etc., mark synchronous points on the curves. *A*, The auricular wave; *s*, the so-called *c* wave caused by the systole of the ventricle; *v*, the stagnation wave caused by the filling of the auricle. It will be noticed that the *c* wave (marked *s* in the tracing) occurs at the beginning of the ventricular systole as marked on the apex beat, and shortly before the pulse in the carotid artery. The height of the *v* wave is reached just after the occurrence of the dicrotic notch on the carotid wave, and coincides with the opening of the auriculoventricular valves; *Af*, the negative wave caused by the effect of the ventricular systole; *Vf*, the negative wave following the opening of the auriculoventricular valves.

attached veins. The second negative wave is, therefore, due to a forcible dilation of the auricle caused by the systole of the ventricle. This negative wave is converted into a positive wave by the steady inflow of venous blood, which continues to pour into the auricle during the whole period of the systole of the ventricle and of the closure of the auriculoventricular valves. In this way the wave *v* is produced. It is frequently of irregular or toothed form and rises somewhat gradually to its maximum. The end or maximum of the wave falls in with the beginning of the muscular relaxation of the ventricle, and the return,

therefore, of the base of the ventricle to its diastolic position. Immediately afterward the auriculoventricular valves open, and the blood accumulated in the auricles is discharged into the ventricle, causing again a sudden fall of pressure in the auricles and veins, the third negative wave.

The true relations of these different venous waves to the sequence of events in the ventricle and aorta are clearly shown



Fig. 219.—Schema of the variations of pressure in the ventricle, auricle, aorta, and superior vena cava during a cardiac cycle in the dog: *a, b*, Systole of the auricle; *b, c, d, e*, systole of the ventricle; *b',* opening of the semilunar valves; *c, d, e*, closure of the semilunar valves; *b, b',* closure of the auriculoventricular valves; *f,* opening of the auriculoventricular valves. On the curve for the auricle and vein the wave from *a* to *b* represents the auricular contraction, the *a* wave; that beginning at *b* is the wave due to ventricular systole, the *c* wave, and the rise of pressure extending from *d* to *e* and ending with the opening of the auriculoventricular valves constitutes the *v* wave. The time relations are given along the abscissa in tenths of a second, the pressure relations in mms. of mercury for the ventricle and aorta are given along the ordinates to the left. (After Fredericq.)

in the diagram given by Fredericq, which is reproduced in Fig. 219. Following this author,\* the series of positive and negative waves which may usually be shown in the auricles and great veins during a single heart beat may be enumerated as follows:

1. The auricular wave (*a* wave), auricular systole.
2. The first negative wave, auricular diastole.
3. First systolic wave (positive), *c* wave. Beginning of ventricular systole. Due to sudden closure and protrusion of the auriculoventricular valves.

\* Fredericq, "Centralblatt f. Physiol.," 22, No. 10, 1908.

4. Second negative wave. At the time of opening of the semi-lunar valves. Due to descent of the base of the ventricle, causing dilatation of auricle.

5. Second systolic wave (positive), *v* wave. Latter part of systole. Due to gradual filling of auricle and at the end to the return of the base of the ventricle to its diastolic position.

6. Postsystolic (third) negative wave begins at moment of opening of the *a-v* valves. Due to emptying of auricular blood into ventricle.

Other waves have been described, especially one in the diastolic phase of the ventricular beat, which is known as the *h* wave (Hirschfelder) or *b* wave (Gibson). This wave occurs between the *v* and the *a* wave and is seen most frequently and distinctly in the case of hearts with a slow rate of beat. The usual explanation of this wave is that it is due to the very sudden distention of the ventricles by the inflowing blood. The rise in intraventricular pressure thus produced brings the auriculoventricular valves suddenly into a position of closure and causes a momentary positive wave in the auricles and great veins. For the variations in the form of the venous pulse under pathological conditions of the heart, reference must be made to clinical literature.\*

\* See Hewlett, "Journal of Medical Research," 17, 1907; "Journal of the Amer. Med. Assoc.," 51, 1908, and Hirschfelder, "Diseases of the Heart and Aorta," Philadelphia, 1910

## CHAPTER XXVIII.

### THE HEART BEAT.

**General Statement.**—We divide the heart into four chambers, —the two auricles and the two ventricles. What we designate as a heart beat begins with the simultaneous contraction of the two auricles, immediately followed by the simultaneous contraction of the two ventricles; then there is a pause, during which the whole heart is at rest and is filling with blood. As a matter of fact, the heart-beat is initiated not by the auricles proper, but by an area of specialized tissue in the right auricle lying between the openings of the two cavæ. This portion of the auricular wall corresponds physiologically to a definite chamber, the venous sinus,

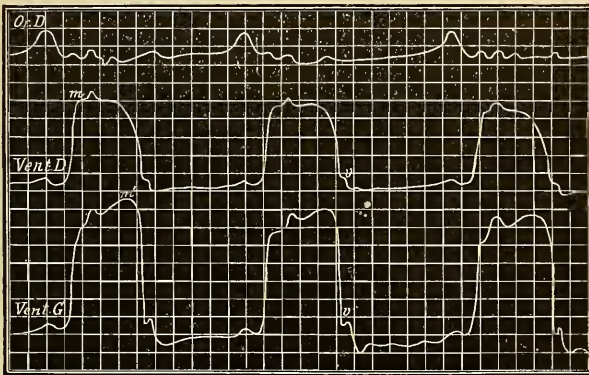

Fig. 220.—To show the time relations of the auricular systole and diastole, and ventricular systole and diastole (Marey): *Or. D.*, Tracing from right auricle; *Vent. D.*, tracing from right ventricle; *Vent. G.*, tracing from left ventricle. Obtained from the heart of the horse by means of tubes communicating with the cavities.

in the heart of the lower vertebrates (see Fig. 224). The contraction of any part of the heart is designated as its *systole*, its relaxation and period of rest as its *diastole*. In the heart-beat we have, therefore, the auricular systole, the ventricular systole, and the heart pause, during which both chambers are in diastole. The general relations of systole, diastole, and pause are represented graphically in the accompanying figure (Fig. 220). It will be noted that the auricular systole is shorter and its diastole longer than the similar conditions in the ventricles.

**The Musculature of the Auricles and Ventricles.**—Embryo-

logically the four-chambered heart is developed from a simple tube, and this origin is indicated in the adult by the fact that the musculature of the two auricles is in large part common to both chambers,—that is, surrounds them as though they were a single chamber,—and the same is true of the ventricles. In the auricles there is a superficial layer of fibers which runs transversely and encircles both auricles. The simultaneous contraction of the two chambers would seem to be insured by this arrangement alone. In addition, each auricle possesses a more or less independent system of fibers, whose course is at right angles to that of the

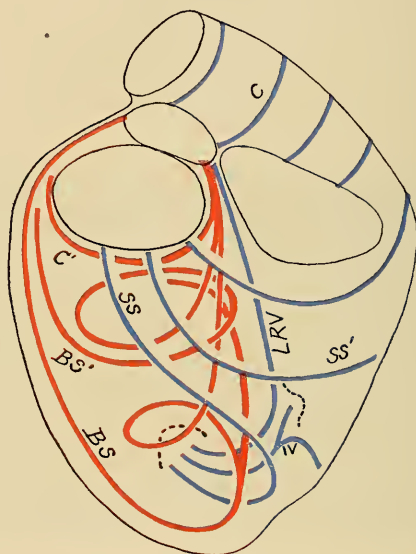

Fig. 221.—Schema to show the course of the superficial and deep fibers of the bulbo-spiral and sino-spiral systems. The heart is viewed from the dorsal side. *BS*, superficial bulbo-spiral system; *BS'*, deep bulbo-spiral system; *SS*, superficial sino-spiral system; *SS'*, deep sino-spiral system; *C*, circular fibers round the conus; *C'*, circular fibers round the base of the aorta and the left ostium; *LRV*, longitudinal bundle of right ventricle, from membranous septum to right ventricle; *IV*, interventricular or interpapillary layer (Mall).

preceding layer. These fibers may be considered as loops arising and ending in the auriculo-ventricular ring. The course of the fibers in the ventricles has been difficult to make out, and several more or less different accounts have been published. The fibers on the surface of the heart arise from the tendinous rings and membranes at the base and take a spiral course to the apex, where they form a vortex and pass into the interior of the left ventricle to enter the septum and make connections with the papillary muscles. In this way they return upon themselves toward the base of the heart and form spiral loops whose contractions serve to approxi-



mate base and apex and at the same time to give a rotation to the apex from left to right. Mall\* divides these superficial fibers into two groups. First, the *superficial bulbo-spiral* fibers (*B S*) which arise from the conus, the left side of the aorta, and the left side of the left ostium venosum, take a spiral course to the apex, where they form the posterior horn of the vortex, and penetrate to the interior of the left ventricle to end in the septum and along the posterior side of the ventricle, making connections also with the posterior papillary muscle. Some of the deeper fibers of this layer encircle the lower part of the ventricle and then pass upward to end at the base of the heart. The bulbo-spiral fibers belong chiefly to the left ventricle. Second, the *superficial sinospiral*

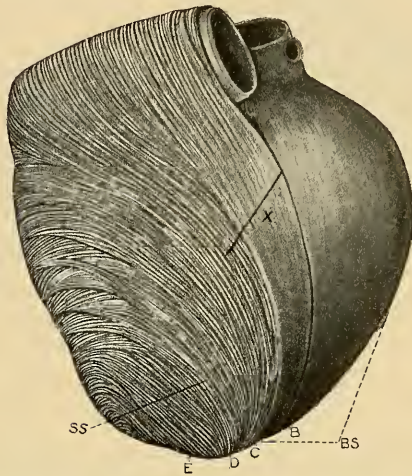

Fig. 222.—Anterior surface of the heart, to show the arrangement of the superficial fibers over the right ventricle: *SS*, Sinospiral band; *BS*, bulbo-spiral band; *B*, *C*, fibers of the bulbo-spiral system as they enter the vortex; *D*, *E*, fibers of the sinospiral band as they enter the vortex (Mall).

*fibers* (*SS*), which arise mostly on the posterior aspect of the heart from the right ostium venosum, the sinus end of the embryonic heart, take a spiral course to the apex over the anterior surface of the right ventricle, running more transversely than the bulbo-spiral group. At the vortex this system forms the anterior horn of the vortex and penetrates into the interior of the left ventricle, to end along the anterior side and in the papillary muscles, particularly the anterior papillary. Beneath these superficial layers lie corresponding deep layers of the bulbo-spiral and sinospiral systems, which have a more transverse or circular course. The deep bulbo-spiral fibers (*BS'*) encircle the left ventricle and end

\* Mall, "The American Journal of Anatomy," 2, 211, 1911.

by way of the septum on the dorsal side of the aorta. These fibers in the developed heart make a strong circular system whose contraction tends to diminish the lumen of the left ventricle. Below the superficial sinospiral system lies the deep sinospiral sheet (*S S'*), which arises from the posterior side of the left ostium and passes transversely to enter the interior of the right ventricle and then turn upward toward the base. At the base of the heart some of the fibers of the bulbospiral system pass circularly round the base of the aorta and the left ostium, and in the right ventricle some of the sinospiral system form circular loops round the conus at the base of the pulmonary artery. As will be described below,

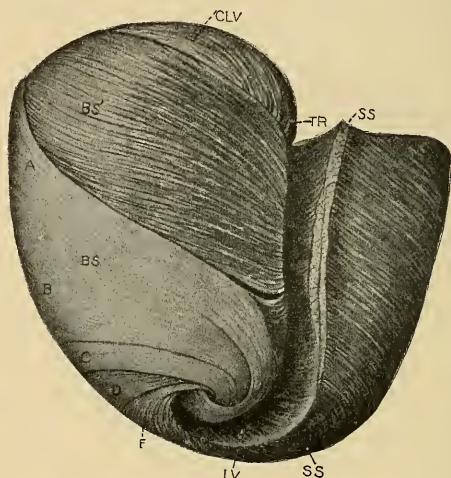

Fig. 223.—Posterior view of heart, somewhat to left, after the superficial sinospiral band has been removed to the posterior longitudinal sulcus: *BS'*, deep bulbospiral band; *BS*, superficial bulbospiral band, *A*, *B*, and *C* are fibers belonging to this system and forming the posterior horn of the vortex; *SS*, superficial sinospiral band, *D* and *E* are fibers belonging to this system and forming the anterior horn of the vortex; *CLV*, the circular band (bulbospiral system) round the left venous ostium (Mall).

there is some physiological evidence to indicate that this latter group of circular fibers around the base of the pulmonary artery and aorta are the last to enter into contraction in the systole of the ventricle, as might be expected from their homology with the musculature of the bulbus arteriosus in the hearts of the lower vertebrates.

**The Auriculoventricular Bundle.**—A matter of very great physiological interest in connection with the invariable sequence of the heart-beat has been the question of the existence of a direct muscular connection between the auricles and ventricles. In the lower vertebrates there is muscular continuity throughout the heart from the venous end to the arterial end. In hearts of this type (see Fig. 224) we may distinguish four different chambers—the sinus venosus, into which the great veins open, the auricle

(right and left), the ventricle (single), and the bulbus arteriosus or bulbus cordis. The musculature of each chamber connects with that of the succeeding one, and the contraction wave, which begins in the sinus, spreads in order to the following divisions of the heart. There is, however, a pause or interruption in the passage of this wave at the sino-auricular junction, at the auriculo-ventricular junction, and at the bulboventricular junction, so that the contraction of each chamber is marked off as a separate occurrence. In the human heart and the mammalian heart in general we are accustomed to distinguish only the auricles and ventricles, but physiological and anatomical studies combined have shown that in such hearts a remnant of the sinus venosus is

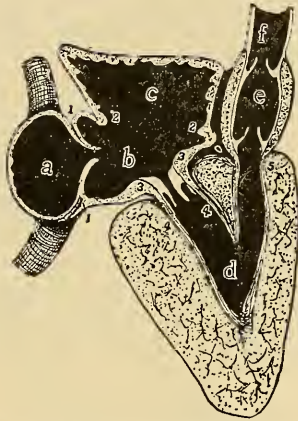

Fig. 224.—A generalized type of vertebrate heart, combining features found in the eel, dogfish and frog (*Keith*): *a*, Sinus venosus and veins; *b*, auricular canal; *c*, auricle; *d*, ventricle; *e*, bulbus cordis; *f*, aorta; 1-1, sino-auricular junction and venous valves; 2-2, canal-auricular junction; 3-3, annular part of auricle; 4-4, invaginated part of auricle; 5, bulboventricular junction.

found in the right auricle, particularly in the area lying between the openings of the venæ cavæ and round the coronary sinus. A special collection of this tissue which lies "in the sulcus terminalis just below the fork formed between the junction of the upper surface of the auricular appendix with the superior vena cava" has been described by Keith and Flack, and is designated as the *sino-auricular node*. The beat of the heart begins in this tissue, as in the case of the hearts of the lower vertebrates, and spreads directly to the auricular muscle, with, perhaps, a pause at a sino-auricular junction, although this is uncertain. At the other end the bulbus cordis is represented in the human heart by the conus arteriosus of the right ventricle, and, as we shall see, there is some evidence that this portion of the ventricle contracts somewhat independ-

ently. The matter of greatest interest in connection with the different chambers has been the nature of the auriculoventricular junction. In the mammalian heart tendinous tissue develops in this region, and for a long time it was supposed that there was no muscular connection between auricles and ventricles. In recent years, however, it has been shown most satisfactorily that there is a peculiar band of cardiac muscle or modified muscle, known usually as the *auriculoventricular bundle*, which connects auricle and ventricle.\* The bundle as a definite structure begins at the base of the interauricular septum, at the posterior margin, and on the right side in a collection of small cells or fibers known as the node, or the

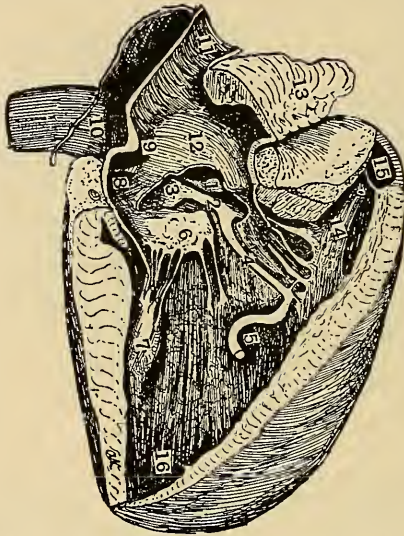

Fig. 225.—To show the position of the auriculoventricular bundle in the heart of the calf: 2, The auriculoventricular bundle. As it runs along the top of the ventricular septum, it is seen to divide into two branches, one entering the right, the other the left, ventricle; 3, the beginning of the bundle in the auricular septum known as the A-V node; 4, the branch of the bundle entering the right ventricle in the septal wall; 1, central cartilage (from Keith).

*auriculoventricular node* (A-V node), it runs as a bundle along the top of the interventricular septum (see Fig. 225), and near the union of the posterior and median flaps of the aortic valve it divides into two main branches, one of which enters the right ventricle, the other the left, each lying beneath the endocardium. Passing down the septal wall, these branches divide, † as represented in Fig. 226, to form a system of strands that can be traced

\* See Retzer, "Archiv f. Anatomie," 1904, p. 1, and "Anatomical Record," 2, 149, 1908; Braeunig, "Archiv f. Physiologie," 1904, suppl. volume, p. 1; Tawara, "Das Reizleitungssystem des Säugethierherzens," Jena, 1906.

† DeWitt, "Anatomical Record," 3, 475, 1909.

over the inner surface of the ventricles, constituting what were formerly designated as Purkinje fibers. The auriculoventricular node in the interauricular septum is connected with the musculature of the auricles, and through muscle bundles in the septum with the remnant of sinus tissue (sino-auricular node) at the mouth of the superior vena cava. The main bundle and the larger branches of this system are surrounded by fibrous tissue, and it is uncertain whether or not it actually contracts during the beat of the heart, but there is little doubt that it constitutes a conducting system of modified muscular tissue through which the excitation is conveyed



Fig. 226.—The auriculoventricular bundle and its terminal ramifications in the interior of the ventricles (from model constructed by Miss De Witt on basis of dissections). The division of the bundle into right and left branches is shown, and the ramifications of each of these branches in the interior of the right and left ventricles. The branching system in the left ventricle is incomplete in the model, as the outer wall of this ventricle had been removed in the dissection.

from right auricle to the ventricles, or perhaps, more correctly speaking, from the auriculoventricular node to the ventricular musculature. The contraction wave of the auricle is not transmitted, therefore, directly to the ventricle, but indirectly through the conducting system, the *A-V* bundle. Some authors\* believe, in fact, that the excitation process which originates in the sino-auricular node spreads independently to the auricular muscle, on the one hand, and to the ventricular muscle on the other. The path in the latter case is first to the auriculoventricular node, and thence through the auriculoventricular bundle to the interior of the ventricles (papillary muscles). The *A-V* node and the main bundle in the human heart are small in size—about 18 mm. long, and from 1.5 to 2.5 mm. wide, and they and their dependent system of fibers or strands in the interior of the ventricles con-

\* Eyster and Meek, "Heart," 5, 119, 1914.

stitute, according to Keith and Flack,\* a remnant of the original invagination of muscular tissue from the auricular ring (Fig. 224), through which auricle and ventricle are connected in the lower vertebrates. In addition to the auriculoventricular bundle Kent describes two other connections between auricles and ventricles. The more important of these lies on the right side of the heart, and consists of a mass of nodal tissue lying in the wall of the right auricle and possessing connections with the musculature of the right auricle and the right ventricle. When all parts of the auriculoventricular groove (including the A-V bundle) are severed, except the right lateral wall at the location of this bundle of Kent, † beats originating in the auricle are transmitted to the ventricle in due sequence. It seems probable that this additional connection between auricle and ventricle, designated as the right lateral connection, may play some rôle, as yet undetermined, in the maintenance of the sequence of the heart beat.

**The Contraction Wave in the Heart.**—It seems to be demonstrated that normally the contraction of the heart begins in the sinus tissue of the right auricle—the so-called sino-auricular node described in the preceding paragraph, or in the neighboring sinus tissue. The tissue of the sino-auricular node is designated sometimes as the pace-maker of the heart, on the assumption that its rhythm sets the pace for the rate of beat of the whole heart. Experiments made to demonstrate this point by excising or destroying the portion of the sinus region containing the node have given conflicting results. ‡ Some authors state that the rate of the heart-beat is not affected by such operations, while others claim that the subsequent auriculoventricular beat takes on permanently a slower rhythm.

In the mammalian heart, when exposed to view, it is evident that the auricular systole is not sufficient to empty its cavity, so far at least as the atrium is concerned. The contraction of the auricular appendages is more forcible. The contraction may be regarded as a rapid peristalsis, which sweeps a portion of the blood before it into the ventricle. The force of the contraction has been determined in a number of cases. For the auricle of the dog's heart the pressure caused by the contraction has been estimated to be equal to 9 to 20 mm. Hg. The systole of the ventricle is to the eye a simultaneous contraction of the whole musculature. Various observers, however, have shown that the wave of contrac-

\* Keith and Flack, "Journal of Anat. and Physiology," 41, 172, 1906, and 43, p. 1.

† Kent, "Proceedings of the Royal Society," B. 87, 198, 1914, and "Journal of Physiology," 48, 1914, "Proc. Physiol. Soc."

‡ See Cohn, Kessel, and Mason, "Heart," 3, 311, 1912, and Moorhouse, "American Journal of Physiology," 30, 358, 1912, and 31, 421, 1913.

tion travels over the heart with a certain velocity, which for the human heart has been estimated at 5 m. per second (Waller), and for the rabbit's heart (Gotch) at 3 m. per second. In regard to the course of the wave there have been great differences of opinion among different investigators. While the older view assumed as a matter of course that the contraction begins at the base and passes toward the apex, the newer knowledge in regard to the conduction system between auricles and ventricles seems to indicate from the anatomical side that the auriculoventricular bundle spreads out upon the papillary muscles in the interior of the ventricle, and that, therefore, the contraction of the ventricles may begin with the papillary musculature and thence spread to the oblique and circular fibers of the ventricles.\* This anatomical indication has been confirmed experimentally by some investigators and contradicted by others. Observations upon the papillary muscles seem to show that they are not the last portion of the musculature to enter into contraction, but whether the ventricular systole begins in them is not so clear, although the trend of recent opinions seems to be toward this view. The course of the contraction wave has been studied chiefly by means of the accompanying electrical variation, and the conflicting results obtained from this method are referred to briefly in the succeeding paragraph. Between the auricular and ventricular contractions there is a perceptible interval, which, for the human heart, can be estimated from a study of the records of the jugular pulse. The interval between the *a* and the *c* waves, the *a-c* interval, as it is called, marks the time intervening between the contraction of the auricles and of the ventricles. This interval may be valued at 0.2 sec. or less (0.12 to 0.2 sec.), and is due chiefly to the time necessary for the excitation wave to pass over the conducting system between auricles and ventricles. In all probability the conduction in this system is slower than in the musculature of the auricles or ventricles. In the dog, for example, the interval between auricular and ventricular contraction is about 0.1 sec. Since the connecting auriculoventricular bundle has a length of 10 to 15 mm., the velocity of the conduction through this bundle must be about 10 to 15 cm. per second.

**The Electrical Variation.**—The contraction of the heart muscle, like that of skeletal muscle, is accompanied or preceded by an electrical change. That is, where the muscle substance is in contraction its electrical potential is different from that of the resting muscle. The advancing wave of contraction causes a corresponding electrical change or, to be more accurate, the ad-

\* Hering, "Pflüger's Archiv f. d. ges. Physiol.," 126, 225, 1909.

vancing wave of excitation, which precedes the actual contraction, is accompanied by an electrical change. If two points of the heart are connected with an electrometer an electrical current will be shown, since the electrical change will affect the electrodes at different times. This electrical variation of the contracting heart muscle may be shown easily by means of the rheoscopic muscle-nerve preparation (see p. 104). If the heart is exposed and the nerve of the preparation is laid over its surface each ventricular systole is accompanied by a kick of the muscle, since the nerve by connecting separated points acts as a conducting wire for the current generated, and is stimulated, therefore, at each systole. Since the muscle-nerve preparation gives only a simple contraction for each ventricular systole, we may assume that this latter contraction is itself simple,—that is, due to a single stimulus. The electrical variation may be obtained also by means of the capillary electrometer or the string-galvanometer (p. 99), and since the movement of the mercury or of the string in these instruments may be photographed, the results can be studied in detail. Owing to the sensitiveness of the instrument, the beat of the human heart may be registered in this way (Waller) when the right hand, giving the potential changes of the base of the heart, is connected with one electrode, and the left hand (apex of heart) is connected with the other. The electrocardiograms thus obtained photographically show that, in the ventricle at least, the electrical variation exhibits several phases, and the character of these phases, that is, whether the base or the apex first shows a negative potential, has been used in discussions upon the direction of the wave of contraction. In Fig. 227 is given an illustration of a human electro-cardiogram obtained by connecting the right and left hands with the electrodes of a string galvanometer. With such an arrangement or "lead" the electrode in the right hand may be regarded as leading off from the auricular end of the heart, while that in the left hand leads off from the apex of the ventricle.\* As the galvanometer is arranged, a negativity (indicative of excitation) toward the auricular end is shown by a movement above the horizontal base line, while a negativity toward the apex is shown by a movement in the opposite direction. The cardiogram shows that the heart-beat begins with a sudden development of negativity at the auricular end, wave *P*; this is interpreted satisfactorily as being due to the excitation of the auricles. The following ventricular stimulation begins with a wave *Q* below the line, which would indicate an

\* For a description of the Electrocardiogram and the literature consult James and Williams, "American Journal of the Medical Sciences," Nov., 1910, or Kraus and Nicolai, "Das Elektrokardiogramm," Leipzig, 1910.



excitation toward the apex of the heart. The interpretation of *Q* has not been made satisfactorily, but in accordance with the anatomical arrangement of the auriculoventricular bundle referred to in the last paragraph it is possible that it indicates that the initial excitation in the ventricle starts in the fibers of the papillary musculature near the apex. *Q* is immediately followed by the large wave *R*, which indicates an excitation at the base of the ventricles, followed by a rapid transition to the opposite phase *S*, as this excitation passes to the apex of the ventricle. The wave *T*, occurring at the end of the ventricular systole, has been difficult to interpret. According to one view\* it indicates that the wave

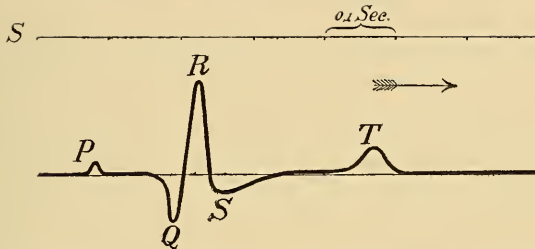
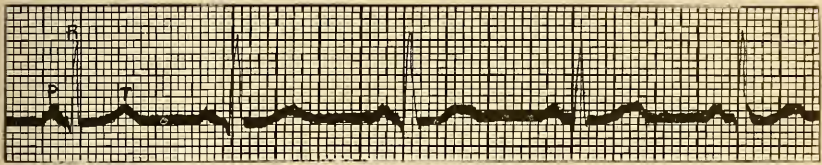

Fig. 227.—Electrocardiogram obtained by photographing the movements of the thread of a string-galvanometer. The upper figure shows the photographed curve, while the lower one is a diagram constructed from the photograph to make clearer the electrical changes in a single cardiac cycle. To obtain this record the electrodes were connected with the right and left hands. Waves with the apex upward indicate that the base of the heart (or the right ventricle) is negative to the apex (or left ventricle). Waves with the apex downward have the opposite significance. Wave *P* is due to the contraction of the auricle. Waves *Q*, *R*, *S*, and *T* occur during the systole of the ventricle. (Einthoven).

of excitation passes last to the basal portion of the ventricle, and consequently that the contraction of the ventricle terminates at this point. This conception is in harmony with the embryological fact that the ventricle develops originally from a tube having a venous and an arterial end, and that this tube becomes bent upon itself so that these two ends, the ostium venosum and the bulbus arteriosus, lie together at the base of the heart. As expressed by Keith, the base of the ventricle consists in reality of two parts—an auricular base and an aortic base, the beginning and the end of the ventricular tube, and the electric cardiogram traces the wave of contraction from one to the other, *R* to *T*, by way of

\* Gotch, "Heart," vol. i., p. 235, 1910.

the apex. Other observers,\* in fact, most of the workers in this field, doubt this interpretation, since the *T* wave may be obtained apparently from any point on the external surface of the heart muscle. Einthoven states that this wave may be positive or negative or may be absent. According to him the whole ventricle is in contraction between the *R* and *T* wave and there is during this period no difference in potential. The *T* wave when present indicates simply that the condition of contraction does not cease simultaneously in all parts of the ventricle. It is evident from these diverging views that it is not possible at present to give a satisfactory interpretation of the electrocardiogram.

**Change in Form of the Ventricle During Systole.**—Much attention has been paid to the external change of form of the ventricle during systole. Does it diminish in size in all diameters or only in certain diameters? The question is one that cannot be answered definitely for all normal conditions, owing to the fact that the form of the heart during diastole varies with the posture of the body. During diastole the heart muscle is quite soft and relaxed, and consequently its shape is influenced by gravity. The exact change of form that it undergoes in passing from diastole to systole will vary with its shape, whatever that may happen to be, in diastole. During systole the musculature, on the contrary, is hard and resisting and the form of the heart in this phase is probably constant. The change from the variable diastolic to the constant systolic form will naturally be different in different positions. With an excised frog's heart one can show that the ventricle is elongated in passing from diastole to systole or one can show the reverse. If the heart is laid upon its side it flattens in diastole so as to increase in length, and systole causes a shortening. If the heart is held or placed with its apex pointing upward it flattens during diastole so as to shorten the diameter from base to apex and during systole this diameter is lengthened. In ourselves the exact change of shape is probably different in the erect from what it is in the recumbent posture. Speaking generally, the accounts agree in stating that the long diameter of the heart is decreased, base and apex are brought closer together, and the diameter from right to left is also decreased, while the anteroposterior or ventrodorsal diameter is increased. That is, the outline of the base of the heart during diastole is an ellipse with its short diameter in the ventrodorsal direction. During systole this outline approaches that of a circle. A more interesting change is described for the apex of the ventricle. Owing to the whorl made by the superficial fibers at this point as they turn to pass into the interior (see Fig. 223),

\* For discussion and literature see Kahn, "Ergebnisse d. Physiologie," 14, 1914; also Eyster and Meek, "Archives of Int. Medicine," 11, 204, 1913.

the systole causes a rotation of the apex, which is thereby forced more firmly against the chest wall. This rotation and erection of the apex during systole may be seen upon the exposed heart of the lower mammals and has been described also for man in cases in which the heart is covered only by the skin, owing to malformation in the chest wall (ectopia cordis) or to surgical operations. The exact position and size of the heart in man and its variations in these respects under various normal and pathological conditions may be studied quite successfully by means of the *x*-rays. When the *x*-rays are passed through the chest, the heart forms a shadow which may be seen with the aid of the fluorescent screen and which may also be photographed. The apparatus used for this purpose may be so arranged that the rays pass through the chest in parallel lines and give a shadow of the exact size of the heart. The arrangement of apparatus for this purpose is designated usually as an *orthodiagraph*, and the photographic record obtained is spoken of as an *orthodiagram*. It may be shown by this means, for example, that during muscular exercise there is an increase in the size of the heart owing to the greater venous inflow, while at the end of exercise, with the cessation of respiratory and muscular activity, the heart becomes smaller than normal, owing to the fact that the faster rate, which is maintained for a while, causes the heart to empty itself more rapidly than it is filled.\*

**The Apex Beat.**—The apex of the heart rests against the chest wall at the fourth or fifth intercostal space, and here the systole may be seen and felt in consequence of a slight protrusion of the wall. Much discussion has ensued as to why this protrusion occurs during systole, since the apex is drawn toward the base and the volume of the heart is diminished by the output of blood. The fact seems to be explained satisfactorily by two considerations: The heart during diastole rests against the chest wall at its apex and a portion of its anterior surface, but causes no protrusion of the wall because the tenseness of this latter is sufficient to flatten or deform the softer heart muscle. During systole the hardened heart muscle, on the contrary, overcomes the now relatively less resistant integument. The rotation of the apex tends also to maintain the contact; so that, although the heart is shortened in its long diameter, the extent of the movement is not sufficient to draw it away from the chest wall. In the second place, the discharge of the heart contents into the curved aorta by tending to straighten this tube causes a movement of the whole heart downward which counteracts the effect of the shortening in the long diameter. The apex beat is proof that the apex remains against the chest wall during systole and in mammals corroborative

\* Nicolai and Zuntz, "Berliner klin. Wochenschrift," No. 18, 1914.

experiments have been made by running needles through the chest wall into the base and the apex of the heart. Such needles act as levers with a fulcrum in the skin, and from the movement of the projecting portion it has been shown that, while the basal portion of the heart moves downward during systole, the apex remains more or less stationary except for the lateral movements due to the rotation.

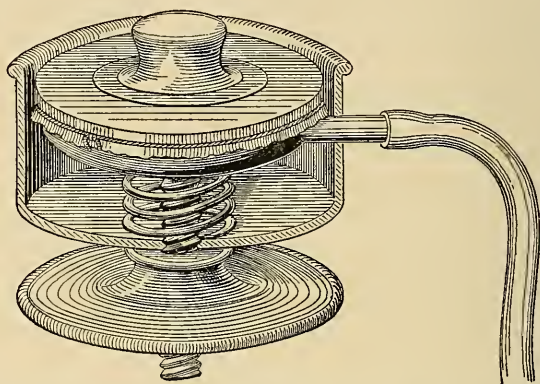

Fig. 228.—Marey's cardiograph. The button on the tambour is pressed upon the chest over the apex. The movements are transmitted through the tube to the right to a recording tambour.

*The Cardiogram.*—The apex beat may be recorded easily by means of appropriate tambours. Several instruments have been especially devised for this purpose and are designated as *cardiographs*. The cardiograph described by Marey is shown in Fig. 228. It consists essentially of a tambour inclosed in a metal box. The

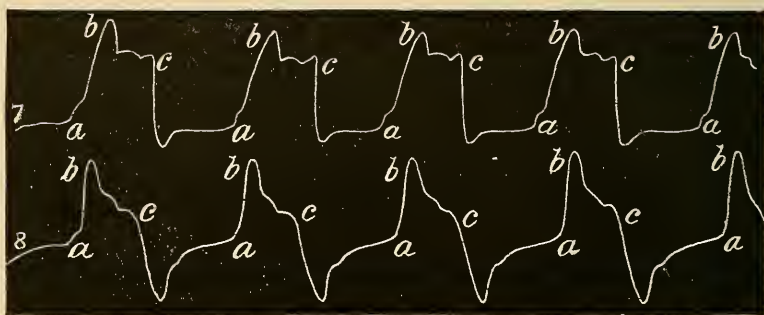

Fig. 229.—Two cardiograms from the same individual to show characteristic records: *a*, Beginning of systole; *b-c*, systolic plateau.—(After Marey.)

rubber membrane of the tambour carries a button which can be brought to bear, under a suitable pressure, upon the apex of the heart. The movements of this button cause pressure changes in the air of the tambour which are transmitted through tubing to a

recording tambour and recorded on a kymographion. A simple and effective cardiograph may be made by pressing a funnel against the skin over the apex and connecting the stem of the funnel by tubing to a suitable recording tambour. The cardiograms obtained by such methods have been the subject of much discussion. The form of the curve varies somewhat with the instrument used, the way in which it is applied, the position of the heart apex with reference to the chest wall, and with the conditions of the circulation, and it is often difficult to give it a correct interpretation. An uncomplicated form of the cardiogram is represented in Fig. 229, 7, and a curve more difficult to interpret in Fig. 229, 8. It should be borne in mind that the cardiograph curve is partly a pressure curve and partly a volume curve,—that is, the changes in volume as well as the changes in pressure of the heart during systole will affect the instrument.

**The Intraventricular Pressure During Systole.**—The best analyses of the details of the systole of the ventricle have been made by a study of the changes in pressure within the ventricle. For this purpose a tube filled with liquid is introduced into the cavity of the ventricle. A tube used for such a purpose is designated as a *heart-sound*. For the right ventricle it is introduced through an opening in the jugular vein and pushed down until it lies in the

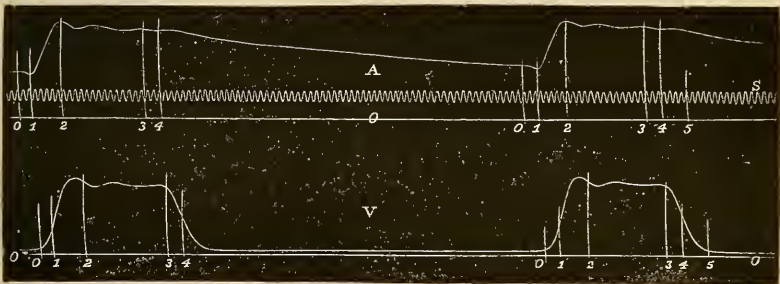

Fig. 230.—Synchronous record of the intraventricular pressure (V), and the aortic pressure (A): S, The time record,—each vibration =  $\frac{1}{100}$  sec.; 0-5, corresponding ordinates in the two curves; 1 marks the opening of the semilunar valves; 3 (or shortly after) marks the closure of these valves and the beginning of diastole.—(Hürthle.)

ventricle, or in some cases it may be thrust through the wall of the ventricle. For the left ventricle it is introduced by way of the carotid or subclavian artery, or through the left auricle or ventricle. The sound is then connected to a suitable recording apparatus by rigid tubing filled with liquid. The changes in pressure in the ventricle are extensive and very rapid. To register them accurately the recording instrument must respond with great promptness and at the same time must be free from inertia movements.

A mercury manometer, for instance, would be entirely useless for such a purpose, since the heavy mass of mercury could not follow accurately the quick changes in pressure. The recording manometer devised by Hürthle (p. 495) has been used very frequently for this purpose, as also somewhat similar instruments in which the vibrations of the tambour membrane are recorded photographically by placing a small mirror on the membrane and reflecting a beam of light from it (optical manometer). A typical curve obtained by means of the Hürthle manometer is given in Fig. 230, V, and two curves as obtained from an optical manometer (Wiggers) in Fig. 230a. (Consult also the classical curve obtained by Chauveau and Marey from the heart of the horse [Fig. 220].) It will be seen that the pressure in the heart rises suddenly with the beginning of the ventricular contraction, and a certain time elapses before this pressure is great enough to open the semilunar valves. The moment that this occurs (1, on the ventricular curve in Fig. 230) is determined by simultaneous measurement of the pressure in the aorta, it being evident that the pressure will begin to rise in this latter vessel the moment that the valves open. The different features of the ventricular systole as gathered from these pressure curves are expressed by Hürthle\* as follows:

- I. Systole, phase of contraction of the muscle fibers (0 to 3 in Fig. 230, V).
  - (a) Period of tension (0 to 1), during which the auriculo-ventricular and semilunar valves are both closed and the heart muscle is squeezing upon the contained blood. This period ends at the opening of the semilunar valves.
  - (b) Period of emptying (1 to 3). During this time the heart is emptying itself into the aorta and the intraventricular pressure remains above aortic pressure. It ends with the cessation of the contraction of the muscle and the beginning of the rapid relaxation.
- II. Diastole, phase of relaxation and rest of the muscle fibers.
  - (a) Period of relaxation from 3 until the curve reaches a horizontal. At the beginning of the relaxation the semilunar valves are closed, and from comparison with the aortic curve the instant of the occurrence of this closure is placed shortly after 3.
  - (b) Period of filling. This period begins as soon as the auriculo-ventricular valves open and the stream of blood, which had been flowing into the auricle throughout the ventricular systole, is permitted to enter the ventricle. During this period of filling the ventricular pressure rises slightly as the heart becomes turgid with blood. This increase of pressure is indicated in most cardiograms by a gradual rise of the curve during this period. It is shown in the curve of Chauveau and Mary, given in Fig. 220.

A feature of the intraventricular pressure curve that has been much discussed is the flattened top, or *plateau*, exhibited in Fig. 230.† According to some authors a period of even pressure of this kind is an artefact due to imperfection in the recording instrument. They claim that with an adequate instrument the pressure

\* Hürthle, "Archiv f. d. gesammte Physiologie," 49, 84, 1891.

† For discussion, see Tigerstedt, "Skandinavisches Archiv f. Physiol.," 28, 37, 1912; also Wiggers, "American Journal of Physiology," 33, 382, 1914.

risers smoothly to a maximum, and then falls off in diastole so that the apex of the curve is rounded and shows no plateau. The results that have accumulated from the use of the more modern instruments seem to show that under normal conditions the pressure curve does give evidence of a flattened top, as shown in Fig. 230a, *e* to *f*, although the plateau, so-called, may have an upward

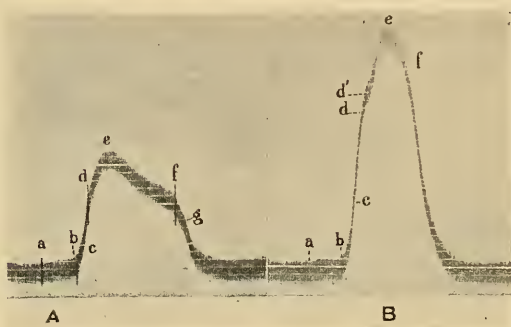

Fig. 230a.—Two curves of intraventricular pressure. Right ventricle, dog's heart. Record *B* taken with a more sensitive manometer than *A*; *ab*, period of auricular systole; *bd*, period of tension before opening of semilunar valves (isometric period); *df*, period of emptying (ejection period); *fg*, closure of the semilunar valves. (Wiggers.)

or a downward slope according to the conditions of pressure in the aorta.

**The Volume Curve and the Ventricular Output.**—In man the volume of the heart under different conditions may be studied by means of the *x*-ray (p. 545). In the lower animals the thorax may be opened with suitable precautions as regards anesthesia and artificial respiration, and the heart may be placed within a plethysmograph (see p. 604) to measure its changes in volume during systole and diastole. If the whole heart is treated in this way the curve of volume changes is complicated by the fact that one chamber, the auricle, is filling, while the other, the ventricle, is emptying. A more useful disposition of the apparatus is to enclose only the ventricles. Several different forms of plethysmograph have been devised for this purpose, and they are usually spoken of as *cardiometers*. The form described by Henderson\* is simple and easily applied to the heart. Its structure and the connections of the recording apparatus are indicated in the diagram given in Fig. 231. The apparatus consists of a rubber ball or glass chamber with a circular opening at one point. Over this opening is placed a membrane of rubber dam with a central opening through which the heart is introduced, as shown in the diagram. The rubber

\* Henderson, "American Journal of Physiology," 16, 325, 1906, and 23, 345, 1909, contain also the literature.

membrane lies snugly in the auriculoventricular groove, making an air-tight joint. The interior of the ball is connected by stiff tubing with a recording tambour. By an arrangement of this kind the ventricles are kept within an air-chamber closed everywhere except at the outlet to the recording tambour. Every change in volume of the ventricles will be recorded accu-

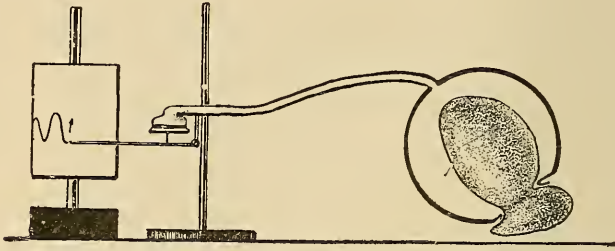

Fig. 231.—Diagram to show the arrangement of the Henderson cardiometer. The recording tambour is inverted, so that the systole will give an up-stroke on the curve. (After *Hirschfelder*.)

rately provided there is no leak. Moreover, these volume changes may be given absolute values in cubic centimeters if the apparatus is calibrated beforehand. The cardiometer furnishes a convenient method of estimating directly the amount of blood entering and leaving the ventricles under varying conditions, as well as the changes in heart-volume that may result from variations in tonicity. When the heart is beating slowly the

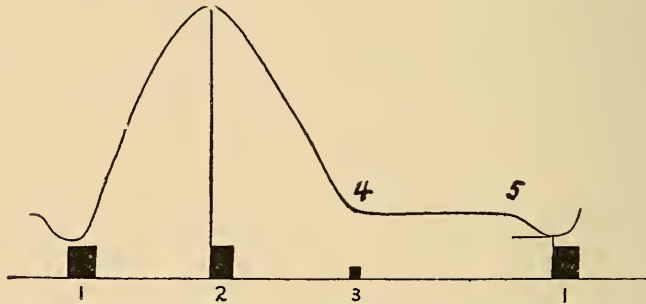

Fig. 232.—Diagram of the normal volume curve (plethysmogram) of the dog's heart when beating at a slow rate (after *Hirschfelder*). The up-stroke represents the systole, the down-stroke the diastole; 4 to 5 the period of diastasis (*Henderson*). At 5 the auricular contraction causes a slight additional dilatation of the ventricle. 1, 2, and 3 represent the time of occurrence of the first, second, and third heart-sounds respectively.

volume curve has the form shown in Fig. 232. During systole the ventricles shrink in size as the blood is discharged into the aorta and pulmonary artery—the up-stroke of the curve. At the end of the systole, after the closure of the semilunar and the



opening of the auriculoventricular valves, the ventricles are dilated rapidly by the inflow of venous blood. Henderson has emphasized the fact that the filling takes place nearly as rapidly as the emptying, owing doubtless to the fact that at the end of ventricular systole the auricles are dilated under some pressure, so that their contents escape at once into the ventricles as soon as the intervening valves are opened. The diastolic curve comes back nearly to the base line and then forms a shoulder (4) from which it approaches gradually to the base line up to the moment of auricular contraction (5). The period of gradual dilation of the nearly filled ventricles, which on the curve is shown from 4 to 5, is called the period of diastasis by Henderson. The heart cycle, so far as the ventricles are concerned, falls, therefore, into three periods: 1, Systole; 2, diastole; 3, diastasis. Variations in heart rate affect chiefly the last period; this becomes shorter and shorter the more rapid the rate. When the heart rate is so rapid that the period of diastasis drops out altogether and the systole begins as soon as the diastole is complete, then we should have the maximum output of blood per minute. An increase of rate beyond this point would lead to a curtailment of the period of diastole and eventually to a diminished output of blood per minute. According to the account just given, the filling of the ventricle is practically completed before the auricles contract. Henderson believes that the contraction of the auricles adds very little or nothing to the change of blood in the ventricles, but other authors, using the same methods, differ from him in this conclusion. It is at least certain that the ventricles are for the most part filled before the auricular contraction comes on—this latter act may add a greater or less amount to this charge, according to the extent to which the inflow of venous blood during diastole has filled the ventricle. The auricular contraction, besides initiating the ventricular systole, doubtless serves, by raising the tension in the ventricular chamber, to bring the auriculoventricular valves more completely into the position of closure. When these valves are deficient, as in mitral stenosis, the contraction of the auricles plays a larger part in completing the filling of the ventricles (Hirschfeldér). For the cases in which it can be applied, the volume curve enables us to estimate the ventricular discharge at each beat and the outflow per minute. It was formerly assumed that at each systole the ventricles emptied themselves completely, but work of the kind described in this paragraph has shown, on the contrary, that at the end of systole a considerable proportion of the blood may be left in the cavity of the ventricle. The amount thus left behind will vary with the rate and other conditions. According to Henderson's figures for the dog, about one-third or

somewhat less of the ventricular charge is left in the heart after systole, when the heart is beating at the normal rate (90), and the quantity of blood discharged from the left ventricle at each systole is approximately .002 of the body weight. It is evident that when the aortic pressure rises to an abnormal level the discharge of blood from the left ventricle will be or may be diminished, with the result that the blood backs up in the left auricle, thus raising the venous pressure in the lungs and retarding the pulmonary circulation. On the other hand, as Henderson has especially emphasized, the outflow from the ventricle must be influenced very directly by the inflow into the auricle from the veins. Variations in the size of the blood-vessels, such as dilatation of the small arteries or possibly loss of tone in the veins, may bring about a condition of venous stasis and cut down the supply of blood to the heart on the venous side. Two observers\* who have studied by indirect means the output of blood from the right ventricle in man state that the volume of blood discharged may vary from 2.8 liters per minute during rest to as much as 21.6 liters during muscular work. They conclude that this great range of output is governed by variations in the venous filling of the heart during diastole. At rest the venous inflow is insufficient to distend the heart completely, but during muscular work the increase in venous pressure and velocity distends the heart, during diastole, to its maximal extent.

**The Heart Sounds.**—An interesting and important feature of the heart beat is the occurrence of the heart sounds. Two sounds are usually described, one at the beginning, the other at the end, of the ventricular systole. The first sound has a deeper pitch and is longer than the second, and their relative pitch and duration are represented frequently by the syllables *lubb-dup*. According to Haycraft,† both tones, from a musical standpoint, fall in the bass clef, and are separated by a musical interval of a minor third. The sounds are readily heard by applying the ear to the thorax over the heart, but for diagnostic purposes the stethoscope is usually employed, and this method of investigation by hearing is designated as *auscultation*. The importance of these heart sounds in diagnosis was first emphasized by Laennec (1819), and since his time a great number of theories have been proposed to explain their causation. Indeed, the subject is not yet closed, although certain general views regarding their cause and the time of their occurrence are generally accepted. The second sound is found to follow immediately upon

\* Krogh and Lindhard, "Skandinavisches Archiv f. Physiologie," 27, 100, 1912.

† "Journal of Physiology," 11, 486, 1890.

the closure of the semilunar valves. The usual view, therefore, is that the sound is due ultimately to the vibrations set up in these valves by their sudden closure. These vibrations are transmitted to the column of blood in the aorta (or pulmonary artery) and then to the intervening tissue of the chest wall. This view is made probable by a number of experimental results, some of the most important of which were brought out by Williams in a report (1836) of a committee appointed by the British Association for the special purpose of investigating the subject. It has been shown: (1) That the second sound disappears before the first sound when the animal is bled to death, and indeed as soon as the heart ceases to throw out a supply of blood sufficient to maintain aortic tension. It disappears also when cuts are made in the ventricles so that the blood may escape otherwise than through the arteries. (2) When the valves of the pulmonary artery and aorta are hooked back in the living animal the second sound is replaced by a murmur due to the rushing back of the blood into the ventricle, and if the valves are dropped back into place the normal second sound is again heard. (3) Similar sounds may be produced if the root of the aorta with its valves in place is excised and attached to a glass tube carrying a column of water. With such an arrangement, if the valves are held open for a moment and then closed sharply by the pressure of the column of water a sound similar to that of the second heart sound is heard.

The physician uses this view of the cause of the second sound in auscultation, and it is evident that the nature of the sound or its replacement by murmurs will give useful testimony regarding the condition of the semilunar valves. The first heart sound has offered more difficulty. It occurs at or shortly before the closure of the auriculo-ventricular valves, and it would seem natural, therefore, to attribute it to the vibration of these valves when suddenly put under tension by the ventricular systole. Most authors, indeed, believe that this factor is at least partially responsible for the sound,—that is, that the sound contains a valvular element. But that this is not the sole cause is shown by the fact that the bloodless beating heart still gives a sound at the time of the ventricular systole. Indeed, if the apex of the rabbit's heart is cut off, it continues to beat for a few minutes and during this time gives a first heart sound. It is usually said, therefore, that the first heart sound is caused by the combination of at least two factors,—a valvular element due to the vibration of the auriculo-ventricular valves, and a muscular element due to the vibration of the contracting muscular mass. Accepting this view, there is a further difficulty in explaining the origin of the muscular element. According to some, it is due to the fact that the contraction of the muscle fibers is not

simultaneous throughout the ventricle and the friction of the interlacing fibers sets up vibration in the muscular mass; according to others, the so-called muscular element is mainly a resonance tone of the ear membrane of the auscultator,—the shock of the contracting heart sets the tympanic membrane to vibrating. It seems useless to attempt a detailed discussion of these conflicting views, since no convincing statements can be made. Practically, the time at which the heart sounds occur is of great importance. A number of observers have recorded the time upon a cardiographic tracing of

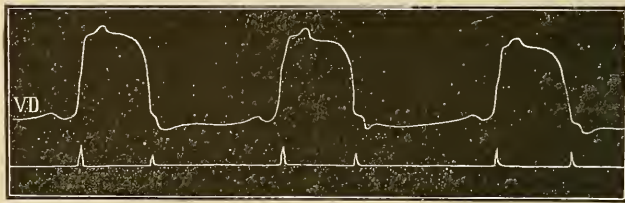

Fig. 233.—To show the time relation of the heart sounds to the ventricular beat (Marey): *V.D.*, Tracing of the ventricular pressure in the right ventricle of the horse. Below the two marks show, respectively, the time of the first and second sounds. The first occurs immediately after the beginning of systole, the second immediately after the beginning of diastole.

the heart beat with results such as are shown in Fig. 233. The figure shows clearly the general fact that the first sound is heard very shortly after the beginning of systole and the second one immediately after the end of systole. The first sound is therefore systolic, and the second sound diastolic. A more exact and detailed study of the time relations of the heart sounds has been made by Einthoven and Geluk.\* These authors obtained graphic records of the heart sounds. The sounds received first by a microphone were transmitted to a capillary electrometer and the movements of the latter were photographed. As one result of their work they give the schema shown in Fig. 234. It will be seen from this figure that the first sound begins about 0.01 sec. before the cardiogram shows the commencement of systole, and that for the first 0.06 sec. the sound is heard only over the apex of the heart (*a-b*). Over the base of the heart (second intercostal space) the first sound is heard (*b* to *c-d*) just at the time when the semilunar valves are opened (*b'*),—that is, at the beginning of the period of emptying according to the classification given on p. 548. The first sound ceases long before the ventricular contraction itself is over,—a fact which would seem to indicate that the muscular element in the first sound is not a muscular sound, such as is given out by a contracting

\* Einthoven and Geluk, "Archiv f. d. gesammte Physiologie," 57, 617, 1894. Einthoven, *ibid.*, 1907, vol. 117. Fahr, "Heart," 4, 147, 1912.

skeletal muscle. The beginning of the second sound seems to mark exactly the time of closure of the semilunar valves. The character and the time relations of the murmurs that accompany or replace the heart sounds form the interesting practical continuation of this theme; but the subject is so large that the student must be referred for this information to the works upon clinical methods.

**The Third Heart Sound.**—Several observers\* have called attention to the fact that in certain individuals a third heart

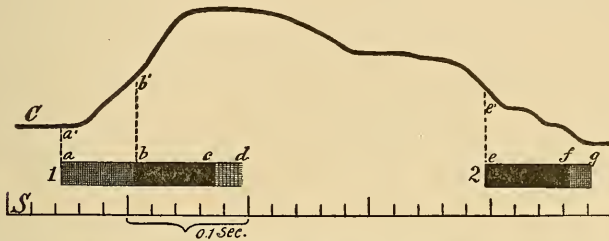

Fig. 234.—Schematic representation of the relation of the heart sounds to the ventricular beat: *C*, The cardiogram; 1, to show the duration of the first heart sound; 2, the duration of the second heart sound; *S*, the time record, each division corresponding to 0.02 sec. In 1, *a-a'* marks the instant that the first heart sound is heard over the apex, and *b-b'* the moment that it is heard at the second intercostal space.—(Einthoven and Geluk.)

sound may be heard very shortly (0.13 sec.) after the beginning of the second sound. Thayer describes this sound as being "softer and of lower pitch" than the second sound, and in some cases as resembling rather a dull thud or hum. In those persons in whom it can be detected it is heard most distinctly over the apex of the heart. Einthoven has shown the existence of this sound by objective methods. By means of a microphone attachment the heart sounds can be transmitted to the string-galvanometer, in which they cause deflections of the string that can be photographed. In this way he has obtained records of the third sound upon individuals in whom the stethoscope failed to reveal its existence. The cause of this sound has been explained differently by the several authors who have investigated it. It occurs early in the diastole, and Einthoven suggests that it is due to an after-vibration of the semilunar valves. Thayer and Gibson suggest the more probable explanation that it is due to a vibration of the auriculoventricular valves which is set up by the sudden inrush of blood from the auricles at the beginning of diastole: This inflow of venous blood distends the ventricle sharply and throws the valves into a position of closure with some suddenness. The sound occurs

\* Thayer, "Boston Med. and Surg. Journal," 158, 713, 1908; Einthoven, "Archiv f. d. ges. Physiol.," 120, 31, 1907; Gibson, "Lancet," 1907, II, 1380.

at about the time of the shoulder on the diastolic limb of the volume curve, as is indicated in the diagram in Fig. 232.

**The Events that Occur During a Single Cardiac Cycle.**—By a complete cardiac cycle is meant the time from any given feature of the heart beat until that feature is again produced. It may be helpful to summarize the events in such a cycle, both as regards the heart and as regards the blood contained in it. We may begin with the closure of the semilunar valves. At that moment the second heart sound is heard and at that moment the ventricle is quickly relaxing from its previous contraction. Since the auriculoventricular valves are still closed (see diagram, Fig. 219), the ventricles for a brief interval are shut off on both sides. The blood is flowing steadily into the auricles and dilating them. As soon as the ventricles relax the pressure of blood in the auricles opens the auriculoventricular valves, and from that moment until the beginning of the auricular systole the blood from the large veins is filling both ventricles and auricles. As stated on p. 551, the venous blood which has been accumulating in the auricles during the ventricular systole flows into the ventricles with some suddenness on the opening of the auriculoventricular valves. The ventricles, therefore, dilate rapidly and the auriculoventricular valves are floated into a position ready for closure. This event occurs at about the time that the third heart sound is heard. In a slowly beating heart there may be quite an interval (period of diastasis) between this point and the auricular contraction. The auricular systole sends a sudden wave of blood into the ventricles, dilating them still further and momentarily blocking or retarding the flow from the large veins, and causing one of the waves seen in the normal venous pulse as recorded in the jugular veins. The ventricular systole follows at once upon the auricular systole, the exact relations in this case depending somewhat upon the pulse rate. As the ventricle enters into contraction the auriculo-ventricular valves are tightly closed, the first sound is heard, and for a short interval the ventricular cavity is again shut off on both sides. Soon the rising pressure in the interior forces open the semilunar valves, and then a column of blood is discharged into the aorta and pulmonary artery as long as the contraction lasts. During this interval the flow at the venous end of the heart continues, the blood being received into the yielding auricles. Indeed, this capacity for receiving the venous inflow during the comparatively long-lasting ventricular systole may be considered as one valuable mechanical function fulfilled by the auricles. The venous flow is never completely blocked and at the most suffers only a slight retardation during

the very brief auricular systole. At the end of the ventricular systole the excess of pressure in the aorta and the pulmonary artery closes the semilunar valves and completes the cycle.

**Time Relations of Systole and Diastole.**—The duration of the separate phases of the heart beat depends naturally on the rate of beat. Assuming a low pulse rate of 70 per minute, the average duration of the different phases may be estimated as follows:

Ventricular systole..... =	0.379 sec.
Ventricular diastole and pause..... =	0.483 “
Auricular systole..... = 0.1 to 0.17 “	
Auricular diastole and pause..... = 0.762 to 0.692 “	

Einthoven and Geluk, in the investigation referred to above, measured the time intervals of systole and diastole during fifteen heart periods of a healthy man, and found that the time for the ventricular systole varied between 0.312 and 0.346 sec., while that for the diastole varied from 0.385 to 0.518 sec. Experiments by a number of observers indicate that in the great changes of rate which the heart may undergo under normal conditions the diastolic phase (period of diastasis) is affected relatively much more than the systolic, as we should expect.

**The Normal Capacity of the Ventricles and the Work Done by the Heart.**—Various efforts have been made to measure the normal capacity of the ventricles in man, but the determination has encountered many difficulties. Experiments and observations made upon the excised heart are of little value, since the distensible walls of the ventricles yield readily to pressure, and it is difficult or impossible to imitate exactly the conditions of pressure that prevail during life. Nor is it certain whether normally the ventricles empty themselves completely during systole; in fact, the evidence from experiments on the lower animals indicates that, contrary to the opinion which formerly prevailed, the ventricles throw out only a portion of their blood at each beat. The older observers (Volkman, Vierordt) attempted to arrive at a determination of the normal output of the ventricles by calculations based upon the velocity of the blood in the carotid and the width of the stream bed. From observations on many animals they arrived at the generalization that at each systole the amount of blood ejected from the ventricles is equal to about  $\frac{1}{10}$  of the body weight. For a man weighing, say, 72 kilograms (158 lbs.) this ratio would give an output for each systole of 180 gms. (6 ozs.). More recent observers, however, have found this estimate too high. Howell and Donaldson\* measured the output directly for the heart of the dog, making use of a heart isolated from the body and kept beating

\* Howell and Donaldson, "Philosophical Transactions," Royal Soc., London, 1884.

by an artificial circulation. The ratio of the output varied with the rate of beat; for a rate of 180 beats per minute it was equal to 0.00117 ( $\frac{1}{853}$ ) of the body weight; for a rate of 120 beats per minute it was equal to 0.0014 ( $\frac{1}{707}$ ). This ratio is therefore about one-half of that proposed by Volkmann. Tigerstedt, from observations upon rabbits, obtained a lower ratio still (0.00042); but from his own results and those obtained by other workers he concludes\* that an average valuation for the volume of blood discharged by each ventricle of the human heart is from 50 to 100 c.c. On this basis one may make an approximate estimate of the work done at each beat. Using Tigerstedt's figures, such results as the following are obtained: On the left side the heart empties its 100 c.c. against a pressure of 150 mms. Hg. (0.150 meter) and on the right side against a pressure of, say, 60 mms. Hg. (0.06 meter). The work done is calculated from the formula  $w=pr$ , in which  $p$  represents the weight of the mass thrown out and  $r$  the resistance or mean aortic pressure. This latter factor must be multiplied by 13.6, the density of mercury, to reduce to a column of blood.

$$\begin{array}{r} \text{Left ventricle, 100 gms.} \times (0.150 \times 13.6) = 204.0 \text{ grammeters.} \\ \text{Right " " 100 " " } \times (0.06 \times 13.6) = 81.6 \text{ " "} \\ \hline 285.6 \text{ grammeters.} \end{array}$$

To this must be added the energy represented by the velocity of the mass ejected into the aorta. Placing this velocity at 500 mms. (0.5 meter) for both aorta and pulmonary artery, the energy represented in mechanical work is estimated from the formula  $\frac{pv^2}{2g}$  in which  $p$  represents the weight of the mass moved,  $v$  the velocity of its movement, and  $g$  the accelerating force of gravity. Applying this formula we have for each ventricle  $\frac{100 \times 0.5^2}{2 \times 9.8} = 1.28$  grammeters, or for both ventricles 2.56 grammeters, making a total of over 288 grammeters of work. That is, the mechanical work done at each contraction of the heart is equal to that necessary to raise 288 gms. a meter in height. The calculations made by different authors as to the amount of blood discharged from each ventricle during systole may be tabulated as follows:

Thomas Young.....	45 gms.				
Volkmann.....	188 "	for weight of	72 kgms.		
Vierordt.....	180 "	"	"	"	"
Fick.....	50-73 "	"	"	"	"
Howell and Donaldson.....	75-90 "	"	"	65 "	"
Hoorweg.....	47 "				
Zuntz.....	60 "				
Tigerstedt.....	50-100 "				
Plumier.....	70 "				
Loewy and v. Schrötter ....	55 "	"	"	60-65 kgms.	
Krogh and Lindhard.....	39-103 "				

\* Tigerstedt, "Lehrbuch der Physiologie des Kreislaufes," p. 152, 1893.



**The Coronary Circulation during the Heart Beat.**—The condition of the blood-flow in the coronary vessels during the phases of the heart beat has been the subject of much speculation and experiment, since it has entered as a factor in the discussion of several mechanical and nutritive problems that are connected with the physiology of the heart. According to a view usually attributed to Thebesius (1708), the flaps of the semilunar valves are thrown back during systole and shut off the coronary circulation, and therefore the coronary vessels, unlike those of other organs, are filled during diastole. In modern times this view has been revived by Brücke, who made it a part of his theory of the "self-regulation" of the heart beat. According to this view, the coronaries are shut off from the aorta during systole by the flaps of the semilunar valves, so that the contraction of the ventricle is not opposed by the distended arteries, while, on the other hand, the reinjection of these vessels from the aorta during diastole aids in the dilatation of the ventricular cavities. Experimental work has shown decisively that the part of this theory relating to the closure of the coronary arteries by the semilunar valves is incorrect.\* Records of pressure changes in the coronary arteries during the heart beat made by Martin and Sedgwick and by Porter show that they are substantially identical

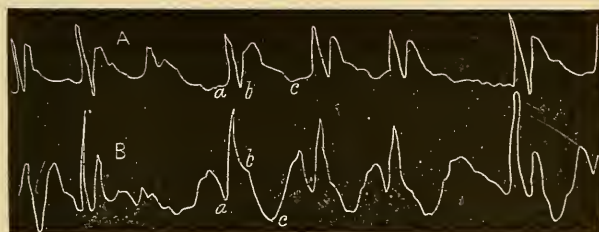

Fig. 235.—Simultaneous record of the blood-pressure (A) and the blood-velocity (B) in the coronary arteries (*Chauveau and Rebatel*): *a*, Marks the beginning of the systole (there is a rise in pressure and in velocity); *b*, marks a second rise of pressure (A) due to the closure of the coronary capillaries by the contracting ventricle (at this moment in B the velocity falls off rapidly); *c*, curve (B) shows an increase in velocity due to the opening of the small coronary vessels at the beginning of diastole.

with those in the carotid or aorta, and records of the velocity of the blood-flow made by Rebatel show that at the beginning of systole the flow in the coronaries suffers a sudden systolic acceleration as in the case of other arteries. During systole, therefore, the mouths of the coronary arteries are in free communication with the aorta. But the coronary system—arteries, capillaries, and veins—is in part imbedded in the musculature of the ventricles, and we should

\* See Porter, "American Journal of Physiology," 1, 145, 1898, for discussion and literature.

suppose that the great pressure exerted by the contracting musculature would at the height of systole clamp off this system and stop the coronary circulation. That this result really happens is indicated by Rebattel's curves of the velocity of the flow in the coronary arteries. As shown in Fig. 235, the great acceleration (*a*) in velocity at the beginning of systole is quickly followed by a drop to zero (*b*) or even a negative value,—that is, a flow in the other direction, toward the aorta. At the end of the first (relaxation) phase of diastole there is again a sudden increase in velocity (*c*), corresponding with the injection of the arteries from the aorta, followed again by a decrease at the end of the diastole at the time when the ventricular cavity is filled with venous blood under some pressure. Porter, moreover, has shown in an interesting series of experiments that when a piece of the ventricle is kept beating, by supplying it with blood through its nutrient artery from a reservoir at constant pressure, each systole causes a jet of blood from the severed vessels at the margin of the piece. In fact, the rhythmical squeeze of its own vessels during systole accelerates effectively the coronary circulation. The volume of blood flowing through the heart vessels increases with the frequency or the force of the beat, since each systole empties the coronary system more or less completely toward the venous side and at each diastole the distended aorta quickly fills the empty vessels.

**The Suction-pump Action of the Heart.**—So far in considering the mechanics of the circulation attention has been directed only to the force-pump action of the heart. All of the energy of the circulation, the velocity of the flow and the internal pressure, has been referred to the force of contraction of the ventricles as the main cause, and to certain accessory factors, such as the respiratory movements and the contractions of the skeletal muscles, as subsidiary causes. It is possible, however, that the heart may also act as a suction-pump, sucking in blood from the venous side in consequence of an active dilatation. According to this view, the heart works after the manner of a syringe bulb, which when squeezed forces out liquid from one end and when relaxed sucks it in from the other in consequence of its elastic dilatation. While this view has long been entertained, modern interest in it was aroused chiefly perhaps by the experiments of Goltz and Gaule, which showed that at some point in the heart beat there is or may be a strong negative pressure in the interior of the ventricles.\* Their method consisted in connecting a manometer with the interior of the ventricle and interposing between the two a valve that opened only toward the heart. The manometer was thus converted into a minimum

\* For a complete discussion of this subject and the literature see the article by Ebstein, "Die Diastole des Herzens," in the "Ergebnisse der Physiologie," vol. iii, part II, 1904.

manometer, which registered the lowest pressure reached during the period of observation. By this method they and others have shown that in an animal (dog) with an opened thorax the pressure in the interior of the ventricles may be negative to an extent equal to 20, 30, or even 50 mms. of mercury. Moreover, by the use of some form of elastic manometer, such as the Hürthle instrument (p. 495), it has been shown that this negative pressure occurs at the end of the period of relaxation, at the time, therefore, at which it might be supposed to exert a marked influence upon the inflow of venous blood. It should be added, however, that a negative pressure can not be shown for every heart beat. It may be absent altogether or slight in amount, varying, no doubt, with the force of contraction and the condition of the heart. Physiologists have attempted to determine the cause of this negative pressure and the extent of its influence on the blood-flow. With regard to the first question, so many answers have been proposed that it is difficult to arrive at a satisfactory opinion. According to some, the heart tends to dilate at the end of its systole by virtue of its own elasticity,—that is, the elasticity of its own musculature or of the connective tissue contained in its substance, for example, beneath the endocardium, in the walls of the arteries, etc. This view, however, finds little or no support from direct experiments made upon the fresh, living heart. If such a heart in a bloodless condition is squeezed by hand there is no evidence of an elastic recoil as in the case of a syringe bulb. Others have traced the expansion of the ventricle and the resulting negative pressure to the sudden injection of the coronary system from the aorta at the beginning of diastole. The heart in contracting exerts a force greater than that of the blood in the coronary vessels, and probably, therefore, these vessels are emptied and their cavities obliterated in part. At the beginning of diastole they are reinjected with blood under a pressure of perhaps 100 mms. of mercury, and this fact seems to offer a probable explanation for a partial dilatation of the ventricular cavity and a production of negative pressure in the brief interval before the opening of the auriculo-ventricular valves. No view, however, has met with general acceptance, and the cause or causes that produce the negative intraventricular pressure are still a subject for investigation. Regarding the second question proposed above,—namely, the extent of the influence of this negative pressure on the flow of venous blood to the ventricles,—much diversity of opinion also exists. Direct experiments made by Martin and Donaldson \*

\* Martin and Donaldson, "Studies from the Biological Laboratory, Johns Hopkins University," 4, 37, 1887; also Martin's "Physiological Papers," Baltimore, 1895. See also, for confirmatory results, von den Velden, "Zeitschrift f. exp. Pathol. u. Therapie," 1906, iii., 432.

indicate that this factor has little or no actual influence upon the venous flow. These authors used an isolated dog's heart kept beating by an artificial supply of blood. At a given moment the stream of blood into the vena cava was shut off and the auricle of the heart was brought into communication with a U tube filled with blood. It was found that the auricle took blood from this tube only so long as the pressure in it was positive. Although the heart continued to beat vigorously, whatever negative pressure was present in the ventricle was unable to suck any blood into the auricle from the U tube. Porter\* also has shown that at the time of a strong negative pressure in the ventricle the auricle may give little or no evidence of a similar fall in pressure. It would seem most probable, therefore, that the negative pressure observed under certain conditions in the ventricles is a fleeting phenomenon, and disappears with the entrance of the first portion of the blood from the auricles. While it may be of value in accelerating the opening of the auriculo-ventricular valves, its influence does not extend to an actual suction of the blood from the veins toward the heart. Other authors, however, on theoretical grounds attribute more actual importance to the negative pressure as a factor in moving the blood. In one respect it would seem that the contractions of the ventricle must exert a direct influence in accelerating the inflow of venous blood into the heart. In the paragraph upon the venous pulse (p. 528) it will be recalled that the steep fall of pressure in the auricles immediately after the *c* wave is attributed mainly to the fact that the contracting ventricles pull the flow of the auricles downward toward the apex as the blood is discharging from the ventricular cavities into the aorta and pulmonary artery. This action for a brief period must exert a suction effect in drawing blood from the veins into the auricles.

**Occlusion of the Coronary Vessels.**—The coronary vessels supply the tissues of the heart with nutrition, including oxygen, so that if the circulation is interrupted the normal contractions soon cease. The branches of the large coronaries form what are known as terminal arteries,—that is, each supplies a separate region of the musculature, and although anastomoses may exist they appear to be too incomplete to allow a collateral circulation to be established when one of the main arteries is occluded. The portion of the heart supplied by it dies, or to use the pathological term, undergoes necrosis. On account of the pathological interests involved—the known serious results that may follow occlusion of any of the coronary vessels or even any interference with the normal structure of the vessels—a number of investigations have been made upon animals to determine the effect of occluding one or more of the coronary

\* "Journal of Physiology," 13, 513, 1892.

vessels.\* It would seem from Porter's experiments that the results of such an operation vary according to the size of the area deprived of its blood. When the arteria septi alone was occluded the heart was not affected, when the arteria coronaria dextra was occluded the ventricular contractions were arrested in 18 per cent. of the cases observed. Occlusion of the ramus descendens of the left coronary artery caused arrest of the ventricles in 50 per cent. of the cases, while occlusion of the circumflex branch of the same artery caused arrest in 80 per cent. of the cases. Ligation of three of the arteries caused stoppage of the heart in all cases.

**Fibrillary Contractions.**—The arrest of the ventricles in the experiments just described followed immediately or within a short period, and the ventricles went into fibrillary contractions. In this curious condition the various fibers of the ventricular muscle, instead of contracting together in a co-ordinated fashion, contract separately and irregularly; so that the surface of the ventricle has the appearance of a vibrating, twitching mass. Such a condition in the ventricle is usually fatal—that is, the musculature is not able to recover its co-ordinated movement. This condition may come on with great suddenness as the result of occlusion of the arteries, of injury to certain parts of the heart, or from strong electrical stimulation. Fibrillation of the auricles also occurs frequently under experimental conditions, and, indeed, in the human heart apparently under pathological conditions. When the auricles are thrown into fibrillation by experimental means the ventricles continue to beat, but in an irregular manner similar to a condition sometimes observed in man and described usually under the term *pulsus irregularis perpetuus*. There is reason to believe that this condition in man is attributable to a fibrillation of the auricles.† The cause of the sudden change from co-ordinated to fibrillary contractions has never been satisfactorily explained. It has been suggested, on the one hand, that it is due to some alteration in the normal process of conduction, the interposition of partial or complete blocks in the course of the excitation wave, and, on the other, that it is caused by the independent formation of impulses in many foci throughout the cardiac musculature.

\* For a description of results and the literature see Porter, "Journal of Physiology," 15, 121, 1893; also "Journal of Experimental Medicine," 1, 1, 1896.

† Cushny, "American Journal of the Medical Sciences," June, 1911.

## CHAPTER XXIX.

### THE CAUSE AND THE SEQUENCE OF THE HEART BEAT—PROPERTIES OF THE HEART MUSCLE.

**General Statement.**—The cause of the heart beat has naturally constituted one of the fundamental objects of physiological inquiry. The various views that have been proposed in different centuries reflect more or less accurately the advancement of the science. With each new discovery of general significance a new point of view is obtained and the theories of the heart beat, like those of the other great problems of physiology, shift their standpoint from generation to generation. The general modern conception of this problem is referred usually to Haller (1757), who first taught that the activity of the heart is not dependent on its connections with the central nervous system. As we shall see, the heart beat is controlled and influenced constantly by the central nervous system, but nevertheless the important point has been established beyond question that the heart continues to beat when all these nervous connections are severed. The central nervous system regulates the activity of the heart, but has nothing to do with the cause of its rhythmical contractions. The heart, in other words, is an automatic organ. When in 1848 Remak discovered that nerve cells are contained in the frog's heart it was natural that the causation of the beat should be attributed to this tissue. Subsequent histological work has demonstrated the existence of numerous nerve cells in the substance of the heart tissue of all vertebrates, and the view that the automaticity of the heart is due in reality to the properties of the contained nerve cells was the prevalent view throughout the middle and latter part of the nineteenth century. In the latter part of the century an opposite view arose,—namely, that the muscular tissue of the heart itself possesses the property of automatic rhythmical contractility. Both these points of view persist to day. The theory that refers the automaticity of the heart beat to the contained nerve cells is designated as the neurogenic theory of the heart beat; the one that refers this property to the muscle tissue itself is known as the myogenic theory. Beyond this question lies the still deeper problem of the explanation of the automaticity itself, the cause or causes of the rhythmical excitation, whether occurring primarily in the muscle cells or in the nerve cells.

The dividing line between the ancient and the modern views of the heart beat is found in the work of William Harvey (1628). Before his time physicians thought along the lines laid down by the ancient masters, Hippocrates, Aristotle, and Galen, in that they believed that the diastole of the heart is the active part of the beat. They believed that the heart dilated at the moment of the apex beat, the dilatation being due to the implanted heat, the vital spirits, a special pulsatile force, etc. The arteries dilated at the same time for a similar reason. For a period of over two thousand years men's minds were so chained to this belief that they apparently could take no other view. Harvey, however, had the boldness and originality to look at the matter differently. He saw and proved that the active movement of the heart is a contraction during systole, which drives blood out of the ventricles into the arteries, and consequently that the pulse of the arteries is not due to their active dilatation, but to a distension by the blood forced into them. Harvey may be considered also as the founder of the myogenic theory of the heart beat. For although he did not speculate concerning the cause of the beat, he taught that the systole is an active contraction of the heart's own musculature not dependent upon any external influence. In the same century the first neurogenic hypothesis was formulated. Willis conceived that the cerebellum controls the activity of the involuntary organs, including the heart. The animal spirits engendered in the cerebellum were conveyed to the heart by the vagus nerve and caused its beat. Borelli formulated a somewhat different view. According to him the nerve juice, *succus spirituosus*, elaborated in the central nervous system was transmitted to the heart through the cardiac nerves and, distilling slowly into the musculature, set up an ebullition which caused an active expansion of the fibers. This expansion constituted the systole and drove the blood out of the heart. Both of these views were disproved or rendered improbable largely by the work of Haller, who in 1757 published the second myogenic theory in a form which, somewhat modified, prevails to-day. Haller believed that the contraction of the heart is due to the inherent irritability of its musculature, and that the venous blood as it enters the heart stimulates it to contraction. Haller's views were generally accepted for some years, but some physiologists continued to believe that the heart beat is controlled directly by the central nervous system. This theory found its most definite expression in the work of Legallois, 1812, who advanced what may be called the second neurogenic hypothesis. From experiments made upon animals he concluded that the principle or force that causes the heart beat is formed in the spinal cord, in all of its parts, and reaches the heart through the branches of the sympathetic nerve supplying this organ. Legallois's conclusions were soon shown to be erroneous, but the general view advocated by him was entertained by some as late as the middle of the 19th century, in fact until experimental physiology had demonstrated the true functions of the vagus and accelerator nerves with reference to the heart. Toward the middle of the 19th century a third form of neurogenic hypothesis arose, which in the beginning seems to have been due to the work or the system of Bichat. According to this author the ganglionic or sympathetic system supplies the tissues of the organic life, meaning thereby the visceral organs which are not under the direct influence of the will. In 1844 Remak discovered that the heart possesses intrinsic nerve ganglia, and this fact seems to have induced most physiologists to believe that these ganglia constitute a motor center for the heart, initiating and co-ordinating its beat. For a period of forty years this form of the neurogenic hypothesis enjoyed almost universal acceptance. In 1881-83 Gaskell published experiments upon the heart of the frog and tortoise in which he gave strong reasons for believing that the beat is myogenic in origin, and that the intrinsic ganglia are simply a part of the inhibitory apparatus of the heart. Since that time many physiologists have adopted the myogenic view, and the current arguments tending to support this rather than the neurogenic hypothesis are presented in the text. The most significant addition to our knowledge of the cause of the heart beat made during the last quarter of a century is the discovery that the inorganic salts of the blood and lymph play a special and essential rôle. The facts bearing upon this interesting discovery are sufficiently described in the text.

**The Neurogenic Theory of the Heart Beat.**—The literature upon this topic is very large.\* The neurogenic theory has suffered some changes in its details since first proposed by Volkmann, particularly in the specific functions assigned to the different ganglia that exist in the heart. In general, however, the theory assumes that the excitation to each beat arises within the nerve cells, and since the cardiac cycle begins with a contraction at what may be called the venous end of the heart,—that is, at the junction of the veins with the auricles,—it is assumed that the excitation or inner stimulus arises in the nerve cells situated in this region. These cells constitute, therefore, what may be called the automatic motor center of the heart. The stimuli generated within it are transmitted through its axons first to the musculature of the venous end of the heart. The subsequent orderly march of this contraction, to auricles and then to ventricles, is also upon this theory usually attributed to the intrinsic nerve cells and fibers. Through a definite mechanism the impulses generated in the motor center are transmitted to subordinate nerve centers through which the auricles are excited, and then to other nerve cells lying in or near the auriculo-ventricular groove or to the nervous tissue in the auriculoventricular bundle through which the ventricles are excited. In this form the theory assumes for the heart an intrinsic central nervous system, as it were, with a principal motor center in which the property of automaticity is chiefly developed and subordinate centers whose activity usually depends upon the principal center, but which may show automatic properties of a lower order if the connections between them and the main center are interrupted. This intrinsic nervous system is responsible not only for the spontaneous origination and normal sequence of the beat, but also for its co-ordination. The many muscular fibers of the ventricle contract normally in a definite manner and sequence, so that their effect is summated. Under abnormal conditions the fibers may contract irregularly, giving the so-called fibrillary contractions of the heart, which are inco-ordinated. It may be said that this conception of the connections of the intrinsic nervous system rests mainly upon deductions from physiological experiments. The histological details regarding the connections of the nerve cells in the heart are not yet sufficiently known, but it can not be said at present that they give any positive support to such a view. In regard to the neurogenic theory the following general statements may be made:

1. Most of the very numerous facts known regarding the heart

\* For general presentations from different standpoints see Gaskell, article on "The Contraction of Cardiac Muscles," in Schäfer's "Text-book of Physiology," vol. ii, 1900; Langendorff, "Herzmuskel und intrakardiale Innervation" in "Ergebnisse der Physiologie," vol. i, part II, 1902; and Cyon, "L'innervation du coeur," Richet's "Dictionnaire du Physiologie," vol. iv, 1900; Flack, in Hill's "Further Advances in Physiology," 1909, 53.



beat and its variations under experimental conditions may be explained in terms of the theory, or at least do not contradict it. The same statement, however, may be made regarding the myogenic theory. Both theories may be applied successfully from a logical standpoint to the explanation of known facts.

2. No single fact is known which can be cited as positive proof that the nerves participate in the production of the normal beat of the vertebrate heart. The experiment by Kronecker and Schmey is sometimes given this significance. These observers have shown that, when a needle is thrust into a certain spot in the dog's ventricle, the regularly contracting heart falls suddenly into fibrillary contractions so far as the ventricles are concerned. The experiment is certainly a striking and interesting one. The needle may be thrust many times into certain portions of the muscular mass without affecting the powerful co-ordinated contractions, but in the region specified by Kronecker a single puncture, if it reaches the right spot, causes the ventricle to fall into irregular fibrillary twitches from which it does not recover. The spot as described by Kronecker is along the line of the septum at the lower border of its upper third. The experiment frequently fails; and it would seem that there must be a definite and quite circumscribed structure whose lesion produces the effect described. We have no evidence as yet what this structure is, and are therefore in no condition to make positive inferences with regard to the bearing of the experiment upon the origin of the heart beat. Carlson\* has described experiments upon the heart of the horseshoe crab (*Limulus*) which seem to show conclusively that in this animal the rhythmical contractions are dependent upon the intrinsic nerve cells. These latter are placed superficially, forming a cord that runs the length of the tubular heart. When this cord is removed the heart ceases to beat. There are reasons, however, which at present make it doubtful whether we can apply the results of this experiment to the vertebrate heart. The crustacean heart differs from the vertebrate heart in its fundamental properties; unlike the latter, it has no refractory period (see p. 575), can be tetanized, and gives submaximal contractions.† It is a tissue, therefore, that resembles in its properties ordinary skeletal muscle in the vertebrate, and, like this muscle, it seems to be lacking in automaticity. Carlson's experiments give, however, another instance of automatic rhythmicity in nerve tissue, and to that extent support the neurogenic theory.

**The Myogenic Theory of the Heart Beat.**—The myogenic theory has been developed chiefly by Gaskell and by Engelmann.

\* Carlson, "American Journal of Physiology," 12, 67, and 471, 1905.

† Hunt, Bookman, and Tierney, "Centralblatt f. Physiologie," 11, 275, 1897.

It assumes that the heart muscle itself possesses the property of automatic rhythmicity and that this property is most highly developed at the venous end. This portion of the heart, therefore, contracts first and the wave of contraction spreads directly to the musculature of the auricle and thence through the auriculoventricular bundle to that of the ventricle. The quickly beating venous end sets the pace, as it were, for the entire heart. The nerve cells and nerve fibres that are present in the heart are upon this theory supposed to be connected with the extrinsic nerves through which the rate and force of the heart beat are regulated, but they are not concerned in the production of the beat. Many experimental facts have been accumulated which give probability to this view, and it has been adopted by many, perhaps most, of the recent workers in this field. Some of the facts that favor this theory are as follows:

1. The anatomical arrangement of the musculature of the heart is not opposed to such a theory. It was formerly stated quite positively that there is no muscular connection between the auricles and ventricles in the mammalian heart, but we now know that these two parts of the heart are connected through a peculiar system of muscular tissue, the auriculoventricular bundle and its ramifications. It may be accepted also that the wave of excitation from the sinus end of the heart passes along this system. All the detectable nerve trunks crossing the auriculoventricular groove may be cut without altering the sequence of the heart beat, but section or compression of the A-V bundle brings on at once the condition of dissociated heart-rhythm known as heart block. The auriculoventricular bundle contains nerve-fibers as well as muscle-fibers, and the advocates of the neurogenic hypothesis make, therefore, the somewhat improbable claim that these particular nerve-fibers of all those that pass between auricle and ventricle are the only ones concerned in the conduction of the normal stimulus from auricle to ventricle.

2. The fact that a contraction started at one part of the heart may travel to other portions through the intervening musculature may be said to be demonstrated. Thus, Engelmann has shown that if the ventricle in the frog's heart is cut in a zigzag fashion, so that strips are obtained which are connected only by narrow bridges, a stimulation applied at one end starts a wave of contraction which propagates itself over all of the pieces. This and similar experiments scarcely permit of explanation on the supposition that conduction from piece to piece is effected by a definite nervous mechanism. So too it has been shown that under certain conditions the normal auriculo-ventricular rhythm can be changed at will to a ventriculo-auricular rhythm. If, for instance, a ligature be tied around the frog's heart between the sinus venosus and the

auricle (first ligature of Stannius) the auricle and ventricle cease to beat. In this quiescent condition a slight mechanical stimulus to the ventricle causes it to beat and its contraction is immediately followed by that of the auricle. A similar reversed rhythm may be obtained from the mammalian heart under suitable conditions. Such an experiment makes it most probable that the contraction is propagated from one chamber to the other directly through the muscular connections. It is not possible at present to conceive that a definite mechanism of neurons should work thus in either direction.

3. There is much probable proof that the heart muscle tissue possesses the property of automatic rhythmical contractions. Experiments, initiated by Gaskell and since extended by numerous observers, show that in the cold-blooded animals strips of heart muscle taken from various parts of the heart will under proper conditions develop rhythmical contractions. It is very improbable that each of these strips, no matter how made, contains its own resident nerve cells or nerve tissue which act as a motor center. These results seem to demonstrate an inherent property of rhythmicity in cardiac muscle, whether or not this rhythmicity is directly responsible for the normal beat.

4. It has been shown that in the embryo chick the heart pulsates normally before the nerve cells have grown into it. More recently it has been demonstrated that portions of the heart-muscle may be removed from the embryo and be kept alive in a blood-plasma medium\*. Isolated pieces of this kind continue to beat and to undergo multiplication and differentiation, giving rise to isolated muscle-cells which exhibit rhythmic contractility. This result indicates very clearly that the embryonic heart muscle is capable of automatic contractility. It is possible of course that at a later stage of development this property may be lost by the muscle, but it is perhaps more probable that the property is retained in some degree throughout life, the greatest power of rhythmicity being exhibited by the least differentiated tissue in the venous end of the heart, the sino-auricular node, in which the heart beat originates.

**Automaticity of the Heart.**—As was said above, the question of the cause or causes of the automatic rhythmical contractions must be sought for whether the phenomenon turns out to be a property of the muscular tissue or of the nervous tissue of the heart. When we say that a given tissue is automatic we mean that the stimuli which excite it to activity arise within the tissue itself, and are not brought to it through extrinsic nerves. In the heart, therefore, we assume that a stimulus is continually being

\* Burrows, "Science," 36, 90, 1912.

produced, and we speak of it as *the inner stimulus*. Experiment and speculation have been directed toward unraveling the nature of this inner stimulus. Most of the physiologists who have expressed an opinion upon the subject have sought an explanation in the composition of the blood or lymph bathing the heart tissue, or in the products of metabolism of the tissue itself. Regarding this latter view there is nothing of the nature of direct experimental evidence in its favor. No product of the metabolism of the heart tissue capable of exerting this stimulating effect has been isolated. In regard to the former view, that the inner stimulus is connected with a definite composition of the blood or lymph, there has been considerable experimental work which is of fundamental significance. While the older physiologists paid attention mainly to the organic substances in the blood, it has been shown in recent years that the inorganic salts are the elements whose influence upon the heart beat is most striking. These salts are in solution in the liquid of the tissue, and are therefore probably more or less completely dissociated. Attention has been directed mainly to the influence of the cations, of which three are especially important,—namely, the sodium, the calcium, and the potassium.

**The Action of the Calcium, Potassium, and Sodium Ions in the Blood and Lymph.**—It has long been known that the heart of a frog or terrapin may be kept beating normally for hours after removal from the body, provided it is supplied with an artificial circulation of blood or lymph, so arranged that this liquid enters the heart through the veins from a reservoir of some sort and is pumped out through the arteries leading from the ventricle. It was first shown by Merunowicz, working under Ludwig's direction, that an aqueous extract of the ash of the blood possesses a similar action.

Ringer afterwards proved that the frog's heart can be kept beating for long periods upon a mixture of sodium chlorid, potassium chlorid, and calcium phosphate or chlorid, and he laid especial stress upon the importance of the calcium. This work was afterwards confirmed and extended by others, who attempted to analyze the part played by the several ions.\* If a frog's or a terrapin's heart is fed with a solution of physiological saline (NaCl, 0.7 per cent.) it beats well for a while, but the beats soon weaken and gradually fade out. If in this condition the heart is fed with a proper mixture of sodium, potassium, and calcium chlorids it beats vigorously and well for very many

\* For literature and discussion see Howell, "American Journal of Physiology," 2, 47, 1898, and 6, 181, 1901, and "Journal of the American Medical Association," 1906. Burrige, "Quarterly Journal of Exp. Physiology," 5, 347, 1912.

hours. A solution containing these three salts in proper proportions is known usually as Ringer's mixture. The exact composition has been varied by different workers, but for the heart of the frog or terrapin the following composition is most effective:

NaCl.....	=	0.7	per cent.
KCl.....	=	0.03	" "
CaCl.....	=	0.025	" "

The addition of a trace of alkali,  $\text{HNaCO}_3$ , 0.003 per cent., often increases the effectiveness of the solution, but it cannot be considered an essential constituent in the same sense as sodium, potassium, and calcium. It has been shown, moreover, that even the mammalian heart can be kept beating for long periods when fed with a Ringer solution if provision is made for a larger supply of oxygen than can be obtained by simple exposure to the air. For the irrigation of the isolated mammalian heart different forms of Ringer's solution have been employed, but the mixture most frequently used is that recommended by Locke, consisting of NaCl, 0.9 per cent.;  $\text{CaCl}_2$ , 0.024 per cent.; KCl, 0.042 per cent.;  $\text{NaHCO}_3$ , 0.01 to 0.03 per cent.; and dextrose, 0.1 per cent. The solution is fed to the heart under an atmosphere of oxygen, and with this solution Locke and others have kept the mammalian heart beating for many hours. The dextrose, while not essential to the action of the irrigating liquid, increases its efficiency, and Locke\* has shown that the sugar is apparently utilized by the heart, since a considerable amount disappears from the solution when the heart is beating strongly. The general fact that comes out of these experiments is that the heart can beat for very long periods upon what has been called an inorganic diet. Moreover, the salts that are used cannot be chosen at random; it is necessary to have salts of the three metals named, and substitution is possible only to a very limited extent. Thus, strontium salts may replace those of calcium more or less perfectly.

It is evident that these salts play some very important part in the production of the rhythmical beat of the heart; and analysis has shown that the sodium, calcium, and potassium has each its special rôle. We may say that the presence of these salts in normal proportions is an absolute necessity for heart activity. A striking experiment which shows the importance of the calcium is to irrigate a terrapin's heart with blood-serum from which the calcium has been removed by precipitation with sodium oxalate. In spite of the fact that all other constituents of the blood are present the heart ceases to beat, and normal contractions can be

\* Locke and Rosenheim, "Journal of Physiology," 36, 205, 1907. See also Knowlton and Starling, *ibid.* 45, 146, 1912.

started again promptly by adding calcium chlorid in right amounts to the oxalated blood. Regarding the specific part taken by each of the cations in the production of the alternate contractions and relaxations, much diversity of opinion exists, owing to our ignorance of the chemical changes going on in the heart during systole and diastole and to the difficulty of controlling experimental conditions. Thus, while it is an easy matter to control accurately the composition of the liquids supplied to the heart, a variable and uncontrollable factor is introduced by the fact that within the tissue elements themselves there is a store of combined calcium, potassium, and sodium which may serve to supply these elements to a greater or less extent to the tissue liquids.

The controversial details upon this question cannot be presented in an elementary book, but the following brief statements may be made regarding one view of the specific effects of the separate cations: (1) The sodium salts in the blood and lymph take the chief part in the maintenance of normal osmotic pressure. The sodium chlorid exists in blood-plasma to the extent of 0.5 to 0.6 per cent., and the normal osmotic pressure of the blood is mainly dependent upon it. A solution of sodium chlorid of 0.7 to 0.9 per cent. forms what is known as physiological saline, and although not adequate to maintain the normal composition and properties of the tissues it fulfills this purpose more perfectly than the solution of any other single substance. The sodium ions have in addition a specific influence upon the state of the heart tissue. Contractility and irritability disappear when they are absent; when present alone, in physiological concentration, in the medium bathing the heart muscles they produce relaxation of the muscle tissue. (2) The calcium ions are present in relatively very small quantities in the blood, but they also are absolutely necessary to contractility and irritability. When present in quantities above normal or when in a proportional excess over the sodium or potassium ions they cause a condition of tonic contraction that has been designated as calcium rigor. (3) The potassium ions are present also in very small quantities, and, unlike the calcium and sodium ions, their presence in the circulating liquid does not seem to be absolutely necessary to rhythmical activity. Under proper conditions a terrapin's heart beats well for a time upon a solution containing only sodium and calcium salts. The potassium seems to promote relaxation of the muscle and in physiological doses it exercises through this effect a regulating influence upon the rate of beat. When the proportion of potassium ions is increased the heart rate is proportionally slowed, and finally the contractions cease altogether, the heart coming to rest in a state of extreme relaxation, known sometimes as potassium inhibition. (4) It appears from these statements

that there is a well-marked antagonism between the effects of the calcium, on the one hand, and the potassium and sodium, on the other. The calcium promotes a state of contraction, the sodium and the potassium a state of relaxation. It is conceivable, therefore, that the alternate states of contraction and relaxation which characterize the rhythmical action of heart muscle are connected in some way with an interaction of an alternating kind between these ions and the living contractile substance of the heart. It is impossible to say positively whether or not the inorganic salts are directly connected with the cause of the beat,—that is, with the origination of the inner stimulus. According to one point of view, they are necessary only to the irritability and contractility of the heart tissue. The inner stimulus is produced otherwise by some unknown reaction, but it is not able to cause a contraction of the heart muscle in the absence of the proper inorganic salts. According to another view, the reaction of these ions with the living substance constitutes or leads to the development of the inner stimulus.

**Physiological Properties of Cardiac Muscle.**—Cardiac muscle exhibits certain properties which distinguish it sharply from skeletal muscular tissue and which have a direct bearing upon the rhythmicity of the contractions and the sequence shown by the different chambers. The most characteristic of these properties are the following:

1. *The contractions of heart muscle are always maximal.* In skeletal muscle and in plain muscle the extent of contraction is related to the strength of the stimulus, and we recognize the existence of a series of submaximal contractions of varying heights. This is not true of heart muscle. As was first shown by Bowditch, a piece of ventricular muscle when stimulated responds, if it responds at all, with a maximal contraction. The apex of a frog's heart does not beat spontaneously, but contracts upon electrical stimulation. If such an apex is connected with a lever to register its contractions, and the electrical stimulus applied to it is gradually increased, the first contraction to appear is maximal, and it is not further increased by augmenting the stimulus. This property is sometimes described by saying (Ranvier) that the contraction of the heart muscle is all or none. This fact must not, however, be interpreted to mean that the force of contraction of heart muscle is invariable under all conditions. Such is not the case. The heart muscle under favorable nutritive conditions may give a much larger and more forcible contraction than is possible under conditions of poor nutrition; but the point is, that, whatever may be the condition of the muscle at any given moment, its contraction in response to artificial stimulation

is maximal for that condition,—that is, does not vary with the strength of the stimulus. As was said above, this property is not

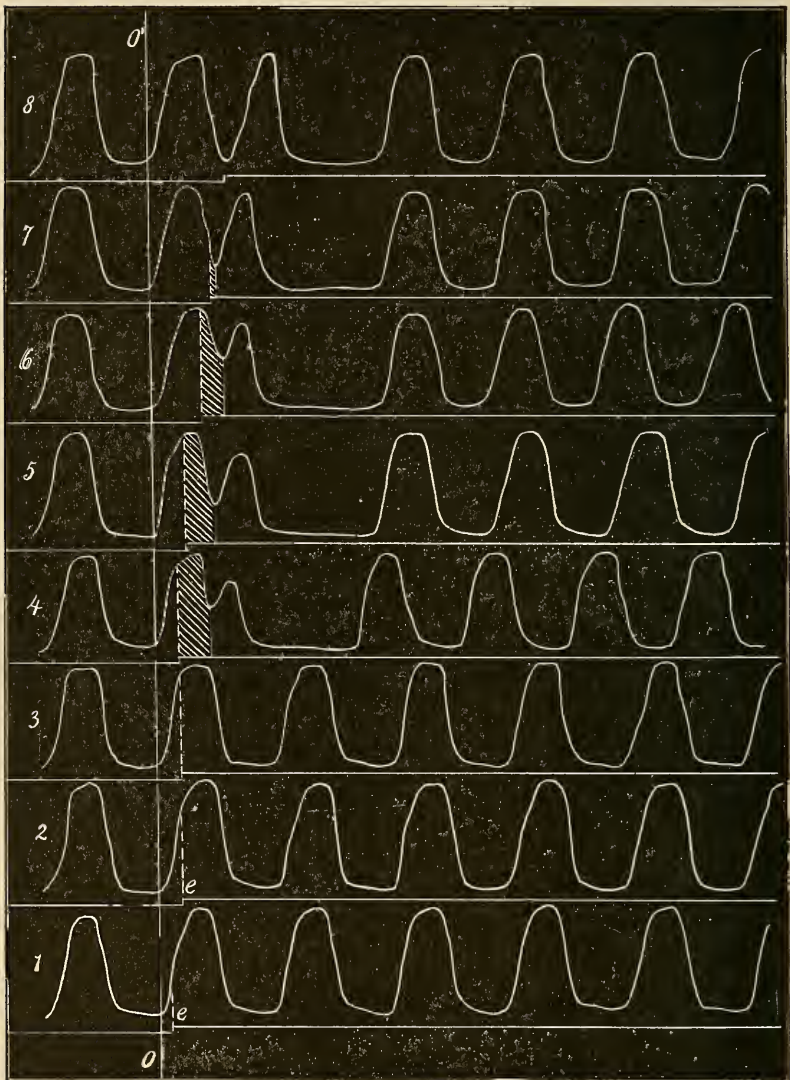

Fig. 236.—To show the effect of a short electrical stimulus applied at different times in the heart beat.—(Marey.) The record is taken from the frog's heart. In 1, 2, and 3 the stimulus (*e*) falls into the heart during systole (refractory period) and has no effect. In 4, 5, 6, 7, and 8 the stimulus falls into the heart toward the end of systole or during diastole, and is followed by an extra systole and corresponding compensatory pause. It will be noted that the latent period (shaded area) between the stimulus and the extra systole is shorter the longer the diastole has proceeded before the stimulus is applied.



exhibited by the crustacean (lobster) heart, but has been shown to be true for the mammalian heart muscle.\*

2. *The refractory period of the beat.* It was shown by Marey † that the heart muscle is irritable to artificial (electrical) stimuli only during the period of diastole. During the period of systole an electrical stimulus has no effect; during the period of diastole such a stimulus calls forth an extra systole and the latent period preceding the extra contraction is shorter the later the stimulus is applied in the diastolic phase. This relationship is well shown by Marey's curves reproduced in Fig. 236. The period of inexcitability is designated as the *refractory period* of the heart beat. Marey defined this refractory period as falling within the first part of the systole, and stated that its duration varies with the actual strength of the stimulus. Later experiments by other investigators make it probable that the refractory period lasts during practically the entire systole. ‡ According to this point of view, therefore, the heart muscle during its period of actual contraction is entirely unirritable, and in this respect it offers a striking difference to skeletal and plain muscle. The existence of this refractory period explains why the heart muscle cannot be thrown into complete tetanic contractions by rapidly repeated stimuli. Since each contraction is accompanied by a condition of loss of irritability, it is obvious that those stimuli that fall into the heart during this period must prove ineffective. The refractory period and the gradual increase in irritability during the diastole may throw some light also on the rhythmical character of the beat. The occurrence of the refractory period and the subsequent gradual return of irritability are connected no doubt with the metabolic changes taking place in the heart muscle. It is in the character of this metabolism that we must seek for the final explanation of these two phenomena and the cause of the rhythmicity of the contractions. As was stated above, it has been shown that the crustacean (lobster) heart muscle does not obey the all-or-none law, is not refractory during systole, and is capable of giving tetanic contractions when rapidly stimulated. In all these respects it differs from the typical heart muscle of the vertebrate, but the difference is perhaps sufficiently explained by the discovery (p. 567) that the crustacean heart, in one form at least, is not an automatically rhythmical tissue. Its rhythmical contractions, like those of the diaphragmatic muscle in the higher vertebrates, depend upon rhythmical impulses received from nerve centers.

\* For experiments on mammalian heart and literature, see Woodworth, "American Journal of Physiology," 8, 213, 1903.

† Marey, "Travaux du laboratoire," 1876, p. 73.

‡ See paper by Woodworth, *loc. cit.* Also Schultz, "American Journal of Physiology," 16, 483, 1906, and 22, 133, 1908.

**The Compensatory Pause.**—It has been observed that when an extra systole is produced by stimulating a ventricle it is followed by a pause longer than usual; the pause, in fact, is of such a length as to compensate exactly for the extra beat; so that the total rate of beat remains the same. The prolonged pause under these conditions is therefore frequently designated as the *compensatory pause*. It has been shown,\* however, that the exact compensation in this case is not referable to a property of heart muscle, but is due to the dependence of the ventricular upon the auricular beat. When the auricle or ventricle is isolated and stimulated the phenomenon of exact compensation is not observed. In an entire heart, on the contrary, the beat originates at the venous end of the auricle and is propagated to the ventricle. If the latter chamber is stimulated so as to give an extra beat out of sequence it will remain in diastole until the next auricular beat stimulates it, and will thus pick up the regular sequence of the heart beat.

**The Normal Sequence of the Heart Beat.**—The normal rhythm of the heart beat is first a contraction of the auricles, then one of the ventricles. Many efforts have been made to determine the precise spot in which the contraction of the heart normally starts. Formerly it was supposed that the contraction began in the great veins just before they pass into the auricle, and it was implied that this initiation of the beat might occur in the pulmonary veins as well as in the venæ cavæ. More recent experiments † which have been made largely upon the isolated heart while perfused with a Ringer-Locke solution have shown pretty conclusively that the most rhythmic part of the heart and the part from which the beat, in all probability, normally starts is an area of the wall of the right auricle lying between the openings of the venæ cavæ, or, according to the most recent views, in that remnant of the sinus tissue known as the sino-auricular node which lies in this region, and which is connected with the auricular muscle and with the auriculoventricular bundle (p. 538). When this portion of the heart is warmed or cooled the rate of beat of the whole heart is correspondingly increased or decreased, while, on the contrary, warming or cooling of the ventricles themselves, the auricular appendages, the left auricle, etc., has no effect upon the heart-rate. From the point of confluence of the venæ cavæ the wave of contraction spreads over the auricles and through the auriculoventricular bundle to the ventricles. This sequence from venous to arterial end is beautifully shown in the frog's heart, in which the contraction begins in the sinus venosus, spreads to the auricles, thence to the ventricle, and finally to the bulbus arteriosus. Under normal conditions this sequence is never reversed, and an explanation of the natural order forms obviously an important part of any complete theory of the heart beat. Those who hold to the neurogenic theory

\* Cushny and Matthews, "Journal of Physiology," 21, 227, 1897.

† Consult especially Adam, "Archiv f. d. ges. Physiol.," 111, 607, 1906; Erlanger and Blackman, "American Journal of Physiology," 19, 125, 1907, and Flack, "Journal of Physiology," 41, 64, 1910.

naturally explain the sequence of the beat by reference to the intrinsic nervous apparatus. If the motor ganglia lie toward the venous end of the heart one can imagine that their discharges may affect the different chambers in sequence, the pause between auricular and ventricular contraction being due, let us say, to the fact that the motor impulses to the ventricle have to act through subordinate nerve cells in the auriculo-ventricular region, and the time necessary for this action brings the ventricular contraction a certain interval later than that of the auricle. There is no immediate proof or disproof of such a view. The numerous experiments made upon the rapidity of conduction of the wave of contraction over the heart are not conclusive either for or against the view. The fact, however, that in the quiescent but still irritable heart the rhythm may be reversed by artificially stimulating the ventricle first seems to the author to speak strongly against the dependence of the sequence upon any definite arrangement of neuron complexes. On the myogenic theory the sequence of the heart beat is accounted for readily by relatively simple assumptions. Gaskell and Engelmann have each laid emphasis upon the facts in this connection, and the application of the myogenic theory to the explanation of the normal sequence of contractions forms one of its most attractive features. Gaskell assumes\* that the rhythmical power of the muscle at the venous end is greater than that at the ventricular end, that is, if pieces from the two ends are examined separately it will be found that the spontaneous rhythm of the tissue from the venous end is more rapid. This portion of the heart, therefore, beating more rapidly, sets the rhythm for the whole organ, since a contraction started at the venous end will propagate itself from chamber to chamber. That each chamber of the heart has a rhythm of its own and that the rhythm of the venous end is the more rapid and constitutes the rhythm of the intact heart has been shown in various ways upon the hearts of different animals. Thus, Tigerstedt has devised an instrument, the atriotome,† by means of which the connections between auricle and ventricle may be crushed without hemorrhage. Under such conditions the ventricle continues to beat, but with a much slower rhythm and with a rhythm entirely independent of that of the auricles. The same result has been obtained in a very striking way by Erlanger. This observer arranged a clamp by means of which he could compress the auriculoventricular bundle connecting auricle and ventricle. When the compression is made the ventricle, after an interval, exhibits a slower rhythm and one entirely independent

\* Gaskell, "Journal of Physiology," 4, 61, 1883; also vol. ii, p. 180, of Schäfer's "Text-book of Physiology," 1900.

† See "Lehrbuch der Physiologie des Kreislaufes," 1893.

of that of the auricles. When the compression is removed the ventricle falls in again with auricular rhythm. By variations in the pressure upon the bundle intermediate conditions may be obtained in which the "block" between auricle and ventricle is only partial, and in which, therefore, the ventricular systole follows regularly every second or third auricular contraction. When the "block" is complete the ventricular rhythm ceases to have any definite relationship to that of the auricle, it beats entirely independently and its rate is slower than that of the auricle. It is interesting to remember that cases of complete or partial heart block occur in man. In the condition known as the Stokes-Adams syndrome the striking feature in addition to attacks of syncope is a permanently slowed pulse, the heart beat falling to 30 or 20 beats per minute or lower. Erlanger has shown that in such cases there may be complete or partial heart block. In the former condition the rhythm of the ventricle is entirely independent of that of the auricle and of course much slower. The ventricles may be beating at 27 per minute and the auricles at 90. In partial block the ratio between the ventricular and auricular rate is definite, every second or third auricular beat being followed by a ventricular systole (see Fig. 237). In a number of these cases it has been shown at autopsy that there was a distinct lesion involving the auriculoventricular bundle, but in other cases lesions of this kind have not been discoverable.\*



Fig. 237.—Cardiogram from a case of Stokes-Adams disease, showing two auricular beats (1, 2) to each ventricular beat.—(Erlanger.) The time-record marks fifths of a second.

In the hearts of the cold-blooded animals the same general results are readily obtained when the tissue between the different chambers is compressed or destroyed. In the frog's heart, for instance, if one ties a ligature (first ligature of Stannius) between the sinus venosus and the auricle, the auricle and ventricle cease beating while the sinus continues pulsating with its normal rhythm. Later the auricle and ventricle may commence beating again, but if this happens their rhythm is slower than that of the sinus and independent of it. So in the terrapin's heart, in which the sequence

\* See Erlanger, "Journal of Experimental Medicine," 1905, vii., 1906, viii., and "American Journal of Physiology," 1906, xv. and xvi. For the literature upon autopsies in cases of Stokes-Adams' disease consult Krumbhaar, "Bulletin of the Ayer Clinical Laboratory," Philadelphia, No. 6, 1910, and Bachmann, "Journal of Exp. Medicine," 16, 41, 1912.

of beat is so beautifully exhibited, if one ties a ligature between auricle and ventricle, or cuts off the ventricle entirely, the sinus venosus and auricle continue beating at their normal rhythm, while the ventricle remains usually entirely quiescent. It would seem from these facts that in the mammalian heart the ventricle when disconnected from the auricle is capable of maintaining a fairly rapid rhythm of its own. At the other extreme, the terrapin's ventricle when similarly treated shows no spontaneous beats at all. These and many other facts that might be quoted support well the general view proposed by Gaskell that the musculature of the venous end of the heart (sino-auricular node) possesses the greater rhythmical power and starts the heart beat, and that the wave of excitation is propagated to the auricles and ventricles through the muscular tissue, or the modified muscular tissue composing the so-called conducting system.

**The Tonicity of the Heart Muscle.**—In describing the physiology of skeletal and plain muscle attention was called to their property of tonicity,—that property by means of which they remain in a more or less permanent although variable condition of contraction. So far as the skeletal muscles are concerned, this condition is dependent upon their connections with the nervous system. Cut the motor nerve, or destroy the motor center, and the muscle loses its tone,—becomes completely relaxed. Tonicity or tonic activity is therefore characteristic of the motor nerve centers, and is due, no doubt, to a more or less continuous inflow of sensory impulses into those centers. The tonus of the nerve centers is a reflex tonus. In the plain muscle the condition of tonus is also marked. The blood-vessels, the bladder, the various viscera are rarely, if ever, entirely relaxed for any length of time. This tonus is also dependent, in many cases, upon a constant innervation through the motor nerves, but after these latter have been destroyed the plain muscle still shows this property of tonicity. So in the heart muscle the power to maintain a certain degree of contraction, a certain state of muscle tension quite independently of the sharp systolic contractions, is very characteristic. At the end of a normal diastole, for example, the ventricle is not entirely relaxed, it retains a certain amount of tonicity as compared with its condition when inhibited through the vagus nerve or when dead. The degree of this tonicity determines, of course, the size of the ventricular cavity (the diastolic volume) and the extent of the charge it will take from the auricles. As will be described in the next chapter the tone of the heart muscle is dependent in part upon its extrinsic nerves, but it is more dependent probably upon the composition of the blood. Like the property of rhythmicity, that of tonicity is most developed at the venous end of the heart. At least this is the

case with the heart of the cold-blooded animals, upon which this property has been studied most carefully. The ventricle of the terrapin, or strips excised from the ventricle and suspended so that their movements can be recorded, often vary greatly in length with differences in condition. These variations are due to changes in tone. Not infrequently these changes take on a rhythmical character; so that if the ventricle is beating one sees upon the record regular tone waves, an alternate slow shortening and slow relaxation quite independent of the rhythmical beats. The tissue of the auricle and especially of the sinus venosus exhibits this property to a much more marked extent (see Fig. 238). The tone—that is, the length of the piece—if in strips, or the capacity of the chamber, if used entire, is continually changing and oftentimes in a rhythmical

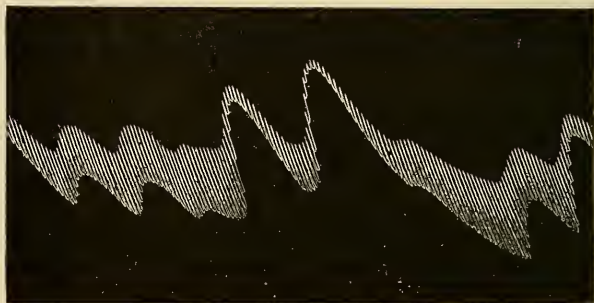

Fig. 238.—To show tone waves in heart muscle. The record shows contractions of a strip of the sinus venosus (terrapin's heart) suspended in a bath of blood-serum. In addition to the sharp contractions marked by the lines there are longer, wave-like shortenings and relaxations, irregular in character, which are due to variations in tone.

way. Fano\* has made a special study of this property and has suggested that the tone changes or contractions may be due to the activity of a substance in the heart different from that which mediates the ordinary contractions. Botazzi† suggests that, while the usual sharp systolic contraction is due to the cross-striated (anisotropic) substance, the slower tone changes may be due to the undifferentiated sarcoplasm. However this may be, the property of tonicity is an important one in the physiology of the heart and of the other visceral organs. Through it a certain tension of the musculature is maintained, and the size of the cavities and, therefore, the output of the ventricles is controlled. A diminution in tonicity constitutes an important factor in the pathological condition known as acute dilatation of the heart.

\* Fano, "Beiträge zur Physiologie," C. Ludwig, zu. s. 70 Geburtstage gewid., Leipzig, 1887.

† "Journal of Physiology," 21, 1, 1897.

## CHAPTER XXX.

### THE CARDIAC NERVES AND THEIR PHYSIOLOGICAL ACTION.

The heart receives two sets of efferent nerve fibers from the central nervous system. One set reaches the heart through the vagus nerves, and, since their activity slows or stops the heart beat, they are spoken of as the *inhibitory* nerve fibers. The other set passes to the heart by way of the sympathetic chain, and since their activity accelerates or augments the heart beat they are designated usually as the *accelerator* nerve fibers. In addition the heart is provided with a set of afferent nerve fibers. Regarding the functional activity of these latter fibers, our experimental knowledge is limited to the fact that some of them, at least, are stimulated at each beat of the heart (p. 614), and that possibly some of them help to form the so-called depressor nerve (p. 614). Under pathological conditions these afferent fibers may produce painful sensations.

**The Course of the Cardiac Fibers.**—The vagus nerve gives off several branches that supply the heart. The superior cardiac branches arise from the vagus in the neck somewhere between the origins of the superior and the inferior laryngeal nerves. The inferior cardiac branches arise from the thoracic portion of the vagus near the origin of the inferior laryngeal (N. recurrens) and, indeed, some of these branches may spring directly from the latter nerve. The inhibitory fibers probably arise in these inferior branches chiefly. Both superior and inferior cardiac branches pass toward the heart and unite with the cardiac branches from the sympathetic chain to form the cardiac plexus. This plexus lies on the arch and ascending portion of the aorta, and from it the heart receives directly both its inhibitory and accelerator fibers. The inhibitory fibers of the heart form a part of the outflow of bulbar autonomic fibers (p. 255) through the vagus nerve. The preganglionic fibers probably end around ganglion cells in the heart, which in turn send their axons as postganglionic fibers to the heart muscle.

**The Action of the Inhibitory Fibers.**—If the vagus nerve in the neck of an animal is cut and its peripheral end is stimulated the heart is slowed or stopped altogether according to the strength of the stimulus. This effect is illustrated in Figs. 239 and 240.

This inhibitory influence upon the heart beat was first described in 1845 by the two brothers, Edward Weber and E. H. Weber. It was a physiological discovery of the first importance, not only as regards the physiology of the heart, but from the standpoint of general physiology, since it gave the first clear instance of the possibility of inhibitory action through nerve fibers.

If the heart is examined during its complete inhibition it will be seen that it stops in diastole, and indeed the diastole is more complete than normal,—the heart dilates to a very large extent, and becomes swollen with blood. This latter fact is taken usually as proof that the action of the inhibitory fibers not only prevents the usual systole, but also removes the tonicity of the musculature. Examination of the heart shows also that the inhibition affects the whole heart,—both auricles and ventricles are slowed or stopped, as the case may be. That the vagus nerve in man also contains inhibitory fibers to the heart is made highly probable by everything known concerning the conditions under which the heart is slowed or stopped temporarily, and has, moreover, been demonstrated directly in several instances upon living men.\* These inhibitory fibers have been shown to exist in all classes of vertebrates and in a number of the invertebrates,—a fact which in itself would indicate the great importance of their influence upon the effective activity of the heart. In the mammals generally employed in laboratory experiments the inhibitory fibers occur in

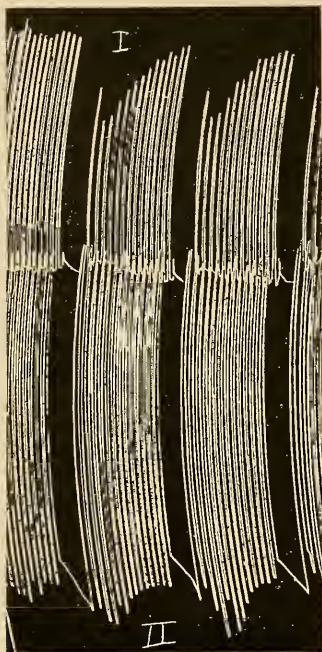

Fig. 239.—To show the inhibition of the terrapin's heart due to stimulation of the vagus nerve. The upper tracing (*I*) records the contractions of the left auricle; the lower (*II*) the contractions of the ventricle. The vagus was stimulated three times, each chamber coming to a complete stop. On removing the stimulus it will be noted that the auricular contractions increase gradually to their normal, while the ventricular contractions start off at full strength.

both vagi; in some of the lower vertebrates, however, especially in the terrapin, the inhibitory fibers may be found exclusively or mainly in the right vagus.

\* See especially Thanoffer, "Centralblatt f. d. med. Wiss.," 1875, who gives an account of an experiment in which the vagi were compressed in the neck, with a resulting stoppage of the heart and loss of consciousness.



**Analysis of the Action of the Inhibitory Fibers.**—The prominent effect of the action of the inhibitory fibers is the slowing

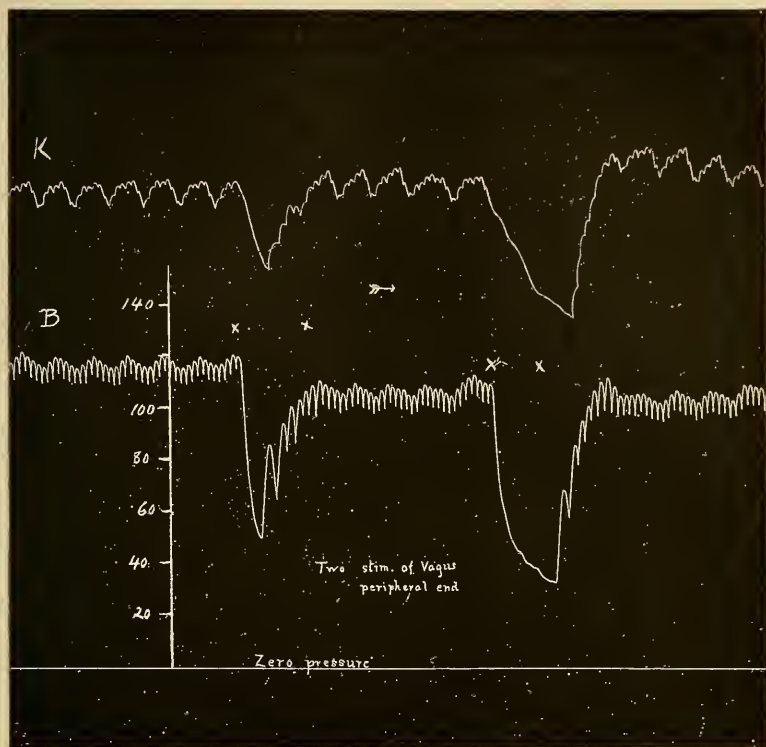

Fig. 240.—To show the inhibition of the heart from stimulation of the vagus in the dog. Record *B* is the blood-pressure tracing. The vagus was stimulated twice. The marks *x, x*, indicate the beginning and end of the stimulus. The first stimulation was weak; it will be noted that the heart escaped and began beating before the stimulus was withdrawn. The second stimulus was stronger; the inhibition lasted some time after removal of the stimulus. The upper curve (*K*) is a plethysmographic (oncometer) tracing of the volume of the kidney. It will be noted that when the heart stops and blood-pressure falls the kidney, like the other organs, diminishes in volume. (*Dawson*.)

of the rate of the heart beat. Numerous observers have called attention to the fact that the vagus fibers may also cause a weakening in the force of the beat as well as a slowing in the rate, or, indeed, the two effects may be obtained separately. This fact has been shown especially for the auricles.\* In the heart of the terrapin one may, by using weak stimuli, obtain only a weakening of the auricular beats without any interference with the rate (Fig. 241), while by increasing the stimulus the slowing in rate becomes evident combined with a diminution in force or extent. Although the

\* Bayliss and Starling, "Journal of Physiology," 13, 410, 1892.

force of the beat may be influenced without altering the rate, the reverse does not hold. Usually, for the auricle, at least, any stimulus that slows the beat also weakens the individual beat. Whether the vagus fibers exercise a similar double influence directly upon the ventricle is not so clear. Some observers find that when the ventricle is inhibited the beats, although slower, are stronger, while others obtain an opposite result. It seems probable, as stated by Johansson and Tigerstedt, that the result obtained depends



Fig. 241.—To show the effect of vagus stimulation on the force only of the auricular beat in the terrapin's heart: *A*, Record of the auricular beats; *V*, record of the ventricular beats. The vagus was stimulated between *x* and *x*. It will be noted that the ventricular beats are not affected, and that the auricular beats diminish in extent without any change in rate.

largely on the strength of stimulus used. These observers found\* that with relatively weak stimuli the contractions of the ventricle, though slower, are stronger, while with stronger stimuli the contractions are diminished in strength as well as rate. The question is complicated by the difficulty of separating the direct effect of the vagus on the ventricle from the indirect effect brought about by the changes in the auricular beat. The inhibitory influence makes itself felt also upon the conductivity of the heart. This fact has been noted by several observers. A striking example is seen in the case of partial heart block. When as the result of some injury or pressure in the auriculo-ventricular region or from some other less

evident cause there is a partial block, so that the ventricle contracts once to two or three beats of the auricle, vagus stimulation may be followed at once, as an after-effect, by a return to the normal beat, a re-establishment of a one-to-one rhythm. Under other circumstances the contrary effect of vagus stimulation has been described. From the results cited it seems evident that the vagus nerve may affect the rate and the force of the contractions, and also the conductivity or the propagation of the wave of excitation. These separate influences have been referred by some authors to the existence of different kinds of nerve fibers, each exerting its own influence, but it seems preferable to assume, on the contrary, that only one kind of fiber is present, and that its influence on the metabolic changes in the heart muscle expresses itself differently upon the several different properties of the tissue according to the extent of its action.

\* See Tigerstedt, "Lehrbuch der Physiologie des Kreislaufes," 1893, p. 247.

Engelmann has made the most complete attempt to analyze the influence exerted by the cardiac nerves (inhibitory and accelerator). He designates these influences under four different heads with the further supposition that they are mediated by different fibers: (1) The chronotropic influence, affecting the rate of contraction, positive chronotropic actions causing an acceleration and negative chronotropic actions a slowing of the rate. (2) The bathmotropic influence, affecting the irritability of the muscular tissue; this also may be positive or negative. (3) The dromotropic influence, positive or negative, affecting the conductivity of the tissue. (4) The inotropic influence, positive or negative, affecting the force or energy of the contractions.\*

**Does the Vagus Affect Both Auricle and Ventricle?**—The inhibitory action of the vagus is most marked upon the venous end of the heart, and the question has arisen as to whether it affects the ventricle directly or not. Gaskell gave evidence to indicate that in the terrapin the auricle only is inhibited, the ventricle stopping because it fails to receive its normal impulse from the auricle. When this heart is inhibited the contractions of the auricle after cessation of inhibition gradually increase in amplitude until the normal size is reached; in the ventricle, on the contrary, the first contraction after inhibition is of normal size or greater than normal (see Fig. 239). When a block is produced in the mammalian heart between auricle and ventricle—by clamping the connecting muscular bundle, for instance—stimulation of the vagus stops the auricle only †, and the result would seem to indicate that the vagus affects only the auricle, unless it is assumed that the clamp has interrupted the inhibitory paths to the ventricle. On the other hand, in favor of the view that the vagus fibers reach the ventricle and influence its beats directly, we have the fact, emphasized by Tigerstedt, namely, that when the connection between auricle and ventricle is severed suddenly the ventricle frequently continues to beat at its own rhythm without any obvious pause. It would seem from this fact that when the whole heart is inhibited by stimulation of the vagus the ventricle does not stop simply because the auricle fails to send on its usual contraction wave, since, if that were so, cutting off the auricle or clamping the connection between it and the ventricle should also bring on a ventricular pause, as happens in the case of the terrapin's heart. It seems, however, to be the general belief of those who have experimented with the subject that the action of the vagus is exerted mainly upon the auricles, and, indeed, there is some evidence ‡ that its effect is felt mainly upon that small portion of the auricle (the sino-auricular node) in which the normal heart-beat takes its origin.

**Escape from Inhibition.**—Strong stimulation of the vagus may stop the entire heart, but the length of time during which the

\* Englemann, "Archiv f. Physiologie," 1900, p. 313, and 1902, suppl. volume, p. 1.

† Erlanger, "Archiv f. d. ges. Physiologie," 127, 77, 1909.

‡ Flack, "Journal of Physiology," 41, 64, 1910.

heart may be maintained in this condition varies in different species and indeed to some extent in different individuals.\* In some animals—cats, for example—the strongest stimulation of the nerve serves frequently only to slow the heart instead of causing complete standstill. In dogs the heart is stopped by relatively weak stimulation, although if the stimulation is maintained the heart, as a rule, escapes from the inhibition. In some dogs the heart may be held inhibited long enough to cause the death of the animal unless artificial respiration is maintained, but usually the heart beat soon breaks through the complete inhibition. The “inner stimulus” in such cases increases in strength sufficiently to overcome the opposing inhibitory influence, and this circumstance may be regarded as an argument against those views that trace the origin of the “inner stimulus” to some of the products formed during the catabolism of contraction. Moderate stimulation of the vagus, sufficient simply to slow the rate of beat, can be maintained without diminution in effect for very long periods; indeed, as is explained in the next paragraph, the heart beat is kept partially inhibited more or less continuously through life by a constant activity of the vagus. In the cold-blooded animals, especially the terrapin, the heart may be kept completely inhibited for hours by stimulation of the vagus. Mills reports that he has kept the heart of the terrapin in this condition for more than four hours.† Most observers state that complete inhibition can be maintained for a longer time when the stimulus is applied alternately to the two vagi, but it is possible that this result is due to the fact that continuous stimulation applied to a nerve usually results in some local loss of irritability.

**Reflex Inhibition of the Heart Beat—Cardio-inhibitory Center.**—The inhibitory fibers may be stimulated reflexly by action upon various sensory nerves or surfaces. One of the first experimental proofs of this fact was furnished by Goltz’s often-quoted “Klopfversuch.”‡ In this experiment, made upon frogs, the observer obtained standstill of the heart by light, rapid taps on the abdomen, and the effect upon the heart failed to appear when the vagi were cut. In the mammals every laboratory worker has had numerous opportunities to observe that stimulation of the central stumps of sensory nerves may cause a reflex slowing of the heart beat. The effect is usually very marked when the central stump of one vagus is stimulated, the other vagus being intact. The vagus carries afferent fibers from the thoracic and abdominal viscera, and most observers state that the heart may be reflexly inhibited most readily by simulation of the sensory surfaces of

\* See Hough, “Journal of Physiology,” 18, 161, 1895.

† “Journal of Physiology,” 6, 246.

‡ Goltz, “Virchow’s Archiv f. pathol. Anatomie, etc.,” 26, 11, 1863.

the abdominal viscera, by a blow upon the viscera, for example, or by sudden distension of the stomach. In man similar results are noticed very frequently. Acute dyspepsia, inflammation of the peritoneum, painful stimulation of sensory surfaces,—the testes, for instance, or the middle ear,—may cause a marked slowing of the heart,—a condition designated as bradycardia. What takes place in all such cases is that the afferent impulses carried into the central nervous system reflexly stimulate the nerve cells in the medulla which give origin to the inhibitory fibers. These cells form a part of the great motor nucleus (N. ambiguus) from which arise the motor fibers of the vagus and the glossopharyngeus. The particular group of cells from which the inhibitory fibers to the heart originate has not been delimited anatomically. Efforts have been made to locate them by vivisection experiments, but this method has shown no more perhaps than that they are found in the region of origin of the vagus nerve. Physiologically, however, this group of cells forms a center which is of the greatest importance in controlling the activity of the heart. It is designated, therefore, as the *cardio-inhibitory center*. We may define the cardio-inhibitory center as a bilateral group of cells lying in the medulla at the level of the nucleus of the vagus and giving rise to the inhibitory fibers of the heart. The two sides are probably connected by commissural cells or else each nucleus sends fibers to the vagus of each side. Through this center all reflexes that affect the heart by way of the inhibitory fibers must take place. These reflexes may be occasioned by incoming sensory impulses through the spinal or cranial nerves, or by impulses coming down from the higher portions of the brain. The center may also be stimulated directly, either by pressure upon the medulla, which may give rise to slow heart beats or, as they are sometimes called, vagal beats, or by changes in the composition of the blood. With regard to the reflex stimulation of this center it is important to bear in mind the general physiological rule that afferent impulses may either excite or inhibit the activity of nerve centers. In the former case the heart rate would be slowed, in the latter case it would be quickened if the center were previously in a state of activity.

**The Tonic Activity of the Cardio-inhibitory Center.**—The cells of the cardio-inhibitory center are in constant activity to a greater or less extent. As a consequence, the heart beat is kept continually at a slower rate than it would normally assume if the inhibitory apparatus did not exist. This tonic activity of the vagus is beautifully exhibited by simple section of the two vagi, or by interrupting, in some other way—cooling, for example—the connection between the center and the heart. When the two vagi are cut the heart rate increases greatly and the blood-pressure rises on account of the greater output of blood in a unit of time (Fig. 242). Section

of one vagus gives usually a partial effect,—that is, the heart-rate is increased somewhat,—but it is still further increased by section of the second vagus. The exact result obtained when the nerves are

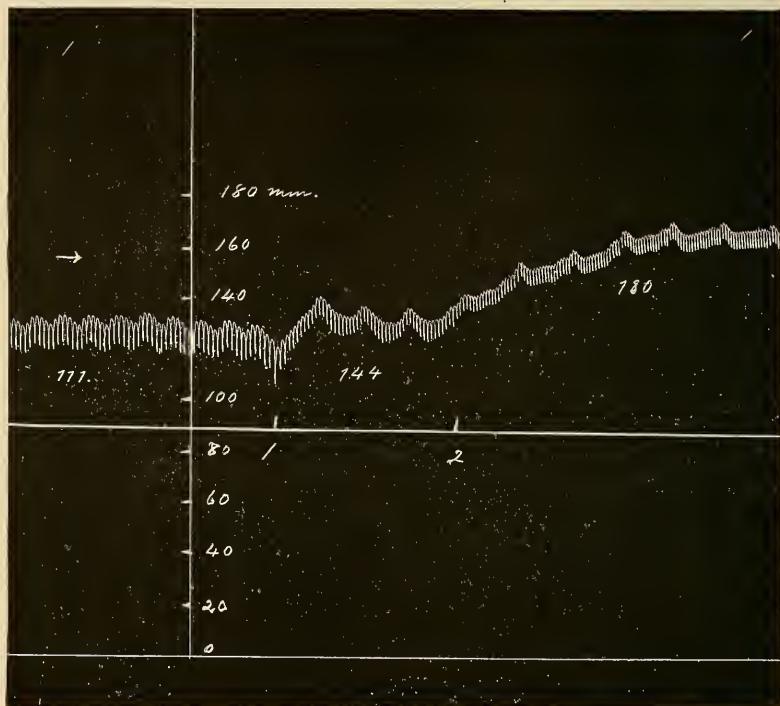

Fig. 242.—To show the effect of section of the two vagi in the dog upon the rate of heart beat and the blood-pressure: 1 marks the section of the vagus on the right side; 2, section of the second vagus. The numerals on the vertical mark the blood-pressures; the numerals on the blood-pressure record give the rate of heart beats. (*Dawson.*)

severed separately varies undoubtedly with the conditions,—for instance, with the intensity of the tonic activity of the center. Throughout life, speaking in general terms, the cardio-inhibitory center keeps the “brakes” on the heart rate, and the extent of its action varies under different conditions. When its tonic action is increased the rate becomes slower; when it is decreased the rate becomes faster. In all probability, this tonic action of the center, like that of the motor centers generally, is in reality a reflex tonus. That is, it is not due to automatic processes generated within the nerve cells by their own metabolism or by changes in their liquid environment, but to stimulations received through sensory nerves. The continuous though varying inflow of impulses into the central nervous system through different nerve paths keeps the center in that state of permanent gentle activity which we

designate as "tone." It is possible, of course, that certain afferent paths may be in specially close functional relationship to the center, and the fact that at each heart beat its own sensory fibers are stimulated (p. 604, Fig. 280) would suggest that these fibers may have this function.

**The Action of Drugs on the Inhibitory Apparatus.**—The existence of the inhibitory fibers to the heart furnishes a means of explaining the cardiac action of a number of drugs,—atropin, muscarin or pilocarpin, nicotin, curare, digitalis, etc.,—for the details of which reference must be made to works on pharmacology.\* The action of the first three named illustrates especially well the application that has been made of physiology in modern pharmacology. Atropin administered to those animals, such as the dog or man, in which the inhibitory fibers of the vagus are in constant activity, causes a quickening of the heart rate. Indeed, the heart beats as rapidly as if both vagi were cut. After the use of atropin, moreover, stimulation of the vagus nerve fails to produce inhibition. The action of atropin is satisfactorily explained by assuming that it paralyzes the endings of the (postganglionic) inhibitory fibers in the heart muscle, just as curare paralyzes the terminations of the motor fibers in skeletal muscle. Atropin exercises a similar effect upon the nerve terminations in the intrinsic muscles of the eyeball and in many of the glands. On the contrary, when muscarin or pilocarpin is administered it causes a slowing and finally a cessation of the heart beat. Since this effect may be removed by the subsequent use of atropin it is assumed that the two former drugs excite or stimulate the endings of the inhibitory fibers in the heart and thus bring the organ to rest in diastole, as happens after electrical stimulation of the vagus nerve. Some authors, however, believe that these drugs do not act upon the terminals of the vagus fibers, but upon the muscular tissue itself or upon a specialized "receptive substance" (Langley) contained in the muscle. A final statement cannot be made upon this point, but the current belief is that the atropin paralyzes while the muscarin or pilocarpin stimulates the endings of the inhibitory fibers in the substance of the heart.

**The Nature of Inhibition.**—Since the discovery of the inhibitory nerves of the heart furnished the first conclusive proof of the existence in the body of definite nerve fibers with apparently the sole function of inhibition, it seems appropriate in this connection to refer to the views regarding the nature of this process. Several general views of the nature of inhibition have been proposed, but the one that is most definite and has met with most favor is that

\* Consult Cushny, "Text-book of Pharmacology and Therapeutics," Philadelphia.

suggested by Gaskell.\* This author has shown that the after-effects of stimulation of the inhibitory fibers are beneficial rather than injurious to the heart; that is, under certain circumstances an improvement may be noticed in the rate or force of the beat or in the conductivity. He has also shown, by an interesting experiment, that during the state of inhibition the heart tissue is made increasingly electropositive in comparison with a dead portion of the tissue. To show this fact the tip of the auricle was killed by heat and this spot (*a*) and a point at the base of the auricle (*b*) were connected with a galvanometer. Under such conditions a strong demarcation current was obtained flowing through the galvanometer from *b* to *a*. If the auricle contracted a negative variation resulted, since during activity *b* became less positive as regards *a*. If, on the contrary, the auricle was inhibited by stimulation of the inhibitory fibers a positive variation was obtained; *b* became more positive toward *a*. On the basis of such results Gaskell concludes that inhibition in the heart is due to a set of metabolic changes of an opposite character to those occurring during contraction. In the latter condition the metabolism is catabolic, and consists in the breaking down of complex substances into simpler ones with the liberation of energy as heat and work. During inhibition, on the contrary, the processes are anabolic or synthetic and result in the formation of increased contractile material whereby the condition of the heart is improved. He would regard the inhibitory fibers, therefore, as the anabolic nerve of the heart and their constant action throughout life as an aid to the nutrition of the heart. The same general view may be extended to all cases of inhibition, and Gaskell believes that all muscular tissues are supplied with anabolic (inhibitory) and catabolic (motor) fibers.†

A more specific theory applicable to the case of the heart has been proposed by the author.‡ In experiments made upon the isolated heart of the dog it has been shown that during stimulation of the vagus potassium in diffusible form is given off from the heart muscle (auricles). It is known that potassium salts in a certain concentration in the circulating liquid will bring the heart to a stand-still, and the state of potassium inhibition thus produced resembles very closely the state of vagus inhibition. Since the vagus when stimulated liberates potassium in a diffusible form, it is suggested that its action in stopping the heart is effected through the agency of this substance. The potassium exists in large percentage in the heart-muscle, but in a combined form, and the theory assumes that the vagus impulses initiate a dissociation or cleavage of some sort which sets free some potassium in soluble form. If it is assumed that this liberation takes place in the part of the heart in which

\* Gaskell, "Philosophical Transactions of the Royal Society," London; Croonian Lecture, part III, 1882; "Journal of Physiology," 7, 46; and Meek and Eyster, "American Journal of Physiology," 30, 271, 1912.

† For a general discussion of this idea and of the importance of inhibitory actions, see Melzer, "Inhibition," "New York Medical Journal," May 13, 20, 27, 1899.

‡ Howell and Duke, "American Journal of Physiology," 21, 51, 1908.



the beat originates, the theory offers a simple explanation of the stoppage of the beat, of the quick recovery after stimulation ceases, and of the retention of irritability to direct stimulation shown by the heart during vagus inhibition. A heart that has been stopped by an excess of potassium chloride added to the circulating liquid beats very promptly as soon as the excess of the potassium is removed, and as in the case of vagus inhibition it seems often to show a noticeable improvement in condition.

That the inhibitory effect of the vagus impulses upon the heart is not due to any peculiarity in properties of these fibers or of the impulses themselves, but is dependent rather upon the place or manner of ending in the heart, has been demonstrated by direct experiment. Erlanger\* has shown that when an ordinary spinal nerve (fifth cervical) is sutured to the peripheral end of the cut vagus, it will, after time for regeneration has been allowed, cause, when stimulated, the usual stoppage of the heart.

**The Course of the Accelerator Fibers.**—The heart receives efferent or motor nerve fibers from the sympathetic system in addition to those reaching it by way of the vagus nerve. Attention was first called to these sympathetic fibers by Legallois (1812), but our recent knowledge dates from the experiments made by von Bezold (1862), which were afterward completed by the Cyon brothers—M. and E. Cyon†—1866. These fibers when stimulated cause an increased rate of beat and are, therefore, designated as the *accelerator* nerve of the heart. Their

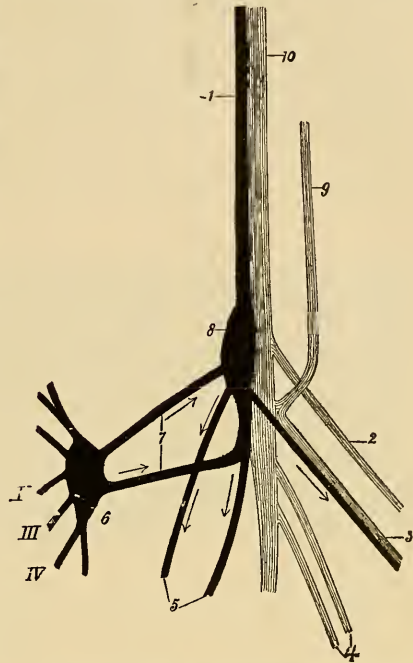

Fig. 243.—Schematic representation of the course of the accelerator fibers to the dog's heart—right side.—(Modified from Pawlow.) The sympathetic nerve is represented in solid black. The course of the accelerator fibers is indicated by arrows. 1, Cervical sympathetic combined in neck with 10, the vagus; 2, 3, 4, 5, rami communicantes from the second, third, and fourth thoracic spinal nerves, carrying most of the accelerator fibers to the sympathetic chain; 7, annulus of Vieussens; 8, inferior cervical ganglion; 2, 3, 4, 5, branches from vagus and vago-sympathetic trunk going to cardiac plexus (some of these—3, 5,—carry accelerator fibers; 9, the inferior laryngeal nerve.

\* Erlanger, "American Journal of Physiology," 13, 372, 1905.

† For the history and literature of the accelerator nerves, see Cyon, article "Cœur," p. 103, in Richet's "Dictionnaire de Physiologie," 1900; or Tigerstedt, "Lehrbuch der Physiologie des Kreislaufes," 260, 1893.

course has been worked out physiologically in a number of animals. Among the mammalia and, indeed, among different animals of the same species there is some variation, but a general conception of their origin and course may be obtained from Figs. 243 and 244, which represent in a schematic way the anatomical path taken by these fibers. They emerge from the spinal cord in the anterior roots of the second, third, and fourth thoracic spinal nerves. According to some authors they may be found also in the fifth thoracic, the first thoracic, or even the lower cervical spinal nerves. They pass then by way of the white rami to the stellate or first thoracic ganglion (6), and thence by way of the annulus of Vieussens (ansa subclavia) (7) to the inferior cervical ganglion. A number of branches leave the sympathetic system and the vagus in this region to pass to the cardiac plexus and thence to the heart. The accelerator fibers are found in some of these branches, mixed in some cases with inhibitory fibers from the vagus. In the cat Boehm has described a special branch (nervus accelerans) which runs from the stellate ganglion directly to the cardiac plexus (Fig. 244).

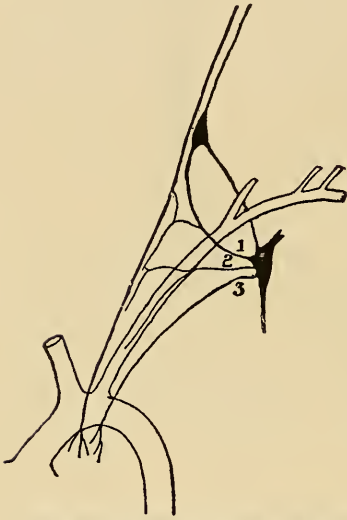

Fig. 244.—Sketch to show the accelerator (and augmentor) branches from the stellate ganglion (in the cat, left side): 1, The ventral branch of the annulus (ansa subclavia); 2, small branch not constantly present; 3, Boehm's accelerator nerve (*N. cardiacus e ganglio stellato*).

The preganglionic portion of **some** of the accelerator fibers ends around the ganglion cells in the first thoracic ganglion, while others apparently make their first termination in the inferior cervical ganglion. The accelerator fibers may be stimulated in the spinal roots in which they emerge (II, III, IV), in the annulus, or in some of the branches that arise from the annulus or from the inferior cervical ganglion (5, 3, 2). It will be borne in mind that no accelerator fibers are found in the cervical sympathetic above the inferior cervical ganglion.

At various times investigators have asserted that accelerator fibers are contained also in the vagus nerve. Thus, it has been shown that, after the paralysis of the inhibitory fibers in the heart by atropin, stimulation of the vagus causes an acceleration of the heart. Little attention has been paid to the physiology of these fibers, since it seems evident that the great outflow of accelerators is made via the sympathetic system.

**The Action of the Accelerator Fibers.**—In experimental work the accelerators are usually stimulated in one or more of the branches represented schematically as 5, 3, 6, in Fig. 243, or 3, in Fig. 244. The effect is an increase in the rate of beat of the heart, which may be very evident, amounting to as much as 70 per cent. or more of the original rate, or may be very slight. When acceleration is obtained the latent period is considerable and the heart does not return at once to its normal rate upon cessation of the stimulus (see Figs. 245 and 246). In some cases the effect upon the heart is an acceleration pure and simple,—that is, the rate of beat is

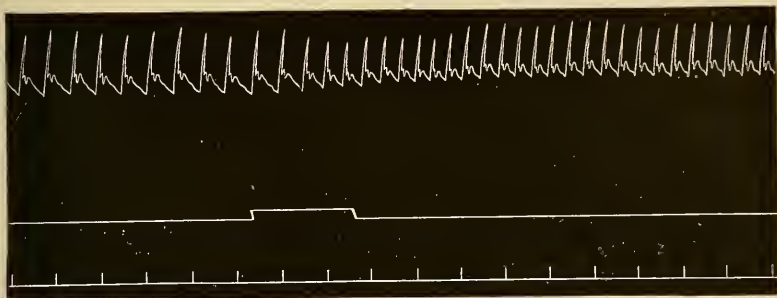

Fig. 245.—To show the acceleration of the heart-rate in dog upon stimulation of the accelerator fibers. The uppermost line gives the heart-rate as recorded by a Hürthle manometer inserted into the carotid; the middle line indicates the beginning and duration of the stimulus (tetanizing induction shocks); the bottom line marks seconds. The pulse-rate was increased from 105 to 135 per minute. The heart did not recover its normal rate until thirty seconds after the stimulation.

increased without any evidence of an increase in the force of the beats. The larger number of beats is offset by the smaller amplitude of each beat; so that the blood-pressure in the arteries is unchanged. In other cases the effect upon the heart may be an increase not only in rate but also in the force or amplitude of the beats, or the rate may remain unaffected and only the amplitude of the heart beats be increased. For these reasons most authors favor the view that the accelerator nerves, so called, contain in reality two sets of fibers, one, the accelerators proper, whose function is simply to accelerate the rate, and one, the augmentors, that cause a more forcible beat. The augmenting action is obtained especially from the nerves of the left side.

**Tonicity of the Accelerators and Reflex Acceleration.**—The results of the most careful work show, without doubt, that the accelerators to the heart are normally in a state of tonic activity.\*

\* For a discussion of this and other points in the physiology of the accelerators see Hunt, "American Journal of Physiology," 2, 395, 1896, and "Journal of Experimental Medicine," 2, 151, 1897.

When these nerves are cut upon both sides the heart rate is decreased. We must believe, therefore, that under normal conditions the heart muscle is under the constant control of two antagonistic influences, one through the inhibitory fibers tending to slow the rate, one through the accelerator fibers tending to quicken the rate. The actual rate at any moment is the resultant of these two influences. While such an arrangement seems at first sight to be unnecessary from a mechanical standpoint, it is doubtless true that it possesses some distinct advantage. Possibly it makes the heart more promptly responsive to reflex regulation. Balanced mechanisms of this kind are found in other parts of the body where smooth and prompt reactions to stimulation seem to be especially necessary,—for example, the constrictor and dilator fibers of the iris, the extensor and flexor muscles of the joints, etc. Physiologists have studied experimentally the effect upon the heart of stimulating simultaneously the inhibitory and the accelerator nerves. The work done upon this subject by Hunt seems to make it very certain that in all such cases the result, so far as the rate is concerned, is the algebraic sum of the effects of the separate stimulations of the nerve. The inhibitory and the accelerator fibers must be considered, therefore, as true antagonists, acting in opposite ways upon the heart. The existence of the accelerator nerves makes possible, of course, their reflex stimulation. Experimentally it is found that stimulation of various sensory nerves—those of the limbs or trunk, for instance—may cause reflexly either an increase or decrease in the heart rate, and as a matter of experience we know that our heart rate may be increased by various changes, particularly by emotional states. The natural explanation of such accelerations is that they are

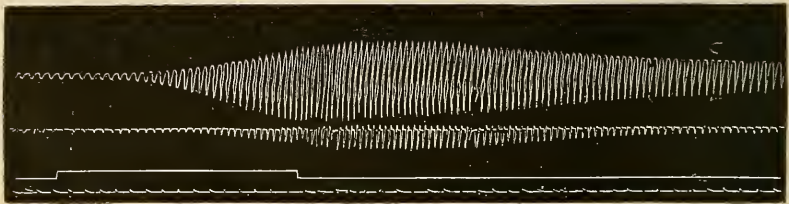

Fig. 246.—To show the acceleration and augmentation produced by a strong stimulus. Isolated cat's heart, stimulation on left side. The upper curve gives the ventricular contractions, the lower one the auricular contractions. The lowermost line gives the time in seconds and the line above indicates the duration of the stimulation of the accelerator nerve.

due to reflex stimulation of the nerve cells in the central nervous system which give rise to the accelerator fibers. But another point of view is possible. An increase in heart rate may be brought about either by a reflex stimulation of the accelerator

fibers or by a reflex inhibition of the cardio-inhibitory center. Hunt especially has presented many experimental facts which indicate that an increase in heart rate from reflex action may be produced by an inhibition of the tonic activity of the cardio-inhibitory center. He finds, for instance, that when the two vagi are cut stimulation of various sensory nerves fails to give any increase in the already rapid heart rate, while, on the contrary, when the two accelerator paths are cut a reflex increase in heart rate may be obtained readily. The negative result after previous section of the vagi may well be due, however, to the fact that the heart is then beating at a very rapid rate, too rapid for the production of an additional acceleration through the ordinary physiological mechanism. Acting on this view, Hooker\* has shown that if the heart is kept slowed by artificial stimulation of the peripheral end of the vagi, then various sensory stimuli will provoke a reflex acceleration which can only occur through the accelerator center. We may conclude, therefore, that the accelerator and the inhibitory fibers are working constantly on the heart, and that its rate is the resultant or algebraic sum of their effects, and that sudden changes in this rate, such as follow from sensory or psychical disturbances of any kind, may be referred to a reflex effect upon either the cardio-inhibitory or the accelerator center. While physiology has demonstrated the general properties of the regulating nerves of the heart, the inhibitory, on the one hand, and the accelerator and augmentor on the other, it is necessary for much more work to be done in order to explain satisfactorily how these nerves participate in the various normal and pathological changes of rate and force of beat.

**The Accelerator Center.**—The accelerator fibers arise primarily in the central nervous system. Since stimulation of the upper cervical region of the cord causes acceleration, it seems evident that the path must begin somewhere in the brain. It has been assumed that, like the inhibitory fibers, the path starts in the medulla, and that, therefore, the cells in that organ which give rise to the accelerator fibers constitute the accelerator center through which reflex effects, if any, take place. As a matter of fact, the location of these cells of origin has not been made out satisfactorily. The matter offers unusual difficulty on the experimental side, owing to the existence of the cardio-inhibitory center in the medulla and the absence of any entirely satisfactory method of distinguishing certainly between reflex acceleration through this center and through the accelerator center.

\* Hooker, "American Journal of Physiology," 19, 417, 1907.

## CHAPTER XXXI.

### THE RATE OF THE HEART BEAT AND ITS VARIATIONS UNDER NORMAL CONDITIONS.

The rate of heart beat changes quickly in response to variations in either the internal or external conditions. Therein lies, in fact, the great value of the regulatory (inhibitory and accelerator) nerves. Through their agency, in large part, the pump of the circulation is reflexly adjusted to suit the changing needs of the organism and adapted more or less successfully to alterations in the external environment. The variations in the rate of beat may be considered under three general heads: (I) Fixed adjustments to the different mechanical conditions of the circulation. (II) Variations caused by reflex effects upon the inhibitory or accelerator nerves. (III) Variations caused by changes in the physical or chemical conditions of the blood.

**The Fixed Adjustments of Rate.**—When we speak of the normal pulse rate we mean the rate in an adult when in a condition of mental and bodily repose. Examination shows that under these circumstances there are great individual variations. The average normal rate for man may be estimated at 70 beats per minute; for woman, 78 to 80 beats; but the normal rate for some individuals may be much lower (50) or much higher (90). Among the conditions for which the heart rate shows a certain constant fixed adaptation the following may be mentioned:

*Variations with Sex.*—The average pulse rate in women is, as a rule, higher than that in men, and this difference seems to hold for all periods of life.

*Variations with Size.*—Tall individuals have a slower pulse rate than short persons of the same age. Several observers have thought that they could detect a constant relationship between size and pulse rate. Thus, Volkmann believed that the pulse rate varies inversely as the five-ninth power of the height. In the same direction it is found that small animals, as a rule, have a higher pulse rate than larger ones. Thus, elephant, 25–28; horse and ox, 36–50; sheep, 60–80; dog, 100–120; rabbit, 150; mice, 700. The smaller the animal, speaking generally, the more rapid is the consumption of oxygen in its tissues, and the increased demand for oxygen is met by an acceleration of the flow, due to the quicker beat of the heart. According to Buchanan\* the heart of the canary beats at the extraordinary rate of 1000 per minute.

\* Buchanan, "Science Progress," July, 1910.

*Variations with Age.*—In line with the last condition it is found in man that the pulse rate is highest in infancy, sinks quite rapidly at first and then more slowly up to adult life, and rises again slightly in very old age at the time that the body undergoes a perceptible shrinkage. The most extensive data upon this point are found in the works of the older observers.\* According to Guy, a condensed summary of the average results obtained at different periods of life, both sexes included, may be given as follows:

At birth.....	140
Infancy.....	120
Childhood.....	100
Youth.....	90
Adult age.....	75
Old age.....	70
Extreme age.....	75-80

**The Variations in Pulse Rate Effected through the Inhibitory and Accelerator Nerves.**—Most of the sudden adaptive changes of the heart rate come under this head. In the laboratory we find that stimulation of all sensory nerve trunks may affect the heart rate, in some cases increasing it, in others the reverse. In life we find that the pulse rate is very responsive to our changing sensations and especially to mental conditions that indicate deep interest or emotional excitement. In a previous paragraph (p. 593) the physiological cause of this effect has been discussed briefly. It may arise either from a reflex excitation of the accelerator nerves or a reflex inhibition of the tonic activity of the inhibitory nerves. The facts at present seem to indicate that both mechanisms are used. In addition to these reflexes associated with conscious states the heart is susceptible to reflex influences of a totally unconscious character connected with the states of activity of the visceral organs. For example, after meals the heart-beat increases usually in rate and especially in force of beat, thereby counteracting the effect on blood-pressure of the large vascular dilatation in the intestinal area.

*Variations in Heart Rate with the Condition of Blood-pressure.*—It has long been known that when the blood-pressure in the arteries falls the pulse rate increases and when it rises the pulse rate decreases. Thus, the low blood-pressure that is characteristic of the condition of surgical shock is associated with a very rapid rate of heart beat. There is a certain inverse relationship between pressure and rate which has the characteristics of a compensatory adaptation. The quicker pulse rate following upon the low pressure tends to increase the output of blood and raise the pressure. There was formerly much discussion as to whether this relationship is brought about by reflexes through the extrinsic nerves of the

\* See Volkmann, "Die Hämodynamik," p. 427, 1850; also Guy, article "Pulse" in Todd's "Cyclopædia of Anatomy and Physiology," 1847-49.

heart or whether it is due to some direct, perhaps mechanical, effect upon the heart. The experiments of Newell Martin upon the isolated heart seem to have settled the matter satisfactorily.\* By a method devised by him he kept dogs' hearts beating for many hours when isolated from all connections with the body except the lungs. Under these conditions it was found that even extreme variations in blood-pressure did not affect the heart rate. Consequently, the variation that does take place under normal conditions must be due to a stimulation of the cardiac nerves. A rise of pressure in the arteries may affect directly the cardio-inhibitory center or it may affect afferent fibers in the heart or arteries, and thus reflexly stimulate the cardio-inhibitory center. This point has been the subject of a number of investigations, but Eyster and Hooker† appear to have demonstrated that both methods of stimulation occur. High arterial pressure affects the medullary center directly and thus slows the rate, but it affects also certain sensory fibers in the aorta at or beyond the arch, and through them causes a reflex slowing.

*Variations with Muscular Exercise.*—It is a matter of everyday experience that the heart rate increases with muscular exercise. A simple change in posture, in fact, suffices to affect the heart rate. The rate is higher when standing (80) than when sitting (70) and higher in this latter condition than when lying down (66). Even light muscular work, such as tapping a telegraph key as rapidly as possible, may raise the heart rate from 60 or 70 to over 100 per minute (Bowen‡), while the effect of moderate or heavy work is correspondingly greater, the pulse rate rising to 150, or even 180 per minute. When the muscular work is continued the pulse rate rises rapidly to a certain maximum, which it maintains more or less constantly during the work. After the cessation of the muscular exercise the rate drops very rapidly, reaching the normal in a few seconds if the work has been light, but only after a long interval, an hour or more, in the case of exhausting muscular work, such as long-distance runs. Speaking in general terms, therefore, it may be said that there is an important immediate effect of muscular exercise on the heart rate, and a longer lasting or relatively permanent effect observed chiefly after strenuous long-continued exercise. This latter effect is due, in all probability, to changes in the blood caused by the waste products of the muscular contraction. One might suppose, for example, a

\* Martin, "Studies from the Biological Laboratory, Johns Hopkins University," 2, 213, 1882; also "Collected Physiological Papers," p. 25, 1895.

† Eyster and Hooker, "American Journal of Physiology," 21, 373, 1908.

‡ Bowen, "Contributions to Medical Research," dedicated to V. C. Vaughan, 1903.



change in the reaction of the blood, which could influence the activity of the medullary cardiac centers, although, as a matter of fact, an adequate explanation of this feature has not been furnished by experimental work. The marked immediate effect of the muscular exercise on the heart rate has aroused the most interest, and it has been studied with care by a number of observers. The rapidity with which the heart rate begins to increase with muscular work indicates that it is a nervous effect which operates either upon the inhibitory apparatus, decreasing its activity, or upon the accelerator apparatus, increasing its activity. The experiments made to determine this latter point have not given concordant results, but the better evidence indicates that the effect in the first place at least is upon the cardio-inhibitory center, decreasing its tone, and, therefore, increasing the heart rate. When, for example, the accelerator nerves are excised in dogs,\* moderate exercise causes as prompt and as large an increase in the heart rate as in normal animals. Accepting this view, the further question remains as to whether this effect is an ordinary reflex action. Some authors suppose that it is. They assume that the sensory nerves in the muscles are stimulated, and that through them is brought about a reflex inhibition of the cardio-inhibitory center. Others, however, have suggested that the effect is not a reflex from the periphery, but an example rather of irradiation in the nerve centers.† That is to say, the discharge of voluntary nerve impulses from the brain, in descending to the cord, affects the cardio-inhibitory center in the medulla, presumably, on the neuron hypothesis, by way of collaterals. Between these two points of view it is not possible to decide at present.

*Variations with the Gaseous Conditions of the Blood.*—In conditions of asphyxia the altered gaseous contents of the blood, increase in  $\text{CO}_2$  and decrease in  $\text{O}_2$ , act upon the medullary centers of the cardiac nerves, causing, first, an increase and then a decrease in heart rate.

**The Variations in Pulse Rate Due to Changes in the Composition or Properties of the Blood.**—The condition under this head that has the most marked influence upon the heart rate is the temperature of the blood. Speaking generally, the rate of beat increases regularly with the temperature of the blood or other circulating liquid up to a certain optimum temperature. On the heart of the cold-blooded animal this relationship is easily demonstrated by supplying the heart with an artificial circulation of Ringer's solution, which can be heated or cooled at pleasure. The rate and force of the beat increase to a maximum, which is

\* Gasser and Meek, "American Journal of Physiology," 34, 48, 1914.

† Johansson, "Skandinavisches Archiv f. Physiologie," 5, 20, 1895.

reached at about 30° C. (see Fig. 247). Beyond this optimum temperature the beats decrease in force and also in rate, becoming irregular or fibrillar before the heart finally comes to rest. Newell Martin\* has shown the same relationship in a very conclusive way upon the isolated heart of the dog. Within physiological

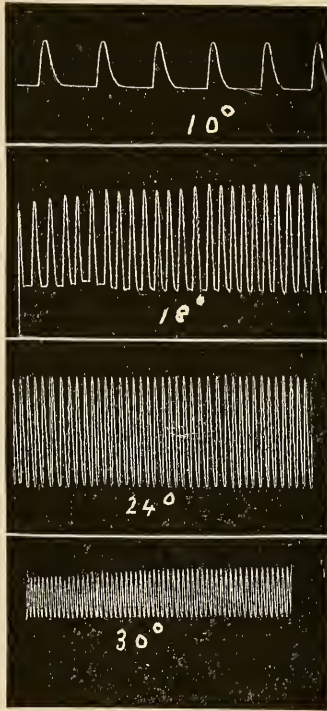

Fig. 247.—To show the effect of temperature on the rate and force of the heart beat. Contractions of the terrapin's ventricle at different temperatures. Kymograph moving at the same speed. At 30° the rate is still increasing, but the extent of contraction has passed its optimum.

limits the rate of beat rises and falls substantially parallel to the variations in temperature as is shown by the chart reproduced in Fig. 248. The accelerated heart rate in fevers is therefore due probably to the direct influence of the high temperature upon the heart itself. The same observer determined experimentally the upper and lower lethal limits of temperature for the mammalian heart. The experiments were made upon cats' hearts kept alive by artificial circulation through the coronary arteries.† It was found that the highest temperature at which the heart will beat is about 44° to 45° C., although a slightly higher temperature may be withstood under special conditions. At the other extreme the mammalian heart ceases to beat when the temperature falls as low as 17° to 18° C.

The rate of the heart beat may be influenced also by many substances added to the blood. The influence of atropin and muscarin has already been alluded to, but changes also in the normal constituents of the blood may have similar effects. An increased output of epinephrin from the adrenal glands, such as may result from emotional excitement (p. 621), will modify the heart beat either directly or through the cardio-inhibitory center of the medulla, and distinct variations in the reaction or the inorganic constituents

\* Martin, "Croonian Lecture, Philosophical Transactions, Royal Society," London, 174, 663, 1883; also "Collected Physiological Papers," p. 40, 1895.

† Martin and Applegarth, "Studies from the Biological Laboratory, Johns Hopkins University," 4, 275, 1890; also "Collected Physiological Papers," p. 97, 1895.

of the blood may also affect the rhythm of the heart. Addition of potassium salts in excess will stop the heart beat entirely, bringing about the condition of potassium inhibition, but such conditions are, for the most part, exceptional or experimental. In the usual

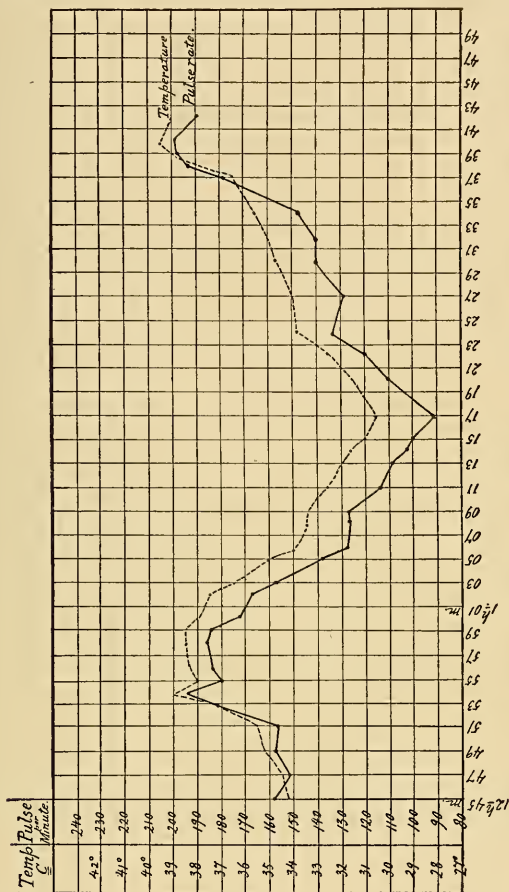

Fig. 248.—Curves showing the effect of temperature on the rate of beat of the mammalian heart.—(Marlin.) Experiment on an isolated dog's heart. The time is given in minutes along the abscissas, from 12 h. 45 m. to 1 h. 51 m. The ordinates to the dotted curve express the temperatures of the blood flowing through the heart. Those to the curve with full line express the corresponding rate of heart beat. It will be seen that the two curves are practically parallel. Temperature and heart rate rise and fall together.

routine of life the heart beat is regulated and adapted to the needs of the body chiefly, as far as we know, through the agency of its extrinsic nerves rather than through modifications of the composition of the blood.

## CHAPTER XXXII.

### THE VASOMOTOR NERVES AND THEIR PHYSIOLOGICAL ACTIVITY.

During the first half of the nineteenth century the physical or mechanical conditions of the circulation were carefully studied and great emphasis was laid upon such properties as the elasticity of the coats of the vessels. The physical adaptability thereby conferred upon the vascular tubes was thought to be sufficient for the purposes of the circulation. We now know that many of the blood-vessels are supplied with motor and inhibitory nerve fibers through whose activity the size of the vascular bed and the distribution of blood to the various organs are regulated. We know, also, that without this nervous control the vascular system fails entirely to meet what seems to be the most important condition of a normal circulation,—namely, the maintenance of a high arterial pressure. Although a number of physiologists had assumed the existence of nerve fibers capable of acting upon the muscular coats of the blood-vessels, the experimental proof of the existence of such nerves, and the beginning of the modern development of the theory of vasomotor regulation were a part of the brilliant contributions to physiology made by Claude Bernard.\* In 1851 Bernard discovered that when the sympathetic nerve is cut in the neck of a rabbit the blood-vessels in the ear on the same side become very much dilated. He and other observers afterward showed that if the peripheral (head) end of the severed nerve is stimulated electrically the ear becomes blanched, owing to a constriction of the blood-vessels. Thus the existence of *vasoconstrictor* nerve fibers to the blood-vessels was demonstrated. A vast amount of experimental work has been done since to ascertain the exact distribution of these fibers to the various organs and the reflex conditions under which they function normally. Few subjects in physiology are of more practical importance to the physician than that of vasomotor regulation; it plays such a large and constant part in the normal activity of the various organs. Bernard was doubly fortunate in being the first to demonstrate the existence of a second class of nerve fibers, which, when stimulated, cause a dilatation of the blood-vessels and which

\* See "Life of Claude Bernard," by Sir Michael Foster, 1899, in the series, "Masters of Medicine."

are therefore designated as vasodilator nerve fibers. This discovery was made in connection with the chorda tympani nerve, a branch of the facial, which sends secretory fibers to the submaxillary gland. When this nerve is cut and the peripheral end is stimulated a secretion of saliva results and at the same time, as Bernard showed, the blood-vessels of the gland dilate; the flow of blood is greatly increased in the efferent vein and may even show a pulse.

In the nervous regulation of the blood-vessels we have to consider, therefore, the existence and physiological activities of two antagonistic sets of nerve fibers: First, the vasoconstrictor fibers, whose action causes a contraction of the muscular coats of the arteries and therefore a diminution in the size of the vessels. Second, the vasodilator nerve fibers, whose action causes an increase in size of the blood-vessels, due probably to a relaxation (inhibition) of the muscular coats of the arteries. Before attempting to describe the present state of our knowledge upon these points it will be helpful to refer to some of the methods by means of which the existence of vasomotor fibers has been demonstrated.

**Methods Used to Determine Vasomotor Action.**—The simplest and most direct proof is obtained from mere inspection, when this is possible. If stimulation of the nerve to an organ causes it to blanch, the presence of vasoconstrictor fibers is demonstrated unless the organ is muscular and the blanching may be regarded as a mechanical result. On the other hand, if stimulation of the nerve to an organ causes it to become congested or flushed with blood the presence of vasodilator fibers may be accepted. It is obvious, however, that this method is applicable in only a few instances and that in no case does it lend itself to quantitative study. 2. Vasomotor effects may be determined by measuring the outflow of blood from the veins. If stimulation of the nerve to an organ causes a decrease in the flow of blood from the veins of that organ, this fact implies the existence of vasoconstrictor fibers, while an opposite result indicates vasodilator fibers. 3. By variations in arterial and venous pressures. When vasoconstrictor fibers are stimulated there is a rise of pressure in the artery supplying the organ and a fall of pressure in the veins emerging from the organ. This result is what we should expect if the constriction takes place in the region of the arterioles. The diminution in size of these vessels by increasing peripheral resistance augments the internal pressure on the arterial side of the resistance, and causes a fall of side pressure on the venous side (see p. 515). If the area involved is large enough the increased resistance will make a perceptible difference in pressure, not only in the organ supplied, but also in the aorta; there will be a rise of general (diastolic) blood-pressure. On the other hand, a vasodilator action in

any organ is accompanied by the reverse changes. Peripheral resistance being diminished there will be a fall of pressure on the arterial side and a rise of pressure on the venous side. When, therefore, the stimulation of any nerve brings about a rise of arterial pressure that can not be referred to a change in the heart beat the inference made is that the result is due to a vasoconstriction. When the method is applied to a definite organ—the brain, for instance—it becomes conclusive only when simultaneous observations are made upon the pressure in the artery and the vein of the organ, and proof is obtained that the pressures at these points vary in opposite directions. 4. By observations upon the volume of the organ. It is obvious that, other conditions remaining unchanged, a vasoconstriction in an organ will be accompanied by a diminution in volume, and a vasodilatation by an increase in volume. This method of studying the blood-supply of an organ is designated as *plethysmography*, and any instrument designed to record the changes in volume of an organ is a *plethysmograph*.\* Plethysmographs have been designed for special organs, and in such cases they have sometimes been given special names. Thus, the plethysmograph used upon the kidney and spleen has been designated as an oncometer, that for the heart, as a cardiometer. The precise form and structure of a plethysmograph varies, of course, with the organ studied, but the principle used is the same in all cases. The organ is inclosed in a box with rigid walls that have an opening at some one point only, and this opening is placed in connection with a recorder of some kind by tubing with rigid walls. The connections between recorder and plethysmograph and the space in the interior of the latter not occupied by the organ may be filled with air or, as is more usually the case, with water. The idea of a plethysmograph may be illustrated by the skull. This structure forms a natural plethysmograph for the brain. If a hole is bored through the skull at any point and a connection is then made with a recorder of some kind, such as a tambour, the volume changes of the brain may be registered successfully.

The plethysmograph generally employed in laboratories, particularly for investigations on man, is some modification of the form devised by Mosso (see Fig. 249). The hand and more or less of the arm is placed in a glass cylinder which is swung freely from a support. The opening around the arm is shut off by a cuff of rubber dam that must be chosen of such a size as to fit the arm snugly without compression of the superficial veins. The forward end of the plethysmograph is connected by tubing with a recorder. Through appropriate openings the cylinder and connecting tubes are filled with warm water and then all openings are closed except the one leading to the recorder. Any increase in volume of the arm will drive water from the plethysmograph to the recorder, and any decrease, on

\* For a description of the development of this method, see François-Franck-Marey's "Travaux du Laboratoire," 1876, p. 1.

the contrary, will suck water from the recorder into the plethysmograph. In the author's laboratory a modification that has been found most convenient is represented in Fig. 250. To avoid escape of water at the upper end of the tube and at the same time to prevent compression of the veins of the arm a very thin rubber glove with long gauntlet is used. The gauntlet is strengthened by cuffs of dam tubing, as shown in the illustration, and all are reflected over the end of the plethysmograph. The outer cuff (3) may be omitted. The hand is inserted into the cylinder and is held in place by flexing the fingers through the rings. The plethysmograph being suspended freely from the ceiling, any movement of the arm will move the instrument as a whole without disturbing the position of the arm in the instrument. By means of rings of hard rubber (*D, E*), one fitting around the rim of the plethysmograph and the other adapted more or less closely to the size of the forearm, the reflected portion of the gauntlet and cuff is held in place and prevented from giving way readily to any rise of pressure in the plethysmograph. The

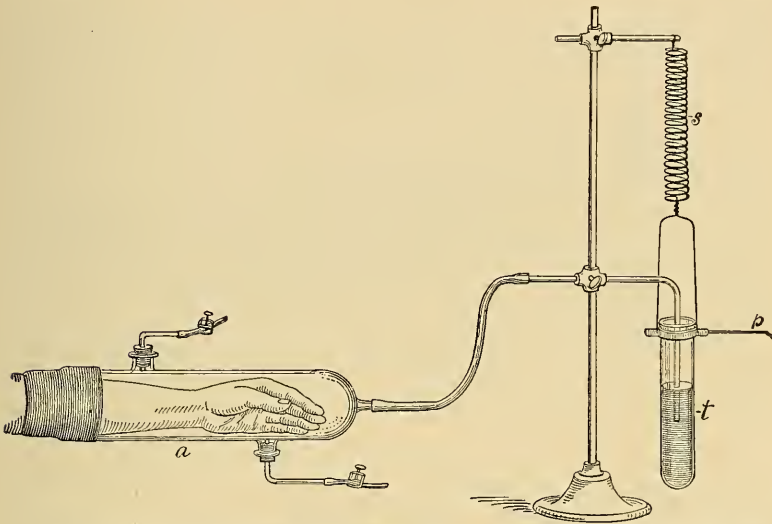

Fig. 249.—A schematic diagram of Mosso's plethysmograph for the arms: *a*, the glass cylinder for the arm, with rubber sleeve and two tubulatures for filling with warm water; *s*, the spiral spring swinging the test tube, *t*. The spring is so calibrated that the level of the liquid in the test tube above the arm remains unchanged as the tube is filled and emptied. The movements of the tube are recorded on a drum by the writing point, *p*.

interior of the latter is connected, as shown in Fig. 249, to a test tube swung by a spiral spring (Bowditch's recorder). The spring is so adjusted by trial that it sinks and rises exactly in proportion to the inflow or outflow of water. By this means the level of the water in the tube is kept constant, and since the position of this level determines the pressure upon the outside of the arm in the plethysmograph this pressure is also kept constant independently of the changes in volume of the arm. The level should be set in the beginning so as to make a slight positive pressure on the arm sufficient to flatten the thin glove to the skin and thus drive out the air between the two. When the apparatus is conveniently arranged, with slings to support the elbow, observations may be made upon the changes in volume of the arm during long periods. The results so obtained are referred to under several headings. With the form of recorder described the plethysmograph gives usually only the slow changes in volume of the arm, due to a greater or less amount of blood. By using a more sensitive recorder and making the con-

nections entirely rigid the smaller, quicker changes in volume caused by the heart beat are also recorded. A volume pulse is obtained resembling in its general form the pressure pulse given by the sphygmograph. When used for this purpose the instrument is described as a *hydrosphygmograph*.

Records taken of the volume of the hand, foot, brain, or any other organ show that in addition to the changes caused by the heart beat and by the respiratory movements, there are other more irregular variations that are continually occurring, the cause of which is to be found in the variations in the amount of blood in the organ. Day and night these changes in volume take place, and they are referable to the activity of the vasomotor system. Vasoconstriction or vasodilatation in the organ itself cause what may be called

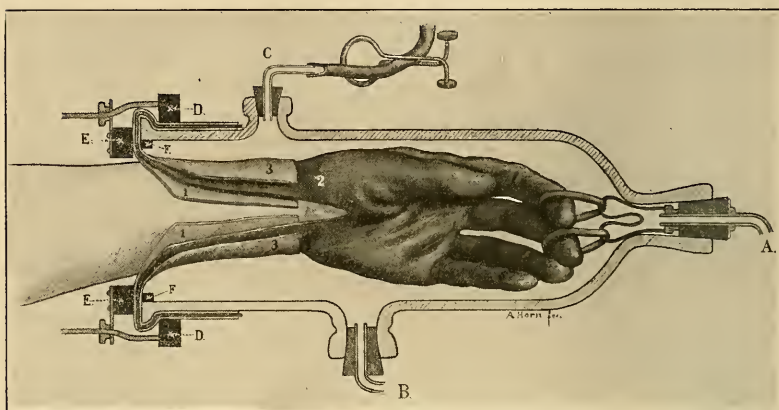

Fig. 250.—Detailed drawing of the glass piezometer with the arrangement of rubber glove to prevent leaking without compressing the veins. 2, The glove with its gauntlet reflected over the end of the glass cylinder; 1 and 3, supporting pieces of stout rubber tubing; D and E, sections of outer and inner rings of hard rubber to fasten the reflected rubber tubing and reduce the opening for the arm.

an active change in volume. But vasoconstriction or vasodilatation in other organs may cause a perceptible change, of a passive kind, in the volume of the organ under observation. For, since the amount of blood remains the same, a change in any one organ must affect more or less the volume—that is, the blood contents—of all other organs.

**General Distribution and Course of the Vasoconstrictor Nerve Fibers.**—These fibers belong to the sympathetic autonomic system, and consist, therefore, of a preganglionic fiber arising in the central nervous system and a postganglionic fiber arising from the cell of some sympathetic ganglion. The general arrangement of the autonomic system (p. 252) should be reviewed in this connection. It has been shown by experiments of the kind described under the last heading that vasoconstrictor fibers are present in



numerous nerve trunks, but especially in those distributed to the skin and to the abdominal and pelvic organs. If, for instance, the sciatic or the splanchnic nerve be cut, to avoid reflex effects, and the peripheral end be stimulated, there will be a strong constriction of the vessels, which may be detected by ocular inspection, blanching; by the increase in arterial pressure; or by the diminution in volume of the organs. The vasoconstrictor fibers supplying these two great regions arise immediately (postganglionic fibers) from one or other of the ganglia constituting the sympathetic chain, or from the large prevertebral ganglia (celiac ganglion, for instance) directly connected with it. Ultimately, of course, they arise in the central nervous system (preganglionic fiber), and it has been shown that, for the regions under consideration, they all, with a few comparatively unimportant exceptions, leave the spinal cord in the great outflow that takes place in the thoracic region from the second

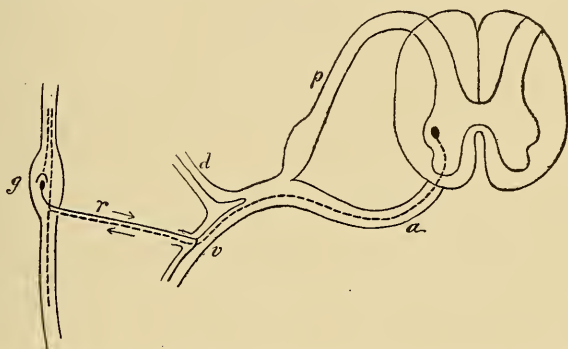

Fig. 251.—Schema to show the path of the preganglionic and postganglionic portions of a vasoconstrictor nerve fiber: *a*, Anterior root, showing the course of the preganglionic fiber as a dotted line; *d*, *v*, dorsal and ventral branches of the spinal nerve; *r*, the ramus communicans; *g*, the sympathetic ganglion. The postganglionic fibers in each ramus come from the sympathetic ganglion with which it is connected. The preganglionic fibers entering at any ganglion may pass up or down to end in the cells of some other ganglion.

thoracic to the second lumbar nerves (p. 254). In this outflow they are mixed with other autonomic fibers, such as the sweat fibers, pilomotor fibers, accelerator fibers to heart, pupilodilator fibers, visceromotor fibers, etc. Emerging in the anterior roots, they pass to the sympathetic chain by way of the corresponding ramus communicans. Having reached the chain, they end in one or other of the ganglia, not necessarily in the ganglion with which the ramus connects anatomically. The preganglionic fibers for the blood-vessels of the submaxillary gland, for instance, enter the first thoracic ganglion of the sympathetic chain, but do not actually terminate until they reach the superior cervical ganglion high in the neck. The postganglionic fibers arise in the ganglion in which the preganglionic fibers terminate. Those destined to supply the skin

of the trunk and extremities pass from the ganglion to the corresponding spinal nerve by way of the ramus communicans (gray ramus) and after reaching the spinal nerve they are distributed with it to its corresponding region (Fig. 251). In the general region

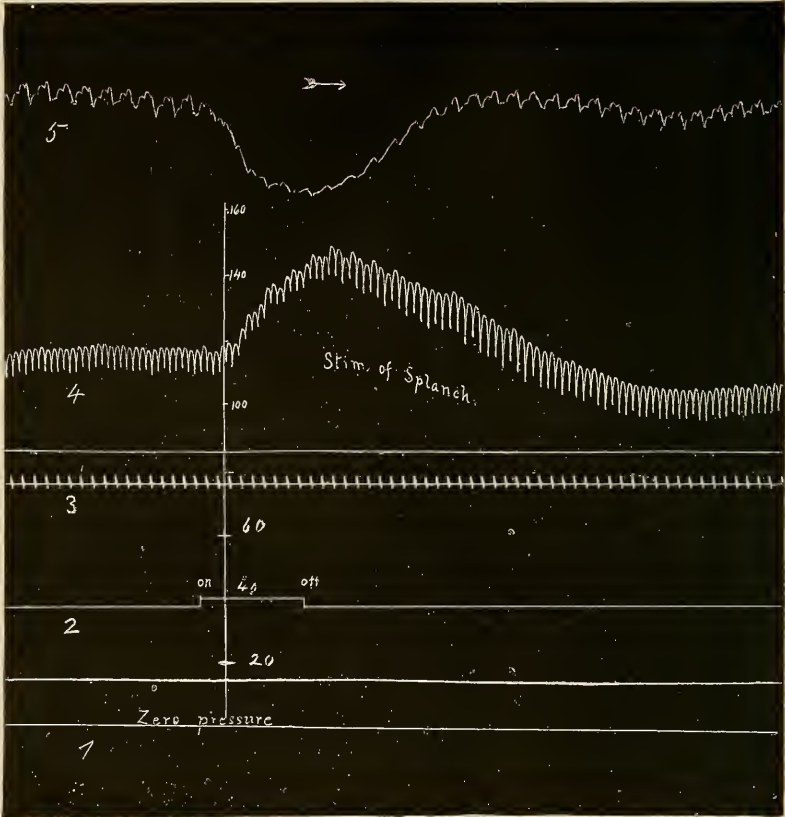

Fig. 252.—Vasomotor effect of stimulation of the splanchnic nerve—peripheral end—in the dog (*Dawson*): 1. The line of zero pressure; 2, the line of the stimulating pen; *on* and *off* mark the beginning and end of the stimulation; 3, the time record in seconds; 4, the blood-pressure record (stimulation causes a marked rise of blood-pressure due to stimulation of vasoconstrictor fibers); 5, plethysmographic tracing of the volume of the kidney (oncometer); stimulation of the splanchnic causes a diminution in volume of the kidney owing to the constriction of its arterioles.

under consideration (lower cervical to upper lumbar) each ramus communicans between a spinal nerve and a sympathetic ganglion consists, therefore, of two parts, one (white ramus) of preganglionic fibers passing from the spinal nerve to the ganglion, the other (gray ramus) of postganglionic fibers coming from the ganglion to the spinal nerve for distribution to the peripheral tissues. It should be borne in mind that the fibers in the white ramus do not return to the spinal nerve by the gray portion of the same ramus,

but passing upward or downward in the sympathetic chain return to some other spinal nerve as postganglionic fibers. In this way, therefore, it happens that the various intercostal nerves and the nerves of the brachial and sciatic plexus contain vasoconstrictor fibers as postganglionic or sympathetic fibers. On the other hand, the vasoconstrictor fibers destined for the great vascular region of the intestines and other abdominal viscera, after reaching the sympathetic chain by way of the white rami as preganglionic fibers, do not return to the spinal nerves by the gray rami. They leave the sympathetic chain, still as preganglionic fibers, in the branches of the splanchnic nerves and through them pass to the celiac ganglion, where they mainly end, and their path is continued by the postganglionic or sympathetic fibers arising from this ganglion. More specific information concerning the origin of the vasomotor fibers to the different organs is given in condensed form farther on. It is quite important in the beginning, however, to obtain a clear general conception of the paths taken by the constrictor fibers from their origin in the spinal cord to their termination, on the one hand, in the vessels of the skin, or, on the other, in the vessels of the abdominal and pelvic viscera.

**The Tonic Activity of the Vasoconstrictor Fibers.**—A very important fact regarding the vasoconstrictor nerve fibers is that they are constantly in action to a greater or less extent. This fact is demonstrated by the simple experiment of cutting them. If the sympathetic nerve in the neck is cut in the rabbit the blood-vessels of the ear become dilated. If the splanchnic nerves on the two sides are cut the intestinal region becomes congested, and the effect in this case is so great that the general arterial pressure falls to a very low point. From these and numerous similar experiments we may conclude that normally the arteries—that is, the arterioles—are kept in a condition of tone by impulses received through the vasoconstrictor fibers. Cut these nerves and the arteries lose their tone and dilate, with the result that, the peripheral resistance being diminished, the lateral pressure falls on the arterial side and rises on the venous side. The relatively enormous effect upon aortic pressure caused by paralysis of the tone of the arteries in the splanchnic area shows that under normal conditions the peripheral resistance in this great area plays a predominant part in the maintenance of normal arterial pressure, and by the same reasoning variations in tone in the arteries of this region must play a very large part in the regulation of arterial pressure.

**The Vasoconstrictor Center.**—As stated in the last two paragraphs, the vasoconstrictor fibers emerge from the cord over a definite region, and they exhibit constant tonic activity. It has been shown, moreover, that if the cord be cut anywhere in the

cervical region all of the constrictor fibers lose their tone; a great vascular dilatation results in both the splanchnic and skin areas. We may infer from this fact that the vasoconstrictor paths originate from nerve cells in the brain and that their tonic activity is to be traced to these cells. Such a group of cells exists in the medulla

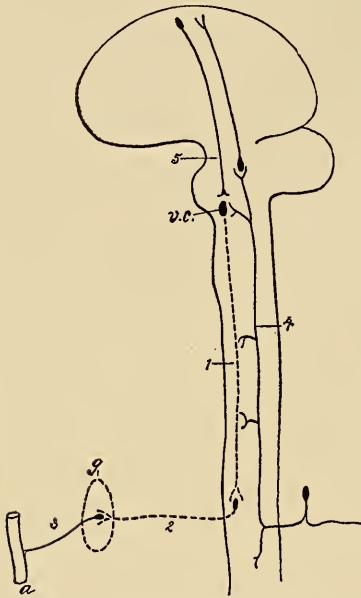

Fig. 253.—Schema to show the path of the vasoconstrictor fibers from the vasoconstrictor center to the blood-vessels and the mechanism for the reflex stimulation of these fibers: *v. c.*, The vasoconstrictor center; 1, the central neuron of the vasoconstrictor path; 2, the spinal neuron (preganglionic fiber); 3, the sympathetic neuron (postganglionic fiber); *a*, the arteriole; 4, the sensory fibers of the posterior root making connections by collaterals with the vasoconstrictor center; 5, an intercentral fiber (efferent) acting upon the vasoconstrictor center.

oblongata, and forms the *vasoconstrictor center*. The axons given off from these cells descend in the cervical cord and terminate at various levels in the anterior horn of gray matter in the region from the upper thoracic to the upper lumbar spinal nerves. A spinal neuron continues the path as the pre-ganglionic vasoconstrictor fiber which terminates, as already described, in some sympathetic ganglion, whence the path is further continued by the post-ganglionic fiber. This arrangement of the constrictor paths is indicated schematically in Fig. 253. The exact location of the group of cells that plays the important rôle of a vasoconstrictor center has not been determined histologically. The region has, however, been delimited roughly by physiological experiments. If the brain is cut through at the level of the midbrain there is no marked loss of vascular tone in the body at large. If, however, similar sections are made farther and farther back a point is

reached at which vascular paralysis begins to be apparent and a point farther down at which this paralysis is as complete as it would be if the cervical cord were cut. Between these two points the vasoconstrictor center must lie. The careful experiments of this kind made by Dittmar\* are now somewhat old. According to his description, the center is bilateral,—that is, consists of a group of cells on each side,—and lies about the middle of the fourth ventricle in the tegmental region, in the neighborhood of the nucleus of the facial and of the superior olivary. In the rabbit it has a

\* "Berichte d. Sächs. Akademie, Math.-phys. Klasse," 1873, p. 449.

length of 3 mms., a breadth of 1 to 1.5 mms., and lies about 2 to 2.5 mms. lateral to the mid-line. Assuming the existence of this group of cells, we must attribute to them functions of the first importance. Like other motor cells, they are capable of being stimulated reflexly and by this means the regulation of the blood-flow is largely controlled. Moreover, they are in constant activity, —due doubtless also to a constant reflex stimulus from the inflow of afferent impulses. The complete loss of this tonic influence would result in a complete vascular paralysis, the small arteries would be dilated, peripheral resistance would be greatly diminished, and the arterial pressure in the aorta would fall from a level of 100–150 mms. Hg to about 20 or 30 mms. Hg,—a pressure insufficient to maintain the life of the organism. We must conceive, also, that in this vasoconstrictor center the different cells are connected by definite paths with the vasoconstrictor fibers to the different regions of the body; that some of the cells, for instance, control the activity of the fibers distributed to the intestinal area, and others govern the vessels of the skin. Under physiological conditions the different parts of the center may, of course, be acted upon separately. In this description of the vasoconstrictor center and the efferent vasoconstrictor fibers reference has been made only to their action on the small arteries. This is, generally speaking, the apparatus, which on the basis of experimental work, we are justified in using to explain the various vasomotor phenomena of the body. There are, however, many observations on record which indicate the possibility that the veins also may be supplied with motor nerve fibers, and that reflex control of the distribution of the blood and the regulation of the return flow to the heart may be exerted in part through changes in the caliber of the venous vessels. Unfortunately, our knowledge upon this point is too incomplete at present to be used with confidence in the explanation of specific phenomena. It is, nevertheless, a possibility that must be held in mind. Some of the more significant facts bearing upon this point are referred to below.

**Vasoconstrictor Reflexes—Pressor and Depressor Nerve Fibers.**—It is obvious that such a mechanism as that described above is susceptible of reflex stimulation through sensory nerves, and according to our general knowledge we should suppose that a tonic center of this kind may have its tonicity increased (excitation) or decreased (inhibition). Numerous experiments in physiology warrant the view that both kinds of effects take place normally. Those afferent nerve fibers which when stimulated cause reflexly an excitation of the vasoconstrictor center, and therefore a peripheral vasoconstriction and rise of arterial pressure, are frequently designated as *pressor fibers*, or their effect upon the circulation is designated as a *pressor effect*. Those afferent fibers,

on the contrary, which when stimulated cause a diminution in the tone of the vasoconstrictor center and therefore a peripheral vasodilatation and fall of arterial pressure, are designated as *depressor nerve fibers*, or their effect upon the circulation is a depressor effect. Pressor effects may be obtained by stimulation of almost any of the large nerves containing afferent fibers, but especially perhaps of the cutaneous nerves. There is abundance of evidence to show that similar results can be obtained in man. The pressor effect manifests itself by a rise in general arterial pressure, if a sufficiently large region is involved, and by a diminution in size of the organ involved. On the other hand, depressor effects may also be obtained from stimulation of many of the large nerve trunks. If one stimulates the central end of the sciatic nerve, for example, one obtains a pressor effect on the circulation in most cases, but under certain conditions a marked depressor effect follows the stimulation.\* The simplest explanation of such a result is that the nerve trunks contain afferent fibers of both kinds. When we apply our electrodes to a nerve we stimulate every fiber in it and the actual result will depend upon which group of fibers exerts the stronger action, and this may vary with the condition

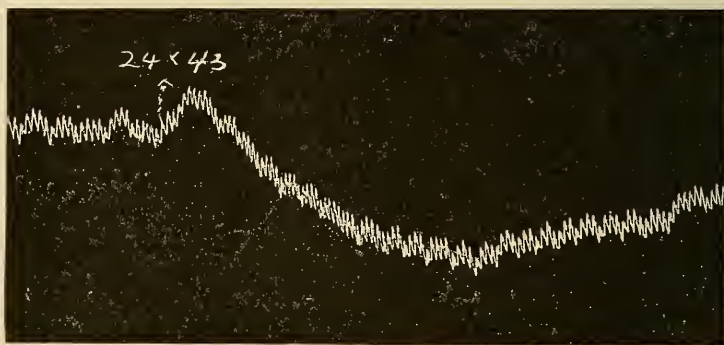

Fig. 254.—Plethysmographic curve of forearm. The volume of the arm was recorded by means of a counter-weighted tambour and the record shows the pulse waves. A problem in mental arithmetic—the product of 24 by 43—caused a marked constriction of the arm.

of the nerve, the condition of the center, the anesthetic used, etc. Under normal conditions no such gross stimulation occurs. The pressor fibers are stimulated under some circumstances, the depressor fibers under others. For instance, when the skin is exposed to cold it is blanched not by a direct, but by a reflex, effect. The low temperature stimulates the sensory (cold) fibers in the skin, and the nerve impulses thus aroused reflexly stimulate the vasoconstrictor center, or a part of it, and cause blanching of the skin. Exposure to high temperatures, on the contrary, flushes the skin,

\* See Hunt, "Journal of Physiology," 18, 381, 1895.

and in this case we may suppose that the sensory impulses carried by the heat nerves inhibit the tone of the vasoconstrictor center and cause dilatation or flushing of the skin. So far as man is concerned, experiments made with the plethysmograph show very clearly that the vasoconstrictor center is easily affected in a pressor or depressor manner by psychical states or activities. Mental work, especially mental interest, however aroused, is followed by a constriction of the blood-vessels of the skin,—a pressor effect (see Fig. 254); and we may find an explanation of the value of the reflex in the supposition that the rise of arterial pressure thus produced

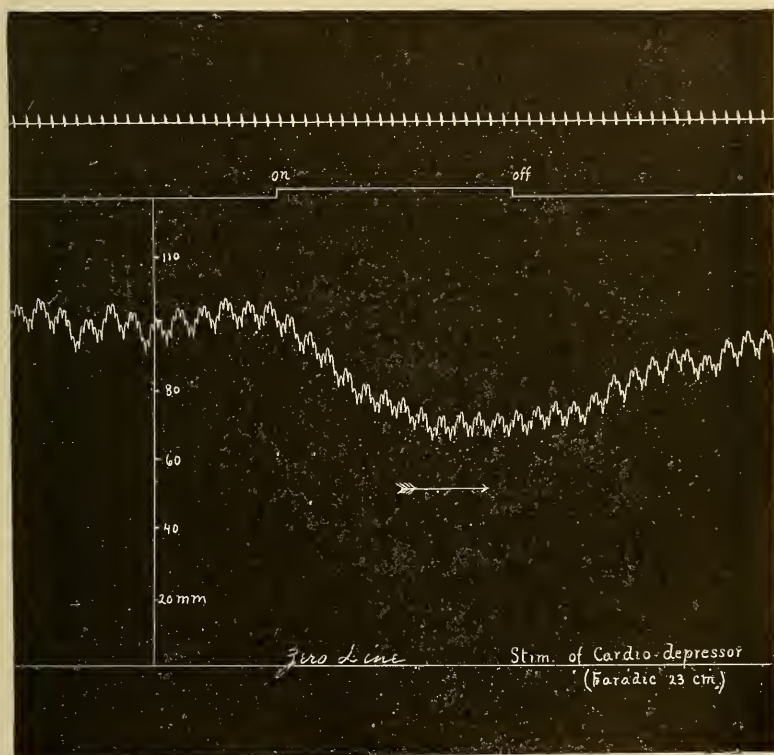

Fig. 255.—Effect of stimulating the central end of the depressor nerve of the heart in a rabbit. The time record marks seconds. *On* and *off* mark the beginning and end of the stimulation. The blood-pressure rises slowly after the removal of the stimulus and eventually reaches the normal level. This complete recovery is not shown in the portion of the record reproduced. (Dawson.)

forces more blood through the brain (p. 634). On the other hand, feelings of embarrassment or shame may be associated with a depressor effect, a dilatation in the vessels of the skin manifested, for example, in the act of blushing. In both cases we must assume intracentral nerve paths between the cortex and the center in the

medulla, the impulses along one path exciting the center, while those along the other inhibit its tone, or, as explained below, excite a vasodilator center. Among the many depressor effects that have been observed on stimulation of afferent nerve fibers one has aroused especial interest—namely, that caused by certain afferent fibers from the heart or from the aorta. These fibers in some animals—the dog, for instance—run in the vagus nerve, but in other animals, the rabbit, they form a separate nerve, the so-called *depressor nerve* of the heart—discovered by Ludwig and Cyon (1866). So far as the effect in question is concerned the physiological evidence indicates that the fibers arise from the descending aorta and it might be more appropriate to speak of them as the depressor nerve of the aorta.\* In the rabbit this nerve forms a branch of the vagus, arising high in the neck by two roots, one from the trunk of the vagus and one from the superior laryngeal branch. It runs toward the heart in the sheath with the vagus and the cervical sympathetic. The nerve is entirely afferent. If it is cut and the peripheral end is stimulated no result follows. If, however, the central end is stimulated a fall of blood-pressure occurs and also perhaps a slowing of the heart beat (see Fig. 255). The latter effect is due to a reflex stimulation of the cardio-inhibitory center and may be eliminated by previous section of the vagi. The fall of blood-pressure is explained by supposing that the nerve, when stimulated, inhibits, to a greater or less extent, the tonic activity of the vasoconstrictor center.† Physiological experiments indicate that the nerve plays an important regulatory rôle.‡ When, for instance, blood-pressure rises above normal limits, it may be supposed that the endings of this nerve in the aorta or heart are stimulated by the mechanical effect, and the blood-pressure is thereby lowered by an inhibition of the tone of the constrictor center. Moreover, it has been shown by Einthoven that every heart beat sends up this nerve a series of nerve impulses, that is, when the nerve is cut and the ends are connected with a string-galvanometer, electrical variations occur synchronous with the heart beat (Fig. 280). To explain this result we can only assume that each heart beat stimulates sensory endings in the heart itself or in the aorta, and that the nerve impulses thus transmitted to the medulla probably play a rôle in maintaining the tonic activity of some of its centers, perhaps, as Einthoven suggests, the tonic activity especially of the cardio-inhibitory center.

\* See Eyster and Hooker, "American Journal of Physiology," 21, 373, 1908; also Köster and Tschermak, "Archiv f. die gesammte Physiologie," 93, 24, 1902.

† See Porter and Beyer, "American Journal of Physiology," 4, 283, 1900; also Bayliss, "Journal of Physiology," 14, 303, 1893.

‡ Sewall and Steiner, "Journal of Physiology," 6, 162, 1885.



A most suggestive example of the regulating action of the depressor nerve is given by Sewall. When the carotids in a rabbit are clamped a variable and not very large rise of arterial pressure is observed. If, however, the depressor nerves are first cut, clamping the carotids causes an extraordinary rise of arterial pressure. When the carotids are closed we may suppose that the resulting anemia of the medulla stimulates the vasoconstrictor center and thus tends to raise arterial pressure, but this effect is neutralized because as the pressure rises the depressor fibers of the heart are stimulated. It seems evident that during life the depressor fibers must exert a very important regulating effect upon the circulation.

A similar nerve has been described anatomically in man, while in animals like the dog, in which it is not present as a separate anatomical structure, it probably exists within the trunk of the vagus. If this latter nerve is cut in the dog and the central end is stimulated a depressor effect is usually obtained.

*Vasoconstrictor Centers in the Spinal Cord.*—From the description of the vasoconstrictor mechanism given above the probable inference may be made that throughout the thoracic region the cells of origin of the preganglionic fibers may, under special conditions, act as subordinate vasoconstrictor centers capable of giving reflexes and of exhibiting some tonic activity. Numerous experiments tend to support this inference. When the spinal cord is cut in the lower thoracic region there is a paralysis of vascular tone in the posterior extremities. If, however, the animal is kept alive the vessels gradually recover their tone, although not connected with the medullary center. The resumption of tone in this case may be attributed to the nerve cells in the lower thoracic and upper lumbar region, since vascular paralysis is again produced when this portion of the cord is destroyed. Finally, Goltz has shown that when the entire cord is destroyed, except the cervical region (p. 154), vascular tone may be restored eventually in the blood-vessels affected. In this case the resumption of tonicity must be referred either to the properties of the muscular coats of the arteries themselves, or to the activity of the sympathetic nerve cells that give rise to the postganglionic fibers. However this may be, it seems quite clear that under normal conditions the great vasoconstrictor center in the medulla is the important seat of tonic and of reflex activity. If the connections of this center with the blood-vessels are destroyed suddenly—for example, by cutting the cervical cord—blood-pressure falls at once to such a low level, 20 to 30 mms. Hg., that death usually results unless artificial means are employed to sustain the animal.

### Rhythmical Activity of the Vasoconstrictor Center.—

Throughout life the vasoconstrictor center is in tone the intensity of which varies with the intensity and character of the reflex impulses playing upon it. Under certain unusual conditions the center may exhibit rhythmical variations in tonicity which make themselves visible as rhythmical rises and falls in the general arterial pressure (Fig. 256), the waves being much longer than those due to the respiratory movements. These waves of blood-pressure are observed often in experiments upon animals, but their ultimate cause is not understood. They are usually designated as Traube-Hering waves, although this term, strictly speaking, belongs to waves, synchronous with the respiratory movements, that were observed by Traube upon animals in which the diaphragm was paralyzed and the thorax was opened. These latter waves are also due to a rhythmical action of the

vasomotor center. During sleep, certain much longer, wave-like variations in the blood-pressure also occur that are again due doubtless to a rhythmical change of tone in the vasoconstrictor center.

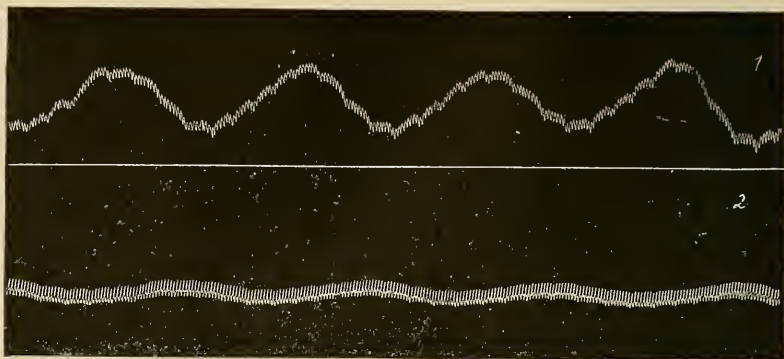

Fig. 256.—Rhythmical vasomotor waves of blood-pressure in a dog (Traube-Hering waves). The upper tracing (1) is the blood-pressure record as taken with the mercury manometer; the lower tracing (2) is taken with a Hürthle manometer. Seven distinct respiratory waves of blood-pressure may be recognized on each large wave. (Dawson.)

### General Course and Distribution of the Vasodilator Fibers.

—By definition a vasodilator fiber is an efferent fiber which when stimulated causes a dilatation of the arteries in the region supplied. In searching for the existence of such fibers in the various nerve trunks physiologists have used all the methods referred to above,—namely, the flushing of the organ as seen by the eye, the increased blood-flow, the increase in volume, or the fall in blood-pressure on the arterial side associated with a rise on the venous side. By these methods vasodilator fibers have been demonstrated in the following regions:

1. In the facial nerve. The dilator fibers are found in the chorda tympani branch and are distributed to the salivary glands (submaxillary and sublingual) and to the anterior two-thirds of the tongue.
2. In the glossopharyngeal nerve. Supplies dilator fibers to the posterior third of tongue, tonsils, pharynx, parotid gland (tympanic nerve).
3. In the sympathetic chain. In the cervical portion of the sympathetic dilator fibers are carried which are distributed to the mucous membrane of the mouth (lips, gums, and palate), nostrils, and the skin of the cheeks. These fibers pass up the neck to the superior cervical ganglion and thence by communicating branches reach the Gasserian ganglion and are distributed to the bucco-facial region in the branches of the fifth cranial nerve.\* From the thoracic portion of the sympathetic vasodilator fibers pass to the abdominal viscera by way of the splanchnic nerves and to the limbs by way of the branches of the brachial and lumbar plexuses, but the data regarding the dilator fibers for these regions are not as yet entirely satisfactory. Goltz and others have shown that dilator fibers are found in the nerves of the limbs, but the origin of these fibers from the sympathetic chain has not been demonstrated.

\* See "Recherches expérimentales sur le système nerveux vasomoteur," Dastre and Morat, 1884.

4. In the *nervi erigentes*. Eckhard first gave conclusive proof that the erection of the penis is essentially a vasodilator phenomenon. The fibers arise from the first, second, and third sacral spinal nerves, pass to the hypogastric plexus as the *nervi erigentes*, and thence are distributed to the erectile tissues of the penis.

#### The General Properties of the Vasodilator Nerve Fibers.—

Unlike the vasoconstrictors, the vasodilators are not in tonic activity; at least, no experimental proof has been given that they are. In the case of the erectile tissue of the penis and the dilators of the glands it would seem that the fibers are in activity only during the functional use of the organ, at which time they are excited reflexly. There has been much discussion in physiology as to the nature of the action of the dilator fibers. The muscular coat of the small arteries runs transversely to the length of the vessel, and it is easy to see that when stimulated to greater contraction through the constrictor fibers it must cause a narrowing of the artery. It is not so evident how the nerve impulses carried by the dilator fibers bring about a widening of the artery. At one time peripheral sympathetic ganglia in the neighborhood of the arteries were used to aid in the explanation, but, since histological evidence of the existence of such ganglia is incomplete, the view that seems to meet with most favor at present is as follows: The dilator fibers end presumably in the muscle of the walls of the arteries, and when stimulated they inhibit the tonic contraction of this musculature and thus bring about a relaxation. These fibers in fact inhibit the tonic contraction of the vascular muscle just as the vagus fibers inhibit the tone of the cardiac muscle. Dilatation caused by a vasodilator nerve fiber always presupposes, therefore, a previous condition of tonic contraction in the walls of the artery, this tonic condition being produced either by the action of vasoconstrictor fibers or by the intrinsic properties of the muscle itself. In the nerves of the limbs, as stated above, both vasoconstrictor and vasodilator effects may be detected by stimulation. It has been shown that the separate fibers may be differentiated by certain differences in properties. Thus, if the peripheral end of the cut sciatic nerve is stimulated by rapidly repeated induction shocks a vasoconstrictor effect is obtained, as shown plethysmographically by a diminution in volume of the limb. If, however, the same nerve is stimulated by slowly repeated induction shocks the dilator effect will predominate,\* indicating a greater degree of irritability on the part of these latter fibers. After section of the sciatic nerve the vasodilators degenerate more slowly than the vasoconstrictors, and they retain their irritability when heated or cooled for a longer time than the constrictors.†

\* Bowditch and Warren, "Journal of Physiology," 7, 439, 1886.

† Howell, Budgett, and Leonard. "Journal of Physiology," 16, 298, 1894.

**Vasodilator Center and Vasodilator Reflexes.**—Since the vasodilator fibers form a system similar to that of the vasoconstrictors, it might be supposed that, like the latter, their activity is controlled from a general center, forming a vasodilator center in the brain similar to the vasoconstrictor center. What evidence we have, however, is against this view. In the dog with his spinal cord severed in the lower thoracic region the penis may show normal erection when the glans is stimulated,—a fact that indicates a reflex center for these dilator fibers in the lumbar cord. For the other clear cases of vasodilator fibers we have no reason at present to believe that they are all normally connected with a single group of nerve cells located in a definite part of the nervous system. The dilator fibers in the facial, glossopharyngeal, and cervical sympathetic (distributed through the trigeminal) all arise probably in the medulla, but not, so far as is known, from a common nucleus. Intimately connected with the question of the existence of a general vasodilator center is the possibility of definite reflex stimulation of the vasodilator fibers. As stated above, reflex dilatation of the blood-vessels may be produced by stimulating various nerve trunks containing afferent fibers. The depressor nerve fibers of the heart give only this effect, and the sensory fibers from certain other regions, notably the middle ear and the testis, cause mainly, if not exclusively, a fall of arterial pressure due presumably to vascular dilatation. The sensory nerves of the trunk and limbs, when stimulated by the gross methods of the laboratory, give either reflex vasoconstriction or reflex vasodilatation, and, as was stated above, there is reason to believe that these trunks contain two kinds of afferent fibers,—the pressor and the depressor. The action of the former predominates usually, but in deep anesthesia, and particularly in those conditions of exposure and exhaustion that precede the appearance of “shock,” the depressor effect is more marked or, indeed, may be the only one obtained. To explain such depressor effects we have two possible theories. They may be due to reflex excitation of the centers giving origin to the vasodilator fibers or to reflex inhibition of the tonic activity of the vasoconstrictor centers. The latter explanation is the one usually given, especially for the typical and perhaps special effect of the depressor nerve of the heart. This explanation seems justified by the general consideration that in the two great vascular areas through whose variations in capacity the blood-flow is chiefly regulated,—namely, the abdominal viscera and the skin,—the vasoconstrictor fibers are chiefly in evidence and are, moreover, in constant tonic activity. On the other hand, the fact that vasodilator fibers exist is presumptive evidence that they are stimulated reflexly, since it is by this means only that they can normally affect the blood-vessels. Some of the many depressor

effects occurring in the body must be due, therefore, to reflex stimulation of the dilators and others to reflex inhibition of the constrictors. It would be convenient to retain the name depressor for the sensory fibers causing the latter effect, and to designate those of the former class by a different name, such as reflex vasodilator fibers.\* Only experimental work can determine positively to which effect any given reflex dilatation is due, but provisionally at least it would seem justifiable to assume that dilatation by reflex stimulation of the vasodilator fibers occurs in those parts of the body in which vasodilator fibers are known to exist. Thus, the erection of the penis from stimulation of the glans may be explained in this way, also the congestion of the salivary glands during activity, the blushing of the face from emotions, and possibly the dilatation in the skeletal muscles during contraction. Gaskell and others have given reasons for believing that the vessels in the muscles are supplied with vasodilator nerve fibers, and Kleen † has shown that mechanical stimulation of the muscles—kneading, massage, etc.—causes a fall of arterial pressure.

*Vasodilatation Due to Afferent Fibers.*—The existence of definite efferent vasodilator fibers in the nerve trunks to the limbs has been made doubtful by the work of Bayliss. This author has discovered certain facts which at present tend to make the question of vasodilatation more obscure, but which, when fully understood, will doubtless give us a much deeper insight into the subject. Briefly stated, he has shown ‡ that stimulation of the posterior roots of the nerves supplying the lumbo-sacral and the brachial plexus causes vascular dilatation in the corresponding limbs. He has given reasons for believing that the fibers involved are afferent fibers from the limbs and that, therefore, when stimulated they must conduct the impulses in a direction opposite to the normal—antidromic. It is most difficult to understand how such impulses, conveyed to the terminations of the sensory fibers, can affect the muscular tissue of the blood-vessels. It is most difficult to understand also how such anatomically afferent fibers can be stimulated reflexly in the central nervous system. Some light has been thrown upon this subject by recent work § upon the vascular dilatation of the conjunctival membrane when irritated locally by substances, such as oil of mustard, that cause inflammation. It has been found that the vascular dilatation in these cases is not due to a direct effect of the irritant on the vessels, and that it is not a reflex effect through the spinal cord or the posterior root ganglia. On the other hand, the effect is not obtained if the terminations of the sensory fibers of the region are anesthetized, or if the sensory nerves to the region are cut and time is allowed for them to degenerate. The hypothesis used to explain the reaction is that the sensory fibers to the region branch at their termination, one branch going to the sensory ending, the other to the blood-vessels. When, therefore, the sensory ending is stimulated there is a local reflex, of the nature of an axon-reflex, through the other limb of the bifurcation, which effects a dilatation of the blood-vessel. If this explanation holds upon further examination, it will establish the existence of a peripheral mechanism for the production of local vasodilatation which has not been taken into account heretofore (see p. 152).

\* See Hunt, "Journal of Physiology," 18, 381, 1895.

† Kleen, "Skandinavisches Archiv f. Physiologie," 247, 1887.

‡ Bayliss, "Journal of Physiology," 26, 173, 1900, and 28, 276, 1902.

§ Ninian Bruce, "Quarterly Journal of Exp. Physiology," 6, 339, 1913; also Bardy, "Skandinavisches Archiv f. Physiologie," 32, 198, 1914.

**General Schema.**—The main facts regarding the vasomotor apparatus may be summarized briefly in tabular form as follows:

Efferent vasomotor nerve fibers.	}	<p>I. Vasoconstrictor fibers—distributed mainly to the skin and the abdominal viscera (splanchnic area), all connected with a general center in the medulla oblongata, and in constant tonic activity.</p> <p>II. Vasodilator fibers—distributed especially to the erectile tissue, glands, bucco-facial region, and muscles; not connected with a general center and not in tonic activity.</p>
Afferent fibers giving vasomotor reflexes.	}	<p>I. Pressor fibers. Cause vascular constriction and rise of arterial pressure from reflex stimulation of the vasoconstrictor center—<i>e. g.</i>, sensory nerves of skin.</p> <p>II. Depressor fibers. Cause vascular dilatation and fall of arterial pressure from reflex inhibition of the tonic activity of the vasoconstrictor center,—<i>e. g.</i>, depressor nerve of heart.</p> <p>III. Depressor (or reflex vasodilator) fibers. Cause vascular dilatation and fall of arterial pressure from stimulation of the vasodilator center,—<i>e. g.</i>, erectile tissue, congestion of glands in functional activity.</p>

It may be supposed that under normal conditions the activity of this mechanism is adjusted so as to control the blood-flow through the different organs in proportion to their needs. When the blood-vessels of a given organ are constricted the flow through that organ is diminished, while that through the rest of the body is increased to a greater or less extent corresponding to the size of the area involved in the constriction. When the blood-vessels of a given organ are dilated the blood-flow through that organ is increased and that through the rest of the body diminished more or less. The adaptability of the vascular system is wonderfully complete, and is worked out mainly through the reflex activity of the nervous system exerted partly through the vasomotor fibers and partly through the regulatory nerves of the heart.

**Regulation of the Blood-supply by Chemical and Mechanical Stimuli.**—From time to time attention has been called to the fact that the calibre of the blood-vessels may be influenced otherwise than through the agency of vasoconstrictor and vasodilator nerve fibers. Gaskell, for example, has shown that acids in slight concentration cause a vascular dilatation. Bayliss\* has generalized the facts of this kind, and has suggested that in addition to the nervous regulation described in the preceding pages there may be formed chemical substances of a definite character which exert a similar useful regulating action. As examples of

\* Bayliss in "Ergebnisse der Physiologie," 1906, v., 319.

this influence, we have the lactic acid produced in muscles during activity and probably also the carbon dioxid produced in this as in other tissues. These substances in physiological concentrations cause a relaxation of muscular tonus by virtue of their acidity and, therefore, may act to produce a local dilatation during functional activity and thus provide the organ with more blood at the time that it is needed. On the other hand, the internal secretion of the adrenal glands (epinephrin) and possibly also of the infundibular portion of the pituitary gland have the reverse effect, causing a vasoconstriction and thus tending to maintain normal vascular tone. Evidence has accumulated in recent years which indicates that the secretion of epinephrin may be increased under various conditions, such as emotional excitement\* or sensory stimulation, and it is possible that by this means the arterial pressure may be increased under conditions which in nature might be supposed to call for mental and muscular activity. Therapeutically, various substances may be introduced into the circulation which, by chemical action, cause a constriction or a dilatation of the peripheral arteries and thus raise or lower general blood-pressure. In the former class of vasoconstricting reagents we have such substances as epinephrin, digitalis, etc., while in the latter class the nitrites, especially amyl nitrite (Brunton), have been much used, particularly in such conditions as angina pectoris, in which a quick relief from a state of vascular hypertension is desirable.

\* Cannon, "Bodily Changes in Pain, Hunger, Fear, and Rage," 1915.



## CHAPTER XXXIII.

### THE VASOMOTOR SUPPLY OF THE DIFFERENT ORGANS.

There are three important organs of the body—namely, the heart, the lungs, and the brain—in which the existence of a vasomotor supply is still a matter of uncertainty. A very great deal of investigation has been attempted with reference to these organs, but the technical difficulties in each case are such that no entirely satisfactory conclusion has been reached. A brief review of some of the experimental work on record will suffice to make evident the present condition of our knowledge.

**Vasomotors of the Heart.**—The coronary vessels lie in or on the musculature of the heart. Any variation in the force of contraction or tonicity of the heart muscle itself will therefore affect possibly the caliber of the arterioles and the rate of blood-flow in the coronary system. At each contraction of the ventricles the coronary circulation is probably interrupted by a compression of the smaller arteries and veins, and the size of these vessels during diastole will naturally vary with the extent of relaxation of the cardiac muscle. Since stimulation of either of the efferent nerves supplying the heart, vagus and sympathetic, affects the condition of the musculature, it is evident at once how difficult it is to distinguish a simultaneous effect upon the coronary arteries, if any such exists. Newell Martin\* found that stimulation of the vagus causes dilatation of the small arteries on the surface of the heart as seen through a hand lens. Moreover, when the heart is exposed and artificial respiration is stopped the arteries may be seen to dilate before the asphyxia causes any general rise of arterial pressure. Martin interpreted these observations to mean that the coronary arteries receive vasodilator fibers through the vagus. Porter† measured the outflow through the coronary veins in an isolated cat's heart kept alive by feeding it with blood through the coronary arteries. He found that this outflow is diminished when the vagus nerve is stimulated, and hence concluded that the vagus carries vasoconstrictor fibers to the heart. Maas‡ reports similar results also obtained from cats' hearts kept alive by an artificial circulation through the coronary arteries. Stimulation of the vagus slowed

\* Martin, "Transactions Medical and Chirurgical Faculty of Maryland," 1891.

† Porter, "Boston Medical and Surgical Journal," January 9, 1896.

‡ Maas, "Archiv f. die gesammte Physiologie," 74, 281, 1899.



the stream (vasoconstrictor fibers), while stimulation of the sympathetic path quickened the flow (vasodilator fibers). Neither Maas nor Porter gives conclusive proof that the heart musculature was not affected by the stimulation. Wiggers reports\* that the effect of epinephrin upon a heart perfused through the coronary arteries, but not beating, is to decrease the flow, while upon the beating heart this effect is reversed, owing to the action of the epinephrin upon the heart contractions. Schaefer,† on the contrary, gets entirely opposite results. When an artificial circulation was maintained through the coronary system and the amount of outflow was determined, he found that this quantity was not definitely influenced by stimulation of either the sympathetic or the vagus branches. Moreover, injection of epinephrin into the coronary circulation had no influence upon the outflow, and since this substance causes an extreme constriction in the vessels of organs provided with vasoconstrictor fibers, the author concludes that the coronary arteries have no vasomotor nerve fibers. Langendorff reports that strips of coronary artery suspended in an epinephrin solution exhibit relaxation instead of the contraction shown by other arteries, and this fact, if corroborated, might be considered as evidence for the presence of vasodilator fibers. It is evident from a consideration of these results that the existence of vasomotor fibers to the heart vessels is still a matter open to investigation.

**Vasomotors of the Pulmonary Arteries.**—The pulmonary circulation is complete in itself, and it differs from the systemic circulation chiefly in that the peripheral resistance in the capillary area is much smaller. Consequently the arterial pressure in the pulmonary artery is small, while the velocity of the blood-flow is greater than in the systemic circuit,—that is, a larger portion of the energy of the contraction of the right ventricle is used in moving the blood. From the mechanical conditions present, it is obvious that the pressure in the pulmonary artery might be increased by a vasoconstriction of the smaller lung arteries, or, on the other hand, by an increase in the blood-flow to the right ventricle through the venæ cavæ, or, lastly, by back pressure from the left auricle when the left ventricle is not emptying itself as well as usual on account of high aortic pressure. While it is comparatively easy, therefore, to measure the pressure in the pulmonary artery, it is difficult, in the interpretation of the changes that occur, to exclude the possibility of the effects being due indirectly to the systemic circulation. Bradford and Dean,‡ by comparing carefully the simultaneous records of the pressures in the aorta and a branch of the pulmonary artery, came to the conclusion that the latter may

\* Wiggers, "American Journal of Physiology," 1909. Proceedings of the American Physiological Society.

† "Archives des sciences biologiques," 11, suppl. volume, 251, 1905.

‡ Bradford and Dean, "Journal of Physiology," 16, 34, 1894.

be affected independently by stimulation of the third, fourth, and fifth thoracic spinal nerves, and hence concluded that these nerves contain vasoconstrictor fibers to the pulmonary vessels, the course of the fibers being, in general, that taken by the accelerator fibers to the heart, namely, to the first thoracic sympathetic ganglion by the rami communicantes and thence to the pulmonary plexus. They give evidence to show that these fibers are stimulated during asphyxia. The authors state, however, that the effects obtained upon the pressure in the pulmonary artery are relatively and absolutely small as compared with the vasomotor effects in the aortic system. Similar results have been obtained by other observers (François-Franck). Using another and more direct method, Brodie and Dixon\* have come to an opposite conclusion. These authors maintained an artificial circulation through the lungs and measured the rate of outflow when the nerves supplying the lungs were stimulated. Under these conditions stimulation of the vagus or the sympathetic caused no definite change in the rate of flow,—a result which would indicate that neither nerve conveys vasomotor fibers to the lung vessels. This conclusion was strengthened by the fact that in similar perfusions made upon other organs (intestines) vasomotor effects were easily demonstrated. Moreover, epinephrin, pilocarpin, and muscarin cause marked vasoconstriction when irrigated through the intestine, but have no such effect upon the vessels in the lungs. These authors conclude that the lung vessels have no vasomotor nerves at all, and their experimental evidence might be accepted as satisfactory except for the fact that a similar method in the hands of another observer has given opposite results. Plumier† finds that the outflow through a perfused lung is diminished in some cases by stimulation of the sympathetic branches to the lungs, and also by the use of epinephrin. Under such conditions it is necessary to defer a decision until more experiments are reported. Regarding the vasomotors of the lungs, one can only say, as in the case of the heart, that their existence has not been demonstrated.

**The Circulation in the Brain and Its Regulation.**—The question of the existence of vasomotor nerves to the brain brings up necessarily the larger question of the special characteristics of the cranial circulation. The brain is contained in a rigid box so that its free expansion or contraction with variations in the amount of blood can not take place as in other organs and we have to consider in how far this fact modifies its circulation.

*The Arterial Supply of the Brain.*—The brain is supplied through the two internal carotids and the two vertebrals, which together form the circle of Willis. It will be remembered also that the

\* Brodie and Dixon, "Journal of Physiology," 30, 476, 1904.

† Plumier, "Journal de physiologie et de pathologie générale," 6, 665, 1904; see also "Archives internationales de physiologie," 1, 189, 1904.

vertebral arteries give off the posterior and the anterior spinal arteries, which supply the spinal cord, and that the last-named artery makes anastomoses along the cord with the intercostal arteries and other branches from the descending aorta. From the anatomical arrangement alone it is evident that the circulation in the brain is very well protected from the possibility of being interrupted by the accidental closure of one or more of its arteries. In some animals, the dog, one can ligate both internal carotids and both vertebrals without causing unconsciousness or the death of the animal. In an animal under these conditions a collateral circulation must be brought into play through the anastomoses of the spinal arteries. In man, on the contrary, it is stated that ligation of both carotids is dangerous or fatal.

*The Venous Supply.*—The venous system of the brain is peculiar, especially in the matter of the venous sinuses. These large spaces are contained between folds of the dura mater or, on the base of the skull, between the dura mater and the bone. The channel hollowed out in the bone is covered with a roof of tough, inextensible dura mater, and indeed in some animals the basal sinuses

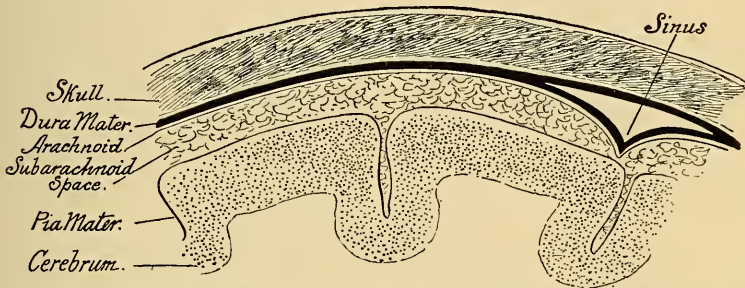

Fig. 257.—Diagram to represent the relations of the meningeal membranes of the cerebrum, the position of the subarachnoidal space and of the venous sinuses.

may in part be entirely incased in bone. The larger cerebral veins open into these sinuses; the openings have no valves, but, on the contrary, are kept patent and protected from closure by the structure of the dura mater around the orifice. The sinuses receive blood also from the veins of the pia mater, dura mater, and from the bones of the skull through the diploic veins. The venous blood emerges from the skull in man mainly through the opening of the lateral sinuses into the internal jugular vein, although there is also a communication in the orbit between the cavernous sinus and the ophthalmic veins through which the cranial blood may pass into the system of facial veins or vice versa, another communication with the venous plexuses of the cord, and a number of small emissary veins. In some of the lower animals—the dog, for instance—the main outflow is into the external jugular through what is known

as the superior cerebral vein. A point of physiological interest is that the venous sinuses and their points of emergence from the skull are by their structure well protected from closure by compression.

*The Meningeal Spaces and Cerebrospinal Liquid.*—The general arrangement of the meningeal membranes, and particularly of the meningeal spaces, is important in connection with the mechanics of the brain circulation. In the skull the dura mater adheres to the bone, the pia mater invests closely the surface of the brain, while between lies the arachnoid (Fig. 257). The capillary space between the arachnoid and the dura, the so-called subdural space, may be neglected. Between the arachnoid and the pia mater, however, lies the sub-

arachnoidal space more or less intersected by septa of connective tissue, but in free communication throughout the brain and cord. This subarachnoidal space is filled with a liquid, the cerebrospinal liquid, which forms a pad inclosing the brain and cord on all sides. The liquid surrounding the cord is in free communication with that in the brain, as is indicated in the accompanying schematic figure (Fig. 258). Within the brain itself there are certain points at the angles and hollows of the different parts of the brain at which the subarachnoidal space is much enlarged, forming the so-called cisternæ, which are in communication one with another by means of the less conspicuous canals (see Fig. 259). The whole system is also in direct communication with the ventricles of the brain on the one hand, through the foramen of

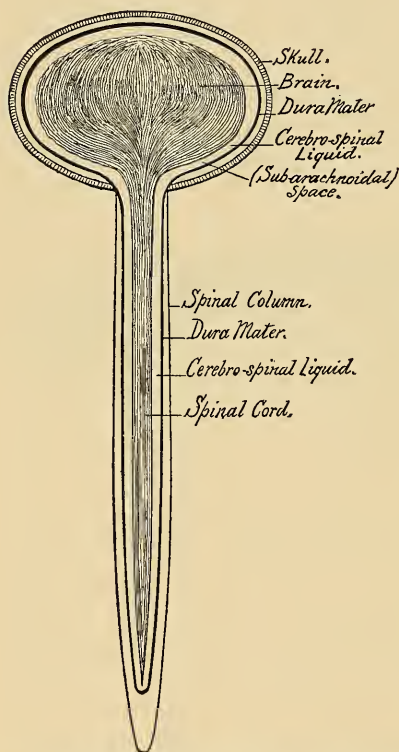

Fig. 258.—Diagram to show the connection of the subarachnoidal space in the brain and the cord.

Magendie, the foramina of Luschka, and perhaps at other places, and on the other hand, along the cranial and spinal nerves it is continued outward in the tissue spaces of the sheaths of these nerves. The Pacchionian bodies constitute also a peculiar feature of the subarachnoidal space. These bodies occur in numbers that vary with

the individual and with age, and are found along the sinuses, especially the superior longitudinal sinus. Each body is a minute, pear-shaped protrusion of the arachnoidal membrane into the interior of a sinus, as represented schematically in Fig. 260. Through these bodies the cerebrospinal liquid is brought into close contact with the venous blood, the two being separated only by a thin layer of dura and the very thin arachnoid. The number of the Pacchionian bodies is hardly sufficient to lead us to suppose that they have a special physiological importance. The cerebrospinal liquid found in the subarachnoidal space and the ventricles of the brain is a very thin, watery liquid having a specific gravity of only 1.007 to 1.008. It contains only traces of proteins and other organic substances, which may vary under pathological conditions. It is thinner and more watery than the lymph, resembling rather the aqueous humor of the eye. The amount of this fluid

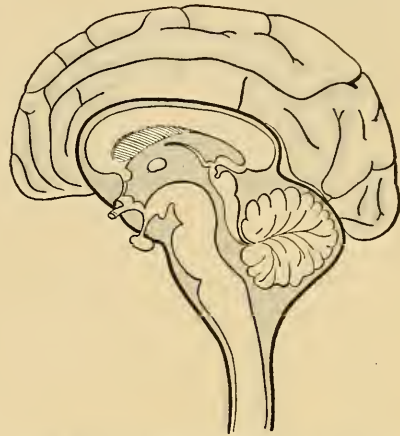

Fig. 259.—Diagram to show the location of the cisternæ and canals of the subarachnoidal space.—(Poirier and Charpy.)

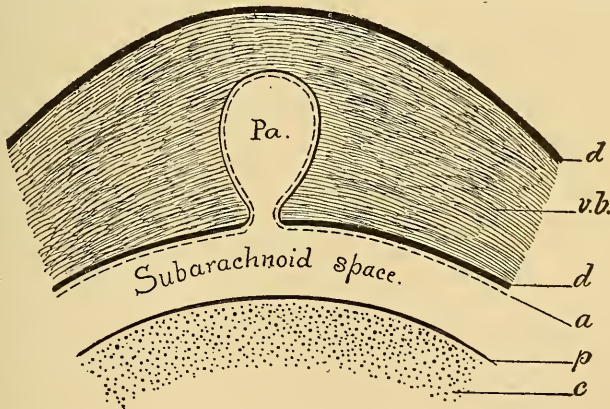

Fig. 260.—Schema to show the relations of the Pacchionian bodies to the sinuses: *d, d*, Folds of the dura mater, inclosing a sinus between them; *v.b.*, the blood in the sinus; *a*, the arachnoidal membrane; *p*, the pia mater; *Pa.*, the Pacchionian body as a projection of the arachnoid into the blood sinus.

present normally is difficult to determine. Various figures have been given, but it is usually stated to amount to 60 to 80 c.c. If

these figures are correct it evidently does not form a thick envelope to the nervous system. Under abnormal conditions (hydrocephalus, etc.) the quantity may be greatly increased, and it is stated that normally the amount increases with age, after puberty, as the brain shrinks in size.\* It is physiologically interesting to find that this liquid may be formed very promptly from the blood and, when in excess, be absorbed quickly by the blood. In fractures of the base of the skull, for instance, the liquid has been observed to drain off steadily at the rate of 200 c.c. or more per day. On the other hand, when one injects physiological saline into the subarachnoidal space under some pressure it is absorbed with surprising rapidity. After death, also, the liquid present in the subarachnoidal space is soon absorbed. Experimental work † indicates that the cerebrospinal liquid is formed within the ventricles from the choroid plexuses, and, indeed, there is some evidence that its formation may be due to a process of active secretion on the part of the epithelial cells covering these plexuses. However that may be, the stream of liquid starts within the ventricles and passes out through the foramen of Magendie and the foramina of Luschka into the subarachnoidal spaces, from which in turn it is absorbed into the cerebral veins. If the aqueduct of Sylvius or the foramina of exit are blocked, the continued formation of liquid within the ventricles may lead to the production of internal hydrocephalus. The rapidity of formation of the secretion is increased apparently by pituitary extracts and diminished by thyroid extracts. ‡

*Intracranial Pressure.*—By intracranial pressure is meant the pressure in the space between the skull and the brain,—therefore the pressure in the subarachnoidal liquid and presumably also the pressure in the ventricles of the brain, since the two spaces are in communication. This pressure may be measured by boring a hole through the skull, dividing the dura, and connecting the underlying space with a manometer. Most observers who have measured this pressure state that it is the same as the venous pressure within the sinuses. This we can understand when we remember the close relations between the subarachnoidal liquid and the large veins and sinuses. We may consider that the large veins are surrounded by the cerebrospinal liquid, and consequently an equilibrium of pressure may be established between them; any rise in the intracranial pressure raises venous pressure by compression of the veins, and probably by accelerating the flow of liquid from the

\* Stillman, "Archives of Internal Medicine," 8, 193, 1911.

† Dandy and Blackfan, "Journal of the Amer. Med. Assoc.," December 20, 1913; also Dixon and Halliburton, "Journal of Physiology," 42, 215, 1913.

‡ Weed and Cushing, "American Journal of Physiology," 36, 77, 1915; also Frazier and Peet, *ibid.*, 36, 464, 1915.

subarachnoidal space into the venous circulation. On the other hand, an increase in venous pressure might be assumed to cause a corresponding rise in intracranial pressure due to the compression following the expansion of the venous walls, and to the retardation of the inflow of cerebrospinal liquid into the veins. If the cerebrospinal liquid is formed in the choroid plexuses by a process of secretion there may be, of course, a secretion pressure not dependent on the mechanical conditions in the vascular circulation, which may cause independent variations in the pressure within the subarachnoidal space. But it is not at all certain that the cerebrospinal liquid is formed by a process of active secretion, and in any event the changes in mechanical pressure within the cerebral veins must influence directly the pressure in the surrounding cerebrospinal liquid, and vice versa in the way described above. Compression of the veins of the neck raises the pressure in the cerebral veins and also intracranial pressure, and a higher general arterial pressure also results finally in a higher pressure in the cerebral veins, and, therefore, in the subarachnoidal space. Under pathological conditions, such as tumors, abscesses, excessive formation of cerebrospinal liquid, etc., which lead to a general compression of the brain, intracranial pressure may be increased beyond normal limits. Experimental investigations show that so long as the intracranial pressure remains below that of the arteries supplying the brain the circulation through the brain is not markedly affected. If, however, the intracranial pressure rises above general arterial pressure the flow through the substance of the brain is prevented and a condition of anemia results which would presumably cause unconsciousness. In anesthetized animals submitted to such a condition it has been shown that a compensation takes place; the anemic condition of the medulla

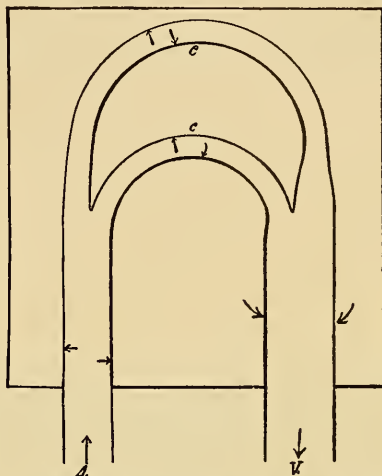

Fig. 261.—Schema to represent the transmission of arterial pressure through the brain substance to the veins: A, The artery, V, the vein, represented as entering into and emerging from a box with rigid walls and filled with incompressible liquid; c, c, the intervening area of small arteries, etc. An expansion of the walls of the arterial system by the pulse wave or by a rise of arterial pressure increases the pressure on the surrounding liquid and this is transmitted through the liquid to the walls of the veins and compresses them, since at this point of the circuit the intravascular pressure is low.

Experimental investigations show that so long as the intracranial pressure remains below that of the arteries supplying the brain the circulation through the brain is not markedly affected. If, however, the intracranial pressure rises above general arterial pressure the flow through the substance of the brain is prevented and a condition of anemia results which would presumably cause unconsciousness. In anesthetized animals submitted to such a condition it has been shown that a compensation takes place; the anemic condition of the medulla

stimulates the cardio-inhibitory center, causing a slower heart beat; at the same time it stimulates also the vasomotor center, causing a general vasoconstriction in the rest of the body, the result of which is to raise the arterial pressure and reestablish the cranial circulation (Cushing).\*

Reduced to its simplest form, the normal conditions may be represented by a schema such as is given in Fig. 261. A system with an artery, capillary area, and a vein is represented as inclosed in a rigid box and surrounded by an incompressible liquid. According to the conditions prevailing in the body, the pressure in the interior of *A* and its branches is much higher than in *V*. If, now, the pressure in *A* is increased the greater pressure brought to bear on the walls will tend to expand them; a greater pressure will thereby be communicated to the outside liquid, which, in turn, will compress the veins correspondingly. The expansion on the arterial side is made possible by a corresponding diminution on the venous side where the internal pressure is least.

The recorded measurements of the intracranial pressure show that it may vary from 50 to 60 mms. of mercury, obtained during the great rise of pressure following strychnin poisoning, to zero or less, as obtained by Hill† from a man while in the erect posture. In this position the negative influence of gravity is at its maximum.

**The Effect of Variations in Arterial Pressure upon the Blood-flow through the Brain.**—Quite a number of observers‡ have proved experimentally that a rise of general pressure is followed not only by an increase in the intracranial tension, but also by an increased blood-flow through the brain. There has been much discussion as to whether a rise of arterial pressure in the basilar arteries can cause any actual increase in the amount of blood in the brain or whether it expresses itself solely or mainly as an increased amount of flow. In the other organs of the body, except perhaps the bones, a general rise of pressure, not accompanied by a constriction of the organ's own arteries, causes a dilatation or congestion of the organ together with an increased blood-flow. Physiologically the congestion—that is, the increased capacity of the vessels—is of no value; the important thing is the increase in the quantity of blood flowing through. In the brain, owing to the peculiarities of its position, it has been suggested that perhaps no actual increase in size is possible. It is evident, however, that the existence of the liquid in the subarachnoidal space makes possible some actual expansion of the organ. For as the pressure upon this liquid increases it

\* Cushing, "American Journal of the Medical Sciences," 1902 and 1903, and also Eyster, Burrows and Essick, "Journal of Experimental Medicine," 11, 489, 1909.

† Bayliss and Hill, "Journal of Physiology," 18, 356, 1895.

‡ See Gärtner and Wagner, "Weiner med. Wochenschrift," 1887; de Boeck and Verhorgen, "Journal de Médecine, etc.," Brussels; Roy and Sherrington, "Journal of Physiology," 11, 85, 1890; Reiner and Schnitzler, "Archiv f. exp. Pathol. u. Pharmakol.," 38, 249, 1897.



may be driven into the dural sac of the cord (Fig. 258) and along the sheaths of the cranial and spinal nerves. To what extent this is actually possible in man we do not know, nor do we know how much cerebrospinal liquid is contained in the skull and brain of man. In the dog Hill\* finds experimentally that the brain can expand only by an amount equal to 2 or 3 c.c. without causing a rise of intracranial tension; so that probably these figures represent the amount of expansion possible in this animal by simple squeezing out of the cerebrospinal liquid. If the rise of arterial pressure is such as to expand the brain beyond this point, then it may not only force out cerebrospinal liquid, if any remains, but, as explained in the last paragraph, it will compress the veins and raise intracranial pressure. To the extent that the veins are compressed as the arteries expand no actual increase in the size or blood-capacity of the brain takes place. That an expansion of the brain arteries compresses the veins is indicated very clearly by the normal occurrence of a venous pulse in this organ. The blood flows out of the veins of the brain in pulses synchronous with the arterial pulses, and this venous pulse may be recorded easily as shown in Fig. 262. In this case the sudden expansion of the arteries compresses the cerebral veins, giving a synchronous rise of pressure in the interior of the sinuses. Some authors (Geigel, Grashey), on purely theoretical



Fig. 262.—Simultaneous record of pulse in the circle of Willis (c) and in the torcular Herophili (t). The tracing from the circle of Willis was obtained by means of a Hürthle manometer connected with the head end of the internal carotid. It will be noted that the pulses are simultaneous, indicating that the venous pulse is due to the transmission of the arterial pulse through the brain substance.

grounds, have held that this compression of the veins in cases of an extensive rise in arterial pressure may result in a diminished blood-flow through the organ,—a sort of self-strangulation of its own circulation. Actual experiment shows that this is not the case. Any ordinary rise of general arterial pressure is accompanied by a greater blood-flow through the brain, so long as the arterial pressure remains above intracranial pressure.—Whether the brain increases in volume as a result of a rise of arterial pressure is, on the physiological side, unimportant; the main point is that the amount of blood flowing through it is increased under such circumstances as

\* Hill, "The Physiology and Pathology of the Cerebral Circulation," London, 1896.

would cause a like result in other organs. That the compression of the veins does not produce any sensible obstruction to the blood-flow may be understood easily. In the first place, this compression does not take place at the narrow exit from the skull,—since at that point the sinuses are protected from the action of intracranial pressure. The compression takes place doubtless upon the cerebral veins emptying into the sinuses, and at this point the venous bed, taken as a whole, is so large that the expansion due to an ordinary rise of arterial pressure is distributed and has but little effect on the volume of the flow. Secondly, very great increases in arterial pressure, up to the point of rupture of the walls, have less and less effect in actually expanding the arteries; a point is reached eventually at which these tubes become practically rigid, so that farther expansion is impossible. This, of course, is true for every organ.

**The Regulation of the Brain Circulation.**—It is still a matter of uncertainty whether the arteries of the brain possess vasomotor nerves. Most of the authors who have studied the matter experimentally have concluded that there are none.\* These authors were unable to show that stimulation of any of the nerve paths that might innervate the brain vessels causes local effects upon the brain circulation. Whenever such stimulations caused a change in pressure or amount of flow in the brain the result was referable to an alteration of general arterial pressure produced by a vasomotor change elsewhere in the body. When as a result of such stimulation the pressure rises in the circle of Willis, one may infer that if this is due to a local constriction in the cerebral arterioles there should be a fall of pressure in the venous sinuses and a diminished flow of blood; if, on the contrary, it is due to a constriction elsewhere in the body that has increased general arterial pressure, but has not constricted the brain circuit, then there should be a rise in venous pressure and intracranial pressure, together with a greater flow of blood through the brain. Most observers obtain this latter result. Some investigators, Hürthle, Francois-Franck, and others,† on the other hand, have obtained results, especially from stimulation of the cervical sympathetic, which indicated local vasoconstriction or vasodilatation in the brain. So far as the experimental results for or against vasomotors are based upon a determination of the amount of flow through the brain or upon measurements of pressure within the circle of Willis, it has been shown that an undetermined factor is involved which makes such observations unsatisfactory.

\* See Roy and Sherrington, Bayliss and Hill, Hill, Gaertner and Wagner, *loc. cit.*, and Hill and MacLeod, "Journal of Physiology," 26, 394, 1901.

† Hürthle, "Archiv f. die gesammte Physiologie," 44, 574, 1889; Francois-Franck, "Archives de physiol. normale et pathologique," 1890; Weber, "Archiv f. Physiologie," 1908, 457.

It has been shown\* in experiments upon dogs that when the intracranial pressure is raised so high as to obliterate the circulation through the brain substance itself an abundant circulation may be maintained through the skull by perfusion into the internal carotid—that is to say, there are paths between the circle of Willis and the emergent veins other than the capillary circulation through the brain substance. One such path is furnished by an anastomosis at the base of the skull between the circle (through the internal carotid) and the ophthalmic branch of the internal maxillary artery. It might, therefore, very well happen that the circulation in the brain substance may be changed without materially affecting the amount of blood-flow from the brain, owing to the fact that these other paths are open. Weber, who used the plethysmographic method of measuring the volume of the brain, states positively that stimulation of the cervical sympathetics, of the cortical surface, and of various sensory nerves gives in animals such changes in brain volume as can only be interpreted by the assumption that the brain vessels possess both vasoconstrictor and vasodilator nerve-fibers. Since these reactions can be obtained reflexly after destruction of the general vasomotor center in the medulla, he is forced to assume a special vasomotor center for the brain lying further forward than the medulla, a conclusion which is not entirely satisfactory. Plethysmographic observations on the brain during sleep, as reported by some observers (p. 269), have also been interpreted as indicating the presence of a local vasomotor apparatus. An argument of a different kind in favor of vasomotor fibers has been submitted by Wiggers.† In experiments made upon an isolated brain (in the skull) perfused with an artificial circulation, he states that addition of epinephrin caused a diminution in the outflow from the organ, thus showing that the epinephrin had caused a constriction somewhere in the circuit. If, as some authors believe, epinephrin acts only on plain muscle that is innervated by sympathetic nerve-fibers, this result furnishes indirect evidence for the existence of such fibers in the case of the brain vessels. Using the same method, this author states that electrical stimulation applied directly to the sheath of the internal carotid at its entrance into the skull also causes a decrease in the outflow, a fact which would indicate the existence of constrictor fibers running in the sheath of this artery. On the whole, it will be seen that the evidence for the existence of a vasomotor regulation of the brain circulation is not conclusive. If vasomotors are present it is possible that they may serve to control the distribution of blood within the cerebral

\* Eyster, Burrows, and Essick, "Journal of Exp. Medicine," II, 489, 1909.

† Wiggers, "American Journal of Physiology," 14, 452, 1905; and 21, 454, 1908.

area, while the general supply to the brain as a whole is increased or decreased by a mechanism of another sort described by Roy and Sherrington. According to these authors the blood-flow through the brain is controlled indirectly by vasomotor effects upon the rest of the body. When, for example, a vasoconstriction occurs in the skin or the splanchnic area the result is a rise of pressure in the aorta, and, therefore, a rise of pressure in the circle of Willis, which then forces more blood through the brain. Adopting this view, we can understand the teleology of certain well-known vasomotor reflexes. Stimulation of the skin generally causes a reflex constriction and rise of pressure, and one can well understand that this result is valuable if it means a greater flow of blood through the brain, since under the conditions of nature such stimulation, especially when painful, demands alertness and increased activity on the part of the animal. Attention has also been called to the fact that in plethysmographic observations on man the most certain and extensive constrictions of the skin vessels are those caused by increased mental activity, especially when it takes the form of emotional excitement. Mosso has shown by observations upon men with trephine holes in the skull that the constriction of the limbs is always accompanied by a dilatation of the brain. This fact, therefore, fits exactly the view that is being considered. The peripheral constriction, by raising general blood-pressure, dilates the brain more or less, and, what is more important, drives more blood through it. It is difficult to understand why psychical activity is associated in this way with a peripheral constriction, and usually an increased heart-rate, unless the object of the reflex is to increase the blood-supply to the brain. Even if vasomotor fibers are subsequently shown to be present in the brain, the importance of this reflex in providing a greater flow to the central organ at the time that it is in activity may still be admitted. A general irrigation, so to speak, is provided for by this means. Local vasomotors may be used to divert this flow mainly through one or another cerebral area.

**Vasomotor Nerves of the Head Region.**—The vasomotor supply of the various parts of the head, including the mouth cavity, has been investigated by many observers. It would appear from the results of most of these investigations that the vasoconstrictor supply for the skin, including the ears, the eye, the mouth, and buccal glands, is derived mainly, if not entirely, from the sympathetic nervous system. These fibers arise from the spinal cord in the upper thoracic nerves, first to the fifth or sixth, emerge by the rami communicantes to the sympathetic chain, in which they pass upward and end, for the most part, in the superior cervical ganglion. From this ganglion they are distributed, by various routes, as postgan-

gliconic fibers. In one interesting instance the constrictor fibers for the head were supposed to take a somewhat different course. It was shown by Schiff, long ago, that in the rabbit the ear receives vasomotor fibers from the auricularis magnus nerve, a branch of the third cervical nerve. Later investigations indicate (Meltzer) that the ear, in fact, receives most of its vasoconstrictor fibers by this route. Fletcher, however, has shown that these fibers do not emerge from the brain in the roots of the third cervical, but rather in the general outflow from the thoracic region. After reaching the sympathetic chain these particular fibers pass to the third cervical by the gray rami from the first thoracic ganglion, which communicate with a number of the cervical nerves. On the other hand, the vasodilator fibers for the head are supplied in part by way of the cervical sympathetic, following the same general path as the constrictors, and in part by way of the cranial nerves (seventh, ninth) and the sympathetic ganglia with which they connect. According to Langley, the outflow of the seventh nerve passes to the sphenopalatine ganglion, whence as postganglionic fibers they accompany the branches of the superior maxillary nerve and cause vasodilatation in the membrane of the nose, soft palate, tonsils, uvula, roof of mouth, upper lips, gums, and pharynx. The well-known dilators of the submaxillary and sublingual glands are contained in the chorda tympani branch of the seventh nerve; the preganglionic fibers terminate probably in the small peripheral ganglia connected with these glands. The fibers that emerge in the ninth pass in part directly to the tongue and in part terminate first in the otic ganglion, whence they are distributed with the branches of the inferior maxillary to the lower lips, cheeks, gums, and parotid and orbital glands. Dastre and Morat describe the vasodilators in the cervical sympathetic as reaching the fifth cranial nerve by communicating branches from the superior cervical ganglion and state that they cause dilatation of the bucco-facial region,—that is, the lips, the gums, cheeks, palate, nasal mucous membrane, and the corresponding skin areas.

**The Trunk and the Limbs.**—The vasoconstrictor fibers for these regions are distributed, so far as is known, chiefly to the skin. They are all derived immediately from the sympathetic chain and ultimately from the outflow in the anterior roots of the thoracic and lumbar spinal nerves. Those for the upper limbs arise from the midthoracic region chiefly (fourth to ninth thoracic nerves), those for the lower limbs arise in the nerves of the lower thoracic and upper lumbar region (eleventh, twelfth, thirteenth thoracic [dog] and first and second lumbar). The vasodilator fibers in the nerves of the limbs have been demonstrated frequently, as already explained. Whether or not these fibers also pass through the

sympathetic system, following the same general course as the vaso constrictors, has not been shown conclusively. The most definite work at present (Bayliss) indicates that the vasodilator effect is directly caused in some unknown way by afferent fibers in the nerves forming the brachial and the sciatic plexus. The theoretical explanations offered for this result have been referred to (p. 619).

**The Abdominal Organs.**—The stomach and intestines receive their most important supply of vasoconstrictor fibers by way of the splanchnic nerves and celiac ganglion. These fibers emerge from the cord in the lower thoracic spinal nerves, from the fifth down, and the upper lumbar nerves, and they supply the whole mesenteric circulation as far as the descending colon. The stomach and intestines are said to receive vasoconstrictor fibers from the vagus nerve also (Lohmann). According to some observers (François-Franck and Hallion), the mesenteric vessels receive a supply of vasodilator fibers by way of the splanchnics, and it is also stated that similar fibers reach this region through the vagus nerve. The pancreas has been shown to receive vasoconstrictor fibers by way of the splanchnics, and the kidney, according to Bradford, receives vasodilator as well as vasoconstrictor fibers from the same nerve. Most of the vasomotor fibers to the kidney of the dog emerge from the cord in the roots of the eleventh, twelfth, and thirteenth thoracic nerves, and those for the liver (François-Franck and Hallion) come from about the same region. The vasoconstrictors to the spleen are said to leave the spinal cord chiefly in the anterior roots of the sixth, seventh, and eighth thoracic nerves.

**The Genital Organs.**—Both vasoconstrictor and vasodilator fibers have been discovered for the external genital organs (penis, scrotum, clitoris, vulva). The vasoconstrictors arise in the dog from the thirteenth thoracic to the fourth lumbar nerves, pass over to the sympathetic chain, and thence reach the organs either by way of the hypogastric nerve and pelvic plexus or by way of the sacral sympathetic ganglia and their branches to the pudic nerves. The vasodilator fibers arise from the sacral spinal nerve, being the best known of the sacral autonomic system. They enter the *nervus erigens* and thence reach the organs by way of the pelvic plexus. The especial importance of these fibers in the process of erection is described in the section on the physiology of the reproductive organs. The internal genital organs—uterus, vagina, vas deferens, seminal vesicles, etc.—receive no vasomotor fibers from the sacral autonomic system,—that is, from the *nervi erigentes*—but do receive a supply of constrictor fibers from the sympathetic system. These latter fibers emerge from the cord in the roots of

the upper lumbar nerves and reach the organs by way of the inferior mesenteric ganglion and hypogastric nerve.\*

**Vasomotor Supply of the Skeletal Muscles.**—Gaskell† especially has given evidence of the existence of vasomotor fibers in the muscles. He concludes, as the result of his work, that the blood-vessels of the muscles receive both vasoconstrictor and vasodilator fibers, but that the latter greatly predominate,—at least, their physiological effect is much more evident in experimental work. As proof of the presence of dilator fibers he gives such results as these: The mylohyoid muscle of the frog is thin enough to be observed directly under the microscope. When curarized and stimulated through its motor nerve the small vessels may be seen to dilate and there is an augmented flow of blood. In a dog section of the motor nerve to a muscle is followed by a greatly increased flow of blood, which, however, is only temporary and is referable to a mechanical stimulation of the dilator fibers. Direct stimulation of the severed nerve causes an increased flow of blood through the muscles, but if the muscles are first completely curarized stimulation causes, on the contrary, a decreased flow. This last result is explained on the supposition that curare paralyzes the endings of the dilator fibers and thus allows the effects of the constrictors to manifest themselves. Since, however, Bayliss has given evidence to show (p. 619) that the dilator effect in the limbs is due to the antidromic action of afferent fibers, it is evident that this important question needs reinvestigation. Various physiologists have shown that muscular activity is accompanied by an increase in the blood-flow through the muscle, as we should expect, but it remains uncertain whether this result is brought about solely by an increased activity of the heart or by the combined effect of vasodilatation and increase in heart-work. Kaufmann‡ takes this latter view in consequence of some interesting results obtained upon horses. He measured the blood-flow through the masseter muscle and the elevator of the lip in a horse in which the muscles were exercised normally by the act of eating. The blood-flow was increased as much as five times over that observed during rest, and that this increase was due in part at least to a local dilatation seems to be proved by the fact that the blood-pressure in the artery supplying the muscle fell, while that in the vein rose. While, therefore, our experimental knowledge of the vasomotors of the muscles needs further investigation, we may provisionally accept the view advocated by Gaskell,—namely, that the vasomotor supply to the

\* For the bibliography of the vasomotor supply to the various organs see Langley, "Ergebnisse der Physiologie," vol. ii., part ii., p. 820, 1903.

† Gaskell, "Journal of Physiology," 1, 262, 1878-79.

‡ Kaufmann, "Archives de physiologie normale et pathologique," 1892, pp. 279 and 495.

muscles consists essentially of dilator fibers and that these fibers are brought into action reflexly whenever the muscles contract, thus providing an increased blood-flow in proportion to the functional activity. It should be added that the local dilatation in the muscles during activity may be due also to the chemical action of the (acid) metabolic products on the blood-vessels (p. 620).

**The Vasomotor Nerves to the Veins.**—It is assumed in physiology that the vasoconstrictors and vasodilators end in the musculature of the small arteries. The veins also have a muscular coat, and it is possible that if this musculature were innervated from the central nervous system we should have another efficient factor in controlling the blood-flow. Mall has given very clear proof that the portal vein receives vasoconstrictor fibers from the splanchnic nerve,\* but this supply may be exceptional, as the portal system itself is unique. The portal vein, indeed, plays the rôle physiologically of an artery in regard to the liver. Roy and Sherrington† give some evidence for the existence of venomotor nerves to the large veins of the neck, and Thompson, as also Bancroft,‡ reports experiments in which it was found that stimulation of the sciatic nerve caused a visible constriction of the superficial veins of the hind limbs. Finally, it has been shown that solutions of epinephrin cause contraction in rings of vein as they do in arterial strips. On the accepted explanation of the way in which epinephrin acts this fact implies that the muscle in the veins is supplied by sympathetic autonomic nerve-fibers. If such a system exists it must exert an important influence upon the supply of blood to the heart.§

### THE CIRCULATION OF THE LYMPH.

The direction of flow of the lymph is from the tissues toward the large lymphatic trunks, the thoracic and the right lymphatic duct. The flow is maintained in this direction mainly by a difference in pressure at the two ends. At the opening of the large trunks into the jugular veins the pressure is very low; in the vein, in fact, it may be zero or even negative as compared with the atmospheric pressure. The opening between the lymph vessel and the vein is protected by a valve which opens toward the vein, and the lymph, therefore, will flow into the vein as long as the pressure in the latter is lower than that in the lymphatic duct. At the other extremity of the system, in the tissue spaces to which the lymphatic capillaries are distributed, the pressure, on the contrary, is high. Its exact amount is not known, but, since the pressure in the blood capillaries is equal to 40–60 mms. Hg, the pressure in the liquid of the surrounding tissues must also be considerable. The tissues are, in fact, in a condition of turgidity owing to the pressure of the lymph in the tissue-spaces. This difference in pressure at the two ends of the lymphatic system is the main constant factor in moving the lymph. It is obvious that in the long run it is dependent upon the pressure within the blood-vessels and therefore upon the force of the heart

\* Mall, "Archiv f. Physiologie," p. 409, 1892.

† Roy and Sherrington, "Journal of Physiology," 11, 85, 1890.

‡ Bancroft, "American Journal of Physiology," 1, 477, 1898.

§ See Henderson, "American Journal of Physiology," 23, 345, 1909.



beat. The contractions of the heart supply the energy, not only for the movement of the blood, but also for the much slower movement of the lymph. The circulation of the lymph is aided, however, by many accessory factors. In some animals there are genuine lymph hearts upon the course of the vessels,—that is, pulsatile expansions of the lymph vessels whose force of beat, controlled by valves, is directly applied to moving the lymph. No such structures are found in the mammalia, but according to some observers the large receptacle at the beginning of the thoracic duct, receptaculum chyli may undergo contractions, and is, besides, under the influence of motor and inhibitory nerves. Such movements, if they occur, must be equivalent to the action of a lymph heart in their influence upon the flow of lymph. The flow of lymph or chyle in the intestinal area is also, without doubt, greatly assisted by the peristaltic and especially by the rhythmic contractions of the musculature of the intestines, and by the independent movements of the villi. The volume of the lymph in this region is especially large and the lymph capillaries and veins are provided with valves. Rhythmical contractions of the musculature of the intestine must squeeze the lymph toward the thoracic duct, acting like a local pump to accelerate the flow of lymph. A similar influence is exerted by the contractions of the skeletal muscles. The compression exerted by the shortened fibers squeezes the lymph vessels and, on account of the valves present, forces the lymph onward toward the larger ducts. The flow of lymph from the resting muscles—the arms and legs, for instance—is normally small in quantity, but during muscular exercise and massage it is obviously increased. This increase may be observed in experimental work by placing a cannula in the thoracic duct. Active or passive movements of the limbs under these conditions will cause a noticeable increase in the outflow from the duct. Still another factor which exercises an influence upon the flow of the lymph is found in the respiratory movements of the thorax. At each inspiration the pressure within the thorax is diminished (increase of negative pressure), and this factor influences the lymph flow in several ways: By increasing the flow of blood through the large veins at the edge of the thorax, jugulars, and subclavians, it doubtless aspirates lymph from the thoracic and right lymphatic ducts into these veins. Moreover, by lowering the pressure upon the intrathoracic portion of the thoracic duct it also aspirates the lymph from the abdominal portion of this vessel.

When we place a cannula in the thoracic duct and measure the outflow directly it is found to be exceedingly slow and variable. Older measurements (Weiss) indicate that it has a velocity in the duct in the neck of about 4 mms. per second, but this velocity changes naturally with the conditions influencing the production of lymph in the tissues. After meals, during the period of absorption from the alimentary canal, the flow is much more abundant than in the fasting animal. Heidenhain estimates that for a dog weighing 10 kgs. the total outflow from the thoracic duct in twenty-four hours is equal to 640 c.c. Munk and Rosenstein, from observations upon a case with a lymph fistula, estimated that in man the flow may be equal to 50 to 100 or 120 c.c. per hour.

## SECTION VI.

### PHYSIOLOGY OF RESPIRATION.

**Historical.**—The term respiration as usually employed in physiology refers to the process of gaseous exchange between an organism and its environment. This exchange consists essentially in the absorption of oxygen by the living matter and the elimination of carbon dioxid. It is one of the generalizations of physiology that all living things, with the exception perhaps of the anaerobic organisms, require oxygen for their vital processes—that is, for the normal course of those chemical changes in the tissue cells which we group under the general term of metabolism. On the other hand, one of the universal end-products of this metabolism is carbon dioxid. Hence, respiration in some form is one great characteristic of living things. In the simplest animals and plants, the unicellular organisms, the exchange between the air (or water) and the organism takes place directly, but in the more complex animals some form of respiratory apparatus is developed whose function consists either in bringing the air or oxygen-laden water to the constituent cells, as in the air tubes of the insects, or in bringing the circulating blood into contact with the air or water, as in the case of animals provided with lungs or gills. In man and the air-breathing vertebrates the latter device is employed and one may distinguish in such animals between internal and external respiration. By the latter term is meant the gaseous exchange, absorption of oxygen and elimination of carbon dioxid, that takes place in the lungs between the blood in the pulmonary capillaries and the air in the alveoli. By internal respiration is meant the similar exchange that takes place in the systemic capillaries between the blood and the tissue elements. All of this exchange is, so to speak, secondary, since the essential process consists in the history of the oxygen after it is absorbed into the tissues,—that is, the part taken by the oxygen in the metabolism of living matter. This process, however, is a part of the subject of nutrition. The food absorbed from the digestive organs and the oxygen taken from the blood have a common history, or at least their reactions are indissolubly connected after they come within the field of influence of the living molecules. This side of the function of the oxygen may be considered, therefore, more appropriately in the section on nutrition. In the present section attention will be directed to the beautiful means that have been adapted to the pur-

pose of supplying the tissues with oxygen and of removing the carbon dioxide.

The true understanding of the object of the act of respiration we owe to Lavoisier, the discoverer of oxygen. In his paper published in 1777, entitled "Experiments on the Respiration of Animals and on the Changes which the Air Undergoes in Passing through the Lungs," he laid the foundations of our present knowledge, and in subsequent work he developed a conception of the nature of physiological oxidations which has dominated the physiological theories of nutrition up to the present time. The discovery of the physiological meaning of respiration and the function of the lungs constitutes the most interesting part of the history of physiology. All the great physiologists of past ages contributed their part to the story, and as we look back we can count distinctly the different steps made toward the truth as we understand it to-day. The history of this subject is not only most instructive in demonstrating the triumphant although slow progress of scientific investigation, but it illustrates well also the intimate interrelations of physiology with the sister sciences of chemistry and physics and the great value of the experimental method. The theory of respiration held in each century was formulated to explain, as far as possible, the facts that were known, and as we look back from our vantage point it is most impressive to realize how well-known phenomena, imperfectly understood, were apparently explained by theories which we now know to be incorrect. Without doubt, many of the explanations accepted to-day will in later times be found to rest upon a similar incomplete knowledge. Each generation must do the best it can with the knowledge of its times.

The history of respiration, the successive steps in its progress may be summarized in a few words. Aristotle thought that the main function of respiration is to regulate the heat of the body, which was supposed to be produced in the heart; hence the increased respirations after muscular exercise when the body-heat is increased. At the same time he believed, with the philosophers of his times, that the body receives something from the air that is necessary to life, a subtle something that he designated as the "pneuma." Praxagoras taught that blood is contained only in the veins, and that the arteries are filled with a gaseous substance, the "pneuma" derived from the air, an unfortunate error that prevailed in medicine for several centuries. The two celebrated anatomists and physiologists of the Alexandrian school, Herophilus and Erasistratus, distinguished two kinds of pneuma, the vital spirits, which are made or extracted from the air in the lungs and whose production constitutes the chief function of respiration, and the animal spirits, elaborated in the brain from the vital spirits and responsible for the functions of motion and sensation. Galen (131 A. D.) demonstrated

that the arteries as well as the veins contain blood, but still believed that the chief function of the respiratory movements is to furnish *pneuma* or vital spirits to the heart. This great physiologist noticed also that the air is necessary for combustion as it is for life, and stated his belief that the explanation of one of these acts would be also an explanation of the other. This thought seems to have been accepted by all the physiologists of subsequent times, but it required over sixteen hundred years of investigation before a satisfactory solution was reached. Galen recognized, moreover, that not only does the blood take something of essential importance from the air,—namely, vital spirits,—but it also gives off something to the air that is injurious to the body, a something which he compared to the smoke of combustion and designated as the “fuliginous vapor.” If we substitute oxygen for vital spirits and carbon dioxide for fuliginous vapor we realize that the essential problem of respiration was already clearly formulated, but could not make further advance until chemical knowledge was more fully developed. Such is the case with some of our physiological problems to-day. Galen also explained satisfactorily the respiratory movements, the action of the muscles of inspiration and expiration, thus destroying the older erroneous theories that the expansion and contraction of the lungs are due to processes of heating and cooling.

Galen's physiology held undisputed sway until the seventeenth century. At that time there arose a school of physiologists, the *iatromechanists*, who proposed to explain all vital phenomena upon known mechanical principles,—the laws of physics and chemistry. For the mystical view of vital spirits they proposed to substitute a more rational and concrete theory. The blood in the lungs becomes red simply because it is minutely subdivided and shaken, just as a tube of blood becomes red when violently agitated. Thus an effort to be more scientific, to use the exact knowledge of physics, led to the adoption of views which we now know were far more erroneous than the ancient and intrinsically correct conception that the blood receives something from the air in the lungs.

In the seventeenth century, however, began those discoveries in chemistry and physiology which eventually led to our present knowledge. Van Helmont (1577-1644) discovered that in the burning of charcoal, the fermentation of wine, and the action of vinegar on chalk a special gas is produced which he called *gas sylvestre* and which we call carbon dioxide. Robert Boyle (1627-1691) published a most interesting series of experiments made with the aid of the recently discovered air-pump which demonstrated the correctness of the view held by Galen that the air contains something necessary for life and for combustion. He showed, moreover, that air that had been repeatedly inspired was no longer capable of maintaining life. Robert Hooke (1635-1703) introduced a

method of artificial respiration by means of a bellows, and demonstrated by sending a continuous stream of air through the lungs that the respiratory movements of these organs are in themselves, as a mechanical process, in no wise an essential feature of respiration. John Mayow in 1688-1674 discovered that air is not a simple element, but contains a definite substance necessary to life and to combustion. He designated this substance as the nitro-aerian vapor or nitrous particles, because he believed that the same substance is present in condensed form, as it were, in common niter, having found that combustion is possible even in a vacuum in the presence of niter.

In the eighteenth century, as is shown in the work of the great physiologist, Haller, the theories of respiration were in many respects in a most unsatisfactory state. The new facts that had been discovered made the old views untenable, but were not in themselves sufficient to explain clearly what actually takes place. Such periods of uncertainty and dissatisfaction are frequent enough in the history of science. In 1757 Joseph Black rediscovered carbon dioxid, calling it fixed air, and showed that it is present in expired air. A little later Priestly discovered and isolated oxygen and nitrogen; but, under the influence of an erroneous view of combustion that had been advanced by Stahl, was unable to give his discoveries a clear and satisfactory application. The final step in this progress was made by the wonderful work of Lavoisier between the years 1771 and 1780. He made correct analyses of air and of carbon dioxid, he explained combustion as an oxidation with the formation of  $\text{CO}_2$  and  $\text{H}_2\text{O}$ , he showed that in respiration the same process occurs, and that the blood takes oxygen from the air and gives back to it in expiration the carbon dioxid and water formed by combustion within the body. He gave us the essential facts in the modern theories of respiration and physiological oxidations.

After Lavoisier the chief positive advances that have been made have been in reference to the condition of the gases in the blood. By means of the gas-pump Magnus (1837) obtained these gases quantitatively and thus procured data which, as Liebig showed, demonstrate that the oxygen is held in the blood, not in simple solution, but in some form of chemical combination, probably with the red corpuscles. Finally it was shown by Stokes and Hoppe-Seyler that the oxygen is held in definite chemical combination with the hemoglobin. The nature of the combination of the carbon dioxid in the blood is not yet entirely understood, while the actual nature of physiological oxidations—that is, the part taken by the oxygen in the chemical reactions of living matter—is one of the great problems of nutrition which may need many years for solution.

## CHAPTER XXXIV.

### THE ORGANS OF EXTERNAL RESPIRATION AND THE RESPIRATORY MOVEMENTS.

**Anatomical Considerations.**—Some of the anatomical arrangements in the lungs which have an immediate physiological interest may be recalled briefly. The structures of the trachea and bronchi are admirably adapted to their functions as air tubes, in that the walls possess flexibility combined with rigidity. The lining of ciliated epithelium throughout the air passages is of importance, primarily it may be assumed, in removing mucus and foreign material from these passages. The smaller bronchi possess a distinct muscular layer, and, as we shall see, this musculature is under the control of a special set of nerve fibers through whose reflex activity the capacity and resistance of the bronchial system may be modified. The smallest bronchioles are expanded into a system of membranous air cells, and in the walls of these thin sacs the capillaries of the pulmonary artery are distributed. The great efficiency of this apparatus is evident when one recalls that every one of the infinite number of red corpuscles is exposed separately to the air of the air cells, so that although the time of transit is brief the entire amount of hemoglobin is nearly completely saturated with oxygen. Each lung is enveloped in its own pleural sac. The space between the parietal and the visceral layer of each sac is the so-called pleural cavity, but it must be borne in mind that under all normal conditions this cavity is only potential,—that is, the parietal and visceral layers are everywhere in contact with each other. Under pathological or accidental conditions air or exudations may enter this space and form an actual cavity. Along the mid-line of the body and around the roots of the lungs we have the mediastinal spaces lying between the pleural sacs of the two sides, but entirely filled with the various thoracic viscera, such as the heart, aorta and its branches, pulmonary artery and veins, venæ cavæ, azygos vein, trachea, esophagus, thoracic duct, various nerves, and lymph glands. All these organs, therefore, lie outside the lungs. A schematic view of these relations is represented in Fig. 263.

**The Thorax as a Closed Cavity.**—The thorax is a cavity entirely shut off from the outside and from the abdominal cavity. In this cavity lie the lungs and the various viscera enumerated above. The lungs may be considered as two large, membranous sacs, as

represented in Fig. 263, the interior of which communicates freely with the outside air through the trachea, glottis, etc., while the outside of the sacs is protected from atmospheric pressure by the walls of the chest. It is to be remembered, of course, that the interior surface of the lungs is multiplied greatly by the subdivision into alveoli. It is estimated that the entire inner surface of the lungs amounts to as much as 90 square meters, over one hundred times the skin surface of the body. The atmospheric pressure on the interior surfaces of the lungs expands these structures under normal conditions until they fill the entire thoracic cavity not occupied by other organs. However the size of the chest cavity varies, that of the lungs must change accordingly; so that at all times the lungs fully fill up every part of the cavity not otherwise occupied. If the wall of the thorax is opened at any point so as to make commu-

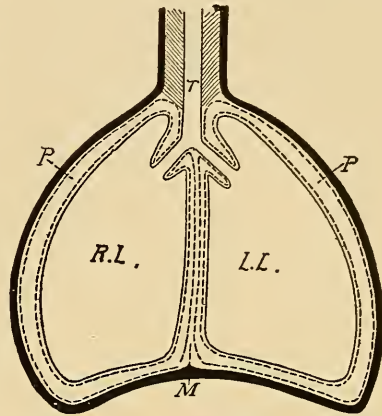

Fig. 263.—Schema to indicate the relations of the parietal and visceral layers of the pleural sacs, and the position of the mediastinal space: *P*, the potential pleural cavity in each sac; *M*, the mediastinal space; *R.L.* and *L.L.*, the cavity of the right and the left lung, respectively; *T*, the trachea. The outlines of the pleura on each side are represented in dotted lines.

nication with the outside air, or, if the wall of the lung is pierced so that the air can communicate with the pleural cavity from the inside, then at once the lungs shrink in size, since the atmospheric pressure is then equalized on the outside and the inside of the sacs. We may consider, therefore, that the thoracic cavity is much larger than the lungs, and that the latter are blown out to fill this cavity by the atmospheric pressure on the inside.

**The Normal Position of the Thorax—*Inspiration and Expiration.***—During life the size of the thorax is continually changing with the respiratory movements. But the size and position taken at the end of a normal expiration may be regarded as the normal position of the thorax; that is, its position when all of the muscles of respiration are at rest, and substantially, therefore, the position of the thorax in the cadaver. Starting from this position, any enlargement of the thorax constitutes an *active inspiration*, the result of which will be to draw more air into the lungs; while starting from the normal position any diminution in the size of the thorax constitutes an *active expiration*, which will drive some air out of the lungs. It is evident, however, that after an active inspiration the

thorax may return passively to its normal position, giving what is known as a passive expiration,—that is, an expiration not caused by muscular effort. So after an active expiration the thorax may return passively to its normal position, giving a passive inspiration. Our normal respiratory movements consist of an active inspiration followed by a passive expiration,

**Mechanism of the Inspiration.**—The chest cavity may be enlarged and an inspiration, therefore, be produced by two methods,—namely, by a contraction of the diaphragm and by an elevation of the ribs.

*Contraction of the Diaphragm.*—From the anatomy of the diaphragm it is evident that its fixed attachment is found in its muscular connections with the lumbar vertebræ, the ribs, and the ensiform cartilage. From these attachments the muscular sheet extends anteriorly along the walls of the thorax and then bends over to form the arch which ends in the central tendon. This latter structure is not entirely free, since it is attached to the pericardium of the heart; but, relatively, it is the movable portion of the diaphragm. Speaking generally, a contraction of the diaphragmatic muscle draws the central tendon downward toward the abdominal cavity and therefore enlarges the chest in the vertical diameter, while an increase in the thoracic cavity around the periphery of the diaphragm is caused also by the flattening of the muscular arch. Two results follow this movement: The lungs are expanded exactly in proportion as the cavity enlarges. There is, of course, at no time any space between the lungs and the diaphragm: as the latter moves downward the lungs follow because of the excess of pressure on their interior. Although ordinarily we speak of the new air being sucked into the lungs during this movement, it is, of course, strictly speaking, forced in by the pressure of the outside atmosphere. On the other hand, the descent of the diaphragm raises the pressure in the abdominal cavity. This cavity is entirely full of viscera and for mechanical purposes may be regarded as being full of liquid. The rise of pressure is transmitted throughout the abdomen and causes the abdominal wall to protrude. Inspiration caused by a contraction of the diaphragm is therefore spoken of either as *diaphragmatic respiration* or as *abdominal respiration*, the latter term having reference to the visible effect on the abdominal walls. In strong contractions of the diaphragm the heart also is pulled downward, and if the movement is forced the lower ribs may be pulled inward to some extent. This last effect would diminish the size of the thorax and therefore would tend to antagonize the inspiratory action of the diaphragm, and other muscles are apparently brought into play to prevent this result. As stated below, the



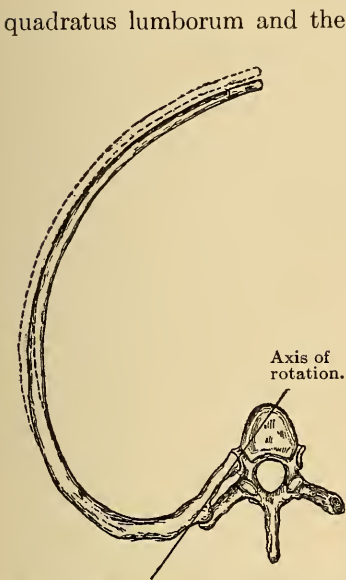

Fig. 264.—Sixth dorsal vertebra and rib.—(Reichert.)

quadratus lumborum and the serratus posticus inferior may have this function of fixating the lower ribs in violent inspirations. The diaphragmatic muscle is innervated on each side by the corresponding phrenic nerve. This nerve arises in the neck from the fourth and fifth cervical spinal nerves, and passes downward in the chest in the mediastinal space, lying close to the heart in part of its course. Section of this nerve paralyzes, of course, the diaphragm on the corresponding side.

*Elevation of the Ribs.*—As a necessary result of the structure of the bony thorax, every elevation of the ribs must cause an enlargement of the thoracic cavity in the dorsoventral and the lateral diameters. We are justified in saying that every muscle whose contraction

causes an elevation of the ribs is an inspiratory muscle. This result is due, in the first place, to the slant of the ribs. Each rib is attached to the spinal column at two points: the head to the body of the vertebra and the tubercle to the transverse process. The up-and-down movements of the ribs may be regarded as rotations around an axis joining these two points,—that is, each point in the rib as it moves up or down describes a circle around this axis (see Fig. 264). If our ribs were set upon the vertebral column so that the plane of the rib formed a right angle with the column, then every movement of the rib up or down would decrease the size of the thorax and therefore cause an expiration. As a matter of fact, however, the ribs slant downward, so that if elevated the sternal end is carried farther away from the sternum and the chest is enlarged in the dorsoventral direction (see Fig. 265). Moreover, as the rib moves upward there

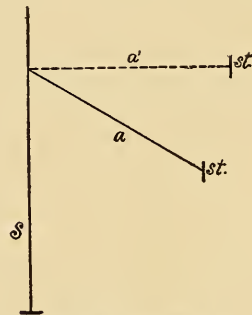

Fig. 265.—Diagram to illustrate the effect of the slant of the ribs: *S*, The spinal column; *a*, the position of the rib in normal expiration; (*a'*) its position (exaggerated) in inspiration (the distance between the spinal column and the sternum (*st.*), the antero-posterior or dorsoventral diameter of the chest is increased). Any movement from the position *a'* would cause an expiration.

is an obvious enlargement of the chest in the lateral diameter. This result may be referred to two causes: In the first place, the axis of the rotation of the ribs,—that is, the line joining the head and the tubercle of the rib is inclined downward so that the plane of rotation, which is, of course, at right angles to this axis, will be inclined outward. As the rib is moved upward, therefore, it must also move outward. Secondly the cartilaginous ends of the ribs are fixed at the sternum so that as they move upward and outward they will be twisted or everted somewhat in the middle, with a torsion of the cartilaginous ends.

**The Muscles of Inspiration.**—In addition to the diaphragm, all muscles attached to the thorax whose contraction causes an elevation of the ribs must be classed as inspiratory muscles. In regard to this latter group the action of some of them is either evident from their anatomical attachments, or the muscles may be stimulated directly and the effect of their contraction be noted. In other cases, however, it is necessary to make use of the method first suggested by Newell Martin,—namely, the determination whether the contraction of the muscle in respiration occurs simultaneously with that of the diaphragm or alternately with it. In the former case it is inspiratory, in the latter expiratory. The following muscles may be classed as inspiratory: *Levatores costarum*. They arise from transverse processes of the seventh cervical and first to eleventh thoracic vertebræ and are inserted into the next rib or the second rib below. *Intercostales externi* muscles. They lie in the intercostal spaces extending from the lower edge of one rib to the upper edge of the rib below; they slant downward and toward the mid-line. These muscles have been assigned different functions by different authors, but the experiments made by Hough,\* using the method of Martin described above, show that they are inspiratory. It was found that in the dog they contract synchronously with the diaphragm. The same authors find that the intercartilaginous portions of the internal intercostals are also inspiratory. The *scaleni*—anterior, medius, and posterior—arise from the transverse processes of the cervical vertebræ and are inserted into the first and second ribs. *M. sterno-cleido-mastoideus* extends from the mastoid process to the sternum and sternal extremity of the clavicle. *M. pectoralis minor* extends from the coracoid process of the scapula to the anterior surface of the second to the fifth rib. *M. serratus posticus superior* extends from the spinous processes of the lower cervical and upper dorsal vertebræ to the second to fifth rib.

**The Muscles of Expiration.**—Expiration—that is, diminution

\* Hough, "Studies from the Biological Laboratory, John Hopkins University," 5, 91, 1893, and Bergendal and Bergman, "Skandinavisches Archiv f. Physiologie," 7, 178, 1896.

in size of the thorax—may also be produced in two ways: First, by forcing the diaphragm farther into the thoracic cavity. This result is obtained, not by any direct action of the diaphragm, but by contracting the muscular walls of the abdomen, the external and internal oblique, the rectus, and the transversus. The contraction of these muscles, which form what has been called the abdominal press, raises the pressure in the abdomen and this, acting upon the under surface of the diaphragm, forces it up into the thorax, provided the glottis is open. If the glottis is kept closed firmly the increased abdominal pressure is felt mainly upon the pelvic organs, and this effect is observed in micturition, defecation, and parturition. Second, by depressing the ribs. The muscles which may be supposed to exert this action are as follows: *M. intercostales interni*. The expiratory action of these muscles, so far as the interosseous portion is concerned, was first definitely shown by Martin, who proved that when they contract they act alternately with the diaphragm.\* *M. triangularis sterni* or the *m. transversus thoracis* is found on the interior of the thorax on the anterior wall. Its fibers pass from the sternum, running upward and outward, to be inserted into the third to sixth rib. The expiratory action of this muscle was demonstrated by Hough according to the method of Martin. *M. iliocostalis lumborum*. The anatomical attachments of this muscle are such as would enable it to depress the ribs; but its functional activity in expiration has not been demonstrated. The *m. serratus posticus inferior* and *m. quadratus lumborum* are both placed anatomically, especially the former, so that their contractions serve to depress the ribs. It has been suggested, however, that they may act in forced inspirations so as to antagonize the tendency of the diaphragm to pull the lower ribs inward. Whether they really act with the diaphragm or alternately with it can only be determined by actual experiment.

**Quiet and Forced Respiratory Movements; Eupnea and Dyspnea.**—Our respiratory movements vary much in amplitude, and the muscles actually involved differ naturally with the extent of the movement. In general, we distinguish two different forms of breathing movements. The ordinary quiet respirations, made without obvious effort, form a condition of respiration designated as eupnea. Difficult or labored breathing is known as dyspnea. It is impossible to draw a sharp line between the two. There are many degrees of dyspnea, and doubtless in quiet breathing the amplitude of the movements may vary considerably before they become distinctly dyspneic. In all conditions of eupnea the chief point to bear in mind is that the expiration is entirely passive.

\* Martin and Hartwell, "Journal of Physiology," 2, 24, 1879.

The inspiration in man is made by the diaphragm alone or by the diaphragm together with some action of the levatores costarum and the external intercostals. At the end of the inspiration the ribs and diaphragm are brought back to the normal position by purely physical forces,—the elasticity of the distended abdominal wall, the elasticity of the expanded lungs, the weight and torsion of the ribs, etc. As soon as the breathing movements become at all forced the action of the above-named inspiratory muscles is increased in intensity, and the other inspiratory muscles, all elevators of the ribs, come into play. Quiet breathing in man at least is mainly diaphragmatic or abdominal, while dyspneic breathing is characterized by a greater action of the elevators of the ribs. When dyspnea reaches a certain stage the expiration also becomes active or forced. The expiratory act is hastened by a contraction of the abdominal muscles or of the depressors of the ribs, and indeed the action of these muscles may compress the chest beyond its normal position, so that the expiration is followed by a passive inspiration which brings the chest to its normal position before the next active inspiration begins.

**Costal and Abdominal Types of Respiration.**—These two types of respiration are based upon the character of the inspiratory movement. An inspiration in which the movement of the abdomen, due to contraction of the diaphragm, is the chief or only feature belongs to the abdominal type. An inspiration in which the elevation of the ribs is a noticeable factor belongs to the costal type. Hutchinson, who introduced this nomenclature,\* laid emphasis chiefly upon the order of the movements. In the abdominal type the abdomen bulges outward first, and this is followed by a movement of the thorax; the movement spreads from the abdomen to the thorax, and, “like a wave, is lost over the thoracic region.” In costal breathing the upper ribs move first and the abdomen second. The terms are meant to apply chiefly to human respiration and have aroused interest in connection with the fact that in quiet breathing in the erect posture the respiration of man belongs to the abdominal type and that of woman to the costal type. It has been a question whether this difference is a genuine sexual distinction or depends simply upon differences in dress. Hutchinson inclined to the view that it forms what we should call a secondary sexual characteristic, and that its physiological value for woman lies in the fact that provision is thus made, as it were, against the period of pregnancy. He states that in twenty-four young girls examined between the ages of eleven and fourteen the costal type was present, although none of them had

\* See Hutchinson, article on “Thorax,” Todd’s “Cyclopædia of Anatomy and Physiology,” 1849.

worn tight dress. Later observers, however (Mays, Kellogg, and others), state that Indian and Chinese women who have not worn tight dress exhibit the abdominal type, and the same statement is made regarding civilized white women who habitually wear loose clothing. It would appear, therefore, that the assumption of the costal type by women in general is due to the hindrance offered by the clothing to the movements of the abdomen. From an examination of four hundred and seven cases Fitz\* concludes that when the restricting effect of dress is removed there is little or no difference in the type of respiration in the two sexes. The natural type is one in which "the movement is fairly equally balanced between chest and abdomen, the abdominal being somewhat in excess." When the respiration becomes dyspneic it takes on a distinctly costal type, and Fitz and others have shown that for an equal increase in girth the thoracic movements cause a greater enlargement of the lungs.

**Accessory Respiratory Movements.**—In addition to the muscles whose action directly enlarges or diminishes the capacity of the thorax certain other muscles connected with the air passages contract rhythmically with the inspirations, and may be designated properly as accessory muscles of inspiration. The muscles especially concerned are those controlling the size of the glottis and the opening of the external nares. At each inspiration the elevators of the wings of the nose come into play. This movement occurs in normal breathing in many animals, such as the rabbit and horse, and in some men, while in dyspneic breathing it is invariably present. The useful result of the movement is to reduce the resistance to the inflow of air. So in many animals the glottis is dilated at each inspiration by the contraction of the posterior crico-arytenoid muscles, and in man also this movement is evident when the breathing is at all forced. The useful result in this case also is a reduction in the resistance offered to the inflow of air.

**The Registration of the Rate and Amplitude of the Respiratory Movements.**—Many methods are employed to register the rate or amplitude of the respiratory movements. Upon man the amplitude may be measured directly by a tape placed at different levels to ascertain the increase in girth, or it may be recorded by some form of lever or tambour applied to the chest or abdomen. A convenient instrument for this purpose is the pneumograph described by Marey, which is illustrated and described in Fig. 266. In animal experimentation the various methods that are employed may be classified under four heads: (1) Methods in which the change in circumference or diameter of the chest or abdomen is recorded. (2) Methods in which the change of pressure in the air

\* Fitz, "Journal of Experimental Medicine," 1, 1896.

passages is recorded. In these methods a tube may be inserted into one of the nostrils for instance, and then connected to a tambour the lever of which makes its record on a kymographion, or if the animal is tracheotomized a side tube upon the tracheal cannula may be connected to a tambour. This method indicates well the rate of movement and the relative amplitude, but has the defect that it

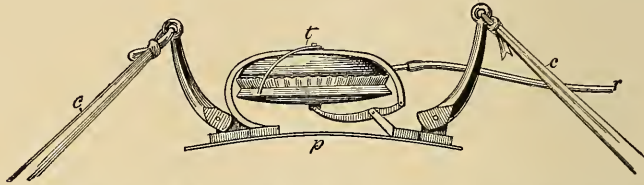

Fig. 266.—Figure of Marey's pneumograph.—(Verdin.) The instrument consists of a tambour (*t*), mounted on a flexible metal plate (*p*). By means of the bands *c* and *c* the metal plate is tied to the chest. Any increase or decrease in the size of the chest will then affect the tambour by the lever arrangement shown in the figure. These changes in the tambour are transmitted through the tube *r* as pressure changes in the contained air to a second tambour (not shown in the figure) which records them upon a smoked drum.

does not record the pause, if any, at the end of inspiration or expiration. A modification of this method that permits an accurate record of the amplitude and duration of the movements consists in connecting the trachea or nostrils with a large bottle of air. The animal breathes into and out of the bottle, and the corresponding

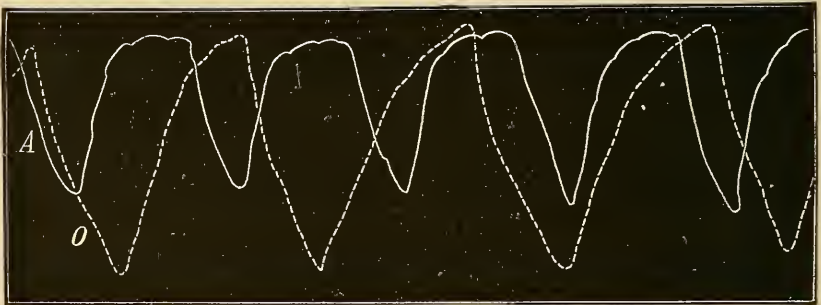

Fig. 267.—Curve of normal respiratory movements.—(Marey.) Curve *A*, full line, represents the movements when the respiration is entirely normal. Downstroke, inspiration; upstroke, expiration. Curve *O*, dotted line, represents the increased amplitude of the movements, slight dyspnea, caused by breathing through a narrow tube.

variations in pressure are recorded by a tambour also connected with the interior of the bottle. (3) Methods in which the change of pressure in the thoracic cavity is recorded. This end may be reached by inserting a cannula into the thoracic wall so that its opening lies in the pleural cavity, or, more simply, a catheter or sound connected at the other end to a tambour may be passed down

the esophagus until its end lies in the intrathoracic portion. Variations in pressure in the mediastinal space synchronous with the respiratory movements affect the esophagus and through it the sound. (4) Methods in which the movements of the diaphragm are recorded either by a tambour or lever thrust between the diaphragm and liver, or by hooks attached directly to muscular slips of the diaphragm. Registration of the movements in man during quiet breathing give us such a record as is seen in Fig. 267. It will be seen that the inspiration (descending limb) is followed at once by an expiration, as we should expect, since, as soon as the inspiratory muscles cease to act, the physical factors mentioned above at once tend to bring the chest back to its normal position. The expiration (ascending limb) is at first rapid and toward the end very gradual, so that there is almost a condition of rest,—an expiratory pause.

#### The Volumes of Air Respired and the Capacity of the Lungs.—

The volume of air respired varies, of course, with the extent of the movements and the size of the individual. This volume may be determined readily in any given case by means of a *spirometer*,—a form of gasometer adapted to this purpose. The construction of this apparatus is represented in Fig. 268. It consists of a graduated cylinder (A) and a receiver (B) filled with water. The cylinder A is counterbalanced by a weight (g) so as to move up and down in the water of B with the least possible resistance. The tube C passes through the wall of B and ends in the interior of A above the level of the water. The free end of this tube is connected with the mouth or nose. When one breathes through this tube the expired air passes into A, which rises from the water to receive it. If A is graduated the amount of air breathed out may be measured directly. The following terms are used: *Vital capacity*. By

vital capacity is meant the quantity of air that can be breathed

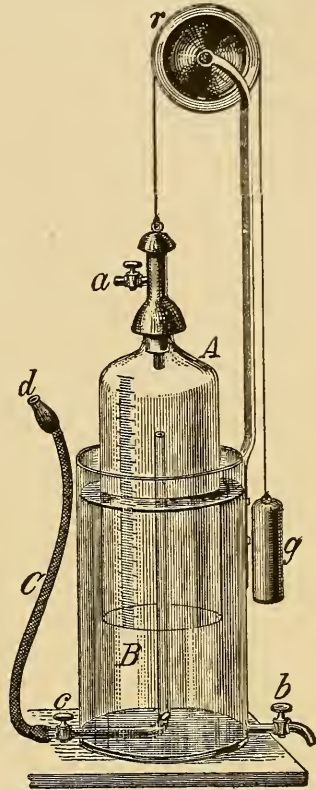

Fig. 268.—Wintrich's modification of Hutchinson's spirometer. —(Reichert.)

out by the deepest possible expiration after making the deepest possible inspiration. It gives a rough measure of lung capacity, and is used in gymnasiums and physical examinations for this purpose. The actual amount varies with the individual; an average figure for the adult man is 3700 c.c. *Tidal air*. By this term is meant the amount of air breathed out in a normal quiet expiration. A similar amount is breathed in, of course, in the previous inspiration, and the term tidal air designates the amount of air that flows in and out of the lungs with each quiet respiratory movement. Here, again, there are individual variations. The average figure for the adult man is 500 c.c. *The complemental air*. This term designates the amount of air that can be breathed in over and above the tidal air by the deepest possible inspiration. It is estimated at 1600 c.c. *The supplemental air*. By this term is meant the amount of air that can be breathed out, after a quiet expiration, by the most forcible expiration. It is equal also to 1600 c.c. It is evident that the complemental air plus the supplemental air plus the tidal air constitute the vital capacity. *The residual air*. After the most forcible expiration the lungs are far from being entirely collapsed. The volume of air that remains behind, after the supplemental air has been driven out, is known as the residual air. The amount of this air has been estimated directly on the cadaver (Hermann). The thorax was first pressed into a position of forced expiration; the trachea was then ligated, the chest opened, the lungs removed and their volume estimated by the amount of water displaced when they were immersed. The average result from such estimations was, in round numbers, 1000 c.c. Under conditions of normal breathing the reserve supply of air in the lungs is equal to the residual air plus the supplemental air,—that is, 2600 c.c. *Minimal air*. When the thorax is opened the lungs collapse, driving out the supplemental and residual air, but not quite completely. Before the air cells are entirely emptied the small bronchi leading to them collapse and their walls adhere with sufficient force to entrap a little air in the alveoli. It is on this account that the excised lungs float in water and are designated as lights by the butcher. The small amount of air caught in this way is designated as the minimal air.

In the fetus before birth the lungs are entirely solid, but after birth, if respirations are made, the lungs do not collapse completely on account of the capture of the minimal air. Whether or not the lungs will float has constituted, therefore, one of the facts used in medicolegal cases to determine if a child was stillborn. The lungs during life may, under certain conditions, again become in parts entirely solid. If any of the alveoli become completely shut off from the trachea, by an accident or by pathological conditions, the air caught in them may be completely absorbed, after a certain interval, by the circulating blood.



**The Size of the Bronchial Tree and the Ventilation of the Lungs.**—Since the reserve supply of air in the lungs may amount to 2600 c.c., while the new air breathed in at each inspiration amounts to only 500 c.c., it would seem at first that the alveolar air is not very efficiently renewed by a quiet inspiration. The actual amount of ventilation effected depends on the capacity of the bronchial tree, sometimes known as the “dead space” of the lungs, since the air filling this space is not useful in the respiratory processes. According to observations founded partly on measurements of casts of the tree and partly upon physiological determinations made by breathing air poor in oxygen, it would seem that this volume may be reckoned at 140 c.c.\* At each inspiration, therefore, at least 360 c.c. of air penetrate into the alveoli, and if evenly disseminated through the lungs add about  $\frac{3}{20}$  to the volume of each alveolus. Once in the alveoli, diffusion must tend to spread the tidal air rapidly, and that this occurs is shown by an interesting experiment performed by Gréhant. He breathed in 500 c.c. of hydrogen instead of air and then examined the amounts of hydrogen breathed out in successive expirations. Only 170 c.c. were recovered in the first expiration, 180 c.c. in the second, 41 in the third, and 40 in the fourth.

**Artificial Respiration.**—In laboratory experiments artificial respiration is employed frequently after the use of curare; when it is necessary to open the chest: after cessation of respirations from overdoses of chloroform or ether, etc. The method used in almost all cases is the reverse of the normal procedure,—that is, the lungs are expanded by positive pressure (pressure in excess of atmospheric). A bellows or blast worked by hand or machinery is connected with the trachea and the lungs are dilated by rhythmical strokes. Provision is made for the escape of expired air by the use of valves or by a side hole in the tracheal cannula. Numerous forms of respiration pumps have been devised for this purpose.

In cases of suspended respiration in human beings from drowning, electrical shocks, pressure upon the medulla, etc., it is necessary to use artificial respiration in order to restore normal breathing. Bellows ordinarily cannot be used in such cases. Some method must be employed to expand and contract the chest alternately, and several different ways have been devised. The Marshall Hall method consists in placing the subject face down and rolling the body from this to a lateral position, making some pressure upon the back while in the prone position. The Sylvester method, which is frequently used, consists in raising the arms above the head and then bringing them down against the sides of the chest so as to compress the latter. The Howard method consists in simply com-

\* See Loewy, “Archiv f. die gesammte Physiologie,” 58, 416.

pressing the lower part of the chest while the subject is in a supine position. Schaefer, who has recently compared these different methods, suggests one of his own, which seems to be effective, saves labor, and is less injurious to the subject.\* He describes it as follows: "It consists in laying the subject in the prone posture, preferably on the ground, with a thick folded garment underneath the chest and epigastrium. The operator puts himself athwart or at the side of the subject, facing his head (see Fig. 269) and places his hands on each side over the lower part of the back (lowest ribs). He then slowly throws the weight of his body forward to bear upon



Fig. 269.—Shows the position to be adopted for effecting artificial respiration in cases of drowning.—(Schaefer.)

his own arms, and thus presses upon the thorax of the subject and forces air out of the lungs. This being effected, he gradually relaxes the pressure by bringing his own body up again to a more erect position, but without moving the hands." These movements are repeated quite regularly at a rate of twelve to fifteen times a minute until normal respiration begins or the possibility of its restoration is abandoned. A half-hour or more may be required before normal breathing movements start.

\* Schäfer, "Medico-chirurgical Transactions," London, vol. lxxxvii., 1904; also "Journal of the American Medical Association," 51, 801, 1908.

## CHAPTER XXXV.

### THE PRESSURE CONDITIONS IN THE LUNGS AND THORAX AND THEIR INFLUENCE UPON THE CIRCULATION.

In considering the pressure changes in respiration the distinction between the pressure in the thorax outside the lungs and the pressure within the lungs and air passages must be kept clearly in mind. The pressure in the thoracic cavity outside the lungs may be designated as the *intrathoracic pressure*; it is the pressure exerted upon the heart, great blood-vessels, thoracic duct, esophagus, etc. The pressure in the interior of the lungs and air passages may be designated as *intrapulmonic pressure*. The relations of the two pressures with reference to the outside atmosphere is indicated schematically in Fig. 270.

**The Intrapulmonic Pressure and its Variations.**—The air passages and the alveoli of the lungs are in free communication with the external air; consequently in every position of rest, whether at the end of inspiration or expiration, the pressure in these cavities is equal to that of the atmosphere outside. During the act of inspiration, however, the intrapulmonic pressure falls temporarily below that of the atmosphere,—that is, during the inflow of air. The extent to which the pressure falls depends naturally upon the rapidity and amplitude of the inspiratory movement and upon the size of the opening to the exterior. The narrowest portion of the air passages is the glottis; consequently the variations in pressure below this point are probably greater than in the pharynx or nasal cavities. If the air passages are abnormally constricted at any point the fall of pressure during inspiration will be correspond-

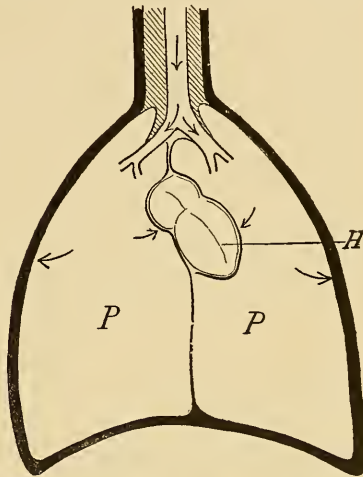

Fig. 270.—Diagram to illustrate how the pressure of the air is exerted through the lung walls upon the heart (*H*) and other organs in the mediastinal space. The pressure on these organs (intrathoracic pressure) is equal to one atmosphere minus the amount of the opposing pressure exerted by the expanded lungs.

ingly magnified in the parts below the constriction, as happens, for instance, in bronchial asthma, edema of the glottis, cold in the head, etc. Under normal conditions the fall of pressure during a quiet inspiration is not large. Donders determined it in man by connecting a water manometer with one nostril and found that it was equal to  $-9$  or  $-10$  mms. water. At the end of an inspiration, if there is a pause, the pressure within the lungs again rises, of course, to atmospheric. During expiration, on the other hand, the collapse of the chest wall takes place with sufficient rapidity to compress the air somewhat during its escape and cause a temporary rise of pressure. In normal expiration Donders estimated this rise as equal to 7 or 8 mms. water. The intrapulmonic pressure may vary greatly from these figures in the positive or negative direction according to the factors mentioned above, especially the intensity of the respiratory movement and the size of the opening to the exterior. The extreme variations are obtained when the opening to the outside is entirely shut off. When an inspiration or an expiration is made with the glottis firmly closed the pressure in the lungs, of course, rises and falls with the rarefaction or compression of the contained air. A strong inspiration under such conditions may lower the pressure by 30 to 80 mms. of mercury, while a strong expiration raises the pressure by an amount equal to 60 to 100 mms. Hg. In the act of coughing we get such a result: the strong spasmodic expirations are made with a closed glottis and consequently cause a marked rise in the intrapulmonic pressure. Such great variations in pressure have a marked influence on the flow of blood to the heart. If, for example, one maintains a strong expiration while keeping the glottis closed, the rise of intrapulmonic and intrathoracic pressure may be sufficient to clamp off the large veins emptying into the right auricle.

**Intrathoracic Pressure.**—When a reference is made to the pressure within the thorax, it is the intrathoracic pressure that is meant,—that is, the pressure in the pleural cavity and mediastinal spaces. This pressure, under normal conditions, is always negative,—that is, is always less than one atmosphere. The reason for this is simply that the lungs are distended to fill the thoracic cavity, and consequently the organs, like the heart, which lie in this cavity outside the lungs, are exposed to a pressure of one atmosphere, minus the force of elastic recoil of the lungs (see Fig. 270). The heart and other intrathoracic organs are protected from the direct pressure of the air by the thoracic walls; they are pressed upon, however, through the lungs, but naturally the atmospheric pressure is reduced by an amount equal to the elastic force of the distended lungs. Intrathoracic pressure, in fact, may be defined as intrapulmonic pressure minus the elastic pull of the lungs, and since under usual conditions the intrapulmonic pressure is equal to that

of the atmosphere, the intrathoracic pressure is less than an atmosphere by an amount equal to the recoil of the lungs. The negative pressure in the thorax is, therefore, equal to the elastic force of the lungs, and is larger the more the lungs are put upon a stretch,—that is, the deeper the inspiration. The amount of this negative pressure has been measured upon both animals and men by two methods: First by Donder's method of attaching a manometer to the trachea and then opening the thoracic walls so as to allow the atmosphere to press upon the exterior face of the lungs. In this way the elastic force of the lungs is determined, and, as explained above, this is equivalent to the negative pressure. Second, by thrusting a trocar through the thoracic wall so that its open end may lie in the pleural or mediastinal cavity, the other end being appropriately connected with a manometer. The older observers (Hutchinson) also made experiments upon freshly excised human lungs, determining their elastic force when distended by known amounts of air. The figures obtained by these different methods have shown some variations, but the following quotations give an idea of the average extent of this negative pressure. Heynsius,\* making use of the figures obtained by Hutchinson, estimates that in man the negative pressure in the thorax at the end of expiration is  $-4.5$  mms. Hg, while at the end of an inspiration it is equal to  $-7.5$  mms. Hg,—a variation during respiration, therefore, of 3 mms. Hg. That is, assuming that the atmospheric pressure is 760 mms. Hg, the conditions of pressure in the thorax and lungs at the end of inspiration and expiration are as follows:

AT THE END OF INSPIRATION.	AT THE END OF EXPIRATION.
Intrapulmonic pressure... 760 mms. Hg.	760 mms. Hg.
Intrathoracic pressure... 752.5 " "	755.5 " "

Aron gives results obtained from a healthy man in whom a canula was connected directly with the pleural cavity.† From 36 determinations he obtained the average result that at the end of quiet inspiration the negative pressure is  $-4.64$  mms. Hg and at the end of expiration  $-3.02$  mms. Hg—results considerably lower than those estimated by Heynsius. It should be borne in mind, however, that these values depend upon the condition of expansion of the chest,—that is, the position of the body and the depth of inspiration. On dogs Heynsius reports as follows: At end of inspiration,  $-9.4$  mms. Hg; end of expiration,  $-3.9$  mms. Hg. On rabbits,  $-4.5$  mms. and  $-2.5$  mms. Hg.

**Variations of Intrathoracic Pressure with Forced and Unusual Respirations.**—After the most forcible expiration, when the air-

\* "Archiv f. die gesammte Physiologie," 29, 265, 1882.

† Aron, quoted from Emerson, "Johns Hopkins Hospital Reports," 11, 194, 1903.

passages are open, the intrathoracic pressure is still negative by a small amount, since the lungs are still expanded beyond what might be called their normal size,—that is, their size when the pressure inside and outside is the same. If, however, a forced expiration is made with the glottis closed, as in the straining movements of defecation, parturition, etc., then naturally the intrathoracic pressure rises with the intrapulmonary pressure. The increased pressure from the compressed air in the lungs is felt upon the organs in the mediastinal spaces. The large veins especially are affected, and the flow in them is partially blocked, as is shown by the swelling of the veins in the neck outside the thorax. The maintenance of such conditions for a considerable period may seriously affect the circulation. The same general effect is obtained also in attacks of coughing, the violent spasmodic expirations with closed glottis causing a visible venous congestion in the head from the obstruction to the venous flow into the heart. Forceful inspirations, on the other hand, lower the intrathoracic pressure—that is, increase the negativity—whether the glottis is open or closed. When the glottis is freely open and a deep inspiration is made the intrathoracic pressure may fall as much as 30 mms. Hg,—that is, become equal to 730 mms. The lungs being much more expanded exert a correspondingly greater elastic force. If the glottis is closed during a deep inspiration then there is little actual expansion of the lungs, but the intrapulmonary pressure falls from the rarefaction of the air in the lungs, and the intrathoracic pressure, of course, falls with it.

**The Origin of the Negative Pressure in the Thorax.**—As is evident from the above explanation, the fact that the pressure in the thorax is less than an atmosphere is due in the long run to the circumstance that the lungs are smaller than the thoracic cavity which they occupy. In the fetus the lungs are solid, and completely fill the thoracic cavity, except for the part occupied by the other organs. It has been a question whether after birth the size of the thoracic cavity is suddenly and permanently increased by the first inspiratory movements, and a negative intrathoracic pressure thus produced at once. The careful experiments of Hermann\* seem to have settled this point. He proved that newly-born children between the first and the fourth day, show no measurable negative pressure in the thorax, and at the eighth day the pressure in the thoracic cavity is less than atmospheric by an amount equal to only  $-0.4$  mm. Hg. The negative pressure as we find it in the adult is evidently developed gradually, and is due to the fact that the thorax increases in size more rapidly and to a greater extent than the lungs, so that to fill the cavity the lungs become more and more expanded. It follows, also, from these facts, that the new-born

\* Hermann, "Archiv f. d. gesammte Physiologie," 30, 276, 1883.

child has practically no reserve supply of air in the lungs; at each expiration the lungs are entirely emptied (except for the minimal air). The ventilation of the lung alveoli is correspondingly more perfect than in older persons.

**Pneumothorax.**—When the pleural cavity on either side is opened by any means air enters and causes a greater or less shrinkage of the corresponding lung. This condition of air within the pleural cavity is designated as pneumothorax. It is evident that air may enter the pleural cavity in one of two general ways: By a puncture of the parietal pleura such as may be made by gunshot or stab wounds in the chest, or by a puncture of the visceral pleura, such as may occur, for example, by the rupture of a tubercle in pulmonary tuberculosis, the air in this case entering from the alveoli of the lungs. From the physical conditions involved it is evident that if the opening into the pleural cavity is kept patent then the lung will collapse completely and eventually will become entirely solid, since the small amount of entrapped minimal air will be absorbed by the blood. The other lung, the heart, etc., will also be displaced somewhat from their normal position by the unusual pressure. If, however, the opening is closed, then the air in the pleural cavity may be absorbed completely by the circulating blood and the lung again expand as this absorption takes place. In human beings pneumothorax occurs most frequently in conditions of disease, particularly pulmonary tuberculosis, and the air in the thorax is associated also with a liquid effusion, this combination being designated sometimes as hydropneumothorax.\*

**The Aspiratory Action of the Thorax.**—The negative pressure prevailing in the thoracic cavity must affect the organs in the mediastinal space. The intrathoracic portion of the esophagus, for instance, is exposed, at times of swallowing at least, to a full atmosphere of pressure on its interior, while on its exterior it is under the diminished intrathoracic pressure. This difference tends to dilate the tube and may aid in the act of swallowing. The main effect of the difference in pressure is felt, however, upon the flow of lymph and blood, especially the latter. The large veins in the neck and axilla are under the pressure of an atmosphere exerted through the skin, and the same is true for the inferior cava in the abdomen. But the superior and inferior cavæ and the right auricle are under a pressure less than one atmosphere. This difference in pressure must act as a constant favoring condition to the flow of blood to the heart. The difference is markedly increased at each inspiration; so that at each such act there is an increase in the velocity and volume of the flow to the heart,—an effect which is

\* See Emerson, "Pneumothorax," Johns Hopkins Hospital Reports, 11, 1, 1903.

usually referred to as the aspiratory action of the thorax. At each inspiration blood is "sucked" from the extrathoracic into the intrathoracic veins. So far as the inferior cava is concerned, this effect is augmented by the simultaneous increase in abdominal pressure. For as the diaphragm descends it raises the pressure in the abdomen as it lowers the pressure in the thorax. The two factors co-operate in forcing more blood from the abdominal to the thoracic portion of the cava. This aspiratory effect upon the venous flow to the heart is made more important by the arrangement of the valves in the jugular, subclavian, and femoral veins, which, as explained on p. 517 facilitate the emptying of the *venous cistern* toward the heart. There should be, of course, a similar effect, but in the opposite direction, upon the flow in the arteries. Each inspiration should retard the arterial outflow from the aorta into its extrathoracic branches. As a matter of fact, this effect probably does not take place. The arteries are thick walled and are distended by a high internal pressure, so that the small change of pressure of three or four millimeters of mercury during inspiration is probably incapable of influencing the caliber of the arteries, while it has a distinct effect upon the thin-walled veins, whose internal pressure is very small. The changes in intrathoracic pressure during respiration must affect the blood-flow also in the pulmonary circuit, the flow from the right to the left side of the heart. This effect is manifested in the so-called respiratory waves of blood-pressure which may be discussed briefly in this connection.

**Respiratory Waves of Blood-pressure.**—When a record is taken of the blood-pressure the tracing shows waves, unless the respiratory movements are very shallow, which are synchronous with the respiratory movements (see Fig. 271). When the respiration is dyspneic the waves of pressure are very marked. To ascertain the exact relations of these variations to the phases of respiration it is necessary to make simultaneous tracings of blood-pressure and respiration movements with the recording pens properly superposed. In the dog it is usually stated that the blood-pressure falls slightly at the beginning of inspiration, but rises during the rest of the act. At the beginning of expiration the pressure continues to rise for a time and then falls during most of this phase. On the whole, therefore, the effect of inspiration, its final effect, is to cause a rise of arterial pressure, while the effect of expiration is to cause a fall. The relationship of the two curves varies in other animals, so that a general statement regarding the relationship between the phase of respiration and the change in blood-pressure cannot be made. In the case of man various methods have been employed to determine this relationship. A continuous record of blood-



pressure in man may be taken by means of the sphygmomanometer according to a principle first suggested by Erlanger. The principle involved is to set the pressure in the cuff on the outside of the arm, somewhat below systolic pressure. The pulsations in the manometer will therefore be submaximal (see p. 504). If now the blood pressure rises the amplitude of the pulsations will increase, since the

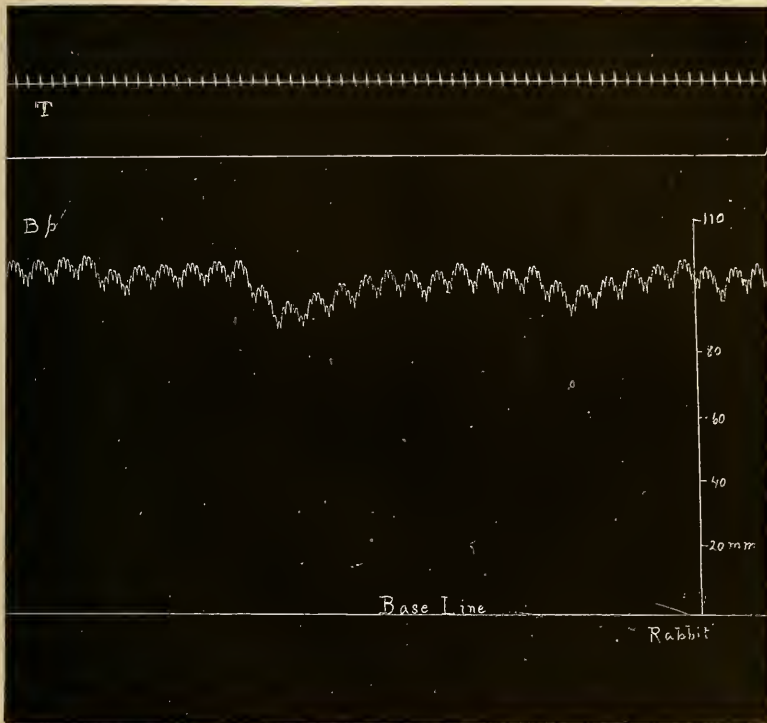

Fig. 271.—Respiratory waves of blood-pressure. Typical blood-pressure record as taken with a mercury manometer: *Bp* the blood-pressure record, shows the separate heart beats and the larger respiratory waves, each of which comprises six to seven heart beats.

intra-arterial diastolic pressure thereby approaches the extra-arterial pressure. The reverse of course happens with a fall of blood-pressure. Making use of this method it is found\* that in some cases in man the blood-pressure falls during inspiration and rises during expiration, while in other cases the reverse relationship holds.

It is generally agreed that this effect of the respiratory

\* Erlanger and Festerling, "Journal of Experimental Medicine," 15, 370, 1912; also Snyder, "American Journal of Physiology," 36, 430, 1915.

movements on the arterial pressure is due mainly to mechanical factors which influence the amount of blood discharged into the aorta. The matter is difficult to analyze successfully,\* but the following factors are the ones which have usually been emphasized. At each inspiration the aspiratory action of the thorax upon the venous flow to the right side of the heart is increased, and consequently more blood is thrown into the pulmonary circulation and eventually into the left ventricle. This factor would tend to increase the output of the heart during inspiration and thereby raise arterial pressure. On the other hand the blood-capacity of the lungs is increased during inspiration, owing to a stretching of the blood-capillaries during the expansion of the lungs, and this increase in capacity may serve, temporarily at least, to hold back the flow of blood to the left ventricle and thereby cause a fall of pressure during the inspiration. In addition to these mechanical factors there is a physiological element which enters into the problem, namely, the change in heart-rate, which tends to augment the outflow from the heart during inspiration.

In some individuals the heart-rate increases very perceptibly during inspiration, the change in rate taking place quite promptly with the beginning of the inspiratory act. In others this phenomenon is less marked, or is absent altogether. It has been shown by Fredericq that this change in dogs occurs when the chest is widely opened and the respiratory movements can have no mechanical effect upon the heart. He suggests, therefore, that the accelerated pulse during inspiration is due to an associated activity in the nerve centers of the medulla. When the inspiratory center discharges its efferent impulses into the phrenic nerves it also sends impulses by a sort of overflow into the neighboring cardio-inhibitory center. This latter center is, thereby, partially inhibited, its tonic effect on the heart is diminished, and the rate of the heart is increased. The variability in this factor in different individuals may help to explain the fact that in some cases the rise in blood-pressure occurs during the phase of inspiration, while in others it coincides rather with the expiration.

\* For the older literature, see de Jager, "Journal of Physiology," 7, 130.

## CHAPTER XXXVI.

### THE CHEMICAL AND PHYSICAL CHANGES IN THE AIR AND THE BLOOD CAUSED BY RESPIRATION.

**The Inspired and the Expired Air.**—The inspired air, atmospheric air, varies in composition in different places. The essential constituents from a physiological standpoint are the oxygen, nitrogen, and carbon dioxid. The new elements—argon, krypton, etc.—have not been shown to have any physiological significance, and are included with the nitrogen. The accidental constituents of the air vary with the locality. In average figures, the composition of this air is, in volume per cent.: nitrogen, 79; oxygen, 20.96; carbon dioxid, 0.04. The expired air varies in composition with the depth of the expiration and, of course, with the composition of the air inspired. Under normal conditions the expired air contains, in volume per cent.: nitrogen, 79; oxygen, 16.02; carbon dioxid, 4.38. In passing once into the lungs the air, therefore, gains 4.34 volumes of carbon dioxid to each hundred, and loses 4.94 volumes of oxygen.

	N.	O.	CO <sub>2</sub> .
Inspired .....	79	20.96	0.04
Expired .....	79	<u>16.02</u>	<u>4.38</u>
		4.94	4.34

This table expresses the main fact of external respiration: the respired air loses oxygen and gains carbon dioxid and consequently the blood absorbs oxygen and eliminates carbon dioxid. It will be noted, also, that the volume of oxygen absorbed is greater than the volume of carbon dioxid given off. This discrepancy is explained by the general fact that the oxygen absorbed is used in the long run to oxidize the carbon and also the hydrogen of the food; consequently, while most of it is eliminated in the expired air as carbon dioxid, some of it is excreted as water. For the sake of completeness it may be stated that traces of hydrogen and methane are also found in the expired air. They probably originate in the intestines from fermentation processes and are carried off in solution in the blood.

**Physical Changes in the Expired Air.**—The expired air is warmed nearly or quite to the body temperature and is nearly saturated with water vapor. Since, as a rule, the air that we inspire is much cooler than the body and is far from being saturated with water vapor, it is evident that the act of respiration entails upon the body a loss of heat and of water. Breathing is, in fact, one of the means by which the body temperature is regulated, although in man it is a subsidiary means. In other animals—the dog, for instance—panting is a very important aid in controlling the body heat. Heat is lost in respiration not simply in warming the air in the air passages, but also by the evaporation of water in the alveoli, the conversion of water from the liquid to the gaseous form being attended by an absorption of heat. Breathing is also one of the means by which the water contents of the body are regulated. The water that we ingest or that is formed within the body is kept within certain limits, and this regulation is effected by the secretions of urine and sweat mainly, but in part also by the constant loss of water from the blood as it passes through the lungs.

**The Injurious Effect of Breathing Expired Air—Ventilation.**—It is generally recognized that in badly ventilated rooms the air acquires a disagreeable odor, perceptible especially immediately on entering, and that persons remaining under such conditions for any length of time suffer from headache, depression, and a general feeling of uncomfortableness. It has been assumed, although without sufficient proof, that these effects are due to the vitiation of the atmosphere by the expired air. When the ventilation is very imperfect and the room greatly crowded death may result, as, for instance, in the historical case of the Black Hole of Calcutta. In extreme cases of this latter kind it is most probable that several causes combine to produce a fatal result. The conditions are such as to lead to a very large increase in carbon dioxide and diminution of oxygen in the respired air—a result which carried to a certain point will itself cause death; and in addition the air becomes heated to a high temperature and saturated with water vapor, both of these latter conditions preventing loss of heat from the body and producing a fever temperature. Under the ordinary conditions of life poor ventilation produces its obviously evil results in rooms temporarily occupied—schools, churches, lecture rooms, theaters, etc.,—and it is important to know what is the cause, and how it may be avoided. On the basis of older work it has been assumed that there is present in the expired air a volatile organic substance which when breathed again, possibly after having undergone some further change, exerts a toxic influence. The evil effects of badly ventilated rooms have been attributed mainly

to this supposed substance. The investigations that have been made upon this substance are, unfortunately, far from being conclusive.\* It seems to be clear that, when the expired air is condensed by passing it into a cooled chamber, the water thus obtained, about 100 c.c. for 2500 liters of air, is clear, odorless, and has only a minute trace of organic matter. If this liquid with or without condensation is injected under the skin or into the blood-vessels no evil result follows, according to the testimony of the majority of observers. But it remains possible, of course, that the substance if present may be destroyed by this method or may escape precipitation in the condensed water. An experiment that was supposed to give a positive indication of the existence of an organic (basic) poison in the expired air is the following, first performed by Brown-Séguard: A series of—say, five—bottles, each of a capacity of a liter or more, are connected together in train so that air can be drawn through them by an aspirator. A live mouse is placed in each bottle, and between bottles 4 and 5 an absorption tube is arranged containing sulphuric acid. Under these conditions only the mouse in bottle 1 gets fresh air, those in the successive bottles get more and more impure air, while in bottle 5 this air is purified to the extent of removing the organic matter by passing it through sulphuric acid. The result of such an experiment as described by some observers is that the mouse in bottle 4 dies after a certain number of hours, the one in bottle 3 later, while those in the first and last bottles show no injurious effects. The obvious conclusion is that death in such cases is due to some organic toxic substance, and not to a mere increase of carbon dioxide, chemical analysis showing that this latter substance does not accumulate sufficiently under these conditions to cause a fatal result. Some other observers have failed to get this effect, but even assuming it to be correct it will be noted that the experiment gives no proof that the organic substance in question is excreted in the expired air. Indeed, the seemingly very careful experiments of Formánek make it probable that in these experiments the toxic substance is ammonia or an ammonia compound, which is not given off from the lungs, but from the decomposition of the urine and feces in the cage. When this latter source of contamination is removed the expired air is practically free from ammonia and without injurious effect. The expired air, therefore, according to work of this character, contains no organic poison which can be regarded as a product of respiration.

\* See Haldane and Smith, "Journal of Pathology and Bacteriology," 1, 168 and 318, 1893; Merkel, "Archiv f. Hygiene," 15, 1, 1892; Formánek, "Archiv f. Hygiene," 38, 1, 1900; Weichardt, *ibid.*, 65, 252, 1908. Amoss, "Journal of Exp. Medicine," 17, 132, 1913.

Some observers (Hermann, Haldane, and Smith) have made careful experiments upon men which also seem to throw much doubt upon the existence of a toxic substance in expired air. Individuals kept in a confined space for a number of hours show no evil effects except when the accumulation of the carbon dioxid has reached a concentration of over 4 per cent. At this concentration rapid breathing is apparent, and if it rises to 10 per cent. great distress is felt and the face becomes congested and blue. These authors conclude that expired air is injurious in itself only from the carbon dioxid it contains, and only when this gas accumulates to a percentage such as is not found in the worst ventilated rooms. As opposed to these negative results, Weichardt reports a series of experiments upon mice in which the expired air of a number of animals was passed through acidulated water, and the latter was then condensed in a vacuum to a small volume and neutralized. When injected into a fresh animal this material brought on a soporific condition, fall of body temperature, and diminution in output of carbon dioxid. The author explains these results on the assumption that some of the so-called fatigue-toxin (kenotoxin) is excreted by way of the lungs, and he believes that the known depressing effects of poor ventilation are an expression of the action of this substance. His results have not been confirmed and, at present, the definitely known evil results of breathing the air of crowded, poorly ventilated rooms must be referred to other possible causes, such as the increase in temperature and moisture. These two conditions cause depression and malaise even when an adequate supply of air is provided. It is possible, also, that the material given off from the skin in the perspiration, sebaceous secretions, etc., may account sufficiently for the odor and, possibly, also for some of the general evil effects. If the ventilation is so poor that the carbon dioxid accumulates to the extent of 3 to 4 per cent., then this factor begins to exercise a direct effect upon the respiratory movements and the general condition,—an effect which increases as the percentage of carbon dioxid rises.

*Ventilation.*—It is obvious from the foregoing statements that our knowledge is not yet sufficiently complete to enable us to say positively at what point air in a room becomes injurious to breathe, whether from products of expiration, or exhalation, or changes in temperature and moisture. The statement is frequently made in the books that, when the air contains as much as 1 per cent. of carbon dioxid (Smith) that has been produced by breathing, evil results, as judged by one's feelings, are sure to occur, but the experiments of Haldane and Smith seem to disprove this statement entirely.

Systems of ventilation which have held in view simply the object of maintaining the air at an approximately normal composition as regards the oxygen and the carbon dioxid have not proved entirely satisfactory in practical use, and probably for the reason that they have neglected to take into account the conditions as regards temperature and moisture. Laboratory experiments tend to show that individuals in a confined space may rebreathe air until its composition is noticeably altered in regard to the carbon dioxid and oxygen, and yet no distress be felt if provision is made for avoiding a rise in temperature and humidity, and, on the other hand, rooms may seem to be poorly ventilated, as judged by the sensations, when the renewal of air is sufficient to prevent an obvious change in its gaseous composition.

**The Gases of the Blood.**—The gases that are contained in the blood are oxygen, carbon dioxid, and nitrogen. These gases may be extracted completely and in a condition for quantitative analysis by means of some form of gas-pump. The principle of most of the gas-pumps used in the physiological laboratories is the same. The apparatus is arranged so that the blood to be examined is brought into a vacuum while kept at the temperature of the body. Under these conditions all of the oxygen and nitrogen and part of the carbon dioxid are given off and may be collected by suitable means. A portion of the carbon dioxid present in the blood is in such stable combination that to remove it it may be necessary to add some dilute acid, such as phosphoric acid. This portion of the carbon dioxid is designated in this connection as the fixed carbon dioxid.

The principle of the gas pump may be explained most easily by describing the simple form devised by Gréhant. The essential parts of this pump are represented in Figure 272. The mercury pump consists of two bulbs, one movable (*M*), the other fixed (*F*). *M* may be raised and lowered by the windlass (*P*). Above *F*, there is a three-way stopcock (*m*) by means of which the chamber *F* may be put into communication with the outside air by way of *C*, or with the bulb *B*, which is to contain the blood, or may be shut off completely. If *M* is raised so as to fill *F* entirely, and the stopcock *m* is shut off, then on lowering *M* the mercury will flow into it, leaving a perfect vacuum in *F*, since the distance between *F* and *M* is greater than the barometric height. If the stopcock *m* is turned so as to throw *F* into communication with *B*, the chamber of this latter is brought under the influence of the vacuum and any gases that it may contain will be distributed between *B* and *F*. If stopcock *m* is again turned off and *M* is raised, the gases in *F* will be condensed at its upper end, and by turning the stopcock *m* properly these gases may be forced to the outside by way of *C* or may be collected, if desired, in a burette filled with mercury and inverted over the opening from *F* contained in the bottom of *C*. In performing an experiment the flask *B*, which is to contain the blood, is connected with *F*, as shown in the figure, all joints being protected from leakage by a seal of water outside, as shown at *h*, which represents a piece of wide rubber tubing filled with water so as to protect a joint between two pieces of glass tubing. *B* is next exhausted completely by raising and lowering *M* a number of times in the way described above until on throwing *B* into communication with a vacuum in *F* no further

gas is given off. The last particles of air may be driven out from *B* by boiling a little water in it. After a complete vacuum has been established in *B* a measured amount of blood is introduced from a graduated syringe, *S*, as represented in the figure. This blood must be taken directly from the vessels of the animal and be introduced into *B* at once. *B* is kept immersed in water

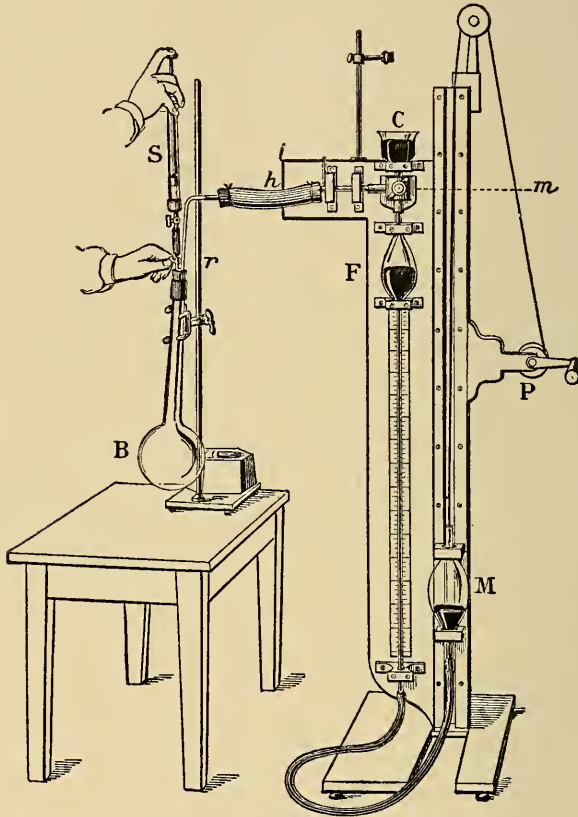

Fig. 272.—Gas pump for extracting the gases of blood (*Gréhant*): *M* and *F*, Mercury receivers; *P*, windlass for raising and lowering *M*; *m*, a three-way stop-cock protected by a seal of mercury or water; *C*, a cup with mercury over which the receiving eudiometer is placed to collect the gases; *B*, the bulb in which, after a vacuum is made, the blood is introduced by the graduated syringe, *S*. By means of the stop-cock *m* the vacuum in *F*, caused by the fall of the mercury, can be placed in communication with *B*. After the gases have diffused over into *F*, *M* is raised, and when the stop-cock *m* is properly turned these gases are driven out through *C* into the receiving tube. The operation is repeated until no more gas is given off from *B*.

at the temperature of the body, and the bulb *M* is now raised and lowered a number of times so that the gases given off from the blood are drawn over into *F* and then by proper manipulation of the stop-cock are driven into a burette fastened over the opening of the tube in *C*. To drive off all of the carbon dioxide a little dilute phosphoric acid must be added to the blood in *B* by means of the syringe, *S*. The gases thus collected into the burette are first measured and are then analyzed for the three important constituents by some of the accepted gasometric methods. The principle involved is to



absorb first from the mixture all of the  $\text{CO}_2$  by introducing a solution of sodium or potassium hydrate. The reading of the volume left after this absorption is completed compared with the first reading gives the volume of  $\text{CO}_2$ . Next, a freshly made alkaline solution of pyrogallic acid is introduced into the tube. This solution absorbs all of the oxygen, whose volume is thus easily determined. The gas that is left unabsorbed after the action of these two solutions is nitrogen. The volumes of gases are reduced, as is the custom, to unit pressure and temperature,—that is, to zero degree centigrade and 760 mms. barometric pressure. A correction must also be made for the tension or pressure exerted by the aqueous vapor in the gases. These corrections are made by means of the following formula:

$$V^1 = \frac{V(B-T)}{760 \times (1 + 0.003665t)}$$

in which  $V^1$  represents the corrected volume,  $V$  the volume actually observed,  $B$  the barometric height at the time and place of the observation,  $T$  the aqueous tension at the temperature of the reading, and  $t$  the temperature in degrees centigrade.

*Determination of the Oxygen by the Potassium Ferricyanide Method.*—For the determination of the oxygen in small quantities of blood a convenient method has been introduced by Haldane which is applicable for clinical as well as experimental purposes. The principle of the method consists in first laking the blood with ammonia and then adding a solution of potassium ferricyanide. A reaction ensues in which oxygen is given off in an amount identical with that obtained by submitting the blood to a vacuum. This method has found its most convenient application in the Barcroft apparatus (Fig. 273), in which the volume of gas liberated is calculated from the pressure change caused in a differential manometer. The manometer ( $M$ ) is a U-tube, provided above with stopcocks through which communication may be made with the outside air, and connected with two pear-shaped bottles in which the blood to be analyzed is placed. The manometer contains also a central tube ( $A$ ) through which the two limbs of the manometer may be filled with clove oil to a certain height about half way up the tubes. In making a determination the stopcocks are left open, and in each of the pear-shaped bottles one places 1 c.c. of blood and 2 c.c. of dilute ammonia. The apparatus is thoroughly shaken to lake the blood, and then on one side a little of a saturated solution of potassium ferricyanide is placed in a special receptacle in the stopper of one of the pear-shaped bottles. The stoppers are inserted, the stopcocks are closed, and then by turning the bottle the ferricyanide is allowed to mix with the blood on its side. Oxygen is given off, and the pressure caused by it is indicated by the difference in level of the clove oil in the two limbs of the manometer. From this pressure difference the volume of the gas is given by the formula  $x = k p$ , in which  $x$  is the volume of the oxygen gas in cubic millimeters,  $p$  is the pressure difference shown by the manometer, and  $k$  is a constant. Before using the apparatus the value of  $k$  must be determined experimentally by liberating a known volume of

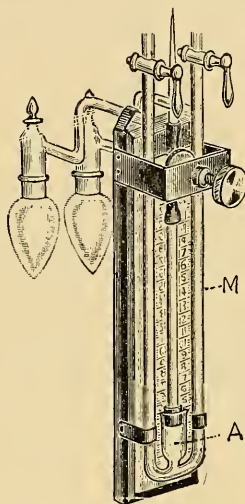

Fig. 273.—Differential manometer for oxygen determination in blood:  $M$ , The manometer containing clove oil;  $A$ , the central tube used to fill  $M$  with the clove oil. The manometer communicates above with the two pear-shaped flasks in which the specimens of blood are placed, and in one of which the oxygen is liberated by the action of the potassium ferricyanide. (See text for description of the method of using.) (Barcroft and Roberts.)

oxygen gas and determining the pressure difference produced. For this purpose pure  $H_2O_2$  is used, and the oxygen is liberated by the addition of a solution of potassium permanganate. In this case  $x$  and  $p$  are known and  $k$  may be calculated.  $k = \frac{x}{p}$ . For technical details consult Barcroft, "The Respiratory Function of the Blood," 1914 (Appendix).

By means of such methods the gases in the blood have been determined. The quantities vary somewhat, of course, with the condition of the animal and with the species of animal. In a quick analysis of dogs' arterial blood made by Pfüger the following figures were obtained reckoned in volumes per cent.: O, 22.6;  $CO_2$ , 34.3; N, 1.8. In this case each 100 c.c. of arterial blood contained 22.6 c.c. of O and 34.3 c.c. of  $CO_2$  measured at  $0^\circ C.$  and 760 mms. Hg. An analysis of human blood (Setschenow) gave closely similar figures; O, 21.6 per cent.;  $CO_2$ , 40.3 per cent.; and N, 1.6 per cent. When the arterial and the venous bloods are compared it is found that the venous blood has more carbon dioxid and less oxygen. Average figures showing the difference in composition are as follows:

	O.	$CO_2$ .	N.
Arterial blood .....	20	38	1.7
Venous blood .....	12	45	1.7
Difference.....	8	<u>7</u>	<u>0</u>

The actual amounts of oxygen and carbon dioxid in the venous blood vary with the nutritive activity of the tissues, and differ therefore in the various organs according to the state of activity of each organ in relation to the volume of its blood supply. This point is well illustrated by some analyses made by Hill and Nabarro\* of the gases in the venous blood from the brain and the muscles, respectively. Their average results when both tissues were at rest were as follows:

	OXYGEN.	CARBON DIOXID.
Venous blood from limbs (femoral)....	6.34 per cent.	45.75 per cent.
“ “ “ brain (torcular) ...	13.49 “ “	41.65 “ “

It will be seen that under similar conditions there is much less oxygen used and carbon dioxid formed in the brain than in the limbs (muscles). In the former organ the physiological oxidations must either be small compared with those of the muscles, or the brain tissues receive a relatively ample supply of blood, so that the tissue metabolism has less effect upon the blood composition. The venous blood as it comes to the lungs is a mixture of bloods from different organs, and its composition in gases will be constant only when the conditions of the body are kept uniform. Much work has been done in physiology to determine the condition in which these various gases are held in the blood. The results obtained show that they are held in small part in solution, but mainly in

\* Hill and Nabarro, "Journal of Physiology," 18, 218, 1895.

chemical combination. To understand the part played by each factor and the conditions that control the exchange of gases in the lungs and tissues it is necessary to recall some facts regarding the physical and chemical properties of gases.

**The Pressure of Gases and the Terms Expressing these Pressures.**—The air around us exists under a pressure of one atmosphere and this pressure is expressed usually in terms of the height of a column of mercury that it will support,—namely, a column of 760 mms. Hg, which is known as the normal barometric pressure at sea-level. Air is a mixture of gases, and according to the mechanical theory of gas-pressure each constituent exerts a pressure corresponding to the proportion of that gas present. In atmospheric air, therefore, the oxygen, being present to the extent of 20 per cent., exerts a pressure of  $\frac{1}{5}$  of an atmosphere or  $\frac{1}{5} \times 760 = 152$  mms. Hg. When we speak of one atmosphere of gas pressure, therefore, we mean a pressure equivalent to 760 mms. Hg, and in any given mixture the pressure exerted by any constituent may be expressed in percentages or fractions of an atmosphere, or in the equivalent height of the mercury column which it will support.

**Absorption of Gases in Liquids.**—When a gas is brought into contact with a liquid with which it does not react chemically a certain number of the moving gaseous molecules penetrate the liquid and become dissolved. Some of these dissolved molecules escape from the water from time to time, again becoming gaseous. It is evident, however, that if a liquid, water, is brought into contact with a gas under definite pressure,—that is, containing a definite number of molecules to a unit volume,—an equilibrium will be established. As many molecules will penetrate the liquid in a given time as escape from it, and the liquid will hold a definite number of the gas molecules in solution; it will be saturated for that pressure of gas. If the pressure of the gas is increased, however, an equilibrium will be established at a higher level and more molecules of gas will be dissolved in the liquid. Experiments have shown, in accordance with this mechanical conception, that the amount of a given gas dissolved by a given liquid varies, the temperature remaining the same, directly with the pressure,—that is, it increases and decreases proportionally with the rise and fall of the gas pressure. This is the law of Henry. On the other hand, the amount of gas dissolved by a liquid varies inversely with the temperature. It follows, also, from the same mechanical views that in a mixture of gases each gas is dissolved in proportion to the pressure that it exerts, and not in proportion to the pressure of the mixture. Air consists, in round numbers, of 4 parts of N and 1 part of O. Consequently, when a volume of water is exposed to the air the oxygen is dissolved according to its “partial pressure,”

—that is, under a pressure of  $\frac{1}{5}$  of an atmosphere (152 mms. Hg). The water will contain only  $\frac{1}{5}$  as much oxygen as it would if exposed to a full atmosphere of oxygen—that is, to pure oxygen. And, on the other hand, if water has been saturated with oxygen at one atmosphere (760 mms.) of pressure and is then exposed to air, four-fifths of the dissolved oxygen will be given off, since the pressure of the surrounding oxygen has been diminished that much. *Absorption coefficient.* By this term is meant the number that expresses the proportion of gas dissolved in a unit volume of the liquid under one atmosphere of pressure. The absorption coefficient will vary, of course, with the temperature. The gases that interest us in this connection are oxygen, nitrogen, and carbon dioxid. The absorption coefficients of these gases for the blood at the temperature of the body are as follows: O, 0.0262; N, 0.0130; CO<sub>2</sub>, 0.5283.\* That is, 1 c.c. of blood at body temperature dissolves 0.0262 of 1 c.c. of oxygen if exposed to an atmosphere of pure oxygen, and so on. The solubility of the CO<sub>2</sub> is therefore twenty times as great as that of oxygen. Accepting these figures, we may calculate how much of these three gases can be held in the arterial blood in physical solution, provided we know the pressure of the gases in the alveoli of the lungs. The composition of the alveolar air will be discussed farther on, but we may assume at present that it contains 80 per cent. of nitrogen, 15 per cent. of oxygen, and 5 per cent. of carbon dioxid. In 100 c.c. of blood, therefore, the following amounts of these gases should be held in solution:

Nitrogen .....	100	× 0.013	× 0.80	= 1.04	c.c.
Oxygen .....	100	× 0.0262	× 0.15	= 0.393	“
Carbon dioxid .....	100	× 0.5283	× 0.05	= 2.64	“

As will be seen from the analyses given above of the actual amounts of these gases obtained from the blood, the nitrogen alone is present in quantities corresponding to what would be expected if it is held in simple physical solution.

**The Tension or Pressure of Gases in Solution or Combination.**—When a gas is held in solution the equilibrium is destroyed if the pressure of this gas in the surrounding medium or atmosphere is changed. If this pressure is increased the liquid takes up more of the gas, and an equilibrium is established at a higher level. If the pressure is decreased the liquid gives off some of the gas. The pressure of the gas in the surrounding atmosphere at which equilibrium is established measures the tension of the gas in the liquid at that time. Thus, when a bowl of water is exposed to the air the tension of the oxygen in solution is 152 mms.

\* As given by Bohr, the absorption coefficients of these three gases at 40° C. are as follows: Oxygen, 0.0231; nitrogen, 0.0118; carbon dioxid, 0.530.

Hg; that of the nitrogen is 608 mms. Hg. If the same water is exposed to pure oxygen the tension of the oxygen in solution is equal to 760 mms. Hg, while that of the nitrogen sinks to zero if the gas that is given off from the water is removed. With compounds such as oxyhemoglobin the tension under which the oxygen is held is measured by the pressure of the gas in the surrounding atmosphere at which the compound neither takes up nor gives off oxygen. If, therefore, it is necessary to determine the tension of any gas held in solution or in dissociable combination it is sufficient to determine the percentage of that gas in the surrounding atmosphere and thus ascertain the partial pressure that it exerts. If the atmosphere contains 5 per cent. of a given gas the partial pressure exerted by it is equal to 38 mms. Hg. ( $760 \times 0.05$ ), and this figure expresses the tension under which the gas is held in solution or combination in a liquid exposed to such an atmosphere. As regards the tension of the gases in arterial and venous blood, this procedure is, of course, not possible, since the blood is surrounded, not by an atmosphere whose composition can be analyzed, but by the liquids of the body, the lymph and cell juices. To determine the tension of the gases in the blood it is necessary to remove the blood from the vessels and bring it into contact with an atmosphere containing a known quantity of O, CO<sub>2</sub>, or N, according to the gas to be measured. By trial an atmosphere can be obtained in which this gas is contained in amounts such that there is no marked increase or decrease in quantity after standing in diffusion relations with the blood. The percentage of the gas in the atmosphere chosen will measure the tension of that gas in the blood. An instrument which has been much used for such determinations is represented

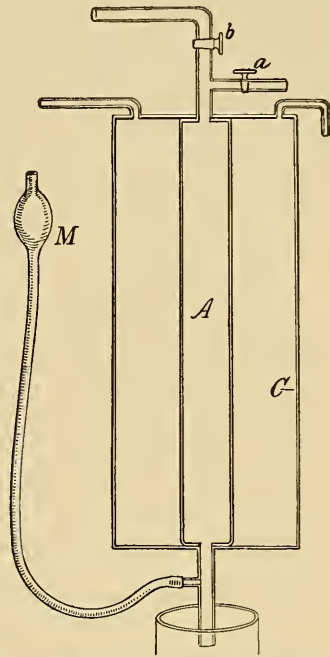

Fig. 274.—Diagram to show the principle of the aerotonometer: *A*, The tube containing a known mixture of gases, O, CO<sub>2</sub>, N; *C*, the outside jacket for maintaining a constant body temperature. When stopcock *b* is open the blood trickles down the sides of *A* and enters into diffusion relations with the contained gases. After equilibrium is reached the stopcock *b* is closed and *a* is opened. By means of the mercury bulb the gases can then be forced out of *A* into a suitable receiver for analysis.

diagrammatically in Fig. 274. It is known as a tonometer or aerotonometer (Pflüger). It consists of a tube (*A*) which can be connected through *b* directly with the blood-vessels. This tube *A* is surrounded by a jacket (*C*) containing warm water, so that the blood may be kept at the body temperature during the experiment. *A* is first completely filled with mercury from the bulb *M* to drive out the air. An atmosphere of known composition is then sucked into *A* by dropping the bulb. Blood is allowed to flow into *A* through the stopcock *b* and to trickle down the sides of the tube. Diffusion relations are set up between the blood and the known atmosphere, and after equilibrium has been established the gas is driven out through *a* into a convenient receiver and analyzed. If two aerotonometers are used, one containing the gas at somewhat higher pressure than that expected, and the other at a somewhat lower pressure, an average result is obtained which expresses with sufficient accuracy the pressure of the given gas in the blood.\*

It is important not to confuse the tension at which a gas is held in a liquid with the volume of the gas in solution. Thus, blood exposed to the air contains its oxygen under a tension of 152 mms. Hg, but the amount of oxygen is equal to 20 volumes per cent. Water exposed to the air contains its oxygen under the same tension, but the amount of gas in solution is less than 1 volume per cent. Tensions of gases in liquids are expressed either in percentages of an atmosphere or in millimeters of mercury. Thus, the tension of oxygen in arterial blood is found to be equal to about 13 per cent. of an atmosphere or 100 mms. Hg. ( $760 \times 0.13$ ).

**The Condition and Significance of the Nitrogen.**—We may accept the view that the nitrogen of the blood is held in physical solution. The amount present corresponds with this view, and, moreover, it is found that the quantity varies directly with the pressure in accordance with the law given above. If an animal is permitted to breathe an atmosphere of oxygen and hydrogen the nitrogen disappears from the blood, and when ordinary air is breathed the nitrogen contents of the arterial and venous bloods exhibit no constant difference in quantity. It seems certain, therefore, that the nitrogen plays no direct rôle in the physiological processes. It is absorbed by the blood in proportion to its partial pressure in the alveoli of the lungs and circulates in the blood in small amounts without exerting any immediate influence upon the tissues.

**Condition of Oxygen in the Blood.**—That the oxygen is not held in the blood merely in solution is indicated, in the first place,

\* For description of more modern instruments, see Tigerstedt, "Handbuch d. physiologischen Methodik," vol. ii., 1911.

by the large quantity present and, in the second place, by the fact that this quantity does not vary directly with the pressure in the surrounding medium. It is definitely known that by far the largest portion of the oxygen is held in chemical combination with the hemoglobin of the red corpuscles, while a much smaller portion, varying with the pressure, is held in solution in the plasma. The compound oxyhemoglobin possesses the important property that when the pressure of oxygen in the surrounding medium falls sufficiently it begins to dissociate and free oxygen is given off. The process of dissociation is facilitated also by increase of temperature, provided, of course, that it does not rise to the point of coagulating the hemoglobin. The amount of dissociation that takes place under different pressures of oxygen in the surrounding medium has been studied both for solutions of pure hemoglobin\* and for defibrinated blood.† It would seem from this work that the compound between oxygen and hemoglobin is more easily dissociated when the hemoglobin is in its natural condition in the corpuscles than when it has been crystallized out and obtained in pure solutions. The results that have been obtained from experiments upon defibrinated blood probably represent, therefore, more nearly the conditions of dissociation in the body. The results obtained by Bohr are indicated in the curve of dissociation shown in Fig. 275, obtained from experiments on dog's blood. At a pressure of oxygen of 152 mms.—that is, when exposed to ordinary air—the hemoglobin is nearly or completely saturated with oxygen. If the oxygen pressure is increased,—if, for instance, the blood is exposed to pure oxygen (pressure, 760 mms.),—no more oxygen is combined chemically by the hemoglobin. Additional oxygen will be taken up by the blood, but only in so far as it can pass into solution in the blood-plasma. Oxygen thus dissolved in the blood-plasma obeys the physical law of solution, and will be at once given off when the oxygen pressure of the surrounding medium is lowered. If the pressure of oxygen falls below that of the air (152 mms.) the chemically combined oxyhemoglobin begins to dissociate slowly at first, but as the pressure falls below 70 mms, the dissociation becomes much more rapid, and the oxygen thus liberated from chemical combination is from a quantitative standpoint much more important than that freed from solution in the plasma. This, in fact, is the process that takes place as the blood circulates through the tissues. The arterial blood enters the capillaries with its hemoglobin nearly saturated with oxygen,—about 19 c.c. to each 100 c.c. of blood. After it leaves the capillaries the venous blood contains only about 12 volumes of oxygen to each 100 c.c. of blood. In the

\* Hufner, "Archiv f. Physiologie," suppl. volume, 1901, p. 213.

† Loewy, "Archiv f. Physiologie," 1904, p. 245.

passage of the capillaries, which takes only about one second, the blood loses, therefore, about 35 per cent. or more of its oxygen. The physical theory of respiration furnishes data to show that this loss is due to a dissociation of the oxyhemoglobin, owing to the fact that in passing through the capillaries the blood is brought into exchange with a surrounding medium—lymph, cell liquid—in which the oxygen pressure is very low. An additional fact of importance in this connection is shown by the curves produced in Fig. 275. In the tissues where the oxyhemoglobin undergoes dissociation with the liberation of oxygen, and in the lungs where the hemoglobin takes up oxygen from the alveolar air, the blood

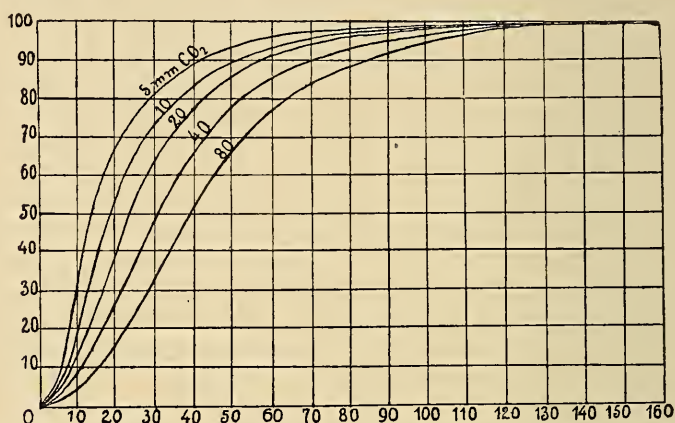

Fig. 275.—Curves of dissociation of the oxyhemoglobin at different pressures of oxygen. Five curves are shown to indicate that the dissociation of the oxyhemoglobin is greatly influenced by the presence of  $\text{CO}_2$ . The figures along the ordinates (10 to 100) indicate percentages of saturation of the hemoglobin with oxygen, while the figures along the abscissa (0 to 160) indicate different pressures of oxygen. The curve marked 5 mm.  $\text{CO}_2$  shows the amount of combination of oxygen and hemoglobin when the  $\text{CO}_2$  is absent or present only in traces. In this curve at a pressure of 30 mms. of oxygen it will be seen that the hemoglobin is 80 per cent. saturated with oxygen, while with a pressure of 40 mms. of  $\text{CO}_2$ , which approximates that in the body, the hemoglobin at the same pressure of oxygen is only 50 per cent. saturated. (After Bohr.)

is surrounded by a medium containing both oxygen and carbon dioxid. Laboratory experiments show that the presence of the carbon dioxid influences the dissociation curve in the direction indicated in the figure. At a carbon dioxid pressure equivalent to that of the alveolar air (40 mms.) it will be noticed that the curve is lower, that is, at any given pressure of oxygen, 30 mms., for example, less oxygen will be held by the hemoglobin, or the percentage saturation of the hemoglobin with oxygen will be lower. So also changes in the reaction of the blood toward the acid side, the condition designated in medicine as acidosis, will be accompanied by a similar lowering of the curve of dissociation, that is, by a diminished capacity of the hemoglobin for oxygen at these



pressures below the saturation point. In determining the actual dissociation curve of the blood in man it is desirable, therefore, to obtain the figures expressing the percentage saturation of the hemoglobin in atmospheres containing carbon dioxide in amounts equal to that found in the alveolar air of the individual examined.

In Fig. 275 *a* a dissociation curve for human blood is given in which this factor was considered. The curve shows also, in the thickness of the line, the individual variations that may be expected in the bloods of normal persons. For example, at an oxygen pressure of 40 mms. the percentage saturation of the hemoglobin for oxygen varies between 70 and 78 or 79. For a blood

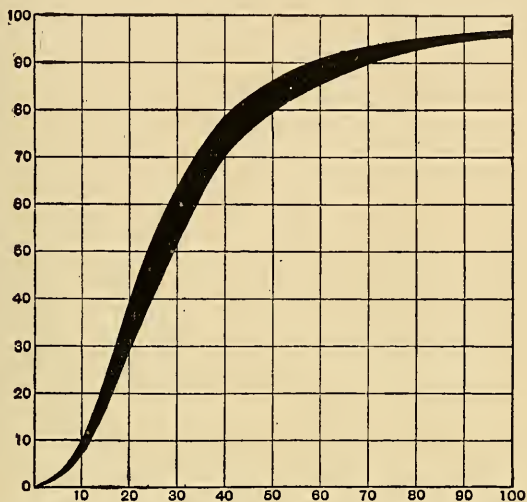

Fig. 275 *a*.—The dissociation curve for human blood. The thickness of the curve indicates the limits within which the curve may fall for normal persons. The figures along the abscissa indicate the pressure of oxygen in mms. of mercury; those along the ordinate indicate the percentage saturation of the hemoglobin with oxygen. (From Barcroft, "The Respiratory Function of the Blood." By permission of University Press, Cambridge, England, Publishers.)

that falls within the limits indicated by the curve Barcroft\* proposes the designation *mesectic*. Bloods which at any given pressure, below saturation, take up a larger percentage of oxygen (higher curve) may be called *pleonectic*, while those which under the same conditions are less saturated than normal (lower curve) are *meionectic*.

**Condition of the Carbon Dioxid in the Blood.**—The condition in which the carbon dioxide is held in the blood is not entirely understood. It has long been recognized that a certain small percentage is held in simple physical solution in the plasma and in the corpuscles, and that a certain additional amount, much

\* Barcroft, "The Respiratory Function of the Blood," 1914.

larger than the preceding, is chemically combined with the alkali of the blood as a carbonate, most probably as a bicarbonate ( $\text{HNaCO}_3$ ). Other facts tend to show that the available alkali of the blood in combination as carbonate or phosphate is not sufficient to combine with the quantity of carbon dioxid normally present. In recent years an additional possibility has been suggested by the discovery (Bohr) that carbon dioxid forms a dissociable compound with hemoglobin (p. 429), and the probability that a similar compound may be formed with the proteins of the plasma. Accepting this suggestion it would seem that the carbon dioxid exists in the blood in three forms. The amounts present in each form is estimated by Loewy\* as follows: In each 100 c.c. of arterial blood, containing normally 40 volume per cent. of carbon dioxid, there is

Physically absorbed in plasma and corpuscles.....	1.9 per cent.
Held as sodium bicarbonate	{ in corpuscles... 6.8 } ..18.8 " "
	{ in plasma .....12.0 }
Held in organic combination	{ in corpuscles .. 7.5 } ..19.3 " "
	{ in plasma .....11.8 }

When serum or plasma is exposed to a vacuum at body temperature only a portion of the carbon dioxid is given off; to obtain the balance it is necessary to add acid to the liquid. This latter portion, liberated only by a stronger acid, is spoken of as the "fixed carbon dioxid." If instead of exposing serum or plasma to a vacuum one uses full blood, that is, plasma or serum plus corpuscles, all the carbon dioxid may be obtained without the necessity of adding acid. This fact has been explained on the supposition that the hemoglobin under these conditions plays the part of an acid in breaking up the compound in which the carbon dioxid is firmly held. Presumably this fixed carbon dioxid is the portion which in the above classification is represented as bicarbonate. Since the portion that is held in organic combination is apparently more easily dissociated, it seems likely that it furnishes the main compound which is physiologically useful in providing a means for the transportation of carbon dioxid from the tissues, where it is formed, to the lungs, where it is eliminated.

**The Physical Theory of Respiration.**—The physical theory of respiration assumes that the gaseous exchange in the lungs and in the tissues takes place in accordance with the physical laws of diffusion of gases. If a permeable membrane separates two volumes of any gas, or two solutions of any gas at different pressures, the molecules of the gas will pass through the membrane in both

\* Loewy, "Handbuch d. Biochemie," 1908, IV.

directions until the pressure is equal on both sides. As the excess of movement is from the point of higher pressure to the point of lower pressure, attention is paid only to this side of the process, and we say that the gas diffuses from a point of high tension to one of lower tension. After equilibrium is established and the pressure is the same on both sides we must imagine that the diffusion is equal in both directions, and the condition is the same as though there were no further diffusion. In order for this theory to hold for the exchange in the body it must be shown that the physical conditions are such as it demands. Numerous experiments have been made, therefore, to determine the actual pressure of the oxygen and carbon dioxide in the venous blood as compared with the pressures of the same gases in the alveolar air, and the pressures in the arterial blood as compared with those in the tissues. Although the actual figures obtained have varied somewhat with the method used, the species or condition of the animal, yet, on the whole, the results tend to support the physical theory.

**The Gaseous Exchange in the Lungs.**—It is difficult to determine the exact composition of the alveolar air. The expired air can, of course, be collected and analyzed, but obviously this is a mixture of the air in the bronchi and the alveoli, and consequently has more oxygen and less carbon dioxide than the air in the alveoli. The probable composition of the alveolar air has been calculated by Zuntz and Loewy for normal quiet breathing in the following way: The capacity of the bronchial tree is 140 c.c., and this air may be considered as similar in composition to atmospheric air, that is, the inspired air. A normal expiration contains 500 c.c.; hence the alveolar air constitutes only 360 c.c. or  $\frac{3}{5}$  of the entire amount. If the expired air contains 4.38 per cent. of  $\text{CO}_2$ , then the alveolar air must contain  $4.38 \div \frac{3}{5}$ , or 6 per cent. of carbon dioxide.\*

Or, to put the mode of calculation in a more general form, the amount of oxygen in the expired air is equal to the amount of oxygen in the true alveolar portion of the expired air plus the amount of oxygen in the "dead space," namely, the trachea and bronchi. Let  $A$  equal the volume of expired air,  $e$  the percentage of oxygen in the expired air,  $a$  the volume of air in the dead space, and  $i$  the percentage of oxygen in this air or what is the same thing in the inspired air. According to the above statement we have the following equation,  $Ae = ai + (A - a)x$ , in which  $x$  represents the unknown percentage of oxygen in the alveolar air. We have, therefore,  $x = \frac{Ae - ai}{A - a}$ . In ordinary breathing these values are as follows:  $A = 500$  c.c.,  $a = 140$  c.c.,  $e = 16.02$  per cent., and  $i = 20.96$  per cent. Substituting these values,  $x$  will be found equal to 14.1 per cent. Reckoned in millimeters of mercury this would be equal to  $(760 \times 0.141)$  107.2 mm. In order, however, to ascertain the true pressure exerted by the oxygen allowance must be made for the barometric pressure and for the tension of the aqueous vapor. In the depths of the lungs the air is saturated with water vapor and the tension of this vapor at the body temperature may be valued at 46.6 mms. Hg. If we suppose

\* For discussion of methods, see Krogh and Lindhard, "Journal of Physiology," 47, 431, 1914.

further that the observation was made at a barometric pressure of 750 mms., then the pressure of the oxygen in the alveoli would be  $(750 - 46.6 \times 0.141) 99 +$  mms. Hg.

Actual observations made by these authors upon human beings in whom the expired air was analyzed indicate that the composition of the alveolar air may vary under different conditions between the following limits: Oxygen between 11 and 17 per cent. of an atmosphere; carbon dioxide between 3.7 and 5.5 per cent. of an atmosphere. Haldane and Priestley have devised a simple method by means of which the last portions of the air breathed out in an expiration may be collected. The sample thus collected represents practically the alveolar air, and its average composition for normal quiet respirations may be given as oxygen, 14.5 per cent.; carbon dioxide, 5.5 per cent.; and nitrogen, 80 per cent.

Loewy and von Schrötter have determined also the average tension of these gases in the blood of man. Their method\* consisted in blocking off one lung or one lobe of a lung by a metal catheter inserted through the trachea. After the lapse of half an hour or so the gases in this occluded portion had reached an equilibrium by interchange with the venous blood which represented the tension actually existing in the circulating venous blood. A portion of this air was then withdrawn by means of a suitable device and was analyzed. Their average result was that in the venous blood the oxygen exists under a tension of 5.3 per cent. of the alveolar atmosphere ( $710 \times .053 = 37.6$  mms. Hg.), and the  $\text{CO}_2$  under a tension of 6 per cent. (42.6 mms. Hg.). The physical relations of pressure between the alveolar air and the gases in the venous blood may be represented as follows:

	OXYGEN.	CARBON DIOXID.
Alveolar air . . . . .	100 mms.	35 to 40 mms.
Membrane . . . . .		
	↓	↑
Venous blood . . . . .	37.6 mms.	42.6 mms.

Diffusion must take place, therefore, in the direction indicated by the arrows. As the oxygen passes through into the blood it is combined with the hemoglobin and it is estimated that the arterial blood as it flows away from the lungs is nearly saturated with oxygen, lacking perhaps only 1 volume per cent. of being completely saturated (Pflüger). That is, if the normal arterial blood contains 19 c.c. of oxygen for each 100 c.c. of blood, it is probable that one more cubic centimeter might be combined by the hemoglobin if exposed fully to the air or oxygen. The difference in tension between the carbon dioxide on the two sides of the membrane is not so great as in the case of the oxygen, but owing to the more rapid

\* Loewy and von Schrötter, "Zeitschrift für experimentelle Pathologie und Therapie," 1, 197, 1905. See also Loewy, "Handbuch der Biochemie," IV<sup>1</sup>, 1908.

diffusion of this gas it is probable that this difference suffices to explain the exchange. In this matter one must bear in mind also the very large expanse of surface offered by the lungs and the very complete subdivision of the mass of blood in the capillaries. Thus, following a calculation made by Zuntz, the surface of the human lungs may be estimated at 90 sq.ms. or 900,000 sq.cms. If we assume that 300 c.c. of carbon dioxid ( $500 \times 0.04 \times 15$ ) are given off from the blood in a minute this would indicate a diffusion through each square centimeter of only 0.0003 c.c. ( $\frac{300}{900000}$ ).

This same idea is expanded by Loewy as follows: The surface of the lungs exposed to the air may be reckoned at 90 square meters, and the thickness of membrane intervening between this air and the blood in the capillaries may be estimated at 0.004 of a millimeter. Under these conditions as much as 6083 c.c. of oxygen might diffuse into the blood in a minute. As a matter of fact only about 250 to 300 c.c. of oxygen are really absorbed per minute in quiet breathing, and not more than ten times this amount in the violent respiration following excessive muscular exercise. It would seem, therefore, that diffusion should suffice to supply the oxygen actually needed. This reasoning applies *a fortiori* to the carbon dioxid, since the velocity of diffusion of this gas through a moist membrane is much (25 times) greater. If the tension of the CO<sub>2</sub> in the blood were only 0.03 mm. higher than that in the alveoli, the known exchange might be explained by diffusion.

**Exchange of Gases in the Tissues.**—The arterial blood passes to the tissues nearly saturated with oxygen so far as the hemoglobin is concerned, and this oxygen is held under a tension equivalent probably to at least 100 mms. Hg. The carbon dioxid is less in quantity than on entering the lungs and exists under a smaller pressure, which may be assumed to be the same as that of the carbon dioxid in the alveoli of the lungs—namely, 5 per cent. of the alveolar atmosphere (35–40 mms.). In the systemic capillaries the blood comes into diffusion relations with the tissues, and direct examination of the latter shows that the oxygen in them exists under a very small pressure, practically zero pressure,\* while the CO<sub>2</sub> is present under a tension (Strassburg) of 7 to 9 per cent. The high tension of the CO<sub>2</sub> is explained by the fact that it is being formed in the tissues constantly as a result of their metabolism, while the low tension of the oxygen is due to the fact that on entering the tissue this substance is combined in some way in a chemical compound too firm to dissociate. The physical conditions are, therefore, such as would cause a stream of CO<sub>2</sub> from tissue to blood and a stream of oxygen in the reverse direction.

	OXYGEN.	CARBON DIOXID.
Arterial blood . . . . .	100 mms.	35 mms.
Wall of capillary . . . . .		↑
	↓	↓
Tissues . . . . .	0 mm.	50 to 70 mms.

\* This conclusion is doubted by some observers, see Barcroft, "Respiratory Function of the Blood," 1914, p. 165.

It is to be remembered that in this exchange the blood and the lymph act as intermediaries. The  $\text{CO}_2$  diffuses from lymph to plasma and from tissues to lymph. The oxygen diffuses from lymph to tissues, from plasma to lymph, and from oxyhemoglobin to plasma. Bohr\* has found experimentally that in blood, when the oxygen tension is low, an increase in the  $\text{CO}_2$  pressure tends to dissociate the oxyhemoglobin (Fig. 275). Since these conditions prevail in the capillaries of the body, it is probable that the presence of the  $\text{CO}_2$  in increased amounts facilitates the liberation of the oxygen.

**Suggested Secretory Activity in the Respiratory Exchange.**—The view that the exchange of gases in the lungs and tissues is entirely explained by the diffusion of the gases from points of high tension to points of low tension, and that the membranes interposed are entirely passive in the process has not passed unchallenged. Certain observers (Bohr, Haldane, and Smith) † claim that the tension of the oxygen in the arterial blood may be higher than the pressure of oxygen in the alveolar air. Bohr, moreover, in a series of experiments made upon dogs ‡ determined by calculation the tension of oxygen within the surface layer of the lungs. This tension was found to vary from 35 to 105 mms. The tension of the arterial blood, determined at the same time, varied from 101 to 144 mms., being in every case distinctly higher than the tension of the oxygen in the surface layer of the lungs. If these facts were fully demonstrated they would show that the physical theory outlined above is insufficient, and would indicate that the membranes concerned take an active part in the passage of the gases, exerting possibly a secretory activity. That the cells of these membranes might secrete the gases is not at all impossible, but at present it seems to be unnecessary to make such a supposition. The results obtained by the observers mentioned in this paragraph have not been corroborated by the numerous other observers who have worked in the same field, and it seems possible that they may be due to experimental errors. A well-known set of experiments that strengthen this conclusion has been reported by Wolffberg and by Nussbaum§ and has since been repeated upon man. In these experiments one bronchus in a dog was completely blocked by a specially designed lung catheter, so arranged as to occlude the bronchus and yet allow the observer to draw off a specimen of the air at any time. In such an occluded lung the captured air is in diffusion relations with the venous blood of the pulmonary artery, and if these relations are maintained for a sufficient time an equilibrium should be established on the physical theory, the tension of the gases in the occluded lungs becoming the same as in the venous blood. Such was found to be the case. When at the end of the experiment air was drawn off and analyzed it was found to contain 3.6 per cent. of  $\text{CO}_2$ , while the tension of the  $\text{CO}_2$  in specimens of the venous blood taken from the right heart was practically identical. If there is an active secretion of  $\text{CO}_2$  from the lungs one should have expected to obtain a higher tension in the carbon dioxide of the alveolar air than in the venous blood.

\* "Skandinavisches Archiv f. Physiologie," 16, 402, 1896.

† See Haldane and Smith, "Journal of Physiology," 20, 497, 1896.

‡ Bohr, in Nagel's "Handbuch der Physiologie des Menschen," 1897, vol. i, part 1, p. 146.

§ "Archiv f. die gesammte Physiologie," 4, 465, 1871, and 7, 296, 1873.

## CHAPTER XXXVII.

### INNERVATION OF THE RESPIRATORY MOVEMENTS.

The nervous supply to the respiratory muscles is received from a number of nerves, the nervous machinery being widely distributed in the brain and cord. The most important of the motor nerves of respiration is the phrenic, which supplies the diaphragm and originates from the fourth and fifth cervical spinal nerves. The N. accessorius and branches of the cervical and brachial plexus innervate the muscles of the neck and shoulder which are concerned in inspiration; the intercostals innervate the muscles of the thorax and abdomen, while branches of the lumbar plexus send fibers to the muscles of the groin. Moreover, the facial sends motor branches to the muscles of the nose and the vagus supplies the muscles of the larynx. All of these muscles belong to the skeletal group and are under voluntary control. Under normal conditions, however, this entire respiratory apparatus works rhythmically without voluntary control, in alternate inspirations and expirations, all the inspiratory muscles contracting together, and all the expiratory muscles together in their turn when the expirations are active. The co-ordinated activity of such an extensive mechanism is explained by the existence of a *respiratory center* in the medulla oblongata.

**The Respiratory Center.**—The discovery of the location of the respiratory center was due mainly to the experiments of two French physiologists, Legallois and Flourens. The latter placed the center in the medulla at the level of the calamus scriptorius, and described it as a very small area or spot, which he designated at first as the vital knot (*nœud vital*) under the mistaken impression that it formed, as it were, a central or focal point of the motor system. It has since been shown that this center, like the vasomotor center, is bilateral. If the medulla is cut through in the mid-line the respirations may proceed in a normal manner. The center consists of two parts, each connected primarily with the musculature of its own side. Each half occupies an area that lies some distance lateral to the mid-line and beneath the floor of the medulla at the general level of the calamus. According to Gierke,\* the area

\* Gierke, "Archiv f. die gesammte Physiologie," 7, 583, 1873; and "Centralblatt f. d. med. Wissenschaften," No. 34, 1885.

extends in rabbits from a point 3 or 4 mms. in front of, to a point 2 or 3 mms. posterior to the calamus. No especial group of cells can be found in this region sufficiently separated anatomically to make it probable that they constitute the center in question. The region has been delimited by vivisection experiments only, and, according to Gierke, corresponds in location to the position of the solitary bundle (*tractus solitarius*). According to Mislawsky,\* it lies near the mid-line in the *formatio reticularis*, while Gad† gives it a relatively large area in the lateral portion of the *formatio reticularis*, the continuation into the medulla of the lateral horn of the gray matter of the cord. Destruction of these areas or section of the cord anywhere between this region and the origin of the phrenic nerve cuts off the respiratory movements, except those of the nose and larynx, and causes death. The rapid death from injuries to the cord or medulla in this region—from hanging, for instance—is explained by the effect upon the respiratory center or its connections.

There is no doubt that the respiratory center in man occupies the same general position as in the other mammals. There is on record a case‡ in which sections were made of the medulla in a new-born infant. On delivery it was necessary to puncture the cranium and remove the brain. The child still lived and the medulla was cut across with scissors. A section at the posterior end of the calamus stopped the respirations immediately, while one somewhat anterior had failed to have this effect.

The general idea of the connections of this center with the respiratory muscles may be described as follows: The respiratory fibers arising in the center pass down the cord, probably in the antero-lateral columns, and end in the gray matter of the cord at the different levels at which the motor nuclei of the respiratory nerves are situated. Whether the connection between the respiratory center and the spinal motor nuclei is made by one or by a series of neurons is not known, but we may assert that the nerve path from the respiratory center to the respiratory muscles must be composed of at least two neurons. According to this conception, the impulses of inspiration and expiration for the entire respiratory mechanism originate in the medullary center and are thence distributed in a co-ordinated way to the lower motor centers in the cord, or, in the case of the nose and larynx, to the motor centers of the vagus and facial.

**Spinal Respiratory Centers.**—At different times various authors (Brown-Séguard, Langendorff, *et al.*) have insisted that there exist one or more spinal respiratory centers, and that the medullary center has not the

\* Mislawsky, "Centralblatt f. die med. Wissenschaften," No. 27, 1885.

† Gad, "Archiv f. Physiologie," 1893, p. 75.

‡ See Kehrer, "Monatshefte f. prakt. Dermatol.," 28, 450, 1892.



commanding importance indicated in the above description. The fact that, when the medulla or cervical cord below the medulla is cut, the animal at once ceases to breathe is explained by these authors on the assumption that the operation causes a prolonged inhibition of the underlying spinal centers. They state that young animals, especially if made hyperirritable by the injection of strychnin, may continue to breathe after section of the cord below the medulla. This point of view, however, has not prevailed in physiology. Other operations on the cord or brain are not attended by such profound inhibition, and indeed Porter and Mühlberg have shown\* that, if half of the cord alone is cut, the movements of the diaphragm on that side are permanently paralyzed. It is entirely conceivable that under exceptional conditions the lower neurons, the direct motor centers of the respiratory muscles, might be made to act rhythmically, since during life they have been rhythmically stimulated from the medullary center; but the evidence at present is altogether against any distinct physiological independence on the part of those neurons.

**The Automatic Activity of the Respiratory Center.**—The constant activity of the respiratory center throughout life suggests the question as to its automaticity. Is it automatic like the heart? That is, are the stimuli discharged from it produced within its own cells as a result of its own metabolism under the normal conditions of circulation? Or, on the other hand, is it, like most of the motor nuclei of the central nervous system, only a reflex center, its motor discharges being dependent upon impulses received from other neurons by way of the sensory paths? Obviously the only way to answer such a question directly is to isolate the center from all afferent paths and leave it connected with the respiratory muscles only by motor nerves. If under such conditions the respiratory rhythm continues the center may be regarded as essentially automatic, however susceptible it may be to reflex influences. A close approximation at least has been made to such an experiment. Rosenthal finds that rhythmical respiratory movements continue after the following operations: first, section of the brain at the corpora quadrigemina to cut off influences from the cerebrum, thalamus, and midbrain; second, section of the vagi, to shut off afferent impulses from the viscera, especially from the lungs; third, section of the cord at the seventh cervical vertebra to exclude sensory influences through all the underlying posterior roots; and, fourth, section of the posterior roots of the cervical spinal nerves. The medulla with its respiratory center was thus isolated from all afferent impulses except such as might enter through the fifth, seventh, eighth, and ninth cranial nerves. Since under these conditions the center continued to act rhythmically we may draw the probable conclusion that it is essentially automatic, and that it probably possesses an intrinsic rhythmical activity resembling that of the heart. An interesting supplementary experiment upon this point is reported by Winterstein.† The rhythmic

\* "American Journal of Physiology," 4, 334, 1900.

† Winterstein, "Pflüger's Archiv," 138, 159, 1911.

activity of the respiratory center has been referred by some authors to reflex stimulation of the center by sensory impulses arising in the respiratory muscles themselves. To exclude this possibility Winterstein curarized an animal to immobilize the respiratory muscles, and then divided the phrenic nerve and connected its central stump with a galvanometer. Under these conditions the galvanometer recorded rhythmic action currents, which demonstrated that the respiratory center was sending out rhythmic discharges of nerve impulses.

**Reflex Stimulation of the Center.**—According to the results of numerous observers, stimulation of any of the sensory nerves of the body may affect the rate or the amplitude of the respiratory movements. This experimental result is confirmed by our own experience, since every one must have noticed that the respiratory movements are readily affected by strong stimulation of the cutaneous nerves—a dash of cold water, for example—as well as through the nerves of sight and hearing. In addition, emotional states are apt to be accompanied by noticeable changes in the respirations, and corresponding to this fact experiment shows that stimulation of certain portions of the cortex and midbrain gives distinct effects upon the respiratory center. We must assume, therefore, that this center is in connection with the sensory fibers of perhaps all of the cranial and spinal nerves, and is influenced also by intracental paths passing from cerebrum to medulla, paths which are efferent as regards the cerebrum, but afferent as regards the medulla. As stated above, the effect of these sensory nerves

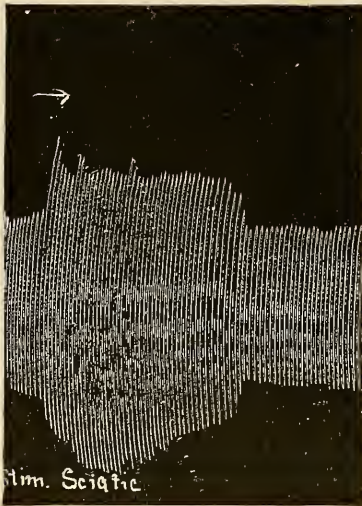

Fig. 276.—To show the augmentation of the respiratory movements caused by stimulation of the sciatic nerve. Experiment upon a rabbit.

upon the activity of the respiratory center is varied; the rate may be changed together with an increased or decreased amplitude, the inspirations and expirations may each be increased, or one phase may be affected more markedly than the other. In general, however, experimental stimulation of a sensory nerve trunk which contains cutaneous fibers gives one of two effects: either a stimulating action, manifested by quicker, stronger inspirations and active expirations, or an inhibitory effect, in which the respirations cease

altogether or become slower and more feeble (Figs. 276 and 277). If in this, as in other similar cases, we assume that the two opposite effects are produced by different nerve fibers we may speak of sensory fibers which have a stimulating or augmenting effect, and of those that have an inhibiting influence on the center, or following the terminology used in the case of the vasomotor center, we may speak of respiratory pressor and respiratory depressor fibers. It is quite probable that these fibers have other functions,—that is, they are not distributed exclusively to the respiratory center. A cutaneous fiber, which through its central chain of neurons eventually ends in the cortex cerebri and gives us a sensation of pain, may

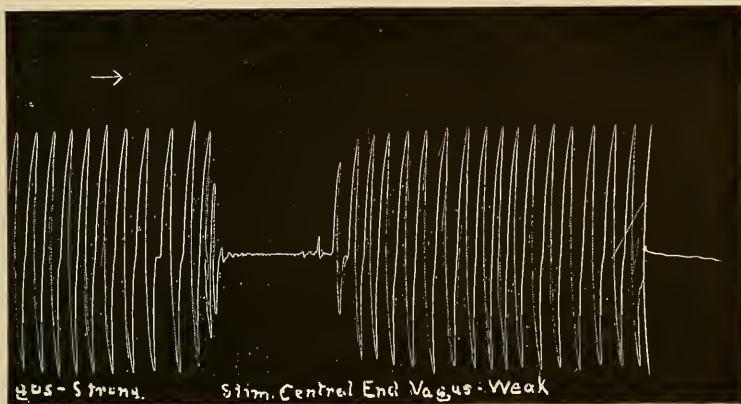

Fig. 277.—To show the inhibition of the respiratory movements in a rabbit due to stimulation of the central end of the vagus. The respiratory movements in this case, before and after stimulation, were forced, owing to the fact that both vagi were cut.

by collateral connections affect also the medullary center and produce effects upon the heart, blood-vessels, and respirations.

**The Special Relations of the Afferent Fibers of the Vagus to the Center.**—Although the sensory nerves in general exert a reflex effect upon the respiratory center, experimental work has shown that the sensory fibers distributed along the respiratory passages from the anterior nares to the alveoli have a specially important relation to this center. This fact is most clearly shown in the case of the sensory fibers of the vagus, which are distributed to the lungs themselves. If the two vagi are cut in the neck the respiratory movements are at once altered in character; they show a much slower rhythm and greater amplitude (Fig. 278). The inspirations especially are deeper and longer, with something of a pause at the end. When only one vagus is cut an intermediate effect may be obtained, the respiratory movements may be slowed somewhat and slightly deepened; but the striking effect is observed

only after section of both nerves. This result is not a temporary one due to the stimulation of cutting, but is permanent, and therefore we may conclude that some influence has been cut off which normally keeps the respiratory movements at a more rapid rate. Experiment has shown that this influence consists in the tonic action of sensory fibers contained in the vagus and distributed to the lungs. It is the constant effect of these fibers on the respiratory center which maintains the normal rhythm; when they are severed the center drops into a slower, unregulated rhythm. Experiment has shown, also, that when the central stump of the divided vagus is stimulated artificially the respiratory center is affected, as indicated by the respiratory movements, in a variety of ways, depending upon the strength of the stimulus and the condition of the center. The two results which are most constantly obtained and which may therefore be especially emphasized are as follows: first, with weak stimuli the inspiratory movements are inhibited partially or completely, giving either smaller movements or, in a condition of narcosis, complete cessation of respirations, with

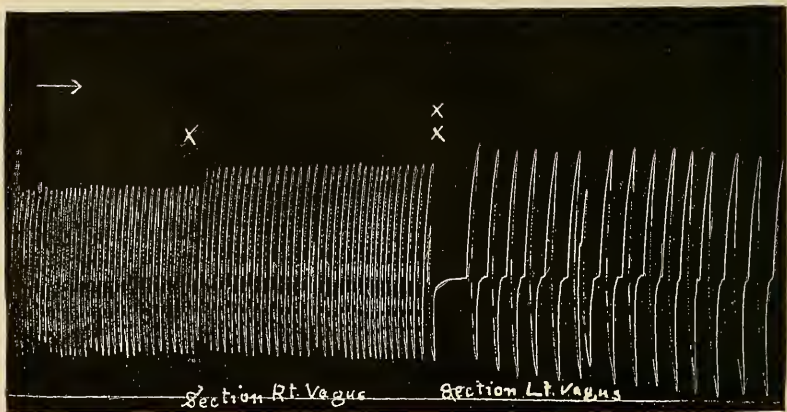

Fig. 278.—To show the effect of section of the vagi on the respiratory movements (rabbit). The right vagus was cut at *x* and caused a slight augmentation and slowing of the movements. The left vagus was cut at *xx* and caused first a short inhibition (due to mechanical stimulation) which was then followed by the typical slow and deep respirations seen under these conditions.—(Dawson.)

the thorax in the stage of passive expiration (Fig. 277), or, second, the rate of the inspiratory movements may be increased and this may end finally in an inspiratory standstill,—that is, the respiratory movements cease with the chest in an inspiratory position (Fig. 279), the inspiratory muscles being in a condition of tetanic contraction. When both the inspiratory and expiratory muscles are considered, the variety of effects that may be obtained from stimulation of the afferent fibers of the vagus is perplexing, especially with strong

stimuli, and has led to much difference of opinion among investigators.\* The two main effects described above are usually interpreted to mean that the vagus contains two kinds of sensory fibers which are distributed to the lungs and act normally on the respiratory center. These are: (I) The inspiratory fibers, whose effect is to increase the rate of inspiratory discharge from the respiratory center; therefore to quicken the rate. (II) The expiratory (or inspiratory inhibiting) fibers, whose effect is to inhibit the inspiratory discharges, partially or completely. Some authors find it simpler to assume only one kind of sensory fiber and to explain the different results by a difference in the nature of the stimulus or

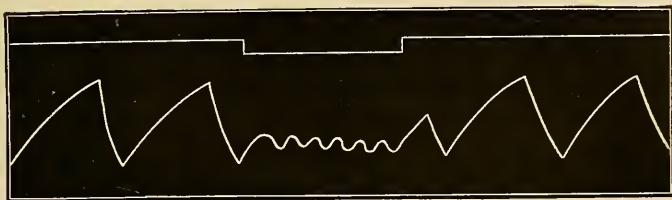

Fig. 279.—To illustrate the inspiratory effect from stimulation of the central end of the vagus. The downstroke represents inspiration; the upstroke, expiration. During the period of stimulation the respirations are increased in frequency and the chest remains in a condition of inspiration.—(Lewandowsky.)

in the condition of the center; but it seems advisable at present, in accordance with the doctrine of specific nerve energies, to hold to the view of two varieties.

**Influence of the Inspiratory and the Inhibitory Fibers of the Vagus on the Normal Respirations.**—It is assumed that these two sets of fibers are in constant activity and keep the respiratory rate more rapid than it would be otherwise. Hence the slowing and deepening of the respirations when the vagi are cut. The way in which these sensory fibers are stimulated normally was referred by Hering and Breuer to the alternate expansion and collapse of the lungs. Each inspiration stimulates the inhibitory fibers in consequence of the expansion of the lungs, and thus cuts short the inspiration, prematurely, as it were. So at each expiration the collapse of the lungs stimulates the inspiratory fibers and brings on an inspiration sooner than would otherwise occur. In this way the respiratory rate is kept automatically at an accelerated rhythm. This hypothesis has been much discussed and many efforts have been made to prove or disprove it by means of experiments. The result of this work on the whole

\* For discussion and literature, see Meltzer, "New York Medical Journal," January 18, 1890. Lewandowsky, "Archiv f. Physiologie," 1896, pp. 195 and 483; also Sjöblom, "Skandinavisches Archiv f. Physiol.," 32, 1, 1914.

tends to show that the hypothesis is essentially correct. Two kinds of afferent fibers exist in the vagus, one of which is stimulated by expansion of the lungs, the other by collapse. This fact is shown most clearly by Einthoven's\* experiments with his string-galvanometer. When the vagus nerve is cut high in the neck and is then connected in the usual way with the string-galvanometer, the latter shows a marked action current throughout each inspiration, indicating, therefore, the passage of a series of nerve impulses during inspiration (Fig. 280). When by suction the lungs were collapsed, another electrical variation of a different character was produced, indicating the existence of a separate set of fibers brought into action by the diminution in volume of the lungs. In quiet respirations the expiration consists in merely a passive return to what may be called the neutral or normal volume of the lungs, and in this movement it is probable that the inspiratory fibers are not affected, being stimulated only by an active expiration. We may assume, therefore, with Gad that the normal rate of respirations is maintained

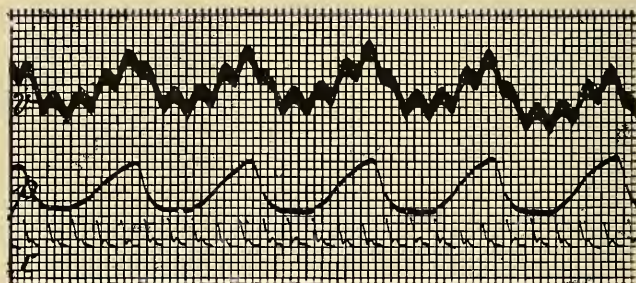

Fig. 280.—To show the electrical changes in the different fibers of the vagus nerve caused by the respirations and the heart beats: *V*, The electrovagogram, the large waves are electrical oscillations synchronous with the respiratory movements. The smaller ones are electrical changes synchronous with the heart beats; *P*, Mechanical record of the respiratory movements, ascent of curve, inspiration; *C*, Mechanical record of pulse beats. (From *Einthoven*.)

by the action of the inhibitory fibers alone. Each inspiration is cut short by the mechanical stimulation of these fibers, but on the collapse of the lungs the new inspiration is due to a normal discharge from the inspiratory center.

Loewy† has shown by an ingenious experiment that the expansion of the lungs is the factor that actually stimulates the sensory fibers and quickens the respiratory rate, as follows: An animal was made to breathe pure oxygen for a while to displace the nitrogen in the alveoli. The chest on one side—

\* Einthoven, "Quarterly Journal of Exp. Physiology," 1908, 1, 243; also "Researches of the Physiological Laboratory of the University of Leyden," VII., 1908.

† "Archiv f. die gesammte Physiologie," 42, 273.

say, the right side—was then opened with the result that the lung collapsed, and, owing to the rapid absorption of the oxygen, soon became practically solid. The respirations (rabbit) showed their normal rate—66. The vagus nerve on the left side was then cut and immediately the respirations took on the character usually shown when both vagi are severed,—respirations = 34. Next the collapsed right lung was expanded by artificial respiration, with the result that the respiratory rate at once returned to normal.

**Respiratory Reflexes from the Larynx, Pharynx, and Nose.**

—The mucous membrane of the larynx receives its sensory fibers from the superior laryngeal nerve. When this nerve is stimulated artificially the respirations are always inhibited; the chest comes to rest in the position of passive expiration. The same effect may be obtained from the sensory fibers of the glossopharyngeal supplying the pharynx, and indeed a temporary inhibition of respirations occurs through this nerve during every act of swallowing. The sensory fibers of the nasal mucous membrane (trigeminal) cause a similar reflex inhibition when stimulated by injurious or so called irrespirable gases, such as HCl, Cl, NH<sub>3</sub>, SO<sub>2</sub>, etc. We may regard this inhibitory influence exerted by the sensory fibers distributed along the air passages as a protective reflex which guards the lungs automatically from injurious gases. This protective action is made more evident by the fact that, together with the cessation of respirations, the glottis is reflexly closed by contraction of the adductor muscles and, if the stimulation is strong, even the bronchial musculature may be contracted, so that in every way the passage to the alveoli is made more difficult. The reflex is, of course, more or less temporary, but it possesses the great advantage of being automatic, and may enable the animal or individual to escape unharmed from a dangerous locality before the increasing irritability of the respiratory center breaks through the inhibition. In special cases the inhibition may last for an unusually long time. Thus, Fredericq states that in aquatic birds water allowed to flow over the beak so as to penetrate slightly into the nostrils brings about an inhibition of respirations for many minutes. There would seem in this case to be a special adaptation of the reflex to the needs of diving. We know also that irritating gases or foreign bodies of any sort that enter the larynx may lead to a coughing reflex,—that is, to a series of expiratory blasts which have a purposeful end in the expulsion of the stimulating object. In this case there is not simply an inhibition of the inspiratory movements, but a reflex excitation of a peculiar type of expiratory movements.

**The Voluntary Control of the Respiratory Movements.**—

We can control the respiratory movements within wide limits, make forced or feeble inspirations or expirations, accelerate the rhythm, or completely inhibit the respirations in any phase. If, however, the “breath is held,”—that is, if the respiratory movements are

inhibited and the glottis is closed, the increasing irritability of the respiratory center eventually breaks through the voluntary inhibition. How far this voluntary control is based upon direct connections between the cerebrum and the respiratory center and how far it depends upon voluntary paths to the separate spinal nuclei of the muscles involved cannot be discussed profitably.

**The Nature of the Respiratory Center.**—The respiratory center located in the medulla oblongata might with more propriety be designated as the inspiratory center. Our normal respirations throughout life consist of an active inspiration and a passive expiration. It is the co-ordinated activity of the inspiratory muscles that is characteristic of the respiratory movements. The expiratory muscles come into action only occasionally and under special conditions. So also when we describe the respiratory center as essentially automatic we refer only to the action on the inspiratory muscles, since a series of active inspiratory movements is the essential feature of respiration. Under certain conditions, however, we do have rhythmical expiratory movements, active expirations. Such movements may occur independently of the respirations proper, as in coughing and laughing, or in the straining movements of defecation, micturition, and parturition; or they may occur as an integral part of the respirations, as in the forced movements of dyspnea. Under the conditions of partial suffocation, for instance, as the blood becomes more and more venous the respirations increase in force and active expirations appear. It becomes a question, therefore, as to the existence of what might be called an expiratory center, a group of nerve cells controlling the co-ordinated activity of the expiratory muscles. The mere fact that in dyspnea we have a rhythmical and co-ordinated activity of these muscles seems to imply the existence of such a center, but there is no definite experimental knowledge as to its location. Assuming that there is such a center, it may be believed that it exists in the medulla, since after section below the medulla there is no evidence of the occurrence of rhythmical expiratory movements even in extreme conditions of venosity of the blood. The expiratory center may or may not be located in the same region as the inspiratory center, but the following general characteristics may be assigned to it: In the first place, it is not automatic; at least not under normal conditions. In the second place, its activity must be dependent in some way upon that of the inspiratory center. Even our most violent respiratory movements show an orderly sequence of inspiration and expiration,—and we may believe that the action of the expiratory center is conditioned by the previous discharge of the inspiratory center, just as in the heart the beat of the ventricle depends upon the previous systole



of the auricle. That an active expiration is not caused reflexly by the mechanical expansion of the lungs seems to be demonstrated by the fact that the most forcible voluntary inspiration is followed by a passive, not an active expiration. Until our knowledge is extended by further experimental work we may consider the expiratory center as a group of cells connected by definite paths with the expiratory muscles and capable of being stimulated in one of at least four general ways: (1) In special reflexes, such as coughing. (2) By voluntary control from the cerebrum, as in straining. (3) By stimulation through afferent fibers from the skin, especially the pain fibers. (4) By the action of an increased venosity of the blood. Under the latter two conditions it is possible that the irritability of the center is so increased that it becomes responsive to the influence of the inspiratory center. The relations of the inspiratory and expiratory centers under the various conditions of artificial stimulation are very complex, and although it is possible to represent these relations more or less completely by schemata of some sort it does not seem advisable at present to seriously consider such hypotheses.

**The Accessory Respiratory Centers of the Midbrain.**—Several observers have called attention to the existence of a possible accessory respiratory center in the midbrain at the level of the posterior colliculus. Martin and Booker found that stimulations in this region caused a marked increase in the rate of inspiratory movements and finally a standstill in inspiration,—that is, a complete tetanic contraction of the inspiratory muscles lasting during the stimulation.\* Lewandowsky† has shown that section of the brain stem at or below the inferior colliculi causes an alteration in the respiratory rhythm similar to that following section of both vagi. After cutting through the inferior colliculi further sections more posteriorly do not add to the effect. He considers that there is an automatic inhibitory center in the midbrain which influences continually the automatic activity of the medullary center.

**The Nature of the Automatic Stimulus to the Respiratory Center.**—We have accepted the view that the respiratory (inspiratory) center is essentially automatic, although very sensitive to reflex stimulation. The further question arises as to the nature of the automatic stimulus. Inasmuch as the activity of the center controls the gaseous exchanges of the blood, it was natural perhaps for physiologists to look to the gases of the blood for the origin of the internal stimulus. Experiments show beyond question that the condition of the gases in the blood has a direct and marked influence upon the activity of the center. If for any reason the blood supplying the center becomes more venous, the respirations are increased in force or rate or both, and indeed the activity of the center is in a general way increased in proportion to the venosity

\* Martin and Booker, "Journal of Physiology," 1, 370, 1878.

† "Archiv f. Physiologie," 1896, 489.

of the blood. On the other hand, if the blood supplying the center is more arterIALIZED than normal, by active ventilation of the lungs, for instance, the center acts more feebly or may fail to act altogether, giving the condition known as apnea. These facts may be accepted as completely demonstrated, but they do not go far enough. When we speak of the arterial blood being more venous than normal we mean that it contains less oxygen and more carbon dioxide than normal arterial blood. Which of these conditions serves to stimulate the center, and which may be regarded as the constant stimulus throughout life? The three possible views have been defended: (1) That the normal stimulus is a lack of sufficient oxygen (Rosenthal). When sufficient O is supplied the center ceases to act, becomes apneic. (2) That the normal stimulus is the presence of an excess of CO<sub>2</sub> (Traube). When this excretion is quickly removed the center ceases to act,—becomes apneic. (3) It is possible that the two factors may co-operate. Much evidence has been collected to show that the action of the respiratory center is increased when the tension of the CO<sub>2</sub> in the blood is raised without altering that of the oxygen, and that a similar result is obtained if the tension of oxygen is greatly diminished without any change in that of the carbon dioxide, so that it must be admitted that a change in either factor, if sufficiently great, acts as a stimulus. Experiments, however, have indicated that the accumulation of the CO<sub>2</sub> is the more efficient stimulus of the two.\* Zuntz reports the following interesting experiments, in which the extent of the respiratory movements was measured by the amount of air breathed in a minute. In one series the amount of oxygen in the air breathed was reduced. This change did not affect the quantity of carbon dioxide in the blood. The following results were obtained:

Normal air.....	volume breathed per minute = 7,325 to 9,000 c.c.
Air with 10 to 11.5 per cent. oxygen.....	“ “ “ “ = 8,166 to 9,428 “
Air with 8 to 10 per cent. oxygen.....	“ “ “ “ = 9,093 to 12,810 “

A reduction of one-half of the oxygen in the air breathed had little effect upon the respirations. From our present standpoint, however, the important thing is not the amount of oxygen in the air, but the amount in the blood. Paul Bert's experiments† upon living animals indicate that when the oxygen of the air is reduced by a half the amount of oxygen in the blood is diminished by about one-third. Assuming this to be correct, it is evident that a very

\* See Zuntz, "Archiv f. Physiologie," 1897, 379. See also Friedländer and Herter, "Zeit. f. physiol. Chemie," 2, 99, and 3, 19.

† Bert, "La pression barométrique," 1878, 691.

considerable reduction may be made in the oxygen of the blood without noticeably affecting the respirations. A similar conclusion may be drawn from Haldane's experiments\* with carbon monoxid. He found upon breathing mixtures of this gas that no distinct effects were observable until the blood was about one-third saturated with the gas,—that is, had lost one-third of its oxygen. Zuntz's experiments, in which the CO<sub>2</sub> in the air breathed was increased, while the oxygen remained normal, gave quite different results, as follows :

Normal air .....	volume breathed per minute,	7,433 c.c.
Air of 20.2 per cent. O, 0.95 per cent. CO <sub>2</sub> .....	“ “ “ “	9,060 “
Air of 18.06 per cent. O, 2.97 per cent. CO <sub>2</sub> .....	“ “ “ “	11,326 “
Air of 18.42 per cent. O, 11.5 per cent. CO <sub>2</sub> .....	“ “ “ “	32,464 “

These and similar results† show that small differences in the amount of the carbon dioxid in the blood have a distinct effect upon the activity of the respiratory center. Under normal conditions the respiratory center receives blood containing 19 to 20 volumes per cent. of oxygen, while the venous blood flowing away from the center still holds 10 to 12 per cent. Considering the small effect of lowering this oxygen supply by one-third, it is difficult to believe that normally the amount of oxygen is so deficient for the normal metabolism as to set up a constant stimulus. The trend of recent work favors rather the view that the normal stimulus to the respiratory center is the carbon dioxid. When this substance is present above a certain amount or tension it acts as a stimulus, directly or indirectly, and gives rise to the moderate movements of normal inspiration. If the tension of the carbon dioxid is increased, the stimulus becomes stronger and leads to the production of a condition of hyperpnea and dyspnea. On the other hand, if for any reason, such as active ventilation of the lungs, the tension of the carbon dioxid in the blood falls below a certain value, estimated by Zuntz as lying between 19 and 24 mms., no stimulation occurs, the center is in a condition of apnea and respiratory movements cease. Accepting the view that carbon dioxid in the blood circulating in the medulla gives rise to the normal stimulus to the respiratory center, one naturally inquires why a deficient supply of oxygen should also stimulate the center. It is true, as stated above, that the supply of oxygen may be diminished considerably before any augmented action of the center is observed, but there seems to be no question that dyspneic movements result when the oxygen tension falls below a certain point. One explanation has been suggested which may be accepted pro-

\* Haldane, "Journal of Physiology," 18, 442, 1895.  
 † See Haldane and Priestley, "Journal of Physiology," 32, 225, 1905.

visionally at least. We may believe that in the metabolism of the nerve cells constituting the center, as in the metabolism of the muscle, certain organic acids, such as lactic acid, are formed which in the presence of a normal supply of oxygen are further oxidized. When, however, the oxygen supply is insufficient these acids may accumulate and serve as a stimulus, either directly or indirectly, by making the cells more irritable to the effect of the carbon dioxid.\* This point of view enables us to understand also some interesting results of the effect of breathing oxygen. When one holds his breath the carbon dioxid tension in the blood increases, and eventually the stimulus becomes so strong that respirations ensue in spite of the strongest effort to inhibit them. This "breaking point" is reached † in 23 to 77 seconds after the carbon dioxid in the alveoli of the lungs has reached a concentration of 6.2 to 7.5 per cent., and the oxygen is reduced to 9 to 11 per cent. If before holding the breath the lungs are filled with oxygen by taking several breaths of the pure gas, the breaking point may be prolonged to as much as 160 seconds, and one observer (Vernon) reports that if the lungs are first thoroughly aërated by forced breathing, so as to wash out the carbon dioxid in the alveoli, and at the end pure oxygen is breathed in, the breaking point may be deferred as long as eight minutes. Evidently, therefore, an accumulation of carbon dioxid in the blood, as indicated by the composition of the alveolar air, is less efficient as a stimulus to the center when an adequate supply of oxygen is provided, and this fact may be explained on the hypothesis that the oxygen prevents the accumulation of the acid products of metabolism.

The two fundamental facts that the respiratory center is stimulated by excess of carbon dioxid and by deficiency of oxygen have been brought together by an hypothesis which assumes that the resulting effect is the same in both cases.‡ According to this view the carbon dioxid does not stimulate the center directly, but indirectly, because like any other acid in solution, it gives rise to the production of hydrogen ions, and these ions constitute a stimulus which begins to be effective when their concentration passes a certain threshold value. Lack of oxygen brings about the same increase in concentration of hydrogen ions owing to the fact that it permits the accumulation of acid products of intermediary metabolism, products which under normal conditions are removed by oxidation. If this view proves to be correct, it is obvious that it implies further that the activity of the respiratory center constitutes an efficient means for preserving the neutrality of the blood, since in proportion as the carbon dioxid concentration, and therefore the hydrogen-ion concentration, increases in the blood the respiratory center will be stimulated. The greater respiratory movements thereby produced will tend to remove the excess of carbon dioxid. A further problem in connection with the action of the respiratory center is the cause of its rhythmic activity. The underlying mechanism of this rhythmicity is obscure, but it is possible that in this instance, as in

\* Haldane and Poulton, "Journal of Physiology," 37, 390, 1908.

† Hill and Flack, "Journal of Physiology," 37, 77, 1908.

‡ Winterstein, "Pflüger's Archiv," 138, 167, 1911.

the case of the heart-muscle, the property is dependent in some way upon the normal balance of calcium, potassium, and sodium in the blood. Variations in the concentration of these elements cause marked changes in the rhythmicity.\*

**The Cause of the First Respiratory Movement.**—The mammalian fetus under normal conditions makes no respiratory movements while *in utero*. After birth and the interruption of the placental circulation the first breath is taken. The cause of this sudden awakening to activity on the part of the respiratory center must be closely connected, if not identical with, the cause of the automatic activity of the center throughout life. Two or perhaps three views have been held regarding its immediate cause: (1) That it is due to the increased vensity of the blood brought about by the interruption of the placental circulation; (2) that it is due to stimulation of the skin by handling, drying, etc.; (3) that it is due to a combination of these causes. Preyer has shown that stimulation of the skin of the fetus while *in utero* and with the placental circulation intact suffices to cause respiratory movements. Cohnstein and Zuntz† have shown that interruption of the placental circulation while the fetus is kept bathed in the amniotic liquid also brings about respirations. Since both of these events occur normally at birth, we may believe that each aids in causing the first respiration, and indeed it may be necessary at times deliberately to increase the stimulation of the skin in order to bring on respiratory movements. If the two causes, stimulation through the nerves and stimulation through the blood, normally co-operate, it may, however, be said that the essential cause, according to the theory adopted in the preceding paragraphs, lies in the greater vensity of the blood, that is, the increased tension of the carbon dioxide following interruption of the placental circulation. During the intra-uterine period it is evident that the fetal blood is aerated so well by exchange with the maternal blood that it does not act as a stimulus to the fetal respiratory center. The fetus is, physiologically speaking, in a condition of apnea. Since the maternal blood acts upon the respiratory center of the mother, while the fetal blood which exchanges gases with it does not act on its own respiratory center, it follows that the fetal respiratory center possesses a lower degree of irritability than that of the mother, and we may assume that this condition is due, in part at least, to the absence of somatic and cutaneous stimuli in the protected fetus.

**Dyspnea, Hyperpnea, Apnea.**—By the term dyspnea in its widest sense we mean any noticeable increase in the force or rate of the respiratory movements. As said above, such a condition may

\* Hooker, "American Journal of Physiology," 31, 1913, "Proceedings of the American Physiological Society."

† Cohnstein and Zuntz, "Arch. f. die gesammte Physiol.," 42, 342, 1888.

be caused either by stimulation of sensory nerves, particularly the pain nerves, or by an increased venosity of the blood—that is, by an increase in the  $\text{CO}_2$ , or by a marked decrease in the oxygen. Changes of other kinds in the composition of the blood, some of which are considered in the next chapter, may also stimulate the respiratory center and cause dyspnea. The dyspneic movements naturally show many degrees of intensity corresponding with the strength of the stimulus, and sometimes the initial stages are designated as *hyperpnea*, while the term dyspnea is reserved for the more labored breathing in which the expirations are active and forced. When dyspnea is produced by withholding air (suffocation) the respiratory movements become more and more violent until they take on a convulsive character. This stage is succeeded by one of apparent calm, indicative of exhaustion of the centers. Deep, long-drawn inspirations follow at intervals and finally cease. The animal lies quietly, with feeble heart beat and dilated pupils, in a condition designated as asphyxia or complete asphyxia.

The term *apnea* means literally a condition of no breathing, and since this condition may occur from several causes some confusion in nomenclature has resulted. In medical literature the term is sometimes employed as a synonym for asphyxia or suffocation. In physiological literature it is restricted to a very interesting condition which is of great importance with reference to the theories of respiration. This condition is one of cessation of breathing movements due to lack of stimulation of the respiratory center. It is brought about by rapid and prolonged ventilation of the lungs. If, for instance, in a rabbit or other animal, a tracheal cannula is inserted and connected with a bellows or respiration apparatus, the lungs may be inflated artificially at a rapid rate for any given period of time. If such an experiment is performed it will be found that when the blasts are stopped the animal makes no breathing movements at all, sometimes for a considerable interval. When the respirations start again they begin with feeble movements, which gradually increase to the normal amplitude (Fig. 281). One may produce a similar condition upon himself, approximately at least, by a series of rapid, forced inspirations. The question of importance is: Why does the respiratory center cease to act? The numerous researches made upon this condition seem to show very clearly that in the ordinary method used to produce it two factors co-operate, namely, a change in the condition of the gases of the blood and a stimulation of sensory fibers in the lungs, the latter factor bringing about a reflex inhibition of the respiratory center. Since either one of these factors alone may cause a cessation of breathing, some authors have distinguished two kinds of apnea, *apnea vera* or chemical apnea, and *apnea vagi*

or inhibitory apnea. It is generally stated\* that after section of the vagi it is more difficult than in the normal animal to produce apnea by vigorous artificial respiration, so doubtless in this last procedure, as usually carried out with a bellows, the rapid stimulation of the inhibitory fibers of the vagus by the expansion of the lungs facilitates the production of a true or chemical apnea. In the preceding paragraphs evidence has been given to show that the normal stimulus to the center is due to the presence of  $\text{CO}_2$ , and it follows logically that the more complete removal of this gas by ventilation of the lungs should be considered as the chief cause of true apnea. Experimentally, this view is well borne out by an old observation of Berns, according to which a condition of apnea

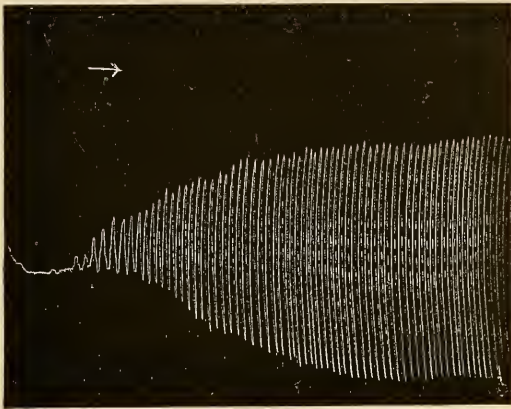

Fig. 281.—To show the recovery from apnea. The animal (rabbit) had been ventilated with a bellows and thrown into a condition of apnea shown at the beginning of the record. The respirations returned first as feeble movements which gradually increased to the normal.—(Dawson.)

in a rabbit may be cut short at any moment by a blast of  $\text{CO}_2$  sent into the lungs, a blast of air having no such effect. This observation is further supported by experiments by Mosso† upon men, in which he shows that apnea cannot be produced by inflation with carbon dioxid. This author designates the condition of diminished  $\text{CO}_2$  in the blood as *acapnia*. According to this terminology, true apnea is due to a condition of *acapnia*.

Much other work has tended to strengthen the general view that a certain tension or pressure of  $\text{CO}_2$  in the blood is necessary to stimulate the respiratory center, and that if the  $\text{CO}_2$  is washed out to a certain point by unusual ventilation of the lungs (condition of *acapnia*), then the respiratory center ceases to

\* See Head, "Journal of Physiology," 10, 1, and 279, 1889.

† Mosso, "Archives italiennes de biologie," 40, 1, 1903.

give off its rhythmic discharges. There is no desire to breathe and the animal lies quiet in a condition of apnea. Voluntary forced respirations in man maintained for some minutes will produce a similar condition. According to the interesting account given by Haldane and Poulton\* an apnea may be produced in this way which will last for 100 to 150 seconds, and before the individual begins to breathe again he may become very blue in the face, owing to the loss of oxygen from the blood. Henderson† has given experimental evidence to show that a marked diminution in the pressure of the CO<sub>2</sub> in the blood, brought about by forced respiration, may cause not only a condition of apnea but also a feeble rapid heart-beat, with fall of blood-pressure and the symptoms of surgical shock. It would appear, therefore, that a certain tension of CO<sub>2</sub> in the blood is necessary for the normal irritability of the vasoconstrictor and cardio-inhibitory centers as well as the respiratory center.‡ In the apneic condition produced by rapid ventilation of the lungs all three centers suffer a diminution in activity. In addition to the factors discussed above, namely reflex inhibition or excitation through sensory nerve fibers and variations in the carbon dioxide of the blood, it is to be borne in mind that this irritable center may be influenced in many other ways, for example, by the specific action of various drugs or toxins, by variations in the inorganic elements of the blood, etc.

**Innervation of the Bronchial Musculature.**—Numerous investigators, using different methods, have demonstrated that the bronchial musculature is supplied through the vagus with motor and inhibitory fibers, bronchoconstrictor and bronchodilator fibers, as they are usually called.§ Stimulation of the constrictors causes a narrowing of the bronchi, and therefore increases the resistance to the inflow and outflow of air. Some observers state that these fibers are normally in a condition of tonic activity (Roy and Brown), but others find little evidence for this belief. An artificial tonus—that is, a condition of maintained activity of the constrictor fibers—may be set up by the action of a number of drugs, such as muscarin, pilocarpin, and physostigmin, which in this case, as in so many other instances of autonomic fibers, are supposed to stimulate the endings of the fibers in the lungs. Their effect is removed by the action of atropin. These fibers are stimulated also during the excitatory stages of asphyxia. Reflex stimulation of the constrictors

\* Haldane and Poulton, "Journal of Physiology," 37, 390, 1908.

† Henderson, "American Journal of Physiology," 21, 128, 1908.

‡ See Mathison, "Journal of Physiology," 42, 283, 1911.

§ For references to literature, see Dixon and Brodie, "Journal of Physiology," 29, 97, 1903.



is obtained most readily (Dixon and Brodie) by irritation of the nasal mucous membrane, and it seems probable that in bronchial or spasmodic asthma these fibers are also stimulated reflexly.

The normal conditions under which the constrictors and dilators are brought into play can scarcely be stated. Irritating vapors or even  $\text{CO}_2$  lead to a bronchoconstriction and this reflex, as stated on p. 693, may be regarded as protective. When a constriction of the bronchial musculature exists it may be abolished by the paralyzing action of atropin, or temporarily by injections of extracts of lobelia or by the anesthetic effect of inhalations of chloroform or ether. Nicotin also causes a dilatation.

## CHAPTER XXXVIII.

### THE INFLUENCE OF VARIOUS CONDITIONS UPON THE RESPIRATIONS.

**The Effect of Muscular Work upon the Respiratory Movements.**—It is a matter of common experience that muscular exercise increases the rate and amplitude of the respiratory movements. Roughly speaking, the increase is proportional to the amount of muscular work, and the relationship is evidently a beneficial adaptation. The greater the amount of work done, the larger will be the amount of  $\text{CO}_2$  produced and the greater will be the need of oxygen. The adaptation was formerly explained in what seemed to be an entirely satisfactory way by assuming that the increased consumption of O and the greater production of  $\text{CO}_2$  in the muscles resulted in rendering the blood more venous, and consequently the respiratory center was stimulated more strongly, and indeed proportionally to the muscular effort. Geppert and Zuntz,\* however, have shown by gas analyses that whatever may be the condition of the venous blood during muscular exercise the arterial blood sent out from the left heart shows no constant change in the quantity or tension of the contained gases. They proved, also, that the effect on the center is not simply a reflex from the nerves in the muscles, since when the hind limbs were made to contract by stimulation the respiratory center was affected in the usual way although all the nerve connections were destroyed. They conclude, therefore, that the respiratory effect of muscular work must be due to certain substances produced in the muscle and given off to the blood. Other experiments (Lehmann) make it probable that these substances are the acid products, lactic acid and acid phosphates, known to be formed in muscle during contraction, and, indeed, it can be shown that the lactic acid in the blood is increased during muscular exercise.† It is not probable, however, that this reaction alone suffices to explain the accelerated respiration during muscular work. The time required for this change to come into action seems to be too long to make it effective as a protection to the muscles. Observations show that the respiratory rate, like the heart rate, is increased very promptly by heavy

\* Geppert and Zuntz, "Archiv f. die gesammte Physiologie," 42, 189, 1888.

† Ryffel, "Journal of Physiology," 39, 1909.

muscular work, and this initial effect at least has been explained in the same way for both mechanism. It is suggested,\* for example, that the voluntary nerve impulses coming down from the brain to the muscles irradiate into the medullary centers and quicken the heart rate by inhibiting the cardio-inhibitory center, and at the same time stimulate the respiratory center or increase its irritability so that it responds more readily to its intrinsic stimulus. When the muscles begin contracting they need more oxygen, and they produce more carbon dioxide to be removed. The quicker heart rate supplies more arterial blood, and the quicker respirations provide for the removal of the carbon dioxide and an adequate supply of oxygen. The more slowly developing change in the reaction of the blood, owing to the formation of acid products in the muscles, may be regarded, perhaps, as a supplementary provision in continued muscular activity for also raising the irritability of the respiratory center and thus ensuring deeper and more rapid breathing movements.

**The Effect of Variations in the Composition of the Air Breathed.**—Variations in the amount of nitrogen in the inspired air have no distinct physiological effect. The important elements to consider are the oxygen and the carbon dioxide.

*Increased Percentages of Oxygen.*—The normal pressure of oxygen in the air is 20 per cent. or 152 mms. We may increase this pressure either by changing the volume per cent. of the gas or by raising the barometric pressure by compression. The somewhat natural supposition that breathing pure oxygen—that is, oxygen at a pressure of 760 mm.—should have a beneficial effect on the oxidations of the body has found no support in physiological experiments. Atmospheric air supplies us with an excess of oxygen over the needs of the body; a still further increase of this excess has no positive advantage. This is true at least for ordinary conditions of rest or moderate activity. In excessive and prolonged muscular exertion the supply may be inadequate, and under these or similar conditions an increase in the percentage of oxygen in the respired air would naturally be advantageous. Paul Bert, in his interesting work on barometric pressures,† has called attention to the fact that at a certain pressure oxygen is not only not beneficial, but, on the contrary, is markedly toxic. From experiments made upon a great variety of animals and plants he concluded that all living things are killed when the oxygen pressure is sufficiently high,—say, 300 to 400 per cent. Warm-blooded animals die with convulsions when submitted to 3 atmospheres of pure oxygen or 15 atmospheres of air. At these high pressures the blood contains about 28 volumes of oxy-

\* Krogh and Lindhard, "Journal of Physiology," 47, 112, 1914.

† "La pression barométrique," p. 764, Paris, 1878.

gen to each 100 c.c. of blood instead of the usual 20 volumes. The additional 8 volumes are contained in solution. Fish also are killed when the oxygen pressure is increased to such a point that the water contains 10 volumes of dissolved oxygen to each 100 c.c. In more recent experiments by Smith,\* made upon mice, it was found that oxygen at pressures of 100 per cent. to 130 per cent. proves fatal in a few days, the animals showing inflammatory changes in the lungs. Oxygen at 180 per cent. kills mice and birds within twenty-four hours. Pressures of two atmospheres of air (40 per cent. O) have no injurious effect. No adequate chemical explanation can be offered at present for this toxic action of oxygen at high tensions. The matter is one of practical importance in connection with caisson and submarine work and the therapeutical use of oxygen.

*Decreased Percentages of Oxygen.*—Numerous observers (Bert, Zuntz, et al.) have shown that a fall in oxygen pressure has no perceptibly injurious result until it reaches about 10 per cent. At or somewhat below this pressure the hemoglobin is unable to take up its full amount of oxygen, and the body consequently suffers from a real deficiency in its oxygen supply, a condition designated as *anoxemia*. According to Bert's experimental results, death with convulsions quickly follows a fall of atmospheric pressure to 250 mms. (oxygen pressure, 50 mms. or 6 to 7 per cent.). Animals supplied with an atmosphere containing a deficient amount of oxygen show dyspneic respirations, which increase in violence and finally become convulsive.

*Increased Percentages of Carbon Dioxid.*—It was pointed out clearly by the researches of Friedländer and Herter† that death from increased percentages of CO<sub>2</sub> is accompanied by symptoms quite different from those due to lack of oxygen. As the CO<sub>2</sub> is increased a noticeable hyperpnea may be observed (Zuntz) at a concentration of about 3 per cent. When the concentration of CO<sub>2</sub> reaches 8 per cent. to 10 or 15 per cent. there is distinct dyspnea; but beyond this point further concentration, instead of augmenting the respirations, decreases them, and the animal dies, at concentrations of 40 to 50 per cent., without convulsions, but with the appearance, rather, of a fatal narcosis. It is probable that in these concentrations the CO<sub>2</sub> exercises a direct toxic action on the nerve cells.

**High and Low Barometric Pressures, Mountain Sickness, Caisson Disease, etc.**—High barometric pressures are used in submarine work, diving, caisson work, etc. As stated above, it follows from the work of Bert and Smith that when the pressure

\* "Journal of Physiology," 24, 19, 1899.

† Friedländer and Herter, "Zeitschrift f. physiol. Chemie," 2, 99, 1878, and 3, 19, 1879.

reaches 5 to 6 atmospheres long continuance in it may be followed by injurious or fatal results due to the toxic action of the oxygen. If the pressure is increased to 15 atmospheres the toxic influence of the oxygen brings on death with convulsions. Practically, however, such pressures are not encountered in submarine work. A caisson is a wooden or steel chamber arranged so that it may be sunk under water. The water is driven out by air under pressure. Since the pressure increases 1 atmosphere for each 10 meters (33 feet), it will be seen that very high pressures of air are not usually required. Caisson workers are at times attacked by serious or even fatal symptoms, not while in the compressed air, but during or after the "decompression" that is necessary in the return to normal conditions. The symptoms consist of pains in the muscles and joints, paralysis, dyspnea, congestion. Those who have investigated the subject\* state that the injurious results are due to a too rapid decompression. When this occurs the gases in the blood, particularly the nitrogen, are suddenly liberated as bubbles, which block the capillaries and thus produce anemia in different organs. If the decompression is effected gradually no evil results follow.

The effect of low barometric pressures is chiefly of interest in connection with residence in high altitudes, balloon ascensions, etc. At certain altitudes, from 3000 to 4000 meters, disagreeable symptoms are experienced by many persons, especially after muscular effort, which are designated usually under the term mountain sickness. The individual so affected suffers from headache, nausea, vertigo, great weakness, etc. Much investigation, especially of recent years, has been devoted to this subject.† Paul Bert concluded, from his numerous experiments, that a fall in barometric pressure acts upon the organism only in so far as there is a diminution of the partial pressure of the oxygen in the air respired. This view has been generally accepted in physiology, and mountain sickness and similar disturbances in balloon ascents have been explained, therefore, as due mainly to the lack of oxygen,—that is, to the condition of anoxemia. Mosso, on the contrary, has insisted upon the part played by the carbon dioxid. He gives experiments to show that there is a diminution in the carbon dioxid contents of the blood (a condition of acapnia), and it is to this, rather than to the anoxemia, that he would attribute the physiological results of low barometric pressures. Other authors lay

\* See Bert, *loc. cit.*, p. 939; also Hill and MacLeod, "Journal of Physiology," 29, 382, and "Journal of Hygiene," 3, 407.

† See "Zunts et al. Höhenklima u. Bergwanderungen in ihrer Wirkung auf d. Menschen," Berlin, 1906. Mosso and Morro, "Archives italiennes de biologie," 39, 387, also vols. 40 and 41. Douglas et al, "Physiological Observations made on Pike's Peak," etc.; "Philosophical Trans.," London, B. 203, 185, 1913.

stress upon the mechanical disturbances of the lung circulation, while still others assume that certain vaguely understood cosmical influences—such as the electrical condition of the air, its ionization, or radiations of some kind—may affect the metabolisms of the body and thus produce the symptoms in question. It would seem that the whole matter is more complex than was at first supposed, but the balance of evidence indicates that the chief factor in the production of mountain sickness is deficiency in oxygen, particularly when the oxygen need of the body is increased, as, for example, in muscular exercise. Experiments seem to show that the total amount of oxygen in the arterial blood may not be diminished, owing to the greater percentage of hemoglobin, but the hemoglobin is less saturated, and the oxygen is under a lower pressure and, therefore, it is not supplied so rapidly to the tissues. At very high altitudes the supply of oxygen for the body probably exhibits only a small margin of safety, and we may suppose that relatively little muscular exercise, with its attendant increase in oxygen consumption, will suffice to deplete the supply to such an extent as to affect the brain centers. The historical incident of the death of Sivel and Crocé-Spinelli at an altitude of 8600 meters (barometric pressure, 262 mms.; oxygen pressure, 52.4 mms.) gives an impressive instance of the physiological effects of extreme altitudes.

The incidents connected with the ascent in the balloon *Zenith* of Sivel, Crocé-Spinelli, and Tissandier, April 15, 1875, are described in detail by the last named in "*La Nature*," 1875, p. 337, also in Bert's "*La pression barometrique*," p. 1061. Only Tissandier survived. The balloonists were provided with bags containing oxygen (72 per cent.), but they were unable to make satisfactory use of them since shortly after passing 7500 meters they became so weak that the effort to raise the arm to seize the oxygen tube was impossible. Tissandier's graphic description relates that at 8000 meters it was impossible for him to speak, and that shortly afterward he became entirely unconscious. None of the three seems to have shown any signs of the violent dyspnea that usually precedes asphyxia caused by lack of oxygen. It is noteworthy, however, that the heart beats were very rapid, and that they experienced at first great depression of muscular strength without loss of consciousness. The onset of complete unconsciousness was sudden, but was preceded by feelings of sleepiness, which, however, were not associated with any distress. These latter facts recall the conditions of "shock," and would suggest that probably the rapid heart beat was an indication of a great fall in blood-pressure, which may have been directly responsible for the muscular weakness and final unconsciousness and death.

**The Respiratory Quotient and its Variations.**—In studying the gaseous exchanges of respiration one may determine the variations in the oxygen absorbed under different conditions or in the carbon dioxide eliminated, or finally in the ratio of one to the other,  $\frac{CO_2}{O_2}$ , which is known as the respiratory quotient. In short-lasting experiments the respiratory quotient is not a very reliable indicator

of the extent or character of the physiological oxidations in the body, since any alteration in the depth or rapidity of the respiratory movements may, by changing the ventilation of the alveoli, make a difference in the output of  $\text{CO}_2$ ,—a difference, however, which would have no significance in regard to the nutritive changes of the body. In longer experiments and in those during which the respiratory movements are not altered the determination of this ratio throws light upon the nature of the material that is undergoing oxidation in the body, as will be apparent from the following considerations: Under ordinary conditions of rest and upon a mixed diet the R. Q. varies between 0.65 and 0.95 (Loewy) or between 0.75 and 0.89 (Magnus Levy). If, however, the material oxidized in the body is entirely carbohydrate, the R. Q. should be equal to unity:  $\frac{\text{CO}_2}{\text{O}_2} = 1$ . All the oxygen used in the combustion might be considered as uniting with the C to form  $\text{CO}_2$ , since enough O is present in the sugar to account for that used in oxidizing the H to  $\text{H}_2\text{O}$ . Or, as expressed in a reaction,

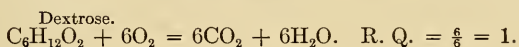

The number of molecules of  $\text{CO}_2$  formed in the oxidation is equal to the number of molecules of  $\text{O}_2$  used. If fats alone are oxidized in the body the R. Q. should be low (0.7), since these substances are poor in oxygen compared with the amount of C and H present in the molecule. The combustion of palmitin may be represented as follows:

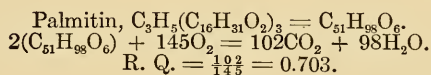

In estimating the respiratory quotient for proteins one must bear in mind the fact that these substances vary somewhat in composition and, moreover, that they are not completely oxidized in the body. Calculations based upon the amount of unoxidized carbon and hydrogen escaping in the urine and feces give the average figure of 0.801 for the R. Q. of proteins. It is evident from these statements that an increase in the proportion of carbohydrate food will cause the R. Q. to approach unity, while an increase in protein and especially in fat will lower its value. In this way we can understand the actual variation observed in the average respiratory quotient of different classes of animals, as shown in the following brief table (Loewy):

Horse, herbivorous—	R.Q.	= 0.960
Sheep, “	“	= 0.900
Man, omnivorous	“	= 0.800
Dog, carnivorous	“	= 0.750.

In starvation, when the body is living only on its own protein and fat, the R. Q. is much lower than under a normal diet with its large proportion of carbohydrate. By a determination of the respiratory quotient before and after varying certain conditions one may ascertain whether the given condition causes a change in the character of the body metabolism. For example, this method has been used to ascertain whether muscular work effects any change in the nature of the material consumed in the body. Experiments made upon this point have given variable results. In a recent extensive series of investigations\* it is stated that the R. Q. tends to rise during muscular work, especially if the work is severe. The increase observed was not great, from 0.85 to 0.88 in moderate work, but so far as a rise occurred, it was interpreted to mean that more carbohydrate material (glycogen) was being oxidized. Under certain special conditions the respiratory quotient may exceed unity or fall distinctly below 0.7. A rise to a value over unity may occur temporarily because of increased ventilation of the alveoli. Deeper and more rapid breathing will drive out some of the  $\text{CO}_2$  in the air of the lungs and thus increase greatly the R. Q. As previously stated, this increase has in itself no nutritional significance, but it is a factor that must be allowed for in such experiments. A more suggestive increase of the R. Q. is observed during convalescence. In this period, as is well known, an individual may increase in weight rapidly, chiefly from the laying on of fat. This fat is made in large part probably from the carbohydrate of the food. An oxygen-rich food, therefore, is converted to an oxygen-poor one, so that some of the oxygen must be split off partly as carbon dioxide, and there is a larger output of this substance in the expired air.

**Modified Respiratory Movements.**—Laughing, coughing, yawning, sneezing, sobbing, and even vomiting may be considered as modified respiratory movements, since the same group of muscles comes into play. These are all movements, with the exception of yawning, which may be regarded as reflexes that have nothing to do directly with the processes of respiration. A most interesting variation of the normal type of respiration is known as the Cheyne-Stokes respiration. It occurs in certain pathological conditions, such as arteriosclerosis, uremic states, fatty degeneration of the heart, and especially under conditions of increased intracranial pressure. It is characterized by the fact that the respiratory movements occur in groups (10 to 30) separated by apneic pauses, which may last for a number (30 to 40) of seconds. After each pause the respirations begin with a small movement, gradually increase

\* Benedict and Cathcart, "Muscular Work, etc.," Carnegie Institution of Washington, 1913.



to a maximum, and then fall off gradually to the point of complete cessation (see Fig. 282). Great variations, however, are shown in the character and number of the respirations during the so-called dyspneic phase. From observations made by means of the sphygmomanometer Eyster\* has shown that in this condition there are also rhythmic waves of blood-pressure (Traube-Hering waves), and according to the relation of these pressure waves to the groups of respirations the Cheyne-Stokes cases fall into two groups. In one group the dyspneic phase coincides with a fall of blood-pressure and a slowing of the pulse-rate. In the other group the reverse relations hold, the blood-pressure and pulse-rate both rising during the dyspneic phase and falling during the apnea. This latter group consists of cases in which there is evidence of

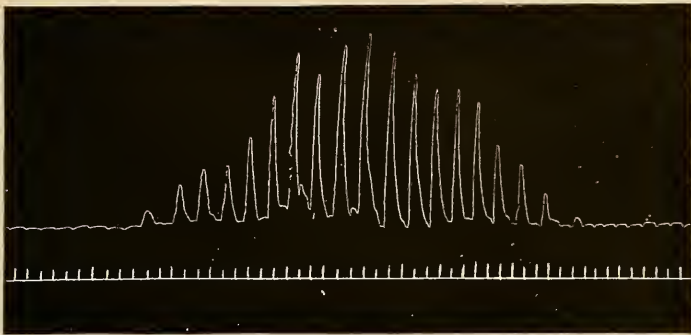

Fig. 282.—Record showing typical Cheyne-Stokes respiration (from a case of aortic and mitral insufficiency with arteriosclerosis). The time record gives seconds.

increased intracranial tension. Under experimental conditions the author was able to show on dogs that an artificial increase in intracranial tension calls forth Cheyne-Stokes respirations, whenever it happens that rhythmic changes in blood-pressure are produced of such a character that the blood-pressure rises and falls alternately above and below the line of intracranial pressure. It is probable, therefore, that in the clinical cases associated with a rise of intracranial pressure the blood-pressure likewise rises and falls above and below intracranial tension, and that the alternating periods of apnea and dyspnea are due to this fact in this class of cases. When the blood-pressure falls below intracranial pressure there is a condition of deep anemia of the medulla sufficient to suspend the activity of the respiratory center. The following rise of blood-pressure by forcing more blood through the medulla calls forth a group of respiratory movements.

\* Eyster, "Journal of Experimental Medicine," 1906.

By examination of the expired air Pembrey\* has shown that during the dyspneic phase the percentage of  $\text{CO}_2$  in the alveolar air is markedly diminished (2 per cent.), and he believes, therefore, that the following phase of apnea is due entirely to this washing out of the  $\text{CO}_2$ , that is, to the removal of the normal stimulus to the respiratory center. Practically he finds that the apneic phase can be removed by the administration of either pure oxygen or carbon dioxid (2.2 to 11.2 per cent.). Pembrey does not give the clinical histories of his patients, but apparently he has studied cases belonging chiefly to Eyster's first group. None of the suggestions made at present seem to account adequately for the very labored breathing at the acme of the dyspneic phase, and the phenomenon evidently requires further experimental study.

More or less rhythmical variations in the strength of the breathing movements have been described also in normal sleep, hibernation, chloral narcosis, high altitudes etc., but nothing so definite and characteristic as in these very interesting Cheyne-Stokes cases.

\* Pembrey, "Journal of Pathology and Bacteriology," 12, 258, 1908.

## SECTION VII.

# PHYSIOLOGY OF DIGESTION AND SECRETION.

---

## CHAPTER XXXIX.

### MOVEMENTS OF THE ALIMENTARY CANAL.

**Mastication.**—Mastication is an entirely voluntary act. The articulation of the mandibles with the skull permits a variety of movements; the jaw may be raised and lowered, may be projected and retracted, or may be moved from side to side, or various combinations of these different directions of movement may be effected. The muscles concerned in these movements and their innervation are described as follows: The masseter, temporal, and internal pterygoids raise the jaw; these muscles are innervated through the inferior maxillary division of the trigeminal. The jaw is depressed mainly by the action of the digastric muscle, assisted in some cases by the mylohyoid and the geniohyoid. The two former receive motor fibers from the inferior maxillary division of the fifth cranial, the last from a branch of the hypoglossal. The lateral movements of the jaws are produced by the external pterygoids, when acting separately. Simultaneous contraction of these muscles on both sides causes projection of the lower jaw. In this latter case forcible retraction of the jaw is produced by the contraction of a part of the temporal muscle. The external pterygoids also receive their motor fibers from the fifth cranial nerve, through its inferior maxillary division. The grinding movements commonly used in masticating the food between the molar teeth are produced by a combination of the action of the external pterygoids, the elevators, and perhaps the depressors. At the same time the movements of the tongue and of the muscles of the cheeks and lips serve to keep the food properly placed for the action of the teeth, and to gather it into position for the act of swallowing.

**Deglutition.**—The act of swallowing is a complicated reflex movement which may be initiated voluntarily, but is, for the most part, completed quite independently of the will. The classical description of the act given by Magendie divides it into three stages,

corresponding to the three anatomical regions—mouth, pharynx, and esophagus—through which the swallowed morsel passes on its way to the stomach. The first stage consists in the passage of the bolus of food through the isthmus of the fauces,—that is, the opening lying between the ridges formed by the palatoglossi muscles, the so-called anterior pillars of the fauces. This part of the act is usually ascribed to the movements of the tongue itself. The bolus of food lying upon its upper surface is forced backward by the elevation of the tongue against the soft palate from the tip toward the base. This portion of the movement may be regarded as voluntary, to the extent at least of manipulating the food into its proper position on the dorsum of the tongue, although it is open to doubt whether the entire movement is usually effected by a voluntary act. Under normal conditions the presence of moist food upon the tongue seems essential to the complete execution of the act; and an attempt to make the movement with very dry material upon the tongue is either not successful or is performed with difficulty. The second act comprises the passage of the bolus from the isthmus of the fauces to the esophagus,—that is, its transit through the pharynx. The pharynx being a common passage for the air and the food, it is important that this part of the act should be consummated quickly. According to the older description, the motor power driving the bolus downward through the pharynx is derived from the contraction of the pharyngeal muscles, particularly the constrictors, which contract from above downward and drive the food into the esophagus. Kronecker and Meltzer,\* however, have shown that the contraction of the mylohyoid muscle in the floor of the mouth is the most important factor in this act of shooting the food suddenly through the pharynx into the esophagus. The contraction of this muscle marks the beginning of the purely involuntary part of the act of swallowing. The bolus of food lies upon the dorsum of the tongue and by the pressure of the front of the tongue against the hard palate it is shut off from the front part of the mouth cavity. When the mylohyoids contract sharply the bolus is put under pressure and is shot into and through the pharynx. This effect is aided by the contraction of the hyoglossi muscles, which by moving the tongue backward and downward tend to increase the pressure put upon the food. Simultaneously, a number of other muscles are brought into action, the general effect of which is to shut off the nasal and laryngeal openings and thus prevent the entrance of

\* Kronecker and Meltzer, "Archiv f. Physiologie," 1883, suppl. volume, p. 328; also "Journal of Experimental Medicine," 2, 453, 1897. For later work, consult Cannon and Moser, "American Journal of Physiology," 1, 435, 1898; Schreiber, "Archiv f. exper. Pathol. u. Pharmakologie," 46, 414, 1901; and Eykman, "Archiv f. die gesammte Physiologie," 99, 513, 1903.

food into the corresponding cavities. The whole reflex is therefore an excellent example of a finely co-ordinated movement.

The following events are described: The mouth cavity is shut off by the position of the tongue against the palate and by the contraction of the muscles of the anterior pillars of the fauces. The opening into the nasal cavity is closed by the elevation of the soft palate (action of the levator palati and tensor palati muscles) and the contraction of the posterior pillars of the fauces (palatopharyngeal muscles) and the elevation of the uvula (azygos uvulæ muscle). The soft palate, uvula, and posterior pillars thus form a sloping surface shutting off the nasal chamber and facilitating the passage of the food backward through the pharynx. The respiratory opening into the larynx is closed by the adduction of the vocal cords (lateral crico-arytenoids and constrictors of the glottis) and by the strong elevation of the entire larynx and a depression of the epiglottis over the larynx (action of the thyrohyoids, digastrics, geniohyoids, and mylohyoids and the muscles in the aryteno-epiglottidean folds). If the elevation of the larynx be prevented by fixation of the thyroid the act of swallowing becomes impossible. There is also at this time, apparently as a regular part of the swallowing reflex, a slight inspiratory movement of the diaphragm, the so-called swallowing respiration. The movements of the epiglottis during this stage of swallowing have been much discussed. The usual view is that it is pressed down upon the laryngeal orifice like the lid of a box and thus effectually protects the respiratory passage. It has been shown, however, that removal of the epiglottis does not prevent normal swallowing, and Stuart and McCormick\* have reported the case of a man in whom part of the pharynx had been permanently removed by surgical operation and in whom the epiglottis could be seen during the act of swallowing. In this individual, according to their observations, the epiglottis was not folded back during swallowing, but remained erect. Kanthack and Anderson† state that in normal individuals the movement of the epiglottis backward during swallowing may be felt by simply passing the finger back into the pharynx until it comes into contact with the epiglottis. According to most observers, it is not necessary for the protection of the larynx that the epiglottis shall be actually folded down over it by the contraction of its own muscles. The forcible lifting of the larynx, together with the descent of the base of the tongue, effects the same result by mechanically crowding the parts together, and the larynx is still further guarded by the approximation of the false and true vocal cords, thus closing the glottis. The whole act is very rapid as well as complex, so that not more

\* "Journal of Anatomy and Physiology," 1892.

† "Journal of Physiology," 14, 154, 1893.

than a second elapses between the beginning of the contraction of the mylohyoids and the entrance of the food into the upper end of the esophagus.

The passage of the food through the esophagus differs apparently with its consistency. When the food is liquid or very soft Kronecker and Meltzer have shown that it is shot through the whole length of the esophagus by the force of the initial act of swallowing. It arrives at the lower end of the esophagus in about 0.1 sec., and may pass immediately into the stomach or may lie some moments in the esophagus according to the conditions of the sphincter guarding the cardiac orifice. When, however, the food is solid or semi-solid, as was shown by Cannon and Moser, it is forced down the esophagus by a peristaltic movement of the musculature. The circular muscles are constricted from above downward by an advancing muscular wave. The upper portion of the esophagus contains cross-striated fibers indicating rapid contraction; the lower end consists of plain muscle only, while the intermediate portion is a mixture of the two varieties. Kronecker and Meltzer believe that each of these segments contracts as a whole and in orderly succession, but other observers, on the evidence furnished by Roentgen-ray photographs, agree that there is no perceptible pause in the downward movement of the wave of contraction. These same movements occur in the swallowing of liquid or soft food, but in such cases the peristaltic wave follows the actual descent of the food. According to the observation of Kronecker and Meltzer, it takes about 6 sec. for the peristaltic wave to reach the stomach, and the passage of the food through the cardia takes place with sufficient energy to give rise to a murmur that may be heard by auscultating over this region. In the case of the more liquid food that is shot at once to the lower end of the esophagus, it may apparently pass at once into the stomach or it may lie in the esophagus until the wave of contraction reaches it (6 sec.) and forces it through the opening. According to the observations made by Hertz,\* liquids or liquid food are held up at the end of the esophagus and pass slowly into the stomach through the sphincter. He estimates that an interval of from 4.6 to 8.6 sec. elapses before the swallowed bolus disappears into the stomach, about one-half of this time being occupied by the passage to the bottom of the esophagus and one-half in the transit through the cardiac orifice of the stomach.

**Nervous Control of Deglutition.**—The entire act of swallowing, as has been said, is essentially a reflex act. Even the comparatively simple wave of contraction that sweeps over the esophagus is due to a reflex nervous stimulation, and is not a simple conduction of

\* Hertz, "Guy's Hospital Reports," 61, 389, 1907.

contraction from one portion of the tube to another. This fact was demonstrated by the experiments of Mosso,\* who found that after removal of an entire segment from the esophagus the peristaltic wave passed in due time to the portion of the esophagus left on the stomach side, in spite of the anatomical break. The same experiment was performed successfully on rabbits by Kronecker and Meltzer. Observation of the stomach end of the esophagus in this animal showed that it went into contraction two seconds after the beginning of a swallowing act whether the esophagus was intact or ligated or completely divided by a transverse incision. A still more striking proof of the same fact is the interesting case cited by v. Mikulicz of a man in whom a portion of the esophagus had been resected on account of a carcinoma. The lower end of the esophagus was given a fistulous opening in the neck and and it was found that food introduced into this opening was not moved toward the stomach until the patient made a swallowing movement.† The afferent nerves concerned in this reflex are the sensory fibers to the mucous membrane of the pharynx and esophagus, including branches of the glossopharyngeal, trigeminal, vagus, and superior laryngeal division of the vagus. Artificial stimulation of this last nerve in the lower animals is known to produce swallowing movements. Several observers have attempted to determine the precise area or areas in the pharyngeal membrane from which the sensory impulses liberating the reflex normally start. According to Kahn,‡ the most effective areas from whose stimulation the reflex may be produced vary in location in different animals. In the rabbit the reflex is originated most easily by stimulation at the entrance to the pharynx—the soft palate—along the line extending from the posterior edge of the hard palate to the tonsils (superior maxillary branch of trigeminal); in the dog irritation of the posterior pharyngeal wall is most effective (glossopharyngeal nerve); in monkeys the area is approximately as in rabbits,—that is, in the region of the tonsils. The motor fibers concerned in the reflex comprise the hypoglossal, the trigeminal, the glossopharyngeal, the vagus, and the spinal accessory. For an act of such complexity and such perfect co-ordination it has been assumed that there is a special nerve center, the swallowing or deglutition center, which has been located in the medulla at the level of the origin of the vagi. There is little positive knowledge, however, concerning the existence of this center as a definite group of intermediary nerve cells, after the type of the vasoconstrictor or respiratory center, which send their axons to the motor nuclei of the several efferent nerves con-

\* Moleschott's "Untersuchungen," 1876, volume xi.

† Quoted from Cohnheim in Nagel's "Handbuch d. Physiologie."

‡ Kahn, "Archiv f. Physiologie," 1903, suppl. volume, 386.

cerned. As in the case of other complicated reflex acts, we can only say that the deglutition reflex is controlled by a definite nervous mechanism the final motor cells of which are scattered in the several motor nuclei of the efferent nerves mentioned above.

So far as the esophagus is concerned, the motor fibers are received from the vagus, and in normal swallowing these fibers are excited reflexly from the pharynx at the beginning of the act. That is to say, the initial sensory stimulus in the pharynx liberates a series of reflex movements which begin with the contraction of the mylohyoid muscle and end with a peristaltic wave that progresses in orderly fashion along the esophagus. It has been shown, however, that the bolus when it reaches the esophagus may start a different order of reflexes by local stimulation of the sensory fibers. These stimuli lead to reflex contraction of the musculature above the bolus, and thus a series of reflexes are liberated which are sufficient to move the bolus downward. If the primary reflex initiated at the beginning of the swallow proves inefficient, that is to say, if it succeeds only in forcing the bolus into the top of the esophagus, it may be assumed that this secondary or accessory mechanism comes into play and provides for the transportation of the bolus to the stomach. In this series of secondary reflexes, as in the more complicated primary reflex, the vagus nerve forms a part of the path and the reflex center lies, therefore, in the medulla.

**Cardiac Sphincter.**—At the cardia or cardiac orifice the circular layer of muscle acts as a sphincter. When the stomach is empty this sphincter is probably relaxed. When the stomach contains food the sphincter is thrown into tone, and thus shuts off the gastric cavity from the esophagus. The sphincter receives both motor and inhibitory fibers from the vagus and inhibitory fibers from the sympathetic system by way of the celiac ganglion. In addition it is supplied from the intrinsic plexus, plexus of Auerbach, which, as elsewhere in the alimentary canal, seems to be capable of regulating the movements of the musculature independently of the extrinsic nerves. The tonic contraction of the sphincter that occurs when the stomach contains food is maintained, according to Cannon,\* by a reflex through this intrinsic plexus, the stimulus initiating the reflex being due to the acid present in the gastric secretion. The peristaltic wave sweeping down the esophagus is preceded, in the lower part of the esophagus at least, by a wave of inhibition or relaxation. This latter phase affects the sphincter and the adjacent musculature of the stomach and clears the path for the bolus, so that the following wave of contraction may squeeze it through the relaxed orifice without serious resistance. After the passage of the bolus into the stomach

\* Cannon, "The Mechanical Factors of Digestion," 1911.



the sphincter again falls into tone until another peristaltic wave approaches from the esophageal side.

**The Anatomy of the Stomach.**—The stomach in man belongs to the simple type as distinguished from the compound stomachs of some of the other mammalia,—the ruminating animals, for example. Physiological and histological investigations have shown, however, that the so-called simple stomachs are divided into parts that have different properties and functions. The names and boundaries of these parts can not be stated precisely, since they vary in different animals, and, moreover, there is some want of agreement among different authors regarding the nomenclature of the parts of the stomach.\* For the purposes of a physiological description we may use the names indicated in the accompanying schematic figure. The main interest lies in the separation of the pyloric part of the stomach or antrum pylori from the main cavity of the stomach. The line of separation is marked by a fissure on the small curvature, incisura angularis (*I. A.*), and on the large curvature by an abrupt change of direction. The pyloric part

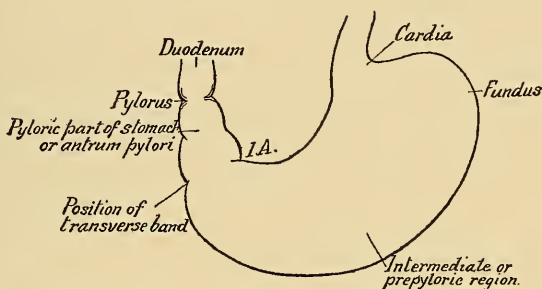

Fig. 283.—Schematic figure to show the different parts of the stomach.—(After Retzius.)

makes an angle, therefore, with the body of the stomach, and differs from the latter in its musculature, the macroscopical and microscopical characteristics of its mucous membrane, and in its functional importance. Some writers divide the antrum further into a pyloric vestibule, forming the larger part of the antrum, and a pyloric canal, consisting of the narrower tube-like portion which connects with the duodenum. The pyloric canal is short, about 3 cm., and is more marked as a separate structure in the stomach of young children. The rest of the stomach falls into two subdivisions, the fundus and the corpus or body. The fundus is the blind, rounded end of the stomach to the left of the cardia, or, in a vertical position of the stomach, the portion that lies above a horizontal plane passing through the cardia; the portion between

\* See His, "Archiv f. Anatomie," 1903, p. 345; also Cunningham, "Transactions of the Royal Society of Edinburgh," 45, 9, 1905-06.

the fundus and the pylorus is the body of the stomach or the intermediate or prepyloric region. This latter region shows in many animals a characteristic structure in its secreting glands, and it is in this portion that the hydrochloric acid of the gastric juice is mainly secreted.

*The Musculature of the Stomach.*—The musculature of the stomach is usually divided into three layers,—a longitudinal, an oblique, and a circular coat. The longitudinal coat is continuous at the cardia with the longitudinal fibers of the esophagus; it spreads out from this point along the length of the stomach, forming a layer of varying thickness; along the curvatures the layer is stronger than on the front and posterior surfaces, while at the pyloric end it increases considerably in thickness, and passes over the pylorus to be continued directly into the longitudinal coat of the duodenum. The layer of oblique fibers is quite incomplete; it seems to be continuous with the circular fibers of the esophagus, and spreads out from the cardia for a certain distance over the front and posterior surfaces of the fundus of the stomach, but toward the pyloric end disappears, seeming to pass into the circular fibers. The circular coat, which is placed between the two preceding layers, is the thickest and most important part of the musculature of the stomach. At the fundus the circular bands are thin and somewhat loosely placed, but toward the pyloric end they increase much in thickness, forming a strong, muscular mass, which, as we shall see, plays the most important part in the movements of the stomach. At the pylorus itself a special development of this layer functions as a sphincter pylori, which with the aid of a circular fold of the mucous membrane makes it possible to shut off the duodenum completely from the cavity of the stomach. The line of separation between the antrum pylori and the body of the stomach is made by a special thickening of the circular fibers which forms a structure known as the “transverse band” by the older writers,\* and described more recently† as the “sphincter antri pylorici.” Under certain conditions, such as vomiting, stimulation of the vagus, etc., this sphincter may be contracted with such force as to separate the antrum entirely from the fundic end of the stomach.

*The Movements of the Stomach.*—The solid food remains in the stomach for several hours, and during this time the musculature contracts in such a way that the thinner portions as they are formed by digestion are ejected from time to time through the pylorus into the intestine. Except at the definite intervals when the pyloric sphincter relaxes the food is entirely shut off from the rest of the alimentary canal by the tonic closure of the sphincters at the cardia

\* See Beaumont, “Physiology of Digestion,” second edition, 1847, p. 104.

† Hofmeister and Schütz, “Archiv f. exper. Pathologie und Pharmakologie,” 1886, vol. xx.

and the pylorus. There is a certain orderliness in the movements of the stomach, and especially in the separation and ejection of the more liquid from the solid parts, which shows the existence of a specially adapted mechanism. These movements have been studied by many investigators, making use of various experimental methods. The first noteworthy contributions to this subject were those made in this country by Beaumont in his famous observations upon Alexis St. Martin, the Canadian voyageur, who had a permanent fistulous opening in his stomach as the result of a gunshot wound.\* In recent years the subject has been studied with great success by means of the *x*-rays,† on the excised stomach,‡ and by means of tambours or sounds introduced into the stomach to measure the pressure changes.§ These researches all unite in emphasizing one fundamental point—namely, that the fundic end of the stomach is not actively concerned in these movements, but serves rather as a reservoir for retaining the bulk of the food, while the muscular pyloric region is the apparatus which triturates and macerates the food and forces it out from time to time into the duodenum. According to the observations made with the *x*-ray apparatus, movements begin a few minutes after the entrance of food into the stomach. Small contractions start in the middle region of the stomach and run toward the pylorus. These moving waves of contraction appear at regular intervals. The pyloric portion becomes lengthened and it may be noticed that in this region the peristaltic waves become more and more forcible as digestion progresses. These running waves or rings of contraction serve to press the stomach contents against the pylorus. According to Cannon, they occur in the cat at intervals of 10 seconds and each wave requires about 20 seconds to reach the pylorus. While in human beings, to judge from the sounds which may be heard upon auscultation when food mixed with air is given, they occur at intervals of about 20 seconds. The obvious result of these movements is to mix the food thoroughly, in the intermediate and pyloric portions of the stomach, with the acid gastric juice and to reduce it to a thin, liquid mass,—the chyme. At certain intervals the pyloric sphincter relaxes and the contraction wave squeezes some of the fluid contents into the duodenum with considerable force. The mechanism controlling the relaxation of this sphincter is obscure. It does not occur with the approach of each contraction wave, but at irregular intervals. Cannon connects it in part with the consistency of the food, but mainly with the effect of the hydrochloric acid in the

\* See Osler, "Journal of the American Medical Association," Nov. 15, 1902, for life of Beaumont and account of his work.

† See Cannon, "American Journal of Physiology," 1, 359, 1898; and Roux and Balthazard, "Archives de Physiologie," 10, 85, 1898.

‡ Hofmeister and Schütz, *loc. cit.*

§ Moritz, "Zeitschrift f. Biologie," 32, 359, 1895.

gastric secretion. Solid objects forced against the pylorus prevent relaxation and retard the passage of the chyme into the intestine. When liquid food alone is taken into the stomach numerous observations, made by means of intestinal fistulas, prove that the material may be forced into the duodenum within a few minutes. Hydrochloric acid in the stomach seems to favor or produce a relaxation of the pyloric sphincter, while in the duodenum, on the contrary, it causes a contraction of the sphincter. In this way it may be imagined that after each ejection of acid chyme the sphincter is kept closed until the acid material in the duodenum is neutralized, and so, automatically, a mechanism is provided by means of which the duodenum is charged at intervals and at such times as it is prepared to receive and neutralize a new quantity of the chyme. According to this description, the portion of the food toward the pyloric end of the stomach is the first to be thoroughly mixed with the gastric juice, and to be broken down partly by digestion and partly by the mechanical action of the contractions. This portion, as it is liquefied, is expelled, and its place is taken by new material forced forward from the fundic end. It would seem that this latter portion of the stomach is in a condition of tone, and the pressure thus put upon the contents is sufficient to force them slowly toward the pyloric end as this becomes emptied. The older view was that the contents of the stomach are kept in a general rotary movement so as to become more or less uniformly mixed; but Cannon's observations, and also those of Grutzner,\* indicate that the material at the fundic end may remain undisturbed for a long time and thus escape mixture with the acid gastric juice, so far at least as the interior of the mass is concerned.

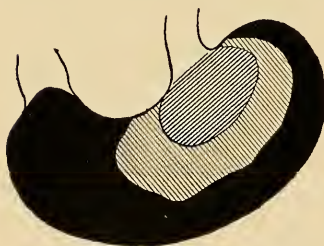

Fig. 284.—Section of frozen stomach of rat during digestion to show the stratification of food given at different times.—(Grutzner.) The food was given in three portions and colored differently: first, black; second, white (indicated by vertical marking); third, red (indicated by transverse marking).

This fact is of importance in connection with the salivary digestion of the starchy foods. Obviously, salivary digestion may proceed for a time in the fundic end without being affected by the acid of the stomach. Grutzner fed rats with food of different colors and found that the successive portions were arranged in definite strata. The food first taken lay next to the walls of the stomach, while the succeeding portions were arranged regularly in the interior in a concentric fashion, as shown in the

figure. Such an arrangement of the food is more readily understood when one recalls that the stomach has never any empty space

\* Grutzner, "Archiv f. die gesammte Physiologie," 106, 463, 1905.

within; its cavity is only as large as its contents, so that the first portion of food eaten entirely fills it and successive portions find the wall layer occupied and are therefore received into the interior. The ingestion of much liquid must interfere somewhat with this stratification. Cannon\* has reported some interesting experiments upon the relative duration of gastric digestion for carbohydrates, proteins, and fats when fed separately and combined. The foods were mixed with subnitrate of bismuth and their position in the stomach and passage into the intestine were watched by means of the Roentgen rays. It was found that carbohydrate food begins to pass out from the stomach soon after ingestion, and requires only about one-half as much time as the proteins for complete gastric digestion. Fats remain long in the stomach when taken alone, and when combined with the other foodstuffs markedly delay their exit through the pylorus. This distinct difference in the main foodstuffs can hardly be referred to mere mechanical consistency, since the fats are liquefied by the heat of the body. Cannon has shown that this regulation is not effected through the agency of the extrinsic nerves. After section of the splanchnics and vagi the difference in time between the ejection of carbohydrate and protein material still exists, so that the control in this matter must be exerted through some local mechanism in the stomach itself. If, in a given diet, the carbohydrate is fed before the protein, the former, having the position of advantage toward the pyloric end, will be ejected promptly into the intestine, while the protein is retained for gastric digestion. If the order is reversed and the protein is fed first, the passage of the carbohydrate out of the stomach will be retarded. This author has also reported numerous interesting experiments, of medical and surgical interest, which indicate that the motor activity of both stomach and intestines may be greatly depressed by certain conditions, especially by mechanical handling or by conditions of general asthenia.

Regarding the general mechanism of the stomach, it may be pointed out that it forms an admirably adapted apparatus for receiving at once, or within a short period, a large amount of food which it reduces to a liquid or semiliquid condition, partly by digestion, partly mechanically, and that it charges the intestine at intervals with small amounts of this chyme in such a condition as to admit of rapid digestion. It seems obvious that without the stomach our mode of eating would have to be changed, as it would not be possible to load the intestine rapidly with a large supply of food such as is consumed at an ordinary meal.

\* Cannon, "American Journal of Physiology," 12, 387, 1904. For a general review of Cannon's work, see "American Journal of the Medical Sciences," April, 1906.

**The Relation of the Nerves to the Movements of the Stomach.**—The stomach receives nerve fibers from two sources,—the vagi and the splanchnics,—but its orderly movements are merely regulated through these extrinsic fibers; it is essentially an automatic organ. Thus, it has been shown that the excised stomach (Hofmeister and Schutz), when kept warm, continues to execute regular movements which, if not identical with those observed under normal conditions, have at least an orderly sequence. So also it would appear from the results of several observers\* that gastric digestion may proceed normally both as regards secretion and movements after section of the extrinsic nerves. We may regard the stomach, considered as a motor mechanism, as an automatic organ like the heart. Its stimuli to movement arise within itself, but these movements are regulated by the action of the extrinsic nerve fibers so as to adapt them to varying conditions. Whether the automaticity is a property of the plain muscle tissue itself, or depends upon the rich supply of intrinsic nerve ganglia (plexuses of Meissner and Auerbach), is a question that cannot be answered definitely at present. The extrinsic nerves not only supply the stomach with efferent fibers, motor and secretory, but also carry afferent fibers from the stomach to the central nervous system. Regarding the purely efferent action of the extrinsic nerves, the results of numerous experiments seem to show quite conclusively that in general the fibers received along the vagus path are motor, artificial stimulation of them causing more or less well-marked contractions of part or all of the musculature of the stomach. It has been shown that the sphincter pylori as well as the rest of the musculature is supplied by motor fibers from these nerves. The fibers coming through the splanchnics, on the contrary, are mainly inhibitory. When stimulated they cause a dilatation of the contracted stomach and a relaxation of the sphincter pylori. Some observers have reported experiments which seem to show that this anatomical separation of the motor and inhibitory fibers is not complete; that some inhibitory fibers may be found in the vagi and some motor fibers in the splanchnics. The anatomical courses of these fibers are insufficiently known, but there seems to be no question as to the existence of the two physiological varieties. Through their activity, without doubt, the movements of the stomach may be influenced, favorably or unfavorably, by conditions directly or indirectly affecting the central nervous system. Wertheimer † has shown experimentally that stimulation of the central end of the sciatic or the vagus nerve may cause reflex inhibition of the tonus of the stomach,

\* See Heidenhain in Hermann's "Handbuch der Physiologie," vol. v., p. 118. Also Cannon, "American Journal of Physiology," 1906.

† "Archiv de physiologie normale et pathologique," 1892, p. 379.

and Doyon\* has confirmed this result in cases in which the movements and tonicity of the stomach were first increased by the action of pilocarpin and strychnin. Cannon, in his observations upon cats, found that all movements of the stomach ceased as soon as the animal showed signs of anxiety, rage, or distress.

**Hunger Contractions.**—After the stomach has been empty for a certain time we experience sensations of hunger that are more or less of a subpainful character and are, therefore, frequently designated as “hunger-pains.” These sensations appear and disappear at irregular intervals until food is taken into the stomach. Cannon and Washburn† first showed that these sensations appear simultaneously with contractions of the stomach, and they suggested that the hunger contractions cause the hunger-pains. These particular movements have been investigated since by Carlson‡ upon a man with a permanent gastric fistula. He finds that when the hunger contractions are occurring they are inhibited by chemical or mechanical stimulation of the gastric mucosa or by the chewing or tasting of palatable food. The hunger contractions must constitute a variety of movements quite different in mode of causation from the movements exhibited during gastric digestion. Like the latter, however, they are essentially automatic, that is to say, they continue when the extrinsic nerves are severed and, therefore, are probably initiated and controlled by the intrinsic nervous apparatus of the stomach. Carlson suggests that the hunger contractions may involve primarily the musculature of the fundic and cardiac region, while the contractions of digestion, as is known, are exhibited chiefly in the musculature at the pyloric end.

**Movements of the Intestines.**—The muscles of the small and the large intestine are arranged in two layers,—an outer longitudinal and an inner circular coat,—while between these coats and in the submucous coat there are present the nerve-plexuses of Auerbach and Meissner. The general arrangement of muscles and nerves is similar, therefore, to that prevailing in the stomach, and in accordance with this we find that the physiological activities exhibited are of much the same character, only, perhaps, not quite so complex.

Two main forms of intestinal movement have been distinguished,—the peristaltic and the pendular or rhythmic.

*Peristalsis.*—The peristaltic movement consists in a constriction of the walls of the intestine, which, beginning at a certain point, passes downward away from the stomach, from segment to segment, while the parts behind the advancing zone of constriction gradually

\* “Archiv de physiologie normale et pathologique,” 1895, p. 374.

† Cannon and Washburn, “American Journal of Physiology,” 29, 441, 1912.

‡ Carlson, *ibid.*, series of papers, vols. 31 to 34, 1912–1914.

relax. The wave of constriction may be recorded by the use of suitable apparatus. When thus recorded it is found that the advancing area of constriction is preceded by an area of inhibition or relaxation, so that the peristaltic movement consists of two parts, following in a definite sequence, which seem to combine to facilitate the movement onward of the intestinal contents; for it is obvious that the wave of constriction will be more effective in forcing the contents forward if just in front of it the intestine is

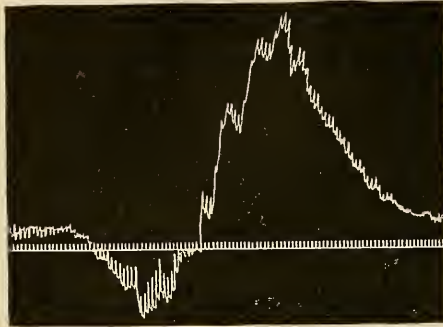

Fig. 285.—Peristaltic contraction of the small intestine (dog). The horizontal line gives the time in seconds. The curve was obtained by recording the diameter of the intestine at a given point during the passage of a peristaltic wave. It will be seen that there was first a dilatation (wave of inhibition), followed by a strong contraction. The smaller waves on the intestinal curve are due to the effect of the respiratory movements on the recording mechanism.

relaxed by inhibition of the tonicity of the muscular coat (Fig. 285). Bayliss and Starling,\* to whom we owe the discovery of this two-fold character of the movement, regard it as a reflex which is controlled within the intestinal wall itself through its intrinsic ganglia and their afferent and efferent connections. When a bolus is inserted into the intestine at any point its effect upon the sensory fibers is such as to cause a reflex contraction of the muscle above the bolus, that is, toward the stomach, and a reflex inhibition or dilatation below. They speak of this definite relationship as the *law of the intestine*; it is described also under the name *myenteric reflex*. It is obvious that the circular layer of muscles is chiefly involved in peristalsis, since constriction can only be produced by contraction of this layer. To what extent the longitudinal muscles enter into the movement is not definitely determined. The term "antiperistalsis" is used to describe the same form of movement running in the opposite direction—that is, toward the stomach. Antiperistalsis is said not to occur under normal conditions; it has been observed in isolated pieces of intestine or in the exposed intestine of living animals when stimulated artificially or after

\* Bayliss and Starling, "Journal of Physiology," 24, 99, 1899.



complete intestinal obstruction (Cannon). The peristaltic wave normally passes downward, and that this direction of movement is dependent upon some definite arrangement in the intestinal walls is shown by the experiments of Mall\* upon reversal of the intestines. In these experiments a portion of the small intestine was resected, turned around, and sutured in place again, so that in this piece what was the lower end became the upper end. In those animals that made a good recovery the nutritive condition gradually became very serious, and when the animals were killed and examined it was found that there was an accumulation of food at the stomach end of the reversed piece of intestine, and that this region showed marked dilatation.

The peristaltic movements of the intestines may be observed upon living animals when the abdomen is opened. If the operation is made in the air and the intestines are exposed to its influence, or if the conditions of temperature and circulation are otherwise disturbed, the movements observed are often violent and irregular. The peristalsis runs rapidly along the intestines and may pass over the whole length in about a minute; at the same time the contraction of the longitudinal muscles gives the bowels a peculiar writhing movement. Movements of this kind are evidently abnormal, and only occur in the body under the strong stimulation of pathological conditions. Normal peristalsis, the object of which is to move the food slowly along the alimentary tract, is quite a different affair. Observers all agree that the wave of contraction is gentle and progresses slowly, although at different rates perhaps in different parts of the intestine. The force of the contraction as measured by Cash † in the dog's intestine is very small. A weight of five to eight grams was sufficient to check the onward movement of the substance in the intestine and to set up violent, colicky contractions which caused the animal evident uneasiness. The time required for the passage of food through the small intestine must vary with its amount and character. From observations made upon man with the *x*-ray, Hertz estimates that on the average it requires about  $4\frac{3}{8}$  hours. After a meal, therefore, we may imagine that at about the time the stomach has finished discharging its contents into the duodenum the first portions have reached the ileocecal valve. That is to say, a column of food, broken into separate segments, stretches at one time practically along the whole length of the small intestine.

*Mechanism of the Peristaltic Movement.*—The means by which the peristaltic movement makes its orderly forward progression have not been determined beyond question. The simplest explana-

\* "Johns Hopkins Hospital Reports," 1, 93, 1896.

† "Proceedings of the Royal Society," London, 41, 1887.

tion would be to assume that an impulse is conveyed directly from cell to cell in the circular muscular coat, so that a contraction started at any point would spread by direct conduction of the contraction change. This theory, however, does not explain satisfactorily the normal conduction of the wave of contraction always in one direction, nor the fact that the wave of contraction is preceded by a wave of inhibition. Moreover, Bayliss and Starling state that, although the peristaltic movements continue after section of the extrinsic nerves,—indeed, become more marked under these conditions,—the application of cocain or nicotin prevents their occurrence. Since these substances may be supposed to act on the intrinsic nerves, it is probable that the co-ordination of the movement is effected through the local nerve ganglia, but our knowledge of the mechanism and physiology of these peripheral nerve-plexuses is as yet quite incomplete.

*Rhythmical Movements.*—In addition to the peristaltic wave a second kind of movement may be observed in the small intestines. It consists essentially in a series of local constrictions of the intestinal wall, the constrictions occurring rhythmically at those points at which masses of food lie.

Cannon\* has studied these movements most successfully by

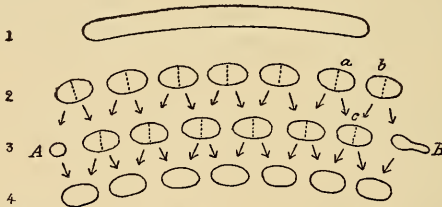

Fig. 286.—Diagram to show the effect of the rhythmical constricting movements of the small intestine upon the contained food. A string of food (1) is divided suddenly into a series of segments (2); each of the latter is again divided and the process is repeated a number of times (3 and 4). Eventually a peristaltic wave sweeps these segments forward a certain distance and gathers them again into a long string, as in (1). The process of segmentation is then repeated as described above. (Cannon.)

means of the Roentgen rays. He finds that as a result of these contractions the masses or strings of food lying in the intestine are suddenly segmented, repeatedly and in a definite manner, into a number of small pieces, which move to and fro as the pieces combine and are again separated (see Fig. 286). These segmentations may proceed at the rate of thirty per minute for a certain time, and the apparent result is that the material is well mixed with the digestive secretions and is brought thoroughly into contact with the absorptive walls. During these rhythmical contractions there is no steady progression of the food; it remains in the same region, although

\* Cannon, "American Journal of Physiology," 6, 251, 1902.

subjected to repeated divisions. From time to time the separated pieces are caught by an advancing peristaltic wave, moved forward a certain distance, and gathered again into a new mass. In this new location the rhythmical contractions again segment and churn the mass before a new peristaltic wave moves it on. According to this description, the rhythmical movements are local contractions (mainly of the circular muscles) which seem to be due to the local distention caused by the food. They occur rhythmically for a certain period and then cease until a new series is started, and it is obvious that they must play a very important part in promoting both the digestion and absorption of the food. Mall\* has suggested that these rhythmical contractions of the circular coats may also act as a pumping mechanism upon the venous plexuses in the walls and thus aid in driving the blood into the portal system. Similar movements have been observed in the human being.† The curious observation is reported‡ that during the period of fasting (dog) the whole gastro-intestinal canal, although empty, shows at intervals rhythmical contractions of its musculature which may last for twenty to thirty minutes (see p. 790).

Cannon suggests a new and convenient nomenclature for the movements of the stomach and intestines as follows:

(1) Rhythmic segmentations.—The rhythmic localized contractions described in the preceding paragraph. Exhibited throughout the small intestine.

(2) Diastalsis.—Downward moving wave of contraction with a preceding wave of inhibition (myenteric reflex). Exhibited chiefly in the small intestine.

(3) Anastalsis.—Upward moving wave of contraction without a preceding phase of inhibition. Exhibited chiefly in the proximal colon.

(4) Katastalsis.—Downward moving wave of contraction without a preceding phase of inhibition. Exhibited chiefly in the stomach.

**Movements of the Intestinal Villi.**—Hambleton § calls attention to the fact that if the intestine of a living animal is opened and spread out under suitable conditions so that the villi may be examined under a binocular microscope, it can be shown that they exhibit active movements of two kinds: First, lashing movements from side to side in various directions; second, what might be called pumping movements, in which the villi are alternately extended and retracted. Doubtless these movements are due to the contractions of the muscular slips, which run into the stroma of the villi from the muscularis mucosæ. If we can suppose that they occur during normal digestion, it is evident that they add a mechanical factor, not hitherto considered, which must help materially in the absorption of the products of digestion.

\* Mall, "Johns Hopkins Hospital Reports," 1896, i., 37.

† Hertz, *loc. cit.*

‡ Boldireff, "Archives des sciences biologiques," 11, 1, 1905.

§ Hambleton, "American Journal of Physiology," 34, 446, 1914.

**The Nervous Control of the Intestinal Movements.**—There is some evidence to show that the rhythmical contractions of the intestines are muscular in origin (myogenic), while the more co-ordinated peristaltic movements depend upon the intrinsic nervous mechanism. The intestine is, however, not dependent for either movement upon its connections with the central nervous system. Like the stomach, it is an automatic organ whose activity is simply regulated through its extrinsic nerves.

The small intestine and the greater part of the large intestine receive visceromotor nerve fibers from the vagi and the sympathetic chain. The former, according to most observers, when artificially stimulated cause movements of the intestine, and are therefore regarded as the motor fibers. It seems probable, however, that the vagi carry or may carry in some animals inhibitory fibers as well, and that the motor effects usually obtained upon stimulation are due to the fact that in these nerves the motor fibers predominate. The fibers received from the sympathetic chain, on the other hand, give mainly an inhibitory effect when stimulated, although some motor fibers apparently may take this path. Bechterew and Mislawski\* state that the sympathetic fibers for the small intestine emerge from the spinal cord as medullated fibers in the sixth dorsal to the first lumbar spinal nerves, (or lower—Bunch) and pass to the sympathetic chain in the splanchnic nerves and thence to the semilunar plexus. The paths of these fibers through the central nervous system are not known, but there are evidently connections extending to the higher brain centers, since psychical states are known to influence the movements of the intestine, and according to some observers stimulation of portions of the cerebral cortex may produce movements or relaxation of the walls of the small and large intestines.

**Effect of Various Conditions upon the Intestinal Movements.**—Experiments have shown that the movements of the intestines may be evoked in many ways in addition to direct stimulation of the extrinsic nerves. Chemical stimuli may be applied directly to the intestinal wall. Mechanical stimulation—pinching, for example, or the introduction of a bolus into the intestinal cavity—may start peristaltic movements. Violent movements may be produced also by shutting off the blood-supply, and again temporarily when the supply is re-established. A condition of dyspnea may also start movements in the intestines or in some cases inhibit movements which are already in progress, the stimulus in this case seeming to act upon the central nervous system and to stimulate both the motor and the inhibitory fibers. Oxygen gas

\* "Archiv f. Physiologie," 1889, suppl. volume.

within the bowels tends to suspend the movements of the intestine, while  $\text{CO}_2$ ,  $\text{CH}_4$ , and  $\text{H}_2\text{S}$  act as stimuli, increasing the movements. Organic acids, such as acetic, propionic, formic, and caprylic, which may be formed normally within the intestine as the result of bacterial action, act also as strong stimulants.

**Movements of the Large Intestine.**—The opening from the small intestine into the large is controlled both by the ileocecal valve and by a sphincter, the ileocecal or ileocolic sphincter. It is stated that this sphincter is normally in tonus and that its condition of tonus is regulated through the splanchnic nerve (Magnus). The musculature in the large intestine has the same general arrangement as in the small, and the usual view has been that the movements are similar, although more infrequent, so that the material received from the small intestine is slowly moved along while becoming more and more solid from the absorption of water. The contents of the ascending colon are soft and semiliquid, but in the distal end of the transverse colon they attain the consistency of the feces. Bayliss and Starling state that their law of intestinal peristalsis holds in this portion of the intestine,—that is, local excitation causes a constriction above and a dilatation below the point stimulated. Cannon,\* from his studies of the normal movements in cats, as seen by the Roentgen rays, comes to the conclusion that the movements in the proximal portion of the large intestine show a marked peculiarity. He divides the large intestine into two parts; in the second, corresponding roughly to the descending and distal portion of the transverse colon, the food is moved toward the rectum by peristaltic waves. A number of constrictions may be seen simultaneously within a length of some inches. In the ascending colon and cecum, on the contrary, the most frequent movement is that of antiperistalsis. The food in this portion of the canal is more or less liquid and its presence sets up running waves of constriction, which pass toward the ileocecal valve. These waves occur in groups separated by periods of rest. They seem to originate from a constricted ring which pulsates, each contraction starting an anastaltic wave. The presence of the ileocecal valve prevents the material from being forced back into the small intestine. The value of this peculiar reversal of the normal movement of the bowels at this particular point would seem to lie in the fact that it delays the passage of the material toward the rectum, and by thoroughly mixing it gives increased opportunities for the completion of the processes of digestion and absorption. In animals with a sacculated colon the separate sacs or haustra may exhibit rhythmic

\* Cannon, *loc. cit.*

contractions somewhat similar to the rhythmic segmentations in the small intestine.\* These movements (haustral churning) would seem to favor also the processes of absorption. Hertz

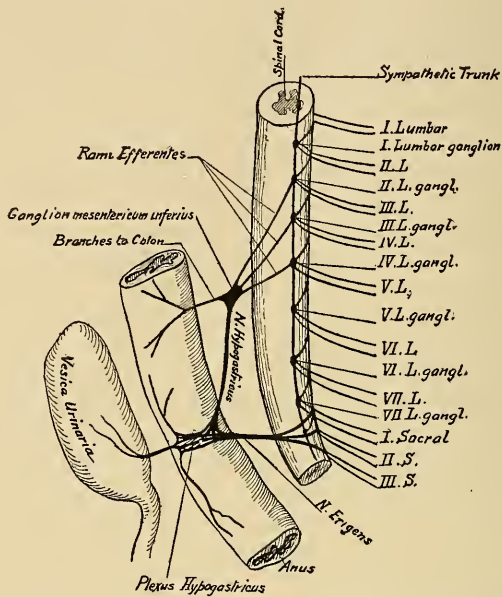

Fig. 287.—Schema to show the innervation of the rectum and internal sphincter of the anus, and the formation of the hypogastric plexus. (After Frankl-Hochwart and Fröhlich.)

estimates that in man the food requires about 2 hours to pass from the ileocecal valve to the hepatic flexure and about  $4\frac{1}{2}$  hours to reach the splenic flexure. As the colon becomes filled some of the material penetrates into the descending part, where the normal peristalsis carries it very slowly toward the rectum.

The large intestine—particularly the descending colon and rectum—receives its nerve supply from two sources (Fig. 287): (1) Fibers which leave the spinal cord in the lumbar nerves (second to fifth in cat), pass to the sympathetic chain, and thence to the inferior mesenteric ganglia, which probably form the termination of the preganglionic fibers. From this point the path is continued by fibers running in the hypogastric nerves and plexus. Stimulation of these fibers has given different results in the hands of various observers, but the most recent work† indicates that they are inhibitory. (2) Fibers that leave

\* Elliott and Barclay-Smith, "Journal of Physiology," 31, 272, 1904.

† Langley and Anderson, "Journal of Physiology," 18, 67, 1895. Bayliss and Starling, *ibid.*, 26, 107, 1900. Also Wischniewsky, in Hermann's "Jahresbericht der Physiologie," vol. xii., 1895.

the cord in the sacral nerves (second to fourth), form part of the *nervi erigentes* and enter into the hypogastric plexus. When stimulated these fibers cause contractions of the muscular coats; they may be regarded, therefore, as motor fibers. As in the case of the small intestine and stomach, we may assume that these motor and inhibitory fibers serve for the reflex regulation and adaptation of the movements.

**Defecation.**—The undigested and indigestible parts of the food, together with some of the *debris* and secretions from the alimentary tract eventually reach the sigmoid flexure and rectum. Authorities differ as to whether the rectum normally contains fecal material or not. According to the observations of Hertz,\* made upon man by means of *x*-rays, fecal material is normally absent from the rectum except just before defecation. It seems probable that a distinct desire to defecate is felt only when the feces have actually entered the rectum and produced some distension. The fecal material is retained within the rectum by the action of the two sphincter muscles which close the anal opening. One of these muscles, the internal sphincter, is a strong band of the circular layer of involuntary muscle which forms one of the coats of the rectum. When the rectum contains fecal material this muscle is thrown into a condition of tonic contraction until the act of defecation begins, when it is relaxed. The external sphincter ani is composed of striated muscle tissue and is under the control of the will to a certain extent. It is supplied by a motor nerve, the *Nn. hemorrhoidales inferiores*, arising from the *N. pudendus* and eventually from the sacral spinal nerves. This muscle, therefore, like striated muscle in general, is innervated directly from the spinal cord, but it possesses properties which are to some extent intermediate between those of plain and of striated muscle. For example, it differs from the latter and resembles the former in the fact that it does not atrophy after section of its motor nerve; it is much less sensitive to the paralyzing action of curare than the typical striated muscle, and it is stated that its curve of contraction, when it is stimulated through its nerve, exhibits a long latent period and a slow contraction and relaxation. Both the internal and the external sphincter are normally in tonus and unite in protecting the anal opening. The force of the tonic contraction of the internal is somewhat less (30 to 60 per cent.) than that of the external sphincter.† The innervation and control of the internal sphincter is better understood

\* Hertz, "Guy's Hospital Reports," 61, 389, 1907.

† Consult Frankl-Hochwart and Fröhlich, "Archiv f. de ges Physiologie," 81, 420.

than that of the external. Like the rest of the rectum, it receives motor fibers from the hypogastric plexus by way of the *nervus erigens*, and inhibitory fibers from the same plexus by way of the hypogastric nerve. It has been possible to show experimentally that each of these sets of fibers may be acted upon reflexly, for example, by stimulation of the sensory nerves in the sciatic. The reflex takes place in this case through the lower portion of the cord. Both the hypogastric nerve and the *N. erigens* contain also afferent fibers. Stimulation of the central end of the severed *N. erigens* gives a reflex inhibition through the hypogastric nerve, and stimulation of the central stump of the cut hypogastric causes a reflex contraction through the *N. erigens*. The act of defecation as it occurs normally is partly a voluntary and partly an involuntary act. The involuntary act consists in peristaltic contractions of the rectum or, indeed, of the whole colon, together with an inhibition of the sphincters. Whether the inhibition of the sphincters is normally entirely an involuntary reflex cannot be stated definitely. No doubt the sensory stimuli arising from the accumulation of fecal material would eventually cause in this way a relaxation of the sphincters, but the act of defecation usually takes place before such a strong necessity arises. It is initiated usually by a voluntary act, and it is possible that in such cases the relaxation of both sphincters may be effected by voluntary inhibition acting upon the spinal centers.

The voluntary factor in defecation consists mainly in the contraction of the abdominal muscles. When these latter muscles are contracted and at the same time the diaphragm is prevented from moving upward by the closure of the glottis, the increased abdominal pressure is brought to bear upon the abdominal and pelvic viscera, and aids strongly in pressing the contents of the descending colon and sigmoid flexure into the rectum. The pressure in the abdominal cavity is still further increased if a deep inspiration is first made and then maintained during the contraction of the abdominal muscles. Hertz, on the basis of his skiagraphic observations, insists that simultaneously with the contraction of the abdominal muscles and the closure of the glottis the diaphragm is also contracted and thus aids in bringing pressure to bear upon the pelvic organs. Although the act of defecation is normally initiated by voluntary effort, it may also be carried out as a purely involuntary reflex when the sensory stimulus is sufficiently strong. Goltz\* has shown that in dogs in which the spinal cord had been severed in the lower thoracic region defecation was performed normally. In later experiments, in which the entire spinal cord was removed

\* "Archiv f. die gesammte Physiologie," 8, 160, 1874; 63, 362, 1896.



except in the cervical and upper part of the thoracic region, it was found that the animal, after it had recovered from the operation, had normal movement once or twice a day, indicating that the rectum and lower bowels acted by virtue of their intrinsic mechanism. An interesting result of these experiments was the fact that the external sphincter suffered no atrophy, although its motor nerve was destroyed, and that it eventually regained its tonic activity.

It would seem that the whole act of defecation is, at bottom, an involuntary reflex. The physiological center for the movement probably lies in the lumbar cord, and it has sensory and motor connections with the rectum and the muscles of defecation. As stated above, the inhibitory fibers to the internal sphincter pass by way of the hypogastric nerve, the motor fibers through the *nervus erigens*, and both of these nerves contain afferent fibers which may reflexly excite inhibition or contraction. But this center is probably provided also with intraspinal connections with the centers of the cerebrum, through which the act may be controlled by voluntary impulses and by various psychical states; the effect of emotions upon defecation being a matter of common knowledge. In infants the essentially involuntary character of the act is well known.

**Vomiting.**—The act of vomiting causes an ejection of the contents of the stomach through the esophagus and mouth to the exterior. It was long debated whether the force producing this ejection comes from a strong contraction of the walls of the stomach itself or whether it is due mainly to the action of the walls of the abdomen. A forcible spasmodic contraction of the abdominal muscles takes place, as may easily be observed by any one upon himself, and it is now believed that the contraction of these muscles is the principal factor in vomiting. Magendie found that if the stomach was extirpated and a bladder containing water was substituted in its place and connected with the esophagus, injection of an emetic caused a typical vomiting movement with ejection of the contents of the bladder. Gianuzzi showed, on the other hand, that upon a curarized animal vomiting could not be produced by an emetic—because, apparently, the muscles of the abdomen were paralyzed by the curare. There are on record a number of observations which tend to show that the stomach is not passive during the act. On the contrary, it may exhibit contractions, more or less violent in character. According to Openchowski,\* the pylorus is closed and the pyloric end of the stomach firmly contracted so as to drive the contents toward the dilated cardiac portion. Cannon states that in cats the normal peristaltic waves pass

\* Openchowski, "Archiv f. Physiologie," 1889, p. 552.

over the pyloric portion in the period preceding the vomiting and that finally a strong contraction at the "transverse band" completely shuts off the pyloric portion from the body of the stomach, which at this time is quite relaxed. The act of vomiting is, in fact, a complex reflex movement into which many muscles enter. The following events are described: The vomiting is usually preceded by a sensation of nausea and a reflex flow of saliva into the mouth. These phenomena are succeeded or accompanied by retching movements, which consist essentially in deep, spasmodic inspirations with a closed glottis. The effect of these movements is to compress the stomach by the descent of the diaphragm, and at the same time to increase decidedly the negative pressure in the thorax, and therefore in the thoracic portion of the esophagus. During one of these retching movements the act of vomiting is effected by a convulsive contraction of the abdominal wall that exerts a sudden additional strong pressure upon the stomach. At the same time the cardiac orifice of the stomach is dilated, probably by an inhibition of the sphincter, and according to the above description the fundic end of the stomach is also dilated, while the pyloric end is in strong contraction. The stomach contents are, therefore, forced violently out of the stomach through the esophagus, the negative pressure in the latter probably assisting in the act. The passage through the esophagus is effected mainly by the force of the contraction of the abdominal muscles; there is no evidence of anti-peristaltic movements on the part of the esophagus itself. During the ejection of the contents of the stomach the glottis is kept closed by the adductor muscles, and usually the nasal chamber is likewise shut off from the pharynx by the contraction of the posterior pillars of the fauces on the palate and uvula. In violent vomiting, however, the vomited material may break through this latter barrier and be ejected partially through the nose.

*Nervous Mechanism of Vomiting.*—That vomiting is a reflex act is abundantly shown by the frequency with which it is produced in consequence of the stimulation of sensory nerves or as the result of injuries to various parts of the central nervous system. After lesions or injuries of the brain vomiting often results. Disagreeable emotions and disturbances of the sense of equilibrium may produce the same result. Irritation of the mucous membrane of various parts of the alimentary canal (as, for example, tickling the back of the pharynx with the finger); disturbances of the urogenital apparatus, the liver, and other visceral organs; artificial stimulation of the trunk of the vagus and of other sensory nerves, may all cause vomiting. Under ordinary conditions, however, irritation of the sensory nerves of the gastric mucous membrane is the most common cause of vomiting. This effect may result from the prod-

ucts of fermentation in the stomach in cases of indigestion, or may be produced intentionally by local emetics, such as mustard, taken into the stomach. The afferent path in this case is through the sensory fibers of the vagus. The efferent paths of the reflex are found in the motor nerves innervating the muscles concerned in the vomiting,—namely, the vagus, the phrenics, and the spinal nerves supplying the abdominal muscles. Whether or not there is a definite vomiting center in which the afferent impulses are received and through which a co-ordinated series of efferent impulses is sent out to the various muscles has not been satisfactorily determined. It has been shown that the portion of the nervous system through which the reflex is effected lies in the medulla, and it may be observed that the muscles concerned in the act, outside those of the stomach, are respiratory muscles. Vomiting, in fact, consists essentially in a simultaneous spasmodic contraction of expiratory (abdominal) muscles and inspiratory muscles (diaphragm). It has therefore been suggested that the reflex involves the stimulation of the respiratory center or some part of it. Thumas claims to have located a vomiting center in the medulla in the immediate neighborhood of the calamus scriptorius. Further evidence, however, is required upon this point. The act of vomiting may be produced not only as a reflex from various sensory nerves, but may also be caused by direct action upon the medullary centers. The action of apomorphin is most easily explained by supposing that it acts directly on the nerve centers.

## CHAPTER XL.

### GENERAL CONSIDERATIONS UPON THE COMPOSITION OF THE FOOD AND THE ACTION OF ENZYMES.

**Foods and Foodstuffs.**—The term food when used in a popular sense includes everything that we eat for the purpose of nourishing the body. From this point of view the food of mankind is of a most varied character, comprising a great variety of products of the animal and vegetable kingdoms. Chemical analysis of the animal and vegetable foods shows, however, that they all contain one or more of five different classes of substances which are usually designated as the foodstuffs (older names, alimentary or proximate principles) on the belief that they form the useful constituent of our foods. The classification of foodstuffs usually given is as follows:

Foodstuffs	{	Water.
		Inorganic salts.
		Proteins.
		Carbohydrates.
		Fats.

From the scientific point of view, a foodstuff or food may be defined as a substance absolutely necessary to the normal composition of the body, as in the case of water and salts, or as a substance which can be acted upon by the tissues of the body in such a way as to yield energy (heat, for example) or to furnish material for the production or repair of living tissue. Moreover, to be a food in the physiological sense, the substance must not directly or indirectly affect injuriously the normal nutritive processes of the tissues. The five substances named above are all foods in this sense. The water and certain salts of sodium, potassium, calcium, magnesium, iron, and perhaps other elements are absolutely necessary to maintain the normal composition of the tissue. Complete withdrawal of any one of these constituents would cause the death of the organism. Proteins, fats, and carbohydrates, on the other hand, are substances whose molecules have a more or less complex structure. When eaten and digested they enter the body liquids, and are employed either in the synthesis of the more complex living matter or they undergo various chemical changes, spoken of in general as metabolism, which result finally in the breaking up of their complex molecules with a liberation of some of their internal

energy. The chemical changes of metabolism or nutrition are, in the long run, mainly exothermic,—that is, they are attended by the production of heat. Some of the chemical or internal energy that held the complex molecules together assumes the form of heat when these molecules are broken down by oxidative changes to simpler, more stable structures, such as water, carbon dioxide, and urea. Proteins, fats, and carbohydrates form materials that the tissue cells are adjusted to act upon after they have undergone certain changes during digestion. Other complex organic compounds containing chemical energy are either injurious to the tissues, or they have a structure such that the tissues cannot act upon them. Such substances cannot be considered as foods in the scientific sense. When, therefore, we desire to know the food value of any animal or vegetable product, we analyze it to determine its composition as regards water, salts, proteins, fats, and carbohydrates. The following table compiled by Munk from the analyses given by König\* may be taken as an indication of the average composition of the most commonly used foods:

COMPOSITION OF FOODS.

IN 100 PARTS.	WATER.	PROTEIN.	FAT.	CARBOHYDRATE.		ASH.
				DIGESTIBLE.	CELLULOSE.	
Meat .....	76.7	20.8	1.5	0.3	...	1.3
Eggs .....	73.7	12.6	12.1	...	...	1.1
Cheese .....	36-60	25-33	7-30	3-7	...	3-4
Cows' milk .....	87.7	3.4	3.2	4.8	...	0.7
Human milk .....	89.7	2.0	3.1	5.0	...	0.2
Wheat flour .....	13.3	10.2	0.9	74.8	0.3	0.5
Wheat bread .....	35.6	7.1	0.2	55.5	0.3	1.1
Rye flour .....	13.7	11.5	2.1	69.7	1.6	1.4
Rye bread .....	42.3	6.1	0.4	49.2	0.5	1.5
Rice .....	13.1	7.0	0.9	77.4	0.6	1.0
Corn .....	13.1	9.9	4.6	68.4	2.5	1.5
Macaroni .....	10.1	9.0	0.3	79.0	0.3	0.5
Peas, beans, lentils	12-15	23-26	1½-2	49-54	4-7	2-3
Potatoes .....	75.5	2.0	0.2	20.6	0.7	1.0
Carrots .....	87.1	1.0	0.2	9.3	1.4	0.9
Cabbages .....	90	2-3	0.5	4-6	1-2	1.3
Mushrooms .....	73-91	4-8	0.5	3-12	1-5	1.2
Fruit .....	84	0.5	...	10	4	0.5

An examination of this table shows that the animal foods, particularly the meats, are characterized by their small percentage in carbohydrate and by a relatively large amount of protein or of protein and fat. With regard to the last two foodstuffs, meats differ

\*See König, "Die menschlichen Nahrungs und Genussmittel"; and Atwater and Bryant, "The Chemical Composition of American Food Materials," Bulletin 28, United States Department of Agriculture, 1899.

very much among themselves. Some idea of the limits of variation may be obtained from the following table, taken chiefly from König's analyses:

	WATER.	PROTEIN.	FAT.	CARBOHYDRATE.	ASH.
Beef, moderately fat . . . .	73.03	20.96	5.41	0.46	1.14
Veal, fat. . . . .	72.31	18.88	7.41	0.07	1.33
Mutton, moderately fat. . .	75.99	17.11	5.77	....	1.33
Pork, lean . . . . .	72.57	20.05	6.81	....	1.10
Ham, salted. . . . .	62.58	22.32	8.68	....	6.42
Pork (bacon), very fat* . .	10.00	3.00	80.50	....	6.5
Mackerel* . . . . .	71.6	18.8	8.2	....	1.4

The vegetable foods are distinguished, as a rule, by their large percentage in carbohydrates and the relatively small amounts of proteins and fats, as seen, for example, in the composition of rice, corn, wheat, and potatoes. Nevertheless, it will be noticed that the proportion of protein in some of the vegetables is not at all insignificant. They are characterized by their excess in carbohydrates rather than by a deficiency in proteins. The composition of peas and other leguminous foods is remarkable for the large percentage of protein, which exceeds that found in meats. Analyses such as are given here are indispensable in determining the true nutritive value of foods. Nevertheless, it must be borne in mind that the chemical composition of a food is not alone sufficient to determine its precise value in nutrition. It is obviously true that it is not what we eat, but what we digest and absorb, that is nutritious to the body; so that, in addition to determining the proportion of food-stuffs in any given food, it is necessary to determine to what extent the several constituents are digested. This factor can be obtained only by actual experiments. It may be said here, however, that in general the proteins of animal foods are more completely digested than are those of vegetables, owing chiefly to the fact that the latter may contain a considerable amount of indigestible cellulose, which tends to protect the protein from the action of the digestive secretions. In the animal foods, therefore, chemical analysis comes nearer to expressing directly the nutritive value.

It must be borne in mind also, as will be explained more in detail in the chapters on nutrition, that our various foods, animal and vegetable, may contain substances other than the proteins, fats, and carbohydrates, which play an accessory or even essential rôle in the complex chemical processes of nutrition. This idea is illustrated by the existence of what are known as *vitamines* (p. 904), and their mysteriously important relation to normal nutrition. The proteins also, it will be found, are not all of equal value in

\* Atwater, "The Chemistry of Foods and Nutrition," 1887.

metabolism, and the same fact is true probably to some extent for the different fats and carbohydrates. The matter is referred to here only to emphasize the point that an analysis giving the percentage of protein, fat, carbohydrate, ash, and water does not in itself reveal the complete nutritive importance of a food. There is much to be learned regarding other special constituents which, at present, cannot be stated in a table of analyses of the foods.

**Accessory Articles of Diet.**—In addition to the foodstuffs proper, our foods contain numerous other substances which in one way or another are useful in nutrition, although not absolutely necessary. These substances, differing in nature and importance, may be classified under the three heads of:

Flavors: The various oils or esters that give odor and taste to foods.

Condiments: Pepper, salt, mustard, etc.

Stimulants: Alcohol, tea, coffee, cocoa, etc.

The specific influence of these substances in digestion and nutrition is considered in the section on Nutrition.

#### **The Chemical Changes of the Foodstuffs during Digestion.**

—The physiology of digestion consists chiefly in the study of the chemical changes that the food undergoes during its passage through the alimentary canal. It happens that these chemical changes are of a peculiar character. The peculiarity is due to the fact that the changes of digestion are effected through the agency of a group of bodies known as *enzymes*, or unorganized ferments, whose chemical action is more obscure than that of the ordinary reagents with which we have to deal. It will save repetition to give here certain general facts that are known with reference to these bodies, reserving for later treatment the details of the action of the specific enzymes found in the different digestive secretions.

### **ENZYMES AND THEIR ACTION.**

**Historical.**—The term fermentation and the idea that it is meant to convey has varied greatly during the course of years. The word at first was applied to certain obvious and apparently spontaneous changes in organic materials which are accompanied by the liberation of bubbles of gas: such, for instance, as the alcoholic fermentations, in which alcohol is formed from sugar; the acid fermentations, as in the souring of milk; and the putrefactive fermentations, by means of which animal substances are disintegrated, with the production of offensive odors. These mysterious phenomena excited naturally the interest of investigators, and with the development of chemical knowledge numerous other processes were discovered which resemble the typical fermentations in that they seem to be due to specific agents whose mode of action differs from the usual chemical reactions, especially in the fact that the causa-

tive agent itself, or the ferment as it is called, is not destroyed or used up in the reaction. Thus it was discovered that germinating barley grains contain a something which can be extracted by water and which can convert starch into sugar (Kirchhoff, 1814). Later this substance was separated by precipitation with alcohol and was given the name of diastase (Payen and Persoz, 1833). Schwann in 1836 demonstrated the existence of a ferment (pepsin) in gastric juice capable of acting upon albuminous substances, and a number of similar bodies were soon discovered: trypsin in the pancreatic juice, amygdalin, invertin, ptyalin, etc. These substances were all designated as ferments, and their action was compared to that of the alcoholic fermentation in yeast, the process of putrefaction, etc. Naturally very many theories have been proposed regarding the cause of the processes of fermentation. For the historical development and interrelation of these theories references must be made to special works.\* It is sufficient here to say that the brilliant work of Pasteur established the fact that the fermentations in the old sense—alcoholic, acid, and putrefactive—are due to the presence and activity of living organisms. He showed, moreover, that many diseases are likewise due to the activity of minute living organisms, and thus justified the view held by some of the older physicians that there is a close similarity in the processes of fermentation and disease. The clear demonstration of the importance of living organisms in some fermentations and the equally clear proof of the existence of another group of ferment actions in which living material is not directly concerned led to a classification which is used even at the present day. This classification divided ferments into two great groups: the living or organized ferments, such as the yeast cell, bacteria, etc.; and the non-living or unorganized ferments, such as pepsin, trypsin, etc., which later were generally designated as enzymes (Kuhne). The separation appeared to be entirely satisfactory until Buchner (1897) showed that an unorganized ferment, an enzyme (zymase) capable of producing alcohol from sugar, may be extracted from yeast cells. Later the same observer (1903) succeeded in extracting enzymes from the lactic-acid-producing bacteria and the acetic-acid-producing bacteria which are capable of giving the same reactions as the living bacteria. These discoveries indicate clearly that there is no essential difference between the activity of living and non-living ferments. The so-called organized ferments probably produce their effects not by virtue of their specific life-metabolism, but by the manufacture within their substance of specific enzymes. If we can accept this

\* Consult Oppenheimer, "Die Fermente und ihre Wirkungen," second edition, 1903; Moore, in "Recent Advances in Physiology and Biochemistry, London and New York," 1906; Vernon, "Intracellular Enzymes," London, 1908; Euler, "General Chemistry of the Enzymes" (translation by Pope), 1912.



conclusion, then the general explanation of fermentation is to be sought in the nature of the enzymatic processes. Within recent years the study of the enzymes has attracted especial attention. The general point of view regarding their mode of action that is most frequently met with to-day is that advocated especially by Ostwald. He assumes, reviving an older view (Berzelius), that the ferment actions are similar to those of catalysis. By catalysis chemists designated a species of reaction which is brought about by the mere contact or presence of certain substances, the catalyzers. Thus, hydrogen and oxygen at ordinary temperatures do not combine to form water, but if spongy platinum is present the two gases unite readily. The platinum does not enter into the reaction, at least it undergoes no change, and it is said, therefore, to act by catalysis. Many similar catalytic reactions are known, and the chemists have reached the important generalization that in such reactions the catalyzer, platinum in the above instance, simply hastens a process which would occur without it, but much more slowly. A catalyzer is a substance, therefore, that alters the velocity of a reaction, but does not initiate it. This idea is illustrated very clearly by the catalysis of hydrogen peroxid. This substance decomposes spontaneously into water and oxygen according to the reaction  $\text{H}_2\text{O}_2 = \text{H}_2\text{O} + \text{O}$ , but the decomposition is greatly hastened by the presence of a catalyzer. Thus, Bredig has shown that platinum in very fine suspension, so-called colloidal solution, exerts a marked accelerating influence upon this reaction; one part of the colloidal platinum to 350 million parts of water may still exercise a perceptible effect. The blood and aqueous extracts of various tissues also catalyze the hydrogen peroxid readily, and this effect has been attributed to the action of an enzyme (catalase). The view has been proposed, therefore, that the enzymes of the body act like the catalyzers of inorganic origin: they influence the velocity of certain special reactions. Such a general conception as this unifies the whole subject of fermentation and holds out the hope that the more precise investigations that are possible in the case of the inorganic catalyzers will eventually lead to a better understanding of the underlying physical causes of fermentation. It should be borne in mind, however, that some of the best known of the ferment actions of the body, such as the peptic or tryptic digestion of protein, fit into this view only theoretically and by analogy. As a matter of fact, albumins at ordinary temperatures do not split up spontaneously into the products formed by the action of pepsin; if we consider that the pepsin simply accelerates a reaction already taking place, it must be stated that this reaction at ordinary temperatures is infinitely slow,—that is, practically does not occur. At higher temperatures, however, similar decompositions of albumin may be obtained without the presence of an enzyme.

**Reversible Reactions.**—It has been shown that under proper conditions many chemical reactions are reversible,—that is, may take place in opposite directions. For instance, acetic acid and ethyl-alcohol brought together react with the production of ethyl-acetate and water:

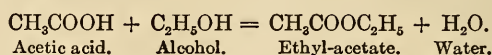

On the other hand, when ethyl-acetate and water are brought together they react with the formation of some acetic acid and ethyl-alcohol, so that the reaction indicated in the above equation takes place in opposite directions, figuratively speaking,—a fact which may be indicated by a symbol of this kind:

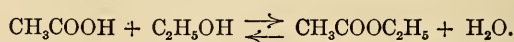

It is evident that in a reversible reaction of this sort the opposite changes will eventually strike an equilibrium, the solution or mixture will contain some of all four substances, and this equilibrium will remain constant as long as the conditions are unchanged. If the conditions are altered, however,—if, for example, some of the substances formed are removed or the mixture is altered as to its concentration,—then the reaction will proceed unequally in the two directions until a new equilibrium is established. The importance, in the present connection, of this conception of reversibility of reactions is found in the fact that a number of the catalytic reactions are also reversible. The catalyzer may not only accelerate a reaction between two substances, but may also accelerate the recombination of the products into the original substances. An excellent instance of this double effect has been obtained by Kastle and Loevenhart in experiments upon one of the enzymes of the animal body, lipase. Lipase is the enzyme which in the body acts upon the neutral fats, converting them into fatty acids and glycerin,—a process that takes place as a usual if not necessary step in the digestion and absorption of fats. The authors above named\* made use of a simple ester analogous to the fats, ethyl-butyrate, and showed that lipase causes not only an hydrolysis of this substance into ethyl-alcohol and butyric acid, but also a synthesis of the two last-named substances into ethyl-butyrate and water. The reaction effected by the lipase is therefore reversible and may be expressed as:

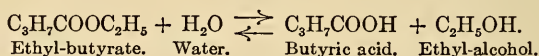

Lipase is capable of exerting probably a similar reversible reaction on the fats in the body. Assuming the existence of such an action in the body, it is possible to explain not only the digestion of fats, but

\* Kastle and Loevenhart, "American Chemical Journal," 24, 491, 1900. See also Loevenhart, "American Physiological Journal," 6, 331, 1902.

also their formation in the tissues and their absorption from the tissues during starvation. That is, according to the conditions of concentration, etc., one and the same enzyme may cause a splitting up of the neutral fat into fatty acids and glycerin or a storing up of neutral fat by the synthesis of fatty acid and glycerin. In the subcutaneous tissues, therefore, fat may be stored, to a certain point, or, if the conditions are altered, the fat that is there may be changed over to the fatty acids and glycerin and be oxidized in the body as food.

A similar reversibility has been shown for some of the other enzymes of the body (maltase by Hill, 1898), but whether or not all of them will be shown to possess this power under the conditions of temperature, etc., that prevail in the body can only be determined by actual experiments.

**The Specificity of Enzymes.**—A most interesting feature of the activity of enzymes is that it is specific. The enzymes that act upon the carbohydrates are not capable of affecting the proteins or fats, and *vice versa*. So in the fermentation of closely related bodies such as the double sugars, the enzyme that acts upon the maltose is not capable of affecting the lactose; each requires seemingly its own specific enzyme. In fact, there is no clear proof that any single enzyme can produce more than one kind of ferment action. If in any extract or secretion two or more kinds of ferment action can be demonstrated, the tendency at present is to attribute these different activities to the existence of separate and specific enzymes. The pancreatic juice, for example, splits proteins, starches, and fats and curdles milk, and there are assumed to be four different enzymes present,—namely, trypsin, diastase, lipase, and rennin. So if an extract containing diastase is also capable of decomposing hydrogen peroxid it is believed that this latter effect is due to the existence of a special enzyme, catalase. It seems quite probable that this specificity of the different enzymes may be related, as Fischer\* has suggested, to the geometrical structure of the substance acted upon. Each ferment is adapted to act upon or become attached to a molecule with a certain definite structure,—fitted to it, in fact, as a key to its lock. In this respect the action of the so-called hydrolytic enzymes differs markedly from the dilute acids or alkalies which hydrolyze many different substances without indication of any specificity. Attention has been called to the fact that this adaptability of enzymes to certain specific structures in the molecules acted upon resembles closely the specific activity of the toxins, and many useful and suggestive comparisons may be drawn between the mode of action of enzymes and toxins. It has become customary to speak of the substance

\* Fisher, "Zeitschrift f. physiolog. Chemie," 26, 71, 1898.

upon which an enzyme acts as its *substrate*, and it has been assumed that the action of the enzyme, like that of the toxins, takes place in two stages; first, the combination of the enzyme and the substrate; second, the breaking down of this compound to give the final products of the reaction. There is some reason for believing that these two stages may be separated, and that enzymes which on account of certain conditions, such as heating, have lost their power of decomposing the substrate, may still have the power of combining with it. Toxins showing a similar property are designated as toxoids, and for the enzyme in this condition the term zymoid has been suggested (Bayliss)

**Definition and Classification of Enzymes (Ferments).**—On the basis of the considerations presented in the preceding paragraphs Oppenheimer suggests the following definition: An enzyme is a substance, produced by living cells, which acts by catalysis. The enzyme itself remains unchanged in this process, and it acts specifically,—that is, each enzyme exerts its activity only upon substances whose molecules have a certain definite structural and stereochemical arrangement. The enzymes of the body are organic substances of a colloid structure whose chemical composition is unknown. A distinction is made frequently between *endo-enzymes* and *exo-enzymes*. Under the latter group are included those enzymes which are eliminated from the cells in which they are formed, and which are found, therefore, in solution in the secretions, for example, the ptyalin of the saliva or the pepsin of the gastric juice. By *endo-enzymes* is meant a group of intracellular enzymes which are not secreted, but are held within the cells in some form of combination. To obtain them in solution or suspension it is necessary to destroy this cell, usually by mechanical means, such as grinding the tissue with sand and, in some cases, by submitting the ground mass to a great pressure in a hydraulic press. The liquid obtained by this latter method is known as the “press juice” of the tissue. In life the *endo-enzymes* play their part within the bounds of the cells in which they are contained, and probably constitute the chief means through which are effected the metabolic processes that characterize living matter.

With regard to the names and classification of the different enzymes, much difficulty is experienced. There is no consensus among workers as to the system to be followed. Duclaux has suggested that an enzyme be designated by the name of the body on which its action is exerted, and that all of them be given the termination *-ase*. The enzyme acting on fat on this system would be named lipase; that on starch, amylase; that on maltose, maltase, etc. The suggestion has been followed in part only, the older enzymes which were first discovered being referred to most frequently under their original names. Having in mind only the needs of

animal physiology, the following classification will be used in the treatment of the subjects of digestion and nutrition:

1. The proteolytic or protein-splitting enzymes. Examples: Pepsin of gastric juice, trypsin of pancreatic juice. They cause a hydrolytic cleavage of the protein molecule.
2. The amylolytic or starch-splitting enzymes. Examples: Ptyalin or salivary diastase, amylase, or pancreatic diastase. Their action is closely similar to that of the classical enzyme of this group—diastase—found in germinating barley grains. They cause a hydrolytic cleavage of the starch molecule.
3. The lipolytic, or fat-splitting enzymes. Example: The lipase found in the pancreatic secretion, in the liver, connective tissues, blood, etc. They cause a hydrolytic cleavage of the fat molecule.
4. The sugar-splitting enzymes. These again fall into two subgroups: (a) The inverting enzymes, which convert the double sugars or disaccharids into the monosaccharids. Examples: Maltase, which splits maltose to dextrose; invertase, which splits cane-sugar to dextrose and levulose; and lactase, which splits milk-sugar (lactose) to dextrose and galactose. (b) The enzymes, which split the monosaccharids. There is evidence of the presence in the tissues of an enzyme capable of splitting the sugar of the blood and tissues (dextrose) into lactic acid.
5. The coagulating enzymes, which convert soluble to insoluble proteins. Example: The coagulation of the casein of milk by rennin.
6. The oxidizing enzymes, or oxidases. A group of enzymes which set up oxidation processes. Some of the details of the activity of these enzymes are considered in the discussion of physiological oxidations (see p. 959).
7. The deaminizing enzymes, which by hydrolytic cleavage split off an  $\text{NH}_2$  group as ammonia. Thus alanin (aminopropionic acid) by hydrolysis loses its  $\text{NH}_2$  group as ammonia and passes into lactic acid.

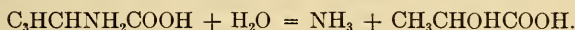

The enzymes contained in the first, second, third, and fourth (a) of these groups are the ones that play the chief rôles in the digestive processes, and it will be noticed that they all act by *hydrolysis*,—that is, they cause the molecules of the substance to undergo decomposition or cleavage by a reaction with water. Thus, in the conversion of maltose to dextrose by the action of maltase the reaction may be expressed so:

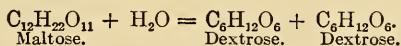

And the hydrolysis of the neutral fats by lipase may be expressed so:

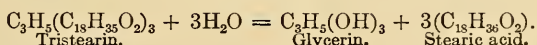

**Protective Enzymes.**—Experimental work in recent years has brought out the interesting and important fact that when foreign proteins, carbohydrates, or fats are introduced into the blood of a living animal corresponding enzymes are formed which are adapted to break down the foreign material by a process of digestion.\*

\* Consult Abderhalden, "Schutzfermente des tierischen organismus," 1912; also Vaughan, "Protein Split Products in Relation to Immunity and Disease," 1913, and "Journal of the Amer. Med. Assoc.," August 1, 1914.

The blood-serum may not contain any proteolytic enzyme capable of hydrolyzing egg-albumin, but if this protein is injected into the animal the serum will then be found to contain an enzyme that digests egg-albumin. Similarly, if cane sugar is injected the blood-serum will show the presence of an inverting enzyme that splits the cane-sugar to its constituent monosaccharids. It has been claimed, moreover, that if any of the cellular material of the animal's own body, not normally present in the blood, finds its way into this liquid, enzymes are produced capable of digesting this blood-foreign material. There is reason to believe that the protective enzymes thus developed show a considerable degree of specificity to the particular foreign material responsible for their formation, and efforts have been made, therefore, to utilize the fact in the diagnosis of abnormal conditions, the method being designated as the *Abderhalden test*, after the name of the physiologist who first proposed its use, or more generally as the method of sero-diagnosis. Thus, in pregnancy, cells from the chorionic villi of the placenta get into the blood of the mother, and examination of her blood-serum shows the presence of an enzyme that digests placental proteins. The biological reaction, whereby these protective enzymes are produced, is similar to that already described in the case of the formation of precipitins (p. 424) and antibodies in general. There can be little doubt that it constitutes a part of the mechanism by which the body acquires immunity to certain infectious diseases, and possibly also it may serve to explain the development of the condition known as hypersensitization or anaphylaxis.

**General Properties of Enzymes.**—The specific reactions of the various enzymes of the body are referred to under separate heads. The following general characteristics may be noted briefly:

*Solubility.*—Most of the enzymes are soluble in water or salt solutions, or in glycerin. By these means they may be extracted conveniently from the various tissues. In some cases, however, such simple methods do not suffice, particularly for the endo-enzymes; the enzyme is either insoluble or is destroyed in the process of extraction, and to prove its presence pieces of the tissue or the juice pressed from the tissue must be employed.

*Temperature.*—The body enzymes are characterized by the fact that they are destroyed by high temperatures (60° C. to 80° C.) and that their effect is retarded in part or entirely by low temperatures. Most of them show an optimum activity at temperatures approximating that of the body.

*Precipitation, Adsorption.*—The enzymes are precipitated from their solutions in part at least by excess of alcohol. This precipitation is frequently used in obtaining purified specimens of enzymes. The enzymes, moreover, show an interesting tendency to be carried down mechanically by flocculent precipitates produced in

their solutions. If protein present in the solution is precipitated, for instance, the enzymes may be carried down with it in part. The mode of union of the enzyme with the precipitate in these cases comes under the general head of mechanical adsorption. It consists in a concentration of the enzyme at the limiting surface between the particles of the precipitate and the solution.

*Incompleteness of their Action.*—In any given mixture of a substance and its enzyme the action of the latter is usually not complete,—that is, all of the substance does not disappear. One explanation for this fact has been found in the reversibility of the action of the enzyme. If the reaction proceeds in both directions, then evidently under fixed conditions a final equilibrium will be reached in which no further apparent change takes place, although in reality the condition is not one of rest, but of balance between opposing processes proceeding at a definite rate. In addition to this factor it may be shown in some cases that the products of the reaction serve to retard further action, possibly by forming a compound of some kind with the enzyme. Within the body itself, on the contrary, the action of an enzyme may be complete, since the products are removed by absorption.

*Active and Inactive Form.*—In many cases it can be shown that the enzyme exists within the cell producing it in an inactive form or even when secreted it may still be inactive. This antecedent or inactive stage is usually designated as *zymogen* or *proferment*. The zymogen may be stored in the cell in the form of granules which are converted into active enzyme at the moment of secretion, or it may be secreted in inactive form and require the co-operation of some other substance before it is capable of effecting its normal reaction. In such cases the second substance is said to activate the enzyme. In connection with the process of activation various terms have been employed to designate the substance responsible for the activation. According to a recent classification\* it has been suggested that inorganic substances causing activation shall be designated simply as *activators*, while organic substances playing a similar rôle shall be named *kinases*. An example of the latter is found in the case of the enterokinase which activates the trypsin of the pancreatic secretion.

*Coenzymes or Coferments.*—In addition to the process of activation it would seem that in some cases the action of an enzyme is facilitated by, or perhaps is even dependent upon the presence of some other substance. Perhaps the best example of this combined activity is furnished by the influence of bile salts upon lipase (p. 798). These cases of coactivity are to be distinguished from activation by the fact that the combination may be easily

\* Samuely, in "Handbuch der Biochemie," i., 1908.

made or unmade, that is to say, it constitutes a reversible reaction. In a mixture of bile salts and lipase, for example, the bile salts may be removed by dialysis. In activation, on the contrary, we have an irreversible reaction—the active trypsin cannot be changed to the inactive trypsinogen.\*

PARTIAL LIST OF THE ENZYMES CONCERNED IN THE PROCESSES OF DIGESTION AND NUTRITION.

	ENZYME.	WHERE CHIEFLY FOUND.	ACTION.	
Act on carbohydrates.	Ptyalin (salivary diastase.	Salivary secretion.	Converts starch to sugar (maltose).	
	Amylase (pancreatic diastase).	Pancreatic secretion.	Converts starch to sugar (maltose).	
	Liver glycogenase.	Liver.	Converts glycogen to dextrose.	
	Muscle glycogenase.	Muscles.	Converts glycogen to dextrose.	
	Invertase.	Small intestine.	Converts cane-sugar to dextrose and levulose.	
	Maltase.	Small intestine, salivary and pancreatic secretion.	Converts maltose to dextrose.	
	Lactase.	Small intestine.	Converts lactose to dextrose and galactose.	
	Glycolytic?	Muscles?	Splits and oxidizes dextrose.	
Acts on fats.	Lipase (steapsin).	Pancreatic secretion, fat, tissues, blood, etc.	Splits neutral fats to fatty acids and glycerin.	
	Act on proteins.	Pepsin.	Gastric juice.	Converts proteins to peptones and proteoses.
		Trypsin.	Pancreatic juice.	Splits proteins into their constituent amino-acids.
		Erepsin.	Small intestine.	Splits peptones and proteoses into their constituent amino-acids.
		Group of autolytic enzymes.	Tissues generally.	Splits proteins into nitrogenous bases and amino-bodies.
	Nucleases.	Pancreas, spleen, thymus, etc.	Split nucleic acid with formation of purin bases, etc.	
Deaminizing enzymes.	Guanase.	Thymus, adrenals, pancreas.	Converts guanin to xanthin by splitting off an $\text{NH}_2$ group as ammonia ( $\text{NH}_3$ ).	
	Adenase.	Spleen, pancreas, liver.	Converts adenin to hypoxanthin by splitting off an $\text{NH}_2$ group as ammonia ( $\text{NH}_3$ ).	
	Deaminase?	Tissues generally.	Splits off the $\text{NH}_2$ group from the amino-acids with the formation of non-nitrogenous organic acids.	

\* Consult Bayliss, "The Nature of Enzyme Action" (series of monographs on Biochemistry), London, 1908.



Oxidases.	Lungs, liver, muscle, etc.	Cause oxidation of organic substances, as in the conversion of hypoxanthin to xanthin and of xanthin to uric acid.
Reductases.	Tissues generally.	Cause reduction or deoxidation as, for example, the reduction of oxyhemoglobin to hemoglobin.
Catalase.	Many tissues.	Decomposes hydrogen peroxid.
Arginase.	Liver, spleen.	Splits arginin with production of urea and ornithin (diamino-valerianic acid).

**Chemical Composition of the Enzymes.**—It was formerly believed that the enzymes belong to the group of proteins. They are formed from living matter, and their solutions as usually prepared give protein reactions. Increased study, however, has made this belief uncertain. The enzymes cling to the proteins when precipitated, and it seems possible that the protein reactions of their solutions may be due, therefore, to an incomplete purification. In fact, it is stated that solutions of some of the enzymes may be prepared which show ferment activity, but give no protein reactions. In this group may be included the lipase, diastase, invertase, pepsin, oxidase, and catalase. Apparently, however, all enzymes contain nitrogen and most of them also sulphur. They probably also contain some ash, especially calcium. Much of the older work upon the composition of supposedly purified preparations of enzymes is not accepted to-day, on the ground that the evidence for the purity of the preparations is insufficient. In spite, however, of the very great amount of attention that has been paid to these substances in recent years, there is at present no agreement as to their chemical structure. The statement made above that they are organic substances, derived from proteins and of a colloidal nature, is perhaps as much as can be said positively in regard to their chemical structure. As a rule, they are destroyed by moderately high temperatures (80° C. or below), they are not easily diffusible through parchment membranes, and, like the proteins, are "salted out" by certain concentrations of neutral salts.

## CHAPTER XLI.

### THE SALIVARY GLANDS AND THEIR DIGESTIVE ACTION.

The first of the secretions with which the food comes into contact is the saliva. This is a mixed secretion from the large salivary glands and the small unnamed mucous and serous glands that open into the mouth cavity.

**The Salivary Glands.**—The salivary glands in man are three in number on each side—the parotid, the submaxillary, and the sublingual. The parotid gland communicates with the mouth by a large duct (Stenson's duct) which opens upon the inner surface of the cheek opposite the second molar tooth of the upper jaw. The submaxillary gland lies below the lower jaw, and its duct (Wharton's duct) opens into the mouth cavity at the side of the frenum of the tongue. The sublingual gland lies in the floor of the mouth to the side of the frenum and opens into the mouth cavity by a number (eight to twenty) of small ducts, known as the ducts of Rivinus. One larger duct that runs parallel with the duct of Wharton and opens separately into the mouth cavity is sometimes present in man. It is known as the duct of Bartholin and occurs normally in the dog.

The course of the nerve fibers supplying the large salivary glands is interesting in view of the physiological results of their stimulation. The description here given applies especially to their arrangement in the dog. These glands receive their nerve supply from two general sources,—namely, the bulbar autonomies (or cerebral fibers) and the sympathetic autonomies. The parotid gland receives its bulbar autonomic fibers from the glossopharyngeal or ninth cranial nerve; they pass into a branch of this nerve, known as the tympanic branch or nerve of Jacobson, thence to the small superficial petrosal nerve, through which they reach the otic ganglion. From this ganglion they pass (postganglionic fibers) by way of the auriculotemporal branch of the inferior maxillary division of the fifth cranial nerve to the parotid gland (Fig. 288). The sympathetic autonomies pass to the superior cervical ganglion by way of the cervical sympathetic (Fig. 112), and thence as postganglionic fibers in branches which accompany the arteries distributed to the gland. The bulbar autonomic supply for the submaxillary and sublingual

glands arises from the brain in the facial nerve and passes out in the chorda tympani branch (Fig. 289). This latter nerve, after emerging from the tympanic cavity through the Glaserian fissure, joins the

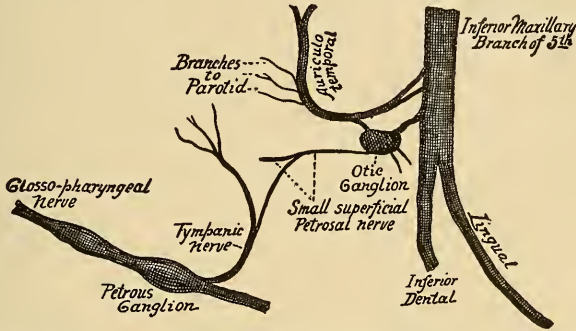

Fig. 288.—Schematic representation of the course of the cerebral fibers to the parotid gland.

lingual nerve. After running with this nerve for a short distance, the secretory (and vasodilator) nerve fibers destined for the submaxillary and sublingual glands branch off and pass to the glands,

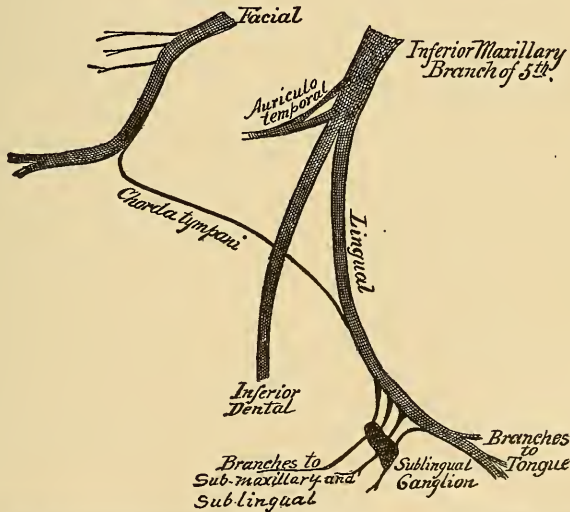

Fig. 289.—Schematic representation of the course of the chorda tympani nerve to the submaxillary gland.

following the course of the ducts. Where the chorda tympani fibers leave the lingual there is a small ganglion which has received the name of submaxillary ganglion. The nerve fibers to the glands

pass close to this ganglion, but Langley has shown that only those destined for the sublingual gland really connect with the nerve cells of the ganglion, and he suggests, therefore, that it should be called the sublingual instead of the submaxillary ganglion. The nerve fibers for the submaxillary gland make connections with nerve cells lying mainly within the hilus of the gland itself. The supply of sympathetic autonomies has the same general course as those for the parotid,—namely, through the cervical sympathetic to the superior cervical ganglion and thence to the glands.

**Histological Structure.**—The salivary glands belong to the type of compound tubular glands. That is, the secreting portions are tubular in shape, although in cross-sections these tubes may present various outlines according as the plane of the section passes through them. The parotid is described usually as a typical serous or albuminous gland. Its secreting epithelium is composed of cells which in the fresh condition as well as in preserved specimens contain numerous fine granules and its secretion contains some albumin. The submaxillary gland differs in histology in different animals. In some, as the dog or cat, the secretory tubes are composed chiefly or exclusively of epithelial cells of the mucous type. In man the gland is of a mixed type, the secretory tubes containing both mucous and albuminous cells. The sublingual gland in man also contains both varieties of cells, although the mucous cells predominate. In accordance with these histological characteristics it is found that the secretion from the submaxillary and sublingual glands is thick and mucilaginous as compared with that from the parotid.

The salivary glands possess definite secretory nerves which when stimulated cause the formation of a secretion. This fact indicates that there must be a direct contact of some kind between the gland cells and the terminations of the secretory fibers. The ending of the nerve fibers in the submaxillary and sublingual glands has been described by a number of observers.\* The accounts differ somewhat as to details of the finer anatomy, but it seems to be clearly established that the secretory fibers from the chorda tympani end first around the intrinsic nerve ganglion cells of the glands (preganglionic fibers), and from these latter cells axons (postganglionic fibers) are distributed to the secreting cells, passing to these cells along the ducts. The nerve fibers terminate in a plexus upon the membrana propria of the alveoli, and from this plexus fine fibrils pass inward to end on and between the secreting cells. It would seem from these observations that the nerve fibrils do not penetrate or fuse with the gland cells, as was formerly supposed, but form a terminal network in contact with the cells, following thus the general schema for the connection between nerve fibers and peripheral tissues.

\* See Huber, "Journal of Experimental Medicine," 1, 281, 1896.

**Composition of the Secretion.**—The saliva as it is found in the mouth is a colorless or opalescent, turbid, and viscid liquid of weakly alkaline reaction to litmus paper, and a specific gravity of about 1.003. It may contain numerous flat cells derived from the epithelium of the mouth, and the peculiar spherical cells known as salivary corpuscles, which seem to be altered leucocytes. The important constituents of the secretion are mucin, a diastatic enzyme known as ptyalin, maltase, traces of protein and of potassium sulphocyanid, and inorganic salts, such as potassium and sodium chlorid, potassium sulphate, sodium carbonate, and calcium carbonate and phosphate. The carbonates are particularly abundant in the saliva, and the secretion in addition contains much carbon dioxid in solution. Thus, Pflüger found that 65 volumes per cent. of  $\text{CO}_2$  might be obtained from the saliva, of which 42.5 per cent. was in the form of carbonates. The amount of  $\text{CO}_2$  in solution and combined is an indication of the active chemical changes occurring in the gland.

Of the organic constituents of the saliva the protein exists in small and variable quantities, and its exact nature is not determined. The mucin gives to the saliva its ropy, mucilaginous character. This substance belongs to the group of combined proteins, glycoproteins (see Appendix), consisting of a protein combined with a carbohydrate group. The most interesting constituent of the mixed saliva is the ptyalin or salivary diastase. This body belongs to the group of enzymes or unorganized ferments, whose general properties have been described. In some animals (dog) ptyalin seems to be normally absent from the fresh saliva.

The secretions of the parotid and the submaxillary glands can be obtained separately by inserting a cannula into the openings of the ducts in the mouth, or, according to the method of Pawlow, by transferring the end of the duct so that it opens upon the skin instead of in the mouth, making thus a salivary fistula. The secretion of the sublingual can only be obtained in sufficient quantities for analysis from the lower animals. Examination of the separate secretions shows that the main difference lies in the fact that the parotid saliva contains no mucin, while that of the submaxillary and especially of the sublingual gland is rich in mucin. The parotid saliva of man seems to be particularly rich in ptyalin as compared with that of the submaxillary.

**The Secretory Nerves.**—The existence of secretory nerves to the salivary glands was discovered by Ludwig in 1851. The discovery is particularly interesting in that it marks the beginning of our knowledge of this kind of nerve fiber. Ludwig found that stimulation of the chorda tympani nerve causes a flow of saliva from the submaxillary gland. He established also several important facts with regard

to the pressure and composition of the secretion which will be referred to presently. It was afterward shown that the salivary glands receive a double nerve supply,—in part by way of the cervical sympathetic and in part through cerebral nerves. It was discovered also that not only are secretory fibers carried to the glands by these paths, but that vasomotor fibers are contained in the same nerves, and the arrangement of these latter fibers is such that the cerebral nerves contain vasodilator fibers that cause a dilatation of the small arteries in the glands and an accelerated blood-flow, while the sympathetic carries vasoconstrictor fibers whose stimulation causes a constriction of the small arteries and a diminished blood-flow. The effect of stimulating these two sets of fibers is found to vary somewhat in different animals. For purposes of description we may confine ourselves to the effects observed on dogs, since much of our fundamental knowledge upon the subject is derived from Heidenhain's\* experiments upon this animal. If the chorda tympani nerve is stimulated by weak induction shocks, the gland begins to secrete promptly, and the secretion, by proper regulation of the stimulation, may be kept up for hours. The secretion thus obtained is thin and watery, flows freely, is abundant in amount, and contains not more than 1 or 2 per cent. of total solids. At the same time there is an increased flow of blood through the gland. The whole gland takes on a redder hue, the veins are distended, and if cut the blood that flows from them is of a redder color than in the resting gland, and may show a distinct pulse—all of which points to a dilatation of the small arteries. If now the sympathetic fibers are stimulated, quite different results are obtained. The secretion is relatively small in amount, flows slowly, is thick and turbid, and may contain as much as 6 per cent. of total solids. At the same time the gland becomes pale, and if the veins be cut the flow from them is slower than in the resting gland, thus indicating that a vasoconstriction has occurred.

The increased vascular supply to the gland accompanying the abundant flow of "chorda saliva" and the diminished flow of blood during the scanty secretion of "sympathetic saliva" suggest naturally the idea that the whole process of secretion may be, at bottom, a vasomotor phenomenon, the amount of secretion depending only on the quantity and pressure of the blood flowing through the gland. It has been shown conclusively that this idea is erroneous and that definite secretory fibers exist. The following facts may be quoted in support of this statement: (1) Ludwig showed that if a mercury manometer is connected with the duct of the submaxillary gland and the chorda is then stimulated for a certain time, the pressure in the

\* "Pflüger's Archiv für die gesammte Physiologie," 17, 1, 1878; also in Hermann's "Handbuch der Physiologie," 1883, vol. v, part i.

duct may become greater than the blood-pressure in the gland. This fact shows that the secretion is not derived entirely by processes of filtration from the blood. (2) If the blood-flow be shut off completely from the gland, stimulation of the chorda still gives a secretion for a short time. (3) If atropin is injected into the gland, stimulation of the chorda causes vascular dilatation, but no secretion. This may be explained by supposing that the atropin paralyzes the secretory, but not the dilator fibers. (4) Hydrochlorate of quinin injected into the gland causes vascular dilatation, but no secretion. In this case the secretory fibers are still irritable, since stimulation of the chorda gives the usual secretion.

A still more marked difference between the effect of stimulation of the cerebral and the sympathetic fibers may be observed in the case of the parotid gland in the dog. Stimulation of the cerebral fibers, in any part of their course, gives an abundant, thin, and watery saliva, poor in solid constituents. Stimulation of the sympathetic fibers alone (provided the cerebral fibers have not been stimulated shortly before and the tympanic nerve has been cut to prevent a reflex effect) gives usually no perceptible secretion at all. But in this last stimulation a marked effect is produced upon the gland, in spite of the absence of a visible secretion. This is shown by the fact that subsequent or simultaneous stimulation of the cerebral fibers causes a secretion very unlike that given by the cerebral fibers alone, in that it is very rich indeed in organic constituents. The amount of organic matter in the secretion may be tenfold that of the saliva obtained by stimulation of the cerebral fibers alone.

*Relation of the Composition of the Secretion to the Strength of Stimulation.*—If the stimulus to the chorda is gradually increased in strength, care being taken not to fatigue the gland, the chemical composition of the secretion is found to change with regard to the relative amounts of the water, the salts, and the organic material. The water and the salts increase in amount with the increased strength of stimulus up to a certain maximal limit, which for the salts is about 0.77 per cent. It is important to observe that this effect may be obtained from a perfectly fresh gland as well as from a gland which had previously been secreting actively. With regard to the organic constituents the precise result obtained depends on the condition of the gland. If previous to the stimulation the gland was in a resting condition and unfatigued, then increased strength of stimulation is followed at first by a rise in the percentage of organic constituents, and this rise in the beginning is more marked than in the case of the salts. But with continued stimulation the increase in organic material soon ceases, and finally the amount begins actually to diminish, and may fall to a low point in spite of the stronger stimulation. On the other hand, if the gland at the beginning of the

experiment had been previously worked to a considerable extent, then an increase in the stimulating current, while it augments the amount of water and salts, either may have no effect at all upon the organic constituents or may cause only a temporary increase, quickly followed by a fall. Similar results may be obtained from stimulation of the cerebral nerves of the parotid gland. The above facts led Heidenhain to believe that the conditions determining the secretion of the organic material are different from those controlling the water and salts, and he gave a rational explanation of the differences observed, in his theory of trophic and secretory fibers.

**Theory of Trophic and Secretory Nerve Fibers.**—This theory supposes that two physiological varieties of nerve fibers are distributed to the salivary glands. One of these varieties controls the secretion of the water and inorganic salts and its fibers may be called secretory fibers proper, while the other, to which the name trophic is given, causes the formation of the organic constituents of the secretion, probably by a direct influence on the metabolism of the cells. Were the trophic fibers to act alone, the organic products would be formed within the cell, but there would be no visible secretion, and this is the hypothesis which Heidenhain uses to explain the results of the experiment described above upon stimulation of the sympathetic fibers to the parotid of the dog. In this animal, apparently, the sympathetic branches to the parotid contain exclusively or almost exclusively trophic fibers, while in the cerebral branches both trophic and secretory fibers proper are present. The results of stimulation of the cerebral and sympathetic branches to the submaxillary gland of the same animal may be explained in terms of this theory by supposing that in the latter nerve trophic fibers preponderate, and in the former the secretory fibers proper.

It is obvious that this anatomical separation of the two sets of fibers along the cerebral and sympathetic paths may be open to individual variations, and that dogs may be found in which the sympathetic branches to the parotid glands contain secretory fibers proper, and therefore give some flow of secretion on stimulation. These variations might also be expected to be more marked when animals of different groups are compared. Thus, Langley\* finds that in cats the sympathetic saliva from the submaxillary gland is less viscid than the chorda saliva,—just the reverse of what occurs in the dog. To apply Heidenhain's theory to this case it is necessary to assume that in the cat the trophic fibers run chiefly in the chorda.

The way in which the trophic fibers act has been briefly indicated. They may be supposed to set up metabolic changes in the protoplasm of the cells, leading to the formation of certain definite prod-

\* "Journal of Physiology," 1, 96, 1878.



ucts, such as mucin or ptyalin. That such changes do occur is abundantly shown by microscopical examination of the resting and the active gland, the details of which will be given presently. That these changes involve processes of oxidation is shown by the fact that during activity the gland takes up more oxygen and gives off more carbon dioxid. There is evidence to show that these gland cells during activity form fresh material from the nourishment supplied by the blood; that is, that anabolic or synthetic processes occur along with the catabolic changes. The latter are the more obvious, and are the changes which are usually associated with the action of the trophic nerve fibers.

The method of action of the secretory fibers proper is difficult to understand. At present the theories suggested are entirely speculative. Experiments have shown that the amount of water given off from the blood during secretion is somewhat greater than the amount contained in the saliva,\* and there is reason to believe that the difference between the two is accounted for by an increase in the flow of lymph from the gland during activity. A satisfactory explanation of the causes leading to and controlling the flow of water cannot yet be given. In a general way it has been assumed that the effect of the nerve impulses is to cause the production of substances within the cells whereby their osmotic pressure is increased, and a stream of water is set up from the blood in the capillaries toward the gland cells, but it cannot be said that this assumption has been supported by the experiments so far made.† We must limit ourselves to the more general statement that the activity of the cells themselves initiates and controls the flow of water.

**Histological Changes During Activity.**—The cells of both the albuminous and mucous glands undergo distinct histological changes in consequence of prolonged activity, and these changes may be recognized both in preparations from the fresh gland and in preserved specimens. In the parotid gland Heidenhain studied the changes in stained sections after hardening in alcohol. In the resting gland the cells are compactly filled with granules that stain readily and are imbedded in a clear ground substance that does not stain. The nucleus is small and more or less irregular in outline. After stimulation of the tympanic nerve the cells show but little alteration, but stimulation of the sympathetic produces a marked change. The cells become smaller, the nuclei more rounded, and the granules more closely packed. This last appearance seems, however, to be

\* Barcroft, "Journal of Physiology," 1900, 25, 479.

† Carlson, Greer, and Becht, "American Journal of Physiology," 19, 360. 1907.

due to the hardening reagents used. A truer picture of what occurs may be obtained from a study of sections of the fresh gland. Langley,\* who first used this method, describes his results as follows: When the animal is in a fasting condition the cells have a granular appearance throughout their substance, the outlines of the different cells being faintly marked by light lines (Fig. 290, *A*). When the gland is made to secrete by giving the animal food, by injecting pilocarpin, or by stimulating the sympathetic nerves, the granules begin to disappear from the outer borders of the cells (Fig. 290, *B*),

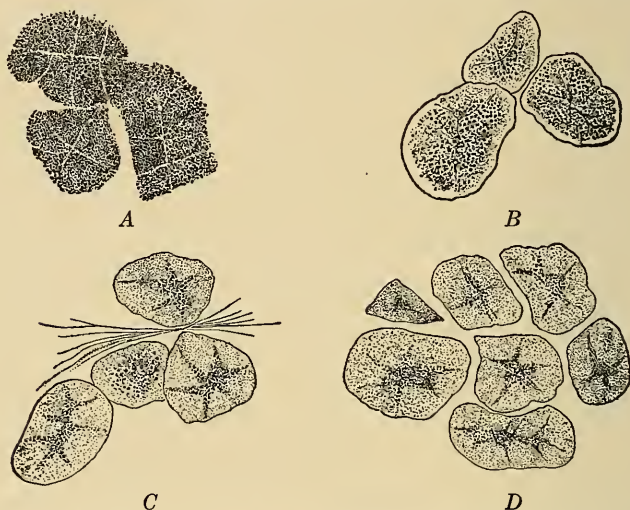

Fig. 290.—Parotid gland of the rabbit in a fresh state, showing portions of the secreting tubules: *A*, In a resting condition; *B*, after secretion caused by pilocarpin; *C*, after stronger secretion, pilocarpin and stimulation of sympathetic; *D*, after long-continued stimulation of sympathetic.—(After Langley.)

so that each cell now shows an outer, clear border and an inner granular one. If the stimulation is continued the granules become fewer in number and are collected near the lumen and the margins of the cells, the clear zone increases in extent, and the cells become smaller (Fig. 290, *C*, *D*). Evidently the granular material is used in some way to make the organic material of the secretion. Since the ptyalin is a conspicuous organic constituent of the secretion, it is assumed that the granules in the resting gland contain the ptyalin, or rather the preliminary material from which the ptyalin is constructed during the act of secretion. On this latter assumption the granules are frequently spoken of as zymogen granules. During the act of secretion two distinct processes seem to be going on in the cell, leaving out of consideration, for the moment, the secretion of the

\* "Journal of Physiology," 2, 260, 1879.

water and the salts. In the first place, the zymogen granules undergo a change such that they are forced or dissolved out of the cell, and, second, a constructive metabolism or anabolism is set up, leading to the formation of new protoplasmic material from the substances contained in the blood and lymph. The new material thus formed is the clear, non-granular substance, which appears first toward the basal sides of the cells. We may suppose that the clear substance during the resting periods undergoes metabolic changes, whether of a catabolic or anabolic character can not be

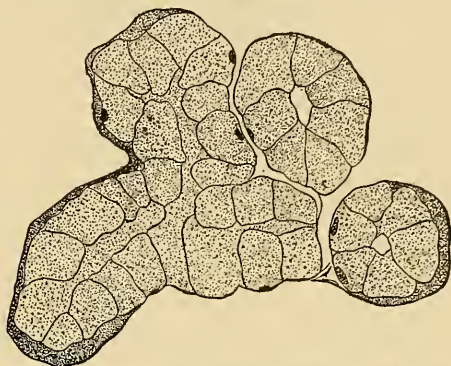

Fig. 291.—Mucous gland: submaxillary of dog; resting stage.

safely asserted, leading to the formation of new granules, and the cells are again ready to form a secretion of normal composition. It should be borne in mind that in these experiments the glands were stimulated beyond normal limits. Under ordinary conditions the cells are probably never depleted of their granular material to the extent represented in the figures.

In the cells of the mucous glands changes equally marked may be observed after prolonged activity.



Fig. 292.—Mucous gland: submaxillary of dog after eight hours' stimulation of the chorda tympani.

marked (Fig. 292) and, according to Heidenhain, some of the mucous cells may break down completely. According to most of the later observers, however, the mucous cells do not actually disintegrate, but form again new material during the period of

In stained sections of the resting gland the cells are large and clear (Fig. 291), with flattened nuclei placed well toward the base of the cell. When the gland is made to secrete the nuclei become more spherical and lie more toward the middle of the cell, and the cells themselves become distinctly smaller. After prolonged secretion the changes become more

rest, as in the case of the goblet cells of the intestine. In the mucous as in the albuminous cells observations upon pieces of the fresh gland seem to give more reliable results than those upon preserved specimens. Langley\* has shown that in the fresh mucous cells of the submaxillary gland numerous large granules may be discovered, about 125 to 250 to a cell. These granules are comparable to those found in the goblet cells, and may be interpreted as consisting of mucin or some preparatory material from which mucin is formed. The granules are sensitive to reagents; addition of water causes them to swell up and disappear. It may be assumed that this happens during secretion, the granules becoming converted to a mucin mass which is extruded from the cell.

**Action of Atropin, Pilocarpin, and Nicotin upon the Secretory Nerves.**—The action of drugs upon the salivary glands and their secretions belongs properly to pharmacology, but the effects of the three drugs mentioned are so decided that they have a peculiar physiological interest. Atropin in small doses injected either into the blood or into the gland duct prevents the action of the cerebral autonomic fibers (tympanic nerve or chorda tympani) upon the glands. This effect may be explained by assuming that the atropin paralyzes the endings of the cerebral fibers in the glands. That it does not act directly upon the gland cells themselves seems to be assured by the interesting fact that, with doses sufficient to throw out entirely the secreting action of the cerebral fibers, the sympathetic fibers are still effective when stimulated. Pilocarpin has directly the opposite effect to atropin. In minimal doses it sets up a continuous secretion of saliva, which may be explained upon the supposition that it stimulates the endings of the secretory fibers in the gland. Within certain limits these drugs antagonize each other,—that is, the effect of pilocarpin may be removed by the subsequent application of atropin, and *vice versa*. Nicotin, according to the experiments of Langley,† prevents the action of the secretory nerves, not by affecting the gland cells or the endings of the nerve fibers around them, but by paralyzing the connections between the nerve fibers and the ganglion cells through which the fibers pass on their way to the gland,—that is, the connection between the pre-ganglionic and postganglionic fibers. If, for example, the superior cervical ganglion is painted with a solution of nicotin, stimulation of the cervical sympathetic below the gland gives no secretion; stimulation, however, of the fibers in the ganglion or between the ganglion and gland gives the usual effect. By the use of this drug Langley is led to believe that the cells of the so-called submaxillary ganglion

\* "Journal of Physiology," 10, 433, 1889.

† "Proceedings of the Royal Society," London, 46, 423, 1889.

are really intercalated in the course of the fibers to the sublingual gland, while the nerve cells with which the submaxillary fibers make connection are found chiefly in the hilus of the gland itself.

**Paralytic Secretion.**—A remarkable phenomenon in connection with the salivary glands is the so-called paralytic secretion. It has been known for a long time that if the chorda tympani is cut the submaxillary gland after a certain time, one to three days, begins to secrete slowly, and the secretion continues uninterruptedly for a long period—as long, perhaps, as several weeks—and eventually the gland itself undergoes atrophy. Langley states that section of the chorda on one side is followed by a continuous secretion from the glands on both sides; the secretion from the gland of the opposite side he designates as the antiparalytic or antilytic secretion. After section of the chorda the nerve fibers peripheral to the section degenerate, the process being completed within a few days. These fibers, however, do not run directly to the gland cell; they terminate in synapses around sympathetic nerve cells placed somewhere along their course,—in the sublingual ganglion, for instance, or within the gland substance itself. It is the axons from these second nerve units that end around the secreting cells. Langley has accumulated some facts to show that within the period of continuance of the paralytic secretion (five to six weeks) the fibers of the sympathetic cells are still irritable to stimulation. He is inclined to believe, therefore, that the continuous secretion is due to a continuous excitation, from some cause, of the local nervous mechanism in the gland. A natural extension of this view which has been suggested (Pawlow) is that normally the activity of the sympathetic cells or of the secreting cells is kept in check by inhibitory fibers. After section of the chorda the action of these fibers falls out and the secretion continues until the glandular tissue undergoes atrophy.

**Normal Mechanism of Salivary Secretion.**—Under normal conditions the flow of saliva from the salivary glands is the result of a reflex stimulation of the secretory nerves. The sensory fibers concerned in this reflex must be chiefly fibers of the glossopharyngeal and lingual nerves supplying the mouth and tongue. Sapid bodies and various other chemical or mechanical stimuli applied to the tongue or mucous membrane of the mouth produce a flow of saliva. The normal flow during mastication must be effected by a reflex of this kind, the sensory impulse being carried to a center and thence transmitted through the efferent nerves to the glands. It is found that section of the chorda prevents the reflex, in spite of the fact that the sympathetic fibers are still intact. No satisfactory explanation of the normal functions of the secretory fibers in the sympathetic has yet been given. Various authors have suggested that possibly

the three large salivary glands respond normally to different stimuli. This view has been supported by Pawlow, who reports that in the dog at least the parotid and the submaxillary may react quite differently. When fistulas were made of the ducts of these glands it was found that the submaxillary responded readily to a great number of stimuli, such as the sight of food, chewing of meats, acids, etc. The parotid, on the contrary, seemed to react only when dry food, dry powdered meat, or bread was placed in the mouth. Dryness in this case appeared to be the efficient stimulus.

Pawlow lays great stress upon the adaptability of the secretion of saliva to the character of the material chewed. Dry, solid food stimulates a large flow of saliva, such as is necessary in order to chew it properly and to form it into a bolus for swallowing. Foods containing much water, on the contrary, excite but little flow of saliva. If one places a handful of clean stones in the mouth of a dog he will move them around with his tongue for a while and then drop them from his mouth; but little or no saliva is secreted. If the same material is given in the form of fine sand a rich flow of saliva is produced, and the necessity for the reflex is evident in this case, since otherwise the material could not be conveniently removed from the mouth. Such adaptations must be regarded from the physiological point of view as special reflexes depending upon some difference in the nervous mechanism set into play.\*

Since the flow of saliva is normally a definite reflex, we should expect a distinct salivary secretion center. This center has been located by physiological experiments in the medulla oblongata, in the formatio reticularis lateral to the facial nucleus. The experiments† consisted in dividing the chorda and the nervus tympanicus and, after a suitable interval, examining sections of the medulla for the appearance of degenerative changes (chromatolysis, p. 128). Owing to the wide connections of nerve cells in the central nervous system, we should expect this center to be affected by stimuli from various sources. As a matter of fact, it is known that the center and through it the glands may be called into activity by stimulation of the sensory fibers of the sciatic, splanchnic, and particularly the vagus nerves. So, too, various psychical acts, such as the thought of savory food and the feeling of nausea preceding vomiting, may be accompanied by a flow of saliva, the effect in this case being due probably to stimulation of the secretion center by nervous impulses descending from the higher nerve centers. Lastly, the medullary center may be inhibited as well as stimulated. The well-known effect of fear, embarrassment, or anxiety in producing a parched throat may be explained in this way as due to the inhibitory action of nerve impulses arising in the cerebral centers.

\* See Pawlow, "The Work of the Digestive Glands," translation by Thompson, London, 1902; also "Ergebnisse der Physiologie," vol. iii., part 1, 1904, and "Archives internationales de physiologie," 1, 119, 1904.

† Yagita and Hayama, "Neurologisches Centralblatt," 738, 1909.

**Electrical Changes in the Gland during Activity.**—It has been shown that the salivary as well as other glands suffer certain changes in electrical potential during activity which are comparable in a general way to the "action currents" observed in muscles and nerves.\*

**The Digestive Action of Saliva—Ptyalin.**—The digestive action proper of the saliva is limited to the starchy food. In human beings and most mammals the saliva contains an active enzyme belonging to the group of diastases and designated usually as ptyalin or salivary diastase. It may be prepared in purified form from saliva by precipitation with alcohol, but its chemical nature, like that of the other enzymes, is still an unsolved problem. Saliva or preparations of ptyalin act readily upon boiled starch, converting it into sugar and dextrin. This action may be demonstrated very readily by holding a little starch paste or starchy food, such as boiled potatoes, in the mouth for a few moments. If the solution is then examined the presence of sugar is readily shown by its reducing action on solutions of copper sulphate (Fehling's solution). There is no doubt that the action of ptyalin upon the starch is hydrolytic. Under the influence of the enzyme the starch molecules take up water and undergo cleavage into simpler molecules. The steps in the process and the final products have been investigated by a very large number of workers, but much yet remains in doubt. The following points seem to be determined: The end-result of the reaction is the formation of maltose, a disaccharid, having the general formula  $C_{12}H_{22}O_{11}$ , and some form of dextrin, a non-crystallizable polysaccharid. When the digestion is effected in a vessel some dextrose ( $C_6H_{12}O_6$ ) may be found among the products, but this is explained on the assumption that there is present in the saliva some maltase, an enzyme capable of splitting maltose into dextrose. So far as the ptyalin itself is concerned, its specific action is to convert starch to maltose and dextrin. It seems very certain, however, that a number of intermediate products are formed consisting of a variety of dextrans, so that the hydrolysis probably takes place in successive stages. There is little agreement as to the exact nature of the intermediate dextrans. The following facts, however, may be easily demonstrated in a salivary digestion carried on in a vessel and examined from time to time. The starch at first gives its deep-blue reaction with iodine; later, instead of a blue, a red reaction is obtained with iodine, and this has been attributed to a special form of dextrin, erythro-dextrin, so named on account of its red reaction. Still later this reaction fails and chemical examination shows the presence of maltose and a form of dextrin which gives no color reaction with iodine and is therefore named achroödextrin. While the number

\* See Biedermann, "Electro-physiology," translation by Welby, London, 1896.

of intermediate products may be large, the main result of the action of the ptyalin is expressed by the following simple schema:

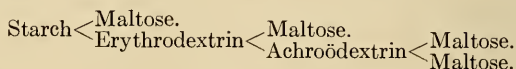

The products formed in this reaction are probably not absorbed as such. The absorption takes place mainly no doubt after the food reaches the small intestine, and we have evidence, as will be stated, that before absorption the maltose is acted upon by the inverting enzymes (maltase) and converted into the simple sugar, dextrose. The ptyalin digestion seems, therefore, to be preparatory, and the combined action of ptyalin and maltase is necessary to get the starch into a condition ready for nutrition. Under the influence of these two enzymes, the complex starch molecule, consisting of a number of  $C_6H_{10}O_5$  groups, is broken down into its constituent elements or building stones, that is to say, to the simple sugars of the formula  $C_6H_{12}O_6$ . The simple sugars or monosaccharids ( $C_6H_{12}O_6$ ), the double sugars or disaccharids ( $C_{12}H_{22}O_{11}$ ), and the dextrans, starches, and cellulose or polysaccharids, with the general formula  $(C_6H_{10}O_5)_n$ , constitute a series of increasing complexity as regards the size of the molecule. By hydrolysis, with enzymes or with acids, the polysaccharids are hydrated and split to form the simpler members of the series, while on the other hand, in the living organism the simple sugars may be synthesized by combining two or more of the groups with dehydration to form the higher polysaccharids, the animal and vegetable starches. A question of practical importance is as to how far salivary digestion affects the starchy foods under usual circumstances. The chewing process in the mouth thoroughly mixes the food and saliva, or should do so, but the bolus is swallowed much too quickly to enable the enzyme to complete its action. In the stomach the gastric juice is sufficiently acid to destroy the ptyalin, and it was therefore supposed formerly that salivary digestion is promptly arrested on the entrance of the food into the stomach, and is normally of but little value as a digestive process. Our recent increase in knowledge regarding the conditions in the stomach (p. 722) shows, on the contrary, that some of the food in an ordinary meal may remain in the fundic end of the stomach for an hour or more untouched by the acid secretion. There is every reason to believe, therefore, that salivary digestion may be carried on in the stomach to an important extent.

**Conditions Influencing the Action of Ptyalin.**—*Temperature.*

—As in the case of the other enzymes, ptyalin is very susceptible to changes of temperature. At  $0^\circ C.$  its activity is said to be suspended entirely. The intensity of its action increases with increase of



temperature from this point, and reaches its maximum at about 40° C. If the temperature is raised much beyond this point, the action decreases, and at from 65° to 70° C. the enzyme is destroyed. In these latter points ptyalin differs from diastase, the enzyme of malt. Diastase shows a maximum action at 50° C. and is destroyed at 80° C.

*Effect of Reaction.*—The normal reaction of saliva is slightly alkaline to litmus. Chittenden has shown, however, that ptyalin acts as well, or even better, in a perfectly neutral medium. A strong alkaline reaction retards or prevents its action. The most marked influence is exerted by acids. Free hydrochloric acid to the extent of only 0.003 per cent. (Chittenden) is sufficient to practically stop the amylolytic action of the enzyme, and a slight further increase in acidity not only stops the action, but also destroys the enzyme.

*Condition of the Starch.*—It is a well-known fact that the conversion of starch to sugar by enzymes takes place much more rapidly with cooked starch—for example, starch paste. In the latter material sugar begins to appear in a few minutes, provided a good enzyme solution is used. With starch in a raw condition, on the contrary, it may be many minutes, or even several hours, before sugar can be detected. The longer time required for raw starch is partly explained by the fact that the starch grains are surrounded by a layer of cellulose or cellulose-like material that resists the action of ptyalin. When boiled, this layer breaks and the starch in the interior becomes exposed. In addition, the starch itself is changed during the boiling; it takes up water, and in this hydrated condition is acted upon more rapidly by the ptyalin. The practical value of cooking vegetable foods is evident from these statements.

**Functions of the Saliva.**—In addition to the digestive action of the saliva on starchy foods it fulfills other important functions. By moistening the food it enables us to reduce the material to a consistency suitable for swallowing and for manipulation by the tongue and other muscles. Moreover, the presence of mucin serves doubtless as a kind of lubricator that insures a smooth passage along the esophageal canal. Finally by dissolving dry and solid food it provides a necessary step in the process of stimulating the taste nerves, and, as is described below, the activity of the taste sensations may play an important part in the secretion of the gastric juice.

## CHAPTER XLII.

### DIGESTION AND ABSORPTION IN THE STOMACH.

The muscular mechanisms by means of which the stomach is charged with food and in turn discharged, small portions at a time, into the duodenum have been described. The present chapter deals only with the chemical and mechanical changes in the food during its stay in the stomach and the extent to which the products of digestion are absorbed.

**The Gastric Glands.**—The tubular glands that permeate the mucous membrane of the stomach throughout its entire extent differ in their histological structure, and therefore doubtless in their secretion, in different parts of the stomach. Two, sometimes three, kinds of glands are distinguished,—the pyloric, fundic (and cardiac). Those in the pyloric part of the stomach (antrum pylori) are characterized chiefly by the fact that in the secreting part of the tubule only one type of gland cell is found, the chief or peptic cell, while in the remainder of the stomach, but particularly in the middle or prepyloric region the glands (fundic glands) are distinguished by the presence of two types of cells,—the chief or central cells and the so-called parietal or border cells (Fig. 293). The third type, the cardiac glands, is found around the cardia, but its area of distribution varies in different animals, and its histological characteristics are not very definite.\* There seems to be a general agreement that the central cells furnish the digestive enzymes of the stomach—pepsin and rennin—and the parietal cells the hydrochloric acid. From a physiological standpoint it is important to remember that the parietal cells are massed, as it were, in the glands of the middle or prepyloric region of the stomach, that they are scanty in the fundus, and absent in the pyloric region. This fact is indicated to the eye by the deeper red or brownish color of the mucous membrane in the prepyloric portion. Grützner† called especial attention to this relation, and in connection with the differences in movements of these two parts of the stomach he suggests that normally the bulk of the food toward the fundus becomes impregnated first with pepsin; then, as it is slowly moved into the prepyloric region, the acid constituent is added. The pyloric glands are said (Heidenhain) to secrete an alkaline liquid containing pepsin, and, according to Edkins and Starling, they form a substance which is capable of acting as a chemical excitant to the

\* See Haane, "Archiv f. Anatomie," 1905, 1.

† Grützner, "Archiv f. die gesammte Physiologie," 106, 463, 1905.

glands secreting the gastric juice (gastric secretin or gastric hormone).\*

**Histological Changes in the Gastric Glands during Secretion.**—

The cells of the gastric glands, especially the so-called central cells, show distinct changes as the result of prolonged activity. Upon preserved specimens, taken from dogs fed at intervals of twenty-four hours, Heidenhain found that in the fasting condition the central cells were large and clear, that during the first six hours of digestion the central cells as well as the border cells increased in



Fig. 293.—Glands of the fundus (dog): *A* and *A'*, during hunger, resting condition; *B*, during the first stage of digestion; *C* and *D*, the second stage of digestion, showing the diminution in the size of the "chief" or central cells.—(After Heidenhain.)

size, but that in a second period, extending from the sixth to the fifteenth hour, the central cells became gradually smaller, while the parietal cells remained large or even increased in size. After the fifteenth hour the central cells increased in size, gradually passing back to the fasting condition (see Fig. 293).

Langley† has succeeded in following the changes in a more satisfactory way by observations made directly upon the living gland.

\* See Starling, "Physiology of Secretion," Chicago, 1906, and Eddins, "Journal of Physiology," 1906, xxxiv., 133.

† "Journal of Physiology," 3, 269, 1880.

He finds that the central cells in the fasting stage are charged with granules, and that during digestion the granules are dissolved, disappearing first from the base of the cell, which then becomes filled with a non-granular material. Observations similar to those made upon other glands demonstrate that these granules represent in all probability a preliminary material from which the gastric enzymes are made during the act of secretion. The granules, therefore, are sometimes described as zymogen granules.

**Means of Obtaining the Gastric Secretion and its Normal Composition.**—The secretion of the gastric membrane is formed in the minute tubular glands scattered over its surface. As there is no common duct, the difficulty of obtaining the secretion for analysis or experiment is considerable. This difficulty has been overcome at different times by the invention of special methods.

The older methods used for obtaining normal gastric juice were very unsatisfactory. An animal was made to swallow a clean sponge to which a string was attached so that the sponge could afterward be removed and its contents be squeezed out; or it was made to eat some indigestible material, to start the secretion of juice; the animal was then killed at the proper time and the contents of its stomach were collected.

The experiments of the older observers on gastric digestion, especially those of the Abbé Spallanzani (1729–1799), furnish most interesting reading. Spallanzani, not content with making experiments on numerous animals (frogs, birds, mammals, etc.) had the courage to carry out a great many upon himself. He swallowed foods of various kinds and in various conditions sewed in linen bags or inclosed in perforated wooden tubes which in turn were covered with linen. The bags and tubes were subsequently passed in the stools and were examined as to the amount and nature of their contents. He seems to have experienced no injury from his experiments, although normally his powers of digestion were quite feeble. As proof that the triturating power of the stomach is not very great he calls attention to the fact that some of the wooden tubes were made very thin, so that the slightest pressure would crush them, and yet they were voided uninjured. So also he found that cherries and grapes when swallowed whole, even if entirely ripe, were usually passed unbroken.

A better method of obtaining normal juice was suggested by the famous observations of Beaumont\* upon Alexis St. Martin. St. Martin, by the premature discharge of his gun, was wounded in the abdomen and stomach. On healing, a fistulous opening remained in the abdominal wall, leading into the stomach, so that the contents of the latter could be inspected. Beaumont made numerous interesting and most valuable observations upon his patient. Since that time it has become customary to make fistulous openings into the stomachs of dogs whenever it is necessary to have the normal juice for examination. Formerly a silver cannula was placed in the

\* Beaumont, "The Physiology of Digestion," 1833; second edition, 1847. For a biographical account of Beaumont, see Osler, "Journal of the American Medical Association," November 15, 1902.

fistula, and at any time the plug closing the cannula might be removed and gastric juice be obtained. In some cases the esophagus has been occluded or excised so as to prevent the mixture of saliva with the gastric juice. Gastric juice may be obtained from human beings also in cases of vomiting or by means of the stomach tube, but in such cases it is necessarily more or less diluted or mixed with food and cannot be used for exact analyses, although specimens of gastric juice obtained by these methods are employed in the diagnosis and treatment of gastric troubles.

From the standpoint of experimental investigation a very important addition to our methods was made by Heidenhain. This observer showed that a portion of the stomach—the fundic end, for instance, or the pyloric end—might be cut away from the rest of the organ and be given an artificial opening to the exterior. By this means the secretion of an isolated fundic or pyloric sac may be obtained and examined as to its quantity and properties. The method was subsequently improved by Pawlow, whose important contributions are referred to below. Fig. 294 gives an idea of the operation as made by Pawlow to isolate a fundic sac with its blood and nerve supply uninjured.

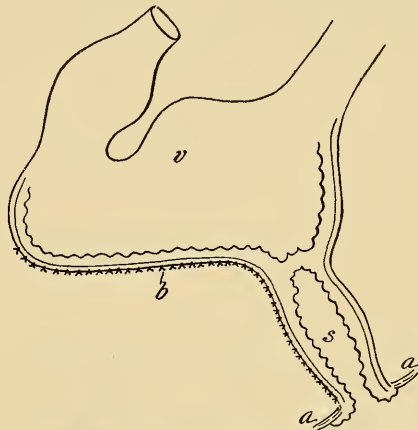

Fig. 294.—To show Pawlow's operation for making an isolated fundic sac from the stomach; *v*, Cavity of the stomach; *s*, the fundic sac, shut off from the stomach and opening at the abdominal wall, *a, a*; *b* indicates the line of sutures.—(Pawlow.)

The normal gastric secretion is a thin, colorless or nearly colorless liquid with a strong acid reaction and a characteristic odor. Its specific gravity varies, but it is never great, the average being about 1.002 to 1.003. Upon analysis the gastric juice is found to contain some protein, some mucin, and inorganic salts, but the essential constituents are an acid (HCl) and two or possibly three enzymes, pepsin, rennin, and lipase. Satisfactory complete analyses of the human juice have not been reported, most of the recent observers confining their attention mainly to the degree of acidity and digestive power. More complete data are published for the secretion in dogs. According to Rosemann,\* the secretion in this animal has a specific gravity of 1002 to 1004 and contains 0.4277 per cent. of dry material, of which 0.1325 per cent. is ash.

\* Rosemann, "Archiv f. d. ges. Physiologie," 118, 467, 1907.

Analysis of the ash shows that it contains 24 per cent. of potassium, 19 per cent. of sodium, and 0.18 per cent. of calcium. The HCl amounts to 0.55 per cent. This author states that in one animal during a secretion lasting  $3\frac{1}{4}$  hours about 5 gm. of chlorin were given off in the secretion in the form of chlorids, an amount about equal to that contained in the entire blood. The organic portion of the secretion, in addition to the digestive enzymes, consists chiefly of protein. Gastric juice does not give a coagulum upon boiling, but the digestive enzymes are thereby destroyed. One of the interesting facts about this secretion is the way in which it withstands putrefaction. It may be kept for a long time, for months even, without becoming putrid and with very little change, if any, in its digestive action or in its total acidity. This fact shows that the juice possesses antiseptic properties, and it is usually supposed that the presence of the free acid accounts for this quality.

**The Acid of Gastric Juice.**—The nature of the free acid in gastric juice was formerly the subject of dispute, some claiming that the acidity is due to HCl, since this acid can be distilled off from the gastric juice, others contending that an organic acid, lactic acid, is present in the secretion. All recent experiments tend to prove that the acidity is due to HCl. This fact was first demonstrated satisfactorily by the analyses of Schmidt, who showed that if, in a given specimen of gastric juice, the chlorids were all precipitated by silver nitrate and the total amount of chlorin was determined, more was found than could be held in combination by the bases present in the secretion. Evidently, some of the chlorin must have been present in combination with hydrogen as hydrochloric acid. Confirmatory evidence of one kind or another has since been obtained. The percentage of HCl in the secretion as it is obtained from an isolated fundic sac of the stomach varies around 0.5 per cent., and we must suppose that this figure represents the concentration of acid in the juice as it is secreted. When the contents of a normal stomach are examined during digestion the acidity is said to be much lower, varying around 0.2 per cent. as a maximum. It would seem, therefore, that in digestion some of the acid is neutralized by the alkaline salts of the saliva or food, or is combined with the protein material of the food or secretion. Clinicians make a distinction between free and combined acid in the gastric secretion. By the first term is meant that the acid exists in solution as in so much water and is, therefore, largely dissociated with the production of a corresponding amount of hydrogen ions. Under the second term is included the acid that is combined in some way with the protein material. In this form the acid is less dissociated and the acidity, that is to say, the concentration of hydrogen ions, is much less. Methods have been devised for estimating the total acidity and the

free and combined acid.\* The application of these methods has shown that after a protein (meat) diet so-called free acid may not appear in the gastric contents for an hour or more. For physiological purposes it is preferable to abandon the use of the terms free and combined acid, and instead to express the degree of acidity in terms of the actual hydrogen-ion concentration. To determine this factor physiochemical methods of some complexity are required, but it has been shown that in place of these methods a series of indicators may be employed which exhibit a range of color changes for concentrations of hydrogen ions that lie within the limits to be expected from specimens of gastric juice. For example, the indicators, methyl-violet, Congo-red, tropaeolin, and methyl-orange, may be used to detect variations between 0.03 and 0.00001 n. Making use of these methods, Michaelis and Davidsohn† find that after a test-meal the hydrogen-ion concentration of the gastric contents is equal to  $1.7 \times 10^{-2}$  (0.017), which would correspond to about a  $\frac{60}{n}$  solution of acid, a solution containing, therefore, less than 0.1 per cent. of hydrochloric acid. Since this gastric juice at the time of secretion contains HCl in the concentration of 0.5 per cent. it is evident that during digestion the acidity is reduced to a much lower level by dilution, and by neutralization by means of the alkaline salts and the proteins of the foods and the secretions.

**The Origin of the HCl.**—That the acid of the gastric juice is a mineral acid and is present in considerable strength is a remarkable fact that has excited much interest. Attempts have been made to ascertain the histological elements concerned in its secretion and the nature of the chemical reaction or reactions by which it is produced. With regard to the first point, it is generally believed that the parietal cells of the gastric tubules constitute the acid-secreting cells. This belief is founded upon the general fact that in the regions in which these cells are chiefly present—that is, the middle region of the stomach—the secretion is distinctly acid, and where they are absent or scanty in number the secretion is alkaline or less acid. In the pyloric region, for instance, these cells are lacking entirely and the secretion is alkaline. Moreover microchemical reactions seem to show clearly that the parietal cells are particularly rich in chlorids, and this fact serves to connect them with the production of the acid. It seems perfectly evident that the HCl must be formed in the long run from the chlorids of the blood. The chief chlorid is NaCl, and by some means this com-

\* Simon, "A Manual of Clinical Diagnosis."

† Michaelis and Davidsohn, "Zeitschrift f. exp. Pathol.," 8, 398, 1911; also Boldyreff, "Quarterly Journal of Exp. Physiol.," 8, 1, 1914.

pound is broken up; the chlorin is combined with hydrogen, and is then secreted upon the free surface of the stomach as HCl. In support of this general statement it has been shown that if the chlorids in the blood are reduced by removing them from the food for a sufficient time the secretion of gastric juice no longer contains acid. On the other hand, addition of NaBr or KI to the food may cause the formation of some HBr and HI, together with HCl in the gastric juice. Maly has suggested that acid phosphates may be produced in the first instance, and then by reacting with the sodium chlorid may give hydrochloric acid, according to the formula,  $\text{NaH}_2\text{PO}_4 + \text{NaCl} = \text{Na}_2\text{HPO}_4 + \text{HCl}$ . Other theories have been proposed, but, as a matter of fact, no explanation of the details of this reaction is satisfactory. Many observers have attempted by microchemical methods to determine the exact points in the gastric glands at which the acid is formed. Most of these attempts have given results which have been difficult to interpret. Harvey and Bensley,\* by making use of dyes (cyanimin and neutral red) which give different colors in neutral, alkaline, and acid media, state that the free acid is found only on the internal surface of the stomach or in the neck of the glands. The parietal cells themselves exhibit an alkaline reaction. These observers advance, therefore, the probable hypothesis that the parietal cells secrete a chlorid of an organic base, and this compound in some way yields free hydrochloric acid only after it reaches the mouth of the gland. While the ultimate source of the chlorin of the hydrochloric acid is to be found in the neutral chlorids of the blood (NaCl), certain as yet unknown intermediate compounds are formed within the parietal cells from which the acid is eventually produced.

**The Secretory Nerves of the Gastric Glands.**—Although several facts indicated to the older observers that the secretion of gastric juice is under the control of nerve fibers, we owe the actual experimental demonstration of this fact to Pawlow.† He demonstrated that the secretion is under the control of the nervous system and that the secretory fibers are contained in the vagus. Direct stimulation of the peripheral end of the cut vagus causes a secretion of gastric juice after a long latent period of several minutes. This long latency may be due possibly to the presence in the vagus of inhibitory fibers to the gland, which, being stimulated simultaneously with the secretory fibers, delay the action of the latter. Very striking proof of the general fact that the secretion is due to the action of vagus fibers is furnished by such experiments as these: Pawlow divided the esophagus in the neck and brought the two ends to the skin so as to

\* Harvey and Bensley, "Biological Bulletin," 23, 225, 1912.

† See Pawlow, "The Work of the Digestive Glands," translated by Thompson, 1902.



make separate fistulous openings to the exterior. Under these conditions, when the animal ate and swallowed food it was discharged to the exterior instead of entering the stomach. The animal thus had the enjoyment of eating without actually filling the stomach. Eating in this style forms what the author called a fictitious or sham meal (*Scheinfütterung*). It was found that it causes an abundant flow of gastric juice as long as the vagi are intact, but has no effect on the secretion when these nerves are cut. Evidently, therefore, the sensations of taste, odor, etc., developed during the mastication and swallowing of food, set up reflexly a stimulation of secretory fibers in the vagus. Pawlow designates a secretion produced in this way as a psychical secretion,—a term which implies that the reflex must be attended by conscious sensations. In favorable cases the fictitious feeding has been continued for five or six hours and a large amount of gastric juice (700 c.c.) has been collected from a fistula, although no food actually entered the stomach. It is important to note, also, that a psychical secretion, once started, may continue for a long time after the stimulus (the eating) has ceased. Experiments have been made upon human beings under similar conditions. Thus, Hornborg\* reports the case of a boy with a stricture of the esophagus and a fistula in the stomach. Food when chewed and swallowed did not reach the stomach, but was regurgitated; it caused, nevertheless, an active psychical secretion in the empty stomach.

#### **Normal Mechanism of the Secretion of the Gastric Juice.—**

During a meal the gastric juice is secreted, under normal conditions, as long as the food remains in the stomach. The modern explanation of the origin, maintenance, and regulation of this flow of secretion is due chiefly to Pawlow. Contrary to a former general belief, he showed that mechanical stimulation of the gastric mucous membrane has no effect on the secretion of the tubules. This factor may therefore be eliminated. In an ordinary meal the secretion first started is due to the sensations of eating—that is, it is a psychical secretion. The afferent stimuli originate in the mouth and nostrils; the efferent path, the secretory fibers, is through the vagus nerve. This reflex insures the beginning at least of gastric digestion, but its effect is supplemented by a further action arising in the stomach itself. It seems that some foods contain substances designated as secretogogues, that are able to cause a secretion of gastric juice when taken into the stomach. Thus, meat extracts, meat juices, soups, etc., are particularly effective in this respect; milk and water cause less secretion. In other foods these ready-formed secretogogues are lacking. Certain common articles of food, such as

\* Hornborg, "Skandinavisches Archiv f. Physiologie," 15, 209, 1904; see also Bickel, "Verhandl. Kongr. f. innere Medizin," 23, 491.

bread and white of eggs, have no effect of this kind at all. If introduced into the stomach of a dog through a fistula so as not to arouse a psychical secretion,—for instance, while the dog's attention is diverted or while he is sleeping,—they cause no flow of gastric juice and are not digested. If such articles of food are eaten, however, they cause a psychical secretion, and when this has acted upon the foods some products of their digestion in turn become capable of arousing a further flow of gastric juice. The steps in the mechanism of secretion are, therefore, three: (1) The psychical secretion; (2) the secretion from secretagogues contained in the food; (3) the secretion from secretagogues contained in the products of digestion. The manner in which the secretagogues act cannot be stated positively. Since the gastric glands possess secretory nerve fibers the first explanation to suggest itself is that the secretagogues by acting on sensory fibers in the gastric mucous membrane reflexly stimulate the secretory fibers. This explanation, however, is rendered untenable by the fact that the effect of these substances is obtained after complete severance of the nervous connections of the stomach. If, therefore, this so-called chemical secretion is produced by a nervous reflex, the nerve centers concerned must lie in the stomach itself, the reflex must take place through the intrinsic ganglion cells. Another more probable explanation has been offered. Edkins\* has shown that decoctions of the pyloric mucous membrane, made by boiling in water, acid or peptone solutions, when injected into the blood cause a marked secretion of gastric juice. These substances when injected alone into the blood cause no such effect, and decoctions of the mucous membrane of the fundic end of the stomach are without action on the gastric secretion. This author suggests, therefore, that the secretagogues, whether preformed in the food or formed during digestion, act upon the pyloric mucous membrane and form a substance which he designates as *gastrin* or *gastric secretin*, and this substance after absorption into the blood is carried to the gastric glands and stimulates them to secretion. The effect is, therefore, not a usual nervous reflex, but an instance of the stimulation of one organ by chemical products formed in another. Starling† has emphasized the fact that this mode of control is frequently employed in the body, as will be described in the following pages in connection with the pancreatic secretion and the internal secretions. He proposes to designate such substances by the general term of *hormones* (from ὁρμαω, arouse or excite). Leaving aside for the moment the way in which the secretagogues excite the secretion it is important to empha-

\* Edkins, "Journal of Physiology," 1906, xxxiv., p. 133.

† Starling, "Recent Advances in the Physiology of Digestion," 1906.

size the fact that in the normal secretion of gastric juice, that is to say, in the secretion which takes place during an ordinary meal, we must distinguish between a *nervous secretion* due to the action of the secretory fibers in the vagus, and a *chemical secretion* due to the chemical stimulation of the secretogues or of the hormones produced by them.

The researches of Pawlow and his co-workers seem also to indicate that the quantity and properties of the secretion vary with

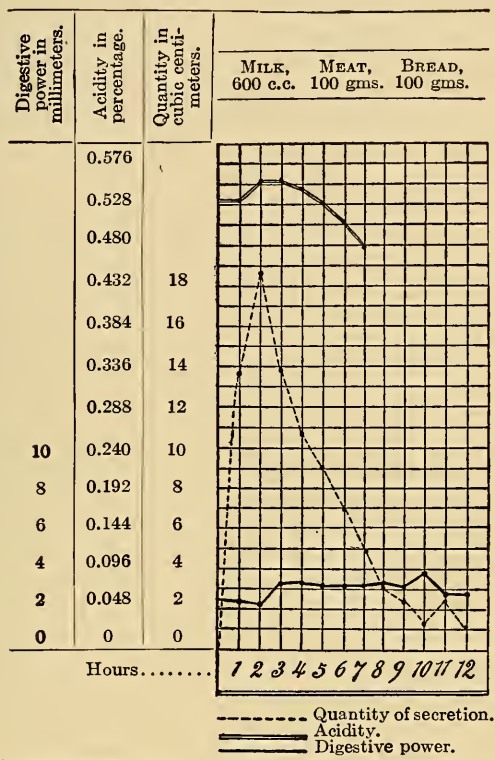

Fig. 295.—Diagram showing the variation in quantity of gastric secretion in the dog after a mixed meal; also the variations in acidity and in digestive power.—(After *Khigine*.)

the character of the food. The quantity of the secretion varies, also, other conditions being the same, with the amount of food to be digested. The apparatus is adjusted in this respect to work economically. Different kinds of food produce secretions varying not only as regards quantity but also in their acidity and digestive action. The secretion produced by bread, though less in quantity than that caused by meat, possesses a greater digestive action. On a given diet the secretion assumes certain characteris-

tics, and Pawlow is convinced that further work will disclose the fact that the secretion of the stomach is not caused normally by general stimuli all affecting it alike, but by specific stimuli contained in the food or produced during digestion, whose action is of such a kind as to arouse reflexly the secretion best adapted to the food ingested.

One of the curves, showing the effect of a mixed diet (milk, 600 c.c.; meat, 100 gms.; bread, 100 gms.) upon the gastric secretion, as determined by Pawlow's method, is reproduced in Fig. 295. It will be noticed that the secretion began shortly after the ingestion of the food (seven minutes), and increased rapidly to a maximum that was reached in two hours. After the second hour the flow decreased rapidly and nearly uniformly to about the tenth hour. The acidity rose slightly between the first and second hours, and then fell gradually. The digestive power showed an increase between the second and third hours.

**Nature and Properties of Pepsin.**—Pepsin is a typical proteolytic enzyme that exhibits the striking peculiarity of acting only in acid media; hence peptic digestion in the stomach is the result of the combined action of pepsin and hydrochloric acid. Pepsin is influenced in its action by temperature, as is the case with the other enzymes; low temperatures retard, and may even suspend its activity, while high temperatures increase it. The optimum temperature is stated to be from 37° to 40° C., while exposure for some time to 80° C. results, when the pepsin is in a moist condition, in the total destruction of the enzyme. Pepsin may be extracted from the gastric mucous membrane by a variety of methods and in different degrees of purity and strength. The commercial preparations of pepsin consist usually of some form of extract of the gastric mucous membrane to which starch or sugar of milk has been added. Laboratory preparations are made conveniently by mincing thoroughly the mucous membrane and then extracting for a long time with glycerin. Glycerin extracts, if not too much diluted with water or blood, keep for an indefinite time. Purer preparations of pepsin have been made by what is known as "Brücke's method," in which the mucous membrane is minced and is then self-digested with a 5 per cent. solution of phosphoric acid. The phosphoric acid is precipitated by the addition of lime-water, and the pepsin is carried down in the flocculent precipitate. This precipitate, after being washed, is carried into solution by dilute hydrochloric acid, and a solution of cholesterin in alcohol and ether is added. The cholesterin is precipitated, and, as before, carries down with it the pepsin. This precipitate is collected, carefully washed, and then treated repeatedly with ether, which dissolves and removes the cholesterin, leaving the pepsin in aqueous solution. This method is interesting not only because it gives a pure form of pepsin, but also in that it illustrates

one of the properties of enzymes—namely, the readiness with which they are adsorbed by precipitates occurring in their solutions.

In spite of much work, the chemical nature of pepsin is undetermined. Pekelharing\* has prepared pepsin from gastric juice by dialysis, the substance precipitating as the acid is dialyzed off. The precipitate may be purified by repeated resolutions in acid followed by dialysis. As prepared by this method pepsin is a substance of a protein nature which contains sulphur and also some chlorin, but no phosphorus. It does not belong, therefore, to the group of nucleoproteins. Other authors, on the contrary, assert that active preparations of pepsin may be obtained which give no protein reactions, although they contain nitrogen.

Pepsin is supposed to be formed in the central cells of the gastric tubules, but as in other cases it is present in the cells as a zymogen or propepsin, which is not changed to the active pepsin until after secretion. The propepsin may be extracted readily from the mucous membrane, and, since it is known that the zymogen is converted quickly to active pepsin by the action of acids, it is evident that in the normal gastric juice the existence of the hydrochloric acid insures that all of the pepsin shall be present in active form. There has been much discussion as to the nature of the secretion of the pyloric glands. Heidenhain isolated this portion of the stomach and collected its secretion. He found that it was alkaline and contained pepsin. Later observers, however, still continue to doubt the secretion of a true pepsin in this portion of the stomach. Glaessner † states that propepsin can not be obtained from extracts of the pyloric glands, and that the proteolytic enzyme that can be shown in this portion of the stomach by self-digestion in acid or alkaline media is not a true gastric pepsin. The possibility that a special secretin (hormone) is formed in the pyloric mucous membrane has been referred to above (p. 776). From the description of the events in the stomach (p. 720) it would seem that the food material which is churned and stirred by the contractions of the pyloric musculature has already been charged with pepsin and hydrochloric acid by the glands of the middle and fundic regions before reaching the antrum pylori.

**Artificial Gastric Juice.**—In studying peptic digestion it is not necessary for all purposes to establish a gastric fistula. The active agents of the normal juice are pepsin and an acid of a proper strength; and, as the pepsin can be extracted and preserved in various ways and the hydrochloric acid can easily be made of the proper strength, an artificial juice can be obtained at any time and may be used in place of the normal secretion for many purposes. In laboratory ex-

\* Pekelharing, "Zeitschrift f. physiol. Chemie," 35, 8, 1902.

† Glaessner, "Beiträge zur chem. Physiol. u. Pathol.," 1, 24, 1901.

periments it is customary to employ a glycerin or commercial preparation of the gastric mucous membrane, and to add a small portion of this preparation to a large bulk of 0.2 per cent. hydrochloric acid. The artificial juice thus made, when kept at a temperature of from 37° to 40° C., will digest proteins rapidly if the preparation of pepsin is a good one. While the strength of the acid employed is generally from 0.2 to 0.3 per cent., digestion will take place in solutions of greater or less acidity. Too great or too small an acidity, however, will retard the process; that is, there is for the action of the pepsin an optimum acidity which, according to the experiments of Michaelis,\* is represented by a concentration of hydrogen ions of about  $4 \times 10^{-2}$  (0.04 n).

**The Pepsin-hydrochloric Acid Digestion of Proteins.**—It has long been known that solid proteins, when exposed to the action of a normal or an artificial gastric juice, swell up and eventually pass into solution. The soluble protein thus formed was known not to be coagulated by heat, and was remarkable also for being more diffusible than other forms of soluble proteins. This end-product of digestion was formerly conceived as a soluble protein with properties fitting it for rapid absorption, and the name of *peptone* was given to it. It was quickly found, however, that the process is complicated—that in the conversion to so-called “peptone” the protein under digestion passes through a number of intermediate stages. The intermediate products were partially isolated and were given specific names, such as *acid-albumin*, *parapeptone*, and *propeptone*. The present conception of the process we owe chiefly to Kühne. This author believed that the protein passes through three general stages before reaching the final condition of peptone. This view is indicated briefly by the following schema:

Native protein.  
Acid albumin (syntonin).  
Primary proteoses (protalbumoses).  
Secondary proteoses (deutero-albumoses).  
Peptone.

The first step is the conversion of the protein to an acid albumin. This change may be considered as being chiefly an effect of the hydrochloric acid, although in some way the combined action of the pepsin-hydrochloric acid compound is more effective than a solution of the acid alone of the same strength. Like the acid albumins (metaproteins) in general (see Appendix), the syntonin is readily precipitated on neutralization. In the beginning of peptic digestion, therefore, if the solution is neutralized with dilute alkali, an abundant precipitate of syntonin occurs. Later on in the digestion, neutralization gives no such effect—the syntonin

\* Michaelis and Mendelssohn, “Biochemische Zeitschrift,” 65, 1, 1914.

has all passed to a further stage of digestion. Under the influence of the pepsin the syntonin undergoes hydrolysis, with the production of a number of bodies which, as a group, are designated as primary proteoses or protalbumoses.\* Although several members of this group have been isolated and given separate names, so much doubt prevails as to the chemical individuality of these substances that it is best perhaps to regard them as a group of compounds which under the continued influence of the pepsin undergo still further hydrolysis with the formation of secondary proteoses or deuterio-albumoses. As compared with the primary proteoses, the secondary ones are distinguished by a greater solubility; they require a stronger saturation with neutral salts to precipitate them. (See Appendix.) The secondary proteoses undergo still further hydrolysis, with the production of peptone, or perhaps it would be better to say peptones. The peptones show still greater solubility, and, in fact, peptone, in Kühne's sense, is that compound or group of compounds formed in peptic digestion which, while still showing protein reactions (biuret reaction), is not coagulated by heat nor precipitated when its solutions are completely saturated with ammonium sulphate. According to the schema and description given above, the several stages in peptic digestion are represented as following in sequence. It should be stated, however, that many authors consider that even in the beginning of the digestion the protein molecule may be split into several complexes, and that some of the end-products may be formed very early in the action. The end-result of the action of the pepsin in the stomach is the conversion of more or less of the protein of the food into the simpler and more soluble peptones and proteoses. The action of the enzyme is preparatory to the more complete hydrolysis that takes place in the intestine under the influence of the trypsin and erepsin, for, as we shall see, the protein of the food is not absorbed into the blood as peptones, but suffers first a further hydrolysis to amino-acids and peptids. While the pepsin is, therefore, a relatively weak proteolytic enzyme, it plays an important rôle in initiating the splitting up of the protein molecule, and its value in this respect is increased by the fact that it is adapted to act upon proteins of all kinds and bring them to a stage suitable for the more complete action of the proteolytic enzymes of the intestinal secretions.

In judging the digestive action of any given specimen of natural or artificial gastric juice it is customary to measure the rapidity

\* The products intermediate between the original protein and the peptone are described in general as albumoses or as proteoses, according as one takes the term protein or albumin as the generic name for the original substance. The term protein is generally used in English; hence, the intermediate products are more appropriately designated as proteoses.

with which an insoluble protein is converted into a soluble form. The method most commonly employed is that devised in Pawlow's laboratory by Mett. The Mett test is made by sucking white of egg into a thin-walled glass tube having an internal diameter of 1 to 2 mms. The egg-albumin is coagulated in the tube by immersing it for five minutes in water at 95° C. After some time the tube is cut into lengths of 10 to 15 mms. and these are used to test the digestive action or amount of pepsin. One or more of the tubes are placed in the solution to be measured and kept for ten hours at body temperature. The digestive power is measured in terms of the length in millimeters of the column of egg-albumin that is dissolved. The relative amounts of pepsin in solutions compared in this way are determined by the law of Schütz, according to which the digestive power is proportional to the square root of the amount of pepsin. If in two specimens of gastric juice the number of millimeters of egg albumin digested was in one case two and in the other three, the pepsin in the two solutions would be as the squares of the numbers, as 4 to 9.

**The Rennin Enzyme (Rennet, Chymosin).**—The property possessed by the mucous membrane of the calf's stomach of curdling milk has been known from remote times, and has been utilized in the manufacture of cheese and curds. This action takes place with remarkable rapidity under favorable conditions, a large mass of milk setting to a firm coagulum within a very brief time. It has been shown that this effect is due to an enzyme—rennin or rennet. The rennin, like the pepsin, is supposed to be formed in the chief cells of the gastric tubules and to be present in the glands in a zymogen form, the prorennin or prochymosin, which after secretion is converted to the active enzyme. This conversion takes place very readily under the influence of acid. Rennin (or its zymogen) may be obtained easily from the mucous membrane of the stomach (with the exception of the pyloric end) by extracting with glycerin or water or by digesting with dilute acid. Good extracts of rennin cause the milk to clot with great rapidity at a temperature of 40° C.; the milk (cows' milk), if undisturbed, sets at first into a solid clot, which afterward shrinks and presses out a clear, yellowish liquid—the whey. With human milk the curd is much less firm, and takes the form of loose flocculi. The whole process resembles much the clotting of blood. The rapidity of clotting is said to vary inversely as the amount of rennin, or, in other words, the product of the amount of rennin and the time necessary for clotting is a constant. The curdling of the milk involves two apparently independent processes: First, the rennin acts upon the casein of the milk and converts it into a substance known as paracasein. The paracasein then reacts with the calcium salts of the milk, forming an insoluble protein, which constitutes the curd or coagulum. According



to this view, the enzyme does not cause clotting directly.\* What takes place when the casein is changed to paracasein is not understood. Hammarsten originally regarded the change as a cleavage process, and this view is still supported by some authors,† although denied by others. Others have supposed that a transformation or rearrangement of molecular structure occurs. Indeed, the differences in properties between casein and paracasein are not great, the most marked difference being that the latter in the presence of calcium salts gives an insoluble coagulum. If soluble calcium salts are removed from milk by the addition of oxalate solutions, it does not curdle upon the addition of rennin. Addition of lime salts restores this property. It should be added that casein is also precipitated from milk by the addition of an excess of acid. The curdling of sour milk in the formation of bonnyclabber is a well-known illustration of this fact. When milk stands for some time the action of bacteria upon the milk-sugar leads to the formation of lactic acid, and when this acid reaches a certain concentration it causes the precipitation of the casein.

So far as our positive knowledge goes, the action of rennin is confined to milk. Casein is the chief protein constituent of milk, and has, therefore, an important nutritive value. It is interesting to find that before its peptic digestion begins the casein is acted upon by an altogether different enzyme. The value of the curdling action is not at once apparent, but we may suppose that casein is more easily digested under the conditions that exist in the body after it has been brought into a solid form, or, perhaps, the coagulation of the casein ensures that it will be retained in the stomach and be submitted to gastric digestion, instead of being ejected promptly into the duodenum, as happens with liquid material. The action of rennin goes no further than the curdling; the digestion of the curd is carried on by the pepsin, and later, in the intestines, by the trypsin, as in the case of other proteins.‡

Rennin is found elsewhere than in the gastric mucosa. It has been described in the pancreatic juice, in the testis, and in many other organs as well as in the tissues of many plants. In fact, wherever proteolytic enzymes are found there also some evidence of a curdling action on milk may be obtained. For this reason some observers § have taken the view that the milk coagulation is not due to a specific ferment, but is an action of the pepsin itself. That is, the proteolytic enzyme is capable of causing the change from casein to paracasein as well as the hydrolysis of the protein. This view is opposed to the prevalent opinion regarding the specificity of enzyme actions, and is con-

\* See Bang, "Skandinavisches Archiv f. Physiologie," 25, 105, 1911.

† Bosworth and van Slyke, "Journal of Biological Chemistry," 19, 67, 1914.

‡ For references to the very abundant literature, consult Oppenheimer, *loc. cit.*

§ See Pawlow and Parastschuk, "Zeitschrift f. physiol. Chemie," 42, 415, 1904; Burge, "American Journal of Physiology," 29, 330, 1912.

tradicted by a number of observers. Burge, for example, reports that if a solution showing both peptic and rennetic action is submitted to the action of an electric current the peptic power is destroyed completely in a certain time, while the rennetic action remains in full force.

Another interesting fact concerning rennin is that when injected into an animal it causes the formation of a specific antibody known as antirennin, which may be detected in the blood. This antirennin added to milk prevents its curdling by rennin, giving a result, therefore, similar to the reaction between toxins and antitoxins.

**The Digestive Changes Undergone by the Food in the Stomach.**—In addition to the pepsin and rennin various observers have described other enzymes in the gastric juice or gastric membrane, but the evidence at hand is uncertain regarding these latter. As was said above, it is probable that the ptyalin swallowed with the food continues to exert its action upon the starchy material in the fundus for a long time, so that in this way the starch digestion in the stomach may be important. Regarding the fats, it is usually believed that they undergo no truly digestive change in the stomach. They are set free from their intimate mixture with other food stuffs by the dissolving action of the gastric juice upon proteins, they are liquefied by the heat of the body, and they are disseminated through the chyme in a coarse emulsion by the movements of the stomach. In this way they are mechanically prepared so that the subsequent action of the pancreatic juice is much favored. When, however, fats are ingested in emulsified form, as in milk, for instance, the lipase of the stomach, according to Volhard, may cause a hydrolysis of some of the fat, with the formation of glycerine and the corresponding fatty acids. It is possible, however, that in such cases the lipase is furnished by regurgitation of the duodenal contents into the stomach and is not formed by the gastric glands. Regarding the proteins, the practical point of interest is as to how far they are digested during their stay in the stomach. It seems probable that this question does not admit of a categorical answer—that is, the extent of the digestion varies under different circumstances; with the consistency of the food, the duration of its stay in the stomach, etc. In some experiments reported by Tobler it is stated that 48 per cent. of a given amount of protein passed through the pylorus as peptones or proteoses, about 20 per cent. entered the intestine undigested, and 20 to 30 per cent. was absorbed from the stomach. In the liquid material (chyme) forced through the pylorus into the duodenum one may find unchanged proteins, primary or secondary proteoses, peptones, or, possibly, cleavage products beyond this stage. It is stated, however, that most of the material is in the form of proteoses (London). The true value of peptic digestion is not so much in its own action as in its combined action with the trypsin, or the trypsin and erepsin found in the intestine.

The preliminary digestion in the stomach is important as regards the protein foods from several standpoints: First, in the matter of mechanical preparation of the food and its discharge in convenient quantities easily handled by the duodenum. Second, in the more or less complete hydrolysis to peptones and proteoses, whereby the subsequent action of the proteolytic enzymes of the intestine must be greatly accelerated. Indeed, in some cases, this preliminary action of the pepsin-hydrochloric acid may be absolutely necessary. Native proteins, such as serum-albumin, are not acted upon by trypsin, but if submitted to pepsin-hydrochloric acid they are quickly digested by this enzyme. These and other facts seem to indicate that the peptic digestion is not so much an end in itself as a preparation for subsequent intestinal digestion. The stomach, therefore, may be removed without a fatal result. Several cases are on record in which the stomach was practically removed by surgical operation, the esophagus being stitched to the duodenum.\* The animals did well and seemed perfectly normal, although special precautions were necessary in the matter of feeding.

**Absorption in the Stomach.**—In the stomach it is possible that there may be absorption of the following substances: Water, salts; sugars and dextrans that may have been formed in salivary digestion from starch, or that may have been eaten as such; the proteoses and peptones formed in the peptic digestion of proteins or albuminoids. In addition, absorption of soluble or liquid substances—drugs, alcohol, etc., that have been swallowed—may occur. It was formerly assumed, without definite proof, that the stomach absorbs easily such things as water, salts, sugars, and peptones. Actual experiments, however, made, under conditions as nearly normal as possible, show, upon the whole, that absorption does not take place readily in the stomach—certainly nothing like so easily as in the intestine. The methods made use of in these experiments have varied, but the most interesting results have been obtained by establishing a fistula of the duodenum just beyond the pylorus.† After establishing this fistula food may be given to the animal and the contents of the stomach as they pass out through the pyloric opening may be caught and examined.

*Water.*—Experiments of the character just described show that water when taken alone is practically not absorbed at all in the stomach. Von Mering's experiments especially show that as soon as water is introduced into the stomach it begins to pass into the

\* Ludwig and Ogata, "Archiv f. Physiologie," 1883, p. 89; Carvallo and Pachon, "Archives de physiologie norm. et path.," 1894, p. 106.

† Compare von Mering, "Verhandl. des Congresses f. innere Med.," 12, 471, 1893; Edkins, "Journal of Physiology," 13, 445, 1892; Brandl, "Zeitschrift f. Biologie," 29, 277, 1892; London, "Zeitschrift f. physiol. Chemie," 62, 446, 1909.

intestine, being forced out in a series of spurts by the contractions of the stomach. Within a comparatively short time practically all the water can be recovered in this way, none or very little having been absorbed in the stomach. For example, in a large dog with a fistula in the duodenum, 500 c.c. of water were given through the mouth. Within twenty-five minutes 495 c.c. had been forced out of the stomach through the duodenal fistula. This result is not true for all liquids; alcohol, for example, is absorbed readily.

*Salts.*—The absorption of salts from the stomach has not been investigated thoroughly. According to Brandl, sodium iodid is absorbed very slowly or not at all in dilute solutions. Not until its solutions reach a concentration of 3 per cent. or more does its absorption become important. This result, if applicable to all the soluble inorganic salts, would indicate that under ordinary conditions they are practically not absorbed in the stomach, since it can not be supposed that they are normally swallowed in solutions so concentrated as 3 per cent. In the same direction Meltzer reports that solutions of strychnin are absorbed with difficulty from the stomach as compared with the intestines, rectum, or even the pharynx. It is said that the absorption of sodium iodid is very much facilitated by the use of condiments, such as mustard and pepper, or alcohol, which act either by causing a greater congestion of the mucous membrane or perhaps by directly stimulating the epithelial cells.

*Sugars and Peptones.*—In regard to the sugars the experiments of von Mering and Brandl indicate that while absorption takes place it is not rapid nor marked unless the solutions are quite concentrated (5 per cent.), and we may infer, therefore, that in an ordinary meal the sugar formed from the starchy foods by the action of the ptyalin is passed on to the intestine for further digestion and absorption. Whether or not any of the digested proteins are absorbed from the stomach has been and still is a matter of controversy. Some of the older experimenters stated that as much as 20 to 30 per cent. of the protein of a meal might be absorbed in the stomach, but the results of the more recent work, on the contrary, indicate that little or no absorption takes place under normal conditions.\* When a definite amount of protein was introduced into the stomach of an experimental animal it could all be recovered, as estimated by nitrogen determinations, from a duodenal fistula.

*Fats.*—As we have seen, fats probably undergo no digestive changes in the stomach. The processes of saponification and emulsification are supposed to be preliminary steps to absorption, and these processes take place usually after the fats have reached the small intestine.

\* London, *loc. cit.*

## CHAPTER XLIII.

### DIGESTION AND ABSORPTION IN THE INTESTINES.

The food undergoes its most profound digestive changes in the intestines, and here also the products of digestion are mainly absorbed. The intestinal digestion begins in the duodenum, and is largely completed by the time that the food arrives at the ileocecal valve. It is effected through the combined action of three secretions,—the pancreatic juice, the secretion from the intestinal glands (*succus entericus*), and the bile. These secretions are mixed with the food from the duodenum on, so that their action proceeds simultaneously. For purposes of description it is necessary to speak of each more or less separately.

**The Pancreas.**—The pancreas forms a long, narrow gland reaching from the spleen to the curvature of the duodenum. Its main duct in man (duct of *Wirsung*) opens into the duodenum, together with the common bile-duct, about 8 to 10 cms. beyond the pylorus. The points at which the duct or ducts of the pancreas enter the intestine vary somewhat in different mammals. In the dog there are two chief ducts, one opening, together with the bile-duct, about 3 to 5 cm. below the pylorus, while a second enters the duodenum some 3 to 5 cms. farther down. In rabbits the principal pancreatic duct opens separately into the duodenum about 35 cms. below the opening of the bile-duct. The pancreas is a compound tubular gland like the salivary glands. The cells lining the secreting portion of the tubules, the alveoli, belong to the serous or albuminous type. They are characterized by the fact that the outer portion of each cell is composed of a clear, non-granular material which stains readily, while the inner portion, the portion facing the lumen, contains numerous granules. Histological study of the gland after active secretion, as compared with the resting state, has shown very conclusively that these granules represent a preparatory material for secretion. As the secretion proceeds the granules are dissolved and discharged into the lumen, while during the periods of rest new granules are formed by metabolic processes at the expense, apparently, of the non-granular material in the basal portion of the cell. (Heidenhain, Kühne, Lea). The histological picture of secretion is in general the same in this as in the salivary and gastric glands, only somewhat more distinctly shown. On the supposition that the granules constitute an antecedent material from which the enzymes

of the secretion are formed they are frequently designated as zymogen granules. The pancreas contains also certain peculiar groups of cells, the islands (or bodies) of Langerhans. These cells probably have nothing to do with the digestive activity of the pancreas. Their supposed function is referred to in the sections on Internal Secretions and Nutrition.

**Composition of the Secretion.**—The pancreatic secretion is an alkaline liquid which in some animals is thin and limpid, in others thick and glairy. The secretion in man belongs to the former type; it is described as water-clear and as having a specific gravity of 1.0075. The secretion may be collected by opening the abdomen and inserting a cannula directly into the duct, or a permanent fistula may be made by the method of Pawlow. This method, applicable to the dog, consists in cutting out a small portion of the duodenum where the pancreatic duct opens and then suturing this piece, the mucous membrane outward, into the abdominal wall. The secretion in this case pours out upon the exterior and may be collected. The animal, however, suffers nutritive disturbances from the loss of the secretion, and requires careful dieting and attention. The secretion of the human pancreas has been collected in several cases in which it was necessary to drain off the pancreatic juice to the exterior. From the observations made in one case\* it appears that the secretion in man is quite abundant, amounting to 500 to 800 c.c. per day. In the cow (Delezenne) from 1½ to 2 liters may be collected in the course of a day. The secretion possesses a strong alkaline reaction, due to the presence of sodium carbonate; it also contains a small amount of coagulable protein and a number of organic substances in traces. The important constituents, however, are three enzymes or their zymogens,—namely, trypsin, a proteolytic enzyme; pancreatic diastase (amylase), an amylolytic enzyme; and lipase (steapsin), a lipolytic enzyme. Some authors state, also, that the secretion contains a rennin enzyme. Glaessner reports that he got no evidence of this last enzyme in human pancreatic juice.

**Secretory Nerve Fibers to the Pancreas.**—The pancreas receives its nerve supply immediately from the celiac plexus, but stimulation of the nerves going to this plexus—namely, the splanchnics and the vagi—have given negative results in the hands of most observers so far as the pancreatic secretion is concerned. Pawlow† and his coworkers claim to have been more successful. Mechanical stimulation or electrical stimulation of the vagus or splanchnic gave

\* See Glaessner, "Zeitschrift f. physiol. Chemie," 40, 465, 1903. Also Wohlgenuth, "Biochem. Zeitschrift," 39, 302, 1912.

† For recent work upon the pancreas and the literature see Pawlow, "The Work of the Digestive Glands," translation by Thompson, 1902; Bayliss and Starling, "Journal of Physiology," 30, 61, 1904; Walter, "Archives des sciences biologiques," 7, 1, 1899.

them a marked flow of pancreatic juice, but when the latter form of stimulus was used upon the splanchnic, it was necessary to cut the nerve some days previously in order that the vasoconstrictor fibers might degenerate. The secretion provoked by stimulation of the vagus is more easily obtained when the stimulus is applied to the nerve in the thorax below the origin of the branches to the heart. The secretion obtained upon stimulation of the nerves is characterized, as in the case of the gastric glands, by a long latent period of some minutes,—a fact that is explained, although not satisfactorily, on the assumption that the nerve trunks stimu-

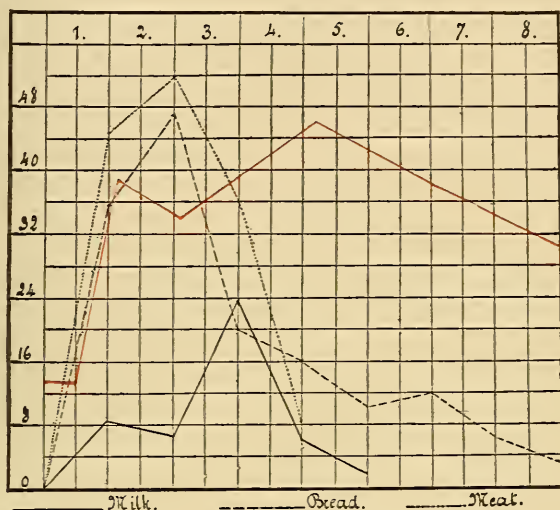

Fig. 296.—Four curves of the secretion of the pancreatic juice, the three in black, from Walter, showing the secretion in dogs on different diets; (1) on 600 c.c. of milk; (2) on 250 gms. bread; (3) on 100 gms. of meat. The curve in red, from Glaessner, shows the secretion in man on a mixed diet, soup, meat, and bread. The figures, 1, 2, 3 etc., along the abscissa indicate hours after the beginning of the meal. The figures along the ordinates indicate the quantity of the secretion in cubic centimeters.

lated contain both secretory and inhibitory fibers and that the antagonistic action of the latter delays the appearance of the secretion. These observations have been taken as proof of the existence of secretory nerve fibers to the pancreas, the fibers running chiefly in the vagus nerve.

**The Curve of Secretion.**—The rate of flow of the pancreatic juice with reference to the period of digestion has been determined by a number of observers. In the careful experiments reported by Walter it is shown that the quantity of secretion is dependent to a considerable extent upon the character of the food. Thus, the flow is more abundant and reaches its maximum sooner after a

meal of bread alone than after a meal of meat alone. It seems possible that the latter point, the time at which the maximum flow is reached, may depend upon the difference in rate at which these foods are ejected from the stomach. Cannon (p. 723) has shown that the carbohydrate foods leave the stomach sooner than the proteins or fats. It is stated, however, that the composition of the secretion varies also with the character of the food, and indeed shows an adaptation to the character of the food. The secretion caused by protein food is especially rich in trypsin, that caused by fatty food in lipase, etc. The mechanism by which this adaptation is secured is not understood. Glaessner\* has measured the rate of flow in man, and his curve for a mixed diet is represented also (in red) in Fig. 296. These curves indicate in general that the secretion of pancreatic juice begins very soon after food enters the stomach, and increases rapidly to a maximum, which is reached somewhere between the second and fourth hour. According to Glaessner's case, there is a continuous small secretion of the juice during fasting. The observations on dogs, on the contrary, indicate an entire cessation of the flow when the stomach is empty.

Boldireff† has reported a very curious activity of the digestive organs during fasting. It seems that (in dogs) when the stomach or even the small intestine is empty the entire gastro-intestinal canal exhibits periodical out-breaks of activity, which occur at intervals of two hours and last for twenty to thirty minutes. During this stage the stomach and intestines exhibit movements, and there is an abundant secretion of pancreatic juice, bile, and intestinal juice, which is subsequently absorbed. Acids introduced into the stomach or intestines prevent the occurrence of these periods, and they are absent, therefore, as long as the stomach contains gastric juice. The author's suggestion that the secretions thus formed furnish active enzymes which are absorbed into the blood and utilized by the tissues in destroying the newly absorbed food does not commend itself as probable.

#### Normal Mechanism of the Pancreatic Secretion—Secretin.

—Much light was thrown upon the mechanism of pancreatic secretion by the discovery (Dolinsky, 1895) that acids brought into contact with the mucous membrane of the duodenum set up promptly a secretion of pancreatic juice. Since this discovery it has been believed that the acid gastric juice is the means that serves to inaugurate the flow from the pancreas. As soon as any of the acid contents of the stomach pass through the pylorus this action begins. Just as the chewing and swallowing of the food initiate the gastric secretion, so the acid of the latter starts the pancreatic secretion. Assuming that the pancreatic gland possesses secretory fibers it was thought at first that the acid acts reflexly through these fibers—that is, the acid in the duodenum acting upon sensory endings causes a reflex stimulation of the efferent secretory fibers. It has been shown, however, that the same effect takes place after section of the vagus and

\* Glaessner, *loc.cit.*

† Boldireff, "Archives des sciences biologiques," 11, 1, 1905.



splanchnic nerves (Popielski), and Bayliss and Starling\* have called attention to another more probable explanation. These authors find that if the mucous membrane of the duodenum (or jejunum) is scraped off and treated with acid (0.4 per cent. HCl) the extract thus made when injected into the blood sets up an active secretion of pancreatic juice. They have shown that this effect is due to a special substance, *secretin*, which is formed by the action of the acid upon some substance (prosecretin) present in the mucous membrane. Secretin is not an enzyme, since its activity is not destroyed by boiling nor by the action of alcohol. The experimental evidence at present favors the view that the normal sequence of events is as follows: The acid of the gastric juice upon reaching the duodenum produces secretin; this in turn is absorbed by the blood, carried to the pancreas, and stimulates this organ to activity. The pancreatic secretion furnishes, therefore, a second example of the group of substances designated by Starling as hormones (p. 776). According to the evidence at present in our possession we must believe that the pancreatic secretion, like the gastric secretion, consists of two parts: 1, A *nervous secretion* caused by the secretory fibers in the vagus and splanchnic; 2, a *chemical secretion* due to the action of the secretin. These two secretions are said to present quite different characters.† The former is thick, opalescent, rich in ferments and proteins, but poor in alkalis. The trypsin contained in it may be secreted in active form, and the secretion is suspended by the action of atropin. Administration of pilocarpin, on the contrary, excites this secretion. The chemical secretion, on the contrary, is thin and watery, contains relatively little ferment or proteins, and is rich in alkali. The trypsin in it is secreted in inactive form (see next paragraph), and the secretion is not affected by the administration of atropin. The normal relation of these two forms of secretion in an ordinary meal is not so apparent as in the case of the gastric secretion, but will doubtless be made clear by subsequent work.

**Activation of the Trypsin—Enterokinase.**—It was discovered in Pawlow's laboratory (Chepowalnikow) that the pancreatic juice obtained from a fistula may have little or no digestive action on proteins, but if brought into contact with the duodenal membrane or an extract of this membrane it shows at once powerful proteolytic properties. This discovery has been confirmed repeatedly. Evidently the proteolytic enzyme of the juice is secreted in a zymogen or pro-enzyme form (trypsinogen), which is activated or converted to trypsin by something contained in the mucous mem-

\* Bayliss and Starling, "Journal of Physiology," 28, 235, 1902.

† Sawitsch, "Zentralblatt f. d. ges. Physiol. u. Pathol. d. Stoffwechsels," 10, 1, 1909.

brane of the small intestine (duodenum, jejunum). This something Pawlow supposed is an enzyme, and since its action is on another enzyme, "a ferment of ferments," he designated it as a kinase or enterokinase. The action of the enterokinase is very prompt and decided and was supposed to be specific, but later observers (Delezenne-Zunz) state that an inactive pancreatic secretion may be activated by a number of salts, especially those of calcium and magnesium. The physiological value of this very interesting relation is not clear, but it seems possible that it may serve to protect the living tissues from the powerful digestive action of the trypsin. The other enzymes of the pancreatic juice, the diastase and the lipase, are secreted in part, at least, in active form.

**The Digestive Action of Pancreatic Juice.**—The digestive action of the secretion depends upon the three enzymes, trypsin, diastase (amylase), and lipase. The specific effects of each may be considered separately.

*Action of Trypsin.*—The activated trypsinogen causes hydrolytic cleavage of the protein molecule in a manner analogous to that described for pepsin. Its action differs from that of pepsin, however, in several respects. It attacks the protein in neutral as well as in slightly acid or markedly alkaline solutions. Its effect upon the protein is more rapid and powerful than that of pepsin and the protein molecule is broken up more completely. As was said in describing the action of pepsin, it and the trypsin really act in series—the change begun by the pepsin is completed by the trypsin. The preliminary action of the pepsin not only hastens that of the trypsin, but to some extent alters it; a protein submitted first to pepsin and then to trypsin is more completely broken up than if the trypsin acted alone. The steps in the hydrolysis of the protein molecule by trypsin have been the subject of a very great amount of study, and views as to the details have changed somewhat from time to time. It would seem that the trypsin, like the pepsin, hydrolyzes the simple proteins first to a proteose, and then to a peptone stage, but the latter product may be split still further into a variety of simpler bodies, the number and character of which depend on the amount of trypsin and the time that it acts. After a prolonged pancreatic digestion no peptone or peptone-like body can be found; in fact, no substance which gives a biuret reaction. Under such conditions the protein molecule is broken up very completely into a great number of smaller molecules, many of which have been identified, while some have as yet escaped detection so far as their chemical structure is concerned. The actual products formed depend on the length of time the trypsin is allowed

to act and the conditions, favorable or unfavorable, under which it acts. The end-products usually obtained most easily are tyrosin, leucin, aspartic acid, glutaminic acid, tryptophan, lysin, arginin, histidin. The first two of these substances have been known for a long time and may be obtained easily in crystalline form from pancreatic digestions. If the trypsin is allowed to exert its complete action upon the protein, the end-products are closely similar to those obtained by boiling protein with acids. The hydrolysis caused by the acids and by the trypsin seems to be nearly identical, although that caused by the acids is probably more complete and perhaps is attended by secondary reactions. The numerous products obtained by this complete hydrolysis consist chiefly of amino-acids—that is, organic acids containing one or more amino-groups ( $\text{NH}_2$ ) in direct union with carbon. Most of them are monamino-acids, that is, contain one  $\text{NH}_2$  group, and this group is united with the carbon occupying the *alpha* position. The nitrogen of the protein molecule appears in the split products chiefly as amino-acids, but in small part as ammonia.

A list of the known amino-acids obtained from proteolytic cleavage of the protein molecule is appended. For a more complete description of their properties and chemical relationships reference must be made to text-books on physiological chemistry. With regard to the nomenclature used, it will be borne in mind that the various carbon atoms in the straight chain of the fatty acids are designated by Greek letters that indicate their position in relation to the carboxyl ( $\text{COOH}$ ) group, as may be illustrated by the formula for caproic acid:

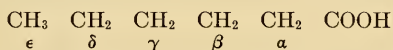

I. AMINO-ACIDS OF THE FATTY ACID (ALIPHATIC) SERIES.

1. Glycocol or glycin (amino-acetic acid):  
 $\text{CH}_2\text{NH}_2\text{COOH}$ .
2. Alanin ( $\alpha$ -aminopropionic acid):  
 $\text{CH}_3\text{CHNH}_2\text{COOH}$ .
3. Serin ( $\alpha$ -amino- $\beta$ -oxypropionic acid):  
 $\text{CH}_2\text{OHCHNH}_2\text{COOH}$ .
4. Cystein ( $\alpha$ -amino- $\beta$ -thiopropionic acid):  
 $\text{CH}_2\text{SHCHNH}_2\text{COOH}$ .
5. Valin ( $\alpha$ -amino-isopropionic acid):



6. Leucin (
- $\alpha$
- amino-isobutylpropionic acid):

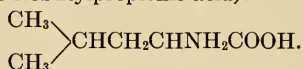

Two other isomeric forms of this compound have been obtained from the split products, namely:

- Isoleucin (methyl-ethyl
- $\alpha$
- aminopropionic acid):



- Normal leucin—norleucin (
- $\alpha$
- aminocaproic acid):



7. Aspartic acid (aminosuccinic acid):

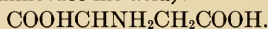

8. Glutamic acid:



9. Lysin (
- $\alpha$
- 
- $\epsilon$
- diaminocaproic acid):



10. Arginin (guanidin
- $\alpha$
- aminovalerianic acid):



## II. AMINO-ACIDS CONTAINING A BENZENE (HOMOCYCLIC) OR A HETERO-CYCLIC NUCLEUS.

These compounds may be regarded as  $\alpha$ -aminopropionic acids in which a hydrogen attached to the  $\beta$ -carbon atom is substituted by a benzene, an indol, or an imidazol group.

1. Phenylalanin (
- $\alpha$
- amino-
- $\beta$
- phenylpropionic acid):

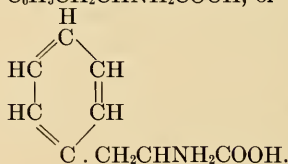

2. Tyrosin (
- $\alpha$
- amino-
- $\beta$
- para-oxyphenylpropionic acid):

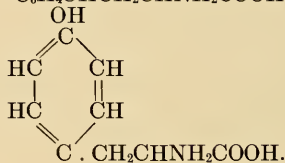

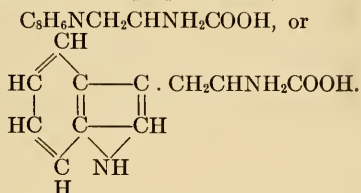
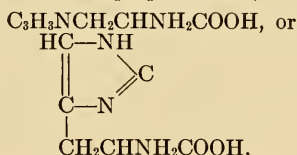
3. Tryptophan ( $\alpha$ -amino- $\beta$ -indolpropionic acid):4. Histidin ( $\alpha$ -amino- $\beta$ -imidazolpropionic acid):

## III. THE PYRROL SERIES.

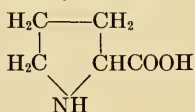
1. Prolin ( $\alpha$ -pyrrolidin carboxylic acid):

## 2. Oxyprolin (oxyprolyl carboxylic acid):

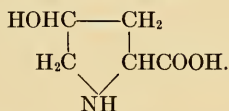

**The Significance of Tryptic Digestion.**—It was formerly supposed that the object of peptic and tryptic digestion is to convert the insoluble and non-dialyzable proteins into the simpler, more soluble, and more diffusible peptones and proteoses. In this way absorption of protein material was explained. This view, however, is not sufficient. On the one hand, it has not been possible to prove conclusively that peptones or proteoses are found in the blood; on the other hand, a better knowledge of the processes of tryptic or of tryptic-ereptic digestion has shown that the hydrolysis does not stop at the peptone stage; the protein molecule is hydrolyzed still further with the production of simpler molecules. At present different views exist as to the extent of this latter process. Some believe that the protein molecule is entirely broken down into its so-called building-stones, that is, the various amino-acids, described on the preceding page. This view is supported by the discovery of the existence of the enzyme erepsin (see below) in the

intestinal mucosa. The action of this latter enzyme is exerted especially upon the albumoses and peptones, breaking them down into the amino-acids, so that apparently whatever peptone or albumose may escape the final action of the trypsin before absorption is likely to be acted upon by the erepsin before reaching the blood.\* Another possible view is that suggested by Abderhalden. † According to this author, the hydrolysis of the protein by pepsin, trypsin, and erepsin is not necessarily complete. Some amino-bodies, such as tyrosin, leucin, arginin, etc., are split off from the protein molecule, but there may remain behind what one may call a nucleus of the original molecule, which serves as the starting-point for a synthesis. This nucleus is a substance or a number of substances intermediate between the peptone and the simpler end-products, and is spoken of as a peptid or polypeptid (see Appendix). It has been shown that in tryptic digestion such substances are formed—that is, substances which are not peptones, since they no longer give the biuret reaction, but which have a certain complexity of structure, since upon hydrolysis with acids they split into a number of amino-acids. But bearing in mind the fact that the action of the trypsin is normally combined with or is supplemented by that of the erepsin, it seems probable that in digestion in the body the protein molecule is broken down completely to its building-stones. The value of this complete splitting of the protein of the food lies in the possibility that thereby the body is able to construct its own peculiar type of protein. Many different kinds of proteins are taken as food, and many of them if introduced directly into the blood act as foreign material incapable of nourishing the tissues. If these proteins are broken down more or less completely during digestion, the tissue cells may reconstruct from the pieces or building-stones a form of protein adaptable to their needs, and more or less characteristic for that particular organism. Just as the letters of the alphabet may be combined in different ways to make different words, so the various amino-acids may be combined to make proteins of many different kinds.

**Action of the Diastatic Enzyme (Amylase) of the Pancreatic Secretion.**—This enzyme is found in the secretion of the pancreas or it may be extracted from the gland. Its action upon starchy foods is similar to or identical with that of ptyalin. It causes an hydrolysis of the starch with the production finally of maltose and achroödextrin. Before absorption these substances are further acted upon by the maltase of the intestinal secretion and

\* Vernon ("Journal of Physiology," 30, 330, 1904) believes that the pancreatic secretion contains two proteolytic enzymes—trypsin proper, which converts the proteins to peptones, and pancreatic erepsin, which breaks up the peptones into the simpler end-products, the amino-bodies.

† Abderhalden, *loc. cit.*



by the histological fact that during the digestion of fats the epithelial cells may be shown to contain fine oil drops in their interior. The tendency of recent work, however, has been to indicate that the fats are completely split into fatty acids and glycerin before absorption, and that the emulsification may be regarded, from a physiological standpoint, as a mechanical preparation for the action of the lipase rather than as a direct preparation for the act of absorption. The two products of the action of the lipase, the glycerin and the fatty acid, are absorbed by the epithelium and again combined to form neutral fat. It is very probable, moreover, that during this synthesis the fatty acids are combined with the glycerine in such proportions as to make for the most part the fat characteristic of the animal, fat of a high melting-point in the case of the sheep, for example, and of a lower melting-point for the dog. In connection with this fact of a synthesis of the split products to form neutral fat, the discovery by Kastle and Loevenhart (see p. 744) that the action of lipase is reversible assumes much significance. It seems quite possible that the same enzyme may cause both the splitting of the fat and the synthesis of the split products, not only in the intestine during absorption, but in the various tissues during the metabolism or the storage of fat. Lipase is found in the blood and in many tissues,—muscle, liver, mammary gland,\* etc.—and during its nutritive history in the body the fat may be split and synthesized a number of times. In this connection it is interesting to note that the process of splitting does not involve much work. Very little heat is liberated in the process, and a correspondingly small amount of energy is needed for the synthesis.†

The lipase as formed in the pancreas is easily destroyed, especially by acids. For this reason probably it is not found usually in simple extracts of the gland made by laboratory methods. It should be added, also, that the action of this enzyme is aided very materially by the presence of bile. This latter secretion contains no lipase itself, but mixtures of bile and pancreatic juice split the neutral fats much more rapidly than the pancreatic juice alone. This effect is now explained on the hypothesis that the bile-acids or the bile-acids and the lecithin either activate a portion of the lipase which is in the state of a proferment or play the part of a coferment (page 749).

**The Intestinal Secretion (Succus Entericus).**—The small intestine is lined with tubular glands, the crypts of Lieberkühn, which in parts of the intestine at least give rise to a liquid secretion, the so-called intestinal juice. To obtain this secretion recourse has been had to the operation known as the Thiry-Vella fistula. In this

\* See Loevenhart, "American Journal of Physiology," 6, 331, 1902.

† Consult Herzog, "Zeitschrift f. physiol. Chemie," 37, 383, 1903.



operation a small portion of the intestine is isolated by cutting through the intestinal wall at two points a certain distance apart. The continuity of the canal is re-established by appropriate suture, while the piece cut out, with its blood and nerve-supply intact, is given an opening to the exterior at one or both ends by suturing to the abdominal wall. In this way a small pouch or loop of the intestine is separated from the rest of the alimentary canal and is so arranged that its secretion can be obtained through the fistulous openings, or material of any kind can be introduced into the loop and be removed after a given time to determine what absorption has taken place. The secretion from these loops is usually said to be small in quantity, especially in the jejunum. Pregl estimates that as much as three liters may be formed in the whole of the small intestine in the course of a day, but this estimate does not rest upon very satisfactory data. The liquid gives an alkaline reaction, owing to the presence of sodium carbonate. Experiments have shown that this liquid has little or no digestive action except upon the starches, and it may perhaps be doubted whether it is a true digestive secretion. Extracts of the walls of the small intestine or the juice squeezed from these walls have been found, on the contrary, to contain four or five different enzymes and to exert a most important influence upon intestinal digestion. These enzymes belong probably to the group of endo-enzymes, and are not actually secreted into the lumen of the intestines. While they are not, strictly speaking, constituents of the intestinal juice, nevertheless it is their action on the food which forms the characteristic contribution to the process of digestion made by the glands of the intestinal wall. These enzymes and their actions are as follows:

1. Enterokinase (see p. 791), an enzyme which in some way activates the proteolytic enzyme of the pancreatic juice, by converting the trypsinogen to trypsin.

2. Erepsin. This enzyme, discovered by Cohnheim,\* acts especially upon the proteoses and peptones, causing further hydrolysis. Its splitting action upon the peptones is supposed to be complete, and the natural suggestion regarding this enzyme is that it supplements the work begun by the trypsin and pepsin. Erepsin occurs not only in the intestinal mucosa, but also, it is claimed, in the liver, kidney, and pancreas, and perhaps in other tissues. Its characteristic is that it is adapted especially to hydrolyze the proteoses and peptones. On the theory that proteins during digestion are broken down completely to their constituent amino-acids, the importance of this enzyme in the normal digestion of proteins has

\* Cohnheim, "Zeitschrift f. physiol. Chemie," 33, 451, 1901; also 35, 134, *et seq.*; Kobzarensko, "Biochemische Zeitschrift," 66, 344, 1914.

gained increased recognition in recent years. The digestion of the protein begun by the pepsin or by the trypsin is carried to completion by the action of the erepsin.

3. Inverting enzymes capable of converting the disaccharids into the monosaccharids. These enzymes are three in number: maltase, which acts upon maltose (and dextrin); invertase or invertin, which acts upon cane-sugar; and lactase, which acts upon lactose. The maltase acts upon the products formed in the digestion of starches, the maltose and dextrin, converting them to dextrose according to the general formula:

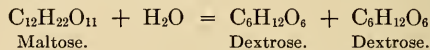

In the same way invertase converts cane-sugar to dextrose and levulose, and lactase changes milk-sugar to dextrose and galactose. This inverting action is necessary to prepare the carbohydrate food for nutritive purposes. Double sugars cannot be used by the tissues and would escape in the urine, but in the form of dextrose or dextrose and levulose they are readily used by the tissues in their normal metabolic processes.

4. Nuclease. An enzyme to which this name may be given is said to occur in the small intestine: It acts upon the nucleic-acid component of nucleoproteins splitting it with the formation of the corresponding purin and pyrimidin nucleotides (see p. 851).

5. Secretin. As explained above, this hormone plays an important rôle in the control of the secretion of the pancreas. It is not an enzyme, but a more stable and definite chemical substance which is secreted or formed in the intestinal mucosa in a preliminary form, prosecretin, and under the influence of acids is changed to secretin. In this latter form it is absorbed, carried to the pancreas, and causes a flow of pancreatic secretion.

It seems probable that the entire physiology of the intestinal secretion is not yet known. Recent work\* shows that when a closed loop of the duodenum is produced by ligatures and is left in the abdomen, the continuity of the alimentary canal being established by a gastro-enterostomy, the animal (dog) dies within a short period with signs of acute intoxication. When the contents of the loop are injected into another animal they cause a similar fatal result. The evidence at hand indicates that the toxic material is formed by the mucosa of the duodenum. Similar loops made at lower points in the intestine do not produce this toxic material. These results throw some light on the fatal effect of high intestinal obstruction in man, and from a physiological standpoint they suggest the existence of a peculiarity in the duodenal mucosa which may prove to be of importance in its normal activity.

**Absorption in the Small Intestine.**—Absorption takes place very readily in the small intestine. The general correctness of this statement may be shown by the use of isolated loops of the intestine.

\* See Whipple, Stone, and Bernheim, "Journal of Exp. Medicine," 17, 286 and 307, 1913.

Salt solutions of varying strengths or even blood-serum nearly identical in composition with the animals' own blood may be absorbed completely from these loops. Examination of the contents of the intestine in the duodenum and at the ileocecal valve shows that the products formed in digestion have largely disappeared in traversing this distance. All the information that we possess indicates, in fact, that the mucous membrane of the small intestine absorbs readily, and it is one of the problems of this part of physiology to explain the means by which this absorption is effected. Anatomically two paths are open to the products absorbed. They may enter the blood directly by passing into the capillaries of the villi, or they may enter the lacteals of the villi, pass into the lymph circulation, and through the thoracic duct of the lymphatic system eventually reach the blood vascular system. The older physiologists assumed that absorption takes place exclusively through the central lacteals of the villi, and hence these vessels were described as the absorbents. We now know that the digested and resynthesized fats are absorbed by way of the lacteals, but that the other products of digestion are absorbed mainly through the blood-vessels, and therefore enter the portal system and pass through the liver before reaching the general circulation. According to observations made upon a patient with a fistula at the end of the small intestine,\* food begins to pass into the large intestine in from two to five and a quarter hours after eating, and it requires nine or more hours before the last of a meal has passed the ileocecal valve; this estimate includes, of course, the time in the stomach. During this passage absorption of the digested products takes place nearly completely. In the fistula case referred to above it was found that 85 per cent. of the protein had disappeared, and similar facts are known regarding the other food-stuffs. The problems that have excited the greatest interest have been, first, the exact form in which the digested products are absorbed, and, second, the means by which this absorption is effected. With regard to the last question, much work has been done to ascertain whether the known physical laws of diffusion, osmosis, and imbibition are sufficient to account for the movements of the absorbed substances or whether it is necessary to refer them in part to some unknown activities of the living epithelial cells. It would seem that diffusion and osmosis occur in the intestines. Concentrated solutions of neutral salts,—sodium chlorid, for instance,—if introduced into a Thiry-Vella loop, cause a flow of water into the lumen in accordance with their high osmotic pressure, and, on the other hand, some of the sodium chlorid diffuses into the blood in accordance with the laws of diffusion. It seems equally clear,

\* Macfadyen, Nencki, and Sieber, "Archiv f. experiment. Pathol. u. Pharmakol.," 28, 311, 1891.

however, that absorption as it actually takes place is not governed simply by the differences in concentration between the contents of the intestine and the blood or lymph, but depends largely upon the properties of the separating wall of living epithelial cells. Thus, the animal's own serum,\* possessing presumably the same concentration and osmotic pressure as the animal's blood, is absorbed completely from an isolated intestinal loop. So also it has been shown that in the absorption of salts from the intestine† the rapidity of absorption stands in no direct relation to the diffusion velocity. The energy that effects the absorption is furnished, therefore, by the wall of the intestine, presumably by the epithelial cells. That this particular form of energy is connected with the living structure is shown by the fact that when the walls are injured by the action of sodium fluorid, potassium arsenate, etc., their absorptive power is diminished and absorption then follows the laws of diffusion and osmosis.‡

**Absorption of the Carbohydrates.**—Our carbohydrate food is absorbed, for the most part, as simple sugars,—monosaccharids. As has been said, there is reason to believe that but little sugar is absorbed in the stomach. Cane-sugar and milk-sugar are inverted in the small intestine by invertase and lactase, the first being converted to dextrose and levulose, the second to dextrose and galactose. If, however, these substances are fed in excess they are absorbed in part without conversion to simple sugar, and in that case may be eliminated in the urine. The bulk of our carbohydrate food is taken, however, in the form of starch, and the conditions for absorption in this case are more favorable. The time required for the digestion of the starch to maltose and dextrin, and the subsequent inversion of these substances to dextrose, insures a slower and more complete absorption. Five hundred grams or more of starch may be digested and absorbed in the course of the day and it all reaches the blood in the form of dextrose. This dextrose enters the portal vein and is distributed first to the liver. In this organ the excess of sugar is withdrawn from the blood and stored as glycogen, so that the amount of sugar in the general circulation is thereby kept quite constant,—about 0.15 per cent. When a large amount of carbohydrate food is eaten, however, it is possible that the liver may not be able to remove the excess completely. In that case the amount of sugar in the general circulation may be increased above normal, giving a condition of *hyperglycemia*, and the excess may be excreted in the urine, thus bringing about the condition known as "*alimentary glycosuria*." The amount of any carbohydrate that can be eaten

\* Heidenhain, "Archiv f. die gesammte Physiologie," 56, 579, 1894.

† Wallace and Cushny, "Archiv f. die gesammte Physiologie," 77, 202, 1899.

‡ Cohnheim, "Zeitschrift f. Biologie," 37, 443, 1899.

without producing alimentary glycosuria is designated by Hofmeister\* as the assimilation limit of that carbohydrate or, to use another terminology, it establishes the degree of *tolerance* of the animal for the particular carbohydrate employed. If taken beyond this limit there is a physiological excess, and some sugar is lost in the urine. The assimilation limit varies with a great many conditions; but, so far as the different forms of carbohydrates are concerned, it is lowest for the milk-sugar and highest for starch. That starch may be eaten in larger amounts than sugar without raising the percentage of sugar in the systemic blood above the normal level is in accord with what we know of the digestion of the two forms of carbohydrates. Dextrose requires no digestion, it is absorbed as such, while cane-sugar needs only to be inverted. Starch, on the contrary, requires the action of ptyalin or amylase and subsequent inversion by maltase. Its absorption will, therefore, be much slower than that of the sugars. In fact, it probably goes on for the period of four or five hours, during which an ordinary meal is making its progress from pylorus to ileocecal valve. During this period the entire quantity of blood in the body is passed through the mesenteric arteries over and over again, and it is probable that even in the portal vein the quantity of sugar at any one moment rises but little above the normal level, and this small excess is held back by the liver cells, so that the systemic circulation is protected from becoming hyperglycemic.

So far as the carbohydrates escape absorption as sugar they are liable to undergo acid fermentation from the bacteria always present in the intestine. As the result of this fermentation there may be produced acetic acid, lactic acid, butyric acid, succinic acid, carbon dioxid, alcohol, hydrogen, etc. This fermentation probably occurs to some extent in the small intestines under normal conditions. Macfadyen,† in the case already referred to, found that the contents of the intestine at the ileocecal valve contained acid equivalent to that of a 0.1 per cent. solution of acetic acid. Under less normal conditions, such as excess of sugars in the diet or deficient absorption, the large production of acids may lead to irritation of the intestines,—diarrhea, etc.

**Absorption of Fats.**—Numerous theories have been held in regard to the mode of absorption of fats. It has been supposed that the emulsified (neutral) fat is ingested directly by the epithelial cells, that the fat droplets enter between the epithelial cells in the so-called cement substance, that the fat droplets are ingested by leucocytes

\* Hofmeister, "Archiv f. exper. Pathol. u. Pharmakol.," 25, 240, 1889, and 26, 355, 1890.

† Macfadyen, Nencki, and Sieber, *loc. cit.*

that lie between the epithelial cells, or lastly that the fat is first split into fatty acid and glycerin and is absorbed by the epithelial cells in these forms. The tendency of recent work is altogether in favor of this last view, and we may adopt it as expressing the theory generally accepted at present. During digestion the epithelial cells contain fat droplets without doubt, but it seems probable that these droplets are formed *in situ* by a synthesis of the absorbed glycerin and fatty acids. The border of the cell is said to be free from fat globules,—a fact which would indicate that the neutral fat is not mechanically ingested as oil drops. But, granting that the fat is absorbed in solution, as fatty acids and glycerin, the mechanism of absorption remains unexplained. It is known that the bile as well as the pancreatic juice plays an important part in the process. The pancreatic juice furnishes the lipase, the bile furnishes the bile salts (glycocholate and taurocholate of sodium) which aid the lipase in splitting the neutral fat, and moreover aid greatly the absorption of the split fats. This latter function is due probably to the fact that the bile (bile salts) dissolves the fatty acids readily\* and thus brings them into contact, in soluble form, with the epithelial cells. When the bile is drained off from the intestine by a fistula of the gall-bladder or duct, a large proportion of the fatty foods escapes absorption and appears in the feces. Direct observation shows that the fat after passing the epithelial lining and entering the stroma of the villus is taken up by the lymphatic vessels, the so-called lacteals. This fact is beautifully demonstrated by the mere appearance of the lymphatics of the mesentery after a meal containing fats. These vessels are injected with milky chyle during the period of absorption so that their entire course is revealed. The chyle on microscopical examination is found to contain fat in the form of an extremely fine emulsion. In this form it is carried to the thoracic duct and thence to the venous circulation. For hours after a meal the blood contains this chyle fat. If a specimen of blood is taken during this time and centrifugalized in the usual way, the chyle fat may be collected at the top in the form of a cream. It is an easy matter to insert a cannula into the thoracic duct at the point at which it opens into the subclavian and jugular veins and thus collect the entire amount of fat absorbed from the intestines by way of the lacteals. Experiments of this kind show that, after deducting the amount of fat that escapes absorption and is lost in the feces, the amount that may be recovered from the thoracic duct is less than that taken in the food. It seems probable, therefore, that some of the fat is absorbed directly by the blood-vessels of the villi. The portion thus absorbed enters the

\* See Moore and Rockwood, "Journal of Physiology," 21, 58, 1897; also Moore and Parker, "Proceedings, Royal Society," London, 58, 64, 1901.

portal vein and passes through the liver before reaching the general circulation. The liver holds back more or less of the fat taking this route, as it is found that during absorption the liver cells show an accumulation of fat droplets in their interior.\* The amount of fat that may be absorbed from the intestines varies with the nature of the fat. Experiments show that the more fluid fats, such as olive oil, are absorbed more completely, that is, less is lost in the feces than in the case of the more solid fats. Comparative experiments have given such results as the following: Olive oil—absorption, 97.7 per cent.; goose and pork fat, 97.5 per cent.; mutton fat, 90 to 92.5 per cent.; spermaceti, 15 per cent. The amount of fat that may be lost in the feces varies also with other conditions. If, for instance, an excess is taken with the food, or if the bile flow is diminished or suppressed, the percentage in the feces is increased. The usual amount of fat allowed as a maximum in dietaries is from 100 to 120 gm. daily.

**Absorption of Proteins.**—Most of the experimental work on record shows that the digested proteins are absorbed by the blood-vessels of the villi, although after excessive feeding of protein a portion may be taken up also in the lymphatics.† This accepted belief rests upon two facts: First (Schmidt-Mülheim), if the thoracic duct (and right lymphatic duct) is ligated, so as to shut off the lymphatic circulation, an animal will absorb and metabolize the usual amount of protein as is indicated by the urea excreted during the period. Second (Munk), if a fistula of the thoracic duct is established and the total lymph flow from the intestines is collected during the period of absorption after a diet of protein, it is found that there is no increase in the quantity of the lymph or in its protein contents. The form in which the digested protein enters the blood has long been a matter of controversy.‡ On the view that we have adopted, namely, that the protein of the food is split into its constituent amino-acids by the successive action of the pepsin, trypsin, and erepsin, we should expect to find these amino-acids in the blood, unless, indeed, they are again synthesized to protein while passing through the intestinal wall. It is only in recent years that methods have been devised for the recognition of amino-acids in such a liquid as blood.§ The application of these methods tends to support the view that the amino-acids enter the blood as such without undergoing synthesis. Alanin and valin have been obtained from the blood in crystalline form, and histidin has been recognized by its

\* See Frank, "Archiv f. Physiologie," 1892, 497, and 1894, 297.

† See Mendel, "American Journal of Physiology," 2, 137, 1899.

‡ See especially Van Slyke and Meyer, "Journal of Biological Chemistry," 16, 197, 1913; also pp. 213 and 231.

§ Folin and Denis, "Journal of Biological Chemistry," 11-87 and 161, 1912; and Van Slyke, *ibid.*, 12, 399, 1912.

reaction.\* Van Slyke and Meyer have shown that in the blood of dogs amino-acids are constantly present in small amounts (3 to 5 mgms. of amino-acid nitrogen to 100 c.c. of blood), and that after a meal of meat this concentration is definitely increased. In the light of recent work, especially that of the authors last named, we may suppose that the normal course of events is as follows: The digested proteins are absorbed as amino-acids and distributed to the tissues by the blood. The tissues select and store certain of these bodies, and probably in each organ subsequent use is made of them to build up new tissue or to repair the wastes of metabolism. That is to say, there is probably no especial form of circulating protein which serves as a pabulum for tissue-repair and growth, but the amino-acids themselves constitute the form in which nitrogen food is presented to the different tissues, just as dextrose constitutes the circulatory form of carbohydrate food. Each tissue from the amino-acids offered to it builds up its own form of protein, and the amino-acids not used for this synthesis may be deaminized and then employed for energy purposes. There is evidence that in the liver especially many of the amino-acids arising from the digested food undergo deamination, the nitrogen being eliminated as urea. During starvation the amino-acid content of the blood is maintained, probably because the tissues themselves or some of them undergo self-digestion or autolysis and thus furnish food material for the active tissues.

Examination of the contents of the small intestine at its junction with the large shows that under normal conditions most of the protein has been absorbed before reaching this point. The process is continued in the large intestine, modified somewhat by bacterial action, and the amount that finally escapes absorption and appears in the feces varies, in perfectly normal individuals, with the character of the protein eaten. According to Munk,† the easily digestible animal foods—such as milk, eggs, and meat—are absorbed to the extent of 97 to 99 per cent., while with vegetable foods the utilization is less complete. This difference is not due, however, to any peculiarity of the vegetable proteins; it is probably an incidental result of the presence of the indigestible cellulose found in our vegetable foods. It is stated that from 17 to 30 per cent. of the protein may be lost in the feces if the vegetable food is in such form as not to be attacked readily by the digestive secretions.

**Digestion and Absorption in the Large Intestine.**—Observations upon the secretions of the large intestine have been made upon

\* Abel, Rowntree and Turner, "Journal of Pharmacology and Exp. Therapeutics," 5, 611, 1914.

† See Munk, "Ergebnisse der Physiologie," vol. i., part 1., 1902, article, "Resorption," for literature and discussion.



human beings in cases of anus præternaturalis, in which the lower portion of the intestine was practically isolated, and also upon lower animals, in which an artificial anus was established at the end of the small intestine. These observations all indicate that the secretion of the large intestine, while it contains much mucus and shows an alkaline reaction, is not characterized by the presence of distinctive enzymes. When the contents of the small intestine pass the valve they still contain a certain amount of unabsorbed food material. As was stated in the chapter on the movements of the intestine, these contents remain a long time in the large intestine, and since they contain the digestive enzymes received in the duodenum the digestive and absorptive processes no doubt continue as in the small intestine. This general fact is well illustrated in experiments made upon dogs, most of whose small intestine (70 to 83 per cent.) had been removed.\* These animals could digest and absorb well, and formed normal feces, provided care was taken with the diet. An excess of fat or indigestible material caused diarrhea and serious loss of food material in the feces. An interesting feature in the large intestine is the marked absorption of water. In the small intestine water is absorbed no doubt in large quantities, but its loss is evidently made good by osmosis or secretion of water into the intestine, since the contents at the ileocecal valve are quite as fluid as at the pylorus. In the large intestine the absorption of water is not compensated by a secretion; the material loses water rapidly while in the ascending colon, and before it reaches the descending colon it has acquired the consistency of the feces. The alkaline reaction of the contents of the large intestine makes a favorable environment for the growth of bacteria, particularly the putrefactive bacteria that attack protein material. Putrefaction is a normal occurrence in the large intestine, and much interest has been shown in its extent and its possible physiological significance.

**Bacterial Action in the Small Intestine.**—In the intestines are found numerous bacteria which are able to hydrolyze the food material, particularly the carbohydrates and proteins. Fermentation of the carbohydrates gives rise to a number of organic acids, such as lactic and acetic acid, but none of the products of fermentation can be regarded as distinctly toxic. Putrefaction of the protein molecule, on the other hand, gives rise to a number of nitrogenous split products that are supposed to have a toxic action. Under normal conditions, on a mixed diet, it appears that in the small intestine carbohydrate fermentation is the characteristic action of the bacteria, while in the large intestine, protein putrefaction undoubtedly occurs. There has been considerable discus-

\* Erlanger and Hewlett, "American Journal of Physiology," 6, 1, 1902.

sion as to the conditions that restrain the protein putrefaction in the small intestine. It has been pointed out that some of the bacteria of the small intestine, *Bacillus coli*, for example, do not cause protein hydrolysis as long as carbohydrate material (sugar) is present,\* so that the mere presence of carbohydrate material serves to protect the protein from the action of the bacteria. In addition, as long as carbohydrates are present and are undergoing fermentation, the organic acids produced tend to neutralize the alkalinity of the intestinal secretion, and may even give an acid reaction to the intestinal contents. An acid reaction is unfavorable to the activity of the bacteria that attack the proteins, and in this way, under conditions of a normal diet, the process of putrefaction in the small intestine is warded off. From this standpoint it would seem to follow that the nature of the bacterial activity in the small intestine will vary with the character of the diet and, moreover, that the diet may be chosen intentionally so as to favor one or the other kind of bacterial action.

**Bacterial Action in the Large Intestine.**—In the large intestine protein putrefaction is a constant and normal occurrence. The reaction here is stated to be alkaline, and whatever protein may have escaped digestion and absorption is in turn acted upon by the bacteria and undergoes so-called putrefactive fermentation. The splitting up of the protein molecule by this process is very complete, and differs in some of its products from the results of hydrolytic cleavage as caused by acids or by trypsin. The list of end-products of putrefaction is a long one. Besides peptones, proteoses, ammonia, and the various amino-acids, there may be produced such substances as indol, skatol, phenol, phenylpropionic and phenylacetic acids, fatty acids, carbon dioxide, hydrogen, marsh gas, hydrogen sulphid, etc. Many of these products are given off in the feces, while others are absorbed in part and excreted subsequently in the urine. In this latter connection especial interest attaches to the phenol, indol, and skatol. Phenol or carbolic acid,  $C_6H_5OH$ , after absorption is combined with sulphuric acid, to form an ethereal sulphate (conjugated sulphate) or phenolsulphonic acid,  $C_6H_5OSO_2OH$ , and in this form is found in the urine. So also with cresol. The indol,  $C_8H_7N$ , and skatol (methyl-indol),  $C_9H_9N$ , are also absorbed, undergo oxidation to indoxyl and skatoxyl, and are then combined or conjugated with sulphuric acid, like the phenol, and in this form are found in the urine— $C_8H_6NOSO_2OH$ , or indoxyl-sulphuric acid, and  $C_9H_8NOSO_2OH$ , skatoxyl-sulphuric acid. These bodies have long been known to occur in the urine, and the proof that they arise primarily from putrefaction of protein material in the large intestine is so conclusive as

\* See Kendall, "Boston Med. and Surgical Journal," 1910, 163, 322, and "Wisconsin Med. Journal," June, 1913.

not to admit of any doubt. The amount to which they occur in the urine is, therefore, an indication of the extent of the putrefaction in the large intestine. We may assume that the indol and skatol arise from the tryptophan group in the protein molecule, and the phenol and cresol from the tyrosin and phenylalanin. There is evidence that other more or less toxic substances belonging to the group of *amines* are produced by the further action of the bacteria on the amino-acids in the protein molecule.

The general relation of the amines to the amino-acids may be expressed by the formula—

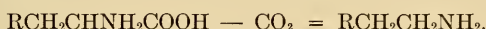

As a group they have a drug-like action on the body resembling that of epinephrin—that is, they may cause a rise of blood-pressure, acceleration of heart, etc. Some of the amines that have been described are putrescin or tetramethylenediamine from arginin, cadaverin or pentamethylenediamine from lysin, imidazolethylamine from histidin, indolethylamine from tryptophan, oxyphenylethylamine from tyrosin.

#### Is the Putrefactive Process of Physiological Importance?—

Recognizing that fermentation by means of bacteria is a normal occurrence in the gastro-intestinal canal, the question has arisen whether this process is in any way necessary to normal digestion and nutrition. It is well known that excessive bacterial action may lead to intestinal troubles, such as diarrhea, or to more serious interference with general nutrition owing to the formation of toxic products. It is, however, possible that some amount of bacterial action may be necessary for completely normal digestion. As a special case it has been pointed out that the gastro-intestinal tract is not provided with enzymes capable of acting upon cellulose, a material that forms such an important constituent of vegetable foods. Bacteria, on the other hand, may hydrolyze the cellulose and render it useful in nutrition. Leaving aside this special case, the question as to the necessity of bacterial action has been investigated directly by attempting to rear young animals under perfectly sterile conditions. Nuttall and Thierfelder\* report some very interesting experiments upon guinea-pigs in which the young animals from birth were kept sterile and fed with perfectly sterile food. They found that the animals lived and increased in weight, and concluded, therefore, that the intestinal bacteria are not necessary to normal nutrition. This conclusion is supported by the observations of Levin, † who finds that animals in the Arctic regions in many cases have no bacteria in their intestines. Schottelius ‡ reports contrary results upon chickens.

\* Nuttall and Thierfelder, "Zeitschrift f. physiol. Chemie," 21, 109, 1895; 22, 62, 1896; 23, 231, 1897.

† Levin, "Skandinavisches Archiv f. Physiologie," 16, 249, 1904.

‡ Schottelius, "Archiv f. Hygiene," 42, 48, 1902.

When kept sterile they lost steadily in weight and showed normal growth only when supplied with food containing bacteria. The idea that the relations between the bacteria and the animal that harbors them constitutes a kind of symbiosis in which each derives a benefit from the other has certainly not been demonstrated. The contrary view, that bacterial putrefaction is the occasion for constant danger to the human organism, has been stated in extreme form, perhaps, by Metchnikoff. According to this author the constant production and absorption of bacterial toxins from the intestine is one of the important causes of a loss of resistance on the part of the body to the changes which bring on senescence and death. At present it seems wise to take the conservative view that while the presence of the bacteria confers no positive benefit, the organism has adapted itself under usual conditions to neutralize their injurious action.

**Composition of the Feces.**—The feces differ widely in amount and in composition with the character of the food. Upon a diet composed exclusively of meats, they are small in amount and dark in color; with an ordinary mixed diet the amount is increased; and it is largest with an exclusively vegetable diet, especially with vegetables containing a large amount of cellulose. The average weight of the feces in twenty-four hours upon a mixed diet is given as 170 gms., while with a vegetable diet it may amount to as much as 400 or 500 gms. The quantitative composition, therefore, varies greatly with the diet. Qualitatively, we find in the feces the following things: (1) Indigestible material, such as ligaments of meat or cellulose from vegetables. (2) Undigested material, such as fragments of meat, starch, or fats which have in some way escaped digestion. Naturally, the quantity of this material present is slight under normal conditions. Some fats, however, are almost always found in feces, either as neutral fats or as fatty acids, and to a small extent as calcium or magnesium soaps. The quantity of fat found is increased by an increase of the fats in the food or by a deficient secretion of bile. (3) Products of the intestinal secretions. Evidence has accumulated in recent years\* to show that the feces in man on an average diet are composed in part of the unabsorbed material of the intestinal secretion. The nitrogen of the feces, formerly supposed to represent only undigested food, seems rather to have its origin largely in these secretions, together with the cellular débris thrown off from the walls of the intestines. (4) Products of bacterial decomposition. The most characteristic of these products are indol and skatol. They are crystalline bodies possessing a disagreeable, fecal odor; this is especially true of skatol, to which

\* Prausnitz, "Zeitschrift f. Biologie," 35, 335, 1897; and Tsuboi, *ibid.*, p. 68.

the odor of the feces is mainly due. (5) Cholesterin, or a derivative, which is found always in small amounts, and is probably derived from the bile. (6) Some of the purin bases, especially guanin and adenin. (7) Mucus and epithelial cells thrown off from the intestinal wall. (8) Pigment. In addition to the color due to the undigested food or to the metallic compounds contained in it, there is normally present in the feces a pigment, urobilin or stercobilin, derived from the pigments (bilirubin) of the bile. Urobilin is formed from the bilirubin by reduction in the large intestine. (9) Inorganic salts—salts of sodium, potassium, calcium, magnesium, and iron, but chiefly the last three together with phosphoric acid. The significance of the calcium and iron salts will be referred to in a subsequent chapter, when speaking of their nutritive importance. (10) Micro-organisms. Great quantities of bacteria of different kinds are found in the feces.

In addition to the feces, there is found often in the large intestine a quantity of gas that may also be eliminated through the rectum. This gas varies in composition. The following substances have been found at one time or another:  $\text{CH}_4$ ,  $\text{CO}_2$ ,  $\text{H}_2$ ,  $\text{N}_2$ ,  $\text{H}_2\text{S}$ . They arise mainly from the bacterial fermentation of the proteins, although some of the  $\text{N}_2$  may be derived from air swallowed with the food.

## CHAPTER XLIV.

### PHYSIOLOGY OF THE LIVER AND THE SPLEEN.

**The liver** plays an important part in the general nutrition of the body. Its functions are manifold, but in the long run they depend upon the properties of the liver cell, which constitutes the anatomical and physiological unit of the organ, although there is histological evidence that some of the endothelial cells of the capillaries of the liver have marked phagocytic properties, and it is possible that their activity may play a contributory part in some of the functions of the liver, for example, in the destruction of the red corpuscles that precedes the formation of bile pigments. The liver cells are seemingly uniform in structure throughout the whole substance of the liver, but to understand clearly the different functions they fulfil one must have a clear idea of their anatomical relations to one another and to the blood-vessels, the lymphatics, and the bile-ducts. The histology of the liver lobule, and the relationship of the portal vein, the hepatic artery, and the bile-duct to the lobule, must be obtained from the text-books upon histology and anatomy. It is sufficient here to recall the fact that each lobule is supplied with blood coming in part from the portal vein and in part from the hepatic artery. The blood from the former source contains the soluble materials absorbed from the alimentary canal, such as sugar and the split products (amino-acids) of protein, and these absorbed products are submitted to the metabolic activity of the liver cells before reaching the general circulation. The hepatic artery brings to the liver cells the arterialized blood sent out to the systemic circulation from the left ventricle. In addition, each lobule gives origin to the bile capillaries which arise between the separate cells and which carry off the bile formed within the cells. In accordance with these facts, the physiology of the liver cell falls naturally into two parts,—one treating of the formation, composition, and physiological significance of bile, and the other dealing with the metabolic changes produced in the mixed blood of the portal vein and the hepatic artery as it flows through the lobules. In this latter division the main phenomena to be studied are the formation of urea and the formation and significance of glycogen, but it cannot be doubted that the liver possesses other important metabolic functions which at present are imperfectly understood, such, for example, as its relations to the production of fibrinogen and of antithrombin, which have been referred to in the section on Blood.

**Bile.**—From a physiological standpoint, bile is partly an excretion carrying off certain waste products, and partly a digestive secretion playing an important rôle in the absorption of fats, and possibly in other ways. Bile is a continuous secretion, but in animals possessing a gall-bladder its ejection into the duodenum is intermittent. Bile is easily obtained from living animals by establishing a fistula of the bile-duct or, as seems preferable, of the gall-bladder. The latter operation has been performed a number of times on human beings. In some cases the entire supply of bile has been diverted in this way to the exterior, and it is an interesting physiological fact that such patients may continue to enjoy fair health, showing that, whatever part the bile takes normally in digestion and absorption, its passage into the intestine is not absolutely necessary to the nutrition of the body. The quantity of bile secreted during the day has been estimated for human beings of average weight (43 to 73 kgms.) as varying between 500 and 800 c.c. This estimate is based upon observations on cases of biliary fistula.\* Chemical analyses of the bile show that, in addition to the water and salts, it contains bile pigments, bile acids, cholesterin, lecithin, neutral fats and soaps, sometimes a trace of urea, and a mucilaginous nucleo-albumin formerly designated improperly as mucin. The last-mentioned substance is not formed in the liver cells, but is added to the bile by the mucous membrane of the bile-ducts and gall-bladder. The quantity of these substances present in the bile varies in different animals and under different conditions. As an illustration of their relative importance in human bile and of the limits of variation, the two following analyses by Hammarsten† may be quoted:

	I.	II.
Solids.....	2.520	2.840
Water.....	97.480	97.160
Mucin and pigment.....	0.529	0.910
Bile salts.....	0.931	0.814
Taurocholate.....	0.3034	0.053
Glycocholate.....	0.6276	0.761
Fatty acids from soap.....	0.1230	0.024
Cholesterin.....	0.0630	0.096
Lecithin } .....	0.0220	0.1286
Fat } .....		
Soluble salts.....	0.8070	0.8051
Insoluble salts.....	0.0250	0.0411

The color of bile varies in different animals according to the preponderance of one or the other of the main bile pigments, bilirubin and biliverdin. The bile of carnivorous animals has usually a golden color, owing to the presence of bilirubin, while that of the her-

\* Copeman and Winston, "Journal of Physiology," 10, 213, 1889; Robson, "Proceedings of the Royal Society," London, 47, 499, 1890; Pfaff and Balch, "Journal of Experimental Medicine," 2, 49, 1897.

† Reported in "Centralblatt f. Physiologie," 1894, No. 8. For other analyses consult Rosenbloom, "Journal of Biological Chemistry," 14, 241, 1913.

bivora is a bright green from the biliverdin. The color of human bile seems to vary: according to some authorities, it is yellow or golden yellow, and this seems especially true of the bile as found in the gall-bladder of the cadaver; according to others, it is of a dark-olive color with the greenish tint predominating. Its reaction is feebly alkaline, and its specific gravity varies in human bile from 1.050 or 1.040 to 1.010. Human bile does not give a distinctive absorption spectrum, but the bile of some herbivora, after exposure to the air at least, gives a characteristic spectrum.

**Bile Pigments.**—Bile, according to the animal from which it is obtained, contains one or the other, or a mixture, of the two pigments, bilirubin and biliverdin. Indeed, it is probable that in some animals at least still other pigments, such as urobilin, may be present in the bile, together with the bilirubin or biliverdin. Biliverdin is supposed to stand to bilirubin in the relation of an oxidation product. Bilirubin is given the formula  $C_{16}H_{18}N_2O_3$ , or  $C_{32}H_{36}N_4O_6$ , and biliverdin,  $C_{16}H_{18}N_2O_4$  or  $C_{32}H_{36}N_4O_8$ , the latter being prepared readily from the former by oxidation. These pigments give a characteristic reaction, known as "Gmelin's reaction," with nitric acid containing some nitrous acid (nitric acid with a yellow color). If a drop of bile and a drop of nitric acid are brought into contact, the former undergoes a succession of color changes, the order being green, blue, violet, red, and reddish yellow. The play of colors is due to successive oxidations of the bile pigments; starting with bilirubin, the first stage (green) is due to the formation of biliverdin. The pigments formed in some of the other stages have been isolated and named. The reaction is very delicate, and it is often used to detect the presence of bile pigments in other liquids—urine, for example. The bile pigments originate from hemoglobin. This origin was first indicated by the fact that in old blood clots or in extravasations there was found a crystalline product, the so-called "hematoïdin," which was undoubtedly derived from hemoglobin, and which upon more careful examination was proved to be identical with bilirubin. It is supposed that when the blood-corpuses disintegrate the liberated hemoglobin is converted by the liver cells to an iron-free compound, bilirubin or biliverdin. The bilirubin is formed from the hematin of the hemoglobin by a process which involves the splitting off of its iron. It is very significant that the iron separated by this means from the hematin is, for the most part, retained in the liver, a small portion only being secreted in the bile. It seems probable that the iron held back in the liver is again used in some way to make new hemoglobin in the hematopoietic organs. Since the hematin constitutes only 4 per cent. of the hemoglobin, it is evident that in the production of the bilirubin a considerable amount



of globin must be formed also, but nothing is known of the fate of this portion of the molecule. Quantitative data are lacking in regard to the amount of bile pigment secreted daily. Owing to the want of a satisfactory method of estimating this substance, its percentage in the bile, as given by different authors, varies greatly, from .04 per cent. to 0.25 per cent. The bile pigments are carried in the bile to the duodenum and are mixed with the food in its long passage through the intestine. Under normal conditions neither bilirubin nor biliverdin occurs in the feces, but in their place is found a reduction product, urobilin, formed in the large intestine, probably in consequence of the activity of the bacteria. Moreover, it is believed that some of the bile pigment is reabsorbed as it passes along the intestine, is carried to the liver in the portal blood, and is again eliminated. That this action occurs, or may occur, has been made probable by experiments of Wertheimer\* on dogs. It happens that sheep's bile contains a pigment (choloheatin) that gives a characteristic spectrum. If some of this pigment is injected into the mesenteric veins of a dog it is eliminated while passing through the liver, and can be recognized unchanged in the bile. The value of this "circulation of the bile," so far as the pigments are concerned, is not apparent.

**Bile Acids.**—"Bile acids" is the name given to two organic acids, *glycocholic* and *taurocholic*, which are always present in bile, and, indeed, form very important constituents of that secretion; they occur in the form of their respective sodium salts. In human bile both acids are usually found, but the proportion of taurocholate is variable, and in some cases it may be absent altogether. Among herbivora the glycocholate predominates, as a rule, although there are some exceptions; among the carnivora, on the other hand, taurocholate occurs usually in greater quantities, and in the dog's bile it is present alone. Glycocholic acid has the formula  $C_{26}H_{43}NO_6$ , and taurocholic acid the formula  $C_{26}H_{45}NSO_7$ . Each of them can be obtained in the form of crystals. When boiled with acids or alkalis these acids take up water and undergo hydrolytic cleavage, the reaction being represented by the following equations:

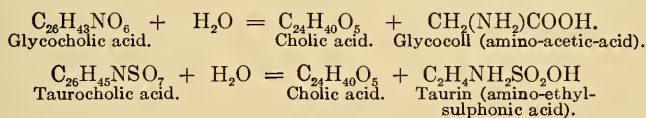

These reactions indicate that the bile acids are probably formed by a reverse process, in the one case by a conjugation of glycocoll with

\* "Archives de physiologie normale et pathologique," 1892, p. 577.

cholic acid, in the other by a union of taurin and cholic acid. In this synthesis the reaction takes place between the carboxyl group of the cholic acid and the amino-group of the glycocholl or taurin, as may be represented by the following equation:

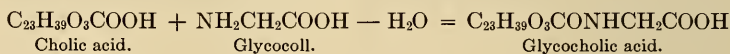

Cholic acid or its compounds, the bile-acids, are usually detected in suspected liquids by the well-known Pettenkofer reaction. As usually performed, the test is made by adding to the liquid a few drops of a 10 per cent. solution of cane-sugar and then strong sulphuric acid. The latter must be added carefully and the temperature be kept below 70° C. If bile acids are present, the liquid assumes a red-violet color. It is now known that the reaction consists in the formation of a substance (furfural) by the action of the acid on sugar, which then reacts with the bile acids. The bile acids are formed directly in the liver cells. This fact, which was for a long time the subject of discussion, has been demonstrated in recent years by an important series of researches made upon birds. It has been shown that if the bile-duct is ligated in these animals, the bile formed is reabsorbed and bile acids and pigments may be detected in the urine and the blood. If, however, the liver is completely extirpated, then no trace of either bile acids or bile pigments can be found in the blood or the urine, showing that these substances are not formed elsewhere in the body than in the liver. It is more difficult to ascertain from what substances they are formed. The chemical origin of the cholic acid is not definitely known. The glycocholl is one of the amino-acids formed by the hydrolysis of proteins, and the liver gets a supply of this material after meals through the portal blood, although, in all probability, it can be formed also within the liver cells by autolytic processes. In any case, so far as it is present in the bile as glycocholic acid, it represents a loss or excretion of so much protein nitrogen. The taurin is likewise derived from protein and presumably from the cystein grouping in the protein molecule. By oxidation the cystein may be converted to cysteinic acid:

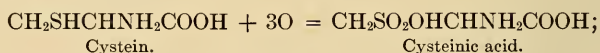

and by loss of CO<sub>2</sub> this is converted to taurin:

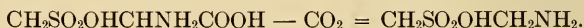

A circumstance of considerable physiological significance is that these acids or their decomposition products are absorbed in part from

the intestine and are again secreted by the liver; as in the case of the pigments, there is an intestinal-hepatic circulation. The value of this reabsorption may lie in the fact that the bile acids constitute a very efficient stimulus to the bile-secreting activity of the cells, being one of the best of cholagogues, or it may be that it economizes material. From what we know of the history of the bile acids it is evident that they are not to be considered solely as excreta: they have some important function to fulfill. The following suggestions as to their value have been made: In the first place, they serve as a menstruum for dissolving the cholesterin which is constantly present in the bile; secondly, they facilitate greatly the splitting and the absorption of fats in the intestine. It is an undoubted fact that when bile is shut off from the intestine the absorption of fats is very much diminished, and it has been shown that this action of the bile in fat absorption is due chiefly to the presence of the bile-acids, and in the same way the known activating influence of bile upon the activity of pancreatic lipase has been traced to the bile-acids. The bile-acids, the taurocholate, at least, possesses the property of precipitating proteins in acid solutions. This property probably explains the fact that the acid chyme as it passes into the duodenum is precipitated by coming into contact with the bile, a fact which has long been known, although its physiological significance is not clear.

**Cholesterin or Cholesterol.**—Cholesterin is a non-nitrogenous substance of the formula  $C_{27}H_{46}O$ . (See p. 78.) It is a constant constituent of the bile, although it occurs in variable quantities. Cholesterin is very widely distributed in the body, being found especially in the white matter (medullary substance) of nerve-fibers. It seems, moreover, to be a constant constituent of all animal and plant cells. It is assumed that cholesterin is not formed in the liver, but that it is eliminated by the liver cells from the blood, which collects it from the various tissues of the body. This is at least a possible explanation of its occurrence in the bile, for it seems certain that the cholesterin is a constant constituent of the blood, either as such or in the form of an ester, that is to say, in combination with a fatty acid, such as stearic acid. Some authors suggest, however, that in the dissolution of red corpuscles that takes place in the liver the cholesterin liberated from the stroma of the corpuscles forms the source of the cholesterin found in the bile. That it is an excretion is indicated by the fact that it is eliminated in the feces, but here again the opposite view has been suggested that the cholesterin is in part at least reabsorbed and used again in the formation of new tissue.\* Cholesterin is insoluble in water or in dilute saline

\* See Gardner and co-workers, "Proc. Royal Soc.," B, vols. 81 and 82, 1910.

liquids, and is held in solution in the bile by means of the bile-acids. Provisionally we may regard it, so far as its occurrence in the bile is concerned, as a waste product of cellular disintegration which is eliminated in the feces. It is excreted also through the skin, in the sebaceous and sweat secretions, and in the milk.

**Lecithin, Fats, and Nucleo-albumin.**—Lecithin,  $C_{44}H_{90}NPO_9$ , is a compound of glycerophosphoric acid with fatty acid radicals (stearic, oleic, or palmitic) and a nitrogenous base, cholin (see p. 78). When hydrolyzed by boiling with alkali it splits up into these three substances. It is found generally as such, or in combination, in all cells, and evidently plays some as yet unknown part in cell metabolism. It occurs in largest quantity in the white matter of the nervous system. In the liver it occurs to a considerable extent both as lecithin and in a more complex combination with a carbohydrate residue, a compound designated as jecorin. So far as it is found in the bile, it represents possibly a waste product derived from the liver or from the body at large, although it is possible that it may undergo hydrolysis in the intestine and be absorbed in the form of its split products. Little is known of its precise physiological significance. According to Hewlett and others it may serve to activate the lipase of the pancreatic secretion.

The special importance, if any, of the small proportion of fats and fatty acids in the bile is unknown. Theropy, mucilaginous character of bile is due to the presence of a body formed in the bile-ducts and gall-bladder. This substance was formerly designated as mucin, but it is now known that in ox bile at least it is not a true mucin, but a nucleo-albumin (see appendix). Hammarsten reports that in human bile some true mucin is found. Outside the fact that it makes the bile viscous, this constituent is not known to possess any especial physiological significance.

**The Secretion of the Bile.**—Numerous experiments have been made to ascertain whether or not the secretion of bile is controlled by a special set of secretory fibers. The secretion itself is continuous, but varies in amount under different conditions. These conditions may be controlled experimentally in part. It has been shown, for example, that stimulation of the spinal cord or splanchnic nerve diminishes the flow of bile, while section of the splanchnic branches may cause an increased flow. These and similar actions are explained, however, by their effect on the blood-flow through the liver. The splanchnics carry vasomotor nerves to the liver, and section or stimulation of these nerves will therefore alter the circulation in the organ. Since the secretion increases when the blood-flow is increased and *vice versa*, it is believed that in this case no special secretory nerve fibers exist. The metabolic processes in the liver cells which

produce the secretion probably go on at all times, but they are increased when the blood-flow is increased. We may believe, therefore, that the quantity of the bile secretion varies with the quantity and composition of the blood flowing through the liver, and that the blood contains normally chemical substances which stimulate the liver cells to secrete bile. It is stated on the basis of experimental evidence\* that when the supply of portal blood is cut off the amount of bile formed is greatly reduced, and that, therefore, it is possible that the substances from which bile is formed or which serve to stimulate the production of bile are furnished chiefly by the portal blood. Substances which stimulate the formation of bile are designated as cholagogues. The therapeutical agents capable of giving this action are still a subject of controversy. On the physiological side the following facts are accepted: Any agent that causes an hemolysis of red corpuscles increases the flow of bile, or the same effect is produced if a solution of hemoglobin is injected directly into the blood. This result is in harmony with the views already stated regarding the significance of the bile pigments as an excretory product of hemoglobin. The cholagogue whose action is most distinct and prolonged is bile itself. When fed or injected directly into the circulation, bile causes an undoubted increase in the secretion. This effect is due both to the bile acids and bile pigments. Since the bile acids have a hemolytic effect on red corpuscles, it might at first be assumed that their action as cholagogues is due indirectly to this circumstance. The action of the bile acids is, however, much more pronounced than that of other hemolytic agents, and it seems certain, therefore, that they exert a specific effect on the liver cells. So also it is stated (Weinberg) that peptones and proteoses have a marked stimulating effect, and since these substances may be brought to the liver in the portal blood, it is possible that they act as stimuli under normal conditions. Lastly, there is evidence that the secretin, whose action upon the pancreatic secretion has been described, exerts a similar effect upon the secretion of bile. Statements differ somewhat in regard to the extent of this action, but it seems to be certain that, when acids (0.5 per cent. HCl) are injected into the duodenum or upper part of the jejunum, the secretion of bile is increased; and, since this effect takes place when the nervous connections are severed, the effect, as in the case of the pancreatic secretion, is explained by assuming that the acid converts prosecretin to secretin, and this latter after absorption into the blood acts upon the liver cells.†

\* Voegtlin and Bernheim, "Journal of Pharmacology and Exp. Therapeutics," 2, 455, 1910.

† See Falloise, quoted in Maly's "Jahres-bericht der Thier-chemie," 33, 611, 1904.

A similar effect may be obtained by injecting secretin directly into the blood. Since during a meal the stomach normally ejects acid chyme into the duodenum, the importance of this secretin reaction in adapting the secretion of bile to the period of digestion is evident.

**The Ejection of Bile into the Duodenum—Function of the Gall-bladder.**—Although the bile is formed more or less continuously, it enters the duodenum periodically during the time of digestion. The secretion during the intervening periods is prevented from entering the duodenum apparently by the fact that the opening of the

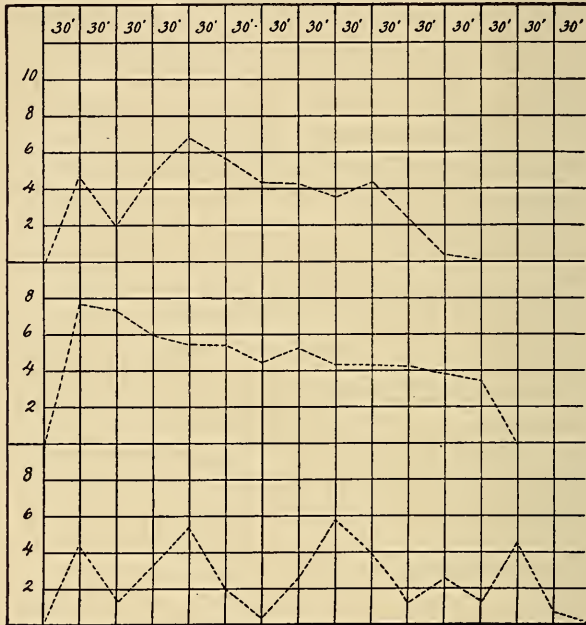

Fig. 297.—Curves showing the velocity of secretion of bile into the duodenum on (1) a diet of milk, uppermost curve; (2) a diet of meat, middle curve; (3) a diet of bread, lowest curve. The divisions on the abscissa represent intervals of thirty minutes; the figures on the ordinates represent the volume of secretion in cubic centimeters.—(Bruns.)

common bile-duct is closed by a sphincter. The secretion, therefore, backs up into the gall-bladder. According to Bruns,\* no bile appears in the duodenum as long as the stomach is empty. When, however, a meal is taken, the ejection of the chyme into the duodenum is followed by an ejection of bile.† It would seem, therefore, that each gush of chyme into the duodenum excites, probably by reflex action, a contraction of the gall-bladder, and an inhibition of the sphincter closing the opening into the intestine.

\* "Archives des sciences biologiques," 7, 87, 1899.

† See also Klodnizki, quoted from Maly's "Jahres-bericht der Thierchemie," 33, 617, 1904.

An interesting application of this fact has been made in surgical practice. After operations upon the gall-bladder trouble is experienced at times owing to the failure of the fistulous opening to heal, so that there is constant oozing of gall. It is found that frequent feeding of the patient facilitates the permanent closure of the fistula, because apparently the sphincter is kept inhibited and the pressure in the gall-bladder is lowered.

The substances in the chyme that are responsible for the stimulation have been investigated by Bruns. He finds that acids, alkalis, and starches are ineffective, and concludes that the reflex is due to the proteins and fats or some of the products of their digestion. The gall-bladder has a muscular coat of plain muscle, and records made of its contractions show that the force exerted is quite small. According to Freese,\* the maximal contraction does not exceed that necessary to overcome the hydrostatic pressure of a column of water 220 mms. in height,—a force, therefore, which is about equivalent to the secretion pressure of bile as determined by Heidenhain. The innervation of the gall-bladder and gall-ducts has been studied especially by Doyon.† It would seem, from the experiments made by this author together with later experiments reported by others,‡ that the bladder receives both motor and inhibitory fibers by way of the splanchnic nerves. These fibers emerge from the spinal cord in the roots of the sixth thoracic to the first lumbar spinal nerve, and pass to the celiac plexus by way of the splanchnic nerves. Motor fibers may occur also in the vagi. Sensory fibers capable of causing a reflex constriction or dilatation of the bladder are found in both the vagus and splanchnic nerves. Stimulation of the central end of the cut splanchnic causes a dilatation of the bladder (reflex stimulation of the inhibitory fibers), while stimulation of the central end of the vagus causes a contraction of the bladder and a dilatation (inhibition) of the sphincter muscle at the opening of the common duct into the intestine. These latter movements are the ones that occur during normal digestion, and we may assume, therefore, that in the normal reflex emptying of the gall-bladder the afferent path for the reflex is formed by the vagus fibers while the efferent path is through the splanchnic nerves.

**Effect of Complete Occlusion of the Bile-duct.**—When the flow of bile is prevented by ligation of the bile-duct, or when this duct is occluded by pathological changes the bile eventually gets into the blood, producing a condition of jaundice (icterus). There has been much discussion as to whether the bile is absorbed directly into the blood from the liver cells or the liver lymph-spaces, or whether it is carried to the blood by way of the lymph-vessels and

\* "Johns Hopkins Hospital Bulletin," June, 1905.

† Doyon, "Archives de physiologie," 1894, p. 19.

‡ Bainbridge and Dale, "Journal of Physiology," 1905, xxxiii., 138.

thoracic duct.\* Experimental evidence points to both possibilities. The increased pressure in the bile system leads possibly to a rupture of the delicate bile capillaries, and the bile thus escapes into the lymph-spaces. From these spaces it may be absorbed directly by the blood-vessels of the liver, or it may be carried off in the lymph-stream toward the thoracic duct.

**General Physiological Importance of Bile.**—The physiological value of bile has been referred to in speaking of its several constituents. It is probably of importance both as a medium of excretion and as a digestive secretion. Its value from the former standpoint we know little about. Certain of its constituents, the bile pigments, cholic acid, cholesterin, and lecithin, may appear in the feces more or less modified, but on the other hand these substances may be reabsorbed in part from the intestine, so that it is difficult to say in how far they are to be regarded as excretory products. On the experimental side it can be shown that a number of dyes when introduced into the blood are eliminated or excreted by way of the bile as well as through the urine, a fact which indicates that the liver may act as an excretory organ. As a digestive secretion, the most important function attributed to the bile is the part it takes in the digestion and absorption of fats. It accelerates greatly the action of the lipase of pancreatic juice in splitting the fats to fatty acids and glycerin, and it aids materially in the absorption of the products of this hydrolysis. A number of observers have shown that when a permanent biliary fistula is made, and the bile is thus prevented from reaching the intestinal canal, a large proportion of the fat of the food escapes absorption and is found in the feces. This action of the bile may be referred directly to the fact that the bile acids serve as a solvent for the fats and fatty acids. It was formerly believed that bile is also of great importance in restraining the processes of putrefaction in the intestine. It was asserted that bile is an efficient antiseptic, and that this property comes into use normally in preventing excessive putrefaction. Bacteriological experiments made by a number of observers have shown, however, that bile itself has very feeble antiseptic properties, as is indicated by the fact that it putrefies readily. The free bile acids and cholalic acid do have a direct retarding effect upon putrefactions outside the body; but this action is not very pronounced, and has not been demonstrated satisfactorily for bile itself. It seems to be generally true that in cases of biliary fistula the feces have a very fetid odor when meat and fat are taken in the food. But the increased putrefaction in these cases may possibly be an indirect result of the withdrawal of bile. It has been suggested, for instance, that the deficient absorption of fat that follows upon the

\* See Mendel and Underhill for literature, "American Journal of Physiology," 14, 252, 1905.



removal of the bile results in the protein and carbohydrate material becoming coated with an insoluble layer of fat, so that the penetration of the digestive enzymes is retarded and greater opportunity is given for the action of bacteria. We may conclude, therefore, that, while there does not seem to be sufficient warrant at present for believing that the bile exerts a direct antiseptic action upon the intestinal contents, nevertheless its presence limits in some way the extent of putrefaction.

**Glycogen.**—One of the most important functions of the liver is the formation of glycogen. This substance was found in the liver in 1857 by Claude Bernard, and is one of several brilliant discoveries made by him. Glycogen has the formula  $(C_6H_{10}O_5)_n$ , which is also the general formula given to vegetable starch; glycogen is therefore frequently spoken of as "animal starch." It gives, however, a portwine-red color with iodine solutions, instead of the familiar deep blue of vegetable starch, and this reaction serves to detect glycogen not only in its solutions, but also in the liver cells. Glycogen is readily soluble in water, and the solutions have a characteristic opalescent appearance. Like starch, glycogen is acted upon by ptyalin and other diastatic enzymes, and the end-products are apparently the same—namely, maltose, or maltose and some dextrin, or else dextrose, depending upon the enzyme used. Under the influence of acids it may be hydrolyzed at once to dextrose.\*

**Occurrence of Glycogen in the Liver.**—Glycogen can be detected in the liver cells microscopically. If the liver of a dog is removed twelve or fourteen hours after a hearty meal, hardened in alcohol, and sectioned, the liver cells are found to contain clumps of clear material which give the iodine reaction for glycogen. Even when distinct aggregations of the glycogen cannot be made out, its presence in the cells is shown by the red reaction with iodine. By this simple method one can demonstrate the important fact that the amount of glycogen in the liver increases after meals and decreases again during the fasting hours, and if the fast is sufficiently prolonged it may disappear altogether. This fact is, however, shown more satisfactorily by quantitative determinations, by chemical means, of the total glycogen present. The amount of glycogen in the liver is quite variable, being influenced by such conditions as the character and amount of the food, muscular exercise, body temperature, drugs, etc. From determinations made upon various animals it may be said that the average amount lies between 1.5 and 4 per cent. of the weight of the liver. But this amount may be increased greatly by feeding upon a diet largely made up of carbohy-

\* The extensive literature of glycogen is collected and reviewed by Cramer in the "Ergebnisse der Physiologie," vol. i, part 1, 1902; and by Pflüger, "Archiv f. die gesammte Physiologie," 96, 1, 1903.

drates. It is said that in the dog the total amount of liver glycogen may be raised to 17 per cent., and in the rabbit to 27 per cent., by this means, while it is estimated for man (Neumeister) that the quantity may be increased to at least 10 per cent. It is usually believed that glycogen exists as such in the liver cells, being deposited in the substance of the cytoplasm. Reasons have been brought forward to show that this is not strictly true, and that the glycogen is probably held in some sort of weak chemical combination. It has been shown, for instance, that although glycogen is easily soluble in cold water, it can not be extracted readily from the liver cells by this agent. One must use hot water, salts of the heavy metals, and other similar agents that may be supposed to break up the combination in which the glycogen exists. For practical purposes, however, we may speak of the glycogen as lying free in the liver-cells, just as we speak of hemoglobin existing as such in the red corpuscles, although it is probably held in some sort of combination.

**Origin of Glycogen.**—To understand clearly the views held as to the origin of liver glycogen, it is necessary to describe briefly the effect of the different foodstuffs upon its formation.

*Effect of Carbohydrates on the Amount of Glycogen.*—The amount of glycogen in the liver is affected very quickly by the quantity of carbohydrates in the food. If the carbohydrates are given in excess, the supply of glycogen may be increased largely beyond the average amount present, as has been stated above. Investigation of the different sugars has shown that dextrose, levulose, saccharose (cane-sugar), and maltose are unquestionably direct glycogen-formers,—that is, glycogen is formed directly from them or from the products into which they are converted during digestion. The bulk of our carbohydrate food reaches the liver as dextrose, or as dextrose and levulose, and these forms of sugar may be converted into glycogen in the liver cells by a simple process of dehydration and condensation, such as may be represented in substance by the formula—

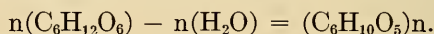

There is no doubt that both dextrose and levulose increase markedly the amount of glycogen in the liver; and, since cane-sugar is inverted in the intestine before absorption, it also must be a true glycogen-former,—a fact that has been abundantly demonstrated by direct experiment. Lusk\* has shown, however, that, if cane-sugar is injected under the skin, it has a very feeble effect in the way of increasing the amount of glycogen in the liver, since under these conditions it is probably absorbed into the blood without undergoing inversion. Experiments with subcutaneous injection of lactose gave similar results, and it is generally believed that the liver cells can not convert

\* Voit, "Zeitschrift f. Biologie," 28, 285, 1891.

the double sugars to glycogen, at least not readily; hence the value of the hydrolysis of these sugars in the alimentary canal before absorption. We may assume, therefore, that dextrose, levulose, and galactose are the true glycogen-formers that occur normally in the blood, and that the disaccharids (cane-sugar, milk-sugar, etc.) and the polysaccharids (starches) are true glycogen-formers to the extent that they are converted into dextrose, levulose, or galactose.

*Effect of Protein on Glycogen Formation.*—In his first studies upon glycogen Bernard asserted that it may be formed from protein material. Since that time some doubt has been thrown on the possibility of this transformation, but it may be said, perhaps, that the trend of all recent work indicates that the amino-acids yielded by proteins may serve as a starting-point for the formation of glycogen. Direct evidence has been obtained for this latter statement by feeding experiments with glycine, alanin, aspartic acid, and other amino-acids.\* It may be assumed that the amino-acids that undergo this change in the liver are first deprived of their nitrogen by a process of deaminization and that the non-nitrogenous organic acid remaining is synthesized to sugar. From alanin, for example, by deaminization, lactic acid would be produced—



and it is believed that the lactic acid can be synthesized to sugar—



The conclusion to be drawn from such experiments is strengthened by clinical experience upon human beings suffering from diabetes. In severe forms of this disease the carbohydrate material of the food escapes oxidation in the body and is secreted unchanged in the urine. If under these conditions the individual is given an exclusively protein diet, sugar still continues to appear in the urine, and it would seem that this sugar can only arise from the protein food. In the similar condition of severe glycosuria that may be produced by the use of phlorizin it has been shown that the animal continues to excrete sugar even when fed on protein alone or when starved. Under such conditions the amount of dextrose in the urine bears a definite ratio to the amount of nitrogen excreted  $\text{D} : \text{N} :: 3.65 : 1$  (Lusk), which would indicate that both arise from the breaking down of the protein molecule. So also the fact that during prolonged starvation, lasting for forty or even ninety days, the blood retains a practically constant composition in sugar indicates that this material is being formed from either the protein

\* Dakin, "Journal of Biological Chemistry," 14, 321, 1913.

or fat-supply of the body. Other considerations tend to exclude the fat, and we are, therefore, led to the belief that the protein can give rise to sugar in the body.

*Effect of Fats upon Glycogen Formation.*—A large number of substances have been found by some observers to increase the store of glycogen in the liver. In some of these cases at least it is evident that the substance is not a direct glycogen-former in the sense that the material is itself converted to glycogen. It may increase the supply of liver glycogen in some indirect way,—for example, by diminishing the consumption of glycogen in the body. The most important substance in this connection from a practical standpoint is fat. Whether or not the body can convert fats into sugar or glycogen is a question about which at present there is much difference of opinion, and much evidence might be cited on each side. Cremer, however, has furnished apparent proof that glycerin acts as a direct glycogen or sugar-former. When fed, especially in the diabetic condition, it causes an increase in the sugar which can not be explained as a result of protein metabolism. Since in the body neutral fats are normally split into glycerin and fatty acid, the fact that glycerin can be converted to sugar seems to carry with it the admission that fats may contribute directly to sugar production. Whether the synthesis of sugar (or glycogen) from glycerin is, so to speak, a normal process or occurs only under especial conditions, cannot be decided at present. Since, however, the glycerin radicle constitutes but a small fraction of the fat molecule, the quantitative importance of a change of this kind cannot be very great under any circumstances.

**The Function of Glycogen—Glycogenic Theory.**—The meaning of the formation of glycogen in the liver has been, and still is, the subject of discussion. The view advanced first by Bernard is perhaps most generally accepted. According to Bernard, glycogen forms a temporary reserve supply of carbohydrate material that is laid up in the liver during digestion and is gradually made use of in the intervals between meals. During digestion the carbohydrate food is absorbed into the blood of the portal system as dextrose or as dextrose, levulose, and galactose. If these sugars passed through the liver unchanged, the contents of the systemic blood in sugar would be increased perceptibly, giving the condition designated as hyperglycemia and the excess of sugar would be excreted by the kidneys. But as the blood from the digestive organs passes through the liver the excess of sugar is abstracted by the liver cells, is dehydrated to make glycogen, and is retained in the cells in this form for a short period. An objection has been made to this part of the glycogenic hypothesis by Pavy on the ground that if all the carbohydrates of a meal were absorbed

into the blood as free sugar, a condition of hyperglycemia and glycosuria must evidently result, because the liver cannot be supposed to handle the large amount of sugar derived from the carbohydrates of an ordinary meal. We know that glycosuria does occur when the carbohydrates are eaten in excess (alimentary glycosuria) for this very reason. But within what we may call the normal limits of a carbohydrate diet it seems most probable that the contents of the portal vein never rise much above the usual level, since the carbohydrate is absorbed slowly during a period of four to five hours, and during this period a very large amount of blood must flow through the intestines, as much perhaps in five hours as 180 to 190 liters, if one may apply to man the results of Burton-Opitz, obtained for the dog, namely, a flow of 31 c.c. per minute for each 100 gms. of intestine. There is, therefore, no reason to suppose that the power of the liver to convert the dextrose to glycogen is overtaxed by the amount of sugar brought to it during digestion. From time to time the glycogen of the liver is reconverted into sugar (dextrose) and is given off to the blood. By this means the percentage of sugar in the systemic blood is kept nearly constant (0.1 to 0.2 per cent.) and within limits best adapted to the use of the tissues. The great importance of the formation of glycogen and the consequent conservation of the sugar supply of the tissues is evident when we consider the nutritive value of carbohydrate food. Carbohydrates form the bulk of our usual diet, and the proper regulation of the supply to the tissues is, therefore, of vital importance in the maintenance of a normal, healthy condition. The second part of this theory, which holds that the glycogen is reconverted to dextrose, is supported by observations upon livers removed from the body. It has been found that shortly after the removal of the liver the supply of glycogen begins to disappear and a corresponding increase in dextrose occurs. Within a comparatively short time all the glycogen is gone and only dextrose is found. It is for this reason that in the estimation of glycogen in the liver it is necessary to mince the organ and to throw it into boiling water as quickly as possible, since by this means the liver cells are killed and the conversion of the glycogen is stopped. How the glycogen is changed to dextrose by the liver is a matter not fully explained. According to most authors, the conversion is due to an enzyme produced in the liver. Extracts of liver, as of some other tissues, yield an enzyme (glycogenase) that changes glycogen to dextrose.\* It is probable, therefore, that the normal conversion of glycogen to dextrose is effected by a special enzyme produced in the liver cells. In this description of the origin and meaning of the liver glycogen reference has been made only to the glycogen derived

\* Tebb, "Journal of Physiology," 22, 423, 1897-98.

directly from digested carbohydrates. The glycogen derived from protein foods, once it is formed in the liver, has, of course, the same functions to fulfil. It is converted into sugar, and eventually is oxidized in the tissues. For the sake of completeness it may be well to add that some of the sugar of the blood formed from the glycogen, when an excess is eaten beyond the energy needs of the tissues, may be converted into fat in the adipose tissues instead of being burnt, and in this way it may be retained in the body as a reserve supply of food of a more stable character.

**Glycogen in the Muscles and other Tissues.**—The history of glycogen is not complete without some reference to its occurrence in the muscles. Glycogen is, in fact, found in various places in the body, and is widely distributed throughout the animal kingdom. It occurs, for example, in leucocytes, in the placenta, in the rapidly growing tissues of the embryo, and in considerable abundance in the oyster and other molluscs. But in our bodies and in those of the mammals generally the most significant occurrence of glycogen, outside the liver, is in the voluntary muscles, of which glycogen forms a normal constituent. It has been estimated that the percentage of glycogen in resting muscle varies from 0.5 to 0.9 per cent., and that in the musculature of the whole body there may be contained an amount of glycogen equal to that in the liver itself. Muscular tissue, as well as liver tissue, has a glycogenetic function—that is, it is capable of laying up a supply of glycogen from the sugar brought to it by the blood. The glycogenetic function of muscle has been demonstrated directly by Kulz,\* who has shown that an isolated muscle irrigated with an artificial supply of blood to which dextrose is added is capable of changing the dextrose to glycogen, as shown by the increase in the latter substance in the muscle after irrigation. Muscle glycogen is to be looked upon as a temporary and local reserve supply of material; so that, while we have in the liver a large general depot for the temporary storage of glycogen for the use of the body at large, the muscular tissue, which, considering its bulk, is the most active tissue of the body from the standpoint of energy production, is also capable of laying up in the form of glycogen any excess of sugar brought to it. The fact that glycogen occurs so widely in the rapidly growing cells of embryos indicates that this glycogenetic function may at times be exercised by any tissue.

**Conditions Affecting the Supply of Glycogen in Muscle and Liver.**—In accordance with the view given above of the general value of glycogen—namely, that it is a temporary reserve supply of carbohydrate material that may be rapidly converted to sugar and oxidized with the liberation of energy—it is found that the supply of glycogen is greatly affected by conditions calling for increased

\* Kulz, "Zeitschrift f. Biologie," 72, 237, 1890.

metabolism in the body. Muscular exercise quickly exhausts the supply of muscle and liver glycogen, provided it is not renewed by new food. Observations on isolated muscles have shown definitely that the local supply of glycogen is diminished when the muscle is made to contract (see p. 67). In a starving animal glycogen finally disappears, except perhaps in traces, but this disappearance occurs much sooner if the animal is made to use its muscles at the same time. It has been shown also by Morat and Dufourt that if a muscle has been made to contract vigorously it takes up much more sugar from an artificial supply of blood sent through it than a similar muscle which has been resting; on the other hand, it has been found that if the nerve of one leg is cut so as to paralyze the muscles of that side of the body, the amount of glycogen is greater in these muscles than in those of the other leg that have been contracting meantime and using up their glycogen. The further history of glycogen is considered in the section on Nutrition.

**Formation of Urea in the Liver.**—The nitrogen contained in the protein material of our food is finally eliminated, mainly in the form of urea. It has been definitely proved that the urea is not formed in the kidneys, the organs that eliminate it. It has long been considered a matter of the greatest importance to ascertain in what organ or tissues urea is formed. Investigations have gone so far as to demonstrate that it arises in part at least in the liver; hence the property of forming urea must be added to the other important functions of the liver cell. Schröder \* performed a number of experiments in which the liver was taken from a freshly killed dog and irrigated through its blood-vessels with a supply of blood obtained from another dog. If the supply of blood was taken from a fasting animal, then circulating it through the isolated liver was not followed by any increase in the amount of urea contained in it. If, on the contrary, the blood was obtained from a well-fed dog, the amount of urea contained in it was distinctly increased by passing it through the liver, thus indicating that the blood of an animal after digestion contains something that the liver can convert to urea. It is to be noted, moreover, that this power is not possessed by all the organs, since blood from well-fed animals showed no increase in urea after being circulated through an isolated kidney or muscle. As further proof of the urea-forming power of the liver Schröder found that if ammonium carbonate was added to the blood circulating through the liver—to that from the fasting as well as from the well-nourished animal—a very decided increase in the urea was always obtained. It follows from the last experiment that the liver cells are able to

\* *Archiv f. experimentelle Pathologie und Pharmakologie*," 15, 364, 1882, and 19, 373, 1885.

convert carbonate of ammonium into urea. The reaction may be expressed by the equation  $(\text{NH}_4)_2\text{CO}_3 - 2\text{H}_2\text{O} = \text{CON}_2\text{H}_4$ . Schön-dorff\* in some later work showed that if the blood of a fasting dog is irrigated through the hind legs of a well-nourished animal, no increase in urea in the blood can be detected; but if the blood, after irrigation through the hind legs, is subsequently passed through the liver, a marked increase in urea results. Obviously, the blood in this experiment derives something from the tissues of the leg which the tissues themselves cannot convert to urea, but which the liver cells can. Finally, in some remarkable experiments upon dogs made by four investigators (Hahn, Massen, Nencki, and Pawlow), which are described more fully in the next chapter, it was shown that when the liver is practically destroyed there is a distinct diminution in the urea of the urine. In birds uric acid takes the place of urea as the main nitrogenous excretion of the body, and Minkowski has shown that in them removal of the liver is followed by an important diminution in the amount of uric acid excreted. From experiments such as these it is safe to conclude that urea is formed in the liver and is then given to the blood and excreted by the kidney. In treating of the physiological history of urea an account will be given of the views proposed with regard to the antecedent substance or substances from which the liver produces urea.

**Physiology of the Spleen.**—Much has been said and written about the spleen, but we are yet in the dark as to the distinctive function or functions of this organ. The few facts that are known may be stated briefly without going into the details of theories that have been offered at one time or another. The older experimenters demonstrated that this organ may be removed from the body without serious injury to the animal. An increase in the size of the lymph-glands and hyperplasia of the bone-marrow has been stated to occur after extirpation; but this is denied by others, and, whether true or not, it gives no decisive clue to the normal functions of the spleen. Observations upon splenectomized dogs indicate that it has some connection with the regulation of the supply of red blood-corpuscles.† Splenectomy is followed always by an anemic condition that lasts, however, for a short period only. After some months the number of red corpuscles returns to normal. On the other hand, injection of splenic extracts causes a distinct although short-lasting increase in the blood-count. These and other effects observed upon the blood, such as an increased resistance to hemolysis, cannot as yet be interpreted satisfactorily. The most definite facts known about the spleen are in connection with its

\* Pflüger's "Archiv f. die gesammte Physiologie," 54, 420, 1893.

† Consult Musser and Krumbhaar, "Journal of Exp. Medicine," 18, 487, 1913, and 20, 108, 1914; also Pearce and Pepper, *ibid.*, 20, 19, 1914.



movements. It has been shown that there is a slow expansion and contraction of the organ synchronous with the digestion periods. After a meal the spleen begins to increase in size, reaching a maximum at about the fifth hour, and then slowly returns to its previous size. This movement, the meaning of which is not known, is probably due to a slow vasodilatation, together, perhaps, with a relaxation of the tonic contraction of the musculature of the trabeculæ. In addition to this slow movement, Roy\* has shown that there is a rhythmical contraction and relaxation of the organ, occurring in cats and dogs at intervals of about one minute. Roy supposes that these contractions are effected through the intrinsic musculature of the organ,—that is, the plain muscle tissue present in the capsule and trabeculæ,—and he believes that the contractions serve to keep up a circulation through the spleen and to make its vascular supply more or less independent of variations in general arterial pressure. The fact that there is a special local arrangement for maintaining its circulation makes the spleen unique among the organs of the body, but no light is thrown upon the nature of the function fulfilled. The spleen is supplied richly with motor nerve fibers which when stimulated either directly or reflexly cause the organ to diminish in volume. According to Schaefer,† these fibers are contained in the splanchnic nerves, which carry also inhibitory fibers whose stimulation produces a dilatation of the spleen.

The chemical composition of the spleen is complicated, but suggestive. Its mineral constituents are characterized by a large percentage of iron, which seems to be present as an organic compound of some kind. Analysis shows also the presence of a number of fatty acids, fats, cholesterin, and, what is perhaps more noteworthy, a number of nitrogenous extractives belonging to the group of purin bases, such as xanthin, hypoxanthin, adenin, guanin, and uric acid. The presence of these bodies seems to indicate that active metabolic changes of some kind occur in the spleen. As to the theories of the splenic functions, the following may be mentioned: (1) The spleen has been supposed to give rise to new red corpuscles. This it undoubtedly does during fetal life and shortly after birth, and in some animals throughout life, but there is no reliable evidence that the function is retained in adult life in man or in most of the mammals. The presence of a large amount of iron in organic combination suggests, however, that the spleen may play a part in the preparation of new hemoglobin, or in the preservation of the iron set free by the death of the red corpuscles. This suggestion is strengthened by the fact that after extirpation of the spleen there is a distinct increase in the daily loss of iron from the body, in dogs an increase

\* "Journal of Physiology," 3, 203, 1881.

† *Ibid.*, 20, 1, 1896.

from 11 to 18 or 29 mgm.\* (2) It has been supposed to be an organ for the destruction of red corpuscles. This view is founded chiefly on microscopical evidence, according to which certain large ameboid cells in the spleen ingest and destroy the old red corpuscles, and partly upon the fact that the spleen tissue seems to be rich in an iron-containing compound. (3) It has been suggested that the spleen is concerned in the production of uric acid. This substance is found in the spleen, as stated above, and it was shown by Horbaczewsky that the spleen contains substances from which uric acid or xanthin may readily be formed by the action of the spleen-tissue itself. Later investigations† have shown that the spleen, like the liver and some other organs, contains special enzymes (adenase, guanase, and xanthin oxydase), by whose action the split products of the nucleins may be converted to uric acid, and it is possible, therefore, that this latter substance may be formed in the spleen.

\* Grossenbacher and Asher, "Zentralblatt f. Physiol," No. 12, 1908.

† Consult Jones and Austrian, "Zeitschrift f. physiol. Chem.," 48, 110, 1906.

## CHAPTER XLV.

### THE KIDNEY AND SKIN AS EXCRETORY ORGANS.

**Structure of the Kidney.**—The kidney is a compound tubular gland. The uriniferous tubules composing it may be roughly separated into a secreting part comprising the capsule, convoluted tubes, and loop of Henle, and a collecting part, the so-called straight or collecting tube, the epithelium of which is assumed not to have any secretory function. Within the secreting part the epithelium differs greatly in character in different regions; its peculiarities may be referred to briefly here so far as they seem to have a physio-

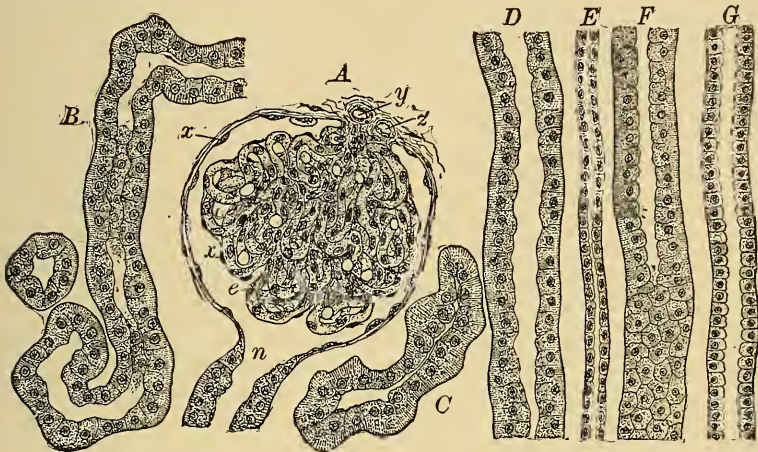

Fig. 298.—Portions of the various divisions of the uriniferous tubules drawn from sections of human kidney: *A*, Malpighian body; *x*, squamous epithelium lining the capsule and reflected over the glomerulus; *y*, *z*, afferent and efferent vessels of the tuft; *e*, nuclei of capillaries; *n*, constricted neck marking passage of capsule into convoluted tubule; *B*, proximal convoluted tubule; *C*, irregular tubule; *D* and *F*, spiral tubules; *E*, ascending limb of Henle's loop; *G*, straight collecting tubule.—(*Piersol*.)

logical bearing, although for a complete description reference must be made to works on histology.

The arrangement of the glandular epithelium in the capsule with reference to the blood-vessels of the glomerulus is worthy of special attention. It will be remembered that each Malpighian corpuscle consists of two principal parts, a tuft of blood-vessels, the glomerulus, and an enveloping expansion of the uriniferous tubule, the capsule. The glomerulus is an interesting structure (see Fig. 298, *A*). It consists of a small afferent artery which after entering the glomerulus, breaks up into a number of capillaries. These capillaries, although twisted

together, do not anastomose, and they unite to form a single efferent vein of a smaller diameter than the afferent artery. The whole structure, therefore, is not an ordinary capillary area, but a *rete mirabile*, and the physical factors are such that within the capillaries of the rete there must be a greatly diminished velocity of the blood-stream, owing to the great increase in the width of the stream bed, and a higher blood-pressure than in ordinary capillaries, owing to the narrow efferent vessel and the capillaries of the tubule which form a resistance beyond the rete. Surrounding this glomerulus is the double-walled capsule. One wall of the capsule is closely adherent to the capillaries of the glomerulus; it not only covers the structure closely, but dips into the interior between the small lobules into which the glomerulus is divided. This layer of the capsule is composed of flattened, endothelial-like cells, the glomerular epithelium, to which great importance is attached in the formation of the secretion. It will be noticed that between the interior of the blood-vessels of the glomerulus and the cavity of the capsule, which is the beginning of the uriniferous tubule, there are interposed only two very thin layers,—namely, the epithelium of the capillary wall and the glomerular epithelium. The apparatus would seem to afford most favorable conditions for filtration of the liquid parts of the blood. The epithelium clothing the convoluted portions of the tubule, including under this designation the so-called irregular and spiral portions and the loop of Henle, is of a character quite different from that of the glomerular epithelium (Fig. 298, *B, C, D, E, F, G*). The cells, speaking generally, are cuboidal or cylindrical, protoplasmic, and granular in appearance; on the side toward the basement membrane they often show a peculiar striation, while on the lumen side the extreme periphery presents a compact border which in some cases shows a cilia-like striation. These cells have the general appearance of an active secretory epithelium, and one theory of urinary secretion attributes this function to them.

**The Secretion of Urine.**—The kidneys receive a rich supply of nerve fibers, but most histologists have been unable to trace any connection between these fibers and the epithelial cells of the kidney tubules.

The majority of purely physiological experiments upon direct stimulation of the nerves going to the kidney are adverse to the theory of secretory fibers, the marked effects obtained in these experiments being all explicable by the changes produced in the blood-flow through the organ. Two general theories of urinary secretion have been proposed. Ludwig held originally that the urine is formed by the simple physical processes of filtration and diffusion. In the glomeruli the conditions are most favorable to filtration, and he supposed that in these structures water filtered through from the

blood, carrying with it not only the inorganic salts, but also the specific elements (urea, etc.) of the secretion. There was thus formed at the beginning of the uriniferous tubules a complete but diluted urine, and in the subsequent passage of this liquid along the convoluted tubes it became concentrated by diffusion with the more concentrated lymph surrounding the outside of the tubules.

Bowman's theory of urinary secretion, which has since been vigorously supported and extended by Heidenhain, was based originally mainly on histological grounds. It assumes that in the glomeruli water and inorganic salts are produced, while the urea and related bodies are eliminated through the activity of the epithelial cells in the convoluted tubes.

The first of these theories (Ludwig) is sometimes spoken of as the mechanical theory, since as originally proposed it attempted to explain the formation and composition of the urine by reference only to the physical forces of filtration and diffusion.\* Adherents of this view in recent years have modified it, however, to the extent that the absorption supposed to take place in the convoluted tubules is designated as a selective absorption, or selective diffusion, the characteristics of which depend upon unknown peculiarities of structure in the epithelial cell, so that it is no longer a purely mechanical theory. The difference between the mechanical and the secretory theories may be stated briefly in this way. The former assumes that in the glomerulus all of the constituents of the urine are produced from the blood, probably by filtration, and that the function of the epithelium lining the convoluted tubules is absorptive, like the epithelium of the intestines, and not secretory. The Bowman view as formulated by Heidenhain teaches that the glomerular epithelium forms the water and salts of the urine by an act of secretion, the ultimate chemistry or physics of which is not known. The theory asserts that the epithelial cells participate actively in the process of secretion and do not serve simply as a passive membrane. The cells of the convoluted tubules are also secretory, their special activity being limited mainly to the organic constituents, urea, etc., although, in this respect,—namely, in the precise distinction between the secretory products of the glomerular epithelium and those of the convoluted tubules,—the theory is not very explicit. Much interest and a large literature have been stimulated by controversies based on these theories, and to-day the facts accumulated are not such as to demonstrate conclusively one view or the other, although, on the whole, perhaps, it may be said that the majority of

\* Sir Lauder Brunton calls my attention to the fact that Ludwig, in some of his earlier investigations (Ustimowitsch, Ludwig's "Arbeiten," 1870), recognized the fact that the flow of urine through the glomeruli is influenced by factors other than the mechanical pressure. He called attention especially to the influence of the diuretic substances present in the blood, such as urea and sodium chlorid.

physiologists adhere to the more conservative view of Bowman-Heidenhain to the extent at least of recognizing that the physical laws of filtration, diffusion, and imbibition, so far as they are known, do not suffice for a satisfactory explanation of the facts.\* As in other similar cases, our knowledge of the physical structure and chemical properties of the walls of the living cells is still very deficient, and it seems necessary to designate these activities by the indefinite term secretion.

**Function of the Glomerulus.**—As stated above, the structure of the glomerulus is peculiar and suggestive of a special adaptation. The mechanical theory looks upon it as a filter, the pressure of the blood in the glomerular capillaries driving the water and salts through the endothelium of the capillaries and the glomerular epithelium into the cavity of the urinary tubule. If we consider only the water and assume that the membranes traversed are freely permeable to its molecules, then it is evident that, upon this theory, the quantity of urine formed will depend upon the filtration pressure, and that this filtration pressure can be expressed by the formula  $F = P - p$ , in which  $P$  represents the blood-pressure in the glomerular capillaries and  $p$  the pressure of the urine in the capsular end of the uriniferous tubules. Some of the interesting facts developed by experiment may be presented in connection with this formula. According to the mechanical theory, the amount of urine formed should vary directly with  $P$  and inversely with  $p$ . The factor  $P$  may be increased in two general ways: First, by those changes which raise general arterial pressure and therefore the pressure in the renal arteries,—such changes, for instance, as are brought about by an increased force of heart beat or a large vasoconstriction. Second, by obstructing or occluding the renal veins. Experiments have been made along these lines. With regard to the first possibility it has been found in general, although not invariably, that raising arterial pressure increases the quantity of urine if the means used are such as may be assumed to raise the pressure in the glomerular capillaries.

The reverse experiment, however, of raising  $P$  by blocking the venous outflow fails entirely to support the theory. When the renal veins are compressed the capillary pressure in the glomeruli must be increased, and, if the veins are blocked entirely, we may suppose that the capillary pressure is raised to the level of that of the renal arteries. In such experiments, however, the flow of urine is diminished instead of being increased, and indeed may be stopped altogether when the veins are completely blocked. The adherents of the mechanical theory have attempted to explain this unfavorable result by assuming that the swollen interlobular veins press upon

\* For discussion and literature see Magnus, "Münchener med. Wochenschrift," 1906, Nos. 28 and 29.

and block the uriniferous tubules. According to the antagonistic theory of Heidenhain, blocking the veins suppresses the secretory activity of the glomerular epithelium by depriving it of oxygen and the chance for removal of  $\text{CO}_2$ ,—that is, by producing local asphyxia. The latter explanation seems the simpler of the two, and it is very strongly supported by the opposite experiment of clamping the renal artery. When this is done the blood-flow through the kidney ceases and the secretion of urine also stops, as would be expected. But when after a few minutes' closure the artery is unclamped, the secretion is not restored with the return of the circulation. On the contrary, a long time (as much as an hour or more) may elapse before the secretion begins. This fact is quite in harmony with the Heidenhain theory, since complete removal of their blood supply might well result in a long-continued injury to the delicate epithelial cells. On the mechanical theory, however, we should expect a contrary result. Injury to the cells should be followed by greater permeability and an increased filtration, as is found to be the case with the production of lymph. These two experiments, blocking the renal artery and the renal vein, seem at present to discredit the filtration theory and to support the secretion theory. If we accept this latter theory it may be asked how it agrees with the experiments mentioned above upon the variations in capillary pressure brought about otherwise than by obstructing the venous outflow. Heidenhain has emphasized the fact that all of these experiments involve not only a variation in capillary pressure, but also in the blood-flow, and that it is open to us to suppose that the effect upon the secretion of urine is dependent upon the rate of flow rather than upon the capillary pressure. If we adopt this explanation we are led again to the secretion hypothesis. Mere rate of flow should not influence filtration, but might affect secretion, since it would alter the volume of blood which passed by the cells in a given time and thereby would vary the quantity of oxygen supplied and of carbon dioxide removed, and also the quantity of chemical substances in the blood which may act as chemical stimuli to the cells. An important fact, which seems at first sight to show a direct influence of pressure, is that when general arterial pressure falls below a certain point, about 40 mm. of mercury, the secretion of urine ceases altogether. Such a condition may be brought about by surgical shock, by hemorrhage, or by section of the spinal cord in the cervical or thoracic region. But here again the great vascular dilation causing this fall of pressure is associated with a feeble circulation, and the effect upon the kidney secretion may well be due to this latter factor.

In addition to varying the factor  $P$  in the formula given above, it is possible also to increase the factor  $p$ . Normally, the pressure

of the urine in the capsule must be very low, owing to the fact that the secretion drains away as rapidly as it is formed. If the ureter is occluded, however, the pressure of the urine will increase, and the filtration pressure  $P-p$  will diminish. When this experiment is performed and the pressure in the ureter is measured by a manometer, it is found to rise to 50 or 60 mms. of mercury and then to remain stationary. This fact might be explained by supposing that when  $p = P$  the secretion stops on account of the failure of the filtration pressure. Little weight, however, can be given to this argument, since it is quite possible that under these conditions the urine may still continue to form, but be reabsorbed under the high tension reached. The experiment simply serves to show the secretion pressure of the urine, and the fact that this pressure rises as high as 50 to 60 mms. mercury, while the capillary pressure is probably somewhat lower, would rather serve as an argument against the filtration theory. Moreover, experiments show\* that when a certain moderate resistance is established in the ureters ( $p = 10$  cms.  $H_2O$ ) the flow of urine is actually increased, a fact entirely opposed to the mechanical theory.

**Function of the Convolted Tubule.**—By the term convolted tubule is meant here the entire stretch from the glomerulus to the straight tubules. Its epithelium varies in character; its cells are distinguished in general, as contrasted with the glomerular epithelium, by a relatively large amount of granular protoplasm. The question of interest at present in regard to this epithelium is whether it is secretory or absorptive. The original view of Ludwig that diffusion takes place in these tubules between the urine and the blood (lymph) in accordance with simple physical laws and that by this action alone the dilute urine is brought to its normal concentration must be abandoned. The mere fact that the urine may be more concentrated in certain constituents than the blood is sufficient evidence that other factors must co-operate. Those who believe that the main function of the tubules is absorptive are obliged to regard this process as physiological, as a selective absorption depending upon the living structure and properties of the epithelial cells. The kind of evidence upon which this view is based is somewhat indirect; a single example may suffice. Cushny states† that if certain diuretics—for example, sodium chlorid and sodium sulphate—are injected simultaneously into the blood and in such amounts that an equal number of the anions ( $Cl$  and  $SO_4$ ) are present, the quantities that are excreted in the urine during the next hour or two follow different curves and vary independently of their concentration in the plasma. While this independence might be

\* Brodie and Cullis, "Journal of Physiology," 1906, xxxiv., 224.

† "Journal of Physiology," 27, 429, 1902.



referred to a specific secretory action, the author finds a simpler explanation in variations in absorption, the epithelium of the convoluted tubule, like that of the intestine, absorbing the sulphate with more difficulty. On the other side, the facts that have been urged in favor of the secretory hypothesis are more numerous and varied. Some of these facts are as follows: (1) It is stated that if the ureters are ligated in birds the urates will be found deposited in the uriniferous tubules, but never at the capsular end. (2) Heidenhain has given proof that the convoluted tubules are capable of excreting indigo-carmin after this substance is injected into the blood. His experiment consisted in injecting the material into the blood, after dividing the cord so as to reduce the rapidity of secretion. After a certain interval the kidney was removed and irrigated with alcohol to precipitate the indigo-carmin *in situ* in the organ. Microscopical examination showed that after this treatment the granules of the indigo-carmin are found in the convoluted tubules, but not in the capsules around the glomeruli. (3) Microchemical staining reactions have been used by several observers to show that salts foreign to the blood, such as the iodids and ferrocyanids, are excreted through the convoluted tubules and not through the glomerulus. Recently Leschke\* has demonstrated by similar staining reactions that urea, uric acid, sodium chlorid, and sodium phosphate are all eliminated through the epithelium of the convoluted tubules. Each of these substances, when introduced into the blood, could be detected in concentrated form in the cells of the convoluted tubules, while no evidence of their presence in the glomeruli could be obtained. (4) Several observers (Van der Stricht, Disse, Trambasti, Gurwitsch†) have described microscopical appearances in the cells lining the tubules indicative of an active secretion. They picture the formation of vesicles in the cells and appearances which indicate the discharge of these vesicles into the cavity of the tubules. (5) Nussbaum made use of the fact that in the frog the glomeruli are supplied by branches of the renal artery, while the rest of the tubes are supplied by the renal portal vein. He stated that if the renal artery is ligated the glomeruli are deprived completely of blood, and that as a result the flow of urine ceases. If under these conditions urea is injected into the circulation, it is excreted together with some water, thus proving the secretory activity of the tubules with regard to urea. These results, although denied at one time, have later been confirmed and extended.‡ (6)

\* Leschke, "Zeitschrift für klinische Medizin," 81, 14, 1914.

† See Gurwitsch, "Archiv f. die gesammte Physiologie," 19, 71, 1902.

‡ Bainbridge and Beddard, "Journal of Physiology," 1906, xxxiv. (Proc. Physiol. Soc.); also Cullis, *ibid.*, p. 250.

Dreser has shown that the acidity of the urine is due to an action of the epithelium of the tubules. If an acid indicator, such as acid fuchsin, is injected into the dorsal lymph-sac of a frog, and an hour or so later the kidneys are examined, it will be found that the convoluted tubules are colored red, while the capsular end is colorless, indicating that the secretion at the latter point has an alkaline reaction. The experiment shows that the acid substances in the urine are produced in the convoluted tubules. The simplest explanation is that they are formed by a secretory activity of the epithelial cells. (7) Studies of the gaseous exchanges in the kidney during diuresis\* and during the glycosuria caused by phlorhizin† tend to support the secretion hypothesis to the extent that they prove an increased metabolism during functional activity. (8) The action of diuretics (see below). On the whole, it must be admitted that the weight of evidence is in favor of the Bowman-Heidenhain theory of secretion.

**Action of Diuretics.**—An important side of the theories of secretion of urine is their application to the action of diuretics. Water; various soluble substances, such as salts, urea, and dextrose; and certain special drugs, such as caffein or digitalis, exert a diuretic action on the kidneys. Much experimental work has been done to ascertain whether the action of these substances can be explained mechanically by their influence on the blood-flow or the blood-pressure in the kidney capillaries, or whether it is necessary to fall back upon a specific stimulating effect exerted by them upon the epithelial cells of the tubules. Adherents of the original Ludwig theory are forced to explain their action by the effect they produce upon the pressure in the kidney capillaries, and, indeed, it has been shown with reference to the saline diuretics that their effect upon the secretion is in proportion to the osmotic pressure they exert. It has been suggested, therefore, that the action of these diuretics lies in the fact that they attract water from the tissues into the blood and thus cause a condition of hydremic plethora. But whether the elimination of this excess of water is due to filtration or to an active secretion by the glomerular epithelium is a question that revives the discussion that has been presented briefly above. Most observers find that the vascular changes in the kidney, particularly after the administration of caffein and digitalis, do not explain satisfactorily the phenomenon of diuresis. It has been shown also that some diuretics cause an increased flow of urine without affecting the amount of oxygen absorbed from the blood by the kidney. Others, however, cause a distinct increase in the oxygen consumption. Since the oxygen consumption may

\* Barcroft and Brodie, "Journal of Physiology," 33, 52, 1906.

† Pavy, Brodie, and Siam, *ibid.*, 29, 467, 1903.

be considered as an indication of cellular activity, this result would tend to show that some diuretics may cause a genuine secretion, while others influence the amount of urine through mechanical or physical influences alone.\* In the case of the inorganic salts it may be said (Magnus) that there is for each salt a "secretion threshold." An increase in concentration above this level leads to the elimination of the excess of salt and an increased secretion of water.

**The Blood-flow through the Kidneys.**—It will be inferred from the discussion above that, other conditions remaining the same, the secretion of the kidney varies with the quantity of blood flowing through it. It is, therefore, important to refer briefly to the nature and especially the regulation of the blood-flow through this organ, although the same subject is referred to in connection with the general description of vasomotor regulation (see Circulation). It has been shown by Landergren † and Tigerstedt that the kidney is a very vascular organ, at least when it is in strong functional activity such as may be produced by the action of diuretics. They estimate that in a minute's time, under the action of diuretics, an amount of blood flows through the kidney equal to the weight of the organ; this is an amount from four to nineteen times as great as occurs in the average supply of the other organs in the systemic circulation. Taking both kidneys into account, their figures show that (in strong diuresis) 5.6 per cent. of the total quantity of blood sent out of the left heart in a minute may pass through the kidneys, although the combined weight of these organs makes only 0.56 per cent. of that of the body (see table p. 485).

The nature of the supply of vasomotor nerves to the kidney and the conditions which bring them into activity are fairly well known, owing to the useful invention of the oncometer by Roy. This instrument is, in principle, a plethysmograph especially modified for use upon the kidney of the living animal. It is a kidney-shaped box of thin brass made in two parts, hinged at the back, and with a clasp in front to hold them together. In the interior of the box thin peritoneal membrane is so fastened to each half that a layer of olive oil may be placed between it and the brass walls. There is thus formed in each half a soft pad of oil upon which the kidney rests. When the kidney, freed as far as possible from fat and surrounding connective tissue, but with the blood-vessels and nerves entering at the hilus entirely uninjured, is laid in one-half of the oncometer, and the other half is shut down upon it and tightly fastened, the organ is surrounded by oil in a box which is liquid-tight at every point except one, from which a tube is led off to some suitable recorder such as a tambour. Under these conditions every increase

\* Barcroft and Straub, *ibid.*, 1910, xli., 213.

† "Skandinavisches Archiv f. Physiologie," 4, 241, 1892.

in the volume of the kidney causes a proportional outflow of oil from the oncometer, which is measured by the recorder, and every diminution in volume is accompanied by a reverse change. At the same time the flow of urine during these changes can be determined by inserting a cannula into the ureter and measuring directly the outflow of urine. By this and other means it has been shown that the kidney receives a rich supply of vasoconstrictor nerve fibers that reach it between and around the entering blood-vessels. These fibers emerge from the spinal cord chiefly in the lower thoracic spinal nerves (tenth to thirteenth in the dog), pass through the sympathetic system, and reach the organ as postganglionic fibers. Stimulation of these nerves causes a contraction of the small arteries of the kidney, a shrinkage in volume of the whole organ as measured by the oncometer (see Fig. 240), and a diminished secretion of urine. When, on the other hand, these constrictor fibers are cut as they enter the hilus of the kidney, the arteries are dilated on account of the removal of the tonic action of the constrictor fibers, the organ enlarges, and a greater quantity of blood passes through it, since the resistance to the blood-flow is diminished while the general arterial pressure in the aorta remains practically the same. Along with this greater flow of blood there is a marked increase in the secretion of urine.

Under normal conditions we must suppose that these fibers are brought into play to a greater or less extent by reflex stimulation, and thus serve to control the blood-flow through the kidney and thereby influence its functional activity. It has been shown, too, that the kidney receives vasodilator nerve-fibers,—that is, fibers which when stimulated directly or reflexly cause a dilatation of the arteries, and therefore a greater flow of blood through the organ. According to Bradford, these fibers emerge from the spinal cord mainly in the anterior roots of the eleventh, twelfth, and thirteenth thoracic spinal nerves. Under normal conditions these fibers are probably thrown into action by reflex stimulation and lead to an increased functional activity. It will be seen, therefore, that the kidneys possess a local nervous mechanism through which their secretory activity may be increased or diminished by corresponding alterations in the blood-supply. So far as is known, this is the only way in which the secretion in the kidneys can be directly affected by the central nervous system. It should be borne in mind, also, that the blood-flow through the kidneys, and therefore their secretory activity, may be affected by conditions influencing general arterial pressure. Conditions such as asphyxia, strychnin poisoning, or painful stimulation of sensory nerves, which cause a general vasoconstriction, influence the kidney in the same way, and tend, therefore, to diminish the flow of blood through it; while conditions

which lower general arterial pressure, such as general vascular dilatation of the skin vessels, may also depress the secretory action of the kidney by diminishing the amount of blood flowing through it.

In what way any given change in the vascular conditions of the body will influence the secretion of the kidney depends upon a number of factors and their relations to one another, but any change which will increase the difference in pressure between the blood in the renal artery and the renal vein will tend to augment the flow of blood unless it is antagonized by a simultaneous constriction in the small arteries of the kidney itself. On the contrary, any vascular dilatation of the vessels in the kidney will tend to increase the blood-flow through it unless there is at the same time such a general fall of blood-pressure as is sufficient to lower the pressure in the renal artery and reduce the driving force of the blood to an extent that more than counteracts the favorable influence of diminished resistance in its small arteries.

**Hormone Stimulation.**—The evidence for the existence of secretory nerves to the kidney is either negative or unsatisfactory. The secretion of urine is probably controlled through chemical stimuli. Various foreign substances, or the normal constituents of the blood when in excess of a certain concentration, are secreted, presumably, on the general theory adopted, because they stimulate in some way the activity of the kidney cells.

The increased amount of urine that occurs when the blood-flow through the gland is increased may be referred in a general way to the greater amount of these chemical stimuli, excretory products, etc., that pass through the organ. The general metabolism of the body is constantly adding to the blood substances of this kind, which manifest some special reaction with the kidney cells that results in their secretion. But, in addition to these general stimuli, it is possible that specific hormones may be produced that are adapted to stimulate the kidneys and correlate their activity to conditions elsewhere in the body. Schaefer\* and Herring have shown that a substance is contained in extracts of the posterior lobe of the pituitary gland which has this action, and it is quite probable that this hormone may function normally, although as yet we know nothing of the conditions under which it acts. Cow† has stated that a similar diuretic hormone is formed in the mucous membrane of the intestine, particularly of the duodenum and jejunum. When water is taken this hormone is carried into the blood with the absorbed water and is responsible for the resulting diuresis. It is stated that water taken by mouth causes

\* Schaefer and Herring, "Philosophical Transactions" (London), B. 199, 1, 1906.

† Cow, "Journal of Physiology," 48, 1, 1914.

diuresis, when a similar amount injected directly into the blood may have no effect. These suggestive experimental facts indicate the possibility that the secretion of the kidney may be controlled in a more specific way than has been supposed heretofore.

**The Composition of Urine.**—The urine of man is a yellowish liquid that varies greatly in depth of color. It has an average specific gravity of 1.020 and usually an acid reaction to litmus paper. This acid reaction is attributed generally to the presence of acid phosphates, particularly acid sodium phosphate ( $\text{NaH}_2\text{PO}_4$ ), but, according to Folin, it is due partially to organic acids. As determined by physicochemical methods, normal human urine shows on the average a true acidity equivalent to a concentration of hydrogen ions of  $10^{-6}$  or 0.000001 grams per liter. In place of the actual concentration of the hydrogen ions it is customary to use the logarithm of the figure expressing the concentration. These logarithms are all negative, but are written without the minus sign as the hydrogen exponent. Thus:

HYDROGEN ION CONCENTRATION.	HYDROGEN EXPONENT.
$1 \times 10^{-1}$ or 0.1 . . . . .	1
$2 \times 10^{-3}$ or 0.002 . . . . .	2.7 (+ 0.3 —3)
$5 \times 10^{-6}$ or 0.000005 . . . . .	5.3 (+ 0.7 —6)

In this nomenclature the acidity of the urine varies between limits, expressed by the figures 4.82 and 7.45 ( $\text{H}^+$  concentrations, 0.000016 and 0.00000008).\* In comparison with these figures it may be recalled that a neutral reaction, such as is shown by water, is expressed by the exponent 7, while blood inclines to the alkaline side, exponent of 7.4 ( $\text{H}^+$  concentration,  $0.4 \times 10^{-7}$ ). One of the conditions influencing the reaction of the urine is the character of the food. On an animal diet the acidity is increased; on a vegetable diet it is diminished and may reach the neutral point or the degree of alkalinity exhibited by the blood. In the latter case the urine may give a blue reaction to litmus paper, owing to the alkaline salts present, but, as has been explained (p. 416), this reaction does not demonstrate a true alkalinity, that is, an excess of  $-\text{OH}$  ions over the  $+\text{H}$  ions. Distinct alkalinity in this sense may be shown when the urine has undergone bacterial fermentation with the production of ammonia. The general explanation of the effect of food that has been suggested (Drechsel) is that upon an animal diet more acids are formed (from the oxidation of the sulphur and phosphorus of the proteins) than in the case of the vegetable foods in which the alkaline salts of the vegetable acids give rise on oxidation in the body to alkaline carbonates. The

\* Henderson and Palmer, "Journal of Biological Chemistry," 13, 394, 1912.

secretory activity of the kidney serves to maintain a normal balance between the acid and basic equivalents in the blood, and the fact that on an ordinary mixed diet the urine has an acid reaction indicates that the acids formed in the body during metabolism must exceed the bases. It is evident from this consideration that the kidneys take an important part in maintaining the substantial neutrality of the blood. The kidneys and the lungs co-operate in this function, the former by the secretion of the excess of acid salts and organic acids or the excess of bases, as the case may be, the latter by the elimination of carbon dioxid.

The composition of the urine is very complex. In addition to the water and inorganic salts the following elements are important, namely, urea, the purin bodies (uric acid, xanthin, hypoxanthin), creatinin, hippuric acid, oxalic acid (calcium oxalate), several conjugated sulphates and conjugated glycuronates, several aromatic oxyacids and nitrogenous acids, fatty acids, dissolved gases (N and CO<sub>2</sub>), and the urinary pigments urochrome and urobilin. This list is not complete; a number of additional substances have been described as occurring constantly or occasionally in traces within the limits of health, and some substances are secreted whose composition is unknown. Under pathological conditions the composition may be still further modified. The complexity of the composition may be understood when it is recalled that through this organ are eliminated some of all the end-products formed in the various tissues, together with products arising from bacterial fermentation in the gastro-intestinal canal and various more or less foreign substances taken with the food. It is not possible to describe all the numerous constituents that have been observed. Attention may be directed to those that quantitatively or otherwise are of chief physiological interest.

**The Nitrogen Elimination in the Urine.**—In the metabolism of the usual foodstuffs—carbohydrates, fats, and proteins—the end-products of their destruction or physiological oxidation in the body are water, carbon dioxid, and nitrogenous waste products (and sulphates and phosphates from the sulphur and phosphorus in the proteins). The water is eliminated in the urine, the sweat, saliva, etc., and the expired air. The CO<sub>2</sub> is eliminated in the expired air, and in smaller part in dissolved form in the secretions (sweat, urine). The nitrogenous excretion, representing the breaking down of protein material, is found in minute part in the sweat, to a larger extent in the feces, but in by far the main amount in the urine. In all problems concerning protein metabolism in the body, both as regards its character and extent, the quantitative study of this excretion is of paramount importance. In order to determine the total amount of protein metabolism it is customary to determine

the total nitrogen eliminated in the urine, without regard to its specific form. This determination is made usually by the method of Kjeldahl. The total weight of nitrogen multiplied by 6.25 gives the amount of protein broken down, since nitrogen forms, on the average, 16 per cent. of the weight of the protein molecule. In an average-sized man the total nitrogen eliminated in a day varies, let us say, between 14 and 18 gms., which would correspond to 88 and 117 gms. of protein. It is often necessary to distinguish between the forms in which this nitrogen is eliminated, and in analyses of the urine for qualitative purposes, that is, to throw light on the kind of metabolism taking place in the body, the following division or partition of the nitrogen is made according to special methods of analysis:\*

1. The *urea nitrogen*, that is, the amount of nitrogen excreted in the form of urea. The amount of nitrogen eliminated in this form varies with the amount of protein food in the diet, as is explained below. Under normal conditions it constitutes 80 per cent. or more of the total nitrogen.

2. The *ammonia nitrogen*, the nitrogen excreted in the form of ammonia salts which liberate free ammonia on the addition of a fixed alkali. Under normal conditions it constitutes from 4 to 5 per cent. of the total nitrogen. Its special metabolic significance is described below.

3. The *creatinin nitrogen*, the nitrogen excreted in the form of creatinin. An average estimate for the human urine is 3.6 per cent. of the total nitrogen. This product has also a special metabolic significance, which is discussed below.

4. The *purin nitrogen*, the nitrogen excreted in the form of purin compounds (uric acid, xanthin, hypoxanthin). These products give an index of the amount of nucleic acid metabolized in the body, and the nitrogen thus eliminated may be given an average value of 1 to 2 per cent. of the total nitrogen.

5. *The Amino-acid Nitrogen.* † Some of the nitrogen is excreted in the form of amino-acids, either free or combined. An example of the combined form is the compound hippuric acid, which consists of benzoic acid in combination with amino-acetic acid (glycin).

6. *Unknown Nitrogen.* Certain nitrogenous substances are excreted in the urine whose structure and physiological significance are as yet undetermined. Among these substances are the so-called oxyproteic acids which contain both nitrogen and sulphur. They are derived presumably from the metabolism of proteins, but the special significance to be attributed to them cannot be stated.

\* Folin, "American Physiological Journal," 13, 45, 1905.

† Henriques and Sörenson, "Zeitschrift für physiol. Chemie," 64, 120, 1910.



The unknown nitrogen may constitute as much as 3 to 5 per cent. of the total nitrogen.

**Origin and Significance of Urea.**—Urea has the formula,  $\text{CO-N}_2\text{H}_4$ . It may be considered as an amid of carbonic acid, and has, therefore, the structural formula of  $\text{CO} \begin{matrix} \text{NH}_2 \\ \text{NH}_2 \end{matrix}$ . It occurs in the urine in relatively large quantities (2 per cent.). As the total quantity of urine secreted in twenty-four hours by an adult male may be placed at from 1500 to 1700 c.c., it follows that from 30 to 34 gms. of urea are eliminated from the body during this period. It is the most important of the nitrogenous excreta of the body, the chief end-product, so far as the nitrogen is concerned, of the physiological metabolism of the proteins of the foods and the tissues. In addition to the urine, urea is found in slight quantities in other secretions—in milk (in traces) and in sweat. In the latter liquid the quantity of urea in twenty-four hours may be quite appreciable—as much, for instance, as 0.8 gm.—although such a large amount is found only after active exercise. Urea is present normally in the blood in an amount equal to 27 to 28 mgms to 100 c.c. of blood (0.028 per cent.), and it has been shown that the tissues generally contain the urea in about the same concentration.\* In fact, the urea diffuses into the tissues with great ease, and when for any reason the concentration in the blood varies the amount in the tissues rises or falls in a corresponding way. The kidneys constantly remove the urea as it is formed, and by their secretory activity the amount of urea in the blood is kept normally at the low level given above. When the kidneys are removed the amount of urea in the blood rises, showing that this substance is formed elsewhere in the body. The history of the formation of urea in the body is not entirely known, but three sources of origin may be stated with some positiveness.

1. Urea arises from ammonia salts which, in the liver, are converted to urea by a process equivalent to dehydration. It has long been known that when ammonium carbonate is added to blood perfused through a liver it is converted to urea.† The reaction may be represented as follows:

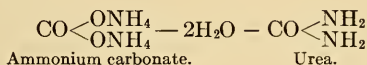

Moreover, the experiments made by Hahn, Pawlow, Massen, and Nencki‡ show that in dogs removal of the liver is followed by a

\* Marshall and Davis, "Journal of Biological Chemistry," 18, 53, 1914.

† Schroeder, "Archiv f. exp. Pathol. u. Pharmakol.," vols. xv. and xix., 1882, 1885.

‡ See "Archiv f. exp. Pathol. u. Pharmakol.," 1893, xxxii., 161.

decrease in the amount of urea in the urine and an increase in the ammonia contents. In these remarkable experiments a fistula (Eck fistula) was made between the portal vein and the inferior vena cava, the result of which was that the whole portal circulation of the liver was abolished, the organ receiving blood only by way of the hepatic artery. If now the latter artery was ligated and the liver was cut away as far as possible, the result was practically a complete extirpation of the organ. Later investigations\* showed that in normal animals the ammonia contents of the blood of the portal vein may be three to four times as great as in arterial blood, but that after removal of the liver the ammonia in the general circulation increases to a point equal to that observed for the portal blood and produces symptoms of poisoning which may result fatally. It would seem, therefore, that the liver protects the body from the poisonous action of the ammonia compounds by converting them to urea. Now in the normal digestive hydrolysis of proteins brought about by the successive action of pepsin, trypsin, and erepsin the protein material is split largely or entirely into its constituent elements and its nitrogen appears mainly in the form of the amino-acids, but to some extent also probably as ammonia. In addition there is evidence that some ammonia is formed in the large intestine, as the result of the action of the putrefactive bacteria. The ammonia produced in these ways is probably carried to the liver and there converted to urea. In what form the ammonia exists in the blood is not positively known; it may be present as a carbonate or possibly, as some observers have thought, as a carbamate. Ammonium carbamate might be changed to urea according to the following reaction:

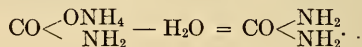

Ammonia salts may arise similarly in the tissues of the body, since the cells contain intracellular enzymes capable of causing hydrolytic cleavage of the protein molecule. So far as ammonia is produced in this way, it will be converted to urea by the action of the liver and possibly by a similar action in other tissues.

2. Urea arises from the monamino-acids by a process of deamination, whereby the  $\text{NH}_2$  group is converted to ammonia and then probably to urea. In the digestion of protein in the alimentary canal amino-acids are formed in quantity. The current belief in physiology is that these amino-acids are carried in the blood to the various tissues and are there resynthesized in part to form the characteristic protein of the tissue. The tissues pick and choose the several amino-acids necessary for their reconstruction or growth.

\* See Nencki and Pawlow, "Archives des sciences biologiques," v., 213.

The amino-acids not so used have their  $\text{NH}_2$  group removed by the process of deaminization, leaving behind an organic acid or oxyacid which is of further use in nutrition, for example, as a source for the production of sugar (p. 825). The general nature of the process is represented by the conversion of alanin to lactic acid.



There is evidence to show that this process of deaminization,\* as well as the further conversion of the ammonia to urea, takes place in the liver, although it is quite possible that both functions may be exhibited by other tissues as well. On this view we can understand why the amount of urea eliminated in the urine rises and falls with the amount of protein taken as food.† On a large protein diet the amount of nitrogenous material supplied is in excess of the amount needed for tissue construction. It may be supposed that the excess nitrogen is promptly removed and excreted as urea according to the process described above. It seems probable that the larger part of the urea actually found in the urine under normal conditions comes in this way rather directly from the food. The nitrogen has never entered into the structure of the body. But on the lowest protein diet or in starvation, when the body is living on its own tissues, urea continues to be formed, so that in part the urea of the urine contains some nitrogen which has probably arisen from the destruction of protein tissue. The intermediate steps in this latter process are not definitely known, but possibly they may be analogous to those described, that is to say, the protein may pass through the stage of amino-acids and subsequently undergo deaminization.

3. Urea arises from the arginin, formed in the cleavage of the protein molecule by conversion of the contained guanidin radicle. Kossel and Dakin‡ have demonstrated the existence of a ferment, present in the liver especially, but found also in the kidney, thymus, muscle, etc., arginase, which is capable of splitting arginin into urea and ornithin. The reaction may be represented by the following equation:

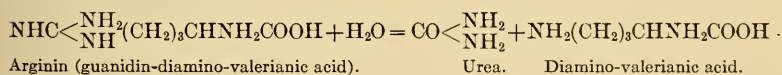

Unlike cases 1 and 2, the urea in this instance is formed from the guanidin residue contained in the arginin and not from the amino-

\* Van Slyke and Meyer, "Journal of Biological Chemistry," 16, 187, *et seq.*, 1914.

† Folin, "American Journal of Physiology," 13, 117, 1905.

‡ "Zeitschrift f. physiol. Chemie," 1904, xlii., 181.

group. Since arginin constitutes one of the split-products of the protein during digestion and probably also one of the split-products in the metabolism of the proteins of the tissues, there is reason to believe that part of the urea actually formed in the body arises by this method. It is possible that by some similar method the nitrogen of the heterocyclic radical in other amino-acids (imidazol, indol, pyrol) may give rise to urea, but nothing is known in regard to this possibility.

**Origin and Significance of the Purin Bodies (Uric Acid, Xanthin, Hypoxanthin, Adenin, Guanin).**—These bodies are related chemically, and appear also to have a common physiological significance. Their chemical relations have been described by Emil Fischer, to whom we owe the term purin bodies. Fischer pointed out that these and other substances belonging to this group have a common nucleus:

$$\begin{array}{c} \text{N} - \text{C} \\ | \quad | \\ \text{C} \quad \text{C} - \text{N} \\ | \quad | \quad \diagup \\ \text{N} - \text{C} - \text{N} > \text{C} \end{array}$$
 which he named the purin nucleus. The hydrogen compound of this nucleus would be designated as purin,

and would have the formula:
 
$$\begin{array}{c} \text{N} = \text{CH} \\ | \quad | \\ \text{HC} \quad \text{C} - \text{NH} \\ || \quad || \\ \text{N} - \text{C} - \text{N} > \text{CH} \end{array}, \text{C}_5\text{H}_4\text{N}_4.$$

tion of an atom of oxygen gives hypoxanthin,  $\text{C}_5\text{H}_4\text{N}_4\text{O}$ :

$$\begin{array}{c} \text{HN} - \text{CO} \\ | \quad | \\ \text{HC} \quad \text{C} - \text{NH} \\ || \quad || \\ \text{N} - \text{C} - \text{N} > \text{CH} \end{array}$$
 Addition of two atoms of oxygen gives xan-

thin,  $\text{C}_5\text{H}_4\text{N}_4\text{O}_2$ :
 
$$\begin{array}{c} \text{HN} - \text{CO} \\ | \quad | \\ \text{CO} \quad \text{C} - \text{NH} \\ | \quad || \\ \text{HN} - \text{C} - \text{N} > \text{CH} \end{array}$$

And addition of three atoms of oxygen gives uric acid,  $\text{C}_5\text{H}_4\text{N}_4\text{O}_3$ :
 
$$\begin{array}{c} \text{HN} - \text{CO} \\ | \quad | \\ \text{CO} \quad \text{C} - \text{NH} \\ | \quad || \\ \text{HN} - \text{C} - \text{N} > \text{CO} \\ \quad \quad \quad | \\ \quad \quad \quad \text{NH} \end{array}$$

from this standpoint might be named trioxypurin. If one of the H atoms in the purin is substituted by an amino-group,  $\text{NH}_2$ , the compound, adenin ( $\text{C}_5\text{H}_5\text{N}_5$ ), is obtained, and the substitution of an  $\text{NH}_2$  group in hypoxanthin gives the compound guanin ( $\text{C}_5\text{H}_5\text{N}_5\text{O}$ ). Moreover, caffen, the active principle of coffee and tea, and theobromin, the active principle of cocoa, are respectively trimethyl and dimethyl compounds of xanthin. We have to distinguish, therefore, three classes of purin compounds, namely, the *oxypurins*, comprising monoxypurin or hypoxanthin, dioxypurin or xanthin, and trioxypurin or uric acid; the *aminopurins*, comprising adenin or

aminopurin and guanin or aminohypoxanthin, and the *methylpurins*, comprising caffenin or trimethyl xanthin ( $C_8H_{10}N_4O_2$  or  $C_5H(CH_3)_3N_4O_2$ ) and theobromin or dimethyl xanthin ( $C_7H_8N_4O_2$  or  $C_5H_2(CH_3)_2N_4O_2$ ). Uric acid, xanthin, and hypoxanthin are found constantly in the urine and in the feces small amounts of xanthin, hypoxanthin, adenin, and guanin may also occur. It has been pointed out\* that these substances come partly from purin bodies taken as food. If materials containing the purin bodies, such as meat, are fed, these bodies are excreted in part in the urine. It is proposed to designate the uric acid, etc., that has this origin as the exogenous purin material. A portion of the amount daily secreted comes, however, from a metabolism of the protein material of the body, and this portion may be distinguished as the endogenous purin bodies. This latter amount is found to be practically constant, 0.15 to 0.20 gm. per day for any one individual, and the amount is not affected by changes in the quantity or character of the food, but varies within certain limits with the manner of life. Evidently the endogenous purin nitrogen represents a special metabolism, probably of the living tissues, that goes on independently, in great measure, of the mere oxidation of food. Evidence has accumulated which shows that the purin bodies of the urine represent the end-products of the metabolism of nucleic acid, either the nucleic acid of the tissues or the nucleic acid of the food.† Nucleic acid exists in the body in more or less definite combination with protein to form the so-called nucleoproteins which are supposed to occur chiefly in the nuclei of the cells. The nucleic acid itself on hydrolysis yields several nitrogenous bases, guanin, adenin, cytosin, and thymin, in addition to phosphoric acid and a carbohydrate. Guanin and adenin are purin bases, while the cytosin and thymin have a different structure and are known as pyrimidin bases. Within the molecule of nucleic acid these constituents are grouped, so that each nitrogenous base is united to a carbohydrate and a phosphoric-acid complex. Such a grouping is designated as a nucleotide, and nucleic acid is frequently spoken of as a tetranucleotide whose structure may be represented diagrammatically as follows:

Adenin-carbohydrate-phosphoric acid.  
 Guanin-carbohydrate-phosphoric acid.  
 Cytosin-carbohydrate-phosphoric acid.  
 Thymin-carbohydrate-phosphoric acid.

The breaking down of the nucleic acid involves the action of a number of different enzymes and the story is complicated and not

\* See Burian and Schur, "Archiv f. die gesammte Physiologie," 94, 273, 1903.

† For a full account and the literature consult Jones, "Nucleic Acids—Their Chemical Properties and Physiological Conduct," 1914.

wholly agreed upon by the different workers. It is supposed that the nucleic acid is liberated from its combination with protein by the action of the known proteolytic enzymes, such as pepsin or trypsin or the similar autolytic enzymes in the tissues. For the destruction of the nucleic acid itself there is a series of special enzymes whose action as described by Jones is essentially as follows:

1. The tetranucleotide is split into two dinucleotides (purin and pyrimidin) by the enzyme tetranuclease. The further history of the pyrimidin nucleotides is not known.

2. The purin nucleotides are split by two enzymes, phosphonuclease and purin-nuclease. The former splits off phosphoric acid and leaves the purin bases in combination with the carbohydrate, giving two compounds known as nucleosides, namely, adenosin and guanosin. The purin-nuclease splits off adenin and guanin in free form .

3. The four substances, adenin, guanin, adenosin, and guanosin, are acted upon by corresponding deaminizing enzymes, adenase, guanase, adenosin-deaminase, and guanosin-deaminase, and converted to oxypurins. For the adenin and guanin the reaction is as follows:

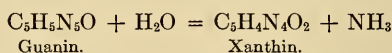
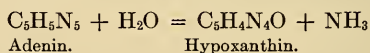

The nucleosides (adenosin and guanosin) may first be converted to the corresponding oxy-compounds (xanthosin and inosin), and then by hydrolysis the carbohydrate is split off with the liberation of xanthin and hypoxanthin.

4. The xanthin and hypoxanthin, under the influence of an oxidase (xanthinoxidase), are in part oxidized to uric acid,  $\text{C}_5\text{H}_4\text{N}_4\text{O}_3$ . In man this oxidase seems to occur only in the liver, so that the immediate production of uric acid must be referred to this organ.

5. In man the uric acid, xanthin, and hypoxanthin represent the final end-products of the metabolism of the nucleic acid or, rather, of the purin nucleotide portion of its molecule, and to the extent that they occur in the urine they indicate so much nucleic acid broken down. In the other mammals the oxidation process goes a step further—the uric acid is converted to allantoin by an oxidase known as uricolytic enzyme or uricase, whose action may be represented by the equation:

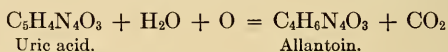

**Origin and Significance of the Creatinin and Creatin.**—Creatinin ( $\text{C}_4\text{H}_7\text{N}_3\text{O}$ ) occurs in the urine, and it was formerly as-

sumed that it is derived from the creatin ( $C_4H_9N_3O_2$ ) found in muscle. Its structural formula is given as  $NHC \begin{matrix} \diagup NH - CO \\ \diagdown N(CH_3)CH_2 \end{matrix}$  and its chemical relations are indicated by the fact that it may be prepared synthetically from methyl-glycocoll and cyanamid—that is, the union of these two substances gives creatin, from which in turn creatinin may be obtained by loss of a molecule of water.



Creatinin occurs in the urine constantly and in amounts equal to 1 to 2 gms. per day, or, according to Schäffer,\* there is an excretion of from 7 to 11 mg. of creatinin nitrogen per kilogram of body-weight. Next to the urea and the ammonia compounds it forms the most important of the known nitrogenous constituent of the urine. Its physiological history is imperfectly known. Under constant conditions of life the amount of creatinin formed in the body is independent of the quantity of protein eaten, and this fact indicates (Folin) that it represents an end-product of the metabolism of living or organized protein tissue rather than one of the results of the metabolism of the food protein. This conclusion is strengthened by the fact that in fevers and other pathological conditions in which there is an increased breaking down of tissues the creatinin excretion is increased.† Creatinin is present in small amounts in the blood, 1 to 2 mgms. per 100 gms. of blood, and in somewhat larger amount in the muscular tissue. Creatin, on the other hand, is present in muscular tissue to a relatively large per cent., 0.5 to 0.6 gm. per 100 gms. of muscle, although Folin contends‡ that this large yield is due to postmortem changes and that in the living muscle little or none is present in free condition. Creatin occurs in the blood in small amounts, but in the urine it is not normally present so far as the normal adult man is concerned. In children, however, it is constantly present in the urine, and in women it is said to occur after menstruation, during pregnancy, and in the puerperium.§ So also in mankind the urine shows the presence of creatin during starvation or in fevers. It has not been found possible to interpret satisfactorily these various facts. According to one view,|| the creatin and creatinin are related and

\* Consult Schäffer, "American Journal of Physiology," 33, 1, 1908.

† Hoogenhuyze and Verploegh, "Zeitschrift f. physiol. Chemie," 57, 161, 1908.

‡ Folin and Denis, "Journal of Biological Chemistry," 17, 493, 1914.

§ Krause, "Quarterly Journal of Exp. Physiology," 7, 87, 1913.

|| Mendel and Rose, "Journal of Biological Chemistry," 10, 213, 1911; also Meyers and Fine, *ibid.*, 15, 283, 1913.

have a common physiological significance in regard to the metabolism. The creatin is regarded as an end-product of the break-down of organized or living protein tissue. It is produced constantly in the tissues and is normally converted to creatinin before it is excreted in the urine. Under exceptional conditions, such as starvation or fever, the disintegration of the tissues is increased and the amount of creatin produced is too large to be wholly changed to creatinin, with the result that both creatin and creatinin appear in the urine. Other observers\* believe that the metabolic history and significance of creatin and creatinin are different. The creatinin formed in the tissues represents an end-product of the breaking down of the organized tissue and, indeed, forms an index of the amount of this tissue wear and tear, but it is given off to the blood and excreted in the urine as creatinin. The creatin, on the contrary, while also constantly formed in the tissues as a result of their metabolism, is not converted to creatinin, but undergoes some further and as yet unknown metabolic change. When creatin is fed to a man, for example, it is not excreted in the urine as creatin or as creatinin, but is used in some way in the body. On this view the significance of the creatin remains undetermined, and its genesis and fate are also left unsettled, except so far as to deny its conversion to creatinin.

**Hippuric Acid.**—This substance has the formula  $C_9H_9NO_3$ . Its molecular structure is known, since upon decomposition it yields benzoic acid and glycocoll, and, moreover, it may be produced synthetically by the union of these two substances. Hippuric acid may be described, therefore, as a benzoyl-amino-acetic acid ( $CH_2-NH[C_6H_5CO]COOH$ ). It is found in considerable quantities in the urine of herbivorous animals (1.5 to 2.5 per cent.), and in much smaller amounts in the urine of man and of the carnivora. In human urine, on an average diet, about 0.7 gm. are excreted in twenty-four hours. If the diet is largely vegetable, this amount may be much increased. This last fact is readily explained, for it has been found that if benzoic acid or substances containing this grouping are fed to animals they appear in the urine as hippuric acid. Evidently a synthesis occurs in the body, and Bunge and Schmieberg proved conclusively that in dogs the union of benzoic acid and glycocoll to form hippuric acid takes place in the kidney itself. Later it was discovered† that the same synthesis may be effected by ground-up kidney tissue, mixed with blood and kept under oxygen pressure. It seems possible, therefore, that the synthesis is due to some specific constituent of the kidney cells,

\* Folin and Krause, *loc. cit.*; also Benedict and Osterberg, "Journal of Biological Chemistry," 18, 195, 1914.

† Bashford and Cramer, "Zeitschrift f. physiol. Chemie," 35, 324, 1902.



possibly an enzyme. Vegetable foods contain benzoic acid compounds, and we can understand, therefore, why when fed they increase the hippuric acid output of the urine. Since in starving animals or animals fed upon meat hippuric acid is still present in the urine, although reduced in amount, it is evident that it arises in part as a result of the body metabolism. The physiological significance of this nitrogenous product is different from those previously considered in that it does not represent the result of a special metabolism of protein food or protein tissue, but is rather a provision by which benzoic acid when present in the food or formed in the body is conjugated with glycin and excreted.

**The Conjugated Sulphates and the Sulphur Excretion.**—The sulphur excretion of the urine possesses an importance similar to that of nitrogen. Sulphur constitutes an element in most of the proteins, and in some form, therefore, it will be represented in the end-products of protein metabolism. The sulphur elimination in the urine, like the nitrogen elimination, has been taken as a measure of the amount of protein destruction. In the urine the sulphur occurs in three forms: (1) In an oxidized form as inorganic sulphates. Some of the sulphates are undoubtedly derived or may be derived from the mineral sulphates ingested with the food, but the larger part arises from the oxidation of the sulphur of the proteins. (2) The so-called conjugated or ethereal sulphates are combinations between sulphuric acid and indoxyl, skatoxyl, phenol, and cresol, giving us phenolsulphuric acid ( $C_6H_5OSO_2OH$ ), cresolsulphuric acid ( $C_7H_7OSO_2OH$ ), indoxylsulphuric acid or indican ( $C_8H_6NOSO_2OH$ ), and skatoxylsulphuric acid ( $C_9H_8NOSO_2OH$ ). The indol, skatol, phenol, and cresol are formed in the large intestine as a result of bacterial putrefaction. They are eliminated in part in the feces, but in part are absorbed into the blood, and after oxidation are conjugated with sulphuric acid and eliminated in the urine. The process of conjugation is valuable from a physiological standpoint, as it converts substances having an injurious action into harmless compounds. It should be added, also, that to a small extent the phenol, indoxyl, and skatoxyl may be secreted in the urine as conjugated glucuronates,—that is, in combination with glycuronic acid ( $C_6H_{10}O_7$ ), a reducing substance closely connected with dextrose. From a nutritional standpoint the amount of these substances present furnishes a measure of the extent of protein putrefaction in the intestine, by virtue of the indol and phenol constituents. All conditions that increase the putrefactive processes in the intestine are accompanied by a parallel increase in the ethereal sulphates. By virtue of the sulphuric acid component these bodies represent also one of the forms in which sulphur is excreted from the

body. (3) Some of the sulphur in the urine may occur in unoxidized form as sulphocyanid or as ethyl-sulphide (Abel)  $[(C_2H_5)_2S]$ . Under certain pathological conditions (cystinuria) some sulphur may be excreted in the form of cystin, but this is not a normal constituent of the urine. For other most interesting and significant changes in the composition of the urine under pathological conditions reference must be made to special works upon the urine or upon pathological chemistry.

**Water and Inorganic Salts.**—Water is lost from the body through three main channels,—namely, the lungs, the skin, and the kidney, the last of these being the most important. The quantity of water lost through the lungs probably varies within small limits only. The quantity lost through the sweat varies, of course, with the temperature, with exercise, etc., and it may be said that the amounts of water secreted through kidney and skin stand in something of an inverse proportion to each other; that is, the greater the quantity lost through the skin, the less will be secreted by the kidneys. Through these three organs, but mainly through the kidneys, the blood is being continually depleted of water, and the loss must be made up by the ingestion of new water. When water is swallowed in excess the superfluous amount is rapidly eliminated through the kidneys, and there is some evidence (p. 843) that in this case the excretion of the excess of water is controlled by a special hormone found in the small intestine. The amount of water secreted may be increased by the action of diuretics, such as potassium nitrate and caffeine.

The inorganic salts of urine consist chiefly of the chlorids, phosphates, and sulphates of the alkalies and the alkaline earths. It may be said, in general, that they arise partly from the salts ingested with the food, and are eliminated from the blood by the kidney in the water secretion; and in part they are formed in the destructive metabolism that takes place in the body, particularly that involving the proteins and related bodies. Sodium chlorid occurs in the largest quantities, averaging about 15 gms. per day, of which the larger part, doubtless, is derived directly from the salt taken in the food. The phosphates occur in combination with calcium and magnesium, but chiefly as the acid phosphates of sodium or potassium. The acid reaction of the urine is usually attributed to these latter substances. The phosphates result in part from the destruction of phosphorus-containing tissues in the body, but chiefly from the phosphates of the food. The sulphates of urine are found partly in an oxidized form as simple sulphates or conjugated with organic compounds, as described above.

**Micturition.**—The urine is secreted continuously by the kidneys, is carried to the bladder through the ureters, and is then at

intervals finally ejected from the bladder through the urethra by the act of micturition.

*Movements of the Ureters.*—The ureters possess a muscular coat consisting of an internal longitudinal and external circular layer. The contractions of this muscular coat form the means by which the urine is driven from the pelvis of the kidney into the bladder. The movements of the ureter have been carefully studied by Engelmann.\* According to his description, the musculature of the ureter contracts spontaneously at intervals of ten to twenty seconds (rabbit), the contraction beginning at the kidney and progressing toward the bladder in the form of a peristaltic wave and with a velocity of about 20 to 30 mms. per second. The result of this movement should be the forcing of the urine into the bladder in a series of gentle, rhythmical spurts, and this method of filling the bladder has been observed in the human being. Suter and Mayer† report some observations upon a boy in whom there was ectopia of the bladder, with exposure of the orifices of the ureters. The flow into the bladder was intermittent and was about equal upon the two sides for the time the child was under observation (three and a half days).

The causation of the contractions of the ureter musculature is not easily explained. Engelmann finds that artificial stimulation of the ureter or of a piece of the ureter may start peristaltic contractions which move in both directions from the point stimulated. He was not able to find ganglion cells in the upper two-thirds of the ureter and was led to believe, therefore, that the contraction originates in the muscular tissue independently of extrinsic or intrinsic nerves, and that the contraction wave propagates itself directly from muscle cell to muscle cell, the entire musculature behaving as though it were a single, colossal, hollow muscle-fiber. Efforts to show a regulatory action upon these movements through the central nervous system have so far given negative results.

*Movements of the Bladder.*—The bladder contains a muscular coat of plain muscle tissue, which, according to the usual description, is arranged so as to make an external longitudinal coat and an internal circular or oblique coat. A thin, longitudinal layer of muscle tissue lying to the interior of the circular coat is also described. The separation between the longitudinal and circular layers is not so definite as in the case of the intestine; they seem, in fact, to form a continuous layer, one passing gradually into the other by a change in the direction of the fibers. At the opening of the bladder into the urethra, the musculature in the submucosa is

\* "Pflüger's Archiv f. die gesammte Physiologie," 2, 243, 1869, and 4, 33; see also Lucas, "American Journal of Physiology," 17, 392, 1906.

† "Archiv f. exper. Pathologie und Pharmakologie," 32, 241, 1893.

strengthened to form a ring around the orifice and along the beginning of the urethra which is supposed to function as a sphincter, the internal sphincter or *sphincter vesicæ internus*. Around the urethra, in the prostatic and membranous portions, is a circular layer of striated muscle that is frequently designated as the external sphincter or sphincter urethræ. The urine brought into the bladder accumulates within its cavity to a certain limit. It is prevented from escaping through the urethra by a tonic contraction of the internal sphincter. When the accumulation becomes greater the external sphincter may be brought into action. Back-flow of urine from the bladder into the ureters is effectually prevented by the oblique course of the ureters through the wall of the bladder. Owing to this circumstance, pressure within the bladder serves to close the mouths of the ureters, and, indeed, the more completely, the higher the pressure. At some point in the filling of the bladder the pressure is sufficient to arouse a conscious sensation of fullness and a desire to micturate. Under normal conditions the act of micturition follows. It consists essentially in a strong contraction of the bladder, with a simultaneous relaxation of the internal sphincter, and of the external sphincter also if this latter is in contraction.

The force of this contraction is considerable, as is evidenced by the height to which the urine may spurt from the end of the urethra. According to Mosso, the contraction may support, in the dog, a column of liquid two meters high. The contractions of the bladder may be and usually are assisted by contractions of the walls of the abdomen, especially toward the end of the act. As in defecation and vomiting, the contraction of the abdominal muscles, when the glottis is closed so as to keep the diaphragm fixed, serves to increase the pressure in the abdominal and pelvic cavities, and thus assists in or completes the emptying of the bladder. It is, however, not an essential part of the act of micturition. The last portions of the urine escaping into the urethra are ejected, in the male, in spurts produced by the rhythmical contractions of the bulbocavernosus muscle.

The act of micturition as it takes place in man is pictured by Rehfisch\* as follows: As the urine accumulates in the bladder the pressure-stimulation of the sensory fibers leads to a reflex stimulation of the internal sphincter. Further accumulation by a pressure effect on the sensory fibers causes reflex contractions of the muscle of the bladder, and the additional sensory stimuli produced by these contractions spreading upward from the lower center occasion the conscious desire to urinate. In the adult at least the urination takes place by a voluntary act, which consists in an inhi-

\* Virchow's "Archiv f. path. Anat.," etc., 150, 111, 1897.

bition of the tonus center in the lumbar cord, whose reflex stimulation has up to this point maintained the tonic contraction of the internal sphincter. The effect of this inhibition is to relax the sphincter and to allow the bladder to empty itself by its reflex contraction, aided perhaps by a voluntary contraction of the abdominal muscles. During the emptying of the bladder the process can be brought to a stop voluntarily by removing the inhibition, thus allowing the internal sphincter to contract and shut off the flow. Rehfisch considers that the external sphincter (and compressor urethræ) play a relatively small rôle, serving as a reserve mechanism to aid in the closure of the urethra.

Mosso and Pellacani\* have made experiments upon women in which a catheter was introduced into the bladder and connected with a recording apparatus to measure the volume of the bladder. Their experiments indicate that the sensation of fullness and desire to micturate come from sensory stimulation, in the bladder itself, caused by the pressure of the urine. They point out that the bladder is very sensitive to reflex stimulation; that every psychological act and every sensory stimulus is apt to cause a contraction or increased tone of the bladder. The bladder is therefore subject to continual changes in size from reflex stimulation, and the pressure within it will depend not simply on the quantity of urine, but on the condition of tone of its muscles. At a certain pressure the sensory nerves are stimulated and under normal conditions micturition ensues. We may understand, from this point of view, how it happens that we have sometimes a strong desire to micturate when the bladder contains but little urine,—for example, under emotional excitement. In such cases if the micturition is prevented, probably by the action of the external sphincter, the bladder may subsequently relax and the sensation of fullness and desire to micturate pass away until the urine accumulates in sufficient quantity, or the pressure is again raised by some circumstance which causes a reflex contraction of the bladder.

*Nervous Mechanism.*—According to Langley and Anderson,† the bladder in cats, dogs, and rabbits receives motor fibers from two sources: (1) From the lumbar nerves, the fibers passing out in the second to the fifth lumbar nerves and reaching the bladder through the sympathetic chain and the inferior mesenteric ganglion and the hypogastric nerves and plexus (Fig. 287). Stimulation of these nerves causes a comparatively feeble contraction of the bladder followed by an inhibition. (2) From the sacral spinal nerves, the fibers originating in the second and third sacral spinal nerves, or in the rabbit in the third and fourth, and taking their course

\* "Archives italiennes de biologie," 1, 1882.

† "Journal of Physiology," 19, 71, 1895.

through the so-called *nervi erigentes* or pelvic nerves and the hypogastric plexus. Stimulation of these nerves causes strong contractions of the bladder, sufficient to empty its contents. (3) Experiments in lower animals indicate that the urethra, in addition to the paths just described, receives fibers also from the pudic branch of the sciatic plexus. According to Nawrocki and Skabitschewsky,\* the spinal sensory fibers from the bladder are found in the posterior roots of the first, second, third, and fourth sacral spinal nerves, particularly the second and third. When these fibers are stimulated they excite reflexly the motor fibers to the bladder found in the anterior roots of the second and third sacral spinal nerves. The relations of this nerve-supply to the act of micturition is difficult to state. That the act is essentially a reflex through the central nervous system is shown by the fact that section of the *nervi erigentes* or of the posterior roots of the sacral spinal nerves abolishes the act and leads to a distention of the bladder. As far as experiments have gone they indicate that the motor path for this reflex lies through the *nervi erigentes* or pelvic nerves, while the afferent paths enter the cord in the posterior roots of the sacral spinal nerves, coming through the pelvic or the pelvic and pudic nerves. The hypogastric nerve apparently does not enter into the reflex, but its inhibitory influence upon the bladder may, by relaxing the tone of the musculature, provide a mechanism for holding larger quantities of urine. So far as the bladder is concerned there is evidence that the hypogastrics and pelvic nerves are constantly in tonic action, one tending to relax and the other to increase the tonicity of the bladder musculature, forming thus balanced antagonists. An interesting feature of the reflex is the part taken by the internal sphincter. During the filling of the bladder this sphincter is in tone, at the time of emptying its tone presumably is inhibited as a part of the reflex act. Experiments indicate that stimulation of the pudic nerve causes contraction of the sphincter, while stimulation of the pelvic nerve causes relaxation. It is possible, therefore, that in reflex micturition the pelvic nerves carry the motor impulses that cause contraction of the bladder musculature and, at the same time, through other fibers, inhibitory impulses that relax the sphincter. The mechanism is, however, complex and needs further investigation.†

**Excretory Functions of the Skin.**—The physiological activities of the skin are varied. It forms, in the first place, a sensory surface covering the body, and interposed, as it were, between the

\* "Archiv f. die gesammte Physiologie," 49, 141, 1891.

† Consult Barrington, "Quarterly Journal of Exp. Physiology," 8, 33, 1914; Elliot, "Journal of Physiology," 35, 367, 1907; Stewart, "American Journal of Physiology," 2, 182, 1899.

external world and the inner mechanism. Nerve fibers of pressure, temperature, and pain are distributed over its surface, and by means of these fibers reflexes of various kinds are effected which keep the body adapted to changes in its environment. The physiology of the skin from this standpoint is discussed in the section on special senses. Again, the skin plays a part of immense value to the body in regulating the body temperature. This regulation, which is effected by variations in the blood supply or the sweat secretion, is described at appropriate places in the sections on Nutrition and Circulation. In the female, during the period of lactation, the mammary glands, which must be reckoned among the organs of the skin, form an important secretion, the milk; the physiology of this gland is referred to in the section on Reproduction. In this section we are concerned with the physiology of the skin from a different standpoint,—namely, as an excretory organ. The excretions of the skin are formed in the sweat-glands and the sebaceous glands.

**Sweat.**—The sweat or perspiration is a secretion of the sweat glands. These latter structures are found over the entire cutaneous surface except in the deeper portions of the external auditory meatus, the prepuce, and the glans penis. They are particularly abundant upon the palms of the hands and the soles of the feet. Krause estimates that their total number for the whole cutaneous surface is about two millions. In man they are formed on the type of simple tubular glands; the terminal portion contains the secretory cells, and at this part the tube is usually coiled to make a more or less compact knot, thus increasing the extent of the secreting surface. The larger ducts have a thin, muscular coat of involuntary tissue that may possibly be concerned in the ejection of the secretion. The secretory cells in the terminal portion are columnar in shape, possess a granular cytoplasm, and are arranged in a single layer. The amount of secretion formed by these glands varies greatly, being influenced by the condition of the atmosphere as regards temperature and moisture, as well as by various physical and psychical states, such as exercise and emotions. The average quantity for twenty-four hours is said to vary between 700 and 900 gms., although this amount may be doubled under certain conditions.

According to an interesting paper by Schierbeck,\* the average quantity of sweat in twenty-four hours may amount to 2 to 3 liters in a person clothed, and therefore with an average temperature of 32° C. surrounding the skin. This author states that the amount of sweat given off from the skin in the form of insensible perspiration increases proportionately with the temperature until a certain critical point is reached (about 33° C. in the person investigated),

\* "Archiv f. Physiologie," 1893, 116; see also Willebrand, "Skandinavisches Archiv f. Physiologie," 13, 337, 1902.

when there is a marked increase in the water eliminated, the increase being simultaneous with the formation of visible sweat. At the same time there is a sudden increase in the  $\text{CO}_2$  eliminated from the skin. It is possible that the sudden increase in  $\text{CO}_2$  is an indication of greater metabolism in the sweat glands in connection with the formation of visible sweat.

*Composition of the Secretion.*—The precise chemical composition of sweat is difficult to determine, owing to the fact that as usually obtained it is liable to be mixed with the sebaceous secretion. Normally it is a very thin secretion of low specific gravity (1.004) and an alkaline reaction, although when first secreted the reaction may be acid owing to admixture with the sebaceous material. The larger part of the inorganic salts consists of sodium chlorid. Small quantities of the alkaline sulphates and phosphates are also present. The organic constituents, though present in mere traces, are quite varied in number. Urea, uric acid, creatinin, aromatic oxyacids, ethereal sulphates of phenol and skatol, serin (oxyaminopropionic acid), and albumin, are said to occur when the sweating is profuse. Argutinsky has shown that after the action of vapor baths, and as the result of muscular work, the amount of urea eliminated in this secretion may be considerable. Under pathological conditions involving a diminished elimination of urea through the kidneys it has been observed that the amount found in the sweat is markedly increased, so that crystals of it may be deposited upon the skin. Under perfectly normal conditions, however, it is obvious that the organic constituents are of minor importance. The main fact to be considered in the secretion of sweat is the formation of water.

**Secretory Fibers to the Sweat Glands.**—Definite experimental proof of the existence of sweat nerves was first obtained by Goltz\* in some experiments upon stimulation of the sciatic nerve in cats. In the cat and dog, in which sweat glands occur on the balls of the feet, the presence of sweat nerves may be demonstrated with great ease. Electrical stimulation of the peripheral end of the divided sciatic nerve, if sufficiently strong, will cause visible drops of sweat to form on the hairless skin of the balls of the feet. When the electrodes are kept at the same spot on the nerve and the stimulation is maintained the secretion soon ceases; but this effect seems to be due to a temporary injury of some kind to the nerve fibers at the point of stimulation, and not to a genuine fatigue of the sweat glands or the sweat fibers, since moving the electrodes to a new point on the nerve farther toward the periphery calls forth a new secretion. The secretion so formed is thin and limpid, and has a marked alkaline reaction. The anatomical course of these fibers

\* "Archiv f. die gesammte Physiologie," 11, 71, 1875.



has been worked out in the cat with great care by Langley.\* He finds that for the hind feet they leave the spinal cord chiefly in the first and second lumbar nerves, enter the sympathetic chain, and emerge from this as postganglionic fibers in the gray rami which pass from the sixth lumbar to the second sacral ganglion, but chiefly in the seventh lumbar and first sacral, and then join the nerves of the sciatic plexus. For the forefoot the fibers leave the spinal cord in the fourth to the tenth thoracic nerves, enter the sympathetic chain, pass upward to the first thoracic ganglion, whence they are continued as postganglionic fibers that pass out of this ganglion by the gray rami communicating with the nerves forming the brachial plexus. The action of the nerve fibers upon the sweat glands can not be explained as an indirect effect,—for instance, as a result of a variation in the blood-flow. Experiments have repeatedly shown that, in the cat, stimulation of the sciatic still calls forth a secretion after the blood has been shut off from the leg by ligation of the aorta, or indeed after the leg has been amputated for as long as twenty minutes. So in human beings it is known that profuse sweating may often accompany a pallid skin, as in terror or nausea, while, on the other hand, the flushed skin of fever is characterized by the absence of perspiration. There seems to be no doubt that the sweat nerves are genuine secretory fibers, causing a secretion in consequence of a direct action on the cells of the sweat glands. In accordance with this physiological fact histological work has demonstrated that special nerve fibers are supplied to the glandular epithelium. According to Arnstein, the terminal fibers form a small, branching, varicose ending in contact with the epithelial cells. The sweat gland may be made to secrete in many ways other than by direct artificial excitation of the sweat fibers,—for example, by external heat, dyspnea, muscular exercise, strong emotions, and by the action of various drugs, such as pilocarpin, muscarin, strychnin, nicotin, picrotoxin, and physostigmin. In all such cases the effect is supposed to result from an action on the sweat fibers, either directly on their terminations or indirectly upon their cells of origin in the central nervous system. In ordinary life the usual cause of profuse sweating is a high external temperature or muscular exercise. With regard to the former it is known that the high temperature does not excite the sweat glands immediately, but through the intervention of the central nervous system. If the nerves going to a limb be cut, exposure of that limb to a high temperature does not cause a secretion, showing that the temperature change alone is not sufficient to excite the gland or its terminal nerve fibers. We must suppose, therefore, that the high temperature acts upon the sensory cutaneous nerves,

\* "Journal of Physiology," 12, 347, 1891.

possibly the heat fibers, and reflexly stimulates the sweat fibers. Although external temperature does not directly excite the glands, it should be stated that it affects their irritability either by direct action on the gland cells or upon the terminal nerve fibers. At a sufficiently low temperature the cat's paw does not secrete at all, and the irritability of the glands is increased by a rise of temperature up to about 45° C.

Dyspnea, muscular exercise, emotions, and many drugs affect the secretion, probably by action on the nerve centers. Pilocarpin, on the contrary, is supposed to stimulate the endings of the nerve-fibers in the glands, while atropin has the opposite effect, completely paralyzing the secretory fibers.

**Sweat Centers in the Central Nervous System.**—The fact that secretion of sweat may be occasioned by stimulation of afferent nerves or by direct action upon the central nervous system, as in the case of dyspnea, implies the existence of physiological centers controlling the secretory fibers. The precise location of the sweat center or centers has not, however, been satisfactorily determined. Histologically and anatomically the arrangement of the sweat fibers resembles that of the vasoconstrictor fibers, and, reasoning from analogy, one might suppose the existence of a general sweat center in the medulla comparable to the vasoconstrictor center, but positive evidence of the existence of such an arrangement is lacking. It has been shown that when the medulla is separated from the cord by a section in the cervical or thoracic region the action of dyspnea, or of various sudorific drugs supposed to act on the central nervous system, may still cause a secretion. On the evidence of results of this character it is assumed that there are spinal sweat centers; but whether these are few in number or represent simply the various nuclei of origin of the fibers to different regions is not definitely known. It is possible that in addition to these spinal centers there is a general regulating center in the medulla.

**Sebaceous Secretion.**—The sebaceous glands are simple or compound alveolar glands found over the cutaneous surface, usually in association with the hairs, although in some cases they occur separately, as, for instance, on the prepuce and glans penis, and on the lips. When they occur with the hairs the short duct opens into the hair follicle, so that the secretion is passed out upon the hair near the point at which it projects from the skin. The alveoli are filled with cuboidal or polygonal epithelial cells, which are arranged in several layers. Those nearest the lumen of the gland are filled with fatty material. These cells are supposed to be cast off bodily, their *detritus* going to form the secretion. New cells are formed from the layer nearest the basement membrane, and thus the glands continue to produce a slow but continuous secretion. The sebaceous

secretion, or sebum, is an oily, semiliquid material that sets, upon exposure to the air, to a cheesy mass, as is seen in the comedones or pimples which so frequently occur upon the skin from occlusion of the opening of the ducts. The exact composition of the secretion is not known. It contains fats and soaps, some cholesterin, albuminous material (part of which is a nucleo-albumin often described as a casein), remnants of epithelial cells, and inorganic salts. The cholesterin occurs in combination with a fatty acid, and is found in especially large quantities in sheep's wool, from which it is extracted and used commercially under the name of lanolin. The sebaceous secretion from different places, or in different animals, is probably somewhat variable in composition as well as in quantity. The secretion of the prepuce is known as the *smegma præputii*; that of the external auditory meatus, mixed with the secretion of the neighboring sweat glands or ceruminous glands, forms the well-known earwax or *cerumen*. The secretion in this place contains a reddish pigment of a bitterish-sweet taste, the composition of which has not been investigated. Upon the skin of the newly born the sebaceous material is accumulated to form the *vernix caseosa*. The well-known uropygial gland of birds is homologous with the mammalian sebaceous glands, and its secretion has been obtained in sufficient quantities for chemical analysis. Physiologically it is believed that the sebaceous secretion affords a protection to the skin and hairs. Its oily character doubtless serves to protect the hairs from becoming too brittle, or, on the other hand, from being too easily saturated with external moisture. In this way it probably aids in making the hairy coat a more perfect protection against the effect of external changes of temperature. Upon the surface of the skin, also, it forms a thin, protective layer that tends to prevent undue loss of heat from evaporation of the sweat and possibly is important in other ways in maintaining the physiological integrity of the external surface.

**Excretion of CO<sub>2</sub>.**—In some of the lower animals—the frog, for example—the skin takes an important part in the respiratory exchanges, eliminating CO<sub>2</sub> and absorbing O. In man, and presumably in the mammalia generally, it has been ascertained that changes of this kind are very slight. Estimates of the amount of CO<sub>2</sub> given off from the skin of man during twenty-four hours vary greatly, but the amount is small, about 7 to 8 gms. in twenty-four hours, unless there is marked sweating, in which case the amount is noticeably increased.

## CHAPTER XLVI.

### SECRETION OF THE DUCTLESS GLANDS—INTERNAL SECRETION.

The term "internal secretion" is used to designate those secretions of glandular tissues which, instead of being carried off to the exterior by a duct, are eliminated in the blood or lymph. The idea that secretory products may be given off in this way has long been held in reference to the ductless glands, such as the thyroid, pituitary body, etc., the absence of a duct suggesting naturally such a possibility. The term, however, seems to have been employed first by Claude Bernard, who emphasized the distinction between the ordinary secretions, or external secretions, and this group of internal secretions. Modern interest in the latter is due largely to work done by Brown-Séquard (1889) upon testicular extracts, work which itself was of doubtful value. This author was led to amplify the conception of an internal secretion by the assumption that all tissues give off a something to the blood which is characteristic, and is of importance in general nutrition. This idea led in turn to a revival of some old notions regarding the treatment of diseases of the different organs by extracts of the corresponding tissue, a therapeutical method usually designated as *opotherapy*. Brown-Séquard's extension of the idea of internal secretion has not been justified by subsequent work, and to-day we must limit the term to tissues that have a glandular structure. Experience has shown, that not only the ductless glands, but some at least of the typical glands provided with ducts may give rise to internal secretions, the pancreas, for example. The work done since 1889 has demonstrated fully that some, perhaps all, of the the ductless glands play a rôle of the very greatest importance in general nutrition. They yield internal secretions of one kind or another, and modern investigations have demonstrated that there is a complicated interrelation among the secretions as regards their action on body metabolism. In view of these facts, the entire group of ductless glands or of glands furnishing definite internal secretions is sometimes united under the designation of the *endocrin* system (*endon*, within, *krino*, I separate). The conception that certain glandular organs may give rise to chemical products which on entering the circulation influence the activity of one or more other organs has recently

found a fruitful application in the study of the digestive secretions. The gastric and pancreatic *secretins* may be regarded as examples of internal secretions. Chemical products of this kind which stimulate the activity of special organs Starling designates as *hormones*.\* From this point of view the active substances formed in the thyroids, adrenal glands, etc., may all be classified as specific hormones. Starling suggests that this means of coördinating the activities of the various parts of a complex organism may be regarded as the most primitive, while the better-known coördination through the medium of a nervous system is of later development. In the mammalian body both methods, as we have seen, are employed.

Schäfer calls attention to the fact that some hormones inhibit functional activity while others act as a chemical stimulant. The term "hormone" (*hormao*, I excite), etymologically considered, is not applicable to the former class. He suggests, therefore, the general term "autacoid substances" for both groups to indicate their drug-like action (*acos*, a remedy), and subdivides them into two groups according as they stimulate or inhibit.

Autacoid substances	}	Hormones—stimulating action.
		Chalones—inhibitory action.

**Liver.**—We do not usually regard the liver as furnishing an internal secretion. As a matter of fact, it does form two products within its cells—glycogen (sugar) and urea—which are subsequently given off to the blood for purposes of general nutrition or for elimination. The processes in this case fall under the general definition of internal secretion, and, in fact, may be used to illustrate specifically the meaning of this term. The history of glycogen and urea has been considered.

**Internal Secretion of the Thyroid Tissues.**—The most important and definite outcome of the work on internal secretions has been obtained with the thyroids. Recent experimental work on this organ makes it necessary for us now to distinguish between the thyroid and the parathyroid tissues. The thyroids proper form two oval bodies lying on the sides of the trachea at its junction with the larynx. They have no ducts, and are composed of vesicles of different sizes, which are lined by a single layer of cuboidal epithelium and contain in their interior a material known as colloid. A number of histologists have traced the formation of this colloid to the lining epithelial cells, and have stated, moreover, that the vesicles finally rupture and discharge the colloid into the surrounding lymphatic spaces. *Accessory thyroids* varying in size and number may be found along the trachea as far down as the heart. They possess a vesicular structure and no doubt have a function similar to that of the thyroid body.

\* For general discussion, consult Starling, "Recent Advances in the Physiology of Digestion," Chicago, 1906.

The *parathyroids* are, according to most authors, quite different structures. Four of these bodies are usually described, two on each side, and their positions vary somewhat in different animals or, indeed, in different individuals.\* In man the superior (or internal) parathyroids are found upon the posterior surface of the thyroid, at the level of the junction of its upper with its middle third. They may be imbedded in the thyroid tissue. The inferior (or external) parathyroids lie near the lower margin of the thyroid on its posterior surface and in some cases lower down on the sides of the trachea. The tissue has a structure quite different from that of the thyroids, being composed of solid masses or columns of epithelial cells which are not arranged in vesicles and contain no colloid.

**Extirpation of the Thyroids and Parathyroids.**—In 1856 Schiff showed that extirpation of the thyroids (complete thyroidectomy) in dogs is followed usually by the death of the animal in one to four weeks. The animal exhibits certain characteristic symptoms, such as muscular tremors, which may pass into convulsions, cachexia, emaciation, and a condition of apathy. This result was confirmed by subsequent observers, but many exceptions were noted. Great interest was shown in these results, because on the surgical side reports were made showing that after complete removal of the thyroids in cases of goiter evil consequences might ensue, either acute convulsive attacks or chronic malnutrition. On the other hand, it became known that atrophy of the thyroids in the young is responsible for the condition of arrested growth and deficient mental development designated as cretinism, and in the adult the same cause gives rise to the peculiar disease of myxedema, characterized by distressing mental deterioration, an edematous condition of the skin, loss of hair, etc. Schiff and others found that the evil results of complete thyroidectomy in dogs might be obviated by grafting pieces of the thyroid in the body, and this knowledge was quickly applied to human beings in cases of myxedema and cretinism with astonishingly successful results. Instead of grafting thyroid tissue it was found, in fact, that injection of extracts under the skin or better still simple feeding of thyroid material gave similar favorable results: the individuals recovered their normal appearance and mental powers.† It is stated that in cases of myxedema the patient may be kept in perfect health by the administration of a

\* Thompson, "Philosophical Transactions, Roy. Soc.," London, B. 201, 91, 1910.

† For a general account of the development of the subject and the literature see "Transactions of the Congress of American Physicians and Surgeons" (Howell, Chittenden, Adami, Putnam, Kinnicutt, Osler), 1897; Jeandelize, "Insuffisance thyroïdienne et parathyroïdienne," Nancy, 1902; Vincent, "Internal Secretions," etc., *Lancet*, Aug. 11 and 18, 1906; also "Ergebnisse der Physiologie," 11, 1911; Biedl, "Innere Sekretion," Berlin, 1913.

little as 60 to 130 mgm. every three or four days. Later Baumann\* succeeding in isolating from the glands a substance designated as *iodothyryn* or *thyroidin*, which shows in large measure the beneficial influence exerted by thyroid extracts in cases of myxedema and parenchymatous goiter. This substance is characterized by containing a large amount of iodine (9.3 per cent. of the dry weight). It is contained in the gland in combination with protein bodies, from which it may be separated by digestion with gastric juice or by boiling with acids.

**The Function of the Parathyroids.**—Most of the results described above were obtained before the existence of the parathyroids was recognized. Early in the history of the subject it was recognized that complete removal of the thyroids proper in herbivorous animals (rats, rabbits) is not attended by a fatal result. Gley and others, however, proved that if the parathyroids also are removed these animals die with the symptoms described in the case of dogs, cats, and other carnivorous animals. This result attracted attention to the parathyroids. Numerous experiments by Moussu, Gley, Vassale and Generale, and others have seemed to show a marked difference between the results of thyroidectomy and parathyroidectomy. When the parathyroids alone are removed the animal dies quickly with acute symptoms, muscular convulsions (tetany), etc.; when the thyroids alone are removed the animal may survive for a long period, but develops a condition of chronic malnutrition,—a slowly increasing cachexia which may exhibit itself in a condition resembling myxedema in man. This distinction has been generally accepted, and it throws much light upon the discrepancy in the results obtained by some of the earlier observers. Complete thyroidectomy with the acutely fatal results usually described includes those cases in which both thyroids and parathyroids were removed, while probably many of the apparently negative results obtained after excision of the thyroids are explicable on the supposition that one or more of the parathyroids were left in the animal. It should be stated, however, that two recent observers, Vincent and Jolly, as the result of numerous experiments made upon different varieties of animals, throw some doubt upon these conclusions. They contend that in herbivorous animals fully half of those operated upon survive complete removal of all thyroid tissue, showing no evil symptoms except perhaps a diminished resistance to infection. Carnivorous animals, on the contrary, usually die after such an operation.† In spite of such contradictory results in the hands of some observers the general opinion

\* "Zeitschrift f. physiolog. Chemie," 21, 319, and 481, 1896.

† See also Halpenny in "Surgery, Gynecology, and Obstetrics," May, 1910.

prevails that complete removal of the parathyroids is followed by acutely toxic results which develop rapidly, and the most common symptom of which is muscular tetany. This tetany exhibits itself as fibrillar contractions of the muscles, a general muscular tremor, tonic and clonic spasms of the muscles or "intention spasms," that is, spasmodic or uncoordinated contractions following upon an effort to make a voluntary movement.\* As is well known, similar symptoms are often observed under other conditions, infantile tetany, gastro-intestinal tetany, etc., and it has been suggested that in all such cases the initial difficulty may consist in the insufficiency of active parathyroid tissue. Several observers have reported that injections of extract of the parathyroids cause the tetany to disappear without, however, protecting the animal from a fatal outcome. Macallum and Voegtlin† find that injection or ingestion of solutions of calcium salts removes completely the symptoms of tetany and restores the animal to an apparently normal condition. They have obtained similar results upon human beings suffering from tetany as a result of unintentional removal of the parathyroids. The experimental evidence in the case of the parathyroids tends to support the view that their function consists in neutralizing in some way toxic substances formed elsewhere in the body, and that, therefore, after removal of these glands death occurs from the accumulation of such toxic bodies in the blood and tissues. Thus Macallum states that in animals in which tetany has developed as a consequence of extirpation of the parathyroids, bleeding and infusion of salt solution causes the tetany to disappear. The results quoted above in regard to the therapeutic value of calcium salts would seem, moreover, to connect the parathyroid function with the calcium metabolism and to relate the development of toxic substances with an insufficiency of calcium, but at present no precise statement can be made in regard to the way in which these bodies perform their very important function. The view that the parathyroids are simply immature thyroid tissue is still supported by some observers, being based chiefly on the histological finding that after removal of the thyroids the parathyroids may hypertrophy and show thyroid cysts containing colloidal material. Most observers, however, take the view outlined above, that the parathyroids have a functional significance essentially different from that of the thyroids, and that the parathyroids as they exist in the body are not simply undeveloped

\* For literature and Summary, see Bing, "Zentralblatt f. d. Physiol. u. Pathol. d. Stoffwechsels," 1908, Nos. 1 and 2; also Biedl, *loc. cit.*

† Macallum and Voegtlin, "Johns Hopkins Hospital Bulletin," March, 1908.



or immature thyroid tissue. At the same time it is becoming generally recognized that different as the functions of these two tissues may be, they are in some way correlated, and that the removal of one of them influences the activity of the other.

**The Function of the Thyroid.**—According to the opinion of most writers on the subject, removal of the thyroid alone, leaving, at least, the external parathyroids uninjured, is followed by the development of a state of chronic malnutrition which expresses itself finally in a condition of cachexia. Following a terminology sometimes used in medical literature, this cachectic condition may be designated as “cachexia thyreopriva,” whereas the convulsive condition or tetany, formerly also described as a symptom of loss of the thyroid, is due rather to removal of the parathyroid, and may be characterized as “tetania parathyreopriva.” No adequate explanation has been furnished of the influence exercised by the thyroid on the nutrition of the body. It is usually assumed that the thyroid cells form an internal secretion containing a specific hormone which acts as a chemical stimulus to other tissues, causing an augmentation of their metabolism. Some justification for this view is found in the effect of feeding thyroid tissue to normal individuals. The result in such cases is a marked increase in the excretion of nitrogen and an augmentation of the oxidations of the body, as shown by an increase in the output of carbon dioxide. On this basis the tissue has been administered for the purpose of reducing the body fat in cases of adiposity, but the details of its influence on the metabolic processes are for the most part unknown, and when used beyond certain limits it may cause heart effects and other disturbances of a pathological nature. In the condition known as exophthalmic goiter there is evidence that the thyroids are hypertrophied, and some of the symptoms of this disease are explicable as the results of an oversecretion of the active hormone, that is to say, there is a condition of hyperthyroidism. As was stated above, Baumann isolated from the thyroid a peculiar substance, iodothyron, which is characterized chemically by its large percentage of iodine, and physiologically by the fact that when used upon patients suffering from a deficiency in functional activity of the thyroid (myxedema, goiter) it gives beneficial results. In the gland this iodothyron is combined with protein to form a thyroglobulin or thyroprotein. There has been much discussion regarding the iodine constituent of the thyroid tissue. Extensive observations have shown that in some entirely healthy animals iodine is absent or is present only in traces, and in animals in which it is present the amount may vary greatly with the character of the food. Hunt gives the following table:

	Per cent. of iodin.
Children's thyroid.....	none.
Maltese kid thyroid.....	none.
Guinea-pig thyroid.....	0.05
Dog thyroid.....	0.061
Cat thyroid.....	0.08
Sheep thyroid.....	0.176
Beef thyroid.....	0.25
Hog thyroid.....	0.33
Human (Wells).....	0.236
Human (goitre).....	0.04

Opinions in regard to the significance of the iodine have varied from the view, on the one hand, that it is an essential constituent of the physiologically active substance secreted by the gland, to the opposite extreme that it is an injurious substance which is bound and made innocuous by the thyroid cells. The balance of evidence seems to favor the first point of view,\* and at present we may conclude that the iodine in some way intensifies the activity of the internal secretion of the thyroid. That it is absolutely necessary to this activity is rendered improbable by the fact that iodine-free thyroids appear still to exercise their normal influence upon metabolism, but administration of iodine in the food not only raises the iodine percentage in the gland, but also increases proportionately the physiological activity of extracts of the tissue. Experiments show also that the known effects of thyroid extracts are greater in the iodine-rich than in the iodine-poor glands.

**Thymus.**—The physiology of the thymus gland is very obscure, in fact, nothing that is definite can be said about its functions, except perhaps that the gland is concerned in some way with the processes of growth. It is assumed that it furnishes an internal secretion, and that in early life at least this secretion influences in an important way some phases of the body metabolism. Formerly, it was supposed that the gland reaches its maximum size at birth and afterward undergoes a process of atrophy or involution so that it is entirely absent in adult life. More careful observations indicate, on the contrary, that the gland retains its size and presumably its full activity until the period of puberty. Thenceforward it does undergo a gradual atrophy, but apparently throughout life some remnants of the gland tissue persist embedded in fat. It appears also that under pathological conditions there may be a persistence of more of this tissue than is normal, or there may be a real hypertrophy together with an overactivity, a condition which might be designated as hyperthymusism. It is recognized now that this activity may be a complicating factor in exophthal-

\* For discussion and literature, consult Hunt, "Studies on Thyroid," "Hygienic Laboratory Bulletin," 1909, No. 47, Washington, D. C.; and Hunt and Seidell, "Journal of Pharmacology and Experimental Therapeutics," 2, 15, 1910.

mic goiter (Graves' disease). The anatomical facts in regard to the involution of the gland after puberty justify the suggestion that the function it exercises is of especial importance in the period preceding the maturation of the sexual glands, but that in post-pubertal life it continues to play some rôle, although of subordinate importance. Very many experiments have been made to determine the nature of the function of this tissue, but at present it is not possible to interpret the results in a satisfactory manner.\* Removal of the gland in young dogs (Basch) is said to cause a retarded growth of the bony tissues and to induce a condition resembling rickets. At the same time the peripheral nervous system shows an increased excitability as determined by the response of the nerves to galvanic stimulation. Somewhat similar but more extensive experiments have been reported by Klose and Vogt. When thymectomy is performed on quite young dogs (10 days), very serious consequences result, ending perhaps in a condition of coma and death. These results develop slowly: there is first a stage of increased fat formation and later one of malnutrition or cachexia which manifests itself strikingly in an atrophic and undeveloped condition of the bones, although there is besides a general asthenic or adynamic condition and mental deterioration. Injections of extract of the gland (Svehla) cause a fall of blood-pressure and some quickening of the heart-beat, but these effects are not specific. Unlike the thyroid and parathyroid glands, the thymus contains no iodine (Mendel). One suggestion made regarding its influence is that there is some sort of reciprocal relationship between it and the reproductive glands. Castration (Henderson) causes a persistent growth and retarded atrophy of the thymus, while removal of the thymus (Paton) hastens the development of the testes. Another more specific hypothesis is the one advocated by Klose and Vogt in the work referred to above, namely, that the thymus is concerned especially in the processes of synthesis of nucleic acid.

Gudernatsch † finds that young tadpoles fed upon thymus gland are stimulated to excessive growth, while the changes of metamorphosis to the frog-stage are correspondingly delayed. When thyroid gland is fed, contrary results are obtained. Further growth is inhibited and the changes of metamorphosis are accelerated, so that dwarf frogs are produced. This apparently direct

\* References: Friedleben, "Die Physiologie der Thymusdrüse," 1858; Verdun, "Dérivés branchiaux chez les vertébrés," 1898; Henderson, "Journal of Physiology," 1904, xxxi., 222; Basch, "Jahrbuch f. Kinderheilkunde," 64, 1906, and 68, 1908; Klose and Vogt, "Klinik u. Biologie d. Thymusdrüse," Tübingen, 1910; Halsted, "Johns Hopkins Hospital Bulletin," August, 1914; Hart, "Virchow's Archiv," 214, 1, 1913.

† Gudernatsch, "Zentralblatt für Physiologie," 1912, No. 7.

proof that the thymus is connected with growth falls in very well with what is stated above in regard to the importance of this organ during the prepubertal period.

**Adrenal Bodies.**—The adrenal bodies—or, as they are frequently called in human anatomy, the suprarenal capsules—belong to the group of ductless glands. It was shown first by Brown-Séquard (1856) that removal of these bodies is followed rapidly by death. This result has been confirmed by many experimenters, and so far as the observations go the effect of complete removal is the same in all animals. The fatal effect is more rapid than in the case of removal of the thyroids, death following the operation usually in two to three days, or, according to some accounts, within a few hours. The symptoms preceding death are great prostration, muscular weakness, and marked diminution in vascular tone. These symptoms resemble those occurring in Addison's disease in man,—a disease which clinical evidence has shown to be associated with pathological lesions in the suprarenal capsules. These older observations indicated clearly enough that the adrenal glands are of essential importance to the life of the organism, but the first indication as to the nature of its activity was furnished by the discovery, made by Oliver and Schäfer,\* of the remarkable effects observed when an extract of the medulla of the gland is injected into the circulation of a living animal. Briefly stated, the effect of such an injection is a pronounced slowing of the heart-beat together with a rise of pressure. The slowing of the heart-beat is due to a stimulation of the cardio-inhibitory center, for if the vagi are cut before making the injection this result drops out; the blood-pressure, on the contrary, not being restrained by the slowing of the heart, rises rapidly and may reach an extraordinary height. The explanation of the effect of the extracts on blood-pressure is given below.

Since effects of this kind were not obtained from extracts of the cortex of the gland, it was apparent from these initial experiments that possibly in the adrenal, as in the thyroid tissue, there are two organs or tissues to be considered whose functions may be very different. Subsequent investigations have served to strengthen this belief. The cortical and medullary tissues are separate anatomically from each other in some of the fishes, and it has been proposed to speak of the cortical tissue as the interrenal system and of the medulla as the adrenal or the chromaffin system, but for our purpose it will be simpler to state briefly the main facts that have been obtained under the headings *cortex* and *medulla*.

\* Oliver and Schäfer, "Journal of Physiology," 18, 230, 1895.

**Physiology of the Medulla.**—*The Active Principle, Epinephrin.*

—Chemical investigations of the substance in the medulla which causes the inhibition of the heart and the rise of blood-pressure have been very successful. The substance has been prepared in pure form, its chemical structure is known, and it has been made synthetically outside the body.\* The credit for the most important initial work is due to Abel, while the final isolation in pure form as crystals was accomplished by Takamine and independently by Aldrich. The last-named observer determined the correct formula for the active substance, namely,  $C_9H_{13}NO_3$ , and later workers (Stolz and Dakin) succeeded in demonstrating its chemical structure as a dioxyphenyl—ethylol-methylamin,  $C_6H_3(OH)_2CHOH-CH_2NHCH_3$ . The presence of the oxyphenyl group in the compound would suggest that in the body it is probably derived from tyrosin. This active substance is designated in the literature under a variety of names, those commonly used being epinephrin and adrenalin. It is a basic body which gives a number of characteristic color reactions, and in alkaline solutions is readily oxidized to a substance that fails to exhibit the characteristic epinephrin reaction on heart-rate and blood-pressure.

**Distribution of the Epinephrin.**—*The Chromaffin Tissues.*—As stated above, the epinephrin occurs in the adrenal gland in the cells of the medulla, but not in those of the cortex. When the medullary cells are treated with chromates they give a characteristic yellow or brown reaction, which is spoken of as a chromaffin reaction and has been used to locate similar cells in other tissues. It would seem that cells of this variety may be found generally or frequently in the sympathetic ganglia, so that it has been suggested that primitively each such ganglion contained two varieties of cells, the nerve cell or ganglion cell and the chromaffin or paraganglion (Elliott) cell. Clumps or strings of such cells occur also along the course of the abdominal aorta below the level of the adrenal glands, and, as was stated above, in some of the fishes the medullary cells of the adrenal gland are separated anatomically from the cortical cells. On account of the color reaction and the demonstration, in some cases at least, that this color reaction indicates the presence of epinephrin, it has become customary to group all the cells exhibiting the chromate reaction under the general term of *chromaffin system* † and to suppose that all this tissue, wherever found, has a common physiological significance. The medulla of the adrenal gland is the most conspicuous and important group of these cells, but it is assumed that in case of removal by disease or experiment

\* For description of chemistry and references, see Barger, "The Simpler Natural Bases" (Monographs on Biochemistry), 1914.

† See Vincent, "Proceedings of the Royal Society," B, 82, 502, 1910.

its functions may be supplied more or less perfectly by the outlying cells belonging to the same tissue.

**Physiological Action of the Epinephrin.**—As stated above, solutions of epinephrin give a marked effect upon the heart-rate and blood-pressure. The great slowing of the heart-rate is due to an action of the epinephrin on the cardio-inhibitory center, since it disappears when the vagi are cut or after the administration of atropin. When this influence of the cardio-inhibitory center is removed it can be shown that the epinephrin causes a stronger and more rapid contraction of the heart, and a similar effect can be obtained upon the isolated heart maintained by an artificial circulation. It seems probable that this effect of the epinephrin is due to a stimulating action upon the endings of the accelerator nerve in the heart. In addition to the heart effect the epinephrin causes a strong contraction of the arterioles in certain areas, and experiments demonstrate that this effect is due mainly to a peripheral action. It is this action that produces the great rise in blood-pressure, seen especially after the antagonistic influence of the cardio-inhibitory center is thrown out by section of the vagi. Under usual conditions this effect on blood-pressure is short-lasting. The arterial pressure after reaching a maximum falls off rapidly to normal, but a new rise can be produced by a new injection. The effect of the epinephrin on blood-pressure is so constant and is produced by such small doses that it may be used quantitatively in estimating the amount of epinephrin in various extracts. Investigation has shown that not all of the arterioles are stimulated to contraction by epinephrin, and the results of many experiments of this kind have led to the generalization (Langley) that the epinephrin acts only upon the plain muscle which receives its innervation from the sympathetic autonomic system, and that its effect upon the musculature, whether of stimulation or of inhibition, is the same as that obtained by direct stimulation of the sympathetic nerve-supply. This selective action of the epinephrin finds some explanation in the hypothesis that it does not affect the muscular substance directly, but acts upon a specialized receptive substance, the *myoneural* junction (Elliott) at the point where the nerve-fiber unites with the muscle-fiber. On the basis of this generalization, perfusion with solutions containing epinephrin has been used as a method for determining whether or not the blood-vessels of any given organ are supplied with vasoconstrictor nerve-fibers. These fibers all belong to the sympathetic autonomic system, and those blood-vessels which exhibit a contraction under the influence of epinephrin probably are supplied with vasoconstrictor nerve-fibers. The use of this method is referred to in connection with the discussion regarding the presence or absence of such nerve-fibers to the arteries of the

brain, the lungs, and the heart. On the same generalization it will be noted that plain muscle receiving inhibitory fibers from the sympathetic autonomic system ought to exhibit a relaxation instead of a contraction when acted upon by epinephrin. This, in fact, seems to be the case. The plain muscle in the intestinal walls receives inhibitory fibers from the sympathetic autonomies (splanchnics), and on this musculature epinephrin does cause loss of tone and relaxation instead of contraction, and another beautiful example of the same kind is obtained from the iris. The dilator muscle of the iris is supplied by nerve-fibers from the sympathetic autonomies, and in correspondence with this fact the epinephrin in very minute doses causes a dilatation of the pupil. On the plain muscle in other organs epinephrin has a somewhat variable effect, differing with conditions or with the animal selected. The uterine musculature, for example, in the pregnant cut is made to contract, but in the non-pregnant condition it shows relaxation. The plain muscle of the bronchioles exhibit relaxation under the influence of the epinephrin, and since these muscles probably receive their nerve-supply through the bulbar autonomies (vagus) their reaction to epinephrin indicates that the above generalization in regard to the sympathetic autonomies must not be understood to mean that the epinephrin acts only on the musculature innervated by the sympathetics, but rather that the muscle so innervated shows a special response to epinephrin action. Even skeletal muscles are distinctly affected by epinephrin. Under the influence of appropriate doses, the contractions are increased in size and the subsequent relaxation seems to be more rapid and complete. In addition to its influence on the muscular or neuromuscular mechanisms epinephrin has an effect upon the body metabolism, especially as regards the carbohydrates. When injected it causes an output of sugar in the urine, which may last for some days. Evidently the epinephrin, in these overdoses, interferes in some way with the sugar-regulating mechanism of the body. Along with the glycosuria there is hyperglycemia, that is, an increase in the sugar-content of the blood, and the usual explanation for this action of the epinephrin is that it stimulates the process of glycogenolysis, the process by which the stored glycogen of the liver is converted to sugar and given to the blood. This production of epinephrin glycosuria has been observed not only under experimental conditions, but also under what may be called normal conditions in which there is evidence of an increased secretion or hypersecretion of the gland. Cannon has described, for example, what he calls emotional glycosuria, a condition in which in consequence of emotional excitement there is an increased secretory activity of the adrenal gland and an accompanying glycosuria. Results of this kind would

seem to indicate that the normal secretion of epinephrin may play a part in the complex sugar-regulating mechanism of the body, and there is evidence, which will be referred to briefly later, that the other glands of internal secretion, or some of them at any rate, are also concerned in the regulation of the sugar supply and sugar consumption. When administered in large doses epinephrin has a distinct or even fatal toxic effect. The lethal dose varies with the animal used and the mode of administration. When given intravenously a dose of as much as 1 mgrm. per kilogram of body weight may be followed by a rapid paralysis of respiration or of the heart, or by a more gradual intoxication accompanied by hemorrhages from the intestinal mucosa.

*The Secretory Nerves of the Adrenal Gland.*—The adrenal glands receive a supply of sympathetic autonomic nerve-fibers by way of the splanchnic nerves. Dreyer\* first demonstrated that the production of epinephrin in the gland may be increased upon stimulation of these fibers and that in all probability the output of epinephrin is regulated through definite secretory fibers. This conclusion has been corroborated by more recent work. Sensory stimulations of various kinds, strong emotional excitement, and other conditions seem to cause a reflex stimulation of the gland and a consequent increase in the concentration of epinephrin in the blood. In fact, it would appear that some of the variations in arterial pressure, which have been explained heretofore as the immediate result of direct or reflex stimulation of vasoconstrictor fibers, may be due rather to a reflex stimulation of the adrenal glands which brings about a vasoconstriction through an increased amount of epinephrin. When the splanchnic nerves (peripheral end) are stimulated, for example, a marked vasoconstriction is produced throughout the so-called splanchnic area. Analysis seems to show that in this case there is a primary constriction due to the action of the vasomotor fibers, but this is followed by an additional constriction caused by the increased output of epinephrin.

*The Functional Significance of the Medullary Tissue.*—The normal functional value of the medullary tissue and of the other chromaffin tissues consists, so far as we know, in the production and secretion of epinephrin, and discussions upon this question have centered, therefore, upon the normal occurrence and significance of the epinephrin. Examination of the venous blood flowing from the adrenal gland discloses the fact that it contains epinephrin. The presence of the base is shown most satisfactorily by its physiological reactions. When the blood from the adrenal vein is collected and injected into another animal it produces the characteristic epinephrin effect upon blood-pressure; other similar tests,

\* Dreyer, "American Journal of Physiology," 2, 203, 1899.



such as the dilatation of the pupil in an excised eye of the frog (Meltzer reaction), the contraction of rings of arteries (Meyer's test), or the relaxation of strips of intestine (Cannon-Hoskin), all agree in indicating that the venous blood flowing from the adrenal gland contains epinephrin. The amount is small, so small that attempts to demonstrate its existence in the general circulation have not been entirely satisfactory; some claim to have shown its presence, while others get negative results. It is generally believed, however, that the blood does receive constantly a supply of epinephrin from the adrenal glands and that this constitutes the internal secretion of the medullary cells. As regards the function of the epinephrin under normal conditions there is some difference of opinion. The usual view is that it serves to maintain a condition of tonicity in the musculature of the heart and blood-vessels innervated by the sympathetic autonomic system and thus insures a normal cardiovascular tone. If the amount of epinephrin falls below normal or fails entirely, a condition of *hypotension* results in consequence of general vascular dilatation. When epinephrin is secreted in excess the opposite condition of *hypertension* prevails. This theory is insufficient in that it does not take into account the other physiological reactions of epinephrin, such as the effect on carbohydrate metabolism, and, moreover, it is not entirely in accord with some observations upon the results of removal of the adrenal glands. In spite of the large amount of experimental work upon the action of epinephrin, it seems necessary at present to recognize the fact that our knowledge is too incomplete to justify any positive statements in regard to its normal rôle in the organism.

As stated above, the rise of blood-pressure and the slow heart-beat caused by injections of epinephrin last but a few minutes. Apparently the excess above the normal concentration in the blood is quickly destroyed in some way. Possibly it is absorbed and oxidized or otherwise changes by the tissues, but on this point also experiments as yet have not given a decisive result.\*

*The Functional Significance of the Cortical Tissue.*—Most observers agree that the cortex does not contain epinephrin, and it is probable, therefore, that its functions are different from those of the medulla. Biedl has shown that in those fishes in which the cortical substance exists as a separate structure, the interrenal body, extirpation of this organ is followed by a condition of progressive muscular weakness ending in death. This result would indicate that the cortical tissues have some specific and essential internal secretion, and it would seem possible, moreover, that the fatal result always following extirpation of the adrenal bodies is due to loss of the cortical rather than the medullary substance. Some experi-

\* For general reviews of literature, consult Biedl, "Innere Sekretion," 1913.

menters, who have studied carefully the effects of partial or complete removal of the adrenals in mammals, record their opinion that it is the cortex rather than the medulla that is essential to life.\* The nature of the secretion furnished by the cortex and its normal functional value are matters of speculation only at present. Chemical examination of the cortex shows the presence of much lipid material, particularly of the cholesterin esters, and it may be that through this material the tissue influences the metabolism in other parts of the body.

Observers have also called attention repeatedly to the fact that the cortex has some relation to the activity of the sexual glands. During pregnancy the cortex undergoes hypertrophy, and in some cases pathological changes affecting the cortex alone have been followed by precocious development of the sexual organs. On the other side, castration causes changes in the adrenal bodies and, indeed, the various phases of sexual life are accompanied by histological changes in the adrenals. But others of the glands of internal secretion have some similar functional relation with the reproductive glands or their contained interstitial tissue, and no specific suggestion can be offered at present in regard to the particular part taken by the adrenal cortex.†

**Pituitary Body (Hypophysis).**—This body is usually described as consisting of two parts—a large anterior lobe of distinct glandular structure and a much smaller posterior lobe of nervous origin and composed chiefly of neuroglia cells and fibers. Embryologically the two lobes are entirely distinct. The anterior lobe arises from an invagination (Rathke's pouch) of the buccal ectoderm. A portion of this epithelium soon develops into a glandular structure, belonging to the type of glands which have no excretory duct and which probably, therefore, form an internal secretion. The posterior lobe arises as an outgrowth from the floor of the third ventricle of the brain, the infundibulum, which comes into contact with the epithelial pouch forming the anterior lobe. The epithelial cells of the latter soon show a differentiation into two parts, one of which gives rise to the anterior lobe, while the other invests the body and neck of the posterior or nervous lobe. To this latter the special name of the *pars intermedia* has been given. When fully formed the posterior lobe consists of two parts, the *pars nervosa*, composed of neuroglia cells and fibers and ependymal cells, and an investing layer of epithelial cells, derived from the buccal ectoderm and known as the *pars intermedia* (see Fig. 299).

\* Crowe and Wislocki, "Johns Hopkins Hospital Bulletin," October, 1914.

† For details and references to literature on this and other points in internal secretion consult the excellent work by Biedl, "Innere Sekretion," Berlin, 1913.

In the pars nervosa characteristic hyaline or colloid bodies occur and histological work makes it probable that this material constitutes an internal secretion. According to Herring,\* it is formed from the epithelium of the pars intermedia. The cells of the latter invade the pars nervosa, undergo a hyaline degeneration, and are finally discharged into the cerebrospinal liquid of the third ventricle. Investigations upon the physiology of the pituitary gland have taken the two usual directions, namely, a study of the effects of removal and a study of the effects of extracts, and obser-

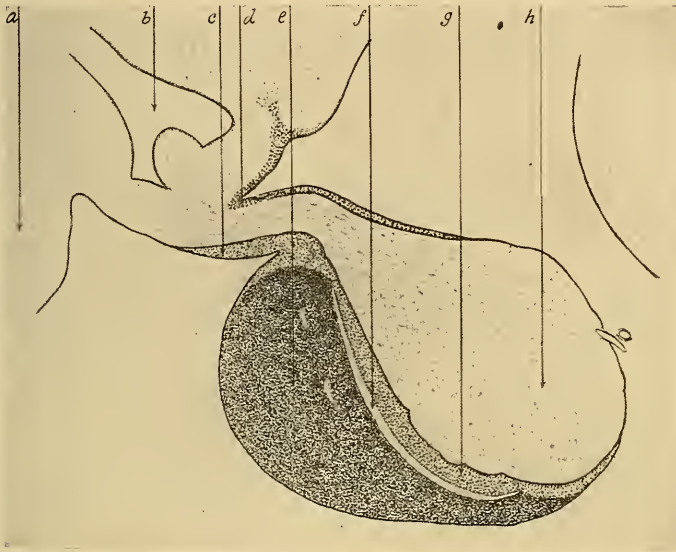

Fig. 299.—Median sagittal section through pituitary of monkey; semidiagrammatic (Herring): *a*, Optic chiasma; *b*, third ventricle; *c*, *g*, pars intermedia; *d*, epithelium of pars intermedia extending round neck of pars nervosa; *e*, pars glandularis seu epithelialis; *f*, intraglandular cleft, lying between pars glandularis (*e*) and pars intermedia (*g*); *h*, pars nervosa.

vations of this character have been made upon this gland as a whole and upon the anterior and posterior lobes taken separately.

*Extracts of the Posterior Lobe.*—Extracts of this lobe contain material from both the pars nervosa and the pars intermedia, but on the evidence stated above it may be assumed that the results obtained are attributable in reality to the pars intermedia, which has a glandular structure and is responsible for the hyaline material found in the nervous part. When extracts of the posterior lobe are injected into the circulation several distinct results have been observed to follow. In the first place there is a characteristic effect

\* Herring, "Quarterly Journal of Experimental Physiology," 1, 121, 161, 281, 1908.

on the circulation—the heart-rate is slowed and the blood-pressure is raised. Both effects are less marked than in the case of epinephrin, but they persist for a longer time.\* Further examination has shown that the extracts seem to exercise a stimulating effect on all or most of the involuntary muscles in the body. The intestine, bladder, and uterus are all made to contract, and this effect is perhaps especially marked in the case of the uterine muscle, so much so in fact that it has been proposed to use such extracts in obstetrical practice to promote the contractions of the uterus. While the epinephrin acts mainly at least on plain muscle innervated by the sympathetic autonomies and gives contraction or relaxation according as the nerve-fibers are motor or inhibitory, the hormone from the posterior lobe of the pituitary gland appears to act directly on the muscle and to cause contraction or increased tone in all cases. In addition to this effect on plain muscle the extracts have a stimulating action on several kinds of glandular tissue.† They cause a distinct diuresis by an effect on the kidneys; they act as a galactagogue to the mammary glands when in functional activity, and it is stated that they accelerate the rate of formation of cerebrospinal liquid. Lastly, these extracts influence the general metabolism, particularly in regard to the carbohydrates. Like the epinephrin, they cause a glycosuria, and apparently in the same way, that is, by accelerating the process of glycogenolysis in the liver.

*Extracts of the Anterior Lobe.*—In marked contrast to the effects obtained from the posterior lobe, extracts of the anterior lobe when injected yield no decisive results. As will be seen below this lobe undoubtedly furnishes an important secretion, but the specific action of this secretion is not revealed by the method of injection.

*Removal of the Pituitary Body.*—Very contradictory reports were made by the earlier observers upon the result of the complete removal of the pituitary body, but since the work of Paulesco it has been generally accepted that hypophysectomy is essentially a fatal operation.‡ The animal dies in a few days after exhibiting a series of premonitory symptoms, such as a fall in temperature, unsteady gait, rapid emaciation, and diarrhea. Further examination has shown that this fatal outcome happens when the anterior lobe alone is removed, and we may conclude, therefore, that the secretion of this gland exercises some profoundly important influ-

\* Howell, "Journal of Experimental Medicine," 3, 245, 1898; also Schäfer and Vincent, "Journal of Physiology," 25, 87, 1899.

† Schäfer and Herring, "Philosophical Transactions Royal Society," London, B, 199, 1; Ott and Scott, "Proceedings Society of Exp. Biol. and Med.," 8, 28, 1910-11; Weed and Cushing, "American Journal of Physiology," 36, 77, 1915.

‡ See Cushing, "The Pituitary Body and Its Disorders," 1912; also Goetsch, "The Quarterly Journal of Medicine," January, 1914.

ence upon metabolism, although the nature of this influence is not as yet understood. Removal of the posterior lobe alone is not fatal, but it is followed by characteristic effects. The animal exhibits a greater tolerance to carbohydrate food, that is to say, a larger quantity of carbohydrate can be taken without causing alimentary glycosuria. There is also a marked increase in the processes of fat formation, so that a tendency to obesity is one indication of a diminished activity of the posterior lobe. When the operation is performed upon young animals the development of the sexual glands is arrested, and the animal later exhibits a eunuchoid condition. On the clinical side observations have been collected which corroborate and extend the conclusions that might be drawn from the results of animal experimentation, although in such cases it has been more difficult to separate the effects due to the anterior and the posterior lobes respectively. When the hypophysis is hypertrophied and is presumably in a condition of hyperactivity, the resulting effects are exhibited chiefly in the matter of the growth of the skeleton. In early life such an effect leads to marked overgrowth or *gigantism*, while in later life it occasions an enlargement of the bones of the face and extremities, a condition known as *acromegaly*. It is assumed that in such cases there is a hypersecretion of the anterior lobe. On the other hand, when there is reason to believe that there is a diminished activity of the pituitary body, for example, from pathological growths pressing upon the gland, the effects usually observed are the production of obesity and sexual infantilism, together with increased tolerance to carbohydrates. These effects are attributed to a hyposecretion of the posterior lobe.

*The Functions of the Pituitary Body.*—It seems evident from the above brief statement of the results of experiments and clinical observations that the pituitary body is essential in some way to normal body-metabolism, and moreover that the anterior and posterior lobes exercise different functions. The differentiation in function between the two parts or two glands cannot be made completely at present, but so far as our knowledge goes it would seem that the anterior lobe furnishes a secretion that stimulates the growth of the skeleton and possibly the connective tissues in general, and in addition exercises some deeper influence on metabolism of an unknown but essential nature. The posterior lobe, on the contrary, furnishes one or several hormones that have a stimulating effect upon several processes—the tone of plain muscle, the secretory activity of several glands, and the process of glycogenolysis. In addition, this portion of the gland shares with others of the ductless glands (thymus, cortex of the adrenal glands) a regulating influence upon the normal development of the reproductive organs. Its influence in this respect resembles and may be con-

nected with the activity of the interstitial tissue within the substance of the ovary or testis.

**The Pineal Body** (*Epiphysis Cerebri*).—This small body projects from the roof of the third ventricle and embryologically develops as an outgrowth from this vesicle of the brain. In early life it has a glandular structure which seems to reach its greatest development at about the seventh year. After this period and particularly after puberty it undergoes a process of involution during which the glandular structure gradually disappears and its place is taken by fibrous tissue. The gland is noteworthy also for the appearance of calcareous concretions, the so-called brain sand, which may appear even in early life. Intravenous injections of extracts of this gland seem to cause a distinct fall in blood-pressure, indicating the presence of a depressor substance. On the pathological side it is stated that in young children invasion of the gland by pathological growths results in distinctive effects. Under such conditions there is presumably a diminished activity of the gland, and the results observed are an accelerated development of the reproductive organs, with an attending mental precocity and an increased growth of the skeleton. The inference made, therefore, from these observations is that in the young child the gland furnishes a secretion which inhibits growth and particularly restrains the development of the reproductive glands, but it should be noted that this conclusion is not well supported by experimental evidence. Total extirpation of the gland gives no decisive effect upon the animal (Dandy).

**Organs of Reproduction.**—Some of the earliest work upon the effect of the internal secretions of the glands was done upon the reproductive glands, especially the testis, by Brown-Séguard.\* According to this observer, extracts of the fresh testis when injected under the skin or into the blood may have a remarkable influence upon the nervous system. Mental and physical vigor, and the activity of the spinal centers, are greatly improved, not only in cases of general prostration and neurasthenia, but also in the case of the aged. Poehl asserts that he has prepared a substance, spermin, to which he gives the formula  $C_5H_{14}N_2$ , which has a very beneficial effect upon the metabolism of the body. He believes that this spermin is the substance that gives to the testicular extracts prepared by Brown-Séguard their stimulating effect. He claims for this substance an extraordinary action as a physiological tonic, but it cannot be said that his assertions have been corroborated by later work. Zoth† and also Pregel seem to

\* "Archives de physiologie normale et pathologique," 1889-92.

† "Pflüger's Archiv f. die gesammte Physiologie," 62, 335, 1896; also 69, 386, 1897.

have obtained exact objective proof, by means of ergographic records, of the stimulating action of the testicular extracts upon the neuromuscular apparatus in man. They find that injections of the testicular extracts cause not only a diminution in the muscular and nervous fatigue resulting from muscular work, but also lessen the subjective fatigue sensations. The natural direction in which we would look for evidence of the existence of an internal secretion on the part of the testes would be in their influence upon the sexual characteristics and sexual appetite. Most of the recent work has indicated quite clearly that the reproductive glands control the development of the sexual characteristics, not by way of a reflex nervous effect but by way of the blood; that is to say, through an internal secretion. This work however, tends to show that the internal secretion is formed not by the reproductive elements proper, the spermatozoa or the spermatogonia, but rather by the so-called interstitial cells of Leydig, which lie outside of the seminal tubules. When a young animal is castrated completely the secondary sexual characters and the sexual appetite do not develop. If, however, the vas deferens is ligated, the sexual elements may disappear while the interstitial cells remain and increase in number. In such animals the sexual instincts and characteristics develop normally. The clearest proof of the importance of the interstitial cells in this regard is furnished by the experiments of Steinach.\* Making use of very young animals this observer has transplanted the testes from their normal position to other regions. Such animals develop normally, show all of the usual secondary sexual characteristics, and manifest full sexual desire and potency at the proper period. When the transplanted glands are examined it is found that the sexual elements are lacking, but the interstitial cells are increased in amount. It would appear from this work that sexual puberty is dependent upon the internal secretion furnished by these cells, and Steinach proposes to designate them collectively as the "puberty gland." This observer reports further remarkable experiments in which young males (rats, guinea pigs) were first castrated and then had transplanted under the skin or in the peritoneal cavity the ovary from a female of the same species. Under such conditions the graft of the ovary takes, and unlike the grafted testicle both the reproductive cells and the interstitial cells survive. In such animals the secondary male characteristics do not develop, his genital organs remain infantile; he exhibits, on the contrary, the female characteristics, as shown by his size, the character of the hair, and especially by the development of mammæ and nipples. So far as the external characteristics are concerned the animal is completely feminized, and

\* Steinach, "Pflüger's Archiv," 144, 71, 1912.

Steinach states that such an animal is sought by the male as though it were a true female. It would follow from these experiments that the internal secretion of the interstitial cells in the ovary and in the testis has each its specific influence in guiding the development of the sexual characteristics, one causing the formation of male, the other of female characteristics. Many experiments and observations indicate that the internal secretions of the ovaries and testes are important, not only as regards so-called secondary sexual characteristics, but also in regard to the body-metabolisms in general. Some evidence for this general view is found in the functional relationship that appears to exist between these organs and other ductless glands. This relationship is most clearly marked with the thymus, the pituitary, and the cortical portion of the adrenal glands. Castration or spaying causes an enlargement of the thymus gland, even in the mature animal in which this gland has undergone considerable involution. The same operation affects the hypophysis and adrenals, although, according to Hatai,\* the effect in this case varies with the sex. In the male castration causes a marked increase in the weight of the hypophysis, while in the female the effect is less distinct. As regards the adrenal glands, castration in the male causes an increased weight of the adrenals, while spaying in the female causes a decrease in weight in these glands. On the other hand, as has been stated above, thymectomy seems to accelerate the development of the reproductive glands, and removal of the posterior lobe of the hypophysis retards their development. The nature of these reciprocal relationships cannot be explained at present, but it may be assumed that they are concerned with modifications of the nature of some of the processes of body-metabolism and that the effects produced depend upon definite hormones or internal secretions. Further evidence of the same character may be found in observations like the following:

In gynecological practice it has been observed that complete ovariectomy with its resulting premature menopause is often followed by distressing symptoms, mental and physical. In such cases many observers have reported that these symptoms may be alleviated by the use of ovarian extracts. Similar results have been reported upon the lower animals. After complete ovariectomy a condition of "heat" may be reproduced by grafting ovarian tissue, † and several observers agree in stating that removal of the ovaries in young animals prevents the normal development of the uterus, while in adult animals it causes the organ to undergo a fibrous degeneration (see section on Reproduction). In the natural menopause, as well as in the premature menopause follow-

\* Hatai, "The Journal of Experimental Zoölogy," 18, 1, 1915.

† Marshall and Jolly, "Philosophical Transactions," B. cxcvii., 99, 1905.



ing complete removal of the ovaries, it is a frequent, though not invariable, result for the individual to gain noticeably in weight. An effect of the ovaries on general nutrition is indicated also by the interesting fact that in cases of osteomalacia, a disease characterized by softening of the bones, removal of the ovaries may exert a favorable influence upon the course of the disease. These indications have found some experimental verification in a research by Loewy and Richter\* made upon dogs. These observers report that complete removal of the ovaries, although at first apparently without effect, resulted in the course of two to three months in a marked diminution in the consumption of oxygen by the animal, measured per kilogram of body weight. If now the animal in this condition was given ovarian extracts (oöphorin tablets), the amount of oxygen consumed was not only brought to its former amount, but considerably increased. A similar result was obtained when the extracts were used upon castrated males. The authors believe that their experiments show that the ovaries form a specific substance which is capable of increasing the oxidations of the body. While the effects described above may be referred probably to the internal secretion of the interstitial cells of the ovaries, other facts indicate that other elements in the gland may also furnish a specific secretion. Thus, the implantation of the fertilized ovum in the uterine mucous membrane and the development of the placenta have been supposed to be effected through the agency of some chemical stimulus arising in the cells of the corpus luteum (see section on Reproduction).

**Pancreas.**—The importance of the external secretion, the pancreatic juice, of the pancreas has long been recognized, but it was not until 1889 that von Mering and Minkowski † proved that it furnishes also an equally important internal secretion. These observers succeeded in extirpating the entire pancreas without causing the immediate death of the animal, and found that in all cases this operation was followed by the appearance of sugar in the urine in considerable quantities. Further observations of their own and of other experimenters have corroborated this result and added a number of interesting facts to our knowledge of this side of the activity of the pancreas. It has been shown that when the pancreas is completely removed a condition of glycosuria inevitably follows, even if carbohydrate food is excluded from the diet. Moreover, as in the similar pathological condition of glycosuria or diabetes mellitus in man, there is an increase in the quantity of urine (polyuria) and of urea, and an abnormal thirst and hunger. Acetone also is

\* Loewy and Richter, "Archiv f. Physiologie," 1889, suppl. volume, p. 174.

† Minkowski, "Archiv f. exper. Pathologie u. Pharmakologie," 31, 85, 1893.

present in the urine. These symptoms in cases of complete extirpation of the pancreas are followed by emaciation and muscular weakness, which finally end in death in two to four weeks. If the pancreas is incompletely removed, the glycosuria may be serious, or slight and transient, or absent altogether, depending upon the amount of pancreatic tissue left. According to the experiments of von Mering and Minkowski on dogs, a residue of one-fourth to one-fifth of the gland is sufficient to prevent the appearance of sugar in the urine, although a smaller fragment may suffice apparently if its physiological condition is favorable. The portion of pancreas left in the body may suffice to prevent glycosuria, partly or completely, even though its connection with the duodenum is entirely interrupted, thus indicating that the suppression of the pancreatic juice is not responsible for the glycosuria. The same fact is shown more conclusively by the following experiments: Glycosuria after complete removal of the pancreas from its normal connections may be prevented partially or completely by grafting a portion of the pancreas elsewhere in the abdominal cavity or even under the skin. So also the ducts of the gland may be completely occluded by ligation or by injection of paraffin without causing a condition of permanent glycosuria.

On the basis of these and similar results it is believed that the pancreas forms an internal secretion which passes into the blood and plays an important, indeed, an essential part in the metabolism of sugar in the body. Moreover, considerable evidence has been accumulated to show that the tissue concerned in this important function is not the pancreatic tissue proper, but that composing the so-called islands of Langerhans. In man these islands are scattered through the pancreas, forming spherical or oval bodies that may reach a diameter of as much as one millimeter. The cells in these bodies are polygonal; their cytoplasm is pale, finely granular, and small in amount. The nuclei possess a thick chromatin network which stains deeply. Each island possesses a rich capillary network that resembles somewhat the glomerulus of the kidney.

According to Ssbolew,\* ligation of the pancreatic duct is followed by a complete atrophy of the pancreatic cells proper, while those of the islands of Langerhans are not affected. Since under these conditions no glycosuria occurs, while removal of the whole organ including the islands is followed by pancreatic diabetes, the obvious conclusion is that the diabetes is due to the loss of the islands. This conclusion is strengthened by reports from the pathological side. A number of observers (Opie, Ssbolew, Herzog, *et al.*) find that in diabetes mellitus in man the islands may be markedly

\* "Virchow's Archiv," 168, 91, 1902; also Homans, "The Journal of Medical Research," 30, 49, 1914.

affected. They show signs of hyaline degeneration or atrophy, or in severe cases may be absent altogether. It should be added that this connection of the islands of Langerhans with the internal secretion of the pancreas is not accepted by all writers. Cases of diabetes are reported in which the islands were apparently not affected,\* and several observers† contend that the islands represent stages in the development of the ordinary secreting alveoli of the pancreas. The most complete histological work seems to show clearly that the islets are permanent organs which persist as such in the pancreas, and presumably have, therefore, some specific functional importance, but the nature of this function and its relation to that of the acinar cells must be considered at present as open questions.‡

Several theories have been advanced to explain the action of the internal secretion of the pancreas. It has been suggested that the secretion contains an enzyme which is necessary for the hydrolysis or oxidation of the sugar of the body, and in the absence of this enzyme the sugar accumulates in the blood and is drained off through the kidney. The long series of experiments that have been undertaken to establish this point of view have yielded contradictory and perplexing results. Observations from several sources indicate that the tissues of a depancreatized dog are still able to consume the sugar of the blood in some degree; that is to say, the tissues can take up sugar from the blood circulating through them,§ but to what extent this sugar is metabolized remains undetermined. Apparently something is lacking in the normal process, but as the nature of the normal process is itself incompletely known, the defect caused by the failure of the pancreatic hormone becomes correspondingly difficult to define. Other investigators adopt an entirely different view of the relation of the pancreas to carbohydrate metabolism. They believe that the internal secretion of the pancreas regulates in some way the output of sugar from the liver. In the absence of this secretion the liver gives off its glycogen as sugar too rapidly, the sugar contents of the blood are thereby increased (hyperglycemia) above normal, and the excess passes out in the urine. A specific form of this hypothesis (Zuelzer||) assumes that the output of sugar from the liver (glycogenolysis) is under the control of two opposing hormones, an accelerating hormone (epinephrin) furnished by the adrenal glands, and an

\* See Pratt, "Journal of the American Medical Association," December 17, 1910.

† Dale, "Philosophical Transactions," B. cxvii., 1904; also Vincent and Thompson, "Journal of Physiology," 1906, xxvii., xxxiv.

‡ Bensley, "American Journal of Anatomy," 12, 297, 1912.

§ See Macleod and Pearce, "American Journal of Physiology," 32, 184, 1913, and 33, 378, 1914; also Verzar, "Biochemische Zeitschrift," 66, 75, 1914.

|| Zuelzer, "Deut. med. Wochenschrift," 34, 1380, 1908.

inhibiting hormone given off by the pancreas. When the pancreas is removed, the accelerating hormone causes an augmentation in the output of sugar and thus produces a condition of hyperglycemia and glycosuria. In support of this view it is claimed that in a depancreatized dog ligation of the adrenal veins prevents the glycosuria. Unfortunately, we can hardly accept this relatively simple hypothesis as expressing the whole truth, for apparently the relation of the sugar-regulating mechanism of the body to the internal secretions is involved and concerns a number of the ductless glands. For example, the posterior lobe of the pituitary body appears to exert an influence on the conversion of glycogen to sugar similar to that attributed to epinephrin, while, on the other hand, thyroid secretion, or at least thyroid feeding, inhibits the formation of glycogen in the liver.\*

\* Cramer and Krause, "Proceedings of the Royal Society," London, B. 86, 550, 1913.

## SECTION VIII.

# NUTRITION AND HEAT PRODUCTION AND REGULATION.

---

## CHAPTER XLVII.

### GENERAL METHODS—HISTORY OF THE PROTEIN FOOD.

Under the head of nutrition or general metabolism we include usually all those changes that occur in our foodstuffs from the time that they are absorbed from the alimentary canal until they are eliminated in the excretions. In many of these processes the oxygen absorbed from the lungs takes a most important part, and the changes directly due to this element, the physiological oxidations of the body, can not be separated from the general metabolic phenomena of the tissues. As was said in another place, the respiratory history of oxygen ceases after this element has reached the tissues; its subsequent participation in the chemical changes of the organism forms an integral part of the nutritional processes. These latter processes are varied and complex and only partially understood. For the sake of simplicity in presentation it is convenient to consider separately each of the so-called foodstuffs,—the proteins, carbohydrates, fats, water, and inorganic salts,—and attempt to trace its nutritive history from the time it is absorbed into the blood until it is eliminated from the body in the form of excretory products. Before undertaking this description it is desirable to call attention to certain general methods and conceptions that have been developed in connection with this part of physiology.

**Nitrogen Equilibrium.**—Among our main foodstuffs the proteins are characterized by containing nitrogen. After this material is metabolized in the body the nitrogen is eliminated in various forms, chiefly in the urine, but to a smaller extent in the feces and sweat. In the feces, moreover, there may be present some undigested protein which, although taken with the food, has never really entered the body. It is evident that the urine, feces (and sweat) may be collected during a given period and analyzed to determine their contents in nitrogen. The sweat is

usually neglected except in observations upon conditions in which muscular activity has been a prominent feature. As a rule, the amount of nitrogen is determined by some modification of the Kjeldahl method. In principle this method consists in heating the material to be analyzed with strong sulphuric acid. The nitrogen is thereby converted to ammonia, which is distilled off and caught in a standardized solution of sulphuric acid. By titration the amount of ammonia can be determined, and from this the amount of nitrogen is estimated. Nitrogen forms a definite percentage of the protein molecule (about 16 per cent.); so that if the weight of nitrogen is multiplied by 6.25 the weight of protein from which it is derived is obtained. If, on the other hand, the nitrogen is determined in the food eaten during the period of the experiment it is evident that a balance may be struck which will determine whether the body is receiving or losing nitrogen. If the balance is even the body is in nitrogen equilibrium—that is, it is receiving in the food as much protein nitrogen as it is metabolizing and eliminating in the excreta. If there is a plus balance in favor of the food it is evident that the body is laying on or storing protein, while if the balance is minus, the body must be losing protein. During the period of growth, in convalescence, etc., the body does store protein, and under these conditions the balance is in favor of the food nitrogen. But throughout adult life under normal conditions our diet is so regulated by the appetite that a nitrogen equilibrium is maintained through long periods. Under experimental conditions, involving, for instance, a special diet, it often becomes necessary to make the analyses for nitrogen in order to determine whether or not the individual is losing or gaining protein or is in equilibrium.

It is important also to bear in mind that nitrogen or protein equilibrium may be established at different levels. If, for instance, a man is in nitrogen equilibrium on a diet containing 10 gms. of nitrogen per day, what will happen if the protein in this diet is doubled? Our experience teaches us that the extra 10 gms. of nitrogen or 62.5 gms. of protein are not stored in the body indefinitely. As a matter of fact, the extra protein is metabolized in the body and nitrogen equilibrium becomes established at a higher level. Whereas under the first condition 10 gms. of nitrogen entered the body in the form of protein and 10 gms. of nitrogen left the body in the form of nitrogenous excreta, under the second condition 20 gms. of nitrogen are consumed per day in the food and 20 gms. are lost per day in the excretions. The total mass of protein tissue in the body may remain the same, or if any increase takes place at the beginning of the change in diet it soon ceases. Experimentally it is found that there is a certain low limit of protein which just suffices to maintain nitrogen equilibrium, and between this level and the

capacity of the body to digest and absorb protein food, nitrogen equilibrium may be maintained upon any given amount of protein.

**Carbon Equilibrium and Body Equilibrium.**—The term “carbon equilibrium” is sometimes used to describe the condition in which the total carbon of the excreta (in the carbon dioxid, urea, etc.) is balanced by the carbon of the food. It is possible that an individual may be in nitrogen equilibrium and yet be losing or gaining in weight, since, although the consumption of proteins may just be covered by the proteins of the food, so far as the nitrogen is concerned, the supply of food may be greater than the body needs or can destroy, and the excess may be stored in the body in the form of glycogen or fat, or, on the other hand, the supply of energy-yielding food may be less than is necessary to cover the needs of the body and some of the fat of the body may be oxidized. In the first case the carbon absorption would exceed the carbon excretion—there would be a plus carbon balance; in the second case the reverse would hold. In the same way we may speak of a water equilibrium or a salts equilibrium, although these terms are not generally used. An adult under normal conditions lives so as to maintain a general body equilibrium; his ingesta of all kinds are balanced by the corresponding excretions, and the individual maintains a practically constant body-weight.

**Complete Balance Experiments—Respiration Chamber.**—

According to the statements made in the last paragraph, it is obvious that if the analytical work is properly done, an exact balance may be drawn between the proteins, fats, and carbohydrates eaten as food and the proteins, fats, and carbohydrates destroyed in the body as represented by the nitrogen and carbon contained in the excreta. Complete experiments of this kind were attempted first by Voit \* and Pettenkofer, to whose work much of our fundamental knowledge is due. In the experiments of these authors, made upon men as well as animals, the total nitrogen of the urine and feces was determined and the total quantity of  $\text{CO}_2$  given off from the lungs was estimated. This last determination was made possible by placing the individual in a specially constructed chamber or *respiration apparatus*. Air was drawn through this room by means of a pump. The total quantity of air passing through the room was measured by a gasometer and definite fractions were drawn off from time to time, which were analyzed for  $\text{CO}_2$ . From the figures thus obtained it was possible to estimate the entire  $\text{CO}_2$  given off during the period of observation. Knowing the total nitrogen and carbon eliminated, it was possible to estimate the amount of protein and fat or carbohydrate destroyed in the body. From the nitrogen the quantity of protein metabolized was

\* See Hermann's "Handbuch der Physiologie," vol. vi., 1881.

obtained by multiplying by 6.25, as explained above. If then the carbon belonging to the amount of protein metabolized was deducted from the total carbon excreta, what was left represented either fat or carbohydrate burnt in the body, and, knowing the amount of these materials taken in the diet, it was possible to ascertain whether the corresponding amount of carbon had all been excreted. By experiments of this kind a nearly perfect balance may be struck between the income and the outgo of the body. Absolute accuracy is not sought for, since the materials eaten vary somewhat in composition and some little of the carbon or nitrogen excreted is found in the secretions from the skin, the saliva, etc., which are not usually examined.

More recent experiments made in this country under the direction of Atwater\* have attempted to balance not only the material income and outgo of the body during a given period, but also the income and outgo of energy. For this purpose the individuals experimented upon were placed in a very carefully constructed respiration chamber so that their expired air could be analyzed as well as the urine and feces. The chamber, however, was also arranged to act as a calorimeter (see p. 947) by means of which the heat given off by the person could be measured. The heat value of the diet being known, it is possible in this way to ascertain whether or not this theoretical amount of heat is actually given off from the body. Atwater's respiration chamber is described as a *respiration calorimeter*; some of the results obtained from its use are referred to later on.

#### **The Effect of Non-protein Food on Nitrogen Equilibrium.—**

By use of the methods referred to above the general influence of the non-protein foods (fats, carbohydrates) upon the protein consumption of the body has been made evident. An animal may be brought into nitrogen equilibrium on protein food alone, the amount of protein required being relatively large. If now non-protein foodstuffs are added to the diet it is found that the amount of protein necessary to maintain nitrogen equilibrium may be reduced correspondingly. With reference to the consumption of protein in the body the non-protein foods are all *protein-sparers*, and herein lies one great peculiarity of their nutritional value. On a mixed diet of protein and non-protein food the proportion of the latter may be increased and that of the former decreased to a marked extent without breaking down nitrogen equilibrium—that is, without causing a loss of protein tissue from the body. This fact is explained by the consideration that in our body the food fulfils two great functions. First, it furnishes the material for the formation of new living matter or the replacement of

\* Atwater, Bulletins 45, 63, 69, United States Department of Agriculture.



the loss of this matter that is continually going on; second, it furnishes a supply of energy for the heat of the body and for the work done by the various cells, the contraction of the muscle, the secretion of the gland, the discharges of the nerve-cells, etc. This second function, the energy requirement, is met by any of the three energy-yielding food-stuffs, carbohydrates, fats, or proteins, especially, as we shall find, by the carbohydrates. For the first function protein (or its split-products) is absolutely needed, and perhaps is alone needed. In any event, if the supply of non-protein is sufficiently large, then the amount of protein can be lowered to a certain irreducible minimum, which is required for purposes of genuine assimilation, that is, the construction of living material.

**The Nutritive History of the Protein Food.**—The digestive changes undergone by protein and its subsequent absorption have been described in the section on Digestion. It will be remembered that the view adopted was that the proteins are completely hydrolyzed into their amino-acids and in this form are absorbed into the blood and distributed to the tissues. The blood from the intestines passes first through the liver before reaching the general circulation, and a question to be determined is whether the amino-acids are acted upon in any specific way by the liver. On this point opinions have differed greatly. After a meal the amino-acids in the blood and in the tissues generally are increased in amount, and this fact would indicate that these substances pass through the liver without undergoing any intermediate metabolism. They are disseminated over the body at large and undergo their subsequent metabolic changes in the several tissues; but it is probable, as is explained below, that one stage in the metabolism of some of these amino-acids may be carried out especially in the liver.

Concerning the further history of the amino-acids or the nature of the processes of protein metabolism in the tissues there have been many different theories and points of view.\* It would be confusing to give summaries of these diverging theories, and it may suffice to indicate briefly the conception that seems to be most in accord with recent work. It may be accepted as a necessary conclusion that some of these amino-acids are recombined by synthetic processes to form organized protein, of the kind characterizing the particular tissue, for only in this way can we understand how the wear and tear of the tissue is replaced or how new protein is made in the growing animal. Whether this synthetic combination is effected by endo-enzymes or under the influence of the living protein of the cells cannot be stated, but we may assume that the several amino-acids which enter into the structure of that particular

\* For a review of these theories consult Mendel, "Ergebnisse der Physiologie," 11, 418, 1911.

kind of protein are combined in general after the manner of the formation of polypeptids p. 1010). This portion of the nitrogenous material that is used to replace tissue waste or to provide new tissue has long been designated as *tissue protein*, and in the adult animal a relatively small fraction of the nitrogenous food may suffice for this purpose. The balance of the nitrogenous material is used, in all probability, not for tissue maintenance or tissue growth, but as a source of energy. When the protein food is large in amount the greater portion no doubt fulfils this function. When the protein food is reduced to minimal proportions the amount left for energy purposes is diminished correspondingly. It will be shown later that ordinarily we eat more protein daily than is required to cover our tissue wastes, that is, to provide the necessary tissue-protein, so that on a customary diet it is probable that a good proportion of the products of protein-digestion is used to furnish energy rather than to construct tissue. The further history of the portion used for energy purposes is not wholly known, but the main point is that the amino-acids constituting this portion undergo deamination. The  $\text{NH}_2$  group is split off to form ammonia that is subsequently converted to urea and excreted, while the organic acid radicle which is left is oxidized to furnish energy or is built into sugar or fat and oxidized at some later period. This portion of the amino-acid, therefore, may be regarded as a source of energy entirely equivalent to that furnished by the non-protein elements of the food, the carbohydrates and the fats. If we grasp the fundamental idea that from the supply of amino-acids furnished to the tissues by the digested food-proteins certain ones are selected to construct the peculiar tissue-protein of the animal, so far as this is required for growth or tissue-repair, then it is evident that the balance is not needed as nitrogenous material, and its nitrogen is removed by deamination, while the remainder of the molecule serves for purposes of energy-supply, just as the non-nitrogenous food-stuffs might do. We may suppose that it is the excess amino-acids not used in tissue construction that undergo this fate.

A third possibility in regard to the fate of the amino-acids, or rather the absorbed products of protein digestion, has been discussed more or less at times in physiology. In addition to the portion that is applied to the repair or construction of tissue, it has been held that another portion may be synthesized to a form of non-organized or non-living protein held as a sort of storage supply in the liquids of the body, that is, the blood and lymph. It has been supposed that this material is called upon first in fasting or starvation, and that it constitutes an easily used form of protein food of limited amount which is designated as *circulating or storage protein*. Our knowledge in regard to this material is quite indefinite at present. Certainly none of the known proteins of blood or lymph seem to discharge this function.

It was supposed formerly that the process of deamination of the excess of the amino-bodies is accomplished mainly in the

liver, but this view has been brought into question lately.\* That the process takes place in the body is beyond doubt, and it is likely that the liver shares in this activity even if it is not the chief tissue concerned. That the body is able to build up its own protein from a mixture of amino-acids, such as is produced in a complete digestive hydrolysis of protein, has been demonstrated beyond doubt by feeding experiments in which the nitrogenous food was all supplied in the form of such a mixture. The first experiments of this kind were made by Loewi.† He fed dogs on a diet consisting of fats, carbohydrates, and protein which had been submitted previously to a prolonged pancreatic digestion until it was completely hydrolyzed. On this diet the animal was maintained in nitrogen-equilibrium. This experiment has been verified and extended by others on man as well as upon dogs, and indeed Abderhalden and Rona report that they have been able to keep a dog not only in nitrogen-equilibrium but with a plus balance of nitrogen when fed on the split products of meat alone, without addition of fats or carbohydrates. This last experiment would indicate that the amino-bodies not only give to the body material from which it can reconstruct its own protein, but they furnish also a usable source of energy for the body needs, a result which we can understand on the hypothesis mentioned above, according to which the amino-acids, after removal of the  $\text{NH}_2$  group, furnish an organic acid residue capable of further oxidation or of synthesis to fats or carbohydrates.

We may accept as a clear result of modern investigation that the body is capable of building up its protein from such relatively simple substances as the amino-acids, in fact the evidence goes to show that normally it is from these amino-acids that the nitrogenous material of the body protein is derived. This striking result has led investigators to test whether the body may utilize sources of nitrogen of even simpler construction, such, for example, as the organic or inorganic salts of ammonia. It has long been known that the plant organism utilizes inorganic forms of nitrogen, such as the ammonia salts or the nitrates, in building up its protein, and it has long been believed that the animal protoplasm is not able to utilize these salts in the same way, that, in other words, its processes of synthesis so far as the protein material is concerned are more limited than in the plants. It has been taught universally that animals for the construction of new tissue must have their nitrogenous food in the form of protein, or, a recent addition, in the form of the split-products of protein. Several observers report (see Grafe, "Zeitschrift f. physiolog. chemie.," 78, 485, 1912) that when animals are fed upon an abundance of carbohydrate food together with some ammonia salt, such as ammonium citrate, acetate, or carbonate, they may maintain a positive nitrogen balance for long periods.

In the metabolism of the amino-acids in the body it is recognized that by diamination and oxidation an oxyacid or ketonic acid may be produced, and it is suggested that this process may be reversed, that an oxyacid, lactic acid formed from sugar, may combine with ammonia, furnished by an am-

\* See Fiske and Sumner, "Journal of Biological Chemistry," 18, 285, 1914.

† For the literature consult Lühje, "Ergebnisse der Physiologie," vii, 1908, or Abderhalden, "Synthese der Zellbausteine," etc., 1912.

monia salt in the diet, to produce an amino-acid, according to the reversible equation—

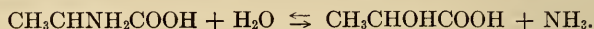

If this is true, then it might follow that an inorganic salt of ammonia could under certain conditions supply the nitrogen necessary for the construction of body-proteins, or at least for some of the amino-acids concerned in this synthesis. The matter is still under investigation. Some observers (Underhill and Goldschmidt, "Journal of Biological Chemistry," 15, 341, 1913) state that there is a difference in this respect between the inorganic and organic salts of ammonia so far as the animal body is concerned. With the inorganic salts (ammonium chlorid) and non-protein food no evidence can be obtained of the utilization of the ammonia. With the organic salts, on the contrary (ammonium citrate or acetate), there is a marked decrease in the nitrogen loss when the animal receives in addition only non-protein food. Other observers, however, doubt the application of these results to normal nutrition. It is possible, for example, that the utilization of the ammonia salts may be effected indirectly through bacterial action in the intestines.

#### The Amount of Protein Necessary for Normal Nutrition.—

As was stated above, nitrogen equilibrium may be maintained on different amounts of protein food. It is important, from a scientific and from an economic standpoint, to determine the low limit for this equilibrium and to ascertain whether, for the purpose of the best as well as the most economical nutrition, this low limit is as good as or preferable to a higher amount of protein in the diet. Examination of the dietaries of civilized races shows that, on the average, 100 to 120 gms. of protein are used daily by an adult man. Voit gives 118 gms. of protein as the average daily consumption. A variable portion of this amount passes into the feces in undigested form, but we may assume that about 100 to 105 gms. are absorbed and actually metabolized in the body. If we take into account the weight of the body, this amount of protein may be estimated as equivalent in round numbers to 1.5 gms. of protein (or 0.23 gm. nitrogen) per kilogram of body-weight. In recent years serious attempts have been made to ascertain how low this daily quota of protein may be reduced without destroying nitrogen equilibrium or injuring the effectiveness of the body for muscular or mental work. Siven was able for short periods to reduce his daily diet of protein to as little as 0.5 gm. (0.08 gm. N.) per kilo of body weight, but probably the most important experiments of this kind are those carried out by Chittenden.\* In this work the experiments were continued over long periods of time, and were made upon three different groups of men, five university teachers, a detail of thirteen men from the Hospital Corps of the Army, and eight university students classed as athletes. The general result of the investigation showed that the body can be maintained in protein equilibrium

\* Consult Chittenden, "Physiological Economy in Nutrition," New York, 1905, for discussion and literature. See also Hinhede, "Skandinavisches Archiv f. Physiol.," 30, 97, 1913.

and in a normal state of efficiency upon a diet containing only 30 to 50 gms. of protein per day, according to the weight of the individual—or, expressed in more general terms, the daily quota of protein per kilo of weight may be reduced from 1.5 gms. (0.23 gm. N.) to about one-half, that is, 0.75 gm. of protein or 0.12 gm. of nitrogen per kilo. This general result has been confirmed on a large scale by the studies made by McCay\* of the metabolism of the Bengalis of India. He finds that the average Bengali metabolizes in his body, so far as may be judged from the nitrogen excreted in the urine, only about 37.5 gms. of protein daily, corresponding to a consumption per kilo of 0.7 gm. of protein or 0.113 gm. of nitrogen. A corresponding average amount of protein is, of course, eaten daily, and on this low protein diet they exist in apparent health. Rubner† also emphasizes the fact that milk, which forms the sole diet of the infant, is a protein poor food. The usual daily diet of the adult has a heat value of from 2400 to 3000 calories (see p. 940). Of this total heat value the protein food in the diets usually recommended forms about 15 to 20 per cent. In milk, however, according to Rubner's estimates, the protein constitutes only about 10 per cent. of the total heat value. As the result of these and similar investigations, the practical question presents itself as to what constitutes the optimum daily quota of protein. If the body can be kept in good condition upon 0.75 gm. per kilo per day, will an ingestion of more than this, say twice as much, prove injurious or beneficial or indifferent to the body? Outside its hygienic aspect the question is important from an economical standpoint, since the proteins are the most expensive foods, and in the feeding of large masses of individuals—armies, schools, asylums, etc.—it is not desirable to waste money on protein food if it is not needed. The full and satisfactory answer to this question must be deferred until more experience is obtained. The report upon the Bengalis, noted above, would seem at first to constitute a satisfactory demonstration of the practicability of a low protein diet, but McCay states that the Bengali is inferior physically to the average European, and is particularly deficient in capacity for muscular work, and he is inclined to attribute this inferiority to the diet. Moreover, the Bengali is quite susceptible to kidney troubles, a fact which seems to destroy one prediction often made by those who advocate a low protein diet, namely, that the smaller amount of work thus thrown on the kidneys would result

\* McCay, "The Metabolism of the Bengalis, Calcutta," 1908. (Scientific Memoirs, Medical Department Government of India, No. 34.) Also later report upon Jail Diets, *ibid.*, No. 37, 1910.

† Rubner, "Das Problem des Lebensdauer," 1908; Cohnheim, "Die Physiologie der Verdauung u. Ernährung," 1908.

in a diminution of diseases of the kidney. The newer conceptions in regard to the digestion and nutritive history of the protein foods certainly seem to favor the adoption of a low protein diet. If protein is eaten in excess of the real assimilation needs of the tissues, all the excess, so far as we can see, might just as well be substituted by carbohydrate or by carbohydrate and fat. The excess nitrogen thus eaten appears to be so much useless ballast which the body very promptly gets rid of. The uncertain point, however, is what constitutes the assimilation need of the tissues. The experiments given above would place this need very low, according to the lowest estimate, at about 5 per cent. of the total energy value of the food. That is to say, if the daily diet contains heat energy equivalent to 2400 calories, only 5 per cent. of this, 120 calories, needs to be in the form of protein, an estimate which would bring the protein to about 30 gms. daily. Many objections have been urged against the attempt to apply this apparently logical conclusion to public dietaries. We are reminded that our knowledge of the details of the metabolism of protein is very incomplete, and it is not certain yet that in the long run a low protein diet would be entirely without injury. Emphasis has been laid also upon the importance of providing what Meltzer has named a "factor of safety," that is to say, a certain margin beyond a bare sufficiency which will be a reserve against unusual demands, but this objection simply serves to restate the question. If a man is accustomed to eat 100 gms. of protein daily and science demonstrates that he can maintain a nitrogen equilibrium on 30 gms., does a reasonable factor of safety require the use of the additional 70 gms., or would perhaps a total of 50 or 60 gms. per day meet every requirement? It seems obvious that we must find out the truth in this matter by observation and experiment. There is one consideration that should induce us to be cautious in making a radical change in the dieting of collections of individuals, such as armies, institutions, etc., and that is, that our instinctive appetite seems to lead us to seek the higher protein diet. We know very little, indeed, about the mechanism of these appetites, but as a matter of fact, they and not the results of science control the amount and kind of food that we eat. Science is rapidly gaining information that enables us to guide or control the appetite for food in a conscious and reasonable way, but at present our knowledge is not sufficient to warrant disregarding the bodily sensations when, as in the case in question, they seem to cause a similar reaction in normal men under varying conditions. Studies of dietaries seem to show that mankind, left to the guidance of the natural appetites, has always, when possible, adopted the high protein level of 90 to 100 gms. per day. Indeed, the uniformity with which this level has been un-

consciously maintained is a striking fact. Among the rich as well as the poor, and in races very differently placed as regards quantity of available food, substantially the same amount of protein (80 to 100 gms.) is consumed daily by each individual. The element of the diet which varies most widely, as Cohnheim points out in an interesting discussion of this question, is the non-protein, particularly the carbohydrate material. Those who are obliged to do much muscular work to earn a living or for the sake of pleasure (sports, athletics) add to their daily quota of protein an excess of carbohydrate food to furnish the requisite energy. On the contrary, those whose daily life requires but little muscular exertion cut down the carbohydrates and fats, and make their diet relatively but not absolutely richer in protein. That mankind has made a mistake in adopting instinctively the higher protein level can hardly be claimed on the basis of our present knowledge.

**Nutritive Value of Different Proteins.**—If we consider all the different kinds of animal and vegetable foods it is evident that a great variety of proteins must be utilized in nutrition. Formerly, it was the belief that all these different proteins (with the exception perhaps of gelatin) have an equal nutritive value. But the knowledge that the composition of these proteins varies in regard to the number and character of their constituent amino-bodies, and the fact that each animal out of the complex offered to it in its food selects certain amino-acids in certain proportions from which to reconstruct its own peculiar body-proteins, suggest naturally the thought that the different proteins may have different values in nutrition. Experiments have demonstrated, in fact, that this is the case. From the standpoint of supplying the energy needs of the body the proteins are, so far as we know, pretty much of the same value, but from the standpoint of supplying material for tissue construction they may differ a great deal. Some proteins, when fed together with an adequate supply of non-protein material and water and salts, furnish all the nitrogenous compounds necessary for maintenance and growth; others under the same conditions fail to support growth or maintenance, or both. The former group may be spoken of as *complete* or *adequate* proteins, the latter as *incomplete* or *inadequate* proteins. The difference between the two kinds seems to lie in the character of the amino-acids of which they are composed. Some of the amino-acids which the body tissues need for repair or growth may be made in the body from other amino-acids, glycine, for example, but others apparently must be furnished in the protein of the food, and if they are lacking, tissue construction is not possible.

It has long been known that gelatin is an inadequate protein in this sense. It is digested easily and absorbed and eventu-

ally undergoes oxidation in the body with the production of carbon dioxide, water, and urea. The energy liberated by this metabolism is utilized no doubt in the body, and the gelatin constitutes an "energy-food" similar in a general way to the carbohydrates and fats, although its various amino-acids must give it to some extent a special significance. The important point in this connection is that gelatin alone or with carbohydrates or fats does not suffice to maintain nitrogen equilibrium. It does not supply fully the nitrogenous material needed for the repair of tissue. This deficiency is explained by the fact that in the composition of the gelatin certain important amino-acids are lacking, tryptophan (indolaminopropionic acid), tyrosin (oxyphenylaminopropionic acid), and cystein (thioaminopropionic acid). It is stated that if a dog is fed upon a diet in which the nitrogenous material is represented only by the split products of a gelatin-hydrolysis he will show a minus nitrogen balance, but if the above-named missing amino-acids are added, particularly the tryptophan, he will then maintain his nitrogen equilibrium.

The history of gelatin as a food is very interesting and, indeed, instructive, since it serves or should serve as a warning against a premature application of the results of scientific investigation. A condensed account of the subject is given by Voit in Hermann's *Handbuch der Physiologie*, vol. vi., p. 396. It would seem that on account of the high nitrogen content of the gelatin, and the fact that it is soluble, there was a tendency to attribute to it an unusual nutritive value. The fact, too, that the gelatin could be obtained from bones which otherwise were burned or thrown away was important in suggesting a means for the economical feeding of the poor. The matter was inquired into by a committee during the French Revolution and subsequently by a commission of the French Academy, who made favorable reports. The success of d'Arcet, in making gelatin economically by a new process, led the Philanthropic Society of Paris to request the Academy of Medicine to investigate whether gelatin is really a nutritious and healthy food. The Academy appointed a commission for the purpose and the report of this commission published in the *Annales de Chimie*, vol. 92, 1814, was most enthusiastic. They recommended gelatin as a most nutritious and healthful food, when its natural insipidity was corrected by the addition of salts and savory herbs. On the basis of this report the article was largely used in the nourishment of hospital patients, but in course of time complaints became so emphatic that doubt was again raised as to its real value. In fact, a reaction set in. The second gelatin commission of the French Academy, 1841, a commission of the Netherlands Institute, 1844, and a report from the Academy of Medicine, Paris, 1850, all condemned gelatin as useless from the standpoint of nourishment, and as injurious rather than beneficial. Thus, as so often happens, public opinion oscillated from one extreme to the other. The true value of the gelatin, as we understand it to-day, was established by Voit's experiments, but it is evident that something remains to be explained. It is not clear why it cannot be borne better in a diet when used in quantity.

Most suggestive results on this question of the nutritive values of the different proteins have been obtained in a series of experiments reported by Osborne and Mendel.\* These observers made

\* Osborne and Mendel, "Carnegie Institution of Washington, Publication 156," parts I and II, 1911; also "Journal of Biological Chemistry," 12, 473, 1912; 13, 233, 1912, and 15, 311, 1913.



use of rats, which were fed with a suitable mixture of inorganic salts, carbohydrate, fats, and some single protein representing the sole form in which nitrogenous material was supplied. They found that in addition to gelatin the protein zein obtained from maize, which is deficient in the amino-acids, tryptophan, lysin, and glycin, is also an inadequate or incomplete protein. Gliadin and hordein which are alcohol soluble proteins obtained from wheat, rye, and barley when fed alone sufficed for maintenance, but not for growth. A young rat fed upon gliadin alone ceased to grow, but did not lose in weight, although the power of growth was not lost, since at any time satisfactory growth could be re-established by substituting a suitable dietary for the gliadin mixture. By the same method it was shown that the leguminous proteins when fed alone are inadequate for growth, although in this case apparently the defect is not due to lack of necessary amino-acids, but to some other undetermined cause. There are, however, many single proteins which, when fed alone, seem to be entirely sufficient to provide all the necessary nitrogenous material for maintenance and growth. Such proteins are, for example, casein from milk, edestin from hemp seed, gluten from wheat, lactalbumin from milk, vitellin, etc. Experiments of this kind bring out in a decisive way the important fundamental fact that proteins differ among themselves in regard to their utility in furnishing material for cell repair and growth, and the evidence at hand goes to show that the qualitative differences are dependent upon variations in the amino-acids of which they are composed. A protein-like zein is inadequate because it is lacking in certain essential amino-acids, namely, tryptophan and lysin. Gliadin and hordein are also inadequate, so far as growth is concerned, because they lack lysin. If the missing amino-acids are supplied, either directly or by using other proteins, then the functions of maintenance and growth are adequately supported. In an ordinary diet we do not, of course, use single proteins. Our foods contain a variety of proteins, and it is not at all probable that a natural diet would be lacking entirely in any of the essential building-stones. Work of the kind described above helps to bring out important data in regard to the particular rôle played by the different amino-acids. In time, no doubt, it will be possible to describe more or less completely the transformations that each of these substances undergoes in the body and the special reactions that may depend upon certain ones of them. At present the most evident outcome of the work reported seems to be that some of these amino-acids, glycin, for example, may be formed *de novo* in the animal body by synthetic processes or by transmutation of other amino-acids, while others, such as tryptophan, lysin, and probably tyrosin, cannot be so manufactured, but have to be supplied from

without in the protein food. It is to be hoped that continuation of this work will reveal ultimately the nature of the chemical reactions of maintenance and growth.

**Vitamines and Other Special Substances.**—From the statements made in the preceding paragraphs of this chapter one might conclude that a perfect food would be one which supplied enough non-protein material (fats and carbohydrates) for the energy needs, all the necessary amino-acids, and the essential amounts of water and inorganic salts. This conclusion has been made doubtful by much recent work, which tends to show that in addition to these fundamental requisites there are certain accessory materials that are necessary, either because they play some essential rôle in the syntheses of the body or influence in some more indirect way the normal direction and character of the metabolism. This unexpected result may be illustrated best by reference to the condition known as beriberi. Beriberi is a disease that occurs chiefly among oriental nations that make great use of rice as a food. The disease takes a variety of forms, but the characteristic symptoms are paralyses, and atrophy and contractures of the limbs. It has been shown that the condition is caused by limiting the diet exclusively or mainly to polished rice, that is, to rice from which the outer layers of the grains have been removed. If the polishings are restored to the diet the condition disappears, or if other materials, such as meat and barley, are used with the polished rice the disease does not occur. The interpretation placed upon these results is that the polishings contain some constituent essential to body-metabolisms. This conclusion has been much strengthened by experiments on fowls. When these animals are fed exclusively on polished rice they develop a condition (polyneuritis) similar to beriberi and soon die. They may be saved by adding the polishings to the diet or by changing the diet. Funk has shown that from the polishings of rice, and from many other of the ordinary foods, there can be isolated a relatively simple nitrogenous base which seems to resemble in structure the pyrimidin bases found as one component of nucleic acid.\* He designates this base as vitamine, and experiments show that when administered to an animal or patient exhibiting the symptoms of beriberi these symptoms disappear. On the basis of this and similar work, Funk suggests that not only beriberi, but other forms of disease which seem to belong to the same class, are due to a deficiency of vitamines in the diet. Scurvy and pellagra may belong in this group, and it is suggested that there may be in our foods several of these vitamines, each with some special rôle to play. They exist in the foods in very small quantities and their physiological importance

\* For a general statement with literature see Funk, "Ergebnisse der Physiologie," 13, 125, 1913.

is not as a source of energy and probably not as direct building-stones. Just how they influence metabolism cannot yet be stated. It is possible that there may be substances in our foods other than the vitamins, as above described, which are essential in some way to metabolism. This possibility is indicated at least by a series of observations reported by several observers, especially by Osborne and Mendel.\* They found that young rats fed on a diet in which the protein was furnished by purified casein, the additional energy material by starch and lard, and the inorganic salts by milk from which the protein had been removed (protein-free milk), grew remarkably well for a period of many days, but subsequently showed a sudden loss of weight. If the diet was changed to one consisting of dried whole milk together with starch and lard, normal growth was resumed, and a similar result was obtained if purified butter-fat, free from nitrogen and phosphorus, was added to the former diet. They interpret these experiments to mean that the butter-fat supplies some essential non-nitrogenous material not contained in the lard-fat. A similar material is contained in the fat of the egg-yolk or of the liver (cod-liver oil).

**The Specific Dynamic Action of Proteins.**—This somewhat indefinite term is used by Rubner to designate the fact that protein foods seem to increase the metabolic processes of the body to a greater extent than the fats or carbohydrates. This peculiarity may be demonstrated, for instance, in the case of an animal that has been starved (eighteen hours) until the gastro-intestinal tract is free from food.† If the heat-production of such an animal is determined at hourly periods, it gives an index of what may be called its basal metabolism when living on the material within its body. If in this condition the animal is fed with carbohydrate (glucose) there will be an increase in heat production, lasting for three or four hours, which may amount to as much as 30 to 40 per cent. Feeding with meat or with some of the amino-acids (glycin, alanin) causes a similar but more marked increase in metabolism. After a large diet of meat the increase may amount to as much as 90 per cent. This effect upon the metabolism is exhibited especially by proteins. Many explanations of it have been proposed, but recent experiments indicate that it is probably due to some direct stimulating action of the intermediary acids, such as lactic or pyruvic acid, which are formed during the further metabolism of the amino-acids in the body. This stimulating effect of proteins may furnish a physiological explanation of the fact that in hot summer weather it is advisable to avoid a meat diet.

\* Osborne and Mendel, "Journal of Biological Chemistry," 15, 311, 1913; 16, 423, 1913.

† See Lusk, "Journal of the American Medical Association," September 5, 1914.

## CHAPTER XLVIII.

### NUTRITIVE HISTORY OF CARBOHYDRATES AND FATS.

**The Carbohydrate Supply of the Body.**—The available carbohydrate material of the body consists of the glycogen found in the tissues, especially in the liver (1 to 4 per cent. or more) and muscles (0.5 per cent.), and the sugar formed from this glycogen and present constantly in the blood to the amount of 0.1 to 0.15 per cent. In addition it is believed that during starvation glycogen or sugar may be made from the protein tissues of the body, and possibly also from the body fat, although this latter source is disputed. The supply of glycogen under normal conditions is maintained chiefly by the carbohydrate food. As was explained in the section on Digestion, the starches, sugars, gums, etc., which constitute the carbohydrate foodstuffs are eventually absorbed into the blood as simple sugars, chiefly dextrose, but probably also some levulose and galactose. These simple sugars constitute the important glycogen formers. With regard to the proteins there is still some difference of opinion as to whether all of them are capable of yielding glycogen to the body. Accepting the modern view that the proteins in digestion are split into their constituent amino-bodies the question of the relation of the protein-food to sugar-formation may be approached most readily by investigating the effect of feeding the different amino-acids separately. A convenient method of studying this point is to feed the amino-acids to dogs rendered diabetic by the use of phlorhizin (p. 912). In such animals the amino-acids, if converted to sugar, will appear in the urine as sugar and can be detected without difficulty. Experiments of this kind\* indicate clearly that a number of amino-acids can yield sugar in the body, for example, glycin, alanin, aspartic, and glutaminic acids (p. 825). We may believe, therefore, that the proteins giving rise to these amino-acids during digestion may serve as glycogen-formers. The store of glycogen in the body is about equally divided between the liver and the muscular tissues, and it is estimated that in man each of these dépôts may contain, at a maximum, about 150 gms. The regulation of the supply of sugar to the blood is usually attributed to the liver. This regu-

\* Lusk, "American Journal of Physiology," 22, 174, 1908; also Ringer and Lusk, "Zeit. f. physiol. chem.," 66, 106, 1910.

lation is adjusted so that the percentage of sugar in the blood is kept astonishingly constant, between 0.1 and 0.2 per cent., not only during the conditions of ordinary living, but under such an abnormal condition as prolonged starvation. It is assumed that this constancy of composition is effected mainly by an enzyme formed in the liver cells, which converts the glycogen to dextrose in proportion as the sugar of the blood is used up by the tissues, and, as was stated in the chapter on Internal Secretions, this process of glycogenolysis may be accelerated or retarded by the action of hormones arising in the ductless glands.

**The Intermediary Metabolism of the Carbohydrate in the Body.**—Some of the carbohydrate of the food may be used in constructive processes in the body, in the building up of nucleic acid, for example, but for the most part it is supposed to be an energy food and eventually is oxidized to carbon dioxide and water. This oxidation is not direct or immediate, but probably takes place through a number of steps. Our knowledge of these intervening stages in the breaking down of the molecule is very incomplete. It is generally believed that the initial stages are of the nature of hydrolyses or cleavages in which some of the chemical energy is liberated and utilized, while the final stages are oxidations in which the greater part of the available energy is set free, probably in the form of heat. Many suggestions have been made in regard to the successive steps in the metabolism, but perhaps the only stage that may be considered as demonstrated is the formation of lactic acid. The molecule of dextrose may give rise to two molecules of lactic acid, according to the formula—

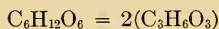

It seems probable that this change is not direct, but takes place through an intervening production of such compounds as glyceric aldehyde or methylglyoxal. According to the latter view, the steps might be represented as follows:

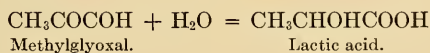
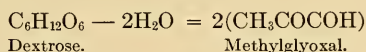

It is known that from many of the tissues of the body an enzyme can be obtained (glyoxalase)\* which converts methylglyoxal to lactic acid. Regarding the further history of the lactic acid there is also much doubt. In the first place, lactic acid may be formed

\* Dakin and Dudley, "Journal of Biological Chemistry," 14, 155, 1913.

not only as above described from dextrose, but also from proteins through deaminization of the amino-acids.

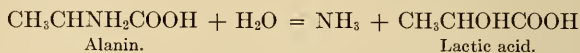

The lactic acid from either source may be resynthesized to sugar by a reversal of the reactions indicated above, or it may be further broken down and finally oxidized to carbon dioxide and water. A possible series of stages in this last process is indicated in the following reactions:\*

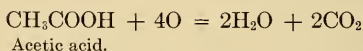
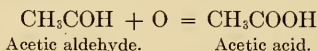
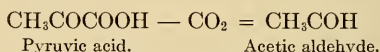
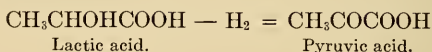

Most of the abundant amount of carbohydrate taken in our daily diet undergoes no doubt this final oxidation and yields up its available energy for the most part in the form of heat, although in part it may be used in muscular work or in other ways—for example, in synthetic processes. The details referred to above are at present uncertain. The steps that may be considered as established are represented by the series:

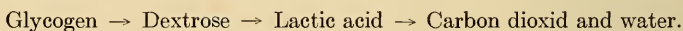

This whole breaking-down process is frequently referred to under the designation of *glycolysis*. We must believe that the series of changes designated under this name involve the operations of a number of different enzymes, and, as has been described previously (p. 888), the internal secretion of the pancreas takes some essential part.

At least one other interesting product formed from sugar has been detected in the body, namely, glycuronic acid. This substance has been obtained from the blood, liver, and urine, and exists usually combined with various toxic or injurious substances, such as the phenols or camphor. When these substances are given to animals or, as in the case of the phenol, are formed in the body, they are apparently conjugated with glycuronic acid and

\* See Neuberg, "Biochemische Zeitschrift," 53, 406, 1913.

excreted, somewhat as the phenol, indol, etc., are conjugated with sulphuric acid and excreted. The relationship of glycuronic acid to sugar is indicated by the following formulas:

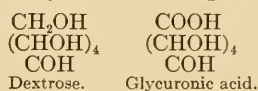

Whether this product is used solely for protection against toxic substances, or constitutes one member of a normal series of metabolisms of the sugar molecule has not been determined.

**Regulation of the Sugar-supply of the Body.**—The regulation of the sugar-supply of the body is a matter of the greatest importance. On the one hand we have the process of the conversion of sugar to glycogen, *glycogenesis*, as it has been called, and the subsequent gradual reconversion of this glycogen to sugar (*glycogenolysis*), according to the needs of the body. On the other hand, we have the processes of consumption of sugar in the tissues for energy purposes, a process designated often as *glycolysis*, the nature of which is discussed in the preceding paragraph. It is evident that these various processes must be adapted one to another, for we know that if for any reason the percentage of sugar in the blood rises but slightly above the normal, a condition designated as *hyperglycemia*, there occurs an escape of sugar in the urine (*glycosuria*). Regulations undoubtedly exist for the control and adaptation of these several processes, and at one point or another these regulations may break down with a resulting disturbance in sugar consumption that manifests itself usually by the development of a condition of diabetes or glycosuria. In the first place it may be recalled that glycosuria, so-called alimentary glycosuria, may result from eating an excess of carbohydrate. In this case apparently sugar absorbed from the alimentary tract is supplied to the liver more rapidly than the latter organ can synthesize it to glycogen. The break down in regulation is in the process of glycogenesis. Stimulation of sensory nerves or lesions of the central nervous system may also produce glycosuria. One of the most interesting experiments in this connection is the piqure or "sugar puncture," first noted by Claude Bernard (1855). A slight puncture of the medulla, made between the levels of origin of the vagus and auditory nerves, results in the appearance of sugar in the urine. The phenomenon has been much investigated, and opinions have differed as to the mechanism of the reaction. According to the older view, the increased sugar production is due to the fact that the puncture stimulates nerve-fibers that act upon the liver cells and cause an augmentation of the process of glycogenolysis. The nerve-fibers in question pass down the cord and,

entering the splanchnic nerves, proceed to the liver by way of the hepatic plexus and nerves. On this view the center in the medulla constitutes a "sugar-regulating center," which may be acted on reflexly and thus control the process of the conversion of glycogen to sugar. Others have held the view that the effect is exercised indirectly through the adrenal glands. They believe that the sugar puncture results in a reflex stimulation of the adrenal glands, whereby more epinephrin is thrown into the circulation, and that the increase in glycogenolysis is due to the action of the epinephrin on the liver cells. Recent experiments do not support wholly either one of these views, but indicate rather that while the nerve-fibers involved act directly upon the liver cells the presence of the adrenal glands is in some way necessary for the reaction.\* Just how this mechanism acts under normal conditions cannot, therefore, be determined. It is known, however, that under conditions of emotional excitement or nervous stress glycosuria is apt to occur, and the explanation usually offered is that the secretion of the adrenals is increased by reflex stimulation with a resulting increase in sugar output from the liver. In both of these possibilities, a reflex stimulation of the hepatic nerves or of the adrenal glands, there is a break down in the completeness of the regulation which affects chiefly the process of glycogenolysis. In this connection we may recall also the severe form of glycosuria following upon removal of the pancreas, the so-called *pancreatic diabetes* (p. 887). Here also the trouble is referable to a change in one of the internal secretions, but in this instance it is a defective rather than an excessive secretion which induces the glycosuria. Whether the loss of the internal secretion of the pancreas affects the stage of glycogenolysis or the stage of glycolysis is perhaps an open question. The usual view has been that this secretion is concerned somehow with the processes of consumption of sugar in the tissues, but in what way it enters into this process remains to be discovered.

In mankind defective sugar metabolism manifests itself chiefly in the disease known as *diabetes mellitus*. In this severe and usually fatal disease the amount of sugar lost daily in the urine may be very large. In severe forms of the disease practically all the carbohydrate of the food may be excreted in the urine in the form of sugar, and even when the carbohydrate in the diet is eliminated completely, sugar continues to be secreted in the urine in considerable amounts. In these latter cases the sugar is supposed usually to have its source in the proteins of the food or of the body, a view which is supported by the fact that the amount of nitrogen and dextrose excreted in the urine may exhibit a constant proportion to each

\* For review and literature consult Macleod, Harvey Lecture, "Journal of the American Medical Association," April 18, 1914.



other. The ratio of dextrose to nitrogen (D : N) is given as 3.65 to 1.\* Special cases have been reported, however, in which the ratio exceeded these figures. The general and specific symptoms observed in diabetes mellitus closely resemble those observed upon dogs suffering from pancreatic diabetes. It seems probable, therefore, that in man the condition of diabetes may also be due in the first place to some trouble in the pancreas which prevents it from giving off its normal internal secretion. Whether or not the activity of the pancreas is impaired in all these cases, the majority of those who have studied the subject agree that the final difficulty lies in the fact that the tissues, especially the muscular tissues, can not utilize the sugar brought to them by the blood. Some writers take an entirely different point of view, holding that the difficulty lies not in the consumption of sugar by the tissues, but at the other end, namely, in the proper handling or assimilation of the sugar as it is absorbed from the alimentary canal, or in an increased production of sugar in the body.† But assuming the correctness of the usual view, it has been a question as to what part of the process of glycolysis is affected. This process it will be remembered is supposed to comprise two general stages, a series of preparatory non-oxidative changes and a terminal series of oxidations yielding  $\text{CO}_2$  and  $\text{H}_2\text{O}$ . Corresponding to this general point of view, some authors have supposed that in the diabetic individual the activity of the enzymes responsible for the preparatory changes is at fault, while others have supported the opposite theory. At present experiments on dogs exhibiting pancreatic diabetes seem to favor the view that it is the second stage that is interfered with.‡ In addition to the sugar found in the urine in diabetes, this secretion may also contain considerable amounts of the acetone bodies, namely,  $\beta$ -oxybutyric acid, aceto-acetic acid, and acetone. It is probable that these bodies represent intermediary products in the metabolism of the fats of the body which escape oxidation, and they appear in the urine of the diabetic either because the power of the tissues to oxidize their fatty foods has also become impaired or, as seems possible in the beginning, at least, simply because in the loss of the power to utilize the energy of the carbohydrates the tissues consume more fat, and whenever the fat consumption is large it is likely to be incomplete, that is, some of the intermediary products fail of oxidation and pass into the general circulation (see p. 916).

\* Lusk, "Elements of the Science of Nutrition," Philadelphia.

† For literature on the metabolism of Diabetes, see Lusk, "Archives of Internal Medicine," Feb., 1909; Magnus-Levy, "The Medical Record," Dec. 3, 1910, and Minkowski, *ibid.*, Feb. 1, 1913.

‡ Verzář, "Biochemische Zeitschrift," 66, 75, 1914.

*Phlorhizin Diabetes*.—Phlorhizin is a vegetable glucoside obtained from the roots of certain trees—*e. g.*, apple, pear. When injected into an animal it causes a glycosuria which is temporary, but which may be renewed by repeated injections. Examination of the blood in this case reveals the fact that the percentage of sugar is not increased, so that the immediate cause of the glycosuria is different from that responsible for the diabetes of man or of animals without the pancreas. A satisfactory explanation of the action of the phlorhizin has not yet been obtained, but it would seem that the drug acts in some way upon the kidney itself—that is, the tissues of the body are probably still able to metabolize the sugar, but the blood is continually depleted of this substance through the kidney; it leaks off through the kidney faster than it can be utilized by the tissues. The evidence at hand seems to indicate that the sugar (in part at least) exists in the blood in some form of colloidal combination, and that under the influence of the phlorhizin the kidney breaks up this combination and eliminates the sugar.\*

From this brief description of the fate of the carbohydrate in the body it is evident that its history as a food-stuff might be considered conveniently under three heads, namely, its supply, its storage, and its consumption. The supply is regulated by the diet. In the usual diet carbohydrate constitutes the chief and also the most variable factor. Its cheapness, its ease of digestion and of consumption make it the most convenient and economical source of energy to the body. When our energy needs are large, as in muscular work, the carbohydrate portion of the diet is increased; when the energy needs are small, as in a sedentary life, the amount of carbohydrate is reduced. The storage of carbohydrate in the body is provided for temporarily by the glycogenetic function of the liver and the muscles. This function may be deranged for a time by injuries to the central nervous system or by hypersecretion of the adrenal glands or the hypophysis, in which case hyperglycemia and glycosuria result. Or the glycogenetic tissues may be inadequate to handle all the sugar absorbed from the alimentary canal (alimentary glycosuria), and in this case also there is a temporary hyperglycemia and glycosuria. At the consumption end the amount of sugar destroyed is controlled by the energy needs of the tissues, especially of the muscles. Failure to destroy the sugar at this point brings on also a hyperglycemia and glycosuria of a more serious nature.

Our sugar-regulating mechanism in fact may prove inadequate

\* For more complete details and the literature, see Macleod, "The Metabolism of the Carbohydrates" in "Recent Advances in Physiology," London and New York, 1906, and Lusk, "Ergebnisse d. Physiologie," 12, 315, 1912.

in one of four general ways, which may be tabulated briefly as follows:

1. Conversion of sugar to glycogen (liver) breaks down in alimentary glycosuria.

2. Conversion of glycogen to sugar (liver) breaks down in injuries to the central nervous system, excessive internal secretion by adrenal gland, etc.

3. Glycolysis of sugar (muscles and other tissues) breaks down in diabetes mellitus and pancreatic diabetes.

4. The normal impermeability of the kidney breaks down in phlorhizin diabetes.

**Functions of the Carbohydrate Food.**—The general value of the carbohydrate food to the organism may be summarized as follows: (1) It furnishes a source of energy for the needs of the tissue cells and particularly for muscular work. It will be remembered that the glycogen of a muscle disappears in proportion to the work done by the muscle, and, indeed, prolonged muscular work, especially during starvation, may wipe out quickly the entire store of glycogen in the body, in the liver as well as in the muscles. It is usually believed, therefore, that the oxidation of the sugar furnishes energy which by the machinery of the muscles is utilized to do work,—that is, to cause muscular contractions. It seems probable that under normal conditions this material furnishes the main, if not the sole source of energy for muscular work. (2) The oxidation of the sugar furnishes an important part of the constant supply of heat needed by the body. Each gram of sugar on oxidation yields — 4 Calories of heat, and, since the carbohydrates form the largest part of our diet and are easily oxidized in the body, they must be regarded as an especially available material for keeping up the supply of animal heat. The largest part of the energy liberated by the oxidation of sugar in the muscles during contraction takes the form of heat, and even during muscular rest the condition of tone is probably attended by a constant oxidation of this material. (3) The oxidation of the sugar protects the protein of the body. Attention has already been called to the fact that an animal may be kept in nitrogen equilibrium on a relatively small protein diet provided carbohydrates (or fats) are also eaten. One may say, in fact, that as the carbohydrate food is increased the protein food may be diminished, down to a certain irreducible minimum which is probably the amount necessary for the reconstruction of new tissue. From the chemical composition of carbohydrates it is evident that they alone cannot serve to build up protoplasm. An animal fed on carbohydrate food alone, no matter how abundant the supply, would eventually starve to death. Within certain limits, however, the carbohy-

drates are protein spacers; the energy provided by their oxidation keeps up the supply of heat and enables the muscles and the other tissues to obtain the energy necessary for their special kind of work, and in this way, chiefly, the carbohydrates protect the living protein from consumption and enable us to reduce the protein material in our diet. Experiments show, in fact, that carbohydrate is much more efficient as a spacer of protein than fat. An animal fed on carbohydrates alone loses less protein from the body than when kept on a fat diet containing the same amount of heat energy, and the minimal amount of protein upon which the body may be kept in nitrogen equilibrium is much lower when the protein is combined with an abundant supply of carbohydrate than in the case of a diet of protein and fat together. It would seem that the body must always have sugar to oxidize. If this material is not furnished in the food, it is obtained by breaking down the body protein itself, as is indicated by the continued formation of sugar in diabetes and also by the fact that even in prolonged starvation the sugar contents of the blood are kept at a normal level. (4) Any excess of carbohydrate, taken as food, beyond the power of the tissues to store as glycogen may be synthesized to form fat. Nutritional experiments, described below, leave no doubt that the fat of the body may be formed from carbohydrate food. It is stated that the fat of the body having this origin, so-called carbohydrate fat, is of a more solid consistency than the fat derived from other sources. (5) To some extent carbohydrate may be utilized in constructive processes. Nucleic acid contains a carbohydrate group, and we have evidence from the experiments of Osborne and Mendel on growing rats that the body can make its own nucleic acid. A carbohydrate group forms part of the molecular complex of some proteins and is a constant constituent of the cerebrosides found so abundantly in the central nervous system. A carbohydrate, lactose, is a normal constituent of the secretion of the mammary glands. In these and similar cases it is not clear whether the carbohydrate group is derived from the carbohydrate of the food or is constructed from other sources, but the former view must be reckoned among the possibilities in enumerating the various functions that may be fulfilled by the carbohydrate of the food.

**Nutritive Value of Fats.**—The fats of food are absorbed into the lacteals, chiefly as neutral fats—the so-called chyle fat. The chyle fat is transported to the blood by way of the great thoracic duct, and after it is poured into the blood it remains in the circulation for a considerable time, being slowly picked out by the tissues which can use it in their metabolic processes. Within these tissues it is oxidized to supply the energy needs of the cells.

The final products of the oxidation are the same as when fat is burnt outside the body—namely,  $\text{CO}_2$  and  $\text{H}_2\text{O}$ —and a corresponding amount of energy must be liberated. Speaking generally, then, the essential nutritive value of the fats is that they furnish energy to the body, and, from a chemical standpoint, they must contain more available energy, weight for weight, than the proteins or the carbohydrates. In a well-nourished animal a large amount of fat is found normally in the adipose tissues, particularly in the so-called “*panniculus adiposus*” beneath the skin, in the folds of the peritoneum, etc. Physiologically, this body fat is to be regarded as a reserve supply of nourishment. When fatty food is eaten and absorbed in excess of the actual metabolic processes of the body, the excess is stored in the adipose tissue as fat, to be drawn upon in case of need—as, for instance, during partial or complete starvation. A starving animal, after its small supply of glycogen is exhausted, lives entirely upon body proteins and fats; the larger the supply of fat, the more effectively will the protein tissues be protected from destruction. In accordance with this fact, it has been shown that when subjected to complete starvation a fat animal survives longer than a lean one. Our supply of fat is called upon not only during complete abstention from food, but also whenever the diet is insufficient to cover the oxidations of the body, as in deficient food, sickness, etc.

**The Intermediary Metabolism of the Fat.**—The fat absorbed as food may subserve in general several different purposes: (1) It may be oxidized with the formation of heat energy. (2) It may be stored in the tissues as part of the body fat. (3) It may be synthesized with other substances to form some more complex constituent of the body, such as lecithin. (4) According to some authors, it may serve under certain conditions as a source of sugar. This latter suggestion is not supported by convincing experiments. The final fate of the fat in the body is, however, to be oxidized to water and carbon dioxid. The nature of the processes involved is not understood. It is generally believed that the first step is the splitting of the fat into fatty acid and glycerin under the influence of the lipase found in so many of the tissues of the body. The fat that lies in the storage tissues—skin, peritoneum, etc.—does not undergo oxidation in these places. In times of need it is absorbed and distributed to the more active tissues, and in this initial process of solution it is probable that a regulative influence is exerted by the lipase as suggested by Loevenhart (see p. 744); that is, by its reversible action this enzyme may control the output of fat to the blood, as the supply of sugar in the blood is kept constant by the diastatic enzyme of the liver. After the action of the lipase we can only say that oxidation takes place, but through how

many stages is not known. It seems probable that the long carbon chain of the fats (stearic acid =  $\text{CH}_3(\text{CH}_2)_{16}\text{COOH}$ ) is deprived in succession of its carbon atoms by oxidation, with the formation of simpler fatty acids, but little positive evidence has been obtained of intermediate products. Perhaps the most significant fact known bearing upon this point is that under conditions which involve a large destruction of fat in the body, as in starvation, fevers, and especially in diabetes,  $\beta$ -oxybutyric acid together with aceto-acetic acid and acetone are excreted in the urine. These three substances are designated as the acetone bodies, and their appearance in the urine makes the condition known as acetonuria. The oxybutyric acid is usually regarded as the source of the other two, as may be inferred from their formulas.  $\beta$ -oxybutyric acid =  $\text{CH}_3\text{CHOHCH}_2\text{COOH}$ . By oxidation this yields aceto-acetic acid,  $\text{CH}_3\text{COCH}_2\text{COOH}$ , and this by loss of  $\text{CO}_2$  is converted to acetone,  $\text{CH}_3\text{COCH}_3$ . Other observers incline to the view that the aceto-acetic acid is the primary product formed in the metabolism and that the oxybutyric acid arises from it by reduction. The occurrence of these bodies is in accord with the view of a serial oxidation of the fatty acids furnished by the fats. Knoop\* has given experimental evidence for the view that the oxidation takes place at the beta-carbon, and that by a series of such beta-oxidations the long carbon chain may be reduced, by the loss of two carbon atoms at a time, to simpler fatty acids. Thus, in stearic acid,  $\text{C}_{15}\text{H}_{31}\text{CH}_2\text{CH}_2\text{COOH}$ , oxidation at the beta-carbon may be assumed to give first a beta-ketonic acid,  $\text{C}_{15}\text{H}_{31}\text{COCH}_2\text{COOH}$ , which, by further oxidation, loses two carbon atoms, with the production of  $\text{CO}_2$  and  $\text{H}_2\text{O}$ , and yields a saturated fatty acid,  $\text{C}_{15}\text{H}_{31}\text{COOH}$ , of simpler structure. On this theory if, as is the case with the fatty acids of animal fat, there is an even number of carbon atoms in the molecule to start with, all of the simpler acids formed by the process of beta-oxidation will also have an even number of carbon atoms. This is the case with the butyric acid which so far represents the concrete example of these intermediate stages, and the same fact is observed for the fatty acids found in milk. It is to be borne in mind that butyric acid and its oxyacid may be derived theoretically, at least, from proteins as well as fats. As has been shown in the previous pages, the amino-acids formed from the proteins may suffer deamination in the body, leaving behind an oxy- or ketonic acid which may then behave as do the similar acids formed by oxidation of the higher fatty acids. Experiments have demonstrated that in this way oxybutyric acid may be derived from a protein source.

**Origin of the Body Fat.**—The views upon the origin of body fat have undergone a number of changes in the last fifty or sixty

\* Knoop, "Hofmeister's Beiträge," 6, 150, 1904.

years, illustrating in an interesting way how development of our experimental methods leads often at first to half-truths which are corrected later by more extensive work. Dumas and others (1840) held to the natural view that the fat of the body originates directly from the fat of the food. Liebig, applying his more exact methods, demonstrated that in some cases at least this source is insufficient to account for all the fat. The fat yielded by the milk of a cow for instance, may be greater in quantity than the fat contained in the food. He also pointed out that the fat of each species of animal is more or less peculiar, the fat of the sheep having a higher melting point than pork fat, and both differing in composition from the fat taken as food. "In hay or the other fodder of oxen no beef suet exists, and no hog's lard can be found in the potato refuse given to swine." He was led to attribute the source of body fat chiefly to the carbohydrate food, and this belief agreed well with the experience of agriculturists as to the use of such foods in fattening animals for market. This view, in turn, was displaced by the theory of Voit, supported by elaborate feeding experiments. Voit believed that the fat of the body is formed mainly or entirely from the protein of the food, the carbohydrate and the fat of the diet being useful only to protect a part of this protein from oxidation. Voit's experiments have been shown by Pflüger to have been based upon erroneous analyses of the meat used in his experiments. Voit assumed that in this meat the ratio  $\frac{N}{C}$  is equal to 1.34 to 1.37, while Pflüger showed that it is lower,\* 1.33. The modern point of view is that the fat of the body originates partly from the fat of the food, particularly in carnivora, and partly from the carbohydrate of the food, especially in herbivora, in whose diet this foodstuff forms such a large part. The possibility that fat may also be formed from protein food must be accepted in accordance with what has been described above concerning the intermediary metabolism of the protein. So far as the amino-acids formed from the food protein during digestion are not reconstructed into the body-protein of the animal, they are deaminized, and the organic acid grouping left may be converted to sugar and glycogen, hence probably also to fat. Protein constitutes relatively only a small fraction of the daily diet, and the modern point of view is that body fat is formed in the first instance from food fat and food carbohydrates.

**Origin of Body Fat from Food Fat.**—The first proofs that the food fats may be deposited as such in the fat tissues of the body were obtained by feeding foreign fats to dogs and demonstrating that these fats can afterward be recognized in the

\* Pflüger's "Archiv f. die gesammte Physiologie," 51, 229, 1892, and 77, 521, 1899.

tissues of the animals.\* Linseed oil, rape-seed oil, and mutton-fat were used in these experiments. Secondly, it has been made probable by feeding experiments that the normal fat of the food undergoes a similar fate. Thus, Hofmann used a dog weighing 26 kgms. and allowed it to starve until its weight was reduced to 16 kgms. It was then fed for five days on a little meat and large quantities of fat. At the end of that time it was killed and analyzed. The body contained 1353 gms. of fat, of which only 131 gms. could have come from the protein used, assuming that this material can serve as a fat former. Much of the fat found, therefore, was probably derived from the fat of the food.

**Origin of Body Fat from Carbohydrates.**—That the body fat may have this origin has been made probable or certain by feeding experiments. Thus, Rubner fed a dog (5.89 kgms.) for two days on a diet of sugar, starch, and fat whose total carbon content was equal to 176.6 gms. During this period the animal excreted 87.1 gms. of carbon. There were retained in the body, therefore, 89.5 gms. carbon. The fat fed, 4.7 gms., contained ( $4.7 \times 0.77$ ) 3.6 gms. C. The total nitrogen excreted during this period was 2.55 gms., which indicated a metabolism, therefore, of 16 gms. ( $2.55 \times 6.25$ ) of body protein. Making the improbable assumption that all of the carbon of this protein was retained in the body, this would account for 8.32 gms. C ( $16 \times 0.52$ ); so that  $3.6 + 8.32$  or 12 gms. C might have originated from sources other than the carbohydrate of the food, leaving, therefore,  $89.5 - 12$  or 77.5 gms. of C, which could have arisen only from the carbohydrate. This quantity of carbon could have been retained only as glycogen or fat. Allowing for the greatest possible storage of glycogen, 78 gms. or 34.6 gms. C, there would still remain 42.9 gms. of C, which could have been retained only as fat. Numerous other fattening experiments of different kinds have been made in which it has been shown that the fat laid on by the animal could not be accounted for by the fat of the food, nor by assuming with Voit that it originated from the protein. The combined testimony of these experiments have satisfied physiologists that the tissues can produce fat from sugar. The chemistry of the change is not understood and cannot be imitated in the laboratory, but it is evident that in the long run it involves a series of important reductions, since in the end the oxygen-rich sugar is transformed to an oxygen-poor fat. In the sugar the oxygen constitutes 53 per cent. of the molecule, while in fat it forms only 11.5 per cent. The oxygen split off in the series of changes should appear as  $H_2O$  and  $CO_2$ , and in accordance with this view it is found experimentally that when

\* Lebedeff, "Centralblatt f. die med. Wiss.," 1881, and Munk, "Virchow's Archiv," 95, 407, 1884.



carbohydrate is being stored as fat there is an increase in the respiratory quotient, that is, in the ratio  $\frac{\text{CO}_2}{\text{O}_2}$ .

**The Source of Body Fat in Ordinary Diets.**—For the purposes of demonstration the experiments made to prove the origin of body fat from carbohydrate or the fat of food have made use of abnormal diets and conditions. It would be a matter of practical interest to ascertain whether upon normal diets the fat of the body arises more easily from the fat or from the carbohydrate of the food. While the question is one to which a positive answer cannot be given, it seems to be probable that the result varies with conditions and the nature of the animal. Experience seems to show that carnivorous animals can be fattened more easily on a fat diet, herbivora on a carbohydrate diet. In animals, like ourselves, there is reason to believe that the carbohydrates are more easily and more quickly destroyed in the body than the fats, and that, therefore, the latter may be more readily deposited in the tissues, although an excess of carbohydrate beyond the actual needs of the body will also be preserved in the form of fat or glycogen.\*

**The Cause of the Deposit of Body Fat—Obesity.**—Our experience shows that individuals differ greatly in the ease with which they form fat. Some upon relatively small diets form much fat, while others remain thin in spite of the ingestion of large amounts of food. Voit has indicated the general reason for this difference—namely, that it depends upon the capacity of the body to destroy food material. When food is supplied and absorbed in excess of this capacity the excess is stored to a small extent as glycogen, but chiefly as body-fat. As stated above, this holds true especially for fat and carbohydrate foods, which, speaking generally, are the variable parts of our diet. A diet which will give such an excess to one individual, may in the body of another of the same weight be all consumed. The oxidizing or metabolizing capacity of the body differs in different individuals and some will lay on fat more readily than others, because for them an excess of material is provided by a relatively small diet. Theoretically, it is possible that in such cases the activity of the fat cells may be greater than normal. One might assume a certain balance between the oxidizing capacity of the tissues in general and the fat-forming activity of the cells of the adipose tissue, and suppose that this balance may be disturbed either by a decrease in one factor or an increase in the other. The administration of thyroid tissue which is known to increase the oxidations of the body leads to a loss of body fat, and this method is sometimes employed to reduce

\* Consult Rosenfeld, "Ergebnisse der Physiologie," vol. i., part I, 1902. Complete literature.

body weight. Those individuals who show little tendency to lay on fat may be made to do so by largely increasing the amount of fat or carbohydrate food, or more certainly by altering the mode of life. A sedentary life, absence of worry, etc., may lead to a tendency of this kind, while a very active muscular life has the opposite effect. Men who lead a very muscular life—farmers, fishermen, etc.—are rarely disposed to accumulate fat to a noticeable degree. So also the use of alcoholic beverages may indirectly favor accumulation of fat, partly because the oxidation of the alcohol protects the fats and carbohydrates from oxidation, and partly also, perhaps, because long-continued use of alcohol may depress the oxidizing capacity of the tissues. The tendency to form fat may exhibit itself in some cases to such an extent as to constitute an almost pathological condition. Obesity, so far as it is not due to some organic lesion, such as a deficiency of the posterior lobe of the hypophysis (p. 883), may be counteracted by altering the mode of life, especially by taking much muscular exercise, and by reducing the diet, so that the total amount of calories represented do not exceed one-half to three-fifths that recognized as the usual average (see p. 940). The diet for such purposes should not only be reduced in amount, but should be as free as possible from excess of fats and carbohydrates, consisting of such material as eggs, fish, lean meat, salads, fruits, etc.\*

\* For practical directions concerning the treatment of obesity by dieting see Gautier, "L'alimentation et les régimes," Paris.

## CHAPTER XLIX.

### NUTRITIVE VALUE OF THE INORGANIC SALTS AND THE ACCESSORY ARTICLES OF DIET.

**The Inorganic Salts.**—The body contains in its tissues and liquids a considerable amount of inorganic material. When any organ is incinerated this material remains as the ash. If we include the bones, which are rich in mineral matter, the average amount of ash in the body amounts to about 4.3 to 4.4 per cent. of its weight. The bones, however, in the adult contain most of this ash (five-sixths). In the soft tissues, like the muscle, the ash constitutes about 0.6 to 0.8 per cent. of the moist weight. The ash consists of chlorids, phosphates, sulphates, carbonates, fluorids, or silicates of potassium, sodium, calcium, magnesium, and iron; iodine occurs also, especially in the thyroid tissues. In the liquids of the body the main salts are sodium chlorid, sodium carbonate, sodium phosphate, potassium and calcium chlorid or phosphate. In considering the organic foodstuffs weight was laid upon their value as sources of energy, as well as upon their function in constructing tissue. The salts have no importance from the former standpoint. Whatever chemical changes they undergo are not attended by any liberation of heat energy—none at least of sufficient importance to be considered. They have, however, most important functions. They maintain a normal composition and osmotic pressure in the liquids and tissues of the body, and by virtue of their osmotic pressure they play an important part in controlling the flow of water to and from the tissues. Moreover, these salts constitute an essential part of the composition of living matter. In some way they are bound up in the structure of the living molecule and are necessary to its normal reactions or irritability. Even the proteins of the body liquids contain definite amounts of ash, and if this ash is removed their properties are seriously altered, as is shown by the fact that ash-free native proteins lose their property of coagulation by heat. The globulins are precipitated from their solutions when the salts are removed. The special importance of the calcium salts in the coagulation of blood and the curdling of milk has been referred to, as also the peculiar part played by the calcium, potassium, and sodium salts in the rhythmical contractions of heart muscle, the irritability of muscular and nervous tissues, and the permeability of the capillary walls and other membranes. The special importance of

the iron salts for the production of hemoglobin is also evident without comment. There can be no doubt, in fact, that each one of the salts of the body has a special nutritive value and a special metabolic history. The time will doubtless come when the special importance of the potassium, sodium, calcium, and magnesium will be understood as well, at least, as we now understand the significance of iron, and quite possibly this knowledge will find a direct therapeutic application, as in the case of iron.\*

**Fatal Effects of Ash-free or Ash-poor Diets.**—Dogs have been fed (Forster) upon a diet composed of ash-free fats and carbohydrates, and meats which had been extracted with water until the salts had been much reduced. The animals were in a moribund condition at the end of 26 to 36 days. It is probable that they would have lived longer if deprived of food entirely, with the exception of water, since the metabolism of the abundant diet provided helped to increase the loss of salts from the body. So also in the numerous experiments made upon growing rats fed upon artificial diets,† it has been shown that if the necessary proteins, fats, and carbohydrates are supplied but the inorganic salts are omitted the animal promptly loses weight and dies.

**The Special Importance of Sodium Chlorid, Calcium, and Iron Salts.**—Sodium chlorid occupies a peculiar position among the inorganic constituents of our diet, in that it is the only one which we deliberately add to our food. The other inorganic material is taken unconsciously in our diet, but although sodium chlorid exists also in our food in relatively large quantities we purposely add more. It is estimated that the average man ingests from 10 to 20 gms. a day. This amount seems to be in excess of the actual necessities of the body, since on experimental diets individuals have been kept in good condition when the total content in sodium chlorid was reduced to one or two grams. This desire for salt is exhibited also by many animals. The farmer provides salt for his stock and wild animals visit the salt-licks at intervals. Bunge has called attention to the fact that among men and animals the desire for salt is limited, for the most part at least, to those that use vegetable food. From the accounts of travelers he shows that when a purely animal diet is used there is no desire for salt; but on a vegetable diet there is a craving for it which may become very intense and unpleasant when circumstances prevent its being obtained. He offers an ingenious explanation for this relation. Most vegetables contain a large amount of potassium salts, and in the blood these salts react with

\* For a brief summary of facts and speculations, see Alba and Neuberg, "Physiologie u. Pathologie des Mineral-Stoffwechsels," 1906, and von Wendt, "Handbuch d. Biochemie," 4, 561, 1911.

† Osborne and Mendel, "Journal of Biological Chemistry," 13, 233, 1912.

the sodium chlorid. Thus, if potassium sulphate were added to the blood it would react with sodium chlorid, giving some potassium chlorid and some sodium sulphate. Both of these salts will be removed by the kidneys, since, except in minute amounts, they are, so to speak, foreign to the blood. This latter liquid will thereby lose some of its supply of sodium salt, whence the craving for more in the food.\* The content of the blood in sodium chlorid remains remarkably constant. When an excess is taken in the food it is removed by the kidneys. On a salt-free diet or in starvation the amount of sodium chlorid secreted in the urine soon falls to a low figure (0.6 gm.), showing that the tissues are holding on to this constituent. It cannot be doubted, however, that under ordinary conditions we use salt in quantities much larger than is necessary to maintain the sodium chlorid content of the blood. It is employed as a condiment for its pleasant flavor, and it is possible that its use is often carried to excess. It can be shown, in fact, that by increasing the intake of salt an edematous condition of the tissues may be produced, owing to the fact that the salt increases the osmotic pressure in the tissues. So also in conditions of edema or inflammation restriction of the salt of the diet may give the contrary result and help to restore the tissues to a normal state as regards their water contents.

The calcium salts of the body play a most important rôle in connection with the irritability of muscle and nerve (p. 570). They are also of obvious importance in furnishing material for the growth of the skeleton. Their importance in this regard has been demonstrated by feeding experiments. Young dogs when given a diet poor in calcium salts fall into a condition resembling rickets in children, owing to a deficient growth of the bones. Pigeons also, when fed upon a similar diet, exhibit an atrophy and fragility of the bones due doubtless to the lack of calcium salts. As in the case of the other food materials, there must be a definite calcium metabolism in the body. It is probable, indeed certain, that most of the calcium salts ingested simply pass through the body without entering into its structure. They are eliminated unchanged or unused in the feces or urine. A small portion, however, must be absorbed and used and a corresponding amount must be eliminated as a true waste product of tissue metabolism. Voit, by experiments upon isolated loops of the intestine, has shown that some calcium is constantly eliminated from the inner surface of the intestine. The amount is small, not exceeding perhaps 0.15 to 0.16 grams per day. There is some evidence that the amount of calcium in the tissues increases with age. This is certainly

\* For an interesting discussion, see Bunge, "Physiologie des Menschen," vol. ii., p. 103, 1901.

true of the bones, which become exceedingly brittle in advanced life, and is evident also in the arteries, whose elasticity diminishes as the calcium salts deposited in their coats are increased. Under pathological conditions deposition of calcium salts (calcium carbonate) in the tissues may be markedly increased, as is shown by the condition of the arteries in arterial sclerosis and the condition of the crystalline lens in senile cataract.

The iron salts that are constantly necessary for the production of new hemoglobin are provided in our food, in which they exist in organic combination. The value of the food in this respect varies greatly, as may be seen from the following table selected from Bunge's analysis:

100 gms. of dry substance contain iron in milligrams, as follows :

White of egg.....	trace	Apples.....	13
Rice.....	1 to 2	Cabbage (green leaves)...	17
Wheat flour (bolted) ..	1.6	Beef.....	17
Cows' milk.....	2.3	Asparagus .....	20
Potatoes.....	6.4	Yolk of egg .....	10 to 24
Peas .....	6.2 to 6.6	Spinach.....	33 to 39
Carrots .....	8.6		

In conditions of malnutrition, particularly in the simple anemias, it becomes necessary to select a diet with reference to its contents in iron or to add iron deliberately to the diet. Therapeutically iron may be given in the form of simple salts with organic or mineral acids or in more complex organic combination. There has been much controversy as to whether the body is capable of taking the iron in inorganic form and synthesizing it into a molecule so complex as that of hemoglobin. Experience, however, seem to show that this is possible, although under normal conditions at least our iron is used in organic form. Bunge first isolated such a compound, a nucleo-albumin containing iron, which he prepared from the egg yolk and called hematogen. This compound must serve as the source of the hemoglobin in the developing chick. When the diet is directed especially toward increasing the iron food it would seem to be wiser to choose these compounds, or, better still, the iron-rich foods, rather than medicinal preparations of the inorganic salts. The daily excretion of iron from the body takes place in the feces rather than in the urine. The experiments of Voit upon isolated loops of the intestine, referred to above, show that iron is eliminated from the walls of the intestine. The whole history of the metabolism of iron in the body is surrounded by much uncertainty. After absorption its synthesis to hemoglobin takes place, as to its final stages, in the red marrow, but it is possible that other organs may take part in the formation of intermediate products. As regards its elimination, we know that the breaking down of the hemoglobin (formation of bile pigments) occurs prob-

ably in the liver, but the final excretion of the iron takes place mainly through the walls of the intestine.

**Accessory Articles of Diet.**—Under this general term we may include all those bodies classed as *condiments*, *flavors*, and *stimulants*, which we habitually take in our diet in order to enhance the attractiveness of the food. These substances may or may not have some heat value to the body—that is, they may undergo oxidation with the liberation of heat energy; but, in general, their value in nutrition is due to other properties.

*The Flavors and Condiments.*—Perhaps the most important influence exerted by these bodies is that by making the food appetizing they increase the secretion of gastric juice. The origin of the so-called psychical secretion has been described (p. 775), and there can be little doubt that the palatableness of food influences greatly the facility with which its gastric digestion is accomplished. It is said, in fact, that dogs will refuse to eat food that has been deprived entirely of its sapidity and flavor, preferring rather to starve. Some of these substances (pepper), as also the stimulants (alcohol), may have an additional value in that they increase the rapidity of absorption from the stomach. Gautier divides the condiments into the following classes: (1) *Aromatics*, comprising vanilla, anise, cinnamon, nutmeg, and other similar essential oils. (2) *Peppers*. (3) The *alliaceous* condiments,—garlic, mustard, etc. (4) The *acid condiments*,—vinegar, citron, pickles, etc. (5) The *salty condiments*, such as table salt. (6) The *sugar condiments*.

*The Stimulants.*—Under this head we include alcohol, tea, coffee, chocolate, or cocoa, and meat extracts (beef tea, etc.). Regarding the last mentioned substance, its physiological value has been made clear by the work of Pawlow (p. 775). Meat extracts of various kinds contain secretagogues which stimulate the gastric glands to secretion. In themselves they may contain very little actual foodstuff. Liebig's extract contains some protein, gelatin, and glycogen, which form an actual nourishment, but its specific value as a gastric stimulant depends upon other constituents, possibly the nitrogenous extractives,—creatin, xanthin, carnin, etc. Coffee and tea owe their well-known stimulating action to the presence of an alkaloid, caffein or trimethyl-xanthin. It may be considered as xanthin in which three of the hydrogen atoms have been replaced by methyl ( $\text{CH}_3$ ) groups, as is indicated in the following structural formulæ:

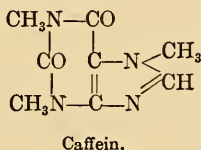
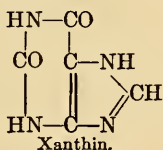

This alkaloid has a diuretic action on the kidneys and a stimulating effect on the nerve centers, as is illustrated by its effect in raising blood-pressure by an action on the vasoconstrictor center. The influence of tea and coffee in preventing sleepiness may be referred to this action on blood-pressure. The use of these substances, according to general experience, augments muscular energy and diminishes the sense of fatigue. Cocoa, or the chocolate made from it by the addition of sugar, contains considerable nourishment in the form of fats, carbohydrates, and proteins, but its stimulating effect is referred to the alkaloid theobromin or dimethylxanthin, and to some extent possibly to the essential oils developed in roasting. The theobromin exerts stimulating effects similar to those of the caffeine, and experiments indicate that in moderate doses of from 20 to 30 grams per day cocoa has no perceptible injurious effect. The methylxanthins are in part oxidized in the body and in part (one-third) excreted in the urine.

*Alcohol.*—The physiological effects of alcohol are of peculiar interest to mankind, owing to its widespread use, and especially to the disastrous results following its intemperate consumption. Those who employ it in excess are in danger of acquiring an alcoholic thirst or habit toward which the body possesses no counter-acting regulation. When food is eaten in excess we experience a feeling of satiety which destroys the desire for more food, and the same regulation prevails in the case of water. With alcoholic drinks, however, the desire may continue long after the alcohol taken has begun to exert an injurious action upon the tissues. The evil effects of excessive use of alcohol are so continually demonstrated upon man that there is no need for experimental investigations to establish this fact. Pathological examination of the tissues in the case of confirmed drunkards has demonstrated the existence of definite lesions in many of the organs,—stomach, liver, heart, nervous system,—and have shown that under these conditions it acts as a tissue poison.\* This result is exhibited not only in cases of chronic alcoholism in which these lesions have developed gradually, but also in cases of acute alcoholism resulting from excessive doses. On the other hand, it is known that many individuals use alcohol in moderate doses throughout life with no noticeable evil result, but, on the contrary, with possible benefit, particularly in advanced life. The matter of practical importance and interest is to determine the physiological rôle of moderate doses of alcohol. Does it serve a useful purpose, acting as a food or stimulant, or is it a poison in all doses to a greater or less extent? The literature upon the subject is very large and

\* See Welch, "The Pathological Effects of Alcohol," in "Physiological Aspects of the Liquor Problem," vol. ii., 1903.



in many respects conflicting. Only a brief summary can be attempted here. Regarding its stimulating action the general experience of mankind attributes a result of this kind to its use in small quantities, but the experimental evidence is of an uncertain nature. Some observers have claimed that the reaction time is diminished after the use of alcohol, but most of the recent investigation goes to show that in the work of skilled labor, in which the neuromuscular machinery is involved, alcohol even in small quantities decreases the efficiency.\* It has been suggested, therefore, that as regards the higher nerve centers it acts from the beginning as a narcotic or paralyzant to the inhibitory centers. By thus removing inhibitory control there is an apparent increase in activity which is not due to a direct stimulating effect. On other mechanisms different results are reported. Thus it is stated that the secretion of the gastric and of the pancreatic juice is markedly increased by the use of alcohol in small doses, so far, at least, as the water secretion is concerned. The content of the secretion in digestive ferments seems to be diminished. On the heart and blood-vessels alcohol in small quantities appears to have no positive effect of a stimulating character. It is known that even in small doses it causes a dilatation of the skin vessels, giving a feeling of warmth and leading to increased loss of heat; but whether this effect is due to a stimulation of the vasodilator centers or, as seems more probable, to a narcotic or depressing action upon the vasoconstrictor centers has not been definitely demonstrated. The experience of explorers bears out the general view that under conditions of stress and of maintained exertion alcohol is of little value as a stimulant to the neuromuscular apparatus. Whatever action it has in this direction is temporary, and is due probably to an initial stimulating effect upon the afferent fibers of the mucous membrane of the stomach. A drink of whisky, for example, may remove promptly the feeling of faintness due to a vasomotor collapse, following an accident, by a reflex effect of this kind on the vasomotor apparatus. After the day's work is done, or in conditions of mental depression, the use of alcohol may remove the sense of fatigue and exhaustion and lead to a sense of well-being. The most important work of recent years has been directed toward determining the nutritive value of alcohol. Does it function under any circumstances as a food? Much depends in such a discussion upon the meaning of the terms used. In the present brief statement it is to be understood that by food is meant material which can be oxidized in the body with the production of usable energy, but without in-

\* For literature and discussion, see Abel, "The Pharmacological Action of Alcohol," in "Physiological Aspects of the Liquor Problem," vol. ii., 1903; and Horsley and Sturge, "Alcohol and the Human Body," 1907.

jurious effect upon the tissues, and moreover a material whose consumption protects some of the other foodstuffs—fats, carbohydrates, and protein—from destruction. In the first place, there is no doubt that alcohol is oxidized in the body. Various observers estimate that as much as 90 to 98 per cent. of the alcohol absorbed is destroyed.\* Since 1 gm. of alcohol, when burnt, yields 7 calories of heat, it is evident that its oxidation in the body must yield a large supply of heat energy. The question arises whether this oxidation of the alcohol occurs in addition to the normal metabolism of the protein and non-protein foodstuffs, or whether it protects and takes the place of these foodstuffs. With regard to the non-proteins a number of observers have attempted to determine the point by ascertaining the total carbon excretion during an alcohol period. If the usual amount of material is burnt, and the alcohol in addition, it is evident that the carbon excretion should be markedly increased. Most observers, however, find that it remains practically the same. Such results as the following have been obtained:

Atwater and Benedict	{ Alcohol-free days..	251.9	gms. carbon.
	{ Alcohol days.....	238.5	“ “
		—13.4	“ “
Bjerre .....	{ Alcohol-free days..	212.58	gms. carbon.
	{ Alcohol days.....	220.84	“ “
		+8.26	“ “
Clopatt .....	{ Alcohol-free days..	214.83	gms. carbon.
	{ Alcohol days.....	220.87	“ “
		+6.04	“ “

These results indicate that the alcohol is used by the body in place of the other carbon-containing foodstuffs, and this conclusion is corroborated by experiments reported by Atwater and Benedict in which the total energy given off from the body as heat was measured in a respiration calorimeter. The average of their experiments gave for the alcohol days 2752 calories and for the alcohol-free days 2723 calories.

Theoretically if the alcohol takes the place of the other material the amount of carbon dioxid excreted should be diminished. One gram of alcohol when oxidized furnishes as much heat as 1.7 gms. of sugar or 0.75 gm. of fat. But 1 gm. of alcohol when burnt yields only 1.91 gms. of CO<sub>2</sub>, while 1.7 gms. of sugar yield 2.77 gms. CO<sub>2</sub>, and 0.75 gm. of fat, 2.13 gms. of CO<sub>2</sub>. If fat were replaced by the alcohol the amount of CO<sub>2</sub> should be reduced about 10 per cent., while if the sugar were replaced the reduction should amount to 31 per cent. That such a reduction is not actually observed is explained by the fact that the alcohol leads to more muscular activity and a greater loss of heat from the congested skin, thus indirectly augmenting the oxidations of the body.

To determine whether the combustion of the alcohol protects the protein material from metabolism to the same extent as is done by

\* See Atwater and Benedict, Bulletin 69, United States Department of Agriculture, 1889; also Memoirs of the National Academy of Sciences, 8, 1902.

carbohydrates and fats, experiments have been made in which the individual was brought into nitrogen equilibrium on a mixed diet. Then for a given period a portion of the carbohydrate was omitted and alcohol in isodynamic amounts was substituted. The result was an increase in the nitrogen excretion, showing that the alcohol did not protect fully the protein tissue. In a third period the first diet was resumed, and after nitrogen equilibrium had again been established the same proportion of carbohydrate was omitted from the diet, but this time alcohol was not substituted. If the diet was poor in protein it was found that less protein was lost from the body when the alcohol was omitted than when it was used. Hence alcohol not only did not take the place of the carbohydrate in protecting the protein, but it actually caused an increased protein consumption.\* Other observers (Neumann, Rosemann †) have found that, although the effect just described may occur in the first few days, yet if the alcohol diet is maintained the injurious effect exercised by it disappears, the body ceases to lose its protein tissue, and may even lay on protein. These results, taken with those given above, indicate, therefore, that the alcohol may actually take the place physiologically of fat or carbohydrates as a source of energy and as a protector of protein metabolism.‡ Under these circumstances, therefore, it acts as a true foodstuff. It is perhaps scarcely necessary to emphasize the fact that this scientific conclusion does not mean that alcohol can be regarded as a practical food. Its expensiveness, its dangers when the dose is too large, etc., prevent us from regarding it in this light. As Rosemann says, however, it is possible that on account of its ready absorption and palatableness it may form a useful substitute for the solid, non-nitrogenous foodstuffs in sickness. This suggestion seems to be supported by many reports of cases in which alcohol has served as the sole or main nutriment during the critical periods of fevers and in other conditions, but it needs to be tested more carefully by direct experiments before it can be accepted generally for practical purposes. In line with this suggestion there are some results upon diabetic patients (Benedict and Török) which indicate that in this condition alcohol used as a food diminishes the production of acetone bodies and protects the protein.

\* See Miura, "Zeitschrift für klin. Medicin," 20, 1892.

† See Rosemann, "Archiv f. die gesammte Physiologie," 86, 307, 1901, and 100, 348, 1903, for discussion and literature. Also "Handbuch d. Biochemie," 4, 413, 1911.

‡ See also Atwater and Benedict, "Memoirs of National Academy of Sciences," 1902; and Atwater, "The Nutritive Value of Alcohol," in "Physiological Aspects of the Liquor Problem," vol. ii., 1903.

## CHAPTER L.

### EFFECT OF MUSCULAR WORK AND TEMPERATURE ON BODY METABOLISM—HEAT ENERGY OF FOODS—DIETETICS.

**The Effect of Muscular Work.**—It is a matter of common knowledge that muscular exercise increases the food consumed, and scientific experiments have shown that it greatly augments the consumption of material in the body. Physiologists have attempted to determine which of our energy-yielding foodstuffs is directly affected by muscular activity. A brief statement of the development of our knowledge upon this point will make clear our present theories. According to Liebig, our foods fulfill two general purposes in the body: they are burnt to supply heat, respiratory foods—fats, and carbohydrates, or they are used to construct tissue, plastic foods—proteins. It seemed to follow, from this generalization, that muscular tissue in activity should use protein material, and it was believed at that time that the metabolism of protein furnished the source of muscular energy. That it is not the sole source was demonstrated by the interesting experiments of Fick and Wislicenus. These physiologists ascended the Faulhorn to a height of 1956 meters. Knowing the weight of his body, each could estimate how much work was done in ascending such a height. Fick's weight, for example, was 66 kilograms; therefore in climbing the mountain he performed  $66 \times 1956 = 129,096$  kilogrammeters of work. In addition, the work of the heart and the respiratory muscles, which could not be determined accurately, was estimated at 30,000 kilogrammeters. There was, moreover, a certain amount of muscular work performed in the movements of the arms and in walking upon level ground that was omitted entirely from their calculations. For seventeen hours before the ascent, during the climb of eight hours, and for six hours afterward their food was entirely non-nitrogenous, so that the urea eliminated came entirely from the protein of the body. Nevertheless, when the urine was collected and the urea estimated, it was found that the energy contained in the protein destroyed, reckoned as heat energy, was entirely insufficient to account for the work done. Although later estimates would modify somewhat the actual figures of their calculation, the margin was so great that

the experiment has been accepted as showing conclusively that the total energy of muscular work does not come necessarily from the oxidation of protein. Later experiments made by Voit upon a dog working in a tread-wheel and upon a man performing work while in the respiratory chamber gave the surprising result that not only may the energy of muscular work be far greater than the heat energy of the protein simultaneously oxidized, but that the performance of muscular work within certain limits does not affect at all the amount of protein metabolized in the body, since the output of urea is the same on working days as during days of rest. Careful experiments by an English physiologist, Parkes, made upon soldiers, while resting and after performing long marches, showed also that there is no distinct increase in the secretion of urea after muscular exercise. It followed from these latter experiments that Liebig's theory as to the source of the energy of muscular work is incorrect, and that the increase in the oxidations in the body, which undoubtedly occurs during muscular activity, must affect only the non-protein material—that is, the fats and carbohydrates. Subsequently the question was reopened by experiments made under Pflüger by Argutinsky.\* In these experiments the total nitrogen excreted was determined with especial care in the sweat as well as in the urine and the feces. The muscular work done consisted in long walks and mountain climbs. Argutinsky found that work caused a marked increase in the elimination of nitrogen, the increase extending over a period of three days, and he estimated that the additional protein metabolized in consequence of the work was sufficient to account for most of the energy expended in performing the walks and climbs. A number of objections have been made to Argutinsky's work. It has been asserted that during his experiment he kept himself upon a diet deficient in non-protein material, and that if the supply of this material had been sufficient there would not have been an increase in protein metabolism. These experiments were repeated in various forms by many observers (Zuntz, Speck, *et al.*), and the general result has been the abandonment of both the former views—the Liebig theory, that the energy comes only from the consumption of protein, and the Voit theory, that it comes only from the oxidation of non-protein material. It has been found that in muscular work carried to the ordinary extent protein material, in excess of that destroyed in conditions of rest, may or may not be used according to the amount of fats and carbohydrates contained in the diet. If these latter elements are in sufficient quantity they furnish the energy required, and the protein metabolism is not increased by work. If, however,

\* Argutinsky, "Pflüger's Archiv f. die gesammte Physiologie," 46, 552, 1890.

the non-proteins are not sufficient in quantity some of the energy is obtained at the expense of the protein of the body, and there is an increase in the nitrogen excretion. We may believe, in fact, that the energy necessary for muscular work may be obtained from any of the customary foodstuffs—carbohydrates, fat, or proteins. It seems probable that the sugar (glycogen) of the muscle is, so to speak, the easiest source; but, when the carbohydrates are deficient or absent altogether in the diet, muscular exercise is accompanied by an increase in the consumption of fats or proteins or both. According to the view adopted in the preceding pages, it will be remembered that when protein-food is used as a source of energy the nitrogen is split off in the tissues by the process of deamination of the amino-acids. According to this view, therefore, the working muscle cells obtain their energy always by oxidation of non-nitrogenous material, although a portion of this material may have been derived ultimately from the protein of the food. The Voit theory is correct to the extent that on an abundant non-protein diet much muscular work may be done without any increase in the consumption of the organized protein tissue. The muscle is a protein machine for the accomplishment of work, but in the performance of moderate work there is apparently no greater wear and tear of the machinery, no greater tissue waste, than under resting conditions. If, however, the muscular work is excessive, the tissue waste may be increased. Argutinsky found an increased nitrogen elimination lasting two or three days after the cessation of the work. It is probable that this result indicates a greater waste of the protein apparatus itself, and this idea is borne out by the fact that under similar conditions other observers have detected an increase in the creatinin and uric acid excretion, nitrogenous wastes that are derived from the tissue protein of muscle. The effect of muscular work on the carbon excretion, carbon dioxid, is, of course, marked and invariable. Some extra material must be oxidized to furnish the energy, and since this material is usually sugar, or sugar and fat, or the non-nitrogenous portion of the protein of the diet, the effect, so far as the excretions are concerned, will be most manifest in the amount of carbon dioxid given off. Pettenkofer and Voit found that the carbon dioxid eliminated by a man during a day of work was nearly double that excreted during a day of rest. Along with this rise in the carbon dioxid excretion there is a corresponding increase in the absorption of oxygen. These results are well illustrated in the following table, which shows the effect of posture and of severe muscular work upon the hourly excretion of carbon dioxid and absorption of oxygen (Benedict and Carpenter).\*

\* Carnegie Institution of Washington, No. 126, 1910.

	CO <sub>2</sub> eliminated.	O <sub>2</sub> absorbed.	Heat produced.
	Grams.	Grams.	Calories.
Man at rest, sleeping.....	23	21	71
Man at rest, sitting.....	33	27	97
Man at rest, standing.....	37	31	114
Man during severe work.....	248	213	653

**Metabolism During Sleep.**—It has been shown that during sleep there is no marked change in the total nitrogen excreted, and therefore no distinct decrease in the protein metabolism. According to Siven, there is a distinct diminution in the secretion of the endogenous purin nitrogen. On the contrary, the carbon dioxid eliminated and the oxygen absorbed are unquestionably diminished. This latter fact finds its simplest explanation in the supposition that the muscles are less active during sleep. The muscles do less work in the way of contractions, and, in addition, probably suffer a diminution in tonicity, which also affects their total metabolism.

**Effect of Variations in Temperature.**—In warm-blooded animals variations of outside temperature within ordinary limits do not affect the body temperature. An account of the means by which this regulation is effected will be found in the chapter upon Animal Heat. So long as the temperature of the body remains constant, it has been found that a fall of outside temperature may increase the oxidation of non-protein material in the body, the increase being in a general way proportional to the fall in temperature. That the increased oxidation affects the non-protein constituents is shown by the fact that the nitrogenous excreta remain unchanged in quantity, other conditions being the same, while the oxygen consumption and the carbon dioxid elimination are increased. This effect of temperature upon the body metabolism is due mainly to a reflex stimulation of the motor nerves to the muscles. The temperature nerves of the skin are affected by a fall in outside temperature, and bring about reflexly an increased innervation of the muscles of the body. Indeed, it is stated\* that unless the lowering of the temperature is sufficient to cause shivering or muscular tension no increase in the excretion of CO<sub>2</sub> results. This fact suffices to explain, therefore, the physiological value of shivering and muscular restlessness when the outside temperature is low. The fact that variations in outside temperature affect only the consumption of non-protein material falls in, therefore, with the conception of the nature of the metabolism of muscle in activity, given above. When the means of regulating

\* Johansson, "Skandinavisches Archiv f. Physiologie," 7, 123, 1897.

the body temperature break down from too long an exposure to excessively low or excessively high temperatures, the total body metabolism, protein as well as non-protein, increases with a rise in body temperature and decreases with a fall in temperature. In fevers arising from pathological causes it has been shown that there is an increased excretion of nitrogen as well as of carbon dioxide.

**Effect of Starvation.**—A starving animal must live upon the material present in its body. This material consists of the fat stored up, the circulating and tissue protein, and the glycogen. The latter, which is present in comparatively small quantities, is quickly used, disappearing more or less rapidly according to the extent of muscular movements made. Thereafter the animal lives on its own protein and fat, and if the starvation is continued to a fatal termination the body becomes correspondingly emaciated. Examination of the several tissues in animals starved to death has brought out some interesting facts. Voit took two cats of nearly equal weight, fed them equally for ten days, and then killed one to serve as a standard for comparison and starved the other for thirteen days; the latter animal lost 1017 gms. in weight, and the loss was divided as follows among the different organs:

	SUPPOSED WEIGHT OF ORGANS BEFORE STARVATION.	ACTUAL LOSS OF ORGANS IN GMS.	LOSS TO EACH 100 GMS. OF FRESH ORGAN (PERCENTAGE LOSS)
Bone .....	393.4	54.7	13.9
Muscle .....	1408.4	429.4	30.5
Liver .....	91.9	49.4	53.7
Kidney .....	25.1	6.5	25.9
Spleen .....	8.7	5.8	66.7
Pancreas .....	6.5	1.1	17.0
Testes .....	2.5	1.0	40.0
Lungs .....	15.8	2.8	17.7
Heart .....	11.5	0.3	2.6
Intestines .....	118.0	20.9	18.0
Brain and cord ....	40.7	1.3	3.2
Skin and hair .....	432.8	89.3	20.6
Fat .....	275.4	267.2	97.0
Blood .....	138.5	37.3	27.0
Remainder .....	136.0	50.0	36.8

According to these results, the greatest absolute loss was in the muscles (429 gms.), while the greatest percentage loss was in the fat (97 per cent.), which had practically disappeared from the body. It is very significant that the central nervous system and the heart, organs which we may suppose were in continual activity, suffered practically no loss of weight: they had lived at the expense of the other tissues. We must suppose that in a starving animal the fat and the protein materials, particularly in the voluntary muscles, pass into solution in the blood, probably as a result of intracellular digestion (autolysis), and are then used to nourish the tissues generally and to supply the heat necessary to maintain the body temperature. Examination of the excreta in starving ani-



mals has shown that a greater quantity of protein is destroyed during the first day or two than in the subsequent days. This fact is explained on the supposition that the body is at first supplied with a certain excess of protein material, circulating protein, derived from its previous food, and that after this is metabolized the animal lives entirely, so far as protein consumption is concerned, upon its "tissue protein." If the animal remains quiet during starvation, the amount of nitrogen excreted daily soon reaches a nearly constant minimum, showing that a practically constant amount of protein (together with fat) is consumed daily to furnish body heat, and material for the energy needs and tissue waste in the active organs, such as the heart. Shortly before death from starvation the daily amount of protein consumed may increase, as shown by the larger amount of nitrogen eliminated. This fact is explained by assuming that the body fat is then exhausted and the animal's metabolism is confined to the tissue proteins alone. The general fact that the loss of protein is greatest during the first one or two days of starvation has been confirmed upon men in a number of interesting experiments made upon professional fasters. For the numerous details as to loss of weight, variations of temperature, etc., carefully recorded in these latter experiments, reference must be made to original sources\* It may be added, in conclusion, that the fatter the body is, to begin with, the longer will starvation be endured, and if water is consumed freely the evil effects of starvation, as well as the disagreeable sensations of hunger, are very much reduced.

**The Potential Energy of Food.**—The food material during digestion and after absorption undergoes numerous chemical changes in the body. Some of these changes are not attended by the liberation of heat to any marked extent. Such is the case, for instance, with the hydrolytic cleavages of the molecule which have been described especially in connection with the digestive processes. As an example of this fact one may take the inversion of the double sugars—one molecule of maltose yields two molecules of dextrose. The heat value of a gram molecule of maltose is 1350.7 calories. The heat value of the dextrose resulting from its inversion is 1347.4 cal., so that the process of hydrolysis liberates only 3.3 cal. or about 0.2 per cent. of the total available energy in the maltose.† Similar hydrolytic cleavages occur doubtless within the tissues, and other changes connected with muscular, nervous, and glandular activity, and the building up and breaking down of the living substance take place constantly as a part of general

\* "Virchow's Archiv," vol. 131, supplement, 1893; and Luciani, "Das Hungern," 1890. See also Weber, "Ergebnisse der Physiologie," vol. i., part 1., 1902.

† See Herzog, "Zeit. f. physiol. chem.," 37, 383, 1903, and Tangl, "Pflüger's Archiv," 115, 1, 1906.

nutritional metabolism. On the other hand, many of the chemical processes occurring in the body are especially valuable on account of the heat liberated. These reactions, for the most part, at least, are oxidations; they are effected under the influence of oxidizing enzymes or by some other means of activating the oxygen. The various stages in the process are not explained, but we know that oxygen is necessary and that the carbon and the hydrogen contained in the substances acted upon appear eventually in the form of oxidation products—namely, carbon dioxide and water—Liebig designated the fats and carbohydrates as respiratory foods on the hypothesis that their fate in the body is to be oxidized and furnish heat. While this view is, in the main, correct, it is evident now that a portion at least of the protein molecule, after the splitting off of the nitrogen, may also undergo oxidation and furnish heat. In Liebig's sense, therefore, the proteins play the part of respiratory or heat-producing foods as well as acting as tissue formers. On the other hand, fats and carbohydrate material may enter to some extent, together with the protein, into the synthesis of cell material, and thus play the rôle of a plastic or tissue-forming as well as of a respiratory food. This possibility is emphasized by modern theories regarding the intermediary metabolism of the carbohydrates (p. 897), according to which it would appear that the lactic acid formed from the carbohydrates may be converted to an amino-acid, after passing through a ketonic acid stage. We cannot divide the foodstuffs, therefore, strictly into two such classes, but we may perhaps consider the chemical processes in the body under the two heads mentioned above—namely, the oxidation or heat-producing changes and those due to hydrolytic cleavages, synthesis, etc., which are attended by a small liberation of heat, or, indeed, may be accompanied by an absorption of energy (synthesis). The great supply of heat energy needed by the body to maintain its temperature comes from the oxidation processes. The heat produced in and given off from the body is estimated in terms of calories. The small calorie (*c*) or gram-calorie is the quantity of heat necessary to raise one gram of water one degree centigrade in temperature, while the large calorie (*C*) or kilogram-calorie is the quantity of heat necessary to raise the temperature of one thousand grams of water one degree. In round numbers an adult man produces in his body and gives off to the surrounding air about 2,400,000 calories (2400 *C.*) of heat per day. This great supply of heat is derived from the physiological oxidation of the carbohydrate, fat, and protein material of the food. These same materials may be oxidized outside the body by burning them at a high temperature or under a high pressure of oxygen, and the heat that they give off in the

process can be measured directly. So far as the fats and carbohydrates are concerned, the end-products of the oxidation in the body are the same as in their combustion out of the body, and we may believe, therefore, that the amount of heat produced is the same in both cases. Consequently the heat value of a gram of fat or carbohydrate burnt outside the body is spoken of as its *combustion equivalent*, and it measures the amount of potential energy of these foodstuffs which is available for the production of heat or for the supply of energy in other forms to the working cells. With regard to the protein, the case is somewhat different. Its end-products in the body are carbon dioxide, water, and urea or some other of the nitrogenous waste products. These nitrogenous wastes are capable of further oxidation with liberation of heat, so that, as far as they are eliminated, the body loses a possible supply of heat energy, which must be subtracted from the total heat energy that the protein gives upon oxidation outside the body, in order to determine the available heat energy yielded within the body. The figures obtained for the heat equivalents of the foodstuffs by burning them outside the body in some form of calorimeter are as follows: 1 gm. of fat yields an average of 9300 calories, or 9.3 large calories (C), 1 gm. of carbohydrate yields an average of 4100 calories (4.1 C.). These figures may be taken, therefore, to express the quantity of heat given to the body by the oxidation within its tissues of these elements of our food. A gram of protein when burnt outside of the body yields on the average 5778 calories. The heat value of the urea is estimated as 1 gm. = 2523 calories. If we assume that all the nitrogen of the protein appears as urea and that 1 gm. of protein yields  $\frac{1}{3}$  gm. of urea, then the available heat energy of a gram of protein should be equal to  $5778 - 841$  (or  $\frac{1}{3}$  of 2523) = 4937 calories. Later workers, however, have given reasons for believing that this last figure is too high. All of the nitrogen is not eliminated as urea, and, moreover, all of the nitrogenous waste is not excreted in the urine; a distinct proportion is given off in the feces. Rubner has calculated the available heat energy of proteins by direct experiments upon animals. In these experiments the heat value of the protein fed was directly determined by burning a sample in a calorimeter. Then after feeding a known amount of the protein the urine and feces were collected and their heat value was determined in the same way. The difference between the total heat value of the protein fed and the heat value lost in its excreted products in the feces and urine gave the actual heat energy obtained from the protein by the animal body. Results obtained by this method give an average value for 1 gm. protein of 4100 calories (4.1 C.), or, since protein contains an average of 16 per cent. of nitrogen, we may say that 1 gm. of nitrogen ingested as protein has a heat value of  $4.1 \times 6.25 = 25.6$  C.

The figures that are used, therefore, in estimating the heat value of our foodstuffs are:

1 gm. protein	= 4100 calories (4.1 C.).
1 gm. carbohydrate (starch)	= 4100 calories (4.1 C.).
1 gm. fat	= 9305 calories (9.3 C.).

Making use of these values, it is obvious that we can calculate the total heat value of any given diet. If we analyze the food for its composition in the three principal foodstuffs we may determine how many calories will be furnished to the body. In many of the tables published to show the composition of the different foods figures are given also to express their heat value or potential energy, on the belief that, for the most part, our food is used as fuel to supply energy to the body. These values for some of our ordinary foods are as follows:\*

	PROTEIN.	FAT.	CARBOHY- DRATE.	ASH.	HEAT VALUE IN CALORIES PER POUND.
Beefsteak, porterhouse.....	19.1	17.9	....	0.8	1110
Beefsteak, round (lean).....	20.2	2.4	....	1.2	475
Corned beef (canned).....	26.3	18.7	....	4.0	1280
Veal, leg (lean).....	19.4	3.7	....	1.1	520
Veal liver.....	19.0	5.3	....	1.3	575
Mutton, leg (lean).....	16.5	10.3	....	0.9	740
Pork, ham (fresh, lean).....	24.8	14.2	....	1.3	1060
Pork chops, medium fat.....	13.4	24.2	....	0.8	1270
Chicken (fowl).....	13.7	12.3	....	0.7	775
Shad.....	9.4	4.8	....	0.7	380
Shad roe.....	20.9	3.8	2.6	1.5	600
Eggs.....	11.7	10.7	....	0.7	680
Milk.....	3.3	4.0	5.0	0.7	325
Oatmeal.....	16.1	7.2	67.5	1.9	1860
Rice.....	8.0	0.3	79.0	0.4	1630
Wheat flour (entire wheat).....	13.8	1.9	71.9	1.0	1675
Green peas.....	7.0	0.5	16.9	1.0	465
Potatoes (raw).....	2.2	0.1	18.4	1.0	385
Spinach.....	2.1	0.3	3.2	2.1	110
Tomatoes.....	0.9	0.4	3.9	0.5	105
Apples.....	0.4	0.5	14.2	0.3	290
Bananas.....	1.3	0.6	22.0	0.8	460

It must be borne in mind, however, that the entire nutritional value of a food is not expressed in its heat value. Some of our food material—the green foods and fruits, for example—are useful and in a measure essential because of their salts and organic acids, in spite of the fact that they contain but little energy that can be utilized by the body. Moreover recent work, already referred to (p. 901), makes it increasingly probable that the different proteins or even the different carbohydrates or fats may be found to have each a specific influence upon metabolism. And, lastly, specific substances may be found in the foods (vitamines), which in some as yet undetermined way are important or essential to

\* Selected from Atwater and Bryant, Bulletin 28 (revised edition), United States Department of Agriculture, 1889.

the metabolism in some part of the body. Thus it is stated that the disease known as beriberi, which formerly in the Japanese navy showed the high incidence of 325 cases out of 1000, has been entirely eradicated by substituting for an exclusive diet of polished rice one of equal quantities of barley and rice. Investigation has shown that the material lost in the process of polishing the rice is a relatively simple organic base (p. 904). In these respects the science of dietetics has a wide field for investigation. In a general way, however, the heat energy of a food expresses its value as a means for supplying the energy needs of the living cells. In the work that these cells perform, whether it is contraction, secretion, or nervous activity, energy is needed, and this energy is carried into the body in the potential chemical energy of the proteins, fats, and carbohydrates, whatever may be the source from which these foodstuffs are obtained.

**Dietetics.**—The subject of the proper nourishment of individuals or collection of individuals in health and in sickness is treated usually in works upon hygiene or dietetics. The practical details of the preparation and composition of diets must be obtained from such sources.\* The general principles upon which practical dieting depends have been obtained, however, from experimental work upon the nutrition of man and the lower animals, some account of which has been given in the foregoing pages. In a healthy adult the main objects of a diet are to furnish sufficient nitrogenous and non-nitrogenous foodstuffs, salts, and water to maintain the body in an equilibrium of material and of energy—that is, the diet must furnish the material for the regeneration of tissue and the material for the heat produced and the muscular work and other work done. Nutritional experiments prove that this object may be accomplished by protein food alone, together with salts and water. It is doubtful, however, whether, in the case of man, such a diet could be continued for long periods without causing some nutritional disturbance, directly or indirectly. It will be remembered that a pure meat diet is not entirely protein, since all flesh contains some fats and carbohydrates (glycogen). The functions of a diet are accomplished more easily and more economically when it consists of proteins and fats, or proteins and carbohydrates, or, as is almost universally the case, of proteins, fats, and carbohydrates. The experience of mankind shows that such a mixed diet is most beneficial to the body and most satisfying to that valuable regulating mechanism of nutrition, the appetite. Expressed in its most general form the cells of our body need food for two purposes: First, to supply the energy needs; second, to furnish the material for the construction of their

\* For practical directions, see Gautier, "L'alimentation et les régimes," 1904; Blyth, "Foods: their Composition and Analysis."

own living substance, that is, for assimilation. The first of these purposes is fulfilled by any of the three energy-yielding foodstuffs, carbohydrates, fats, or proteins, but as a matter of fact we use chiefly the carbohydrates on account of their economy and the ease with which they are utilized by the body. For the second purpose, the construction of protoplasm or living matter proteins (or their cleavage products, the various amino-bodies) are absolutely necessary.\* In accordance with this specific and necessary function of the protein we find that the amount used in the daily diet is fairly constant, about 100 gms., while the proportions of fat and carbohydrate show wide variations. Since from the energy standpoint the fats and carbohydrates have a common function, serving as fuel for the energy needs of the body, we ought to be able to exchange them in the diet in the ratio of their heat values.

This ratio, or as it is frequently called, the *isodynamic equivalent*, is as 9.3 to 4.1 or 2.3 to 1, and within the limits permitted by the appetite we should be able to substitute 1 part of fat for 2.3 parts of sugar or starch. Experiments upon animals, as well as the experience of mankind, show that this substitution can be made, although it is not advisable to eliminate either of these foodstuffs entirely from the diet. The fact that within certain limits fats and carbohydrates may be substituted for each other is illustrated in a general way by the different diets recommended by various physiologists, since it will be noticed that in those in which the proportion of fat is large the amount of carbohydrate is reduced.

#### AVERAGE DIETS AND THEIR HEAT VALUES.

MOLESCHOTT.		RANKE.		VOIT.	
	CALORIES.		CALORIES.		CALORIES.
Protein . . . . .	130 gms. . . . . 533	100 gms. . . . .	410	118 gms. . . . .	483
Fats . . . . .	40 " . . . . . 372	100 " . . . . .	930	56 " . . . . .	520
Carbohydrates . . . . .	550 " . . . . . 2275	240 " . . . . .	984	500 " . . . . .	2050
	2980		2324		3053
FORSTER.		ATWATER.			
	CALORIES.		CALORIES.		
Protein . . . . .	131 gms. . . . . 567	125 gms. . . . .	512		
Fats . . . . .	68 " . . . . . 632	125 " . . . . .	1172		
Carbohydrates . . . . .	494 " . . . . . 1825	400 " . . . . .	1640		
	2024		3324		

The average heat value of these diets is equal to 2742 calories, of which about 18 per cent. is furnished by the protein. Generally speaking, it will be found that in the dietaries selected voluntarily by mankind the protein furnishes from 15 to 20 per cent. of the total heat value of the diet. According to some physiologists this proportion is unnecessarily large and it might be reduced to as little as 5 or 10 per cent. Whether or not such a change is

\* See p. 897 for a possible amendment to this general statement.

justified has already been discussed to some extent (p. 898). Leaving aside this point, it is usually estimated in round numbers that the diet should furnish daily 2400 Calories for an individual weighing 60 kgms., or about 40 Calories per kgm. of body weight. It will be noticed that in all cases the greatest portion of this energy is obtained from the carbohydrate food, which, on account of its economy, its abundance, and its ease of digestion and oxidation in the body, constitutes the bulk of our diet. In cases of excessive muscular work the food eaten may supply more than twice the average heat value given above. Thus, Atwater and Sherman estimate that in a six-day bicycle race by professionals the heat value of the food for the different participants varied from 4770 to 6095 Calories. Chittenden, in the work previously referred to,\* has raised the question whether the heat value of the diet ordinarily employed is unnecessarily high. In his own case he found that the body could be well nourished on a diet containing a total heat value of only 1600 Calories or 28 Calories per kgm. of body weight instead of 40 Calories. The diet in this case, it will be remembered, contained only 36 to 40 gms. of protein in place of the 100 to 130 gms. recommended in the diets mentioned above. The question thus raised is one that must be decided by actual experience, but from the numerous statistical and experimental results now available† it would appear, as has been stated above, that the total energy necessary in a diet, estimated in terms of its heat value, varies chiefly with the amount of muscular work to be done. Persons who lead a very muscular life require a correspondingly large amount of energy in the diet, and this demand is met usually by augmenting the proportion of carbohydrate and fat, especially the carbohydrate. Since the amount of protein is not varied greatly in such cases the diet is relatively poor in this foodstuff. On the contrary, those who lead a sedentary life, including, broadly speaking, all the well-to-do class, require less energy in their diet, and they can afford to reduce the proportion of carbohydrate and fat. The diet in such cases may be relatively rich in protein, although the amount per kilogram of body weight is not increased, in fact, is usually diminished somewhat. These facts are illustrated in Atwater's estimate of the diet necessary for men performing different amounts of muscular work.

	PROTEIN.	CARBOHYDRATE AND FAT.
Man doing hard muscular work.....	600 cal.	3550 cal.
Man doing moderate muscular work.....	500 "	2900 "
Man doing no muscular work.....	360 "	2040 "

\* Chittenden, "Physiological Economy in Nutrition," 1905.

† See especially the numerous Bulletins of the U. S. Department of Agriculture, Nos. 28, 116, 129, 149, etc.

On comparing these diets it will be observed that in performing hard muscular work the diet contained 1700 Calories of energy beyond that used when no work was done. About six-sevenths of this increase was provided for by the carbohydrates and fats. It will be seen also that in this case the proportion of the total energy obtained from protein remained practically unchanged.

Mankind is guided and has been guided in all times by the control of the appetite, using this term in a general sense to designate the conscious desire for food, and also the desire, more or less clearly recognized, for special kinds of food. If scientific experiments indicate that this regulatory apparatus leads us to ingest more food than is actually required for the assimilation needs and the energy needs of the body, it remains for observation and experiment to determine whether this excess is beneficial or useless or, perhaps, even harmful.

Munk gives an interesting table showing how much of certain familiar articles of food would be necessary, if taken alone, to supply the requisite daily amount of protein or non-protein material; his estimates are based upon the percentage composition of the foods and upon experimental data showing the extent of absorption of the foodstuffs in each food. In this table he supposes that the daily diet should contain 110 gms. of protein = 17.5 gms. of N, and non-proteins sufficient to contain 270 gms. of C:

	FOR 110 GMS. PROTEIN (17.5 GMS. N).	FOR 270 GMS. C.
Milk.....	2900 gms.	3800 gms.
Meat (lean).....	540 "	2000 "
Hen's eggs.....	18 eggs.	37 eggs.
Wheat flour.....	800 gms.	670 gms.
Wheat bread.....	1650 "	1000 "
Rye bread.....	1900 "	1100 "
Rice.....	1870 "	750 "
Corn.....	990 "	660 "
Peas.....	520 "	750 "
Potatoes.....	4500 "	2550 "

As Munk points out, this table shows that any single food, if taken in quantities sufficient to supply the nitrogen, would give too much or too little carbon and the reverse; those animal foods which, in certain amounts, supply the nitrogen needed furnish only from one-fourth to two-thirds of the necessary amount of carbon and, *vice versa*, the vegetable foods if taken in sufficient quantity to supply the carbon would not give sufficient nitrogen, or if used alone to furnish the requisite nitrogen would give an excess of carbon. This same fact is illustrated in another way in a table compiled by Cohnheim.\* To furnish the body with its necessary daily

\* Cohnheim, "Die Physiologie der Verdauung und Ernährung," 1908.



quota of 100 grams of protein the following amounts of different foods, expressed in their heat values, would be required:

Meat.....	495	Coarse bread.....	4552
Eggs.....	1133	Fine bread.....	4720
Cheese.....	1704	Potatoes.....	5000
Milk.....	2070	Rice.....	5600
Corn.....	4104		

It is evident from this table that a person leading a sedentary life who used a vegetable diet alone would be required, in order to obtain his necessary protein, to consume much more carbohydrate than from an energy standpoint was needed by the body. As Cohnheim points out, the animal foods are for this reason especially suited to supply the protein needs of those who lead a comparatively inactive life. In practical dieting we are accustomed to get our supply of proteins, fats, and carbohydrates from both vegetable and animal foods. To illustrate this fact by an actual case, in which the food was carefully analyzed, an experimenter weighing 67 kgms. records that he kept himself in nitrogen equilibrium upon a diet in which the protein was distributed as follows:

300 gms. meat	=	63.08 gms. protein	=	9.78 gms. N.
666.3 c.c. milk	=	18.74 " "	=	2.905 " "
100 gms. rice	=	7.74 " "	=	1.2 " "
100 " bread	=	11.32 " "	=	1.755 " "
500 c.c. wine	=	1.17 " "	=	0.182 gm. "
		<hr/>		<hr/>
		102.05 " "	=	15.868 gms. "

For a person in health and leading an active, normal life, appetite and experience seem to be safe and sufficient guides by which to control the diet; they may be relied upon, at least, to protect the body from undernutrition. The opposite danger of overeating is a real one, particularly among those who do not lead an active life. It is, however, a hygienic offence that is usually committed knowingly and may consequently be controlled by those who have sufficient wisdom. Physiological knowledge emphasizes clearly enough the great fact that the mechanisms of nutrition and digestion, like the other mechanisms of the body, should not be subjected to unnecessary strain. For those who are in health, the important rule to follow in the matter of diet is to avoid an excess in eating. In conditions of disease, in regulating the diet of children or of collections of individuals, as in the army, navy, etc., it is necessary for purposes of hygiene or for purposes of economy to arrange the diet in accordance with the knowledge obtained from experience and from scientific investigations. In this direction much has already been accomplished, but more remains to be done, particularly perhaps in the relation of diet to pathological conditions.

## CHAPTER LI.

### THE PRODUCTION OF HEAT IN THE BODY—ITS MEASUREMENT AND REGULATION—BODY TEMPERATURE—CALORIMETRY—PHYSIOLOGICAL OXIDATIONS.

It is customary to date our modern ideas of the origin of animal heat from the time of Lavoisier (1774–77). To the older physiologists it was a most difficult problem. The animal's body produces heat continually and maintains a temperature higher, as a rule, than that of the surrounding air. Since oxygen and the nature of ordinary combustions were unknown, they naturally explained this heat formation by reference to causes which the science of the day had shown to be capable of producing warmth, such as friction and fermentation. Haller (1757), for instance, taught that the body heat arises mainly from the friction of the circulating blood and the movements of the heart and blood-vessels, and this view found currency in text-books well into the nineteenth century. Lavoisier first gave to the physiologist the conception that the heat produced in the body is due to a combustion or oxidation, and that therein lies the significance of our respiration of oxygen. He believed himself that this oxidation takes place in the lungs,—that is, the blood brings to the lungs a hydrocarbonous material which is attacked by the oxygen and burnt with the formation of water and carbon dioxid and the liberation of heat. Later experimenters demonstrated that the heat production does not occur in the lungs, at least not exclusively, but over the whole of the body. After a long and interesting controversy it was also shown satisfactorily that the oxidations of the body do not occur in the blood, but in the tissues themselves. The oxygen is transported to the cells and there does its work of effecting oxidations and giving rise to heat. This heat is equalized more or less over the whole body, chiefly by the circulation of the blood, which absorbs heat from the warmer organs and distributes it to the cooler ones. The body temperature is maintained at a nearly constant level by an intricate adjustment of physiological reflexes which together constitute the heat-regulating mechanism. Such in brief is the general theory of our time regarding heat production in the body. Many of the problems that interested the older phys-

iologists have been solved satisfactorily, but there remain, of course, many more to interest this and succeeding generations. Investigations in this field at present are directed mainly to an effort to understand the details of the heat-regulating apparatus, on the one hand, and, on the other, to comprehend more satisfactorily the nature of the process of oxidation. This latter problem is one of common interest at present in chemistry and in physiology.

**The Body Temperature.**—We divide animals into the two great classes of warm blooded and cold blooded, according as their temperature is or is not above that of the surrounding air. In this sense, birds and mammals are warm blooded and reptiles, amphibia, and fishes are cold blooded. The names, however, are badly chosen. The difference of deepest significance between the mammals and birds, on the one hand, and the fishes, amphibia, and reptiles, on the other, is that in the former the body temperature is, within wide limits, independent of the outside temperature; it remains practically constant during winter and summer, whether the surrounding air is hotter or cooler than the body. They are, therefore, constant-temperature animals (homoiothermous). The reptiles, amphibia, and fishes, on the contrary, have a body temperature that changes with the environment. On winter days their temperature is low, approximately that of the surrounding air or water, and in summer their body temperature rises to correspond with that of the outside. Strictly speaking, they are cold blooded only in cold surroundings. This group may be designated as the changeable-temperature animals (poikilothermous). The warm-blooded animals maintain a constant high body temperature on account of their relatively active oxidations and the existence of a heat-regulating mechanism. In the cold-blooded animals the oxidations are not so intense and a heat-regulating mechanism is absent or poorly developed. The hibernating animals form a group intermediate in many ways between these two classes. They possess a heat-regulating apparatus that maintains a constant body temperature under most conditions, but breaks down in very cold weather; so that during the period of winter sleep their temperature is but little above that of the surrounding air. In some of the cold-blooded animals the production of heat during warm weather is more rapid than its loss; so that they exhibit a body temperature slightly higher than the surrounding medium. A hive of bees in activity may raise the temperature within the hive through a number of degrees, and snakes and many reptiles show a temperature of  $2^{\circ}$  to  $8^{\circ}$  C. above that of the air. So also some reptiles possess a rudimentary means of protecting their bodies from too great a rise of temperature,—for instance, by accelerated breathing, whereby more water is evap-

orated from the lungs and thus more heat is lost.\* The distinction between the two great groups of animals is not absolute, but it is sufficiently marked to constitute a striking physiological characteristic.

The temperature of the human body is measured usually by thermometers placed in the mouth, in the axilla, or in the rectum. Measurements made in this way show that in general the temperature in the interior of the body (rectal) is slightly higher than on the surface of the skin. The average temperature in the rectum is  $37.2^{\circ}$  C. ( $98.96^{\circ}$  F.); in the axilla,  $36.9^{\circ}$  C. ( $98.45^{\circ}$  F.); in the mouth,  $36.87^{\circ}$  C. ( $98.36^{\circ}$  F.). We may speak of the body temperature, therefore, in the places in which it can be conveniently measured, as varying between  $36.87^{\circ}$  C. and  $37.2^{\circ}$  C. Some of the internal organs have a higher temperature, particularly during their period of greatest activity. The temperature of man, measured in the places mentioned, shows also a distinct variation during the day, a diurnal rhythm. This daily variation has been measured by many observers, and shows individual peculiarities that depend largely upon the manner of living, time of meals, etc. In general it may be said that the lowest temperature is shown early in the morning,—6 to 7 A.M.; that it rises slowly during the day to reach its maximum in the evening, 5 to 7 P.M.; and falls again during the night. The difference between early morning and late afternoon or evening may amount to a degree or more centigrade, and this fact must be borne in mind by physicians when observing the temperature of patients. Muscular activity and food appear to be the factors that are mainly responsible for the rise in temperature during the day. Most observers state that when the habits of life are reversed for some time—that is, when work is performed and meals are eaten during the night, and the day is given up to sleep and rest—the daily variation of temperature is inverted to correspond,—that is, the highest temperature is observed in the early morning and the lowest in the late afternoon. Age also has a slight influence. Newly born infants and young children have a somewhat higher temperature than adults. The difference may amount to half a degree or a degree centigrade,— $37.6^{\circ}$  C. in infants as compared with  $36.6^{\circ}$  C. or  $37.1^{\circ}$  C. in the adult. It is known, also, that the heat-regulating mechanism in infants and young children is not so efficient as in adults, and that therefore febrile disturbances are more easily excited in the former than in the latter. In the matter of body temperature, as in so many other characteristics, aged people show a tendency to revert to infantile conditions. Their temperature, according to most observers, is slightly higher than in middle life.

\* See Langlois, "Journal de physiologie et de pathol. générale," 1902, 249.

Among physiological conditions that influence the body temperature, muscular work and meals, as stated above, have the most positive effect. Marked muscular activity implies a great increase in the production of heat in the body and most observers find that the initial result at least is a small rise in body temperature,—a fact which indicates that the heat regulation is not perfect; the excess of heat produced is not dissipated promptly. In the period of rest following upon work, on the contrary, the body temperature may fall, owing probably to the fact that more heat is lost through the flushed skin than is produced within the body. In this matter of the effect of muscular work individual variations are to be expected, since the perfection of the heat-regulating mechanisms may vary somewhat in different persons. Meals also cause a slight rise in body temperature, which reaches its maximum about an hour and a half after the ingestion of the food. The explanation in this case also is to be found doubtless in a greater production of heat, due to the increased metabolism set up by the food (specific dynamic action, see p. 905). The excessive production of heat is not compensated completely by a corresponding increase in the heat dissipated.\* It is sufficiently obvious, perhaps, from these facts that the temperature as measured by the thermometer is a balance between the amount of heat produced and the amount of heat lost or dissipated. The thermometer alone gives us no certain indication of the quantity of heat produced in the body. A temperature higher than normal, fever temperature, may be due either to an excessive production of heat or to a deficient dissipation. To understand and control the processes by which the body temperature is kept normal it is necessary to discover a means for ascertaining at any time the actual quantities of heat produced and dissipated, and the effect upon each factor of different normal and pathological conditions. The method used for determining the quantity of heat is designated as calorimetry. It is necessary, therefore, to describe the principle and construction of calorimeters and the methods of calorimetry before attempting to explain the mechanism of heat regulation.

**Calorimetry.**—A calorimeter is an instrument for measuring the quantity of heat given off from a body. The unit employed in these determinations is the calorie,—that is, the amount of heat necessary to raise 1 gm. of water  $1^{\circ}$  C., or more accurately the amount of heat required to raise 1 gm. of water from  $15^{\circ}$  to  $16^{\circ}$  C. This unit is sometimes designated as a small calorie to distinguish it from the large calorie (C),—that is, the quantity of heat necessary to raise 1 kgm. of water  $1^{\circ}$  C. The large calorie is equal to 1000

\* For further details see Richet, "La chaleur animale," 1889; and Pembrey, "Animal Heat," Schaefer's "Text-book of Physiology," vol. i, 1898.

small calories. In physiology calorimeters have been used for two main purposes: to determine the heat equivalent of foods,—that is, the amount of heat given off when the various foodstuffs are burned,—and, secondly, to determine the heat produced and the heat dissipated by living animals during a given period. For the first purpose the apparatus that is most frequently employed at present is the bomb calorimeter devised by Berthelot. The bomb consists of a strong steel cylinder in which the food to be burned is placed

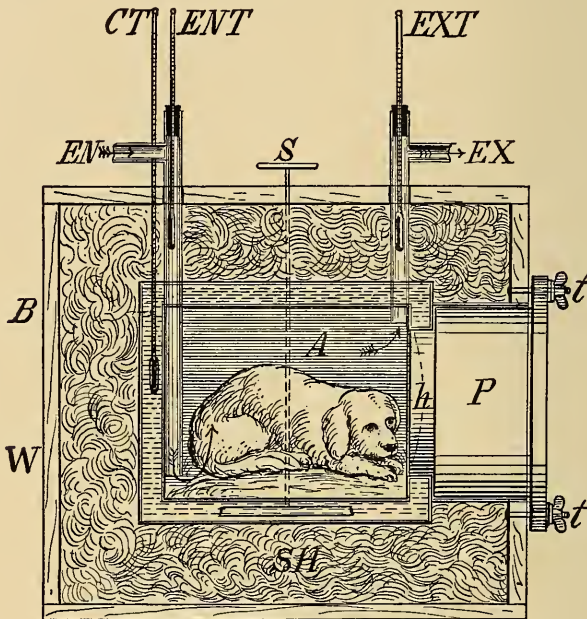

Fig. 300.—Reichert's water calorimeter.

and which is filled with oxygen. The combustion of the foodstuff is initiated by means of a spiral of platinum wire heated by an electrical current. The bomb is immersed in water and the heat given off raises the temperature of the water a certain number of degrees centigrade. The weight of water being known, the amount of heat is easily expressed in calories. For the purpose of measuring the heat given off by living animals two principal forms of calorimeter are used, each form having a number of modifications. These two forms are the water calorimeter and the air calorimeter. The water calorimeter was the form used in the first experiments on record (Crawford, 1779). In principle it consists of a double-walled box with a known weight of water between the walls. The animal is placed in the inner box and the

heat given off is absorbed by the water. Knowing the weight of the water and how much its temperature is raised, the data are at hand for determining the number of calories given off during the experiment. One form of this variety of calorimeter, used in this country by Reichert, is shown in Fig. 300. It consists of two concentric boxes of metal with the space between them filled with water. The animal is placed in the inner box (*A*). The two boxes are inclosed in a large wooden box, the space between the metal and wooden boxes being filled with shavings (*SH*). The object of this outer box is to prevent radiation of heat from the metal boxes. The tubes *EN* and *EX*, which lead into the interior chamber containing the animal, are for the entrance and exit of the ventilating air. A thermometer is placed in each to determine the heat carried off by the air. The thermometer, *CT*, measures the temperature of the water, and *S* is a stirrer to keep the water well mixed and thus insure a uniform temperature. When the animal is placed in the apparatus the heat given off warms not only the water, but also the metal; so that to determine the total heat the weight of metal must be reduced to an equivalent amount of water by multiplying its weight by its specific heat, or, a more simple method, the *calorimetric equivalent* of the apparatus is determined,—that is, the actual amount of heat necessary to raise the temperature of the apparatus, water and metal, one degree. This value is obtained by burning in the apparatus a known weight of some substance (alcohol, hydrogen) whose heat of combustion is known. Knowing how much heat is given off by this combustion and how much the temperature of the apparatus is raised, the calorimetric equivalent is easily calculated and may be used subsequently in estimating the results obtained from animals. In the use of the apparatus many precautions must be observed. These practical details need not be described here except to say that account must be taken of the warming of the air used to ventilate the apparatus and of any changes in the amount of its moisture. The calorimeter used in this way measures directly the amount of heat given off from the animal during the period of observation. The amount of heat produced in the animal's body during this time may be the same, or may be more or less. To arrive at a knowledge of this factor observations must be made upon the animal's body temperature by means of a thermometer in the rectum. If this body temperature is the same at the end as at the beginning of the experiment then it is obvious that the heat produced must have been equal to the heat lost. If the animal's body temperature has fallen, then it is evident that less heat has been produced than was lost. To ascertain how much less, the weight of the animal is multiplied by its specific heat (0.8)

to reduce it to so much water, and this product is multiplied by the difference in body temperature at the beginning and the end of the experiment. The product is obtained in calories and is subtracted from the amount of heat lost, as determined by the calorimeter, to obtain the amount of heat produced. If, on the contrary, the animal's temperature has risen during the experiment the body has produced more heat than it has dissipated. The increase may be determined as above by multiplying the weight of the animal, the specific heat of the body, and the difference in temperature. This amount added to the heat lost gives the heat produced.

Many investigators have used some form of air calorimeter. An air calorimeter consists essentially of a double-walled chamber or box with air between the walls. The animal is placed in the inner box and the heat given off is measured by the expansion of the air between the walls. Many different forms are used, preference being given to some modification of the differential air calorimeter. In this last-named instrument two exactly similar chambers are constructed; one contains the animal, while the other serves as a dummy. These two chambers are balanced against each other, the air space in the dummy being heated by immersion in a bath or by burning hydrogen in the interior. As these sources of heat are known and can be controlled, it is evident that if the dummy is made to balance exactly the chamber containing the animal the amount of heat given off in each is the same.\*

*The Respiration Calorimeter.*—When a calorimeter is so arranged that the composition of the air drawn through the apparatus for ventilation can be determined, as well as the amount of heat produced, the apparatus becomes a respiration calorimeter. In such an apparatus, if proper provision is made for analyzing the urine, the feces, and the food, the total carbon and nitrogen excretion may be obtained simultaneously with the heat loss. Since we may calculate from the carbon and nitrogen excretion how much protein, fat, and carbohydrate have been burnt in the body, and since the heat values of these constituents are known, it is evident that we may reckon indirectly how much heat ought to be produced from the combustion of so much material. This method of arriving at the heat production is designated *indirect calorimetry*. With an adequate respiration calorimeter it is possible to ascertain whether the results calculated by the method of indirect calorimetry really correspond with the heat obtained by direct measurement. In the hands of good observers the correspondence is very close, and gives substantial proof of the scientific belief

\* For detailed accounts of special forms of air calorimeters see Rubner, "Calorimetrische Methodik," 1891; and Rosenthal, "Archiv f. Physiologie," 1897, p. 170.



that in the living body the energy liberated as heat or as heat and work is all contained in potential form in the foodstuffs eaten. By means of the respiration calorimeter we can obtain a balance between the energy income and outgo of the body as well as between the material income and outgo,—that is, the carbon and nitrogen equilibrium. The most complete and elaborate form of respiration calorimeter used is that devised by Atwater and Rosa for experiments upon man.\* The respiration chamber used is a small room lighted and furnished so that an individual may remain in it for long periods without discomfort. As shown in Fig. 301, this

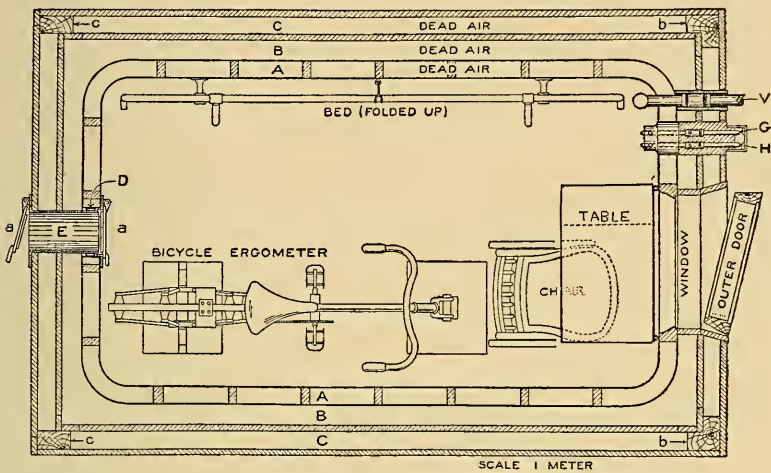

Fig. 301.—Horizontal section of respiration calorimeter. Portions shaded are of wood; A, dead-air space between Cu and Zn walls; B, dead-air space between Zn wall and inside wooden wall; C, dead-air space between inside and outside wooden walls; D, pneumatic-packing air and heat insulated; E, food-aperture tube; a, a, airtight ports (glass); H, ingoing water for absorbing heat; G, outgoing water; V, ventilating air current. (Atwater and Benedict.)

room is arranged as a calorimeter. It has several walls of metal and wood to prevent loss of heat to the outside or the reverse, and by means of water circulating through a system of pipes within the room the heat given up by the body is carried off. By regulating this flow of water the temperature of the chamber can be kept constant. Knowing the temperature of the water as it enters and leaves the chamber and the volume of the flow, the heat production of the individual may be calculated in terms of calories. For the determination of the carbon dioxide and water air is drawn through the room by means of a rotary pump and a closed circuit is employed, that is to say, the same air is kept circulating through the

\* See Atwater and Rosa, Bulletin 63, United States Department of Agriculture, 1899; and for recent improvements, Atwater and Benedict, "A Respiration Calorimeter," Carnegie Institution, Washington, 1905.

room, but provision is made for absorbing the  $\text{CO}_2$  and water as it is formed, and for adding new oxygen from an oxygen tank as it is needed. This arrangement is represented schematically in Fig. 301a. By means of this apparatus many interesting and important experiments have been made upon the nutrition of man under different physiological and pathological conditions, and it seems probable that it will supplant entirely the earlier forms of calorimeter described in the preceding pages. As an indication of its sensitiveness the following result may be quoted

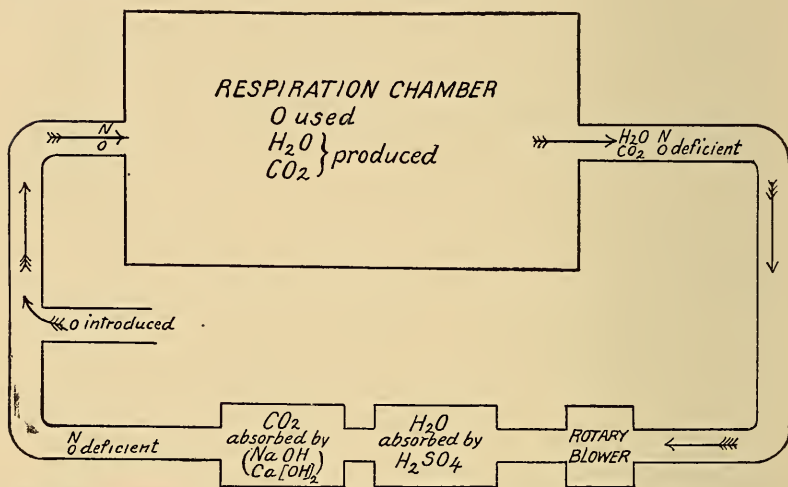

Fig. 301a.—Diagram of circulation of air through respiration apparatus. (Atwater and Benedict.)

from observations made upon a man who, while in the apparatus, did much muscular work on a bicycle ergometer:

Income:	Potential energy of material metabolized in body =	5459 Cal.
Outgo	Energy given off from the body as heat . . . . .	4833 Cal.
	Heat equivalent of muscular work . . . . .	602 Cal.
	5435 Cal.	5435 Cal.
	Experimental error . . . . .	24 Cal.

**Results of Calorimetric Measurements.**—The actual results obtained from direct calorimetric measurements corroborate those deduced from the study of the energy given off in the oxidation of the foodstuffs of the daily diet. They show that man under conditions of ordinary life gives off heat from his body to the amount of about 24 calories per kilogram of weight during twenty-four hours, that is, about 1 calorie per hour per kilogram of body weight.\*

\* Benedict, *et al.*, "Journal of Biological Chemistry," 18, 139, 1914.

This amount is increased greatly under conditions demanding much muscular work. This loss of heat is, of course, made good by the production of an equal amount within the body by the oxidation of the food material.\* Actual experiments upon different animals show that small animals produce more heat in proportion to their weight than larger animals of the same species, owing to their relatively larger surface, and, therefore, greater loss of heat. This fact has been expressed by Rubner in what he calls his *surface area law*. According to this law the metabolism is proportional to the surface area, or for the same amount of surface area there will be the same production of heat. He estimates that in man there is produced in twenty-four hours for each square meter of surface 1042 calories. More extensive observations by later observers give a lower figure, 700 to 900 calories.

### HEAT REGULATION.

From a general standpoint the most important problem that the physiologist has to study is the means by which the heat production and heat loss are so regulated as to maintain a practically constant body temperature. Experiments show that the mechanism of heat regulation is very complex and is two-sided,—that is, the body possesses means of controlling the loss of heat as well as the production of heat, and under the conditions of normal life both means are used.

**Regulation of the Heat Loss.**—Heat is regularly lost from our bodies in a number of different ways, which may be classified as follows:

1. Through the excreta, urine, feces, saliva, which are at the temperature of the body when voided.
2. Through the expired air. This air is warmer than the inspired air, and, moreover, is nearly saturated with water-vapor. The vaporization of water requires heat, which is, of course, taken from the body supply. Each gram of water requires for its vaporization about 0.5 cal.
3. By evaporation of the sweat from the skin. The amount lost in this way increases naturally with the amount of sweat secreted.
4. By conduction and especially by radiation of heat from the skin.

The relative values of these different means of heat loss are estimated as follows by Vierordt:

1. By urine and feces.....	1.8 per cent. or	48 calories.
2. By expired air: Warming of air.....	3.5 “ “	84 “
Vaporization of water from lungs.....	7.2 “ “	182 “
3. By evaporation from skin.....	14.5 “ “	364 “
4. By radiation and conduction from skin....	73.0 “ “	1792 “
	Total daily loss =	2470 “

\* See Rubner, “Zeitschrift f. Biologie,” 19, 535, 1883; and “Gesetze des Energieverbrauchs,” 1902.

It is obvious that the relative importance of these factors will vary with conditions. Thus, high external temperatures will tend to diminish the loss from radiation while increasing that from evaporation, owing to the greater production of sweat. The variation in this respect is well illustrated by the following table, compiled by Rubner, from experiments made upon a starving dog:\*

Temperature.	Calories lost by radiation and conduction.	Calories lost by evaporation.	Total calories of metabolism.
7° C.	78.5	7.9	86.4
15°	55.3	7.7	63.0
20°	45.3	10.6	55.9
25°	41.0	13.2	54.2
30°	33.2	23.0	56.2

It will be noted that between 25° and 30° C. there was a marked increase in the loss of heat through evaporation.

In man loss of heat is regulated chiefly by controlling the important factors of evaporation and radiation. We accomplish this end in part deliberately or voluntarily by the use of appropriate clothing. Clothing of any kind captures a layer of warm and moist air between it and the skin and thus diminishes greatly the loss by evaporation and by radiation. In cold weather the amount and character of the clothing is changed in order to diminish the heat loss. The ideal clothing for this purpose is made of material, such as wool, which, while porous enough to permit adequate ventilation of the air next to the skin, is at the same time a poor conductor of heat and thus diminishes the main factor of loss by radiation. The most important means of controlling the heat loss, however, is by automatic reflex control through the sweat nerves and the vasomotor nerves. By these means the amount of perspiration evaporated from the skin and the amount of warm blood sent through the skin are controlled. Rubner speaks of this side of the heat regulation as the *physical regulation*. By its means the body may be safeguarded from an abnormal rise of temperature. In warm weather the secretion of sweat is greatly increased by reflex stimulation of the sweat nerves. The greater amount of water requires a greater amount of heat to vaporize it, and thus the heat loss is increased. The value of this control is illustrated by a case recorded by Zuntz† of a man who possessed no sweat glands. In summer this individual was incapacitated for work, since even a small degree of muscular activity would cause an increase in his body temperature to 40° or 41° C.

\* Taken from Lusk, "Elements of the Science of Nutrition," Philadelphia, 1906..

† Zuntz, "Deutsch medizinisch-Zeitung," 1903, No. 25.

The control through the vasomotor nerves is doubtless even more important. The blood-vessels bring the warm blood to the skin, where it loses its heat by conduction and especially by radiation to the cooler air. When the surrounding air is much below the temperature of the body the vasoconstrictor center is stimulated, the blood-vessels in the skin are constricted, the supply of warm blood to the skin is diminished, and therefore the amount of heat lost is less. The reflex in this case may be attributed primarily to the action of the cool air on the cold nerves of the skin. The impulses carried by these fibers to the nerve centers stimulate the vasoconstrictor center or that part of it controlling the vasomotor fibers to the skin. On warm days, on the contrary, the blood-vessels in the skin are dilated sometimes to an extreme extent, the supply of warm blood is therefore increased, and more heat is lost if the air is lower in temperature than the blood. The reflex in this case may be regarded possibly as an inhibition of the vasoconstrictor center through the warm nerves of the skin. Substances, such as alcohol, which cause a dilatation of the skin vessels also increase the loss of body heat, in some cases to a sufficient extent to lower the body temperature. To a smaller extent our heat loss is controlled through an acceleration of the breathing movements. The greatly increased respirations in muscular activity must aid somewhat in eliminating the excess of heat produced, although this factor must be much less important than the sweating and the flushing of the skin which are produced reflexly during muscular work. In some of the lower animals—the dog, for instance—in which the sweat nerves are absent over most of the body and in which the coat of hair interferes with the free loss by radiation, it is found that the loss through the respiratory channel is relatively more important. The panting of the dog is a familiar phenomenon. Richet has studied this reflex upon dogs and has designated the greatly accelerated breathing in warm weather or after muscular exercise as thermic polypnea (according to Gad, tachypnea). He assumes a special center for the reflex situated in the medulla and acting through the respiratory center. It is a curious fact, as shown by Langlois, that some reptiles exhibit a similar reflex; when their body temperature is raised to 39° C. they show a condition of marked polypnea (rapid breathing) the apparent object of which is to augment the loss of heat from the body.

**Regulation of Heat Production.**—Heat production is varied in the body by increasing or decreasing the physiological oxidations. This end is effected in part voluntarily by muscular exercise or by taking food. Muscular contractions are attended by a marked liberation of heat and it is a part of everyone's experience

that by work or muscular activity the effect of outside cold may be counteracted. During fasting a certain amount of body material (glycogen, fat, protein) is oxidized and sufficient heat is produced to counterbalance the heat that is lost. If food is taken it will be oxidized, and the supply of body material will be spared. But the digested products of the foodstuffs, especially of the proteins, stimulate the body metabolisms (specific dynamic action, p. 905), and cause an increase in heat production. By this means, therefore, the quantity of heat formed in the body may be raised temporarily above the usual level. In normal individuals this regulation is not, strictly speaking, voluntary. Outside cold is most effective in stimulating the appetite and thus leading us to increase the diet. In this, as in other respects, the appetite serves to control the amount of food in proportion to the needs of the body. The purely involuntary control of heat production consists of an involuntary reflex upon muscular metabolism and possibly in the existence of a special set of heat centers and heat nerves. With regard to the first effect we have the striking experiments quoted by Pflüger,\* according to which a rabbit paralyzed by large doses of curare is no longer able to maintain its body temperature when the outside temperature is changed. The rabbit behaves, in fact, like a cold-blooded animal. In the calorimeter it shows a marked loss of heat production, and its temperature may be made to go up and down with the outside temperature. The same result may be obtained by section of all the motor nerves,—that is, section of the spinal cord in the upper cervical region. Rubner has shown by calorimetric experiments upon animals that although the body temperature, as we know, may remain constant when the outside temperature is changed, the heat production is increased as the outside temperature is lowered. This fact is well shown by the following table, compiled by Rubner, from experiments made upon a fasting guinea-pig:†

Temperature of air.	Temperature of animal.	Grams of CO <sub>2</sub> eliminated per hour and per kilogram of animal.
0.0° C.	37.0° C.	2.905
11.1	37.2	2.151
20.8	37.4	1.766
25.7	37.0	1.540
30.3	37.7	1.317
34.9	38.2	1.273
40.0	39.5	1.454

From 0° to about 35° C. the animal's body temperature remained practically constant, but the oxidations at the lower temperature

\* Pflüger, "Archiv f. die gesammte Physiologie," 18, 255, 1878.

† Taken from Lusk, *loc. cit.*

were over twice the amount of those at the higher temperature. At about 33° C. the metabolism of the mammal, according to Rubner, is at its minimum. From 35° to 40° C. the heat regulating mechanism in the experiments quoted broke down, in that heat loss was prevented to such an extent by the outside high temperature that the body temperature rose in spite of the diminution in heat production. The increased production of heat in the body in consequence of a fall in external temperature is a characteristic property of warm-blooded animals. Rubner designates this side of the regulating mechanism as the *chemical regulation*, and he calls attention, moreover, to the fact that in mankind, owing to our custom of protecting the surface of the body by clothing and by artificial heat, chemical regulation plays less of a rôle than in the lower animals. Man, in fact, keeps most of his skin surrounded by a warm layer of air at about the temperature (33° C.) at which the metabolism, as affected by temperature, is minimal. Cold baths, cold winds, and various climatic conditions, such as high altitudes and sea-side conditions, may cause a marked increase in body metabolism. Johansson\* has shown that the increased oxidations that occur under the influence of outside cold, as measured by the CO<sub>2</sub> output, occur only when muscular tension is increased or shivering is noticed. We may believe, therefore, that the increased oxidations caused by cold are due to motor reflexes upon the skeletal muscles. These reflexes take place doubtless through the motor fibers, and lead to an augmented muscular tone or to small contractions (shivering), according to their intensity. This fact accords with one's personal sensations regarding the condition of his muscles in cold weather.

**The Existence of Heat Centers and Heat Nerves.**—Physiologists have long supposed that there may be in the body a special set of heat nerves and heat centers, separate in their action from the motor, secretory, and other efferent nerves that influence the metabolism of the peripheral organs. It is supposed that these fibers, if they exist, when in activity augment or inhibit the physiological oxidations in the tissues, and that this effect has for its specific object an increase or decrease in heat production, outside of any functional activity of the tissues. Bernard thought at first that he had demonstrated the existence of calorific fibers in the cervical sympathetic, but it was afterward recognized that the fibers in question are vasoconstrictors. Since that time very numerous experiments have been made with this object in view, but it must be admitted that no conclusive proof has yet been obtained of the existence of such a system. The evidence that has been most re-

\* Johansson, "Skandinavisches Archiv. f. Physiologie," 7, 123, 1897.

lied upon is the effect of lesions, experimental or pathological, of definite portions of the brain or cord. The following facts are significant: A number of observers\* have found that section or puncture of the brain at the junction of medulla and pons causes an increase in heat production and a rise of temperature. Section of the cord in the cervical region is, on the other hand, attended usually by a fall in body temperature. These experiments might be interpreted to mean that there exists in the brain anterior to the medulla a general heat center of an inhibitory character. Under normal conditions this center may hold the lower heat-producing centers in check. When cut off by section this inhibitory influence is removed and increase in heat production and body temperature results. A second important fact, brought out by Ott,† is that injury to the corpus striatum causes a rise in heat production and body temperature. This result has been confirmed by many other investigators, making use especially of what is known as the "heat puncture." In this experiment, made upon rabbits, a probe or style is inserted into the brain so as to puncture the corpus striatum. The result in the majority of cases is a rise of temperature which may last for a long time, although the animal shows no paralysis and apparently no other effect from the operation. According to some observers,‡ the increased production of heat takes place mainly in the liver, and is due to the oxidation of the glycogen. According to others (Aronsohn), the increased production of heat occurs mainly in the muscles. The fever produced by the "heat puncture" seems to be due essentially to an irritation of the nervous system, and is an experimental demonstration of the possibility of fever arising from lesions of the nerve centers. White and others have described similar disturbances of heat production from lesions of the optic thalamus. Heat centers have been located also in the septum lucidum, in the cortex, the midbrain, pons, and medulla. The great amount of experimental work done along these lines has been inspired doubtless by the hope of discovering a special heat-regulating nervous apparatus which if demonstrated would enable us to explain the causation of fevers. In its most elaborate form this hypothesis assumes the existence of primary heat-producing (thermogenic) centers in the cord and brain from which the calorific or heat nerves arise. These centers in turn are controlled by regulating (thermotaxic) centers of an augmenting and inhibitory character in the higher portions of the brain. By reflex influences upon these latter centers the activity of the thermo-

\* See Wood, "Fever," "Smithsonian Contributions to Knowledge," Washington, 1880.

† Ott, "Journal of Nervous and Mental Diseases," 1884, 1887, 1888; also "Fever, Its Thermotaxis and Metabolism," 1914.

‡ Rolly, "Deutsches Archiv f. klinische Medicin," 78, 250, 1903.



genic centers may be increased or diminished and the production of heat in the body controlled. While such an apparatus may exist, it is nevertheless true that the evidence in favor of it so far produced has failed to convince the majority of physiologists. The existence of a special set of heat nerves, in fact, is still unproved. Most physiologists, perhaps, believe that variations in heat production occur, as stated above, by alterations in the intensity of the oxidations in the muscles brought about by reflex excitation through the motor nerve fibers, and that a special set of heat fibers does not exist. We may at present adopt the conservative view that heat production and heat dissipation in the body are controlled not by a special heat-regulating apparatus composed of heat centers and heat nerves, but by the co-ordinated activity of a number of different centers in addition to the voluntary means already specified. The unconscious regulation of the body temperature is effected chiefly through the following centers:

- |                  |   |   |
|------------------|---|---|
| Heat dissipation | } | 1. The sweat centers and sweat nerves.  |
|                  |   | 2. The vasoconstrictor center and the vasoconstrictor nerve fibers to the skin. |
|                  |   | 3. The respiratory center.  |
| Heat production  | } | 1. The motor nerve centers and the motor nerve fibers to the skeletal muscles.  |
|                  |   | 2. The quantity and character of the food as determined by the appetite.        |

**Theories of Physiological Oxidations.**—Lavoisier compared the oxidations in the body to the oxidation of organic substances in combustions at high temperatures. He supposed that the molecular oxygen unites directly with the substances oxidized in one case as in the other. It soon became evident, however, that this direct analogy is not applicable. The material that is oxidized in the body—fats, carbohydrates, proteins—is consumed with a certain rapidity,—in the case of muscular contractions with great rapidity,—and we know that these same materials out of the body at a temperature of 39° C. are oxidized with extreme slowness. It became customary, therefore, to speak of the oxidations in the body as indirect, meaning thereby that the material is not acted upon directly by the molecular oxygen. Within recent years it has been shown that the oxidation in ordinary combustions—the burning of gaseous hydrogen, for instance—is not explained by assuming that the oxygen unites directly with the hydrogen. It is stated, for instance, that this combustion does not take place if both gases are entirely free from water vapor; the presence of water is necessary for the oxidation. Chemists are not agreed as to the exact nature of simple combustion, and it is therefore increasingly difficult to compare these processes with the oxidations in the body. Leaving aside the details of the process, it may still be believed that the metabolism of material in the body by means of which its heat

energy is produced is at bottom comparable to ordinary combustions. Oxygen is absolutely necessary to the process in each case; the same end-products are formed and the same amount of heat is liberated in the one case as in the other. The fundamental point that the physiologist is attempting to solve is the means by which the body accomplishes these oxidations at such a low temperature. The theories suggested to explain this fact have changed naturally with the advance of chemical knowledge. After the discovery of ozone (Schönbein, 1840) and its great power of oxidation as compared with oxygen it was suggested that in some way the oxygen in the body is ozonized and is thus able to burn the food material. Gorp-Besanez showed that some of the oxidations that take place in the body can be successfully accomplished outside the body with the aid of ozone, especially in the presence of alkalies or alkaline carbonates. Others suggested that the oxygen in the body becomes converted to atomic oxygen and is thus enabled to attack the tissue materials. Hoppe-Seyler formulated a theory according to which the living molecule is first split into smaller molecules by the hydrolytic action of ferments. In this process, as in fermentation, to which he compared it, hydrogen is liberated in the nascent or atomic state, and this hydrogen acting upon the oxygen forms water with the liberation of some atomic oxygen, which in turn oxidizes the split products of the fermentation. Others still (Traube) laid stress upon the possibility of the formation of hydrogen peroxid or similar organic peroxids which are then capable of effecting the oxidation of the body material. This latter theory, in modified form still prevails.\*

The great amount of experimental and theoretical work upon the nature and cause of physiological oxidations has established pretty clearly two general beliefs which it is important to keep in mind. It has been shown, in the first place, that the amount of the oxidation is governed by the tissue itself and not by the quantity of oxygen present. The view that by increasing the amount of oxygen offered to the tissue the intensity of the oxidations can likewise be increased was formerly held and is still met with. It is often supposed, for example, that by breathing pure oxygen the oxidations of the body may be augmented. On the contrary, the facts indicate that when a sufficient supply of oxygen is provided any further increase has no immediate effect in aiding or hastening the oxidations. The intensity of the process is conditioned by the tissue itself. The initial stimulus or substance that sets going the whole reaction arises within the tissues. The second generalization that seems to be accepted more and more of recent years is that the oxidations of the body, those reactions that give rise to much heat,

\* See Engler and Weissberg, "Kritische Studien über die Vorgänge der Autoxydation," 1904.

do not affect the living tissue itself. They take place under the influence of the living matter, or by the aid of substances (enzymes) formed by the living matter, but the material actually burnt is not organized living substance. As the living yeast cells break down sugar in the liquid surrounding them, so the living tissue cells metabolize and oxidize the dead food material contained in the lymph and tissue liquid in which they are bathed. The opposite point of view was ably advocated by Pflüger. This observer, in fact, explained the mystery of physiological oxidations by assuming that the oxygen together with the food material is synthesized into the highly complex and unstable living molecules. The active intramolecular movement within these molecules leads constantly to a breaking down, a splitting off of simpler molecules which constitute the products of physiological oxidation. The instability of the molecule is due to its size and the activity of the intramolecular movements, or, as Pflüger expressed it, "The intramolecular heat of the cell is its life." This point of view, however, has not found acceptance of late years. It is implied or stated by most recent authors that the food material is attacked and oxidized outside the living molecule, in the form of fat, sugar, protein, or rather in the form of the intermediary products arising in the metabolism of these substances. The tendency for many years has been to show that these processes in the body are chemical changes that do not differ fundamentally from similar processes outside the body. The point of view actually adopted by most workers is that the living matter effects its wonderful changes in the food material by making use of intracellular ferments or enzymes (endo-enzymes).\* That such enzymes are formed, one may say, generally in the tissues of the body, has been brought out in the preceding chapters upon Digestion and Nutrition. It is necessary only to recall the facts that lipase, the fat-splitting enzyme, has been isolated from many tissues, and that in the liver and muscles and probably other tissues there exist enzymes capable of converting glycogen to sugar or the reverse, and of oxidizing the sugar completely by the serial action of several intracellular enzymes. Finally, with regard to the protein material, it is now recognized that proteolytic enzymes are formed within many, if not all, of the living tissues. This point is demonstrated by the fact of *autolysis*,—that is, if living tissue is taken from the body, with precautions against contamination by bacteria, and while under perfect aseptic conditions is kept warm and moist, it will digest itself. The protein is split up into the same simple hydrolytic products as are obtained by boiling it with acids. It has been shown that this digestion is due to enzymes—autolytic enzymes—formed within the living tissue. There is no

\* For literature, see Vernon, "Intracellular Enzymes," London, 1908.

doubt, therefore, of the existence of intracellular enzymes, and that these substances play a conspicuous part in the metabolism of food material. The lipase, the diastase, and the autolytic enzymes (proteases) just referred to all belong to the group that cause hydrolytic cleavages—that is, they induce splitting or decomposition of the material by a reaction with water. The supposition has naturally been made that probably the oxidations of the body are effected also by enzymes which in some way activate the oxygen. Enzymes of this character have been found; they are designated in general as *oxidases* or as *oxidases* and *peroxidases*, the former term referring to those enzymes that effect oxidations in the presence of oxygen, while the latter is applied to certain enzymes supposed to act only in the presence of peroxids. Bach and Chodat\* have simplified this conception by the hypothesis that all the oxidizing enzymes of the tissues are peroxidases, that is to say, substances which have the power of liberating active oxygen from hydrogen peroxide or similarly constituted organic peroxides. They assume that there are present in the tissues certain organic substances produced by the cells, of an enzyme nature, and designated as oxygenases, which have the property of combining with the oxygen furnished by the blood to form organic peroxides, and that these peroxides, under the influence of peroxidase, give up their oxygen in atomic or active form, which then effects the characteristic physiological oxidations. This view can be presented schematically by the following equations, in which A represents the oxygenase, P the peroxidase, and B the tissue material which undergoes oxidation:

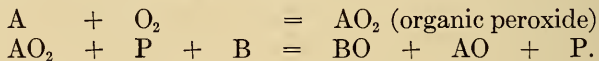

According to this view the oxidations in the body are primarily due to the formation of the organic peroxides, and the mode of action of these peroxides would be represented outside the body by the reactions of hydrogen peroxide ( $H_2O_2$ ). As a matter of fact it has been found that many of the characteristic oxidations that occur in the body, such as the oxidation of the fatty acids at the  $\beta$ -carbon atom in the chain, the oxidation of glucose to glycuronic acid, etc., may be imitated outside the body by oxidation with hydrogen peroxide, but not by other oxidizing agents.† This collateral evidence gives important support to the theory. On the other hand, oxidases or peroxidases have been discovered in the blood, milk, and in various of the tissues of the body, such as the lymphocytes, sperm cells, etc.‡ They can be tested for by a

\* Bach, "Handbuch d. Biochemie, Ergänzungsband," 1913.

† Consult Dakin, "Oxidations and Reductions in the Animal Body," 1912.

‡ For discussion and literature consult Kastle, "The Oxidases," Bulletin No. 59, 1910, Hygienic Laboratory, Washington, D. C.; also Bach, *loc. cit.*

number of reactions, chiefly color reactions, such as the bluing of a tincture of guaiacum in the presence of a peroxide or the conversion of a colorless or leucobase to a colored oxidation product. Some of these oxidases or peroxidases have been given specific names in accordance with the particular compounds whose oxidation they effect. For example, *xanthinoxidase*, which effects the oxidation of hypoxanthin and xanthin to uric acid; the glycolytic oxidase or oxidases, which effect the oxidation of the intermediary products of sugar metabolism in the tissues; *tyrosinase*, which effects the oxidation of tyrosin, and in this way is supposed by many observers to give rise to various animal pigments, such as melanin; the *aldehydases*, which effect the oxidation of aldehydes to their corresponding acids—salicylic aldehyd, for instance, to salicylic acids. This list might be greatly extended, particularly if those that occur in the plants were also considered, but as it is, it suffices perhaps to illustrate the general belief regarding the wide-spread occurrence and the specific properties of these important substances. Whereas, formerly, the general belief among physiologists was that physiological or vital oxidations are effected as part of the metabolism of the living substance, the tendency at present is to assume that these oxidations are not effected directly by changes in the living substance, but indirectly, in that the latter forms these organic peroxides and peroxidases through whose interaction the oxygen is liberated in active form. The oxidations effected by this means are the principal source of the development of heat in the body—they are especially exothermic reactions. Many other of the chemical changes of metabolism, such as the hydrolytic cleavages, liberate but little heat, and others still, such as the syntheses of one kind or another in which there is a union of compounds to form more complex substances, may even be attended by an absorption of heat, that is, a conversion of heat energy to the energy of chemical affinity. The oxidizing reactions constitute, therefore, a large and very characteristic feature of the metabolism of the warm-blooded animals. The heat thus produced by the oxidation of our food material serves to maintain the body temperature at its normal high level, and establishes a temperature environment at which the enzymatic and chemical metabolism of the tissues is at its optimum. In addition some physiologists believe that a portion of this heat is used in the work of the body, that is to say, they regard the body as a sort of thermodynamical engine in which the energy of the food is obtained first as heat, and the heat is then utilized in part for the other energy needs of the body. Others, however, are unwilling to accept this view of the body mechanism, and prefer to believe that the chemical energy of the food can be utilized directly for the various energy needs of the body without passing through the form of heat.

## SECTION IX.

### THE PHYSIOLOGY OF REPRODUCTION.

With the exception of the phenomenon of consciousness, no fact of life excites more interest and seems to offer greater difficulties to an adequate explanation than the function of reproduction. The male cell (spermatozoön) and the female cell (ovum) unite to form a new cell which thereupon begins to grow rapidly and produces an organism that in all of its manifold peculiarities of structure and function is essentially a replica of its parents. The fundamental problems presented in this act of reproduction are those of fertilization and heredity. In the former we must ascertain why the union of the two cells is necessary or advantageous, and the secret of the stimulating influence upon growth that arises from this union. Under the term heredity we express the obvious, yet mysterious fact that the fertilized ovum of each species develops into a structure like that of its parents. Both of these important problems are essentially of a physiological character,—that is, they deal with properties of the living material composing the reproductive cells; but, at present, biological investigation along these lines is largely in the morphological stage. The part of the subject that can be studied with most success is the structural changes that are associated with fertilization and reproduction. Great, indeed wonderful, progress has been made during the last century, but it is needless perhaps to say that much remains unexplained, and that in this, as in so many other problems of nature, the greater our knowledge the clearer becomes our vision of the difficulties and complexities of a final scientific explanation. Outside these fundamental problems there are other accessory functions connected, for instance, with the external genital organs which in a measure are of more immediate practical interest. In one way or another these functions are necessary or helpful to the final union of the reproductive cells. They form a part of the reproductive life which comes more immediately under our observation and control, and constitute, therefore, a subject which has been more accessible to investigation. In the brief treatment given in the following chapters more emphasis is laid upon this side, the accessory phenomena of reproduction, than upon the deeper, more fundamental prob-

lems, in view of the fact that the accessory phenomena are the ones which have at present the greater practical interest.

The function of reproduction is often omitted from physiological courses, and the reason perhaps is partly that the structural features and the development of the embryo have been assigned to the department of anatomy, and partly because it is a function not essential to the maintenance of the existence and reactions of the organism. The reproductive organs might be eliminated entirely and the power of the body as an organism to maintain its individual existence not be seriously interfered with. The physiological importance of the reproductive organs lies not in their co-operation in the communal life of the various parts of the body, but in their adaptation to produce another similar being. We may explain, therefore, the co-ordinating mechanisms of the body without reference to the reproductive tissues, except so far as their supposed internal secretions affect general or specific metabolism.

---

## CHAPTER LII.

### PHYSIOLOGY OF THE FEMALE REPRODUCTIVE ORGANS.

**The Graafian Follicle and the Corpus Luteum.**—The functional value of the ovary is connected with the formation and rupture of the Graafian follicles, whereby an ovum is liberated. The primordial follicles consist of an ovum surrounded by a layer of follicular epithelium. Beginning at a certain time after birth and continuing throughout the period of active sexual life, some of these primordial follicles develop into mature Graafian follicles and migrate to the surface of the ovary. The change consists in a proliferation of the follicular epithelium and the formation of a serous liquid, the *liquor folliculi*, between the layers of this epithelium. In the matured follicle there is a connective tissue covering, the *theca folliculi*, formed from the stroma of the ovary and consisting of two coats or tunics—the external and the internal. The cells in the internal tunic develop a yellowish pigment as the follicle grows, and are sometimes designated as lutein cells. Within the capsule formed by the internal tunic there is a layer of follicular cells known as the *membrana granulosa* and attached to one side is a mass of the same cells, the *discus proligerus*—within which the ovum is imbedded. The follicular liquid lies between. This liquid increases in amount, and when the follicle has reached the

surface it forms a vesicle projecting to the exterior. This projecting portion is nearly bloodless and thinner than the rest of the wall of the follicle. It is designated as the *stigma*. When fully mature the follicle ruptures at the stigma and the egg, together with the surrounding follicular cells of the discus proligerus and a portion of the membrana granulosa, is extruded, the egg being received into the open end of the Fallopian tube. According to Clark,\* the rupture of the follicle is brought about by an increasing vascular congestion of the ovary. The tension within the ovary is thereby increased, the follicle is forced to the surface, and the circulation at the most projecting portion is interfered with to such an extent as to cause necrotic changes at the stigma, at which rupture finally occurs. After the bursting of the follicle its walls collapse, and the central cavity receives also some blood from the ruptured vessels of the theca. Later on the vesicle becomes filled with cells containing a yellow pigment. These cells increase rapidly and form a festooned border of increasing thickness around the central blood clot. The vesicle at this stage, on account of the yellow color of the new cells, is known as a corpus luteum. The structure thus formed increases in size for a period and then undergoes retrogressive changes and is finally completely absorbed. The duration of the period of growth and retrogression varies according as the egg liberated becomes fertilized or not. If fertilization does not occur, as is the case in the usual monthly periods, the corpus luteum reaches its maximum size within two to three weeks and then begins to be absorbed. It is frequently designated under these circumstances as the false corpus luteum (*corpus luteum spurium*) or corpus luteum of menstruation. In case the egg is fertilized and the woman becomes pregnant the life history of the corpus luteum is much prolonged. Instead of undergoing absorption after the third week it continues to increase in size by multiplication of the lutein cells during the first few months of pregnancy, and does not show retrogressive changes until the sixth month or later. The total size of the corpus in such cases is much larger than in menstruation, and it was designated, therefore, by the older writers as the true corpus luteum (*corpus luteum verum*) or corpus luteum of pregnancy. Later observers agree that there is no essential difference in structure between the true and the false corpus luteum, although the former has a longer history and attains a greater size. The point of greatest structural interest in the corpus luteum is the origin of the yellow (lutein) cells. Histologists have been and still are divided upon this point; some believe that they arise from the cells of the membrana granulosa, others that they come from the connective tissue cells in the internal capsule (*theca interna*) of the follicle.

\* Clark, "Johns Hopkins Hospital Reports," 7, 181, 1898.



The majority of writers seem to favor the latter view.\* Regarding the physiological importance of the corpus opinions also differ. Some regard it as simply a protective mechanism by means of which the empty space in the follicle is filled up by a tissue which is afterward easily absorbed, instead of by scar tissue. Others, however, attribute to the lutein cells secretory functions of the most important character in connection with the subsequent development of the egg and the activities of the uterus. Some reference will be made to these views farther on.

**Menstruation.**—The attainment of sexual maturity or puberty is marked by a number of visible changes in the body, but in the female the characteristic change is the appearance of the menstrual flow from the uterus. The age at which this phenomenon occurs shows many individual variations, but the average for temperate climates is given usually at 14 to 15 years. In the warmer countries the age is earlier,—8 to 10 years,—and in the cold regions somewhat later,—16 years. The racial characteristic in this respect is said to be maintained, however, after generations of residence in countries of a different climate, as is illustrated by the relatively early appearance of menstruation among Jews even in the colder countries. After the phenomenon appears it occurs at regular intervals of 28 days, more or less, and hence is known as the monthly period, menses, menstruation, or catamenia. The interval is not absolutely regular, and shows many individual variations within limits which may be placed at 20 to 35 days. Absence of the menstrual flow is designated as a condition of amenorrhea. Certain premonitory symptoms usually precede the appearance of the menses, such as pains in the back or head or a general feeling of discomfort, although in some cases these symptoms are absent. When these premonitory symptoms are unusually painful or serious and the flow is difficult or irregular the condition is designated as dysmenorrhea. The flow begins with a discharge of mucus, which later becomes mixed with blood. The quantity of blood lost is subject to individual variations, but it may amount to as much as 100 to 200 gms. The flow continues for 3 or 4 days and then subsides. Under normal conditions this phenomenon occurs regularly throughout sexual life,—that is, during the period in which conception is possible. If fertilization occurs, menstruation is suspended during pregnancy and the period of lactation. At the forty-fifth to the fiftieth year menstruation disappears permanently, and this change marks what is known as the natural menopause, climacteric, or change of life. The change is sometimes abrupt, sometimes very gradual, being preceded by irreg-

\* For discussion and literature see Marshall, "The Physiology of Reproduction," London, 1910; and Loeb, "Journal of the American Medical Association," 1906, xlv., 416.

ularities in menstruation, and it is not infrequently associated with psychical and physical disturbances of a serious character. If at any time during sexual life the ovaries are completely removed by surgical operation menstruation is brought to a close, this condition being designated as artificial menopause.

**Structural Changes in the Uterus During Menstruation.**—Menstruation is a phenomenon of the uterus. The lining mucous membrane, the endometrium, in the period of four or five days preceding the flow, becomes rapidly thicker and its superficial layers are congested with blood, and indeed in places small collections of blood may be noticed. Opinions differ very much as to the change undergone by this thickened membrane during the flow. According to some authors, most of the membrane is thrown off and the blood escapes from the denuded surface mixed with pieces of the membrane. According to others, no material destruction of the membrane occurs, the blood that escapes being due to small capillary extravasations or perhaps mainly to a process of diapedesis. It would seem that the amount of destruction of the endometrium must be subject to individual variations. After the cessation of the flow the mucous membrane is rapidly repaired by regenerative changes in the tissues; the surface epithelium, if denuded, is replaced by proliferation of the cells lining the uterine glands and the thickened, edematous condition of the membrane rapidly subsides during a period of six or seven days. While the escape of blood takes place only from the surface of the uterus, the other reproductive organs—the ovary, the Fallopian tubes, and even the external genital organs—share to some extent in the vascular congestion exhibited by the uterus during the period preceding the menstrual flow. The mucous membrane of the uterus may be said to exhibit a constantly recurring menstrual cycle which falls into four periods: (1) Period of growth in the few (5) days preceding menstruation, characterized by a rapid increase in the stroma, blood-vessels, epithelium, etc., of the membrane. (2) The menstruation or period of degeneration (4 days), during which the capillary hemorrhage takes place and the epithelium suffers degenerative changes and is cast off more or less. (3) The period of regeneration (7 days), during which the mucous membrane returns to its normal size. (4) The period of rest (12 days), during which the endometrium remains in a quiescent condition.

**The Phenomenon of Heat (Æstrus) in Lower Mammals.**—The phenomenon known as heat in lower mammals resembles, in many essential respects, menstruation in human beings, and they may be regarded as homologous functions. Heat is a period of sexual excitement which occurs one or more times during the year and during which the female will take the male. The condition

lasts, as a rule, for several days, and in the female is accompanied by changes which resemble those of menstruation. The external genital organs become swollen and in many animals there is a discharge of mucus or mucus and blood from the uterus. Histologically the mucous membrane of the uterus undergoes changes similar to those of menstruation—that is, the membrane increases in size and becomes congested with blood—and it exhibits a phase of degeneration during which some of the epithelial lining may be cast off and some hemorrhage occur. As in the case of the menstrual period, the heat period or œstrous cycle may be divided into four subperiods (Marshall and Jolly): the *proœstrum*, during which the genital organs are congested and bleeding occurs, corresponds with menstruation; the *œstrus*, the period of sexual desire; the *metaœstrum*, the period of repair and return to normal conditions, and the *anœstrum*, the period of rest. If sexual union is prevented during this period heat passes away in a few days, but recurs again at intervals which vary in the different mammals: 4 weeks in the monkey, mare, etc.; 3 to 4 weeks in the cow; 2½ to 4 weeks in the sheep; 9 to 18 days in the sow; 12 to 16 weeks in the bitch, etc. The recurrence of the period under these circumstances suggests at once the essential resemblance to the monthly periods of women. According to Heape's most interesting observations upon monkeys (*Semnopithecus*),\* some of these animals show a regular monthly flow lasting for 4 days, except when conception takes place. The changes during heat must be considered as physiologically homologous to those of menstruation. The sexual excitement that attends the condition in the lower animals is not distinctly represented in man, although it is commonly said that in the period following menstruation the sexual desire is stronger than at other times, but in the changes undergone by the uterus and the fact that these changes are connected, as a rule, with the liberation of an egg from the ovary (ovulation), the two phenomena are physiologically similar.

**Relation of the Ovaries to Menstruation.**—It appears to be clearly demonstrated that the phenomenon of menstruation is dependent upon a periodical activity in the ovaries. When the ovaries are completely removed menstruation ceases (artificial menopause) and the uterus undergoes atrophy. When the ovaries are congenitally lacking or rudimentary, a condition of amenorrhea also exists. These facts and the connection of the ovaries with menstruation are further corroborated in a striking way by experiments upon transplantation or grafting of the ovary. This experiment has been performed upon lower animals (apes) as well as upon

\* Heape, "Philosophical Transactions, Royal Society," 185 (B), 1894, and 188 (B), 1897.

human beings. Removal of both ovaries in apes is followed by a cessation of menstruation. Transplantation of an ovary under the skin serves to maintain menstruation, but if subsequently removed this function disappears.\* In the human being Morris and Glass obtained similar results.† An ovary or a piece of an ovary transplanted into the uterus itself or the broad ligament caused a return of the menstrual periods which had ceased after surgical removal of the glands, or brought on free menstruation in conditions of amenorrhea or dysmenorrhea.

Many views have been proposed to explain this relationship between ovary and uterus. In most cases it has been assumed that the menstruation in the uterus is connected with the act of ovulation,—that is, the ripening and discharge of a Graafian follicle. Gynecologists, it is true, have accumulated facts to show that ovulation may occur independently of menstruation, but, as a rule, the two acts occur together, not simultaneously, but in a definite sequence, and the significance of menstruation is to be found in its physiological connection with the fate of the ovum. It was believed at first that the processes in the ovary influence the uterus by a nervous reflex. This view finds its most complete expression in the theory formulated by Pflüger. According to this physiologist, the congestion of the uterus which leads to menstruation and the congestion of the ovary which leads to ovulation are both reflex vasodilator effects due to the mechanical stimulation of the sensory nerves of the ovary by the growth in size of the follicle. As this structure develops the mechanical stimulus increases in intensity, the congestion in both organs becomes more pronounced and leads finally to the bursting of the follicle and the hemorrhage in the uterus. This very attractive theory does not, however, accord with the facts. Goltz and Rein‡ have shown by experiments upon dogs that when the nerves going to the uterus are completely severed from their central connections the animals can be fertilized, become pregnant, and give birth to a litter of young. Moreover, the experiments upon transplantation referred to above seem to show quite conclusively that a nervous connection is not essential to the influence that the ovary exerts upon the uterus. The present view, therefore, is that this influence is exerted through the blood,—the other great system connecting the organs with one another. The usual assumption is that the ovaries form an internal secretion which is given to the blood or lymph and upon reaching the uterine tissues serves to stimulate the mucous membrane to a more active growth. This theory has been elaborated

\* Halban, "Deutsche Gesellschaft f. Gynäkol." 9, 1901.

† Glass, "Medical News," 523, 1899; Morris, "Medical Record," 83, 1901.

‡ Rein "Archiv f. die gesammte Physiologie," vol. xxiii.

most fully perhaps by Fraenkel,\* who believes that this internal secretion is furnished by the yellow cells of the corpus luteum. This observer, from the results of operations upon women, believes that the ovum is normally discharged two weeks before menstruation, and the resulting increased activity of the cells of the corpus luteum is responsible for the secretion which stimulates the uterus to the augmented growth that takes place in the premenstrual period. Whether or not the monthly change in the endometrium is directly dependent upon an internal secretion from the ovary or is an independent cyclic process peculiar to this tissue, there seems to be no doubt that the physiological integrity of the uterus as a whole is dependent upon the ovaries. Removal of the ovaries in the young prevents the normal development of the uterus, while removal in the adult causes a degeneration of the uterus, which, however, can be averted by a successful transplantation of ovarian tissue.† In the lower animals Marshall and Jolly‡ have been able to show that extracts of the ovaries, taken from an animal in or just before heat (proœstrous or œstrous period), when injected into an animal during the œstrum bring on a transient condition of heat. These authors do not believe, however, that the chemical stimulus (hormone) formed in the ovary is developed by the cells of the corpus luteum, since according to their observation on cats and dogs ovulation does not occur until after heat has begun (proœstrum); nor does it depend upon the mere maturation of the follicles, since when these are opened by puncture, some time before maturation, heat appears in due season.

**The Physiological Significance of Menstruation.**—Naturally many views have been proposed to explain the significance of menstruation. According to the Mosaic law, it is a process of purification; others have seen in it a mechanism to remove an excess of nutriment in the body; but since the period in which our knowledge of the structure of the organs concerned and of the histological changes during the act became more definite, theories of the meaning of menstruation have usually assumed that it is a preparation for the reception of the fertilized ovum. These views have taken two divergent forms according as the act of ovulation was believed to precede or to happen simultaneously with or subsequently to the act of menstruation. According to one view, the

\* Fraenkel, "Archiv f. Gynäkologie," 68, 2, 1903. See also Ihm, "Monatsschrift f. Geburtshülfe u. Gynäkol.," 21, 515, 1905, for discussion and extensive literature.

† Carmichael and Jolly, "Proc. Roy. Soc.," B, 79, 1907, and Marshall and Jolly, "Roy. Soc. Edinb.," 45, 589, 1907.

‡ Marshall and Jolly, "Philosophical Transactions, Royal Society," London, 1905, B. cxviii., 99; also Marshall and Runciman, "Journal of Physiology," 49, 17, 1914.

swelling and congestion of the membrane constitute a preparation for the reception of the fertilized ovum. If the ovum fails of fertilization, then degenerative changes ensue, and the membrane or a portion of it is cast off in the menstrual flow, while the remainder is absorbed. According to this view, menstruation is an indication that fertilization has not taken place.\* This view falls in with the belief that ovulation normally precedes menstruation by a considerable interval. A modification or extension of this general hypothesis is proposed by Bryce and Teacher.† They believe that the process of menstruation is a cyclic one, which has for its object the preparation of the endometrium for the reception of the ovum. The monthly regeneration keeps this membrane in that condition of youthful irritability which enables it to respond promptly to the stimulus of the ovum by the formation of a decidua. The other point of view was advocated especially by Pflüger in connection with his theory of a common cause of ovulation and menstruation. He assumed that menstruation occurs before the ovum reaches the uterus and that its physiological value lies in the fact that a raw surface is thus made upon which the ovum is grafted. Menstruation, according to him, is an operation of nature for the grafting of the fertilized ovum upon the maternal organism. This view finds considerable support in the fact that in some of the lower animals (dogs) the flow of blood (proœstrum) precedes fertilization.

**The Effect of the Menstrual Cycle on Other Functions.**—It is natural to suppose that such marked changes as occur in the ovary and uterus during the menstrual cycle should have an influence upon other parts of the body. As a matter of fact, it is known that in general the sense of well-being varies with the phases of the cycle. At the time of or in the period just preceding the menstrual flow there is usually a more or less marked sense of ill-being or despondency, and a diminution in general efficiency. Efforts have been made to explain these subjective changes on the assumption that the body processes may undergo wave-like variations corresponding with the menstrual cycle.‡ The numerous reports made prove in general that the body temperature and pulse-rate do show such a wave moment, reaching a maximum just before menstruation and falling to a minimum shortly after menstruation. The changes, however, are very slight and hardly

\* This view finds expression in the aphorisms: "Women menstruate because they do not conceive," Powers, and "The menstrual crisis is the physiological homologue of parturition," Jacobi.

† Bryce and Teacher, "Early Development and Imbedding of the Human Ovum," 1908.

‡ Jacobi, "Boylston Prize Essay—The Question of Rest for Women during Menstruation," 1876.

seem to be sufficient to have any distinct influence on the body metabolism. In regard to blood-pressure the statement is frequently made that there is a fall at or during the menstrual flow, but some observers fail to get this result and, in any case, it is not very extensive.\* On the whole, the experimental evidence thus far obtained does not seem to indicate any very significant alteration in the bodily functions as a result of menstruation.

**The Passage of the Ovum into the Uterus.**—The means by which the ovum gains entrance to the Fallopian tubes has given rise to much speculation and some interesting experiments. It was formerly believed (Haller) that at the time of ovulation the fimbriated end of the Fallopian tube is brought against the ovary, the movement being due to a congestion or a sort of erection of the fimbriæ. This movement has not been observed, and, as experiments show that small objects introduced into the pelvic cavity are taken up by the tubes, it is believed that the cilia upon the fimbriæ and in the tubes may suffice to set up a current that is sufficient to direct the movements of the ovum. Attention has been called to the fact that in animals with a bicornate uterus the ova may be liberated from the ovary on one side, as shown by the presence of the corpora lutea, while the embryos are developed in the horn of the other side. As further evidence for the same possibility of migration it has been shown that the ovary may be excised on one side and the horn of the uterus on the other and yet the animal may become pregnant after sexual union. It would seem probable, therefore, that the ovum is discharged into the pelvic cavity and may be caught up by the ciliary movements at the end of the tube on the same side, or may traverse the pelvic cavity in the narrow spaces between the viscera and be received by the tube on the other side. Such a view explains the possible occurrence of true abdominal pregnancies, and suggests also the possibility that ova may at times fail to reach the uterus at all and may undergo destruction and absorption in the abdominal cavity. In some of the lower animals—the dog, for example—provision is made for the more certain entrance of the ova into the tubes by the fact that the latter end in connection with a membranous sac of peritoneum which envelopes the ovary. The sexual fertilization of the ovum is supposed to take place shortly after its entrance into the Fallopian tube, since spermatozoa have been found in this region, and the fertilized ovum, before reaching the seat of its implantation in the body of the uterus, has begun its development. By the act of coitus the spermatozoa are deposited at the mouth of the uterus, whence they make their way toward the tubes,

\* King, "American Journal of Physiology," 34, 203, 1914; also Mosher, "Johns Hopkins Hospital Bulletin," 12, 178, 1901.

being guided in their movements very probably by the opposing force of the ciliary contractions in the uterus. It is known that the cilia of the tubes and uterus contract so as to drive inert objects toward the vagina and they carry the egg in this direction, but the spermatozoa, being moved by the contractions of their own cilia or tails, are stimulated to advance against this ciliary current. The act of fertilization of the ovum is preceded by certain preparatory changes in the ovum itself which are described under the term maturation.

**Maturation of the Ovum.**—The process of maturation occurs before or just after the spermatozoön enters the ovum. At the time the latter is extruded from the follicle it is a single cell sur-

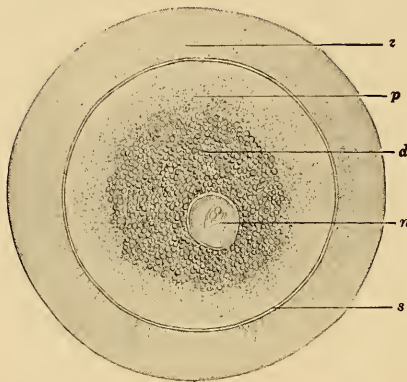

Fig. 302.—Human ovum (Lee, modified from Nagel): *n*, Nucleus (germinal vesicle) containing the ameboid nucleolus (germinal spot); *d*, deutoplasmic zone; *p*, protoplasmic zone; *z*, zona radiata; *s*, perivitellin space.

rounded by a layer of follicular epithelium forming the corona radiata, which is subsequently lost. The egg proper consists of cytoplasm and a nucleus or germinal vesicle containing a nucleolus or germinal spot. Within the cytoplasm is a definite collection of food material or yolk which is sometimes designated as deutoplasm. The whole structure is surrounded by a membrane known as the zona radiata (Fig. 302). Before or after the egg reaches the Fal-

lopian tube its nucleus undergoes the changes preparatory to a mitotic division. The changes that occur in an ordinary cell division are represented schematically in Fig. 303. The nucleus at first presents the ordinary chromatin network, and in the cytoplasm lies the minute structure known as the centrosome. This latter divides into two daughter-centrosomes (*b*) which move to opposite sides of the nucleus and become surrounded by rays, each centrosome with its radiating system forming an astrosphere. The chromatin material in the nucleus meanwhile has collected into larger threads known as chromosomes (*c*), and the nuclear membrane disappears (*d*). The number of chromosomes is definite for each species of animal. The chromosomes arrange themselves equatorially between the astrospheres and then each divides longitudinally into two parts (*f*). These parts migrate or are drawn toward their respective centrosomes (*g*, *h*, *i*), and this



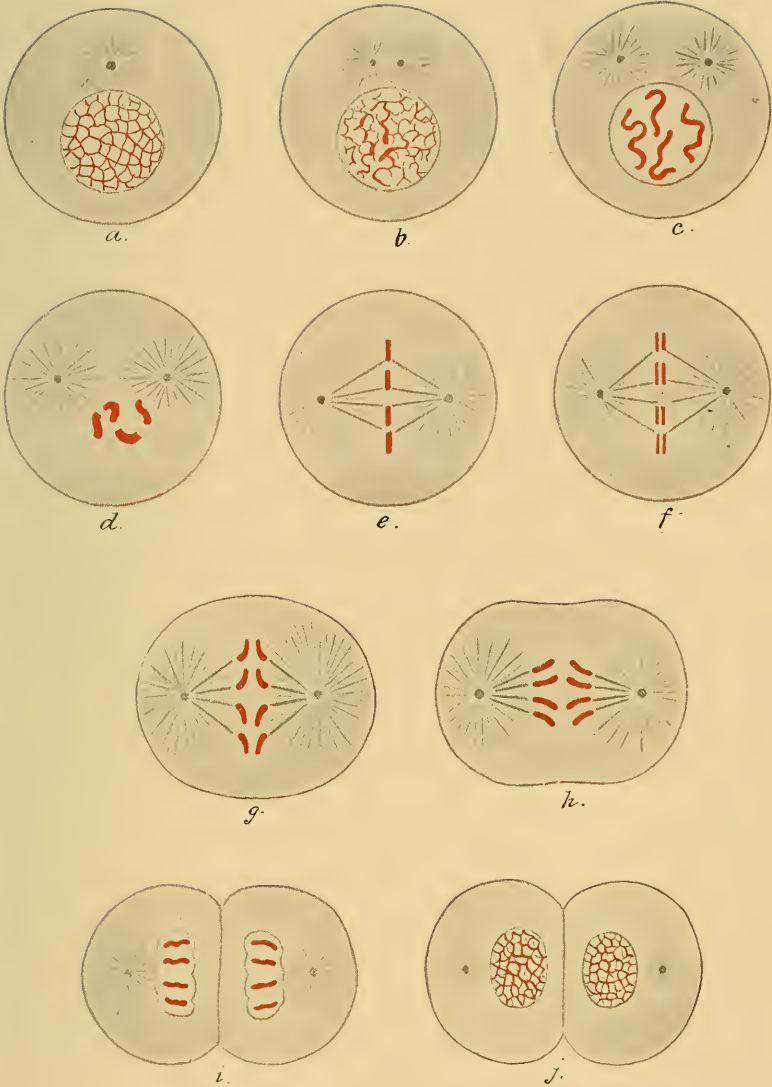

Fig. 303.—Schematic representation of the processes occurring during cell division.—  
(Boveri.)



division is followed by a separation of the cytoplasm into two parts. Thus, two daughter-cells are formed, each containing the same number of chromosomes as the parent cell, but only half the amount of chromatin material. In ordinary cell division the chromosomes again form a resting reticulum and a nuclear membrane, and the chromatin substance increases in quantity. The primitive egg-cells, or oögonia, divide according to this schema, but before an ovum is ready for fertilization it undergoes a process of maturation which consists in two successive cell divisions differing somewhat from the type just described. Preceding the first of these divisions the various chromosomes come together in pairs and fuse more or less completely, the process of conjugation being designated as the period of synapsis. The evidence indicates that in this pairing of the chromosomes one of each pair was originally maternal in its origin, the other was paternal. The result of the conjugation is to reduce the number of chromosomes typical for the species by one-half. In man, for example, the typical number of chromosomes for the tissue cells is 48; by the synapsis they are reduced to 24. Following the synapsis the ovum undergoes the first of the maturation divisions, sometimes known as the reduction division. The two ova produced are very unequal in size; the smaller one is known as the first polar body, and it subsequently degenerates. The larger one is the ovum, but it now contains only half the typical number of chromosomes, since in the division the paired chromosomes separate, one of each pair going to the polar body. The separation of the paired chromosomes is such that the ovum gets some that were of maternal and some that were of paternal origin. After the formation of the first polar body the ovum again divides, this time in a typical way, with an equal splitting of the chromosomes, except that again there is a great disparity in size, the smaller cell being known as the second polar body.\* Since the first polar body after its separation may again divide into two cells, the process of maturation results in the formation of four cells, three of which are polar bodies and may be regarded as abortive ova. The fourth, the matured ovum, retains practically all of the original cytoplasm, but has lost a part of its chromatin material and, according to Boveri, also its centrosome. The production of these four cells may be represented, therefore, by a schema of the kind shown in Fig. 304.

From a biological standpoint the reduction of chromosomes throws much light upon the significance of fertilization by the male cell. The spermatozoön before it is ripe undergoes a process of

\* Wilson, "The Cell in Inheritance and Development," also Conklin, "Heredity and Environment," 1914.

maturation essentially similar to that described for the ovum. Two cell divisions take place with the formation of four spermatozoa, each of which, however, is a functional spermatozoön. In the process of division the number of chromosomes in each cell is reduced to half—part of maternal and part of paternal origin. When the matured ovum and the matured spermatozoön fuse, therefore, each brings half the normal number of chromosomes, and the resulting fertilized ovum is a cell with its chromosomes restored to their usual number. The chromosomes are believed to contain the material which conveys hereditary characteristics. The chromosomes of maternal origin contain carriers of characteristics belonging to the stock of the mother, and the paternal chromosomes the carriers for the qualities transmitted through the paternal side. The process which causes each element to lose a part of this material before its union with the cell of the oppo-

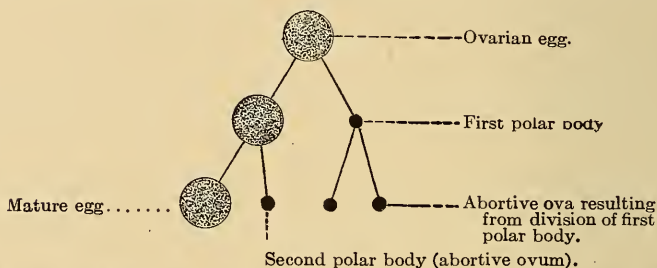

Fig. 304.—Schema to indicate the process of maturation of the ovum.—(Boveri.)

site sex is, from this standpoint, a provision by means of which the fertilized egg, from which the offspring develops, shall inherit the characteristics of the stock to which each parent belongs, without increase in the typical number of the chromosomes.\*

**Fertilization of the Ovum.**—The spermatozoön comes into contact with the ovum probably at the beginning of the Fallopian tubes. The meeting of the two cells is possibly not simply a matter of accidental contact, although the number of spermatozoa discharged by the male at coitus is so great that there would seem to be little chance for the ovum to fail to meet some of them. Experiments upon the reproductive elements of plants indicate, however, that the egg may contain substances which serve to attract the spermatozoön, within a certain radius, by that force which is described under the name of chemotaxis. However this may be, the egg unites with a spermatozoön and under normal conditions with only one. A number of the spermatozoa may penetrate

\* For a popular presentation see Boveri, "Das Problem der Befruchtung," Jena, 1902, and Conklin, *loc. cit.*



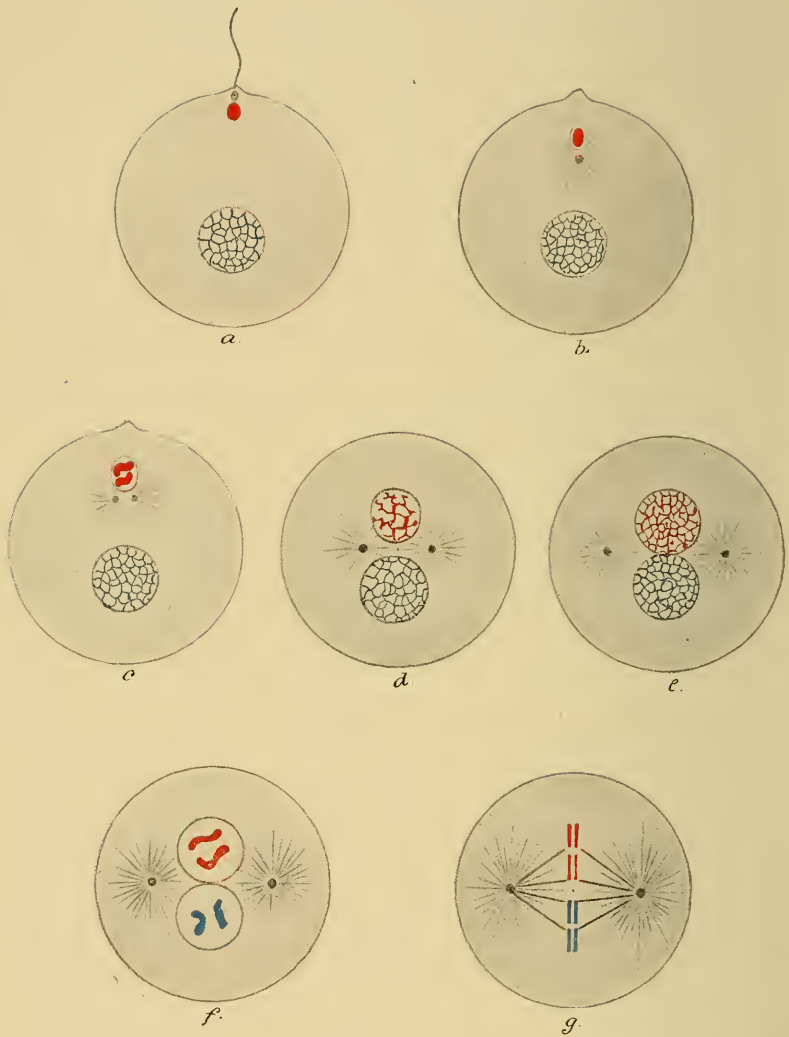

Fig. 305.—Schematic representation of the processes occurring during the fertilization and subsequent segmentation of the ovum.—(Boveri.) The chromatin (chromosomes) of the ovum is represented in blue, that of the spermatozoon in red.

the zona radiata, but so soon as one has come into contact with the cytoplasm of the egg a reaction ensues in the surface layer which makes it impervious to other spermatozoa. The spermatozoön consists of three essential parts,—the head, the middle piece, and the tail. The last named is the organ of locomotion, and after the spermatozoön enters the egg this portion atrophies and disappears, probably by absorption. The head of the spermatozoön represents the nucleus, and contains the valuable chromatin material. On entering the egg it moves toward the nucleus of the latter, meanwhile enlarging and taking on the character of a nucleus. The egg now contains two nuclei,—one belonging to it originally, the female pronucleus; one brought into it by the spermatozoön, the male pronucleus. The two come together and fuse,—superficially at least,—forming the nucleus of the fertilized egg, or the segmentation nucleus. The middle piece of the spermatozoön also enters the egg, but its exact function and fate is still a matter of uncertainty. Boveri believes that it brings into the egg a centrosome or material which induces the formation of a centrosome in the ovum, and is, therefore, of the greatest importance in initiating the actual process of cell division which begins promptly after the fusion of the nuclei. In the segmentation nucleus the normal number of chromosomes is restored, and it is believed that in the subsequent divisions of the cell to form the embryo the chromosomes are so divided that each cell gets an equal division of maternal and paternal chromosomes, and thus shares the hereditary characteristics of each parental stock. This view is represented in a schematic way by Fig. 305, taken from Boveri, the maternal and paternal chromosomes being indicated by different colors. According to this description, both egg and spermatozoön are incomplete cells before fusion. The egg contains a nucleus and a large cell body, cytoplasm, rich in nutritive material, but it lacks a centrosome or the conditions necessary for the formation of an astrosphere, so that it cannot multiply. The spermatozoön has also chromatin for a nucleus, and a centrosome or the material which may give rise to a centrosome, but it lacks cytoplasm—that is, food material for growth. It would seem that if the spermatozoön could be given a quantity of cytoplasm it would proceed to develop an embryo without the aid of an ovum. This experiment has, in fact, been made by Boveri. Eggs of the sea-urchin were shaken violently so as to break them into fragments. If now a spermatozoön entered one of these fragments, which consisted only of cytoplasm, cell multiplication began and proceeded to the formation of a larva. On the other hand, it would seem to be equally evident that if a centrosome was present in the egg or some influence could be brought to bear upon it to initiate the process of

cell division, it would develop without a spermatozoön. In some animals eggs do normally develop at times without fertilization by a spermatozoön (parthenogenesis), the eggs that have this property probably preserving their centrosomes. Loeb\* has shown, however, in some most interesting experiments that certain eggs, especially those of the sea-urchin (*Strongylocentrotus purpuratus*), which normally develop by fertilization with spermatozoa, may be made to develop by physicochemical means. Numerous means for bringing about artificial fertilization have been described. One method is to treat the egg for a minute or two with an acid (acetic, formic, etc.), which causes the formation of a membrane. They are then placed for a certain interval in a hypertonic sea water, made by adding sodium chlorid to ordinary sea water. They are then transferred to normal sea water and after an hour or so they begin to multiply and eventually develop into normal larvæ. Similar although less complete results were obtained previously by Morgan. Experiments of this character would indicate that the spermatozoön brings into the ovum definite substances, which, by chemical or physicochemical means, initiate and control the process of segmentation. Suggestions as to the nature of these substances are at present very hypothetical. Robertson† states that he is able to isolate from spermatozoa a substance which can fertilize the ovum, that is, cause the formation of a fertilization membrane. The substance is not defined chemically, otherwise than to state that it is not a protein nor an enzyme. He proposes for it the name *oöcytin*. On the other hand, F. R. Lillie‡ claims that fertilization is due to a substance produced in the egg itself—designated as *fertilizin*—which acts as an amboceptor binding the sperm by a spermophile group. He conceives that the sperm when thus bound activates the ovophile side chain in the fertilizin, which then causes fertilization. According to this view the egg is really self-fertilizing, the spermatozoön furnishing simply an activating substance, and the function of the sperm can be assumed by the above-mentioned reagents which induce artificial fertilization.

**Implantation of the Ovum.**—After fertilization in the tube the ovum begins to segment and multiply, and meanwhile is carried toward the uterus, probably by the action of the cilia lining the tube. Upon reaching the cavity of the uterus it becomes attached to the mucous membrane, usually in the neighborhood of the fundus. The membrane of the uterus has become much thickened meanwhile, and in this condition is known usually as the decidua. The

\* Loeb, "University of California Publications," 2, pp. 83, 89, and 113, 1905. See also Wilson, "Archiv. f. entwick. Mechanik," 12, 1901.

† Robertson, "Journal of Biological Chemistry," 12, 163, 1912.

‡ F. R. Lillie, "Science," October, 1913.



portion to which the egg becomes attached is the decidua serotina, and it eventually develops into the placenta, the organ through which the maternal nutriment is supplied to the fetus. The ovum has made considerable progress in its development before reaching the uterus, having formed amnion and chorion, with chorionic villi. Some of the ectodermal cells in the chorion become specialized to form a group of trophoblastic cells which have a digestive action, and it is suggested that the activity of these cells enables the ovum to become attached to the decidual membrane and to hollow out spaces in which the chorionic papilla become inserted.\* The further development of the egg into a fetus, the formation of the decidua graviditatis, and the placenta are anatomical features that need not be described here. Details of these structures will be found in works on anatomy, embryology, or obstetrics. On the physiological side it has been found that removal of the ovaries, or even destruction of the corpora lutea, shortly after pregnancy has begun brings the process to an end, while a similar operation later in pregnancy has no effect upon the developing fetus or the subsequent act of parturition. It seems, therefore, that the process of implantation of the ovum in the uterine mucous membrane and the development of a placenta are dependent in some way upon the ovaries. The apparent explanation of the connection is given in the hypothesis that the corpora lutea, during their rapid development at the beginning of pregnancy, give off an internal secretion which controls or influences in some essential way the processes connected with the fixing of the fertilized ovum.†

#### The Nutrition of the Embryo—Physiology of the Placenta.

—At the time of fertilization the ovum contains a small amount of nutriment in its cytoplasm. The amount, however, in the mammalian ovum is small and suffices probably only for the initial stages of growth. When the ovum becomes implanted in the decidual membrane of the uterus the new material for growth must be absorbed directly from the maternal blood of the uterus. Within a short time, however, the chorionic villi begin to burrow into the uterine membrane at the point of attachment, the decidua serotina, and the placenta gradually forms as a definite organ for the control of fetal nutrition. The details of histological structure of this organ must be obtained from anatomical sources. For the purposes of understanding its general functions it is sufficient to recall that the placenta consists essentially of vascular chorionic papillæ from the fetus bathed in large blood-spaces in the decidual membrane of the mother. The fetal and the maternal blood do not come into actual contact; they are separated from each other by the walls of

\* See Minot, "Transactions of the American Gynecological Society," 1904.

† Marshall and Jolly and Fraenkel, *loc. cit.*

the fetal blood-vessels and the epithelial layers of the chorionic villi, but an active diffusion relation is set up between them. Nutritive material, protein, fat, and carbohydrate, and oxygen pass from the maternal to the fetal blood, and the waste products of fetal metabolism—carbon dioxide, nitrogenous wastes, etc., pass from the fetal to the maternal blood. The nutrition of the fetal tissues is maintained, in fact, in much the same way as though it were an actual part of the maternal organism. That material passes from the maternal to the fetal blood is a necessary inference from the growth of the fetus. The fact has also been demonstrated repeatedly by direct experiment. Madder added to the food of the mother colors the bones of the embryo. Salts of various kinds, sugar, drugs, etc., injected into the maternal circulation may afterward be detected in the fetal blood. But we are far from having data that would justify us in supposing that the exchange between the two bloods is effected by the known physical processes of osmosis, diffusion, and filtration. The difficulties in understanding the exchange in this case are the same as in the absorption of nourishment by the tissues generally. It is perhaps generally assumed that the chorionic villi play an active part in the process, functioning, in fact, in much the same way as the intestinal villi. This assumption implies that the epithelial cells of the villi take an active part in the absorption of material by virtue of processes which cannot be wholly explained, but which without doubt are due to the chemical and physical properties of the substance of which they are composed. This assumption does not mean that the simpler and better understood physical properties of diffusion and osmosis are not also important. The respiratory exchange of gases, the diffusion of water, salts, and sugar, may be largely controlled in this way. There are no facts at least which contradict such an assumption. The passage of fats and proteins, however, would seem to require some special activity in the chorionic tissue, which may be connected with the presence of special enzymes. Glycogen occurs in the placenta itself and in all the tissues of the embryo during the period of most active growth. In the later period of embryonic life, as the liver assumes its functions, the glycogen becomes more localized to this organ and disappears, except for traces, in the skin, lungs, and other tissues in which it was present at first in considerable quantities. It would appear, therefore, that glycogen (sugar) represents one of the important materials for the growth of the embryo, and that in the beginning at least the tissues generally have a glycogenetic power. The sugar brought to the placenta in the maternal blood passes over into the fetal blood and the excess beyond that immediately consumed is deposited in the tissues as glycogen. The body fat of the fetus is at first slight in

amount, but after the sixth month begins to increase with some rapidity. The fat-forming tissues are in full activity, therefore, before birth, and function doubtless in the same way as in the adult. Before birth also the various organs begin to take on their normal activity. The kidney may form urine long before birth, as is shown by the presence of this secretion in the bladder, and, shortly before birth at least, it has the power of producing hippuric acid, as may be shown by injecting benzoates into the blood of the mother. The kidney functions of the embryo, however, are doubtless performed chiefly by the placenta and the kidney of the mother up to the time of birth. That the liver also begins to assume its functions early is shown by the fact that from the fifth to the sixth month one may find bile in the gall-bladder. In the intestine, colon, there is found also a collection of excrement, the meconium, which shows that the motor and secretory functions of the intestinal canal may be present in the last months of fetal life. From the pancreas a proteolytic enzyme may be extracted at the time of birth or before, but the amylolytic enzyme is not formed apparently until some time later. It is stated, at least, that it is not present at birth. In general, it is evident that for a long period the maternal organism digests and prepares the food for the embryo, excretes the wastes, regulates the conditions of temperature, etc., as it does for a portion of its own substance, but as the fetus approaches term its tissues and organs begin to assume more of an independent activity, as indeed must be the case in preparation for the sudden change at birth. In this respect, as in all parts of the reproductive process, we meet with regulations whose mechanism is but dimly understood.

**Changes in the Maternal Organism during Pregnancy.**—The two most distinct effects upon the mother that result from pregnancy are the growth of the uterus and of the mammary gland. The virgin uterus is small and firm, weighing from 30 to 40 gms., while at the end of pregnancy it may weigh as much as 1000 gms. This great increase in material is due partly to the growth of new muscular tissue and partly to an hypertrophy of the muscle already present. In the uterus at term the muscle cells are much longer and larger than in the organ before the implantation of the fertilized ovum. The stimulus that initiates and controls this new growth is seemingly the fertilized ovum itself, but the physiological means employed are not comprehended. We know from experiments upon lower animals (Rein) that when all connections with the central nervous system are severed the fetus develops normally and the uterus increases correspondingly in size and weight. The influence of the ovum on the uterus must be exerted, therefore, in all probability, through some chemical stimulus which it gives to the organ. The effect

of the presence and growth of the fetus on the mammary gland is treated in a separate paragraph below. In addition to these two visible effects it is evident that the growth of the fetus has an important influence on general metabolism and therefore upon the whole maternal organism. This fact is indicated by the marked changes often exhibited in the physical and mental condition of the mother. It is shown more precisely by a study of the nutritional changes. Numerous investigations have been made upon this subject, especially as regards the nitrogen equilibrium. During the latter part of pregnancy, especially, the nitrogen balance is positive—that is, nitrogen is stored as protein—due doubtless both to the growth of the embryo and the increase in material in the uterus and mammary gland. The proportion of ammonia in the urine increases during pregnancy and especially during labor.

**Parturition.**—The fetus “comes to term” usually in the tenth menstrual period after conception—that is, about 280 days after the last menstruation. The actual time of delivery, however shows considerable variation. Delivery occurs in consequence of contractions, more or less periodical, of the musculature of the uterus, and reflex as well as voluntary contractions of the abdominal muscles. It has been shown that delivery may occur when the nerves connecting the uterus with the central nervous system are severed, so that the act is essentially an independent function of the uterus, although under normal conditions the contractions of this organ are doubtless influenced by reflex effects through its extrinsic nerves. It has been shown that contractions of the gravid uterus may be caused by stimulation of various sensory nerves, and in women it is known that delivery may be precipitated prematurely by various mental or physical disturbances. The interesting problem physiologically is to determine the normal factor or factors that bring on uterine contractions at term. Various more or less unsatisfactory theories have been proposed. Some authors attribute the act to a change in the maternal organism, such as mechanical distension of the uterus, a venous condition of the blood, a degenerative change in the placenta, etc., while others suppose that the initial stimulus comes from the fetus. In the latter case it is suggested that the increasing metabolism of the fetus is insufficiently provided for by the placental exchange, and that therefore certain products are formed which serve to stimulate the uterus to contraction. Healy and Kastle\* suggest another hypothesis for which they give some experimental support. They believe that a hormone is formed in the mammary gland, which at this time takes on an accelerated development, and this hormone by a stimulating effect on the uterus initiates normal labor.

\* Healy and Kastle, “Bulletin 160, Ky. Agricultural Exp. Station,” 1912.

The duration of the labor pains is variable, but usually they are longer in primiparæ, ten to twenty hours or more, than in multiparæ. After the fetus is delivered the contractions of the uterus continue until the placenta also is expelled as the "after-birth." During these latter contractions the fetal blood in the placenta is, for the most part, squeezed into the circulation of the newborn child. The hemorrhage from the walls of the uterus due to the rupture of the placenta may be profuse at first, but under normal conditions is soon controlled by the firm contraction of the uterine walls.

**The Mammary Glands.**—At the time of puberty the mammary glands increase in size, but this growth is confined largely to the connective tissue; the true glandular tissue remains rudimentary and functionless. There is reason to believe that the growth of the gland in the prepubertal period, like other secondary sexual characteristics, is controlled by an internal secretion from the interstitial tissue of the ovaries (p. 885). At the time of conception the glandular tissue is in some way stimulated to further growth. Secreting alveoli are formed, and during the latter part of pregnancy they produce an incomplete secretion, scanty in amount, known as colostrum. After delivery the gland evidently is again brought under the influence of special stimuli. It becomes rapidly enlarged and a more abundant secretion is formed. For the first day or two this secretion still has the characteristics of colostrum, but on the third or fourth day the true milk is formed and thereafter is produced abundantly, during the period of lactation, under the influence of the act of milking. If during this period a new conception occurs, the milk secretion is altered in composition and finally ceases. On the other hand, if the act of nursing is abandoned permanently the glands after a preliminary stage of turgidity undergo retrogressive changes that result in the cessation of secretory activity. The colostrum secretion that occurs during pregnancy and for a day or two after birth differs from milk in its composition and histological structure. It is a thin, yellowish liquid containing a larger percentage of albumin and globulin and a smaller percentage of milk-sugar and fat than normal milk. Under the microscope it shows, in addition to some fat droplets, certain large elements,—the colostrum corpuscles. These consist of spherical cells filled with fat droplets, and are most probably leucocytes filled with fat which they have ingested. Colostrum corpuscles may occur in milk whenever the secretion of the gland is interfered with, and their presence may be taken as an indication of an incomplete secretion.

**Conditions Controlling the Secretion of the Mammary Gland.**—The physiological connection between the uterus and the mammary gland is shown by the facts mentioned in the pre-

ceding paragraph. That the ovary also shares in this influence either directly or through its effect on the uterus is shown by the fact that after complete ovariectomy the mammary gland undergoes atrophy. This undoubted influence of one organ upon the other might be exerted either through the central nervous system or by way of the circulation. There are indications that the secretion of the mammary glands is under the control, to some extent at least, of the central nervous system. For instance, in women during the period of lactation cases have been recorded in which the secretion was altered or perhaps entirely suppressed by strong emotions, by an epileptic attack, etc. This indication has not received satisfactory confirmation from the side of experimental physiology. Eckhard found that section of the main nerve-trunk supplying the gland in goats, the external spermatic, caused no difference in the quantity or quality of the secretion. Röhrig obtained more positive results, inasmuch as he found that some of the branches of the external spermatic supply vasomotor fibers to the blood-vessels of the gland and influence the secretion of milk by controlling the local blood-flow in the gland. Section of the inferior branch of this nerve, for example, gave increased secretion, while stimulation caused diminished secretion, as in the case of the vasoconstrictor fibers to the kidney. These results have not been confirmed by others—in fact, they have been subjected to adverse criticism—and they cannot, therefore, be accepted unhesitatingly.

After apparently complete separation of the gland from all its extrinsic nerves, not only does the secretion, if it was previously present, continue to form, although less in quantity, but in operations of this kind upon pregnant animals the glands increase in size during pregnancy and become functional after the act of parturition.\* This result confirms the older experiments of Goltz, Rein, and others, according to which section of all the nerves going to the uterus does not prevent the normal effect on lactation after delivery. Regarding the question of the existence of secretory nerves, Basch† reports that extirpation of the celiac ganglion or section of the spermatic nerve does not prevent the secretion, but causes the appearance of colostrum corpuscles.

Experiments, therefore, as far as they have been carried indicate that the gland is under the regulating control of the central nervous system, either through secretory or more probably through vasomotor fibers. The bond of connection between the mammary gland and the uterus is, however, established mainly

\* Mironow, "Archives des sciences biologiques," St. Petersburg, 3, 353, 1894.

† Basch, "Ergebnisse der Physiologie," vol. ii., part 1, 1903.

through the blood rather than through the nervous system. Some direct evidence for this point of view is furnished by the interesting experiments of Starling and Lane-Claypon.\* These authors found that extracts made from the body of the fetus, or rather from the bodies of many fetuses, when injected repeatedly into a virgin rabbit caused a genuine development of the mammary glands closely simulating the growth that normally occurs during pregnancy. Since similar extracts made from ovaries, placental and uterine tissues had no effect, they conclude that a specific chemical substance (a hormone) is produced in the fetus itself and, after absorption into the maternal blood, acts upon the mammary gland, stimulating it to growth. Since the birth of the fetus is followed by active secretion in the mammary glands they adopt further the view that this substance, while promoting the growth of the gland tissue, inhibits the catabolic processes which lead to the formation of the secretion. With the birth of the fetus this substance is withdrawn and secretion begins, and, on the contrary, the secretion is suspended when a new pregnancy is well advanced. Further evidence of the same kind is furnished by the interesting case of the Blazek sisters.† These twins had a common circulation but separate nervous systems. Pregnancy and parturition in one was followed by a secretion of the mammary glands of both.

As was said in speaking of the histology of the gland, the secreting alveoli are not fully formed until the first pregnancy. During the period of gestation the epithelial cells multiply, the alveoli are formed, and after parturition secretion begins. As the liquid is formed it accumulates in the enlarged galactophorous ducts, and after the tension has reached a certain point further secretion is apparently inhibited. If the ducts are emptied, by the infant or otherwise, a new secretion begins. The emptying of the ducts, in fact, seems to constitute the normal physiological stimulus to the gland-cells, but how this act affects the secreting cells, whether reflexly or directly, is not known.

The possibility that the mammary secretion is influenced by various internal secretions has been brought out by the experiments of Ott and Scott.‡ These observers find that extracts of several glands, particularly of the posterior lobe of the hypophysis and of the corpus luteum, have a distinct stimulating effect upon the mammary gland. Whether or not this influence is exerted normally remains to be determined.

**Composition of the Milk.**—The composition of milk is com-

\* Lane-Claypon and Starling, "Proceedings of the Royal Society," 1906, B. lxxvii.; see also Starling in "Lancet," 1905.

† Basch, "Deut. Med. Wochenschrift," 36, 981, 1910.

‡ Ott and Scott, "Therapeutic Gazette," Oct., 1911, May and Nov., 1912.

plex and variable.\* The important constituents are the fats, held in emulsion as minute oil droplets, and consisting chiefly of olein and palmitin; casein, a nucleo-albumin which clots under the influence of rennin; milk-albumin or lactalbumin, a protein resembling serum-albumin; lactoglobulin; lactose or milk-sugar; lecithin, cholesterolin, phosphocarnic acid, urea, creatin, citric acid, enzymes, and mineral salts. It is well known also that many foreign substances—drugs, flavors, etc.—introduced with the food are secreted in the milk. An average composition is: proteins, 2 to 3 per cent.; fats, 3 to 4 per cent.; sugar, 6 to 7 per cent.; salts, 0.2 to 0.3 per cent. The fact that casein and milk-sugar do not exist preformed in the blood is an argument in favor of the view that they are formed by the secretory metabolism of the gland cells. The special composition of the milk-fat and the histological appearance of the gland cells during secretion suggest the view that the fat is also constructed within the gland itself. Bunge has called attention to the fact that the inorganic salts of milk differ quantitatively from those in the blood-plasma and resemble closely the proportions found in the body of the young animal, thus indicating an adaptive secretion. This fact is illustrated in the following table giving the mineral constituents in 100 parts of ash:

	YOUNG PUP.	DOGS' MILK.	DOGS' SERUM.
K <sub>2</sub> O.....	8.5	10.7	2.4
Na <sub>2</sub> O.....	8.2	6.1	52.1
CaO.....	35.8	34.4	2.1
MgO.....	1.6	1.5	0.5
Fe <sub>2</sub> O <sub>3</sub> .....	0.34	0.14	0.12
P <sub>2</sub> O <sub>5</sub> .....	39.8	37.5	5.9
Cl.....	7.3	12.4	47.6

On account of the use of cows' milk in place of human milk in the nourishment of infants much attention has been given to the relative composition and properties of the two secretions. The chief difference between the two lies apparently in the casein. The casein of human milk is smaller in amount, curdles in looser flocks than that of cows' milk, and seems to dissolve more easily and completely in gastric juice. The former also contains relatively more lecithin and less ash, particularly the lime salts. On the other hand, cows' milk contains less sugar and fat. In using it, therefore, for the nutrition of infants it is customary to add water and sugar. The composition of cows' milk is so well known that it is easy to modify it for special cases according to the indications. The rules for this procedure will be found in works upon pediatrics.

\* For data as to composition and hygienic relations, see Bulletin 41, "Hygienic Laboratory," Public Health and Marine Hospital Service, U. S., Washington, 1908.



## CHAPTER LIII.

### PHYSIOLOGY OF THE MALE REPRODUCTIVE ORGANS.

**Puberty.**—The sexual life of the male is longer than that of the female. Puberty or sexual maturity begins somewhat later,—in temperate climates at about the fifteenth year; but there is no distinct limitation of the reproductive powers in old age corresponding to the menopause of the female. At the time of puberty and for a short preceding period the boy grows more rapidly in stature and weight, and the assumption of its complete functions by the testis exerts a general influence upon the organism as a whole. One of the superficial changes at this period which is very evident is the alteration in pitch of the voice. Owing to the rapid growth of the larynx and the vocal cords the voice becomes markedly deeper, and the change is in some cases sufficiently sudden to cause the well-known phenomenon of the breaking of the voice. The neuromuscular control of the vocal cords becomes for a time uncertain. The completion of puberty can not be determined in the boy with the same exactness as in the girl, in whom menstruation furnishes a visible sign of sexual maturity. Part of the sexual mechanism may be functional long before the time of puberty, as is shown by the presence of sexual desire and the possibility of erection; but fully developed spermatozoa are not produced until this period, and indeed the presence of ripe and functional spermatozoa in the testis is the only certain sign that sexual maturity has been attained. Puberty as thus defined consists in the maturation of the testis in the male, and of the ovary in the female.

It will be recalled that in the interesting work upon the internal secretion of the testes reported by Steinach (p. 885), he emphasizes the fact that these organs consist of two distinct parts, the reproductive cells proper lining the seminiferous tubules and the interstitial tissue. This latter tissue forms the internal secretion, which is responsible in all probability for the development of the secondary sexual characteristics, such as the enlargement of the penis and its accessory glands (vesicles, prostate), the appearance of sexual desire, the prepubertal growth, etc. Since the full development of these characteristics marks the appearance of puberty, Steinach proposes to designate the mass of interstitial tissue as the "pubertal gland." Normally, the full establishment of the sex

characteristics is coincident with the maturation of functional activity in the generative part of the gland, and the practical indication of the completion of puberty is the formation of spermatozoa. In Steinach's experiments these two functions of the testis were separated, and puberty, so far as the development of sex characteristics was concerned, was established without the production of spermatozoa. It seems probable that the secretions of the interstitial tissue begin to influence the rest of the organism some time before the generative elements mature, since sexual appetite may be present before puberty, and the prepubertal growth changes appear gradually. The history of this tissue, moreover, is bound up in some intimate way with the activity of other glands of internal secretion, with the thymus, the cortical portion of the adrenal gland, and particularly with the pituitary gland. It will be remembered that deficiency of the pituitary gland (posterior lobe) is accompanied by a condition of sexual infantilism.

**The Properties of the Spermatozoa.**—The development and maturation of the spermatozoa in the testis has been followed successfully by histological means. The mother-cells of the spermatozoa, the spermatocytes, give rise to four daughter-cells, spermatids, each of which develops into a functional spermatozoön. The process in this case is something more than mere cell division, since in the spermatozoa eventually produced the number of chromosomes present in the nucleus—that is, the head of the spermatozoön—are reduced by one-half. The process of production of the spermatozoa is therefore quite analogous to the maturation of the ovum during the formation of the polar bodies. The formation and maturation of the spermatozoa may be represented by a schema similar to that used in the case of the ova, as follows (Fig. 306): In the case of the ovum four ova are produced, but only one is functional, and this one, the ripe egg, is characterized by its large amount of cytoplasm, its inability to undergo further cell division until fertilized, and the reduction of its chromosomes to half the number characteristic of the body cells of the species. In the case of the spermatozoa, the four cells produced are all functional,\* and are characterized by the practical loss of cytoplasm, reduction of chromosomes by one-half, and inability to multiply until cell material is furnished. The two cells supplement each other, therefore. Their union restores the normal number of chromosomes, part of which are now maternal and part paternal; the egg supplies the cytoplasm and the spermatozoön nuclear material and the definite stimulus that leads to multiplication.

\* It is an interesting fact that in some cases (bees) two kinds of spermatids are formed by an unequal division of the spermatocyte, and the smaller of the two is abortive, as in the case of the polar bodies of the egg.

The spermatozoa are produced in enormous numbers. It is calculated that at ejaculation each cubic centimeter of the liquid contains from sixty to seventy millions of these cells. The adult ripe spermatozoön is characterized as an independent cell by its great motility, due to the cilia-like contractions of its tail. Its power of movement or its vitality is retained under favorable conditions for very long periods. The most striking instance of this fact is found in the case

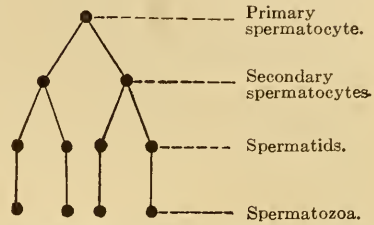

Fig. 306.—Schema to indicate the process of maturation of the spermatozoa.—(Boveri).

of bats. In these animals copulation takes place in the fall and the uterus of the female retains the spermatozoa in activity until the period of ovulation in the following spring. Even in the human being it is believed that the spermatozoa may exist for many days in the uterus and Fallopian tubes of the female. In the semen that is ejaculated during coitus the spermatozoa are mixed with the secretions of the accessory reproductive glands, such as the seminal vesicles, the prostate gland, and Cowper's gland. The specific influence of each of these secretions is not entirely understood, but experiments show that in some way they are essential to or aid greatly in maintaining the motility of the spermatozoa. Steinach\* has found, for example, that removal of the prostate gland and seminal vesicles in white rats prevents successful fertilization of the female, although the ability and desire to copulate are not interfered with. This result has been corroborated by Walker.† According to this author, removal of both the prostate and seminal vesicles in the rat leaves the testes in apparently normal condition, but the animals are not able to fertilize the female. Removal of the testes, on the other hand, prevents the development of the prostate in the young animal and causes atrophy of the gland in the adult. Evidently, therefore, the testis controls, in some way, probably by a hormone, the metabolic processes in the prostate. Walker believes that the prostatic secretion aids in rendering the spermatozoön properly motile. The secretion of the seminal vesicles in the rat exhibits a curious property of clotting upon mixture with the secretion of a small gland at its base—the coagulating gland. If the secretion of the vesicles follows the ejaculation of the semen, it is possible that the coagulation of the former serves to occlude the

\* See Steinach, "Archiv f. die gesammte Physiologie," 56, 1894, and Walker, "Archiv f. Anatomie u. Physiologie," 1889, p. 313.

† Walker, "Johns Hopkins Hospital Reports," 16, 1911, and "Johns Hopkins Bulletin," 21, 1910.

vagina in the female and thus prevent the loss of the fertilizing liquid. The union of spermatozoön and ovum is believed to take place usually in the Fallopian tube, and under normal conditions only one spermatozoön penetrates into the egg. The remainder of the great number that may be present eventually perish. The changes that take place during the process of fertilization have already been described (p. 976).

**Chemistry of the Spermatozoa.**—Much chemical work has been done upon the composition of spermatozoa, particularly in the fishes. The results have been most interesting from a chemical standpoint, and biologically they are suggestive in that the analytical work has been done upon the heads of the spermatozoa. These heads consist entirely of nuclear material, and contain the substance or substances which convey the hereditary characteristics of the father, or, to speak more accurately, of the race to which the father belongs. Whatever progress may be made in the understanding of the chemistry of this material is a step toward the solution of the most difficult and mysterious side of reproduction, the power of hereditary transmission. Miescher, in investigations upon the spermatozoa of salmon, discovered that the heads are composed essentially of an organic combination of phosphoric acid, since designated as nucleic acid, united with a basic albuminous body, protamin. This view has been confirmed and extended by later observers, especially by Kossel and his pupils.\* The head of the spermatozoön, the male pronucleus in fertilization, may be defined, in the case of the fishes at least, as "a salt of an organic base and an organic acid, a protamin-nucleic acid compound." The term protamin is used now to designate a group of closely related proteins obtained from the spermatozoa of different animals. The special protamin of each species is designated according to the zoölogical name of that species; thus the protamin of salmon is salmin, of herring (*Clupea harengus*), clupein, and so on. The protamins are all strong bases; their aqueous solutions give an alkaline reaction, and they unite readily with various acids to form well-defined salts. They are protein bodies, giving the biuret reaction readily even without the addition of alkali, and they are precipitated by most of the general precipitants of proteins, such as the neutral salts, the alkaloidal reagents, etc. Their solutions, however, are not coagulated by heat. The molecular formula for salmin is given as  $C_{30}H_{57}N_{17}O_6$ . When decomposed by the action of acids they yield simpler basic products, the so-called hexon bases or diamino-bodies, and particularly the base arginin ( $C_6H_{14}N_4O_2$ ), which is contained in the protamin of

\* For literature and details of the chemistry of spermatozoa, see Burian, in "Ergebnisse der Physiologie," vol. iii., part I, 1904, and 1906, v., 832.

the spermatozoa in greater abundance than in any other protein. The protamins differ from most other protein compounds by their relative simplicity; they contain no cystin grouping, therefore no sulphur; no carbohydrate grouping in most of the compounds examined; and no tyrosin complex. In the spermatozoa of some fishes the protamins are replaced by more complex compounds belonging to the group of histons which show properties somewhat intermediate between those of protamins and ordinary proteins, and in general it may be said that the head of the spermatozoon, like the nuclei of cells in general, consists chiefly of a nucleoprotein compound, that is, a compound of nucleic acid with a protein body of a more or less distinctly basic character.\* The nucleic acid component of the spermatozoon resembles the same substance as obtained from the nuclei of other cells. In the spermatozoa of the salmon this nucleic acid has the formula  $C_{40}H_{56}N_{14}P_4O_{26}$ . On decomposition by hydrolysis it yields at first some of the purin bases (adenin, guanin), and on deeper cleavage a number of compounds, including the pyrimidin derivatives, thymine, uracil, and cytosin. While the chemical studies upon spermatozoa, thus briefly referred to, have greatly extended our knowledge, it is still impossible to say that they have given any information concerning the peculiar functions of the spermatozoa in fertilization.

**The Act of Erection.**—In the sexual life of the male the act of erection of the penis during coitus offers a most striking physical phenomenon. During this act the penis becomes hard and erect, owing to an engorgement with blood. The structure of the corpora cavernosa and corpus spongiosum is adapted to this function, being composed of relatively large spaces inclosed in trabeculæ of connective and plain muscle tissue,—the so-called erectile tissue. Many theories have been proposed to explain the mechanism of erection, but it is generally agreed that the work of Eckhard † demonstrated the essential facts in the process. This investigator discovered that in the dog stimulation of the *nervi erigentes* causes erection. These nerves are composed of autonomic fibers arising from the sacral portion of the spinal cord (see Figs. 111 and 112). They arise from the sacral spinal nerves, first to third (dog), on each side and help to form the pelvic plexus. They contain vasodilator fibers to the penis, as well as to the rectum and anus, and also visceromotor fibers to the descending colon, rectum, and anus. Eckhard, Lovén, and others ‡ have shown that when these fibers are stimulated there is a large dilatation of the arterioles in the erectile tissue of the penis and a

\* Burian, *loc. cit.*

† Eckhard, "Beiträge zur Anatomie und Physiologie," 2, 123, 1863, and 4, 69, 1869.

‡ See especially François-Franck, "Archives de Physiol. norm. et pathol.," 1895, 122, 138.

greatly augmented blood-flow to the organ. If the erectile tissue is cut or the dorsal vein is opened the blood-flow under usual conditions is a slow stream, but when the *nervus erigens* is stimulated the outflow is very greatly increased; according to Eckhard's measurements, eight to fifteen times more blood flows out of the organ. The act of erection is therefore due essentially to a vascular dilatation of the small arteries whereby the cavernous spaces become filled with blood under considerable pressure. The cavernous tissues are distended to the limits permitted by their tough, fibrous wall. It seems probable that the turgidity or rigidity of the congested organ is completed by a partial occlusion of the venous outflow, which is effected by a compression of the efferent vein by means of the extrinsic muscles (*ischio* and *bulbocavernosus*) and possibly by the intrinsic musculature as well. This compression does not occlude the blood-flow completely, but serves to increase greatly the venous pressure. This explanation of the act of erection, while no doubt correct, so far as it goes, leaves undetermined the means by which the dilatation of the small arteries is produced. Vasodilator nerve fibers in general are assumed to produce a dilatation by inhibiting the peripheral tonicity of the arterial walls. If this explanation is applied to the case under consideration it forces us to believe that throughout life, except for the very occasional acts of erection, the arteries in the penis are kept in a constant condition of active tone. Moreover, on this view we should expect that section of the vasoconstrictor fibers to the penis, by abolishing the tone of the arteries, would also cause erection. These constrictor fibers arise from the second to fifth lumbar spinal nerves, and reach the organ by way of the hypogastric nerve and plexus and the pudic nerve. No such result of their section is reported and it seems that in the matter of erection the actual mechanism of the great dilatation caused by the *nervi erigentes* still contains some points that need investigation.

**The Reflex Apparatus of Erection and Ejaculation.**—The dilatation of the arteries of the penis during erection is normally a reflex act, effected through a center in the lumbar cord. This center may be acted upon by impulses descending from the brain, as in the case of erotic sensations, or by afferent impulses arising in some part of the genital tract,—from the testes themselves, from the urethra or prostate gland, and especially from the glans penis. Mechanical stimulation of the glans leads to erection, and Eckhard showed in dogs that section of the pudic nerve prevents this reflex from occurring, proving, therefore, that the sensory fibers concerned run in the pudic nerve. Stimulation of these latter fibers leads also to erotic sensations and eventually to the completion of the sexual orgasm. This latter act brings about the forcible ejection of the

sperm through the urethra. It is initiated by contractions of the musculature of the vasa deferentia, ejaculatory duct, the seminal vesicles, and the prostate gland, which force the spermatozoa, together with the secretions of the vesicles and prostate gland, into the urethra, whence they are expelled in the culminating stage of the orgasm by the rhythmical contractions of the ischiocavernosus and bulbocavernosus muscles, together with the constrictor urethræ. The immediate center for this complex reflex is assumed to lie in the lumbar cord, since, according to the experiments of Goltz, mechanical stimulation of the glans in dogs causes erection and seminal emission after the lumbar cord is severed from the rest of the central nervous system. Under ordinary conditions the act is accompanied by strong psychical reactions which indicate that the cortical region of the cerebrum is involved. It is interesting in this connection to find that electrical stimulation of a definite region in the cortex\* of dogs may cause erection and ejaculation.

\* Pussep, quoted from Hermann's "Jahresbericht der Physiologie," vol. xi, 1903.

## CHAPTER LIV.

### HEREDITY—DETERMINATION OF SEX—GROWTH AND SENESCENCE.

**Heredity.**—The development of the fertilized ovum offers two general phenomena for consideration: First, the mere fact of multiplication by which an infinite number of cells are produced by successive cell-divisions; second, the fact that these cells become differentiated in structure in an orderly and determinate way so as to form an organism of definite structure like those which gave origin to the ovum and the spermatozoön. In other words, the fertilized ovum possesses a property which, for want of a better term, we may designate as a form-building power. The ovum develops true to its species, or, indeed, more or less strictly in accordance with the peculiarities of structure characteristic of its parents. The object of a complete theory of heredity is to ascertain the mechanical causes—that is, the physicochemical properties—resident in the fertilized ovum which impel it to follow in each case a definite line of development. The discussions upon this point have centered around two fundamentally different conceptions designated as evolution and epigenesis.

*Evolution and Epigenesis.*—The earlier embryologists found a superficial explanation of this problem in the view that in the germ cells there exists a miniature animal already preformed, and that its development under the influence of fertilization consists in a process of growth by means of which the minute organism is unfolded, as it were. The process of development is a process of evolution of a pre-existing structure. Inasmuch as countless individuals develop in successive generations, it was assumed also that in the germ cell there are included countless miniature organisms,—one incased, as it were, in the other. Some of the embryologists of that period conceived that the undeveloped embryos are contained in the ovum,—the ovists,—while others believed that they are present in the spermatozoön, the animalculists. Other embryologists pointed out that the fertilized egg shows no indication of a preformed structure, and therefore concluded that development starts from an essentially structureless cell, and consists in the successive formation and addition of new parts which do not pre-



exist as such in the fertilized egg. This view in contradistinction to the evolution theory was designated as epigenesis. Microscopical investigation has demonstrated beyond all doubt that the fertilized ovum is a simple cell devoid of any parts or organs resembling those of the adult, and the evolution theory in its crude form has been entirely disproved. Nevertheless the controversy between the evolutionists and epigenesists still exists in modified form. For it is evident that in the fertilized ovum there may exist preformed mechanisms or complexes of molecules which, while in no way resembling anatomically the subsequently developed parts of the organism, nevertheless are the foundation stones, to use a figure of speech, upon which the character of the adult structure depends. Such a view in one form or another is probably held by most biologists, since it avoids the well-nigh inconceivable difficulties offered by a completely epigenetic theory. If the fertilized ovum of one animal is in the beginning substantially similar to that of any other animal the epigenesist must ascertain what combination of conditions during the process of development causes the egg, in a dog, for instance, to develop always into a dog, and moreover into a certain species of dog resembling more or less exactly the parent organisms. The infinite difficulties encountered by such a point of view are apparent at once. In this, as in other similar problems, experimental work is gradually accumulating facts which throw some light upon the matter and may eventually lead us to the right explanation. It has been made highly probable that the chromatin material in the nuclei of the germ cells, the chromosomes, constitute the physical basis of hereditary transmission of racial characteristics. In the fertilized egg, it will be remembered, half of the chromosomes come from the mother and half from the father, and there is good reason for believing that the maternal chromosomes are the bearers of the maternal characteristics, and the chromosomes derived from the spermatozoön convey the hereditary traits of the father. It must not be understood from this statement that the characteristics of the parent are directly transmitted or handed over to the reproductive cells. On the contrary, the ova of the mother are cells lineally descended from the ovum that gave rise to her as an individual, and the structures or determiners in the chromosomes of the ova are not derived from the body of the mother, but are transmitted from the original ovum. By this means there is constituted a physical continuity of the germinal material from generation to generation. The hereditary characteristics contained in the structure of the germ cells are racial—they belong to the stock and are not created anew in each generation. The spermatozoön, so far as it enters into the structure of the fertilized ovum, consists only of chromatin material

or chromosomes conveying the carriers or determiners of hereditary traits belonging to the parental stock of germ plasm. The ovum contains chromosomes that in the same way add hereditary characteristics from the maternal strain of germ plasm. When these two cells unite a new individual is begun, and his hereditary traits are, so to speak, defined, and they constitute a mixture from two strains, but a mixture the composition of which may be infinitely varied. Modern biologists insist that the cytoplasm of the ovum also conveys certain general hereditary characteristics of a fundamental kind, such as the polarity and symmetry of the future organism and possibly also its pattern or the relative position of future organs. Such a view, it will be noticed, implies at once preformed structures in the gametes and constitutes one form of an evolutionary hypothesis. This view is further supported by the interesting experiments of Wilson.\*

This author has shown that in certain mollusks (*Dentalium* or *Patella*), if a portion of the egg is cut off, the remaining portion upon fertilization develops into a defective animal that is not a whole embryo, but rather a piece or fragment of an embryo. Or if the fertilized egg after its first segmentation is separated artificially into two independent cells, each develops an embryo, but neither one is completely formed—each is lacking in certain structures and the two must be taken together to constitute an entirely normal animal. By experiments of this kind it has been shown that certain definite portions of the egg are responsible for the formation of particular organs in the adult. If these portions of the egg are removed the organs in question are not developed. Many interesting general theories of heredity have been proposed by Darwin, Nägeli, Weissmann, Mendel, Galton, Brooks, and others. It is impossible to give here an outline of all these theories, but a word may be said regarding the work of de Vries and Mendel, which have given rise recently to so much discussion. For fuller information the reader is referred to special treatises on the subject.† According to the well-known views of Darwin in regard to the action of natural selection it was assumed that new varieties and species are formed by the cumulative action of selection upon small fluctuating variations. By this cumulative selection certain variations are preserved and strengthened until they are sufficiently marked to constitute a specific difference, the process requiring naturally a long period of time. In contrast with this view de Vries has suggested what is commonly known as the theory of mutations. According to this view the variability in

\* Wilson, "Science," February 24, 1905, for a popular discussion; also "Journal of Experimental Zoölogy," 1, 1 and 197, 1904, and 2, 371, 1905.

† Hertwig, "The Biological Problems of To-day"; Delage, "L'hérédité et les grands problèmes de la biologie générale," 1903; Thomson, "Heredity," 1908; Conklin, "Heredity and Environment," 1914.

the germ plasm is such that it may at times give rise not to fluctuating variations, but to marked and permanent variations, and these latter, if advantageous to the animal, are preserved by natural selection. Such permanent variations are known as mutations or "sports," and in consequence of their formation and preservation the process of evolution may proceed much more rapidly than was assumed to be the case in the original form of Darwin's hypothesis. The contribution made to our understanding of heredity by the work of Mendel and those who have used his conceptions is most significant. By the Mendelian law or Mendelian inheritance is meant in the first place the general idea that characteristics handed down by inheritance from parents to offspring may be treated as separate units. It is implied in this view that these unit characters are conveyed by definite substances or structures in the germ plasm which, for convenience, have been designated as "determiners" or "unit-factors." Their nature is, of course, unknown. In some cases parental characteristics may apparently blend in the children, as, for example, in the case of color, the mulatto being in this regard a blend of a white and a black parent. In most cases, however, there is no blending, but an alternation of one or the other of a pair of contrasting characteristics. As regards such a pair of alternating characteristics Mendel found that one will be dominant, the other recessive, whenever they are brought together. That is to say, if each parent possesses one of such alternating characteristics, brown eyes and blue eyes, for example, the children will all show the dominant characteristic, in this case brown eyes, but the other characteristic will be present in a recessive or concealed form. In the hybrids possessing both characteristics the germ cells are so divided that half of them possess the dominant alone and half the recessive alone. This constitutes the law of the "purity of the germ cells" or of the "segregation of the gametes." If two such hybrids breed together it follows from the law of probabilities that in the offspring three out of four will show the dominant characteristic and one the recessive characteristic. Moreover, of those that show the dominant characteristic two will be hybrids, containing also the recessive, but one will be a pure dominant. This result may be understood from the following formula, in which D and R represent respectively the dominant and the recessive:

$$\begin{array}{c} D-R \\ | \quad | = 1 \text{ DD, } 2D(R) \text{ and } 1 \text{ RR.} \\ D-R \end{array}$$

If two pure recessives or two pure dominants breed together, only a recessive or a dominant, as the case may be, will be exhibited in the offspring, and in this way pure characteristics may be

selected and established. Such a process of selection is simple in the case of the recessive characteristics, but in the case of the dominant it is, of course, more difficult to distinguish between the DD and the D(R). The distinction may be made by breeding with an animal showing the recessive. If the dominant is pure, all of the offspring will exhibit the dominant characteristics. If, on the contrary, it is a hybrid, the offspring will be half dominant and half recessive, according to the formula:

$$\begin{array}{c} D-R \\ | \quad | \\ \hline R-R \end{array} = DR, DR, RR, RR.$$

The many attempts to verify this law in breeding have shown that it expresses probably a great truth, although the application of it to the practical purposes of breeding is beset with many complications. The newer experimental work in heredity has emphasized the importance of breeding experiments made with what are known as "pure lines," that is to say, with those plants or animals which are capable of propagation without cross fertilization.\* These experiments have tended to prove that the characteristics of each race or species are inherent in its germ plasm and will breed true if not fertilized or mixed with germ plasm from another individual of different origin. When there is cross fertilization, the offspring are hybrids which exhibit some of the characteristics of each parent. According to the Mendelian law, the unit factors conveying these characteristics are sorted out or segregated in the reproductive cells of the parents. If a cross fertilization is effected, for example, between a white and a crimson flower of the same species the offspring show an intermediate pink color. The fusion of characteristics is, however, only apparent, for in the reproductive cells of the pink hybrids the factors conveying the white and crimson characters will again be separated. That is to say, one-half of the reproductive cells will have the factor for white and one-half the factor for crimson. Two pink hybrids bred together will produce offspring whose color characteristics may be predicted, according to the Mendelian principle, as follows:

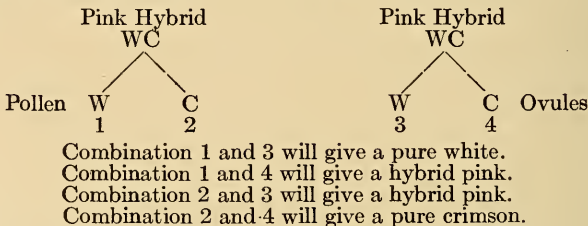

\* For a general presentation see "American Naturalist," February and March, 1911, Jennings and others.

The results obtained from crossing hybrids is not always as simple as is indicated in this schema, since so-called characteristics may be dependent not upon a single but upon several factors. In general, however, the Mendelian principles of the existence of unit characters and segregation of these characters in the germ cells are accepted. They throw some light upon what was before a very mysterious process. The point of view suggested by these principles leads us to lay great stress, in the matter of breeding, upon the importance of the characteristics of the racial strains, and to value less than formerly the importance of characteristics acquired during the life of the individual parent, or, expressed in another way, the modern tendency is to believe that "nature counts for more than nurture." As a matter of fact in the development of an individual both nature and nurture play important parts; nature, that is the character of the stock, determines the potential possibilities in the fertilized ovum, while nurture, or the character of the environment, is influential in exciting or repressing the development of these possibilities. The full comprehension of the fundamental importance of the heredity factor is mainly responsible for the modern movement of eugenics, which hopes to improve the quality of the race by limiting the growth of poor stock in mankind and encouraging the breeding from the best stock.

**Determination of Sex.**—The conditions which lead to the determination of the sex of the developing ovum have attracted much investigation and speculation. In the absence of precise data very numerous and oftentimes very peculiar theories have been advanced.\* Such views as the following have been maintained: that the sex is determined by the ova alone; that it is determined by the spermatozoa alone; that one side (right ovary or testis) contains male elements, the other female; that the sex is a result of the interaction of the ovum and spermatozoön, the most virile element producing its own sex, or according to another possibility "the superior parent produces the opposite sex"; that the sex depends on the time relation of coitus to menstruation, fertilization before menstruation favoring male births, after menstruation female births; that it depends upon the nutritive conditions of the ovum during development or of the maternal parent; that it depends upon the relative ages of the parents; that there are preformed male and female ova and male and female spermatozoa, etc. What we may call the scientific study of the problem began with the collection of statistics of births. Statistics in Europe of 5,935,000 births indicate that 106 male children are born to

\* For accounts of the various theories and discussion, see Morgan, "Heredity and Sex," 1913; Wilson, "Proceedings of the Roy. Soc.," B., 88, 1914 (Croonian Lecture); Lenhossek, "Das Problem der geschlechtsbestimmenden Ursachen," 1903.

160 female, and the data from other countries show the same fact of an excess of male children. Owing to the greater death-rate of the male, the proportion of male to female in the adult population of Europe is as 1000 to 1024. Examination of these statistics with reference to determining conditions led to the formulation of the so-called Hofacker-Sadler law or laws, which may be stated as follows: (1) When the man is older than the woman the ratio of male births is increased (113 to 100). (2) When the parents are of equal age the ratio of female births is increased (93.5 males to 100 females). (3) When the woman is older the ratio of female births is still further increased (88.2 to 100). These laws have been corroborated by some statisticians and contradicted or modified by others. Ploss attempted to show that poor nutritive conditions affecting the parents, especially the mother, favor the birth of boys. Dusing combined these results in a sort of general compensatory law of nature, according to which a deficiency in either sex leads, by a process of natural selection, to an increase in the births of the opposite sex. Thus, when males are few in number,—as the result, for instance, of wars,—females marry later and more males are produced. When males are in excess early marriages are the rule and this condition favors an excess of female births. However interesting these statistics may be, it is very evident that they do not touch the real problem of the cause of the determination of sex.

Modern work has turned largely to observations and direct experiments upon the lower animals, and particularly to cytological studies of the reproductive cells. The trend of this work tends to oppose an older view founded largely upon experiments on frogs, bees, and wasps, according to which the sex is controlled or may be controlled by the conditions of nourishment during development, favorable conditions of nutriment leading to the development of female cells from the germinal epithelium of the embryo. On the contrary, it is now believed that while such external conditions may affect the sex ratio, the factors that actually determine sex are internal and the sex of the fertilized ovum is fixed at the time of fertilization. The view that holds at present connects the determination of sex with the presence or absence of an accessory chromosome, the *x*-chromosome, in the matured spermatozoön. In many animals the spermatocyte, like the other cells of the male, contains an odd number of chromosomes. In man, for example, the number is given as 47. When synapsis of these chromosomes occurs in the process of maturation, 23 pairs are formed and one odd one, the *x*-chromosome. At the reduction division to form the spermatozoa these pairs separate, one going to each daughter-cell, but the *x*-chromosome being unpaired goes to one only of the

daughter-cells. As a consequence two kinds of spermatozoa are formed in equal numbers, one kind possessing the  $x$ -chromosome, and the other without this element. In the ova, on the contrary, there is an even number of chromosomes, the  $x$ -chromosomes are paired like the others and the matured ova all have, therefore, an  $x$ -chromosome. Much evidence has been brought forward to show that when a spermatozoön containing an  $x$ -chromosome fertilizes an ovum a female results, while an ovum fertilized by a spermatozoön without an  $x$ -chromosome yields a male. This result is expressed in the following diagram in which the presence of an  $x$ -chromosome is represented by an  $x$ .

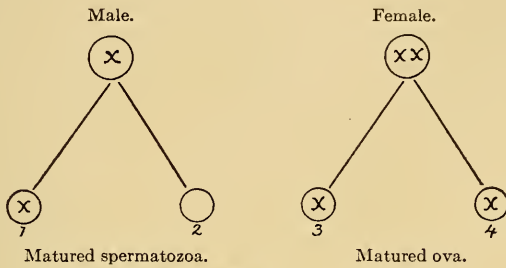

Fig. 307.

The combinations 1, 3 and 1, 4 give rise to females, and the combinations 2, 3 and 2, 4 give rise to males. It is said that in some animals (aphids) only the spermatozoa containing an  $x$ -chromosome mature, and as a result all the progeny from sexual union are females. In some cases the male gamete has two  $x$ -chromosomes, but of unequal size, the larger one being then designated as the  $x$ -chromosome and the smaller one as the  $y$ -chromosomes. In the union with the ova the spermatozoa with  $y$ -chromosomes produce males; the others, females.

We owe the establishment of this important generalization largely to American investigators (McClung, Wilson, Stevens). It enables us to treat sex as a Mendelian characteristic transmitted by certain hereditary units or determiners. When two of these are united in a fertilized ovum a female results, while a single one gives rise to a male. From this point of view it has been possible to construct satisfactory schemata to explain the many known instances of sex-linked inheritance, such as hemophilia and color-blindness in man.

**Growth and Senescence.**—The body increases rapidly after birth in size and weight. It is the popular idea that the rate of growth increases up to maturity and then declines as old age advances. As a matter of fact, careful examination of the facts shows

that the rate of growth decreases from birth to old age, although not uniformly. At the pubertal period and at other times its downward tendency may be arrested for a time. But, speaking generally, the maximum rate of growth is reached some time during the intra-uterine period, and after birth the curve falls steadily. Senescence has begun to appear at the time we are born.\* Thus, according to the statistics of Quetelet, the average male child weighs at birth  $6\frac{1}{2}$  pounds. At the end of the first year it weighs  $18\frac{1}{2}$  pounds, a gain of 12 pounds. At the end of the second year it weighs 23 pounds, a gain of only  $4\frac{1}{2}$  pounds, and so on, the rate of increase falling rapidly with advancing years. Jackson† has published an interesting series of observations upon the relative and absolute growth of the human fetus and its different organs during the intra-uterine period. Relative growth is defined as the "ratio of the gain during a given period to the weight at the beginning of the period." From this standpoint he finds that the maximum rate of growth occurs during the first month of fetal life. As determined by the volume of the fetus the ovum increases more than 10,000 times in size during this period. In the succeeding months of intra-uterine life the relative monthly growth rate may be expressed by the figures 74, 11, 1.75, .82, .67, .50, .47, .45. During this period the absolute weight is, of course, increasing rapidly, and according to Jackson's observations the total weight of the embryo may be calculated at any time from the formula  $\text{weight (g)} = \left( \frac{\text{Age (days)}}{37} \right)^4$ .

Friedenthal‡ gives the following figures for the growth of the fetus, including the membranes and placenta:

AGE IN DAYS.	WEIGHT IN GMS.	ABSOLUTE INCREASE PER DAY (GMS.).	PERCENTAGE INCREASE PER DAY.
0	0.000004		
8	0.03	0.0037	90,000
17	0.86	0.092	307
20	1.4	0.18	16
26	2.0	0.1	6
35	2.9	0.1	4.5
40	19.0	3.2	29
60	220.0	10.0	8.4
100	800.0	14.5	3.0
120	1200.0	20.0	2.0
196	2800.0	21.0	1.1
250	3800.0	19.0	0.6
280	4500.0	23.0	0.5

The statistics of extra-uterine growth have been collected and tabulated with great care by a number of observers; for this

\* See Minot, "Journal of Physiology," 12, 97.

† Jackson, "The American Journal of Anatomy," 9, 119, 1909.

‡ Friedenthal, "Physiologie d. Menschenwachstums," 1914.



country especially by Bowditch, Porter, and Beyer.\* An interesting feature of the records collected by Bowditch is the proof that the prepubertal acceleration of growth comes earlier in girls than in boys, so that between the ages of twelve and fifteen the average girl is heavier and taller than the boy. Later, the boy's growth is accelerated and his stature and weight increase beyond that of the girl. Robertson† has accumulated some facts which indicate that the growth of the individual does not proceed with a uniformly accelerated or a uniformly retarded velocity, but rather in cycles, each of which, expressed graphically, takes the form of an S-shaped curve. He believes that there are three, possibly four, of these curves. The first begins with the implantation of the ovum and terminates about a year after birth. From observations made on the weights of infants born before and after the normal period he concludes that the increments of weight in each case follow the same curve. An infant born after the normal period has increased in weight while in the uterus as it would have grown in the same period of extra-uterine life. The second cycle starts toward the close of the first year, reaches its maximum at five and one-half years, and then falls off. The third cycle begins at the end of the second, reaches its maximum at puberty, and terminates at adult life. The signs of old age may be detected in other ways than by observations upon the rate of growth. Changes take place in the composition of the tissues; these changes, at first scarcely noticeable, become gradually more obvious as old age advances. The bones become more brittle from an increase in their inorganic salts, the cartilages become more rigid and calcareous, the crystalline lens gradually loses its elasticity, the muscles lose their vigor, the hairs their pigment, the nuclei of the nerve cells become smaller, and so on. In every way there is increasing evidence, as the years grow, that the metabolism of the living matter of the body becomes less and less perfect; the power of the protoplasm itself becomes more and more limited, and we may suppose would eventually fail, bringing about what might be called a natural death. As a matter of fact, death of the organism usually results from the failure of some one of its many complex mechanisms, while the majority of the tissues are still able to maintain their existence if supplied with proper conditions of nourishment. The physiological evidences of an increasing senescence warrant the view, however, that death is a necessary result of the properties of living matter in all the tissues except possibly the reproductive elements.

\* See Bowditch, "Report of State Board of Health of Massachusetts," 1877, 1879, and 1891; Porter, "Transactions, Academy of Science," St. Louis, 1893-94; Beyer, "Proceedings of United States Naval Institute," 21, 297, 1895.

† Robertson, "American Journal of Physiology," 37, 1, 1915.

The course of metabolism is such that it is self-limited, and even if perfect conditions were supplied natural death would eventually result. As a rule, however, death is, so to speak, accidental rather than natural. This point of view was emphasized by Ray Lankester in the distinction which he drew between specific longevity and potential longevity. By specific longevity he designated the expectation of life at birth of a normal individual, this expectation being determined by the interaction of two factors—namely, the innate constitutional properties of the protoplasm and adverse environmental conditions. By potential longevity is meant the duration of life which might be expected under an ideal environment. The average specific longevity, reckoned from birth, is greatest in the most civilized communities and reaches at present the length of forty-five to fifty years. Quite probably the advances of medical knowledge, especially of preventive medicine, may continue to increase the average of this expectation of life. What the potential longevity of man would be if protected from all accidents and disease cannot be stated with any certainty, but on the basis of the exceptional cases of longevity reported we may assume that it would exceed one hundred years. The most authentic of the cases reported of unusual longevity is that of Thomas Parr. An account of his life and the results of a postmortem examination by Harvey are given in Volume III of the "Philosophical Transactions of the Royal Society of London." "He died after he had outlived nine princes, in the tenth year of the tenth of them, at the age of one hundred and fifty-two years and nine months." The immediate cause of his death was attributed to a change of food and air and habits of life, as he was brought from Shropshire to London, "where he fed high and drunk plentifully of the best wines."\* With reference to the phenomenon of senescence as a necessary attribute of living matter, Weissmann has called attention to the fact that inasmuch as the species continues to exist after the individual dies, we must believe that the protoplasm of the reproductive elements is not subject to natural death, but has a self-perpetuating metabolism which under proper conditions makes it immortal. Weissmann† designates the protoplasm of the germ cells as germ-plasm, that of the rest of the body as somatoplasm, and inasmuch as the former continues to propagate itself indefinitely under proper conditions, while the latter has a limited existence, he concludes that originally protoplasm possessed the property of

\* A picture of Parr painted by van Dyck (1635) is exhibited in the Royal Gallery, Dresden, No. 1032.

† Weissmann, "Essays upon Heredity and Kindred Biological Problems"; also "Germ-plasm" in the "Contemporary Science Series."

potential immortality. That is, barring accidents, disease, etc., it was capable of reproducing itself indefinitely. He assumes, moreover, that this property is exhibited at present in many of the simpler forms of life, such as the ameba. This latter phase of his theory has been the subject of much interesting investigation,\* with some contradictory results, but it has been shown (Woodruff) that a specimen of paramecium, isolated and kept in a varying culture-medium during three and a half years, passed through 2000 divisions at an average rate of three in every 48 hours, without the appearance of signs of senility. Later experiments by the same author continued over five years indicated that the single cell originally isolated "possessed the potentiality to produce similar cells to the number represented by 2 raised to the 3029th power, or a volume of protoplasm approximately equal to  $10^{1000}$  times the volume of the earth." Such a result would indicate the essential correctness of Weissmann's view. One of the most significant and definite contributions to the subject of growth has been made by Rubner† upon the basis of the energy factor. His estimates were made upon data collected for man and the following mammalia, horse, cow, sheep, pig, dog, cat, rabbit, and guinea-pig—and they bring out the surprising fact that human growth constitutes a type of its own, differing greatly from that shown by the other mammals named. His conclusions are expressed in two general laws which are founded upon calculations made upon these animals in the first period after birth during the time necessary for doubling the weight of the animal: First, *the law of constant energy consumption*. During the first period of growth the total amount of energy necessary for maintenance (metabolism) and growth, as expressed by the heat value of the food consumed, is the same for all mammals except man. To form one kilogram of animal weight requires in round numbers 4808 Calories in food; while for man about six times this amount is needed. Since the several mammals considered require very different times to double their weight, it follows from this law that the shorter the time necessary for this result the more intense will be the metabolism, or, expressed in another way, the rapidity of growth is proportional to the intensity of the metabolic processes. Second, *the law of the constant growth quotient*. In all the mammals considered, with the exception of man, the same fractional part of the entire food energy is utilized for growth. This fractional portion is designated as the "growth-quotient," and it averages 34 per cent., that is to say, for every

\* See Maupas, "Archives de zoologie expérimentale et générale," 6, 165, 1888; Götze, "Ueber den Ursprung des Todes," 1883; Woodruff, "American Naturalist," 42, 500; also "Archiv f. Protistenkunde," 21, 263, 1911.

† Rubner, "Das Problem der Lebensdauer," etc., Berlin, 1908.

1000 calories of food 340 calories are applied to growth. In man, on the contrary, the growth quotient is only 5 per cent. This growth quotient is a specific property of the cell and a characteristic of youthfulness. It has its maximal value at birth, so far as extra-uterine life is concerned, and then sinks slowly, so that at maturity, that is, at the end of the growth period, it becomes zero. Thence forward the energy of the food is utilized only for the maintenance of the cells and for the work they perform, none is applied to growth. Rubner suggests that the power to grow possessed by the cells of the young organism depends upon some special mechanisms of a chemical nature, that is, probably certain special chemical complexes which are responsible for the "growth tendency" (Wachstumstrieb). In connection with this growth energy or growth tendency it will be remembered that in the chapter on Internal Secretion evidence was given that in early infancy the thymus forms apparently an internal secretion or hormone which controls or stimulates the process of growth, and the anterior lobe of the pituitary gland also forms an internal secretion which has a similar action. It will be noted also that both of these glands affect mainly the growth of the skeleton. The increase in size of an animal is normally estimated largely from the growth of the skeleton, and Aron has shown in a most interesting way that the growth energy resides chiefly in this tissue. According to this author, young growing dogs if given a diet insufficient to maintain their body weight will still continue to grow, since the skeleton increases in size at the expense of the other tissues, particularly of the muscular tissues. The growth tendency in the skeletal tissue is so strong that other tissues are absorbed to furnish the necessary material. This marked growth tendency of the skeleton, as we have just said, is controlled or stimulated by secretions from the thymus and hypophysis and possibly from other sources. The fact that a tissue in which the growth tendency is marked will live at the expense of other tissues finds an illustration in other ways, for example, in the development of malignant growths, such as cancer or in the processes of regeneration in the lower forms of life. Stockhard reports that in the medusa, when unfed, a regenerating tissue may grow rapidly by feeding on the old body tissues. It would seem that this tendency to grow must, as Rubner suggests, depend upon some peculiarity in the chemical structure of the tissue which exhibits it. Moreover, there is considerable evidence that for growth to take place certain specific building materials must be furnished in the diet. As stated on p. 902, Osborne and Mendel have shown that in growing rats certain proteins supply this material; other proteins apparently are lacking in it, but may

yield material adequate for maintenance of the *status quo*, while still others are inadequate either for maintenance or growth. It will be recalled also that it is claimed that certain specific nitrogenous substances, the so-called vitamins, must also be furnished in the food for special metabolisms of the body that are essential to life. It would seem possible that scientific investigations may eventually enable us to control or even prolong the period of growth through dietary treatment.

After the period of maturity has been reached the question arises whether the subsequent duration of life can be foretold or formulated in any definite way. The older naturalists conceived that the duration of mature life might represent a definite multiple of the period of youth. According to Buffon this multiple is 6 to 7, according to Flourens it is 5—that is, the mean duration of life is 5 to 7 times that required for the completion of growth. The data gathered in regard to the average duration of life among different animals have not borne out these suggestions, and Rubner discusses the matter again from the energy standpoint. He estimates the number of calories of food which are required for each kilogram of body weight in the different mammalia from the end of the period of youth to the end of life. For man this period is estimated at sixty years (20 to 80). On this basis he finds that each human kilogram requires 725,770 Calories, while for the other mammalia for which data are accessible an average of only 191,600 Calories is required, and the figures in the latter animals are so close as almost to warrant the belief that the same amount is required by each animal in spite of the great variations in the duration of life. It follows from these figures that the human cell is characterized, as compared with that of the other mammalia, by its much greater total capacity for obtaining energy from the foodstuffs. This capacity, the property of assimilation, implies chemical changes and transformations in the living matter, and the fact that eventually this property languishes and expires, that is, the fact that there is such a thing as natural or physiological death, means that the somatic protoplasm is capable of effecting only a limited number of such transformations. In man a greater number is possible than in the other mammals, and among the latter the number is practically the same, but in the smaller animals, with their more intense metabolism, the series is completed in a shorter time than in the case of the larger animals. Rubner states, moreover, that if a cell, the yeast cell, for example, by artificial means is forced to live without growing and multiplying it dies in a very short time. In some way the processes of growth contain the very source of the maintenance of life. The injurious by-products which accompany simple metabolism in the

living matter are in some way obviated or neutralized by the growth changes. Rubner suggests, somewhat in the line of Darwin's theory of pangenesis and of Weissmann's theory of the cause of death in the somatoplasm, that the body-cells give off certain molecular complexes which are necessary to the growth processes, and these complexes are taken up by the reproductive cells. After the animal has reached the period of puberty, of reproductive power, and provision is thus made for the perpetuation of the species, the individual organism is depleted of the power of growth and senescence and death become inevitable. There are no actual facts at present to support such a view and, indeed, it is at variance with prevalent ideas regarding the lack of direct influence of the somatic cells upon the germ cells.

## APPENDIX.

### PROTEINS AND THEIR CLASSIFICATION.

**Definition and General Structure.**—Proteins or albumins are complex organic compounds containing nitrogen which, although differing much in their composition, are related in their properties. They are formed by living matter, and occur in the tissues and liquids of plants and animals, of which they form the most characteristic constituent. On ultimate analysis they are all found to contain carbon, hydrogen, oxygen, and nitrogen; most of them contain also some sulphur, and some, in addition, phosphorus or iron. As usually obtained, they leave also some ash when incinerated, showing that they hold in combination some inorganic salts. Percentage analyses of the most common proteins of the body show that the above named constituents occur in the following proportions:

Carbon .....	50	to	55	per cent.
Hydrogen .....	6.5	to	7.3	“ “
Nitrogen .....	15	to	17.6	“ “
Oxygen .....	19	to	24	“ “
Sulphur.....	0.3	to	2.4	“ “

The clearest insight into the structure of the protein molecule has been obtained by a study of its decomposition products. When submitted to the action of proteolytic enzymes, or putrefaction, or acid at high temperatures, the large molecules split into a number of simpler bodies in consequence of hydrolytic cleavage. These end-products are very numerous, and, while they differ somewhat for the different proteins, yet a number of them are the same or similar for all proteins. The great variety in the end-products is an indication of the complexity of the molecule, while their similarity is proof that the various proteins are all built, so to speak, upon a common plan, by the union of certain groupings which may be more numerous in one protein than in another. This fact becomes evident from a brief consideration of the products obtained by hydrolytic cleavage with acids. The groupings represented by the following compounds may be supposed to exist preformed in protein molecules, some possibly containing them all, some only a portion of the list, while the different groups vary in their proportional amounts in the various proteins (see p. 793):

#### *Amino-acids.*

1. Glycocoll or glycine (amino-acetic acid).
2. Alanin (aminopropionic acid).
3. Valin (aminovalerianic acid).
4. Leucin (aminocaproic acid).
5. Isoleucin (aminocaproic acid).
6. Norleucin (aminocaproic acid).
7. Lysin (diaminocaproic acid).
8. Serin (oxyaminopropionic acid).
9. Cystein (aminothiopropionic acid).
10. Phenylalanin (phenylaminopropionic acid).
11. Tyrosin (oxyphenylaminopropionic acid).
12. Tryptophan (indolaminopropionic acid).
13. Histidin (imidazolaminopropionic acid).
14. Arginin (guanidinaminovalerianic acid).
15. Aspartic acid (aminosuccinic acid).
16. Glutaminic acid (aminoglutaric acid).
17. Prolin (pyrrolidin-carboxylic acid).
18. Oxyprolin (oxyprolidin-carboxylic acid).

These split products are all amino-acids, some of them belonging to the fatty acid (aliphatic) series of carbon compounds, some to the aromatic (carbocyclic) series, and some to the heterocyclic (pyrrol, indol) series. In what may be considered the simplest proteins occurring in nature—namely, the protamins found in the spermatozoa—only from four to six of these groups occur, while in some of the more familiar proteins, such as serum-albumin or casein, a much larger number is found. This fact is illustrated by the following table, taken from Aberhalden, which shows the composition of several proteins belonging to different classes. It will be noted that except for the salmin the known products sum up to less than 100 per cent., showing that there is a large portion of the molecule as yet unknown.

	SERUM ALBUMIN.	SERUM GLOBULIN.	CASEIN.	SALMIN.
Glycin.....	0	3.5	0	
Alanin.....	2.7	2.2	0.9	
Valin.....	.....	present	1.0	4.3
Leucin.....	20.0	18.7	10.5	
Prolin.....	1.0	2.8	3.1	11.0
Phenylalamin.....	3.1	3.8	3.2	
Glutaminic acid.....	7.7	8.5	11.0	
Aspartic acid.....	3.1	2.5	1.2	
Cystin.....	2.3	0.7	.065	
Serin.....	0.6	.....	0.23	7.8
Tyrosin.....	2.1	2.5	4.5	
Tryptophan.....	present	present	1.5	
Diaminotrioxylodecoic acid....	.....	.....	0.75	
Oxyprolin.....	.....	.....	0.25	
Lysin.....	.....	.....	5.80	
Arginin.....	.....	.....	4.84	87.4
Histidin.....	.....	.....	2.59	

The *α*-amino-acids of which these end-products consist all contain the

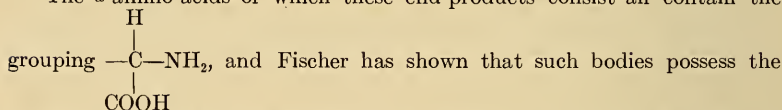

property of combining with one another to make complex molecules containing two, three, or more groups of amino-acids. The combination takes place with the elimination of water formed by the union of the OH of the carboxyl (COOH) group in one acid and the H of the amino (NH<sub>2</sub>) group in another. Thus, two molecules of amino-acetic acid (glycocoll) may be made to unite to form a compound, glycylglycin, as follows:

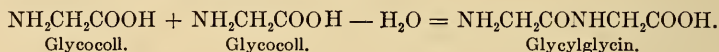

Compounds of this kind are designated by Fischer as peptids. When formed from the union of two amino-acids they are known as dipeptids; from three, as tripeptids, etc. The more complicated compounds of this sort, the polypeptids, begin to show reactions similar to those of the proteins. Some of them give the biuret reaction, some are acted upon and split by proteolytic enzymes. It seems justifiable, therefore, to consider proteins as essentially polypeptid compounds of greater or less complexity—that is, they are acid-amids formed by the union of a number of *α*-amino-acid compounds. More than a hundred of these artificial polypeptids have been thus synthesized, one of the most complex, an octa-deca peptid, consisting of eighteen mon-amino acids, fifteen molecules of glycin, and three of leucin, with a total molecular weight of 1213. This conception of the structure of the protein molecule explains a number of their general characteristics—for instance: (1) The fact that they are all decomposed and yield similar products under the influence of proteolytic enzymes or boiling dilute acid. (2) The fact that the proteins



are all so alike in their general properties in spite of the great differences in the complexity of their molecular structure. (3) The fact that they show both basic and acid characters. (4) The fact that they all give the biuret reaction\* (see below).

In addition to the amino-acids some proteins—egg-albumin, for example—yield a carbohydrate body upon decomposition. The carbohydrate obtained is an amino-sugar compound, usually glucosamin,  $C_6H_{13}NO_5$ . It is detected by its reducing action and by the formation of an osazone. It seems probable, therefore, that some of the proteins at least contain such a grouping as part of the molecular complex, but at present it is undetermined how many possess this peculiarity of structure.

**General Reactions of the Proteins.**—It is evident from what has been said in the preceding paragraph that proteins may give different reactions according to the kinds of groupings contained in the molecule. The reactions common to all proteins are few in number, the most certain perhaps being the biuret reaction, the hydrolysis by proteolytic enzymes or putrefactive organisms, and the nature of the split products formed by these latter hydrolyses or by the action of boiling dilute acids. A very large number of reactions, however, have been described which hold for some or all of the proteins usually found in the tissues and liquids of the body. These reactions may be described under two heads: (1) Precipitation of the protein when in solution; (2) color reactions.

**1. Precipitants.**—For one or another protein the following reagents cause precipitation:

1. The addition of an excess of alcohol.
2. Boiling (heat coagulation).
3. The addition of mineral acids,—*e. g.*, nitric acid.
4. The salts of the heavy metals,—*e. g.*, acetate of lead, copper sulphate, etc.
5. Addition of neutral salts of the alkalis to a greater or less degree of concentration,—*e. g.*, sodium chlorid, ammonium sulphate.
6. Ferrocyanid of potassium after previous acidification by acetic acid.
7. Tannic acid after previous acidification by acetic acid.
8. Phosphotungstic or phosphomolybdic acid in the presence of free mineral acids.
9. Iodin in solution in potassium iodid, after previous acidification with a mineral acid.
10. Picric acid in solutions acidified by organic acids.
11. Trichloroacetic acid.

This list might be extended still further, but it comprises the precipitating reagents that are ordinarily used. Some of them, particularly Nos. 7, 8, and 9, give reactions in solutions containing excessively minute traces of protein.

12. **Precipitins.** In this connection a brief reference may be made to the interesting group of bodies known as precipitins. As stated on p. 424, the animal organism has the power, when foreign cells are injected into it, of forming anti-bodies by a specific biological reaction. It has been discovered that anti-bodies or, as they are called in this case, precipitins may be produced in the same way if protein solutions or solutions of animal tissue are injected into the circulation. Thus, if cows' milk be injected under the skin of a rabbit there will be produced within the rabbit's blood a precipitin which is capable of precipitating the casein of cows' milk, although it may have no action on the milk of other animals. In the same way any given foreign protein, when injected under the skin of an animal, may cause the production of a precipitin capable of precipitating that particular protein from its solutions. The precipitin is not absolutely specific for the protein used to produce it, but nearly so. If a rabbit is immunized with

\* For further details, see Cohnheim, "Chemie der Eiweisskörper," second edition, 1904; or Abderhalden, "Lehrbuch d. physiol. Chemie," 1914; and Rosenheim, in "Science Progress," April and July, 1908.

human blood a precipitin is produced in the animal's blood which causes a precipitate when mixed with human blood or with that of some of the higher monkeys, but gives no reaction with the blood of other mammals. The reaction may be used, therefore, in a measure to test the blood-relationship of different animals.\* It has been suggested that the reaction may also be of practical importance in medicolegal cases, in determining whether a given blood-stain is or is not human blood. For such a purpose a human antiserum is first produced by injecting human serum into a rabbit. The serum of the rabbit is then mixed with an extract of the suspected blood-stain made with salt solution; if a precipitate forms it proves that the blood stain is human blood provided the possibility of its being monkey's blood is excluded. Concerning the nature of the precipitins, little is known. They combine quantitatively with the protein precipitated and they are inactivated (hematosera) by a temperature of 70° C. Their reactions are not sufficiently specific to be used as a means of detecting or distinguishing closely related proteins.

## II. The Color Reactions of Proteins.

1. The biuret reaction. The protein solution is made strongly alkaline with caustic soda or potash and a few drops of a dilute solution of copper sulphate are added carefully so as to avoid an excess. A purple color is obtained. Some proteins (peptones) give a red purple, others a blue purple. If only a blue color, without any mixture of red, is obtained, no protein is present. At present this reaction gives the best single test for protein. It obtains its name from the fact that it is given by biuret  $\text{HN} < \begin{matrix} \text{CONH}_2 \\ \text{CONH}_2 \end{matrix}$ , a compound that may be formed by heating urea. Two molecules of urea give off a molecule of ammonia and form biuret.
2. The ninhydrin reaction. Proteins and some of their split products give a blue reaction with ninhydrin (triketohydrindene hydrate). This reaction is especially useful in testing for the amino-acids or peptids when the hydrolysis of the protein has gone so far that a biuret reaction is no longer given. One to two drops of the reagent are added to 1 c.c. of the suspected liquid, and the solution is heated to boiling. On cooling, a blue color develops if  $\alpha$ -amino-acids or their derivatives are present.
3. The Millon reaction. The protein solution is boiled with Millon's reagent. The solution or the precipitate, if one is formed, takes on a reddish color, which varies in intensity with different proteins. Millon's reagent consists of a solution of mercuric nitrate in nitric acid containing some mercurous nitrate. This reaction is supposed to be given by the tyrosin (oxy-aromatic) grouping in the protein molecule, and fails, therefore, with those proteins in which tyrosin is not present.
4. Tyrosin reagent. Folin and Denis† report a new color reaction for the detection of phenol compounds which may be used for the quantitative determination of tyrosin. The reagent consists of sodium tungstate, 10 per cent.; phosphomolybdic acid, 2 per cent.; and phosphoric acid, 10 per cent. After addition of the reagent the blue color is developed by further addition of an excess of a saturated solution of sodium carbonate.
5. The xanthoproteic reaction. Nitric acid is added to strong acid reaction and the solution is then boiled. After cooling, ammonia is added. The ammonia causes the development of a deep-yellow color if protein is present. This reaction is supposed to be due to the presence in the molecule of the groupings belonging to the aromatic series.

\* For many interesting experiments and the literature, see Nuttall, "Blood Immunity and Relationship," Cambridge, 1904.

† Folin and Denis, "Journal of Biological Chemistry," 12, 240, 1912.

6. Adamkiewicz's reaction. A mixture is made of one volume of concentrated sulphuric and two volumes of glacial acetic acid; if the protein solution is added to this mixture and warmed a reddish-violet color is obtained. According to Hopkins and Cole, the reaction depends upon the presence of glyoxylic acid in the acetic acid, but according to Homer it is really a formaldehyd reaction. The action of the sulphuric acid upon the glyoxylic acid produces some formaldehyd. This reaction seems to be due to the tryptophan grouping in the protein molecule.
7. Liebermann's reaction. Dry protein purified with alcohol and ether gives a blue color upon boiling with strong hydrochloric acid.
8. The lead sulphid reaction. The protein solution is boiled with a solution of a lead salt made strongly alkaline with soda or potash. A black precipitate or black or brown coloration results, according to the amount of protein. The color is due to the splitting off of sulphur and formation of lead sulphid. It is given, therefore, by the sulphur-containing groups in the protein molecule.
9. The Molisch reaction. A few drops of an alcoholic solution of  $\alpha$ -naphthol are added to the protein solution and then strong sulphuric acid. A violet color is obtained. This reaction is given by the carbohydrate grouping in the protein molecule. The strong acid forms furfural from this group, which then reacts with the naphthol. The reaction is not given by those proteins that do not contain a carbohydrate group.

**Classification of the Proteins.**—No classification of the proteins has been proposed which is entirely satisfactory. Eventually a classification may be obtained based upon the chemical structure of the various proteins, the number and arrangement of the constituent amino bodies, but our knowledge at present is much too incomplete for this purpose. We must be content with a less satisfactory system based in part upon empirical reactions which have gradually been recognized in the course of physiological investigations.

In the following classification the recommendations are followed of the Joint Committee on Protein Nomenclature appointed by the American Physiological Society and the American Society of Biological Chemists ("American Journal of Physiology, Proc. Physiol. Soc.," vol. xxi., 1908):

- |  |  |  |   |  |  |   |   |                                       |
|--|--|--|---|--|--|---|---|---------------------------------------|
| I. Simple proteins (protein substances which yield only $\alpha$ -amino acids or their derivatives on hydrolysis).                           | {  | Albumins.<br>Globulins.<br>Glutelins.<br>Alcohol-soluble proteins (prolamines).<br>Albuminoids.<br>Histons.<br>Protamins.  |   |  |  |   |   |                                       |
| II. Conjugated proteins (substances which contain the protein molecule united to some other molecule or molecules otherwise than as a salt). | {  | Glycoproteins.<br>Nucleoproteins.<br>Hemoglobins (chromoproteins).<br>Phosphoproteins.<br>Lecithoproteins.   |   |  |  |   |   |                                       |
| III. Derived proteins  | {  | <table style="border: none;"> <tr> <td style="vertical-align: middle;">{</td> <td style="vertical-align: middle;">Primary protein derivatives (formed through hydrolytic changes which cause only slight alterations of the protein molecule).</td> <td style="vertical-align: middle;">} Proteans.<br/>Metaproteins.<br/>Coagulated proteins.</td> </tr> <tr> <td style="vertical-align: middle;">{</td> <td style="vertical-align: middle;">Secondary protein derivatives. (Products of further hydrolytic cleavage of the protein molecule.)</td> <td style="vertical-align: middle;">} Proteoses.<br/>Peptones.<br/>Peptids.</td> </tr> </table> | { | Primary protein derivatives (formed through hydrolytic changes which cause only slight alterations of the protein molecule). | } Proteans.<br>Metaproteins.<br>Coagulated proteins. | { | Secondary protein derivatives. (Products of further hydrolytic cleavage of the protein molecule.) | } Proteoses.<br>Peptones.<br>Peptids. |
| {  | Primary protein derivatives (formed through hydrolytic changes which cause only slight alterations of the protein molecule). | } Proteans.<br>Metaproteins.<br>Coagulated proteins.   |   |  |  |   |   |                                       |
| {  | Secondary protein derivatives. (Products of further hydrolytic cleavage of the protein molecule.)                            | } Proteoses.<br>Peptones.<br>Peptids.  |   |  |  |   |   |                                       |

**The Albumins.**—In addition to the albumins found in the cellular tissues, the cell albumins, the conspicuous examples of this group are serum-

albumin, milk-albumin (lactalbumin), and egg-albumin (ovalbumin). They are characterized as a class by the fact that they are coagulable by heat in solutions with a neutral or acid reaction, and are soluble in water free from salts. In accordance with the latter part of this definition they are not precipitated by dialysis. They are precipitated from their solutions with more difficulty by saturation with neutral salts, ammonium sulphate, than the globulins with which they are usually associated. Empirically, as regards the liquids of the body, it is stated that they require more than half saturation with ammonium sulphate for precipitation (see section on Blood). All three albumins referred to here may be obtained in crystallized form. They are not precipitated by saturation with sodium chloride or magnesium sulphate unless the solution is made acid. They are rich in sulphur, containing from 1.6 to 2.2 per cent., and on hydrolysis they yield no glycocholl.

**The Globulins.**—Proteins belonging to this group are found in the cell tissues together with albumins. The forms that have been most studied are serum-globulin (paraglobulin) and fibrinogen (blood, lymph, and transudata), milk-globulin (lactoglobulin), and egg-globulin. As contrasted with the albumins, they are coagulable by heat, but are insoluble in pure water. They are readily soluble in dilute solutions of neutral salts, that is, salts of strong bases with strong acids. In consequence of their insolubility in water they are precipitated by dialysis. This reaction is not distinctive, however, as the precipitation is not complete. Some of the so-called globulin remains in solution after the salts have been removed as completely as possible by dialysis. They are also precipitated partially from their dilute solutions by the addition of weak acids or by a stream of carbon dioxide. Practically they are isolated from accompanying albumins by precipitation with neutral salts. In neutral solutions the globulins are completely precipitated by saturation with magnesium sulphate or half saturation with ammonium sulphate. In the blood several different forms of globulin are distinguished by the degree of saturation with ammonium sulphate necessary for their precipitation (see Blood). The separations made by this method are not, however, satisfactory. Nor, indeed, is the separation between globulins and albumins altogether satisfactory. It would seem that these proteins are so closely related that distinctive reactions are difficult to obtain on account of the existence of forms intermediate between the extremes that are used as types.

**The Glutelins.**—These proteins occur in abundance in the seeds of cereals. They are insoluble in all neutral solvents, but are readily dissolved by very dilute acids or alkalis.

**Alcohol-soluble Proteins (Prolamines).**—Found in quantity in cereals, but not in other seeds. They are soluble in alcohol (70–80 per cent.), but insoluble in water or in absolute alcohol. Gliadin of wheat and rye and hordein of barley are examples. On hydrolysis these proteins give a very large percentage of glutamic acid (20 to 37 per cent.) and from 20 to 30 per cent. of their nitrogen is given off as ammonia.\*

**Albuminoids.**—Simple proteins which are characterized by great insolubility in all neutral solvents. They form the principle constituent of the skeletal tissues and connective tissues, epidermis, hairs, etc., including such members as elastin, keratin, and collagen. Physiologically it has been found that gelatin, a derivative of collagen, does not suffice for the construction of living protein, and cannot be used in place of the other proteins to maintain nitrogen equilibrium. This peculiarity seems to be due to the absence of certain necessary amino-acids in its molecule. (See p. 902.)

**Protamins and Histons.**—The histons are defined as being soluble in water and insoluble in very dilute ammonia. They yield precipitates with solutions of other proteins and give a coagulum on heating. Protamins are soluble in water, not coagulated by heating, and, like the histons, have the property of precipitating other proteins in aqueous solutions. They possess strong basic properties and form stable salts. The protamins have been obtained (Miescher-Kossel) from the heads of the spermatozoa in fishes, in which they exist in combination with nucleic acid. They differ considerably

\* For description of this and other vegetable proteins, see Osborne, "Science," Oct. 2, 1908.

in the spermatozoa of different animals, and are, therefore, designated according to the zoological name of the fish from which they arise, as salmin, sturin, clupein, scombrin, etc. They show a biuret reaction, but in most cases fail to give Millon's reaction. On hydrolysis they give split products, which consist chiefly of the so-called diamino-bodies (arginin, histidin, lysin) rather than the monamino-acids. Some of the latter may occur, however, such as alanin, serin, aminovalerianic or  $\alpha$ -pyrrolidin-carboxylic acid. The protamins all give an alkaline reaction, form salts with acids, and are precipitated easily. Their molecular structure is relatively simple. Salmin is given the formula  $C_{30}H_{57}C_{17}H_6$ . The molecule contains no sulphur and is characterized also by its large percentage of nitrogen. Protamin must be regarded as the simplest form of protein occurring normally in the animal body, a protein in which many of the groupings, such as cystin, tyrosin, carbohydrates, found in the usual protein molecule are entirely lacking and in which the basic groupings (arginin) predominate. The histons form a series of compounds intermediate in many ways between the protamins and the usual proteins. The reaction usually considered as characteristic of the class is that they are precipitated by ammonia. They are precipitated also by the alkaloidal reagents—*e. g.*, phosphotungstic acid—in neutral solutions. Ordinary proteins give a precipitate with these reagents only in acid solutions, while the protamins give one even in alkaline solutions. Protamins, histons, and the usual proteins form a series, therefore, in which the basic reaction is less and less marked. The best known of the histons is the globin obtained from hemoglobin; another form has been obtained from the nucleohiston in the white corpuscles, from the spermatozoa of mackerel (scombrin), codfish (gadushiston), sea-urchin (arbacin), and frog (lotahiston). They do not occur free in the liquids or tissues of the body, but in combination, as in the case of hemoglobin. They give the biuret reaction, a faint Millon reaction, and also respond to the tests for sulphur. The products obtained by their hydrolytic cleavage are much more numerous than in the case of the protamins—a fact which would indicate that their molecular structure is correspondingly more complex.

**The Conjugated Proteins.**—The *chromoproteins* or *hemoglobins* may be defined as consisting of a simple protein in combination with a pigment grouping, such as occurs in the case of hemoglobin. A number of such compounds are known—hemoglobin, hemocyanin, hemerythrin, chlorocruorin—all characterized physiologically by the fact that they serve to transport oxygen from the air or water to the tissues. On boiling, heating with alkalis or acids, etc., they readily decompose into their constituent parts (see Blood). *Glycoproteins* are compounds of a carbohydrate group with a simple protein. Numerous bodies have been put in this class; some of them contain phosphorus (phosphoglucoproteins). Those free from phosphorus fall into two divisions: one, the mucins, which on decomposition yield the carbohydrate group in the form of an amino-sugar (glucosamin), and one, the chondroproteins, found in the connective tissues and in the pathological substance known as amyloid, which yield their carbohydrate group in the form of chondroitin-sulphuric acid ( $C_{18}H_{27}NSO_{17}$ ). True mucin is obtained from the secretion of the salivary glands and the mucous glands of the various mucous membranes. The *nucleoproteins* constitute the most interesting of the group of compound proteins. They are recognized as forming an important constituent of the cell nuclei. They may be defined as consisting of a compound of simple protein with a nucleic acid. In the nuclei (head) of spermatozoa the compound, in some cases at least (fishes), contains a nucleic acid and a protamin. In other cases the protein constituent is more complex. On digestion with pepsin-hydrochloric acid the more complex nucleoproteins split, with the formation, first, of a protein substance and a simpler nucleoprotein, richer in phosphorus and designated as a nuclein. On further decomposition this latter yields a nucleic acid. Nucleic acid is, therefore, the characteristic constituent, and a number of different forms have been described, all rich in phosphorus, such as thymonucleic acid, salmonnucleic acid, guanylic acid, etc. Levene and Jacobs have shown that the various nucleic acids are constructed on a general type which consists of a phosphoric acid group linked to a nitrogenous base by means of a carbohydrate group. This latter group is *d* ribose, one of the pentoses. Compounds of this type

they propose to designate as nucleotides. When the phosphoric acid is split off a compound of the carbohydrate and the nitrogenous base is left, and on further hydrolysis the carbohydrate may be split off and various nitrogenous substances be formed, such as purin bases or pyrimidin derivatives. These final decomposition products are characteristic of the true nucleoproteins as distinguished from the phosphorus-containing proteins, the nucleo-albumins or phosphoproteins, such as casein. The percentage of phosphorus in the nucleoproteins varies, according to the complexity of the molecule, between 0.5 and 1.6 per cent.

The *lecithoproteins* consist of compounds of the protein molecule with lecithin (lecithans, phosphatids), while the *phosphoproteins* are compounds of the protein molecule with some, as yet undefined, phosphorus-containing substance other than a nucleic acid or lecithin. This group contains such proteins as the vitellin of the yolk and casein of milk, which were formerly designated as nucleo-albumins.

**The Derived Proteins.**—Under this designation are included products derived from the simple proteins by hydrolysis. When the hydrolytic change involves only a slight change in the protein molecule we have what are known as primary derivatives, of which three groups are made: (1) Proteans, certain insoluble products which result from the incipient action of water, enzymes, or very dilute acids. (2) Metaproteins, products which result from the further action of acids or alkalis, by means of which the protein is converted into a form soluble in weak acids or alkalis, but precipitated on neutralization. This group includes what was formerly designated as acid or alkali albumin. (3) Coagulated protein—insoluble products formed by the action of heat, alcohol, etc.

If the hydrolysis proceeds further, certain cleavage products result which are simpler than these just named, but are more complex than the final products of complete hydrolysis (amino-acids). These intermediate cleavage products are grouped under the term secondary derivatives and include: (1) *Proteoses*, products which are soluble in water, not coagulated by heat, and are completely precipitated by saturation with ammonium sulphate or zinc sulphate. (2) *Peptones*, products which are soluble in water, are not coagulated by heat, and are not precipitated by saturation with ammonium sulphate. (3) *Peptids*, products which consist of two or more amino-acids in which the carboxyl group of one is united with the amino group of another, with the elimination of a molecule of water. The peptones probably are simply polypeptids or mixtures of polypeptids.

## DIFFUSION AND OSMOSIS.

In recent years the physical conceptions of the nature of the processes of diffusion and osmosis have changed considerably. As these newer conceptions have entered largely into current medical literature, it seems advisable to give a brief description of them for the use of those students of physiology who may be unacquainted with the modern nomenclature. The very limited space that can be devoted to the subject forbids anything more than a condensed elementary presentation. For fuller information reference must be made to special treatises.\*

**Diffusion, Dialysis, and Osmosis.**—When two gases are brought into contact a homogeneous mixture of the two is soon obtained. This interpenetration of the gases is spoken of as diffusion, and it is due to the continual movements of the gaseous molecules to and fro within the limits of the confining space. So also when two miscible liquids or solutions are brought into contact a diffusion occurs for the same reason, the movements of the molecules finally effecting a homogeneous mixture. If the two liquids happen to be separated by a membrane diffusion will still occur, provided the membrane is permeable to the liquid molecules, and in time the liquids

\* Consult Cohen, "Physical Chemistry for Physicians and Biologists," translated by Fischer, 1903. H. C. Jones, "The Theory of Electrolytic Dissociation," 1900; "Diffusion Osmosis, and Filtration," by E. W. Reid, in Schäfer's "Text-book of Physiology," 1898.

on the two sides will be mixtures having a uniform composition. Not only water molecules, but the molecules of many substances in solution, such as sugar, may pass to and fro through membranes, so that two liquids separated from each other by an intervening membrane and originally unlike in composition may finally, by the act of diffusion, come to have the same composition. Diffusion of this kind through a membrane is frequently spoken of as dialysis or osmosis. In the body we deal with aqueous solutions of various substances that are separated from each other by living membranes, such as the walls of the blood capillaries or of the alimentary canal, and the laws of diffusion through membranes are of immediate importance in explaining the passage of water and dissolved substances through these living septa. In aqueous solutions such as we have in the body we must take into account the movements of the molecules of the solvent, water, as well as of the substances dissolved. These latter may have different degrees of diffusibility as compared with one another or with the water molecules, and it frequently happens that a membrane that is permeable to water molecules is less permeable or even impermeable to the molecules of the substances in solution. For this reason the diffusion stream of water and of the dissolved substances may be differentiated, as it were, to a greater or less extent. The energy or force responsible for the diffusion of molecules in solution is an outcome of the intrinsic energy of the molecules which keeps them in movement. This energy is designated as osmotic pressure. It can be measured accurately, although its exact nature is not understood.

**Osmotic Pressure.**—If we imagine two masses of water separated by a permeable membrane, we can readily understand that as many water molecules will pass through from one side as from the other; the two streams, in fact, will neutralize each other, and the volumes of the two masses of water will remain unchanged. The movement of the water molecules in this case is not actually observed, but it is assumed to take place on the theory that the liquid molecules are continually in motion and that the membrane, being permeable, offers no obstacle to their movements. If, now, on one side of the membrane we place a solution of some crystalloid substance, such as common salt, and on the other side pure water, then it will be found that an excess of water will pass from the water side to the side containing the solution. In the older terminology it was said that the salt attracted this water, but in the newer theories the same fact is expressed by saying that the salt in solution exerts a certain osmotic pressure, in consequence of which more water flows from the water side to the side of the solution than in the reverse direction. As a matter of experiment it is found that the osmotic pressure varies with the amount of the substance in solution. If in experiments of this kind a semipermeable membrane is chosen—that is, a membrane that is permeable to the water molecules, but not to the molecules of the substance in solution—the stream of water to the side of the crystalloid will continue until the hydrostatic pressure on this side reaches a certain point, and the hydrostatic pressure thus caused may be taken as a measure of the osmotic pressure exerted by the substance in solution. Under these conditions it can be shown that the osmotic pressure is proportional to the concentration of the solution, or, in other words, to the number of molecules (and ions) of the crystalloid in solution. As a matter of fact, most of the membranes that we have to deal with in the body are only approximately semipermeable—that is, while they are readily permeable to water molecules, they are also permeable, although with more or less difficulty, to the substances in solution. In such cases we get an osmotic stream of water to the side of the dissolved crystalloid, but at the same time the molecules of the latter pass to some extent through the membrane, by diffusion, to the other side. In course of time, therefore, the dissolved crystalloid will be equally distributed on the two sides of the membrane, the osmotic pressure on both sides will become equal, and osmosis of the water will cease to be apparent, since it is equal in the two directions. All substances in true solution are capable of exerting osmotic pressure, and the important discovery has been made that the osmotic pressure, measured in terms of atmospheres or the pressure of a column of water or mercury, is equal to the gas pressure that would be exerted by a number of

molecules of gas equal to that of the crystalloid in solution, if confined within the same space and kept at the same temperature.\* A perfectly satisfactory explanation of the nature of osmotic pressure has not been furnished. We must be content to use the term to express the fact described. It is a matter of great importance to measure the osmotic pressures of various solutions. As was stated above, this measurement can be made for any solution provided a really semipermeable membrane is constructed. As a matter of fact, however, the use of such membranes has not been general. In actual experiments other methods have been employed, and a brief statement of a theoretical and a practical method of arriving at the value of osmotic pressures may be of service in further illustrating the meaning of the term. Before stating these methods it becomes necessary to define two terms—namely, electrolytes and gram-molecular solutions—that are much used in this connection.

**Electrolytes.**—The molecules of many substances when brought into a state of solution are believed to be dissociated into two or more parts, known as ions. The completeness of the dissociation varies with the substance used, and for any one substance with the degree of dilution. Roughly speaking, the greater the dilution, the more nearly complete is the dissociation. The ions liberated by this act of dissociation carry an electrical charge and when an electrical current is led into the solution it is conducted in a definite direction by the movements or migration of the charged ions. The molecules of perfectly pure water undergo almost no dissociation, and water, therefore, does not appreciably conduct the electrical current. If some NaCl is dissolved in water, a certain number of its molecules become dissociated into a Na ion charged positively with electricity and a Cl ion charged negatively, and the solution becomes a conductor of the electrical current. Substances that exhibit this property of dissociation into electrically-charged ions are known as electrolytes, to distinguish them from other soluble substances, such as sugar, that do not dissociate in solution and, therefore, do not conduct the electrical current. Speaking generally, it may be said that all salts, bases, and acids belong to the group of electrolytes. The conception of electrolytes is very important for the reason that the act of dissociation obviously increases the number of particles moving in the solution and thereby increases the osmotic pressure, since it has been found experimentally that, so far as osmotic pressures are concerned, an ion plays the same part as a molecule. It follows, therefore, that the osmotic pressure of any given electrolyte in solution is increased in proportion to the degree to which it is dissociated. As the liquids of the body contain electrolytes in solution it becomes necessary, in estimating their osmotic pressure, to take this fact into consideration.

**Gram-molecular Solutions.**—The concentration of a given substance in solution may be stated by the usual method of percentages, but from the standpoint of osmotic pressure a more convenient method is the use of the unit known as a gram-molecular solution. A gram-molecule of any substance is a quantity in grams of the substance equal to its molecular weight, while a gram-molecular solution is one containing a gram-molecule of the substance to a liter of the solution. Thus, a gram-molecular solution of sodium chlorid is one containing 58.5 gms. (Na, 23; Cl, 35.5) of the salt to a liter, while a gram-molecular solution of cane-sugar contains 342 gms. ( $C_{12}H_{22}O_{11}$ ) to a liter. Similarly a gram-molecule of H is 2 gms. by weight of this gas, and if this weight of H were compressed to the volume of a liter it would be comparable to a gram-molecular solution. Since the weight of a molecule of H is to the weight of a molecule of cane-sugar as 2 is to 342, it follows that a liter containing 2 gms. of H has the same number of

\* The interesting researches of Morse and Frazer ("The American Chemical Journal," 34, 1, 1905), who have succeeded in making semipermeable membranes in such a form as may be used for determining directly the osmotic pressures of concentrated (normal) solutions, have shown that this law is not accurately stated. The actual pressure is that which would be exerted if the particles in solution were gasified at the same temperature and kept to the volume of the pure solvent used (water), instead of the volume of the entire solution.



molecules of H in it as a liter of solution containing 342 gms. of sugar has of sugar molecules. On the assumption that a molecule in solution exerts an osmotic pressure that is exactly equal to the gas-pressure exerted by a gas molecule moving in the same space and at the same temperature, we are justified in saying that the osmotic pressure of a gram-molecular solution of cane-sugar, or of any other substance that is not an electrolyte, is equal to the gas-pressure of 2 gms. of H when compressed to the volume of 1 liter. This fact gives a means of calculating the osmotic pressure of solutions in certain cases according to the following method:

**Calculation of the Osmotic Pressure of Solutions.**—To illustrate this method we may take a simple problem such as the determination of the osmotic pressure of a 1 per cent. solution of cane-sugar. One gm. of H at atmospheric pressure occupies a volume of 11.16 liters; 2 gms. of H, therefore, under the same conditions will occupy a volume of 22.32 liters. A gram-molecule of H—that is, 2 gms. of H—when brought to the volume of 1 liter will exert a gas-pressure equal to that of 22.32 liters compressed to 1 liter—that is, a pressure of 22.32 atmospheres. A gram-molecular solution of cane-sugar, since it contains the same number of molecules in a liter, must therefore exert an osmotic pressure equal to 22.32 atmospheres. A 1 per cent. solution of cane-sugar contains, however, only 10 gms. of sugar to a liter; hence the osmotic pressure of the sugar in such a solution will be  $\frac{10}{342}$  of 22.32 atmospheres, or 0.65 of an atmosphere, which in terms of a column of mercury gives  $760 \times 0.65 = 494$  mms. This figure expresses the osmotic pressure of a 1 per cent. solution of cane-sugar when dialyzed against pure water through a membrane impermeable to the sugar molecules. In such an experiment water would pass to the sugar side until the hydrostatic pressure on this side was increased by an amount equal to the pressure of a column of mercury 494 mms. high. Certain additional calculations that it is necessary to make for the temperature of the solution need not be specified in this connection. If, however, we wish to apply this method to the calculation of the osmotic pressure of a given solution of an electrolyte, it is necessary first to ascertain the degree of dissociation of the electrolyte into its ions, since, as was said above, dissociation increases the number of parts in solution and to the same extent increases osmotic pressure. In the body the liquids that concern us contain a variety of substances in solution, electrolytes as well as non-electrolytes. In order, therefore, to calculate the osmotic pressure of such complex solutions it is necessary to ascertain the amount of each substance present, and, in the case of electrolytes, the degree of dissociation. Under experimental conditions such a calculation is practically impossible, and recourse must be had to other methods. One of the simplest and most easily applied of these methods is the determination of the freezing point of the solution.

#### Determination of Osmotic Pressure by Means of the Freezing Point.

—This method depends upon the fact that the freezing point of water is lowered by substances in solution, and it has been discovered that the amount of lowering is proportional to the number of parts (molecules and ions) present in the solution. Since the osmotic pressure is also proportional to the number of parts in solution, it is convenient to take the lowering of the freezing point of a solution as an index or measure of its osmotic pressure. In practice a simple apparatus (Beckmann's apparatus) is used, consisting essentially of a very delicate and adjustable differential thermometer. By means of this instrument the freezing point of pure water is first ascertained upon the empirical scale of the thermometer. The freezing point of the solution under examination is then determined, and the number of degrees or fractions of a degree by which its freezing point is lower than that of pure water is noted. The lowering of the freezing point in degrees centigrade is expressed usually by the symbol  $\Delta$ . For example, mammalian blood-serum gives  $\Delta = 0.56^\circ \text{C}$ . A 0.95 per cent. solution of NaCl gives the same  $\Delta$ ; hence the two solutions exert the same osmotic pressure, or, to put it in another way, a 0.95 per cent. solution of NaCl is isotonic or isosmotic with mammalian serum. The  $\Delta$  of any given solution may be expressed in terms of a gram-molecular solution by dividing it by the constant 1.87, since a

gram-molecular solution of a non-electrolyte is known to lower the freezing point  $1.87^{\circ}$  C. Thus, if blood-serum gives  $\Delta = 0.56^{\circ}$  C., its concentration in terms of a gram-molecular solution will be  $\frac{0.56}{.187}$ , or 0.3. In other words, blood-serum has 0.3 of the osmotic pressure exerted by a gram-molecular solution of a non-electrolyte,—that is,  $22.32 \times 0.3$ , or 6.696 atmospheres.

**Remarks upon the Application of the Foregoing Facts in Physiology.**—In the body water and substances in solution are continually passing through membranes,—for example, in the production of lymph, in the absorption of water and digested foodstuffs from the alimentary canal, in the nutritive exchanges between the tissue elements and the blood or lymph, in the production of the various secretions, and so on. In these cases it is a matter of the greatest difficulty to give a satisfactory explanation of the forces controlling the flow to and fro of the water and dissolved substances, but there can be little doubt that in all of them the physical forces of filtration and osmotic pressure take an important part. Whatever can be learned, therefore, concerning these processes must in the end have an important bearing upon the explanation of the nutritive exchanges between the blood and tissues. Some additional facts may be mentioned to indicate the applications that are made of these processes in explaining physiological phenomena.

**Osmotic Pressure of Proteins.**—The osmotic pressure exerted by crystalloids, such as the ordinary soluble salts, is, as we have seen, very considerable, but the ready diffusibility of most of these salts through animal membranes limits very materially their influence upon the flow of water in the body. Thus, if we should inject a strong solution of common salt directly into the blood-vessels, the first effect would be the setting up of an osmotic stream from the tissues to the blood and the production of a condition of hydremic plethora within the blood-vessels. The salt, however, would soon diffuse out into the tissues, and to the degree that this occurred its effect in diluting the blood would tend to diminish because the part of the salt that got into the extravascular lymph spaces would now exert an osmotic pressure in the opposite direction, drawing water from the blood. This fact, together with the further fact that an excess of salts in the body is soon removed by the excretory organs, gives to such substances a smaller influence in directing the water stream than would at first be supposed when the intensity of their osmotic action is considered. In addition to the crystalloids the liquids of our bodies contain also a certain amount of protein, the blood, especially, containing over 6 per cent. of this substance. It has been generally assumed that proteins in solution exert little or no osmotic pressure, but Starling\* and others have claimed, on the contrary, that they exert a distinct, although small, osmotic pressure, and it is possible that this fact is of special importance in absorption, because the proteins do not diffuse or diffuse with great difficulty, and their effect remains, therefore, so to speak, as a permanent factor. According to Starling, the osmotic pressure exerted by the proteins of serum is equal to about 30 mms. of mercury. That the osmotic pressure of the serum proteins is so small is not surprising if we remember the very high molecular weight of this substance. In serum the proteins are present in a concentration of about 7 per cent., but owing to their large molecular weight comparatively few protein molecules are present in a solution of this concentration; and, assuming that the dissolved protein follows the laws discovered for crystalloids, its osmotic pressure would depend upon the number of molecules in solution. By means of this weak but constant osmotic pressure of the indiffusible protein it is possible to explain theoretically the fact that an isotonic or even a hypertonic solution of diffusible crystalloid may be completely absorbed by the blood from the peritoneal cavity.

**Isotonic, Hypertonic, and Hypotonic Solutions.**—In physiology the osmotic pressures exerted by various solutions are compared usually with that of the blood-serum. In this sense an isotonic or isosmotic solution is one having an osmotic pressure equal to that of serum, a hypertonic or hyperosmotic solution is one whose osmotic pressure exceeds that of serum,

\* "Journal of Physiology," 24, 317, 1899.

and a hypotonic or hyposmotic solution is one whose osmotic pressure is less than that of serum.

**Diffusion, or Dialysis, of Soluble Constituents.**—If two liquids of unequal concentration in a given constituent are separated by a membrane entirely permeable to the dissolved molecules of the substance, a greater number of these molecules will pass over from the more concentrated to the less concentrated side, and in time the composition will be the same on the two sides of the membrane. Diffusion of soluble constituents continually takes place, therefore, from the points of greater concentration to those of less, and this may happen quite independently of the direction of the osmotic stream of water. If, for instance, a 0.9 per cent. solution of sodium chlorid is injected into the peritoneal cavity, it will enter into diffusion relations with the blood in the blood-vessels; its concentration in sodium chlorid being greater than that of the blood, the excess will tend to pass into the blood, while sodium carbonate, urea, sugar, and other soluble crystalloidal substances will pass from the blood into the salt solution in the peritoneal cavity. Through the action of this process of diffusion we can understand how certain constituents of the blood may pass to the tissues of various glands in amounts greater than can be explained if we supposed that the lymph of these tissues is derived solely by filtration from the blood-plasma. Another important conception in this connection is the possibility that the capillary walls may be permeable in different degrees to the various soluble constituents of the blood, and furthermore the possibility that the permeability of the capillary walls may vary in different organs. With regard to the first possibility it has been shown that the blood capillaries are more permeable to the urea molecules than to sugar or NaCl. With the aid of these facts it is possible to explain in large measure the transportation of material from the blood to the tissues, and *vice versa*. For example, to follow a line of reasoning used by Roth, we may suppose that the functional activity of the tissue elements is attended by a consumption of material which in turn is made good by the dissolved molecules in the tissue lymph. The concentration of the latter is thereby lowered, and in consequence a diffusion stream of these substances is set up with the more concentrated blood. In this way, by diffusion, a constant supply of dissolved material is kept in motion from the blood to the tissue elements. On the other hand, the functional activity of the tissue elements is accompanied by a breaking down of the complex protein molecule, with the formation of simpler, more stable molecules of crystalloid character, such as the sulphates, phosphates, and urea or some precursor of urea. As these bodies pass into the tissue lymph they tend to increase its concentration, and thus by the greater osmotic pressure developed they serve to attract water from the blood to the lymph, forming one efficient factor in the production of lymph. On the other hand, as these substances accumulate in the lymph to a concentration greater than that possessed by the same substances in the blood, they will diffuse toward the blood. By this means the waste products of activity are drawn off to the blood, from which, in turn, they are removed by the action of the excretory organs.

**Diffusion of Proteins.**—This simple explanation on purely physical grounds of the flow of material between the blood and the tissues can only be applied, however, at present to the diffusible crystalloids, such as the salts, urea, and sugar. The proteins of the blood, which are supposed to be so important for the nutrition of the tissues, are practically indiffusible through animal membranes, so far as we know. It is difficult to explain their passage from the blood through the capillary walls into the lymph. Provisionally it may be assumed that this passage is due to filtration. The blood-plasma in the capillaries is under a slightly higher pressure than the lymph of the tissues, and this higher pressure tends to squeeze the blood constituents, including the protein, through the capillary walls. So far as the protein nutrition of the tissues is concerned, the difficulty in regard to the indiffusibility of the proteins is met by the modern conception that the digested protein of the food circulates in the blood as amino-acids, and is supplied to the tissues in this form. The amino-acids have much simpler molecules and may pass through the capillary walls by diffusion.



# INDEX.

- ABDERHALDEN test, 748  
Abdominal respiration, 646  
  type of respiration, 650  
Absolute power of muscle, 39  
Absorption coefficient, 674  
  in large intestine, 806  
  in small intestine, 800  
  in stomach, 785  
  of carbohydrates, 802  
  of fats, 803  
  of proteins, 805  
  spectra of hemoglobin, 431  
A-c interval (heart), 541  
Acapnia, 701, 707  
Accelerator center for heart, 595  
  nerves, effect of, on heart-rate, 597  
  of heart, 591  
  reflex stimulation of, 593  
Accessory thyroids, 867  
Accommodation in eye, limits of, 316  
  mechanism of, 313  
  reflex, 326  
Acetone bodies, 916  
Achromatic series of visual sensations,  
  349  
  vision, 357  
Achroödextrin, 765  
Acid albumin in gastric digestion, 780  
  aceto-acetic, 916  
  amino-acetic, 793, 1009  
  aminocaproic, 794, 1009  
  aminoglutaric, 1009  
  aminopropionic, 793, 1009  
  aminosuccinic, 794, 1009  
  aminothiopropionic, 1009  
  aminovalerianic, 794, 1009  
  aspartic, 794, 1009  
  cholic, 815  
  conjugated sulphuric, 808, 855  
  diaminocaproic, 794, 1009  
  glutaminic, 794, 1009  
  glycocholic, 815  
  glycuronic, 908  
  guanidinaminovalerianic, 1009  
  hippuric, 854  
  imidazolpropionic, 795, 1009  
  indolpropionic, 795, 1009  
  isobutylpropionic, 794  
  lactic, 64  
  oxyaminopropionic, 1009  
  oxybutyric, 916  
Acid, oxyphenylaminopropionic, 1009  
  oxypropionic, 793  
  oxyproteic, 846  
  oxypyrollidin-carboxylic, 793, 1009  
  phenylaminopropionic, 794, 1009  
  pyrrolidin-carboxylic, 795, 1009  
  pyruvic, 908  
  taurocholic, 815  
  thiopropionic, 793  
Acidity, definition of, 416  
Acromegaly, 883  
Action current, diphasic, 103  
  in heart, 542  
  in muscle, 102  
  in nerve, 102  
  in retina, 337  
  monophasic, 103  
  relation to contraction wave, 105  
  to nerve impulse, 105  
Activation of lipase, 798  
  of trypsin, 791  
Activators, 749  
Adamkiewicz's reaction for proteins,  
  1013  
Addison's disease, 874  
Adenase, 750, 852  
Adenin, 65, 851  
Adenosin, 852  
Adrenal bodies, functions of, 878  
  secretory nerves of, 878  
Adrenalin, 875  
Aërial perspective, 376  
Aërotonometer, 676  
Afferent fibers in cranial nerves, 83  
  position of, in posterior roots, 82  
  vasodilatation due to, 619  
  nerve-fibers, 79  
After-images in eye, 352  
Agnosia, 205, 222  
Agraphia, 221  
Air, effect of variations in, on res-  
  pirations, 705  
Alanin, 793, 1009  
Albumin, properties of, 1013. See also  
  *Protein*.  
Albuminoids, nutritive value of, 901  
Albumon, 452  
Alcohol as food, 926  
  effect of, on gastric absorption, 786  
  physiological action of, 926  
  use of, in diabetes, 929

- Alexia, 221  
 Alexins, 425  
 Alimentary canal, movements of, 713  
   glycosuria, 802  
   principles of food, 738  
 Alkalinity, true, 416  
   titration, 419  
 Altitude, effect of, on red corpuscles, 439  
 Amboceptors, 425  
 Ametropia, 319  
 Amines, 809  
 Amino-acetic acid, 793, 1009  
 Amino-acids as part of protein molecule, 793, 1009  
 Aminocaproic acid, 794, 1009  
 Aminoglutaric acid, 1009  
 Aminopropionic acid, 793, 1009  
 Aminopurins, 850  
 Aminosuccinic acid, 794, 1009  
 Aminovalerianic acid, 794, 1009  
 Ammonia nitrogen in urine, 846  
   salts, relation of, to urea, 847  
 Ammonium carbamate as precursor of urea, 848  
   carbonate as precursor of urea, 847  
 Amylase, 796  
 Amyolytic enzyme, 747  
 Anacrotic pulse, 526  
 Anaglyph, 379  
 Anaphylaxis, 748  
 Anelectrotonic currents, 107  
 Anelectrotonus, 87  
 Angström unit, 336  
 Anisotropic substance in muscle, 20  
 Anode as stimulus to muscle, 87  
   to nerve, 87  
   physical, 93  
   physiological, 93  
 Anomalous trichromatic vision, 354  
 Anoxemia, 706  
 Anterior commissure, 187, 217  
   roots of spinal nerves, 82  
 Antidromic impulse in vasodilator nerve-fibers, 82  
 Antigen, 424  
 Antilytic secretion, 763  
 Antiparalytic secretion, 763  
 Antithrombin, 463  
 Antrum pylori of stomach, 719  
 Anus præternaturalis, 807  
 Apex-beat of heart, 545  
 Aphasia, motor, 219  
   sensory, 221  
 Aphemia, 219, 221  
 Apnea, 699  
 Apraxia, 221  
 Arginase, 849  
 Arginin, 794, 849, 990, 1015  
 Argyll-Robertson pupil, 327  
 Arterial pressure. See *Circulation*.  
 Artificial muscle of Engelmann, 72, 73  
 Artificial respiration, 655, 664  
   stimuli of nerve-fibers, 84  
 Ascending paths in spinal cord, 169  
 Aspartic acid, 794, 1009  
 Asphyxia, 700  
   effect of, on heart-rate, 599  
 Aspiratory action of thorax, 661  
 Association areas in brain, 223, 225  
   system of fibers in cerebrum, 185  
 Astereognosis, 204  
 Astigmatism, 320  
 Atropin, action of, on heart, 589  
   on iris, 328  
   on salivary secretion, 762  
   on sweat secretion, 864  
 Auditory center in cortex, 212  
   nerve, course of, in brain, 213  
   effect of secretion of, 408  
   sensations. See *Ear*.  
   striæ, 215  
 Auricle. See *Heart*.  
 Auriculoventricular bundle of heart, 536, 576  
   effect of compressing, 577  
   node, 538  
 Auscultation, 552  
 Autacoid substances, 867  
 Autolysis, 961  
 Autolytic enzymes, 750  
 Automaticity of heart-beat, 569  
 Autonomic fibers from brain, 255  
   from sacral cord, 256  
   from spinal cord, 253  
   nerve-fibers, normal stimulation of, 257  
   nervous system, general relations of, 251  
 Axial stream in arteries and veins, 482  
 Axon reflexes, 151
- BACTERIAL action in intestines, 807  
 Balance experiments in nutrition, 893  
 Balloon ascensions, effect of, 708  
 Barometric pressures, effect of, 706  
 Bartholin, duct of, 752  
 Basilar membrane, function of, 399  
 Bathmotropic nerve-fibers to heart, 585  
 Bechterew's nucleus, 214, 235  
 Bell-Magendie law, 82  
 Beri-beri, 904  
 Bilateral representation in motor areas, 199  
 Bile, composition of, 813  
   curve of secretion of, 820  
   effect of occluding bile-ducts, 821  
   ejection of, into duodenum, 820  
   functions of, summary, 822  
   quantity of, 813  
   secretion of, 818

- Bile-acids, composition of, 815  
 Bile-duct, sphincter of, 821  
 Bile-pigments, 437, 814  
 Bile-salts, importance of, in fat digestion, 804, 822  
 Bilirubin, 814  
 Biliverdin, 814  
 Binocular perspective, 378, 380  
   vision, 368  
     horopter in, 375  
     struggle of visual fields in, 375  
     value of, in judgments of distance, 381  
       of size, 381  
 Biological reaction, 425  
 Births, ratio of male and female, 999  
 Biuret reaction for proteins, 1012  
 Bladder, urinary, movements of, 857  
   sphincter of, 857  
   gall-, movements of, 820  
 Blind spot in eye, 337  
 Blood, blood-plates of, physiology of, 444  
   circulation of. See *Circulation*.  
   coagulation of, 452  
   condition of carbon dioxid in, 679  
     of nitrogen in, 676  
   curve of dissociation of oxyhemoglobin, 678  
   defibrinated, 416  
   gases of, 669  
   general properties of, 415  
   hemoglobin of, 420  
     amount, 426  
     nature, 426  
   hemolysis of red corpuscles, 421  
   histological structure of, 415  
   leukocytes of, 442  
   meionectic, 679  
   mesectic, 679  
   nucleoprotein in, 452  
   osmotic pressure of, 422  
   pleonectic, 679  
   proteins of, 447, 449  
   reaction of, 416  
   red corpuscles of, 420  
     fate of, 437  
     origin of, 437  
   regeneration of, after hemorrhage, 469  
   specific gravity of, 419  
   total quantity of, 468  
   transfusion of, 471  
 Blood-plasma, composition of, 447  
 Blood-plates, properties of, 444  
 Blood-pressure, 489  
   diastolic, 493  
   effect of menstruation upon, 971  
   in brain, 630, 631  
   in capillaries, 499  
   in man, 500, 505  
   mean, 493  
 Blood-pressure, relation of, to heart-rate, 597  
   respiratory waves of, 662  
   systolic, 493  
   Traube-Hering waves of, 616  
   venous and capillary, 507  
 Blood-serum, 416, 448  
 Body equilibrium in nutrition, 893  
   sense area, 203  
   temperature in man, 945  
 Bowman's theory of urinary secretion, 835  
 Brachium conjunctivum, 235  
   pontis, 237  
 Brain, association areas of, 223  
   auditory center in, 212  
   center for olfaction, 216  
   for taste, 218  
   centers affected in aphasia, 219, 223  
   development of cortical areas, 226  
   effect of variations in arterial pressure upon, 630  
   histological differentiation of cortex of, 229  
   intracranial pressure in, 628  
   localization of function in, 192  
   motor areas of, 196  
   regulation of circulation in, 624  
   sensory areas of, 202  
   vascular supply of, 624  
 Brightness in visual sensations, 347  
 Bronchi, capacity of, 655  
   constrictor and dilator fibers of, 702  
 Bulbospiral fibers of heart, 535  
 CAFFEIN, 925  
 Caisson disease, 706  
 Calcarine fissure, relation of, to vision, 210  
 Calcium, amount of, in cataract, 924  
   salts, effect of, on heart, 570  
     in curdling of milk, 782  
     nutritive value of, 922  
     secretion of, in milk, 475  
 Calorie, definition of, 947  
 Calorimeters, varieties of, 947  
 Calorimetric equivalent, 949  
   measurements, 952  
 Calorimetry, indirect, 950  
   principles of, 947  
 Cannula, washout, 491  
 Capillary blood-pressure, 499  
   electrometer, construction of, 98  
 Carbohemoglobin, 429  
 Carbohydrates, absorption of, 802  
   as glycogen formers, 824  
   as source of body fat, 919  
   fermentation of, in intestine, 807  
   general functions of, 913  
   metabolism of, in body, 907  
   of muscle, 63

- Carbohydrates, regulation of supply of, 909  
supply of, in body, 906
- Carbon dioxide, action on respiratory center, 697  
condition of, in blood, 679  
effect of, in inspired air, 697, 706  
on dissociation of oxyhemoglobin, 677  
on respiratory movements, 697  
excretion of, through skin, 865  
in balance experiments, 893  
in saliva, 755  
production of, in muscle, 66  
tension of, in alveolar air, 681  
in arterial blood, 682  
in tissues, 683  
in venous blood, 682  
equilibrium, 893  
monoxid hemoglobin, 429
- Cardiac cycle, 556  
glands of stomach, 768  
muscle, properties of, 58, 573  
nerves. See *Heart*.  
sphincter, 718
- Cardiogram, 546
- Cardio-inhibitory center, 586
- Carnin, 65
- Carnosin, 64
- Casein, 782, 986
- Catalase, 743, 751
- Catalysis, 743
- Catelectrotonic currents, 107
- Catelectrotonus, 87
- Cathode as stimulus, 87  
physical and physiological, 93
- Centers in cerebrum. See *Cerebrum*.
- Central field of vision, 342
- Centrosome, 974
- Cerebellum, ending of spinal tracts in, 172, 236  
experimental work upon, 239  
general functions of, 241  
localization of function in, 243  
paths connecting with other parts of brain, 235  
psychical functions of, 243  
structure of, 233
- Cerebrin, 79
- Cerebrogalactosides, 79
- Cerebrosides, 79
- Cerebrospinal liquid, 626  
origin of, 628
- Cerebrum, association areas of, 233  
center for hearing, 212  
for olfaction, 216  
for vision, 207  
centers affected in aphasia, 219  
commissural system of fibers in, 186  
development of cortical areas in, 226  
general physiology of, 183
- Cerebrum, histological differentiation of cortex, 229  
histology of cortex, 184  
localization of function in, 192  
motor areas of, 196  
projection system of fibers in, 185  
results of ablation of, 190  
sensory areas of, 202  
system of fibers in, 185  
vasomotor supply of, 632
- Cerumen, 865
- Chemical heat regulations, 957  
secretion, gastric, 777  
pancreatic, 791
- Chemotaxis, 126, 976
- Cheyne-Stokes respiration, 710, 711
- Cholesterin, 78, 811, 817, 865
- Cholic acid, 815
- Cholin, 78
- Chorda tympani nerve, 294, 753, 755
- Chromaffin tissue, 875
- Chromatic aberration in eye, 319  
visual sensations, 350
- Chromatolysis, 129
- Chromophile substance in nerve-cells, 134
- Chromoproteins, 1015
- Chromosomes, 954, 974, 995
- Chronotropic nerve-fibers to heart, 585
- Chyle fat, 804
- Chymosin, 782
- Ciliary muscle, action of, in accommodation, 314  
nerves to, 324
- Ciliated epithelium, 58
- Circulating proteins, 896
- Circulation, accessory factors in, 517  
as seen under microscope, 482  
curve showing pressures in, 494, 497, 498  
data concerning pressures in (man), 505  
mean pressures in, 496  
diastole and systole of heart, 533  
effect of adrenal extracts upon, 874, 875  
of heart-beat and size of arteries upon, 487  
explanation of side pressure in, 510  
of velocity changes in, 487  
pressure in, 511  
factors of normal pressure and velocity in, 513  
form of pulse wave, 523  
general curve of velocities in, 487  
statement of pressure relations, 489  
hydrostatic effects upon, 515  
importance of elasticity of arteries, 512  
in brain, 624



- Circulation in kidneys, 841  
 means of determining blood-pressure in, 489, 500  
 velocities in, 485  
 pressure in coronary system, 589  
 in pulmonary system, 518  
 pulse pressures in, 493  
 regulation of blood supply, 620  
 respiratory waves of pressure in, 662  
 systole and diastole of heart, 533  
 systolic, diastolic, and mean pressures in, 493  
 velocities in, 485  
 time required for complete, 488  
 Traube-Hering waves of pressure in, 616  
 velocity in capillaries, 485  
 in coronary system, 558  
 in man, 485  
 in pulmonary system, 518  
 of pulse wave, 521
- Clarke's column, 163  
 Claudication, intermittent, 32  
 Clotting. See *Coagulation*.  
 Cocain, action of, on iris, 328  
 Coagulation, blood, 452  
 intravascular, 464  
 means of hastening and retarding, 465  
 theories of, 455
- Cochlea, functions of, 398  
 sensory epithelium of, 392
- Coefficient, absorption, 674  
 temperature, 115
- Coferment, 749
- Cold spots on skin, 280
- Color blindness, 354  
 contrasts, 353  
 fusion, 350  
 saturation, 350  
 sense of retina, 357  
 vision, theories of, 360
- Combustion equivalents of foods, 937
- Comma tract of Schultze, 180
- Commissural system of fibers (cerebrum), 186
- Common sensations, 272
- Compensatory pause in heart-beat, 576
- Complemental air, 654
- Complementary colors, 351
- Compound muscular contractions, 41
- Condiments, 741, 925
- Conditioned reflexes, 190
- Conduction as physiological property, 75  
 direction of, in nerve-fibers, 114
- Conjugate foci, 307
- Conjugated sulphates, 855
- Contraction, 17, 32. See also *Muscle*.  
 Contralateral conduction in cord, 176
- Convoluted tubules of kidney, 833, 838
- Core-model of nerve, 108
- Coronary arteries, effect of occlusion of, 562  
 vasomotor supply of, 622<sup>1</sup>
- Corpora quadrigemina, relation of, to visual apparatus, 208, 211  
 striata, functions of, 231
- Corpus callosum, structure and function, 230  
 luteum, 966  
 trapezoideum, 215
- Corresponding points of retina, 376
- Cortex of cerebrum, general physiology of, 186  
 histology of, 183, 229
- Corti, rods of, 392
- Cortical tissue, functional significance, of, 879
- Costal respiration, 650
- Cowper's glands, 989
- Cranial nerves, afferent fibers in, 83  
 efferent fibers of, 83  
 nuclei of origin of, 245
- Cranioscopy, 192
- Creatin, 64, 852
- Creatinin, 64, 852
- Cresol-sulphuric acid, 808, 855
- Cretinism, 868
- Crystalline lens, calcium of, in cataract, 924
- Curve, contraction, of artificial muscle, 72  
 of arterial pulse, 524, 527  
 of plain muscle, 57  
 of skeletal muscle, 26  
 dissociation of oxyhemoglobin, 678  
 extensibility and elasticity of muscle, 20  
 gastric secretion, 777  
 intensity of sleep, 260  
 pancreatic secretion, 789  
 pressures in vascular system, 494, 497, 498  
 relations of heart sounds, 553, 554  
 respiratory movements, 652  
 secretion of bile, 820  
 systolic, diastolic, and mean blood-pressures, 493  
 velocity of blood-flow, 487  
 venous pulse, 529  
 visual acuity of retina, 345  
 work of muscle, 40
- Cycloplegia, 329
- Cystein, 793, 816
- Cytozym, 462
- DEAD space of lungs, 655
- Deamidizing enzymes, 748

- Death rigor, chemical changes during, 69  
 in muscle, 52  
 theories of, 1003
- Deep reflexes, 160  
 sensibility, 278, 287, 289
- Defecation, 733
- Degeneration in nerve-fibers, 125
- Deglutition, 713  
 nervous control of, 716
- Deiter's cells in cochlea, 392  
 nucleus, 214, 235
- Demarcation current, muscle and nerve, 95
- Demilunes of salivary glands, 752
- Depressor nerve-fibers, 611  
 of heart, 614
- Derived proteins, 1016
- Descending paths, spinal cord, 178, 180
- Deuteranopia, 355
- Deutero-albumoses, 780
- De Vries' theory of mutation, 996
- Diabetes, 909  
 mellitus, 910  
 pancreatic, 910  
 phloridzin, 912  
 use of alcohol in, 929
- Dialysis, definition of, 1021
- Diaphragm, action of, 646
- Diaphragmatic respiration, 646
- Diaschisis, 195
- Diastase, 747  
 discovery of, 742
- Diastasis of heart, 551
- Diastole, duration of, in heart, 557
- Diastolic arterial pressure, 493  
 method of determining, in animals, 495  
 in man, 501
- Dicrotic pulse wave, 525
- Diet, accessory articles of, 741, 925  
 average daily, 939, 940  
 effect of reduction of salts in, 922
- Dietetics, general principles of, 939
- Diffusion circles on retina, 313  
 definition of, 1016
- Digestion in large intestine, 806  
 in small intestine, 787  
 in stomach, 784
- Diopter, definition of, 317
- Dioptries of eye, 306
- Diplopia, 370, 373
- Direct field of vision, eye, 342
- Discord, physiological explanation of, 402
- Dissociation of oxyhemoglobin, 678
- Diuretics, action of, 840
- Dominant characteristics in heredity, 997
- Dromograph, 484
- Dromotropic nerve-fibers to heart, 585
- Dualistic theory (blood-corpuscles), 442
- Duct of Bartholin, 752  
 of Rivinus, 752  
 of Stenson, 752  
 of Wharton, 752  
 of Wirsung, 787
- Dyspnea, 649, 699
- Dyspraxia, 231
- EAR, effect of section of auditory nerves, 408  
 of stimulation of semicircular canals, 407
- Eustachian tube of, 491
- Flourens' experiments on semicircular canals, 405  
 functions in analyzing sound waves, 398  
 of cochlea, 398  
 of ear-bones, 387  
 of sacculus, 412  
 of utriculus, 412
- intrinsic muscles of, 390  
 limits of hearing, 402  
 position of bones in, 387  
 projection of auditory sensations, 391
- semicircular canals of, 404  
 sensations of discord, 402  
 of harmony, 402
- sensory epithelium in cochlea, 392  
 structure of, 393, 399  
 bones of, 387
- theories of functions of semicircular canals of, 408
- tympenic membrane of, 386
- Eck fistula, 848
- Efferent nerve-fibers, 79  
 occurrence in anterior roots, 81  
 in cranial nerves, 83
- Ejaculation of spermatic liquid, 992
- Elasticity and extensibility of muscle, 20
- Electrical changes in heart, 541, 692  
 in muscle and nerve, 95  
 with respiratory movements, 692
- Electrocardiograms, 542
- Electrodes, non-polarizable, 100  
 stimulating, 86
- Electrolytes, effect of, on osmotic pressure, 1018
- Electrotonic currents, 107
- Electrotonus, 87
- Eleventh cranial nerve, nucleus of, 250
- Embryo, nutrition of, 979
- Endocrin system, 866
- Endogenous fibers of spinal cord, 170
- Energy of muscular contraction, 36
- Enterokinase, 791, 799
- Entoptic phenomena, 366

Enzymes, adenase, 750, 851  
 amylase, 796  
 arginase, 849  
 chemistry of, 751  
 classification of, 746  
 deaminizing, 748  
 definition of, 746  
 endoenzymes, 746  
 enterokinase, 791, 799  
 erepsin, 796, 800  
 exoenzymes, 746  
 general properties of, 748  
 glycolytic, 750  
 guanase, 750, 852  
 historical account of, 741  
 intracellular, 961  
 inverting, 800  
 lipase, 797  
 nuclease, 750  
 of muscle, 65  
 oxidases, 748, 962  
 pepsin, 778  
 peroxidases, 962  
 protective, 747  
 ptyalin, 765  
 rennin, 782  
 reversible reactions of, 744  
 specificity of, 745  
 trypsin, 792  
 Epicritic sensations, 279  
 sensibility, 278  
 Epigenesis, 990  
 Epinephrin, 879  
 increased, effect on heart-beat, 600  
 physiological action of, 876  
 Erection, physiology of, 991  
 Erepsin, 800  
 Ergograph, 47  
 Erythroblasts, 439  
 Erythrocytes. See *Red blood-corpuscles*.  
 Erythrodextrin, 766  
 Eserin, action of, on iris, 328  
 Ethereal sulphates, 855  
 Eupnea, 649  
 Eustachian tube, 391  
 Evolution, hypothesis of, in heredity, 994  
 Exogenous fibers in spinal cord, 170  
 Exophthalmic goiter, 871, 872  
 Expiration. See also *Respiration*.  
 definition of, 645  
 expiratory center, 694  
 muscles of, 648  
 Expired air, composition of, 665  
 injurious effects of, 666  
 Extensibility of muscle, 20  
 Extensor thrust reflex, 158  
 Eye, abnormalities in refraction of, 319  
 accommodation in, 313  
 action of drugs upon, 328

Eye, acuity of vision in, 343  
 after-images in, 352  
 as optical instrument, 306  
 binocular field of vision, 372  
 perspective, 378  
 chromatic aberration in, 319  
 color blindness of, 354  
 contrasts in, 353  
 vision in, 349  
 complementary colors, 351  
 corresponding points in, 372  
 dark adapted, 338, 346  
 diffusion circles in, 313  
 diplopia in, 370, 373  
 direct field of vision in, 342  
 entoptic phenomena in, 366  
 far point of distinct vision, 316  
 function of cones, 358  
 of rods, 358  
 fundamental color sensations, 351  
 horopter, 375  
 indirect field of vision in, 342  
 inversion of image in, 311  
 light adapted, 338, 347  
 reflex in, 326  
 movements of, 368  
 muscular insufficiency, 370  
 nature of visual stimuli, 338  
 near point of distinct vision, 316  
 nodal point of, 310  
 ophthalmoscopic examination of, 331  
 optical defects of, 319  
 delusions, 382  
 physics of formation of image in, 309  
 qualities of visual sensations, 349  
 reduced schematic (Listing), 310  
 refractive power of, 317  
 size of retinal images, 312  
 spherical aberration in, 319  
 stereoscopic vision, 378  
 struggle of visual fields, 375  
 suppression of visual images, 375  
 theories of color vision, 360  
 threshold stimulus of, 345  
 visual field of, 340  
 judgments, 376  
 purple of, 338  
 Eye-muscles, action of, 368  
 FACIAL nerve, dilator fibers in, 616  
 nucleus of, 249  
 Far point of distinct vision, 316  
 Fat, absorption of, 803  
 as glycogen former, 826  
 digestion of, 797  
 in stomach, 786  
 excessive formation of, in obesity, 919  
 in bile, 818

- Fat, metabolism of, in body, 915  
 mode of oxidation of, in body, 916  
 nutritive value of, 914  
 of chyle, 804  
 origin of, from carbohydrates, 918  
 in body, 917
- Fatigue in nerve-fibers, 117  
 muscular, 49  
 of olfactory organs, 303  
 theories of, 70  
 toxin, 71, 668
- Feces, composition of, 810
- Fermentation in intestine, 807  
 of carbohydrates in small intestine, 803
- Ferments, historical account of, 741
- Fertilization of ovum, 976
- Fertilizin, 978
- Fibrillary contractions of heart, 563
- Fibrin ferment, preparation of, 455  
 relations to blood-clot, 452, 453
- Fibrinogen, 450  
 preparation of, 455
- Fictitious meal (Pawlow), 774
- Fifth cranial nerve, 247
- Fillet, lateral, 215  
 median, 204
- Fistula, Eck's, 848  
 gall-bladder, 813  
 stomach, 771  
 Thiry-Vella, 798
- Flavors, 740  
 dietary, importance of, 925
- Flechsig's myelinization method, 165
- Fluorid solution, effect on clotting, 467
- Food, composition of, 740  
 definition of, 740  
 potential energy of, 935
- Foodstuffs, definition of, 740
- Fourth cranial nerve, nucleus of, 247
- Fovea, center for, in occipital cortex, 211  
 of retina, size of, 343
- Franklin theory of color vision, 364
- Freezing-point, method of determining, 1019
- Fundic glands of stomach, 768
- Fundus of stomach, 719
- GALL-BLADDER, functions of, 820  
 nerves of, 821
- Galvanometer, construction of, 96  
 d'Arsonval, 97  
 string, 99
- Gases, laws governing absorption of, 673  
 of blood, 669  
 pressure of, 673  
 tension of, in solution, 674
- Gas-pump, 670
- Gastric glands, 768
- Gastric glands, histological changes  
 in, during secretion, 769  
 secretory nerves of, 774  
 secretion, acid of, 772  
 chemical, 777  
 composition of, 770, 771  
 curve of, 777  
 means of obtaining, 770  
 nervous, 777  
 normal mechanism of, 775
- Gelatin, history of, as a food, 902  
 nutritive value of, 902
- Genital organs, vasomotor supply of, 636
- Germ plasm, definition of, 1004
- Gigantism, 883
- Glans penis, sensibility of, 280
- Gliadin, nutritive value of, 903
- Globin, 426, 1015
- Globulicidal action of blood-serum, 423
- Globulins, general properties of, 1014
- Glomerulus of kidney, functions of, 836
- Glossopharyngeal nerve, dilator fibers  
 in, 616  
 nucleus, 249
- Glucosamin, 1011
- Glutaminic acid, 794, 1009
- Gluteins, 1014
- Glutolin, 452
- Glycin, 793, 1009
- Glycocholic acid, 815
- Glycocoll, 793, 1009
- Glycogen, amount of, in liver, 823  
 discovery of, 823  
 glyco-genic theory, 826  
 importance of, in embryo, 980  
 in muscle, 63, 828  
 loss of, during muscular contractions, 67  
 metabolism of, in body, 914  
 origin of, 824  
 supply of, in body, 906
- Glycogenase, 750
- Glycogenesis, 909
- Glycogenolysis, 909
- Glycolysis of sugars in body, 908
- Glycoproteins, 1013
- Glycosuria, 909  
 alimentary, 802
- Glycylglycin, 1010
- Glyoxalase, 907
- Gmelin's reaction for bile-pigments, 814
- Goiter, exophthalmic, 871, 872
- Golgi's nerve cells, second type, 133  
 pericellular nerve net, 135
- Graafian follicle, structure of, 965
- Gram-molecular solution, 1018
- Growth, 1001
- Guanase, 750, 852

- Guanin, 65, 851  
 Guanosin, 852  
 Gudden's commissure, 209, 216
- HARMONY, physiological cause of, 402  
 Haustral churning, 732  
 Hearing. See *Ear*.  
   cortical center of, 212  
   limits of, 402  
 Heart, accelerator center for, 595  
   nerves of, 591  
   action, current of, 542  
   of inhibitory nerves, 581  
   analysis of inhibition, 583  
   apex-beat of, 545  
   auriculoventricular bundle, 536, 576  
   automaticity of, 564  
   capacity of ventricles of, 557  
   cardiac nerves of, course, 581  
   cardiogram, 546  
   cardio-inhibitory center of, 586  
   causation of beat, 564  
   change in form of ventricle in systole, 544  
   compensatory pause of, 576  
   contraction wave in, 540  
   coronary circulation in, 559  
   course of cardiac nerves, 581  
   depressor nerve of, 614  
   diastasis of, 551  
   diastole and systole of, 533  
     time relations of, 557  
   effect of calcium upon, 570  
     of drugs on, 589  
     of occlusion of coronaries upon, 562  
     of potassium upon, 570  
     of sodium upon, 570  
   electrical changes in, 541, 692  
   escape from inhibition, 585  
   events of a cardiac cycle, 556  
   fibrillary contractions, 563  
   historical account of beat of, 565  
   inhibition of auricle, 585  
     of ventricle, 585  
   intraventricular pressure during systole, 547  
   intrinsic nerves of, 566  
   maximal contractions of, 573  
   musculature of, 533  
   myogenic theory of beat of, 567  
   negative pressure in, 560  
   neurogenic theory of beat of, 566  
   rate of beat as affected by age, 596  
     by blood-pressure, 597  
     by intrinsic nerves, 597  
     by muscular exercise, 598  
     by sex, 596  
     by size, 596  
     by temperature, 599  
   reflex acceleration of beat, 593
- Heart, refractory period of, 575  
 sequence of beat of, 576  
 sounds of, 552  
 suction-pump action of, 560  
 systole and diastole of, 533  
   time relations of, 557  
 systolic plateau of beat, 548  
 theories of inhibition of, 589  
 third sound of, 555  
 tonic inhibition of, 587  
 tonicity of muscle of, 579  
 vasomotors of, 622  
 ventricle of, in systole, 544  
 ventricular output of, 549  
 volume curve of, 549  
 work done by, 557
- Heart-block, 578  
 Heart-muscle, general properties of, 58, 573  
 Heat centers, 957  
   equivalent of foodstuffs, 936  
   loss of, physiological regulation of, 953  
   nerves, 957  
   production in hydrolysis, 935  
     physiological regulation of, 955  
   puncture, 958  
   regulation, chemical, 957  
     general statement of, 953  
     physical, 954  
   rigor of muscle, 53  
   sexual, in lower animals, 968
- Helmholtz theory of color vision, 361  
 Helweg's bundle, spinal cord, 181  
 Hematin, 427, 436  
 Hematoidin, 437  
 Hematopoietic tissue, 438  
 Hematoporphyrin, 437  
 Hemeralopia (night-blindness), 360  
 Hemianopia (quadrant), 211  
 Hemin, 436  
 Hemiplegia, 198  
 Hemochromogen, 426, 437  
 Hemodromograph, 484  
 Hemoglobin, absorption spectra of, 431  
   compounds of, with carbon dioxide, 429  
     monoxid, 429  
     nitric oxid, 428  
     oxygen, 428  
   condition of, in corpuscles, 420  
   crystals of, 430  
   curve of dissociation of oxyhemoglobin, 678  
   derivative compounds of, 435  
   iron in, 429  
   nature and amount of, 426
- Hemolysins, natural and acquired, 423  
 Hemolysis, 421  
 Hemophags, 438  
 Hemophilia, 454

- Hemorrhage, effect of, 469  
 Heredity, definition and history, 994  
 Hering theory of color vision, 362  
 Hexon bases, 980  
 Hippuric acid, 854  
 Histidin, 795, 1009  
 Histochematins, 437  
 Histons, 991, 1014  
 Hofacker-Sadler law, 1000  
 Homoiothermous animals, 945  
 Homolateral conduction in cord, 176  
 Hordein, nutritive value of, 903  
 Hormones, 776  
   stimulation of kidneys by, 843  
 Horopter, 375  
 Hunger, sense of, 290  
 Hunger-contractions, 725  
 Hydrocele liquid, 450  
 Hydrochloric acid, combined, in gastric secretion, 772  
   function of, in peptic digestion, 780  
   in gastric juice, 772  
 Hydrogel, 452  
 Hydrogen exponent, 418  
   ion concentration, 418  
 Hydrolysis, 748  
   heat energy of, 935  
 Hydrostatic factor in circulation, 515  
 Hyperglycemia, 909  
 Hypermetropia, 321  
 Hyperpnea, 699  
 Hypertension, 879  
 Hyperthymusism, 872  
 Hyperthyroidism, 871  
 Hypertonic solutions, 1020  
 Hypnotic sleep, 269  
 Hypnotoxin, 266  
 Hypoglossal nerve, nucleus of, 250  
 Hypotension, 879  
 Hypotonic solutions, 1020  
 Hypoxanthin, 65, 850
- IDENTICAL** points of retina, 372  
 Identity theory of nerve impulse, 123  
 Immune body, 425  
 Incongruence of retinas, 373  
 Indican, 855  
 Indirect calorimetry, 950  
   field of vision, eye, 342  
 Indoxyl sulphuric acid, 808, 855  
 Induction coil, 24  
 Inert layer in circulation, 482  
 Inheritance, Mendelian, 997  
 Inhibition, escape from, in heart, 585  
   of heart, 581  
   of knee-jerk, 156  
   of reflexes, 147  
   of respiratory movements, 691  
   reflex of heart, 586
- Inhibition, theories of, 589  
 Inhibitory theories of sleep, 265  
 Inotropic nerves to heart, 585  
 Inspiration. See also *Respiration*.  
   definition of, 645  
   increased heart-rate during, 664  
   means of producing, 646  
   muscles of, 648  
 Inspired air, composition of, 665  
 Intermediary metabolism of carbohydrates, 907  
   of fats, 915  
   of nucleoproteins, 851  
   of proteins, 895  
   products of muscle metabolism, 67  
 Intermittent claudication, 32  
 Internal secretion, adrenals, 874  
   definition and historical account, 866  
   liver, 867  
   ovary, 886  
   pancreas, 887  
   testis, 884  
   thyroid tissues, 867  
   sensations, 273  
 Interrenal system, 874  
 Interstitial tissue, 885, 987  
 Intestinal movements, effect of various conditions upon, 730  
   secretion, 798  
   villi, movements of, 729  
 Intestines, bacterial action in, 807  
   large, movements of, 731  
   nervous control of movements of, 730  
   reaction of contents of, 808  
   small, movements of, 725  
 Intracellular enzymes, 961  
 Intracranial pressure, 628  
 Intra-ocular pressure, 330  
 Intrapulmonic pressure, 657  
 Intrathoracic pressure, 658  
   origin of, 660  
   variations of, with forced breathing, 659  
 Intraventricular pressure, 547  
 Introductory contractions of muscle, 34  
 Invertase, 750, 800  
 Involuntary muscle, 55  
 Iodothyryn, 869, 871  
 Iris, action of drugs upon, 328  
   antagonistic action of muscles upon, 325  
   muscles and nerves of, 324  
 Iron, effect of removal of spleen on, 831  
   in hemoglobin, 429  
   salts, source and nutritive importance of, 922  
 Irritability, definition of, 23  
   of muscle, 23

- Irritability of nerve-fibers, 84  
 Isodynamic equivalent of foodstuffs, 940  
 Isoleucin, 794, 1009  
 Isometric muscular contractions, 28  
 Isotonic muscular contractions, 28  
 solutions, definition of, 1020  
 Isotropic substance in muscle, 20
- JACOBSON, nerve of, 752  
 Judgments, visual, of distance and size, 381  
 perspective or solidity, 376
- KENOTOXIN, 71, 668  
 Kephalin, 464  
 Kidney, action of diuretics on, 840  
 blood-flow through, 841  
 composition of secretion of (urine), 843  
 function of convoluted tubules, 838  
 of glomerulus, 836  
 secretion of urine in, 834  
 stimulation of, by hormones, 843  
 structure of, 833  
 Kinases, 749  
 Kjeldahl's method for determination of nitrogen, 846, 892  
 Knee-jerk, conditions influencing, 159  
 definition of, 155  
 explanation of, 157  
 reinforcement of, 155  
 use of, as diagnostic sign, 160
- LABOR, physiology of, 982  
 Lactic acid in muscle, 64  
 increase of, during contractions, 64, 67  
 Laked blood, 421  
 Langerhans, islands of, 888, 889  
 Large intestine, digestion and absorption of food in, 806  
 movements of, 731  
 Larynx, reflex effects from, on respirations, 693  
 Latent period of muscular contraction, 27  
 Law of constant energy consumption, 1005  
 growth-quotient, 1005  
 of intestine, 726  
 of surface area, 953  
 Lead sulphid reaction for proteins, 1013  
 Lecithin, 78, 818  
 as complement, 425  
 Lecithoproteins, 1016  
 Lemniscus, lateral, 215  
 median, 204
- Leucin, 794, 1009  
 Leukocytes, effect of hemorrhage upon, 471  
 functions of, 443  
 structure and classification, 442  
 variations in number of, 443  
 Leydig's cells, 885  
 Liebermann's reaction for proteins, 1013  
 Liebig's classification of foodstuffs, 930  
 Light-reflex in eye, 326  
 Lipase, 747  
 activation of, 798  
 in pancreatic secretion, 796  
 reversible reaction of, 744  
 Lipoids, 77  
 Lissauer, tract of, 168, 169  
 Listing's law, 370  
 schematic eye, 310  
 Liver, acids of, 815  
 bile pigments of, 814  
 formation of urea in, 829  
 glycogen of, 823  
 glycogenic action of, 826, 827  
 internal secretion of, 867  
 pulse, 528  
 quantity of bile, 813  
 secretion of bile, 818  
 Localization of function in cerebellum, 243  
 in cerebrum, 192  
 Localizing power of skin, 283  
 Locke's solution, 571  
 Locomotor ataxia, 171  
 Ludwig theory of urinary secretion, 834  
 Luminosity of visual sensations, 347  
 Lungs, gaseous exchanges in, 681  
 total surface of, 645, 683  
 vasomotors of, 623  
 Lymph, action of lymphagogues, 475  
 circulation of, 638  
 formation of, 474  
 summary of factors concerned in formation of, 478  
 Lymphoblasts, 443  
 Lymphocytes, 442  
 Lysin, 794, 1009, 1015
- MACROPHAGS, 438  
 Macular field, 343  
 Maltase, 750, 765, 796, 800  
 Maltose, 766, 796  
 Mammary glands, conditions controlling secretion of, 983  
 structure and functions, 983  
 Manometer, Hürthle's, 495  
 maximum and minimum, 495  
 use of, for determining blood-pressure, 489

- Mast-cells, 443  
 Mastication, 713  
 Mathematical perspective, 377  
 Mean blood-pressure, 494  
 Medulla oblongata, 245  
   physiology of, 875  
   respiratory center in, 685  
 Medullary striæ, 215  
   tissue, functional significance of, 878  
 Meionectic blood, 679  
 Mendelian law of inheritance, 997  
 Meningeal spaces, 626  
 Menstruation, 967  
   effect of, on other functions, 971  
   physiological significance of, 971  
 Mercury manometer, use of, for blood-pressures, 489  
 Mesetic blood, 679  
 Metabolism, definition of, 891  
   intermediary, of carbohydrates, 909  
   of fats, 915  
   of nucleoproteins, 851  
   of proteins, 895  
 Metaproteins, 1016  
 Metathrombin, 464  
 Methemoglobin, 435  
 Methylglyoxal, 907  
 Methylpurins, 851  
 Microphage, 444  
 Micturition, physiology of, 856  
 Milk, composition of, 985  
 Millon's reaction for proteins, 1012  
 Minimal air, 654  
 Miosis, definition of, 328  
 Molisch reaction for proteins, 1013  
 Monakow's bundle, 180  
 Motor aphasia, 219  
   areas of brain, 196  
   paths in spinal cord, 178  
   points in man, 92  
 Mountain sickness, 706  
 Movements of alimentary canal, defecation, 733  
   deglutition, 713  
   large intestine, 731  
   mastication, 713  
   small intestine, 725  
   stomach, 720  
   vomiting, 735  
 Mucin in saliva, 755  
 Muscarin, action of, on heart, 589  
   on iris, 328  
   on sweat-glands, 864  
 Muscle, absolute power of, 39  
   action current of, 102  
   artificial stimulation of, 24  
   carbohydrates of, 63  
   cardiac, properties of, 58, 573  
   chemical changes of, in contraction, 66  
   composition of, 61  
   compound contractions of, 41  
   contraction of, 25  
     wave of, 35  
   contracture of, 32  
   curve of work of, 40  
   death rigor, 52  
   demarcation current of, 95  
   direct irritability of, 23  
   disappearance of glycogen in, 67  
   effect of temperature upon, 29  
     of veratrin upon, 31  
   efficiency of, as work-machine, 38  
   energy liberated in, 36  
   Engelmann's artificial, 72, 73  
   enzymes of, 65  
   ergographic records from, 47  
   extensibility and elasticity of, 20  
   fatigue of, 35, 49, 70  
   glycogen of, 828  
   heat rigor of, 52  
   inorganic salts of, 65  
   introductory contractions of, 34  
   isotonic and isometric contractions of, 28  
   lactic acid of, 64  
   latent period of contraction of, 27  
   maximal and submaximal contractions of, 29  
   myogenic tonus of, 57  
   neurogenic tonus of, 57  
   nitrogenous extractives of, 61, 64  
   number of stimuli necessary for tetanus, 45  
   pale fibers in, 19, 26  
   pigments of, 65  
   plain, 55  
   plasma, 19, 61  
   production of carbon dioxide in, 65  
   proteins of, 61  
   red fibers in, 19, 26  
   sarco-plasm, 19  
   simple contraction of, 25  
   smooth, 55  
   stroma, 62  
   structure of fiber, 18  
     by polarized light, 19  
   summation of contractions of, 43  
   theories of nature of contraction, 72  
   tone of, during contraction, 44  
   tonicity of, 51  
   vasomotor supply of, 637  
   voluntary contractions of, 45  
   white and red fibers of, 19  
 Muscle-sense, cortical area for, 203  
   importance of, in visual judgments, 377  
   paths for, in spinal cord, 172, 174  
   quality of, 289  
 Muscular contraction, electrical variation in, 105  
   intermediary chemical products in, 66



- Muscular insufficiency in movements  
 of eye-balls, 370  
 or deep sensibility, 287  
 work, effect of, on heart-rate, 598  
 on physiological oxidations, 930  
 on protein metabolism, 931  
 on respiratory movements, 704
- Musical sounds, classification and properties of, 394
- Mutations, theories of, 996
- Mydriasis, definition of, 328
- Myelin sheath of nerve-fibers, function of, 76
- Myelinization method of Flechsig, 164, 226
- Myeloblasts, 443
- Myenteric reflex, 726
- Myofibrillæ (of plain muscle), 55
- Myogen, 62  
 fibrin, 62
- Myogenic theory of heart-beat, 567  
 tonus, 57
- Myohematin, 437
- Myopia, 320
- Myosin, 62  
 fibrin, 62
- Myxedema, 868
- NARCOSIS, effect of, upon nerve impulse, 116
- Near point of distinct vision, 316
- Negative pressure in thorax, 658, 660  
 in ventricle, 560  
 variation in muscle and nerve, 102, 103
- Nerve, abducens, nucleus of, 249  
 auditory, 213  
 chorda tympani, 294, 753, 755  
 facial, nucleus of, 249  
 fourth cranial, nucleus of, 247  
 glossopharyngeal, nucleus of, 249  
 hemorrhoidalis inferior, 733  
 hypoglossal, nucleus of, 250  
 motor and sensory roots of, 81  
 olfactory, 216  
 optic, 208  
 pudendus, 733  
 recurrent, sensibility of anterior roots, 82  
 secretory, of adrenal glands, 878  
 spinal accessory, nucleus of, 250  
 third cranial, nucleus of, 246  
 trigeminal, nucleus of, 247  
 twelfth cranial, nucleus of, 250  
 vagus, nucleus of, 249
- Nerve-cell, chromatolysis of, 128  
 classification of, in spinal cord, 162  
 degenerative changes in, 127  
 general physiology of, 135  
 internal structure of, 134  
 metabolism in, 138
- Nerve-cell, neuron doctrine, 129  
 reaction of, 136  
 refractory period of, 139  
 summation of stimuli in, 138  
 varieties of, 131
- Nerve-fibers, action current of, 102  
 afferent and efferent, 79  
 anodal and cathodal stimulation of, 87  
 antidromic impulses in, 82  
 artificial stimuli of, 84  
 autoregeneration of, 127  
 chemistry of, 77  
 classification of, 80  
 core model of, 108  
 degeneration and regeneration of, 125  
 demarcation current of, 95  
 direction of conduction, 114  
 du Bois-Reymond's law of stimulation, 86  
 electrical stimulation of, in man, 93  
 electrotonic currents of, 107  
 electrotonus of, 87  
 impulse in, historical, 110  
 independent irritability of, 84  
 metabolism in, during activity, 119  
 myelin sheath of, 76  
 nutritive relations to nerve-cells, 123  
 opening and closing tetanus of, 90  
 Pflüger's law of stimulation of, 92  
 stimulation of, in man, 90  
 structure of, 75  
 unipolar method of stimulating, 91
- Nerve-impulse, historical, 110  
 metabolism during, 119  
 modification of, by various influences, 116  
 qualitative changes in, 80, 122  
 relation of, to action current, 105, 114  
 theories of, 120  
 velocity of, 111
- Nervi erigentes, 256, 617, 636
- Nervous secretion, gastric, 777  
 pancreatic, 791
- Neurogenic theory of heart-beat, 566  
 tonus, 57
- Neuron doctrine, 129
- Neurons, varieties of, 131
- Nicotin, action of, on salivary secretion, 762  
 on sweat secretion, 863  
 use of, in tracing autonomic fibers, 254
- Night-blindness, hemeralopia, 360
- Ninhydrin reaction, for protein, 1012
- Ninth cranial nerve, nucleus of, 249
- Nissl's granules, 134
- Nitric oxid hemoglobin, 429
- Nitrogen, condition of, in blood, 676

- Nitrogen, determination of, 892  
 equilibrium, 891  
 effect of non-protein food on, 894  
 excretion in urine, 845
- Nitrogenous extractives of muscle, 65
- Nodal point of eye, 312
- Non-polarizable electrodes, 100
- Norleucin, 794
- Normoblasts, 439
- Nuclease, 750
- Nucleo-albumin in bile, 818
- Nucleoproteins, 1015  
 in blood, 452  
 intermediary metabolism of, 851
- OBESITY**, physiological cause of, 919
- Ohm's law of composition of sound waves, 397
- Olfaction, end-organ for, 299  
 mechanism of, 300
- Olfactometer, 304
- Olfactory associations, 305  
 bulb, histological structure of, 217  
 center in cortex, 216  
 nerve, course of fibers of, in brain, 218  
 organs, fatigue of, 303  
 sensations, classification of, 301  
 conflict of, 305  
 qualities of, 301  
 threshold stimulus, 303  
 sense cells, 300  
 stimuli, nature of, 301
- Oncometer, 841
- Oöcytin, 978
- Oögonia, 975
- Ophthalmometer, 334
- Ophthalmoscope, 331
- Opothrapy, 866
- Opsonins, 444
- Optic chiasma, decussation in, 209  
 nerve, course of fibers of, in brain, 208  
 radiation, 209  
 thalamus, functions of, in vision, 212  
 tracts, structure of, 209
- Optical deceptions, 382
- Optograms on retina, 339
- Orthodiagram, 545
- Orthodiagraph, 545
- Osmosis, definition of, 1016
- Osmotic pressure, definition of, 1017  
 determination of, 1019  
 of blood, 422
- Oval field of Flechsig, 180
- Ovaries, internal secretion of, 886  
 relation of, to menstruation, 970
- Overtones, production of, 397
- Ovulation, 966
- Ovum, fertilization of, 976
- Ovum, implantation of, in uterus, 978  
 maturation of, 974  
 passage of, into uterus, 973
- Oxalate solutions, effect of, on coagulation, 467
- Oxidases, 748, 959
- Oxidations, theories of, 959
- Oxygen, action of, on respiratory center, 696, 705  
 compound of, with hemoglobin, 428  
 condition of, in blood, 676  
 effects of varying pressures of, on respiration, 705  
 potassium ferricyanide method of determining, 671  
 tension of, in alveolar air, 681  
 in tissues, 683  
 in venous blood, 681
- Oxygenase, 962
- Oxyhemoglobin, 428
- Oxyprolin, 795, 1009
- Oxyproteic acid, 846
- Oxypurins, 850
- PACCHIONIAN** bodies of brain, 627
- Pain sense, distribution and characteristics of, 286  
 localization of, 286  
 path for, in cord, 174
- Pains, hunger-, 725
- Pale fibers of muscle, 19, 26
- Pancreas, action of lipase in, 797  
 anatomy of, 787  
 curve of secretion of, 789  
 digestive action of secretion, 792  
 on carbohydrates, 797  
 internal secretion of, 887  
 normal mechanism of secretion, 790  
 secretory nerves of, 788
- Pancreatic secretion, chemical, 791  
 nervous, 791
- Paraglobulin, 450
- Paralysis (motor), 198
- Paralytic secretion (saliva), 763
- Parapeptone, 780
- Paraphasia, 220
- Parathyroid, structure and function of, 868, 869
- Parthenogenesis, 978
- Parturition, physiology of, 982
- Pendular movements (intestine), 725  
 sound waves, 395
- Pepsin, 778  
 discovery of, 742  
 properties of, 778
- Pepsin-hydrochloric acid digestion, 780
- Peptids, 796, 1010
- Peptone, 780  
 absorption of, in stomach, 786  
 effect on clotting of blood, 468

- Peptozym, 468  
 Pericardial liquid, 450  
 Perimeter, 342  
 Peripheral field of vision, 342  
   resistance in circulation, 514  
 Peristalsis, 725  
 Peroxidases, 962  
 Perspiration. See *Sweat*.  
 Pettenkofer's reaction, 816  
 Pflüger's law of stimulation, 88  
   tetanus, 90  
 Phagocytes, 444  
 Phenolsulphuric acid, 855  
 Phenomenon of conditioned reflexes,  
   190  
 Phenylalanin, 794, 1009  
 Phlorhizin diabetes, 912  
 Phosphatids, 78  
 Phosphoproteins, 1016  
 Phrenology, 192  
 Phrenosin, 79  
 Physical heat, regulation, 954  
 Physiological diplopia, 373  
   oxidations, theories of, 959  
   Lavoisier's work, 641, 944  
   point (vision), 344  
   saline, 423  
 Physostigmin, action of, on iris, 328  
 Pilocarpin, action of, on heart, 589  
   on iris, 328  
   on salivary glands, 253  
   on sweat glands, 864  
 Pineal body, 884  
 Piqure, 909  
 Pituitary body, structure and func-  
   tions of, 880, 883  
   effects of removal of, 882  
   extracts of anterior lobe of, 882  
   posterior lobe of, 881  
 Placenta, functions of, 979  
 Plain muscle, 55  
 Plasma of blood, composition of, 447  
 Pleonectic blood, 679  
 Plethysmography, 604  
 Pneumogastric nerve. See *Vagus*.  
 Pneumograph, 651  
 Pneumothorax, 661  
 Poikilothermous animals, 945  
 Polar bodies of ovum, 975  
 Polypeptid, 796, 1010  
 Positive electrical variation in heart,  
   590  
 Posterior funiculi, descending tracts  
   of, 177, 180  
   tracts of, 169  
   root, cells of, origin of, 83  
   ganglia, type of cells in, 131  
   termination in cord, 168  
 Postganglionic nerve-fibers, 252  
 Potassium ferrieyanide method of de-  
   termining oxygen, 671  
   salts, action of, on heart, 570, 601  
 Potential energy of food, 935  
 Precipitins, 1011  
 Predicrotic pulse-wave, 525  
 Preganglionic nerve-fibers, 252  
 Pregnancy, changes in, 981  
 Prepyramidal tracts, 180  
 Presbyopia, 316, 321  
 Press-juice, 746  
 Pressor nerve-fibers, 611  
 Pressure of gases in solution, 674  
   sense, deep, 279  
   distribution of, 283  
   localizing power, etc., 283  
 Primary proteoses, 780  
 Principal axis of lens, 307  
   focal distance, 307  
 Projection system of fibers (brain), 185  
 Prolamines, 1014  
 Prolin, 795, 1009  
 Propeptone, 780  
 Prostate gland, 989, 992, 993  
 Protalbumoses, 780  
 Protamins, 990, 1014  
 Protanopia, 355  
 Proteases, 747  
 Protective enzymes, 748  
 Proteins, absorption of, in intestine,  
   805  
   adequate, 901  
   as glycogen formers, 825  
   circulating, 896  
   classification of, 1013  
   definition and structure of, 1009  
   diffusion of, 1021  
   excretion of nitrogen of, 845, 846  
   general reactions of, 1011  
   in blood-plasma, 449  
   inadequate, 901  
   necessary amount of, in diet, 898  
   938, 939  
   normal metabolism in body, 895  
   nutritive value of, 901  
   of muscle, 61  
   osmotic pressure of, 1020  
   putrefaction of, in large intestine,  
   808  
   specific dynamic action of, 905  
   storage, 896  
   synthesis of, in body, 805  
 Proteolytic enzymes, 747  
 Proteoses, 1016  
   general properties of, 781  
 Protopathic sensations, 279  
   sensitivity, 278  
 Proximate principles of food, 738  
 Psychophysical law, 275  
 Ptomaines, 809  
 Ptyalin, 755  
   action of, in stomach, 724, 766  
   digestive action of, 765  
   effect of various conditions upon,  
   766

- Pubertal gland, 885, 987  
 Puberty, 967, 987  
 Pulmonary arteries, vasomotors of, 623  
   circulation, peculiarities of, 518  
   variations of, pressure in, 519  
 Pulse, anacrotic waves of, 526  
   catacrotic waves of, 525  
   form of wave, 524  
   general statement, 520  
   varieties of, in health and disease, 527  
   velocity of propagation of, 521  
   venous, 528  
 Pulse-pressure, 493  
 Pulsus irregularis perpetuus, 563  
 Purin bases, 64, 850  
 Purkinje, images of, 314  
   phenomenon, 349  
 Putrefaction in intestines, 808  
 Pyloric glands of stomach, 768  
   secretion of, 779  
 Pyramidal tract in brain, 197  
   in spinal cord, 178  
 Pyrrol compounds in protein molecule, 795  
 Pyrrolidin-carboxylic acid, 795, 1009  
 Pyruvic acid, 908
- QUADRANT hemianopia, 211  
 Quotient, respiratory, 708
- REACTION of degeneration, 93  
   time, 112  
 Reactions, biological, 425  
   for proteins, 1011  
   Gmelin's, 814  
   of blood, 416  
   of contents of small intestine, 807  
   of urine, 843  
   Pettenkofer's, 816  
 Recessive characteristics in inheritance, 997  
 Reciprocal innervation, 148  
 Recurrent sensibility of anterior roots, 82  
 Red blood-corpuses, chemical composition of, 448  
   condition of hemoglobin in, 420  
   effect of hemorrhage upon, 438  
   hemolysis of, 421  
   number and size of, 420  
   origin and fate of, 437  
   variations in number of, 439  
   fibers in muscles, 19, 26  
 Reduced hemoglobin, 428  
   schematic eye, 310  
 Reflex actions, axon reflexes, 151  
   classification of, 142  
   conditioned, 190
- Reflex actions, definition and historical, 140  
   deep, 160  
   unconditioned, 190  
   extensor thrust, 158  
   from parts of brain, 149  
   influence of condition of cord on, 149  
   of sensory endings upon, 145  
   inhibition of, 147  
   of heart, 586  
   knee-jerk, 155  
   myenteric, 726  
   of erection and ejaculation, 992  
   of respiratory center, 688, 692  
   of vasomotor nerves, 611  
   preparation of reflex frog, 142  
   reflex arc, 141  
   respiratory, from nose, larynx, and pharynx, 693  
   special and deep reflexes of cord, 160  
   spinal reflexes, 142  
   theory of, 144  
   through peripheral ganglia, 150  
   vasodilator nerves, 618  
   time of, 146  
   Türk's method of studying, 149  
   special spinal, 160  
   spinal, 142  
 Refractive power of eye, 317  
 Refractory period of heart-beat, 575  
   of nerve-cell, 139  
   of nerve-fiber, 119  
 Regeneration in nerve-fibers, 125  
 Reinforcement of knee-kick, 155  
 Reproduction, changes during pregnancy, 981  
   in uterus in menstruation, 968  
   chemistry of spermatozoa, 990  
   determination of sex, 999  
   erection, 991  
   fertilization of ovum, 976  
   functions of placenta, 979  
   general statements, 964  
   growth and senescence, 1001  
   heredity, 994  
   implantation of ovum, 978  
   mammary glands, 983  
   menstruation, 967  
   nutrition of embryo, 979  
   ovulation, 965  
   parturition, 982  
   properties of spermatozoa, 988  
   relation of ovaries to menstruation, 969  
   structure and functions of corpus luteum, 965  
   of Graafian follicles, 965  
 Residual air, 654  
 Resonance, importance of, in functions of ear, 398

- Respiration, abdominal type, 650  
 acapnia, 701, 707  
 accessory centers of, in the brain, 695  
   respiratory movements, 651  
 anatomy of thorax, 644  
 apnea, 699  
 artificial, 655, 664  
 asphyxia, 700  
 aspiratory action of, on blood-flow, 661  
 automatic action of respiratory center, 687  
 bronchoconstrictor and bronchodilator fibers, 702  
 calorimeter, 950  
 capacity of the bronchi, 655  
 chamber, 893  
 chemical composition of inspired and expired air, 665  
 Cheyne-Stokes type of, 710, 711  
 complementary air, 654  
 condition of carbon dioxide in blood, 679  
 costal, 650  
 definition of inspiration and expiration, 645  
 dissociation of oxyhemoglobin, 678  
 dyspnea, 649, 699  
 effect of anemia upon, 711  
   of changes in barometric pressure upon, 706  
   in composition of air, 705  
   of muscular work upon, 704  
 exchange of gases in, 665  
 forced, 649  
 gaseous exchange in lungs, 681  
 gases of blood, 669  
 history of, 640  
 hyperpnea, 699  
 increased heart-rate during inspiration, 576  
 injurious effect of expired air, 666  
 intrapulmonic pressure, 657  
 intrathoracic pressure, 658  
 mechanism of inspiration, 646  
 methods of recording, 651  
 minimal air, 654  
 modified, respiratory movements, 710  
 mountain sickness, 706  
 muscles of expiration, 648  
   of inspiration, 648  
 negative pressure in thorax, 659  
 normal stimulus of, 695  
   ventilation of alveoli, 655  
 of swallowing, 715  
 origin of negative pressure in thorax, 660  
 physical theory of, 680  
 physiological anatomy of organs of, 644
- Respiration, pneumothorax, 661  
 reflex stimulation of respiratory center, 688  
 relation of vagus nerve to, 689  
 residual air, 654  
 respiratory center, 685  
   quotient, 708  
   waves of blood-pressure, 662  
 secretion of gases in lungs, 683  
 spinal respiratory centers, 686  
 supplemental air, 654  
 tension of gases in alveolar air, 682  
   in arterial blood, 682  
   in tissues, 683  
   in venous blood, 682  
 tidal air, 654  
 value of nitrogen in, 676  
 ventilation, principles of, 666  
 vital capacity, 653  
 volumes of air respired, 652  
 voluntary control of, 693  
 Respiratory center, 685, 694  
   automatic activity of, 687  
   normal stimulus of, 695  
   reflex stimulation of, 697  
 movements, electrical changes in, 692  
 quotient, 708  
 waves of blood-pressure, 662  
 Restiform body, 235  
 Retina, action current of, 337  
 acuity of vision in, 343  
 after-images from, 352  
 color-blindness of, 354  
   contrasts in, 353  
   vision in, 349  
 corresponding points of, 372  
 distribution of color sense in, 357  
 entoptic phenomena, 366  
 function of rods and cones of, 358  
 fundamental and complementary colors, 351  
 light adapted and dark adapted, 346  
 portion of, stimulated by light, 336  
 projection of, on occipital lobes, 210  
 qualities of visual sensations from, 349  
 size of fovea in, 343  
 theories of color vision in, 360  
 threshold stimulus of, 345  
 visual purple of, 338  
 Retinoscope, 333  
 Reversible chemical reactions, 744  
 Rheoscopic frog preparation, 104  
 Rhodopsin, 338  
 Ribs, action of, in inspiration, 647  
 Rice, relation to beri-beri, 904  
 Rigor of muscle, 52, 68  
 Ringer's solution, 571  
 Ritter's tetanus, 90  
 Rivinus, ducts of, 752

- Rods and cones of eye, functions of, 358
- Romberg's symptom, 240
- Rubner's laws of growth, 1005  
 surface area law, 953
- Rubrospinal tract, 180, 199
- SACCULUS, functions of, 412
- Saliva, chorda, 756  
 composition of, 755  
 digestive action of, 765  
 general functions of, 767  
 secretory nerves for, 755  
 sympathetic, 756
- Salivary glands, action of drugs upon, 762  
 anatomical relations, 752  
 histological changes during activity, 759  
 structure of, 752  
 normal stimulation of, 763  
 secretory centers for, 764  
 nerve-fibers of, 756  
 theory of secretory nerves, 758
- Salts, absorption of, in stomach, 786  
 excretion of, 856, 922  
 general nutritive importance of, 922
- Sarcolactic acid, 64
- Sarcostyles, 19
- Sebaceous glands, secretion of, 864
- Secondary axes of a lens, 308  
 degeneration, nerve-fibers, 124, 164  
 proteoses, 780
- Secretin, gastric, 776  
 pancreatic, 791
- Secretion, 752  
 internal, 866  
 paralytic (saliva), 763  
 of bile, 818  
 of gastric juice, 774  
 of intestinal juice, 798  
 of pancreatic juice, 788  
 of saliva, 755  
 of sebaceous glands, 864  
 of sweat, 861  
 of urine, 834
- Secretagogues of gastric glands, 776
- Secretory nerves of salivary glands, 755
- Semicircular canals, direct stimulation of, 407  
 Fluorens' experiments upon, 405  
 structure of, 404  
 temporary and permanent effects of operations on, 406  
 theories of functions of, 408
- Seminal vesicles, function of, 989
- Senescence, 1001
- Senses, classification of, 271  
 cutaneous and internal, 278
- Sensibility, muscular, 287
- Sensibility of glans penis, 279  
 protopathic and epicritic, 278
- Sensory aphasia, 221  
 areas of cortex, 202  
 paths in spinal cord, 169, 172
- Sequence of heart-beat, 576
- Serin, 793, 1009
- Serodiagnosis, 748
- Serozym, 462
- Serum, action of foreign, 423
- Serum-albumin, 449
- Serum-globulin, 450, 1014
- Seventh cranial nerve, nucleus of, 249
- Sex, determination of, 999
- Sexual infantilism, 883
- Side-pressure in blood-vessels, 510
- Sinoauricular node, 537
- Sinospiral fibers of heart, 535
- Sixth cranial nerve, nucleus of, 249
- Skatoxylsulphuric acid, 855
- Skeletal muscular tissue, structure of, 17
- Skiascope, 333
- Skin, excretory functions of, 860  
 sweat glands of, 861
- Sleep, changes in circulation during, 261  
 curves of intensity of, 260  
 effect of sensory stimulation during, 264  
 hypnotic, 269  
 metabolism during, 933  
 physiological phenomena of, 258  
 theories of, 265
- Small intestine, absorption in, 800
- Smegma præputii, 865
- Smell, center for, in brain, 216  
 end-organ of, 299
- Smelling, mechanism of, 300
- Sodium chlorid, nutritive value of, 922  
 salts, effect of, on heart-beat, 570
- Somatoplasm, definition of, 1004
- Sound, sensations of. See *Ear*.  
 waves, nature and action of, 394  
 overtones of, 397  
 simple and compound, 395
- Specific energy of taste sensations, 297  
 gravity of blood, 419  
 nerve energies, doctrine of, 122, 273  
 of cutaneous nerves, 281
- Spectra, absorption, blood, 431
- Spectroscope, 432
- Spermatozoa, chemistry of, 990  
 maturation of, 988  
 properties of, 988
- Spermin, 884
- Spherical aberration in eye, 319
- Sphincter, cardiac, 718  
 external, of anus, 733  
 ileocecal, 731  
 internal, of anus, 733  
 of bile-duet, 821

- Sphincter of bladder, 858  
 Sphygmography, 523  
 Sphygmomanometers for determining blood-pressure in man, 500  
 Spinal cord as path of conduction, 162  
   classification of tracts in, 165  
   effect of removing, 153  
   general relations of gray and white matter in, 164  
   groups of cells in, 162  
   Helweg's bundle in, 181  
   homolateral and contralateral conduction in, 176  
   less well-known tracts of, 180  
   Monakow's bundle in, 180  
   paths in, for cutaneous impulses, 174  
   pyramidal tracts of, 180  
   reflex activities of, 140  
   tonic activity of, 152  
   tracts of, in lateral funiculi, 172  
     in posterior funiculi, 169  
     in white matter, 165  
   vestibulospinal tract, 181, 235  
 reflex movements, 142  
 reflexes, 142  
   in mammals, 145  
   respiratory center, 686  
 Spirometer, 653  
 Spleen, physiology of, 830  
 Stannius, first ligature of, 578  
 Stapedius muscle, function of, 390  
 Starvation, effect of, on body-metabolism, 934  
 Steapsin. See *Lipase*.  
 Stenson's duct, 752  
 Stereognostic perception, 204  
 Stereoscopic vision, 378  
 Stethoscope, 552  
 Stifel's figure, 336  
 Stimulants, 741  
   nutritive importance of, 925  
 Stimuli, artificial, of muscle, 24  
   of nerve, 84  
 Stokes-Adams syndrome, 578  
 Stokes' reducing agent, 434  
 Stomach, absorption in, 785  
   anatomy of, 719  
   automaticity of, 724  
   digestion in, 784  
   glands of, 768  
   histological changes in, during activity, 769  
   means of obtaining secretion of, 770  
   mechanism of gastric secretion, 775  
   movements of, 720  
   musculature of, 720  
   properties of pepsin of, 778  
   secretory nerves of, 774  
 Storage proteins, 896  
 Strabismus, 370  
 String galvanometer, 99  
 Stromuhr, 483  
 Subliminal stimulus, 346  
 Submaxillary ganglion, 752  
 Substrata, 746  
 Succus entericus, 798  
 Sugar puncture, 909  
   regulation of supply of, in body, 909  
 Sugars. See *Carbohydrates*.  
 Sulphur, forms in which excreted, 855  
 Summation of muscular contractions, 42  
   of stimuli in nerve-centers, 138  
 Superior olivary body, relation of, to auditory paths, 215  
 Supplemental air, 654  
 Surface area law, 953  
 Swallowing, 713  
   respiration, 715  
 Sweat, amount and composition of, 861  
   nerve-centers for, 864  
   nerves, action of, in heat regulation, 954  
   secretory fibers of, 862  
 Sympathetic nervous system, general relations, 251  
   resonance, 398  
 Syntonin, 781  
 Systole, duration of, in heart, 557  
 Systolic arterial pressure, 493  
   determination of, in animals, 495  
   in man, 500  
   plateau of ventricular contraction, 548  
 TABLES dorsalis, 171  
 Tactile discrimination, 175, 286  
   localization, 286  
 Taste buds, 296  
   center for, in brain, 218  
   nerves of, 294  
   sensations, classification of, 296  
     specific energy of, 297  
     threshold stimulus, 299  
   sense of, 294  
   stimuli, mode of action, 298  
 Tectorial membrane, 400  
 Temperature. See *Heat*.  
   coefficient, 115  
   effect of, on body metabolism, 933  
     on gases in solution, 673  
     on heart-rate, 600  
     on muscular contraction, 29  
   of human body, 946  
   sense, distribution and characteristics, 280, 282  
   path for, in spinal cord, 174  
   punctiform distribution of, 280  
 Tension of gases in solution, 674

- Tensor tympani muscle, function of, 394
- Tenth cranial nerve, nucleus of, 249
- Testis, internal secretion of, 884
- Tetanus, number of stimuli necessary for, 45  
of muscle, 41  
opening and closing, 90
- Theobromin, 851, 926
- Third cranial nerve, nucleus of, 246  
heart sound, 555
- Thirst, sense of, 292
- Thorax as closed cavity, 644  
aspiratory action of, 661  
normal position of, 645  
origin of negative pressure in, 660
- Thrombin, 456  
method of obtaining, 457
- Thrombogen, 457
- Thrombokinas, 461
- Thromboplastic substances, 460
- Thrombosis, 454
- Thyroid, extirpation of, 868  
function of, 871  
internal secretion of, 867
- Tidal air, 654
- Tigroid substance in nerve-cells, 134
- Tissue protein, 896
- Tissues, exchanges of gases in, 683
- Titration alkalinity, 419
- Tone (musical) of muscular contraction, 44
- Tonicity of heart-muscle, 579  
of muscle, 51  
of nerve-centers, 153
- Tonometer, 675
- Tonus, myogenic, 57  
neurogenic, 57
- Touch sense, path of, in cord, 174
- Tract of Lissauer, 168, 169
- Tracts in cerebellum, 235  
in spinal cord, 165  
of Flechsig, 167  
of Gowers, 167  
of Helweg (olivospinal), 181  
of Monakow (rubrospinal), 180, 199
- Traube-Hering waves, 616
- Treppe in muscular contractions, 34
- Trigeminal nerve, area of distribution of, 247  
nucleus of, 247
- Tritanopia, 355
- Trophic nerve-fibers, salivary glands, 758
- Trypsin, 747, 792
- Tryptophan, 795
- Türk's method for reflex time, 149
- Twelfth cranial nerve, nucleus of, 251
- Tympanic membrane, 386
- Tyrosin, 794, 1009  
reagent, 1012
- UNCONDITIONED reflexes, 190
- Unipolar method of stimulation, 91
- Unitarian theory (blood-corpuseles), 443
- Urea, formation of, in liver, 829  
origin and significance of, 847, 1009
- Ureters, contractions of, 857
- Urethra, sphincter of, 858
- Uric acid, 64, 850  
in spleen, 832  
significance of, 850
- Uricolytic enzyme, 852
- Urinary bladder, movements of, 857  
nerves of, 859.  
pigments, 845
- Urination, physiological mechanism of, 857
- Urine, composition of, 843  
nitrogenous excreta of, 845  
origin of acidity of, 840, 843  
reaction of, 843  
secretion of, 834  
pressure of, 838
- Uterus, changes of, during menstruation, 968  
effect of, on mammary glands 983
- Utriculus, function of, 412
- VAGUS nerve, action of, on gastric secretion, 774  
on heart, 581. See also *Inhibition*.  
on pancreas, 788  
as motor nerve to stomach, 724  
nucleus of, 249  
relations of, to respiratory center, 689
- Valin, 793, 1009
- Vasomotor fibers, centers for, in cord, 615  
in brain, 634  
to pulmonary arterics, 623  
nerves, action of, in heat regulation, 954  
course and distribution, 606, 616  
general properties of dilators, 617  
history of discovery of, 602  
methods used to demonstrate, 603  
of heart, 622  
position of constrictor center, 609  
reflex actions of, 611  
rhythmical action of constrictor center, 615  
to abdominal organs, 636  
to dilator center and reflexes, 618  
to genital organs, 636  
to head, 634  
to kidneys, 841  
to skeletal muscles, 637  
to trunk and limbs, 635  
to veins, 638



- Vasomotor nerves, tonic activity of, 609
- Veins, vasomotor supply of, 638
- Velocity of blood-flow. See *Circulation*.  
 pressure in blood-vessels, 511
- Venous blood-pressures, 507  
 cistern, 517  
 pulse, 528  
 in brain sinuses, 631
- Ventilation, principles of, 666
- Ventricle. See *Heart*.
- Veratrin, effect of, on muscle, 31
- Vernix caseosa, 865
- Vestibular nerve, 214
- Vestibulospinal tract of spinal cord, 181, 235
- Villi, intestinal, movements of, 729
- Vision. See *Eye* and *Retina*.
- Visual acuity, 343  
 center in cortex, 207  
 field, binocular, 372  
 monocular, 342  
 fields, conflict of, in binocular vision, 375  
 purple, 338
- Vital capacity, 653
- Vitamine, 740, 904
- Volume curve of heart, 549
- Voluntary muscular contractions, 45
- Vomiting, 735
- WALLERIAN degeneration, 124, 164
- Warm spots of skin, 280
- Water, absorption of, in stomach, 786  
 excretion of, 856
- Weber-Fechner law, 285
- Wharton's duct, 752
- Wirsung, duct of, 787
- Work done by contracting muscle, 40
- XANTHIN, 65, 850  
 oxidase, 852
- Xanthoproteic reaction for proteins, 1012
- ZYMOGEN, 749  
 granules, 760
- Zymoids, 746



---

---

SAUNDERS' BOOKS

— on —

# SURGERY

and

# ANATOMY

---

W. B. SAUNDERS COMPANY

WEST WASHINGTON SQUARE

PHILADELPHIA

9, HENRIETTA STREET

COVENT GARDEN, LONDON

---

---

## Crile & Lower's Anoci-Association

**Anoci-Association.** By GEORGE W. CRILE, M. D., F. R. C. S., Professor of Surgery, and WILLIAM E. LOWER, M. D., Assistant Professor of Genito-Urinary Surgery, Western Reserve University. Octavo of 275 pages, illustrated. Cloth, \$3.00 net.

REPRINTED IN TWO MONTHS

Anoci-association robs surgery of its harshness, diminishes postoperative mortality, lessens shock, nausea, vomiting, gas pains, backache, nephritis, pneumonia, and other postoperative complications. You get here, first of all, a monograph on *shock*—its kinetic theory, its histologic and clinical pathology, and its treatment. Then follow chapters on the principles of *anoci-association*; the technic of its *application* in the administration of the anesthetic in abdominal, gynecologic, and genito-urinary work; in operations for cancer of the breast, rectum, stomach, uterus, larynx, and tongue; in exophthalmic goiter operations; in operations on the brain and the extremities. Then come chapters on *anoci-association* and *blood-pressure*, and the technic of nitrous-oxid-oxygen anesthesia.

## Crile on Emotions

Just Out

The papers in this volume give the steps by which Dr. Crile established his *kinetic theory of shock*. They show the phylogenetic origin of the emotions and the pathologic identity of traumatic and emotional shock, and point out most convincingly the *clinical application* of these premises and their broad, general significance in every phase of life.

Octavo of 240 pages, illustrated. By GEORGE W. CRILE, M. D., Professor of Surgery, Western Reserve University, Cleveland. Cloth, \$3.00 net.

# The New Keen's Surgery

**Surgery:** ITS PRINCIPLES AND PRACTICE. Written by 81 eminent specialists. Edited by W. W. KEEN, M. D., LL.D., HON. F.R.C.S., ENG. AND EDIN., Emeritus Professor of the Principles of Surgery and of Clinical Surgery at the Jefferson Medical College. Six octavos of 1050 pages each, containing 3100 original illustrations, 157 in colors. Per volume: Cloth, \$7.00 net; Half Morocco, \$8.00 net.

## VOLUME VI GIVES YOU THE NEWEST SURGERY

### ALL THE ADVANTAGES OF A REVISION AT ONE-FIFTH THE COST

We have issued a Volume VI of "Keen"—the volume of the newest surgery. In this way you get all the advantages of a complete and thorough revision at but *one-fifth the cost*. It makes Keen's Surgery the best, the most up-to-date surgery on the market.

In this sixth volume you get the newest surgery—both general and special—from the pens of those same international authorities who have made the success of Keen's Surgery world-wide. Each man has searched for the new, the *really useful*, in his particular field, and he gives it to you here. Here you get the newest surgery, and fully illustrated. Then, further, you get a *complete index* to the entire six volumes, covering 125 pages, but so arranged that reference to it is extremely easy. If you want the newest surgery, you must turn to the new "Keen" for it.

---

# Bryan's Surgery

**Principles of Surgery.** By W. A. BRYAN, M. D., Professor of Surgery and Clinical Surgery at Vanderbilt University, Nashville. Octavo of 677 pages, with 224 original illustrations. Cloth, \$4.00 net.

## ILLUSTRATED

Dr. Bryan here gives you facts, accurately and concisely stated, without which no modern practitioner can do modern work. He discredits many fallacious ideas, giving you *facts* instead. He shows you in a most practical way the relations between surgical pathology and the resultant symptomatology, and points out the influence such information has on *treatment*.

**Dr. A. Vander Veer, Albany Medical College**

"It comes to us full of new ideas. So much that is clear and concise has been added that it is fascinating to study the work. It is bound to receive a hearty welcome."

# Hornsby and Schmidt's The Modern Hospital

**The Modern Hospital.** Its Inspiration; Its Construction; Its Equipment; Its Management. By JOHN A. HORNSBY, M. D., Secretary, Hospital Section, American Medical Association; and RICHARD E. SCHMIDT, Architect. Large octavo of 644 pages, with 207 illustrations. Cloth, \$7.00 net; Half Morocco, \$8.50 net.

## HOSPITAL EFFICIENCY

"Hornsby and Schmidt" tells you just exactly how to plan, construct, equip, and manage a hospital in all its departments, giving you every detail. It gives you exact data regarding heating, ventilating, plumbing, refrigerating, etc.—*and the costs*. It tells you how to equip a modern hospital with modern appliances. It tells you what you need in the operating room, the wards, the private rooms, the dining room, the kitchen—every division of hospital housekeeping. It gives you the duties of the directors, the superintendent, the various staffs, their relations to each other. It tells you all about nurses' training-schools—their management, curriculum, rules, regulations, etc. It gives you hundreds of valuable points on the business management of hospitals—large and small.

**Howell Wright**, *Superintendent City Hospital, Cleveland*

"To me the book is invaluable. I have a copy on my desk and scarcely a day passes but what I consult it and find what I want."

# Allen's Local Anesthesia

**Local Anesthesia.** By CARROLL W. ALLEN, M. D., Instructor in Clinical Surgery at Tulane University of Louisiana. Octavo of 608 pages, illustrated. Cloth, \$6.00 net; Half Morocco, \$7.50 net.

## JUST READY

This is a complete work on this subject. You get the history of local anesthesia, a chapter on nerves and sensation, giving particular attention to *pain*—what it is and its psychic control. Then comes a chapter on osmosis and diffusion. Each local anesthetic is taken up in detail, giving very special attention to *cocain* and *novocain*, pointing out the action on the nervous system, the value of adrenalin, paralysis caused by cocain anesthesia, control of toxicity. You get Crile's method of administering adrenalin and salt solution, the exact way to produce the intradermal wheal, to pinch the flesh for the insertion of the needle—all *shown* you step by step. You get full discussions of paraneural, intraneural, and spinal analgesia, intravenous and intra-arterial anesthesia, and Hackenbuck's regional anesthesia by circumferential injections. You get indications, contraindications, an article on *anoci-association*, with Crile's technic for producing anesthesia. Then the production of local anesthesia in the various regions is taken up in detail. Spinal analgesia and epidural injections are considered in a monograph of 45 pages. There is a large section on *dental anesthesia*.

# Cotton's Dislocations and Joint Fractures

**Dislocations and Joint Fractures.** By FREDERIC JAY COTTON, M. D., First Assistant Surgeon to the Boston City Hospital. Octavo of 654 pages, with 1201 original illustrations. Cloth, \$6.00 net; Half Morocco, \$7.50 net.

## TWO PRINTINGS IN EIGHT MONTHS

Dr. Cotton's clinical and teaching experience in this field has especially fitted him to write a practical work on this subject. He has written a book clear and definite in style, systematic in presentation, and accurate in statement. The illustrations possess the feature of showing just those points the author wishes to emphasize. This is made possible because the author is himself the artist.

### Boston Medical and Surgical Journal

"The work is delightful, spirited, scholarly, and original, and is not only a book of reference, but a book for casual reading. It brings the subject up to date, a feat long neglected."

---

# Murphy's Famous Clinics

**Clinics of John B. Murphy, M.D., at Mercy Hospital, Chicago.** Issued serially, one number every other month (six numbers a year). Each issue about 200 octavo pages, illustrated. Per year: \$8.00; Cloth, \$12.00. Sold only by the calendar year.

## DOWN-TO-THE-MINUTE SURGERY

This is just the work you have been waiting for—a permanent record of the teachings of this great surgeon. These are *not* students' clinics, but delivered at Mercy Hospital, Chicago, *for physicians only*. They are *postgraduate clinics*. These CLINICS are published *just as delivered* by Dr. Murphy, an expert stenographer taking down everything Dr. Murphy says and does. In this way these CLINICS retain all that individual force and charm so characteristic of the clinical teaching of this distinguished surgeon. But the most vital point about *these* CLINICS is that they are *absolutely fresh*. They give you a continuous postgraduate course right in your own office with John B. Murphy as your teacher. They have been called "The Practitioner's Text-book."

# Crandon and Ehrenfried's Surgical After-treatment

**Surgical After-treatment.** A Manual of the Conduct of Surgical Convalescence. By L. R. G. CRANDON, M. D., Assistant in Surgery, and ALBERT EHRENFRIED, M. D., Assistant in Anatomy, Harvard Medical School. Octavo of 831 pages, with 265 original illustrations. Cloth, \$6.00 net; Half Morocco, \$7.50 net.

## THE NEW (2d) EDITION, PRACTICALLY REWRITTEN

This work tells how best to manage all problems and emergencies of surgical convalescence from recovery-room to discharge. It gives *all the details* completely, definitely, yet concisely, and does not refer the reader to some other work perhaps not then available. The post-operative conduct of all operations is given, arranged alphabetically by regions. A special feature is the elaborate chapter on *Vaccine Therapy, Immunization by Inoculation and Specific Sera*, by Dr. George P. Sanborn, a disciple of Sir A. E. Wright. The text is illustrated.

### The Therapeutic Gazette

"The book is one which can be read with much profit by the active surgeon and will be generally commended by him."

# Papers from the Mayo Clinic

**Collected Papers by the Staff of St. Mary's Hospital, Mayo Clinic.** By WILLIAM J. MAYO, M. D., CHARLES H. MAYO, M. D., and their ASSOCIATES at St. Mary's Hospital, Rochester, Minn. Papers of 1905-1909, 1910, 1911, 1912, 1913, 1914. Each an octavo of about 800 pages, illustrated. Per volume: Cloth, \$5.50 net.

## PAPERS OF 1914 JUST READY

These volumes give you all the clinical teachings, all the important papers of W. J. and C. H. Mayo and their associates at St. Mary's Hospital. They give you the advances in operative technic, in methods of diagnosis as developed at this great clinic. This new volume, although called the *1914 volume*, gives you many papers that did not appear until *well into 1915*, quite a few being scheduled for as late as May and June. You should add this volume to your Mayo files.

### Bulletin Medical and Chirurgical Faculty of Maryland

"Much of the work done at the Mayo Clinic and recorded in these papers has been epoch-making in character. \* \* \* Represents a most substantial block of modern surgical progress."

**A Collection of Papers** (published previous to 1909). By WILLIAM J. MAYO, M. D., and CHARLES H. MAYO, M. D. Two octavos of 525 pages each, illustrated. Per set: Cloth, \$10.00 net.

# Mumford's Practice of Surgery

**The Practice of Surgery.** By JAMES G. MUMFORD, M. D., Instructor in Surgery, Harvard Medical School. Octavo of 1032 pages, with 682 illustrations. Cloth, \$7.00 net; Half Morocco, \$8.50 net.

**JUST OUT—NEW (2d) EDITION**

This, as its title implies, is a work on the *clinical* side of surgery—surgery as it is seen at the bedside, in the accident ward, and in the operating room. It expresses the matured outgrowth of twenty years of active hospital and private surgical practice, together with the experience gained from clinical teaching, classroom discussions, and lectures.

**John B. Murphy, M.D.,** *Professor of Surgery, Northwestern Medical School, Chicago.*

"This work truly represents Dr. Mumford's intellectual capacity and scope, and presents in a terse, forceful, yet pleasing manner, the live surgical topics of the day. It is in every particular up to date, and shows that rare quality of accentuating the essential and omitting the unnecessary."

---

# DaCosta's Modern Surgery

**Modern Surgery—GENERAL AND OPERATIVE.** By JOHN CHALMERS DACOSTA, M. D., Samuel D. Gross Professor of Surgery, Jefferson Medical College, Philadelphia. Octavo of 1515 pages, with 1085 illustrations. Cloth, \$6.00 net; Half Morocco, \$7.50 net.

**NEW (7th) EDITION**

A surgery, to be of the maximum value, must be up to date, must be complete, must have behind its statements the sure authority of experience, must be so arranged that it can be consulted quickly; in a word, it must be practical and dependable. Such a surgery is DaCosta's. Always an excellent work, for this edition it has been very materially improved by the addition of new matter to the extent of over 250 pages and by a most thorough revision of the old matter. Many old cuts have been replaced by new ones, and nearly 150 additional illustrations have been added.

**Rudolph Matas, M. D.,** *Professor of Surgery, Tulane University of Louisiana.*

"This edition is destined to rank as high as its predecessors, which have placed the learned author in the fore of text-book writers. The more I scrutinize its pages the more I admire the marvelous capacity of the author to compress so much knowledge in so small a space."



# Scudder's Treatment of Fractures

WITH NOTES ON DISLOCATIONS

**The Treatment of Fractures:** with Notes on a few Common Dislocations. By CHARLES L. SCUDDER, M.D., Surgeon to the Massachusetts General Hospital, Boston. Octavo of 708 pages, with 994 original illustrations. Polished Buckram, \$6.00 net; Half Morocco, \$7.50 net.

THE NEW (7th) EDITION, ENLARGED  
OVER 33,500 COPIES

The fact that this work has attained a seventh edition indicates its practical value. In this edition Dr. Scudder has made numerous additions throughout the text, and has added many new illustrations, greatly enhancing the value of the work. In every way this new edition reflects the very latest advances in the treatment of fractures.

**J. F. Binnie, M.D., University of Kansas**

"Scudder's Fractures is the most successful book on the subject that has ever been published. I keep it at hand regularly."

---

## Scudder's Tumors of the Jaws

**Tumors of the Jaws.** By CHARLES L. SCUDDER, M.D., Surgeon to the Massachusetts General Hospital, Boston. Octavo of 395 pages, with 353 illustrations, 6 in colors. Cloth, \$6.00 net; Half Morocco, \$7.50 net.

WITH NEW ILLUSTRATIONS

Dr. Scudder in this book tells you how to determine in each case the *form* of new growth present and then points out the best treatment. As the tendency of malignant disease of the jaws is to grow into the accessory sinuses and toward the base of the skull, an intimate knowledge of the anatomy of these sinuses is essential. Dr. Scudder has included, therefore, sufficient anatomy and a number of illustrations of an anatomic nature. Whether general practitioner or surgeon, you need this new book because it gives you just the information you want.

# Sisson's Anatomy of Domestic Animals

**Anatomy of the Domestic Animals.** By SEPTIMUS SISSON, S. B., V. S., Professor of Comparative Anatomy in Ohio State University. Octavo volume of 930 pages, with 725 illustrations, mostly original and many in colors. Cloth, \$7.00 net; Half Morocco, \$8.50 net.

## JUST OUT—NEW (2d) EDITION, RESET

Dr. Sisson's work has been entirely reset. More than 300 new and original illustrations have been introduced, the book now containing 725 illustrations, *100 of them in colors*. This makes Dr. Sisson's work an *atlas of comparative anatomy* as well as a descriptive text-book. The *nomenclature* throughout has been changed to conform to that adopted by the American Veterinary Medical Association. The work takes up the horse, the cow, the ox, the pig, the dog, the sheep—really a comparative anatomy of the domesticated animals.

### Boston Medical and Surgical Journal

"It is not amiss to say that the work ranks with the best. A marked advance in English veterinary literature, upon which student and practitioner may well congratulate themselves and no medical school can afford to be without."

# Gant on Constipation and Intestinal Obstruction

**Constipation and Intestinal Obstruction.** By SAMUEL G. GANT, M. D., Professor of Diseases of the Rectum and Anus, New York Post-Graduate Medical School and Hospital. Octavo of 559 pages, with 250 original illustrations. Cloth, \$6.00 net; Half Morocco, \$7.50 net.

## INCLUDING RECTUM AND ANUS

In this work the consideration given to the medical treatment of constipation is unusually extensive. The practitioner will find of great assistance the chapter devoted to formulas. The descriptions of the operative procedures are concise, yet fully explicit.

### The Proctologist

"Were the profession better posted on the contents of this book there would be less suffering from the ill effects of constipation. We congratulate the author on this most complete book."

# Kelly & Noble's Gynecology and Abdominal Surgery

**Gynecology and Abdominal Surgery.** Edited by HOWARD A. KELLY, M.D., Professor of Gynecology in Johns Hopkins University; and CHARLES P. NOBLE, M.D., formerly Clinical Professor of Gynecology in the Woman's Medical College, Philadelphia. Two imperial octavo volumes of 950 pages each, containing 880 original illustrations, some in colors. Per volume: Cloth, \$8.00 net; Half Morocco, \$9.50 net.

## WITH 880 ILLUSTRATIONS—TRANSLATED INTO SPANISH

This work possesses a number of valuable features not to be found in any other publication covering the same fields. It contains a chapter upon the bacteriology and one upon the pathology of gynecology, and a large chapter devoted entirely to *medical gynecology*, written especially for the physician engaged in general practice. *Abdominal surgery* proper, as distinct from gynecology, is fully treated, embracing operations upon the stomach, intestines, liver, bile-ducts, pancreas, spleen, kidneys, ureter, bladder, and peritoneum.

### American Journal of Medical Sciences

"It is needless to say that the work has been thoroughly done; the names of the authors and editors would guarantee this, but much may be said in praise of the method of presentation, and attention may be called to the inclusion of matter not to be found elsewhere."

---

# Bickham's Operative Surgery

**A Text-Book of Operative Surgery.** By WARREN STONE BICKHAM, M.D., of New York. Octavo of 1200 pages, with 854 original illustrations. Cloth, \$6.50 net; Half Morocco, \$8.00 net.

## THE NEW (3d) EDITION

This work completely covers the surgical anatomy and operative technic involved in the operations of general surgery. The practicability of the work is particularly emphasized in the 854 magnificent illustrations.

### Boston Medical and Surgical Journal

"The book is a valuable contribution to the literature of operative surgery. It represents a vast amount of careful work and technical knowledge on the part of the author. For the surgeon in active practice or the instructor of surgery it is an unusually good review of the subject."

# Eisendrath's Surgical Diagnosis

**A Text-Book of Surgical Diagnosis.** By DANIEL N. EISENDRATH, M.D., Professor of Surgery in the College of Physicians and Surgeons, Chicago. Octavo of 885 pages, with 574 entirely new and original text-illustrations and some colored plates. Cloth, \$6.50 net; Half Morocco, \$8.00 net.

## THE NEW (2d) EDITION

Of first importance in every surgical condition is a correct diagnosis, for upon this depends the treatment to be pursued; and the two—diagnosis and treatment—constitute the most practical part of practical surgery. Dr. Eisendrath takes up each disease and injury amenable to surgical treatment, and sets forth the means of correct diagnosis in a systematic and comprehensive way. Definite directions as to methods of examination are presented clearly and concisely, providing for all contingencies that might arise in any given case. Each illustration indicates precisely how to diagnose the condition considered.

### **Surgery, Gynecology, and Obstetrics**

"The book is one which is well adapted to the uses of the practising surgeon who desires information concisely and accurately given. . . . Nothing of diagnostic importance is omitted, yet the author does not run into endless detail."

# Eisendrath's Clinical Anatomy

**A Text-Book of Clinical Anatomy.** By DANIEL N. EISENDRATH, A.B., M.D., Professor of Surgery in the College of Physicians and Surgeons, Chicago. Octavo of 535 pages, illustrated. Cloth, \$5.00 net; Half Morocco, \$6.50 net.

## THE NEW (2d) EDITION

This new anatomy discusses the subject from the clinical standpoint. A portion of each chapter is devoted to the examination of the living through palpation and marking of surface outlines of landmarks, vessels, nerves, thoracic and abdominal viscera. The illustrations are from new and original drawings and photographs. This edition has been carefully revised.

### **Medical Record, New York**

"A special recommendation for the figures is that they are mostly original and were made for the purpose in view. The sections of joints and trunks are those of formalized cadavers and are unimpeachable in accuracy."

# Fenger Memorial Volumes

**Fenger Memorial Volumes.** Edited by LUDVIG HEKTOEN, M. D., Professor of Pathology, Rush Medical College, Chicago. Two octavos of 525 pages each. Per set: Cloth, \$15.00 net; Half Morocco, \$18.00 net.

## LIMITED EDITION

These handsome volumes consist of all the important papers written by the late Christian Fenger, for many years professor of surgery at Rush Medical College, Chicago. Not only the papers published in English are included, but also those which originally appeared in Danish, German, and French.

The name of Christian Fenger typifies thoroughness, extreme care, deep research, and sound judgment. His contributions to the advancement of the world's surgical knowledge are indeed as valuable and interesting reading to-day as at the time of their original publication. They are pregnant with suggestions. Fenger's literary prolificacy may be judged from this memorial volume—over 1000 pages.

# Sobotta and McMurrich's Human Anatomy

**Atlas and Text-Book of Human Anatomy.** In Three Volumes. By J. SOBOTTA, M. D., of Würzburg. Edited, with additions, by J. PLAYFAIR McMURRICH, A. M., PH. D., Professor of Anatomy, University of Toronto, Canada. Three large quartos, each containing about 250 pages of text and over 300 illustrations, mostly in colors. Per volume: Cloth, \$6.00 net; Half Morocco, \$7.50 net.

**Edward Martin, M.D.,** *Professor of Clinical Surgery, University of Pennsylvania*

"This is a piece of bookmaking which is truly admirable, with plates and text so well chosen and so clear that the work is most useful to the practising surgeon."

# Campbell's Surgical Anatomy

**A Text-Book of Surgical Anatomy.** By WILLIAM FRANCIS CAMPBELL, M. D., Professor of Anatomy, Long Island College Hospital. Octavo of 675 pages, with 319 original illustrations. Cloth, \$5.00 net.

## SECOND EDITION

This is in the fullest sense an applied anatomy—an anatomy that will be of inestimable value to the surgeon because only those facts are discussed and only those structures and regions emphasized that have a peculiar interest to him.

**Boston Medical and Surgical Journal**

"The author has an excellent command of his subject, and treats it with the freedom and the conviction of the experienced anatomist. He is also an admirable clinician."

# Moynihan's Abdominal Operations

**Abdominal Operations.** By SIR BERKELEY MOYNIHAN, M. S. (LONDON), F. R. C. S., of Leeds, England. Two octavos, totaling nearly 1000 pages, with 385 illustrations. Per set: Cloth, \$10.00 net; Half Morocco, \$13.00 net.

## JUST OUT—NEW (3d) EDITION, ENLARGED

This *new (3d) edition* was so thoroughly revised that the work had to be reset from cover to cover. Over 150 pages of new matter and some 85 new illustrations were added, making 385 illustrations, 5 of them in colors—really an *atlas of abdominal surgery*. This work is a personal record of Moynihan's operative work. You get his own successful methods of diagnosis. You get his own technic, in every case fully illustrated with handsome pictures. You get the bacteriology of the stomach and intestines, sterilization and preparation of patient and operator. You get complications, sequels, and after-care. Then the various operations are detailed with forceful clearness, discussing first gastric operations, following with intestinal operations, operations upon the liver, the pancreas, the spleen. Two new chapters added in this edition are *excision of gastric ulcer* and *complete gastrectomy*, giving the latest developments in these operative measures.

## Moynihan's Duodenal Ulcer

Second  
Edition

**Duodenal Ulcer.** By SIR BERKELEY MOYNIHAN, M. S. (LONDON), F. R. C. S., Leeds, England. Octavo of 486 pages, illustrated. Cloth, \$5.00 net; Half Morocco, \$6.50 net.

For the *practitioner*, who first meets with these cases, Mr. Moynihan fixes the diagnosis with precision, so that the case, if desired, may be referred in the early stage to the surgeon. The *surgeon* finds here the newest and best technic as used by one of the leaders in this field.

"Easily the best work on the subject; coming, as it does, from the pen of one of the masters of surgery of the upper abdomen, it may be accepted as authoritative."—*London Lancet*.

## Moynihan on Gall-stones

Second  
Edition

**Gall-stones and Their Surgical Treatment.** By SIR BERKELEY MOYNIHAN, M. S. (LONDON), F. R. C. S., Leeds, England. Octavo of 458 pages, illustrated. Cloth, \$5.00 net; Half Morocco, \$6.50 net.

This work gives special attention to the early symptoms in cholelithiasis, enabling you to diagnose the case in the early stages.

"We can heartily recommend this work as most satisfactory and of the greatest practical value."—*American Journal of the Medical Sciences*.

## Schultze and Stewart's Topographic Anatomy

**Atlas and Text-Book of Topographic and Applied Anatomy.** By PROF. DR. O. SCHULTZE, of Würzburg. Edited, with additions, by GEORGE D. STEWART, M.D., Professor of Anatomy and Clinical Surgery, University and Bellevue Hospital Medical College, N. Y. Large quarto of 189 pages, with 25 colored figures on 22 colored lithographic plates, and 89 text-cuts, 60 in colors. Cloth, \$5.50 net.

## Griffith's Hand-Book of Surgery

**A Manual of Surgery.** By FREDERIC R. GRIFFITH, M. D., Surgeon to the Bellevue Dispensary, New York City. 12mo of 579 pages, with 417 illustrations. Flexible leather, \$2.00 net.

## Keen's Addresses and Other Papers

**Addresses and Other Papers.** Delivered by WILLIAM W. KEEN, M. D., LL.D., F. R. C. S. (Hon.), Professor of the Principles of Surgery and of Clinical Surgery, Jefferson Medical College, Philadelphia. Octavo volume of 441 pages, illustrated. Cloth, \$3.75 net.

## Keen on the Surgery of Typhoid

**The Surgical Complications and Sequels of Typhoid Fever.** By WM. W. KEEN, M.D., LL.D., F.R.C.S. (Hon.), Professor of the Principles of Surgery and of Clinical Surgery, Jefferson Medical College, Philadelphia, etc. Octavo volume of 386 pages, illustrated. Cloth, \$3.00 net.

## Dannreuther's Minor and Emergency Surgery

**Minor and Emergency Surgery.** By WALTER T. DANNREUTHER, M. D., Surgeon to St. Elizabeth's Hospital and to St. Bartholomew's Clinic, New York City. 12mo of 225 pages, illustrated. Cloth, \$1.25 net.

## Bier's Hyperemia

Second Edition

**Bier's Hyperemic Treatment** in Surgery, Medicine, and the Specialties: A Manual of its Practical Application. By WILLY MEYER, M. D., Professor of Surgery at the New York Post-Graduate Medical School and Hospital; and PROF. DR. VICTOR SCHMIEDEN, Assistant to Prof. Bier, University of Berlin, Germany. Octavo of 280 pages, with original illustrations. Cloth, \$3.00 net.

"We commend this work to all those who are interested in the treatment of infections, either acute or chronic, for it is the only authoritative treatise we have in the English language."—*New York State Journal of Medicine.*

## Morris' Dawn of the Fourth Era in Surgery

**Dawn of the Fourth Era in Surgery and Other Articles.** By ROBERT T. MORRIS, M. D., Professor of Surgery, New York Post-Graduate Medical School and Hospital. 12mo of 145 pages, illustrated. \$1.25 net.

## Haynes' Anatomy

**A Manual of Anatomy.** By IRVING S. HAYNES, M.D., Professor of Practical Anatomy, Cornell University Medical College. Octavo, 680 pages, with 42 diagrams and 134 full-page half-tones. Cloth, \$2.50 net.

## American Pocket Dictionary

New (8th) Edition

**The American Pocket Medical Dictionary.** Edited by W. A. NEWMAN DORLAND, A. M., M. D., Editor "American Illustrated Medical Dictionary." 677 pages. Full leather, limp, with gold edges, \$1.00 net; with patent thumb index, \$1.25 net.

## Fowler's Surgery

In Two Volumes

**A Treatise on Surgery.** By GEORGE R. FOWLER, M. D., Emeritus Professor of Surgery, New York Polyclinic. Two imperial octavos of 725 pages each, with 888 original text-illustrations and 4 colored plates. Per set: Cloth, \$15.00 net; Half Morocco, \$18.00 net.

## International Text-Book of Surgery

Second Edition

**The International Text-Book of Surgery.** In two volumes. By American and British authors. Edited by J. COLLINS WARREN, M. D., LL. D., F. R. C. S. (Hon.), Professor of Surgery, Harvard Medical School; and A. PEARCE GOULD, M. S., F. R. C. S., of London, England. Vol. I.: *General and Operative Surgery*. Royal octavo, 975 pages, 461 illustrations, 9 full-page colored plates. Vol. II.: *Special or Regional Surgery*. Royal octavo, 1122 pages, 499 illustrations, and 8 full-page colored plates. Per volume: Cloth, \$5.00 net; Half Morocco, \$6.50 net.

## American Text-Book of Surgery

Fourth Edition

**American Text-Book of Surgery.** Edited by W. W. KEEN, M. D., LL. D., Hon. F. R. C. S., Eng. and Edin., and J. WILLIAM WHITE, M. D., Ph. D. Octavo, 1363 pages, 551 text-cuts and 39 colored and half-tone plates. Cloth, \$7.00 net; Half Morocco, \$8.50 net.

## Robson and Cammidge on the Pancreas

**The Pancreas: Its Surgery and Pathology.** By A. W. MAYO ROBSON, F. R. C. S., of London, England; and P. J. CAMMIDGE, F. R. C. S., of London, England. Octavo of 546 pages, illustrated. Cloth, \$5.00 net; Half Morocco, \$6.50 net.



## American Illustrated Dictionary

The New (7th) Edition

**The American Illustrated Medical Dictionary.** With tables of Arteries, Muscles, Nerves, Veins, etc.; of Bacilli, Bacteria, etc.; Eponymic Tables of Diseases, Operations, Stains, Tests, etc. By W. A. NEWMAN DORLAND, M.D. Large octavo, 1107 pages. Flexible leather, \$4.50 net; with thumb index, \$5.00 net.

**Howard A. Kelly, M.D.,** *Professor of Gynecology, Johns Hopkins University, Baltimore.*

"Dr. Dorland's dictionary is admirable. It is so well gotten up and of such convenient size. No errors have been found in my use of it."

## Golebiewski and Bailey's Accident Diseases

**Atlas and Epitome of Diseases Caused by Accidents.** By DR. ED. GOLEBIEWSKI, of Berlin. Edited, with additions, by PEARCE BAILEY, M.D. Consulting Neurologist to St. Luke's Hospital, New York City. With 71 colored figures on 40 plates, 143 text-cuts, and 549 pages of text. Cloth, \$4.00 net. *In Saunders' Hand-Atlas Series.*

## Helferich and Bloodgood on Fractures

**Atlas and Epitome of Traumatic Fractures and Dislocations** By PROF. DR. H. HELFERICH, of Greifswald, Prussia. Edited, with additions, by JOSEPH C. BLOODGOOD, M. D., Associate in Surgery, Johns Hopkins University, Baltimore. 216 colored figures on 64 lithographic plates, 190 text-cuts, and 353 pages of text. Cloth, \$3.00 net. *In Saunders' Atlas Series.*

## Sultan and Coley on Abdominal Hernias

**Atlas and Epitome of Abdominal Hernias.** By PR. DR. G. SULTAN, of Gottingen. Edited, with additions, by WM. B. COLEY, M. D., Clinical Lecturer and Instructor in Surgery, Columbia University, New York. 119 illustrations, 36 in colors, and 277 pages of text. Cloth, \$3.00 net. *In Saunders' Hand-Atlas Series.*

## Warren's Surgical Pathology

Second Edition

**Surgical Pathology and Therapeutics.** By J. COLLINS WARREN, M.D., LL.D., F.R.C.S. (HON.), Professor of Surgery, Harvard Medical School. Octavo, 873 pages; 136 illustrations, 33 in colors. Cloth, \$5.00 net; Half Morocco, \$6.50 net.

## Zuckerlandl and DaCosta's Surgery

Second Edition

**Atlas and Epitome of Operative Surgery.** By DR. O. ZUCKERLANDL, of Vienna. Edited, with additions, by J. CHALMERS DACOSTA, M.D., Samuel D. Gross Professor of Surgery, Jefferson Medical College, Philadelphia. 40 colored plates, 278 text-cuts, and 410 pages of text. Cloth, \$3.50 net. *In Saunders' Atlas Series.*

## Moore's Orthopedic Surgery

**A Manual of Orthopedic Surgery.** By JAMES E. MOORE, M.D., Professor of Clinical Surgery, University of Minnesota, College of Medicine and Surgery. Octavo of 356 pages, handsomely illustrated. Cloth, \$2.50 net.

"The book is eminently practical. It is a safe guide in the understanding and treatment of orthopedic cases. Should be owned by every surgeon and practitioner."—*Annals of Surgery*

## Fowler's Operating Room

New (3d) Edition, Reset

**The Operating Room and the Patient.** By RUSSELL S. FOWLER, M. D., Surgeon to the German Hospital, Brooklyn, New York. Octavo of 611 pages, illustrated. Cloth, \$3.50 net.

Dr. Fowler has written his book for surgeons, nurses assisting at an operation, internes, and all others whose duties bring them into the operating room. It contains explicit directions for the preparation of material, instruments needed, position of patient, etc., all beautifully illustrated.

## Nancrede's Principles of Surgery

New (2d) Edition

**Lectures on the Principles of Surgery.** By CHAS. B. NANCREDE, M.D., LL.D., Professor of Surgery and of Clinical Surgery, University of Michigan, Ann Arbor. Octavo, 407 pages, illustrated. Cloth, \$2.50 net.

"We can strongly recommend this book to all students and those who would see something of the scientific foundation upon which the art of surgery is built."—*Quarterly Medical Journal, Sheffield, England.*

## Nancrede's Essentials of Anatomy.

Seventh Edition

**Essentials of Anatomy**, including the Anatomy of the Viscera. By CHAS. B. NANCREDE, M.D., Professor of Surgery and of Clinical Surgery, University of Michigan, Ann Arbor. Crown octavo, 388 pages; 180 cuts. With an Appendix containing over 60 illustrations of the osteology of the body. Based on *Gray's Anatomy*. Cloth, \$1.00 net. *In Saunders' Question Compendis.*

"The questions have been wisely selected, and the answers accurately and concisely given."—*University Medical Magazine.*

## Martin's Essentials of Surgery.

Seventh Edition  
Revised

**Essentials of Surgery.** Containing also Venereal Diseases, Surgical Landmarks, Minor and Operative Surgery, and a complete description, with illustrations, of the Handkerchief and Roller Bandages. By EDWARD MARTIN, A.M., M.D., Professor of Clinical Surgery, University of Pennsylvania, etc. Crown octavo, 338 pages, illustrated. With an Appendix on Antiseptic Surgery, etc. Cloth, \$1.00 net. *In Saunders' Question Compendis.*

"Written to assist the student, it will be of undoubted value to the practitioner, containing as it does the essence of surgical work."—*Boston Medical and Surgical Journal.*

## Metheny's Dissection Methods

Just Issued

**Dissection Methods and Guides.** By DAVID GREGG METHENY, M. D., L. R. C. P., L. R. C. S. (EDIN.), L. F. P. S. (GLAS.), Associate in Anatomy, Jefferson Medical College, Philadelphia. Octavo of 131 pages, illustrated.

Cloth, \$1.25 net.

This work bridges the gap heretofore existing between the descriptive text-book and the dissecting table. In order that it may be used in connection with any text-book or atlas both the old and the new anatomic names are given. Everything the student could be expected to do is carefully explained in detail.











YALE  
UNIVERSITY



CUSHING/WHITNEY  
MEDICAL LIBRARY

Accession no.

Author *Hewell, W<sup>m</sup> H.*

*A text-book of  
physiology... 6th ed.*

Call no.

*Hist Q034  
H68*

