

**PRACTICAL
PHYSIOLOGICAL CHEMISTRY**

H A W K

of the atmosphere. The oxygen concentration in the atmosphere is assumed to be 20.9%. The oxygen concentration in the water is assumed to be 100% of the oxygen concentration in the atmosphere. The oxygen concentration in the water is assumed to be 100% of the oxygen concentration in the atmosphere.

The oxygen concentration in the water is assumed to be 100% of the oxygen concentration in the atmosphere. The oxygen concentration in the water is assumed to be 100% of the oxygen concentration in the atmosphere. The oxygen concentration in the water is assumed to be 100% of the oxygen concentration in the atmosphere.

The oxygen concentration in the water is assumed to be 100% of the oxygen concentration in the atmosphere. The oxygen concentration in the water is assumed to be 100% of the oxygen concentration in the atmosphere. The oxygen concentration in the water is assumed to be 100% of the oxygen concentration in the atmosphere.

The oxygen concentration in the water is assumed to be 100% of the oxygen concentration in the atmosphere. The oxygen concentration in the water is assumed to be 100% of the oxygen concentration in the atmosphere. The oxygen concentration in the water is assumed to be 100% of the oxygen concentration in the atmosphere.

The oxygen concentration in the water is assumed to be 100% of the oxygen concentration in the atmosphere. The oxygen concentration in the water is assumed to be 100% of the oxygen concentration in the atmosphere. The oxygen concentration in the water is assumed to be 100% of the oxygen concentration in the atmosphere.

The oxygen concentration in the water is assumed to be 100% of the oxygen concentration in the atmosphere. The oxygen concentration in the water is assumed to be 100% of the oxygen concentration in the atmosphere. The oxygen concentration in the water is assumed to be 100% of the oxygen concentration in the atmosphere.

The oxygen concentration in the water is assumed to be 100% of the oxygen concentration in the atmosphere. The oxygen concentration in the water is assumed to be 100% of the oxygen concentration in the atmosphere. The oxygen concentration in the water is assumed to be 100% of the oxygen concentration in the atmosphere.

The oxygen concentration in the water is assumed to be 100% of the oxygen concentration in the atmosphere. The oxygen concentration in the water is assumed to be 100% of the oxygen concentration in the atmosphere. The oxygen concentration in the water is assumed to be 100% of the oxygen concentration in the atmosphere.

The oxygen concentration in the water is assumed to be 100% of the oxygen concentration in the atmosphere. The oxygen concentration in the water is assumed to be 100% of the oxygen concentration in the atmosphere. The oxygen concentration in the water is assumed to be 100% of the oxygen concentration in the atmosphere.



Absorption Spectra.

PLATE I.

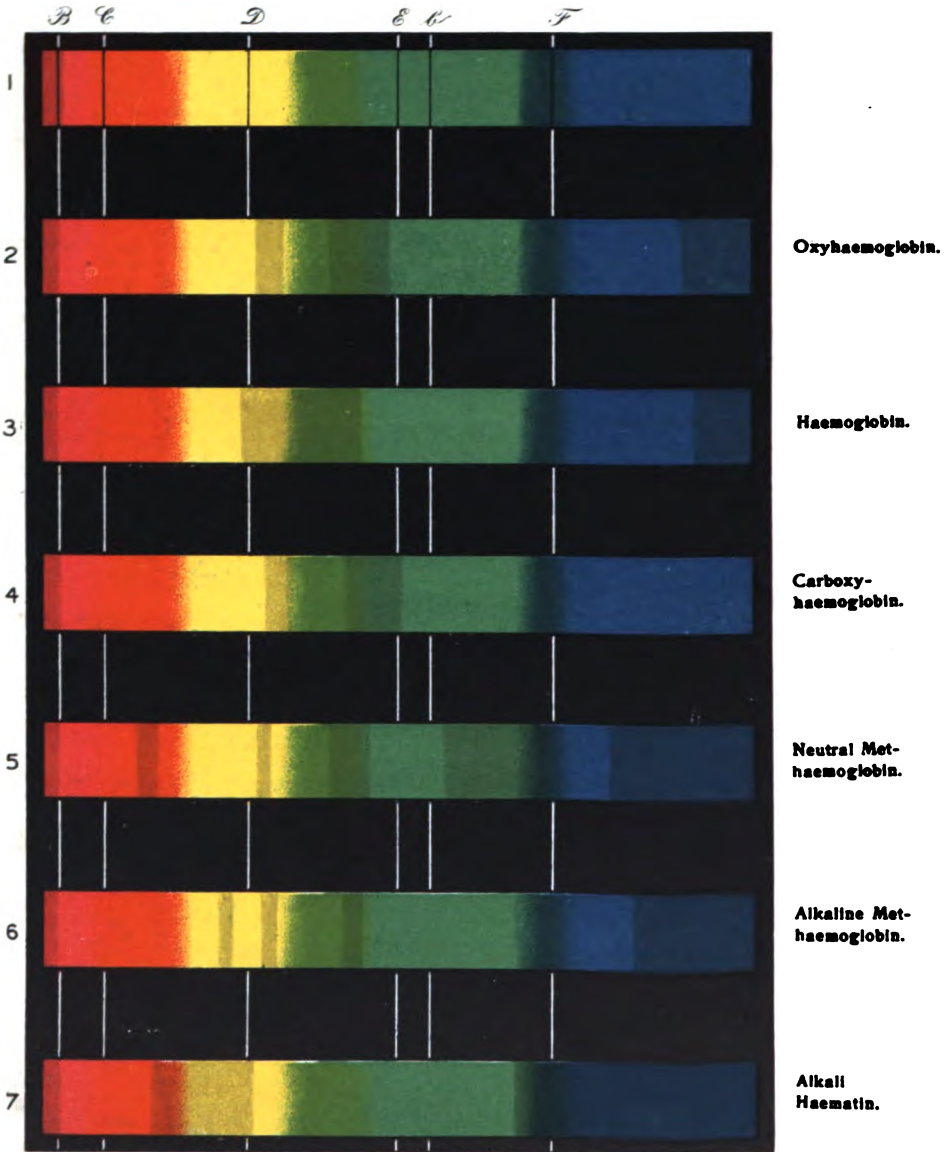

Absorption Spectra.

PLATE II.

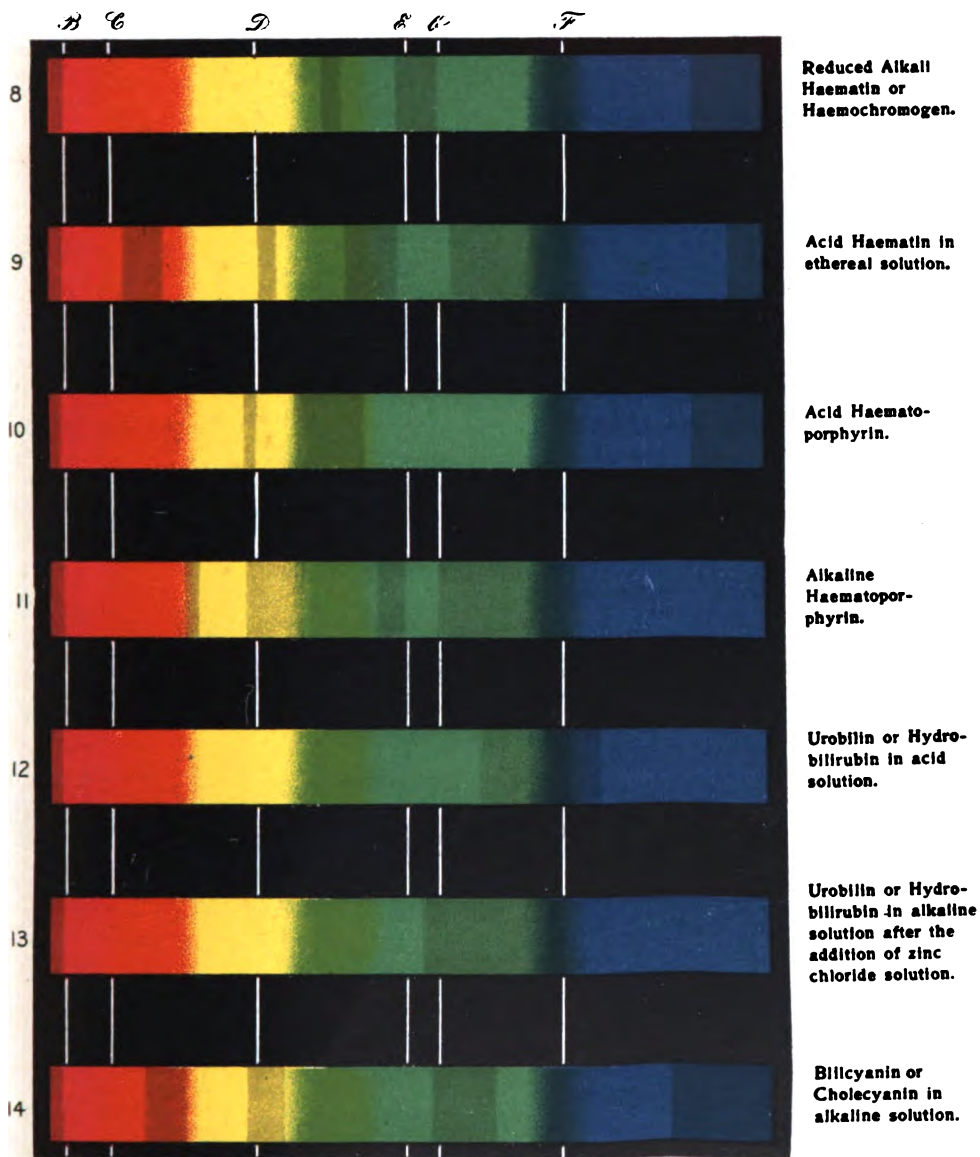



PRACTICAL PHYSIOLOGICAL CHEMISTRY

A BOOK DESIGNED FOR USE IN COURSES IN PRACTICAL
PHYSIOLOGICAL CHEMISTRY IN SCHOOLS
OF MEDICINE AND OF SCIENCE

BY

PHILIP B. HAWK, M. S., Ph. D.
PROFESSOR OF PHYSIOLOGICAL CHEMISTRY AND TOXICOLOGY IN THE
JEFFERSON MEDICAL COLLEGE OF PHILADELPHIA

SIXTH EDITION, REVISED AND ENLARGED

WITH TWO FULL-PAGE PLATES OF ABSORPTION SPECTRA IN COLORS
FOUR ADDITIONAL FULL-PAGE COLOR PLATES AND ONE
HUNDRED AND EIGHTY-FIVE FIGURES OF WHICH
TWELVE ARE IN COLORS

PHILADELPHIA
P. BLAKISTON'S SON & CO.
1012 WALNUT STREET

FIRST EDITION, COPYRIGHT, 1907, BY P. BLAKISTON'S SON & Co.
SECOND EDITION, COPYRIGHT, 1909, BY P. BLAKISTON'S SON & Co.
THIRD EDITION, COPYRIGHT, 1910, BY P. BLAKISTON'S SON & Co.
FOURTH EDITION, COPYRIGHT, 1912, BY P. BLAKISTON'S SON & Co.
REPRINTED, OCTOBER, 1913, AND MAY, 1915
FIFTH EDITION, COPYRIGHT, 1916, BY P. BLAKISTON'S SON & Co.
REPRINTED, OCTOBER, 1917
SIXTH EDITION, COPYRIGHT, 1918, BY P. BLAKISTON'S SON & Co.
REPRINTED, AUGUST, 1919

THE MAPLE PRESS YORK PA

WASHER

F514
H372
1012

THESE PAGES ARE
AFFECTIONATELY DEDICATED
TO
_MY PARENTS

PREFACE TO THE SIXTH EDITION

The entire book has been thoroughly revised in an attempt to bring it strictly up to date. In view of the great clinical importance of the chemical phases of the phenomena of acidosis a new chapter on "Acidosis" has been introduced. The chapters on Metabolism, Blood Analysis, Gastric Digestion, and Quantitative Analysis of Urine have been considerably expanded, and the question of Growth has been treated experimentally. Two radical changes in the Quantitative section are the substitution of Van Slyke's procedure for all former methods for the determination of acetone bodies in urine, and the elimination of all methods for the determination of urea, except those based upon the use of urease.

Among the new cuts introduced are those showing the curds of human and cows' milk at different stages of digestion; pentosazones prepared from the urine of a patient in the Jefferson Hospital; growth curves of albino rats on different diets; curves showing the psychical and chemical stimulation of gastric juice; the Van Slyke Carbon Dioxide Apparatus; the Fridericia apparatus; Kober's nephelometer-colorimeter; and Bergeim's intragastric conductance apparatus.

The author is particularly indebted to Dr. Olaf Bergeim and Dr. Clarence A. Smith for their aid in revising the book. He is also under obligation to Professors Chester C. Fowler and J. C. Blake and Drs. Donald D. Van Slyke, Thomas B. Osborne, and Albert R. Merz for timely suggestions, and to Messrs B. L. Fleming and E. L. Small for assistance in proof reading. The permission of Drs. Olaf Bergeim, Martin E. Rehfuss, H. R. Fishback, J. M. Evvard, Raymond J. Miller, and Robert A. Lichtenthaler to insert unpublished material is also appreciated.

It is a pleasure to once more testify to the courtesy and consideration extended to the author by the publishers of this volume.



CONTENTS

	PAGE
CHAPTER I	
ENZYMES AND THEIR ACTION	I
CHAPTER II	
CARBOHYDRATES	19
CHAPTER III	
SALIVARY DIGESTION	54
CHAPTER IV	
PROTEINS: THEIR DECOMPOSITION AND SYNTHESIS	63
CHAPTER V	
PROTEINS: THEIR CLASSIFICATION AND PROPERTIES	93
CHAPTER VI	
NUCLEIC ACIDS AND NUCLEOPROTEINS	123
CHAPTER VII	
GASTRIC DIGESTION.	138
CHAPTER VIII	
GASTRIC ANALYSIS	151
CHAPTER IX	
FATS	180
CHAPTER X	
PANCREATIC DIGESTION	189
CHAPTER XI	
INTESTINAL DIGESTION	199
CHAPTER XII	
BILE	206
CHAPTER XIII	
PUTREFACTION PRODUCTS	216
CHAPTER XIV	
FECES.	225

	PAGE
CHAPTER XV	
BLOOD AND LYMPH	249
CHAPTER XVI	
BLOOD ANALYSIS	274
CHAPTER XVII	
ACIDOSIS.	319
CHAPTER XVIII	
MILK	341
CHAPTER XIX	
EPITHELIAL AND CONNECTIVE TISSUES	359
CHAPTER XX	
MUSCULAR TISSUE	368
CHAPTER XXI	
NERVOUS TISSUE.	381
CHAPTER XXII	
URINE: GENERAL CHARACTERISTICS OF NORMAL AND PATHOLOGICAL URINE . . .	387
CHAPTER XXIII	
URINE: PHYSIOLOGICAL CONSTITUENTS	397
CHAPTER XXIV	
URINE: PATHOLOGICAL CONSTITUENTS.	440
CHAPTER XXV	
URINE: ORGANIZED AND UNORGANIZED SEDIMENTS.	486
CHAPTER XXVI	
URINE: CALCULI	504
CHAPTER XXVII	
URINE: QUANTITATIVE ANALYSIS	508
CHAPTER XXVIII	
METABOLISM	584
REAGENTS AND SOLUTIONS.	617
INDEX.	635

LIST OF ILLUSTRATIONS

PLATE	PAGE
I. Absorption Spectra }	<i>Frontispiece</i>
II. Absorption Spectra }	
III. Osazones	Opposite page 22
IV. Normal Erythrocytes and Leucocytes	Opposite page 253
V. Uric Acid Crystals	Opposite page 408
VI. Ammonium Urate.	Opposite page 491
FIGURE	PAGE
1. Apparatus for Quantitative Determination of Catalase	17
2. Dialyzing Apparatus for Students' Use	24
3. Apparatus for Alcoholic Fermentation Experiment	31
4. Iodoform	31
5. Einhorn Saccharometer	31
6. One Form of Laurent Polariscope.	32
7. Diagrammatic Representation of the Course of the Light through the Laurent Polariscope	34
8. Polariscope (Schmidt and Hänsch Model)	34
9. Potato Starch	44
10. Bean Starch.	44
11. Arrowroot Starch.	44
12. Rye Starch	44
13. Barley Starch	44
14. Oat Starch.	44
15. Buckwheat Starch	44
16. Maize Starch.	44
17. Rice Starch	44
18. Pea Starch.	44
19. Wheat Starch	44
20. Microscopical Constituents of Saliva.	58
21. Glycocoll Ester Hydrochloride	72
22. Serine.	73
23. Phenylalanine	74
24. Fischer Apparatus	75
25. Tyrosine.	76
26. Cystine	76
27. Histidine Dichloride	78
28. Leucine	80
29. Lysine Picrate	81
30. Aspartic Acid	81
31. Glutamic Acid.	83
32. Levo- α -Proline.	84
33. Copper Salt of Proline.	84
34. Van Slyke Amino Nitrogen Apparatus.	88
35. Section of Van Slyke Apparatus	88
36. Coagulation Temperature Apparatus	106
37. Edestin	109
38. Excelsin, the Protein of the Brazil Nut	110

FIGURE	PAGE
39. Guanine Chloride	135
40. Hypoxanthine Chloride	136
41. Curves Showing Stimulatory Power of Water	144
42. Curves Showing Stimulatory Power of Water	144
43. Curves Showing Stimulatory Power of Beef Extract	148
44. Curves Showing Psychical Stimulation of Gastric Secretion	149
45. Normal and Pathological Curves after an Ewald Meal	151
46. Reh fuss Stomach Tube	152
47. Bergeim Intragastric Conductance Apparatus	153
48. Curves Showing Relationship of Conductance to Acidities	153
49. Influence of Acid Introduced into the Normal Human Stomach	154
50. Hydrogen Ion Concentration Chart	161
51. Acidity Curves of Normal Human Stomach	167
52. Acidity Curves from a Case of Hyperacidity	168
53. Acidity and Protein Curves in Gastric Carcinoma	168
54. Total Acidity and Protein Curves in Benign Achylia	169
55. Microscopical Constituents of the Gastric Contents	176
56. Beef Fat	180
57. Mutton Fat	183
58. Pork Fat	185
59. Palmitic Acid	186
60. Melting-point Apparatus	187
61. Bile Salts	209
62. Bilirubin (Hematoidin)	209
63. Cholesterol	214
64. Taurine	215
65. Glycocoll	215
66. Ammonium Chloride	220
67. Hematoidin Crystals from Acholic Stools	226
68. Charcot-Leyden Crystals	229
69. Boas' Sieve	233
70-75. Microscopical Constituents of Feces	234-235
76. Oxyhemoglobin Crystals from Blood of the Guinea-pig	255
77. Oxyhemoglobin Crystals from Blood of the Rat	255
78. Oxyhemoglobin Crystals from Blood of the Horse	256
79. Oxyhemoglobin Crystals from Blood of the Squirrel	256
80. Oxyhemoglobin Crystals from Blood of the Dog	257
81. Oxyhemoglobin Crystals from Blood of the Cat	257
82. Oxyhemoglobin Crystals from Blood of the Necturus	258
83. Effect of Water on Erythrocytes	265
84. Hemin Crystals from Human Blood	269
85. Hemin Crystals from Sheep Blood	269
86. Sodium Chloride	271
87. Apparatus for Epstein's Sugar Method	285
88. Bang Reduction Flask	287
89. Bloor's Nephelometer	296
90. Nephelometer in Position, Showing Relation to Source of Light	297
91. Kober's Nephelometer—Colorimeter	298
92. Direct-vision Spectroscope	301
93. Angular-vision Spectroscope Arranged for Absorption Analysis	302
94. Diagram of Angular-vision Spectroscope	302
95. Fleischl's Hemometer	305
96. Pipette of Fleischl's Hemometer	306
97. Colored Glass Wedge of Fleischl's Hemometer	306

FIGURE	PAGE
98. Dare's Hemoglobinometer	307
99. Horizontal Section of Dare's Hemoglobinometer	308
100. Method of Filling the Capillary Observation Cell of Dare's Hemoglobinometer.	308
101. Thomas-Zeiss Counting Chamber.	309
102. Thomas-Zeiss Capillary Pipettes.	310
103. Ordinary Ruling of Thomas-Zeiss Counting Chamber.	311
104. Zappert's Modified Ruling of Thomas-Zeiss Counting Chamber.	312
105. Bürker's Pipettes, Mixing Flasks, and Counting Chamber.	314
106. Ruling of Bürker Counting Chamber	315
107. Schema	317
108. Bürker Counting Chamber.	317
109. Van Slyke Carbon Dioxide Apparatus.	326
110. Tube Used in Collecting Blood.	326
111. Separatory Funnel used in Saturating Blood Plasma with Carbon Dioxide.	327
112. Fridericia Apparatus	332
113. Normal Milk and Colostrum.	343
114. Curd of Human Milk.	344
115. Curd of Human Milk.	344
116. Curd of Cows' Milk	344
117. Curd of Cows' Milk.	344
118. Lactose	347
119. Calcium Phosphate.	351
120. Centrifuge Tube used in Babcock Fat Method.	353
121. Croll's Fat Apparatus.	354
122. Soxhlet Apparatus	355
123. Feser's Lactoscope	355
124. Creatine.	371
125. Xanthine	373
126. Hypoxanthine Silver Nitrate.	380
127. Xanthine Silver Nitrate.	380
128. Deposit in Ammoniacal Fermentation.	390
129. Deposit in Acid Fermentation	391
130. Urinometer and Cylinder	392
131. Beckmann-Heidenhain Freezing-point Apparatus.	393
132. Urea	400
133. Urea Nitrate.	402
134. Melting-point Tubes Fastened to Bulb of Thermometer.	403
135. Urea Oxalate.	404
136. Pure Uric Acid.	408
137. Creatinine.	410
138. Creatinine-Zinc Chloride.	413
139. Hippuric Acid	417
140. Allantoïn from Cat's Urine.	420
141. Benzoic Acid	424
142. Calcium Sulphate.	433
143. "Triple Phosphate"	436
144. Albumoscope.	452
145. Pentosazone	471
146. Marsh Apparatus.	477
147. The Purdy Electric Centrifuge	486
148. Sediment Tube for the Purdy Electric Centrifuge.	486
149. Calcium Oxalate	488
150. Calcium Carbonate.	488
151. Various Forms of Uric Acid	490

FIGURE	PAGE
152. Acid Sodium Urate.	491
153. Cystine	491
154. Crystals of Impure Leucine	492
155. Epithelium from Different Areas of the Urinary Tract.	495
156. Pus Corpuscles.	496
157. Hyaline Casts	497
158. Granular Casts	498
159. Granular Casts.	499
160. Epithelial Casts	499
161. Blood, Pus, Hyaline and Epithelial Casts	499
162. Fatty Casts	500
163. Fatty and Waxy Casts	500
164. Cylindroids	501
165. Crenated Erythrocytes	502
166. Human Spermatozoa	503
167. Folin Fume Absorber.	512
168. Duboscq Colorimeter	515
169, 170. Forms of Apparatus used in Methods of Folin and Associates for Determination of Total Nitrogen, Urea and Ammonia	516
171. Bock and Benedict Apparatus	518
172. Gullick Micro-oxidation Flask	519
173. Van Slyke and Cullen Apparatus.	521
174. Folin's Ammonia Apparatus.	523
175. Folin Improved Absorption Tube.	524
176. Ruhemann's Uricometer.	537
177. Hall's Purinometer	540
178. Esbach's Albuminometer	555
179. Growth Curve of Albino Rat	586
180. Growth Curve of Albino Rat	587
181. Blood Sugar as Influenced by Diet	589
182. Blood Sugar Curve of Diabetic after Glucose Ingestion	590
183. Influence of Protein Ingestion on Endogenous Uric Acid Output	596
184. The Endogenous Uric Acid Output during Fasting	596
185. Berthelot-Atwater Bomb Colorimeter.	607

PHYSIOLOGICAL CHEMISTRY

CHAPTER I

ENZYMES AND THEIR ACTION

According to the old classification ferments were divided into two classes, the *organized ferments* and the *unorganized ferments*. As organized ferments or true ferments there were grouped such substances as *yeast* and certain *bacteria* which were supposed to act by virtue of vital processes, whereas the unorganized ferments included *salivary amylase* (ptyalin), *gastric protease* (pepsin), *pancreatic protease* (trypsin), etc., which were described as "non-living unorganized substances of a chemical nature." Kühne designated this latter class of substances as *enzymes* (ἐν ζύμῃ—in yeast). This division into organized ferments (true ferments) and unorganized ferments (enzymes) was generally accepted and was practically unquestioned until Buchner overthrew it in the year 1897 by his epoch-making investigations on zymase. Previous to this time many writers had expressed the opinion that the action of the ferment organisms was similar to that of the unorganized ferments or enzymes and that therefore the activity of the former was possibly due to the production of a substance in the cell, which was in nature similar to an enzyme. Investigation after investigation, however, failed to isolate any such principle from an active cell and the exponents of the "vital" theory became strengthened in their belief that certain fermentative processes brought about by living cells could not occur apart from the biological activity of such cells. However, as early as 1858, Traube has enunciated, in substance, the principles which were destined to be fundamental in our modern theory of fermentation. He expressed the belief that the yeast cell produced a product in its metabolic activities which had the property of reacting with sugar with the production of carbon dioxide and alcohol, and further that this reaction between the product of the metabolism of the yeast cell and the sugar occurred *without aid from the original cell*. It was not until 1897, however, that this theory was placed upon a firm experimental basis. This was brought about through the efforts of Buchner, who succeeded in isolating from the living yeast cells a substance (zymase) which, when freed from the last trace of organized cellular material, was able to bring

about the identical fermentative processes which, up to this time, had been deemed possible only in the presence of the active, living yeast cell.

Buchner's manipulation of the yeast cells consisted in first grinding them with sand and infusorial earth, after which the finely divided material was subjected to great pressure (300 atmospheres) and yielded a liquid which possessed the fermentative activity of the unchanged yeast cell.¹ This liquid contained *zymase*, the principal enzyme of the yeast cell. Later the lactic-acid- and acetic-acid-producing bacteria were subjected by Buchner to treatment similar to that accorded the yeast cells, and the active intracellular enzymes were obtained. Many other instances are on record in which a soluble, active agent has been isolated from ferment cells, with the result that it is pretty well established that all the so-called organized ferments elaborate substances of this character.

Enzymes act by *catalysis* and hence may be termed catalyzers or catalysts. A simple rough definition of a catalyst is "a substance which alters the velocity of a chemical reaction without undergoing any apparent physical or chemical change itself and without becoming a part of the product formed." It is a well-known fact that the velocity of the greater number of chemical reactions may be changed through the presence of some catalyst. For example, take the case of hydrogen peroxide. It spontaneously decomposes slowly into water and oxygen. In the presence of colloidal platinum,² however, the decomposition is much accelerated and ceases only when the destruction of the hydrogen peroxide is complete. Without multiplying instances, suffice it to say that there is a close analogy between inorganic catalysts and enzymes, the main point of difference between the enzymes and most of the inorganic catalysts being that the enzymes are colloids. The great majority of enzymes are hydrolytic in character.

We may define an enzyme as *an organic catalyst which is elaborated by an animal or vegetable cell and whose activity is entirely independent of any of the life processes of such a cell*. According to this definition the enzyme *zymase* elaborated by the yeast cell is entirely comparable to the enzyme *pepsin* elaborated by the cells of the stomach mucosa. One is derived from a vegetable cell, the other from an animal cell, yet the activity of neither is dependent upon the integrity of the cell.

Inasmuch as each of the enzymes has an action which is more or less specific in character, and since it is a fairly simple matter, ordinarily, to determine the character of that action, the classification of the enzymes

¹In later investigations the process was improved by freezing the ground cells with liquid air and finely pulverizing them before applying the pressure.

²Produced by the passage of electric sparks between two platinum terminals immersed in distilled water, thus liberating ultra-microscopic particles.

is not attended with very great difficulties. They are ordinarily classified according to the nature of the substrate¹ or according to the type of reaction they bring about. Thus we have various classes of enzymes, such as *amylolytic*,² *proteolytic*, *lipolytic*, *glycolytic*, *uricolytic*, *autolytic*, *oxidizing*, *reducing*, *inverting*, *protein-coagulating*, *deamidizing*, etc. In every instance the class name indicates the individual type of enzymatic activity which the enzymes included in that class are capable of accomplishing. For example, amylolytic enzymes facilitate the hydrolysis of starch (*amylum*) and related substances, lipolytic enzymes facilitate the hydrolysis of fats (*λίπος*), whereas through the agency of uricolytic enzymes uric acid is broken down. There is a tendency, at the present time, to harmonize the nomenclature of the enzymes by the use of the termination *-ase*. According to this system of nomenclature, all starch-transforming enzymes, or so-called amylolytic enzymes, are called *amylases*; all fat-splitting enzymes are called *lipases*, etc. Thus *ptyalin*, the amylolytic enzyme of the saliva, would be termed *salivary amylase* in order to distinguish it from *pancreatic amylase* (*amylopsin*) and *vegetable amylases* (*diastase*, etc.). According to the same system, the fat-splitting enzyme of the gastric juice would be termed *gastric lipase* to differentiate it from *pancreatic lipase* (*steapsin*), the fat-splitting enzyme of the pancreatic juice.

Defensive (protective) enzymes are those believed to be manufactured by certain cells (perhaps the leucocytes) and passed into the circulating blood in order to digest any foreign material of endogenous or exogenous origin that may have found its way into the circulation. The most important defensive enzymes are proteolytic enzymes. *Abderhalden*³ claims that the parenteral introduction of any foreign protein into the animal body will be followed by the appearance in the blood of a defensive enzyme capable of digesting that protein. He also claims that in pregnancy the passage into the blood of protein material in the form of cells and fragments of chorionic villi will cause the appearance in the blood of a defensive proteolytic enzyme capable of digesting placenta protein. The *Abderhalden reaction* for pregnancy is based upon this hypothesis. The reaction has been widely employed and much has been said both for and against its accuracy.⁴ Modifications of the reaction have been suggested as aids in the diagnosis of various

¹ Substance acted upon. See Lippmann: *Ber. d. Deutsch. Chem. Ges.*, 36, 331, 1903.

² Armstrong suggests the use of the termination "clastic" instead of "lytic." He calls attention to the fact that *amylolytic*, in analogy with *electrolytic*, means "decomposition by means of starch" and is therefore a misnomer. He suggests the use of *amylolclastic*, *proteolclastic*, etc.

³ *Abwehrfermente des tierischen Organismus*, 5th Ed., Berlin, 1915, Springer.

⁴ Bronfenbrenner: *Jour. Am. Med. Assn.*, 65, 1268, 1915. Van Slyke: *New York Med. Jour.*, 103, 219, 1916. Taylor: *Jour. Biol. Chem.*, 22, 59, 1915. Hulton: *Jour. Biol. Chem.*, 25, 163, 1916. Kuriyama: *Jour. Biol. Chem.*, 25, 534, 1916.

disorders, e.g., cancer, tuberculosis, dementia præcox, etc. These are also of doubtful value. Recent work has also thrown much doubt upon the original contention of Abderhalden as to the formation of protective enzymes following the parenteral introduction of protein, carbohydrates and other substances. Abderhalden, however, maintains that his original contention is correct.¹

Our knowledge regarding the distribution of enzymes has been wonderfully broadened in recent years. Up to within a few years, the real scientific information as to the enzymes of the animal organism, for example, was limited, in the main, to a rather crude understanding of the enzymes intimately connected with the main digestive functions of the organism. We now have occasion to believe that enzymes are doubtless present in every animal cell and are actively associated with all vital phenomena. As a preëminent example of such cellular activity may be cited the liver cell with its reputed complement of 15-20 or more enzymes.

A list of the more important enzymes together with their *classes, distribution, substrates and end-products* is given below.

CLASSIFICATION OF ENZYMES

Name and Class	Distribution	Substrate	End-products
Carbohydrases.....		Carbohydrates.....	
1. <i>Amylases</i>		Starch, dextrin, etc.....	
(a) <i>Pancreatic</i>	Pancreatic juice.....	Starch, dextrin, etc.....	Maltose.
(amylopsin)			
(b) <i>Salivary</i>	Saliva.....	Starch, dextrin, etc.....	Maltose.
(ptyalin)			
(c) <i>Vegetable</i>	Malt, rice fungus, etc.....	Starch, dextrin, etc.....	Maltose.
2. <i>Glycogenase</i>	Liver, muscles?.....	Glycogen.....	Dextrin and maltose (glucose?)
3. <i>Inulase</i>	Fungi, other plants.....	Inulin.....	Fructose.
4. <i>Lactase</i>	Intestinal juice and mucosa.	Lactose.....	Glucose and galactose.
5. <i>Maltase</i>	Blood serum, liver, saliva, pancreatic and intestinal juices and lymph.	Maltose.....	Glucose.
6. <i>Sucrase</i>	Intestinal juice and mucosa.	Sucrose.....	Glucose and fructose.
(invertase)			
7. <i>Zymase</i>	Yeast.....	Sugars.....	Alcohol, CO ₂ , etc.
Carboxylase.....	Yeast.....	COOH group of aliphatic acids.	Carbon dioxide.
Deaminases.....		Amino compounds.....	
1. <i>Adenase</i>	Animal tissues.....	Adenine.....	Hypoxanthine.
2. <i>Arginase</i>	Intestine, liver, kidney, spleen, etc.	Arginine.....	Ornithine and urea.
3. <i>Guanase</i>	Animal tissues.....	Guanine.....	Xanthine.
4. <i>Urease</i>	Micrococcus ureæ, soy bean, etc.	Urea.....	Carbon dioxide and ammonia.
Glucosidases.....		Glucosides (amygdalin and others).	
1. <i>Emulsin</i>	Plants.....	β -glucosides.....	Glucose, etc.
2. <i>Invertase</i>	Yeast, etc.....	α -glucosides.....	Glucose, etc.

¹ Abderhalden: *Correspondenz-Blatt für Schweizer Aerzte*, 47, 1745, 1917.

CLASSIFICATION OF ENZYMES.—*Continued*

Name and Class	Distribution	Substrate	End-products
<i>Lipases.</i>			
1. Autolytic.....	Animal tissues.....	Fats.....	Fatty acid and glycerol
2. <i>Pancreatic</i> (steapsin)	Pancreatic juice.....	Fats.....	Fatty acid and glycerol.
3. Vegetable.....	Castor bean, etc.....	Fats.....	Fatty acid and glycerol.
<i>Nucleases.</i>			
1. Nucleicacidase..	Intestinal mucosa and juice, other tissues.	Nucleic acid and derivatives Nucleic acid.....	Nucleotides.
2. Nucleotidase...	Intestinal mucosa and juice, other tissues.	Nucleotides.....	Phosphoric acid and nucleosides.
3. Nucleosidase...	Tissues.....	Nucleosides.....	Carbohydrate and bases.
<i>Oxidases.</i>			
1. <i>Catalase</i>	Plant and animal tissues...	Hydrogen peroxide.....	Oxygen or oxidation products.
2. Laccase.....	Lac tree, fungi, etc.....	Polyhydric para-phenols as hydroquinol and pyrogallol.	Oxidation products.
3. <i>Peroxidase</i>	Plant and animal tissues...	Organic peroxides.....	Oxygen or oxidation products.
4. Purine-oxidases. (a) Hypoxanthine oxidase.	Animal tissues.....	Purines. Hypoxanthine.....	Xanthine.
(b) Uricase.....	Animal tissues.....	Uric acid.....	Allantoin.
(c) Xanthine..... oxidase.	Animal tissues.....	Xanthine.....	Uric acid.
5. Tyrosinase.....	Plant and animal tissues...	Tyrosine.....	Homogentisic acid, etc.
<i>Peptases.</i>			
1. <i>Erepsin</i>	Intestinal mucosa and juice, other tissues.	Polypeptids..... Peptids, also peptones and casein.	Simpler peptids and amino acids.
Phytase.....	Rice bran, liver, blood....	Phytin.....	Inositol and phosphoric acid.
<i>Proteases.</i>			
1. <i>Coagulases</i> (a) <i>Rennin</i> (gastric)	Gastric juice.....	Proteins..... Proteins in solution..... Casein.....	Paracasein.
(b) <i>Rennin</i> (pancreatic)	Pancreatic juice.....	Casein.....	Paracasein.
(c) <i>Thrombin</i>	Blood.....	Fibrinogen.....	Fibrin.
2. <i>Pepsin</i> (acid-protease)	Gastric juice.....	Proteins.....	Proteoses, peptones, and peptides.
3. <i>Trypsin</i> (alkali-protease)	Pancreatic juice.....	Proteins.....	Proteoses, peptones, peptides, amino-acids.
4. Vegetable proteases. (a) <i>Bromelin</i>	Pineapple.....	Proteins.....	Proteoses, peptones, etc.
(b) <i>Papain</i> (papayotin).	Pawpaw.....	Proteins.....	Proteoses, peptones, etc.
Purinasases (see Purine Oxidases and Purine Deaminases).			

In text-book discussions of the enzymes it is customary to say that very little is known regarding the chemical characteristics of these substances since no member of the enzyme group has, up to the present time, been prepared in an *absolutely pure condition*. Apparently, however, from the nature of the facts in the case, it would be much more accurate to say that we absolutely *do not know* whether a specific enzyme has, or has not, been prepared in a pure state. (Some authors, like Arthus, have assumed that enzymes are not chemical individuals, but *properties conferred upon bodies*.) The enzymes are very difficult to prepare in anything like a condition approximating purity, since they are very prone to change their nature during the process by which the

investigator is attempting to isolate them. For this reason we have absolutely no proof that the final product obtained is, or is not, in the same state of purity it possessed in the original cell. Some of the enzymes are more or less closely associated with the proteins from the fact that they are both formed in every cell as the result of the cellular activity, both may be removed from solution by "salting-out," both are for the most part non-diffusible and are probably very similar as regards elementary composition. Hence in the preparation of some enzymes it is extremely difficult to make an absolute separation from the protein. Most of the evidence points to the protein character of enzymes.¹ Under certain conditions enzymes are readily adsorbed by shredded protein material, such as fibrin, and may successfully resist the most prolonged attempts at washing them free. We may summarize some of the properties of the great body of enzymes as follows: Enzymes are soluble in *dilute* glycerol, sodium chloride solution, *dilute* alcohol, and water, and precipitable by ammonium sulphate and *strong* alcohol. Their presence may be proven from the nature of the end-products of their action and not through the agency of any chemical test. They are *colloidal* and *non-diffusible*, and occur closely associated with protein material with which they generally possess many properties in common. Each enzyme shows the greatest activity at a certain temperature called the *optimum* temperature; there is also a *minimum* and a *maximum* temperature for each specific enzyme. Their action is inhibited by sufficiently lowering the temperature, although some activity may be shown at 0°C. or even at lower temperatures and freezing does not, in most cases, permanently injure enzymes. Most enzymes, if in solution, are entirely destroyed by subjecting them to a temperature of 70°-100°C. The best known enzymes, whether derived from warm-blooded or cold-blooded animals, are most active between 35°-45°C. The nature of the surrounding media alters the velocity of the enzymatic action, some enzymes being more active in acid solution whereas others require an alkaline fluid.

Many of the more important enzymes do not occur performed within the cell, but are present in the form of a *zymogen* or mother-substance. In order to yield the active enzyme this zymogen must be transformed in a certain specific manner and by a certain specific substance. This transformation of the inactive zymogen into the active enzyme is termed *activation*. For instance, the zymogen of the enzyme pepsin of the gastric juice, termed *pepsinogen*, is activated by the *hydrochloric acid* secreted by the gastric cells (see page 141), whereas the activation of the *trypsinogen* of the pancreatic juice is brought about by a

¹Others seem to be like the substrate on which they act, e.g., carbohydrate.

substance termed *enterokinase*¹ (see page 200). These are examples of many well-known activation processes going on continually within the animal organism. The agency which is instrumental in activating a zymogen is generally termed a *zymo-exciter* or a *kinase*. In the cases cited hydrochloric acid would be termed a *zymo-exciter* and *enterokinase* would be termed a *kinase*.

After filtering yeast juice, prepared by the Buchner process (see page 2), through a Martin gelatin filter, Harden and Young showed that the colloids left behind and the filtrate were both inactive fermentatively. Upon treating the colloid material (enzyme) with some of the filtrate, however, the mixture was shown to be able to bring about pronounced fermentation. It is believed that a *co-enzyme* present in the filtrate was the efficient agent in the transformation of the inactive enzyme. It is necessary to make frequent renewals of the co-enzyme in order to maintain continuous fermentation. It was further shown that this co-enzyme, in addition to being diffusible, was not destroyed by boiling and that it disappeared from yeast juice when this latter was fermented or allowed to undergo autolysis. The exact nature of this co-enzyme of zymase is unknown. The co-enzyme action, in this case, is probably dependent upon the presence of two individual agencies, one of which is *phosphates*.

It has been shown by Loevenhart that the property of acting as a pancreatic lipase co-enzyme is vested in *bile salts*, and Magnus has further shown that the synthetic salts are as efficient in this regard as the natural ones. A few other instances of co-enzyme demonstrations have been reported.

Electrolytes are very important factors in facilitating or inhibiting enzyme action.² For example, the Cl ion in proper amount facilitates the action of amylases.³ In fact the presence of the Cl or Br ion is apparently absolutely essential to the activity of pancreatic amylase, inasmuch as dialysis renders this enzyme inactive, the activity returning on the addition of sodium chloride.⁴ The acidity or hydrogen ion concentration of the solution also exerts much influence on the activity of enzymes. It has been demonstrated in the case of certain enzymes, at least, that the continuous vibration or shaking of their solutions tends to produce a destruction of the enzyme. Ultraviolet light also has a destructive action on enzymes.

The so-called "specificity" of enzyme action is an interesting and important fact. That enzymes are very specific as to the character of

¹ According to Delezenne, trypsinogen may be rapidly activated by soluble calcium salts.

² For literature, see Kendall and Sherman: *Jour. Am. Chem. Soc.*, 32, 1087, 1910.

³ Wohlgemuth: *Biochemische Zeitschrift*, 9, 10, 1908.

⁴ Bierry: *Ibid.*, 40, 357, 1912.

the *substrate*, or substance acted upon, is well known. Emil Fischer investigated this problem of specificity extensively in connection with the fermentation of sugars and reached the conclusion that enzymes, with the possible exception of certain oxidases, can act only upon such substances as have a specific stereo-isomeric relationship to themselves. He considers that the enzyme and its substrate must have an inter-relation, *such as the key has to the lock*, or the reaction does not occur. Fischer was able to predict, in certain definite cases, from a knowledge of the constitution and stereo-chemical relationships of a substance, whether or not it would be acted upon by a certain enzyme. An application of this specificity of enzyme action may be seen in the well-known facts that certain enzymes act on carbohydrates, others on fats, and others on protein; and, moreover, that the group of those which transform carbohydrates, for example, is further subdivided into specific enzymes each of which has the power of acting alone upon some one sugar.

It has been conclusively shown, in the case of certain enzymes,¹ at least, that their action is a *reversible* one and is, in all its main features, directly analogous to the reversible reactions produced by chemical means. For instance, in the saponification of ethyl-butyrate by means of pancreatic lipase, it has been shown that upon the formation of the end-products of the reaction, *i.e.*, butyric acid and ethyl alcohol, there is reversion² and the reaction is stationary. This does not mean there are no chemical changes going on, but simply indicates that chemical *equilibrium* has been established, and that the change in one direction is counterbalanced by the change in the opposite direction. Pancreatic lipase was one of the first enzymes to have the reversibility of its reaction clearly demonstrated.³ A knowledge of the fact that lipase possesses this reversibility of action is of extreme physiological importance and aids us materially in the explanation of the processes involved in the digestion, absorption, and deposition of fats in the animal organism (see page 182).

Euler⁴ claims that enzymatic *cleavage* and *synthesis* are often brought about by two different components of an enzyme preparation. He would indicate this fact by giving the termination *-ese* to those enzymes exerting a synthetic function. For example, the enzyme which catalyzes the formation of nitriles Euler would call *nitrilase* in distinction from *nitrilase* which splits nitriles. He would further designate as phos-

¹This is probably a general condition.

²The re-synthesis of ethyl-butyrate from its hydrolysis products. This may be indicated thus:



³This principle was *first* demonstrated in connection with the enzyme maltase (see p. 57).

⁴Euler: *Zeitschrift für physiologische Chemie*, 74, 13, 1911.

phatase the enzyme which builds up phosphoric acid esters of carbohydrates in distinction from phosphatase which causes their cleavage. In the same way he would differentiate the lipolytic enzymes into lipases and lipeses.

In respect to many enzymes it has been found that the law governing the action of inorganic catalyzers is directly applicable, *i.e.*, that the *intensity is almost directly proportional to the concentration of the enzyme*. In the case of enzymes, however, there is a difference in that a maximum intensity is soon reached and that subsequent concentration of the enzyme is productive of no further increase in intensity. Enzymes which have been shown to obey this *linear law* are lipase, sucrase, rennin, and trypsin. In *certain instances*, where this law of direct proportionality between the intensity of action and the concentration of enzymes does not hold, it has been found that the *Schütz-Borissow law*, first experimentally demonstrated by E. Schütz, was applicable. This is to the effect that the intensity is directly proportional to the square root of the concentration, or conversely, that *the relative concentrations of enzyme preparations are directly proportional to the squares of the intensities*.¹

It has been shown that there are certain substances which possess the property of directly inhibiting or preventing the action of a catalyzer. These are called *anti-catalyzers* or paralyzers and have been compared with the *anti-toxins*. Related to this class of anti-catalytic agents stand the *anti-enzymes*. The first anti-enzyme to be reported was the *anti-rennin* of Morgenroth. This was produced by injecting into an animal increasing doses of rennet solution, whereupon an "anti" substance was subsequently found both in the serum and in the milk, which prevented the enzyme rennin from exerting its normal activity in the presence of casein. In other words, *anti-rennin* had been formed in the serum of the animal,² through the repeated injections of rennet solution. Since the discovery of this anti-enzyme, anti-bodies have been demonstrated for pepsin, trypsin, lipase, urease, amylase, laccase, tyrosinase, emulsin, papain, and thrombin. According to Weinland, the reason why the stomach does not digest itself is, that during life there is present in the mucous membrane of the stomach an *anti-enzyme (anti-pepsin)* which has the property of inhibiting the action of pepsin. A similar substance (*anti-trypsin*) is present in the intestinal mucosa as well as in the tissues of various intestinal worms. It is probable that among the substances commonly classified as anti-enzymes are included inhibitory agents of widely differing characters.

¹ This Schütz-Borissow law is not generally applicable.

² Serum is normally *anti-tryptic*.

The investigations of Ehrlich¹ and of Neuberg² have served to cause a complete revision of our ideas regarding yeast fermentation. Ehrlich, for example, has shown that *yeast will liberate ammonia from amino acids* and leave behind a non-nitrogenous complex. Among these complexes amyl alcohol, succinic acid and others may be mentioned. Thus, *amyl alcohol* results from the fermentation of leucine, whereas ethyl alcohol results from the fermentation of sugar. Neuberg has demonstrated the presence in the yeast of an enzyme termed *carboxylase* which has the property of *splitting off carbon dioxide from the carboxyl group of amino and other aliphatic acids*. The findings mentioned above constitute the basis for much important work on so-called "sugar-free fermentation."

For a more extended consideration of enzymes the student is referred to the following sources.

BAYLISS.—The Nature of Enzyme Action, Third Edition, Longmans, Green and Co., New York and London, 1914.

BEATTY.—The Method of Enzyme Action, P. Blakiston's Son and Co., Philadelphia, 1917.

COHNHEIM.—Enzymes, Wiley and Sons, New York, 1912.

DUCLAUX.—Traité de Microbiologie, Masson and Co., Paris.

EFFRONT.—(a) Enzymes and their Applications, Translated by Prescott, Wiley and Sons, New York. (b) Biochemical Catalysts in Life and Industry. Proteolytic Enzymes, Translated by Prescott and Venable, Wiley and Sons, New York, 1917.

EULER.—(a) Allgemeine Chemie der Enzyme, Bergmann, Wiesbaden, 1910. (b) Ergebnisse der Physiologie, 1909-10. (c) General Chemistry of the Enzymes, Translated by Pope, Wiley and Sons, 1912.

OPPENHEIMER.—Die Fermente und Ihre Wirkungen, Vierte Auflage, Vogel, Leipzig.

SAMUELY.—Handbuch der Biochemie des Menschen und der Thiere (Oppenheimer), Gustav Fischer, Jena, 1910-11.

WOHLGEMUTH.—Grundriss der Fermentmethoden, Springer, Berlin. 1913.

EXPERIMENTS ON ENZYMES AND ANTI-ENZYMES

A. Experiments on Enzymes³

I. AMYLASES

1. Demonstration of Salivary Amylase.⁴—To 25 c.c. of a 1 per cent starch paste in a small beaker, add 5 drops of saliva and stir thoroughly. At intervals

¹ Ehrlich: *Biochemische Zeitschrift*, 36, 477, 1911.

² Neuberg and Collaborators: *Biochemische Zeitschrift*, 31, 170; 32, 323; 36 (60, 68, and 76), 1911.

³ If it is deemed advisable by the instructor to give all the practical work upon enzymes at this point in the course, additional experiments will be found in Chapters III, VI, VII, X and XI.

⁴ For a discussion of this enzyme see p. 55.

of a minute remove a drop of the solution to one of the depressions of a test-tablet and test by the iodine test.¹ If the blue color with iodine still forms after five minutes, add another 5 drops of saliva.

The opalescence of the starch solution should soon disappear, indicating the formation of *soluble starch (amidulin)* which gives a blue color with iodine. This body should soon be transformed into *erythro-dextrin* which gives a red color with iodine, and this, in turn, should pass into *achroodextrin* which gives *no color* with iodine. This point is called the *achromic point*. When this point is reached test by Fehling's test² to show the production of a reducing substance (maltose). A positive Fehling's test may be obtained while the solution still reacts red with iodine, inasmuch as some sugar is formed from the soluble starch coincidentally with the formation of the erythro-dextrin. For further discussion of the transformation of starch see page 56.

2. **Demonstration of Pancreatic Amylase.**³—Proceed exactly as indicated above in the Demonstration of Salivary Amylase except that the saliva is replaced by 5 c.c. of pancreatic extract prepared as described on p. 193.⁴ Pancreatic amylase transforms the starch in a manner entirely analogous to the transformation resulting from the action of salivary amylase.

3. **Preparation of Vegetable Amylase.**—Extract finely ground malt with water, filter and subject the filtrate to alcoholic fermentation by means of yeast. When fermentation is complete filter off the yeast and precipitate the amylase from the filtrate by the addition of alcohol. The precipitate may be filtered off and obtained in the form of a fine white powder.

A purer preparation⁵ is obtained if the solution is dialyzed against water at about 10°C. (in the ice-box) for 24 hours, filtered and precipitated with alcohol or acetone. First alcohol or acetone to make a 50 per cent solution is added, the precipitate thus formed being rejected, while the precipitate formed on the addition of sufficient alcohol or acetone to make a final concentration of 65–70 per cent is preserved, and dried in a vacuum desiccator at a low temperature.

4. **Demonstration of Vegetable Amylase.**—This enzyme may be demonstrated according to the directions given under Demonstration of Salivary Amylase, page 10, with the exception that the saliva used in that experiment is replaced by an aqueous solution of the vegetable amylase powder prepared as described above.⁶

¹ See p. 45.

² See p. 25.

³ For a discussion of this enzyme see p. 191.

⁴ Commercial preparations of pancreatic amylase may be substituted for the pancreatic extract.

⁵ Sherman and Schlesinger: *J. Am. Ch. Soc.*, 35, 1617, 1915.

⁶ If desired the *first* aqueous extract of the original malt may be used in this demonstration. Commercial *taka-diastase* may also be employed.

II. PROTEASES

1. Preparation of Gastric Protease.¹—Treat the finely comminuted mucosa of a pig's stomach with 0.4 per cent hydrochloric acid and extract at 38°C. for 24–48 hours. The filtrate from this mixture constitutes a very satisfactory acid extract of gastric protease (see page 145).

2. Demonstration of Gastric Protease.—Introduce some protein material (fibrin, coagulated egg-white, or washed lean beef) into the acid extract of gastric protease prepared as above described,² add an equal volume of 0.4 per cent hydrochloric acid and place the mixture at 38°C. for 2–3 days. Identify the products of digestion according to directions given on page 145.

Carmine-fibrin may also be used in this test. This is prepared by running fibrin through a meat chopper washing carefully and placing in a ½ per cent ammoniacal carmine solution (very little excess ammonia should be present) until the maximum coloration of the fibrin (a dark red) is obtained. The fibrin is then washed in water and water acidified with acetic acid. It is preserved under glycerol.

To 15 c.c. of the solution to be tested add a small amount of the carmine fibrin and allow to digest at *room temperature*. Digestion will be shown by the setting free of carmine with coloration of the solution. This is a delicate test for pepsin. A control should be run using acid of same strength as that of enzyme solution tested.

3. Preparation of Pancreatic Protease.³—A satisfactory extract of this enzyme may be made from the pancreas of a pig or sheep according to the directions given on page 193.

4. Demonstration of Pancreatic Protease.—Into an alkaline extract of pancreatic protease,⁴ prepared as directed on page 193, introduce some fibrin, coagulated egg-white or lean beef and place the mixture at 38°C. for 2–5 days.⁵ At the end of that period separate and identify the end-products of the action of pancreatic protease according to the directions given on page 193.

Congo-red fibrin may be used in this test. This may be prepared by placing fibrin in faintly alkaline congo-red solution and heating to 80°C. The fibrin is then washed. A small amount of this colored fibrin is placed in the slightly alkaline solution of the enzyme. Digestion is shown by a red coloration of the solution due to setting free of congo red.

¹ Also called *pepsin*, *pepsase*, *gastric protease* and *acid protease*. For a discussion of this enzyme see p. 141.

² If so desired, a solution of commercial pepsin powder in 0.2 per cent hydrochloric acid may be substituted for the extract of mucosa.

³ Also called *trypsin*, *trypcase*, *pancreatic protease* and *alkali protease*. For a discussion of this enzyme see p. 190.

⁴ A 0.25 per cent sodium carbonate solution of commercial *trypsin* or *pancreatin* may be substituted.

⁵ A few c.c. of toluene or an alcoholic solution of thymol should be added to prevent putrefaction.

5. Demonstration of a Vegetable Protease.—A commercial preparation of *papain* (*papayotin*, *carase* or *papase*), the protease of the fruit of the pawpaw (*carica papaya*), may be used in this connection. Follow the same procedure as that described under Gastric Protease (see p. 12).

It has been demonstrated by Mendel and Blood¹ that the presence of HCN will accelerate the proteolytic activity of papain. It is suggested that the HCN acts as a so-called *co-enzyme* (see page 7).

Vines² believes that "papain" consists of a mixture of two enzymes, a pepsin and an erepsin. Mendel and Blood do not consider the evidence on this point as conclusive.

III. LIPASES

1. Preparation of Pancreatic Lipase.³—An extract of this enzyme may be prepared from the pancreas of the pig or sheep according to the directions given on page 193.⁴

2. Demonstration of Pancreatic Lipase.—Into each of two test-tubes introduce 10 c.c. of milk and a small amount of litmus powder. To the contents of one tube add 3 c.c. of a neutral extract of pancreatic lipase and to the contents of the other tube add 3 c.c. of a boiled neutral extract of pancreatic lipase. Keep the tubes at 38°C. and watch for color changes.

The blue color of the litmus powder will gradually give place to a red. This change in color of the litmus from blue to red has been brought about by the fatty acid which has been produced through the lipolytic action exercised by the lipase upon the milk fats.

3. Preparation of Vegetable Lipase.—This enzyme may be readily prepared from castor beans, several months' old, by the following procedure.⁵ Grind the shelled beans very fine⁶ and extract for twenty-four-hour periods with alcohol-ether and ether, in turn. Reduce the semi-fat-free material to the finest possible consistency by means of mortar and pestle and pass this material through a sieve of very fine mesh. Place this material in a Soxhlet extractor and extract for one week. This fat-free powder may then be used to demonstrate the action of vegetable lipase. Powder prepared as described may be used in quantitative tests. For ordinary qualitative tests it is not necessary to remove the last traces of fat and therefore the extraction period in the Soxhlet apparatus may be much shortened.

4. Demonstration of Vegetable Lipase.—The lipolytic action of the lipase prepared from the castor bean, as just described, may be demonstrated in a manner entirely analogous to that used in the Demonstration of Pancreatic Lipase, see above. Proceed as indicated in that experiment and substitute the vegetable lipase powder for the neutral extract of pancreatic lipase. The type of action is entirely analogous in the two instances.

¹ Mendel and Blood: *Journal of Biological Chemistry*, 8, 177, 1910.

² Vines: *Annals of Botany*, 19, 174, 1905.

³ Also called steapsin. For a discussion of the enzyme see p. 192. A very active lipolytic extract may also be prepared from the liver.

⁴ If preferred, a *glycerol extract* may be prepared according to the directions given by Kanitz (*Zeitschrift für physiologische Chemie*, 46, 482, 1906) or commercial *pancreatin* may be employed.

⁵ A. E. Taylor: *On Fermentation; University of California Publications*, 1907.

⁶ The shells should be removed without the use of water. These beans are *poisonous*, due to their content of *ricin*.

An experiment similar to Experiment 3, page 198, may also be tried if desired. In this experiment 0.2 c.c. of either *ethyl butyrate* or *amyl acetate* may be employed.

IV. INVERTASES¹

1. **Preparation of Vegetable Sucrase.**²—Thoroughly grind about 100 grams of brewer's or baker's yeast in a mortar with sand. Spread the ground yeast in thin layers on glass or porous plates and dry it rapidly in a current of dry, warm air. Powder this dry yeast, extract it with distilled water and filter. Pour the filtrate into acetone, stir and after permitting the acetone mixture to stand for a few minutes filter on a Buchner funnel. The resulting precipitate, after drying and pulverizing, may be used to demonstrate vegetable sucrase.

2. **Demonstration of Vegetable Sucrase.**—To about 5 c.c. of a 1 per cent solution of sucrose in a test-tube add a small amount of the sucrase powder prepared as directed above. Place the tube at 38°C. for 24–72 hours and at the end of that period test the solution by Fehling's test (see page 25.) Reduction indicates that the active sucrase powder has transformed the non-reducing sucrose into glucose and fructose, and these sugars, in turn, have reduced the Fehling solution.

For other experiments on Invertases, see Chapter XI.

V. OXIDASES³

1. **Demonstration of Oxidase.**—Oxidases or oxidizing enzymes constitute a very important group of intracellular enzymes. They are intimately connected with the oxidation processes in the plant and animal organisms.

1. Cut a thin slice from a freshly pared potato, place it on a watch glass and examine at intervals during the laboratory exercise. Note that the colorless potato gradually becomes brown.

This is due to the oxidation of para-oxyphenyl substances such as tyrosine, in the cells and in the intracellular juice of the potato. Two oxidases which have the power of accelerating the oxidation of para-oxyphenyl compounds are called *tyrosinase* and *laccase*.

2. **Preparation of Potato Extract.**—Scrape a pared potato by means of a knife or scalpel or comminute the potato substance by means of a grater. Extract the macerated potato substance by means of water. Strain through cheese cloth and filter the extract. Make an iodine test on the solid substance (see Starch, page 45), and save the water extract for use in the following experiments.

3. **Oxidation of Para-oxyphenyl Compounds by Potato Oxidases.**—Introduce 5 c.c. of filtered potato extract prepared as indicated above, into each of six test-tubes. Introduce additional reagents into the tubes according to the following series:

- (a) Potato extract + 5 drops of toluene (control).
- (b) Potato extract + 5 drops of ether (control).

¹ *The inverting enzymes of the alimentary tract*; Mendel and Mitchell: *American Journal of Physiology*, 20, 81, 1907–08.

² For a discussion of this enzyme see p. 199.

³ These experiments have been adapted from directions contained in the *Laboratory Notes of Professor Gies of the College of Physicians and Surgeons, New York*.

- (c) Potato extract + 5 drops of 1 per cent phenol solution.
- (d) Potato extract + 5 drops of 1 per cent "tri-cresol" solution.
- (e) Potato extract (boiled and cooled) + 5 drops of 1 per cent phenol solution.
- (f) Potato extract (boiled and cooled) + 5 drops of 1 per cent "tri-cresol" solution.

solution.

Shake the contents of the six tubes thoroughly. Are there any immediate color changes? Place the tubes in your rack, and examine them at the next laboratory exercise.

4. Experiments with Typical Oxidase Reagents.—Introduce 5 c.c. of filtered potato extract into each of four test-tubes. Add oxidase reagents as follows:

- (a) Potato extract + 10 drops of guaiac solution.¹
- (b) Potato extract + 10 drops of α -naphthol solution.²
- (c) Potato extract + 10 drops of para-phenylenediamine hydrochloride solution.³

(d) Potato extract + 5 drops of α -naphthol solution + 5 drops of para-phenylenediamine hydrochloride solution + 5 drops of 10 per cent sodium carbonate (Indophenol Test).

Shake the contents of each tube thoroughly and note immediate color changes. Place the tubes in the rack and leave them undisturbed until the end of the laboratory exercise. Note any changes or peculiarities in the coloration effects, especially at the surface of the liquid.

In tube (a) the guaiaconic acid of the guaiac resin has been oxidized and formed *guaiac blue*.

In tube (b) a *violet* coloration due to the production of di-naphthol appears. The oxidase has oxidized the α -naphthol.

In tube (c) we have a change whose chemistry is not well known.

In tube (d) we have the production of indophenol from the α -naphthol and the para-phenylenediamine hydrochloride under the influence of oxidase. The indophenol is soluble in the alkaline solution. The color gradually changes from *red* to *purple* as the indophenol accumulates.

The production of the above colors does not possess any biological significance. These colors simply serve to indicate that certain reactions are taking place which occur normally in living cells, although in the latter case they are of course unaccompanied by any color change. Intracellular oxidase favors the utilization of oxygen by a cell, just as the potato oxidase has facilitated the oxidation of the chromogens in the above tests.

VI. CATALASE

Demonstration of Catalase.—The various animal tissues as liver, kidney, blood, lung, muscle and brain contain enzymes called catalases which possess the property of decomposing hydrogen peroxide. Cata-

¹ Made by dissolving 0.5 gram of guaiac resin in 30 c.c. of 95 per cent alcohol.

² Made by dissolving 1 gram of α -naphthol in 100 c.c. of 95 per cent alcohol.

³ Dissolve 1 gram of para-phenylene diamine hydrochloride in 100 c.c. of water.

lase brings about oxidations indirectly, that is, only in the presence of hydrogen peroxide and for this reason is considered by some to be distinct from the true oxidizing enzymes.¹ Catalase is also found in many plant tissues and an extract of it may be prepared from potatoes.

1. **Vegetable Catalase.**—Into each of four test-tubes place 5 c.c. of filtered potato extract prepared as in Experiment 2, page 14. Prepare a second series of four tubes (see 4, 15p.), but use a boiled potato extract. Prepare also a third series using water instead of potato extract. Now add to each of the twelve tubes 5 drops of a 3 per cent solution of hydrogen peroxide. While the resultant lively effervescence, characteristic of the action of catalase, is in progress add to each series the four "Typical Oxidase Reagents" in the order and quantities specified in the preceding experiment(4). Allow the tubes to remain undisturbed and carefully note comparative effects during the remainder of the laboratory exercise.² Compare with results of experiment(4).

2. **Animal Catalase.**—The presence of this enzyme may also be demonstrated as follows: Introduce into a low, broad, wide-mouthed bottle some pulped liver tissue and a porcelain crucible containing *neutral* hydrogen peroxide.³ Connect the bottle with a eudiometer filled with water, upset the crucible of hydrogen peroxide upon the liver pulp and note the collection of gas in the eudiometer. This gas is oxygen which has been liberated from the hydrogen peroxide through the action of the catalase of the liver tissue.

See next experiment for a method for the quantitative determination of catalase based on the above principle.

3. **Quantitative Determination of Catalase.**⁴—In the determination of the catalase values of tissues weighed portions of the tissue under examination should be ground with sand in a mortar then treated with four volumes of chloroform water and permitted to extract for 24 hours at room temperature. An apparatus such as that shown in Fig. 1 may be employed in determining the catalase values. The main features of the apparatus are based upon those of a delivery funnel for introducing liquids under increased or diminished pressure.

In making a determination introduce a measured volume (1-4 c.c.) of the filtered extract⁵ into the small flask and insert the modified Johnson burette graduated to 5 c.c. and containing 50 c.c. of hydrogen peroxide (Oakland dioxygen neutral⁶ to Congo red) into the neck of the flask. Fill the eudiometer with water and place in position. Close cocks A and C and open cocks B and D thus permitting 5 c.c. of the peroxide to flow into the flask. Shake the contents of the flask briskly⁷ and record the volume of oxygen evolved in a two-minute period taking readings at intervals of fifteen seconds.

Calculation.—When a series of comparative tests are made on different tissues or on the same tissue under different conditions it is considered satisfactory to make

¹ Reed: *Bot. Gaz.*, 62, 409, 1916.

²This experiment has been adapted from one contained in the Laboratory Notes of Professor Gies of the College of Physicians and Surgeons, New York.

³Mendel and Leavenworth: *American Journal of Physiology*, 21, 85, 1908.

⁴Hawk: *Journal of the American Chemical Society*, 33, 425, 1911.

⁵If less than 4 c.c. of extract are used the volume should be made up to 4 c.c. by the addition of distilled water.

⁶An acid reaction modifies the rate of the oxygen evolution. (See Mendel and Leavenworth, *American Journal of Physiology*, 21, 85, 1908.)

⁷In making a series of comparative tests it is essential that the shaking process should be uniform from determination to determination.

a comparison of the catalase values upon the basis of the *volume of oxygen evolved in a period of two minutes from 5 c.c. of neutral hydrogen peroxide by means of 1 c.c. of a 1 : 4 chloroform-water extract of the tissue.*

B. Experiments on Anti-Enzymes

1. **Preparation of an Extract of Anti-Pepsin.**¹—Grind up a number of intestinal worms (ascaris)² with quartz sand in a mortar. Subject this mass to high pressure, filter the resultant juice and treat it with alcohol until a concentration of 60 per cent is reached. If any precipitate forms it should be filtered off³ and alcohol added to the filtrate until the concentration of alcohol is 85 per cent, or over. The anti-enzyme is precipitated by this concentration. Permit this precipitate to stand

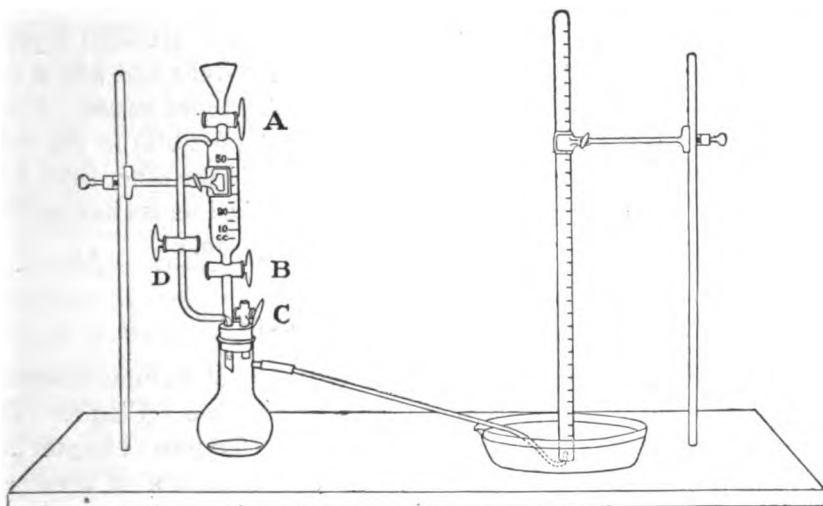

FIG. 1.—APPARATUS FOR QUANTITATIVE DETERMINATION OF CATALASE.

for twenty-four hours, then filter it off, wash it with 95 per cent alcohol, absolute alcohol, and ether, in turn, and finally dry the substance over sulphuric acid. The sticky powder which results may be used in this form or may be dissolved in water as desired and the aqueous solution used.⁴

2. **Demonstration of Anti-Pepsin.**⁵—Introduce into a test-tube a few fibrin shreds and equal volumes of pepsin-hydrochloric acid⁶ and ascaris extract made as indicated above. Prepare a control tube in which the ascaris extract is replaced by water. Place the tubes at 38°C. Ordinarily in one hour the fibrin in the control tube will be completely digested. The fibrin in the tube containing the ascaris extract may, however, remain unchanged for days, thus indicating the inhibitory influence exerted by the anti-enzyme present in this extract.

¹ Anti-gastric-protease or anti-acid-protease.

² These may be readily obtained from pigs at a slaughter house.

³ This precipitate consists of impurities, the anti-enzyme not being precipitated until a higher concentration of alcohol is reached.

⁴ The original ascaris extract possesses much greater activity than either the powder or the aqueous solution.

⁵ Martin H. Fischer: *Physiology of Alimentation*, 1907, p. 134.

⁶ Made by bringing 0.015 gram of pepsin into solution in 7 c.c. of water and 0.23 gram of concentrated hydrochloric acid.

3. **Preparation of an Extract of Anti-Trypsin.**¹—The extract may be prepared from the intestinal worm, *ascaris*, according to the directions given on page 17.

4. **Demonstration of Anti-Trypsin.**—Introduce into a test-tube a few shreds of fibrin and equal volumes of an artificial tryptic solution² and the *ascaris* extract made as described on page 17. Prepare a control tube in which the *ascaris* extract is replaced by water. Place the two tubes at 38°C.

Ordinarily the fibrin in the control tube will be completely digested in two hours. The fibrin in the tube containing the *ascaris* extract may, however, remain unchanged for days, thus indicating the inhibitory influence of the anti-enzyme.

Blood serum also contains *anti-trypsin*. This may be demonstrated as follows: Introduce equal volumes of serum and artificial tryptic solution (prepared as described above) into a test-tube and add a few shreds of fibrin. Prepare a *control* tube containing *boiled* serum. Place in two tubes as 38°C. It will be observed that the fibrin in the tube containing the *boiled* serum digests, whereas that in the other tube does not digest. The anti-trypsin present in the unboiled serum has exerted an inhibitory influence upon the action of the trypsin.

C. Quantitative Applications

Methods for the quantitative determination of various enzymes will be found in the following chapters: **Amylase** (Chapter X); **Erepsin** (Chapter XI); **Pepsin** (Chapter VIII); **Trypsin** (Chapter X). For the application of **Urease** to the determination of urea, see Chapters XVI and XXVII.

¹ Anti-pancreatic-protease or anti-alkali-protease.

² Made by dissolving 0.04 gram of sodium carbonate and 0.015 gram of trypsin in 8 c.c. of water.

CHAPTER II

CARBOHYDRATES

The name carbohydrates is given to a class of bodies which are an especially prominent constituent of plants and which are found also in the animal body either free or as an integral part of various proteins. They are called carbohydrates because they contain the elements C, H and O; the H and O being present in the proportion to form water. The term is not strictly appropriate inasmuch as there are bodies, such as acetic acid, lactic acid and inositol, which have H and O present in the proportion to form water, but which are not carbohydrates, and there are also true carbohydrates which do not have H and O present in this proportion, *e.g.*, rhamnose, $C_6H_{12}O_5$.

Chemically considered, the carbohydrates are aldehyde or ketone derivatives of complex alcohols. Treated from this standpoint, the aldehyde derivatives are spoken of as aldoses, and the ketone derivatives are spoken of as ketoses. The carbohydrates are also frequently named according to the number of oxygen atoms present in the molecule, *e.g.*, trioses, pentoses, and hexoses.

The more common carbohydrates may be classified as follows:

I. Monosaccharides.

1. Pentoses, $C_5H_{10}O_5$.
 - (a) Arabinose.
 - (b) Xylose.
 - (c) Rhamnose (Methyl-pentose), $C_6H_{12}O_5$.
2. Hexoses, $C_6H_{12}O_6$.
 - (a) Glucose.
 - (b) Fructose. *levulose*
 - (c) Galactose.

II. Disaccharides, $C_{12}H_{22}O_{11}$.

1. Maltose.
2. Lactose.
3. Iso-Maltose.
4. Sucrose.

III. Trisaccharides, $C_{18}H_{32}O_{16}$.

1. Raffinose.

IV. Polysaccharides, ($C_6H_{10}O_5$) .

1. Gum and Vegetable Mucilage Group.

(a) Dextrin.

(b) Vegetable Gums.

2. Starch Group.

(a) Starch.

(b) Inulin.

(c) Glycogen.

(d) Lichenin.

3. Cellulose Group.

(a) Cellulose.

(b) Hemicelluloses.

(1) Pentosans.

Gum Arabic.

(2) Hexosans.

Galactans.

Agar-agar.

Each member of the above carbohydrate classes, except the members of the pentose group, may be supposed to contain the group $C_6H_{10}O_5$, called the *saccharide group*. The polysaccharides consist of this group alone taken a large number of times, whereas the disaccharides may be supposed to contain two such groups plus a molecule of water, and the monosaccharides to contain one such group plus a molecule of water. Thus, $(C_6H_{10}O_5)_x = \text{polysaccharide}$, $(C_6H_{10}O_5)_2 + H_2O \rightarrow \text{disaccharide}$, $C_6H_{10}O_5 + H_2O \rightarrow \text{monosaccharide}$. In a general way the solubility of the carbohydrates varies with the number of saccharide groups present, the substances containing the largest number of these groups being the least soluble. This means simply that, as a class, the monosaccharides (hexoses) are the most soluble and the polysaccharides (starches and cellulose) are the least soluble.

MONOSACCHARIDES

Hexoses, $C_6H_{12}O_6$

The hexoses are monosaccharides containing six oxygen atoms in a molecule. They are the most important of the simple sugars, and two of the principal hexoses, glucose and fructose, occur widely distributed in plants and fruits. Of these two hexoses, glucose results from the hydrolysis of starch, whereas both glucose and fructose are formed in the hydrolysis of sucrose. Galactose, which with glucose results from the hydrolysis of lactose, is also an important hexose. These three hexoses are fermentable by yeast, and yield levulinic acid upon heating

with dilute mineral acids. They reduce metallic oxides in alkaline solution, are optically active and extremely soluble. With phenylhydrazine they form characteristic osazones.

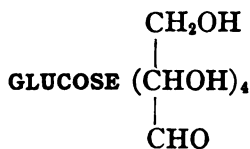

Glucose, also called dextrose or grape sugar, is present in the blood in small amount and also occurs in traces in normal urine.¹ After the ingestion of large amounts of sucrose, lactose or glucose, causing the *assimilation limit* to be exceeded, an alimentary glycosuria may arise. In diabetes mellitus very large amounts of glucose are excreted in the urine. The following structural formula has been suggested by Victor Meyer for *d*-glucose:

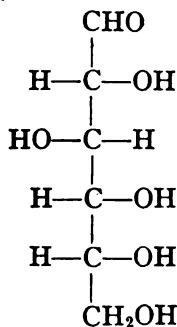

(For further discussion of glucose see section on Hexoses, page 20.)

EXPERIMENTS ON GLUCOSE

The following tests are made on glucose as a typical carbohydrate and are *not specific for this sugar*. A specific test for glucose is the Phenylhydrazine Reaction (3) in the absence of a positive Resorcinol-Hydrochloric Acid Reaction (see page 35).

1. Solubility.—Test the solubility of glucose in the “ordinary solvents” and in alcohol. (In the solubility test throughout the book we shall designate the following solvents as the “ordinary solvents;” H₂O; 10 per cent NaCl; 0.5 per cent Na₂CO₃; 0.2 per cent HCl; concentrated KOH; concentrated HCl.)

2. α -Naphthol Reaction (Molisch).—Place approximately 5 c.c. of concentrated H₂SO₄ in a test-tube. Incline the tube and slowly pour down the inner side of it approximately 5 c.c. of the sugar solution to which 2 drops of Molisch's reagent (a 15 per cent alcoholic solution of α -naphthol) has been added, so that the sugar solution will not mix with the acid. A reddish-violet zone is produced at the point of contact.

¹ See Folin's test for sugar in normal urine (*Jour. Biol. Chem.*, 22, 327, 1915); also Benedict: *Jour Biol. Chem.*, 31, 195, 1918.

The reaction is due to the formation of furfural,¹

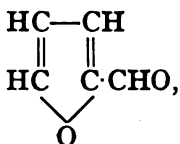

by the acid. The test is given by all bodies containing a carbohydrate group and is therefore not specific and, in consequence, of very little practical importance.

3. Phenylhydrazine Reaction.—Test according to one of the following methods: (a) To a small amount of phenylhydrazine mixture (enough to fill the rounded portion of a small test-tube) furnished by the instructor,² add 5 c.c. of the sugar solution, shake well and heat on a boiling water-bath for one-half to three-quarters of an hour. Allow the tube to cool slowly (not under the tap) and examine the crystals microscopically (Plate III, opposite).

If the solution has become too concentrated in the boiling process it will be light red in color and no crystals will separate until it is diluted with water.

Yellow crystalline bodies called *osazones* are formed from certain sugars under these conditions, in general each individual sugar giving rise to an osazone of a definite crystalline form which is typical for that sugar. It is important to remember in this connection that, of the simple sugars of interest in physiological chemistry, glucose and fructose yield the same osazone. Each osazone has a definite melting-point and as a further and more accurate means of identification it may be recrystallized and identified by the determination of its melting-point and nitrogen content. Garard and Sherman³ claim that "With the best conditions it is possible to detect 5 mg. of glucose in 10 cc. of solution since a distinct precipitate is formed. If the solution is cooled, 1 mg. gives a distinct precipitate. If the original solution is neutral and comparatively free from other organic matter this test will show 1 part of glucose in 10,000 of water or 1 mg. in a 0.01 per cent. solution. At this dilution the precipitate is sufficiently copious, so that there is no question about its presence."

The reaction taking place in the formation of *phenylglucosazone* is as follows:

¹ According to v. Ekenstein and Blanksma (*Ber. d. d. chem. Gesell.*, 43, 2358, 1910), oxymethylfurfural is formed.

² This mixture is prepared by combining 2 parts of phenylhydrazine hydrochloride and 3 parts of sodium acetate by weight. These are thoroughly mixed in a mortar.

³ Garard and Sherman: *Jour. Am. Chem. Soc.*, 40, 955, 1918.

PLATE III.



OSAZONES.

Upper form, dextrosazone; central form, maltosazone; lower form, lactosazone.

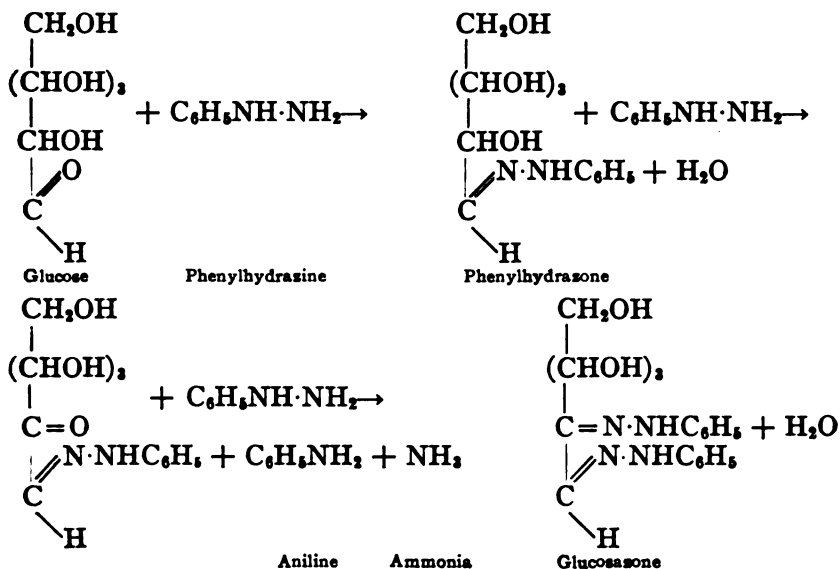

(b) Place 5 c.c. of the sugar solution in a test-tube, add 1 c.c. of the phenylhydrazine-acetate solution furnished by the instructor,¹ and heat on a boiling water-bath for one-half to three-quarters of an hour. Allow the liquid to cool slowly and examine the crystals microscopically (Plate III, opposite p. 22).

The phenylhydrazine test has been so modified by Cipollina as to be of use as a *rapid clinical test*. The directions for this test are given in the next experiment.

4. **Cipollina's Test.**—Thoroughly mix 4 c.c. of dextrose solution, 5 drops of phenylhydrazine (the base) and ½ c.c. of glacial acetic acid in a test-tube. Heat the mixture for about one minute over a low flame, shaking the tube continually to prevent loss of fluid by bumping. Add 4–5 drops of sodium hydroxide (sp. gr. 1.16), being certain that the fluid in the test-tube remains acid, heat the mixture again for a moment and then cool the contents of the tube. Ordinarily the crystals form at once, especially if the sugar solution possesses a low specific gravity. If they do not appear immediately allow the tube to stand at least 20 minutes before deciding upon the absence of sugar.

Examine the crystals under the microscope and compare them with those shown in Plate III, opposite page 22.

5. **Precipitation by Alcohol.**—To 10 c.c. of 95 per cent alcohol add about 2 c.c. of dextrose solution. Compare the result with that obtained under Dextrin, 5, page 48.

6. **Iodine Test.**—Make the regular iodine test as given under Starch, 5, page 45, and keep this result in mind for comparison with the results obtained later with starch and with dextrin.

7. **Diffusibility of Glucose.**—Test the diffusibility of glucose solution through animal membrane or parchment paper, making a dialyzer like one of the models shown in Fig. 2.

¹ This solution is prepared by mixing one part *by volume*, in each case, of glacial acetic acid, one part of water and two parts of phenylhydrazine (the base).

A most satisfactory dialyzing bag may be made of collodion as follows: Pour a solution of collodion into a clean dry Erlenmeyer flask or test-tube. While rotating the vessel on its longitudinal axis, gradually pour out the collodion, at the same time being careful that the interior surface of the flask is completely coated with the solution. Continue the rotation in the inverted position until the collodion ceases to flow. After the solution has evaporated such that the collodion skin on the rim is dry and stiff, cut or loosen it around the edge of the rim. With a pipette or wash bottle run in a few cubic centimeters of water between the membrane and the wall of the flask or test-tube. Shake the inclined vessel while rotating on its longitudinal axis, thus detaching the membrane. Now withdraw the detached bag and fill with water, to determine whether or not it contains defects.¹

All monosaccharides and disaccharides are diffusible, but many polysaccharides are not.

8. Influence of Alkali (Moore's Test).—To 2–3 c.c. of sugar solution in a test-tube add an equal volume of concentrated KOH or NaOH, and boil. The solution

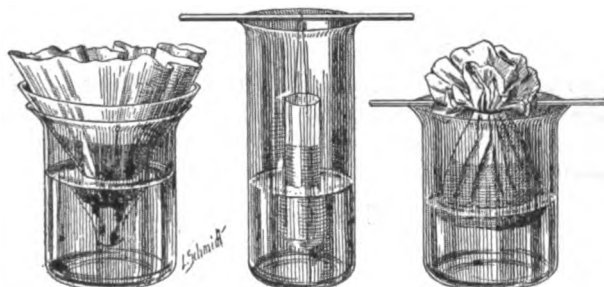

FIG. 2.—DIALYZING APPARATUS FOR STUDENTS' USE.

darkens and finally assumes a brown color. At this point the odor of caramel may be detected.

This test is of little practical value for the detection of glucose. The alkali brings about condensation and decomposition. The brown color is due to the formation of condensation products. Among the decomposition products are the potassium or sodium salts of certain organic acids.

9. Reduction Tests.—To their aldehyde or ketone structure many sugars owe the property of readily reducing alkaline solutions of the oxides of metals like copper, bismuth and mercury; they also possess the property of reducing ammoniacal silver solutions with the separation of metallic silver. Upon this property of reduction the most widely used tests for sugars are based. When whitish-blue cupric hydroxide in suspension in an alkaline liquid is heated it is converted into insoluble black cupric oxide, but if a reducing agent like certain sugars be present the cupric hydroxide is reduced to insoluble yellow or red cuprous oxide. These changes are indicated as follows:

¹ Gies: Quoted by Clark. *Bioch. Bull.*, 1, 198, 1911.

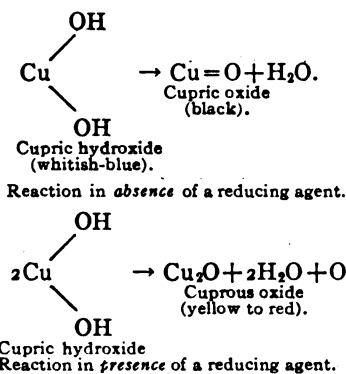

The chemical equations here discussed are exemplified in Trommer's and Fehling's tests.

(a) *Trommer's Test*.—To 5 c.c. of sugar solution in a test-tube add one-half its volume of KOH or NaOH. Mix thoroughly and add, drop by drop, a *very dilute* solution of copper sulphate. Continue the addition until there is a slight permanent precipitate of cupric hydroxide and in consequence the solution is slightly turbid. Heat, and the cupric hydroxide is reduced to yellow or brownish-red cuprous oxide.

If the solution of copper sulphate used is too strong a small brownish-red precipitate produced in a weak sugar solution may be entirely masked. On the other hand, particularly in testing for sugar in the urine, if too little copper sulphate is used a light-colored precipitate formed by uric acid and purine bases may obscure the brownish-red precipitate of cuprous oxide. The action of KOH or NaOH in the presence of an excess of sugar and insufficient copper will produce a brownish color. Phosphates of the alkaline earths may also be precipitated in the alkaline solution and be mistaken for cuprous oxide. Trommer's test is not very satisfactory.

Salkowski¹ has proposed a modification of the Trommer procedure which he claims is a very accurate sugar test.

(b) *Fehling's Test*.—To about 1 c.c. of Fehling's solution² in a test-tube add about 4 c.c. of water, and boil.³ [The cupric hydroxide is held in solution by the sodium potassium tartrate (Rochelle salt).] This is done to determine whether the solution will of itself cause the formation of a precipitate of brownish-red cuprous oxide. If such a precipitate forms, the Fehling's solution must not be used. Add sugar solution to the warm Fehling's solution a few drops at a time and heat the mixture after each addition. The production of yellow or brownish-red cuprous oxide indicates that reduction has taken place. The yellowish precipitate is more likely to occur if the sugar solution is added

¹ Salkowski: *Zeit. physiol. Chem.*, 79, 164, 1912.

² Fehling's solution is composed of two definite solutions—a copper sulphate solution and an alkaline tartrate solution—which may be prepared as follows:

Copper sulphate solution = 34.65 grams of copper sulphate dissolved in water and made up to 500 c.c.

Alkaline tartrate solution = 125 grams of potassium hydroxide and 173 grams of Rochelle salt dissolved in water and made up to 500 c.c.

These solutions should be preserved separately in rubber-stoppered bottles and mixed in equal volumes when needed for use. This is done to prevent deterioration.

³ More dilute Fehling's solution should be used in testing very dilute sugar solutions. In case of concentrated sugar solutions it may sometimes be desirable to use a larger volume of the Fehling's solution.

rapidly and in large amount, whereas with a less rapid addition of smaller amounts of sugar solution the brownish-red precipitate is generally formed. The differences in color of the cuprous oxide precipitates under different conditions are apparently due to differences in the size of the particles, the more finely divided precipitates having a yellow color, while the coarser ones are red. In the presence of protective colloidal substances the yellow precipitate is usually formed.¹

This is a much more satisfactory test than Trommer's, but even this test is not entirely reliable when used to detect sugar in the urine. Such bodies as *conjugate glycuronates*, *uric acid*, *nulceoprotein*, and *homogen-tisic acid* when present in sufficient amount may produce a result similar to that produced by sugar. *Phosphates of the alkaline earths* may be precipitated by the alkali of the Fehling's solution and in appearance may be mistaken for cuprous oxide. Cupric hydroxide may also be reduced to cuprous oxide and this in turn be dissolved by *creatinine*, a normal urinary constituent. This will give the urine under examination a greenish tinge and may obscure the sugar reaction even when a considerable amount of sugar is present. According to Laird,² even small amounts of creatinine will *retard the reaction velocity* of reducing sugars with Fehling's solution.

In testing urine preserved by *chloroform* a positive test may be obtained in the absence of sugar. This is due to the fact that the hot alkali produces formic acid (a reducing fatty acid) from the chloroform.

Ammonium salts also interfere with Fehling's test. If present in excess the solution (*e.g.*, urine) should be made alkaline and boiled in order to decompose the ammonium salts.

If the solution under examination by Fehling's test is acid in reaction it must be neutralized or made alkaline before applying the test.

(c) **Benedict's Modifications of Fehling's Test.—First Modification.**—To 2 c.c. of Benedict's solution³ in a test-tube add 6 c.c. of distilled water and 7–9 drops (not more) of the solution under examination. Boil the mixture vigorously for about 15–30 seconds and permit it to cool to room temperature spontaneously.

If sugar is present in the solution a precipitate will form which is often *bluish-green* or *green* at first, especially if the percentage of sugar is low, and which usually becomes *yellowish* upon standing. If the sugar

¹Fischer and Hooker: *Science*, N. S., 45, 505, 1917.

²Laird: *Journal of Pathology and Bacteriology*, 16, 398, 1912.

³Benedict's modified Fehling solution consists of two definite solutions—a copper sulphate solution and an alkaline tartrate solution, which may be prepared as follows:

Copper sulphate solution = 34.65 grams of copper sulphate dissolved in water and made up to 500 c.c.

Alkaline tartrate solution = 100 grams of anhydrous *sodium carbonate* and 173 grams of Rochelle salt dissolved in water and made up to 500 c.c.

These solutions should be preserved separately in rubber-stoppered bottles and mixed in equal volumes when needed for use. This is done to prevent deterioration.

present exceeds 0.06 per cent this precipitate generally forms at or below the boiling-point, whereas if less than 0.06 per cent of sugar is present the precipitate forms more slowly and generally only after the solution has cooled.

Benedict claims, whereas the original Fehling test will not serve to detect sugar when present in a concentration of less than 0.1 per cent, that the above modification will serve to detect sugar when present in as small quantity as 0.015–0.02 per cent. Corroboration of this claim of increased delicacy has been submitted by Harrison.¹

The modified Fehling solution used in the above test differs from the original Fehling solution in that 100 grams of sodium carbonate is substituted for the 125 grams of potassium hydroxide ordinarily used, thus forming a Fehling solution which is considerably less alkaline than the original. This alteration in the composition of the Fehling solution is of advantage in the detection of sugar in the urine inasmuch as the strong alkalinity of the ordinary Fehling solution has a tendency, when the reagent is boiled with a urine containing a small amount of glucose, to decompose sufficient of the sugar to render the detection of the remaining portion exceedingly difficult by the usual technic. Benedict claims that for this reason the use of this modified solution permits the detection of much smaller amounts of sugar than does the use of the ordinary Fehling solution.

Second Modification.²—Benedict has further modified his solution and has succeeded in obtaining one which does not deteriorate upon long standing.³ The following is the procedure for the detection of glucose in solution. To 5 c.c. of the reagent in a test-tube add 8 (not more) drops of the solution under examination. Boil the mixture vigorously for from one to two minutes and then allow the fluid to cool spontaneously. In the presence of dextrose the entire body of the solution will be filled with a precipitate, which may be red, yellow or green in color, depending upon the amount of sugar present. If no glucose is present, the solution will remain perfectly clear. (If urine is being tested, it may show a very faint turbidity, due to precipitated urates.)

Even very small quantities of glucose (0.1 per cent) yield precipitates of surprising bulk with this reagent, and the positive reaction for

¹ Harrison: *Pharm. Jour.*, 87, 746, 1911.

² Benedict: *Jour. Am. Med. Ass'n*, 57, 1193, 1911.

³ Benedict's new solution has the following composition:

Copper sulphate.....	17.3 grams.
Sodium citrate.....	173.0 grams.
Sodium carbonate (anhydrous).....	100.0 grams.
Distilled water to make 1 liter.	

With the aid of heat dissolve the sodium citrate and carbonate in about 600 c.c. of water. Pour (through a folded filter paper if necessary) into a glass graduate and make up to 850 c.c. Dissolve the copper sulphate in about 100 c.c. of water and make up to 150 c.c. Pour the carbonate-citrate solution into a large beaker or casserole and add the copper sulphate solution slowly, with constant stirring. The mixed solution is ready for use and does not deteriorate upon long standing.

glucose is the filling of the entire body of the solution with a precipitate, so that the solution becomes opaque. Since *amount* rather than color of the precipitate is made the basis of this test, it may be applied even for the detection of small quantities of glucose, as readily in artificial light as in daylight. Chloroform does not interfere with this test nor do uric acid or creatinine interfere to such an extent as in the case of Fehling's test.

It has been shown that alkaline phosphates may be used in place of tartrates or citrates to hold cupric hydroxide in solution and sugar reagents based on this principle have been employed.¹

(d) **Mercuric Oxide Reduction Test (Cramer).**²—This test depends on the reduction of mercuric oxide in a weakly alkaline solution, with the formation of metallic mercury. The degree of alkalinity is an important factor, as the test becomes more sensitive but less specific the greater the alkalinity of the reagent.

For the detection of reducing sugar in aqueous solution proceed as follows: Introduce 3 c.c. of Cramer's "2.5 reagent" into a test-tube³ and heat to boiling. The solution remains clear, but turns slightly yellow. Add 3 c.c. of the sugar solution and again heat to boiling. Remove the tube from the flame and note that the mixture becomes turbid, darkens, and that on standing a precipitate of finely divided mercury settles to the bottom of the tube.

This test is positive with such sugars as give other reduction tests, *e.g.*, glucose, fructose, lactose, maltose, arabinose, etc. If the reducing sugar be present in aqueous solution a slight reduction may be obtained with 1 mg. of glucose. If the reagent be made strongly alkaline, it ceases to be specific for reducing sugars and chemically allied substances and is reduced by other organic substances, *e.g.*, creatinine.

It is claimed that this test is free from fallacies inherent in Fehling's test as the result of the reducing action of uric acid and creatinine.

The test is more sensitive than the Fehling's or Nylander's reactions, and is particularly suitable for the examination of urines in which the amount of sugar present exceeds the normal amount only slightly.

(e) **Bismuth Reduction Test (Boettger).**—To 5 c.c. of sugar solution in a test-tube add 1 c.c. of KOH or NaOH and a very small amount of bismuth subnitrate, and boil. The solution will gradually darken and finally assume a black color due to reduced bismuth. If the test is made on urine containing albumin this must be

¹ Folin and McElroy: *Jour. Biol. Chem.*, 33, 513, 1918.

² Cramer: *Bioch. Jour.*, 9, 156, 1915.

³ Cramer's "2.5 Reagent."—0.4 gram mercuric oxide (red or yellow) and 6 grams potassium iodide are dissolved in 100 c.c. water. This solution is weakly alkaline. The alkalinity must now be adjusted so that 10 c.c. of the reagent are neutralized by 2.5 c.c. of N/10 acid, using phenolphthalein as indicator. This is done by titrating 10 c.c. of the reagent with N/10 acid and, after the alkalinity of the reagent has thus been determined, adding the requisite amount of N/10 acid or alkali to the bulk of the reagent. The reagent is a clear colorless solution which turns slightly yellow on heating and becomes colorless again on cooling. It must remain clear on boiling.

removed, by boiling and filtering, before applying the test, since with albumin a similar change of color is produced (bismuth sulphide).

(f) **Bismuth Reduction Test (Nylander).**—To 5 c.c. of sugar solution in a test-tube add one-tenth its volume of Nylander's reagent¹ and heat for five minutes in a boiling water-bath.² The solution will darken if reducing sugar is present, and upon standing for a few moments a black color will appear.

This color is due to the precipitation of bismuth. If the test is made on urine containing albumin this must be removed, by boiling and filtering, before applying the test, since with albumin a similar change of color is produced. Glucose when present to the extent of 0.08 per cent may be easily detected by this reaction (Rabe³ claims that 0.01 per cent sugar may be so detected). Uric acid and creatinine which interfere with the Fehling's test do not interfere with the Nylander test. It is claimed by Bechold that the bismuth reduction tests give a negative reaction with solutions containing sugar when mercuric chloride or chloroform is present. Other observers⁴ have failed to verify the inhibitory action of mercuric chloride and have shown that the inhibitory influence of chloroform may be overcome by raising the temperature of the urine to the boiling-point for a period of five minutes previous to making the test. Urines rich in *indican*, *urochrome*, *uroerythrin* or *hematoporphyrin*, as well as urines excreted after the ingestion of large amounts of certain *medicinal substances*, may give a darkening of Nylander's reagent similar to that of a true sugar reaction. It is a disputed point whether the urine after the administration of urotropin will reduce Nylander's reagent.⁵ Strausz⁶ has recently shown that the urine of diabetics to whom "Iothion" (diiodohydroxypropane) has been administered will give a negative Nylander-Almén reaction and respond positively to the Fehling and polariscopic tests. "Iothion" also interferes with the Nylander-Almén test *in vitro* whereas KI and I do not.

According to Rustin and Otto, the addition of PtCl₂ increases the delicacy of Nylander-Almén reaction. They claim that this procedure causes the sugar to be converted *quantitatively*. No quantitative method has yet been devised, however, based upon this principle.

¹ Nylander's reagent is prepared by digesting 2 grams of bismuth subnitrate and 4 grams of Rochelle salt in 100 c.c. of a 10 per cent potassium hydroxide solution. The reagent is then cooled and filtered.

² Hammarsten suggests that the mixture should be boiled 2-5 minutes (according to the sugar content) over a free flame and the tube then permitted to stand 5 minutes before drawing conclusions.

³ Rabe: *Apoth. Ztg.*, 29, 554, 1914.

⁴ Rehfuß and Hawk: *Journal of Biological Chemistry*; 7, 267, 1910; also Zeidlitz: *Uppsala Läkarefören. Forh.*, N. F., 11, 1906.

⁵ Abt: *Archives of Pediatrics*, 24, 275, 1907; also Weitbrecht: *Schweiz. Wochschr.*, 47, 577, 1909.

⁶ Strausz: *Münch. med. Woch.*, 59, 85, 1912.

Bohmansson¹ before testing the urine under examination treats it (10 c.c.) with $\frac{1}{2}$ volume of 25 per cent hydrochloric acid and about $\frac{1}{2}$ volume of boneblack. This mixture is shaken one minute, then filtered and the neutralized filtrate tested by Nylander-Almén reaction. Bohmansson claims that this procedure removes certain interfering substances, in particular *urochrome*.

A positive bismuth reduction test is probably due to the following reactions:

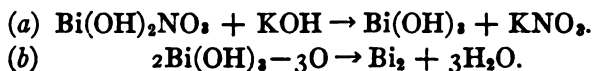

(g) **Barfoed's Test.**—Place about 5 c.c. of Barfoed's solution² in a test-tube and heat to boiling. Add glucose solution slowly, a few drops at a time, heating after each addition. Reduction is indicated by the formation of a red precipitate of cuprous oxide. If the precipitate does not form after boiling one-half minute³ allow the tube to stand a few minutes and examine.

According to Welker⁴ chlorides interfere pronouncedly with the reaction causing the formation of a green precipitate.

Barfoed's test is *not* a specific test for glucose as is frequently stated, but simply serves to detect *monosaccharides*. Disaccharides will also respond to the test, under proper conditions of acidity.⁵ Also if the sugar solution is boiled sufficiently long, in contact with the reagent, to hydrolyze the disaccharide through the action of the acetic acid present in the Barfoed's solution a positive test results.⁶ Barfoed's is a copper reduction test, but differs from Fehling's and other reduction tests in that the reduction is brought about in an acid solution. It is unsuited for the detection of sugar in urine.

(h) **Picric Acid Test.**—To 5 c.c. of the sugar solution add 2–3 c.c. of saturated picric acid solution and about 1 c.c. of 10 per cent KOH. Warm. Note the development of a mahogany red color in the presence of glucose due to reduction of the picric acid with the formation of picramic acid:

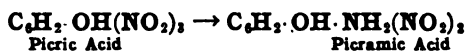

This test has been made the basis of a method for the colorimetric determination of sugar in blood. See Chapter XVI.

10. **Alcoholic Fermentation.**—Prepare 500 c.c. of a concentrated (10 per cent) solution of glucose, add a small amount of egg albumin or commercial peptone and introduce the mixture into a liter flask. Add yeast, and by means of a bent

¹ Bohmansson: *Biochem. Zeit.*, 19, p. 281.

² Barfoed's solution is prepared as follows: Dissolve 9 grams of neutral crystallized copper acetate in 100 c.c. of water and add 1.2 c.c. of 50 per cent acetic acid. This solution should be freshly made.

³ Blake: *Jour. Am. Chem. Soc.*, 38, 1245, 1916.

⁴ Welker: *Jour. Am. Chem. Soc.*, 37, 2227, 1915.

⁵ Mathews and McGuigan: *Am. Jour. Physiol.*, 19, 175, 1907.

⁶ Hinkle and Sherman: *Jour. Am. Chem. Soc.*, 29, 1744, 1907.

tube connect this flask with a second flask containing a solution of barium hydroxide protected from the air by a soda lime tube in the stopper (see Fig. 3).

Place the flasks in a warm place and note the passage of gas bubbles into the barium hydroxide solution. As these gas bubbles (CO_2) enter, a white precipitate of barium carbonate will form. The glucose has been fermented according to the following equation:

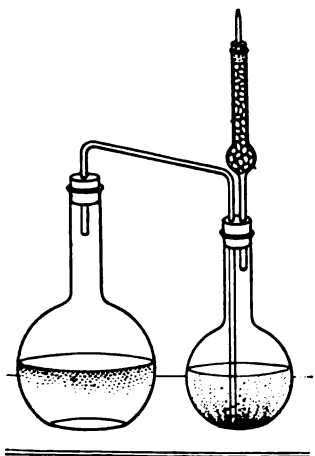

FIG. 3.—FERMENTATION APPARATUS.

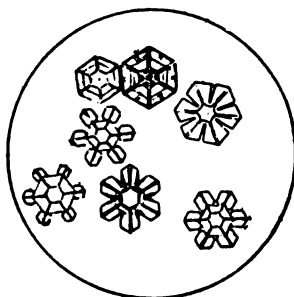

FIG. 4.—IODOFORM. (*Autenrieth.*)



When the activity of the yeast has practically ceased decant the supernatant fluid, return it to the cleaned flask, connect with a condenser and distil. Catch the first portion of the distillate, which may be redistilled if its alcohol content is low, and test for alcohol by one of the following reactions:

(a) Iodoform Test.—Render 2–3 c.c. of the distillate alkaline with potassium hydroxide solution and add a few drops of iodine solution. Heat gently and note the formation of iodoform crystals. Examine these crystals under the microscope and compare them with those in Fig. 4.

(b) Aldehyde Test.—Place 5 c.c. of the distillate in a test-tube, add a few drops of potassium dichromate solution, $\text{K}_2\text{Cr}_2\text{O}_7$, and render it acid with dilute sulphuric acid. Boil the acid solution and note the odor of aldehyde changing to that of acetic acid.

11. Fermentation Test.—“Rub up” in a mortar about 20 c.c. of the sugar solution with a small piece of compressed yeast. Transfer the mixture to a saccharometer (shown in Fig. 5) and stand it aside in a warm place for about twelve hours. If the sugar is fermentable, alcoholic fermentation will occur and carbon dioxide will collect as a gas in the upper portion of the tube. On the completion of fermentation introduce a little potassium hydroxide solution into the graduated portion by means of a bent pipette, fill the bulb portion with water, place the thumb tightly over the opening in the apparatus and invert the saccharometer.

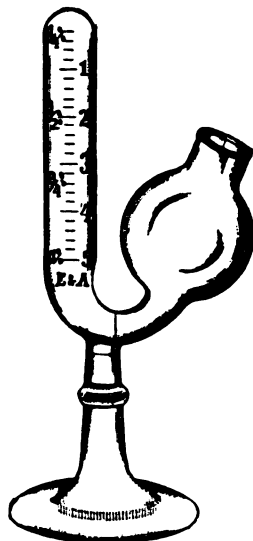

FIG. 5.—EINHORN SACCHAROMETER.

Remembering that KOH has the power to absorb CO₂, how do you explain the result? Filter some of the mixture. To 5 c.c. of the filtrate add several drops of a solution of iodine in potassium iodide (enough to give a yellow color to the whole mixture). Warm gently. Note iodoform odor and examine under microscope for crystals of iodoform (see Fig. 4). What does a positive test here indicate?

12. **Formation of Caramel.**—Gently heat a small amount of pulverized glucose in a test-tube. After the sugar has melted and turned brown, allow the tube to cool, add water and warm. The coloring matter produced is known as *caramel*.

13. **Demonstration of Optical Activity.**—A demonstration of the use of the polariscope, by the instructor, each student being required to take readings and compute the "specific rotation."

USE OF THE POLARISCOPE

For a detailed description of the different forms of polariscopes, the method of manipulation and the principles involved, the student is referred to any standard text-book of physics. A brief description fol-

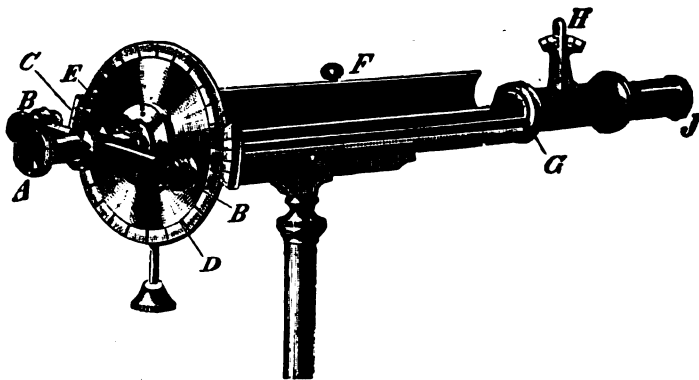

FIG. 6.—ONE FORM OF LAURENT POLARISCOPE.

B, Microscope for reading the scale; *C*, a vernier; *E*, position of the analyzing Nicol prism; *H*, polarizing Nicol prism in the tube below this point.

lows. An ordinary ray of light vibrates in every direction. If such a ray is caused to pass through a "polarizing" Nicol prism it is resolved into *two rays*, one of which vibrates in every direction as before and a second ray which vibrates in *one plane only*. This latter ray is said to be *polarized*. Many organic substances (sugar, proteins, etc.) have the power of twisting or rotating this plane of polarized light, the extent to which the plane is rotated depending upon the number of molecules

¹The findings of Neuberg and associates² indicate that the liberation of carbon dioxide by yeast is not necessarily a criterion of the presence of sugar. The presence of an enzyme, called *carboxylase*, has been demonstrated in yeast which has the power of splitting off CO₂ from the carboxyl group of amino- and other aliphatic acids.

²Neuberg and Associates: *Biochem. Zeitsch.*, 31, 170; 32, 323; 36, (60, 68, 76), 1911.

which the polarized light passes. Substances which possess this power are said to be "optically active." The *specific rotation* of a substance is the rotation expressed in degrees which is afforded by 1 gram of substance dissolved in 1 c.c. of water in a tube one decimeter in length. The specific rotation, $(\alpha)_D$, may be calculated by means of the following formula:

$$(\alpha)_D = \frac{\alpha}{p \cdot l}$$

in which

D = sodium light.

α = observed rotation in degrees.

p = grams of substance dissolved in 1 c.c. of liquid.

l = length of the tube in decimeters.

If the specific rotation has been determined and it is desired to ascertain the per cent of the substance in solution, this may be obtained by the use of the following formula,

$$p = \frac{\alpha}{(\alpha)_D l}$$

The value of p multiplied by 100 will be the percentage of the substance in solution.

SPECIFIC ROTATIONS OF MORE COMMON CARBOHYDRATES¹

<i>d</i> -Glucose.....	+ 52.5°	Sucrose.....	+ 66.5°
<i>d</i> -Fructose.....	- 92.3°	Lactose.....	+ 52.5°
<i>d</i> -Galactose.....	+ 81.5°	Maltose.....	+ 137.0°
<i>d</i> -Mannose.....	+ 14.2°	Raffinose.....	+ 104.0°
<i>l</i> -Arabinose.....	+ 104.5°	Dextrin.....	+ 195.0°
<i>l</i> -Xylose.....	+ 19.0°	Starch (soluble).....	+ 196.0°
Rhamnose.....	+ 9.0°	Glycogen.....	+ 197.0°

An instrument by means of which the extent of the rotation may be determined is called a *polariscope* or *polarimeter*. Such an instrument designed especially for the examination of sugar solutions is termed a *saccharimeter* or *polarizing saccharimeter*. The form of polariscope in Fig. 6, page 32, consists essentially of a long barrel provided with a Nicol prism at either end (Fig. 7). The solution under examination is contained in a tube which is placed between these two prisms. At the front end of the instrument is an adjusting eyepiece for focusing and a large recording disc which registers in degrees and fractions of a

¹The specific rotation varies with the temperature and concentration of the solution. The figures here given are for concentrations of about 10 per cent and temperatures of about 20°C. Fresh solutions may give markedly different values due to mutarotation, the figures here given representing the constant values obtained on standing.

degree. The light is admitted into the far end of the instrument and is polarized by passing through a Nicol prism. This polarized ray then traverses the column of liquid within the tube mentioned above and if the substance is optically active the plane of the polarized ray is

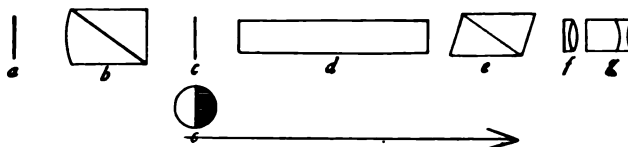

FIG. 7.—DIAGRAMMATIC REPRESENTATION OF THE COURSE OF THE LIGHT THROUGH THE LAURENT POLARISCOPE. (The direction is reversed from that of Fig. 6, p. 32.)

a, Bichromate plate to purify the light; *b*, the polarizing Nicol prism; *c*, a thin quartz plate covering one-half the field and essential in producing a second polarized plane; *d*, tube to contain the liquid under examination; *e*, the analyzing Nicol prism; *f* and *g*, ocular lenses.

rotated to the right or left. Bodies rotating the ray to the right are called *dextro-rotatory* and those rotating it to the left *levo-rotatory*.

Within the apparatus is a disc which is so arranged as to be without lines and uniformly light at zero. Upon placing the optically active

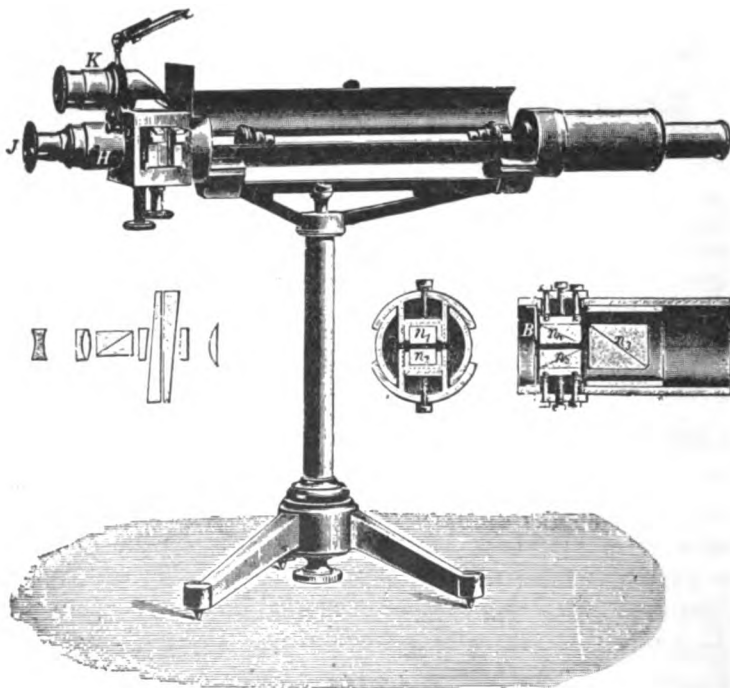

FIG. 8.—POLARISCOPE (SCHMIDT AND HÄNSCH MODEL).

substance in position, however, the plane of polarized light is rotated or turned and it is necessary to rotate the disc through a certain number of degrees in order to secure the normal conditions, *i.e.*, "without lines

and uniformly light." The difference between this reading and the *zero* is α or the observed rotation in degrees.

Sugar solutions (glucose, levulose, lactose, maltose, but not sucrose) when freshly prepared possess a changing rotation, so called *mutarotation*. For this reason such solutions before polariscopic examination should be allowed to stand over night, heated to 100°C. and then cooled, or treated with a drop of ammonia followed by a drop of acid.

Polarizing saccharimeters are also constructed by which the percentage of sugar in solution is determined by making an observation and multiplying the value of each division on a horizontal sliding scale by the value of the division expressed in terms of dextrose. This factor may vary according to the instrument.

"Optical" methods embracing the determination of the optical activity are being utilized in recent years in many "quantitative" connections.¹

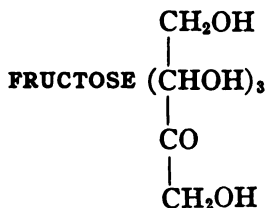

As already stated, fructose, sometimes called levulose or fruit sugar, occurs widely disseminated throughout the plant kingdom in company with glucose. Its reducing power is somewhat weaker than that of dextrose. Fructose does not ordinarily occur in the urine in diabetes mellitus, but has been found in exceptional cases. With phenylhydrazine it forms the same osazone as glucose. With methylphenylhydrazine, levulose forms a characteristic methylphenylfructosazone.

(For a further discussion of fructose see the section on Hexoses, page 20.)

EXPERIMENTS ON FRUCTOSE

1-6. Repeat Solubility, Fehling's, Phenylhydrazine, Barfoed's, Nylander's, and Fermentation tests as given under Glucose, pages 21-32.

7. Resorcinol-Hydrochloric Acid Reaction (Seliwanoff).—To 5 c.c. of Seliwanoff's reagent¹ in a test-tube add a few drops of a fructose solution and heat the mixture to boiling. A positive reaction is indicated by the production of a red color and the separation of a brown-red precipitate. The latter may be dissolved in alcohol to which it will impart a striking red color.

¹Abderhalden and Schmidt: "Determination of blood content by means of the optical method," *Zeit. physiol. Chem.*, 66, 120, 1910; also C. Neuberger: "Determination of nucleic acid cleavage by polarization," *Biochemische Zeitschrift*, 30, 505, 1911.

²Seliwanoff's reagent may be prepared by dissolving 0.05 gram of resorcinol in 100 c.c. of dilute (1 : 2) hydrochloric acid.

If the boiling be prolonged a similar reaction may be obtained with solutions of glucose or maltose. This has been explained¹ in the case of glucose as due to the transformation of the glucose into fructose by the catalytic action of the hydrochloric acid. The precautions necessary for a positive test for levulose are as follows: The concentration of the hydrochloric acid must not be more than 12 per cent. The reaction (red color) and the precipitate must be observed after not more than 20–30 seconds boiling. Glucose must not be present in amounts exceeding 2 per cent. The precipitate must be soluble in alcohol with a bright red color.

8. Borchardt's Reaction.—To about 5 c.c. of a solution of fructose in a test-tube add an equal volume of 25 per cent hydrochloric acid and a few crystals of resorcinol. Heat to boiling and after the production of a red color, cool the tube under running water and transfer to an evaporating dish or beaker. Make the mixture slightly alkaline with *solid* potassium hydroxide, return it to a test-tube, add 2–3 c.c. of acetic ether and shake the tube vigorously. In the presence of levulose, the acetic ether is colored yellow. (For further discussion of the test see Chapter XXIV.)

9. Formation of Methylphenylfructosazone.—To a solution of 1.8 grams of levulose in 10 c.c. of water add 4 grams² of methylphenylhydrazine and enough alcohol to clarify the solution. Introduce 4 c.c. of 50 per cent acetic acid and heat the mixture for 5–10 minutes on a boiling water-bath.³ On standing 15 minutes at room temperature, crystallization begins and is complete in two hours. By scratching the sides of the flask or by inoculation, the solution quickly congeals to form a thick paste of reddish-yellow silky needles. These are the crystals of *methylphenylfructosazone*. They may be recrystallized from hot 95 per cent alcohol and melt at 153°C.

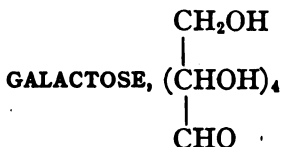

Galactose occurs with glucose as one of the products of the hydrolysis of lactose. It is dextro-rotatory, forms an osazone with phenylhydrazine and ferments slowly with yeast. Upon oxidation with nitric acid galactose yields mucic acid, thus differentiating this monosaccharide from glucose and fructose. Lactose also yields mucic acid under these conditions. The mucic acid test may be used in urine examination to differentiate lactose and galactose from other reducing sugars.

EXPERIMENTS ON GALACTOSE

1. Phloroglucinol-Hydrochloric Acid Reaction (Tollens).—To equal volumes of galactose solution and hydrochloric acid (sp. gr. 1.09) add a little phloroglucinol,

¹ Koenigsfeld: *Bioch. Zeit.*, 38, 311, 1912.

² 3.66 grams if absolutely pure.

³ Longer heating is to be avoided.

and heat the mixture on a boiling water-bath. Galactose, pentose and glycuronic acid will be indicated by the appearance of a red color. Galactose may be differentiated from the two latter substances in that its solutions exhibit no absorption bands upon spectroscopical examination.

2. Mucic Acid Test.—Treat 100 c.c. of the solution containing galactose with 20 c.c. of concentrated nitric acid (sp. gr. 1.4) and evaporate the mixture in a broad, shallow glass vessel on a boiling water-bath until the volume of the mixture has been reduced to about 20 c.c. At this point the fluid should be clear, and a fine white precipitate of mucic acid should form.

If the percentage of galactose present is low it may be necessary to cool the solution and permit it to stand for some time before the precipitate will form. It is impossible to differentiate between galactose and lactose by this test, but the reaction serves to differentiate these two sugars from all other reducing sugars. Differentiate lactose from galactose by means of Barfoed's test (page 30).

3. Phenylhydrazine Reaction.—Make the test according to directions given under Glucose, 3 or 4, pages 22 and 23.

Pentoses, $C_5H_{10}O_5$

In plants, and more particularly in certain gums, very complex carbohydrates, called pentosans (see page 50), occur. These pentosans through hydrolysis by acids may be transformed into pentoses. Pentoses do not ordinarily occur in the animal organism, but have been found in the urine of morphine habitués and others, their occurrence sometimes being a persistent condition without known cause. They may be obtained from the hydrolysis of nucleoproteins being present in the nucleic acid complex of the molecule. Pentoses are non-fermentable have strong reducing power and form osazones with phenylhydrazine. Pentoses are an important constituent of the dietary of herbivorous animals. Glycogen is said to be formed after the ingestion of these sugars containing five oxygen atoms. This, however, has not been conclusively proven. On distillation with strong hydrochloric acid pentoses and pentosans yield furfural, which can be detected by its characteristic red reaction with aniline-acetate paper.

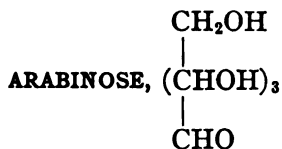

Arabinose is one of the most important of the pentoses. The *L*-arabinose may be obtained from gum arabic, plum or cherry gum by boiling for 10 minutes with concentrated hydrochloric acid. This pentose is dextro-rotatory, forms an osazone and has reducing power,

but does not ferment. The *i*-arabinose has been isolated from the urine and yields an osazone which melts at 166°–168°C.

EXPERIMENTS ON ARABINOSE

1. **Orcinol-Hydrochloric Acid Reaction (Bial).**¹—To 5 c.c. of Bial's reagent² in a test-tube add 2–3 c.c. of the arabinose solution and heat the mixture gently until the first bubbles rise to the surface. Immediately or upon cooling the solution becomes green and a flocculent precipitate of the same color may form. (For further discussion see Chapter XXIV.) The test may also be performed by adding the pentose to the hot reagent.

It is claimed that this test is more delicate than the original orcinol test (see 3) and more accurate, since menthol, kreosotal, etc., respond to the original orcinol test but not to Bial's. Sachs³ has offered suggestions as to modification of the test in order to avoid confusion with glycuronic acid.

2. **Phloroglucinol-Hydrochloric Acid Reaction (Tollens).**—To equal volumes of arabinose solution and hydrochloric acid (sp. gr. 1.09) add a little phloroglucinol and heat the mixture on a boiling water-bath. Galactose, pentose or glycuronic acid will be indicated by the appearance of a red color. To differentiate between these bodies make a spectroscopic examination and look for the absorption band between *D* and *E* given by pentoses and glycuronic acid. Differentiate between the two latter bodies by the melting-points of their osazones.

Compare the reaction with that obtained with galactose (page 36).

3. **Orcinol Test.**—Repeat 2, using orcinol instead of phloroglucinol. A succession of colors from red through reddish blue to green is produced. A green precipitate is formed which is soluble in amyl alcohol and has absorption bands between *C* and *D*.

4. **Phenyldiazine Reaction.**—Make this test on the arabinose solution according to directions given under Glucose, 3 or 4, pages 22 and 23.

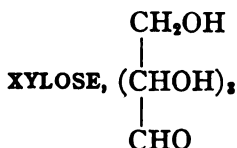

Xylose, or wood sugar, is obtained by boiling wood gums with dilute acids as explained under Arabinose, page 37. It is dextro-rotatory, forms an osazone and has reducing power, but does not ferment.

EXPERIMENTS ON XYLOSE

1–4. Same as for arabinose (see above).

¹ Bial: *Deut. med. Woch.*, 28, 252, 1902, and *Berl. klin. Woch.*, No. 18, 1903.

² Orcinol..... 1.5 gram.

Fuming HCl..... 500 grams.

Ferric chloride (10 per cent) 20–30 drops.

³ Sachs: *Bioch. Zeit.*, 1, 383, 1906, and 2, 245, 1906.

RHAMNOSE, C₆H₁₂O₅

Rhamnose or methyl-pentose is an example of a true carbohydrate which does not have the H and O atoms present in the proportion to form water. Its formula is C₆H₁₂O₅. It has been found that rhamnose when ingested by rabbits or hens has a positive influence upon the formation of glycogen in those organisms.

DISACCHARIDES, C₁₂H₂₂O₁₁

The disaccharides as a class may be divided into two rather distinct groups. The first group would include those disaccharides which are found in nature as such, *e.g.*, *sucrose* and *lactose*, and the second group would include those disaccharides formed in the hydrolysis of more complex carbohydrates, *e.g.*, *maltose* and *iso-maltose*.

The disaccharides have the general formula C₁₂H₂₂O₁₁, to which, in the process of hydrolysis, a molecule of water is added causing the single disaccharide molecule to split into two monosaccharide (hexose) molecules. The products of the hydrolysis of the more common disaccharides are as follows:

Maltose = glucose + glucose.

Lactose = glucose + galactose.

Sucrose = glucose + fructose.

All of the more common disaccharides *except sucrose* have the power of reducing certain metallic oxides in alkaline solution, notably those of copper and bismuth. This reducing power is due to the presence of the *aldehyde group* (—CHO) in the sugar molecule.

MALTOSE, C₁₂H₂₂O₁₁

Maltose or malt sugar is formed in the hydrolysis of starch through the action of an enzyme, *vegetable amylase (diastase)*, contained in sprouting barley or malt. Certain enzymes in the saliva and in the pancreatic juice may also cause a similar hydrolysis. Maltose is also an intermediate product of the action of dilute mineral acids upon starch. It is strongly dextro-rotatory, reduces metallic oxides in alkaline solution and is fermentable by yeast after being inverted (see Polysaccharides, page 43) by the enzyme *maltase* of the yeast. In common with the other disaccharides, maltose may be hydrolyzed with the formation of two molecules of monosaccharide. In this instance the products are two molecules of glucose. With phenylhydrazine maltose forms an osazone, *maltozone*. The following formula represents the probable structure of maltose:

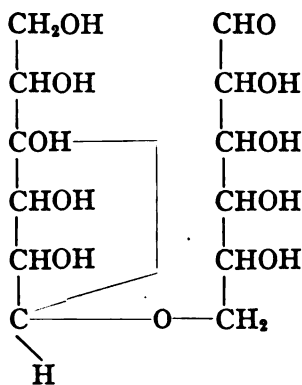

Maltose.

EXPERIMENTS ON MALTOSE

1-6. Repeat Solubility, Fehling's, Nylander's, Phenylhydrazine, Barfoed's and Fermentation tests as given under Glucose, pages 21-31.

ISO-MALTOSE, $\text{C}_{12}\text{H}_{22}\text{O}_{11}$

Iso-maltose, an isomeric form of maltose, is formed along with maltose, by the action of diastase upon starch paste, and also by the action of hydrochloric acid upon glucose. It also occurs with maltose as one of the products of salivary digestion. It is dextro-rotatory and with phenylhydrazine gives an osazone which is characteristic. Iso-maltose is very soluble and reduces the oxides of bismuth and copper in alkaline solution. Pure iso-maltose is probably only slightly fermentable.

LACTOSE, $\text{C}_{12}\text{H}_{22}\text{O}_{11}$

Lactose or milk sugar occurs ordinarily only in milk, but has often been found in the urine of women during pregnancy and lactation. It may also occur in the urine of normal persons after the ingestion of unusually large amounts of lactose in the food. It has a strong reducing power, is dextro-rotatory and forms an osazone with phenylhydrazine. Upon hydrolysis lactose yields one molecule of glucose and one molecule of galactose.

In the souring of milk the *Bacterium lactis acidi* or *Streptococcus lacticus* and certain other micro-organisms bring about lactic acid fermentation by transforming the lactose of the milk into lactic acid,

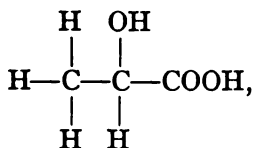

and alcohol. This same reaction may occur in the alimentary canal as the result of the action of putrefactive bacteria. In the preparation of kephyr and koumyss the lactose of the milk undergoes alcoholic fermentation, through the action of ferments other than yeast, and at the same time lactic acid is produced. Lactose and galactose yield *mucic acid* on oxidation with nitric acid. This fact is made use of in urine analysis to facilitate the differentiation of these sugars from other reducing sugars.

Lactose is *not* fermentable by the ordinary baker's yeast.

EXPERIMENTS ON LACTOSE

1-6. Repeat Solubility, Fehling's, Phenylhydrazine, Barfoed's, Nylander's and Fermentation tests as given under Glucose, pages 21-31.

7. Mucic Acid Test.—Treat 100 c.c. of the solution containing lactose with 20 c.c. of concentrated nitric acid (sp. gr. 1.4) and evaporate the mixture in a broad, shallow glass vessel on a boiling water-bath, until the volume of the mixture has been reduced to about 20 c.c. At this point the fluid should be clear, and a fine white precipitate of mucic acid should form.

If the percentage of lactose present is low it may be necessary to cool the solution and permit it to stand for some time before the precipitate will appear. It is impossible to differentiate between lactose and galactose by this test, but the reaction serves to differentiate these two sugars from all other reducing sugars.

Differentiate lactose from galactose by means of Barfoed's test, page 30.

SUCROSE, C₁₂H₂₂O₁₁

Sucrose, also called saccharose or cane sugar, is one of the most important of the sugars and occurs very extensively distributed in plants, particularly in the sugar cane, sugar beet, sugar millet and in certain palms and maples.

Sucrose is dextro-rotatory and upon hydrolysis, as before mentioned, the molecule of sucrose takes on a molecule of water and breaks down into two molecules of monosaccharide. The monosaccharides formed in this instance are glucose and fructose. This is the reaction:

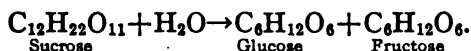

This process is called *inversion* and may be produced by bacteria, enzymes, and certain weak acids. After this inversion the previously strongly dextro-rotatory solution becomes levo-rotatory. This is due to the fact that the fructose molecule is more strongly levo-rotatory than the glucose molecule is dextro-rotatory. The product of this inversion is called *invert sugar*.

Sucrose does *not* reduce metallic oxides in alkaline solution and forms *no* osazone with phenylhydrazine. Prolonged boiling in the presence of an *acid* phenylhydrazine solution will, however, hydrolyze the sucrose and cause the formation of glucosozone and fructosozone. It is not fermentable directly by yeast, but must first be *inverted* by the enzyme *sucrase* (*invertase* or *invertin*) contained in the yeast. The probable structure of sucrose may be represented by the following formula. Note the absence of any free ketone or aldehyde group.

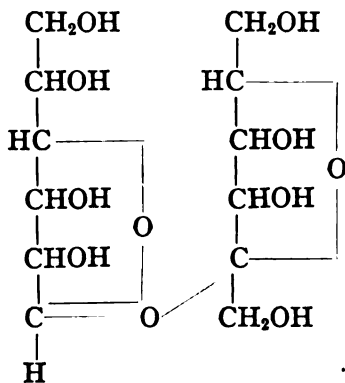

Sucrose.

EXPERIMENTS ON SUCROSE

1-6. Repeat Solubility, Fehling's, Nylander's, Barfoed's, Phenylhydrazine and Fermentation tests according to the directions given under Glucose, pages 21-31.

7. Inversion of Sucrose.—To 25 c.c. of sucrose solution in a beaker add 5 drops of concentrated H_2SO_4 and boil one minute. Cool the solution and render neutral with saturated barium hydroxide. Filter off the precipitate of barium sulphate and upon the resulting fluid repeat the phenylhydrazine, Fehling, Nylander's and Barfoed's reactions as given under Glucose, pp. 22, 25 and 30; and the Resorcinol-Hydrochloric Acid Reaction (Seliwanoff), as given under Fructose, page 35. Explain the results.

TRISACCHARIDES, $\text{C}_{18}\text{H}_{32}\text{O}_{16}$

RAFFINOSE

This trisaccharide, also called melitose, or melitriose occurs in cotton seed, Australian manna, and in the molasses from the preparation of beet sugar. It is dextro-rotatory, does not reduce Fehling's solution, and is only partly fermentable by yeast.

Raffinose may be hydrolyzed by weak acids the same as the polysaccharides are hydrolyzed, the products being fructose and melibiose; further hydrolysis of the melibiose yields glucose and galactose. Raffinose may also be hydrolyzed by the enzyme raffinase, occurring in certain bacteria and yeasts.¹

¹ Kuriyama and Mendel: *Jour. Biol. Chem.*, 31, 125, 1917.

POLYSACCHARIDES, $(C_6H_{10}O_5)_x$

In general the polysaccharides are amorphous bodies, a few, however, are crystallizable. Through the action of certain enzymes or weak acids the polysaccharides may be hydrolyzed with the formation of monosaccharides. As a class the polysaccharides are quite insoluble and are non-fermentable until inverted. By inversion is meant the hydrolysis of disaccharide or polysaccharide sugars to form monosaccharides, as indicated in the following equations:

STARCH, $(C_6H_{10}O_5)_x$

Starch is widely distributed throughout the vegetable kingdom, occurring in grains, fruits, and tubers. It occurs in granular form, the microscopical appearance being typical for each individual starch. The granules, which differ in size according to the source, contain, according to recent work,¹ at least three principal ingredients, *amylocellulose* forming the cell walls, making up about 10 per cent of the starch granules and not reacting with iodine; *amylose*, comprising about 70 per cent of the granules and giving a blue color with iodine; and *amylopectin*, the substance giving the high viscosity to starch pastes, making up about 20 per cent of the granules, and giving no color with iodine. Ordinary starch is insoluble in cold water, but if boiled with water the cell walls are ruptured and *starch paste* results. In general starch gives a blue color with iodine.

Starch is acted upon by amylases, e.g., salivary amylase (*ptyalin*) and pancreatic amylase (*amylapsin*), with the formation of *soluble starch*, *erythro-dextrin*, *achroo-dextrins*, and *maltose* (see Salivary Digestion, page 54). Maltose is the principal end-product of this enzyme action. Upon boiling a starch solution with a dilute mineral acid a series of similar bodies is formed, but under these conditions *glucose* is the principal end-product.

Soluble starch may be prepared by the action of dilute hydrochloric acid on ordinary starch for several weeks, or at higher temperatures for a shorter period. By precipitation with alcohol this may be obtained in a dry form readily soluble in cold water.²

EXPERIMENTS ON STARCH

1. Preparation of Potato Starch.—Pare a raw potato, comminute it upon a fine grater, mix with water, and "whip up" the pulped material vigorously before

¹ Blake: *Jour. Am. Chem. Soc.*, 38, 1245, 1916; 39, 315, 1917. Maquenne and Roux: *Ann. Chim. Phys.*, 9, 179, 1906.

² Fernbach: *Proceedings 8th Int. Cong. Appl. Chem.*, 13, 131, 1912. Chapin: *Jour. Ind. and Eng. Chem.*, 6, 649, 1914.

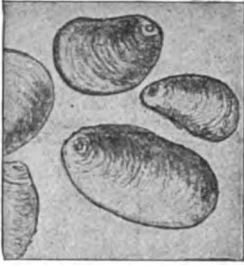

FIG. 9.—POTATO.



FIG. 10.—BEAN.



FIG. 11.—ARROWROOT.



FIG. 12.—RYE.



FIG. 13.—BARLEY.

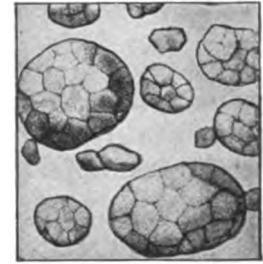

FIG. 14.—OAT.



FIG. 15.—BUCKWHEAT.



FIG. 16.—MAIZE.



FIG. 17.—RICE.



FIG. 18.—PEA.



FIG. 19.—WHEAT.

STARCH GRANULES FROM VARIOUS SOURCES. (*Leffmann and Beam.*)

straining it through cheese cloth or gauze to remove the coarse particles. The starch rapidly settles to the bottom and can be washed by repeated decantation. Allow the compact mass of starch to drain thoroughly and spread it out on a watch glass to dry in the air. If so desired this preparation may be used in the experiments which follow.

2. **Microscopical Examination.**—Examine microscopically the granules of the various starches submitted and compare them with those shown in Figs. 9–19, page 44. The suspension of the granules in a drop of water will facilitate the microscopical examination.

3. **Solubility.**—Try the solubility of one form of starch in each of the ordinary solvents (see page 21). If uncertain regarding the solubility in any reagent, filter and test the filtrate with iodine solution as given under 5 below. The production of a blue color would indicate that the starch had been dissolved by the solvent.

4. **Iodine Test.**—Place a few granules of starch in one of the depressions of a porcelain test-tablet and treat with a drop of a dilute solution of iodine in potassium iodide. The granules are colored blue due to the formation of so-called iodide of starch. The amylo-cellulose of the granule is not stained as may be seen by examining microscopically.

5. **Iodine Test on Starch Paste.**¹—Repeat the iodine test using the starch paste. Place 2–3 c.c. of starch paste² in a test-tube, add a drop of the dilute iodine solution and observe the production of a blue color. Heat the tube and note the disappearance of the color. It reappears on cooling.

In similar tests note the influence of alcohol and of alkali upon the so-called iodide of starch.

The composition of the iodide of starch is not definitely known. In performing this test the solution must always be neutral or acid in reaction.

6. **Fehling's Test.**—On starch paste (see page 25).

7. **Hydrolysis of Starch.**—Place about 25 c.c. of starch paste in a small beaker, add 10 drops of concentrated HCl, and boil. By means of a small pipette, at the end of each minute, remove a drop of the solution to the test-tablet and make the regular iodine test. As the testing proceeds the blue color should gradually fade and finally disappear. At this point, after cooling and neutralizing with solid KOH, Fehling's test (see page 25) should give a positive result due to the formation of a reducing sugar from the starch. Make the phenylhydrazine test upon some of the hydrolyzed starch. What sugar has been formed?

8. **Influence of Tannic Acid.**—Add an excess of tannic acid solution to a small amount of starch paste in a test-tube. The liquid will become strongly opaque and ordinarily a yellowish-white precipitate is produced. Compare this result with the result of the similar experiment on dextrin (page 48).

9. **Diffusibility of Starch Paste.**—Test the diffusibility of starch paste through animal membrane, parchment paper or collodion, making a dialyzer like one of the models shown in Fig. 2, page 24.

¹ **Preparation of Starch Paste.**—Grind 2 grams of starch powder in a mortar with a small amount of cold water. Bring 200 c.c. of water to the boiling-point and add the starch mixture from the mortar with continuous stirring. Bring again to the boiling-point and allow it to cool. This makes an approximate 1 per cent starch paste which is a very satisfactory strength for general use.

² For this particular test a starch paste of very satisfactory strength may be made by mixing 1 c.c. of a 1 per cent starch paste with 200 c.c. of water.

INULIN, $(C_6H_{10}O_5)_x$

Inulin is a polysaccharide which may be obtained as a white, odorless, tasteless powder from the tubers of the artichoke, elecampane, or dahlia. It has also been prepared from the roots of chicory, dandelion, and burdock. It is very slightly soluble in cold water and quite easily soluble in hot water. In cold alcohol of 60 per cent or over it is practically insoluble. Inulin gives a negative reaction with iodine solution. The "yellow" color reaction with iodine mentioned in many books is doubtless merely the normal color of the iodine solution. It is very difficult to prepare inulin which does not reduce Fehling's solution slightly. This reducing power may be due to an impurity. Practically all commercial preparations of inulin possess considerable reducing power.

Inulin is levo-rotatory and upon hydrolysis by acids or by the enzyme *inulase* it yields the monosaccharide fructose which readily reduces Fehling's solution. The ordinary amylolytic enzymes occurring in the animal body do not digest inulin. A small part of the ingested inulin may be hydrolyzed by the acid gastric juice, but Lewis¹ has recently shown that "the value of inulin as a significant source of energy in human dietaries must be questioned."

EXPERIMENTS ON INULIN

1. Solubility.—Try the solubility of inulin powder in hot and cold water and alcohol. If uncertain regarding the solubility in any reagent, filter and neutralize the filtrate if it is alkaline in reaction. Add a drop of concentrated hydrochloric acid to the filtrate and boil it for one minute. Render the solution neutral or slightly alkaline with solid potassium hydroxide and try Fehling's test. What is the significance of a positive Fehling's test in this connection?

2. Iodine Test.—(a) Place 2-3 c.c. of the inulin solution in a test-tube and add a drop of dilute iodine solution. What do you observe?

(b) Place a small amount of inulin powder in one of the depressions of a test-tablet and add a drop of dilute iodine solution. Is the effect any different from that observed above?

3. Molisch's Reaction.—Repeat this test according to directions given under Glucose, 2, page 21.

4. Fehling's Test.—Make this test on the inulin solution according to the instructions given under Glucose, page 25. Is there any reduction?²

5. Hydrolysis of Inulin.—Place 5 c.c. of inulin solution in a test-tube, add a drop of concentrated hydrochloric acid and boil it for one minute. Now cool the solution, neutralize it with concentrated KOH and test the reducing action of 1 c.c. of the solution upon 1 c.c. of diluted (1 : 4) Fehling's solution. Also

¹ Lewis: *Journal American Medical Ass'n*, 58, 1176, 1912

² See the discussion of the properties of inulin, above.

try the Resorcinol-Hydrochloric Acid reaction as given on p. 35. Explain the result.¹

GLYCOGEN, $(C_6H_{10}O_5)_x$

(For discussion and experiments see Muscular Tissue, Chapter XX.)

LICHENIN, $(C_6H_{10}O_5)_x$

Lichenin may be obtained from *Cetraria islandica* (Iceland moss). It forms a difficultly soluble jelly in cold water and an opalescent solution in hot water. It is optically inactive and gives no color with iodine. Upon hydrolysis with dilute mineral acids lichenin yields dextrans and glucose. It is said to be most nearly related chemically to starch. Saliva, pancreatic juice, malt diastase, and gastric juice have no noticeable action on lichenin.

DEXTRIN, $(C_6H_{10}O_5)_x$

The dextrans are the bodies formed midway in the stages of the hydrolysis of starch by weak acids or an enzyme. They are amorphous bodies which are easily soluble in water, acids, and alkalis, but are insoluble in alcohol or ether. Dextrans are dextro-rotatory and are not fermentable by yeast.

The dextrans may be hydrolyzed by dilute acids to form *glucose* and by amylases to form *maltose*. With iodine one form of dextrin (erythro-dextrin) gives a red color. Their power to reduce Fehling's solution is questioned. The lower members of the dextrin series probably reduce.

EXPERIMENTS ON DEXTRIN

1. Solubility.—Test the solubility of pulverized dextrin in hot and cold water. Dextrin forms a clear solution in hot water, distinguishing it from glycogen which gives an opalescent solution.

2. Iodine Test.—Place a drop of dextrin solution in one of the depressions of the test-tablet and add a dilute solution of iodine in potassium iodide. A red color results due to the formation of the red iodide of dextrin. Ordinary dextrin preparations contain some starch and in the presence of starch it is necessary to have an excess of iodine present. If the reaction is not sufficiently pronounced make a stronger solution from pulverized dextrin and repeat the test. The solution should be slightly acid to secure the best results.

Make proper tests to show that the red iodide of dextrin is influenced by

¹ If the inulin solution gave a positive Fehling test in the last experiment it will be necessary to check the hydrolysis experiment as follows: To 5 c.c. of the inulin solution in a test-tube add one drop of concentrated hydrochloric acid, neutralize with concentrated KOH solution and test the reducing action of 1 c.c. of the resulting solution upon 1 c.c. of diluted (1:4) Fehling's solution. This will show the normal reducing power of the inulin solution. In case the inulin was hydrolyzed, the Fehling's test in the hydrolysis experiment should show a more pronounced reduction than that observed in the check experiment.

heat, alkali, and alcohol in a similar manner to the blue iodide of starch (see page 45).

The color in the case of dextrin does not reappear as readily on cooling as in the case of starch.

3. Fehling's Test.—See if the dextrin solution will reduce Fehling's solution.

4. Hydrolysis of Dextrin.—Take 25 c.c. of dextrin solution in a small beaker, add 5 drops of dilute hydrochloric acid, and boil. By means of a small pipette, at the end of each minute, remove a drop of the solution to one of the depressions of the test-tablet and make the iodine test. The power of the solution to produce a color with iodine should rapidly disappear. When a negative reaction is obtained cool the solution and neutralize it with concentrated potassium hydroxide. Try Fehling's test (see page 25). This reaction is now strongly positive, due to the formation of a reducing sugar. Determine the nature of the sugar by means of the phenylhydrazine test (see pages 22 and 23).

5. Precipitation by Alcohol.—To about 50 c.c. of 95 per cent alcohol in a small beaker add about 10 c.c. of a concentrated dextrin solution. Dextrin is thrown out of solution as a gummy white precipitate. Compare the result with that obtained under Glucose, 5, page 23.

6. Influence of Tannic Acid.—Add an excess of tannic acid solution to a small amount of dextrin solution in a test-tube. No precipitate forms. This result differs from the result of the similar experiment upon starch (see Starch, 8, page 45).

7. Diffusibility of Dextrin.—(See Starch, 9, page 45.)

CELLULOSE, $(C_6H_{10}O_5)_x$

This complex polysaccharide forms a large portion of the cell wall of plants. It is extremely insoluble and its molecule is much more complex than the starch molecule. The best quality of filter paper and the ordinary absorbent cotton are good types of cellulose.

At one time there was but a single known solvent for cellulose. Further investigation has, however, revealed a long list of cellulose solvents. (See Experiment 7.)

Cellulose is not hydrolyzed by boiling with dilute mineral acids. It may be hydrolyzed, however, by treating with concentrated sulphuric acid then subsequently diluting the solution with water and boiling. The product of this hydrolysis is glucose.

There is some difference of opinion as to the exact extent to which cellulose is utilized in the animal organism. It is no doubt, more efficiently utilized by herbivora than by carnivora or by man. It is claimed that about 25 per cent may be utilized by herbivora, less than 5 per cent by dogs whereas the quantity utilized by man is "too small for it to play a rôle of importance in the diet of a normal individual."¹ In neither man nor the lower animals has there been demonstrated any formation

¹Swartz: Transactions of the Connecticut Academy of Arts and Sciences, 16, 247, 1911.

of sugar or glycogen from cellulose.¹ It is probable that the cellulose which disappears from the intestine is transformed for the most part into fatty acids.²

EXPERIMENTS ON CELLULOSE

1. **Solubility.**—Test the solubility of cellulose in water, dilute and concentrated acid and alkali.

2. **Iodine Test.**—Add a drop of dilute iodine solution to a few shreds of cotton on a test-tablet. Cellulose differs from starch and dextrin in giving no color with iodine.

3. **Formation of Amyloid.**³—Add 10 c.c. of dilute and 5 c.c. of concentrated H_2SO_4 to some absorbent cotton in a test-tube. When entirely dissolved (without heating) pour one-half of the solution into another test-tube, cool it and dilute with water. Amyloid forms as a gummy precipitate and gives a brown or blue coloration with iodine.

After allowing the second portion of the acid solution of cotton to stand about 10 minutes, dilute it with water in a small beaker and boil for 15–30 minutes. Now cool, neutralize with solid KOH and test with Fehling's solution. Glucose has been formed from the cellulose by the action of the acid.

4. **Ammoniacal Cupric Hydroxide Solubility Test (Schweitzer).**—Place a little absorbent cotton in a test-tube, add Schweitzer's reagent,⁴ and stir the cellulose with a glass rod. When completely dissolved acidify the solution with acetic acid. An amorphous precipitate of cellulose is produced.

5. **Hydrochloric Acid—Zinc Chloride Solubility Test (Cross and Bevan).**⁵—Place a little absorbent cotton in a test-tube, add Cross and Bevan's reagent,⁶ and stir the cellulose with a glass rod. When solution is complete reprecipitate the cellulose with 95 per cent alcohol.

6. **Iodine-Zinc Chloride Reaction.**—Place a little absorbent cotton or quantitative filter paper in a test-tube and treat it with the iodine-zinc chloride reagent.⁷ A blue color forms on standing. Amyloid has been formed from the cellulose through the action of the $ZnCl_2$ and the iodine solution has stained the amyloid blue.

7. **Other Cellulose Solvents.**—It has been demonstrated by Deming⁸ that there are many excellent solvents for cellulose (filter paper). For example, the concentrated aqueous solutions of certain salts such as *antimony trichloride*,

¹ Lusk: *American Journal of Physiology*, 27, 467, 1911; also Hoffmann, Inaugural dissertation, Halle-Wittenberg, 1910.

² Tappeiner: *Zeitschrift für Biologie*, 24, 105, 1888.

³ This body derives its name from *amylum* (starch) and is not to be confounded with amyloid, the glycoprotein.

⁴ Schweitzer's reagent is made by adding potassium hydroxide to a 5 per cent solution of copper sulphate, which contains 5 per cent of ammonium chloride, until precipitation is complete. A precipitate of cupric hydroxide forms and this is filtered off, washed, and 3 grams of the moist cupric hydroxide brought into solution in a liter of 20 per cent ammonium hydroxide.

⁵ Cross and Bevan: *Chemical News*, 63, p. 66.

⁶ Cross and Bevan's reagent may be prepared by combining two parts of concentrated hydrochloric acid and one part of zinc chloride, by weight.

⁷ The iodine-zinc chloride reagent as suggested by Nowopokrowsky (*Beihefte Botan. Centr.*, 28, 90, 1912) may be made by dissolving 20 grams $ZnCl_2$ in 8.5 c.c. water and when cool introducing the iodine solution (3 grams KI + 1.5 gram I in 60 c.c. water) drop by drop until iodine begins to precipitate.

⁸ Deming: *Journal American Chemical Society*, 33, 1515, 1911.

stannous chloride and *zinc bromide*. In hydrochloric acid solution the solvent action of the above salts is increased. The following salts are also good solvents in hydrochloric acid solution: *mercuric chloride*, *bismuth chloride*, *antimony pentachloride*, *tin tetrachloride* and *titanium tetrachloride*. In the case of the last-mentioned salt the swollen, transparent character of the cellulose fibers preliminary to solution can be seen very nicely.

Try selected solvents suggested by the instructor.

HEMICELLULOSES

The hemicelluloses differ from cellulose in that they may be hydrolyzed upon boiling with dilute mineral acids. They differ from other polysaccharides in not being readily digested by amylases. Hemicellulose may yield pentosans, or hexosans upon hydrolysis.

Pentosans.—Pentosans yield pentoses upon hydrolysis. So far as is known they do not occur in the animal kingdom. They have, however, a very wide distribution in the vegetable kingdom, being present in leaves, roots, seeds, and stems of all forms of plants, many times in intimate association or even chemical combination with galactans. In herbivora, pentosans are 40–80 per cent utilized.¹ The few tests on record as to the pentosan utilization by man² indicate that 80–95 per cent disappear from the intestine. According to Cramer,³ bacteria are efficient hemicellulose transformers. It has not yet been demonstrated that pentosans form glycogen in man, and for this reason they must be considered as playing an unimportant part in human nutrition. Gum arabic an important pentosan may be hydrolyzed by concentrated hydrochloric acid if boiled for a short time. The pentose arabinose results from such hydrolysis.

Galactans.—In common with the pentosans the galactans have a very wide distribution in the vegetable kingdom. The pure galactans yield galactose upon hydrolysis. One of the most important members of the galactan group is *agar-agar*, a product prepared from certain types of Asiatic sea-weed. This galactan is about 50 per cent utilizable by herbivora⁴ and 8–27 per cent utilizable by man.⁵ Agar ingestion has been shown to be a very efficient therapeutic aid in cases of chronic constipation.⁶ This is particularly true when the constipation is due to the formation of dry, hard, fecal masses (*scybala*), a type of fecal formation which frequently follows the ingestion of a diet which is

¹ Swartz: Transactions of the Connecticut Academy of Arts and Sciences, 16, 247, 1911.

² König and Reinhardt: *Zeit. f. Untersuchung der Nahrungs u. Genussmittel*, 5, 110, 1902.

³ Cramer: Inaug. Diss., Hille, 1910.

⁴ Lohrlich: *Zeit. f. exper. Path. u. Pharm.*, 5, 478, 1908.

⁵ Saiki: *Jour. Biol. Chem.*, 2, 251, 1906.

⁶ Mendel: *Zentralblatt f. d. gesammte Phys. u. Path. des Stoffw.*, No. 17, 1, 1908.

Schmidt: *Münch. med. Woch.*, 52, 1970, 1905.

very thoroughly digested and absorbed. The agar, because of its relative indigestibility and its property of absorbing water yields a bulky fecal mass which is sufficiently soft to permit of easy evacuation. Agar has been used with good results in the treatment of constipation in children.¹ Agar is not limited to its use in connection with constipation, but may serve in other capacities as an aid to intestinal therapeutics.²

EXPERIMENTS ON A PENTOSAN

1. Solubility.—Test the solubility of gum arabic in hot and cold water and alcohol.

2. Iodine Test.—Add a drop of dilute iodine solution to a little gum arabic on a test-tablet. It resembles cellulose in giving no color with iodine.

3. Hydrolysis of Gum Arabic.—Introduce a little gum arabic into a test-tube, add 5–10 c.c. of strong hydrochloric acid (conc. HCl and water 1 : 1) and heat to boiling for 5–10 minutes. Cool, neutralize with potassium hydroxide and test by the Fehling or some other reduction test. A positive reaction should be obtained indicating that the gum arabic has been hydrolyzed by the acid with the production of a reducing substance. What is this reducing substance? How would you identify it?

EXPERIMENTS ON A GALACTAN

1. Solubility.—Test the solubility of agar-agar in hot and cold water. Observe its marked property of imbibing water (see above).

2. Iodine Test.—Add a drop of dilute iodine solution to a little agar-agar on a test-tablet. It resembles cellulose in giving no color with iodine.

3. Hydrolysis of Agar-agar.—Introduce a few pieces of agar-agar into a test-tube, add 5–10 c.c. of strong hydrochloric acid (conc. HCl and water 1 : 1) and heat to boiling for 5–10 minutes. Cool, neutralize with potassium hydroxide and test by the Fehling or some other reduction test. A positive reaction should be obtained indicating that the agar-agar has been hydrolyzed by the acid with the production of a reducing substance. What is this reducing substance? How would you identify it?

REVIEW OF CARBOHYDRATES

In order to facilitate the student's review of the carbohydrates, the preparation of a chart similar to the appended model is recommended. The signs + and – may be conveniently used to indicate positive and negative reaction. Only those carbohydrates which are of greatest importance from the standpoint of physiological chemistry have been included in the chart.

¹ Morse: *Journal American Medical Ass'n.*, 55, 934, 1910.

² Einhorn: *Berl. klin. Woch.*, 49, 113, 1912.

MODEL CHART FOR REVIEW PURPOSES

Carbo- hydrate	Solubility	α -Naphthol Reaction (Molisch)	Moore's Test	Fehling's Test	Nylander-Almén Test	Barfoed's Test	Iodine Test	Resorcinol-Hydrochloric Acid Reaction (Selivanoff)	Orcinol-Hydrochloric Acid Reaction (Bial)	Mucic Acid Test	Precipitation by Alcohol	Osazone	Rotation	Diffusibility	Fermentation	Products of Hydrolysis	Remarks
Glucose.																	
Fructose.																	
Pentose.																	
Maltose.																	
Lactose.																	
Sucrose.																	
Starch.																	
Inulin.																	
Glycogen.																	
Dextrin.																	
Cellulose.																	
Gum Arabic.																	
Agar-agar.																	

"UNKNOWN" SOLUTIONS OF CARBOHYDRATES

At this point the student will be given several "unknown" solutions, each solution containing one or more of the carbohydrates studied. He will be required to detect, by means of the tests on the preceding pages, each carbohydrate constituent of the several "unknown" solutions and hand in, to the instructor, a written report of his findings, on slips furnished by the laboratory.

The scheme given on page 53 may be of use in this connection.

SCHEME FOR THE DETECTION OF CARBOHYDRATES

If the solution is alkaline, neutralize or make faintly acid with HCl. Test a few drops on a test-tablet or in a test-tube with iodine solution.

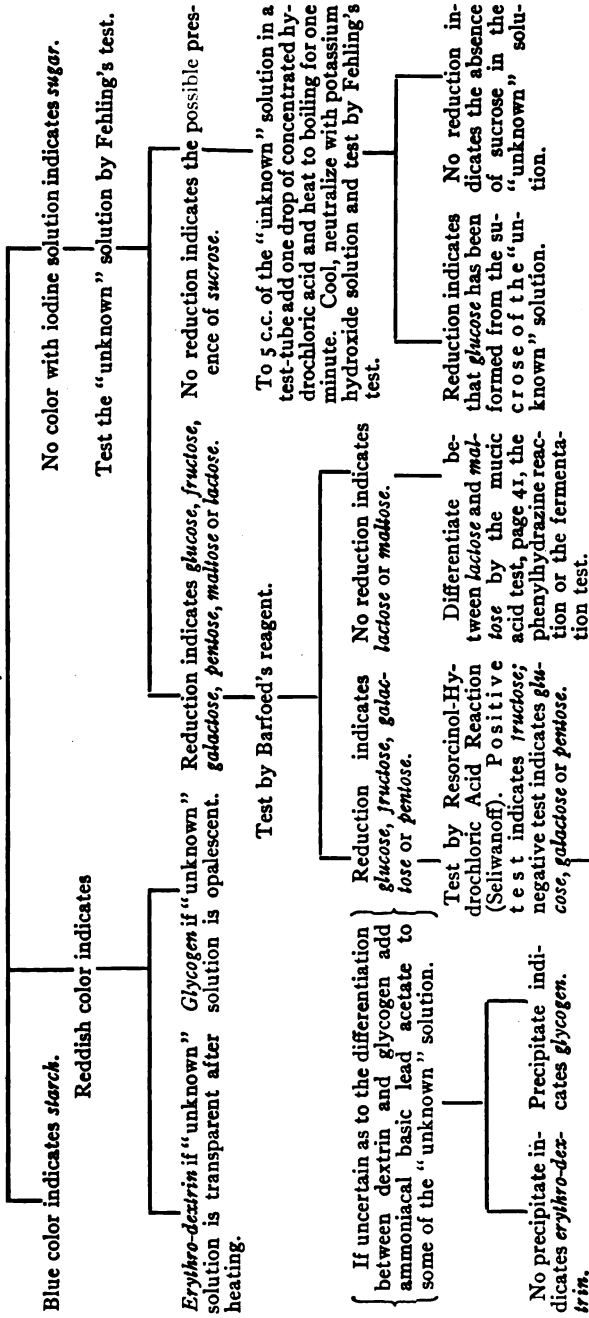

Try mucic acid test, page 41.

Positive reaction indicates galactose. If mucic acid test is negative differentiate between glucose and pentose by the Orcinol-Hydrochloric Acid Reaction (Bial).

Positive reaction indicates galactose. If mucic acid test is negative differentiate between glucose and pentose by the Orcinol-Hydrochloric Acid Reaction (Bial).

Positive reaction indicates galactose. If mucic acid test is negative differentiate between glucose and pentose by the Orcinol-Hydrochloric Acid Reaction (Bial).

Positive reaction indicates galactose. If mucic acid test is negative differentiate between glucose and pentose by the Orcinol-Hydrochloric Acid Reaction (Bial).

Positive reaction indicates galactose. If mucic acid test is negative differentiate between glucose and pentose by the Orcinol-Hydrochloric Acid Reaction (Bial).

CHAPTER III

SALIVARY DIGESTION

THE saliva is secreted by three pairs of glands, the submaxillary, sublingual, and parotid, reinforced by numerous small glands called buccal glands. The saliva secreted by each pair of glands possesses certain definite characteristics peculiar to itself. For instance, in man the parotid glands ordinarily secrete a thin, watery fluid, the submaxillary glands secrete a somewhat thicker fluid containing mucin, while the product of the sublingual glands has a more mucilaginous character. The saliva as collected from the mouth is the combined product of all the glands mentioned. The fact that there are pronounced variations in the composition of different fractions of saliva secreted by the same normal individual on a uniform diet has been emphasized by Lothrop and Gies.¹

The saliva may be induced to flow by many forms of stimuli, such as *chemical, mechanical, electrical, thermal, and psychical*, the nature and amount of the secretion depending, to a limited degree, upon the particular class of stimuli employed as well as upon the character of the individual stimulus. For example, in experiments upon dogs it has been found that the mechanical stimulus afforded by dropping several pebbles into the animal's mouth caused the flow of but one or two drops of saliva, whereas the mechanical stimulus afforded by sand thrown into the mouth induced a copious flow of thin watery fluid. Again, when ice-water or snow was placed in the animal's mouth no saliva was seen, while an acid or anything possessing a bitter taste, which the dog wished to reject, caused a free flow of the thin saliva. On the other hand, when articles of food were placed in the dog's mouth the animal secreted a thicker saliva having a higher mucin content—a fluid which would lubricate the food and assist in the passage of the bolus through the esophagus. It was further found that by simply drawing the attention of the animal to any of the substances named above, results were obtained similar to those secured when the substances were actually placed in the animal's mouth. For example, when a pretense was made of throwing sand into the dog's mouth, a watery saliva was secreted, whereas food under the same conditions excited a thicker and more slimy secretion. The exhibition of dry food, in which the dog had no par-

¹Lothrop and Gies: *Journal of the Allied (Dental) Societies*, 6, 65, 1911.

ticular interest (dry bread), caused the secretion of a large amount of watery saliva, while the presentation of moist food, which was eagerly desired by the animal, called forth a much smaller secretion, slimy in character. These experiments show it to be rather difficult to differentiate between the influence of physiological and psychical stimuli.

The amount of saliva secreted by an adult in 24 hours has been variously placed, as the result of experiment and observation, between 1000 and 1500 c.c., the exact amount depending, among other conditions, upon the character of the food.

The saliva of adults ordinarily has a weak, alkaline reaction to litmus, but becomes acid, in some instances, 2-3 hours after a meal or during fasting. The saliva of the newborn is generally neutral to litmus, whereas that of infants, especially those breast-fed, is generally acid.¹ The alkalinity of saliva is due principally to di-sodium hydrogen phosphate (Na_2HPO_4) and its average alkalinity may be said to be equivalent to 0.08-0.1 per cent sodium carbonate. The saliva is the most dilute of all the digestive secretions, having an average specific gravity of 1.005 and containing only 0.5 per cent of solid matter. Among the solids are found albumin, globulin, mucin, urea, the enzymes salivary amylase (ptyalin), maltase, and peptide-splitting enzymes, phosphates, and other inorganic constituents. Potassium thiocyanate, KSCN, is also generally present in the saliva. It has been claimed that this substance is present in greatest amount in the saliva of habitual smokers. The significance of thiocyanate in the saliva is not known; it probably comes from the ingested thiocyanates and from the breaking down of protein material. The attempts to show some relationship between tooth decay and the thiocyanate content of the saliva secreted into the mouth cavity have met with failure. The most recent experiments² indicate a virtual absence of such relationship.

The so-called tartar formation on the teeth is composed almost entirely of calcium phosphate with some calcium carbonate, mucin, epithelial cells, and organic débris derived from the food. The calcium salts are held in solution as acid salts, and are probably precipitated by the ammonia of the breath. The various organic substances just mentioned are carried down in the precipitation of the calcium salts.

The suggestion has been made that mucin is the salivary constituent "which is particularly influential in the development of local conditions favoring the onset of dental decay."³

The principal enzyme of the saliva is known as *salivary amylase* or *ptyalin*. This is an *amylolytic* enzyme (see page 4), so called because it

¹Allaria: *Monatsschr. für Kinderheilkunde*, 10, 179, 1911.

²Lothrop and Gies: *Journal of the Allied (Dental) Societies*, 6, 65, 1911.

³Id.: *Ibid.*, 5, No. 4, 1910.

possesses the property of transforming complex carbohydrates such as starch and dextrin into simpler bodies. The action of salivary amylase is one of hydrolysis and through this action a series of simpler bodies are formed from the complex starch. The first product of the action of the ptyalin of the saliva upon starch paste is *soluble starch* (amidulin) and its formation is indicated by the disappearance of the opalescence of the starch solution. This body resembles true starch in giving a blue color with iodine. Next follows the formation, in succession, of a series of dextrins, called *erythro-dextrin*, *α-achroo-dextrin*, *β-achroo-dextrin*, and *γ-achroo-dextrin*, the *erythro-dextrin* being formed directly from *soluble starch* and later being itself transformed into *α-achroo-dextrin* from which in turn are produced *β-achroo-dextrin*, *γ-achroo-dextrin* and perhaps other dextrins. Accompanying each dextrin a small amount of maltose is formed, the quantity of maltose growing gradually larger as the process of transformation progresses. (*Erythro-dextrin* gives a red color with iodine, the other dextrins give no color.) The next stage is the transformation of the final dextrin into *maltose*, the latter being the principal end-product of the salivary digestion of starch. At this point a small amount of *glucose* is formed from the maltose through the action of the enzyme *maltase*. The above changes may be represented graphically as follows:¹

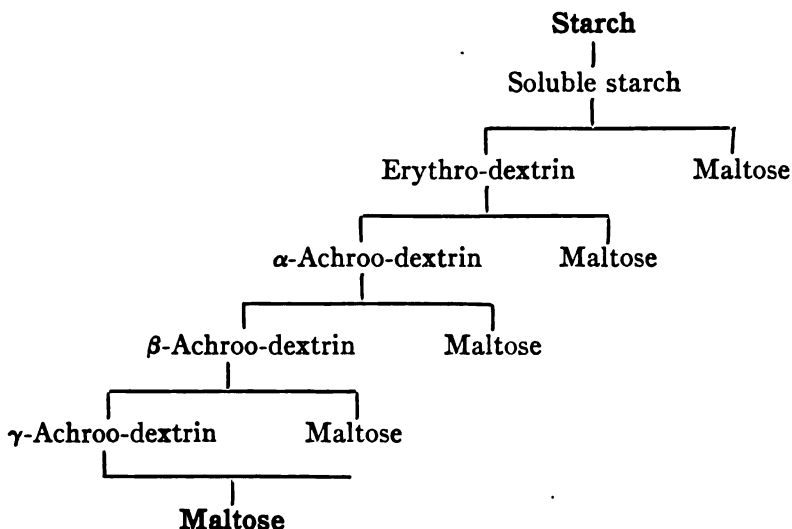

Salivary amylase acts in alkaline, neutral, or combined acid solutions. It will act in the presence of relatively strong *combined HCl* (see page 140), whereas a trace (0.003 per cent to 0.0006 per cent) of ordinary

¹ For a recent discussion of starch digestion see Blake: *Jour. Am. Chem. Soc.*, 38, 1245, 1916; 39, 315, 1917.

free hydrochloric acid will not only prevent the action but will destroy the enzyme. By sufficiently increasing the alkalinity of the saliva to litmus, the action of the salivary amylase is inhibited.

It has been shown by Cannon that salivary digestion may proceed for a considerable period after the food reaches the stomach, owing to the slowness with which the contents are thoroughly mixed with the acid gastric juice and the consequent tardy destruction of the enzyme. Food in the pyloric end of the stomach is soon mixed with the gastric secretion, but food in the cardiac end is not mixed with the acid gastric juice for a considerable period of time and in this region during that time salivary digestion may proceed undisturbed.

It has been found that salivary amylase acts more efficiently when the saliva is diluted from 4 to 7 times.¹

Water softened by lime² inhibits the action of salivary amylase due to the presence of magnesium hydroxide in this water.³ Electrolytes have an important influence upon the action of amylases. The Cl ion has a pronounced facilitating action (see Pancreatic Amylase).

The question of the *adaptation* of the salivary secretion to diet is one which has received considerable attention. It has been claimed, on the basis of experimental evidence,⁴ that the continued feeding of a carbohydrate diet causes the secretion of a saliva which contains a higher concentration of salivary amylase and one which is therefore able to more efficiently digest the carbohydrate fed. On the other hand, strong evidence⁵ has been submitted that the amylase content of the saliva is not increased through the continued feeding of a carbohydrate diet. In general the consensus of opinion is *opposed to the adaptation of digestive secretions to diet*.

Maltase, sometimes called glucase, is the second enzyme of the saliva. The principal function of maltase is the splitting of maltose into glucose. Besides occurring in the saliva it is also present in the pancreatic and intestinal juices. For experimental purposes the enzyme is ordinarily prepared from corn. The principles of the "reversibility" of enzyme action were first demonstrated in connection with maltase by Croft Hill.

It is claimed that the saliva contains dipeptide- and tripeptide-splitting enzymes.⁶ Leucyl-glycyl-alanine was the tripeptide split,

¹ Bergeim and Hawk: *Jour. Am. Chem. Soc.*, 35, 461, 1913.

² Prepared by treating tap water with one-sixth its volume of saturated lime water, allowing to stand 24 hours and filtering.

³ Bergeim and Hawk: *Jour. Am. Chem. Soc.*, 35, 1049, 1913.

⁴ Neilson and Terry: *American Journal of Physiology*, 15, 406, 1905; Neilson and Lewis: *Journal of Biological Chemistry*, 4, 501, 1908.

⁵ Mendel: *American Journal of the Medical Sciences*, Oct., 1909; Mendel and Underhill: *Journal of Biological Chemistry*, 3, 135, 1907; Mendel, Chapman and Blood: *Medical Record*, Aug. 27, 1910.

⁶ Koelker: *Zeitschrift für physiol. Chem.*, 76, 27, 1911.

whereas the cleavage of several dipeptids was brought about. The action is similar to that of intestinal erepsin (see Chapter XI). Later investigations (see page 203), apparently have demonstrated that the peptolytic power of saliva, at least in some cases, is due to bacteria.

Microscopical examination of the saliva reveals salivary corpuscles, bacteria, food débris, epithelial cells, mucus, and fungi. In certain pathological conditions of the mouth, pus cells and blood corpuscles may be found in the saliva.

EXPERIMENTS ON SALIVA

A satisfactory method of obtaining the saliva necessary for the experiments which follow is to chew a small piece of pure paraffin wax, thus stimulating the flow of the secretion, which may be collected in a small beaker. Filtered saliva is to be used in every experiment except for the microscopical examination.

1. **Microscopical Examination.**—Examine a drop of unfiltered saliva microscopically, after staining with methylene blue, and compare with Fig. 20 below.

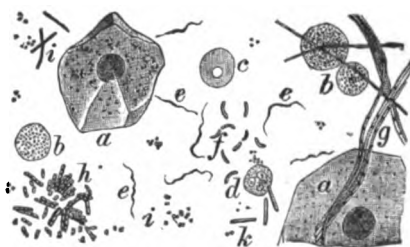

FIG. 20.—MICROSCOPICAL CONSTITUENTS OF SALIVA.

a, Epithelial cells; *b*, salivary corpuscles; *c*, fat drops; *d*, leucocytes; *e*, *f* and *g*, bacteria; *h*, *i*, and *k*, fission-fungi.

2. **Reaction.**—Test the reaction to litmus, phenolphthalein and Congo red.

3. **Specific Gravity.**—Partially fill a urinometer cylinder with saliva, introduce the urinometer, and observe the reading.

4. **Test for Mucin.**—To a small amount of saliva in a test-tube add 1–2 drops of dilute acetic acid. Mucin is precipitated.

5. **Biuret Test.**—Render a little saliva alkaline with an equal volume of KOH and add a few drops of a very dilute (2–5 drops in a test-tube of water) copper sulphate solution. The formation of a purplish-violet color is due to mucin.

This reaction is given by protein material and simply indicates that mucin is a protein.

6. **Millon's Reaction.**²—Add a few drops of Millon's reagent to a little saliva. A light yellow precipitate formed by the mucin gradually turns red upon being gently heated.

This reaction indicates the presence of protein (mucin).

¹ The significance of this reaction is pointed out on p. 100.

² The significance of this reaction is pointed out on p. 98.

7. **Preparation of Mucin.**—Pour 25 c.c. of saliva into 100 c.c. of 95 per cent alcohol, stirring constantly. Cover the vessel and allow the precipitate to stand at least 12 hours. Pour off the supernatant liquid, collect the precipitate on a filter and wash it, in turn, with alcohol and ether. Finally dry the precipitate, remove it from the paper and make the following tests on the mucin: (a) Test its solubility in the ordinary solvents (see page 21); (b) Millon's reaction; (c) dissolve a small amount in KOH, and try the biuret test on the solution; (d) boil the remainder, with 10–25 c.c. of water to which 5 c.c. of dilute HCl has been added, until the solution becomes brownish. Cool, render alkaline with solid KOH, and test by Fehling's solution. A reduction should take place.

Mucin is what is known as a conjugated protein or glycoprotein (see page 112) and upon boiling with the acid the carbohydrate group in the molecule has been split off from the protein portion and its presence is indicated by the reduction of Fehling's solution.

8. **Inorganic Matter.**—Test for chlorides, phosphates, sulphates, and calcium. For chlorides, acidify with HNO₃ and add AgNO₃. For phosphates, acidify with HNO₃, heat and add molybdate solution.¹ For sulphates, acidify with HCl and add BaCl₂ and warm. For calcium, acidify with acetic acid, CH₃-COOH, and add ammonium oxalate, (NH₄)₂C₂O₄.

9. **Viscosity Test.**—Place filter papers in two funnels, and to each add an equal quantity of starch paste (5 c.c.). Add a few drops of saliva to one lot of paste and an equivalent amount of water to the other. Note the progress of filtration in each case. Why does one solution filter more rapidly than the other?

10. **Test for Nitrites.**—Add 1–2 drops of dilute H₂SO₄ to a little saliva and thoroughly stir. Now add a few drops of a potassium iodide solution and some starch paste. Nitrous acid is formed which liberates iodine, causing the formation of the blue iodide of starch.

11. **Thiocyanate Tests.**—(a) **Ferric Chloride Test.**—To a little saliva in a small porcelain crucible, or dish, add a few drops of dilute ferric chloride and acidify slightly with HCl. Red ferric thiocyanate Fe(SCN)₃ forms. To show that the red coloration is not due to iron phosphate add a drop of HgCl₂, when colorless mercuric thiocyanate forms.

(b) **Solera's Reaction.**—This test depends upon the liberation of iodine through the action of thiocyanate upon iodic acid. Moisten a strip of starch paste-iodic acid test paper² with a little saliva. If thiocyanate be present the test paper will assume a blue color, due to the liberation of iodine and the subsequent formation of the so-called iodide of starch.

12. **Digestion of Starch Paste.**—To 25 c.c. of starch paste in a small beaker, add 5 drops of saliva and stir thoroughly. At intervals of a minute remove a drop of the solution to one of the depressions in a test-tablet and test by the iodine test. If the blue color with iodine still forms after five minutes, add another 5 drops of saliva. The opalescence of the starch solution should soon disappear, indicating the formation of soluble starch which gives a blue color with iodine.

¹ See "Reagents and Solutions," p. 626.

² This test paper is prepared as follows: Saturate a good quality of filter paper with 0.5 per cent starch paste to which has been added sufficient iodic acid to make a 1 per cent solution of iodic acid and allow the paper to dry in the air. Cut it in strips of suitable size and preserve for use.

This body should soon be transformed into erythro-dextrin which gives a red color with iodine, and this in turn should pass into achroo-dextrin which gives no color with iodine. This is called the achromic point. When this point is reached test by Fehling's test to show the production of a reducing body. A positive Fehling's test may be obtained while the solution still reacts red with iodine inasmuch as some maltose is formed from the soluble starch coincidentally with the formation of the erythro-dextrin. How long did it take for a complete transformation of the starch? For a graphic representation of the above changes see page 56.

13. Separation of the Products of Salivary Digestion.—To 25 c.c. of starch paste in a small beaker add 1 c.c. of saliva and stir thoroughly. At intervals of one minute test a drop of the mixture by the iodine test. If the blue color persists after five minutes add another 1 c.c. of saliva. When the mixture reacts red with iodine, indicating that erythro-dextrin has been formed, add 100 c.c. of 95 per cent alcohol. Allow to stand until the white precipitate has settled. Filter, evaporate the filtrate to dryness, dissolve the residue in 5–10 c.c. of water and try Fehling's test (page 25) and the phenylhydrazine reaction (see Glucose, 3, page 22). On the dextrin precipitate try the iodine test (page 45). Also hydrolyze the dextrin as given under Dextrin, 4, page 48.

14. Digestion of Dry Starch.—In a test-tube shake up a small amount of dry starch with a little water. Add a few drops of saliva, mix well, and allow to stand. After 10–20 minutes filter and test the filtrate by Fehling's test. What is the result and why?

Dry starch is very slowly digested by salivary amylase.

15. Digestion of Inulin.—To 5 c.c. of inulin solution in a test-tube add 10 drops of saliva and place the tube in the incubator or water-bath at 40°C. After one-half hour test the solution by Fehling's test.¹ Is any reducing substance present? What do you conclude regarding the salivary digestion of inulin?

16. Influence of Temperature.—In each of four tubes place about 5 c.c. of starch paste. Immerse one tube in cold water from the faucet, keep a second at room temperature, and place a third in the incubator or the water-bath at 40°C. (If the temperature of the bath or incubator is allowed to rise to 70°C. or over the enzyme is destroyed and no digestion takes place.) Now add to the contents of each of these three tubes two drops of saliva and shake well; to the contents of the fourth tube add two drops of boiled saliva. Test frequently by the iodine test, using the test-tablet, and note in which tube the most rapid digestion occurs. Explain the results.

17. Influence of Dilution.²—Take a series of six test-tubes each containing 9 c.c. of water. Add 1 c.c. of saliva to tube 1 and shake thoroughly. Transfer 1 c.c. of the solution from tube 1 to tube 2 and after mixing thoroughly 6 saliva 1 c.c. from tube 2 to tube 3. Continue in this manner until you have transfer solutions of gradually decreasing strength. Now add starch paste in equal amounts to each tube, mix very thoroughly, and place in the incubator or water-

¹ If the inulin solution gives a reduction before being acted upon by the saliva it will be necessary to determine the extent of the original reduction by means of a "check" test (see P. 47).

² The technic of Wohlgemuth's method (see Chapter X) may be employed in this test if so desired.

bath at 40°C. After 10–20 minutes test by both the iodine and Fehling's tests. In how great dilution does your saliva act?

18. Influence of Acids and Alkalis.—(a) Influence of Free Acid.—Prepare a series of six tubes in each of which is placed 4 c.c. of one of the following strengths of free HCl: 0.2 per cent, 0.1 per cent, 0.05 per cent, 0.025 per cent, 0.0125 per cent and 0.006 per cent. Now add 2 c.c. of starch paste to each tube and shake them thoroughly. Complete the solutions by adding 2 c.c. of saliva to each and repeat the shaking. The total acidity of this series would be as follows: 0.1 per cent, 0.05 per cent, 0.025 per cent, 0.0125 per cent, 0.006 per cent and 0.003 per cent. Place these tubes on the water-bath at 40°C. for 10–20 minutes. Divide the contents of each tube into two parts, testing one part by the iodine test and testing the other, after neutralization, by Fehling's test. What do you find?

(b) Influence of Combined Acid (Protein Salt).—Repeat the first three experiments of the above series using combined hydrochloric acid (see page 140) instead of the free acid. How does the action of the combined acid differ from that of the free acid? (For a discussion of combined acid see page 140.)

(c) Influence of Alkali.—Repeat the first four experiments under (a) replacing the HCl by 2 per cent, 1 per cent, 0.5 per cent and 0.25 per cent Na_2CO_3 . Neutralize the alkalinity before trying the iodine test (see Starch, 5, page 45).

(d) Nature of the Action of Acid and Alkali.—Place 2 c.c. of saliva and 2 c.c. of 0.2 per cent HCl in a test-tube and leave for 15 minutes. Neutralize the solution, add 4 c.c. of starch paste and place the tube in the incubator or water-bath at 40°C. In 10 minutes test by the iodine and Fehling's tests and explain the result. Repeat the experiment, replacing the 0.2 per cent HCl by 2 per cent Na_2CO_3 . What do you deduce from these two experiments?

19. Influence of Metallic Salts, etc.—In each of a series of tubes place 4 c.c. of starch paste and 0.5 c.c. of one of the solutions named below. Shake well, add 0.5 c.c. of saliva to each tube, thoroughly mix, and place in the incubator or water-bath at 40°C. for 10–20 minutes. Show the progress of digestion by means of the iodine and Fehling tests. Use the following chemicals: *Metallic salts*, 10 per cent lead acetate, 2 per cent copper sulphate, 5 per cent ferric chloride, 8 per cent mercuric chloride; *Neutral salts*, 10 per cent sodium chloride, 10 per cent magnesium sulphate, 3 per cent barium chloride, 10 per cent Rochelle salt. Also try the influence of 2 per cent carbolic acid, 95 per cent alcohol, and ether and chloroform. What are your conclusions?

Antiseptics do not necessarily inhibit enzyme action.

20. Excretion of Potassium Iodide.—Ingest a small dose of potassium iodide (0.2 gram) contained in a gelatin capsule, quickly rinse out the mouth with water, and then test the saliva at once for iodine. This test should be negative. Make additional tests for iodine at two-minute intervals. The test for iodine is made as follows: Take 1 c.c. of NaNO_2 and 1 c.c. of dilute H_2SO_4 in a test-tube, add a little saliva directly from the mouth, and a small amount of starch paste. The formation of a blue color signifies that the potassium iodide is being excreted through the salivary glands. Note the length of time elapsing between the ingestion of the potassium iodide and the appearance of the first traces of the substance in the saliva. If convenient, the urine may also be tested. The

¹ Instead of this mixture a few drops of HNO_3 possessing a yellowish or brownish color due to the presence of HNO_2 may be employed.

chemical reactions taking place in this experiment are indicated in the following equations :

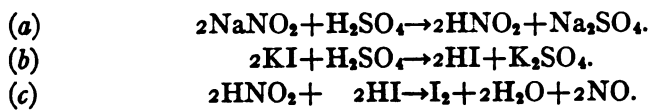

CHAPTER IV

PROTEINS:¹ THEIR DECOMPOSITION AND SYNTHESIS

THE proteins are a class of substances which, in the light of our present knowledge, consist, *in the main*, of combinations of α -amino acids or their derivatives. These protein substances form the chief constituents of many of the fluids of the body, constitute the organic basis of animal tissue, and at the same time occupy a decidedly preeminent position among our organic food-stuffs. They are absolutely necessary to the uses of the animal organism for the continuance of life and they cannot be satisfactorily replaced in the diet of such an organism by any other dietary constituent either organic or inorganic. Such an organism may *exist* without protein food for a period of time, the length of the period varying according to the specific organism and the nature of the substitution offered for the protein portion of the diet. Such a period is, however, distinctly one of *existence* rather than one of normal life and one which is consequently not accompanied by such a full and free exercise of the various functions of the organism as would be possible upon an evenly balanced ration, *i.e.*, one containing the requisite amount of protein food. These protein substances are, furthermore, essential constituents of *all living cells* and therefore without them *vegetable life* as well as animal life is impossible.

The proteins, which constitute such an important group of substances, differ from carbohydrates and fats very decidedly in elementary composition. In addition to containing *carbon*, *hydrogen*, and *oxygen*, which are present in fats and carbohydrates, the proteins invariably contain *nitrogen* in their molecule and generally *sulphur* also. Proteins have also been described which contain *phosphorus*, *iron*, *copper*, *iodine*, *manganese*, and *zinc*. The percentage composition of the more important members of the group of protein substances would fall within the following limits: C=50-55 per cent, H=6-7.3 per cent, O=19-24 per cent, N=15-19 per cent, S=0.3-2.5 per cent, P=0.4-0.8 per cent *when present*. When *iron*, *copper*, *iodine*, *manganese*, or *zinc* are present in the protein molecule they are practically without

¹ The term *proteid* has been very widely used by English-speaking scientists to signify the class of substances we have called *proteins*.

exception present only in *traces* and with the exception of *iodine* are probably not constituents of the protein molecule.¹

Of all the various elements of the protein molecule, *nitrogen* is by far the most important. The human body needs nitrogen for the continuation of life, but it cannot use the nitrogen of the air or that in various other combinations as we find it in nitrates, nitrites, etc. However, in the protein molecule the nitrogen is present in a form which is utilizable by the body. The nitrogen in the protein molecule occurs in at least *four* different forms as follows:

- I. Monamino acid nitrogen.
- II. Diamino acid nitrogen or *basic* nitrogen.
- III. Amide nitrogen.
- IV. A guanidine residue.

The actual structure of the protein molecule is still unknown, and we have as yet no means by which its molecular weight can be even approximately established. The many attempts which have been made to determine this have led to very different results, some of which are given in the following table:

Globin	= 15000—16086
Oxyhemoglobin	= 14800—15000—16655—16730

Of these figures, those given for oxyhemoglobin deserve the most consideration, for these are based on the atomic ratios of the sulphur and iron contained in this substance. The simplest formula that can be calculated from analyses of oxyhemoglobin, namely,



serves to show the great complexity of this substance.

The decomposition² of protein substances may be brought about by oxidation or hydrolysis, but inasmuch as the hydrolytic procedure has been productive of the more satisfactory results, that type of decomposition procedure alone is used at present. This hydrolysis of the protein molecule may be accomplished by acids, alkalis, or superheated steam, and in digestion by the action of the proteolytic enzymes. The character of the decomposition products varies according to the method utilized in tearing the molecule apart. Bearing this in mind, we may say that the decomposition products of proteins include *proteoses*, *peptones*, *peptides*, *carbon dioxide*, *ammonia*, *hydrogen sulphide*, and *amino*

¹Some investigators regard these elements as contaminations, or constituents of some non-protein substance combined with the protein.

²The terms "degradation," "dissociation," and "cleavage," are often used in this connection.

acids. These amino acids¹ constitute a long list of important substances which contain nuclei belonging either to the *aliphatic*, *carbocyclic*, or *heterocyclic* classes of compounds. The list includes *glycocoll (glycine)*, *alanine*, *serine*, *phenylalanine*, *tyrosine*, *cystine*, *tryptophane*, *histidine*, *valine*, *arginine*, *leucine*, *isoleucine*, *lysine*, *aspartic acid*, *glutamic acid*, *proline*, *oxyproline*, and *norleucine*. Of these amino acids, tyrosine and phenylalanine contain carbocyclic nuclei; histidine, proline, and tryptophane contain heterocyclic nuclei; and the remaining members of the list, as given, contain aliphatic nuclei. The amino acids are preëminently the most important class of protein decomposition products. These amino acids are all α -amino acids, and, with the exception of glycocoll, are all optically active. Furthermore, they are amphoteric substances and consequently are able to form salts with both bases and acids. These properties are inherent in the NH_2 and COOH groups of the amino acids.

The decomposition products of protein may be grouped as *primary* and *secondary* decomposition products. By *primary* products are meant those which exist as radicals within the protein molecule and which are liberated, upon cleavage of this molecule, with their carbon chains intact and the position of their nitrogen unaltered. The *secondary* products are those which result from the disintegration of the primary cleavage products. No matter what method is used to decompose a given protein molecule, the primary products are largely the same under all conditions.²

In the process of hydrolysis the protein molecule is gradually broken down and less complicated aggregates than the original molecule are formed, which are known as *proteoses*, *peptones*, and *peptides*, and which still possess true protein characteristics. Further hydrolysis causes the ultimate transformation of these substances, of a protein nature, into the amino acids of known chemical structure. In this decomposition the protein molecule is not broken down in a regular manner into $\frac{1}{2}$, $\frac{1}{4}$, $\frac{1}{8}$ portions and the amino acids formed *in a group* at the termination of the hydrolysis. On the contrary, certain amino acids are formed very early in the process, in fact while the main hydrolytic action has proceeded no further than the proteose stage. Gradually the complexity of the protein portion undergoing decomposition is simplified by the splitting off of the amino acids and finally it is so far decomposed through previous cleavages that it yields only amino acids at the succeeding cleavage. In short, the general plan of the hydrolysis of the protein molecule is similar to the hydrolysis of starch. In the case

¹ For a discussion of amino acids see Underhill's "Physiology of Amino Acids," Yale University Press, Nov., 1915.

² Alkaline hydrolysis yields *urea* and *ornithine* which result from *arginine*, the product of acid hydrolysis.

of starch there is formed a series of dextrans of gradually decreasing complexity and coincidentally with the formation of each dextrin a small amount of sugar is split off and finally nothing but sugar remains. In the case of protein hydrolysis there is a series of proteins of gradually decreasing complexity produced and coincidentally with the formation of each new protein substance amino acids are split off and finally the sole products remaining are amino acids.

Inasmuch as diversity in the method of decomposing a given protein does not result in an equally diversified line of decomposition products, but, on the other hand, yields products which are quite comparable in character, it may be argued that there are probably well-defined lines of cleavage in the individual protein molecule and that no matter what the force brought to bear to tear such a molecule apart, the disintegration, when it comes, will yield in every case certain definite fragments. These fragments may be called the "building stones" of the protein molecule, a term used by some of the German investigators. Take, for example, the decomposition of protein which may be brought about through the action of the enzyme *trypsin* of the pancreatic juice. When this enzyme is allowed to act upon a given protein, the latter is disintegrated in a series of definite cleavages, resulting in the formation of *proteoses*, *peptones*, and *peptides* in regular order, the peptides being the last of the decomposition products which possess protein characteristics. They are all built up from amino acids and are therefore closely related to these acids on the one side and to peptones on the other. We have *di-*, *tri-*, *tetra-*, *penta-*, *deca-*, and *poly-peptides* which are named according to the number of amino acids included in the peptide molecule. Following the peptides there are a diverse assortment of *monamino* and *diamino* acids which constitute the final products of the protein decomposition. These acids are devoid of any protein characteristics and are therefore decidedly different from the original substance from which they were derived. From a protein of huge molecular weight, a typical colloid, perhaps but slightly soluble, and entirely non-diffusible, we have passed by way of proteoses, peptones, and peptides to a class of simpler crystalline substances which are, for the most part, readily soluble and diffusible.

These amino acids after their production in the process of digestion, as just indicated, are synthesized within the cells of the organism to form protein material which goes to build up the tissues of the body. It is thus seen that the amino acids are of prime importance in the animal economy. It was formerly believed that these essential factors in metabolism and nutrition could not be produced within the animal organism from their elements, but were only yielded upon the hydro-

ysis of ingested protein of animal or vegetable origin. Experiments, however, by Abderhalden and by Grafe and Schläpfer and others indicate that the nitrogen of food protein may in part be replaced by ammonium salts. Experiments by Osborne and others also indicate amino acid synthesis by animals.

Important data regarding the decomposition products of the protein molecule are given in the tables which follow.

COMPARISON OF THE DECOMPOSITION PRODUCTS OF PROTAMINES, AND OTHER PROTEINS.

Decomposition Product.	PROTAMINES. ¹ (Per cent of total nitrogen of amino acid.)						OTHER PROTEINS. (Per cent of amino acids in proteins.)						
	Scombrine.	Cycloptertine.	Sturtine.	α -cyprinine.	β -cyprinine.	Clupeine.	Salmine.	Gliadin ² (wheat).	Edestin. ³	Casein. ⁴	Gelatin. ⁵	Globin. ⁶	*Zein. ⁷
Glycocoll.....	0	3.8	0	16.5	0	0	
Alanine.....	+	...	+	+	2.00	3.6	1.5	0.8	4.2	9.79	
Valine.....	+	+	+	1.65	3.34	6.2	7.2	1.0	1.88
Leucine.....	+	6.62	14.5	9.4	2.1	29.0	19.55	
Proline.....	3.8	+	4.3	13.22	4.1	6.7	5.2	2.3	9.04
Phenylalanine.....	2.35	3.1	3.2	0.4	4.2	6.55	
Aspartic acid.....	0.58	4.5	1.4	0.56	4.4	1.71	
Glutamic acid.....	43.66	18.74	11.0	1.88	1.7	26.17	
Serine.....	+	3.25	0.13	0.33	0.5	0.4	0.6	1.02
Tyrosine.....	...	2.2	...	+	1.5	...	1.50 ⁸	2.1	4.5	0	1.3	3.55	
Arginine.....	88.8	67.7	63.5	8.7	28.0	88.0	89.2	2.70 ⁹	14.2	4.84	7.62	5.4	1.55
Lysine.....	8.4	30.3	6.6	0.6 ⁹	1.7	5.95	2.75	4.3	0
Histidine.....	11.8	1.50 ⁹	2.2	2.50	0.40	11.0	0.82
Tryptophane.....	+	+	1.0 ¹⁰	+	1.5	0	+	0
Cystine.....	0.45	1.00	0.065	0	0.3	?
Oxyproline.....	?	0 ¹¹	0.23	6.4	1.0	?
Ammonia.....	5.22	2.3	1.61	3.64

When we examine the formulas of the principal members of the crystalline end-products of protein decomposition we note that they are

¹ Kossel: *Zeit. physiol. Chem.*, 44, 347, 1905.
² Osborne and Guest: *Jour. Biol. Chem.*, 9, 425, 1911.
³ Abderhalden, Kossel and others.
⁴ Abderhalden, Fischer, Mörner and others.
⁵ Fischer, Levene and Aders: *Zeit. physiol. Chem.*, 35, 70, 1902; also Levene and Beatty: *Ibid.*, 49, 252, 1906.
⁶ Abderhalden: *Zeit. physiol. Chem.*, 37, 484, 1903.
⁷ Osborne and Liddle, *Am. Jour. Physiol.*, 26, 295, 1910.
⁸ Osborne and Leavenworth: *Unpublished data furnished by authors.*
⁹ Osborne, Van Slyke, Leavenworth and Vinograd: *Jour. Biol. Chem.*, 22, 259, 1915.
¹⁰ Roughly estimated.
¹¹ Osborne and Liddle: *Am. Jour. Physiol.*, 26, 295, 1910.
 * This unique and important protein has probably been more carefully analyzed than any other.

AMINO ACIDS OBTAINED UPON DECOMPOSITION OF THE PROTEIN MOLECULE

Nomenclature.	Nucleus. ¹	Formula.	Class.	Optical activity.	Discovered.		Maximum yield.			
					By	Date.	Per cent.	Obtained by	Date.	From decomposition of
<i>Arginine</i> : δ guanidin-α-amino-valeric acid.	A	$C_6H_{14}N_4O_3$	Monobasic, diamino.	d	Schulze and Steiger.	1886	89.20 ³	Kossel and Pringle.	1906	Salmine.
<i>Alanine</i> : α-amino-propionic acid.	A	$C_3H_7NO_2$	Monobasic, monamino.	d	Schützenberger and Bourgeois.	1875	24.00	Aberhalden and Spack.	1909	Tussah silk fibroin.
<i>Lysine</i> : α-ε-diaminocaproic acid.	A	$C_6H_{14}N_2O_2$	Monobasic, diamino.	d	Drechsel.....	1889	28.80	Kossel and Dakin.	1904	α-Cyprinine.
<i>Histidine</i> : α-amino-β-imidazolyl-propionic acid.	C	$C_6H_9N_3O_2$	Monobasic, monamino.	l	Kossel.....	1896	12.90	Kossel and Kutscher.	1900	Sturine.
<i>Proline</i> : α-pyrrolidine-carboxylic acid.	H. P.	$C_5H_9NO_2$	Pyrrol derivative.	l	Fischer.....	1901	13.73	Osborne and Clapp.	1907	Hordein.
<i>Tryptophane</i> : β-indolyl-α-amino-propionic acid.	H. I.	$C_{11}H_{12}N_2O_2$	Indol derivative.	l	Hopkins and Cole.	1901	1.5(?)	Fischer.....	1901	Casein.
<i>Oxyproline</i> : oxγ-α-pyrrolidine-carboxylic acid.	H. P.	$C_6H_9NO_3$	Pyrrol derivative.	l	Fischer.....	1902	6.4	Levene and Beatty.	1906	Gelatin.
<i>Isoleucine</i> : α-amino-β-methyl-β-ethyl-propionic acid.	A	$C_8H_{16}NO_2$	Monobasic, monamino.	d	Ehrlich.....	1903	3.0	Levene, Van Slyke and Birchard.	1910	Fibrin-Heteroproteose.
<i>Norleucine</i> (<i>Caprine</i>): α-amino caproic acid.	A	$C_8H_{15}NO_2$	Monobasic, monamino.	dl	Aberhalden and Weil	1913		Aberhalden and Weil	1913	Nerve tissue

¹ Aliphatic; C = Carbocyclic; H. I. = Heterocyclic (Indole ring); H. P. = Heterocyclic (Pyrrol ring). ³ Per cent of total nitrogen.

AMINO ACIDS OBTAINED UPON DECOMPOSITION OF THE PROTEIN MOLECULE.—Continued

Nomenclature.	Nucleus. ¹	Formula.	Class.	Optical activity.	Discovered.		Maximum yield.			
					By	Date.	Per cent.	Obtained by	Date.	From decomposition of
<i>Cystine</i> : di (β -thio- α -amino-propionic acid).	A	$C_6H_{16}O_4N_2S_2$	(Disulphide of) monobasic, monamino.	<i>l</i>	Wollaston.....	1810	13.92	Mörner.....	1901	Human hair.
<i>Leucine</i> : α -amino-isobutyl-acetic acid.	A	$C_6H_{12}NO_2$...	Monobasic, monamino.	<i>l</i>	Proust.....	1818	29.04	Abderhalden	1903	Globin.
<i>Glycocoll</i> : amino acetic acid.	A	$C_2H_5NO_2$...	Monobasic, monamino.	<i>s</i>	Bracconot.....	1820	37.5	Abderhalden and Behrend.	1909	Canton silk.
<i>Aspartic acid</i> : amino-succinic acid.	A	$C_4H_7NO_4$...	Dibasic, monamino.	<i>l</i>	Plisson.....	1827	23.8c	Abderhalden and Strauss	1906	Spongin.
<i>Tyrosine</i> : α -amino- β -para-hydroxyphenyl-propionic acid.	C	$C_9H_{11}NO_3$...	Monobasic, monamino.	<i>l</i>	Liebig.....	1846	10.06	Kutscher....	1903	Zein.
<i>Valine</i> : α -amino-isovaleric acid.	A	$C_6H_{11}NO_2$...	Monobasic, monamino.	<i>d</i>	Group-Besanez	1856	7.20	Osborne and Guest.	1911	Casein.
<i>Serine</i> : α -amino- β -hydroxy-propionic acid.	A	$C_3H_7NO_3$...	Oxymonamino	<i>l</i>	Cramer.....	1865	7.80	Kossel and Dakin.	1904	Salmine.
<i>Glutamic acid</i> : α -aminonormal-glutaric acid.	A	$C_6H_9NO_4$...	Dibasic, monamino.	<i>d</i>	Ritthausen....	1866	43.66	Osborne and Guest.	1911	Gliadin.
<i>Phenylalanine</i> : β -phenyl- α -amino-propionic acid.	C	$C_9H_{11}NO_2$...	Monobasic, monamino.	<i>l</i>	Schulze and Barbieri.	1877	6.96	Langstein...	1903	Zein.

¹ A = Aliphatic; C = Carbocyclic; H. I. = Heterocyclic (Indole ring); H. P. = Heterocyclic (Pyrrol ring).

invariably acids, as has already been mentioned, and contain an NH_2 group in the α position. This relation of the NH_2 group to the acid radical is *constant*, no matter what other groups or radicals are present. We may have straight *chains* as in alanine and glutamic acid, the *benzene ring* as in phenylalanine, or we may have *sulphurized bodies* as in cystine and still the formula is always of the same type, *i.e.*,



It is seen that this characteristic grouping in the amino acid provides each one of these ultimate fragments of the protein molecule with both a strong *acid* and a strong *basic* group. For this reason it is theoretically possible for a large number of these amino acids to combine and the resulting combinations may be very great in number, since there is such a varied assortment of the acids. The protein molecule, which is of such mammoth proportions, is probably constructed on a foundation of this sort. Many valuable data have been collected regarding the synthetic production of protein substances, the leaders in this line of investigation being Fischer and Abderhalden. After having gathered a mass of data regarding the final products of the protein decomposition and demonstrating that amino acids were the ultimate results of the various forms of decomposition, these investigators, and notably Fischer, set about in an effort to form, from these amino acids, by synthetic means, substances which should possess protein characteristics. The simplest of these bodies formed in this way was synthesized from two molecules of glycocoll with the liberation of water, thus:



The body thus formed is a *dipeptide*, called *glycyl-glycine*. In an analogous manner may be produced *leucyl-leucine*, through the synthesis of two molecules of leucine or *leucyl-alanyl-glycine* through the union of one molecule of leucine, one of alanine, and one of glycocoll. By this procedure Fischer and his pupils have been able to make a large number of peptides containing varied numbers of amino acid radicals, the name *polypeptides* being given to the whole group of synthetic substances thus formed. One of the most complex polypeptides yet produced is one containing fifteen glycocoll and three leucine residues.

Notwithstanding the fact that most synthetic polypeptides are produced through a union of amino acids by means of their imide bonds, it must not be imagined that the protein molecule is constructed from

amino acids linked together in straight chains in a manner analogous to the formation of simple peptides, such as glycyl-glycine. The molecular structure of the proteins is much too complex to be explained upon any such simple formation as that. There must be a variety of linkings, since there is a varied assortment of decomposition products of totally different structure.

Many of these synthetic bodies respond to the biuret test, are precipitated by phosphotungstic acid, and behave, in other ways, as to leave no doubt as to their protein characteristics. For instance, a number of amino acids each possessing a *sweet* taste have been synthesized in such a manner as to yield a polypeptide of *bitter* taste, a well-known characteristic of peptones. From the fact that the polypeptides formed in the manner indicated have free acidic and basic radicals we gather the explanation of the amphoteric character of true proteins.

For the benefit of those especially interested in such matters a photograph of the Fischer apparatus (Fig. 24, page 75) used in the fractional distillation, *in vacuo*, of the esters of the decomposition products of the proteins, as well as micro-photographs and drawings of preparations of several of these decomposition products (Figs. 21 to 33, pages 72 to 84) are introduced. For the preparations and the photograph of the apparatus the author is indebted to Dr. T. B. Osborne, of New Haven, Conn., who has made many important observations upon the hydrolysis of proteins. The reproduction of the crystalline form of some of the more recent of the products may be of interest to those viewing the field of physiological chemistry from other than the student's aspect.

An extended discussion of the various decomposition products being out of place in a book of this character, we will simply make a few general statements in connection with the primary decomposition products.

DISCUSSION OF THE PRODUCTS

Ammonia, NH₃.—Ammonia is an important decomposition product of all proteins and probably arises from an amide group combined with a carboxyl group of some of the amino acids. It is possible that the dibasic acids, aspartic and glutamic, furnish most of these carboxyl groups. This is indicated by the more or less close relationship which exists between the amount of ammonia and that of the dibasic acids which the several proteins yield upon decomposition. The elimination of the ammonia from proteins under the action of acids and alkalis is very similar to that from amides like asparagine.

Glycocoll (glycine), CH₂(NH₂)·COOH.—Glycocoll, or *amino acetic*

acid, is the simplest of the amino acids which occurs as a *protein decomposition product*¹ and has the following formula:

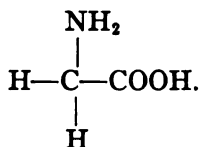

Glycocoll, as the formula shows, contains no asymmetric carbon atom, and is the only amino acid yielded by protein decomposition which is *optically inactive*. Glycocoll and leucine were among the first decomposition products of proteins to be discovered. Upon administering benzoic acid to man or lower animals the output of hippuric acid in the

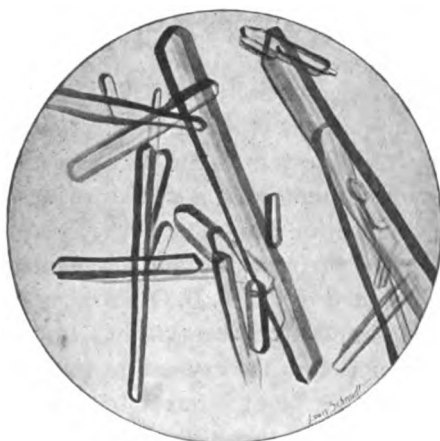
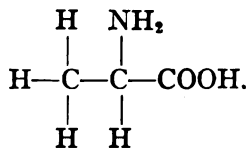

FIG. 21.—GLYCOCOLL ESTER HYDROCHLORIDE.

urine is greatly increased, thus showing a synthesis from benzoic acid and glycocoll in the organism (see page 609, Chapter XXVIII). Glycocoll, ingested in small amount, is excreted in the urine as urea, whereas if administered in excess it appears in part unchanged in the urine. It is usually separated from the mixture of protein decomposition products as the hydrochloride of the ester. The crystalline form of this compound is shown in Fig. 21.

Alanine, $\text{CH}_3\cdot\text{CH}(\text{NH}_2)\cdot\text{COOH}$.—Alanine is *α-amino-propionic acid*, and as such it may be represented structurally as follows:



¹ Amino formic acid (carbamic acid), $\text{NH}_2\cdot\text{COOH}$, is the *simplest* amino acid.

Obtained from protein substances, alanine is dextro-rotatory, is very soluble in water, and possesses a sweet taste. Tyrosine, phenylalanine, cystine, and serine are derivatives of alanine. This amino acid has been obtained from nearly all proteins examined. Its absence from those proteins from which it has not been obtained has not been proven. Most proteins yield relatively small amounts of alanine.

Serine, $\text{CH}_2(\text{OH})\cdot\text{CH}(\text{NH}_2)\cdot\text{COOH}$.—Serine is α -amino- β -hydroxy-propionic acid and possesses the following structural formula:

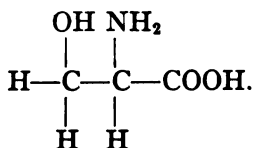

Serine obtained from proteins is levo-rotatory, possesses a sweet taste, and is quite soluble in water. Serine is not obtained in quantity from

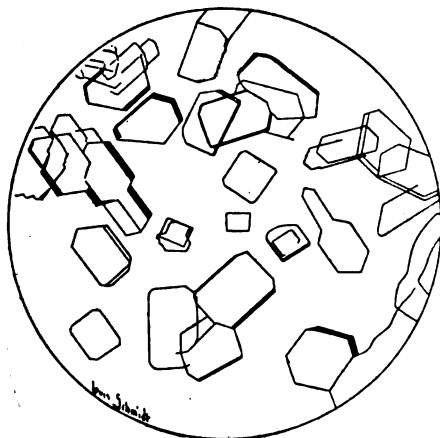
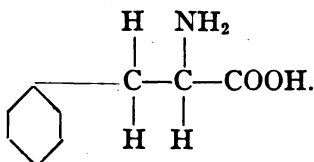

FIG. 22.—SERINE.

most proteins, but is yielded abundantly by *silk glue*. Owing to the difficulty of separating serine it has not been found in a number of proteins in which it probably occurs. Serine crystals are shown in Fig. 22.

Phenylalanine, $\text{C}_6\text{H}_5\cdot\text{CH}_2\cdot\text{CH}(\text{NH}_2)\cdot\text{COOH}$.—This product is β -phenyl- α -amino-propionic acid, and may be represented graphically as follows:



The levo-rotatory form is obtained from proteins. Phenylalanine has been obtained from all the proteins examined except from the protamines and some of the albuminoids. The yield of this body from the decomposition of proteins is frequently greater than the yield of tyrosine. The crystalline form of phenylalanine is shown in Fig. 23.

Tyrosine, $C_6H_4(OH) \cdot CH_2 \cdot CH(NH_2) \cdot COOH$.—Tyrosine, one of the first discovered end-products of protein decomposition, is the amino acid, *α-amino-β-para-hydroxy-phenyl-propionic acid* or *hydroxy phenylalanine*. It has the following formula.

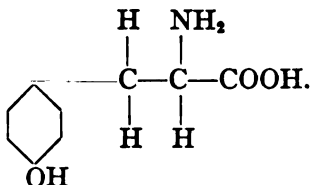

The tyrosine which results from protein decomposition is usually levo-rotatory. Tyrosine is one of the end-products of tryptic digestion and usually separates in conspicuous amount early in the process of diges-

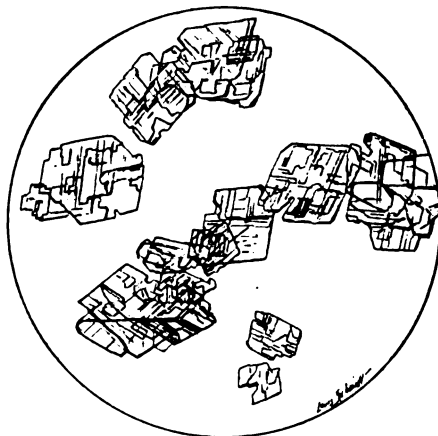

FIG. 23.—PHENYLALANINE.

tion. It does not occur, however, as an end-product of the decomposition of gelatin.

Tyrosine is found in old cheese, and derives its name from this fact. It crystallizes in tufts, sheaves, or balls of fine needles, which decompose at 295°C . and are sparingly soluble in cold (1-2454) water, but much more so in boiling (1-154) water. Tyrosine forms soluble salts with alkalis, ammonia, or mineral acids, and is soluble with difficulty in acetic acid. It responds to Millon's reaction, thus showing the presence

of the hydroxyphenyl group, but gives no other protein test. The aromatic groups present in tyrosine, phenylalanine, and tryptophane cause proteins to yield a positive xanthoproteic reaction. In severe cases of typhoid fever and smallpox, in acute yellow atrophy of the liver, and in

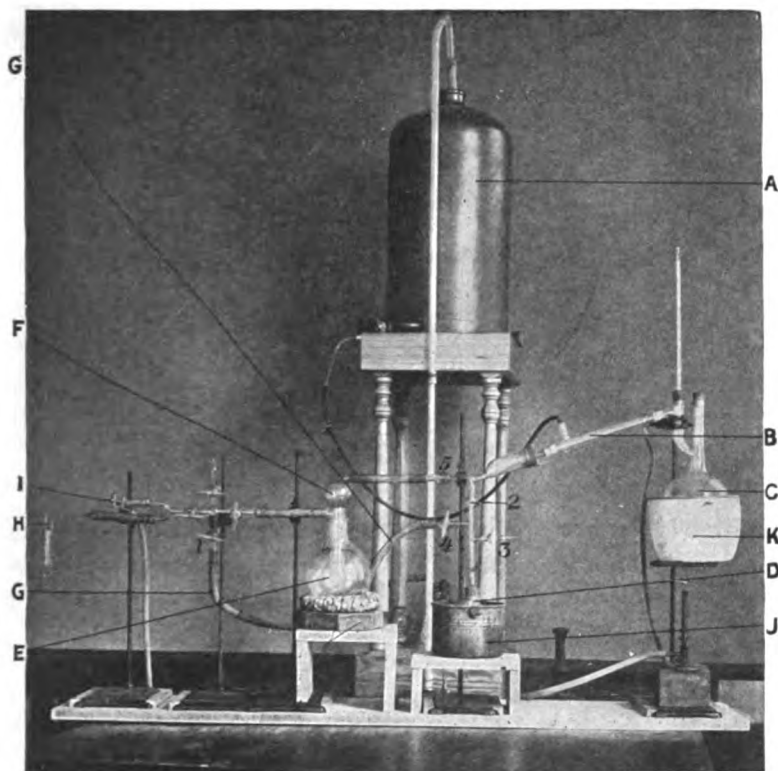

FIG. 24.—FISCHER APPARATUS.

Reproduced from a photograph made by Prof. E. T. Reichert, of the University of Pennsylvania. The negative was furnished by Dr. T. B. Osborne, of New Haven, Conn.

A, Tank into which freezing mixture is pumped and from which it flows through the condenser, B; C, flask from which the esters are distilled, the distillate being collected in D; E, a Dewar flask containing liquid air serving as a cooler for condensing tube F; G and G', tubes leading to the Geryck pump by which the vacuum is maintained; I, tube leading to a McLeod gauge (not shown in figure); J, a bath containing freezing mixture in which the receiver D is immersed; K, a bath of water during the first part of the distillation and of oil during the last part of the process; 1-5, stopcocks which permit the cutting out of different parts of the apparatus as the procedure demands.

acute phosphorus poisoning, tyrosine has been found in the urine. Tyrosine crystals are shown in Fig. 25, page 76.

Cystine, $C_6H_{12}O_4N_2S_2$.—Friedmann has shown cystine to be *di* (β -thio- α -amino-propionic acid) and to possess the following structural formula:

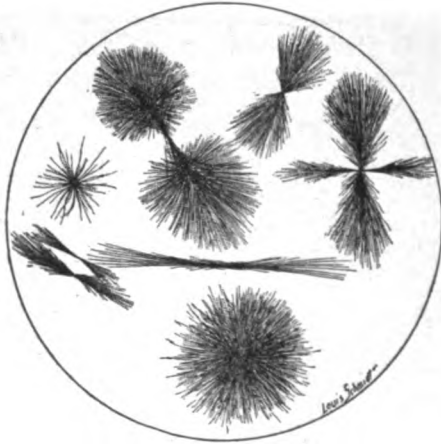
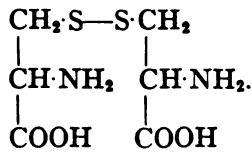

FIG 25.—TYROSINE.

Cystine is the principal sulphur-containing body obtained from the decomposition of protein substances. It is obtained in greatest amount as a decomposition product of keratin-containing tissues as horn, hoof,

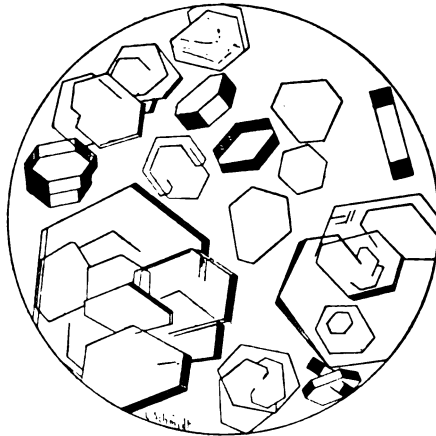

FIG. 26.—CYSTINE.

and hair. Cystine occurs in small amount in normal urine and is greatly increased in quantity under certain pathological conditions. It crystallizes in thin, colorless, hexagonal plates which are shown in Fig.

26. Cystine is very *slightly* soluble in water but its salts, with both bases and acids,¹ are *readily* soluble in water. It is levo-rotatory.

It was formerly claimed that cystine occurred in two forms, *i.e.*, stone-cystine and protein-cystine, and that these two forms are distinct in their properties. This view is incorrect.

For the preparation of cystine from wool or hair see page 87.

For a discussion of cystine sediments in urine see Chapter XXV.

Tryptophane, $C_8H_6N \cdot CH_2 \cdot CH(NH_2) \cdot COOH$.—Recently Ellinger and Flamand have shown that tryptophane possesses the following formula:

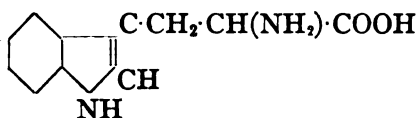

It is therefore β -indolyl- α -amino-propionic acid. Tryptophane is the *mother-substance* of indole, skatole, skatolyl acetic acid and skatolyl carboxylic acid, all of which are formed as *secondary* decomposition products of proteins (see Chapter XIII on Putrefaction Products). Its presence in protein substances may be shown by means of the Hopkins-Cole reaction (see page 99). It may be detected in a tryptic digestion mixture through its property of giving a violet color reaction with bromine water.¹ Tryptophane is yielded by nearly all proteins, but has been shown to be *entirely absent from zein*, the prolamin (alcohol-soluble protein) of maize, and also from gelatin.

According to Osborne and Mendel,² tryptophane is present in maximum amount in *lactalbumin*. Upon being heated to 285°C. tryptophane decomposes with the evolution of gas.

Histidine, $C_3H_3N_2 \cdot CH_2 \cdot CH(NH_2) \cdot COOH$.—Histidine is α -amino- β -imidazolyl-propionic acid or β -imidazolyl-alanine with the following structural formula:

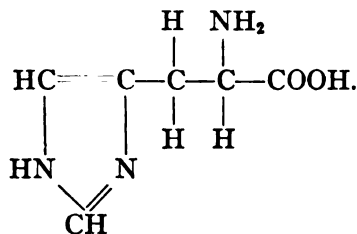

The histidine obtained from proteins is levo-rotatory. It has been obtained from all the proteins thus far examined, the majority of them yielding about 2.5 per cent of the amino acid. However, about 11 per

¹ Kurajeff: *Zeit. physiol. Chem.*, 36, 501, 1898-99.

² Osborne and Mendel: *Jour. Biol. Chem.*, 20, 357, 1915.

cent was obtained by Abderhalden from *globin*, the protein constituent of oxyhemoglobin, and about 13 per cent by Kossel and Kutscher from the protamine *sturine*.

Crystals of histidine dichloride are shown in Fig. 27.

Knoop's Color Reaction for Histidine.—To an aqueous solution of histidine or a histidine salt in a test-tube add a little bromine water. A yellow coloration develops in the cold and upon further addition of bromine water becomes permanent. If the tube be heated,¹ the color will disappear and will shortly be replaced by a faint red coloration which gradually passes into a deep wine red. Usually black, amorphous particles separate out and the solution becomes turbid.

The reaction cannot be obtained in solutions containing free alkali. It is best to use such an amount of bromine as will produce a permanent

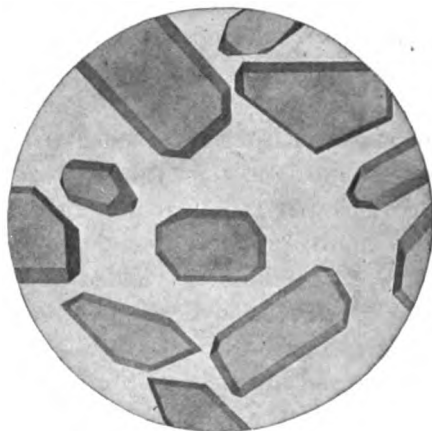
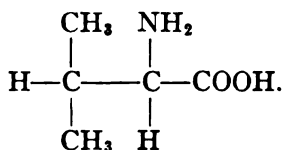

FIG. 27.—HISTIDINE DICHLORIDE.

yellow color in the cold. The use of a less amount of bromine than this produces a weak coloration, whereas an excess of bromine prevents the reaction. The test is not very delicate, but a characteristic reaction may always be obtained in 1 : 1000 solutions. The only histidine derivative which yields a similar coloration is imidazolylethylamine, and the reaction in this case is rather weak as compared with the color obtained with histidine or histidine salts.

Valine, $C_5H_{11}NO_2$.—The amino-valeric acid obtained from proteins is *α-amino-isovaleric acid*, and as such bears the following formula:



¹ The same reaction will take place in the cold more slowly.

It closely resembles leucine in many of its properties, but is more soluble in water. It is a difficult matter to identify valine in the presence of leucine and isoleucine inasmuch as these amino acids crystallize together in such a way that the combination persists even after repeated recrystallizations. Valine is dextro-rotatory.

Arginine, $C_6H_{14}N_4O_2$.—Arginine is δ -guanidine- α -amino-valeric acid and possesses the following structural formula:

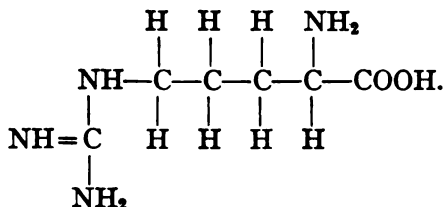

It has been obtained from every protein so far subjected to decomposition. The arginine obtained from proteins is dextro-rotatory, and has pronounced basic properties, reacts strongly alkaline to litmus, and forms stable carbonates. Because of these facts, Kossel considers arginine to be the nucleus of the protein molecule. It is obtained in widely different amounts from different proteins, over 85 per cent of certain protamines having been obtained in the form of this amino acid. It is claimed that in the ordinary metabolic activities of the animal body arginine gives rise to urea. While this claim is probably true, it should, at the same time, be borne in mind that the greater part of the protein nitrogen is eliminated as urea and that, therefore, but a very small part can arise from arginine.

Leucine, $C_6H_{12}NO_2$.—Leucine is an abundant end-product of the decomposition of protein material, and was one of the first of these products to be discovered. It is α -amino-isobutyl-acetic acid, and therefore has the following formula.

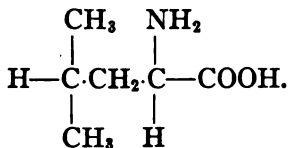

The leucine which results from protein decomposition is *l*-leucine. Leucine is present *normally* in the pancreas, thymus, thyroid, spleen, brain, liver, kidneys, and salivary glands. It has been found *pathologically* in the urine (in acute yellow atrophy of the liver, in acute phosphorus poisoning, and in severe cases of typhoid fever and smallpox), and in the liver, blood and pus.

Pure leucine crystallizes in thin, white, hexagonal plates. Crystals

of pure leucine are reproduced in Fig. 28. It is rather easily soluble in water (46 parts), alkalis, ammonia, and acids. On rapid heating to 295°C ., leucine decomposes with the formation of carbon dioxide, ammonia, and amylamine. Aqueous solutions of leucine obtained from proteins are levo-rotatory, but its acid or alkaline solutions are dextro-rotatory. So-called impure leucine¹ is a slightly refractive substance, which generally crystallizes in balls having a radial structure, or in aggregations of spherical bodies, Fig. 154, Chapter XXV.

Isoleucine, $\text{C}_6\text{H}_{13}\text{NO}_2$.—Isoleucine is α -amino- β -methyl- β -ethyl-propionic acid, and possesses the following structural formula:

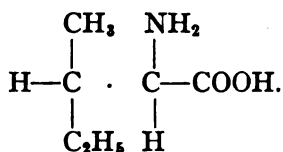

FIG. 28.—LEUCINE.

This amino acid was discovered by Ehrlich in 1903. Its presence has been established among the decomposition products of only a few proteins, although it probably occurs among those of many or most of them. Ehrlich has shown that the *d*-amyl alcohol which is produced by yeast fermentation originates from isoleucine and the isoamylalcohol originates from leucine. Isoleucine is dextro-rotatory.

Lysine, $\text{CH}_2(\text{NH}_2)\cdot\text{CH}_2\cdot\text{CH}_2\cdot\text{CH}(\text{NH}_2)\cdot\text{COOH}$.—The three bodies, lysine, arginine, and histidine, are frequently classed together as the *hexone bases*. Lysine was the first of the bases discovered. It is α - ϵ -diamino-caproic acid and hence possesses the following structure:

¹ These balls of so-called *impure* leucine do contain considerable leucine, but inasmuch as they may contain many other things it is a bad practice to allude to them as *leucine*.

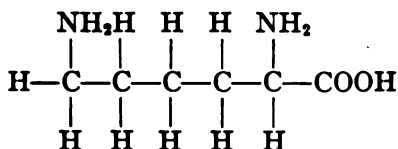

FIG. 29.—LYSINE PICRATE.

It is dextro-rotatory and is found in relatively large amount in casein and gelatin. Lysine is obtained from nearly all proteins, but is absent from the vegetable proteins which are soluble in strong alcohol. It is



FIG. 30.—ASPARTIC ACID.

the mother-substance of cadaverin and has never been obtained in crystalline form. Lysine is usually obtained as the picrate which is sparingly soluble in water and crystallizes readily. These crystals are shown in Fig. 29.

Aspartic Acid, C₄H₇NO₄.—Aspartic acid is *amino-succinic acid* and has the following structural formula:

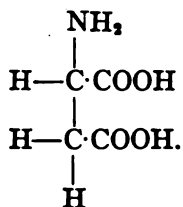

The amide of aspartic acid, *asparagine*, is very widely distributed in the vegetable kingdom. *Asparagine* has the following formula:

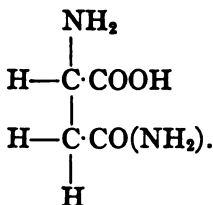

The crystalline form of aspartic acid is exhibited in Fig. 30.

Aspartic acid has been found among the decomposition products of all the proteins examined, *except the protamines*. It has not been obtained, however, in very large proportion from any of them. The aspartic acid obtained from protein is *levo-rotatory*.

Glutamic Acid, C₅H₉NO₄.—This acid is *α-amino-normal-glutaric acid* and as such bears the following graphic formula:

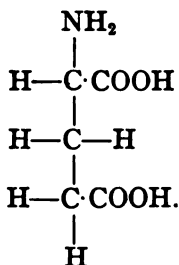

Glutamic acid is yielded by all the proteins thus far examined, except the protamines, and by most of these in larger amount than any other of their decomposition products. It is yielded in especially large proportion by most of the proteins of seeds, 43.66 per cent having been obtained by Osborne and Guest¹ by the hydrolysis of gliadin, the prolamin of wheat. This is the largest amount of any single decomposition product yet obtained from any protein except the protamines.

¹ Osborne and Guest: *Jour. Biol. Chem.*, 9, 425, 1911.

Glutamic acid and aspartic acid are the only dibasic acids which have thus far been obtained as decomposition products of proteins. As there is an apparent relation between the proportion of these acids and that of ammonia which the different proteins yield it is possible that one of the carboxyl groups of these acids is united with NH₂ as an amide, the other carboxyl group being united in polypeptide union (see page 70) with some other amino acid. This might be represented by the following formula:

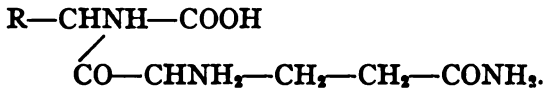

It has been shown by Thierfelder and Sherwin¹ that the amide, glutamine, is a product of normal metabolism and hence this substance rather than glutamic acid is present in the protein molecule.

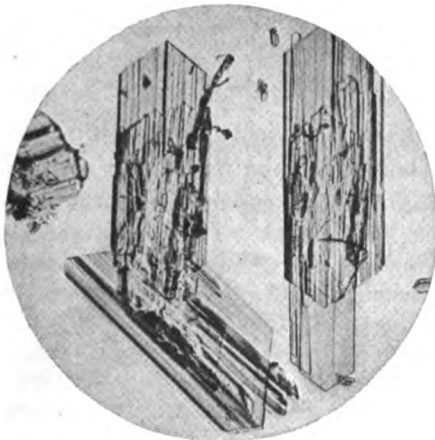
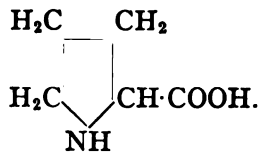

FIG. 31.—GLUTAMIC ACID.

Reproduced from a micro-photograph made by Prof. E. T. Reichert, of the University of Pennsylvania.

The glutamic acid, yielded by proteins upon hydrolysis, is dextro-rotatory. Crystals of glutamic acid are reproduced in Fig. 31.

Proline, C₅H₉NO₂.—Proline is *α-pyrrolidine-carboxylic acid* and possesses the following graphic structure:



Proline was first obtained as a decomposition product of casein. Pro-

¹Thierfelder and Sherwin: *Zeit. Physiol. Chemie.*, 94, 1, 1915.

line obtained from proteins is levo-rotatory and is the only protein decomposition product which is readily soluble in alcohol. It is also one of the few heterocyclic compounds obtained from proteins. Proline has been found among the decomposition products of all proteins except the

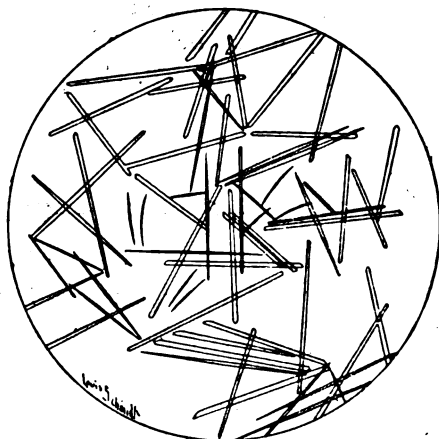

FIG. 32.—LEVO- α -PROLINE.

protamines. The maximum yield reported is 13.73 per cent obtained by Osborne and Clapp from the hydrolysis of hordein. Fischer and Bochner¹ have obtained 7.7 per cent from the hydrolysis of gelatin.



FIG. 33.—COPPER SALT OF PROLINE.

Reproduced from a micro-photograph made by Prof. E. T. Reichert, of the University of Pennsylvania.

The crystalline form of *levo- α -proline* is shown in Fig. 32 and the copper salt of proline is represented by a micro-photograph in Fig. 33. The crystals of the copper salt have a deep blue color, but when they

¹Fischer and Bochner: *Zeit. phys. chem.*, 65, 118, 1910.

lose their water of crystallization they assume a characteristic violet color.

Oxyproline, $C_5H_9NO_3$.—Oxyproline was discovered by Fischer. It has as yet been obtained from only a few proteins, but this may be due to the fact that only a few have been examined for its presence. The position of the hydroxyl group has not yet been established.

Diaminotrihydroxydodecanoic Acid, $C_{12}H_{26}N_2O_5$.—This amino acid was discovered by Fischer and Abderhalden as a product of the hydrolysis of casein. It has thus far been obtained from no other source. It is levo-rotatory and its constitution has not been determined.

EXPERIMENTS

Protein Decomposition.—While the ordinary courses in physiological chemistry preclude any extended study of the decomposition products of proteins, the manipulation of a simple decomposition and the subsequent isolation and study of a few of the products most easily and quickly obtained will not be without interest.¹ To this end the student may use the following decomposition procedure.

Treat the protein (coagulated egg albumin) in a large flask with water containing 3–5 per cent of H_2SO_4 and place it on a water-bath until the protein material has been decomposed and there remains a fine, fluffy, insoluble residue. Filter off this residue and neutralize the filtrate with $Ba(OH)_2$ and $BaCO_3$. Filter off the precipitate of $BaSO_4$, which forms and when certain that the fluid is neutral or faintly acid,² concentrate (first on a wire gauze and later on a water-bath) to a syrup. This syrup contains the end-products of the decomposition of the protein, among which are proteoses, peptones, tyrosine, leucine, etc. Add 95 per cent alcohol slowly to the warm syrup until no more precipitate forms, stirring continuously with a glass rod. This precipitate consists of proteoses and peptones. Gather the sticky precipitate on the rod or the sides of the dish and, after warming the solution gently for a few moments, filter it through a filter paper which has not been previously moistened. After dissolving the precipitate of proteoses and peptones in water³ the solution may be treated according to the method of separation given on page 120.

The leucine and tyrosine, etc., are in solution in the warm alcoholic filtrate. Concentrate this filtrate on the water-bath to a thin syrup, transfer it to a beaker, and allow it to stand over night in a cool place for crystallization. The tyrosine first crystallizes (Fig. 25, page 76), followed later by the formation of characteristic

¹ The procedure here set forth has nothing in common with the procedure by means of which the long line of decomposition products just enumerated are obtained. This latter process is an exceedingly complicated one which is entirely outside the province of any course in physiological chemistry.

² If the solution is alkaline in reaction at this point, the amino acids will be broken down and ammonia will be evolved.

³ At this point the aqueous solution of the proteoses and peptones may be filtered to remove any $BaSO_4$ which may still remain. Tyrosine crystals will also be found here, since it is less soluble than the leucine and may adhere to the proteose-peptone precipitate. Add the crystals of tyrosine to the warm alcohol filtrate.

crystals of impure leucine (see Fig. 154, Chapter XXV). After examining these crystals under the microscope, strain off the crystalline material through fine muslin, heat it gently in a little water to dissolve the leucine (the tyrosine will be practically insoluble) and filter. Concentrate the filtrate and allow it to stand in a cool place over night for the crude leucine to crystallize. Filter off the crystals and use them in the tests for leucine given on page 87. The crystals of tyrosine remaining on the paper from the first filtration may be used in the tests for tyrosine as given below. If desired, the tyrosine and leucine may be purified by recrystallizing in the usual manner. Habermann has suggested a method of separating leucine and tyrosine by means of glacial acetic acid.

EXPERIMENTS ON TYROSINE

Make the following tests with the tyrosine crystals prepared in the above experiments, or upon those obtained during the preparation of *cystine* (see page 87), or upon some pure tyrosine furnished by the instructor.

1. **Microscopical Examination.**—Place a minute crystal of tyrosine on a slide, add a drop of water, cover with a cover-glass, and examine microscopically. Now run more water under the cover-glass and warm in a Bunsen flame until the tyrosine has dissolved. Allow the solution to cool slowly, then examine again microscopically, and compare the crystals with those shown in Fig. 25, page 76.

2. **Solubility.**—Try the solubility of very small amounts of tyrosine in cold and hot water, cold and hot 95 per cent alcohol, dilute NH_4OH , dilute KOH and dilute HCl .

3. **Sublimation.**—Place a little tyrosine in a dry test-tube, heat gently and notice that the material does not sublime. How does this compare with the result of Experiment 3 under Leucine?

4. **Hoffman's Reaction.**—This is the name given to Millon's reaction when employed to detect tyrosine. Add about 3 c.c. of water and a few drops of Millon's reagent to a little tyrosine in a test-tube. Upon dissolving the tyrosine by heat the solution gradually darkens and may assume a dark red color. What group does this test show to be present in tyrosine?

5. **Sulphuric Acid Test (Piria).**—Warm a little tyrosine on a watch glass on a boiling water-bath for 20 minutes with 3–5 drops of conc. H_2SO_4 . Tyrosine-sulphuric acid is formed in the process. Cool the solution and wash it into a small beaker with water. Now add CaCO_3 in substance slowly with stirring, until the reaction of the solution is no longer acid. Filter, concentrate the filtrate, and add it to a few drops (avoid an excess) of very dilute neutral ferric chloride. A purple or violet color, due to the formation of the ferric salt of tyrosine-sulphuric acid, is produced. This is one of the most satisfactory tests for the identification of tyrosine.

6. **Formaldehyde-Sulphuric Acid Test (Mörner).**—Add about 3 c.c. of Mörner's reagent¹ to a little tyrosine in a test-tube, and gently raise the temperature to the boiling-point. A green color results.

¹ Mörner's reagent is prepared by thoroughly mixing 1 volume of formalin, 45 volumes of distilled water, and 55 volumes of concentrated sulphuric acid.

7. Folin and Denis's Test.¹—To 1–2 c.c. of the solution to be tested add an equal volume of a special reagent (containing 10 per cent sodium tungstate, 2 per cent phosphomolybdic acid and 10 per cent phosphoric acid) and 3–10 c.c. of a saturated solution of sodium carbonate. A blue color indicates tyrosine. It is said to detect 1 part in one million.

Abderhalden² claims the reagent also reacts with tryptophane, oxytryptophane and *L*-oxyproline.

EXPERIMENTS ON LEUCINE

Make the following tests upon the leucine crystals already prepared or upon some pure leucine furnished by the instructor.

1, 2 and 3. Repeat these experiments according to the directions given under Tyrosine (pages 86 and 87).

PREPARATION OF CYSTINE³

From 50 to 500 grams of wool or hair is pushed into a (Jena) flask and concentrated hydrochloric acid (200 c.c. to each 100 grams of wool) is added. In order to get a part of the acid quickly to the bottom of the flask a part of the acid may be put in first, then the wool, and finally the remaining acid. A condenser consisting only of a glass tube 2 to 3 ft. long is inserted and the mixture is boiled until the biuret reaction is entirely negative. The wool dissolves in a few minutes and if much cystine is desired more wool and acid can then be introduced. After three to five hours' boiling with moderate quantities of wool the biuret reaction has usually disappeared.

To the hot acid solution of amino acids so obtained is added at once an excess of solid sodium acetate, i.e., until the Congo red reaction for mineral acids is entirely negative. A dark, heavy precipitate containing practically all the cystine is obtained. After a few hours' standing at room temperature the liquid is filtered off and the precipitate is washed with cold water. (From the mother liquor diluted with the wash water is usually obtained on long standing a second precipitate consisting chiefly of tyrosine.)

The crude cystine is then dissolved in boiling 3–5 per cent hydrochloric acid and the solution is decolorized with good boneblack which should have been previously thoroughly digested with hot, dilute hydrochloric acid and then washed with water in order to remove the calcium phosphate. The hot filtrate from the boneblack should be as clear as water. If it is not perfectly colorless the boneblack treatment should be repeated and if a colorless solution is not then obtained the fault lies with the quality of the boneblack. The last filtrate is heated to boiling and the cystine precipitated by a slow addition of concentrated hot sodium acetate solution.

Large amounts of colorless cystine consisting of typical hexagonal plates can thus be prepared without difficulty and with very little labor. Compare the microscopical appearance of these crystals with those shown in Fig. 26, page 76.

¹ Folin and Denis: *Jour. Biol. Chem.*, 12, 245, 1912.

² Abderhalden: *Zeit. Physiol. Chem.*, 85, 91, 1913.

³ Folin: *Jour. Biol. Chem.*, 8, 9, 1910.

THE QUANTITATIVE DETERMINATION OF ALIPHATIC AMINO GROUPS

Method of Van Slyke.—*Principle.*—This method for the determination of aliphatic amino nitrogen is based on the measurement of the nitrogen gas evolved in the reaction,

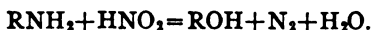

During the process the following reaction also takes place, the nitrous acid solution decomposing spontaneously with the formation of nitric oxide.

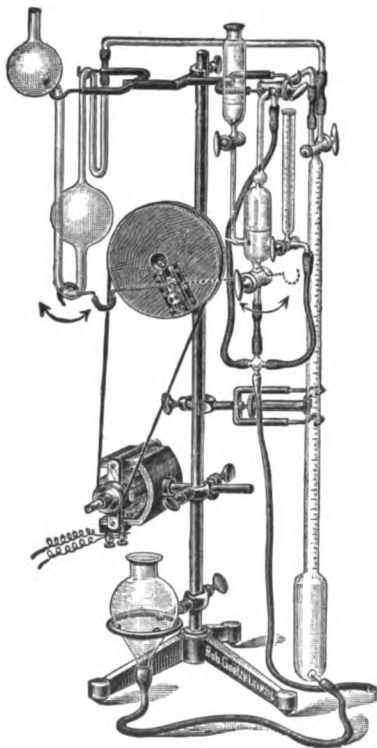

FIG. 34.—VAN SLYKE AMINO NITROGEN APPARATUS.

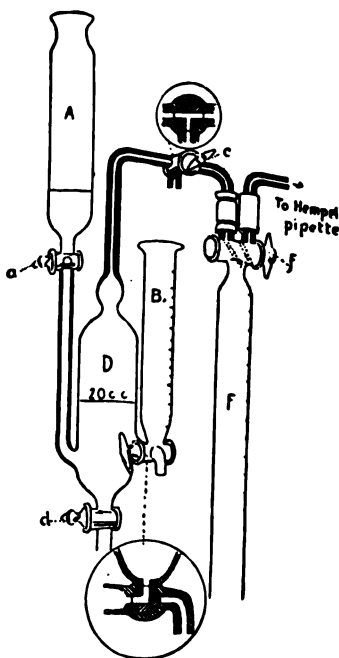

FIG. 35.—SECTION OF VAN SLYKE APPARATUS.

This latter reaction is utilized in displacing all the air of the apparatus with nitric oxide. The amino solution is then introduced, evolution of nitrogen mixed with nitric oxide resulting. The oxide is absorbed with alkaline permanganate solution and the pure nitrogen measured in a special gas burette shown in the figure.

Procedure.—The determination is carried out in three stages:

1. *Displacement of Air by Nitric Oxide.*—Water from *F* (see Figs. 34 and 35), fills the capillary leading to the Hempel pipette and also the other capillary as far as *c*. Into *A* one pours a volume of glacial acetic acid sufficient to fill one-

¹ Van Slyke: *Jour. Biol. Chem.*, 12, 275, 1912; 16, 121 and 125, 1913.

fifth of *D*. For convenience, *A* is etched with a mark to measure this amount. The acid is run into *D*, cock *c* being turned so as to let the air escape from *D*. Through *A* one now pours sodium nitrite solution (30 grams NaNO_2 to 100 c.c. H_2O) until *D* is full of solution and enough excess is present to rise a little above the cock into *A*. It is convenient to mark *A* for measuring off this amount also. The gas exit from *D* is now closed at *c*, and, *a* being open, *D* is shaken for a few seconds. The nitric oxide, which instantly collects, is let out at *c*, and the shaking repeated. The second crop of nitric oxide which washes out the last portions of air, is also let out at *c*. *D* is now connected with the motor and shaken till all but 20 c.c. of the solution have been displaced by nitric oxide and driven back into *A*. A mark on *D* indicates the 20 c.c. point. One then closes *a* and turns *c* and *f* so that *D* and *F* are connected. The above manipulations require between one and two minutes.

2. *Decomposition of the Amino Substance*.—Of the amino solution to be analyzed 10 c.c. or less, as the case may be, are measured off in *B*. Any excess added above the mark can be run off through the outflow tube. The desired amount is then run into *D*, which is already connected with the motor, as shown in Fig. 34. It is shaken when α -amino acids are being analyzed for a period of three to five minutes. With α -amino acids, proteins or partially or completely hydrolyzed proteins, we find that at the most five minutes vigorous shaking completes the reaction. Only in the case of some native proteins which, when deaminized form unwieldy coagula that mechanically interfere with the thorough agitation of the mixture, a longer time may be required. In case a viscous solution is being analyzed and the liquid threatens to foam over into *F*, *B* is rinsed out and a little caprylic alcohol is added through it. For amino substances such as amino purins, requiring a longer time than five minutes to react, one merely mixes the reacting solutions and lets them stand the required length of time, then shakes about two minutes to drive the nitrogen completely out of solution.

When it is known that the solution to be analyzed is likely to foam violently, it is advisable to add caprylic alcohol through *B* before the amino solution. *B* is then rinsed with alcohol and dried with ether or a roll of filter paper before it receives the amino solution.

3. *Absorption of Nitric Oxide and Measurement of Nitrogen*.—The reaction being completed, all the gas in *D* is displaced into *F* by liquid from *A* and the mixture of nitrogen and nitric oxide is driven from *F* into the absorption pipette.¹ The driving rod is then connected with the pipette by lifting the hook from the shoulder of *d* and placing the other hook, on the opposite side of the driving rod, over the horizontal lower tube of the pipette. The latter is then shaken by the motor for a minute, which, with any but almost completely exhausted permanganate solutions, completes the absorption of nitric oxide. The pure nitrogen is then measured in *F*. During the above operations *a* is left open, to permit displacement of liquid from *D* as nitric oxide forms in *D*.

Blank determinations, performed as above except that 10 c.c. of distilled water replaces the solution of amino substance, must be performed on every fresh lot of nitrite used. Nitrite giving a much larger correction than 0.3 to 0.4 c.c. should be rejected.

The room temperature and the barometric pressure must be noted. The

¹ The solution in the absorption pipette is 40 grams KMnO_4 and 25 grams KOH in a liter.

MILLIGRAMS OF AMINO NITROGEN CORRESPONDING TO 1 C.C. OF NITROGEN GAS AT 11°-30°C.; 728-772 MM. PRESSURE

t	728	730	732	734	736	738	740	742	744	746	748	750	t
11°	0.5680	0.5695	0.5510	0.5725	0.5745	0.5760	0.5775	0.5790	0.5805	0.5820	0.5840	0.5855	11°
12°	0.5655	0.5670	0.5685	0.5700	0.5720	0.5735	0.5750	0.5765	0.5780	0.5795	0.5815	0.5830	12°
13°	0.5630	0.5645	0.5660	0.5675	0.5695	0.5710	0.5725	0.5740	0.5755	0.5770	0.5785	0.5805	13°
14°	0.5605	0.5620	0.5635	0.5650	0.5665	0.5680	0.5700	0.5715	0.5730	0.5745	0.5760	0.5775	14°
15°	0.5580	0.5595	0.5610	0.5625	0.5640	0.5655	0.5670	0.5685	0.5705	0.5720	0.5735	0.5750	15°
16°	0.5555	0.5570	0.5585	0.5600	0.5615	0.5630	0.5645	0.5660	0.5675	0.5690	0.5710	0.5725	16°
17°	0.5525	0.5540	0.5555	0.5575	0.5590	0.5605	0.5620	0.5635	0.5650	0.5665	0.5680	0.5695	17°
18°	0.5500	0.5515	0.5530	0.5545	0.5560	0.5580	0.5595	0.5610	0.5625	0.5640	0.5655	0.5670	18°
19°	0.5475	0.5490	0.5505	0.5520	0.5535	0.5550	0.5565	0.5580	0.5595	0.5610	0.5630	0.5645	19°
20°	0.5445	0.5460	0.5475	0.5495	0.5510	0.5525	0.5540	0.5555	0.5570	0.5585	0.5600	0.5615	20°
21°	0.5420	0.5435	0.5450	0.5465	0.5480	0.5495	0.5510	0.5525	0.5540	0.5555	0.5575	0.5590	21°
22°	0.5395	0.5410	0.5425	0.5440	0.5455	0.5470	0.5485	0.5500	0.5515	0.5530	0.5545	0.5560	22°
23°	0.5365	0.5380	0.5395	0.5410	0.5425	0.5440	0.5455	0.5470	0.5485	0.5500	0.5515	0.5530	23°
24°	0.5335	0.5350	0.5365	0.5380	0.5400	0.5415	0.5430	0.5445	0.5460	0.5475	0.5490	0.5505	24°
25°	0.5310	0.5325	0.5340	0.5355	0.5370	0.5385	0.5400	0.5415	0.5430	0.5445	0.5460	0.5475	25°
26°	0.5260	0.5295	0.5310	0.5325	0.5340	0.5355	0.5370	0.5365	0.5400	0.5415	0.5430	0.5445	26°
27°	0.5250	0.5265	0.5280	0.5295	0.5310	0.5325	0.5340	0.5355	0.5370	0.5385	0.5400	0.5415	27°
28°	0.5220	0.5235	0.5250	0.5265	0.5280	0.5295	0.5310	0.5325	0.5340	0.5355	0.5370	0.5385	28°
29°	0.5195	0.5210	0.5220	0.5235	0.5250	0.5265	0.5280	0.5295	0.5310	0.5325	0.5340	0.5355	29°
30°	0.5160	0.5175	0.5190	0.5205	0.5220	0.5235	0.5250	0.5265	0.5280	0.5295	0.5310	0.5325	30°
t	728	730	732	734	736	738	740	742	744	746	748	750	t

t	752	754	756	758	760	762	764	766	768	770	772	t
11°	0.5870	0.5885	0.5900	0.5915	0.5935	0.5950	0.5965	0.5980	0.5995	0.6010	0.6030	11°
12°	0.5845	0.5860	0.5875	0.5890	0.5905	0.5925	0.5940	0.5955	0.5970	0.5985	0.6000	12°
13°	0.5820	0.5835	0.5850	0.5865	0.5880	0.5895	0.5910	0.5930	0.5945	0.5960	0.5975	13°
14°	0.5790	0.5805	0.5825	0.5840	0.5855	0.5870	0.5885	0.5900	0.5915	0.5935	0.5950	14°
15°	0.5765	0.5765	0.5795	0.5810	0.5830	0.5845	0.5860	0.5875	0.5890	0.5905	0.5920	15°
16°	0.5740	0.5755	0.5770	0.5785	0.5800	0.5815	0.5830	0.5850	0.5865	0.5880	0.5895	16°
17°	0.5710	0.5730	0.5745	0.5760	0.5775	0.5790	0.5805	0.5820	0.5825	0.5850	0.5865	17°
18°	0.5685	0.5700	0.5715	0.5730	0.5745	0.5765	0.5780	0.5795	0.5810	0.5825	0.5840	18°
19°	0.5660	0.5675	0.5690	0.5705	0.5720	0.5735	0.5750	0.5765	0.5780	0.5795	0.5810	19°
20°	0.5630	0.5645	0.5660	0.5675	0.5690	0.5705	0.5725	0.5740	0.5755	0.5770	0.5785	20°
21°	0.5605	0.5620	0.5635	0.5650	0.5665	0.5680	0.5695	0.5710	0.5725	0.5740	0.5755	21°
22°	0.5575	0.5590	0.5605	0.5620	0.5635	0.5650	0.5665	0.5680	0.5695	0.5715	0.5730	22°
23°	0.5545	0.5560	0.5575	0.5595	0.5610	0.5625	0.5640	0.5655	0.5670	0.5685	0.5700	23°
24°	0.5520	0.5535	0.5550	0.5565	0.5580	0.5595	0.5610	0.5625	0.5640	0.5655	0.5670	24°
25°	0.5490	0.5505	0.5520	0.5535	0.5550	0.5565	0.5580	0.5595	0.5610	0.5625	0.5640	25°
26°	0.5460	0.5475	0.5490	0.5505	0.5520	0.5535	0.5550	0.5565	0.5580	0.5595	0.5610	26°
27°	0.5430	0.5445	0.5460	0.5475	0.5490	0.5505	0.5520	0.5535	0.5550	0.5565	0.5580	27°
28°	0.5400	0.5415	0.5430	0.5445	0.5460	0.5475	0.5490	0.5505	0.5520	0.5535	0.5550	28°
29°	0.5370	0.5385	0.5400	0.5415	0.5430	0.5445	0.5460	0.5475	0.5490	0.5505	0.5520	29°
30°	0.5340	0.5355	0.5370	0.5385	0.5400	0.5415	0.5430	0.5445	0.5460	0.5475	0.5490	30°
t	752	754	756	758	760	762	764	766	768	770	772	t

¹ *Journal of Biological Chemistry*, 12, 275, 1912. Van Slyke: The Quantitative Determination of Amino Groups.

calculation of the weight of nitrogen gas corresponding to the volume obtained is most readily made with the aid of the tables (see page 90) devised for this purpose.¹

The Van Slyke Micro-apparatus.²—In later work Van Slyke has used to a large extent an apparatus which differs from the one described above only in being considerably smaller. More accurate measurements can be made with this and smaller amounts of amino nitrogen determined. In using this only 10 c.c. of nitrite solution and 2.5 c.c. of acetic acid are required for an analysis. One-fifth the amount of substance may be analyzed with the same degree of accuracy as with the larger apparatus. Practically the only alteration from the mode of operation already detailed above, is in the speeds at which the deaminizing bulb and the Hempel pipette are shaken. During the first stage of the analysis the deaminizing bulb should be shaken by the motor at a very high rate of speed, about as fast as the eye can follow or an unnecessary amount of time is lost in freeing the apparatus from air. This stage is also much accelerated by warming the nitrite solution to 30° before it is used, in case a low room temperature has reduced the temperature of the solutions below 20°. In the third stage when the nitric oxide is being absorbed by the permanganate, the Hempel pipette should be shaken not faster than twice per second. This is to prevent the breaking off of small gas bubbles.

It is especially necessary that in the first stage the removal of air be complete. This is assured by shaking the solution in the deaminizing bulb back each time, in this stage, until the bulb is two-thirds filled with nitric oxide.

For the determination of total and free amino acid nitrogen in the urine by this method see chapter on Quantitative Analysis of Urine.

ESTIMATION OF AMINO-ACID NITROGEN

Method of Harding and MacLean.³—*Principle.*—Amino-acid mixtures when treated with triketohydrindene hydrate give a colored solution which may be compared colorimetrically with a standard.

Procedure.—One c.c. of the solution to be estimated (containing not more than 0.05 mg. of amino-acid α -nitrogen and neutral to phenolphthalein, is mixed with 1 c.c. of a 10 per cent aqueous solution of pure pyridine and 1 c.c. of a freshly prepared 2 per cent solution of triketohydrindene hydrate and heated in a rapidly boiling constant-level water-bath for 20 minutes. At the end of that time the test tube is removed, cooled and diluted to a suitable volume, usually 100 c.c., but if the amino-acid α -nitrogen is very small in amount a correspondingly smaller dilution can be used. The solution is compared with a standard in a Duboscq colorimeter. The standard solution is prepared by dissolving 0.3178 gm. of pure, freshly crystallized alanine in a liter of distilled water. The solution contains 0.05 mg. of N per c.c. Treat 1 c.c. of this standard just as above, except that only 1 c.c. of triketohydrindene is required. The standard solution is stable for three months. Amounts of amino nitrogen from 0.005 to 0.05 mg. may be determined. The

¹ See Van Slyke: *Jour. Biol. Chem.*, 12, 275, 1912 or Gattermann: *Praxis des organischen Chemikers*, ninth edition. In using the tables in the latter work or similar tables it should be borne in mind that the volume of nitrogen gas must be divided by two, inasmuch as only one-half of the nitrogen collected comes from the amino groups.

² Either apparatus may be obtained from Emil Greiner, 45 Cliff Street, New York, or from Robert Goetze, Leipzig. Van Slyke has recently described a third form of his apparatus about half of the size of the earlier micro-apparatus. This has a more accurate burette so that the gas volumes can be read to 0.001 c.c. (Van Slyke: *Jour. Biol. Chem.*, 23, 407, 1915.)

³ Harding and MacLean: *Jour. Biol. Chem.*, 20, 217, 1915; 24, 503, 1916; 25, 319, 1916.

method is inaccurate for cystine and has not yet been adapted for use with biological fluids other than solutions of protein hydrolysis products formed by acid or tryptic hydrolysis.

Method of Kober and Sugiura.¹—Kober and Sugiura have devised microchemical methods for the determination of α and β -amino acids and certain derivatives in products of protein hydrolysis and other mixtures based upon the property of these amino acids and derivatives of dissolving cupric hydroxide quantitatively in neutral or slightly alkaline solution. The reaction is said to be very rapid and sensitive. See original articles for details.

¹ Kober and Sugiura: *J. Am. Ch. Soc.*, 35, 1546, 1913.

Kober: *J. Ind. Eng. Ch.*, 9, 501, 1917.

CHAPTER V

PROTEINS: THEIR CLASSIFICATION AND PROPERTIES

FROM what has already been said in Chapter IV regarding the protein substances it will be recognized that the grouping of the diverse forms of this class of substances in a logical manner is not an easy task. The fats and carbohydrates may be classified upon the fundamental principles of their stereo-chemical relationships, whereas such a system of classification in the case of the proteins is absolutely impossible since, as we have already stated, the molecular structure of these complex substances is unknown. Because of the diversity of standpoint from which the proteins may be viewed, relative to their grouping in the form of a logically classified series, it is obvious that there is an opportunity for the presentation of classifications of a widely divergent character. The fact that there were until recent years at least a dozen different classifications which were recognized by various groups of English-speaking investigators emphasizes the difficulties in the way of the individual or individuals who would offer a classification which should merit universal adoption. Realizing the great handicap and disadvantage which the great diversity of the protein classifications was forcing upon the workers in this field, the Chemical and Physiological Societies of England drafted a classification which appealed to these groups of scientists as fulfilling all requirements and presented it for the consideration of the American Physiological Society and the American Society of Biological Chemists. The outcome of this has been that there are now only *two* protein classifications which are recognized by English-speaking scientists, one the British Classification, the other the American Classification. These classifications are very similar and doubtless will ultimately be merged into a single classification. In our consideration of the proteins we shall conform in all details to the American Classification. In this connection we will say, however, that we feel that the English Societies have strong grounds for preferring the use of the term *scleroproteins* for albuminoids and *chromoproteins* for hemoglobins. The two classifications are as follows:

CLASSIFICATION OF PROTEINS ADOPTED BY THE AMERICAN PHYSIOLOGICAL SOCIETY AND THE AMERICAN SOCIETY OF BIOLOGICAL CHEMISTS

I. SIMPLE PROTEINS

Protein substances which yield *only* α -amino acids or their derivatives on hydrolysis.

(a) **Albumins.**—Soluble in pure water and coagulable by heat, e.g., *ovalbumin* from *egg white*, *serum albumin* from *blood serum*, *lactalbumin* from *milk*, *vegetable albumins*.

(b) **Globulins.**—Insoluble in pure water but soluble in neutral solutions of salts of strong bases with strong acids,¹ e.g., *serum globulin*, *ovoglobulin* from *egg yolk*, *edestin* from *hemp seed*, *amandin* from *almond* and *peach kernel*, and other *vegetable globulins*.

(c) **Glutelins.**—Simple proteins insoluble in *all neutral solvents*, but readily soluble in very dilute acids and alkalis,² e.g., *glutenin* from *wheat*.

(d) **Alcohol-soluble Proteins (Prolamins).**³—Simple proteins soluble in 70–80 per cent alcohol, insoluble in water, absolute alcohol, and other *neutral solvents*,⁴ e.g., *zein* from *corn*, *gliadin* from *wheat* and *rye*, *hordein* from *barley*, and *bynin* from *malt*.

(e) **Albuminoids.**—Simple proteins possessing a similar structure to those already mentioned, but characterized by a pronounced insolubility in all neutral solvents,⁵ e.g., *elastin* from *ligament*, *collagen* from *tendon*, *keratin* from *horn* and *hoof*.

(f) **Histones.**—Soluble in water and insoluble in very dilute ammonia, and, in the absence of ammonium salts, insoluble even in excess of ammonia; yield precipitates with solutions of other proteins and a coagulum on heating which is easily soluble in very dilute acids. On hydrolysis they yield a large number of amino acids among which the basic ones predominate. In short, histones are basic proteins which stand between protamines and true proteins, e.g., *globin* from *hemoglobin*, *scombrone* from *mackerel sperm*, *thymus histone*.

(g) **Protamines.**—Simpler polypeptides than the proteins included in the preceding groups. They are soluble in water, uncoagulable by

¹ The precipitation limits with ammonium sulphate should not be made a basis for distinguishing the albumins from the globulins.

² Such substances occur in abundance in the seeds of cereals and doubtless represent a well-defined natural group of simple proteins.

³ The name *prolamins* has been suggested for these alcohol-soluble proteins by Dr. Thomas B. Osborne (*Science*, 1908, xviii, p. 417). It is a very fitting term inasmuch as upon hydrolysis they yield particularly large amounts of *proline* and *ammonia*.

⁴ The subclasses defined (a, b, c, d.) are exemplified by proteins obtained from both plants and animals. The use of appropriate prefixes will suffice to indicate the origin of the compounds, e.g., *ovoglobulin*, *lactalbumin*, etc.

⁵ These form the principal organic constituents of the skeletal structure of animals and also their external covering and its appendages. This definition does not provide for gelatin which is, however, an artificial derivative of collagen.

heat, have the property of precipitating aqueous solutions of other proteins, possess strong basic properties and form stable salts with strong mineral acids. They yield comparatively few amino acids, among which the basic ones predominate. They are the *simplest natural proteins*, e.g., *salmine* from *salmon sperm*, *sturine* from *sturgeon sperm*, *clupeine* from *herring sperm*, *scombrine* from *mackerel sperm*.

II. CONJUGATED PROTEINS

Substances which contain the protein molecule united to some other molecule or molecules otherwise than as a salt.

(a) **Nucleoproteins.**—Compounds of one or more protein molecules with nucleic acid, e.g., *cytoglobulin* from *cytoplasm*, *nucleohistone* from *nucleus*.

(b) **Glycoproteins.**—Compounds of the protein molecule with a substance or substances containing a carbohydrate group other than a nucleic acid, e.g., *mucins* and *mucoids* (*osseomucoid* from *bone*, *tendonmucoid* from *tendon*, *ichthulin* from *carp eggs*, *helico*protein from *snail*).

(c) **Phosphoproteins.**—Compounds of the protein molecule with some, as yet undefined, phosphorus-containing substances other than a nucleic acid or lecithin,¹ e.g., *casein* from *milk*, *ovovitellin* from *egg yolk*.

(d) **Hemoglobins.**—Compounds of the protein molecule with hematin, or some similar substance, e.g., *hemoglobin* from *red blood cells*, *hemocyanin* from *blood of invertebrates*.

(e) **Lecithoproteins.**—Compounds of the protein molecule with *lecithins*.

III. DERIVED PROTEINS

I. PRIMARY PROTEIN DERIVATIVES

Derivatives of the protein molecule apparently formed through hydrolytic changes which involve only slight alteration of the protein molecule.

(a) **Proteans.**—Insoluble products which apparently result from the incipient action of water, very dilute acids or enzymes, e.g., *myosan* from *myosin*, *edestan* from *edestin*.

(b) **Metaproteins.**—Products of the further action of acids and alkalis whereby the molecule is so far altered as to form products soluble in

¹ The accumulated chemical evidence distinctly points to the propriety of classifying the phosphoproteins as conjugated compounds, i.e., they are possibly esters of some phosphoric acid or acids and protein.

very weak acids and alkalis but insoluble in neutral fluids, *e.g.*, *acid metaprotein (acid albuminate)*, *alkali metaprotein (alkali albuminate)*.

(c) **Coagulated Proteins.**—Insoluble products which result from (1) the action of heat on their solutions, or (2) the action of alcohol on the protein.

2. SECONDARY PROTEIN DERIVATIVES¹

Products of the further hydrolytic cleavage of the protein molecule.

(a) **Proteoses.**—Soluble in water, non-coagulable by heat, and precipitated by saturating their solutions with ammonium—or zinc sulphate,² *e.g.*, *protoproteose*, *deuteroproteose*.

(b) **Peptones.**—Soluble in water, non-coagulable by heat, but *not precipitated* by saturating their solutions with ammonium sulphate,³ *e.g.*, *anti-peptone*, *amphopeptone*.

(c) **Peptides.**—Definitely characterized combinations of two or more amino acids, the *carboxyl* group of one being united with the *amino* group of the other with the elimination of a molecule of water,⁴ *e.g.*, *dipeptides*, *tripeptides*, *tetrapeptides*, *pentapeptides*.

CLASSIFICATION OF PROTEINS ADOPTED BY THE CHEMICAL AND PHYSIOLOGICAL SOCIETIES OF ENGLAND

I. SIMPLE PROTEINS

1. Protamines, *e.g.*, *salmine*, *clupeine*.
2. Histones, *e.g.*, *globin*, *scombrone*.
3. Albumins, *e.g.*, *ovalbumin*, *serum albumin*, *vegetable albumins*.
4. Globulins, *e.g.*, *serum globulin*, *ovoglobulin*, *vegetable globulins*.
5. Glutelins, *e.g.*, *glutenin*.
6. Alcohol-soluble proteins, *e.g.*, *zein*, *gliadin*.
7. Scleroproteins, *e.g.*, *elastin*, *keratin*.
8. Phosphoproteins, *e.g.*, *casein*, *vitellin*.

II. CONJUGATED PROTEINS

1. Glucoproteins, *e.g.*, *mucins*, *mucoïds*.
2. Nucleoproteins, *e.g.*, *nucleohistone*, *cytoglobulin*.
3. Chromoproteins, *e.g.*, *hemoglobin*, *hemocyanin*.

¹ The term secondary protein derivatives is used because the formation of the primary derivatives usually precedes the formation of the secondary derivatives.

² As thus defined, this term does not strictly cover all the protein derivatives commonly called proteoses, *e.g.*, heteroproteose and dysproteose.

³ In this group the kyrines may be included. For the present it is believed that it will be helpful to retain this term as defined, reserving the expression *peptide* for the simpler compounds of definite structure, such as dipeptides, etc.

⁴ The peptones are undoubtedly peptides or mixtures of peptides, the latter term being at present used to designate those of definite structure.

III. PRODUCTS OF PROTEIN HYDROLYSIS

1. Infraproteins, e.g., *acid infraprotein (acid albuminate)*, *alkali infraprotein (alkali albuminate)*.
2. Proteoses, e.g., *protoproteose*, *heteroproteose*, *deuteroproteose*.
3. Peptones, e.g., *amphopeptone*, *antipeptone*.
4. Polypeptides, e.g., *dipeptides*, *tripeptides*, *tetrapeptides*.

CONSIDERATIONS OF THE VARIOUS CLASSES OF PROTEINS

SIMPLE PROTEINS

The simple proteins are true protein substances which, upon hydrolysis, yield *only* α -amino acids or their derivatives. "Although no means are at present available whereby the chemical individuality of any protein can be established, a number of simple proteins have been isolated from animal and vegetable tissues which have been so well characterized by constancy of ultimate composition and uniformity of physical properties that they may be treated as chemical individuals until further knowledge makes it possible to characterize them more definitely." Under simple proteins we may class albumins, globulins, glutelins, prolamins, albuminoids, histones and protamines.

ALBUMINS

Albumins constitute the first class of simple proteins and may be defined as simple proteins which are coagulable by heat and soluble in pure (salt-free) water. Those of animal origin are not precipitated upon saturating their *neutral* solutions at 30°C. with sodium chloride or magnesium sulphate, but if a saturated solution of this character be acidified with acetic acid the albumin precipitates. All albumins of *animal* origin may be precipitated by saturating their solutions with ammonium sulphate.¹ They may be thrown out of solution by the addition of a sufficient quantity of a mineral acid, whereas a weak acidity produces a slight precipitate which dissolves upon agitating the solution. Metallic salts also possess the property of precipitating albumins, some of the precipitates being soluble in excess of the reagent, whereas others are insoluble in such an excess. Of those proteins which occur native the albumins contain the highest percentage of sulphur, ranging from 1.6 to 2.5 per cent. Some albumins have been

¹ In this connection, Osborne's observation that there are certain *vegetable* albumins which are precipitated by saturating their solutions with sodium chloride or magnesium sulphate or by half-saturating with ammonium sulphate, is of interest.

obtained in crystalline form, notably egg albumin, serum albumin, and lactalbumin, but the fact that they may be obtained in crystalline form does not necessarily prove them to be chemical individuals.

GENERAL COLOR REACTIONS OF PROTEINS

These color reactions are due to a reaction between some one or more of the constituent radicals or groups of the complex protein molecule and the chemical reagent or reagents used in any given test. Not all proteins contain the same groups and for this reason the various color tests will yield reactions varying in intensity of color according to the nature of the groups contained in the particular protein under examination. Various substances not proteins respond to certain of these color reactions, and it is therefore essential to submit the material under examination to several tests before concluding definitely regarding its nature.

TECHNIC OF THE COLOR REACTIONS

1. **Millon's Reaction.**—To 5 c.c. of a dilute solution of egg albumin¹ in a test-tube add a few drops of Millon's reagent. A white precipitate forms which turns red when heated.

This test is a particularly satisfactory one for use on *solid* proteins, in which case the reagent is added directly to the solid substance and heat applied, which causes the substance to assume a red color. Such proteins as are not precipitated by mineral acids, for example certain of the proteoses and peptones, yield a *red solution* instead of a red precipitate.

The reaction is due to the presence of the *hydroxy-phenyl group*, $-C_6H_4OH$, in the protein molecule and certain non-proteins such as tyrosine, phenol (carbolic acid) and thymol also respond to the reaction. Inasmuch as the tyrosine grouping is the only hydroxyphenyl grouping which has definitely been proven to be present in the protein molecule it is evident that protein substances respond to Millon's reaction because of the presence of this tyrosine complex. The test is not a very satisfactory one for use in solutions containing inorganic salts in large amount, since the mercury of the Millon's reagent² is thus precipitated and the reagent rendered inert. This reagent is therefore never used for the detection of protein material in the urine. If the solution under

¹ This egg albumin solution may be prepared by beating egg-white with 6–10 volumes of water. The precipitate of ovoglobulin is filtered off and the filtrate used in the tests.

² Millon's reagent consists of mercury dissolved in nitric acid containing some nitrous acid. It is prepared by digesting one part (by weight) of mercury with two parts (by weight) of HNO_3 (sp. gr. 1.42) and diluting the resulting solution with two volumes of water.

examination is strongly alkaline it should be neutralized inasmuch as the alkali will precipitate yellow or black oxides of mercury.

2. **Xanthoproteic Reaction.**—To 2–3 c.c. of egg albumin solution in a test-tube add concentrated nitric acid. A white precipitate forms, which upon heating turns yellow and finally dissolves, imparting to the solution a yellow color. Cool the solution and carefully add ammonium hydroxide, potassium hydroxide, or sodium hydroxide in excess. Note that the yellow color deepens into an orange.

This reaction is due to the presence in the protein molecule of the *phenyl group*— C_6H_5 , with which the nitric acid forms certain nitro modifications. The particular complexes of the protein molecule which are of especial importance in this connection are those of tyrosine, phenylalanine, and tryptophane. The test is not a satisfactory one for use in urinary examination because of the color of the end-reaction.

3. **Glyoxylic Acid Reaction (Hopkins-Cole).**¹—Place 1–2 c.c. of egg albumin solution and 3 c.c. of glyoxylic acid, $CHO.COOH + H_2O$ or $CH(OH).COOH$, solution (Hopkins-Cole reagent²) in a test-tube and mix thoroughly. In a second tube place 5 c.c. of concentrated sulphuric acid. Incline the tube containing sulphuric acid and by means of a pipette allow the albumin-glyoxylic acid solution to flow carefully down the side. When stratified in this manner a reddish-violet color forms at the zone of contact of the two fluids.

In performing the test on a solid substance employ modification described on page 107.

This color is due to the presence of the *tryptophane group*. Gelatin does not respond to this test. For formula of tryptophane see page 77. Benedict³ has suggested a new reagent for use in carrying out the Hopkins-Cole reaction.⁴ Nitrates ($NaNO_3$ and KNO_3) chlorates, nitrites, or excess of chlorides, entirely prevent the reaction whereas formaldehyde or nitric acid interfere somewhat.⁵ The sulphuric acid used must be pure.

¹ Hopkins and Cole: *Journal of Physiology*, 27, 418, 1902.

² Hopkins-Cole reagent is prepared as follows: To one liter of a saturated solution of oxalic acid add 60 grams of sodium amalgam and allow the mixture to stand until the evolution of gas ceases. Filter and dilute with 2–3 volumes of water.

³ Benedict: *Journal of Biological Chemistry*, 6, 51, 1909.

⁴ Benedict's modified Hopkins-Cole reagent is prepared as follows: Ten grams of powdered magnesium are placed in a large Erlenmeyer flask and shaken up with enough distilled water to liberally cover the magnesium. Two hundred and fifty c.c. of a cold, saturated solution of oxalic acid is now added slowly. The reaction proceeds very rapidly and with the liberation of much heat, so that the flask should be cooled under running water during the addition of the acid. The contents of the flask are shaken after the addition of the last portion of the acid and then poured upon a filter, to remove the insoluble magnesium oxalate. A little wash water is poured through the filter, the filtrate acidified with acetic acid to prevent the partial precipitation of the magnesium on long standing, and made up to a liter with distilled water. This solution contains only the magnesium salt of glyoxylic acid.

⁵ Mathewson: Dissertation (Columbia Univ.), Eschenbach Publishing Co., Easton, Pa., 1912. Cole: *Practical Physiological Chemistry*, 4th Ed., 1914.

4. Biuret Test.—To 2–3 c.c. of egg albumin solution in a test-tube add an equal volume of concentrated potassium hydroxide solution, mix thoroughly, and add slowly a very dilute (2–5 drops in a test-tube of water) copper sulphate solution until a purplish-violet or pinkish-violet color is produced. The depth of the color depends upon the nature of the protein; proteoses, and peptones giving a decided pink, while the color produced with gelatin is not far removed from a blue.

This reaction is given by those substances which contain *two amino groups* in their molecule, these groups either being joined directly together or through a single atom of nitrogen or carbon. The amino groups mentioned must either be two CONH_2 groups or one CONH_2 group and one CSNH_2 , $\text{C}(\text{NH})\text{NH}_2$ or CH_2NH_2 group. It follows from this fact that substances which are non-protein in character but which contain the necessary groups will respond to the biuret test. As examples of such substances may be cited *oxamide*,

and *biuret*,

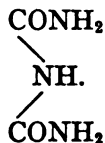

The test derives its name from the fact that this latter substance which is formed on heating urea to 180°C . (see page 403) will respond to the test. Protein material responds positively since there are two CONH_2 groups in the protein molecule.

According to Schiff the end-reaction of the biuret test is dependent upon the formation of a copper-potassium-biuret compound (cupri-potassium biuret or biuret potassium cupric hydroxide). This substance was obtained by Schiff in the form of long red needles. It has the following formula:

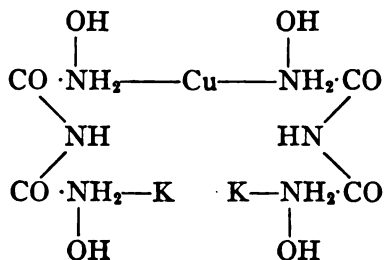

If much magnesium sulphate is present a precipitate of magnesium hydroxide forms which interferes with the test. If considerable ammonium sulphate is present a large excess of alkali must be used.

Testing Colored Solutions by Biuret Test.—If the color of the solution is such as to interfere with the end-reaction of the biuret test, proceed as follows: Make the solution strongly alkaline with potassium hydroxide and add a solution of copper sulphate. Shake up the mixture with alcohol and if protein is present the alcohol will assume the typical biuret coloration. This procedure is not applicable in case the pigment of the original solution is soluble in alcohol. Excess of the copper salt need not be avoided in this test.

*Gies's Biuret Reagent.*¹—Gies has devised a reagent for use in the biuret test. This reagent consists of 10 per cent KOH solution, to which 25 c.c. of 3 per cent CuSO₄ solution per liter has been added. This imparts a slight though distinct blue color to the clear liquid. This reagent is of material assistance in performing the biuret test.

Biuret Paper of Kantor and Gies.—According to Kantor and Gies² when filter paper is immersed in the above reagent and subsequently dried it forms a very satisfactory "biuret paper" which may be used in a manner analogous to indicator papers. Moist papers may be used in the examination of powders which are neutral or alkaline in reaction. In preparing the "biuret paper," if the filter paper is left for a sufficient length of time in the reagent all traces of the copper sulphate will be removed from the solution.

5. Ring Biuret Test (Posner).—This test is particularly satisfactory for use on *dilute* protein solutions, and is carried out as follows. To some dilute egg albumin in a test-tube add one-half its volume of potassium hydroxide solution. Now hold the tube in an inclined position and allow some very dilute copper sulphate solution, made as suggested on page 100, to flow down the side, being especially careful to prevent the fluids from mixing. At the juncture of the two solutions the typical end-reaction of the biuret test should appear as a colored zone (see Biuret Test, page 100).

6. The Triketohydrindene Hydrate (Ninhydrin) Reaction.—To 5 c.c. of dilute protein solution add one-half c.c. of a 0.1 per cent solution of triketohydrindene hydrate, heat to boiling for one to two minutes and allow to cool. A blue color develops if the test is positive.

This test gives positive results with proteins, peptones, peptides, and amino acids which possess a free carboxyl and α -amino group. In a concentration of 1 per cent the ammonium salts of weak acids react positively, as do also the ammonium salts of strong acids in very high concentration. Certain amines also give the reaction.³

¹ Gies: Proceedings of Society of Biological Chemists, *Journal of Biological Chemistry*, 7, 60, 1910.

² Kantor and Gies: *Proc. Soc. Biol. Chem.*, p. 11, 1910.

³ Harding and Warnerford: *Jour. Biol. Chem.*, 25, 319, 1916.

Harding and MacLean: *Jour. Biol. Chem.*, 25, 337, 1916.

PRECIPITATION REACTIONS AND OTHER PROTEIN TESTS

There are three forms in which proteins may be precipitated, *i.e.*, *unaltered*, as an *albuminate*, and as an *insoluble salt*. An instance of the precipitation in a *native* or *unaltered* condition is seen in the so-called *salting-out* experiments. Various salts, notably $(\text{NH}_4)_2\text{SO}_4$, ZnSO_4 , MgSO_4 , Na_2SO_4 and NaCl , possess the power, when added in *solid form* to certain definite protein solutions, of rendering the menstruum incapable of holding the protein in solution, thereby causing the protein to be precipitated or *salted-out*, to use the common term. Mineral acids and alcohol also precipitate proteins unaltered. In the case of concentrated acids the protein is dissolved in the presence of an excess of acid with the formation of a protein salt. Proteins are precipitated as *albuminates* when treated with certain metallic salts, and precipitated as *insoluble salts* when weak organic acids such as certain of the alkaloidal reagents are added to their solutions.

If certain acids (picric, phosphotungstic, phosphomolybdic, tannic, or chromic) be added to a *neutral* albumin solution, a precipitate of an *insoluble protein salt* occurs. If, however, the salts of these acids be added no precipitate occurs. The addition of a small amount of acid, as acetic acid, to such a solution will cause a precipitate to form.¹

The effect of the addition of the salts of the heavy metals is in the first instance to cause a precipitation of the protein. In many cases, however, the addition of an excess of such salts causes the solution of the precipitate, while a further excess may cause a reprecipitation. The precipitate which is first formed in a protein solution by the addition of the salts of the heavy metals may be redissolved not only by an excess of such salts but by an excess of protein as well.²

Colloidal iron, kaolin and alumina cream are frequently used for removing proteins from solution. The process is one of adsorption and has been adapted to certain quantitative methods.

It is generally stated that globulins are precipitated from their solutions upon *half* saturation with ammonium sulphate and that albumins are precipitated upon *complete* saturation by this salt. Comparatively few exceptions were found to this rule until proteins of *vegetable* origin came to be more extensively studied. These studies, furthered especially by Osborne and associates, have demonstrated very clearly that the characterization of a globulin as a protein which is precipitated by *half* saturation with ammonium sulphate, can no longer hold. Certain vegetable globulins have been isolated which are not precipi-

¹ Mathews: *Amer. Jour. of Physiology*, 1, 445, 1898.

² Pauli: *Hofmeister's Beilage*, 6, 233, 1904-05; Robertson: *Ergebnisse der Physiologie*, 10, 290, 1910.

tated by this salt until a concentration is reached *greater than that secured by half-saturation*. As an example of an albumin which does not conform to the definition of an albumin as regards its precipitation by ammonium sulphate may be mentioned the *leucosin* of the wheat germ, which is precipitated from its solution upon *half-saturation* with ammonium sulphate. The limits of precipitation by ammonium sulphate, therefore, do not furnish a sufficiently accurate basis for the differentiation of globulins from albumins. It has further been determined that a given protein which is precipitable by ammonium sulphate cannot be "salted-out" by the same concentration of the salt under all conditions.

EXPERIMENTS

1. **Influence of Concentrated Mineral Acids, Alkalis and Organic Acids.**—Prepare five test-tubes each containing 5 c.c. of concentrated egg albumin solution. To the first add concentrated H_2SO_4 , drop by drop, until an excess of the acid has been added. Note any changes which may occur in the solution. Allow the tube to stand for 24 hours and at the end of that period observe any alteration which may have taken place. Heat the tube and note any further change which may occur. Repeat the experiment in the four remaining tubes with concentrated hydrochloric acid, concentrated nitric acid, concentrated potassium hydroxide and acetic acid. How do strong mineral acids, strong alkalis, and strong organic acids differ in their action toward protein solutions?

2. **Precipitation by Metallic Salts.**—Prepare six tubes each containing 2-3 c.c. of dilute egg albumin solution. To the first add mercuric chloride, drop by drop slowly, until an excess of the reagent has been added, noting any changes which may occur. If not added very gradually the formation of the precipitate may not be noted, due to its solubility in excess of the reagent. Repeat the experiment with lead acetate, silver nitrate, copper sulphate, ferric chloride, and barium chloride, using very dilute solutions.

Egg albumin is used as an antidote for lead or mercury poisoning. Why? Is it an equally good antidote for the other metallic salts tested?

3. **Precipitation by Alkaloidal Reagents.**—Prepare six tubes each containing 2-3 c.c. of dilute egg albumin solution. To the first add picric acid drop by drop until an excess of the reagent has been added, noting any changes which may occur. Repeat the experiment with trichloroacetic acid, tannic acid, phosphotungstic acid, phosphomolybdic acid, and potassio-mercuric iodide. Are these precipitates soluble in excess of the reagent? Acidify with hydrochloric acid before testing with the last three reagents.

4. **Nitric Acid Test (Heller).**—Place 5 c.c. of concentrated nitric acid in a test-tube, incline the tube, and by means of a pipette allow the dilute albumin solution to flow slowly down the side. The liquids should stratify with the formation of a white zone of precipitated albumin at the point of juncture. This is a very delicate test and is further discussed on page 451.

An apparatus called the *albumoscope* or *horismascope* has been devised for use in the tests of this character and has met with considerable favor. The method of using the albumoscope is described on p. 104. The instrument is shown in Fig. 144. P. 452.

Use of the Albumoscope.—This instrument is intended to facilitate the making of "ring" tests such as Heller's and Roberts'. In making a test about 5 c.c. of the solution under examination is first introduced into the apparatus through the larger arm and the reagent used in the particular test is then introduced through the capillary arm and allowed to flow down underneath the solution under examination. If a reasonable amount of care is taken there is no possibility of mixing the two solutions and a definitely defined white "ring" is easily obtained at the zone of contact.

5. Nitric Acid.—MgSO₄ Test (Roberts).—Place 5 c.c. of Roberts' reagent¹ in a test-tube, incline the tube, and by means of a pipette allow the albumin solution to flow slowly down the side. The liquids should stratify with the formation of a white zone of precipitated albumin at the point of juncture. This test is a modification of Heller's ring test and is rather more satisfactory. The albumoscope may also be used in making this test (see Fig. 130, page 424).

6. Spiegler's Ring Test.—Place 5 c.c. of Spiegler's reagent² in a test-tube, incline the tube, and by means of a pipette allow 5 c.c. of albumin solution, acidified with acetic acid, to flow slowly down the side. A white zone will form at the point of contact. This is an exceedingly delicate test, in fact too delicate for ordinary clinical purposes, since it serves to detect albumin when present in the merest trace (1:250,000). This test is further discussed on page 424.

7. Tanret's Test.—To 5 c.c. of albumin solution in a test-tube add Tanret's reagent,³ drop by drop, until a turbidity or precipitate forms. This is an exceedingly delicate test. Sometimes the albumin solution is stratified upon the reagent as in Heller's or Roberts' ring tests. In urine examination it is claimed by Repiton that the presence of urates lowers the delicacy of the test. Tanret claims that the removal of urates is not necessary inasmuch as the urate precipitate will disappear on warming and the albumin precipitate will not. He says, however, that mucin interferes with the delicacy of his test and should be removed by acidification with acetic acid and filtration before testing for albumin.

8. Sodium Chloride and Acetic Acid Test.—Mix 2 volumes of albumin solution and 1 volume of a saturated solution of sodium chloride in a test-tube, acidify with acetic acid, and heat to boiling. The production of a cloudiness or the formation of a precipitate indicates the presence of albumin.

9. Acetic Acid and Potassium Ferrocyanide Test.—To 5 c.c. of dilute egg albumin solution in a test-tube add 5–10 drops of acetic acid. Mix well and add potassium ferrocyanide, drop by drop, until a precipitate forms. This test is very delicate.

Schmiedl claims that a precipitate of Fe(Cn)₆K₂Zn or Fe(Cn)₆Zn₂, is formed when solutions containing zinc are subjected to this test, and that this precipitate resembles the precipitate secured with protein

¹ Roberts' reagent is composed of 1 volume of concentrated HNO₃ and 5 volumes of a saturated solution of MgSO₄.

² Spiegler's reagent has the following composition:

Tartaric acid.....	20 grams.
Mercuric chloride.....	40 grams.
Sodium chloride.....	50 grams.
Glycerol.....	100 grams.
Distilled water.....	1000 grams.

³ Tanret's reagent is prepared as follows: Dissolve 1.35 grams of mercuric chloride in 25 c.c. of water, add to this solution 3.32 grams of potassium iodide dissolved in 25 c.c. of water, then make the total solution up to 60 c.c. with water and add 20 c.c. of glacial acetic acid to the combined solutions.

solutions. In the case of human urine a reaction was obtained when 0.000022 gram of zinc per cubic centimeter was present. Schmiiedl further found that the urine collected from rabbits housed in zinc-lined cages possessed a zinc content which was sufficient to yield a ready response to the test. Zinc is the only interfering substance so far reported.

10. Salting-out Experiments.—(a) To 25 c.c. of egg albumin solution in a small beaker add solid ammonium sulphate to the point of saturation, keeping the temperature of the solution below 40°C. Filter, test the precipitate by Millon's reaction and the filtrate by the biuret test. What are your conclusions? (b) Repeat the above experiment, making the saturation with solid sodium chloride. How does this result differ from the result of the saturation with ammonium sulphate? Add 2-3 drops of acetic acid. What occurs?

All proteins *except peptones* are precipitated by saturating their solutions with ammonium sulphate. Most *globulins* are precipitated by saturating their solutions with sodium chloride (see Globulins, page 108); serum globulin, however, is not thus precipitated. If the saturated solution is subsequently acidified, all proteins *except peptones* are precipitated.

Soaps may be salted-out in a similar manner (see page 185).

11. Coagulation or Boiling Test.—Heat 25 c.c. of dilute egg albumin solution to the boiling-point in a small evaporating dish. The albumin coagulates. Complete coagulation may be obtained by acidifying the solution with 3-5 drops of acetic acid¹ at the boiling-point. Test the coagulum by Millon's reaction.

The acid is added to neutralize any possible alkalinity of the solution, to dissolve any substances which are not albumin and to facilitate coagulation (see further discussion on pages 117 and 452).

12. Coagulation Temperature.—Prepare four test-tubes each containing 5 c.c. of neutral egg albumin solution. To the first add 1 drop of 0.2 per cent hydrochloric acid, to the second add 1 drop of 0.5 per cent sodium carbonate solution, to the third add 1 drop of 10 per cent sodium chloride solution and leave the fourth neutral in reaction. Partly fill a beaker of medium size with water and place it within a second larger beaker which also contains water, the two vessels being separated by pieces of cork. Fasten the four test-tubes compactly together by means of a rubber band, lower them into the water of the inner beaker and suspend them, by means of a clamp attached to one of the tubes, in such a manner that the albumin solutions shall be midway between the upper and lower surfaces of the water. In one of the tubes place a thermometer with its bulb entirely beneath the surface of the albumin solution (Fig. 36). Gently heat the water in the beakers, noting carefully any changes which may occur in the albumin solutions and record the exact temperature at which these changes occur. The first appearance of an opacity in an albumin solution indicates the commencement of coagulation and the temperature at which this occurs should be recorded as the coagulation temperature for that particular albumin solution.

¹ Nitric acid is often used in place of acetic acid in this test. In case nitric acid is used, ordinarily 1-2 drops are sufficient.

What is the order in which the four solutions coagulate?

Repeat the experiment, adding to the first tube 1 drop of acetic acid, to the second 1 drop of concentrated potassium hydroxide solution, to the third 2 drops of a 10 per cent sodium chloride solution and leave the fourth neutral as before.

What is the order of coagulation here? Why? See page 117.

13. **Precipitation by Alcohol.**—Prepare three test-tubes each containing about 10 c.c. of 95 per cent alcohol. To the first add 1 drop of 0.2 per cent hydrochloric acid, to the second 1 drop of potassium hydroxide solution and leave the third neutral in reaction. Add to each tube a few drops of egg albumin solution and note the results. What do you conclude from this experiment?

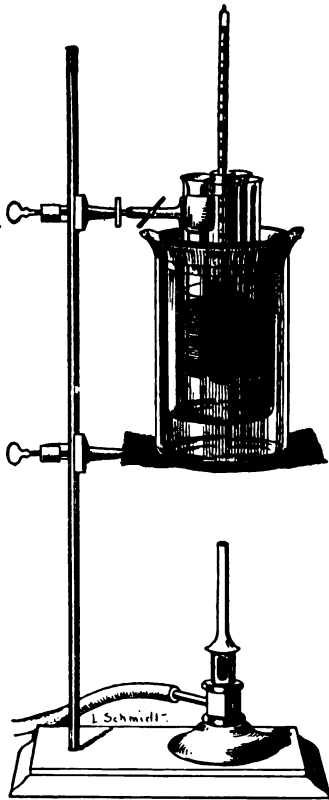

FIG. 36.—COAGULATION TEMPERATURE APPARATUS.

If in acid or neutral solution alcohol precipitates proteins unaltered, but if allowed to remain under alcohol the protein is transformed. The "fixing" of tissues for histological examination by means of alcohol is an illustration of the application of this transformation produced by alcohol. It apparently is a process of dehydration.

14. **Crystallization of Egg Albumin.**¹—Carefully remove the egg-white from a number of absolutely fresh eggs.² Measure the volume of the egg-white and add an equal volume of saturated ammonium sulphate a small portion at a time, beating the mixture vigorously after each addition.³ Filter the mixture through a large pleated filter paper.⁴ Measure the volume of the filtrate. To 100 c.c. of the filtrate add very carefully a 10 per cent solution of acetic acid from a burette being certain to note the exact volume of the acid used. The acid should be added drop by drop, the albumin mixture being gently shaken during the process. Add acid until the precipitate which forms at each addition is no longer dissolved when the albumin is shaken, and an opalescent mixture is secured. (It is generally rather difficult to determine this point, inasmuch as suspended air bubbles may simulate a precipitate.) As soon as the solution is milky, indicating that a permanent precipitate has formed, run in from the burette 1 c.c. of the acetic acid. This should produce a heavy white precipitate. Now take the burette reading to determine the exact volume of acid used in the treatment of 100 c.c. of the albumin mixture.

¹ Hopkins and Pinkus: *Jour. Physiol.*, 23.

² If not perfectly fresh the albumin will not crystallize.

³ Note the odor of ammonia. What causes it?

⁴ Sometimes better results are obtained by permitting the mixture to stand several hours before filtering.

Calculate the exact volume of acid necessary to precipitate the remaining portion of the original albumin mixture and add this calculated quantity. Mix the two portions of albumin and allow to stand over night. Remove a drop of the suspended material to a slide and examine microscopically. Crystals in the form of fine needles will be observed. This is the crystallized egg albumin. To recrystallize, filter off the crystals and dissolve them in the smallest possible volume of water. Filter, and to the filtrate carefully add saturated ammonium sulphate until a faint, permanent precipitate is formed. Allow the mixture to stand several hours and examine as before. The crystals of albumin should be somewhat larger than when first examined.

The above method may also be used for crystallizing serum albumin from the fresh blood serum of the horse, mule or ass.

15. Preparation of Powdered Egg Albumin.—This may be prepared as follows: Ordinary egg-white finely divided by means of scissors or a beater is treated with 4 volumes of water and filtered. The filtrate is evaporated on a water-bath at about 50°C. and the residue powdered in a mortar.

16. Tests on Powdered Egg Albumin.—With powdered albumin prepared as described above (by yourself or furnished by the instructor), try the following tests:

(a) **Solubility.**—Test the solubility of the albumin in water, sodium chloride, dilute acid and alkali.

(b) **Millon's Reaction.**

(c) **Glyoxylic Acid Reaction (Hopkins-Cole).**—When used to detect the presence of protein in solid form this reaction should be conducted as follows: Place 5 c.c. of concentrated sulphuric acid in a test-tube and add carefully, by means of a pipette, 3–5 c.c. of Hopkins-Cole reagent. Introduce a small amount of the solid substance to be tested, agitate the tube slightly, and note that the suspended pieces assume a reddish-violet color, which is the characteristic end-reaction of the Hopkins-Cole test; later the solution will also assume the reddish-violet color.

(d) **Composition Test.**—Heat some of the dry powder in a dry test-tube in which is suspended a strip of moistened red litmus paper and across the mouth of which is placed a piece of filter paper moistened with lead acetate solution. As the powder is heated it chars, indicating the presence of carbon; the fumes of ammonia are evolved, turning the red litmus paper blue and indicating the presence of nitrogen and hydrogen; the lead acetate paper is blackened, indicating the presence of sulphur, and the deposition of moisture on the side of the tube indicates the presence of hydrogen. Moisture indicates hydrogen only in case both powder and test-tube used in the test are absolutely dry.

(e) **Coagulation Test.**—Immerse a dry test-tube containing a little powdered egg albumin in boiling water for a few moments. Remove and test the solubility of the albumin according to the directions given under (a) above. It is still soluble. Why has it not been coagulated? Repeat the above experiments with powdered serum albumin and see how the results compare with those just obtained.

SULPHUR IN PROTEIN

Sulphur is believed to be present in two different forms in the protein molecule. The first form, which is present in greatest amount,

is that loosely combined with carbon and hydrogen. An example of this combination is shown in *cystine*,

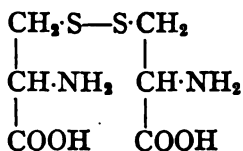

Sulphur in this form is variously termed *unoxidized*, *loosely combined*, *mercaptan*, and *lead-blackening* sulphur. The second form is combined in a more stable manner with carbon and oxygen and is known as *oxidized* or *acid* sulphur. The protamines are the only class of sulphur-free proteins.

TESTS FOR SULPHUR

1. Tests for Unoxidized Sulphur.—(a) To equal volumes of KOH and egg albumin solutions in a test-tube add 1–2 drops of lead acetate solution and boil the mixture. Unoxidized sulphur is indicated by a darkening of the solution, the color deepening into a black if sufficient sulphur is present. Add hydrochloric acid and note the characteristic odor evolved from the solution. Write the reactions for this test. (b) Place equal volumes of KOH and egg albumin solutions in a test-tube and boil the mixture vigorously. Cool, make acid with glacial acetic acid and add 1–2 drops of lead acetate. A darkening indicates the presence of unoxidized sulphur.

2. Test for Total Sulphur (Unoxidized and Oxidized).—Place the substance to be examined (powdered egg albumin) in a small porcelain crucible, add a suitable amount of solid fusion mixture (sodium carbonate and potassium nitrate mixed in the proportion 2 : 1) and heat carefully until a colorless mixture results. (Sodium peroxide may be used in place of this fusion mixture if desired.) Cool, dissolve the cake in a little warm water and filter. Acidify the filtrate with hydrochloric acid, heat it to the boiling-point and add a small amount of barium chloride solution. A white precipitate forms if sulphur is present. What is this precipitate?

GLOBULINS

Globulins are simple proteins especially predominant in the vegetable kingdom. They are closely related to the albumins and in common with them give all the ordinary protein tests. Globulins differ from the albumins in being insoluble in pure (salt-free) water. They are, however, soluble in neutral solutions of salts of strong bases with strong acids. Most globulins are precipitated from their solutions by saturation with solid sodium chloride or magnesium sulphate. As a class they are much less stable than the albumins, a fact shown by the increasing difficulty with which a globulin dissolves during the course of successive reprecipitations.

We have used an albumin of animal origin (egg albumin), for all

the protein tests thus far, whereas the globulin to be studied will be prepared from a vegetable source. There being no essential difference between animal and vegetable proteins, the vegetable globulin we shall study may be taken as a true type of all globulins, both animal and vegetable.

EXPERIMENTS ON GLOBULIN

Preparation of the Globulin.—Extract 20–30 grams (a handful) of crushed hemp seed with a 5 per cent solution of sodium chloride for one-half hour at 60°C. Filter while hot through a paper moistened with 5 per cent sodium chloride solution. Place the filtrate in a water-bath at 60°C. and allow both to cool spontaneously and stand for 24 hours in order that the globulin may crystallize slowly as the temperature of the bath falls. In case the filtrate is cloudy it should be warmed to 60°C. in order to produce a clear solution. The globulin is soluble



FIG. 37.—EDESTIN.

in hot 5 per cent sodium chloride solution and is thus extracted from the hemp seed, but upon cooling this solution much of the globulin separates in crystalline form. This particular globulin is called edestin. It crystallizes in several different forms, chiefly octahedra (see Fig. 37, above). (The crystalline form of excelsin, a protein obtained from the Brazil nut, is shown in Fig. 38, p. 110. This vegetable protein crystallizes in the form of hexagonal plates.) Filter off the edestin and make the following tests on the crystalline body and on the filtrate which still contains some of the extracted globulin.

Tests on Crystallized Edestin.—Microscopical examination (see Fig. 37).

(2) **Solubility.**—Try the solubility in the ordinary solvents (see page 21). Keep these solubilities in mind for comparison with those of edestan, to be made later (see page 115).

(3) **Millon's Reaction.**

(4) **Coagulation Test.**—Place a small amount of the globulin in a test-tube, add a little water and boil. Now add dilute hydrochloric acid and note that the protein no longer dissolves. It has been coagulated.

(5) Dissolve the remainder of the edestin in 0.2 per cent hydrochloric acid and preserve this acid solution for use in the experiments on proteans (see page 115).

Tests on Edestin Filtrate.—(1) Influence of Protein Precipitants.—Try a few protein precipitants such as nitric acid, tannic acid, picric acid, and mercuric chloride.

(2) Biuret Test.

(3) Coagulation Test.—Boil some of the filtrate in a test-tube. What happens?

(4) Saturation with Sodium Chloride.—Saturate some of the filtrate with solid sodium chloride. How does this result differ from that obtained upon saturating egg albumin solution with solid sodium chloride?

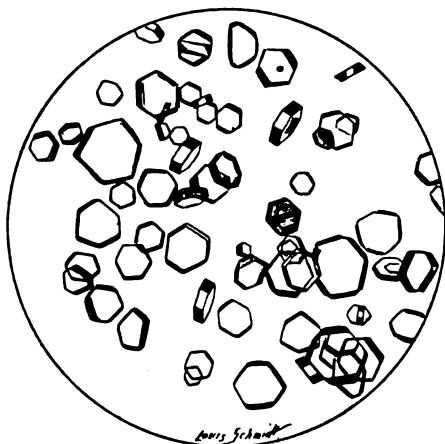

FIG. 38.—EXCELSIN, THE PROTEIN OF THE BRAZIL NUT.

(Drawn from crystals furnished by Dr. Thomas B. Osborne, New Haven, Conn.)

(5) Precipitation by Dilution.—Dilute some of the filtrate with 10–15¹/₂ volumes of water. Why does the globulin precipitate?

Glutelins

It has been repeatedly shown, particularly by Osborne, that after extracting the seeds of cereals with water, neutral salt solution, and strong alcohol, there still remains a residue which contains protein material which may be extracted by very dilute acid or alkali. These proteins which are insoluble in all neutral solvents, but readily soluble in very dilute acids and alkalis are called *glutelins*. The only member of the group which has yet received a name is the *glutenin* of wheat, a protein which constitutes nearly 50 per cent of the gluten, the remainder being principally *gliadin*. It is not definitely known whether *glutelins* occur as constituents of all seeds.

Gluten: Preparation and Tests.¹—To about 50 grams of wheat flour in a casserole or evaporating dish, add a little water and mix thoroughly until a stiff dough results. Knead this dough thoroughly and permit it to stand for about a half hour. This is done in order that the maximum quantity of gluten may be obtained. Treat the dough with about 200 c.c. of water and knead it thoroughly. Note the yellowish color of the dough and the milky appearance of the water due to suspended starch granules. (Place a drop of the suspension on a slide, cover with a cover slip, run underneath the slip a drop of iodine solution and observe the stained starch granules under the microscope.) Filter and apply a protein color reaction (see page 98) to the filtrate. It should be positive, indicating that water-soluble proteins were present in the flour. Add fresh water to the dough and repeat the kneading process. Continue this procedure with fresh addition of water until practically no starch granules are noted in suspension. To a small piece of the yellow, fibrous gluten apply Millon's Reaction (page 98). This test shows gluten to be protein material. Utilize the remainder of the gluten in the preparation of gliadin (page 112).

Glutenin: Preparation and Tests.—(In the preparation of gliadin (page 112) it is customary to remove this prolamin from the crude gluten by extracting with 70 per cent alcohol. Inasmuch as gluten consists chiefly of gliadin and glutenin the portion of the gluten remaining after the extraction of the alcohol-soluble protein gliadin may be utilized for the preparation of glutenin.)

To the finely divided residue from the preparation of gliadin (page 112) in a flask or bottle add about 250 c.c. of 70 per cent alcohol. Allow to stand for about 48 hours with repeated shaking in order to remove any remaining gliadin. Crude glutenin remains. To purify the glutenin treat it in a mortar, with sufficient 0.2 per cent NaOH to dissolve it, and filter the liquid through a wet pleated filter. Neutralize the filtrate carefully, with 0.2 per cent HCl adding the acid drop by drop with thorough mixing after each addition. (The glutenin is soluble in excess of acid.) Filter off the glutenin precipitate and wash several times with 70 per cent alcohol and finally with water. Apply the following tests:

1. Solubility in water, salt solution, 0.2 per cent HCl and 0.5 per cent Na₂CO₃.
2. Millon's Reaction.

Prolamins (Alcohol-soluble Proteins)

The term prolamin has been proposed by Osborne for the group of proteins formerly termed "alcohol-soluble proteins." The name is very appropriate inasmuch as these proteins yield, upon hydrolysis, especially large amounts of *proline* and *ammonia*. The prolamins are simple proteins which are insoluble in water, *absolute* alcohol and other neutral solvents, but are soluble in 70 to 80 per cent alcohol and in dilute acids and alkalis. They occur widely distributed, particularly in the vegetable kingdom. The only prolamins yet described are the *zein* of maize, the *hordein* of barley, the *gliadin* of wheat and rye, and the *bynin* of malt. They yield relatively large amounts of glutamic acid on hy-

¹This experiment as well as those on *glutenin* and *gliadin* which follow have been adapted from directions given in Laboratory Notes of Professor Gies, College of Physicians and Surgeons, New York.

drololysis but *no lysin*. The largest percentage of glutamic acid (43.66 per cent) ever obtained as a decomposition product of a protein substance has very recently been obtained by Osborne and Guest from the hydrolysis of the prolamins *gliadin*.¹ This yield of glutamic acid is also the largest amount of any single decomposition product yet obtained from any protein *except protamines*.

Gliadin: Preparation and Tests.—Introduce the finely divided crude gluten as prepared on page 111 into a flask or bottle, add about 250 c.c. of 70 per cent alcohol² and allow the mixture to stand 24 hours with occasional shaking. Filter (retaining the undissolved portion for preparation of glutenin, page 111), evaporate the filtrate to dryness in a porcelain dish over a water-bath. Pulverize the dry material. Apply the following tests to this gliadin powder:

Solubility and Protein Tests.—Test the solubility in alcohol (30 per cent, 50 per cent and 70 per cent), water, 0.9 per cent NaCl, 0.2 per cent HCl and 0.5 per cent Na₂CO₃. Shake each test repeatedly and filter. To the filtrate apply Coagulation test (page 105) and Biuret test (page 100).

Albuminoids (Scleroproteins)

The albuminoids yield hydrolytic products similar to those obtained from the other simple proteins already considered, thus indicating that they possess essentially the same chemical structure. They differ from all other proteins, whether simple, conjugated, or derived, in that they are insoluble in all neutral solvents. The albuminoids include "the principal organic constituents of the skeletal structure of animals as well as their external covering and its appendages." Some of the principal albuminoids are *keratin*, *elastin*, *collagen*, *reticulin*, *spongine*, and *fibroin*. Gelatin cannot be classed as an albuminoid although it is a transformation product of collagen. The various albuminoids differ from each other in certain fundamental characteristics which will be considered in detail under Epithelial and Connective Tissue (see Chapter XIX).

CONJUGATED PROTEINS

Conjugated proteins consist of a protein molecule united to some other molecule or molecules otherwise than as a salt. We have *glycoproteins*, *nucleoproteins*, *hemoglobins* (chromoproteins), *phosphoproteins* and *lecithoproteins* as the five classes of conjugated proteins.

Glycoproteins may be considered as compounds of the protein mole-

¹Osborne and Guest: *Jour. Biol. Chem.*, 9, 425, 1911. Up to this time the yield of 41.32 per cent obtained by Kleinschmitt from hordein was the maximum yield.

²Bailey and Blish claim that 50 per cent alcohol is more satisfactory (*Jour. Biol. Chem.*, 23, 345, 1915).

cule with a substance or substances containing a carbohydrate group other than a nucleic acid. The *glycoproteins* yield, upon decomposition, protein and carbohydrate derivatives, notably glucosamine, $\text{CH}_2\text{OH}-(\text{CHOH})_3.\text{CH}(\text{NH}_2).\text{CHO}$, and galactosamine, $\text{OHCH}_2.(\text{CHOH})_3.\text{CH}(\text{NH}_2).\text{CHO}$. The principal glycoproteins are *mucoids*, *mucins*, and *chondroproteins*. By the term *mucoid* we may in general designate those glycoproteins which occur in tissues, such as *tendomuroid* from tendinous tissue and *osseomuroid* from bone. (For the preparation of tendomuroid see Chapter XIX.) The elementary composition of these typical mucoids is as follows:

	N.	S.	C.	H.	O.
Tendomuroid ¹	11.75	2.33	48.76	6.53	30.60
Osseomuroid ²	12.22	2.32	47.43	6.63	31.40

The term *mucins* may be said in general to include those forms of glycoproteins which occur in the secretions and fluids of the body. (For the preparation of salivary mucin see Chapter III.) Chondroproteins are so named because *chondromuroid*, the principal member of the group, is derived from cartilage (chondrigen). *Amyloid*,³ which appears pathologically in the spleen, liver, and kidneys, is also a chondroprotein.

The *phosphoproteins* are considered to be "compounds of the protein molecule and some, as yet undefined, phosphorus-containing substances other than a nucleic acid or lecithin." The percentage of phosphorus in phosphoproteins is very similar to that in nucleoproteins, but they differ from this latter class of proteins in that they do not yield any purine bases upon hydrolytic cleavage. Two of the common phosphoproteins are the *casein* of milk and the *ovovitellin* of the egg-yolk. The phosphorus in these, as in all proteins, exists in phosphoric acid radicals. For the preparation of a typical phosphoprotein (casein) see Chapter XVIII.

The *hemoglobins* (chromoproteins) are compounds of the protein molecule with hematin or some similar substance. The principal member of the group is the hemoglobin of the blood. Upon hydrolytic cleavage this hemoglobin yields a protein termed *globin* and a coloring matter termed *hemochromogen*. The latter substance contains *iron* and upon coming into contact with oxygen is oxidized to form *hematin*. *Hemocyanin*, another member of the class of hemoglobins, occurs in the blood of certain invertebrates, notably cephalopods, gasteropods, and

¹Chittenden and Gies: *Jour. Exp. Med.*, 1, 186, 1896.

²Hawk and Gies: *Amer. Jour. Physiol.*, 5, 387, 1901.

³Not to be confused with the substance *amyloid* which may be formed from cellulose (see p. 49).

crustacea. Hemocyanin generally contains either *copper*, *manganese*, or *zinc* in place of the *iron* of the hemoglobin molecule. For the preparation of hemoglobin in crystalline form see Chapter XV.

The *lecithoproteins* consist of a protein molecule joined to lecithin. They have been comparatively little studied and may possibly be *mixtures* of protein and lecithin.

For consideration of *nucleoproteins* see Chapter VI.

DERIVED PROTEINS

These substances are derivatives which are formed through hydrolytic changes of the original protein molecule. They may be divided into two groups, the *primary* protein derivatives and the *secondary* protein derivatives. The term secondary derivatives is made use of in this connection since the formation of the primary derivatives generally precedes the formation of these secondary derivatives. These derived proteins are obtained from native simple proteins by hydrolyses of various kinds, *e.g.*, through the action of acids, alkalis, heat, or enzymes. The particular class of derived protein desired regulates the method of treatment to which the native protein is subjected.

Primary Protein Derivatives

The primary protein derivatives are "apparently formed through hydrolytic changes which involve only slight alterations of the protein molecule." This class includes *proteans*, *metaproteins* and *coagulated proteins*.

PROTEANS

Proteans are those insoluble protein substances which are produced from proteins originally soluble through the incipient action of water, enzymes, or very dilute acids. It is well known that globulins become insoluble upon repeated reprecipitation and it may possibly be found that the greater number of the proteans are transformed globulins. Osborne, however, believes that nearly all proteins may give rise to proteans. This investigator who has so very thoroughly investigated many of the vegetable proteins claims that the hydrogen ion is the active agent in the transformation. The protean produced from the transformation of *edestin* is called *edestan*, that produced from *myosin* is called *myosan*, etc. The name protean was first given to this class of proteins by Osborne in 1900 in connection with his studies of edestin.

EXPERIMENTS ON PROTEANS

Preparation and Study of Edestan.—Prepare edestin according to the directions given on page 109. Bring the edestin into solution in 0.2 per cent hydrochloric acid and permit the acid solution to stand for about one-half hour.¹ Neutralize with a 0.5 per cent solution of sodium carbonate, filter off the precipitate of edestan and make the following tests:

1. **Solubility.**—Try the solubility in water, sodium chloride, dilute acid and alkali. Note the altered solubility of the *edestan* as compared with that of edestin (see page 109).

2. **Millon's Reaction.**

3. **Coagulation Test.**—Place a small amount of the protean in a test-tube, add a little water and boil. Now add dilute hydrochloric acid and note that the protein no longer dissolves. It has been coagulated.

4. **Tests on Edestan Solution.**—Dissolve the remainder of the edestan precipitate in 0.2 per cent hydrochloric acid and make the following tests:

(a) *Biuret Test*

(b) *Influence of Protein Precipitants.*—Try a few protein precipitants such as *picric acid* and *mercuric chloride*.

METAPROTEINS

The metaproteins are formed from the native simple proteins through an action similar to that by which proteans are formed. In the case of the *metaproteins*, however, the changes in the original protein molecule are more profound. These derived proteins are characterized by being soluble in very weak acids and alkalis, but *insoluble in neutral fluids*. The metaproteins were formerly termed *albuminates*, but inasmuch as the termination *ate* signifies *a salt* it has always been somewhat of a misnomer.

Two of the principal metaproteins are the *acid metaprotein* or so-called acid albuminate and the *alkali metaprotein* or so-called alkali albuminate. They differ from the native simple proteins principally in being insoluble in sodium chloride solution and in not being coagulated *except when suspended in neutral fluids*. Both forms of metaprotein are precipitated upon the approximate neutralization of their solutions. They are precipitated by saturating their solutions with ammonium sulphate, and by sodium chloride also, provided they are dissolved in an acid solution. Acid metaprotein contains a higher percentage of nitrogen and sulphur than the alkali metaprotein from the same source, since some of the nitrogen and sulphur of the original protein is liberated in the formation of the latter. Because of this fact, it is impossible to transform an alkali metaprotein into an acid metaprotein, while it is possible to reverse the process and transform the acid metaprotein into the alkali modification.

¹ The edestan solution preserved from experiment (5), p. 110, may be used.

EXPERIMENTS ON METAPROTEINS

ACID METAPROTEIN (ACID ALBUMINATE)

Preparation and Study.—Take 25 grams of hashed lean beef washed free from the major portion of blood and inorganic matter, and place it in a medium-sized beaker with 100 c.c. of 0.2 per cent HCl. Place it on a boiling water-bath for one-half hour, filter, cool, and divide the filtrate into two parts. Neutralize the first part with dilute KOH solution, filter off the precipitate of acid metaprotein and make the following tests:

(1) Solubility.—Solubility in the ordinary solvents (see page 21).

(2) Millon's Reaction.

(3) Coagulation Test.—Suspend a little of the metaprotein in water (neutral solution) and heat to boiling for a few moments. Now add 1–2 drops of KOH solution to the water and see if the metaprotein is still soluble in dilute alkali. What is the result and why?

(4) Test for Unoxidized Sulphur (see page 108).

Subject the second part of the original solution to the following tests:

(5) Coagulation Test.—Heat some of the solution to boiling in a test-tube. Does it coagulate?

(6) Biuret Test.

(7) Influence of Protein Precipitants.—Try a few protein precipitants such as picric acid and mercuric chloride. How do the results obtained compare with those from the experiments on egg albumin? (See page 103.)

ALKALI METAPROTEIN (ALKALI ALBUMINATE)

Preparation and Study.—Carefully separate the white from the yolk of a hen's egg and place the former in an evaporating dish. Add concentrated potassium hydroxide solution, drop by drop, stirring continuously. The mass gradually thickens and finally assumes the consistency of jelly. This is solid alkali metaprotein or "Lieberkühn's jelly." Do not add an excess of potassium hydroxide or the jelly will dissolve. Cut it into small pieces, place a cloth or wire gauze over the dish, and by means of running water wash the pieces free from adherent alkali. Now add a small amount of water, which forms a weak alkaline solution with the alkali within the pieces, and dissolve the jelly by gentle heat. Cool the solution and divide it into two parts. Proceed as follows with the first part: Neutralize with dilute hydrochloric acid, noting the odor of the liberated hydrogen sulphide as the alkali metaprotein precipitates. Filter off the precipitate and test as for acid metaprotein (tests 1, 2, 3 and 4), above, noting particularly the sulphur test. How does this test compare with that given by the acid metaprotein? Make tests on the second part of the solution the same as for acid metaprotein (tests 5, 6 and 7) above.

Coagulated Proteins

These derived proteins are produced from unaltered protein materials by heat, by long standing under alcohol, or by the continuous movement of their solutions such as that produced by rapid stirring or shaking. In particular instances, such as the formation of fibrin from

fibrinogen (see page 260), the coagulation may be produced by enzyme action. Ordinary soluble proteins after having been transformed into the coagulated modification are no longer soluble in the ordinary solvents. Upon being heated in the presence of strong acids or alkalis, coagulated proteins are converted into metaproteins.

Many proteins coagulate at an approximately fixed temperature under definite conditions (see pages 105 and 368). This characteristic may be applied to separate different coagulable proteins from the same solution by fractional coagulation. The coagulation temperature frequently may serve in a measure to identify proteins in a manner similar to the melting-point or boiling-point of many other organic substances. The separation of proteins by fractional coagulation is thus analogous to the separation of volatile substances by means of *fractional distillation*. This method of separating proteins is not a satisfactory one, however, inasmuch as proteins in solution have different effects upon one another and also because of the fact that the nature of the solvent causes a variation in the temperature at which a given protein coagulates. The nature of the process involved in the coagulation of proteins by heat is not well understood, but it is probable that in addition to the altered arrangement of the component atoms in the molecule, there is a mild hydrolysis which is accompanied by the liberation of minute amounts of hydrogen, nitrogen, and sulphur. The presence of a neutral salt or a trace of mineral acid may facilitate the coagulation of a protein solution (see page 105), whereas any appreciable amount of acid or alkali will retard or entirely prevent such coagulation.

It has been shown that the coagulation of proteins by heat proceeds in two stages:¹ first, a reaction between the protein and the hot water (denaturation), and second, an agglutination or separation of the altered protein in particulate form. The concentration of acid, or hydrogen ion, in the solution influences the coagulation of proteins, such that the original protein is acted upon less readily by hot water alone than in the presence of acid. The formation of the coagulum is accompanied by the disappearance of the free acid from the solution, indicating the formation of a protein salt. A disturbance of the equilibrium between the hydrolyzed and unhydrolyzed portions of the protein salt, due to the greater rapidity with which the unhydrolyzed portion is precipitated, results in the gradual removal of both protein and acid from the solution. This has been offered as an explanation of the decreasing acidity.

According to Chick and Martin, the addition of neutral salts to the acid solution of the salt-free protein to be coagulated results in a *decreased*

¹ Chick and Martin: *Journal of Physiology*, 43 1, 1911.

rate of coagulation. This is due in part to the decrease in the concentration of the free acid, which results from the disturbance of the equilibrium between the protein and acid and also in part to the direct influence which the salts exert upon the protein. The presence of neutral salts may under certain circumstances facilitate the coagulation of proteins by heat.

The temperature at which egg-white is coagulated causes a difference in the appearance of the coagulum.¹ Coagulated egg-white which has been immersed in water at a *low* temperature and then gradually heated to the coagulating temperature is more translucent and has a bluish color, whereas egg-white which has been immersed in water heated to a temperature *above* the coagulating temperature is creamy white in color. They also possess different digestibilities.

EXPERIMENTS ON COAGULATED PROTEIN

Ordinary coagulated egg-white may be used in the following tests:

1. **Solubility.**—Try the solubility of small pieces of coagulated protein in each of the ordinary solvents (see page 21).

2. **Millon's Reaction.**

3. **Xanthoproteic Reaction.**—Partly dissolve a medium-sized piece of the protein in concentrated nitric acid. Cool the solution and add an excess of ammonium hydroxide. Both the protein solution and the undissolved protein will be colored orange.

4. **Biuret Test.**—Partly dissolve a medium-sized piece of the protein in concentrated potassium hydroxide solution. If the proper dilution of copper sulphate solution is now added the white coagulated protein, as well as the protein solution, will assume the characteristic purplish-violet color.

5. **Glyoxylic Acid Reaction (Hopkins-Cole).**—Conduct this test according to the modification given on page 99.

Secondary Protein Derivatives

These derivatives result from a more profound cleavage of the protein molecule than that which occurs in the formation of the primary derivatives. The class included *proteoses*, *peptones*, and *peptides*.

PROTEOSES AND PEPTONES

Proteoses are intermediate products in the digestion of proteins by proteolytic enzymes, as well as in the decomposition of proteins by hydrolysis and the putrefaction of proteins through the action of bacteria. Proteoses are called *albumoses* by some writers, but it seems more logical to reserve the term albumose for the proteose of albumin.

Peptones are formed after the proteoses and it has been customary to

¹ Frank: *Journal of Biological Chemistry*, 9, 463, 1911.

consider them as the last product of the processes before mentioned which still possess true protein characteristics. In other words, it has been considered that the protein nature of the end-products of the cleavage of the protein molecule ceased with the peptones, and that the simpler bodies formed from peptones were substances of a different nature (see page 65). However, as the end-products have been more carefully studied, it has been found to be no easy matter to designate the exact character of a peptone or to indicate the exact point at which the *peptone* characteristic ends and the *peptide* characteristic begins. The situation regarding the proteoses, peptones and peptides is at present a most unsatisfactory one because of the unsettled state of our knowledge regarding them. The exact differences between certain members of the peptone and peptide groups remain to be more accurately established. It has been quite well established that the peptones are peptides or mixtures of peptides, but the term peptide is used at present to designate only those possessing a definite structure.

There are several proteoses (protoproteose, heteroproteose and deuteroproteose), and at least two peptones (amphopeptone and anti-peptone), which result from proteolysis. The differentiation of the various proteoses and peptones at present in use is rather unsatisfactory. These compounds are classified according to their varying solubilities, especially in ammonium sulphate solutions of different strengths. The exact differences in composition between the various members of the group remain to be more accurately established. Because of the difficulty attending the separation of these bodies, pure proteose and peptone are not easy to procure. The so-called peptones sold commercially contain a large amount of proteose. As a class the proteoses and peptones are very soluble, diffusible bodies which are non-coagulable by heat. *Peptones differ from proteoses in being more diffusible, non-precipitable by $(\text{NH}_4)_2\text{SO}_4$, and by their failure to give any reaction with potassium ferrocyanide and acetic acid, potassio-mercuric iodide and HCl, picric acid, and trichloroacetic acid.* Peptones may be precipitated by phosphotungstic acid, phosphomolybdic acid, absolute alcohol and tannic acid, but an excess of the precipitant may dissolve the precipitate. The so-called *primary proteoses* are precipitated by HNO_3 and are the only members of the proteose-peptone group which are so precipitated.

Some of the more general characteristics of the proteose-peptone group may be noted by making the following simple tests on a proteose-peptone powder:

- (1) **Solubility.**—Solubility in hot and cold water and sodium chloride solution.
- (2) **Millon's Reaction.**

Dissolve a little of the powder in water and test the solution as follows:

(1) **Precipitation by Picric Acid.**—To 5 c.c. of proteose-peptone solution in a test-tube add picric acid until a permanent precipitate forms. The precipitate disappears on heating and returns on cooling.

(2) **Precipitation by a Mineral Acid.**—Try the precipitation by nitric acid.

(3) **Coagulation Test.**—Heat a little proteose-peptone solution to boiling. Does it coagulate like the other simple proteins studied?

SEPARATION OF PROTEOSES AND PEPTONES¹

Place 50 c.c. of proteose-peptone solution in an evaporating dish or casserole, and half-saturate it with ammonium sulphate solution, which may be accomplished by adding an equal volume of saturated ammonium sulphate solution. At this point note the appearance of a precipitate of the primary proteoses (protoproteose and heteroproteose). Now heat the half-saturated solution and its suspended precipitate to boiling and saturate the solution with solid ammonium sulphate. At full saturation the secondary proteoses (deuteroproteoses) are precipitated. The peptones remain in solution.

Proceed as follows with the precipitate of proteoses: Collect the sticky precipitate on a rubber-tipped stirring rod or remove it by means of a watch glass to a small evaporating dish and dissolve it in a little water. To remove the ammonium sulphate, which adhered to the precipitate and is now in solution, add barium carbonate, boil, and filter off the precipitate of barium sulphate. Concentrate the proteose solution to a small volume² and make the following tests:

(1) **Biuret Test.**

(2) **Precipitation by Nitric Acid.**—What would a precipitate at this point indicate?

(3) **Precipitation by Trichloroacetic Acid.**—This precipitate dissolves on heating and returns on cooling.

(4) **Precipitation by Picric Acid.**—This precipitate also disappears on heating and returns on cooling.

(5) **Precipitation by Potassio-mercuric Iodide and Hydrochloric Acid.**

(6) **Coagulation Test.**—Boil a little in a test-tube. Does it coagulate?

(7) **Acetic Acid and Potassium Ferrocyanide Test.**

The solution containing the peptones should be cooled and filtered, and the ammonium sulphate in solution removed by boiling with barium carbonate as described above. After filtering off the barium sulphate precipitate, concentrate the peptone filtrate to a small volume and repeat the tests as given under the proteose solution, above. Also try the precipitation by phosphotungstic acid and by tannic acid. In the biuret test the solution should be made very strongly alkaline with solid potassium hydroxide.

PEPTIDES

The peptides are "definitely characterized combinations of two or more amino acids, the carboxyl (COOH) group of one being united

¹The separation of proteoses and peptones by means of fractional precipitation with ammonium sulphate does not possess the significance it was once supposed to possess inasmuch as the boundary between these substances and *peptides* is not well defined (see p. 118).

²If the proteoses are desired in powder form, this concentrated proteose solution may now be precipitated by alcohol, and this precipitate, after being washed with absolute alcohol and with ether, may be dried and powdered.

with the amino (NH₂) group of the other with the elimination of a molecule of water." These peptides are more fully discussed on pages 70 and 118.

REVIEW OF PROTEINS

In order to facilitate the student's review of the proteins, the preparation of a chart similar to the model given is recommended. The signs + and - may be conveniently used to indicate positive and negative reactions.

MODEL CHART FOR REVIEW PURPOSES

Protein	Solubility					Protein Color Test	Precipitation Tests						Salting-out Tests		Diffusion	Coagulation by Heat	
	Water	10 % NaCl	0.2 % HCl	0.5 % Na ₂ CO ₃	Conc. HCl		Conc. KOH	Mineral Acid (HNO ₃)	Metallic Salt (HgCl ₂)	Alcohol	Pot. Ferrocyanide + Acetic Acid	Potassio-mercuric Iodide + HCl	Picric Acid	Trichloroacetic Acid			(NH ₄) ₂ SO ₄
Albumin																	
Globulin																	
Nucleoprotein																	
Phosphoprotein																	
Glucoprotein																	
Acid metaprotein																	
Alkali metaprotein																	
Proteose																	
Peptone																	
Coagulated protein																	

"UNKNOWN" MIXTURES AND SOLUTIONS OF PROTEINS

At this point the student's knowledge of the characteristics of the various proteins studied will be tested by requiring him to examine several "unknown" protein mixtures or solutions and make full report upon the same. The scheme given on page 122 may be used in this examination.

SCHEME FOR THE DETECTION OF PROTEINS

If the solution is acid or alkaline it should be *approximately* neutralized. If the solution is acid or alkaline it should be *approximately* neutralized. The neutralization need not necessarily proceed until an exact neutral reaction is obtained but should cease at the point where the largest precipitate is secured.

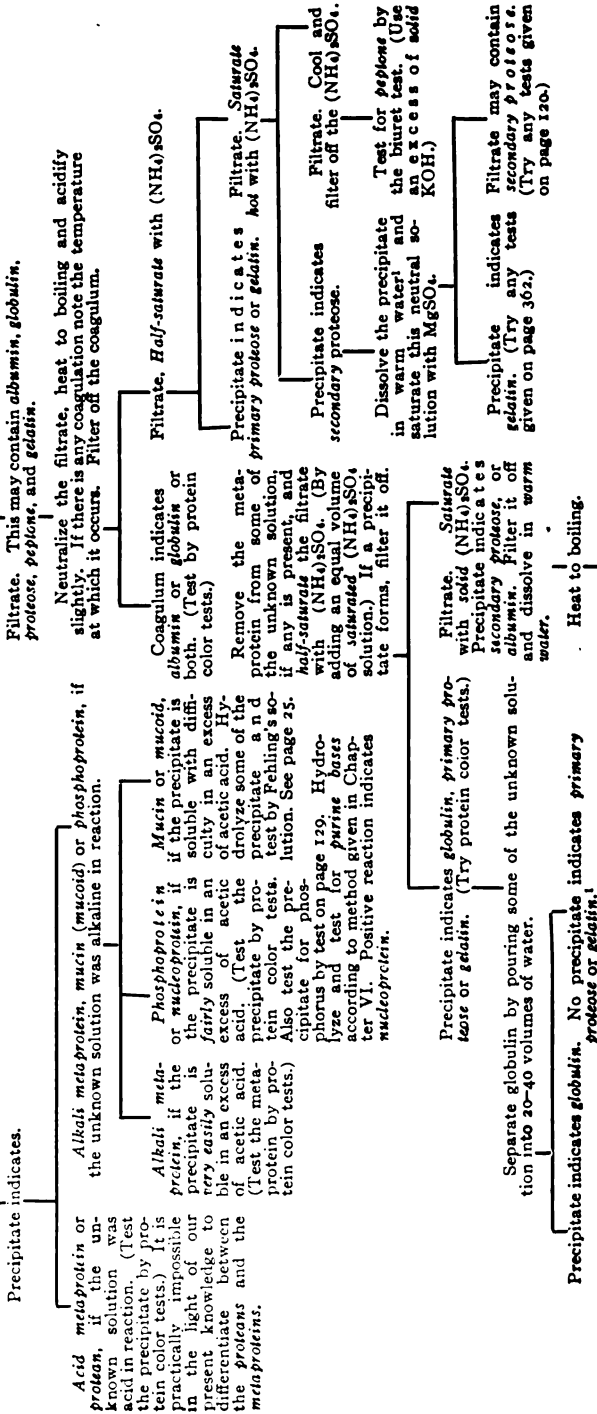

Precipitate indicates globulin, primary proteose or gelatin. No precipitate indicates *primary proteose or gelatin*.¹

Separate globulin by pouring some of the unknown solution into 20-40 volumes of water.

Precipitate indicates *globulin, primary proteose or gelatin*. (Try protein color tests.)

Filtrate. *Saturate* with solid $(NH_4)_2SO_4$. Precipitate indicates *secondary proteose, or albumin*. Filter it off and dissolve in warm water.

Heat to boiling.

No coagulation indicates *secondary proteose*. (Try protein color test.)

Coagulation indicates *albumin*.

¹ We may also differentiate between gelatin and proteose by means of the Hopkins-Cole reaction (see page 99). A positive reaction here would indicate proteose and a negative reaction would indicate gelatin.

CHAPTER VI

NUCLEIC ACIDS AND NUCLEOPROTEINS¹

The Nucleoproteins.—The nucleoproteins occur widely distributed in the animal and plant kingdoms, being found in nearly all cells and particularly in the nuclei of cells. They are found in especially large amounts in glandular tissues such as those of the thymus, pancreas and spleen. The nucleoproteins are combinations of protein with a phosphorus-containing substance known as nucleic acid. As different nucleic acids exist and are found in combination with different proteins, a variety of nucleoproteins exist. The protein combined with the nucleic acid is in certain cases a histone, the conjugated protein in this case being called a nucleohistone.

The nucleoproteins give the ordinary protein color reactions. They are acidic in character and insoluble in water. They are readily soluble in weak alkali but are precipitated from such solution on the addition of acetic acid in excess of which they dissolve with more or less difficulty although readily soluble in dilute hydrochloric acid. We distinguish them from mucins, which are likewise precipitated by acetic acid through the fact that the latter give no tests for phosphorus on decomposition.

The nucleoproteins are very complex and unstable substances and are probably in many cases to be considered as mixtures of protein and nucleic acid rather than as definite compounds. Under the action of the gastric juice or of weak acid nucleoproteins lose a portion of their protein content and are transformed into a rather ill-defined class of substances known as *nucleins* which still possess some protein in combination with the nucleic acid molecule. In most cases the decomposition does not proceed further in gastric digestion. Through the action of the pancreatic juice, however, the remainder of the protein is split off and the nucleic acid set free. The decomposition of nucleoprotein may be diagrammatically expressed thus, although the course of decomposition is probably not quite so simple as indicated.

¹ For review of the literature on nucleic acids and nucleases see Monograph on "Nucleic Acids" by Walter Jones, New York, 1914, Longmans Green & Co.

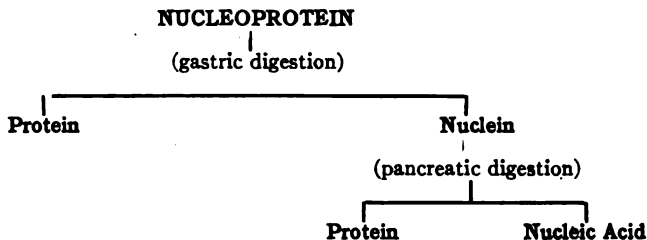

The Nucleic Acids.—The nucleic acids of the animal body occur mainly in combination with protein material in the so-called nucleoproteins of which they form the characteristic radicals (see page 123). The amount and character of the protein with which the nucleic acid molecule is combined varies and the acid may in certain cases be found in cells in a free form. Naturally those tissues are richest in nucleic acid which contain the largest amount of nuclear material and of nucleoprotein. Such are the glandular tissues of the body as the thymus, spleen, pancreas, liver, etc. The heads of the spermatozoa consist almost entirely of nucleic acid in combination with protamine.

The nucleic acids are a distinct class of substances, characterized by their decomposition products. They are strongly acid in reaction and contain considerable phosphorus. They may be divided into two main groups, the *animal* and the *plant* nucleic acids. The two classes differ in certain respects but all of the true animal nucleic acids appear to be practically identical in composition. Animal nucleic acid is most readily prepared from the thymus while plant nucleic acid is most readily obtained from yeast.

The nucleic acids are difficultly soluble in cold water, more readily in hot water, insoluble in alcohol, but readily soluble in weak alkali with the formation of the alkali salt. If pure they do not give the protein color reactions. They are optically active. They are precipitated from their alkaline solutions by HCl, but only the plant nucleic acid is precipitated by acetic acid. In weak acid solution they are precipitated by protein the combination being considered a "nuclein." They form insoluble salts with alkaline earth and heavy metals. The sodium salt of animal nucleic acid in 4 per cent solution is liquid while warm but solidifies to a gelatinous mass on cooling. Plant nucleic acid does not do this.

The nucleic acids on hydrolysis yield phosphoric acid, purine and pyrimidine bases, and a carbohydrate or carbohydrate derivative. The composition varies slightly with the type of nucleic acid. Plant nucleic acids contain a pentose group while animal nucleic acids contain a

hexose group. Both types contain the purine bases, guanine and adenine and the pyrimidine base cytosine. Plant nucleic acid contains also the pyrimidine base uracil, which in the animal nucleic acid is substituted by the base thymine. The nucleic acids are not, however, simple substances whose molecules contain a single phosphoric acid or carbohydrate group. They are apparently combinations of several radicals known as *nucleotides* each of which contains one carbohydrate group combined with a single base and a single phosphoric acid molecule. Thus the following structural formula has been suggested for yeast nucleic acid by Jones and Read¹ indicating that it contains four nucleotide radicals linked through the carbohydrate groups. Levene² does not consider this linkage through carbohydrate as established. All agree that the compound is a tetranucleotide.

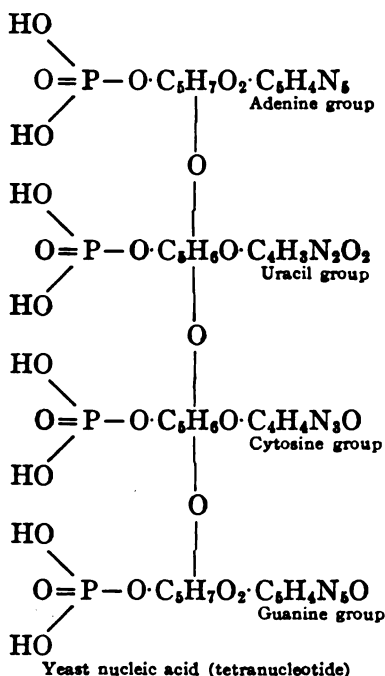

The cleavage of the nucleic acid molecule into its corresponding nucleotides is brought about during digestion by enzymes present in the intestinal juice and intestinal mucosa. Enzymes of similar origin act further on the nucleotides thus formed and split off the phosphoric acid radicals together with carbohydrate-base compounds which are called *nucleosides*. The decomposition prior to absorption does not probably proceed further than to the formation of nucleotides and

¹ Jones and Read: *Jour. Biol. Chem.*, 31, 111, 1917.

² Levene: *Jour. Biol. Chem.*, 31, 591, 1917.

nucleosides. Many tissues however contain enzymes capable of completing the decomposition with liberation of the carbohydrate and basic radicals. The purine bases may also be deaminized while still in combination as nucleosides and further hydrolysis would then lead to the direct liberation of the oxypurines instead of their precursors, the amino-purines.

Jones¹ has suggested a method by which the course of the decomposition of the nucleic acid molecule can be followed. By this means it is readily shown that phosphoric acid is liberated at very different rates from the different nucleotides.

The following outline will indicate the course of decomposition of a nucleic acid and the enzymes involved in the process.

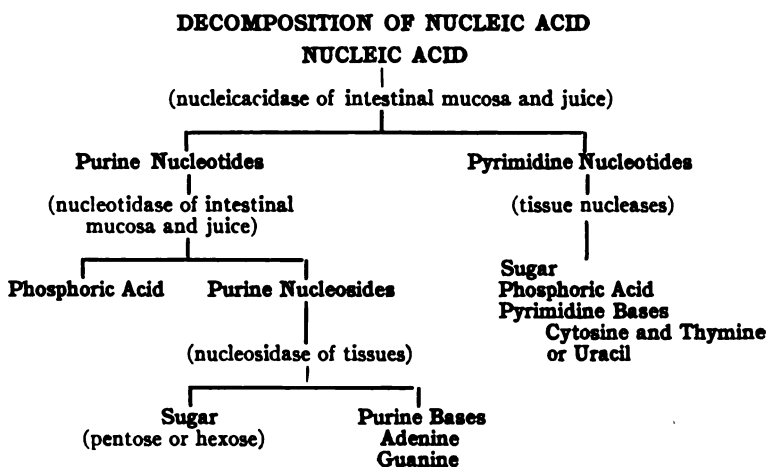

With regard to the fate of the various radicals of the nucleic acids in the body after absorption little is definitely known. The phosphoric acid may of course be built up into phosphorus-containing cell constituents such as nucleoproteins, phosphoproteins or phosphatides, or be eliminated as phosphate in the urine. The carbohydrate portion may undergo the usual transformations of intermediary carbohydrate metabolism. The nucleosides appear to be ordinarily absorbed unchanged from the intestine and may be to a certain extent directly re-synthesized in the animal body to nucleoprotein. The excess over body requirement must, however, be decomposed, although a certain portion may possibly be stored up in the individual cells or in certain organs. Enzymes capable of decomposing nucleic acids are found in most of the cells of the body.

The Purine Bases.—As has been indicated the basic substances present in nucleic acid belong to two classes the *purine* and *pyrimidine*

¹ Jones: Presidential address before the Society of Biological Chemists, Boston, Dec 27, 1915.

bases. The purine bases set free on the decomposition of nucleic acid are *adenine* and *guanine* belonging to the class of *amino purines*. The fate of the amino purines in the animal body is of considerable interest. It has been shown that certain tissues contain enzymes which transform these amino purines first to corresponding *oxypurines* known as *hypoxanthine* and *xanthine* and finally to *uric acid*. It is probable that different enzymes enter into the various steps of these transformations leading to the formation of uric acid. Still another enzyme carries the oxidation further with the formation of the compound *allantoin*. This enzyme is known as *uricase*. The purine enzymes are widely distributed in tissues. The transformations brought about are indicated in the following diagrams.

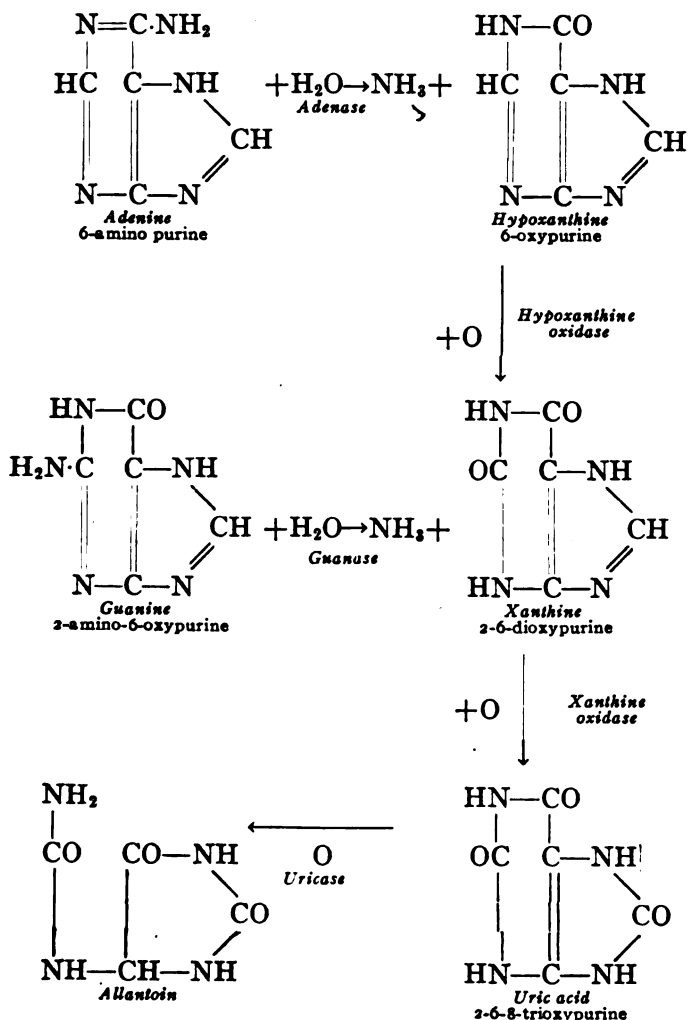

All of the physiologically important purine bodies are precipitated by ammoniacal silver nitrate solution in the cold and by copper sulphate and sodium bisulphite in boiling solutions. Some of them are readily identified by their crystalline forms or the crystalline forms of certain of their salts. Uric acid differs from the other purines in being insoluble in dilute sulphuric acid. The purine bodies may be distinguished to a certain extent also by the reactions which they give when their solutions are evaporated with nitric acid and the residue treated with ammonia. Uric acid gives the characteristic formation of the purple murexide (ammonium purpurate). Potassium hydroxide changes this to a bluish-violet color which disappears on heating. Xanthine and guanine form yellow compounds with nitric acid which turn purple or violet on treating with potassium hydroxide. The color in this case is not lost by heating. Adenine and hypoxanthine do not give a color reaction with nitric acid.

The Pyrimidine Bases.—The pyrimidine bases entering into the composition of nucleic acid are *thymine*, *cytosine* and *uracil*. Cytosine is found in both types of nucleic acid, while thymine is found only in animal nucleic acid and uracil only in plant nucleic acid. They possess the following formulas.

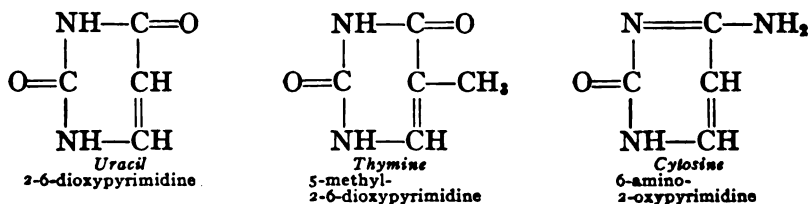

With regard to the fate of pyrimidine bases in metabolism very little is known. When the bases as such are fed they reappear unchanged in the urine.¹ If nucleic acid is fed this does not occur which indicates that the pyrimidine bases may undergo certain alterations in the animal body while still existing in combination.

EXPERIMENTS

1. Preparation of Nucleoprotein from Yeast.²—Place two small cakes of ordinary compressed yeast in a mortar. Sprinkle a small horn-spoonful of sand over the yeast, add 5 c.c. of ether and 10 c.c. of water and thoroughly triturate the mixture, grinding vigorously. The ether kills the yeast, in which condition the comminution of the cells with sand is more thoroughly effected. Occasionally during the trituration process add 1 or 2 c.c. of water until the mixture is comparatively fluid. The whole process of maceration can be completed in five

¹ Mendel and Myers: *Am. J. Physiol.*, 26, 77, 1910.

² All experiments on nucleoprotein of yeast have been taken from Laboratory Notes of Professor W. J. Gies, of College of Physicians and Surgeons, New York.

minutes. Pour the thick liquid into a bottle aiding the transfer with enough 0.4 per cent NaOH to make a final volume of about 125 c.c. The alkali extracts the nucleoprotein along with the water-soluble proteins of the yeast. Add a little toluene and allow to stand with frequent shaking for 12–24 hours. Filter through a wet, fluted filter. While thoroughly stirring add 1 drop at a time of 10 per cent HCl cautiously continuing the addition as long as the milkiness of the mixture can be increased. Continue until the protein completely separates and the liquid is practically clear. Note that the solution is now acid in reaction. Excess of acid causes resolution. Filter on a wet, fluted filter. Retain the precipitate on the filter for nucleoprotein tests.

2. Tests on Nucleoprotein.—Try the following tests on the nucleoprotein prepared as above.

(a) Try the xanthoproteic and Millon's tests.

(b) Test the solubility in water, 10 per cent NaCl, 10 per cent HCl, dilute KOH, and alcohol.

(c) Test for organically combined phosphorus by one of the following methods.

Tests for Phosphorus in Organic Matter.—1. Fusion Test.—To a small amount of the substance in a crucible add about five times its bulk of fusion mixture (2 parts of sodium carbonate to 1 of potassium nitrate). Heat carefully until the resulting mixture is colorless. Cool, dissolve the mass in a little warm water, acidify with nitric acid, heat to about 65°C. and add a few cubic centimeters of molybdate solution. In the presence of phosphorus a yellow precipitate ammonium of phosphomolybdate is formed.

Instead of acidifying with nitric acid, the aqueous solution may be approximately neutralized with hydrochloric acid, a few cubic centimeters of magnesia mixture added and then excess of ammonium hydroxide solution. A white precipitate of magnesium ammonium phosphate is formed.

2. Moist Ashing Procedure.—Treat a small amount of the substance in a large test-tube with about 1 c.c. of concentrated sulphuric acid. Then add drop by drop an equal volume of concentrated nitric acid, and warm gently until a clear solution is obtained. A few more drops of nitric acid may be added if necessary. This treatment with sulphuric and nitric acids must be carried out with the greatest caution particularly when fatty substances are present; otherwise an explosive reaction may take place. Dilute the acid solution with a little water, make slightly alkaline with ammonia and then acid with nitric acid. Add molybdate solution and warm. A yellow precipitate is formed.

(d) Dissolve a little of the precipitate in very dilute KOH and then make slightly acid with acetic acid.

(e) Mix a small portion of the nucleoprotein with 10 c.c. of alcohol. Filter and wash free from HCl with more alcohol. (Freedom from HCl is indicated by absence of AgNO₃-chloride reaction in the filtrate.) Wash free from alcohol with a little water. Transfer small particles of the precipitate to moistened red and blue litmus paper on a microscopic slide. What is the reaction of nucleoprotein thus freed from adherent acid?

3. To Show the Presence of Purine Base Radicals in Nucleoprotein.—The nucleic acid portion of the protein molecule contains phosphoric acid, carbohydrate, and purin base radicals (see page 126). Hence on the complete acid hydrolysis of nucleoprotein material these substances will be liberated as well as the decomposition products of the protein part of the molecule. To show their pres-

ence proceed as follows: Transfer the precipitate of nucleoprotein remaining from the previous experiment to a small flask and add 25–50 c.c. of 5 per cent H_2SO_4 . Boil for an hour or more to decompose. Maintain the original volume by adding water. The solution becomes brown due to formation of melanin-like substances. The purine bases are set free. Retain one-fourth of the solution for the next experiment. Transfer the remainder to a casserole and add ammonia with thorough mixing, a little at a time, until the fluid is nearly neutral. Then make slightly alkaline with dilute ammonia and filter if not clear. Transfer to a beaker and add about 10 c.c. of 5 per cent ammoniacal silver nitrate solution. Purine bases if present will yield a brown flocculent precipitate of their silver compounds. If a precipitate does not appear immediately, examine the solution after it has been allowed to stand for some time undisturbed.

4. To show the Presence of Protein, Carbohydrate, and Phosphoric Acid Radicals in Nucleoprotein.—Filter the greater portion of the acid liquid which was reserved from the preceding experiment. Apply the following tests to portions of it: (a) The biuret test. (b) The xanthoproteic test. (c) Molisch test. (d) Fehling's test. (e) Test for phosphate.

5. Preparation of Thymus Nucleoprotein.—About 100 grams of fresh thymus gland (lymphatic glands may also be used) freed as nearly as possible from adherent fat are run through a meat chopper. To this material in a flask add 300 c.c. of 0.9 per cent NaCl and allow to stand 24–48 hours in the cold. A little chloroform and toluene should be added as preservatives, and the mixture shaken occasionally during this period. Filter. A milk white liquid is obtained. Precipitate the nucleoprotein from solution by the careful addition of dilute acetic acid. Excess of the acid should be avoided. Ordinarily acetic acid to make a 1 per cent solution is sufficient. Filter off the precipitate. Wash with alcohol and then with ether and dry.

6. Experiments on Thymus Nucleoprotein.—Repeat the experiments given under Yeast Nucleoprotein (page 129).

7. Preparation of Yeast Nucleic Acid.—Dilute 50 c.c. of 1 per cent NaOH with 250 c.c. of water in a casserole and add to this solution 100 grams of compressed yeast cut in small pieces. Heat on the water-bath for half an hour with occasional stirring. Remove from the bath and filter at once through a folded filter. To the cooled filtrate add acetic acid until faintly acid to litmus. Filter again. Evaporate the solution to 100 c.c. or less and filter if necessary. Allow to cool to 40°C. or below, then pour with vigorous stirring into 200 c.c. of 95 per cent alcohol containing 2 c.c. of concentrated HCl. Allow to settle and wash the precipitate by decantation in a tall vessel, twice with 95 per cent alcohol and twice with ether. Transfer to a filter paper. Allow to drain and dry at room temperature.

8. Tests on Nucleic Acid from Yeast.¹—1. Test the solubility of nucleic acid in cold and hot water, in alcohol, and in dilute acid and alkali. To the solution in alkali add dilute HCl drop by drop until the solution is acid, then add excess of concentrated HCl.

Does nucleic acid coagulate on boiling? Does the solution in hot water gelatinize on cooling?

2. Try xanthoproteic reaction and biuret test.

3. Dissolve a little nucleic acid in water with the aid of heat. Test the re-

¹ A satisfactory preparation of yeast nucleic acid may be obtained from Merck and Co.

action of different portions of the solution with litmus, alizarin, and Congo red solution.

4. Boil a small portion of the nucleic acid with about 10 c.c. of 10 per cent sulphuric acid for one to two minutes. Divide into three portions.

(a) To one portion apply carbohydrate tests, e.g., the α -naphthol (Molisch) reaction and Bial's test. What do these indicate?

(b) To a second portion apply a test for purine bases. Add an excess of ammonia and then a little silver nitrate solution.

(c) To the third portion apply test for phosphate, adding ammonia in slight excess, then making acid with nitric acid, adding molybdic solution and warming.

9. Preparation of Thymus Nucleic Acid.¹—"To a boiling mixture of 200 c.c. of water, 10 grams of sodium acetate and 3.3 grams of NaOH, is added in small successive portions 100 grams of trimmed and finely ground thymus gland. The tissue usually dissolves completely forming a pale brown liquid, but any resistant portions are either removed or gotten into solution by heating for a short time over a small flame. The vessel containing the products is now immersed in a briskly boiling water-bath where it is allowed to remain with occasional stirring for two hours, when the product is diluted with one-third its volume of water and made faintly but distinctly acid to litmus with 50 per cent acetic acid. The amount of acid required is about 10 c.c. but the final additions must be made with care because the fluid will not filter unless the proper condition of acidity is reached. Any difficulty met at this point may be easily overcome by the alternate addition of acetic acid and sodium hydroxide and testing a small portion of the material after each addition on a small flat filter that has been heated with boiling water. When the acidity has finally been obtained which is favorable to rapid filtration, the material is heated to vigorous boiling and filtered with a hot water funnel. Under proper conditions the filtration proceeds with considerable rapidity and continuously leaves a green slime on the filter and gives a pale yellow filtrate which gelatinizes upon cooling. The filtrate and washings are evaporated on a water-bath to about 75 c.c. and while warm the concentrated solution is poured slowly into 100 c.c. of 95 per cent alcohol. On standing over night the precipitated *sodium nucleate* settles sharply to a spongy white mass from which the bulk of brown alcoholic fluid can be sharply decanted and the remainder pressed out with a spatula leaving the material in one cohesive mass. The substance is washed by decantation in turn with 80 per cent and 95 per cent alcohol and, after pressing out the last wash fluid as far as possible is transferred to a flask with 30 c.c. of hot water and heated on a water-bath. In half an hour or less, insoluble phosphates will collect leaving a perfectly transparent interstitial fluid which is treated with 1 c.c. of 20 per cent NaOH to lower the viscosity and filtered with a hot water funnel. The perfectly transparent yellow filtrate is acidified with acetic acid and poured into 70 c.c. of 95 per cent alcohol when sodium nucleate will be precipitated which can be washed by decantation as before with alcohol of increasing strength and ground in a mortar with absolute alcohol until it has crumbled to a fine white powder. If necessary the absolute alcohol may be decanted and renewed once or twice but not oftener because the nucleate emulsifies with alcohol after the last traces of acetic acid and sodium acetate have been washed away. The material is finally washed on a filter with absolute alcohol and allowed to dry in a sulphuric acid desiccator. The yield of nucleic acid is about 3.3 grams from 100 grams of gland. The product is a fine white non-hygroscopic powder

¹ From Monograph on "Nucleic Acids" by Walter Jones: Longmans, Green & Co.

that can scarcely be improved by any method of purification. It is a soluble sodium salt of thymus nucleic acid but is generally referred to simply as thymus nucleic acid. Very similar or identical substances may be prepared by the same procedure from other animal tissues, rich in cell nuclei such as the pancreas and spleen."

10. Tests on Thymus Nucleic Acid.—1-4. Repeat the experiments as given under yeast nucleic acid, page 130. 5. Make a 4 per cent solution of thymus nucleic acid in hot water (0.4 gram to 10 c.c.). Allow to cool. What happens? Divide into two portions. To one add a little NaOH solution; to the other add acetic acid. Then neutralize carefully in each case.

Both acetic acid and NaOH decrease the viscosity of the nucleate solution. It may be changed back and forth from the gelatinous to the fluid condition by the alternate addition of acid and alkali.

11. Tests on Purine Bases and Derivatives.—(a) **Xanthine.**—1. **Silver Nitrate Reaction.**—Dissolve a little xanthine in ammonia and add silver nitrate solution. Examine a little of the precipitate microscopically. (See page 380.)

2. **Copper Sulphate Reaction.**—Dissolve a little of the substance in dilute alkali, make faintly acid with acetic acid. Heat to boiling. Add 1 c.c. 10 per cent CuSO_4 and then a few drops at a time of sodium bisulphite (saturated solution) until the precipitate becomes yellowish. All of the purines give this reaction.

3. **Nitric Acid Test.**—Place a small amount of the substance in a small evaporating dish, add a few drops of concentrated nitric acid, and evaporate to dryness very carefully on a water-bath. The yellow residue upon moistening with caustic potash becomes red in color and upon further heating assumes a purplish-red hue. Now add a few drops of water and warm. A yellow solution results which yields a red residue upon evaporation. Compare with similar reaction on other purine bases and uric acid. (See Murexide test, Chapter XXIII.)

4. **Weidel's Reaction.**—Bring a small amount of the substance into solution in bromine water. Evaporate to dryness on a water-bath. Remove the stopper from an ammonia bottle and by blowing across the mouth of the bottle direct the fumes of ammonia so that they come into contact with the dry residue. Under these conditions the presence of xanthine is shown by the residue assuming a red color. A somewhat brighter color may be obtained by using a trace of nitric acid with the bromine water. By the use of this modification, however, we may get a positive reaction with bodies other than xanthine.

(b) **Hypoxanthine.**—1. Repeat Experiments 1 and 3 under Xanthine. Examine the crystals of hypoxanthine silver nitrate under the microscope. (See page 380.)

2. Dissolve a little of the substance in a very small amount of hot 6 per cent nitric acid and allow to cool. Characteristic whetstone crystals of hypoxanthine nitrate should be formed. Examine under the microscope. (See Fig. 40, page 136.)

(c) **Adenine.**—1. Warm a few crystals of adenine in a test-tube with a little water. They should become cloudy at 53°C.

2. Dissolve a little adenine in hot water and add a few drops of picric acid. Examine the pale yellow crystals under the microscope. The picrate crystallizes as needle clusters.

3. Repeat Experiment 3 under Xanthine.

(d) **Guanine.**—1. Dissolve a little substance in 20–25 times its weight of boiling 5 per cent alcohol. Allow to cool and examine crystals microscopically.

2. For other tests on uric acid see Chapter XXIII on Urine.

3. Dissolve a little guanine in 20–25 times its weight of boiling 5 per cent hydrochloric acid. Allow to cool and examine crystals under microscope. (See Fig. 39, page 135.)

4. Perform Experiment 3 under Xanthine.

(e) **Uric Acid.**—1. On a small amount of uric acid try the test as given under Xanthine number 3. This test on uric acid is called the Murexide test.

12. **Isolation of Guanine and Adenine from Nucleic Acid (Method of Walter Jones).**¹—The amino purines may be isolated from yeast or thymus nucleic acid or from glandular tissue (such as the pancreas) after hydrolysis of the material with sulphuric acid.

In the case of yeast nucleic acid, heat 10 grams of the substance with 50 c.c. of 10 per cent sulphuric acid on a boiling water-bath for about two hours, replacing any water lost, or using a condenser tube. To the hot solution add concentrated ammonia slowly until approximately neutral. Then add enough excess of ammonia to make about a 2 per cent solution. Filter off the precipitate of guanine and wash it with 1 per cent ammonia. Dissolve in as small an amount of 20 per cent sulphuric acid as possible, add a little animal charcoal and boil. Filter, heat to boiling and precipitate with excess of ammonia. Filter, dry the precipitate at 40°C. and dissolve it in about 20 parts of boiling 5 per cent hydrochloric acid. As the solution cools guanine chloride separates out as needle-shaped crystals. Filter off, wash with very dilute hydrochloric acid and dry in the air (do not put in desiccator). Perform the nitric acid test on the product.

Combine the ammoniacal filtrates obtained in the isolation and purification of guanine. Filter if necessary. The ammonia may then be boiled off and an excess of picric acid added in which case a yellow precipitate of adenine picrate is produced which is filtered off and dried. It is better, however, to neutralize the ammonia of the combined filtrates and make faintly acid with sulphuric acid. Then precipitate the adenine as its copper compound (see directions under experiment on Demonstration of Nucleases B) decomposing this with hydrogen sulphide and evaporating the filtrate from the copper sulphide to dryness on the water-bath. Dissolve the residue in hot 5 per cent sulphuric acid and allow to crystallize out. If necessary dissolve in hot water decolorize with a little charcoal and allow to crystallize out again. The compound has the formula $(C_5H_5N_5)_2 \cdot H_2SO_4 \cdot 2H_2O$. Apply the picric acid and nitric acid tests as given under adenine (page 132).

13. **The Pyrimidine Derivatives.**—The pyrimidine derivatives, cytosine, thymine, and uracil, are separated from nucleic acid with some difficulty. The following test may be made on a solution of cytosine or uracil. Thymine does not give the test.

Wheeler-Johnson Reaction for Uracil and Cytosine.—To about 5 c.c. of the solution under examination add bromine water until the color is permanent. Avoid the addition of a large excess as this will interfere with the test. In case the solution contains only small quantities of cytosine or uracil it is advisable to remove any excess of bromine by passing a stream of air through the

¹ See Walter Jones: Monograph on "Nucleic Acids," 1914, Longmans, Green & Co.

solution. Now add an excess of an aqueous solution of barium hydroxide and note the appearance of a purple color.

Very dilute solutions do not give the test. Under these conditions the solution should be evaporated to dryness, the residue dissolved in a little bromine water and the excess of bromine removed. Then upon adding an excess of barium hydroxide a decided bluish-pink or lavender color will appear in the presence of as small an amount as 0.001 gram of uracil.

In testing solutions for cytosine it is preferable to warm or boil the solution with bromine water, and after cooling the solution to apply the test as suggested above, being careful to have a slight excess of bromine present before adding barium hydroxide.

14. Demonstration of Nucleases and Purinases in Tissues.¹—All glandular tissues contain nucleic acids and enzymes capable of their hydrolysis as well as the transformation of liberated purine bodies. By allowing autolysis (self-digestion) to take place in such a tissue and studying the products formed it is possible to determine what enzymes were present in the tissue under examination. Typical results may be obtained by using ox and pig spleens, which differ in the purine enzymes which they contain. The two experiments should be run in parallel.

A. Preparation of the Material for Digestion.—Run the gland once or twice through a meat chopper. Introduce about 650 grams into a two liter bottle, fill about three-quarters full of water, add 20 c.c. of chloroform, and allow to remain at room temperature for 12–36 hours with occasional agitation. Strain through linen and replace the turbid extract in the bottle with 10 c.c. of chloroform. This solution contains the enzymes and nucleic acid of the tissue. (Reserve 50 c.c. of one of the extracts for the experiment on phosphonuclease (E), which should also be started at this time.) The bottle is tightly closed and allowed to remain in the thermostat 4–5 days.

B. Separation of Purine Derivatives from Other Substances.—Introduce the products into a saucepan or large evaporating dish, heat to brisk boiling, make faintly alkaline with caustic soda, boil a few minutes, make faintly acid with acetic acid, boil vigorously and filter hot. (If desired one-half of the filtrate may be treated with 100 c.c. of 20 per cent sulphuric acid per liter and boiled for one hour, keeping at constant volume. At the end of the hydrolysis the sulphuric acid is nearly neutralized with caustic soda and the purine bases of the solution determined as in the other half of the filtrate. This will give information as to the presence of deaminases acting upon the amino purines remaining in combination.) To the boiling filtrate add 100 c.c. of 10 per cent copper sulphate and small successive portions (2–5 c.c.) of sodium bisulphite (commercial saturated solution) until the precipitate takes on a decided yellow color due to precipitation of cuprous oxide. Filter, wash the precipitate with boiling water, pierce the filter and wash the precipitate into a flask. Add 1 per cent sodium sulphide solution to decom-

¹ From Monograph on "Nucleic Acids" and Laboratory Notes in Physiological Chemistry by Professor Walter Jones of Johns Hopkins University, with additions.

pose the copper compound continuing the addition until the precipitate becomes uniformly black and then in small successive portions, testing a drop of the product after each addition by bringing it into contact with a drop of lead acetate on a filter paper. To the boiling fluid add acetic acid (in the case of the extract of pig's spleen and other solutions containing guanine the acetic acid should be replaced by dilute sulphuric) until the insoluble copper sulphide collects and filter the hot fluid as quickly as possible.

C. Treatment of the Filtrate from Pig's Spleen.—When the filtrate from the copper sulphide is cold make strongly alkaline with ammonia and precipitate the purine compounds with a slight excess of ammoniacal silver nitrate. Filter, wash thoroughly with cold water. Pierce the paper, wash the precipitate into a flask with boiling water and decompose the silver precipitate with hydrochloric acid. When enough acid has been added the silver chloride will settle as a heavy caseous precipitate leaving clear interstitial fluid. Filter and heat the filtrate to boiling. Treat with an excess of ammonia (enough to make about 1-2 per cent).

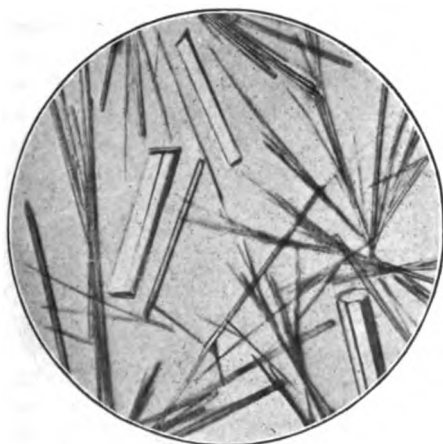

FIG. 39.—GUANINE CHLORIDE.

(Reproduced from crystals furnished by Professor Walter Jones.)

Allow to cool and filter off the guanine which precipitates. Wash the guanine with 1 per cent ammonia and then suspend it in a little hot water and add a few drops of 20 per cent sulphuric acid to dissolve it. At the boiling point add a little animal charcoal, boil and filter. Make strongly alkaline with ammonia. Snow white guanine is precipitated. Dissolve the precipitate in 20 volumes of boiling 5 per cent hydrochloric acid. Upon cooling beautiful needle-shaped crystals of guanine chloride separate. (See Fig. 39.)

Evaporate the filtrate from the guanine to dryness on the water-bath to expel ammonia. Moisten with hydrochloric acid and again evaporate. Treat the residue with warm water. Does it dissolve almost completely indicating the absence of xanthine and uric acid? Test a drop of the solution with picric acid. If no precipitate is obtained adenine is absent. Evaporate to dryness, moisten with alcohol and again evaporate. Dissolve the residue in about 30 parts of hot 6 per cent nitric acid. On cooling, characteristic whetstone crystals of hypoxanthine nitrate form. (See Fig. 40, page 136.) The xanthine nitric acid color test should be practically negative on this product.

What does the finding of guanine and hypoxanthine but not adenine or xanthine indicate as to the type of purine deaminase present in the pig's spleen?

D. Treatment of Filtrate from Ox Spleen.—The filtrate from the copper sulphide should be evaporated to dryness on the water-bath. Extract with cold water. Test a part of this aqueous solution with picric acid. A lack of precipitate indicates the absence of adenine. To another portion add ammonia (a lack of precipitate indicates the absence of guanine), and then a little ammoniacal silver nitrate solution (lack of appreciable precipitate indicates absence of purines of any kind in more than traces). Dissolve half of the residue, which should consist mainly of uric acid and xanthine, in as few drops of concentrated sulphuric acid as possible and dilute with 4 volumes of water. Stir until the uric acid begins to separate and then let stand for about three hours. The uric acid is completely precipitated. Apply the murexide test. To the remainder of the xanthine-uric acid residue add a little 4 per cent potassium hydroxide solution. Warm and add an equal volume of 30 per cent nitric acid. Allow to cool.

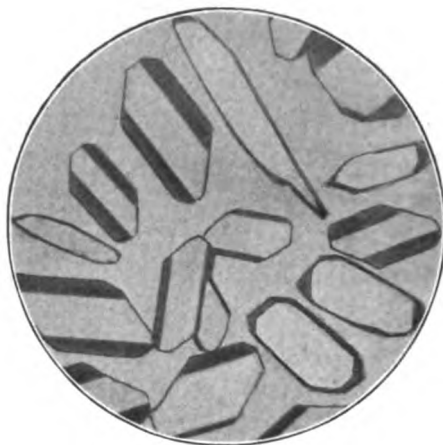

FIG. 40.—HYPOXANTHINE CHLORIDE.¹
(Reproduced from crystals furnished by Professor Walter Jones.)

Xanthine nitrate separates out in a granular form, showing characteristic crystals under the microscope. Apply the nitric acid test.

What does the presence of uric acid and xanthine and the absence of guanine and adenine indicate as to the purine enzymes of ox spleen?

E. Demonstration of Nucleotidase (Phosphonuclease).—In this experiment use the 50 c.c. portion of enzyme solution retained from Experiment A preceding. Prepare a 2 per cent solution of yeast nucleic acid aiding the solution by the slow addition of KOH solution until the reaction, as indicated by a few drops of litmus added, is neutral. Prepare a series of three large test-tubes as follows: In No. 1 place 10 c.c. of enzyme solution and 5 c.c. of nucleic acid. In No. 2 place 10 c.c. of enzyme solution and 5 c.c. of water. In No. 3 place 10 c.c. of enzyme solution, boiled and 5 c.c. of nucleic acid. To each tube add 2–3 c.c. each of CHCl_3 and toluene as preservatives. Place the tubes at 37°C. for 24 hours. Add 1 c.c. of litmus solution to each tube and note whether any changes in reaction have taken

¹Hypoxanthine nitrate crystallizes in similar form.

place. Put the tubes in boiling water for a few minutes to coagulate proteins. Then add 5 c.c. of 5 per cent HCl and let stand for an hour. This precipitates any unaltered nucleic acid which may be present. Filter and take an aliquot portion of each filtrate (15 c.c.). Add magnesia mixture and a few cubic centimeters of strong ammonia. Let stand over night. Any phosphoric acid present will be precipitated as magnesium ammonium phosphate. Observe the relative amounts of phosphate in each case. Has any phosphate been set free from the nucleic acid added? From the nucleic acid of the gland extract?

15. Experiments on Uricase (Uricolytic Enzyme).—A. Preparation of Extract Containing Uricase.—Extract about 50 grams of pulped kidney tissue of the ox with 200 c.c. of toluene or chloroform water at 38°C. for 24 hours, with occasional shaking. Filter and use the filtrate in the following experiment.

B. Demonstration of Uricase.—Add about 0.1 gram of uric acid to 10 c.c. of water and bring the uric acid into solution by the addition of the minimal quantity of KOH. To 5 c.c. of this uric acid solution in a test-tube add 50 c.c. of the uricolytic enzyme extract prepared as described above. Prepare a second tube containing a like amount of the uric acid solution but boil the extract before it is introduced. Place the two tubes at 38°C. for two days. The vessels should be open to the air and the contents stirred occasionally, or much better, a continuous current of air which has gone through a chloroform wash bottle is passed through the mixture. Make both mixtures faintly acid with acetic acid and boil. Filter and take an aliquot of each filtrate. Evaporate to low volume, make faintly alkaline with ammonia and filter. Add a few cubic centimeters of ammoniacal silver nitrate solution. Any uric acid will be precipitated as silver urate. The control should give a heavy precipitate while the test should show no precipitate or one much lighter than the control, due to uric acid destruction in the latter case.

If it is desired to separate out the pure uric acid the silver-purine precipitate may then be filtered off. It is washed with water and transferred to a beaker with the aid of a little water. To the mixture add a few cubic centimeters of hydrogen sulphide solution and a few drops of HCl and allow to stand over night. The uric acid should separate out in crystalline form and should be found in less amount in the test than in the control experiment. The uric acid may also be titrated with permanganate as in the Folin-Shaffer method for uric acid in urine. (See Chapter XXVII on Quantitative Analysis of Urine.) This will enable us to determine exactly how much of the uric acid was destroyed through the action of the enzyme extract.

CHAPTER VII

GASTRIC DIGESTION

GASTRIC digestion takes place in the stomach and is promoted by the gastric juice, which is secreted by the glands of the stomach mucosa. These glands are of two kinds, fundus glands and pyloric glands which are situated, as their names imply, in the regions of the fundus and pylorus. The principal foods acted upon in gastric digestion are the proteins which are so changed by its processes as to become better prepared for further digestion in the intestine and for their final absorption.

From reliable experiments made upon lower animals and man it is evident that the gastric juice is secreted as the result of stimuli of two forms, *i.e.*, *psychical* stimuli and *chemical* stimuli. The psychical form of stimuli may be produced by the sight, thought, or taste of food, and the chemical stimuli may be produced by certain substances, such as water, milk, the extractives of meat, etc., when coming in contact with the stomach mucosa. The stimulatory power of water has been very strikingly demonstrated.¹ The claim that the drinking of water with meals is harmful because such a procedure causes a dilution of the gastric juice, has no basis in fact. The drinking of water with meals by normal individuals has been found to be accompanied by a more economical utilization of the ingested proteins, fats and carbohydrates. Various other desirable and *no undesirable* features have been demonstrated as accompanying or following such a dietary procedure.² No *experimental* evidence has been submitted which can justly be interpreted as showing any harmful influence to accompany or follow the drinking, by normal persons, of large quantities of water at meal time.

The volume of gastric juice secreted during any given period of digestion varies with the quantity and kind of the food. These conclusions were deduced principally from a series of so-called *delusive feeding* experiments. A dog was prepared with two esophageal openings and a gastric fistula. When thus prepared and fed foods of various

¹ Foster and Lambert: *Journ. Exper. Med.*, 10, 820, 1908.

Bergeim, Rehfuß and Hawk: *Jour. Biol. Chem.*, 19, 345, 1914.

Ivy: *Proceedings Amer. Physiol. Soc. (Amer. Jour. Physiol.)* 45, 561, 1918.

King and Hanford: *Ibid.*, 562.

Sutherland: *Ibid.*, 563.

² Hawk: *University of Pennsylvania Medical Bulletin*, 18, 1, 1905.

Fowler and Hawk: *Jour. Exper. Med.*, 12, 388, 1910.

Hattrem and Hawk: *Arch. Int. Med.*, 7, 610, 1911.

Mattill and Hawk: *Jour. Am. Chem. Soc.*, 33, pp. 1978, 1999, and 2019, 1911.

Hawk: *Arch. Int. Med.*, 8, 382, 1911.

Hawk: *Proceedings Soc. Exp. Biol. and Med.*, 8, 36, 1910.

Fairhall and Hawk: *Jour. Am. Chem. Soc.*, 34, 546, 1912.

Howe and Hawk: *Jour. Biol. Chem.*, 11, 129, 1912.

Hawk: *Biochem. Bull.*, 3, 420, 1914.

kinds such as meat and bread, the material instead of passing to the stomach, would invariably find its way out of the animal's body at the upper esophageal opening. Through the medium of the gastric fistula the course of the secretion of gastric juice could be carefully followed. It was found that when the dog ate meat, for example, there was a large secretion of gastric juice notwithstanding no portion of the food eaten had reached the stomach. Further experiments made through the medium of a *cul-de-sac* formed from the stomach wall have given us many valuable conclusions, among others those regarding the influence of the chemical stimuli. The method followed was to feed the animal certain substances and note the secretion of gastric juice in the miniature stomach while the real process of digestion was taking place in the stomach proper.

Normal gastric juice is a thin, light colored fluid which is acid in reaction and has a specific gravity varying between 1.001 and 1.010. It contains only 2-3 per cent of solid matter which is made up principally of hydrochloric acid, sodium chloride, potassium chloride, earthy phosphates, mucin and the enzymes *pepsin*, *gastric rennin*, and *gastric lipase*; the hydrochloric acid and the enzymes are of the greatest importance. The acidity of the gastric juice is due to *free* hydrochloric acid. It was formerly believed that this acid was secreted by the parietal cells of the fundus as well as by the chief cells of both the fundus and pyloric glands. It has been claimed,¹ however, that *the parietal cell is the seat of the formation of the hydrochloric acid*. This conclusion is based upon the formation of Prussian blue after the subcutaneous injection of potassium ferrocyanide and ammonium ferric citrate (rabbits and guinea-pigs) and the subsequent (3 to 30 hours) microscopical examination of the gastric mucosa. The acid was shown to be present in the lumina of the gland tubules and in the canaliculi of the parietal cells; traces were also apparently present in the cytoplasm. Later Bensley and Harvey² showed by means of dyes which act as vital stains and as indicators very sensitive to alkali that the *secretion in the parietal cells is slightly alkaline whereas that in the lumen of the gland proper is very nearly neutral*. Therefore, the acid is formed entirely above the level of the gland proper, *i.e.*, in the foveolæ and on the surface. Hammett³ and still more recently Macallum and Collip⁴ have confirmed Miss Fitzgerald's claim that the acid is formed in the parietal cells.

It was believed that hydrochloric acid was generally present in the gastric juice of man to the extent of about 0.2 per cent. When the

¹ Fitzgerald: *Proceedings Royal Society (B)*, 83, 56, 1910.

² Bensley and Harvey: *Biological Bulletin*, 23, 225, 1912.

³ Hammett: *Anatomical Record*, 9, 21, 1915.

⁴ Reported before Society of Biological Chemists, Boston, Dec. 27, 1915.

amount of hydrochloric acid varied to any considerable degree from this value a condition of hypoacidity or hyperacidity was said to be established. On the basis of more recent experiments,¹ however, it appears that the actual acidity of the gastric juice of man as secreted by the glands is 0.4 to 0.5 per cent hydrochloric acid. Boldyreff believes that this acidity is lowered to about 0.2 per cent by regurgitation of alkaline fluid from the intestine (Chapter VIII on Gastric Analysis). Hydrochloric acid has the power of combining with protein substances taken in the food, thus forming so-called *combined* hydrochloric acid. This combined acid is a less potent germicide than *free* hydrochloric acid and has less power to destroy the amylolytic enzyme *salivary amylase (ptyalin)* of the saliva. This last fact explains to a degree the possibility of the continuance of salivary digestion in the stomach.

The term *combined* hydrochloric acid is really a misnomer. When *free* hydrochloric acid is treated with a protein the latter functions as a base and a *salt* is formed. Therefore, instead of having "*combined hydrochloric acid*" we have a *protein salt of hydrochloric acid*. This salt ionizes differently from the free acid. This fact explains the variation in the germicidal properties of the two solutions as well as their different action toward enzymes, such, for example, as salivary amylase (see page 61).

The hydrochloric acid of the gastric juice forms a medium in which the pepsin can most satisfactorily digest the protein food, and at the same time it acts as an antiseptic or germicide which prevents putrefactive processes in the stomach. It also possesses the power of inverting cane sugar, this property being due to the hydrogen ion. When the hydrochloric acid of the gastric juice is diminished in quantity (hypoacidity) or absent, as it may be in many cases of functional or organic disease, there is no check to the growth of micro-organisms in the stomach. There are, however, certain of the more resistant spores which even the normal acidity of the gastric juice will not destroy. A condition of hypoacidity may also give rise to fermentation with the formation of comparatively large amounts of such substances as lactic acid and butyric acid.

The question of the origin of the hydrochloric acid of the gastric juice is a problem to whose solution many investigators have given much attention. Many theories have been proposed, among them the interaction of sodium chloride with carbonic acid,² with acid phosphate³

¹ Babkin: Die äussere Sekretion der Verdauungsdrüsen, Berlin, 1914, p. 113.

Boldyreff: *Quart. Jour. Exper. Physiol.*, 8, 1, 1914.

Carlson: *Am. Jour. Physiol.*, 38, 248, 1915.

² Bunge: *Physiologic and Pathologic Chemistry*, 2nd. Eng. Ed., Philadelphia, 1902, p. 135.

³ Maly: *Zeit. f. physiol. Chem.*, 1, 174, 1877. Macallum and Collip: Reported before the Society of Biological Chemists, Boston, Dec. 27, 1915.

or with organic acids. On the other hand, it is possible that hydrochloric acid is set free from combination with some weak base as ammonia¹ or that free phosphoric acid valences may be set free by the enzymic hydrolysis of organic phosphoric acid esters.² We cannot go into a discussion of these various theories. That the hydrochloric acid arises from the chlorides of the blood appears to be well established but the same cannot be said with regard to the immediate or ultimate origin of the hydrogen ions involved in the reaction.

The most important of the enzymes of the gastric juice is the proteolytic enzyme *pepsin*. The pepsin does not originate as such in the gastric cells but is formed from its precursor, the *zymogen* or mother-substance *pepsinogen*, which is apparently produced by the parietal cells of the fundus as well as by the chief cells of the fundus and pyloric glands. Pepsinogen may be differentiated from pepsin from the fact that it is more resistant to alkali.³ Upon coming into contact with the hydrochloric acid of the secretion this pepsinogen is immediately transformed into pepsin. Pepsin is not active in alkaline or neutral solutions, but requires at least a faint acidity before it can exert its power to dissolve and digest proteins. The percentage of hydrochloric acid facilitating the most rapid peptic action varies with the character of the protein acted upon, *e.g.*, 0.08 per cent to 0.1 per cent for the digestion of fibrin and 0.25 per cent for the digestion of coagulated egg-white. While hydrochloric acid is the acid usually employed to promote artificial peptic proteolysis, other acids, organic and inorganic, will serve the same purpose. Acidity of the liquid is necessary to promote the activity of the pepsin, but the acidity need not necessarily be confined to hydrochloric acid.

In common with many other enzymes pepsin acts best at about 38°–40°C. and its digestive power decreases as the temperature is lowered, the enzyme being only slightly active at 0°C. Its power is only temporarily inhibited by the application of such low temperatures, however, and the enzyme regains its full proteolytic power upon raising the temperature to 40°C. As the temperature of a digestive mixture is raised above 40°C. the pepsin gradually loses its activity until at about 80°–100°C. its proteolytic power is permanently destroyed.

Our ideas regarding the nature of the products formed in the course of peptic proteolysis have undergone considerable revision in recent years. The former view that these products included only acid albuminate (acid metaprotein), proteoses, peptones and peptides is no

¹ Mathews: *Physiological Chemistry*, New York, 1915, p. 374.

² Bergeim: *Proc. Soc. Exp. Biol. and Med.*, 12, 21, 1914.

³ Langley: *Jour. of Physiol.*, 3, 246.

longer tenable. From the investigations of numerous observers we have learned that artificial gastric digestion *if permitted to proceed for a sufficiently long period* will yield, in addition to proteoses, peptones and peptides, a long list of protein cleavage products which are crystalline in character, including *leucine, tyrosine, alanine, phenylalanine, aspartic acid, glutamic acid, proline, leucinimide, valine, and lysine*. A similar group of substances may result from the action of the enzyme trypsin (see page 190). The relative amounts of proteoses, peptones, and crystalline substances formed depends to a great extent upon the character of the protein undergoing digestion, *e.g.*, a greater proportion of proteoses results from the digestion of fibrin than from the digestion of coagulated egg-white. We must not be led into the error of thinking that the large number of protein cleavage products just mentioned are formed in the course of normal gastric digestion *within the animal organism*. They are formed only after comparatively long-continued hydrolysis. In pancreatic digestion, however, there are formed even under normal conditions the large number of cleavage products to which reference has been made. Peptic proteolysis, therefore, within the animal organism differs from tryptic proteolysis (see page 190) in that the former yields larger amounts of proteoses, smaller amounts of peptones and no considerable quantity of crystalline bodies as end-products in the brief period during which proteins are ordinarily subjected to gastric digestion. Prolonged hydrolysis with gastric juice does, however, yield considerable quantities of the non-protein end-products. In cases of cancer of the stomach a peptide-splitting enzyme (erepsin) is said to be present in the stomach contents. This enzyme is believed to be elaborated by the cancer tissue and its identification is of importance in connection with the diagnosis of gastric cancer. The glycyl-tryptophane test¹ is sometimes used for this purpose. This test has been very severely criticized (see page 203).

Abderhalden and Meyer² have shown active pepsin to be present in the contents of all parts of the small intestine. It is suggested that pepsin may be adsorbed in the stomach by such protein substances as pass into the intestine in solid form and that the pepsin thus protected may bring about gastric digestion whenever the reaction of the surrounding intestinal contents is favorable. This fact may be of importance in connection with the profound proteolysis taking place in the intestine. Heretofore, this process was believed to be furthered alone by trypsin and erepsin. The passage of adsorbed pepsin into the intestine may be an efficient aid to the proper digestion of solid proteins

¹Neubauer and Fischer: *Deut. Arch. f. klin. Med.*, 97, 499, 1909.

²Abderhalden and Meyer: *Zeit. für physiol. Chem.*, 74, 67, 1911.

which are ingested without sufficient mastication ("bolted")¹ and which consequently, at times, pass into the intestine in rather large pieces (see Chapter XIV on Feces).

Gastric rennin, the second enzyme of the gastric juice, is what is known as a *milk curdling* or *protein coagulating* enzyme. Rennin acts upon the casein of the milk, splitting it into a *peptone-like* body and *soluble paracasein*. This soluble body, in the presence of calcium salts, combines with calcium, forming *calcium paracasein* which is insoluble and precipitates. There is some uncertainty regarding the reaction to litmus in which gastric rennin shows the greatest activity. It is, however, said to be active in neutral, alkaline, or acid solution. However, it probably possesses its greatest activity in the presence of a slight acid reaction, as would naturally be expected. It is especially abundant in the gastric mucosa of the calf, and is used to curdle the milk used in cheese making. Gastric rennin is always present normally in the gastric juice, but in certain pathological conditions such as atrophy of the mucosa, chronic catarrh of the stomach, or in carcinoma it may be absent.

The theory, that the proteolytic activity and the milk curdling property of the gastric juice reside in a single substance, is causing much controversy at the present time. The theory was originally advanced by the Pawlow school.² According to Nencki and Sieber,³ the milk curdling and protein hydrolyzing activities reside in definite and distinct side chains of a single mammoth molecule. The view which has rather the strongest support, however, is to the effect that there are two entirely distinct enzymes. Important evidence has been advanced in favor of this view of Hammarsten,⁴ Taylor,⁵ and Hemmeter.⁶ Burge⁷ has reported experiments upon the influence of a direct electric current upon solutions possessing typical rennin and peptic activities. By this means he was able to prepare a solution possessing strong rennin activity but entirely devoid of peptic activity. This furnishes strong evidence against the identity of the two enzymes but does not necessarily deny the accuracy of the side-chain theory.

Gastric lipase, the third enzyme of the gastric juice, is a fat-splitting enzyme. It possesses but slight activity when the gastric juice is of normal acidity, but evinces its action principally at such times as a

¹ Foster and Hawk: *Proceedings of the Eighth International Congress of Applied Chemistry*, New York, September, 1912.

² Pawlow and Parastschuk: *Zeitschrift für Physiologische Chemie*, 42, 415, 1904.

³ Nencki and Sieber: *Zeitschrift für Physiologische Chemie*, 23, 191, 1901.

⁴ Hammarsten: *Zeitschrift für Physiologische Chemie*, 56, 18, 1908; 94, 291, 1915.

⁵ Taylor: *Journal of Biological Chemistry*, 5, 399, 1909.

⁶ Hemmeter: *Berliner klinische Wochenschrift*, Ewald Festnummer, 44, 1905.

⁷ Burge: *American Journal of Physiology*, 29, 1912.

gastric juice of low acidity is secreted either from physiological or pathological cause. The digestion of fat in the stomach is, however, at most, of but slight importance as compared with the digestion of fat in the intestine through the action of the lipase of the pancreatic juice (see page 192).

Boldyreff¹ has shown *trypsin* to be present in stomach contents, due to regurgitation of intestinal contents through the pylorus. This claim has been verified by others² (see Chapter VIII on Gastric Analysis).

COLLECTION OF HUMAN GASTRIC JUICE

Have one or more volunteers from the class take the Rehffuss Stomach Tube as directed on page 163. The subjects must omit breakfast if the tube is taken

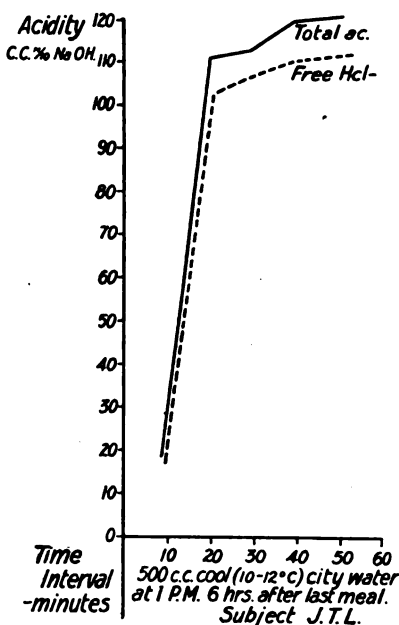

FIG. 41.—CURVES SHOWING STIMULATORY POWER OF WATER.

(Bergeim, Rehffuss and Hawk: *Journal Biological Chemistry*, 19, 345, 1914.)

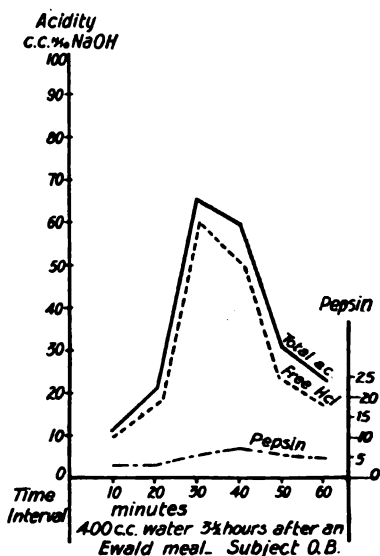

FIG. 42.—CURVES SHOWING STIMULATORY POWER OF WATER.

(Bergeim, Rehffuss and Hawk: *Journal Biological Chemistry*, 19, 345, 1914.)

in the morning or luncheon if taken in the afternoon. Empty the stomach (see pp. 164-5) and, with the tube still in place, allow each subject to drink 250 c.c. of water. The water will stimulate the flow of gastric juice and will itself quickly leave the stomach. In many instances fairly concentrated gastric juice may be obtained from the stomach in from 30 to 45 minutes after the introduction of the water. Remove this gastric juice according to procedure outlined on pp. 165-6. For composition of human gastric juice see page 155.

¹ Boldyreff: *Quart. Jour. Exper. Physiol.*, 8, 1, 1914.

² Spencer Meyer, Rehffuss and Hawk: *Am. Jour. Physiol.*, 39, 459, 1916.

See also Experiment 11, page 148. If thought desirable the gastric juice resulting from psychical stimulation (see page 149) may be collected instead of that following the chemical stimulation of water. (Curves showing the stimulatory power of water are given in Figs. 41 and 42.)

PREPARATION OF AN ARTIFICIAL GASTRIC JUICE

Dissect the mucous membrane of a pig's stomach from the muscular portion and discard the latter. Divide the mucous membrane into two parts ($\frac{4}{5}$ and $\frac{1}{5}$). Cut up the larger portion, place it in a large-sized beaker with 0.4 per cent hydrochloric acid and keep at 38° – 40° C. for at least 24 hours. Filter off the residue, consisting of nuclein and other substances, and use the filtrate as an artificial gastric juice. This filtrate contains pepsin, rennin, and the products of the digestion of the stomach tissue, i.e., acid metaprotein (acid albuminate), proteoses, peptones, etc.

PREPARATION OF A GLYCEROL EXTRACT OF PIG'S STOMACH

Take the one-fifth portion of the mucous membrane of the pig's stomach not used in the preparation of the artificial gastric juice, cut it up finely, place it in a small-sized beaker and cover the membrane with glycerol. Stir frequently and allow to stand at room temperature for at least 24 hours. The glycerol will extract the pepsinogen. Separate, with a pipette or by other means, the glycerol from the pieces of mucous membrane and use the glycerol extract as required in the later experiments.

PRODUCTS OF GASTRIC DIGESTION

Into the artificial gastric juice, prepared as above described, place the protein material (fibrin, coagulated egg-white, or lean beef) provided for you by the instructor, add 0.4 per cent hydrochloric acid as suggested by the instructor and keep the digestion mixture at 40° C. for two to three days. Stir frequently and keep free hydrochloric acid present in the solution (for tests for free hydrochloric acid see page 152).

The original protein has been digested and the solution now contains the products of peptic proteolysis, i.e., acid metaprotein (acid albuminate), proteoses, peptones, etc. The insoluble residue may include nuclein and other substances. Filter the digestion mixture and after testing for free hydrochloric acid neutralize the filtrate with potassium hydroxide solution. If any of the acid metaprotein (acid albuminate) is still untransformed into proteoses it will precipitate upon neutralization. If any precipitate forms heat the mixture to boiling, and filter. If no precipitate forms proceed without filtering.

We now have a solution containing a mixture consisting principally of proteoses and peptones. Separate and identify the proteoses and peptones according to the directions given on pages 119 and 120.

GENERAL EXPERIMENTS ON GASTRIC DIGESTION

1. Conditions Essential for the Action of Pepsin.—Prepare four test-tubes as follows:

- (a) Five c.c. of pepsin solution.
- (b) Five c.c. of 0.4 per cent hydrochloric acid.
- (c) Five c.c. of pepsin-hydrochloric acid solution.
- (d) Two or 3 c.c. of pepsin solution and 2-3 c.c. of 0.5 per cent sodium carbonate solution.

Introduce into each tube a small piece of fibrin and place them in the incubator or water-bath at 40°C. for one-half hour, carefully noting any changes which occur.¹ (Carmine-fibrin may be used to advantage in this and the following tests under Gastric Digestion. In this case, however, the experiments should be conducted at room temperature. For directions as to the preparation of carmine-fibrin see Chapter I.) Now combine the contents of tubes (a) and (b) and see if any further change occurs after standing at 40°C. for 15-20 minutes. Explain the results obtained from these five experiments.

2. Influence of Different Temperatures.—In each of four test-tubes place 5 c.c. of pepsin-hydrochloric acid solution. Immerse one tube in cold water from the faucet, keep a second tube at room temperature and place a third in the incubator or water-bath at 40°C. Boil the contents of the fourth tube for a few moments, then cool and also keep it at 40°C. Into each tube introduce a small piece of fibrin and note the progress of digestion. In which tube does the most rapid digestion occur? Explain this.

3. The Most Favorable Acidity.—Prepare three tubes as follows:

- (a) Five c.c. of 0.2 per cent pepsin-hydrochloric acid solution.
- (b) Two or 3 c.c. of 0.2 per cent hydrochloric acid + 1 c.c. of concentrated hydrochloric acid + 5 c.c. pepsin solution.
- (c) One c.c. of 0.2 per cent pepsin-hydrochloric acid solution + 5 c.c. of water.

Introduce a small piece of fibrin into each tube, keep them at 40°C., and note the progress of digestion. In which degree of acidity does the fibrin digest the most rapidly?

4. Differentiation between Pepsin and Pepsinogen.—Prepare five tubes as follows:

- (a) Few drops of glycerol extract of pepsinogen + 2-3 c.c. of water.
- (b) Few drops of glycerol extract of pepsinogen + 5 c.c. of 0.2 per cent hydrochloric acid.
- (c) Few drops of glycerol extract of pepsinogen + 5 c.c. of 0.5 per cent sodium carbonate.
- (d) Two or 3 c.c. of pepsin solution + 2-3 c.c. of 1 per cent sodium carbonate.
- (e) Few drops of glycerol extract of pepsinogen + 5 c.c. of 1 per cent sodium carbonate.

Add a small piece of fibrin to the contents of each tube, keep the five tubes at 40°C. for one-half hour and observe any changes which may have occurred. To (a) add an equal volume of 0.4 per cent hydrochloric acid, neutralize (c), (d) and (e) with hydrochloric acid and add an equal volume of 0.4 per cent hydrochloric acid. Place these tubes at 40°C. again and note any further changes which may

¹ Digestion of fibrin in a pepsin-hydrochloric acid solution is indicated first by a *swelling* of the protein due to the action of the acid, and later by a *disintegration* and *dissolving* of the fibrin due to the action of the pepsin-hydrochloric acid. If uncertain at any time whether digestion has taken place, the solution under examination may be filtered and the biuret test applied to the filtrate. A positive reaction will signify the presence of acid metaprotein (acid albuminate), proteoses (albumoses), or peptones, the presence of any one of which would indicate that digestion has taken place.

occur. What contrast do we find in the results from the last three tubes? On the basis of these tests what is the relative resistance of pepsin and pepsinogen to alkalis?

5. **Comparative Digestive Power of Pepsin with Different Acids.**—Prepare a series of tubes each containing a N/10 solution of one of the following acids: hydrochloric, sulphuric, nitric, combined hydrochloric, acetic, lactic and oxalic. To each acid add a few drops of the glycerol extract of pig's stomach and a small piece of fibrin. Shake well, place at 40°C., and note the progress of digestion. In which tubes does the most rapid digestion occur?

6. **Influence of Metallic Salts, etc.**—Prepare a series of tubes and into each tube introduce 4 c.c. of pepsin-hydrochloric acid solution and 0.5 c.c. of one of the chemicals listed in Experiment 19 under Salivary Digestion, page 61. Introduce a small piece of fibrin into each of the tubes and keep them at 40°C. for one-half hour. Note the variations in the progress of digestion. Where has the least rapid digestion occurred?

7. **Sahl's Desmoid Reaction.**—This is a method for testing gastric function without using the stomach tube. The underlying principle of the test is the fact that raw catgut may be digested in gastric juice but is entirely indigestible in pancreatic juice. The test is made as follows: A methylene-blue pill is introduced into a small rubber bag and the mouth of the bag subsequently tied with catgut.¹ The small bag is then ingested immediately after the mid-day meal and the urine examined 5, 7, 9 and 18–20 hours later for methylene blue. If methylene blue is present in appreciable quantity, it will impart to the urine a greenish-blue color. If not present in sufficient amount to impart this color the urine should be boiled with one-fifth its volume of glacial acetic acid, whereupon a greenish-blue color results if the chromogen of methylene blue is present. This contingency seldom arises, however, inasmuch as in most cases of uncolored urine it will be found that the rubber bag has passed through the stomach unopened. If the methylene blue is found in the urine inside of 18–20 hours a satisfactory gastric function is indicated.

For Einhorn's bead method for the study of digestive function see chapter on Feces.

8. **Testing the Motor and Functional Activities of the Stomach.**—This test is performed the same as Experiment 20 under Salivary Digestion, page 61. If the experiment was carried out under salivary digestion it will not be necessary to repeat it here.

9. **Influence of Bile.**—Prepare three tubes as follows:

- (a) Five c.c. of pepsin-hydrochloric acid solution + 0.5–1 c.c. of bile.
- (b) Five c.c. of pepsin-hydrochloric acid solution + 5 c.c. of bile.
- (c) Five c.c. of pepsin-hydrochloric acid solution.

Introduce into each tube a small piece of fibrin. Keep the tubes at 40°C. and note the progress of digestion. Does the bile exert any appreciable influence? How?

¹About 0.05 gram of methylene blue is mixed with sufficient *ext. glycyrrhizæ* to form a pill about 3–4 mm. in diameter. The pill is then placed in the center of a square piece of thin rubber dam and a little bag-like receptacle constructed by a twisting movement. The neck of the bag is then closed by wrapping three turns of catgut about it. The most satisfactory catgut to use is *number 00 raw catgut* which has previously been soaked in water until soft. When ready for use the bag should sink instantly when placed in water and be water-tight.

10. Influence of Gastric Rennin on Milk.—Prepare a series of five tubes as follows:

(a) Five c.c. of fresh milk + 0.2 per cent hydrochloric acid (add slowly until precipitate forms).

(b) Five c.c. of fresh milk + 5 drops of rennin solution.¹

(c) Five c.c. of fresh milk + 10 drops of 0.5 per cent sodium carbonate solution.

(d) Five c.c. of fresh milk + 10 drops of a saturated solution of ammonium oxalate.

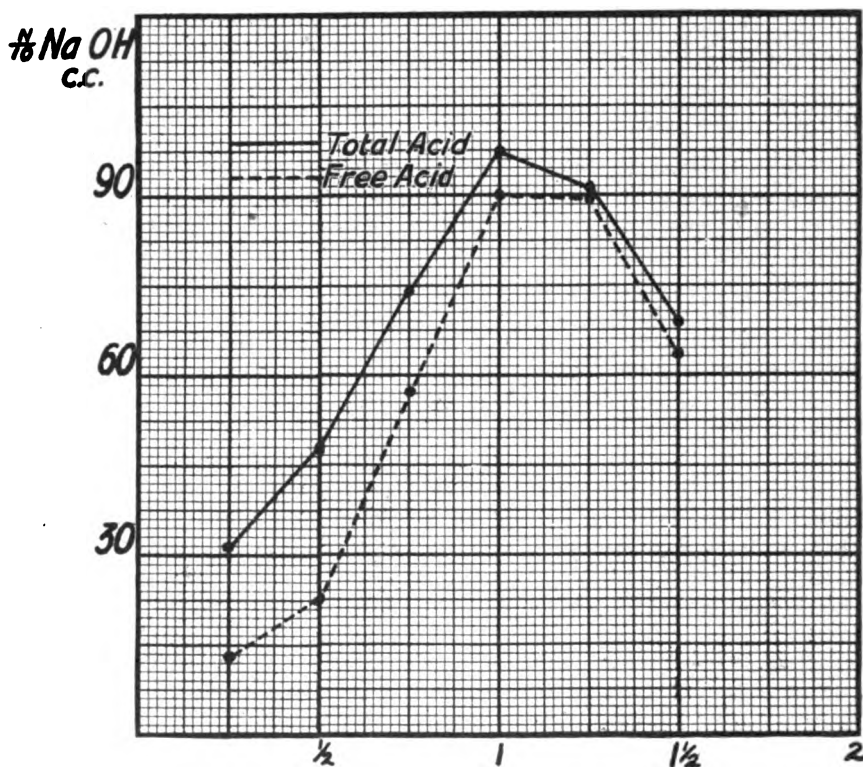

FIG. 43.—CURVES SHOWING STIMULATORY POWER OF BEEF EXTRACT
(Plotted from unpublished data collected in the author's laboratory by Professor Chester C. Fowler.)

(e) Five c.c. of fresh milk + 5 drops of 0.2 per cent hydrochloric acid. Now to each of the tubes (c), (d), and (e) add 5 drops of rennin solution. Place the whole series of five tubes at 40°C. and after 10–15 minutes note what is occurring in the different tubes. Give a reason for each particular result. How do ammonium oxalate and sodium carbonate prevent coagulation?

11. Characteristics of Human Gastric Juice.—Take some of the human gastric juice collected as described on page 144 and show that it is acid in reaction, that it contains chlorides and that it has the power to digest protein material and to curdle milk.

¹Any good commercial rennin or rennet preparation may be used in preparing this solution.

12. Chemical Stimulation of Gastric Secretion.—Have one or more volunteers from the class take the Rehffuss Stomach Tube as directed on page 163. The subjects must omit breakfast if the tube is taken in the morning or luncheon if taken in the afternoon. Empty the stomach (see pp. 164-5) and, with the tube still in position, allow each subject to drink 250 c.c. of bouillon prepared by dissolving one bouillon cube in hot water. Collect samples of gastric contents

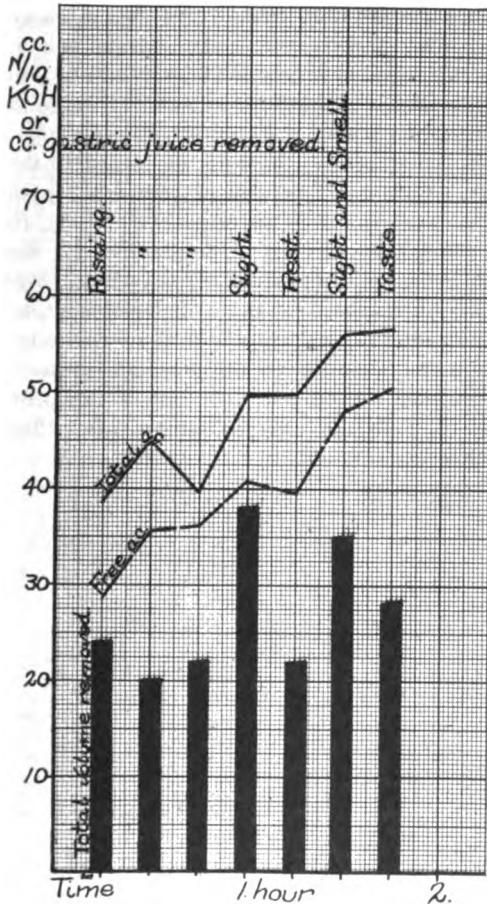

FIG. 44.—CURVES SHOWING PSYCHICAL STIMULATION OF GASTRIC SECRETION. (Plotted from unpublished data in the author's laboratory by Dr. Raymond J. Miller.)

at intervals until the stomach is empty as described under 5 on page 165. The samples thus collected may be examined qualitatively for acid, chlorides, pepsin and rennin or they may be submitted to the quantitative procedure given under 6 on page 166. If the examination is made quantitative the data may be recorded in the form of a curve such as shown in Fig. 43 page, 148.

13. Psychical Stimulation of Gastric Secretion.—Have one or more volunteers from the class take the Rehffuss Stomach Tube as directed on page 163. The subjects must omit breakfast if the tube is taken in the morning or luncheon if taken in the afternoon. Empty the stomach (see pp. 164-5) and while the

tube is still in position permit the subjects to see and smell an appetizing beef-steak while it is being cooked. They may also be permitted to taste some of the material provided care is taken that none is swallowed. Empty the stomach completely at 10 minute intervals as described under 5 on page 166. Measure the volume of each sample and examine them qualitatively for acid, chlorides, pepsin and rennin. If preferred the quantitative procedure given under 6 on page 166 may be substituted for the qualitative examination. On the basis of the quantitative data a curve such as shown on page 149 may be constructed.

14. Automatic Regulation of Gastric Acidity.—Have one or more volunteers from the class take the Rehfuß Stomach Tube as directed on page 163. The subjects must omit breakfast if the tube is taken in the morning or luncheon if taken in the afternoon. Empty the stomach (see pp. 164-5) and, with the tube still in position, introduce 100 c.c. of 0.5 per cent HCl through the tube by means of a syringe. Withdraw samples of stomach contents at 15 minute intervals, until the stomach is empty, as described on page 166. A qualitative examination of the samples will indicate a progressive decrease in acidity until an acid concentration in the neighborhood of 0.2-0.3 per cent is reached. Trypsin (p. 172) and bile (p. 175) may also be shown to be present, in at least some of the samples, thus indicating regurgitation from the duodenum. If it is desired to make the examination quantitative the procedure described on page 166, section 6, may be followed. From the data thus determined a curve such as that shown in Fig. 49, page 154, may be constructed. (For a discussion of regurgitation see pages 154 and 155.)

CHAPTER VIII

GASTRIC ANALYSIS

The method of gastric analysis which has been in vogue clinically for years (see page 177) entails the feeding of a standard test meal, the removal of the complete stomach contents at the end of a *one-hour period*, and the analysis of the material so removed. That this method is inaccurate has been repeatedly demonstrated in the author's laboratory¹ and elsewhere.² Furthermore, owing to the bulk of the old form of stomach tube and the discomfort occasioned by its use, it is impossible to follow the *whole cycle* of digestion and estimate, step

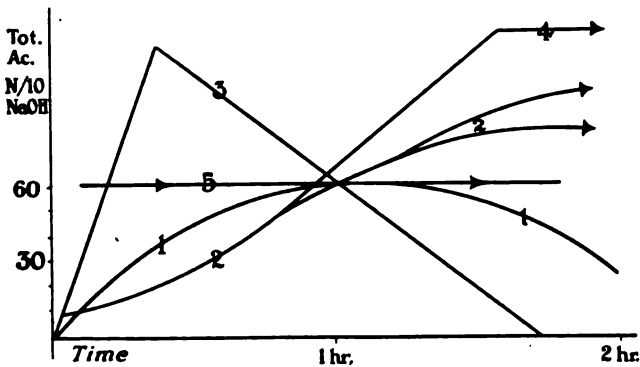

FIG. 45.—NORMAL AND PATHOLOGICAL CURVES AFTER AN EWALD MEAL.

1. normal curve; 2, delayed digestion with late hyperacidity; 3, larval hyperacidity; 4, tardive hyperacidity; 5, marked continued secretion from obstruction.

by step, the exact changes which take place in the stomach after the introduction of definite food mixtures into that organ.

Realizing the inadequacy of the procedure entailed in the old method of gastric analysis, a new procedure has been developed by Dr. Martin E. Rehfuss in the author's laboratory. This so-called "Fractional Method" entails the analysis of samples of material withdrawn from the stomach (by syringe) at short intervals for a period of two hours or more (until stomach is empty) after the ingestion of the test meal. By this means the observer is able to follow the *entire cycle* of

¹ Rehfuss: *Jour. Am. Med. Ass'n*, 64, 569, 1914.

Rehfuss, Bergeim and Hawk: *Jour. Am. Med. Ass'n*, 63, 909, 1914.

Bergeim, Rehfuss and Hawk: *Jour. Am. Med. Ass'n*, 63, 11, 1914.

² Harmer and Dodd: *Arch. Int. Med.*, Nov. 13, 1913, p. 488.

gastric digestion and is not limited, as in the old method, to information derived from the analysis of a single sample of stomach contents withdrawn at the end of one hour. That the acid values obtained by the old method may be grossly misinterpreted and lead to an incorrect diagnosis is indicated by the foregoing diagram (Fig. 45).

It is set forth in the above diagram that various types of abnormal gastric secretion would be considered normal on the basis of a single examination at the end of one hour whereas the application of the *fractional method* reveals the abnormality of the secretion and enables a rapid and correct diagnosis. The removal of samples of gastric contents at short intervals, for a period of two hours or more after a test meal, is made possible by the use of a modified stomach tube¹ of small diameter (No. 12 French tubing) and fitted with a metal tip.

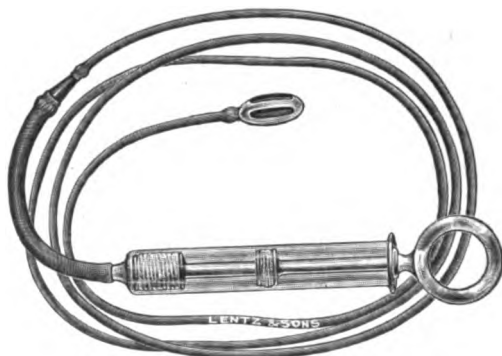

FIG. 46.—REHFUSS STOMACH TUBE.

The tip is slotted with large perforations, the diameter of each being equivalent to the maximum bore of the tubing. Such a tube can be left in the stomach through the entire cycle of gastric digestion without inconvenience to the patient.² A cut of the Rehfuss stomach tube (Fig. 46) is shown above.³

More recently Bergeim,⁴ working in the author's laboratory, has devised a very useful apparatus for the determination of *intra*gastric conductance and temperature. The apparatus is also provided with an aspiration tube similar to that of the Rehfuss tube which make possible the removal of samples of gastric contents for chemical analysis. This apparatus is shown in Fig. 47, page 153. Curves .

¹ Rehfuss: *Am. Jour. Med. Sci.*, June, 1914.

² McClendon has recently suggested the introduction of an electrode into the stomach in an attempt to follow the consecutive changes in the hydrogen ion concentration of the stomach contents (see *Am. Jour. Physiol.*, 38, 180, 1915).

³ This tube is manufactured by Charles Lentz & Sons, Philadelphia.

⁴ Bergeim: *Amer. Jour. Physiol.*, 45, 1, 1917.

showing the relationship of conductance to acidities are given in Fig. 48, page 153.

The idea of making a *fractional* examination of gastric contents is not new. Most of such attempts have been made, however, by using the old type of stomach tube and removing the *entire stomach contents* at different intervals on successive days, e.g., after fifteen minutes the first day, thirty minutes the second day, forty-five minutes the third day, etc. Hayem¹ was the first to employ this method and later

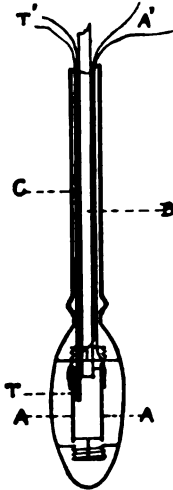

FIG. 47.

FIG. 47.—BERGEIM INTRAGASTRIC CONDUCTANCE APPARATUS.

Diagrammatic cross-section showing platinum electrodes A, A, with leads A'; thermocouple T with leads, T; tube for aspiration B; and outer protecting tube C. (Bergeim: *American Journal of Physiology*, 45, 1, 1917.)

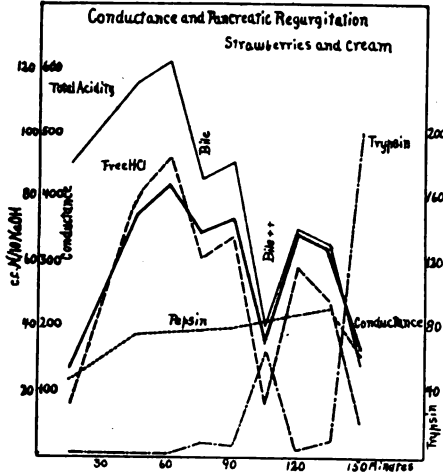

FIG. 48.

FIG. 48.—CURVES SHOWING RELATIONSHIP OF CONDUCTANCE TO ACIDITIES. (Bergeim: *American Journal of Physiology*, 45, 1, 1917.)

Ewald and Boas,² Reichmann,³ v. Jaksch,⁴ Kornemann,⁵ Schule⁶ and Gregersen⁷ followed a similar procedure. The first report of data from the entire gastric cycle obtained by means of a small bore tube were made by Ehrenreich.⁸ This investigator used a Nélaton catheter. Skaller⁹ has reported a few experiments in which a small bore stomach tube with a metal tip was employed and the stomach contents subjected to fractional analysis.

¹ Hayem: Brouardel & Gilbert's, *Traite de Medecine*, 4, 236, 1905.
² Ewald & Boas: *Virchow's Arch.*, 101, 325, 1885.
³ Reichmann: *Zeit. f. klin. Med.*, 24, 565, 1885.
⁴ v. Jaksch: *Zeit. f. klin. Med.*, 19, 383, 1890.
⁵ Kornemann: *Arch. f. Verdauungskr.*, p. 369, 1912.
⁶ Schule: *Zeit. f. klin. Med.*, 27, 461, 1895.
⁷ Gregersen: *Arch. f. Verdauungskr.*, 19, 263, 1913.
⁸ Ehrenreich: *Zeit. f. klin. Med.*, p. 231, 1912.
⁹ Skaller: *Berl. klin. Woch.*, 50, No. 47, 1913.

Until recent years, the consensus of opinion based principally upon the work of the Pawlow school¹ was to the effect that the gastric juice of normal man had an average acid concentration of 0.2 per cent hydrochloric acid, whereas the gastric juice of the dog and cat had an average acid concentration of 0.4–0.5 per cent hydrochloric acid. These experiments were based principally upon the examination of the pure gastric juice of the lower animals as compared with the stomach contents of man. Later experiments² have, however, demonstrated that the acid concentration of the *freshly secreted* gastric juice of man is similar to that of the dog, *i.e.*, 0.4–0.5 per cent. Boldyreff claims

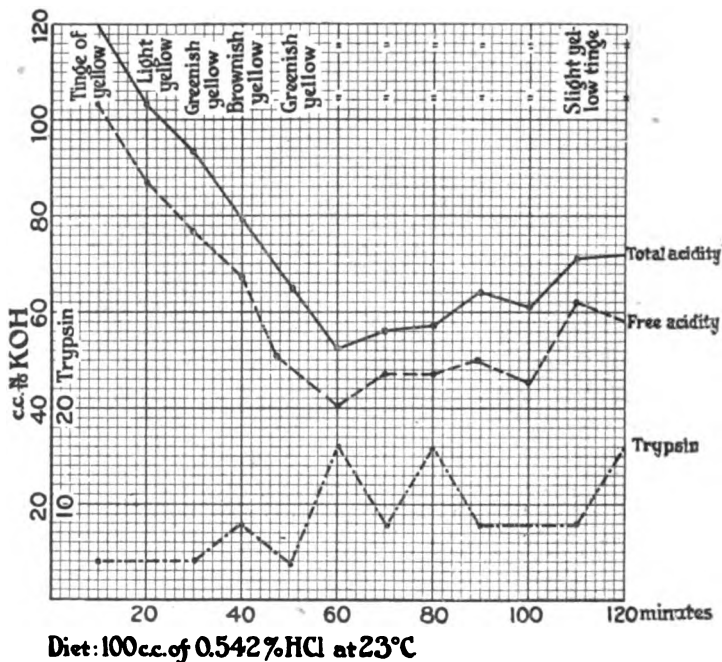

FIG. 49.—INFLUENCE OF ACID INTRODUCED INTO THE NORMAL HUMAN STOMACH. (Spencer, Meyer, Rehfuß and Hawk: *American Journal of Physiology*, March, 1916.)

that this initial high acidity of the human gastric juice is normally lowered to the "optimum acidity" of 0.15–0.2 per cent hydrochloric acid by *regurgitation of alkaline fluids* (bile, pancreatic and intestinal juices) from the intestine. This constitutes what Boldyreff terms "*the automatic regulation of gastric acidity.*" This claim has been

¹ Pawlow: *The Work of the Digestive Glands*. Translated by Thompson, Second Edition, 1910.

² Babkin: *Die Äussere Sekretion der Verdauungsdrüsen*, Berlin, 1914.

Boldyreff: Transactions of 11th Congress of Physicians, St. Petersburg, 1909.

Boldyreff: *Quart. Jour. Exp. Physiol.*, 8, 1, 1914.

Carlson: *Am. Jour. Physiol.*, 38, 248, 1915.

Bergeim, Rehfuß & Hawk: *Jour. Biol. Chem.*, 19, 345, 1914.

substantiated by experiments made in the author's laboratory¹ and elsewhere.² Both bile and trypsin are easily identified in the stomach contents of man after the introduction of 0.5 per cent hydrochloric acid into the empty organ. The above points are illustrated by the chart shown in Fig. 49, page 154.³

The composition of human gastric juice and of the residuum (see page 164) is given in the following table:

COMPOSITION OF HUMAN GASTRIC JUICE

Constituent	Appetite juice ⁴	Residuum ⁵
Specific gravity.....	1.007	1.006
Δ degrees.....	-0.55	-0.47
Total acidity, per cent.....	0.45	0.30
Per 100 c.c. of Juice		
Total solids, gram.....	0.55	0.98 ⁶
Organic solids, gram.....	0.41	0.53 ⁶
Inorganic solids, gram.....	0.14	0.45 ⁶
Total nitrogen, gram.....	0.060	0.066 ⁶
Total phosphorus, gram.....		0.005 ⁶
Total sulphur, gram.....		0.007 ⁶
Ammonia N, gram.....	0.002-3	
Amino-acid N, gram.....	0.003-9	
Chlorides, gram.....	0.5	

THE USE OF INDICATORS IN DETERMINING THE REACTION OF GASTRIC JUICE AND OTHER FLUIDS

The reaction of the gastric juice and other body fluids is most readily tested by means of *indicators*, so-called because they show changes of color with differing degrees of acidity or alkalinity of the solution. They behave as though they were weak acids or bases whose ions and unionized molecules have different colors. Modern theories of color in organic compounds however class them as tautomeric substances.

A neutral solution is one in which there are equal numbers of hy-

¹ Spencer, Meyer, Reh fuss and Hawk: *Am. Jour. Physiol.*, 39, 459, 1916.

² Migai: *Diss.*, St. Petersburg, 1909.

Milosorov: *Zent. Physiol.*, 28, 615, 1914.

Zaitzeff: *Russky Vrach.*, 14, No. 29, 1915.

³ Spencer et al: *Loc. cit.*

⁴ Carlson: *Loc. cit.*

⁵ Fowler, Reh fuss and Hawk: *Loc. cit.*

⁶ Fowler & Buchanan: Unpublished.

drogen and hydroxyl ions. An acid solution has a preponderance of hydrogen ion and an alkaline solution an excess of hydroxyl ion. All indicators do not show changes of color at the true neutral point, but at some fixed degree of acidity (or alkalinity), *i.e.*, at a definite hydrogen or hydroxyl ion concentration. Indicators which change color at the approximate true neutral point are litmus and rosolic acid, while phenolphthalein changes color in a slightly alkaline solution. Congo red, sodium alizarin sulphonate and tropæolin OO are examples of indicators which change color in an acid solution.

Organic acids in general are not sufficiently strong; *i.e.*, do not dissociate with the production of enough hydrogen ion to cause color changes in dilute solution with indicators of the last-mentioned class. Litmus, rosolic acid and phenolphthalein, however, change at so low a hydrogen ion concentration that they are affected by dilute solutions of organic acids and may be used for their titration. Even very dilute solutions of *mineral* acids are sufficiently acid to produce color changes with Congo red, alizarin, etc., and hence these indicators may be used in the titration of mineral acid. Phenolphthalein which changes color in a weakly alkaline solution indicates the presence of acid combined with weakly alkaline substances (as protein) as well as other types of acid such as acid salts, and hence, is used in the titration of solutions for their *total* acidity.

The hydrogen ion concentration of pure water or a neutral solution is approximately 1×10^{-7} , being expressed as approximate moles of hydrogen ion per liter. That is, water is a $1/10,000,000$ N solution of hydrogen ions. The concentration of hydroxyl ions in pure water or a neutral solution is exactly equal to that of the hydrogen ions, so that water may be considered to be an $N/10,000,000$ alkali as well as an $N/10,000,000$ acid. Hydrogen ion concentrations are often expressed for the sake of brevity as their logarithms with the sign reversed. For example the logarithm of 1×10^{-7} would be -7.0 and according to this notation the H ion concentration would be expressed as $P_H = 7.0$. The product of the hydrogen ion concentration (H^+) by the hydroxyl ion concentration (OH^-) is constant at about 1×10^{-14} so that as (H^+) increases from 1×10^{-7} ($P_H = 7.0$) to 1×10^{-4} ($P_H = 4.0$) the (OH^-) falls to 1×10^{-10} , and *vice versa*. It must be borne in mind that higher figures for the logarithmic notation indicate lower figures for (H^+). The hydrogen ion concentrations at which certain indicators commonly used in titration work change color, are indicated below.

Indicator	Hydrogen ion concentration	True nature of solution when the color changes
Phenolphthalein.....	Between 1×10^{-8} and 1×10^{-9}	Alkaline.
Neutral red.....	1×10^{-7}	Neutral.
Rosolic acid.....	1×10^{-7}	Neutral.
Litmus.....	Between 1×10^{-6} and 1×10^{-7}	Neutral.
Sodium alizarin sulphamate.....	Between 1×10^{-6} and 1×10^{-6}	Acid.
Congo red.....	Between 1×10^{-6} and 1×10^{-6}	Acid.
Dimethyl-amino-azobenzene.....	Between 1×10^{-3} and 1×10^{-4}	Acid.
Methyl orange.....	Between 1×10^{-2} and 1×10^{-3}	Acid.
Tropæolin OO.....	1×10^{-2}	Acid.

Tests with Indicators.—Prepare a series of solutions of varying acidities as outlined in the following table, page 158. Introduce 5 or 10 c.c. portions of each of these into a series of test-tubes and add to each a few drops of a solution of Tropæolin OO. Make a note of the colors produced, in the spaces left for this purpose. In the same way test out the other indicators mentioned, in order, using in each case a few drops of the indicator solution. The tests using the last three mentioned indicators: Günzberg's, Boas' and Tropæolin (evaporation test) are carried out differently as indicated below.

Are the following assumptions, on which the use of certain of these indicators in gastric analysis is based, borne out by your findings?

1. That Töpfer's reagent (Dimethyl-amino-azo-benzene) gives its characteristic pinkish-red color only in the presence of free HCl.

2. That a blue color with Congo red indicates free hydrochloric (or other mineral acid), a violet color indicates an organic acid, and a brown color indicates combined hydrochloric acid.

3. That Tropæolin OO and methyl orange are indicators for free mineral acid.

4. That alizarin reacts to free mineral acid, organic acids and acid salts but not to combined HCl.

5. That phenolphthalein can be used in titrating total acidity, that is, acidity due to mineral and organic acids, acid salts and combined acid.

6. That iodine is liberated from KI-KIO₃ to a relatively slight extent by other than free mineral acid.

7. That Günzberg's test is the most satisfactory one for free HCl and that Boas' reagent and Tropæolin OO are also delicate reagents for free mineral acid.

Special Tests for Free HCl.—Perform the following tests on the solutions as outlined above and tabulate the results.

1. **Günzberg's Reagent.**¹—Place 1-2 drops of the reagent in a small porcelain evaporating dish and carefully evaporate to dryness over a low flame. Insert a glass stirring rod into the mixture to be tested and draw the moist end of the

¹Günzberg's reagent is prepared by dissolving 2 grams of phloroglucinol and 1 gram of vanillin in 100 c.c. of 95 per cent alcohol.

TABULATION ON RESULTS OF TESTS ON INDICATORS

Solution	Approximate H ion concentration	1 Tropæolin CO (4)	2 Methyl orange	3 Töpfer's reagent	4 Sahl's reagent (KI-KIO ₃) (2 c.c.)	5 Congo red	6 Alizarin	7 Litmus	8 Neutral red	9 Phenolphthalein	10 Günzberg's reagent	11 Boas' reagent	12 Tropæolin OO (evaporation test)
1. 0.4 per cent HCl.....	N/10 $\times 10^{-1}$												
2. 0.04 per cent HCl.....	N/100 $\times 10^{-2}$												
3. 0.6 per cent acetic acid.....	N/10 $\times 10^{-3}$												
4. 0.04 per cent combined HCl(3)	N/100 $\times 10^{-4}$												
5. Acid phosphate 1:9(1).....	M/15 $\times 10^{-6}$												
6. Water.....	$\times 10^{-7}$												
7. Basic phosphate 20:1(1)...	M/15 $\times 10^{-8}$												
8. Borate-NaOH 6:4(2).....	N/10 $\times 10^{-10}$												
9. NaOH 0.4 per cent.....	N/10 $\times 10^{-13}$												

(1) Make up a solution of potassium dihydrogen phosphate of $\frac{1}{2}$ molecular strength (9.078 grams to a liter of water) and one of disodium hydrogen phosphate (obtained by drying the ordinary salt in the air for a few weeks) $\text{Na}_2\text{HPO}_4 \cdot 2\text{H}_2\text{O}$ of similar strength (11.876 grams to a liter). To prepare the acid phosphate solution used in the test mix 1 part of the solution of the disodium salt with 9 parts of the solution of the dihydrogen phosphate. For the basic phosphate solution the proportions are 20:1.

(2) Borate-NaOH solution. Prepare a borate solution by dissolving 12.404 grams of pure boric acid (0.2 mol.) in 100 c.c. N NaOH solution and dilute with water to a liter. Prepare the Borate-NaOH solution by mixing 6 parts of the borate solution with 4 parts of N/10 NaOH.

(3) Combined HCl. Treat 0.04 per cent HCl with a small amount of Witte's peptone and boil until the solution no longer gives a blue but only a brown color with Congo red paper.

(4) Indicator solutions. *Tropæolin OO*. 0.05 gram in 100 c.c. 50 per cent alcohol. *Methyl orange*. 0.1 gram in 100 c.c. water. *Töpfer's reagent*. 0.5 gram dimethyl-amino-azo-benzene in 100 c.c. 95 per cent alcohol. *KI-KIO₃*, mix equal volumes of 8 per cent KIO₃ and 48 per cent KI solutions. *Congo red*. 0.5 gram in 90 c.c. water and add 10 c.c. 95 per cent alcohol. *Alizarin*, 1 gram sodium alizarin sulphate in 100 c.c. water. *Lilmas*, preferably aso-litmin 1 per cent solution in water. *Neutral red*. 0.05 gram in 50 c.c. 95 per cent alcohol, add 50 c.c. water. *Phenolphthalein*. 1 gram in 100 c.c. 95 per cent alcohol.

rod through the dried reagent. Warm again gently and note the production of a purplish-red color in the presence of free hydrochloric acid.

2. Boas' Reagent.¹—Perform this test in the same manner as 1, above. Free hydrochloric acid is indicated by the production of a rose-red color which becomes less pronounced on cooling.

3. Tropæolin OO,²

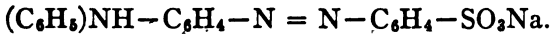

Place 2 drops of the solution to be tested and 1 drop of the indicator in an evaporating dish and evaporate to dryness over a low flame. The formation of a reddish-violet color indicates free hydrochloric acid.

This test may also be conducted in the same manner as 1, above.

HYDROGEN ION CONCENTRATION AND TITRATABLE ACIDITY

The acidity of a solution may be determined in two different ways by means of indicators. One method is by titration with standard alkali using the indicator to determine the end point of the titration. For this purpose the indicator should be one which gives a sharp color change which is sensitive to the form of acidity which is to be determined, and which is not destroyed by any substance contained in the titration mixture. Thus phenolphthalein can be used for the titration of strong bases and nearly all weak acids, but cannot be used for weak bases, and is unsatisfactory in the presence of ammonium salts. Methyl orange on the other hand is useful for strong acids and weak bases such as ammonia and for the soluble carbonates but cannot be used for weak acids such as carbonic acid or the organic acids. Almost any indicator may be used in the titration of mineral acids against strong bases such as KOH inasmuch as under these conditions 1 drop of the standard solution will throw the hydrogen ion concentration so far beyond that of neutrality that the turning point of any common indicator will be passed.

Titration does not, however, enable us to determine in all cases the true acidity of a solution, that is, its hydrogen ion concentration. In the case of strong acids and bases very accurate results for the true acidity may be obtained in this way. In the case of weak acids or bases the titration values may give but slight information as to the true acidity. Thus in the case of a slightly dissociated acid, such as acetic acid, as fast as the acidity due to its dissociated hydrogen ions is neutralized the undissociated acid ionizes further and the titration value finally obtained represents the total acid present at the beginning both ionized and unionized. Salts of strong acids and very weak bases and *vice*

¹ Boas' reagent is prepared by dissolving 5 grams of resorcinol and 3 grams of sucrose in 100 c.c. of 50 per cent alcohol.

² Prepared by dissolving 0.05 gram of tropæolin OO in 100 c.c. of 50 per cent alcohol.

versa also hydrolyze during the course of the titration and the values obtained in no sense represent the true acidity.

Hydrogen ion concentrations may be determined through a certain range by means of indicators. The unknown solution is treated with a few drops of indicator and the color obtained compared with that produced with the same amount of indicator and a solution of known hydrogen ion concentration. If the same tint is produced in both cases the two acidities are the same. This is of course only true when the indicator chosen is a suitable one, that is, one that shows definite color changes in hydrogen ion concentrations in the neighborhood of that of the unknown. The choice of indicators for this purpose is somewhat different than that for titration purposes. For use in the determination of the hydrogen ion concentration of a solution we need an indicator showing a very gradual change in color through a given range, one which is not readily affected by the presence of neutral salts or other substances likely to be present, and the color of which does not fade too rapidly. The ranges through which a number of indicators may be used with satisfactory results for the determination of hydrogen ion concentrations is indicated in the chart (Fig. 50, page 161). Those surrounded by the heavy lines are the most satisfactory.

The chart also indicates how standard solutions of definite hydrogen ion concentrations may be made up from a series of stock solutions, by mixing in various proportions. The stock solutions indicated on the chart were suggested by Sørensen and are as follows: 0.10 N HCl; 0.10 N NaOH; 7.505 g. glycocoll plus 5.85 gm. NaCl per liter; 11.876 g. $\text{Na}_2\text{HPO}_4 \cdot 2\text{H}_2\text{O}$ per liter; 9.078 g. KH_2PO_4 per liter; 21.008 g. citric acid in 1 liter of 0.20 N NaOH; 12.404 g. boric acid in 1 liter of 0.10 N NaOH. The other solutions are 0.20 N sodium acetate and 0.20 N acetic acid. Solutions of known hydrogen ion concentration are prepared from these by mixing in the proportions indicated on the chart, the abscissæ representing parts of the more alkaline or less acid constituent. Thus a mixture of seven volumes of the sodium acetate stock solution with three volumes of the stock acetic acid solution gives a mixture with an hydrogen ion concentration of 1×10^{-5} (exponent: 5.0). The mixtures are most satisfactory through the ranges where the hydrogen ion concentration changes most gradually, that is, through the flatter portions of the curves.

The amounts of indicator solutions and their strengths to be used in the determinations of hydrogen ion concentrations in 10 c.c. portions of unknown solution are indicated below.

INDICATOR SOLUTIONS

	Drops	Preparation of solution
1. Alizarin yellow R (ρ -nitrobenzene-azo-salicylic acid)	10-5	0.1 gram to 1000 c.c. water.
2. Azolitmin (litmus)		Aqueous solution.
3. Cochineal		Alcoholic solution.
4. 2, 5-dinitro-hydroquinol	5-2	1 gram to 1000 c.c. alcohol.
5. Mauvein	8-1	0.5 gram to 1000 c.c. water.
6. Methyl orange	5-3	0.1 gram recrystallized salt to 1000 c.c. water.
7. Methyl red	4-2	Saturated solution in 50 per cent alcohol.
8. Methyl violet	8-1	0.5 gram to 1000 c.c. water.
9. Neutral red	20-10	0.1 gram in 500 c.c. alcohol, and 500 c.c. water.
10. ρ -Nitrophenol	20-3	0.4 gram to 60 c.c. alcohol, 940 c.c. water.
11. Phenolphthalein	20-3	0.5 gram to 500 c.c. alcohol, 500 c.c. water.
12. Rosolic acid	15-6	0.4 gram to 400 c.c. alcohol, 600 c.c. water.
13. Thymolphthalein	10-3	0.4 gram to 500 c.c. alcohol, 500 c.c. water.
14. Tropæolin O	10-5	0.1 gram to 1000 c.c. water.
15. Tropæolin OO	5-3	Of recrystallized salt, 0.1 gram to 1000 c.c. water.
16. Tropæolin OOO	10-4	0.1 gram to 1000 c.c. water.

Determination of Hydrogen Ion Concentration.—Introduce 10 c.c. portions of the unknown solution into a series of test-tubes of similar diameter and of clear glass. Test first with litmus paper which changes at about the neutral point. According to whether the reaction is acid or basic to litmus test other indicators on the acid side such as ρ -nitrophenol, methyl orange and tropæolin OO, or on the basic side as phenolphthalein. Select an indicator which gives with the solution neither its maximum acid or maximum basic color. Note from the chart through what range this indicator exhibits its characteristic change of color. Then to 10 c.c. portions of standard solutions of known hydrogen ion concentration (furnished by the instructor), which cover approximately the same range as the indicator add exactly the same number of drops of indicator solution as was added to the standard. Compare colors of unknown and standards until one is found which matches and which consequently possesses the same hydrogen ion concentration. If the unknown is so strongly acid or basic that none of the indicators mentioned can be used directly it will be necessary to dilute it with 10 or a greater number of volumes of water before testing further.

In case the unknown solution is slightly colored the standards should likewise be brought to the same tint by the addition of some coloring agent as Bismarck brown, methyl orange, methyl violet, etc., before making the comparison.

For applications of the indicator method for the determination of hydrogen ion concentration to biological fluids see chapters on the quantitative analysis of blood (XVI) and urine (XXVII).

Comparison of H Ion Concentration and Titratable Acidity.—1. Determine colorimetrically the H ion concentration of an N/100 solution of hydrochloric acid using tropæolin OO as an indicator and of an N/100 acetic acid using methyl orange as an indicator. Note the great difference between the true acidities of the two solutions.

Titrate 10 c.c. portions of N/100 hydrochloric acid and of N/100 acetic acid with N/100 KOH using phenolphthalein as an indicator. Note that identical results are obtained for the titratable acidities of the two.

2. Determine colorimetrically the H ion concentration of an N/100 KOH

solution using tropæolin O as an indicator, and of an N/100 ammonia solution using phenolphthalein as an indicator. Note the results and then titrate 10 c.c. portions of both solutions with N/100 HCl using alizarin as an indicator.

3. Mix equal portions of M/15 potassium dihydrogen phosphate and M/15 disodium phosphate (see chart). Note that the mixture is practically neutral to litmus. Titrate one 10 c.c. portion of this mixture with N/10 KOH, using phenolphthalein as an indicator. Titrate another portion with N/10 HCl solution, using methyl orange as an indicator.

4. Mix equal volumes of N/5 sodium acetate solution and N/5 acetic acid. Note that the mixture is acid to litmus. Titrate one 10 c.c. portion with N/10 HCl using tropæolin OO as an indicator. Titrate another portion with N/10 KOH using phenolphthalein as an indicator.

THE FRACTIONAL METHOD OF GASTRIC ANALYSIS

Procedure in Gastric Analysis by the Fractional Method

1. Introduction of the stomach tube.(see pages 163 and 164).
2. Removal of the residuum (see pages 164 and 165).
3. Feeding the test meal (see page 165).
4. Feeding the retention meal (in special cases), see page 165.
5. Removing samples of stomach contents for analysis (see page 165).
6. Examination of the samples for:
 - (a) Total acidity (see page 162).
 - (b) Free acidity (see page 168).
 - (c) Pepsin (see page 169).
 - (d) Trypsin (not a routine procedure), see page 172.
 - (e) Lactic acid (see page 173).
 - (f) Occult blood (see page 174).
 - (g) Bile (see page 175).
 - (h) Microscopical constituents (see page 176).

1. Introduction of the Stomach Tube.—Whereas the large tube is directly inserted by propulsion, the Rehfuß tube is swallowed in the natural manner and aided by gravity. The tube may be passed in one of three ways, *i.e.*: (1) lubricated; (2) with aid of fluid; (3) after throat is cocaineized. When passed by the first method the tip of the tube, after thorough lubrication with glycerol or liquid petrolatum, is seized between the thumb and forefinger and placed on the tongue. Then with the aid of the forefinger the tip is pushed backward until it reaches the root of the tongue and is engaged in the oropharynx. Then the patient is encouraged to swallow persistently while the tube is slowly fed into the mouth. After slight discomfort in the pharynx and its passage past the level of the cricoid cartilage, practically no discomfort is felt. This

method is used when it is essential that the pure gastric secretion or residuum be obtained. Ordinarily, however, it is much easier to swallow the tube by the second method. This method consists in placing the tip in the oropharynx and then giving the patient a measured quantity of water or tea to swallow. The movements induced by the swallowing carry the tube rapidly to the stomach with a minimum of discomfort. When an Ewald meal (see below) is given, part of the tea can be reserved for swallowing the tube. This procedure makes it scarcely more arduous than the swallowing of food. Should the patient, however, be extremely neurotic or the unfortunate possessor of marked pharyngeal hyperesthesia, cocain hydrochloride in 2 per cent aqueous solution can be applied to the throat rendering the passage of the tube practically insensitive. When the tube has entered the stomach, aspiration of the material shows the characteristic gastric contents. Should the tip remain in the esophagus through transient cardiospasm or other cause, aspiration results in the removal of only a very small specimen having all the characteristics of the pharyngeal and esophageal secretions.

2. **Removal of Residuum.**—If the so-called “empty” stomach is examined in the morning before any food or drink has been taken it will be found to contain considerable material. This is termed residuum. Before a test meal is introduced into the stomach, this organ should be emptied. If this is not done we cannot consider the samples withdrawn after the test meal is eaten as representing the secretory activity of the gastric cells under the influence of the stimulation of the test meal. It has been generally recognized, clinically, that a residuum above 20 c.c. is pathological.¹ Such a volume has been considered as indicative of hypersecretion, and this in turn in many cases indicates an organic lesion. The observations indicating that a residuum of over 20 c.c. was pathological, were made upon residuums removed by means of the old type of stomach tube which does not completely empty the stomach.² When the residuum is completely removed by means of the Rehffuss tube it has been demonstrated that the *normal* residuum is practically always over 20 c.c. and that the average is about 50 c.c. for both men³ and women.⁴ The normal residuum has been found to possess all the qualities of a physiologically active gastric juice with

¹Loeper: *Leçons de pathologie digestive*, 1912, Series 2, pp. 17-19.

Zweig: *Magen- und Darmkrankheiten*, p. 459.

Kemp: *Diseases of the Stomach, Intestines and Pancreas*, 1912, p. 133.

Wolff: *Taschenbuch der Magen- und Darmkrankheiten*, p. 22.

²Harmer and Dodd: *Loc. cit.*

³Rehffuss, Bergeim and Hawk: *Jour. Am. Med. Ass'n*, 63, 11, 1914.

Fowler, Rehffuss and Hawk: *Jour. Am. Med. Ass'n*, 65, 1021, 1915.

⁴Fowler and Zentmire: *Jour. Am. Med. Ass'n*, 68, 167, 1917.

an average total acidity of 30 and an average free acidity of 18.5. The residuum is often colored by bile. This is particularly true if the fluid has a relatively high acidity. Trypsin is also generally present. These findings indicate regurgitation (see page 172). Pathological residuums may contain blood, pus, mucus and may show food retention which is indicative of disturbed food evacuation. The quantity may also be much increased due to hypersecretion. A residuum of large volume possessing a total acidity value of 70 or over may indicate ulcer.

Analysis of Residuum.—Remove the residuum as directed under (5), below, and analyze the fluid according to methods outlined on page 166.

3. The Test Meal.—Before making an analysis of the stomach contents it is customary to introduce something into the stomach which will stimulate the gastric cells. The response to this stimulation is then measured clinically by the determination of total acidity, free acidity and pepsin in the stomach contents. Many forms of test meal have been used.

The test meal most widely employed is the Ewald test meal. This consists of 2 pieces (35 grams) of toast and 8 ounces (250 c.c.) of tea.

Inasmuch as it was demonstrated in the author's laboratory¹ that water gave a similar gastric stimulation to that produced by the Ewald meal it was suggested that a simple water meal might be substituted for the Ewald meal. This water meal also has the added advantage of enabling one to determine the presence of food rests and to test more accurately for lactic acid, blood and bile.

4. The Retention Meal.—In order to obtain more information regarding gastric motility than is furnished by the ordinary test meal described above the patient may be fed a so-called *retention meal*. This meal is fed in place of the regular evening meal and contains substances readily detected. In the morning before breakfast (7-8 a. m.) remove the stomach contents (residuum, see page 164) by aspiration and examine for food rests. The normal stomach should give no evidences of food retention. A satisfactory retention meal consists of 4 ounces each of boiled string beans and rice.² Diets containing prunes, raspberry marmalade, lycopodium powder, etc., have also been employed. In many instances an ordinary mixed diet will serve the purpose.

5. Removal of Samples for Analysis.—At intervals of exactly 15 minutes from the time the test meal is eaten until the stomach is empty

¹ Bergeim, Rehfuss, and Hawk: *Jour. Biol. Chem.*, 19, 345, 1914.

Rehfuss, Bergeim and Hawk: *Jour. Am. Med. Ass'n*, 63, 11, 1914.

² Myers and Fine: *Essentials of Pathological Chemistry*, 1913.

5-6 c.c. samples of gastric contents are withdrawn from the stomach by means of aspiration.

In the removal of samples from the stomach, it is essential that very little traction be employed. To completely empty the stomach, aspiration is practised in four positions: (a) on the back; (b) on the stomach; (c) on right side, (d) on left side. This results in complete evacuation of the stomach. Three tests may be employed to determine whether the stomach is empty: (1) No more material can be aspirated in any position; (2) injection of air and auscultation over the stomach with a stethoscope reveals a sticky rale and not a series of gurgling rales such as is heard when there is material in the stomach; (3) lavage or irrigation through the tube which shows the absence of all food in the stomach.

6. Examination of the Samples.—The old methods of gastric analysis involved the collection (by analysis and calculation) of data regarding several types of acidity (see Töpfer's method, page 177). The modern tendency among clinicians is to lay particular emphasis upon the values for total acidity and free acidity. The determination of the peptic activity is also important as well as the demonstration of the presence or absence of occult blood, lactic acid, mucus, food rests, etc.

Procedure.—Strain each sample through a fine-mesh cheese cloth.¹ Examine the residue for mucus, blood and food rests. Use the strained stomach contents for the determination of total acidity, free acidity and peptic activity by methods which follow.

(a) **Determination of Total Acidity.**—*Principle.*—The indicator used is phenolphthalein. Since the indicator reacts with mineral acid, organic acid, combined acid and acid salts the values obtained represent the *total* acidity of the solution.

Procedure.—Measure 1 c.c. of the strained stomach contents by means of an Ostwald pipette and introduce it into a low-form 60 c.c. porcelain evaporating dish. Dilute with 15 c.c. of distilled water. Add 2 drops of a 1 per cent alcoholic solution of phenolphthalein and titrate with N/100 sodium hydroxide until a faint pink color is obtained and persists for about two minutes.² Take the burette reading and calculate the total acidity.

¹ The examination for microscopical constituents (see (h) p. 176) should be made on the original (unstrained) gastric contents. Tests for occult blood may be made on the *sediment* if desired.

² *Procedure for Serial Titrations.*—When a series of titrations are to be made the following procedure may be used: Arrange the numbered evaporating dishes in rows on a tray. Introduce 1 c.c. of the proper sample into each dish, dilute with 10 c.c. of water and add the indicator. Add the N/100 NaOH to contents of dish No. 1 at a definite rate until a point is reached at which a faint pink color is obtained, as described above. Return dish No. 1 to its place in the tray and place dish No. 2 under the burette. Take the burette reading of No. 1. Then titrate No. 2 in the same way. Continue the series. This procedure has the advantage of being *speedy* and *accurate*. There is a slight error made by the rapid addition of the NaOH but it is *uniform* and the results (titrations) are therefore comparable.

Calculation.—Note the number of cubic centimeters of $N/100$ NaOH required to neutralize 1 c.c. of stomach contents, and multiply it by 10 to obtain the number of cubic centimeters $N/10$ NaOH necessary to neutralize 100 c.c. of stomach contents. This is the method of calculation most widely used. For other forms of expressing total acidity see page 178. Plot your results in a form similar to those shown in Figs. 51 and 52.

Curves Obtained by the Fractional Method.—When an Ewald test meal is given to normal individuals a curve such as indicated below is usually obtained. The curve may vary within certain limits depending on individual idiosyncrasies, but is usually found to follow the curve depicted, and the meal normally leaves the stomach in two and one-

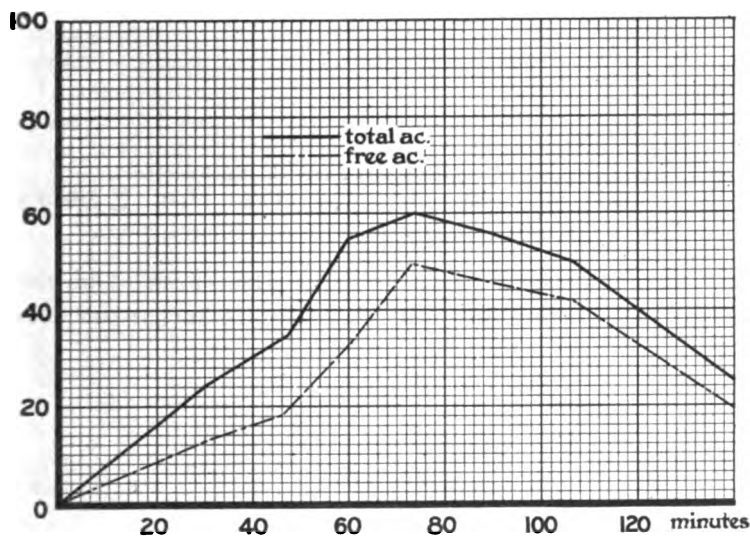

FIG. 51.—ACIDITY CURVES OF NORMAL HUMAN STOMACH.

half hours. Pathologically every variation occurs, both in time of evacuation as well as the character of the curve and the quantity of the secretion elaborated. Fig. 45 represents some of the possibilities of pathological cases, but a consideration of their interpretation is outside the purpose of the present volume. It will be evident, however, from a consideration of the figure that the cycle of gastric digestion is a constantly changing one, and no information concerning the trend of digestion can be obtained by an examination of only a single stage of digestion. Marked changes may precede or follow that stage and the possibilities suggested in Fig. 45 are all observed clinically and are of varying significance. Typical curves from cases of hyperacidity, gastric carcinoma and achylia are shown in Figs. 52, 53 and 54 respectively.

(b) **Determination of Free Acidity.**—The reagent most widely used, clinically, for the determination of free hydrochloric acid in stomach

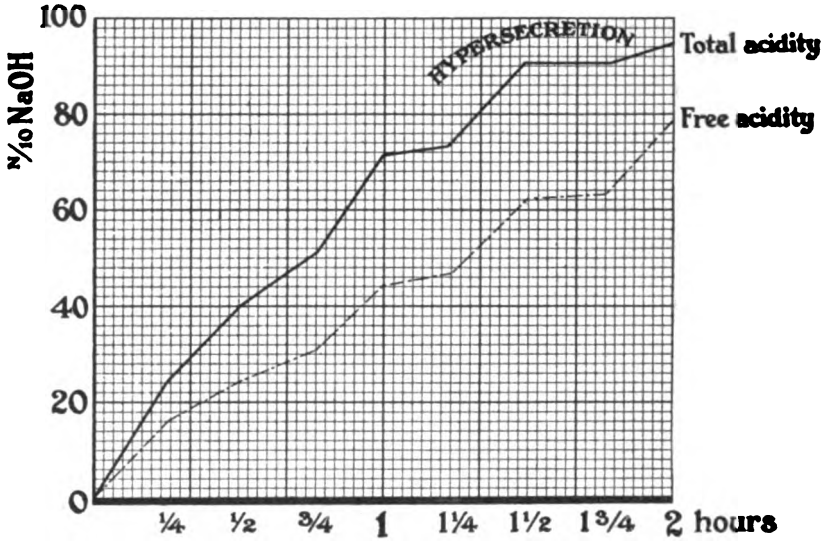

FIG. 52.—ACIDITY CURVES FROM A CASE OF HYPERACIDITY.

contents is Töpfer's reagent (see page 177). It has been found, however, that this reagent gives rather inaccurate results due to the uncertain

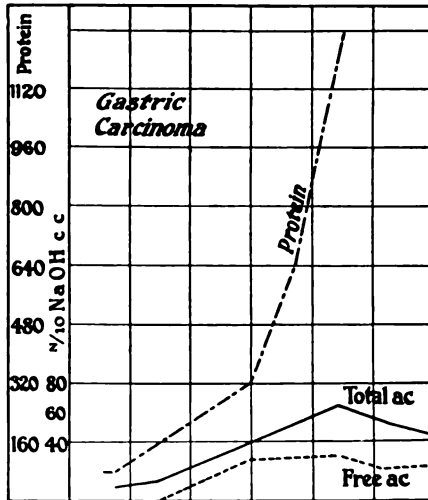

FIG. 53.—ACIDITY AND PROTEIN CURVES IN GASTRIC CARCINOMA. (Clarke and Rehfsuss: *Jour. Am. Med. Ass'n*, 64, 1737, 1915.)

end point. For this reason we have employed Sahli's reagent.¹ This reagent contains KI and KIO₃ and liberates iodine in the presence of

¹A mixture of equal parts of a 48 per cent solution of potassium iodide and an 8 per cent solution of potassium iodate.

free hydrochloric acid. The liberated iodine is titrated by thiosulphate using starch as an indicator. It gives values similar to Töpfer's reagent in average acidities.¹ Acidities other than free hydrochloric react to a certain extent with Sahli's reagent, so that, for example, high results are obtained after the ingestion of acid fruits.

Procedure.—Measure 1 c.c. of the strained stomach contents by means of an Ostwald pipette and introduce it into a 60 c.c. porcelain evaporating dish. Dilute with 10 c.c. of distilled water, and add 1 c.c. of Sahli's reagent (a mixture of equal parts of 48 per cent KI and 8 per cent KIO₃). Allow the stomach contents thus treated to stand for five minutes and then titrate with N/100 sodium thiosulphate until only a faint yellow color remains. Now add 5–10 drops of a 1 per cent solution of soluble starch and continue the titration until the blue color disappears. In serial titrations the same procedure may be employed as described on page 166, note 2.

Calculation.—Note the number of cubic centimeters of N/100 sodium thiosulphate required to titrate 1 c.c. of stomach contents to the total disappearance of blue color in the presence of starch. Inasmuch as N/100 thiosulphate is equivalent to N/100 alkali, this value indicates the number of cubic centimeters of N/100 sodium hydroxide necessary to neutralize the free hydrochloric acid in

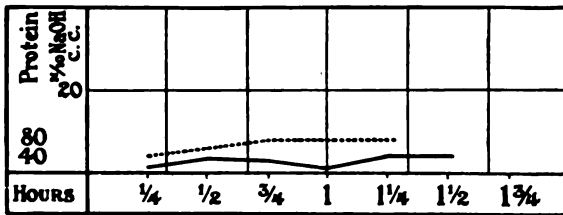

FIG. 54.—TOTAL ACIDITY AND PROTEIN CURVES IN BENIGN ACHYLIA (SOLID LINE REPRESENTS ACIDITY). (Clarke and Rehfuess: *Jour. Am. Med. Ass'n*, 64, 1737, 1915.)

1 c.c. of the stomach contents. Multiply the value by 10 to obtain the number of cubic centimeters of N/10 NaOH necessary to neutralize 100 c.c. of stomach contents. This is the method of calculation most widely used. For other forms of expressing free acidity see page 178. Plot your results in a curve similar to those shown in Figs. 49, 51, and 52, pages 154, 167 and 168.

(c) **Determination of Peptic Activity.**—(1) **Method of Mett² as Modified by Nirenstein and Schiff.³**—*Principle.*—Small glass tubes filled with coagulated egg albumin are introduced into the solution to be tested, and kept for a definite length of time in the incubator. The protein column is digested at both ends of the tube to an extent depending upon the amount of pepsin present. The method is not strictly accurate but is the most satisfactory for clinical purposes on account of its simplicity. Nirenstein and Schiff showed that human gastric

¹ Fowler, Bergeim and Hawk: Unpublished data.

² Mett: *Arch. f. Anat. u. Physiol.*, Verda 1894, 68.

³ Nirenstein and Schiff: *Arch. f. ankerungsstechn*, 8, 559, 1902.

juice contained inhibiting substances the effect of which is overcome by the dilution recommended.

Procedure.—Introduce into a small Erlenmeyer flask 1 c.c. of gastric juice and 15 c.c. of N/20 HCl (= 0.18 per cent HCl). Add two Mett tubes prepared as indicated below, stopper the flask to prevent evaporation and place in an incubator at 37°C. for 24 hours. By means of a low power microscope and a millimeter scale (graduated to half millimeters) determine accurately the length of the column of albumin digested at each end of the tubes. It is well to run the determination in duplicate in which case the result is the average of the eight figures obtained. Ordinarily from 2–4 mm. of albumin are digested by normal human gastric juice.

Calculation.—The peptic power is expressed as the square of the number of millimeters of albumin digested. This is based on the Schütz-Borissow law that the amount of proteolytic enzyme present in a digestion mixture is proportional to the square of the number of millimeters of albumin digested. Therefore a gastric juice which digests 2 mm. of albumin contains four times as much pepsin as one which digests only 1 mm. of albumin.

Example.—If the microscopic reading gives on an average 2.2 mm. of albumin digested the pepsin value for the diluted juice would be $2.2^2 = 4.84$, and for the pure undiluted juice, $4.84 \times 16 = 77.44$.

Preparation of Mett Tubes (Christiansen's Method).¹—The liquid portions of the whites of several eggs are mixed and strained through cheese cloth. The mixture should be homogeneous and free from air bubbles. It is best to allow the egg-white to stand for two or three hours in a vacuum desiccator to more completely remove air. A number of thin-walled glass tubes of 1–2 mm. internal diameter are thoroughly cleaned and dried and cut into lengths of about 10 inches. These are sucked full of the egg-white and kept in a horizontal position. Into a large evaporating dish or basin 5–10 liters of water are introduced and heated to boiling. The vessel is then removed from the fire and stirred with a thermometer until the temperature sinks to exactly 85°C. The tubes filled with egg-white are immediately introduced and left in the water until it has cooled. The tubes thus prepared are soft boiled, more easily digested than hard boiled tubes, and free from air bubbles. The ends are sealed by dipping in melted paraffin or sealing wax (preferably the latter), and the tubes can be kept thus for a long time. When ready for use mark with a file and break into pieces about $\frac{3}{4}$ inch long. After cutting, the tubes should be immediately introduced into the digestion mixture or may be kept a short time under water. Tubes whose ends are not squarely broken off must be rejected.

The digestibility of different egg-whites varies widely. Hence in making up a new set of tubes if we wish our results to be comparable these tubes must be standardized against those first prepared. This may be done by running simultaneous tests with tubes from the two series, using the same gastric juice and comparing the lengths of the columns digested in each case. Christiansen's method of preparing tubes of the same digestibility is to be preferred. He proceeds as in the original preparation of the tubes except that as the water cools from 90°–80°C. a single tube containing the new egg-white is dropped in at each degree change of temperature, that is at 90°, 89°, etc. Pieces of each of these tubes as well as of the original standard tubes are then allowed to digest simultaneously in portions of the

¹Christiansen: *Biochem. Zeit.*, 46, 257, 1912.

same gastric juice. One of these tubes should show a digestibility equal to that of the standard tubes. For example the tube coagulated at 88°C. may show the proper digestibility. Then the new series of tubes should be made in the same manner as this one, that is introduced at 88°C. The tubes thus prepared should be again checked up with the standard to see that no mistake has been made.

(2) **Rose's Modification¹ of the Jacoby-Solms Method.²**—Dissolve 0.25 gram of the globulin of the ordinary garden pea,³ *Pisum sativum*, in 100 c.c. of 10 per cent sodium chloride solution, warming slightly if necessary.⁴ Filter and introduce 1 c.c. of the clear filtrate into each of a series of six⁵ test-tubes about 1 cm. in diameter. Introduce into each tube 1 c.c. of 0.6 per cent hydrochloric acid and permit a period of about five minutes to elapse for the development of the turbidity. Make a known volume of the gastric juice (5–10 c.c. is sufficient) exactly neutral to litmus paper with dilute alkali; and record the volume of the alkali so used. If acid metaprotein precipitates, filter it off; if there is no precipitate proceed without filtration. Dilute the clear neutral solution with a known quantity of distilled water (usually 5 volumes) making proper allowance for the volume of alkali used in the neutralization. Boil 5–10 c.c. of the diluted juice, filter and add the following decreasing volumes (c.c.) to the series of six tubes: 1.0, 0.9, 0.7, 0.5, 0.2, 0.0. Make the measurements by means of a 1 c.c. pipette graduated in 0.01 c.c. Now rapidly introduce the *unboiled*, diluted juice in the following increasing volumes (c.c.) in order: 0.0, 0.1, 0.3, 0.5, 0.8, 1.0. Each tube now contains a total volume of 3 c.c. and a total acidity of 0.2 per cent hydrochloric acid. Shake each tube thoroughly and place them at 50–52°C. for 15 minutes or at 35–36°C. for one hour. Examine the series of tubes at the end of the digestion period and select that tube which contains the smallest quantity of gastric juice and which *shows no turbidity*. The volume of the juice used in this tube is taken as the basis for the calculation of the peptic activity.

Calculation.—The peptic activity is expressed in terms of 1 c.c. of the *undiluted* juice. For example, if it requires 0.5 c.c. of the diluted juice (five-fold dilution) to clear up the turbidity in 1 c.c. of the globulin solution in the proper experimental time interval (15 minutes or one hour according to temperature) the peptic activity would be expressed as follows:

$$(1 \div 0.5) \times 5 = 10 \text{ (peptic activity).}$$

¹ Rose: *Archives of Internal Medicine*, 5, 459, 1910.

² Solms: *Zeitschrift für klinische Medizin*, 64, 159, 1907.

³ The globulin may be prepared as follows: "The finely ground peas, freed as much as possible from the outer coating, are repeatedly extracted with large quantities of 10 per cent sodium chloride solution, the extracts combined, strained through fine bolting-cloth, and allowed to stand over night in large cylinders to deposit insoluble matter. The supernatant fluid is siphoned off and saturated with ammonium sulphate. The precipitate of albumin and globulin is filtered off, suspended in a little water, and dialyzed in running water for three days, until the salt has been removed, and the albumins have been dissolved. The globulins are filtered off and washed two or three times to remove the last trace of albumins. To purify further, the precipitate is extracted with 10 per cent sodium chloride solution, and filtered until perfectly clear. The resulting solution is neutralized to litmus paper by the cautious addition of dilute sodium hydroxide, and again dialyzed in running water for three days to remove the salts completely. The precipitated globulins are then filtered off and dried on a water-bath at 40°C. During the entire process of separation the proteins should be preserved with a mixture of alcoholic thymol and toluol." This dried globulin is used in the clinical procedure.

⁴ This solution may be preserved at least two months under toluene.

⁵ A longer series of tubes may be used if desired. However, experience has shown that a series of six ordinarily affords sufficient range for all diagnostic purposes.

According to this scale of pepsin units 10 may be considered as "normal" peptic activity. These units are about $\frac{1}{10}$ as large as those expressed by the Jacoby-Solms scale.

Inasmuch as it has been shown¹ that blood serum contains an antipepsin it is said to be advisable to test the gastric juice for blood before determining its proteolytic power. However, Dezani² claims that the methods for demonstrating antipepsin in the blood are not adequate.

(3) **Given's Modification of Rose's Method.**³—The gastric contents are strained through cheese cloth. Two c.c. are measured by means of an Ostwald pipette into a 25 c.c. stoppered volumetric cylinder, and diluted to the mark with distilled water. Into each of seven small test-tubes (1×10 cm.) is measured, with an Ostwald pipette, 1 c.c. of a 0.25 per cent filtered pea globulin in 10 per cent sodium chloride solution. To each tube is added 1 c.c. of 0.6 per cent hydrochloric acid, also by means of an Ostwald pipette. The tubes are allowed to stand about five minutes, until the maximum turbidity develops. To the first five, distilled water is added as follows: To the first, 0.9 c.c.; to the second, 0.8 c.c.; to the third, 0.7 c.c.; to the fourth, 0.6 c.c.; and to the fifth, 0.2 c.c.; to the sixth and seventh, none. Then there are rapidly added to each test-tube the following amounts of the diluted (1:12.5) gastric juice; to the first, 0.1 c.c.; to the second, 0.2 c.c.; to the third, 0.3 c.c.; to the fourth, 0.5 c.c.; to the fifth, 0.8 c.c.; to the sixth, 1.0 c.c.; and to the seventh, 1.0 c.c. of the diluted juice boiled. These measurements can be accurately made with a 1 c.c. pipette graduated in 0.01 c.c. All tubes are then immersed for 15 minutes in a water-bath at 50° to 52°C. At the end of this time, the tube is selected which is clear and contains the least amount of diluted gastric juice. Upon this basis, the peptic activity is calculated as the number of cubic centimeters of 0.25 per cent globulin digested by 1 c.c. of undiluted gastric juice. For example, if tube 2 containing 0.3 c.c. of a 12.5 times diluted juice be clear, then the result would be expressed:

$$\text{Peptic activity} = (1 \div 0.3) \times 12.5 = 41.2.$$

Ordinarily this scheme of seven tubes is used, though it is not a rule. If the free acidity be high, sometimes a dilution of $\frac{1}{25}$ is made. The number of tubes used will depend upon the accuracy desired.

(d) **Determination of Tryptic Activity.**—Trypsin is not a gastric enzyme but occurs in the pancreatic juice (see page 191). In case of regurgitation of intestinal contents through the pylorus trypsin would be passed into the stomach. This regurgitation is doubtless of frequent occurrence and may even be a normal mechanism by which gastric acidity is regulated (see page 154). Trypsin is, therefore, generally present in the contents of the normal human stomach. Inasmuch, however, as trypsin is destroyed by the pepsin-hydrochloric acid of the gastric juice, determinations of this enzyme must be carried out immediately after aspirations of the gastric contents, particularly where the acidity of the latter is high.

¹ Oguro: *Biochemische Zeitschrift*, 22, 266, 1909.

² Dezani: *Arch. farm. Oper.*, 22, 287, 1916.

³ Givens: *Hygienic Lab. Bull.* 101, p. 71, August, 1915.

Spencer's Method.¹—(a) Prepare five reagent tubes, Nos. 1, 2, 3, 4, and 5; more if desired.

To tubes 1 and 2 add 0.5 c.c. of gastric contents (filter if cloudy).

(b) To tubes 2, 3, 4, and 5 add 0.5 c.c. of distilled water.

(c) From tube 2 remove 0.5 c.c. of its mixed contents and add to tube 3. Mix thoroughly and add 0.5 c.c. from tube 3 to tube 4. Repeat for tube 5.

We now have dilutions of gastric contents of 1, $\frac{1}{2}$, $\frac{1}{4}$, $\frac{1}{8}$, and $\frac{1}{16}$.

(d) To each tube add one drop of phenolphthalein solution (phenolphthalein 1 gram; alcohol (95 per cent) 100 c.c.); then add drop by drop a 2 per cent sodium carbonate solution until a light pink color is produced.

(e) To tubes 1, 2, 3, and 4 add 0.5 c.c. of casein solution. Tube 5 must receive 1 c.c. of casein solution, since it contains 1 c.c. of the diluted gastric contents. For the casein solution, dissolve 0.4 gram of casein in 40 c.c. of N/10 NaOH. Add 130 c.c. of distilled water, then 30 c.c. of N/10 HCl. This leaves the solution alkaline to the extent of 10 c.c. of N/10 NaOH, minus about 3 c.c. neutralized by the casein.

(f) Incubate for five hours at 40°C.

(g) Precipitate the undigested casein by dropwise addition of a solution of the following composition: glacial acetic acid 1 c.c., alcohol (95 per cent) 50 c.c., distilled water 50 c.c. The tubes in which digestion has been complete remain clear; others become turbid.

(h) The tryptic values are expressed in terms of dilution. Thus, complete digestion in tube 3 (a dilution of $\frac{1}{4}$) shows four times the tryptic power of undiluted gastric juice; taken as a standard as 1, therefore, its tryptic value is 4.

(i) Controls of boiled gastric contents plus casein solution, and of distilled water plus casein solution, treated as above stated, must show no digestion, and become turbid on addition of the precipitating solution.

(e) **Detection of Lactic Acid.**—When the acidity of the stomach contents is reduced to a low value there may occur considerable fermentation of carbohydrates which have been introduced into the stomach in the ingested food. This fermentation yields various organic acids among which lactic acid is particularly prominent. It is important, therefore, in case of low gastric acidity that the stomach contents be examined for lactic acid.

Tests. 1. Ether-Ferric Chloride Test (Strauss).—A satisfactory deduction regarding the presence of lactic acid can only be made by removing the lactic acid from disturbing factors (*e.g.*, hydrochloric acid, protein digestion products, etc.) present in the stomach contents. Lactic acid may be extracted from the stomach contents by ether. The following technic not only serves to detect lactic acid but also gives an approximate idea as to the amount of the acid present.

Procedure.—Introduce 5 c.c. of strained stomach contents into a small graduated separatory funnel, add 20 c.c. of ether and shake the mixture thoroughly.

¹Elaborated by Dr. W. H. Spencer (*Jour. Biol. Chem.*, 21, 165, 1915) in the author's laboratory for the specific purpose of determining trypsin in gastric juice. For other trypsin methods see Chapter X.

Permit the ether to separate, then allow all the fluid to run out of the separatory funnel except the upper 5 c.c. of ether. To this ether extract add 20 c.c. distilled water and 2 drops of a 10 per cent solution of ferric chloride and shake the mixture gently. A slight green color is obtained in the presence of 0.05 per cent lactic acid whereas 0.1 per cent lactic acid yields a very intense yellowish-green color.

2. **Ferric Chloride Test (Kelling).**—Fill a test-tube with water, add 1-2 drops of a 10 per cent solution of ferric chloride and mix thoroughly to form a liquid which is very faintly colored. Divide the solution into two parts and keep one part as a control. To the other part add a small amount of the strained gastric contents and to the control tube add a similar volume of water. Lactic acid is indicated by the immediate development of a distinct yellow color in the tube containing the gastric contents.

The color in this test is due to the formation of ferric lactate.

3. **Uffelmann's Reaction.**—To 5 c.c. of Uffelmann's reagent¹ in a test-tube add an equal volume of strained gastric juice. A canary yellow or greenish-yellow color develops if lactic acid be present to the extent of 0.01 per cent or over.

Other organic acid gives a similar reaction. Mineral acids such as hydrochloric acid discharge the blue coloration leaving a *colorless* solution. In other words, the color of the reagent is weakened in the presence of an *acid* reaction.

4. **Hopkins' Thiophene Reaction.**—Place about 5 c.c. of concentrated sulphuric acid in a test-tube and add 1 drop of a saturated solution of copper sulphate.² Introduce a few drops of the gastric contents, shake the tube well, and immerse it in the boiling water of a beaker-water-bath for one or two minutes. Now remove the tube, cool it under running water, add 2-3 drops of a dilute alcoholic solution³ of thiophene, C₄H₄S, from a pipette, replace the tube in the beaker and carefully observe any color change which may occur. Lactic acid is indicated by the appearance of a bright *cherry-red* color which forms rapidly. This color may be made more or less permanent by cooling the tube as soon as the color is produced. Excess of thiophene produces a deep yellow or brown color with sulphuric acid. The test is not wholly specific though the author claims it to be more so than Uffelmann's reaction.

(f) **Detection of Occult Blood.**⁴—1. **Ortho-tolidin Test (Ruttan and Hardisty).**⁵—To 1 c.c. of a 4 per cent glacial acetic acid solution of o-tolidin⁶ in a test-tube add 1 c.c. of the gastric juice under examination and 1 c.c. of 3 per cent hydrogen peroxide. In the presence of blood a bluish color develops (sometimes rather slowly) and persists for some time (several hours in some instances).

¹ Uffelmann's reagent is prepared by adding ferric chloride solution to a 1 per cent solution of carbolic acid until an amethyst-blue color is obtained, due in part to the formation of a ferric salt of carbolic acid and in part to the reduction of some of the iron.

² This is added to catalyze the oxidation which follows.

³ About 10-20 drops in 100 c.c. of 95 per cent alcohol.

⁴ These tests may be made upon the strained stomach contents or upon the solid residue.

⁵ Ruttan and Hardisty: *Canadian Medicine Ass'n Journal*, Nov., 1912; also *Biochem. Bull.*, 2, 225, 1913.

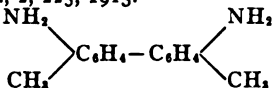

This test is said to be as sensitive for the detection of occult blood in feces and stomach contents as is the benzidine reaction. It is also claimed to be more satisfactory for urine than any other blood test. The acetic acid solution may be kept for one month with no reduction in delicacy.

2. Benzidine Reaction.—This is one of the most delicate of the reactions for the detection of blood. Different benzidine preparations vary greatly in their sensitiveness, however. Inasmuch as benzidine solutions change readily upon contact with light it is essential that they be kept in a dark place. The test is performed as follows: To a saturated solution of benzidine in alcohol or glacial acetic acid add an equal volume of 3 per cent hydrogen peroxide and 1 c.c. of the gastric contents under examination. If the mixture is not already acid render it so with acetic acid, and note the appearance of a blue color. A control test should be made substituting water for the solution under examination.

The sensitiveness of the benzidine reaction is greater when applied to aqueous solutions than when applied to the urine. According to Ascarelli the benzidine reaction serves to detect blood when present in a dilution of 1:300,000. (For further discussion of this test see chapter on Blood.)

(g) Detection of Bile in Stomach Contents.—If we accept Boldyreff's theory as to the automatic regulation of gastric acidity¹ under normal conditions by the regurgitation of alkaline material from the intestine, then the presence of bile in the gastric juice does not possess the clinical significance it has been accorded. However, if an ordinary Ewald meal be fed, and bile in any considerable quantity be found throughout the entire course of digestion it may indicate, pathologically, a stenosis below the level of the common bile duct. Frequently samples of gastric contents are encountered which are uncolored and which nevertheless contain bile. It is also true that bile may be adsorbed from stomach contents by mucus and food rests. The regulation technic for bile testing is often inadequate to demonstrate the presence of this fluid in gastric contents. The following procedure based upon the oxidation of the bilirubin with nitric acid forming green biliverdin is delicate and easy of application.

Procedure.—Saturate 10 c.c. of the fluid portion of the stomach contents with powdered ammonium sulphate. This may be accomplished by shaking for one to two minutes. It generally requires about 1 inch of powdered sulphate in the bottom of an ordinary test-tube to obtain full saturation. When the fluid is saturated add 1-3 c.c. of acetone and thoroughly mix the contents of the tube by inverting the tube five or six times. (It is better not to shake.) Permit the tube to stand and allow the acetone to rise to the surface. This acetone contains the bile pigment if any is present in the stomach contents. Allow a drop

¹ Boldyreff: *Quart. Jour. Exp. Med.*, 8, 1, 1914.

of yellow nitric acid to flow down the side of the tube and note the green color in the acetone.

This green color is biliverdin which has been produced from the bilirubin by oxidation with nitric acid. If too much acid is added the green color will be oxidized to a purple or red. If the acetone does not rise to the surface promptly the liquid has not been completely saturated with ammonium sulphate.

If the stomach contents contains large amounts of bile as indicated by a deep green color, 4-5 drops of the fluid may be diluted with 10 c.c. water and the above test applied.

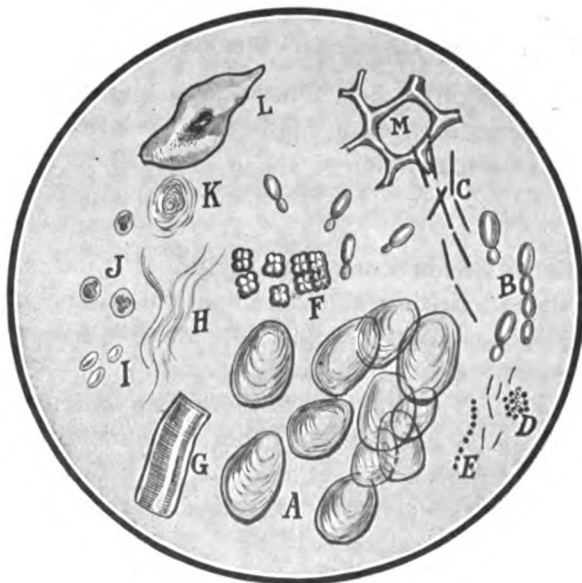

FIG. 55.—MICROSCOPICAL CONSTITUENTS OF THE GASTRIC CONTENTS.

A, Starch cells; *B*, yeast cells; *C*, Oppler-Boas bacilli; *D*, staphylococci; *E*, streptococci; *F*, sarcinae; *G*, muscle fibre; *H*, mucus; *I*, red blood cells; *J*, leucocytes; *K*, snail-like mucus formations; *L*, squamous epithelial cell; *M*, cellulose.

(h) **Microscopy of the Gastric Contents.**—A microscopical examination of the gastric contents is a routine clinical procedure.

When an Ewald meal is given the starch granules in various stages of digestion are observed together with epithelia from the pharynx, esophagus, and occasionally the stomach. Gastric and salivary mucus are seen and readily recognized by their ropy appearance. Pathologically various bacteria are seen, sarcinae, Oppler-Boas bacilli, streptococci, leptothrix, etc. Retained food from previous meals is readily recognized by its histological appearance; meat fibers, vegetable cells, and cellulose may all occur in pathological retention. In certain

pathological processes such as ulcer and cancer, red blood cells, pus, and even the cancer cells themselves may be found. For illustrations of the microscopical constituents of gastric contents, see Fig. 55.

Procedure.—Examine a drop of the original (mixed) stomach contents unstained under the low and high powers of the microscope. Compare your findings with the microscopical views shown in Fig. 55.

Wolff Technic for the Protein Concentration of the Gastric Contents.¹—Owing to the diagnostic importance of the protein concentration of the gastric secretion, a short note of this test is given here. Under normal conditions the protein concentration follows that of acidity rather closely. In certain cases, however, such as carcinoma (Fig. 53), there is an actual increase in the protein concentration of the gastric juice out of all proportion to the acidity. The test may be made as follows: The regular Ewald test meal is fed and specimens of the gastric contents are obtained at 15-minute intervals by means of the Rehfuss tube. One c.c. of the filtered juice is then diluted with 9 c.c. of water representing a dilution of 1:10; 5 c.c. of this mixture is again added to 5 c.c. of water and a dilution of 1:20 obtained; this is again repeated using 5 c.c. of the mixture last obtained and 5 c.c. of distilled water and the dilutions are kept up until a series is obtained representing 1:10, 1:20, 1:40, 1:80, 1:160, 1:320, and if necessary 1:640 or more. They are then stratified with approximately 1 c.c. of Wolff's reagent,² care being taken that the liquids do not mix. The tubes should be read immediately against a dark background and the tube giving a protein ring at the greatest dilution of gastric juice recorded. A glance at Fig. 53 will show a pronounced case of gastric carcinoma. With normal acid figures the protein concentration evolves proportionally to the acidity. A case of achylia is shown in Fig. 54.

Töpfer's Method of Gastric Analysis

This method is much less elaborate than many others but is sufficiently accurate for ordinary clinical purposes. The method embraces the volumetric determination of (1) *total acidity*, (2) *free acidity (organic and inorganic)*,³ and (3) *free hydrochloric acid*, and the subsequent calculation of (4) *combined acidity* and (5) *acidity due to organic acids and acid salts*, from the data thus obtained.

Procedure.—Feed the Ewald test meal as directed on page 165. At the end of *one hour* remove the *entire stomach contents* and analyze as directed below. This method of procedure is less accurate than the Fractional Method (see page 151). Measure the volume of the gastric contents, strain it through cheese cloth and introduce 10 c.c. of the strained material into each of three small beakers or porcelain dishes.⁴ Label the vessels *A*, *B*, and *C*, respectively, and proceed with the analysis

¹ Wolff: Magen- und Darmkrankh., Berlin, 1912, p. 217; also *Berl. klin. Woch.*, May 29, 1911, and March 18, 1912.

Rolph: *Med. Rec.*, 1913, p. 848.

Clarke and Rehfuss: *Jour. Am. Med. Ass'n*, 64, 1737, 1915.

² Phosphotungstic acid.....	0.3 c.c.
Concentrated hydrochloric acid.....	1.0 c.c.
Alcohol 95 per cent.....	20.0 c.c.
Distilled water sufficient to make.....	100.0 c.c.

³ For a discussion of *combined acid* see chapter on Gastric Digestion.

⁴ If sufficient gastric juice is not available it may be diluted with water or a smaller amount, e.g., 5 c.c., taken for each determination.

according to the directions given below. The volume of fluid present in the stomach one hour after an Ewald meal varies under normal conditions between 50 and 100 c.c. In cases of hypersecretion or defective motility 200–300 c.c. may be found. Very excessive volumes, e.g., 500–3000 c.c., are indicative of dilatation of the stomach and suggest pyloric stenosis, either benign or malignant.

1. **Total Acidity.**¹—Add 3 drops of a 1 per cent alcoholic solution of phenolphthalein² to the contents of vessel *A* and titrate with N/10 sodium hydroxide solution until a *faint pink* color is produced and persists for almost two minutes. Take the burette reading and calculate the total acidity.

Calculation.—The total acidity may be expressed in the following ways:

1. The number of cubic centimeters of N/10 sodium hydroxide solution necessary to neutralize 100 c.c. of gastric juice.
2. The weight (in grams) of sodium hydroxide necessary to neutralize 100 c.c. of gastric juice.
3. The weight (in grams) of hydrochloric acid which the total acidity of 100 c.c. of gastric juice represents, i.e., percentage of hydrochloric acid.

The forms of expression most frequently employed are 1 and 3, preference being given to the former, particularly in clinical work.

In making the calculation note the number of cubic centimeters of N/10 sodium hydroxide required to neutralize 10 c.c. of the gastric juice and multiply it by 10 to obtain the number of cubic centimeters necessary to neutralize 100 c.c. of the fluid. If it is desired to express the acidity of 100 c.c. of gastric juice in terms of hydrochloric acid, by weight, multiply the value just obtained by 0.00365.³

2. **Free Acidity (Organic and Inorganic).**—Add 3 drops of sodium alizarin sulphionate solution⁴ to the contents of vessel *B* and titrate with N/10 sodium hydroxide solution until a *violet* color is produced. In this titration the red color, which appears after the tinge of yellow due to the addition of the indicator has disappeared, must be entirely replaced by a *distinct violet color*. Take the burette reading and calculate the free acidity due to organic and inorganic acids.

Calculation.—Since the indicator used reacts to both organic and inorganic acids, the number of cubic centimeters of N/10 sodium hydroxide used indicates the free acidity of 10 c.c. of gastric juice. The data for 100 c.c. of gastric juice may be calculated according to the directions given under Total Acidity, page 166.

3. **Free Hydrochloric Acid.**⁵—Add 4 drops of di-methyl-amino-azobenzene (Töpfer's reagent) solution⁶ to the contents of the vessel *C* and titrate with N/10 sodium hydroxide solution until the initial red color is replaced by *orange yellow*.⁷ Take the burette reading and calculate the free acidity.

Calculation.—The indicator used reacts only to free hydrochloric acid, hence the number of cubic centimeters of N/10 sodium hydroxide used indicates the volume necessary to neutralize the *free hydrochloric acid* of 10 c.c. of gastric juice. To determine the data for 100 c.c. of gastric juice proceed according to the directions given under Total Acidity, page 166.

¹ This includes free and combined acid and acid salts.

² One gram of phenolphthalein dissolved in 100 c.c. of 95 per cent alcohol.

³ One c.c. of N/10 hydrochloric acid contains 0.00365 gram of hydrochloric acid.

⁴ One gram of sodium alizarin sulphionate dissolved in 100 c.c. of water.

⁵ Hydrochloric acid *not* combined with protein material.

⁶ One-half gram dissolved in 100 c.c. of 95 per cent alcohol.

⁷ If the orange yellow color appears as soon as the indicator is added it denotes the *absence of free acid*.

4. **Combined Acidity.**—This value may be obtained by subtracting the number of cubic centimeters of $N/10$ sodium hydroxide used in neutralizing the contents of vessel *B* from the number of cubic centimeters of $N/10$ sodium hydroxide used in neutralizing *A*. The data for 100 c.c. of gastric juice may be calculated according to directions given under Total Acidity, page 166.

5. **Acidity Due to Organic Acids and Acid Salts.**—This value may be conveniently calculated by subtracting the number of cubic centimeters of $N/10$ sodium hydroxide used in neutralizing the contents of vessel *C* from the number of cubic centimeters of $N/10$ sodium hydroxide solution used in neutralizing the contents of vessel *B*. The remainder indicates the number of cubic centimeters of $N/10$ sodium hydroxide solution necessary to neutralize the acidity due to organic acids and acid salts present in 10 c.c. of gastric juice. The data for 100 c.c. of gastric juice may be calculated according to directions given under Total Acidity, page 166.

CHAPTER IX

FATS

Fats occur very widely distributed in the plant and animal kingdoms, and constitute the third general class of food-stuffs. In plant organisms they are to be found in the seeds, roots, and fruit, while each individual tissue and organ of an animal organism contains more or less of the substance. In the animal organism fats are especially abundant in the bone marrow and adipose tissue. They contain the same elements as the carbohydrates, *i.e.*, carbon, hydrogen, and oxygen, but the oxygen is present in smaller percentage than in the carbohydrates



FIG. 56.—BEEF FAT. (*Long.*)

and the hydrogen and oxygen are not present in the proportion to form water.

Chemically considered the fats are esters¹ of the tri-atomic alcohol, glycerol, and the mono-basic fatty acids. In the formation of these fats three molecules of water result. This water arises by the replacement of the H's of the carboxyl groups of the three fatty acid molecules by the glycerol radical, thus yielding the following type of formula. In this case the combination is with palmitic acid ($C_{15}H_{31}COOH$).

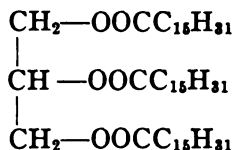

¹ An ester is an acid, one or more of whose acid hydrogens is replaced by an organic radical.

The three fatty acid radicals entering into the structure of a neutral fat may be the radicals of the same fatty acid or they may consist of the radicals of three different fatty acids.

By hydrolysis of a neutral fat, *i.e.*, by the addition to the molecule of those elements which are eliminated in the formation of the fat from glycerol and fatty acid, it may be resolved into its component parts, *i.e.*, glycerol and fatty acid. In the case of palmitin the following would be the reaction:

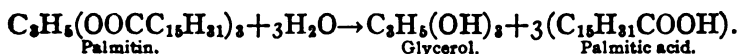

This process is called *saponification* and may be produced by boiling with alkalis; by the action of steam under pressure; by long-continued contact with air and light; by the action of certain bacteria and by fat-splitting enzymes or lipases, *e.g.*, *pancreatic lipase* (see page 192). The cells forming the walls of the intestines evidently possess the peculiar property of synthesizing the glycerol and fatty acid thus formed so that after absorption these bodies appear in the blood not in their individual form but as neutral fats.

The principal animal fats with which we have to deal are *stearin*, *palmitin*, *olein*, and *butyrin*. Such less important forms as laurin and myristin may occur abundantly in plant organisms. The older system of nomenclature for these fats was to apply the prefix "tri" in each case (*e.g.*, *tri-palmitin*) since three fatty acid radicals are contained in the neutral fat molecule.

The fatty acids corresponding to the above-mentioned animal fats are *stearic*, $\text{CH}_3(\text{CH}_2)_{16}\text{COOH}$; *palmitic*, $\text{CH}_3(\text{CH}_2)_{14}\text{COOH}$; *oleic*, $\text{CH}_3(\text{CH}_2)_7\text{CH}=\text{CH}(\text{CH}_2)_7\text{COOH}$; and *butyric*, $\text{CH}_3(\text{CH}_2)_2\text{COOH}$. Stearic, palmitic and butyric acids are *saturated* fatty acids, whereas oleic acid belongs to the class of *unsaturated* acids. Linoleic acid is also unsaturated. Upon the presence of these unsaturated fatty acids depends the property which certain fats possess of absorbing or combining with iodine. The determination of this so-called "iodine absorption number" is important in the differentiation of fats and oils. Fats containing the *unsaturated acids* oleic and linoleic may be transformed by "hydrogenation"¹ into the fats containing the corresponding *saturated acid* (stearic). The oleic acid is changed thus:

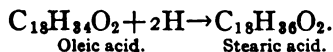

Fats occur ordinarily as mixtures of several individual fats. For

¹ Addition of hydrogen to the molecule, producing a "hydrogenated fat."

example, the fat found in animal tissues is a mixture of olein, palmitin and stearin, the percentage of any one of these fats present depending upon the particular species of animal from whose tissue the fat was derived. Thus the ordinary mutton fat contains more stearin and less olein than the pork fat. Human fat contains from 67 per cent to 85 per cent of olein and, according to Benedict and Osterberg, upon analysis yields 76.08 per cent of carbon and 11.78 per cent of hydrogen. Butter consists in large part of olein and palmitin. Stearin, butyrin, caproin and traces of other fats are also present.

Pure neutral fats are odorless, tasteless, and generally colorless. They are insoluble in the ordinary protein solvents such as water, salt solutions, and dilute acids and alkalis, but are very readily soluble in ether, benzene, chloroform, and *boiling* alcohol. The neutral fats are non-volatile substances possessing a *neutral* reaction. If allowed to remain in contact with the air for a sufficient length of time they become yellow in color, assume an *acid* reaction and are said to be *rancid*. The neutral fats may be crystallized, some of them with great facility. The crystalline forms of some of the more common fats are reproduced in Figs. 56, 57 and 58 on pages 180, 183 and 185. Each individual fat possesses a specific melting-point, and this property of melting at a definite temperature may be used as a means of differentiation in the same way as the coagulation temperature (see page 105) is used for the differentiation for coagulable proteins. When shaken with water, or a solution of albumin, soap, or acacia, the liquid fats are finely divided and assume a condition known as an *emulsion*. The emulsion with water is transitory, while the emulsions with soap, acacia, or albumin are permanent.

The fat ingested continues essentially unaltered until it reaches the intestine where it is acted upon by *pancreatic lipase (steapsin)*, the fat-splitting enzyme of the pancreatic juice (see page 192), and glycerol and fatty acid are formed. The glycerol is absorbed directly. The fatty acid thus formed unites with the alkalis of the pancreatic juice and forms soluble soaps. These soaps are readily absorbed. That bile is of assistance in the absorption of fat is indicated by the increase of fat in the feces when for any reason bile does not pass into the intestine. Bloor¹ claims that neither petroleum hydrocarbons nor nonsaponifiable esters, *e.g.*, wool fat (lanolin), are absorbed. He believes that *saponification is a necessary preliminary to absorption*.

The fat distributed throughout the animal body is formed partly from the ingested fat and partly from carbohydrates and the "carbon

¹ Bloor: *Jour. Biol. Chem.*, 15, 105, 1913.

moiety" of protein material. The formation of *adipocere*¹ and the occurrence of *fatty degeneration* are sometimes given as proofs of the formation of fat from protein. This is questioned by many investigators. Rather more satisfactory and direct proof of the formation of fat from protein material has been obtained by Hofmann in experimentation with *fly-maggots*. The normal content of fat in a number of maggots was determined and later the fat content of others which had developed in blood (84 per cent of the solid matter of blood plasma is protein material) was determined. The fat content was found to have increased 700 to 1100 per cent as a result of the diet of blood proteins.



FIG. 57.—MUTTON FAT. (*Long.*)

The celebrated experiments of Pettenkofer and Voit, however, have furnished what is, perhaps, the most substantial positive evidence of the formation of fat from protein. These investigators fed dogs large amounts of lean meat, daily, and through examination of urine, feces and expired air were enabled to account for *only part of the ingested carbon*, although obtaining a satisfactory nitrogen balance. The discrepancy in the carbon balance was explained upon the theory that the protein of the ingested meat had been split into a *nitrogenous* and a *non-nitrogenous* portion in the organism, and that the non-nitrogenous portion, the so-called "carbon moiety" of the protein, had been subsequently transformed into fat and deposited as such in the tissues of the organism. Later evidence in favor of the formation of fat from protein has been furnished by the experiments of Weinland. This investigator worked with the larvæ of *Calliphora*,² these larvæ being rubbed up

¹A very complete analysis of adipocere was reported by Ruttan and Marshall before the Society of Biological Chemists, Boston, Dec. 27, 1915.

²The ordinary "blow-fly."

in a mortar¹ with Witte's peptone and water to form a homogeneous mixture. After placing these mixtures at 38°C. for 24 hours the fat content was found to have increased, as much as 140 per cent in some instances. The active agency in this transformation of fat is the *larval tissue*, since the tissues of both the dead and living larvæ possess the property. Data are given from control tests which show that the action of bacteria in this transformation of protein was excluded.

Some investigators are not inclined to accept any data regarding the formation of fat from protein as conclusive.

EXPERIMENTS ON FATS

1. Solubility.—Test the solubility of olive oil in water, dilute acid and alkali and in cold alcohol, hot alcohol, chloroform, ether, and carbon tetrachloride.

2. Formation of a Transparent Spot on Paper.—Place a drop of olive oil upon a piece of ordinary writing paper. Note the transparent appearance of the paper at the point of contact with the fat.

3. Reaction.—Try the reaction of fresh olive oil to litmus, Congo red and phenolphthalein. Repeat the test with rancid olive oil.² What is the reaction of a fresh fat and how does this reaction change upon allowing the fat to stand for some time?

4. Formation of Acrolein.—To a little olive oil in a mortar add some dry potassium bisulphate, KHSO_4 , and rub up thoroughly. Transfer to a dry test-tube and cautiously heat. Note the irritating odor of acrolein. The glycerol of the fat has been dehydrolyzed and acrylic aldehyde or acrolein has been produced. This is the reaction which takes place:

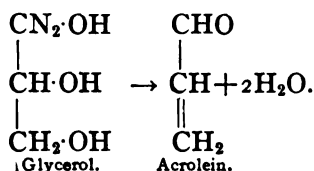

5. Emulsification.—(a) Shake up a drop of neutral³ olive oil with a little water in a test-tube. The fat becomes finely divided, forming an emulsion. This is not a permanent emulsion since the fat separates and rises to the top upon standing.

(b) To 5 c.c. of water in a test-tube add 2 or 3 drops of 0.5 per cent Na_2CO_3 . Introduce into this faintly alkaline solution a drop of neutral olive oil and shake. The emulsion while not permanent is not so transitory as in the cases of water free from sodium carbonate.

(c) Repeat (b) using rancid olive oil. What sort of an emulsion do you get

¹ Intact larvæ were used in some experiments.

² To prepare *rancid* olive oil add 5 drops of oleic acid to 10 c.c. of olive oil.

³ Neutral olive oil may be prepared by shaking ordinary olive oil with a 10 per cent solution of sodium carbonate. This mixture should then be extracted with ether and the ether removed by evaporation. The residue is *neutral* olive oil.

and why? It is impossible to emulsify a highly rancid fat due to the excessive formation of rather insoluble soaps about the oil drops.

(d) Shake a drop of neutral olive oil with dilute albumin solution. What is the nature of this emulsion? Examine it under the microscope.

6. Fat Crystals.—Dissolve a small piece of lard in ether in a test-tube, add an equal volume of alcohol and allow the alcohol-ether mixture to evaporate spontaneously. Examine the crystals under the microscope and compare them with those reproduced in Figs. 56, 57, and 58, on pages 180, 183 and 185.

7. Saponification of Bayberry Tallow.¹—Fill a large casserole two-thirds full of water rendered strongly alkaline with solid potassium hydroxide (a stick one inch in length). Add about 10 grams of bayberry tallow and boil, keeping the volume constant by adding water as needed. When saponification is com-



FIG. 58.—PORK FAT.

plete² remove 25 c.c. of the soap solution for use in Experiment 8 and add concentrated hydrochloric acid slowly to the remainder until no further precipitate is produced.³ Cool the solution and the precipitate of free fatty acid will rise to the surface and form a cake. In this instance the fatty acid is principally palmitic acid. Remove the cake, break it into small pieces, wash it with water by decantation and transfer to a small beaker by means of 95 per cent alcohol. Heat on a water-bath until the palmitic acid is dissolved, then filter through a dry filter paper and allow the filtrate to cool slowly in order to obtain satisfactory crystals. Write the reactions which have taken place in this experiment.

When the palmitic acid has completely crystallized filter off the alcohol, dry the crystals between filter papers and try the tests given in Experiment 10, p. 186.

8. Salting-out Experiments.—To 25 c.c. of soap solution, prepared as described above, add solid sodium chloride to the point of saturation, with continual stirring. A menstruum is thus formed in which the soap is insoluble. This

¹ Bayberry tallow is derived from the fatty covering of the berries of the *wax myrtle*. It is therefore frequently called "myrtle wax" or "bayberry wax."

² Place 2 or 3 drops in a test-tube full of water. If saponification is complete the products will remain in solution and no oil will separate.

³ Under some conditions a purer product is obtained if the soap solution is cooled before precipitating the fatty acid.

salting-out process is entirely analogous to the salting-out of proteins (see page 105).

9. **Formation of Insoluble Soaps.**—Introduce 5 c.c. of soap solution into each of two test-tubes. To the contents of one tube add a small amount of a solution of calcium chloride and to the contents of the other tube add a small amount of a solution of magnesium sulphate. Note the formation of insoluble soaps of calcium and magnesium.

10. **Palmitic Acid.**—(a) Examine the crystals under the microscope and compare them with those shown in Fig. 59, below.

(b) **Solubility.**—Try the solubility of palmitic acid in the same solvents as used on fats (see page 184).

(c) **Melting-point.**—Determine the melting-point of palmitic acid by one of the methods given on page 187.



FIG. 59.—PALMITIC ACID.

(d) **Formation of Transparent Spot on Paper.**—Melt a little of the fatty acid and allow a drop to fall upon a piece of ordinary writing paper. How does this compare with the action of a fat under similar circumstances?

(e) **Acrolein Test.**—Apply the test as given under 4, page 184. Explain the result.

(f) **Iodine Absorption Test.**—For directions see Experiment 13.

11. **Saponification of Lard.**—To 25 grams of lard in a flask add 75 c.c. of alcoholic-potash solution and warm upon a water-bath until saponification is complete. (This point is indicated by the complete solubility of a drop of the solution when allowed to fall into a little water.) Now transfer the solution from the flask to an evaporating dish containing about 100 c.c. of water and heat on a water-bath until all the alcohol has been driven off. Precipitate the fatty acid with hydrochloric acid and cool the solution. Remove the fatty acid which rises to the surface,¹ neutralize the solution with sodium carbonate and evaporate to dryness. Extract the residue with alcohol, remove the alcohol by evaporation upon a water-bath and on the residue of glycerol thus obtained make the tests as given below.

12. **Glycerol.** (a) **Taste.**—What is the taste of glycerol?

¹ After drying the acid make an *iodine absorption test* as described in Experiment 13.

(b) Solubility.—Try the solubility of glycerol in water, alcohol and ether.

(c) Hypochlorite-Orcinol Reaction.¹—This is based on the oxidation of glycerol to the corresponding aldose sugar glycerose and the detection of the latter by means of orcinol. Homologues of glycerol as well as the corresponding acids and certain sugars as glucose and mannose give the reaction. The first named occur seldom while the latter may be removed with baryta.

Two to 3 c.c. of a 1 per cent or 0.1 per cent solution of glycerol in water is treated with exactly 3 drops (= 0.12 c.c.) normal NaOCl² and boiled for a minute. To the liquid while still hot add 3 drops of hydrochloric acid (sp. gr. 1.124) and boil 30–60 seconds to drive off chlorine, a colorless solution being obtained. Then add an equal volume of fuming hydrochloric acid and a small knife-point of orcinol. On boiling the mixture becomes a beautiful violet or green blue. The precipitate formed is soluble in amyl alcohol and may be examined spectroscopically.

(d) Acrolein Test.—Repeat the test as given under 4, page 184.

(e) Borax Fusion Test.—Fuse a little glycerol on a platinum wire with some powdered borax and note the characteristic green flame. This color is due to the glycerol ester of boric acid.

(f) Fehling's Test.—How does this result compare with the results on the sugars?

(g) Solution of Cu(OH)₂. Form a little cupric hydroxide by mixing copper sulphate and potassium hydroxide. Add a little glycerol to this suspended precipitate and note what occurs.

13. Iodine Absorption Test.—Dissolve a small amount of an unsaturated organic acid, e.g., oleic acid, in chloroform. Add 2–3 drops of Hübl's iodine solution³ and shake. The solution will be decolorized if unsaturated acids are present. This is due to the absorption of the iodine. The test should be controlled by shaking chloroform and iodine solution to which no acid has been added.

14. Melting-point of Fat.—First Method.—Insert one of the melting-point tubes, furnished by the instructor, into the liquid fat and draw up the fat until the bulb of the tube is about one-half full of the material. Then fuse one end of the tube in the flame of a Bunsen burner

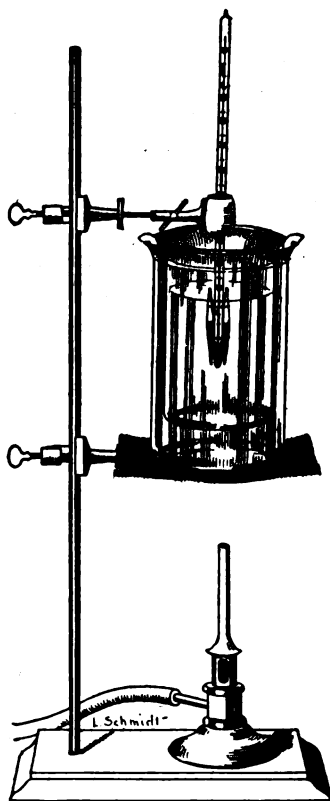

FIG. 60.—MELTING-POINT APPARATUS.

¹ Mandel and Neuberg: *Bioch. Zeit.*, 71, 214, 1915.

² Made according to Raschig: *Ber.*, 40, 4586, 1907.

³ Prepared by dissolving 26 grams of iodine and 30 grams of mercuric chloride in one liter of 95 per cent alcohol.

and fasten the tube to a thermometer by means of a rubber band in such a manner that the bottom of the fat column is on a level with the bulb of the thermometer (Fig. 60, p. 187). Fill a beaker of medium size about two-thirds full of water and place it within a second larger beaker which also contains water, the two vessels being separated by pieces of cork. Immerse the bulb of the thermometer and the attached tube in such a way that the bulb is about midway between the upper and the lower surfaces of the water of the inner beaker. The upper end of the tube being open it must extend above the surface of the surrounding water. Apply gentle heat, stir the water, and note the temperature at which the fat first begins to melt. This point is indicated by the initial transparency. For ordinary fats, raise the temperature very cautiously from 30°C. To determine the congealing-point remove the flame and note the temperature at which the fat begins to solidify. Record the melting- and congealing-points of the various fats submitted by the instructor.

Second Method.—Fill a small evaporating dish about one-half full of mercury and place it on a water-bath. Put a small drop of the fat under examination on an ordinary cover-glass and place this upon the surface of the mercury. Raise the temperature of the water-bath slowly and by means of a thermometer whose bulb is immersed in the mercury, note the melting-point of the fat. Determine the congealing-point by removing the flame and leaving the fat drop and cover-glass in position upon the mercury. How do the melting-points as determined by this method compare with those as determined by the first method? Which method is the more accurate, and why?

CHAPTER X

PANCREATIC DIGESTION¹

As soon as the food mixture leaves the stomach it comes into intimate contact with the bile and the pancreatic juice. Since these fluids are alkaline in reaction (see Bile, page 206) there can obviously be no further peptic activity after they have become intimately mixed with the chyme and have neutralized the acidity previously imparted to it by the hydrochloric acid of the gastric juice. The pancreatic juice reaches the intestine through the duct of Wirsung which opens into the intestine near the pylorus.

Normally the secretion of pancreatic juice is brought about by the stimulation produced by the acid chyme as it enters the duodenum. Therefore, any factor which produces an increased flow of gastric juice such, for example, as water² will cause a stimulation of the pancreatic secretion. The secretion of pancreatic juice is probably not due to a nervous reflex as was believed by Pawlow but rather, as Bayliss and Starling have shown, is dependent upon the presence, in the epithelial cells of the duodenum and jejunum of a body known as *prosecretin*. This body is changed into *secretin* through the hydrolytic action of the acid present in the chyme. The secretin is then absorbed by the blood, passes to the pancreas and stimulates the pancreatic cells, causing a flow of pancreatic juice. The quantity of juice secreted under these conditions is proportional to the amount of secretin present. The activity of secretin solutions is not diminished by boiling, hence the body does not react like an enzyme. Further study of the body may show it to be a definite chemical individual of relatively low molecular weight. It has not been possible thus far to obtain secretin from any tissues except the mucous membrane of the duodenum and jejunum.

This *secretin* mentioned above belongs to the class of substances called *hormones* or chemical messengers. These hormones play a very important part in the coordination of the activities of certain functions and glands. Other important hormones are those elaborated by the thyroids, the adrenals, the pituitary body (hypophysis), the embryo and

¹ Under this head we will consider only such digestive processes as are brought about by enzymes originating in the pancreas. In the following chapter on Intestinal Digestion will be found a consideration of such enzymes as have a true *intestinal origin*.

² See chapter on Gastric Digestion.

the reproductive glands. It is claimed by some that all active organs of the body produce hormones.

The juice as obtained from a permanent fistula differs greatly in its properties from the juice as obtained from temporary fistula, and neither form of fluid possesses the properties of the normal fluid. Pancreatic juice collected by Glaessner from a natural fistula has been found to be a colorless, clear, strongly alkaline fluid which foams readily. It is further characterized by containing albumin, globulin, proteose, and peptone; nucleoprotein is also present in traces.¹ The average daily secretion of pancreatic juice is 650 c.c. and its specific gravity is 1.008. The fluid contains 1.3 per cent of solid matter and the freezing-point is -0.47°C . The normal pancreatic secretion contains at least four distinct enzymes. They are *trypsin*, a proteolytic enzyme; *pancreatic amylase* (amylopsin), an amylolytic enzyme; *pancreatic lipase* (steapsin), a fat-splitting enzyme; and *pancreatic rennin*, a milk-coagulating enzyme.

The most important of the four enzymes of the pancreatic juice is the proteolytic enzyme *trypsin*. This enzyme resembles pepsin in so far as each has the power of breaking down protein material, but the trypsin has much greater digestive power and is able to cause a more complete decomposition of the complex protein molecule. In the process of normal digestion the protein constituents of the diet are for the most part transformed into proteoses (albumoses) and peptones before coming in contact with the enzyme trypsin. This is not absolutely essential, however, since trypsin possesses digestive activity sufficient to transform unaltered native proteins and to produce from their complex molecules comparatively simple fragments. Among the products of tryptic digestion are *proteoses*, *peptones*, *peptides*, *leucine*, *tyrosine*, *aspartic acid*, *glutamic acid*, *alanine*, *phenylalanine*, *glycocoll*, *cystine*, *serine*, *valine*, *proline*, *oxyproline*, *isoleucine*, *arginine*, *lysine*, *histidine*, and *tryptophane*. (The crystalline forms of many of these products are reproduced in Chapter IV.) Trypsin does not occur preformed in the gland, but exists there as a zymogen called *trypsinogen* which bears the same relation to trypsin that pepsinogen does to pepsin. Trypsin has never been obtained in a pure form and therefore very little can be stated definitely as to its nature. The enzyme is the most active in alkaline solution but is also active in neutral or slightly acid solutions. Trypsin is destroyed by mineral acids and may also be destroyed by comparatively weak alkali (2 per cent sodium carbonate) if left in contact for a sufficiently long time. Trypsinogen, on the other hand, is more resistant to the actions of alkalis. In pancreatic digestion the pro-

¹ Glaessner: *Zeitschrift für physiologische Chemie*, 40, 476, 1904.

tein does not swell as is the case in gastric digestion, but becomes more or less "honey-combed" and finally disintegrates.

The presence of active *pepsin* in the contents of the intestine has been demonstrated by Abderhalden and Meyer.¹ It may possibly be that pepsin may play a part in the profound intestinal proteolysis which has up to this time been assigned to trypsin and erepsin (see chapter on Gastric Digestion).

The pancreatic juice which is collected by means of a fistula possesses practically no power to digest protein matter. A body called *enterokinase* occurs in the intestinal juice and has the power of converting trypsinogen into trypsin. This process is known as the "activation" of trypsinogen and through it a juice which is incapable of digesting protein may be made active. (For further discussion of enterokinase see chapter on Intestinal Digestion.) Mendel and Rettger² and others have demonstrated that activation of trypsinogen into trypsin may be brought about in the gland as well as in the intestine of the living organism. The manner of the activation in the gland and the nature of the body causing it are unknown at present. Prym³ denies that such an activation occurs.

Delezenne claims that trypsinogen may be activated by soluble *calcium salts*. He reports experiments which indicate that proteolytically inactive pancreatic juice, obtained directly from the duct, when treated with salts of this character, assumes the property of digesting protein material. This process by which the trypsinogen is activated through the instrumentality of calcium salts is very rapid and is designated by Delezenne as an "explosion." The suggestion of Mays that there may possibly be several precursors of trypsin one of which is activated by enterokinase and the others by other agents, is of interest in this connection.

Boldyreff⁴ has demonstrated the presence of trypsin in the stomach due to the regurgitation of duodenal contents through the pylorus (see Chapters VII and VIII). Others⁵ have confirmed this finding (see chapter on Gastric Analysis).

Pancreatic amylase (amylopsin), the second of the pancreatic enzymes, is an amylolytic enzyme which possesses somewhat greater digestive power than the salivary amylase (ptyalin) of the saliva. As its name implies, its activity is confined to the starches, and the products of its amylolytic action are dextrins and sugar. The sugar is principally

¹ Abderhalden and Meyer: *Zeit. physiol. Chem.*, 74, 67, 1911.

² Mendel and Rettger: *American Journal of Physiology*, 7.

³ Prym: *Pflüger's Archiv*, 104 and 107.

⁴ Boldyreff: Transactions of the 11th Pirogoff's Congress of Physicians, St. Petersburg, 1910.

⁵ Spencer, Meyer, Rehfuss and Hawk: *American Jour. Physiol.*, 39, 459, 1916.

maltose and this, by the further action of an inverting enzyme (maltase), is transformed into glucose.

It is possible that the saliva as a digestive fluid is not absolutely essential. The salivary amylase (ptyalin) is destroyed by the hydrochloric acid of the gastric juice and is therefore inactive when the chyme reaches the intestine. Should undigested starch be present at this point, however, it would be quickly transformed by the active pancreatic amylase. This enzyme is not present in the pancreatic juice of infants during the first few weeks of life, thus showing very clearly that a starchy diet is not normal for this period.

The pronounced influence of electrolytes upon the action of pancreatic amylase and other amylases has been demonstrated many times.¹ In fact the removal of electrolytes from pancreatic juice by dialysis yields a juice which possesses *no power to split starch*. It also appears that the Cl or Br ion is absolutely essential to the activity of animal amylases.²

It has been claimed that pancreatic amylase has a slight digestive action upon *unboiled* starch.

The extent to which amylase is present in the feces has been taken as the index of pancreatic activity.

The third enzyme of the pancreatic juice is called *pancreatic lipase* (*steapsin*) and is a fat-splitting enzyme. It has the power of splitting the neutral fats of the food by hydrolysis, into fatty acid and glycerol. A typical reaction would be as follows:

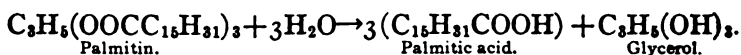

Recent researches make it probable that fats undergo saponification prior to their absorption. The fatty acids formed unite with the alkalis of the pancreatic juice and intestinal secretion to form soluble soaps which are readily absorbed. It was formerly believed that the fats could also be absorbed in emulsion—a condition promoted by the presence of the soluble soaps. After absorption the fatty acids are resynthesized to form neutral fats with glycerol.

Bloor³ has reported experiments which “make it extremely probable that fats can be absorbed only in water-soluble form and that saponification is a necessary preliminary to absorption.” Petroleum hydrocarbons and non-saponifiable esters, *e.g.*, *wool fat* (lanolin) were un-

¹ For the literature see Kendall and Sherman: *Jour. Am. Chem. Soc.*, 32, 1087, 1910.

² Wohlgemuth: *Biochem. Zeit.*, 9, 10, 1908; and Kendall and Sherman: *Jour. Am. Chem. Soc.*, 32, 1087, 1910. Bierry: *Biochem. Zeit.*, 40, 357, 1912.

³ Bloor: *Jour. Biol. Chem.*, 15, 105, 1913.

absorbed. Bloor further claims¹ that in the absorption of fats there is a tendency toward the formation of a uniform chyle fat, presumably the characteristic body fat of the animal.

Pancreatic lipase is very unstable and is easily rendered inert by the action of acid. For this reason it is not possible to prepare an extract having a satisfactory fat-splitting power from a pancreas which has been removed from the organism for a sufficiently long time to have become acid in reaction.

The fourth enzyme of the pancreatic juice is called *pancreatic rennin*. It is a milk-coagulating enzyme whose action is very similar to that of the *gastric rennin* found in the gastric juice. It is supposed to show its greatest activity at a temperature varying from 60° to 65°C.

PREPARATION OF AN ARTIFICIAL PANCREATIC JUICE²

After removing the fat from the pancreas of a pig or sheep, finely divide the organ by means of scissors and grind it in a mortar. If convenient, the use of an ordinary meat chopper is a very satisfactory means of preparing the pancreas.

When finely divided as above the pancreas should be placed in a 500 c.c. flask, about 150 c.c. of 30 per cent alcohol added and the flask and contents shaken frequently for 24 hours. (What is the reaction of this alcoholic extract at the end of this period, and why?) Strain the alcoholic extract through cheese cloth, filter, nearly neutralize with potassium hydroxide solution and then exactly neutralize it with 0.5 per cent sodium carbonate.

Products of Tryptic Digestion

Introduce into a 250 c.c. flask 20 grams of casein, 10 c.c. of the artificial pancreatic juice prepared as described above and 100 c.c. of 1 per cent sodium carbonate. Allow to digest at 40°C. for 8 to 10 days with the addition of a few cubic centimeters each of chloroform and toluene, the flask being stoppered with cotton. As the chloroform and toluene evaporate they must be renewed. Heat the mixture to boiling and at the boiling-point add acetic acid drop by drop until the mixture is acid in reaction. Cool and filter.

To five c.c. of the filtrate add bromine water drop by drop. Note the development of pink color which disappears in the presence of an excess of the reagent. This reaction indicates the presence of tryptophane.³

To another 5 c.c. portion of the filtrate add 10 drops of concentrated sulphuric acid and 10 c.c. of a 10 per cent solution of mercuric sulphate in 5 per cent sulphuric acid. After mixing and allowing to stand for a few minutes filter off the yellow precipitate which forms. This is a mercury compound of tryptophane.⁴

¹ Bloor: *Jour. Biol. Chem.*, 16, 517, 1914.

² For other methods of preparation see Karl Mays: *Zeitschrift für physiologische Chemie*, 38, 428, 1903.

³ Kurajeff: *Zeit. physiol. Chem.*, 36, 501, 1898-99.

⁴ It has been claimed that a similar yellow precipitate forms in the presence of tyrosine, cystine and polypeptides. For quantitative estimation of tryptophane see Homer: *Jour. Biol. Chem.*, 22, 369, 1915.

Filter off the precipitate reserving the filtrate and wash the precipitate on the filter paper thoroughly with several small portions of water.

To small portions of the precipitate apply the Hopkins-Cole, xanthoproteic, and Millon tests. Tryptophane gives a positive reaction with the first two of these tests being responsible for the Hopkins-Cole reaction as applied to protein (see Chapter V).

Test portions of the filtrate from the mercuric precipitate by the Hopkins-Cole, xanthoproteic, and Millon reactions. Tyrosine responds to the latter two tests.

To the remainder of the filtrate add a few drops of ammonia¹ and evaporate to a volume of 10 to 20 c.c. using at first a free flame and completing the evaporation on a water-bath. Transfer to a beaker and allow to stand for 1 or 2 days. Examine microscopically the crystals which separate out. Tyrosine crystallizes in sheaves of needles (see Fig. 25). Leucine forms small rosettes. Apply Mörner's reaction for tyrosine (see p. 86).

GENERAL EXPERIMENTS ON PANCREATIC DIGESTION

EXPERIMENTS ON TRYPSIN²

1. The Most Favorable Reaction for Tryptic Digestion.—Prepare seven tubes as follows:

- (a) 2-3 c.c. of neutral pancreatic extract + 2-3 c.c. of water.
- (b) 2-3 c.c. of neutral pancreatic extract + 2-3 c.c. of 1 per cent sodium carbonate.
- (c) 2-3 c.c. of neutral pancreatic extract + 2-3 c.c. of 0.5 per cent sodium carbonate.
- (d) 2-3 c.c. of neutral pancreatic extract + 2-3 c.c. of 0.2 per cent hydrochloric acid.
- (e) 2-3 c.c. of neutral pancreatic extract + 2-3 c.c. of 0.2 per cent combined hydrochloric acid.
- (f) 2-3 c.c. of neutral pancreatic extract + 2-3 c.c. of 0.4 per cent boric acid.
- (g) 2-3 c.c. of neutral pancreatic extract + 2-3 c.c. of 0.4 per cent acetic acid.

Add a small piece of fibrin³ to the contents of each tube and keep them at 40°C. noting the progress of digestion. In which tube do we find the most satisfactory digestion, and why? How do the indications of the digestion of fibrin by trypsin differ from the indications of the digestion of fibrin by pepsin?

2. The Most Favorable Temperature.—(For this and the following series of experiments under tryptic digestion use the neutral extract plus an equal volume of 0.5 per cent sodium carbonate.) In each of four tubes place 5 c.c. of alkaline pancreatic extract. Immerse one tube in cold water from the faucet, keep a second at room temperature and place a third in the incubator or water-bath at 40°C. Boil the contents of the fourth for a few moments, then cool and also keep

¹ If the solution is alkaline in reaction, while it is being concentrated, the amino acids will be broken down and ammonia will be liberated.

² For these experiments as well as for those on the other pancreatic enzymes commercial preparations of *trypsin* and *pancreatin* may be employed.

³ *Congo red fibrin* may be used in this and the following tests on tryptic digestion. If used the experiments should be made at room temperature. For preparation of this fibrin see Chapter I.

it at 40°C. Into each tube introduce a small piece of fibrin and note the progress of digestion. In which tube does the most rapid digestion occur? What is the reason?

3. Influence of Bile.—Prepare three tubes as follows:

- (a) 5 c.c. of pancreatic extract + 0.5-1 c.c. of bile.
- (b) 5 c.c. of pancreatic extract + 5 c.c. of bile.
- (c) 5 c.c. of pancreatic extract.

Introduce into each tube a small piece of fibrin and keep them at 40°C. Shake the tubes frequently and note the progress of digestion. Does the presence of bile retard tryptic digestion? How do these results agree with those obtained under gastric digestion?

4. Quantitative Determination of Tryptic Activity.¹—Gross' Method.—This method is based upon the principle that faintly alkaline solutions of casein are precipitated upon the addition of dilute (1 per cent) acetic acid whereas its digestion products are not so precipitated. The method follows: Prepare a series of tubes each containing 10 c.c. of a 0.1 per cent solution of pure, fat-free casein,² which has been heated to a temperature of 40°C. Add to the contents of the series of tubes increasing amounts of the trypsin solution under examination,³ and place them at 40°C. for fifteen minutes. At the end of this time remove the tubes and acidify the contents of each with a few drops of dilute (1 per cent) acetic acid. The tubes in which the casein is completely digested will remain clear when acidified, while those tubes which contain undigested casein will become more or less turbid under these conditions. Select the first tube in the series which exhibits no turbidity upon acidification, thus indicating complete digestion of the casein, and calculate the tryptic activity of the enzyme solution under examination.

Calculation.—The unit of tryptic activity is an expression of the power of 1 c.c. of the fluid under examination exerted for a period of fifteen minutes on 10 c.c. of a 0.1 per cent casein solution. For example, if 0.5 c.c. of a trypsin solution completely digests 10 c.c. of a 0.1 per cent solution of casein in fifteen minutes, the activity of that solution would be expressed as follows:

$$\text{Tryptic activity} = 1 \div 0.5 = 2.$$

Such a trypsin solution would be said to possess an activity of 2. If 0.3 c.c. of the trypsin solution had been required the solution would be said to possess an activity of 3.3; i.e., $1 \div 0.3 = 3.3$.

EXPERIMENTS ON PANCREATIC AMYLASE

1. The Most Favorable Reaction.—Prepare four tubes as follows:

- (a) 1 c.c. of neutral pancreatic extract + 1 c.c. of starch paste + 2 c.c. of water.
- (b) 1 c.c. of neutral pancreatic extract + 1 c.c. of starch paste + 2 c.c. of 1 per cent sodium carbonate.

¹ For a discussion of Spencer's method for the quantitative determination of trypsin in stomach contents see chapter on Gastric Analysis.

² Made by dissolving 1 gram of Grüber's casein in a liter of 0.1 per cent sodium carbonate. A little chloroform may be added to prevent bacterial action.

³ The amount of solution used may vary from 0.1-1 c.c. The measurements may conveniently be made by means of a 1 c.c. graduated pipette.

(c) 1 c.c. of neutral pancreatic extract+1 c.c. of starch paste+2 c.c. of 0.5 per cent sodium carbonate.

(d) 1 c.c. of neutral pancreatic extract+1 c.c. of starch paste+2 c.c. of 0.2 per cent hydrochloric acid.

Shake each tube thoroughly and place them in the incubator or water-bath at 40°C. At the end of a half-hour divide the contents of each tube into two parts and test one part by the iodine test and the other part by Fehling's test. Where do you find the most satisfactory digestion? How do the results compare with those obtained from Experiment 1 under Trypsin, page 194?

2. The Most Favorable Temperature.—(For this and the following series of experiments upon pancreatic amylase use the neutral extract plus an equal volume of 0.5 per cent sodium carbonate.) In each of four tubes place 2-3 c.c. of alkaline pancreatic extract. Immerse one tube in cold water from the faucet, keep a second at room temperature, and place a third on the water-bath at 40°C. Boil the contents of the fourth for a few moments, then cool and also keep it at 40°C. Into each tube introduce 2-3 c.c. of starch paste and note the progress of digestion. At the end of one-half hour divide the contents of each tube into two parts and test one part by the iodine test and the other part by Fehling's test. In which tube do you find the most satisfactory digestion? How does this result compare with the result obtained in the similar series of experiments under Trypsin (see page 194)?

3. Influence of Bile.—Prepare three tubes as follows:

(a) 2-3 c.c. of pancreatic extract+2-3 c.c. of starch paste+0.5-1 c.c. of bile.

(b) 2-3 c.c. of pancreatic extract+2-3 c.c. of starch paste+5 c.c. of bile.

(c) 2-3 c.c. of pancreatic extract+2-3 c.c. of starch paste.

Shake the tubes thoroughly and place them in the incubator or water-bath at 40°C. Note the progress of digestion frequently and at the end of a half-hour divide the contents of each tube into two parts and test one part by the iodine test and the other part by Fehling's test. What are your conclusions regarding the influence of bile upon the action of pancreatic amylase?

4. Digestion of Dry Starch.—To a little dry starch in a test-tube add about 5 c.c. of pancreatic extract and place the tube in the incubator or water-bath at 40°C. At the end of a half-hour filter and test separate portions of the filtrate by the iodine and Fehling tests. What do you conclude regarding the action of pancreatic amylase upon dry starch? Compare this result with that obtained in the similar experiment under Salivary Digestion (page 60).

5. Digestion of Inulin.—To 5 c.c. of inulin solution in a test-tube add 10 drops of pancreatic extract and place the tube in the incubator or water-bath at 40°C. After one-half hour test the solution by Fehling's test.¹ Is any reducing substance present? What do you conclude regarding the digestion of inulin by pancreatic amylase?

6. Quantitative Determination of Amyolytic Activity.—Wohlgemuth's Method.² Arrange a series of test-tubes with diminishing quantities of the enzyme solution under examination, introduce into each tube 5 c.c. of 1 per cent

¹ If the inulin solution gives a reduction before being acted upon by the pancreatic juice it will be necessary to determine the extent of the original reduction by means of a "check" test (see p. 47).

² Wohlgemuth: *Biochemische Zeitschrift*, 9, 1, 1908.

solution of soluble starch¹ and place each tube at once in a bath of ice-water.² When all the tubes have been prepared in this way and placed in the ice-water bath they are transferred to a water-bath or incubator and kept at 38°C. for from 30 minutes to an hour.³ At the end of this digestion period the tubes are again removed to the bath of ice-water in order that the action of the enzyme may be stopped.

Dilute the contents of each tube, to within about 1/2 inch of the top, with water, add one drop of a N/10 solution of iodine and shake the tube and contents thoroughly. A series of colors ranging from dark blue through bluish violet and reddish yellow to yellow, will be formed.⁴ The dark blue color shows the presence of unchanged starch, the bluish-violet indicates a mixture of starch and erythro-dextrin, whereas the reddish-yellow signifies that erythro-dextrin and maltose are present and the yellow solution denotes the complete transformation of starch into maltose. Examine the tubes carefully before a white background and select the last tube in the series which shows the entire absence of all blue color, thus indicating that the starch has been completely transformed into dextrans and sugar. In case of indecision between two tubes, add an extra drop of the iodine solution, and observe them again, after shaking.

Calculation.—The amylolytic activity⁵ of a given solution is expressed in terms of the activity of 1 c.c. of such a solution. For example, if it is found that 0.02 c.c. of an amylolytic solution, acting at 38°C., completely transformed the starch in 5 c.c. of a 1 per cent starch solution in 30 minutes, the amylolytic activity of such a solution would be expressed as follows:

$$D_{30}^{38} = 250$$

This indicates that 1 c.c. of the solution under examination possesses the power of completely digesting 250 c.c. of 1 per cent starch solution in 30 minutes at 38°C.

Wohlgemuth has suggested a slight alteration in the above procedure for use in the determination of the amylase content of the feces.⁶ A modification of the Wohlgemuth procedure⁷ for this purpose is given in the chapter on Feces.

EXPERIMENTS ON PANCREATIC LIPASE

1. Influence of Bile on Action of Lipase.—Prepare five test-tubes as follows:
(a) 5 c.c. neutral pancreatic extract + 0.5 c.c. olive oil + 4.5 c.c. water.

¹ Kahibaum's soluble starch is satisfactory. In preparing the 1 per cent solution, the weighed starch powder should be dissolved in *cold* distilled water in a casserole and stirred until a homogeneous suspension is obtained. The mixture should then be heated, with constant stirring, until it is clear. This ordinarily takes about 8-10 minutes. A slightly opaque solution is thus obtained which should be cooled and made up to the proper volume before using.

² Ordinarily a series of six tubes is satisfactory, the volumes of the enzyme solution used ranging from 1 c.c. to 0.1 c.c. and the measurements being made by means of a 1 c.c. graduated pipette. All tubes should contain the same volume of material. To accomplish this add appropriate amounts of distilled water to tubes receiving less than 1 c.c. of enzyme solution. Each tube should be placed in the ice-water bath as soon as the starch solution is introduced. It will be found convenient to use a small wire basket to hold the tubes.

³ Longer digestion periods may be used where it is deemed advisable. If exceedingly weak solutions are being investigated, it may be most satisfactory to permit the digestion to extend over a period of 24 hours.

⁴ See p. 56.

⁵ Designated by "D" the first letter of "diastatic."

⁶ Wohlgemuth: *Berliner klinische Wochenschrift*, 47, 92, 1910.

⁷ Hawk: *Archives of Internal Medicine*, 8, 552, 1911.

- (b) 0.5 c.c. olive oil + 9.5 c.c. water.
- (c) 0.5 c.c. olive oil + 8.5 c.c. water + 1 c.c. bile.
- (d) 5 c.c. neutral pancreatic extract + 0.5 c.c. olive oil + 3.5 c.c. water + 1 c.c. bile.
- (e) 5 c.c. neutral pancreatic extract + 3.5 c.c. water + 1 c.c. bile.

Shake the tubes thoroughly, add a drop of toluene to each and place them in an incubator or water-bath at 40° for 24 hours. At the end of this period add a drop of phenolphthalein to each tube and titrate with N/20 NaOH to a permanent pink color. Shake the tube during the titration. Record the amount of N/20 alkali necessary to neutralize the contents of each tube. Which tube required the most? Why?

2. "Litmus-milk" Test.—Into each of two test-tubes introduce 10 c.c. of milk and a small amount of litmus solution. To the contents of one tube add 3 c.c. of neutral pancreatic extract¹ and to the contents of the other tube add 3 c.c. of water or of boiled neutral pancreatic extract. Keep the tubes at 40°C. and note any changes which may occur. What is the result and how do you explain it?

3. Ethyl Butyrate Test.—Into each of two test-tubes introduce 4 c.c. of water, 2 c.c. of ethyl butyrate, $C_2H_7COO.C_2H_5$, and a small amount of litmus powder. To the contents of one tube add 4 c.c. of neutral pancreatic extract and to the contents of the other tube add 4 c.c. of water or of boiled neutral pancreatic extract. Keep the tubes at 40°C. and observe any change which may occur. What is the result and how do you explain it? Write the equation for the reaction which has taken place.

EXPERIMENTS ON PANCREATIC RENNIN

Prepare four test-tubes as follows:

- (a) 5 c.c. of milk + 10 drops of neutral pancreatic extract.
- (b) 5 c.c. of milk + 20 drops of neutral pancreatic extract.
- (c) 5 c.c. of milk + 10 drops of alkaline pancreatic extract.
- (d) 5 c.c. of milk + 20 drops of alkaline pancreatic extract.

Place the tubes at 60°–65°C. for a half hour without shaking. Note the formation of a clot.² How does the action of pancreatic rennin compare with the action of the gastric rennin?

¹ Commercial *pancreatin* may be used in this test if desired.

² This reaction will not always succeed, owing to conditions which are not well understood.

CHAPTER XI

INTESTINAL DIGESTION

Strictly speaking, all digestive processes which take place in the intestine may be classed under Intestinal Digestion. However, we will consider under Intestinal Digestion only those digestive processes which are brought about by *enzymes which have their origin in the intestine*. The activities of those enzymes which originate in the pancreas we have considered in Chapter X under Pancreatic Digestion.

It has been shown¹ that the reaction of the small intestine may vary from acid to alkaline and is influenced by the state of digestion.

The enzymes of the intestinal juice (*succus entericus*) are of great importance to the animal organism. These enzymes include *erepsin*, *sucrase*, *maltase*, *lactase*, *nucleases*, and *enterokinase*.

Erepsin is a proteolytic enzyme which has the property of acting upon the proteoses, peptones, and peptides which are formed through the action of trypsin, and further splitting them into *amino-acids*. Erepsin has no power of digesting any native proteins except caseinogen, histones, and protamines. It possesses its greatest activity in an alkaline solution, although it is slightly active in acid solution. An extract of the intestinal erepsin may be prepared by treating the finely divided intestine of a *cat*, *dog*, or *pig* with toluene or chloroform-water and permitting the mixture to stand with occasional shaking for 24-72 hours. Enzymes similar to erepsin occur in various tissues of the organism.

In cases of gastric cancer a peptide-splitting enzyme is claimed to be present in the stomach contents. The glycyl-tryptophane test is sometimes used for its detection. Some investigators claim that the peptide-splitting power of gastric juice in cancer is generally due to the regurgitation of trypsin or erepsin from the intestine or to the presence in the gastric contents of swallowed saliva which possesses peptolytic power. The peptide-splitting power of saliva may be due to a specific enzyme or to the presence of bacteria (see Glycyl-tryptophane Reaction, page 203).

The three invertases *sucrase*, *maltase*, and *lactase* are also important enzymes of the intestinal mucosa. The *sucrase* acts upon sucrose and inverts it with the formation of *invert sugar* (glucose and fructose). Some investigators claim that sucrase is also present in saliva and gastric juice. It probably does not exist normally in either of these

¹ Long and Fenger: *Jour. Am. Chem. Soc.*, 39, 1278, 1917.

digestive juices, however, and if found owes its presence to the excretory processes of certain bacteria. Sucrases may also be obtained from several vegetable sources. For investigational purposes it is ordinarily obtained from yeast (see page 14). It exhibits its greatest activity in the presence of a slight acidity, but if the acidity be increased to any extent the reaction is inhibited.

Lactase is an enzyme which inverts lactose with the consequent formation of glucose and galactose. Its action is entirely analogous, in type, to that of sucrase. It has apparently been proven that lactase occurs in the intestinal mucosa of the young of all animals which suckle their offspring.¹ It may also occur in the intestinal mucosa of certain adult animals if such animals be maintained upon a ration containing more or less lactose. Fischer and Armstrong have demonstrated the reversible action² of lactase.

Maltase possesses the power of splitting maltose, the end-product of the digestion of starch, into glucose. It was first discovered in the urine and shortly after this time its presence was noted in the small intestine and the saliva. Corn is sometimes used as the medium for the preparation of the enzyme for experimental purposes. It occurs in corn in a very active state. It was in connection with maltase that the principles of the "reversibility of enzyme action" were first demonstrated.

Enterokinase possesses the power of "activating" trypsinogen (see Chapters I and X). In other words, trypsinogen as formed by the pancreas has no proteolytic power, but when this inactive trypsinogen reaches the intestine and comes into contact with enterokinase the latter transforms it into active trypsin. Enterokinase is not always present in the intestinal juice since it is secreted only after the pancreatic juice reaches the intestine. It resembles the enzymes in that its activity is destroyed by heat, but differs materially from this class of bodies in that a certain quantity is capable of activating only a definite quantity of trypsinogen. It is, however, generally classified as an enzyme. Enterokinase has been detected in the higher animals, and a kinase possessing similar properties has been shown to be present in bacteria, fungi, impure fibrin, lymph glands, and snake-venom.

The intestinal juice and the epithelium of the intestinal wall contain enzymes capable of hydrolyzing nucleic acids and as these acids are not acted upon by the gastric juice and probably not to any great extent by pure pancreatic juice, the intestine apparently plays the chief rôle in decomposition or digestion of these substances. At least two

¹ Mendel and Mitchell: *American Journal of Physiology*, 20, 81, 1907.

² See p. 8.

enzymes take part in this digestion process, one decomposing the nucleic acid with formation of simple nucleotides containing a single radical each of phosphoric acid, carbohydrate and base (see chapter on Nucleic Acids). This enzyme may be called *nucleicacidase*. Another enzyme present in the intestine and intestinal juice decomposes these nucleotides with the liberation of phosphoric acid. This enzyme may be called *nucleotidase* or *phosphonuclease*. The intestinal mucosa also decomposes many other organic phosphorus compounds with liberation of their phosphoric acid.¹ Thus glycerophosphoric acid and hexose-phosphoric acid as well as phosphoproteins are split in a similar manner, the phosphoric acid they contain thus being absorbed in the free form.

GENERAL EXPERIMENTS ON INTESTINAL DIGESTION

Demonstration of Enterokinase.—Trypsinogen may be activated by enterokinase. This activation occurs normally in the intestine. Calcium salts also bring about a similar activation of the trypsinogen.

Procedure.—Prepare an extract of trypsinogen by grinding 10 grams of the fresh, fat-free pancreas of the pig with a little sand. Gradually add 100 c.c. of water during the grinding process. Strain through cheese cloth.

Prepare an extract of enterokinase by grinding 5 grams of fresh, fat-free duodenal mucosa² of the pig with a little sand. Gradually add 50 c.c. of water during the grinding process. Strain through cheese cloth.

Prepare the following series of tubes:

- (a) 10 c.c. pancreas extract + 5 c.c. water.
- (b) 10 c.c. pancreas extract + 5 c.c. duodenal extract.
- (c) 5 c.c. duodenal extract + 10 c.c. water.
- (d) 10 c.c. pancreas extract + 5 c.c. duodenal extract.
- (e) 10 c.c. pancreas extract + 5 c.c. duodenal extract (boiled).
- (f) 10 c.c. pancreas extract + 5 c.c. of 4 per cent calcium chloride.

Boil the contents of tube (d) for five minutes and cool to 40°C. Keep all six tubes at 40°C. for 20 minutes.

To each tube add 5 c.c. of 10 per cent sodium carbonate and mix the contents thoroughly and immediately. Introduce into each tube the same quantity (size of a pea) of fresh fibrin. Shake the tubes and place them at 40°C. Observe the tubes frequently for one hour to note digestive changes. Tubes (b) and (f) should show most rapid digestion. Why?

EXPERIMENTS ON INTESTINAL NUCLEASES

1. **Preparation of Intestinal Extract.**—Wash thoroughly 100 grams of pig's intestine and run through a meat chopper several times. Introduce into a 500 c.c. mixing cylinder and add normal salt solution to make 500 c.c. Allow to

¹ Plimmer: *Biochem. J.*, 7, 43, 1913.

² The dried mucosa may be substituted if desired.

stand for 6–24 hours at room temperature, shaking occasionally, toluene being added as a preservative. Strain and filter.

2. Demonstration of Intestinal Nucleases.—Prepare a 2 per cent solution of yeast nucleic acid put in solution with the aid of just sufficient NaOH solution to make the resulting mixture neutral to litmus. To each of two large test-tubes add 20 c.c. of the intestinal extract prepared as above. Boil one for one to two minutes. To each tube then add 10 c.c. of the 2 per cent nucleic acid solution. Add 2–3 c.c. each of toluene and chloroform to each mixture. Keep at 38°C. for 24 hours.

Heat the tubes to boiling in a water-bath to coagulate protein. Add 5 c.c. of 5 per cent HCl and allow to stand for one hour. This precipitates any unchanged nucleic acid. Filter and take aliquots of the filtrate (about 20 c.c.). Precipitate the phosphate from each mixture by adding 5 c.c. of magnesia mixture and 5 c.c. of ammonia. Allow to stand over night. A heavy precipitate of magnesium ammonium phosphate should be found in the test experiment indicating that the phosphoric acid of the nucleic acid had been liberated by the nucleotidase of the intestinal extract. The control should show only a slight precipitate.

If desired the phosphorus of the precipitates may be determined quantitatively by dissolving in 2 per cent HNO₃, precipitating as the phosphomolybdate and determining volumetrically according to the Neumann procedure (see p. 574).

EXPERIMENTS ON EREPSIN

1. Preparation of Erepsin.—Grind the mucous membrane of the small intestine of a cat, dog, or pig with sand in a mortar. Treat the finely divided membrane with toluene or chloroform-water and permit the mixture to stand, with occasional shaking, for 24–72 hours.¹ Filter the extract thus prepared through cotton and use the filtrate in the following experiment.

2. Demonstration of Erepsin.—To about 5 c.c. of a 1 per cent solution of Witte's peptone in a test-tube add about 1 c.c. of the erepsin extract prepared as described above and make the mixture slightly alkaline (0.1 per cent) with sodium carbonate. Prepare a second tube containing a like amount of peptone solution but boil the erepsin extract before introducing it. Place the two tubes at 38°C. for two to three days. At the end of that period heat the contents of each tube to boiling, filter and try the biuret test on each filtrate. In making these tests care should be taken to use like amounts of filtrate, potassium hydroxide and copper sulphate in each test in order that the drawing of correct conclusions may be facilitated. The contents of the tube which contained the boiled extract should show a deep pink color with the biuret test, due to the peptone still present. On the other hand, the biuret test upon the contents of the tube containing the unboiled extract should be negative or exhibit, at the most, a faint pink or blue color, signifying that the peptone, through the influence of the erepsin, has been transformed, in great part at least, into amino-acids which do not respond to the biuret test.²

¹ The enzyme may also be extracted by means of *glycerol* or *alkaline "physiological" salt solution* if desired.

² *Strictly speaking*, this erepsin demonstration is not adequate unless a control test is made with *native protein* (except casein, histones and protamines) to show that the extract is *trypsin-free* and digests peptone but not native protein.

3. The Glycyl-tryptophane Reaction.—The dipeptide glycyl-tryptophane¹ may be used in place of the peptone solution for the demonstration of erepsin. It is claimed to be of service in the diagnosis of gastric cancer. It is claimed that a peptide-splitting enzyme (erepsin) is present in the stomach contents of individuals suffering from cancer of the stomach, whereas the stomach contents of normal individuals contains no such enzyme. The glycyl-tryptophane test, therefore, may sometimes furnish a means of aiding in the diagnosis of this disorder. As applied to stomach contents, the test is as follows:² Introduce about 10 c.c. of the filtrate from the stomach contents into a test-tube, add a little glycyl-tryptophane and a layer of toluene, and place the tube in an incubator at 38°C. for 24 hours. At the end of this time by means of a pipette transfer 2–3 c.c. of the fluid from beneath the toluene to a test-tube, add a few drops of 3 per cent acetic acid and carefully introduce bromine vapors. Shake the tube and note the production of a red color if tryptophane is present. The tryptophane has, of course, been liberated from the peptide through the action of the peptide-splitting enzyme (erepsin) elaborated by the cancer tissue.

If an excess of bromine is added the color will vanish. If no rose color is noted, add more bromine vapors carefully with shaking until further addition of the vapors causes the production of a yellowish color. This indicates an excess of bromine and constitutes a negative test. Occasionally the rose color indicating a positive test is so transitory as to escape detection unless the test be very carefully performed.

Several fallacies have been pointed out in connection with this test. In the first place the regurgitation of duodenal contents through the pylorus might insure the presence in the stomach of erepsin and trypsin either of which possesses peptide-splitting power. It has also been claimed that saliva contains an enzyme capable of splitting glycyl-tryptophane. Doubt has, however, been cast upon the dipeptide-splitting agent of the saliva by Smithies³ and by Jacque and Woodyatt,⁴ who point to bacteria as the peptolytic agents. In any event saliva contains something which is capable of splitting the glycyltryptophan, thus making the entrance of saliva into the stomach an important source of error, so far as the utility of this test is concerned, as a diagnostic aid. Bacteria may, of course, be removed from the gastric juice by passing the fluid through an effective filter.

EXPERIMENTS ON INVERTASES⁵

1. Preparation of an Extract of Sucrase.—Treat the finely divided epithelium of the small intestine of a dog, pig, rat, rabbit, or hen with about 3 volumes of a 2 per cent solution of sodium fluoride and permit the mixture to

¹ This dipeptide is sold commercially under the name "Ferment Diagnosticon."

² Neubauer and Fischer: *Deutsches Archiv f. klinische Medizin*, 97, 499, 1909.

³ Smithies: *Arch. Int. Med.*, 10, 521, 1912.

⁴ Jacque and Woodyatt: *Arch. Int. Med.*, Dec., 1912, p. 560.

⁵ "The Inverting Enzymes of the Alimentary Tract," Mendel and Mitchell: *American Journal of Physiology*, 20, 81, 1907–08.

stand at room temperature for 24 hours. Strain the extract through cloth or absorbent cotton and use the strained material in the following demonstration.

2. **Demonstration of Sucrase.**—To about 5 c.c. of a 1 per cent solution of sucrose, in a test-tube, add about 1 c.c. of a 2 per cent sodium fluoride intestinal extract, prepared as described above. Prepare a control tube in which the intestinal extract is boiled before being added to the sugar solution. Place the two tubes at 38°C. for two hours.¹ Heat the mixture to boiling to coagulate the protein material, filter, and test the filtrate by Fehling's test (see page 25). The tube containing the boiled extract should give no response to Fehling's test, whereas the tube containing the unboiled extract should reduce the Fehling's solution. This reduction is due to the formation of invert sugar (see page 41) from the sucrose through the action of the enzyme sucrase which is present in the intestinal epithelium.

For preparation and demonstration of Vegetable Sucrase see Chapter I.

3. **Preparation of an Extract of Lactase.**—Treat the finely divided epithelium of the small intestine of a kitten, puppy, or pig embryo with about 3 volumes of a 2 per cent solution of sodium fluoride and permit the mixture to stand at room temperature for 24 hours. Strain the extract through cloth or absorbent cotton and use the strained material in the following demonstration.

4. **Demonstration of Lactase.**²—To about 5 c.c. of a 1 per cent solution of lactose in a test-tube add about 1 c.c. of a toluene-water or a 2 per cent sodium fluoride extract of the first part of the small intestine³ of a kitten, puppy, or pig embryo prepared as described above. Prepare a control tube in which the intestinal extract is boiled before being added to the sugar solution. Place the two tubes at 38°C. for 24 hours. At the end of this period add 1 c.c. of the digestion mixture to 5 c.c. of Barfoed's reagent⁴ and place the tubes in a boiling water-bath.⁵ Examine the tubes at the end of three minutes against a black background in a good light. If no cuprous oxide is visible replace the tubes and repeat the examination at the end of the fourth and fifth minutes. If no reduction is then observed permit the tubes to stand at room temperature for 5-10 minutes and examine again.⁶

It has been determined that disaccharide solutions will not reduce Barfoed's reagent until after they have been heated for 9-10 minutes on a boiling water-bath in contact with the reagent.⁷ Therefore in the above test, if the tube containing the unboiled extract exhibits any reduction after being heated as indicated, for a period of five minutes or less, and the control tube containing boiled extract shows no reduction, it may be concluded that lactase was present in the intestinal extract.⁸

¹ If a positive result is not obtained in this time permit the digestion to proceed for a longer period.

² Roaf: *Bio-Chemical Journal*, 3, 182, 1908.

³ Duodenum and first part of jejunum.

⁴ To 4.5 grams of neutral crystallized copper acetate in 900 c.c. of water add 0.6 c.c. of glacial acetic acid and make the total volume of the solution 1 liter.

⁵ Care should be taken to see that the water in the bath reaches at least to the upper level of the contents of the tubes.

⁶ Sometimes the drawing of conclusions is facilitated by pouring the mixture from the tube and examining the bottom of the tube for adherent cuprous oxide.

⁷ The heating for 9-10 minutes is sufficient to transform the disaccharide into monosaccharide.

⁸ The reduction would, of course, be due to the action of the *glucose* and *galactose* which had been formed from the lactose through the action of the enzyme *lactase*.

5. Preparation of an Extract of Maltase.—Treat the finely divided epithelium of the small intestine of a cat, kitten, or pig (embryo or adult) with about 3 volumes of a 2 per cent solution of sodium fluoride and permit the mixture to stand at room temperature for 24 hours. Strain the extract through cloth and use the strained material in the following demonstration.

6. Demonstration of Maltase.—Proceed exactly as indicated in the demonstration of lactase, p. 204, except that a 1 per cent solution of maltose is substituted for the lactose solution. The extract used may be prepared from the upper part of the intestine of a cat, kitten, or pig (embryo or adult). In the case of lactase, as indicated, the intestine used should be that of a kitten, puppy, or pig (embryo).

CHAPTER XII

BILE

THE bile is secreted continuously by the liver and passes into the intestine through the common bile duct which opens near the pylorus. Bile is *not* secreted continuously *into the intestine*. In a fasting animal no bile enters the intestine, but when food is taken the bile begins to flow; the length of time elapsing between the ingestion of the food and the secretion of the bile as well as the qualitative and quantitative characteristics of the secretion depending upon the nature of the food ingested. Fats, the extractives of meat and the protein end-products of gastric digestion (proteoses and peptones), cause a copious secretion of bile, whereas such substances as water, acids and boiled starch paste fail to do so. In general a rich protein diet is supposed to increase the amount of bile secreted, whereas a carbohydrate diet would cause a much less decided increase and might even tend to decrease the amount. It has been demonstrated by Bayliss and Starling that the secretion of bile is under the control of the same mechanism that regulates the flow of pancreatic juice (see page 189). In other words, the hydrochloric acid of the chyme, as it enters the duodenum transforms prosecretin into secretin and this in turn enters the circulation, is carried to the liver, and stimulates the bile-forming mechanism to increased activity.

We may look upon the bile as an *excretion* as well as a *secretion*. In the fulfillment of its excretory function it passes such bodies as lecithin, metallic substances, cholesterol, and the decomposition products of hemoglobin into the intestine and in this way aids in removing them from the organism. The bile assists materially in the absorption of fats from the intestine by its solvent action on the fatty acids formed by the action of the pancreatic juice.

The bile is a ropy, viscid substance which is usually alkaline in reaction to litmus,¹ and ordinarily possesses a decidedly bitter taste. It varies in color in the different animals, the principal variations being yellow, brown and green. Fresh human bile from the living organism ordinarily has a green or golden-yellow color. Post-mortem bile is variable in color. It is very difficult to determine accurately the amount of normal bile secreted during any given period. For an adult man it

¹ It does not contain more than a slight excess of hydroxyl ions, however.

has been variously estimated at from 500 c.c. to 1100 c.c. for 24 hours. The specific gravity of the bile varies between 1.010 and 1.040, and the freezing-point is about -0.56°C . As secreted by the liver, the bile is a clear, limpid fluid which contains a relatively low content of solid matter. Such bile would have a specific gravity of approximately 1.010. After it reaches the gall-bladder, however, it becomes mixed with mucous material from the walls of the gall-bladder, and this process coupled with the continuous absorption of water from the bile has a tendency to concentrate the secretion. Therefore the bile as we find it in the gall-bladder ordinarily possesses a higher specific gravity than that of the freshly secreted fluid. The specific gravity under these conditions may run as high as 1.040.

The principal constituents of the bile are the *salts of the bile acids, bile pigments, neutral fats, lecithin, phosphatides, nucleoprotein, mucin, and cholesterol*, besides the salts of *iron, copper, calcium, and magnesium*. *Zinc* has also frequently been found in traces.

The *quantitative* composition of bile varies according to the source of the bile, *i.e.*, whether the bile for analysis is obtained from the gall-

QUANTITATIVE COMPOSITION OF BILE¹

(Parts per 1000)

Constituent	Bladder bile, Hammarsten ²	Biliary fistula, Rosenbloom ³
Water.....	829.7	970.2
Solids.....	170.3	39.8
Bile salts.....	97.0	10.1
Mucin and pigments.....	41.9	4.86
Cholesterol.....	9.9	2.61 ⁵
Fat.....	1.9	6.85
Soaps.....	11.2 ⁴	2.6
Lecithin.....	2.2	6.42
Inorganic matter.....	5.1	9.2
Fatty acids.....	Included under "soaps"	1.2

¹ For other analyses see Czylharz, Fuchs and v. Fürth: *Bioch. Zeit.*, 49, 120, 1913.

² Hammarsten: *Pincussohn's Med.-Chem. Lab. Hilfsbuch*, Leipzig, 1912, p. 388.

³ Rosenbloom: *Jour. Biol. Chem.*, 14, 241, 1913.

⁴ Includes fatty acids.

⁵ Includes cholesterol esters.

bladder or by means of a fistula before it reaches the gall-bladder. The variation in the composition of these two types of bile is shown in the preceding selected analyses.

The bile acids, which are elaborated exclusively by the hepatic cells, may be divided into two groups, the *glycocholic acid* group and the *taurocholic acid* group. In human bile glycocholic acid predominates, while taurocholic acid is the more abundant in the bile of carnivora. The bile acids are conjugate *amino-acids*, the glycocholic acid yielding *glycocoll*,

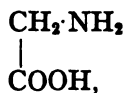

and *cholic acid* upon decomposition, whereas taurocholic acid gives rise to *taurine*,

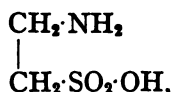

and *cholic acid* under like conditions. Glycocholic acid contains some nitrogen but no sulphur, whereas taurocholic acid contains both these elements. The sulphur of the taurocholic acid is present in the *taurine* (amino-ethyl-sulphonic-acid), of which it is a characteristic constituent. There are several varieties of cholic acid and therefore we have several forms of glycocholic and taurocholic acids, the variation in constitution depending upon the nature of the cholic acid which enters into the combination. The bile acids are present in the bile as salts of one of the alkalis, generally sodium. The sodium glycocholate and sodium taurocholate may be isolated in crystalline form, either as balls or rosettes of fine needles or in the form of prisms having ordinarily four or six sides (Fig. 61, page 209). The salts of the bile acids are dextro-rotatory. Among other properties these salts have the power of holding the cholesterol and lecithin of the bile in solution.

Hammarsten has demonstrated a third group of bile acids in the bile of the shark. This same group very probably occurs in certain other animals also. These acids are very rich in sulphur and resemble ethereal sulphuric acids inasmuch as upon treatment with boiling hydrochloric acid they yield sulphuric acid.

The bile pigments are important and interesting biliary constituents. The following have been isolated: *bilirubin*, *biliverdin*, *bilifuscin*, *biliprasin*, *bilihumin*, *bilicyanin*, *choleprasin*, and *choletelin*. Of these, bilirubin and biliverdin are the most important and predominate in normal bile. The colors possessed by the various varieties of normal bile are due almost entirely to these two pigments, the biliverdin being

the predominant pigment in greenish bile and the bilirubin being the principal pigment in lighter colored bile. The pigments, other than the two just mentioned, have been found almost exclusively in biliary calculi or in altered bile obtained at post-mortem examinations.

Bilirubin, which is perhaps the most important of the bile pigments, is apparently derived from the blood pigment, the iron freed in the

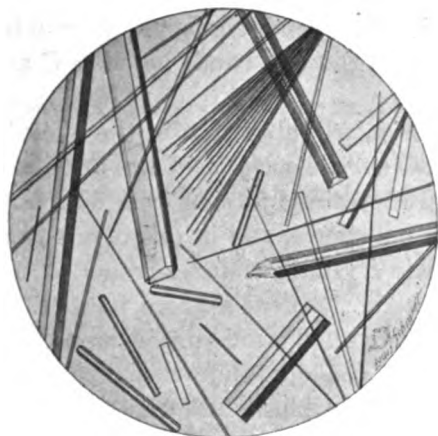

FIG. 61.—BILE SALTS.

process being held in the liver. Bilirubin has the same percentage composition as hematoporphyrin, which may be produced from hematin. It is a specific product of the liver cells, but may also be formed in other parts of the body. The pigment may be isolated in the form of a reddish-yellow powder or may be obtained in part, in the form of reddish-

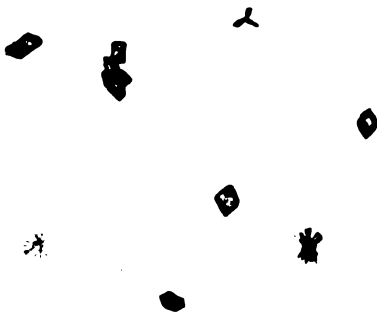

FIG. 62.—BILIRUBIN (HEMATOIDIN). (*Ogden*.)

yellow rhombic plates (Fig. 62) upon the spontaneous evaporation of its chloroform solution. The crystalline form of bilirubin is practically the same as that of hematoidin. It is easily soluble in chloroform, somewhat less soluble in alcohol and only slightly soluble in ether and benzene. Bilirubin has the power of combining with

certain metals, particularly calcium, to form combinations which are no longer soluble in the solvents of the unaltered pigment. Upon long standing in contact with the air, the reddish-yellow bilirubin is oxidized with the formation of the green biliverdin. Bilirubin occurs in animal fluids as soluble bilirubin-alkali.

Solutions of bilirubin exhibit no absorption bands. If an ammoniacal solution of bilirubin-alkali in water is treated with a solution of zinc chloride, however, it shows bands similar to those of bilicyanin (Absorption Spectra, Plate II), the two bands between C and D being rather well defined.

Biliverdin is particularly abundant in the bile of herbivora. It is soluble in alcohol and glacial acetic acid and insoluble in water, chloroform, and ether. Biliverdin is formed from bilirubin upon oxidation. It is an amorphous substance, and in this differs from bilirubin which may be at least partly crystallized under proper conditions. Biliverdin may be obtained in the form of a green powder. In common with bilirubin, it may be converted into hydrobilirubin by nascent hydrogen.

The neutral solution of bilicyanin or cholecyanin is bluish green or steel blue and possesses a blue fluorescence, the alkaline solution is green with no appreciable fluorescence, and the strongly acid solution is violet blue. The alkaline solution exhibits three absorption bands, the first a dark, well-defined band between C and D, somewhat nearer C; the second a less sharply defined band extending across D and the third a rather faint band between E and F, near E (Absorption Spectra, Plate II). The strongly acid solution exhibits two absorption bands, both lying between C and E and separated by a narrow space near D. A third band, exceedingly faint, may ordinarily be seen between b and F.

Bile pigments are converted into *urobilinogen* (urobilin) in the intestine. This is absorbed, carried to the liver and *reconverted into bile pigment*. In diseases of the liver the liver cell loses the capacity to convert the urobilinogen and this is then excreted in the urine. The presence of urobilinogen in urine, therefore, may be considered as an index of *functional liver incapacity*.¹

Biliary calculi, otherwise designated as *biliary concretions* or *gall stones*, are frequently formed in the gall-bladder. These deposits may be divided into three classes, *cholesterol calculi*, *pigment calculi*, and calculi made up almost entirely of *inorganic material*. This last class of calculus is formed principally of the carbonate and phosphate of calcium and is rarely found in man although quite common to cattle. The pigment calculus is also found in cattle, but is more common to man than the inorganic calculus. This pigment calculus ordinarily

¹ Rowntree, Hurwitz and Bloomfield: *Johns Hopkins Hospital Bulletin*, Nov., 1913.

consists principally of bilirubin in combination with calcium; biliverdin is sometimes found in small amount. The cholesterol calculus is the one found most frequently in man. These may be formed almost entirely of cholesterol, in which event the color of the calculus is very light, or they may contain more or less pigment and inorganic matter mixed with the cholesterol, which tends to give us calculi of various colors.

For discussion of cholesterol see page 383.

EXPERIMENTS ON BILE

1. **Reaction.**—Test the reaction of fresh ox bile to litmus, phenolphthalein and Congo red.

2. **Nucleoprotein.**—Acidify a small amount of bile with dilute acetic acid. A precipitate of nucleoprotein forms. Bile acids will also precipitate here under proper conditions of acidity.

3. **Inorganic Constituents.**—Test for chlorides, sulphates, and phosphates (see page 59).

4. **Tests for Bile Pigments.**—Practically all of these tests for bile pigments are based on the oxidation of the pigment, by a variety of reagents, with the formation of a series of colored derivatives, *e.g.*, biliverdin (green), bilicyanin (blue), choletelin (yellow).

(a) **Gmelin's Test.**—To about 5 c.c. of concentrated nitric acid in a test-tube add 2-3 c.c. of diluted bile carefully so that the two fluids do not mix. At the point of contact note the various colored rings, green, blue, violet, red and reddish yellow. Repeat this test with different dilutions of bile and observe its delicacy.

(b) **Rosenbach's Modification of Gmelin's Test.**—Filter 5 c.c. of diluted bile through a small filter paper. Introduce a drop of concentrated nitric acid into the cone of the paper and note the succession of colors as given in Gmelin's test.

(c) **Nakayama's Reaction.**—To 5 c.c. of diluted bile in a test-tube add an equal volume of a 10 per cent solution of barium chloride, centrifugate the mixture, pour off the supernatant fluid, and heat the precipitate with 2 c.c. of Nakayama's reagent.¹ In the presence of bile pigments the solution assumes a blue or green color.

(d) **Huppert's Reaction.**—Thoroughly shake equal volumes of undiluted bile and milk of lime in a test-tube. The pigments unite with the calcium and are precipitated. Filter off the precipitate, wash it with water, and transfer to a small beaker. Add alcohol acidified slightly with hydrochloric acid and warm upon a water-bath until the solution becomes colored an emerald green.

In examining urine for bile pigments, according to Steensma, this procedure may give negative results even in the presence of the pigments, owing to the fact that the acid-alcohol is not a sufficiently strong oxidizing agent. He therefore suggests the addition of a drop of a 0.5 per cent solution of sodium nitrite to the acid-alcohol mixture before warming on the water-bath. Try this modification also.

(e) **Hammarsten's Reaction.**—To about 5 c.c. of Hammarsten's reagent² in a

¹Prepared by combining 99 c.c. of alcohol and 1 c.c. of *fuming* hydrochloric acid containing 4 grams of ferric chloride per liter.

²Hammarsten's reagent is made by mixing 1 volume of 25 per cent nitric acid and 19 volumes of 25 per cent hydrochloric acid and then adding 1 volume of this acid mixture to 4 volumes of 95 per cent alcohol.

small evaporating dish add a few drops of diluted bile. A green color is produced. If more of the reagent is now added the play of colors as observed in Gmelin's test may be obtained.

(f) **Smith's Test.**—To 2–3 c.c. of diluted bile in a test-tube add carefully about 5 c.c. of dilute tincture of iodine (1 : 10) so that the fluids do not mix. A play of colors, *green, blue and violet*, is observed. In making this test upon the urine ordinarily only the *green* color is observed.

(g) **Salkowski-Schipper's Reaction.**—To 10 c.c. of diluted bile in a test-tube add 5 drops of a 20 per cent solution of sodium carbonate and 10 drops of a 20 per cent solution of calcium chloride. Filter off the resultant precipitate upon a hardened filter paper and wash it with water. Remove the precipitate to a small porcelain dish, add 3 c.c. of an acid-alcohol mixture¹ and a few drops of a dilute solution of sodium nitrite and heat. The production of a green color indicates the presence of bile pigments.

(h) **Bonanno's Reaction.**²—Place 5–10 c.c. of diluted bile in a small porcelain evaporating dish and add a few drops of Bonanno's reagent.³ An emerald-green color will develop.

5. **Test for Bile Acids.**—(a) **Sucrose-H₂SO₄ Test (Pettenkofer).**—To 5 c.c. of diluted bile in a test-tube add 5 drops of a 5 per cent solution of sucrose. Now run about 2–3 c.c. of concentrated sulphuric acid carefully down the side of the tube and note the red ring at the point of contact. Upon slightly agitating the contents of the tube the whole solution gradually assumes a reddish color. As the tube becomes warm, it should be cooled in running water in order that the temperature of the solution may not rise above 70°C.

It is claimed that this test is not satisfactory in the presence of protein and chromogenic substances which yield interfering colors with sulphuric acid.

(b) **Furfural-H₂SO₄ Test.—Mylius's Modification of Pettenkofer's Test.**—To approximately 5 c.c. of diluted bile in a test-tube add 3 drops of a very dilute (1 : 1000) aqueous solution of furfural,

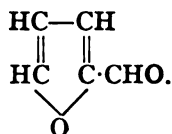

Now run about 2–3 c.c. of concentrated sulphuric acid carefully down the side of the tube and note the red ring as above. In this case, also, upon shaking the tube the whole solution is colored red. Keep the temperature of the solution below 70°C. as before.

(c) **Foam Test (v. Udránsky).**—To 5 c.c. of diluted bile in a test-tube add 3–4 drops of a very dilute (1 : 1000) aqueous solution of furfural. Place the thumb over the top of the tube and shake the tube until a thick foam is formed. By means of a small pipette add 2–3 drops of concentrated sulphuric acid to the foam and note the dark pink coloration produced.

¹ Made by adding 5 c.c. of concentrated hydrochloric acid to 95 c.c. of 96 per cent alcohol.

² *Il Tommasi*, 2, No. 21.

³ This reagent may be prepared by dissolving 2 grams of sodium nitrite in 100 c.c. of concentrated hydrochloric acid.

(d) **Surface Tension Test (Hay).**—This test is based upon the principle that bile acids have the property of reducing the surface tension of fluids in which they are contained. The test is performed as follows: Cool about 10 c.c. of diluted bile in a test-tube to 17°C. or lower and sprinkle a little finely pulverized sulphur upon the surface of the fluid. The presence of bile acids is indicated if the sulphur sinks to the bottom of the liquid, the rapidity with which the sulphur sinks depending upon the quantity of bile acids present in the mixture. The test is said to react with bile acids when they are present in the ratio of 1:120,000.

(e) **Neukomm's Modification of Pettenkofer's Test.**—To a few drops of diluted bile in an evaporating dish add a trace of a dilute sucrose solution and one or more drops of dilute sulphuric acid. Evaporate on a water-bath and note the development of a *violet* color at the edge of the evaporating mixture. Discontinue the evaporation as soon as the color is observed.

(f) **Peptone Test (Oliver).**—To 5 c.c. of diluted bile add 2–3 drops of acetic acid, filtering if necessary. Add an equal volume of a 1 per cent solution of Witte's peptone to the acid solution. A precipitate is produced which is insoluble in excess of acetic acid. This precipitate is a compound of protein and bile acids.

6. **Crystallization of Bile Salts.**—To 25 c.c. of undiluted bile in an evaporating dish add enough animal charcoal to form a paste and evaporate to dryness on a water-bath. Remove the residue, grind it in a mortar, and transfer it to a small flask. Add about 50 c.c. of 95 per cent alcohol and boil on a water-bath for 20 minutes. Filter, and add ether to the filtrate until there is a slight permanent cloudiness. Cover the vessel and stand it away until crystallization is complete. Examine the crystals under the microscope and compare them with those shown in Fig. 61, page 209. Try one of the tests for bile acids upon some of the crystals.

7. **Analysis of Biliary Calculi.**—Grind the calculus in a mortar with 10 c.c. of ether. Filter.

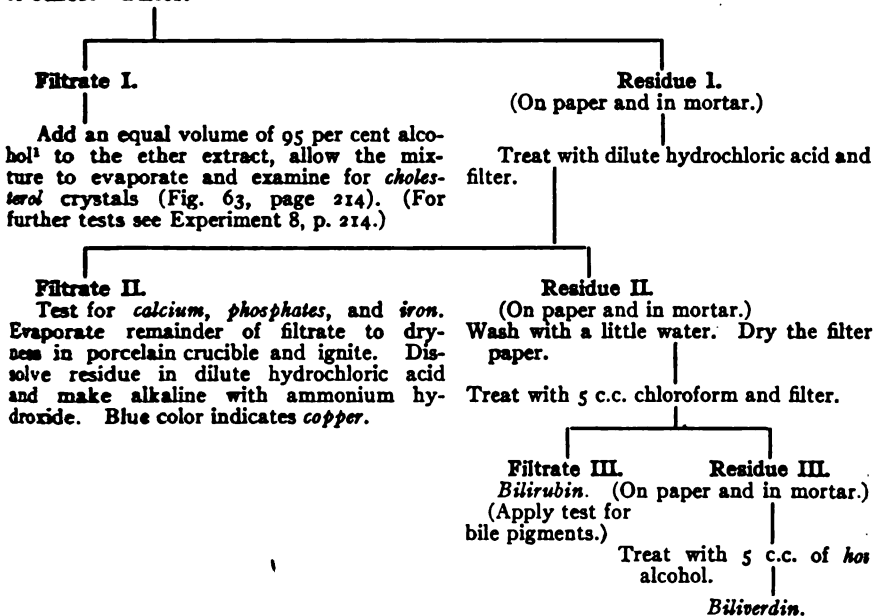

¹ The alcohol is added because of the fact that it is often found that crystallization from pure ether does not yield typical cholesterol crystals.

8. Tests for Cholesterol.

(a) **Microscopical Examination.**—Examine the crystals under the microscope and compare them with those shown in Fig. 63, below.

(b) **Sulphuric Acid Test (Salkowski).**—Dissolve a few crystals of cholesterol in a little chloroform and add an equal volume of concentrated sulphuric acid. A play of colors from bluish-red to cherry-red and purple is noted in the chloroform while the acid assumes a marked green fluorescence.

(c) **Acetic Anhydride- H_2SO_4 Test (Liebermann-Burchard).**—Dissolve a few crystals of cholesterol in 2 c.c. of chloroform in a dry test-tube. Now add 10 drops of acetic anhydride and 1-3 drops of concentrated sulphuric acid. The solution becomes red, then blue, and finally bluish-green in color. This reaction is used in the quantitative determination of cholesterol (see Chapter XVI).

(d) **Iodine-sulphuric Acid Test.**—Place a few crystals of cholesterol in one of the depressions of a test-tablet and treat with a drop of concentrated sulphuric acid and a drop of a very dilute solution of iodine. A play of colors consisting of *violet*, *blue*, *green*, and *red* results.

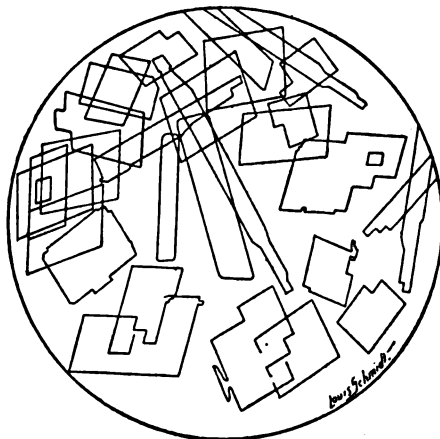

FIG. 63.—CHOLESTEROL.

(e) **Schiff's Reaction.**—To a little cholesterol in an evaporating dish add a few drops of a reagent made by adding 1 volume of 10 per cent ferric chloride to 3 volumes of concentrated sulphuric acid. Evaporate to dryness over a low flame and observe the *reddish-violet* residue which changes to a *bluish-violet*.

9. Preparation of Taurine.—To 300 c.c. of bile in a casserole add 100 c.c. of hydrochloric acid and heat until a sticky mass (dyslysin) is formed. This point may be determined by drawing out a thread-like portion of the mass by means of a glass rod, and if it solidifies immediately and assumes a brittle character we may conclude that all the taurocholic and glycocholic acid has been decomposed. Decant the solution and concentrate it to a small volume on the water-bath. Filter the hot solution to remove sodium chloride and other substances which may have separated, and evaporate the filtrate to dryness. Dissolve the residue in 5 per cent hydrochloric acid and precipitate with 10 volumes of 95 per cent alcohol. Filter off the taurine and recrystallize it from hot water. (Save the alcoholic filtrate for the preparation of glycocholl, p. 215.) Make the following tests upon the taurine crystals.

(a) Examine them under the microscope and compare with Fig. 64.

(b) Heat a crystal upon platinum foil. The taurine at first melts, then turns brown, and finally carbonizes as the temperature is raised. Note the suffocating odor. What is it?



FIG. 64.—TAURINE.

(c) Test the solubility of the crystals in water and in alcohol.

(d) Grind up a crystal with four times its volume of dry sodium carbonate and fuse on platinum foil. Cool the residue, transfer it to a test-tube, and dissolve it in water. Add a little dilute sulphuric acid and note the odor of hydrogen sulphide. Hold a piece of filter paper, moistened with a *small* amount of lead acetate, over the opening of the test-tube and observe the formation of lead sulphide.



FIG. 65.—GLYCOCOLL.

10. Preparation of Glycocoll.—Concentrate the alcoholic filtrate from the last experiment (9) until no more alcohol remains. The glycocoll is present here in the form of an hydrochloride and may be liberated from this combination by the addition of freshly precipitated lead hydroxide or by lead hydroxide solution. Remove the lead by hydrogen sulphide. Filter and decolorize the filtrate by animal charcoal. Filter again, concentrate the filtrate, and set it aside for crystallization. Glycocoll separates as colorless crystals (Fig. 65).

CHAPTER XIII

PUTREFACTION PRODUCTS

THE putrefactive processes in the intestine are the result of the action of bacteria upon the protein material present. This bacterial action which is the combined effort of many forms of micro-organisms is confined almost exclusively to the large intestine. Some of the products of the putrefaction of proteins are identical with those formed in tryptic digestion, although the decomposition of the protein material is much more extensive when subjected to putrefaction. Some of the more important of the putrefaction products are the following: *Indole*, *skatole*, *paracresol*, *phenol*, *para-oxyphenylpropionic acid*, *para-oxyphenylacetic acid*, *volatile fatty acids*, *hydrogen sulphide*, *methane*, *methyl mercaptan*, *hydrogen*, and *carbon dioxide*, besides *proteoses*, *peptones*, *peptides*, *ammonia*, and *amino-acids*. *Basic substances* such as *choline*, *neurine*, *putrescine* and *cadaverine* are present under certain conditions. Of the putrefaction products the indole, skatole, phenol, and paracresol appear in part in the urine as ethereal sulphuric acids, whereas the oxyacids mentioned pass unchanged into the urine. The potassium indoxyl sulphate (page 414) content of the urine is a rough indicator of the extent of the putrefaction within the intestine.

The portion of the indole which is excreted in the urine is first subjected to a series of changes within the organism and is subsequently eliminated as *indican*. These changes may be represented thus:

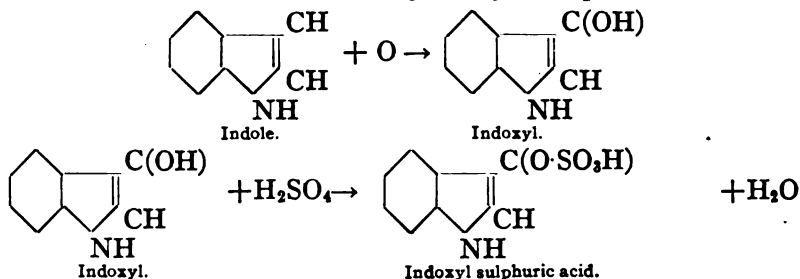

In the presence of potassium salts the indoxyl sulphuric acid is then transformed into indoxyl potassium sulphate (or indican),

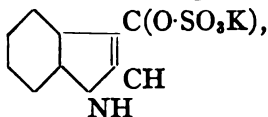

and eliminated as such in the urine.

Indican may be decomposed by treatment with concentrated hydrochloric acid (see tests on page 415) into sulphuric acid and indoxyl. The latter body may then be oxidized to form indigo-blue thus:

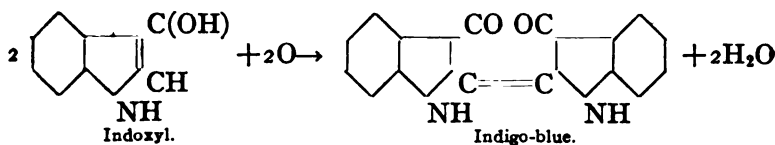

This same reaction may also occur under pathological conditions *within the organism*, thus giving rise to the appearance of crystals of indigo-blue in the urine.

Skatole or *methyl indole* possesses the following structure:

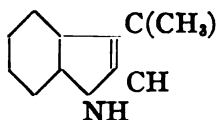

In common with indole it is changed within the organism and eliminated in the form of a chromogenic substance. Skatole is, however, of less importance as a putrefaction product than indole and ordinarily occurs in much smaller amount. The tryptophane group of the protein molecule yields the indole and skatole formed in intestinal putrefaction, but the reasons for the transformation of the major portion of this tryptophane into indole and the minor portion into skatole are not well understood. Indole is more toxic than skatole.

Phenol occurs in fairly large amount in certain abnormal conditions of the organism, but ordinarily the amount is very small. It is probably derived from the tyrosine group of the protein molecule. Phenol is conjugated in the liver to form phenyl potassium sulphate and appears in the urine in this form (Baumann and Herter). Para-cresol occurs in the urine as cresyl potassium sulphate.

Regarding the claim of Nencki that methyl mercaptan is formed as a gas during intestinal putrefaction it is an important fact that Herter¹ was unable to detect the mercaptan in *fresh* feces. He was, therefore, not inclined to accept the theory that methyl mercaptan is formed in *ordinary* intestinal putrefaction but believed that it may be formed in *exceptional* cases. Hydrogen sulphide is, however, formed in all cases of intestinal putrefaction.

It has been demonstrated that putrefaction processes in the human intestine may be retarded by the ingestion of a *carbohydrate diet*.² The putrefactive organisms are *facultative organisms* and prefer a carbo-

¹Herter: "Bacterial Infections of the Digestive Tract, p. 227."

²Kendall: *Jour. Med. Res.*, 24, 411, 1911; also *Pediatrics*, 23, No. 9, 1910.

hydrate medium if it is available. These organisms are also unable to exert their maximum activity in an acid medium and therefore the acids resulting from the carbohydrate fermentation would tend to lessen their activity.

It has been shown by Kutscher and his associates¹ that many acids and bases formed in putrefaction and which have been considered as originating alone from bacterial action, may also be formed in certain phases of metabolism in both the plant and animal kingdoms. These transformation products of amino-acids have been termed "aporrhemas." The following aporrhemas may result from putrefaction processes:

Aporrhema	Amino-acid source
Iminazoethylamine.....	Histidine.
Iminazolypropionic acid.....	
Ornithine.....	Arginine.
Tetramethylendiamine.....	
Aminovaleric acid.....	Lysine.
Pentamethylendiamine.....	
Amino-butyric acid.....	Glutamic acid.
Alanine.....	
Succinic acid.....	Aspartic acid.
Isovaleric acid.....	
Phenylethylamine.....	Leucine.
Phenylacetic acid.....	
Phenylpropionic acid.....	Phenylalanine.
p-Hydroxyphenylacetic acid.....	
p-Hydroxyphenylpropionic acid.....	Tyrosine.
Indole.....	
Skatole.....	Tryptophane.
Indolylacetic acid.....	
Indolylpropionic acid.....	

EXPERIMENTS ON PUTREFACTION PRODUCTS

In many courses in physiological chemistry the instructors are so limited for time that no extended study of the products of putrefaction can very well be attempted. Under such conditions the scheme here submitted may be used profitably in the way of demonstration. Where the number of students is not too great, a single large putrefaction may be started, and, after the initial distillation, both the resulting distillate and residue may be distributed to the members of the class for individual manipulation.

Preparation of Putrefaction Mixture.—Place a weighed mixture of coagulated egg albumin and ground lean meat in a flask or bottle and add approximately 2 liters of water for every kilogram of protein used. Sterilize the vessel and contents, inoculate with the colon bacillus, and keep at 40°C. for two or three weeks. If cultures of the colon bacillus are not available, add 60 c.c. of a cold saturated

¹ Ackermann and Kutscher: *Zeit. physiol. Chem.*, 69, 265, 1910.

Ackermann: *Ibid.*, 273.

Engelard and Kutscher: *Ibid.*, 282.

solution of sodium carbonate for every liter of water previously added and inoculate with some putrescent material (pancreas or feces).¹ Mix the putrefaction mixture very thoroughly by shaking and insert a cork furnished with a glass tube to which is attached a wash bottle containing a 3 per cent solution of mercuric cyanide.² This device is for the purpose of collecting the methyl mercaptan, a gas formed during the process of putrefaction. It also serves to diminish the odor arising from the putrefying material. Place the putrefaction mixture at 40°C. for two or three weeks and at the end of that time make a separation of the products of putrefaction according to the following directions:

Subject the mixture to distillation until the distillate and residue are approximately equal in volume.

PART I

MANIPULATION OF THE DISTILLATE

Acidify with hydrochloric acid and extract with ether.

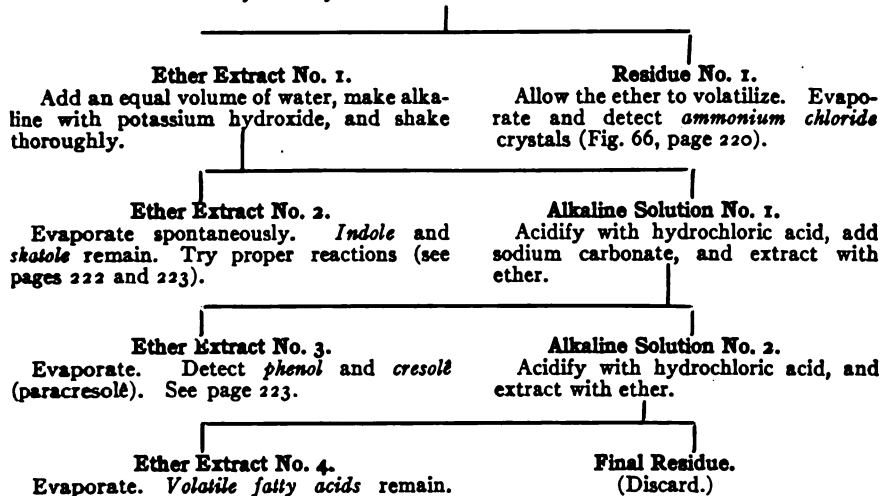

DETAILED DIRECTIONS FOR MAKING THE SEPARATIONS INDICATED IN THE SCHEME

Preliminary Ether Extraction.—This extraction may be conveniently conducted in a separatory funnel. Mix the fluids for extraction in the ratio of *two* volumes of ether to *three* volumes of the distillate. Shake very thoroughly for a few moments, then draw off the extracted fluid and add a new portion of the distillate. Repeat the process until the entire distillate has been extracted. Add a small amount of fresh ether at each extraction to replace that dissolved by the water in the preceding extraction.

¹Putrefying protein may be prepared by treating 10 grams of finely ground lean meat with 100 c.c. of water and 2 c.c. of a saturated solution of sodium carbonate and keeping the mixture at 40°C. for 24 hours.

²Concentrated sulphuric acid containing a small amount of *isatin* may be used as a substitute for mercuric cyanide. When this modification is employed it is necessary to use calcium chloride tubes to exclude moisture from the isatin solution.

Residue No. 1.—Unite the portions of the distillate extracted as above and allow the ether to volatilize spontaneously. Evaporate until crystallization begins. Examine the crystals under the microscope. Ammonium chloride predominates. Explain its presence.

Ether Extract No. 1.—Add equal volume of water, render the mixture alkaline with potassium hydroxide, and shake thoroughly by means of a separatory funnel as before. The *volatile fatty acids*, contained among the putrefaction products, would be dissolved by the alkaline solution (No. 1) whereas any indole or skatole would remain in the ethereal solution (No. 2).

Alkaline Solution No. 1.—Acidify with hydrochloric acid and add sodium carbonate solution until the fluid is neutral or slightly acid from the presence of carbonic acid. At this point a portion of the solution, after being heated for a few moments, should possess an alkaline reaction on cooling. Extract the whole mixture with ether in the usual way, using care in the manipulation of the stop cock to

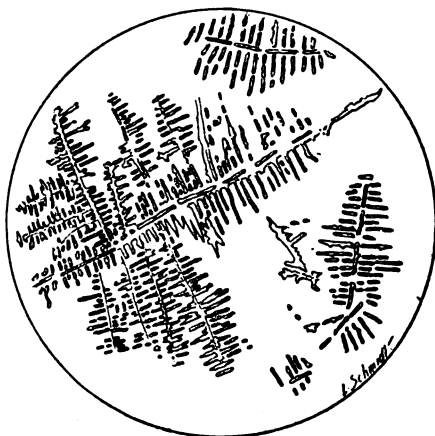

FIG. 66.—AMMONIUM CHLORIDE.

relieve the pressure due to the evolution of carbon dioxide. The ether (Ether Extract No. 3) removes any *phenol* or *cresol* which may be present while the volatile fatty acids will remain in the alkaline solution (No. 2) as alkali salts.

Ether Extract No. 2.—Drive off the major portion of the ether at a low temperature on a water-bath and allow the residue to evaporate spontaneously. Indole and skatole should be present here. Prove the presence of these bodies. For tests for indole and skatole see pages 222 and 223.

Alkaline Solution No. 2.—Make strongly acid with hydrochloric acid and extract with a small amount of ether, using a separatory funnel. As carbon dioxide is liberated here, care must be used in the manipulation of the stop cock of the funnel in relieving the pressure within the vessel. The volatile fatty acids are dissolved by the ether (Ether Extract No. 4).

Ether Extract No. 3.—Evaporate this ethereal solution on a water-bath. The oily residue contains phenol and cresol. The cresol is present for the most part as paracresol. Add some water to the oily residue and heat it in a flask. Cool and prove the presence of phenol and cresol. For tests for these bodies see page 223.

Ether Extract No. 4.—Evaporate on a water-bath. The volatile fatty acids remain in the residue.

PART II
MANIPULATION OF THE RESIDUE

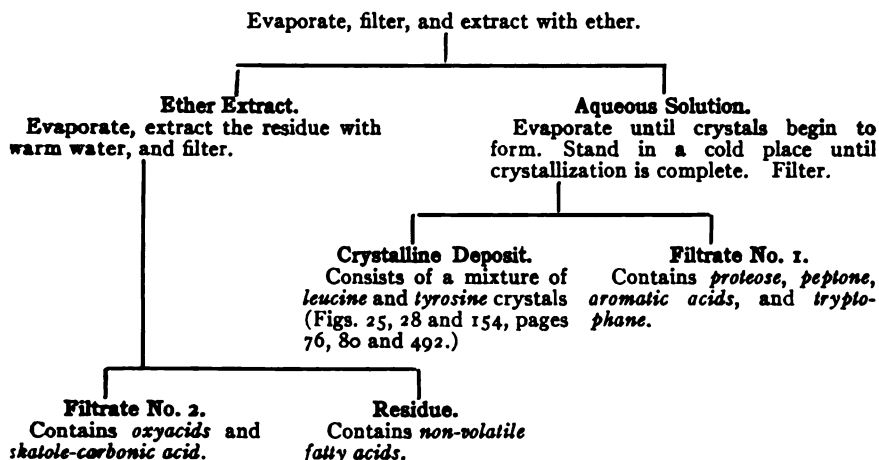

DETAILED DIRECTIONS FOR MAKING THE SEPARATIONS INDICATED IN THE SCHEME

Preliminary Ether Extraction.—This extraction may be conducted in a separatory funnel. In order to make a satisfactory extraction the mixture should be shaken thoroughly. Separate the ethereal solution from the aqueous portion and treat them according to the directions given on page 219.

Ether Extract.—Evaporate this solution on a safety water-bath until the ether has been entirely removed. Extract the residue with warm water and filter.

Aqueous Solution.—Evaporate this solution until crystallization begins. Stand the solution in a cold place until no more crystals form. This crystalline mass consists of impure leucine and tyrosine. Filter off the crystals.

Crystalline Deposit.—Examine the crystals under the microscope and compare them with those reproduced in Figs. 25, 28, and 154, pages 76, 80, and 492. Do the forms of the crystals of leucine and tyrosine resemble those previously examined? Make a separation of the leucine and tyrosine and apply typical tests according to directions given on pages 86 and 87.

Filtrate No. 1.—Make a test for tryptophane with bromine water (see page 193), and also with the Hopkins-Cole reagent (see page 99). Use the remainder of the filtrate for the separation of proteoses and peptones. Make the separation according to the directions given on page 120.

Filtrate No. 2.—This solution contains para-oxyphenylacetic acid, para-oxyphenylpropionic acid and skatole-carbonic acid. Prove the presence of these bodies by appropriate tests. Tests for oxyacids and skatole-carbonic acid are given on page 224.

TESTS FOR VARIOUS PUTREFACTION PRODUCTS

Tests for Indole

The various tests for *indole* and *skatole* may be carried out upon an aqueous solution of these products or upon an aqueous solution of the residue from Ether Extract No. 2 (see page 220). A distillate secured by distilling a putrefaction mixture first in alkaline and then in acid reaction may also be employed.

1. Herter's β -Naphthaquinone Reaction.—(a) To a dilute aqueous solution of indole (1:500,000) add 1 drop of a 2 per cent solution of β -naphthaquinone-sodium-monosulphonate. No reaction occurs. Add a drop of a 10 per cent solution of potassium hydroxide and note the gradual development of a blue or blue-green color which fades to green if an excess of the alkali is added. Render the green or blue-green solution acid and note the appearance of a pink color. Heat facilitates the development of the color reaction.

One part of indole in one million parts of water may be detected by means of this test if carefully performed.

(b) If the alkali be added to a more concentrated indole solution before the introduction of the naphthaquinone, the course of the reaction is different, particularly if the indole solution is somewhat more concentrated than that mentioned above and if heat is used. Under these conditions the blue indole compound ultimately forms as fine acicular crystals which rise to the surface.

If we do not wait for the production of the crystalline body but as soon as the blue color forms, shake the aqueous solution with chloroform, the blue color disappears from the solution and the chloroform assumes a pinkish-red hue. This is a distinguishing feature of the indole reaction and facilitates the differentiation of indole from other bodies which yield a similar blue color. A very satisfactory method for the quantitative determination of indole is based upon the principle underlying this test (see chapter on Feces).

2. Formaldehyde Reaction (Konto).—To 1 c.c. of the material under examination in a test-tube add 3 drops of a 40 per cent solution of formaldehyde and 1 c.c. of concentrated sulphuric acid. Now agitate the mixture and note the appearance of a violet-red color if a trace of indole is present. The test is said to serve for the detection of indole when present in a dilution of 1:700,000.

Skatole gives a yellow or brown color under the above conditions.

3. Cholera-red Reaction.—To a little of the material under examination in a test-tube add one-tenth its volume of a 0.02 per cent solution of potassium nitrite and mix thoroughly. Carefully run concentrated sulphuric acid down the side of the tube so that it forms a layer at the bottom. Note the purple color. Neutralize with potassium hydroxide and observe the production of a bluish-green color.

4. Nitroprusside Reaction (Legal).—To a small amount of the material under examination in a test-tube add a few drops of a freshly prepared solution of sodium nitroprusside, $\text{Na}_2\text{Fe}(\text{CN})_5\text{NO} + 2\text{H}_2\text{O}$. Render alkaline with potassium hydroxide and note the production of a violet color. If the solution is now acidified with glacial acetic acid the violet is transformed into a blue.

5. **Pine Wood Test.**—Moisten a pine splinter with concentrated hydrochloric acid and insert it into the material under examination. The wood assumes a cherry-red color.

6. **Nitroso-indole Nitrate Test.**—Acidify some of the material under examination with nitric acid, add a few drops of a potassium nitrite solution and note the production of a red precipitate of nitroso-indole nitrate. If the residue contains but little indole simply a red coloration will result. Compare this result with the result of the similar test on skatole.

Tests for Skatole

1. **Herter's Para-dimethylaminobenzaldehyde Reaction.**¹—To 5 c.c. of the distillate or aqueous solution under examination add 1 c.c. of an acid solution of para-dimethylaminobenzaldehyde² and heat the mixture to boiling. A purplish-blue coloration is produced³ which may be intensified through the addition of a few drops of concentrated hydrochloric acid. If the solution be cooled under running water it loses its purplish tinge of color and becomes a definite blue. The solution at this point may be somewhat opalescent through the separation of uncombined para-dimethylaminobenzaldehyde. Care should be taken not to add an excess of hydrochloric acid inasmuch as the end-reaction has a tendency to fade under the influence of a high acidity.

A rough idea regarding the actual quantity of skatole in a mixture may be obtained by extracting this blue solution with chloroform and subsequently comparing this chloroform solution, by means of a colorimeter (Duboscq), with the maximal reaction, obtained with a skatole solution of known strength.

2. **Color Reaction with Hydrochloric Acid.**—Acidify some of the residue with concentrated hydrochloric acid. Note the production of a violet color.

3. Acidify some of the residue with nitric acid and add a few drops of a potassium nitrite solution. Note the white turbidity. Compare this result with the result of the similar test on indole.

Tests for Phenol and Cresole

1. **Color Test.**—Test a little of the solution with Millon's reagent. A red color results. Compare this test with the similar one under Tyrosine (see page 86).

2. **Ferric Chloride Test.**—Add a few drops of neutral ferric chloride solution to a little of the material under examination. A dirty bluish-gray color is formed.

3. **Formation of Bromine Compounds.**—Add some bromine water to a little of the fluid under examination. Note the crystalline precipitate of tribromphenol and tribromcresol. The reaction for phenol is as follows:



¹ Herter: *Bacterial Infections of the Digestive Tract*, 1907, p. 141.

² Made by dissolving 5 grams of para-dimethylaminobenzaldehyde in 100 c.c. of 10 per cent sulphuric acid.

³ If the color does not appear add more of the aldehyde solution.

4. **Nitric Acid Test.**—Add some nitric acid to some of the material under examination. Heat and note a yellow color due to the production of picric acid (trinitrophenol) from phenol. This is the reaction:

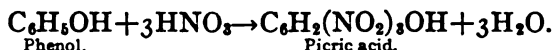

Tests for Oxyacids

1. **Color Test.**—Test a little of the solution with Millon's reagent. A red color results.

2. **Bromine Water Test.**—Add a few drops of bromine water to some of the filtrate. A turbidity or precipitate is observed.

Test for Skatole-carbonic Acid

Ferric Chloride Test.—Acidify some of the filtrate with hydrochloric acid, add a few drops of ferric chloride solution, and heat. Compare the end-reaction with that given by phenol.

CHAPTER XIV

FECES

THE feces are the residual mass of material remaining in the intestine after the full and complete exercise of the digestive and absorptive functions and are ultimately expelled from the body through the rectum.

They may be said to be composed of the following substances:

1. Food residues: (a) those portions of the food which have escaped absorption, and (b) that part of the diet either not digested or incapable of absorption.
2. The remains of the intestinal and digestive secretions not destroyed or reabsorbed.
3. Substances excreted into the intestinal tract, notably salts of calcium, iron, and other metals.
4. The bacterial flora of the intestinal tract.
5. Cellular elements to which may be added, under pathological conditions, blood, pus, mucus, serum, and parasites.
6. Abnormally: enteroliths, gall stones, and pancreatic calculi.

The *amount* of the fecal discharge varies with the individual and the diet. Upon an ordinary mixed diet various authorities claim that the daily excretion by an adult male will aggregate 110-170 grams with a solid content ranging between 25 and 45 grams; the fecal discharge of such an individual upon a vegetable diet will be much greater and may even be as great as 350 grams and possess a solid content of 75 grams. In the author's own experience the average daily output of moist feces, calculated on the basis of data secured from the examination of over 1000 stools, was about 100 grams. The variation in the normal daily output being so great renders this factor of very little value for diagnostic purposes, except where the composition of the diet is accurately known. Lesions of the digestive tract, a defective absorptive function, or increased peristalsis as well as an admixture of mucus, pus, blood, and pathological products of the intestinal wall, may cause the total amount of excrement to be markedly increased. An idea of the variation of the percentage of dry matter in the feces, evacuated after the ingestion of different diets, may be gathered from a consideration of the following table.¹

¹Schmidt & Strasburger: "Die Fäzes des Menschen," Berlin, 1915.

INFLUENCE OF DIET ON FECAL DRY MATTER

Diet		Dry Matter Percent.
Milk	Nursing infant.....	15.0
	Adult.....	28.0
Meat.....		29.0
Bread.....		25.0
Potatoes.....		15.0
Cabbage.....		4.4
Mixed Diet.....		26.0

The fecal *pigment* of the normal adult is hydrobilirubin. This pigment originates from the bilirubin which is secreted into the intestine in the bile, the transformation from bilirubin to hydrobilirubin being brought about through the activity of certain bacteria. Hydro-

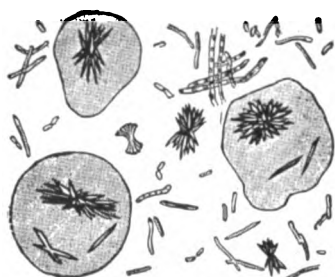

FIG. 67.—HEMATOIDIN CRYSTALS FROM ACHOLIC STOOLS. (v. Jaksch.)

Color of crystals same as the color of those in Fig. 62, page 209.

bilirubin is sometimes called stercobilin and bears a close resemblance to urobilin or may even be identical with that pigment. Neither bilirubin nor biliverdin occurs normally in the fecal discharge of adults, although the former may be detected in the excrement of nursing infants. If these pigments are found in the feces of adults, they indicate an abnormally rapid transit through the large bowel thus preventing their transformation into hydrobilirubin. Frequently, in some way as yet unknown,

probably through the agency of certain bacterial processes, colorless hydrobilirubinogen (leucohydrobilirubin) is formed which after the passage of the movement and exposure to air is reconverted into hydrobilirubin. This may explain in some cases the darkening of the stool when exposed to the air. The most important factor in determining the color of the fecal discharge is the diet. A mixed diet, for instance, produces stools which vary in color from light to dark brown, an exclusive meat diet gives rise to a brownish-black stool, whereas the stool resulting from a milk diet is invariably light colored. Certain pigmented foods, such as the chlorophyllic vegetables and various varieties of berries, each afford stools having a characteristic color. Certain drugs act in a similar way to color the fecal discharge. This is well illustrated by the occurrence of green stools following the use of calomel, of black stools after bismuth ingestion, and of yellow stools following the administration of rhubarb, senna or santonin. The green

color of the calomel stool is generally believed to be due to biliverdin. v. Jaksch, however, claims to have proven this view to be incorrect since he was able to detect hydrobilirubin (or urobilin) but *no biliverdin* in stools after the administration of calomel. The bismuth stool was at one time thought to derive its color from the black sulphide which is formed from the subnitrate of bismuth. We now know¹ that the color is due to the reduction of the bismuth compound (subnitrate) to *bismuth suboxide*. In cases of biliary obstruction the grayish-white *acholic* stool is formed.

Under normal conditions the odor of feces is due to skatole and indole, two bodies formed in the course of putrefactive processes occurring within the intestine (see page 216). Such bodies as methane, methyl mercaptan, and hydrogen sulphide may also add to the disagreeable character of the odor. The intensity of the odor depends to a large degree upon the character of the diet, being very marked in stools from a meat diet, much less marked in stools from a vegetable diet, and frequently hardly detectable in stools from a milk diet. Thus the stool of the infant is ordinarily nearly odorless and any decided odor may generally be readily traced to some pathological source.

A neutral reaction ordinarily predominates in normal stools, although slightly alkaline or even acid stools are met with. The acid reaction is encountered much less frequently than the alkaline, and then commonly only following a vegetable diet.

Experiments in which the actual hydrogen ion concentration of the feces was determined indicate that the reaction of the excreta is uniformly *slightly alkaline*.² Pronounced dietary changes, *e.g.*, low protein diet, high protein diet, fasting, water drinking with meals, produce at most only minor changes in the reaction of the feces.

The form and consistency of the stool is dependent, in large measure, upon the nature of the diet. Under normal conditions the consistency may vary from a thin, pasty discharge to a firmly formed stool. Stools which are exceedingly thin and watery ordinarily have a pathological significance. In general the feces of the carnivorous animals are of a firmer consistency than those of the herbivora.

The continued ingestion of a diet which is very thoroughly digested and absorbed is frequently accompanied by the formation of dry, hard fecal masses (*scybala*). Constipation generally results, due to the small bulk of the feces and its lack of moisture. At present the formation of *scybala* is considered pathological, as an expression of spastic constipation. To counteract this tendency toward constipation the ingestion

¹Quincke: *Munch. med. Woch.*, p. 854, 1896.

²Howe and Hawk: *Jour. Biol. Chem.*, 11, 129, 1912.

of *agar-agar*¹ has been suggested.² This agar is relatively indigestible and readily absorbs water (about 16 times its weight), thus forming a bulky fecal mass which is sufficiently soft to permit of easy evacuation. Agar is not limited to its use in connection with constipation; it may serve in other capacities as an aid to intestinal therapeutics by serving as a vehicle for certain drugs.³

It is frequently desirable for clinical or experimental purposes to make an examination of the fecal output which constitutes the residual mass from a certain definite diet. Under such conditions, it is customary to cause the person under observation to ingest some substance, at the beginning and end of the period in question, which shall sufficiently differ in color and consistency from the surrounding feces as to render comparatively easy the differentiation of the feces of that period from the feces of the immediately preceding and succeeding periods. One of the most satisfactory methods of making this "separation" is by means of the ingestion of a gelatin capsule containing about 0.2 gram of powdered charcoal at the beginning and end of the period under observation. This procedure causes the appearance of *two black zones* of charcoal in the fecal mass and thus renders comparatively simple the differentiation of the feces of the intermediate period. Carmine (0.3 gram) may be used in a similar manner and forms *two dark red zones*. Some similar method for the "separation of feces" is universally practised in connection with the scientifically accurate type of nutrition or metabolism experiment which embraces the collection of useful data regarding the income and outgo of nitrogen and other elements.

Among the macroscopical constituents of the feces may be mentioned the following: Intestinal parasites and their ova, undigested food particles, gall stones, pathological products of the intestinal wall, enteroliths, intestinal sand, and objects which have been accidentally swallowed.

The fecal constituents which at various times and under different conditions may be detected by the use of the microscope are as follows: Constituents derived from the food, such as *muscle fibers, connective-tissue shreds, starch granules, and fat*; form elements derived from the intestinal tract, such as *epithelium, erythrocytes, and leucocytes; mucus; pus corpuscles; parasites and bacteria*. In addition to the constituents named the following *crystalline deposits* may be detected: *cholesterol, koprosterol, soaps, fatty acid, fat, hematoidin, "triple phos-*

¹ Agar-agar is a product prepared from certain types of Asiatic sea-weed. It is a carbohydrate and is classified as a *galactan* in the polysaccharide group.

² Mendel: *Zent. f. ges. Physiol. u. Path. des Stoffw.*, No. 17, p. 1, 1908; Schmidt: *Münch. med. Woch.*, 52, 1970, 1905.

³ Einhorn: *Berl. klin. Woch.*, 49, 113, 1912.

phate," Charcot-Leyden crystals, and the oxalate, carbonate, phosphate, sulphate, and lactate of calcium. (See Figs. 70 to 75, pp. 234 and 235.)

The koprosterol of the feces is similar to cholesterol, and may be formed by the reduction of the latter. It responds to cholesterol color tests and has the same solubility, but possesses a lower melting-point and crystallizes in fine needles instead of plates such as cholesterol forms.

The detection of minute quantities of blood in the feces ("occult blood") has recently become a recognized aid to a correct diagnosis of certain disorders. In these instances the hemorrhage is ordinarily so slight that the identification by means of macroscopical characteristics as well as the microscopical identification through the detection of erythrocytes are both unsatisfactory in their results. Of the tests given for the detection of "occult blood" the *benzidine reaction* and the *ortho-tolidin* and *hematein* tests (page 237) are probably the most satisfactory. Since "occult blood" occurs with considerable regularity and frequency in gastrointestinal cancer and in gastric and duodenal ulcer, its detection in the feces is of especial value as an aid to a correct diagnosis of these disorders. Certain precautions are essential, such as the establishment of a meat-free diet over a period of time before the specimen is collected. (Feces from a meat diet will give an occult blood reaction with some of the most delicate tests.) Bleeding from the bowel such as is seen in hemorrhoids, as well as the admixture of menstrual blood, is to be considered in the interpretation of the result.



FIG. 68.—CHARCOT-LEYDEN CRYSTALS.

It has been quite clearly shown that the intestine of the newly born is sterile. However, this condition is quickly altered and bacteria may be present in the feces before or after the first ingestion of food. There are three possible means of infecting the intestine, *i.e.*, by way of the mouth or anus or through the blood. The infection by means of the blood seldom occurs except under pathological conditions, thus limiting the general infection to the mouth and anus.

In infants with pronounced constipation two-thirds of the dry substance of the stools has been found to consist of bacteria. In the stools of normal adults probably about one-third of the dry substance is bacteria.¹ The average excretion of dry bacteria in 24 hours for an adult is about 8 grams. The output of fecal bacteria has been found to undergo a decrease under the influence of water drinking with meals.²

¹Schittenhelm and Tollens found bacteria to comprise 42 per cent of the dry matter. This value is, however, undoubtedly too high.

²Mattill and Hawk: *Jour. Am. Chem. Soc.*, 33, 1999, 1911; Blatherwick and Hawk: *Bioch. Bull.*, 3, 28, 1913.

There was also a decrease in intestinal putrefaction,¹ a fact which indicates that at least a part of the bacterial deficit was made up of putrefactive organisms. In some cases over 50 per cent of the total nitrogen of feces has been shown to be *bacterial nitrogen*.²

Various enzymes have been detected in the feces. The first one so demonstrated was pancreatic amylase.³ The amylase content of the feces is believed to be an index of the activity of the pancreatic function.⁴ The excretion of this enzyme has been found to increase under the influence of water drinking with meals.⁵ Other enzymes which have been found in the feces under various conditions are trypsin, rennin, maltase, sucrase, lactase, nuclease and lipase.⁶ In an abnormally rapid transit of food through the intestinal tract, such as is seen in certain diarrheas, nearly all of these enzymes may be detected.

Some of the more important organisms met with in the feces are the following:⁷ *B. coli*, *B. lactis aërogenes*, *Bact. Welchii*, *B. bifidus*, and *coccal forms*. Of these the first three types mentioned are *gas-forming* organisms. The production of gas by the fecal flora in dextrose-bouillon is subject to great variations under pathological conditions; alterations in the diet of normal persons will also cause wide fluctuations. Data as to the production of gas are of considerable importance in a diagnostic way, although the exact cause of the variation is not yet established. It should be borne in mind in this connection that gas volumes are frequently variable with the same individual. For this reason it is necessary in every instance to follow the gas production for a considerable period of time before drawing conclusions.⁸ While the question of the study of bacterial flora of the feces is a question beyond the range of this work, mention may be made here of the character of the organisms observed by Gram staining of the stool after administration of different types of diet. It has been shown that when the diet is markedly protein, the protein type of flora becomes predominant in the stools. Gram-stained smears show a fairly equal distribution of Gram-negative and Gram-positive organisms. Among the latter are largely the subtiloid organisms with some of the *Bact. Welchii*, together with a moderate number of *diplococci* and *coccioid* forms. Most of the Gram-negative organisms resemble the *B. coli*. When the diet is

¹ Hattrem and Hawk: *Arch. Int. Med.*, 7, 610, 1911; Blatherwick, Sherwin and Hawk: *loc. cit.*

² MacNeal, Latzer and Kerr: *Jour. Inf. Dis.*, 6, 123, 1909; Mattill and Hawk: *Jour. Exp. Med.*, 14, 433, 1911; Blatherwick and Hawk: *Biochem. Bull.*, 3, 28, 1913.

³ Wegscheider: *Inaug. Diss.*, Strassburg, 1875.

⁴ Wohlgenuth: *Berl. klin. Woch.*, 47, 3, 92, 1910.

⁵ Hawk: *Arch. Int. Med.*, 8, 382, 1911.

⁶ Ury: *Biochem. Zeit.*, 23, 152, 1900.

⁷ Herter and Kendall: *Journal of Biological Chemistry*, 5, 283, 1908.

⁸ Herter and Kendall: *loc. cit.*

carbohydrate the field is strongly Gram positive and has a more homogeneous appearance. The bacteria seen consist chiefly of long slender Gram-positive rods belonging to the *B. acidophilus* and *B. bifidus* groups.¹

The nitrogen present in the feces exists principally in the form of *bacteria, unabsorbed intestinal secretions and digestive juices, epithelial cells, mucus material and food residues*. In the early days of nutrition study the fecal nitrogen was believed to consist principally of food residues. We now know that such residues ordinarily make up but a small part of the nitrogen quota of the stools of normal individuals who exercise normal mastication.² When meat has been "bolted," however, from 0.5 gram to 16 grams of macroscopical meat residues have been found in a single stool.³ The phrase "metabolic product nitrogen" is frequently used as a designation for all fecal nitrogen except that present as food residues and bacteria. Bacteria cannot logically be classed under "metabolic" nitrogen since they doubtless develop at the expense of food nitrogen as well as at the expense of that in the form of intestinal secretions. In the accurate study of "protein utilization"⁴ a correction should be made for "metabolic nitrogen." Data regarding the output of metabolic nitrogen may be secured by determining the fecal nitrogen excretion on a diet of proper energy value but *containing no nitrogen*.⁵ Agar-agar may be utilized advantageously in connection with such a nitrogen-free diet.

Feces are still excreted from the intestine even when no food is ingested. Carefully conducted fasting experiments have demonstrated this. A dog nourished on an ordinary diet to which *bone ash* has been added will excrete a *grey feces*. When fasted such an animal will, after a few days, excrete a small amount of a greenish-brown mass, *containing no bone ash*. These are *fasting feces*. It is of a pitch-like consistency and turns black on contact with the air.⁶ Adult fasting men have been found to excrete 7-8 grams of feces per day, the daily nitrogen value being about 0.1 gram.⁷ No separating medium such as charcoal or carmine (page 228) should be used in differentiating fasting feces.

In recent years the examination of feces for evidences of parasitism (detection of parasites and their ova) has taken on an added importance. The investigation of the hookworm has been particularly developed.

¹ Cammidge: *The Feces of Children and Adults*, 1914, p. 126.

² Kermauner: *Zeit. für Biol.*, 35, 316, 1897.

³ Foster and Hawk: *Jour. Am. Chem. Soc.*, 37, 1347, 1915.

⁴ The percentage of the ingested protein which is absorbed from the intestine. To calculate this factor subtract the metabolic nitrogen from the total fecal nitrogen and then subtract this value from the food nitrogen and divide by the food nitrogen. (See "Protein Utilization," p. 590.)

⁵ Tsuboi: *Zeit. für Biol.*, 35, 68, 1897; Mendel and Fine: *Jour. Biol. Chem.*, 11, 5, 1912.

⁶ Howe and Hawk: *Jour. Am. Chem. Soc.*, 33, 215, 1911.

⁷ Howe, Mattill and Hawk: *Ibid.*, 33, 568, 1911.

(For methods and discussion see *Bulletin* 135, Bureau of Animal Industry, U.S. Department of Agriculture, 1911, M. C. Hall.)

For diagnostic purposes the macroscopical and microscopical examinations of the feces ordinarily yield much more satisfactory data than are secured from its chemical examination. Possibly with the exception of certain examinations for occult blood, the most satisfactory data for diagnostic purposes are secured by microscopical examination. This presupposes a knowledge of microscopical technic and the use of certain microchemical tests, by which much information can be obtained. The principle underlying this examination consists in the study of the actual changes which the various food-stuffs have undergone during digestion. A knowledge of the changes which occur in normal digestion and which are seen in normal feces enables one to readily detect pathological variations. One diet widely used for this purpose is the Schmidt diet which is given below. The modification¹ described is better adapted to American conditions.

The *Schmidt intestinal diet* is as follows:

In the *morning*: 0.5 liter of milk, or if milk does not agree 0.5 liter of cocoa (prepared from 20 grams of cocoa powder, 10 grams sugar, 400 grams water, and 100 grams milk). To this add 50 grams zwiebach.

In the *forenoon*: 0.5 liter oatmeal gruel (made from 40 grams oatmeal), 10 grams butter, 100 grams milk, 300 grams water, 1 egg strained.

At *noon*: 125 grams of chopped beef (raw weight) broiled rare with 20 grams of butter, so that the interior will remain raw. To this add 250 grams potato broth (made of 190 grams mashed potatoes, 100 grams milk, 10 grams of butter).

In the *afternoon*: as in the morning.

In the *evening*: as in the forenoon.

This diet necessitates five meals a day especially prepared and does not follow the average American dietary. In simple microscopical examinations for food digestion, the following diet as more closely approximating the ordinary dietary regime is suggested. Should chemical determinations for fat be desired all fat containing foods can be eliminated except those in which its specific content is known and a measured amount of fat given. The feces can then be separated by means of carmine.

Modified Schmidt Diet

Breakfast:

- 100 grams cream of wheat or oatmeal
- 60 grams toast
- 20 grams butter
- 250 c.c. milk.

¹ Used by Dr. Rehffuss at Jefferson Hospital.

Luncheon:

Rice soup (chicken broth with rice)
 100 grams green vegetable (asparagus)
 100 grams mashed potato
 60 grams toast
 20 grams butter
 250 c.c. milk.

4 o'clock:

250 c.c. of milk.

Dinner:

150 grams of chopped meat, grilled on the outside and rare in the center
 100 grams green vegetable (spinach)
 100 grams mashed potatoes
 60 grams of toast
 20 grams of butter
 250 c.c. milk
 Stewed fruit.

EXPERIMENTS ON FECES

1. Macroscopical Examination.—If the stool is watery pour it into a shallow dish and examine directly. If it is firm or pasty it should be treated with water and carefully stirred before the examination for macroscopical constituents is attempted. The macroscopical constituents may be collected very satisfactorily by means of a double layer of cheese cloth.

A Boas sieve (Fig. 69) may also be used to collect the macroscopical constituents of feces. This sieve is constructed of two easily detachable hemispheres which are held together by means of a bayonet catch. In using the apparatus the feces are spread out upon a very fine sieve contained in the lower hemisphere and a stream of water is allowed to play upon it through the medium of an opening in the upper hemisphere. The apparatus is provided with an orifice in the upper hemisphere through which the feces may be stirred by means of a glass rod during the washing process. After 15–30 minutes washing nothing but the coarse fecal constituents remain upon the sieve.

2. Microscopical Examination.—After the ingestion of the test diet (see Schmidt diet above) for several days, a specimen of the movement is collected. Any gross abnormalities are recorded in the form, consistence, and character of the stool as well as the admixture of certain pathological elements such as pus, blood, mucus, and parasites. The movement is then rubbed out on plates and the presence of undigested food-stuffs sought for. Normally the test diet is almost completely digested and no gross undigested material is found. Therefore the presence of these macroscopic rests is in itself evidence of disturbed digestion. Clean slides and cover-glasses are then prepared and a small representative portion of the movement is placed on each of three slides. The routine clinical method of examination follows: To the first slide



FIG. 69.—BOAS SIEVE.

is added a drop of distilled water and it is then examined with low and high powers.

Meat fibers are readily recognized by their yellowish hyaline appearance possibly with a few striæ still visible in the fibers. Should

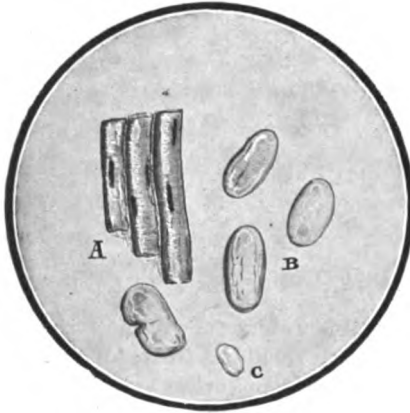

FIG. 70.—A, intact undigested meat fibers; B, partially digested meat fibers; C, almost completely digested meat fibers.



FIG. 71.—A, neutral fat; B, fatty acid liberated by acetic acid; C, soaps; D, fatty acid crystals.



FIG. 72.—A, elastic tissue; B, white fibrous tissue (macroscopic); C, white fibrous tissue (microscopic.)



FIG. 73.—A, cellulose remains of vegetables; B, empty potato cells; C, potato cells filled with starch, and stained with iodine; D, hard cells found in pears; E, spiral and woody fibers from pith of vegetables; F, vegetable hairs.

FIGS. 70 TO 73.—MICROSCOPICAL CONSTITUENTS OF FECES.

meat fibers be found bound together by connective tissue or raw connective tissue, either white fibrous or yellow elastic, be noted, it indicates a disturbance of gastric function inasmuch as one of the specific functions of the gastric juice is to dissolve the intercellular tissue

binding together the fibers. If large numbers of meat fibers are found after a test diet, particularly if the nuclei are still intact in the fibers, the inference of poor or low pancreatic function is justifiable. This is true if it can be demonstrated that the food has been sufficiently long in its transit through the intestinal tract to permit the pancreatic enzymes to carry on their work. A dilute solution of methylene blue will readily show the nuclei if present.

The second slide is examined for fats and then treated with acetic acid and heated to split any soaps which may be present and form fatty acid.

Fats are met with in three forms (a) neutral fats readily demonstrated by Sudan III, Scharlach R or Osmic acid; (b) fatty acids which are usually found in the form of needle-like crystals soluble in ether, alcohol, and solutions of sodium

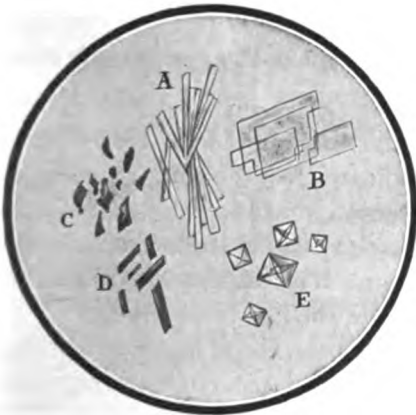

FIG. 74.—A, calcium sulphate crystals; B, cholesterol crystals; C, charcoal detritus; D, bismuth sub-oxide crystals; E, calcium oxalate crystals.

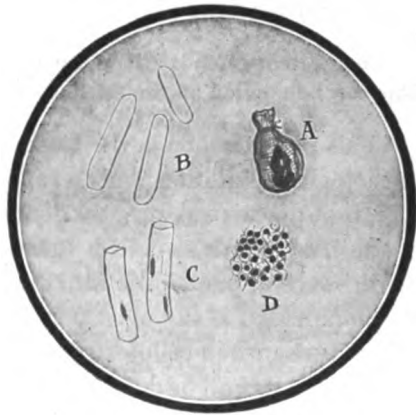

FIG. 75.—A, Schmidt test bag for study of pancreatic function; B, nuclei of meat fibers digested; C, nuclei of meat fibers undigested; D, undigested stained thymus cells.

FIGS. 74 AND 75.—MICROSCOPICAL CONSTITUENTS OF FECES.

hydrate (these crystals do not stain with Sudan III but form drops on being warmed); (c) soaps are usually found in the feces either as amorphous flakes or scallop shell-like formations, but may occasionally occur in crystalline form. The calcium soaps which compose the bulk of the soaps in the feces can be distinguished from the potassium and sodium compounds because of their insolubility in hot water, alcohol, and ether. On heating with 30 per cent acetic acid, fatty acids are set free in drops which crystallize out on cooling.

The estimation of fats is a rather important matter and the trained observer can usually detect disturbances in fat digestion. Normally there are fats present in the movement, but abnormally their quantity is relatively increased either in total fat, or in one of its components.

While it is true that bacterial activity plays a considerable rôle in the digestion of fats, a marked increase in fat usually indicates pancreatic disease, or a disturbance in pancreatic function. This is, of course, the case only when the amount of fat ingested is not in excess of that which can be readily handled under normal conditions. In cases of pure biliary obstruction without pancreatic involvement, fat-splitting takes place in a normal way, but the fatty acids and soaps formed are not absorbed owing to the absence of bile. Such a movement is full of soaps and fatty acid crystals which on treatment with acetic acid show a marked increase in total fat over normal. Failure of absorption owing to extensive disease of the intestinal mucosa can produce a similar picture but will usually give some cytological evidence of intestinal disease. Pure pancreatic disease gives a marked increase in total and neutral fat with the presence of bile.

Undigested starches are readily recognized by their blue reaction with iodine. This can be studied on the third slide.

This phenomenon is the least frequent among the different forms of pathological digestion and usually indicates food bolting, an excessive ingestion of, or poor preparation of carbohydrate food, or an infection of the bowel with so-called "gärungsdyspepsia" rather than an actual disturbance of pancreatic function inasmuch as the amylolytic function of the pancreas is the most persistent and the last to disappear.

Disturbance in cellulose digestion, the presence of blood, leucocytes, mucus, etc., can all be demonstrated by appropriate technic and represent a chapter in the study of the feces of great diagnostic importance, but one which is beyond the province of this volume. (For further discussion, see page 232. For cuts of fecal constituents found microscopically, see pages 234 and 235.)

3. Reaction.—Thoroughly mix the feces and apply moist red and blue litmus papers to the surface. If the stool is hard it should be mixed with water before the reaction is taken. Examine the stool as soon after defecation as is convenient, since the reaction may change very rapidly. The reaction of the normal stools of adult man is ordinarily neutral or faintly alkaline to litmus, but seldom acid. Infants' stools are generally acid in reaction. Try the reaction to Congo red paper. Also test the reaction of fecal extract to phenolphthalein.

4. Starch.—If any imperfectly cooked starch-containing food has been ingested it will be possible to detect starch granules by a microscopical examination of the feces. If the granules are not detected by a microscopical examination, the feces should be placed in an evaporating dish or casserole and boiled with water for a few minutes. Filter and test the filtrate by the iodine test in the usual way (see page 45).

5. Cholesterol, Koprosterol and Fat.—Introduce about 5 grams of moist feces into a 100 c.c. glass-stoppered cylinder. Add 30 c.c. of distilled water and

25 c.c. of ether, then stopper the cylinder and shake vigorously for five minutes. Allow to separate, pour or pipette off the ethereal solution. Filter and remove the ether by evaporation. The residue contains cholesterol and the mixed fats of the feces. For every gram of fat add about 1.5 grams of solid potassium hydroxide and 25 c.c. of 95 per cent alcohol and boil in a flask on a water-bath for one-half hour, maintaining the volume of alcohol constant. This alcoholic-potash has saponified the mixed fats and we now have a mixture of soaps, cholesterol and koprosterol. Add sodium chloride, in substance, to the mixture and extract with ether to dissolve out the cholesterol and koprosterol. Remove the ether by evaporation and examine the residue microscopically for cholesterol and koprosterol crystals. Try any of the other tests for cholesterol as given on page 214.

6. Blood.—Undecomposed blood may be detected macroscopically. If uncertain, look for erythrocytes under the microscope, and spectroscopically for the spectrum of oxyhemoglobin (see Absorption Spectra, Plate I).

In case the blood has been altered or is present in minute amount ("occult blood"), and cannot be detected by the means just mentioned, the following tests may be tried:

(a) **Benzidine Reaction.**—Make a thin fecal suspension using about 5 c.c. of distilled water, and heat it to boiling to render oxidizing enzymes inactive. To 2 c.c. of a saturated solution of benzidine in glacial acetic acid add 3 c.c. of 3 per cent hydrogen peroxide and 2-3 drops of the cooled fecal suspension. A clear blue color appears within one to two minutes in the presence of blood. If the mixture is not shaken a ring of color will form at the top. Minute traces of blood are more easily detected by the latter procedure.

Wagner¹ has simplified the benzidin test so that it can be applied much more conveniently.

Slide Modification.—Take up a little of the solid stool on a match, smear it on an object glass and pour the reagent over it. It turns blue if there is blood present and there is no misleading green tint from fluid. Make the solution as follows: Add a knife-tip of benzidine to 2 c.c. of glacial acetic acid, and add 20 drops of a 3 per cent solution of hydrogen peroxide.

By this dry technic there is no danger of soiling the fingers, and the test is more sensitive than the usual "wet" benzidine test. The smear of stool is either blue or it is not blue. The rapidity of the color change gives some idea as to the proportion of blood in the stool; with much blood present the change to blue is instantaneous. It is claimed by Vaughn² that pus and the usual drugs and foods ingested do not interfere with the reaction.

(b) **Ortho-tolidin Test (Ruttan and Hardisty)**³—To 1 c.c. of a 4 per cent

¹ Wagner: *Zentbl. für Chirurgie*, 41, No. 28, 1914.

² Vaughn: *Jour. of Lab., Clin. Med.*, 2, 437, 1917.

³ Ruttan and Hardisty: *Canadian Medical Ass'n Journal*, Nov., 1912, also *Biochemical Bull.*, 2, 225, 1913.

glacial acetic acid solution of o-tolidin¹ in a test-tube add 1 c.c. of the solution under examination and 1 c.c. of 3 per cent hydrogen peroxide. In the presence of blood a bluish color develops (sometimes rather slowly) and persists for some time (several hours in some instances).

This test is said to be as sensitive for the detection of occult blood in feces and stomach contents as is the benzidine reaction. It is also claimed to be more satisfactory for urine than any other blood test. The acetic acid solution may be kept for one month with no reduction in delicacy.

(c) *Phenolphthalein Test*.²—Make a thin fecal suspension using about 5 c.c. of distilled water. Heat to boiling,³ cool and add 2 c.c. of the suspension to 1 c.c. of the phenolphthalein reagent⁴ and a few drops of hydrogen peroxide. A pink or red color promptly forms in the presence of blood.

Schirokauer⁵ makes the statement that a mixture of alcohol and glacial acetic acid will give the phenolphthalein reaction for occult blood. The action of an oxidizing agent will make this reaction more distinct. Von Cзыlharz and Neustadt⁶ find that a solution of sodium salicylate added to a blood-free extract of feces will give a very deceptive reaction, while feces after the administration of sodium salicylate by mouth gave the same reaction. The same was true of acetyl salicylic acid and other similar drugs. Their studies in clinical cases likewise indicated that the phenolphthalein test was unreliable.

(d) *Hematein Reaction for Occult Blood*.—Couturier⁷ advises the use of hematein⁸ in testing for occult blood. It is only slightly soluble in water, but gives a pronounced red color. In contact with sodium hydroxide this red solution turns a deep violet blue, giving an insoluble compound of hematein and sodium. This compound, exposed to the air oxidizes after several days, and gives brownish or yellowish compounds, depending on dilution. This change is only hastened a little by the addition of hydrogen peroxide, but if a trace of blood is added to the hydrogen peroxide, it takes place almost instantly. To avoid oxidation, the hematein sodium mixture should be prepared just before use. Three fluids

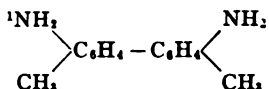

¹ Boas: *Deut. med. Woch.*, 37, 62, 1911.

² Boas suggests using an ether extract of the fecal suspension thus eliminating the necessity of boiling. However, oxidizing enzymes are the main sources of error here and the action is easily and effectively eliminated by boiling. (See White: *Boston Medical and Surgical Journal*, 164, 876, 1911.)

³ Prepared by dissolving 1-2 grams of phenolphthalein and 25 grams of KOH in 100 c.c. of distilled water. Add 1 gram of powdered zinc and heat gently until the solution is decolorized. Prepared in this way the solution will not deteriorate on standing.

⁴ *Deutsch. med. Woch.*, Aug. 6, 1914.

⁵ *Wien. med. Woch.*, Sept. 5, 1914.

⁶ *Lyon Med.*, 46, 313, 1914.

⁷ *Hematein* is a brownish-red crystalline substance derived from hematoxylin by the successive action of ammonia and acetic acid. It should not be confused with *hematin*, the hemoglobin derivative.

are required: (1) a 0.05 per cent aqueous solution of hematein; (2) a 40 per cent solution of sodium hydroxide and (3) 3 per cent hydrogen peroxide. These will keep almost indefinitely.

The test may be performed as follows: Take 4-5 c.c. of the liquid specimen in a tube and in another tube take the same amount of material known not to contain blood as a control. To each add 4-5 c.c. of the sodium hydroxide solution and shake. Then to each of the tubes add 2 drops of the hematein solution. A blue color of about equal intensity will develop in both tubes. Then add 10 drops of hydrogen peroxide to each tube and compare. If blood is present, the tube containing it will turn very rapidly (in three or four seconds) to violet red, then in twenty seconds to clear brown, in forty seconds to pale yellow while the second tube will not show these changes for several minutes. The reaction is said to detect blood when present in a concentration of 1 part in 400,000.

(c) *Aloin-turpentine Test*.—Mix the stool very thoroughly and take about 5 grams of the mixture for the test. Reduce this sample to a semi-fluid mass by means of distilled water and extract very thoroughly with an equal volume of ether to remove any fat which may be present. Now treat the extracted feces with one-third its volume of glacial acetic acid and 10 c.c. of ether and extract very thoroughly as before. The acid-ether extract will rise to the top and may be removed.

Introduce 2-3 c.c. of this acid-ether solution into a test-tube, add an equal volume of a dilute solution of aloin in 70 per cent alcohol and 2-3 c.c. of ozonized turpentine and shake the tube gently. If blood is present the entire volume of fluid ordinarily becomes pink and finally cherry red. In some instances the color will be limited to the aloin solution which sinks to the bottom. This color reaction should occur within 15 minutes in order to indicate a positive test for blood, since the aloin will turn red of itself if allowed to stand for a longer period. The color is ordinarily light yellow in a negative test. Hydrogen peroxide is not a satisfactory substitute for turpentine in the test.

(f) *Cowie's Guaiac Test*.—To 1 gram of moist feces add 4-5 c.c. of glacial acetic acid and extract the mixture with 30 c.c. of ether. To 1-2 c.c. of the extract add an equal volume of water, agitate the mixture, introduce a few granules of powdered guaiac resin, and after bringing the resin into solution, gradually add 30 drops of old turpentine or hydrogen peroxide. A blue color indicates the presence of blood. Cowie claims that by means of this test an intestinal hemorrhage of 1 gram can easily be detected by an examination of the feces.

(g) *Weber's Guaiac Test*.—Mix a little feces with 30 per cent acetic acid to form a fluid mass. Transfer to a test-tube and extract with ether. If blood is present the ether will assume a brownish-red color. Filter off the ether extract and to a portion of the filtrate add an alcoholic solution of guaiac (strength about 1:60),¹ drop by drop, until the fluid becomes turbid. Now add hydrogen peroxide or old turpentine. In the presence of blood a blue color is produced (see page 262).

(h) *Acid-hematin*.—Examine some of the ethereal extract from Experiment (g) spectroscopically. Note the typical spectrum of acid-hematin (see Absorption Spectra, Plate II).

7. *Hydrobilirubin. Schmidt's Test*.—Rub up a small amount of feces in a mortar with a concentrated aqueous solution of mercuric chloride. Transfer to a

¹ Buckmaster advises the use of an alcoholic solution of guaiacetic acid instead of an alcoholic solution of guaiac resin.

shallow, flat-bottomed dish and allow to stand 6-24 hours. The presence of hydrobilirubin will be indicated by a deep red color being imparted to the particles of feces containing this pigment. This red color is due to the formation of hydrobilirubin-mercury. If unaltered bilirubin is present in any portion of the feces that portion will be green in color due to the oxidation of bilirubin to biliverdin.

Another method for the detection of hydrobilirubin is the following: Treat the dry feces with absolute alcohol acidified with sulphuric acid and shake thoroughly. The acidified alcohol extracts the pigment and assumes a reddish color. Examine a little of this fluid spectroscopically and note the typical spectrum of hydrobilirubin (Absorption Spectra, Plate II).

8. **Bilirubin.**¹ (a) **Gmelin's Test.**—Place a few drops of concentrated nitric acid in an evaporating dish or on a porcelain test-tablet and allow a few drops of the feces and water to mix with it. The usual play of colors of Gmelin's test is produced, i.e., green, blue, violet, red, and yellow. If so desired, this test may be executed on a slide and observed under a microscope.

(b) **Huppert's Test.**—Treat the feces with water to form a semi-fluid mass, add an equal amount of milk of lime, shake thoroughly, and filter. Wash the precipitate with water, then transfer both the paper and the precipitate to a small beaker or flask, add a small amount of 95 per cent alcohol acidified slightly with sulphuric acid, and heat to boiling on a water-bath. The presence of bilirubin is indicated by the alcohol assuming a green color.

Steensma advises the addition of a drop of a 0.5 per cent solution of sodium nitrite to the acid-alcohol mixture before warming on the water-bath. Try this modification also.

9. **Bile Acids.**—Extract a small amount of feces with alcohol and filter. Evaporate the filtrate on a water-bath to drive off the alcohol and dissolve the residue in water made slightly alkaline with potassium hydroxide. Upon this aqueous solution try any of the tests for bile acids given on page 212.

10. **Casein.**—Extract the fresh feces first with a dilute solution of sodium chloride, and later with water acidified with dilute acetic acid, to remove soluble proteins. Now extract the feces with 0.5 per cent sodium carbonate and filter. Add dilute acetic acid to the filtrate to precipitate the casein, being careful not to add an excess of the reagent as the casein would dissolve. Filter off the casein and test it according to directions given on page 351. Casein is found principally in the feces of children who have been fed a milk diet. Mucin would also be extracted by the dilute alkali, if present in the feces. What test could you make on the newly precipitated body to differentiate between mucin and casein?

11. **Nucleoprotein.**—Mix the stool thoroughly with water, transfer to a flask, and add an equal amount of saturated lime water. Shake frequently for a few hours, filter, and precipitate the nucleoprotein with acetic acid. Filter off this precipitate and test it as follows:

(a) **Phosphorus.**—Test for phosphorus by fusion (see page 129).

(b) **Solubility.**—Try the solubility in the ordinary solvents.

(c) **Protein Color Test.**—Try any of the protein color tests.

¹ The detection of bilirubin in the feces is comparatively simple provided it is not accompanied by other pigments. When other pigments are present, however, it is difficult to detect the bilirubin and, at times, may be found impossible.

What proof have you that the above body was not mucin? What other test can you use to differentiate between nucleoprotein and mucin?

12. **Albumin and Globulin.**—Extract the fresh feces with a dilute solution of sodium chloride. (The preliminary extract from the preparation of casein (10), above, may be utilized here.) Filter, and saturate a portion of the filtrate with sodium chloride in substance. A precipitate signifies globulin. Filter off the precipitate and acidify the filtrate slightly with dilute acetic acid. A precipitate at this point signifies albumin. Make a protein color test on each of these bodies.

13. **Proteose and Peptone.**—Heat to boiling the portion of the sodium chloride extract not used in the last experiment. Filter off the coagulum, if any forms. Acidify the filtrate slightly with acetic acid and saturate with sodium chloride in substance. A precipitate here indicates proteose. Filter it off and test it according to directions given on page 120. Test the filtrate for peptone by the biuret test.

14. **Inorganic Constituents.**—Incinerate a small amount of feces in a crucible and dissolve the ash in a small volume of dilute nitric acid. Dilute with water and filter. Make the following tests upon the clear filtrate.

(a) *Chlorides.*—Acidify with nitric acid and add silver nitrate.

(b) *Phosphates.*—Acidify with nitric acid, add molybdc solution, and warm gently.

(c) *Sulphates.*—Acidify with hydrochloric acid, add barium chloride, and warm.

(d) *Calcium.*—Neutralize with ammonium hydroxide, make slightly acid with acetic acid and add ammonium oxalate. Let stand.

(e) *Magnesium.*—Neutralize with ammonium hydroxide, and add Na_2HPO_4 and excess of NH_4OH . Let stand.

15. **Indole Reactions.**—Rub up the stool with water to form a thin paste and distill first in alkaline and then in acid solution. Test the distillate by any of the tests for the detection of indole in putrefaction mixtures (see page 222).

16. **Schmidt's Nuclei Test.**—This test serves as an aid to the diagnosis of pancreatic insufficiency. The test is founded upon the theory that cell nuclei are digestible *only* in pancreatic juice, and therefore that the appearance in the feces of such nuclei indicates insufficiency of pancreatic secretion.

The procedure is as follows: Cubes of fresh beef about 0.5 cm. square are enclosed in small gauze bags and ingested with a test meal. Subsequently the fecal mass resulting from this test meal is examined, the bag opened, and the condition of the enclosed residue determined. Under normal conditions the nuclei would be digested. Therefore if the nuclei are found to be for the most part undigested, and the intervening period has been sufficient to permit of the full activity of the pancreatic function (at least six hours), it may be considered a sign of pancreatic insufficiency (see Fig. 75, p. 235).

It has been claimed by Steele that under certain conditions the non-digestion of the nuclei may indicate a general lowering of the digestive power rather than a true pancreatic insufficiency.

Kashiwado¹ has suggested the use of stained cell nuclei in this test. A preparation put out under the name "Gefarbte gewebskerne zur

¹Kashiwado: *Deut. Arch. Klin. Med.*, 104, 584, 1911.

Pankreasfunktionsprüfung nach Prof. Dr. Schmidt und Dr. Kashiwado consists of a mixed preparation of thymus cells, the nuclei of which are stained by iron hematoxylin, and lycopodium powder. After administration, the lycopodium, which is readily recognized, is sought for in the stool and when found that portion is examined for the stained thymus cells. Their statement is as follows: If stained nuclei are not found in the feces after an intestinal transit of sufficient duration (at least six hours) normal pancreatic function (external) is indicated. If, however, all or part of the cells are found, a definite disturbance in pancreatic function is present.

17. Influence of Drugs upon the Color of the Stool.—Ingest an ordinary mixed diet, take the indicated dose of one of the following drugs, "separate" the feces (see page 610) and after the "marker" appears note the color of the stools evacuated:

Drug	Dose	Color of stool
Bismuth subnitrate, grams.	5	Black.
Calomel, mg.	130-140	Green.
Reduced iron, mg.	65-70	Grayish black turning darker on exposure to air.
Methylene blue, mg.	130-140	Blue, especially after exposure to air.
Manganese dioxide, mg.	130-140	Dark brown or black.
Hematoxylin, grams.	1	Reddish brown.
Rhubarb, c.c. fluid extract	2	Yellow.
Senna, c.c. fluid extract.	4	Dark yellow.
Cambogia, mg.	130-140	Dark yellow.
Santonin, mg.	65-70	Dark yellow.

18. Einhorn's Bead Test.¹—This is a method for testing the digestive function. In some respects it is similar to Sahli's desmoid reaction (see Gastric Analysis). The procedure consists in wrapping the material under examination (catgut, fish-bone, raw beef, cooked potatoes, thymus gland or mutton fat, etc.) in gauze to which glass beads of various colors are attached and enclosing gauze and beads in a gelatine capsule.² The gelatine capsule is swallowed and the beads serve to facilitate the separation of the gauze from the feces. The residue

¹ Einhorn: *The Post-Graduate*, May, 1912: *Boas' Arch.*, 12, 26, 1906; 13, 35, 1907; *Ibid.*, 475; 15, part 2, 1909.

² Ordinarily two substances are attached to each bead, three beads tied together and enclosed in one capsule. Test capsules may be obtained from Eimer and Amend, New York.

within the gauze is then examined. If beads appear in much less than 24 hours an accelerated motility is indicated, whereas an interval of 48 hours or over elapsing indicates retarded motility. If gastric function alone is to be studied silk threads are attached to the beads and the latter are withdrawn and examined before they have passed into the intestine.

19. "Separation" of Feces.—In order to become familiar with the method ordinarily utilized in metabolism experiments to differentiate the feces which correspond to the food ingested during any given interval, and at the same time to secure data as to the length of time necessary for ingested substances to pass through the alimentary tract proceed as follows: Just before one of the three meals of the day ingest a gelatine capsule (No. 00) containing 0.2–0.3 of a gram of carmine or charcoal. Make an inspection of all stools subsequently dropped and note the time interval elapsing between the ingestion of the capsule and the appearance of its contents in the feces. Under normal conditions this period is ordinarily 24 hours. This test is thus an index of intestinal motility.

20. Influence of Foods upon the Color of the Stool.—Ingest a diet which contains a liberal quantity of one of the following articles of diet, "separate" the feces (page 610) and after the "marker" appears note the color of the stools evacuated:

Article of diet	Color of stool
Milk.....	Light yellow or grayish white.
Meat.....	Brownish black.
Chlorophyllic vegetables, e.g., spinach.....	Greenish.
Non-chlorophyllic vegetables.....	Light brown.
Cherries or blackberries.....	Reddish brown.
Cocoa.....	Dark red or chocolate brown.
Coffee.....	Dark brown.
Corn meal.....	Light colored.

21. Quantitative Determination of Fecal Amylase (The Author's¹ Modification of Wohlgemuth's² Method).—Weigh accurately about 2 grams of fresh feces into a mortar,³ add 8 c.c. of a phosphate-chloride solution (0.1 mol dihydrogen sodium phosphate and 0.2 mol disodium hydrogen phosphate per liter of 1 per cent sodium chloride), 2 c.c. at a time, rubbing the feces mixture to a homogeneous consistency after each addition of the extraction medium. Permit the mixture to stand at room temperature for a half-hour with frequent stirring. We now have a neutral fecal suspension. Transfer this suspension to a 15 c.c. graduated centrifuge tube, being sure to wash the mortar and pestle carefully with the phosphate-chloride solution and add all washings to the suspension in the centrifuge tube. The suspension is now made up to the 15 c.c. mark with the phosphate-chloride solution

¹ Hawk: *Arch. Int. Med.*, 8, 552, 1911.

² Wohlgemuth: *Berl. klin. Woch.*, 47, 3, 92, 1910; also see page 196, this book.

³ Duplicate determinations should be made.

and centrifugated for a 15-minute period, or longer if necessary, to secure satisfactory sedimentation. At this point, read and record the height of the sediment column. Remove the supernatant liquid by means of a bent pipette, transfer it to a 50 c.c. volumetric flask and dilute it to the 50 c.c. mark with the phosphate-chloride solution. Mix the fecal extract thoroughly by shaking and determine its amyolytic activity. For this purpose a series of six graduated tubes is prepared, containing volumes of the extract ranging from 2.5 c.c. to 0.078 c.c. Each of the intermediate tubes in this series will thus contain one-half as much fluid as the preceding tube. Now make the contents of each tube 2.5 c.c. by means of the phosphate-chloride solution in order to secure a uniform electrolyte concentration. Introduce 5 c.c. of a 1 per cent soluble starch solution¹ and three drops of toluene into each tube, thoroughly mix the contents by shaking, close the tubes by means of stoppers and place them in an incubator at 38°C. for 24 hours. At the end of this time remove the tubes, fill each to within half an inch of the top with ice-water, add 1 drop of tenth-normal iodine solution, thoroughly mix the contents and examine the tubes carefully with the aid of a strong light. Select the last tube in the series which shows entire absence of blue color, thus indicating that the starch has been completely transformed into dextrin and sugar, and calculate the amyolytic activity on the basis of this dilution. In case of indecision between two tubes, add an extra drop of the iodine solution and observe them again.²

The amyolytic value, Df, of a given stool, may be expressed in terms of 1 c.c. of the sediment obtained by centrifugation as above described. For example, if it is found that 0.31 c.c. of the phosphate-chloride extract of the stool acting at 38°C. for 24 hours completely transformed the starch in 5 c.c. of a 1 per cent starch solution, then we would have the following proportion:

$$0.31 : 5 \text{ (c.c. starch) :: } 1 \text{ (c.c. extract) : } X$$

The value of X in this case is 16.1, which means that 1 c.c. of the fecal extract possesses the power of completely digesting 16.1 c.c. of a 1 per cent starch solution in 24 hours at 38°C.

Inasmuch as stools vary so greatly as to water content, it is essential to an accurate comparison of stools that such comparison be made on the basis of the solid matter. Supposing, for example, that in the above determination we had 6.2 c.c. of sediment. Since the supernatant fluid was removed and made up to

¹In preparing the 1 per cent solution, the weighed starch powder should be dissolved in cold distilled water in a casserole and stirred until a homogeneous suspension is obtained. The mixture should then be heated with constant stirring, until it is clear. This ordinarily takes from eight to ten minutes. A slightly opaque solution is thus obtained, which should be cooled and made up to the proper volume before using.

²Theoretically we would expect the colors to range from a light yellow to a dark blue, with red tubes holding an intermediate position in the series. This color sequence does often occur, but its occurrence is far from universal. Many times the first tubes in the series, *i.e.*, those containing the largest quantities of the fecal extract, will exhibit a bluish cast of color which should not be confused with the starch color reaction. When these blue tubes are present, they are generally followed by yellow, red and blue tubes in order, the final blue tube, of course, being the regulation starch reaction. Occasionally greenish colors will be obtained to the left of the red color. It also sometimes happens that it is somewhat difficult to determine in which tube to the right of the red color the starch blue color is first detected, unless the tube be examined carefully before a strong light. In every instance, however, when these blue and green colors are observed, it is noted that tubes possessing the true dextrin red color are always present between these tubes and the tubes possessing the true starch blue color. It is evident, therefore, that these bluish tints in the tubes to the left of the dextrin color cannot be due to the presence of starch. The cause of the blue color reaction in the first tubes of the series has not been ascertained as yet.

50 c.c. before testing its amyolytic value, it is evident that 1 c.c. of this sediment is equivalent to 8.1 c.c. of extract. Therefore, in order to derive the amyolytic value of 1 c.c. of sediment, we must multiply the value (16.1) as obtained above for the extract, by 8.1. This yields 130.4 and enables us to express the activity as follows:

$$Df_{24h}^{38^{\circ}} = 130.4$$

The above method of calculation is that suggested by Wohlgemuth. In case time and facilities permit of the determination of the moisture content of the feces, it is much more accurate and satisfactory to place the amyolytic values of the stools on a "gram of dry matter" basis. The amyolytic values of the stools are expressed as the number of cubic centimeters of 1 per cent starch solution which the amylase content of 1 gram of dry feces is capable of digesting.

22. Quantitative Determination of Fecal Bacteria.¹—The method is a simplification of MacNeal's adaptation of the Strasburger procedure.² About 2 grams of feces are accurately weighed and placed in a 50 c.c. centrifuge tube. To the feces in the tube a few drops of 0.2 per cent hydrochloric acid are added, and the material is mixed to a smooth paste by means of a glass rod. Further amounts of the acid are added with continued crushing and stirring until the material is thoroughly suspended. The tube is then whirled in the centrifuge at high speed for one-half to one minute. The suspension is found sedimented into more or less definite layers, the uppermost of which is fairly free from the larger particles. The upper and more liquid portion of the suspension is now drawn off by means of a pipette and transferred to a beaker.³ The sediment remaining in the tube is again rubbed up with the glass rod with the addition of further amounts of dilute acid, and again centrifugalized for one-half to one minute. The supernatant liquid is pipetted off and added to the first, the same pipette being used for the one determination throughout.⁴ A third portion of the dilute acid is then added to the sediment, which is again mixed by stirring and again centrifugalized. All the washings are added to the first one, and during the process care is taken to wash the material from the walls and mouth of the centrifuge tube down into it. Finally, when the sediment is sufficiently free from bacteria, the various remaining particles are visibly clean, and the supernatant liquid after centrifugalization remains almost clear. This is removed to the beaker in which are now practically all the bacteria present in the original portion of feces, together with some solid matter not yet separated. In the centrifuge tubes there is a considerable amount of bacteria-free solid matter.

The suspension is now transferred to the same centrifuge tube, centrifugalized for a minute, and the supernatant liquid transferred to a clean beaker by means of the same pipette. The tube is then refilled from the first beaker and thus all the suspension centrifugalized a second time. The beaker is finally carefully washed with the aid of a rubber-tipped glass rod, the second sediment in the centrifuge tube is washed free of bacteria by means of this wash water and by successive portions of the dilute acid, and the supernatant liquid after centrifugalization is added to the contents of the second beaker. The second clean sediment is added to the

¹ Mattill and Hawk: *Jour. Exp. Med.*, 14, 433, 1911.

² MacNeal, Latzer and Kerr, *Jour. Inf. Dis.*, 6, 123, 1909.

³ A 25 c.c. pipette is the most satisfactory size; to facilitate observation, the delivery tube is bent near the bulb to an angle of about 120 degrees.

⁴ A convenient support for the pipettes is a wire spring on a glass base, such as is used on a desk for pen-holders. The delivery tube, just where it is bent, is inserted between the wires, and any liquid not delivered collects in the bend of the tube.

first. The bacterial suspension now in the second beaker is again centrifugalized in the same way and a third portion of bacteria-free sediment is separated. Frequently a fourth serial centrifugalization is performed—always if the third sediment is of appreciable quantity. At all stages of the separation, small portions of the dilute hydrochloric acid are used, so that the final suspension shall not be too voluminous. Ordinarily it amounts to 125 to 200 c.c. At the same time, the final amount of fluid should not be too small, as shown by Ehrenpfordt,¹ because the viscosity accompanying increased concentration prevents proper and complete sedimentation.

To the final bacterial suspension an equal volume of alcohol is added and the beaker set aside to concentrate. A water-bath at 50° to 60°C. is very satisfactory. After two or three days, when the liquid is concentrated to about 50 c.c., the beaker is removed and about 200 c.c. of alcohol are added. The beaker is covered and allowed to stand at room temperature for 24 hours. At the end of this time the bacterial substance is generally settled, so that most of the clear supernatant liquid, of dark brown color, can be directly siphoned off without loss of solid matter. The remainder is then transferred to centrifuge tubes, centrifugalized, and the remaining clear liquid pipetted off.² The sediment consists of the bodies of the bacteria, and is transferred to a Kjeldahl flask for nitrogen determination. This is the bacterial nitrogen. Where a determination of bacterial dry substance is desired, the sediment of bacteria is extracted by absolute alcohol and ether in succession, transferred to a weighed porcelain crucible, and dried at 102°C. to constant weight. This dried sample is then used in the nitrogen determination. Our procedure differs from that of MacNeal in that the bacterial dry matter is not determined. A saving of about seven days' time and of considerable labor is accomplished by this omission.

Inasmuch as it has been shown by various investigators that such bacteria as are present in the feces contain on the average about 11 per cent of nitrogen, the values for bacterial nitrogen as determined by our method may conveniently serve as a basis for the calculation of the actual output of bacterial substance.

23. Quantitative Determination of Indol in Feces. Bergeim's Modification of the Herter-Foster Method.³—*Principle.*—The feces are distilled from alkaline solution to remove phenols. This distillate is again distilled from acid solution to remove ammonia. The indol in the final distillate is treated with β -naphthaquinone sodium monosulphonate and alkali and the blue compound formed extracted with chloroform and determined colorimetrically.

Procedure.—Rub 30–50 grams of the fresh, well-mixed feces in a mortar with water to a uniform consistency. Transfer to a wide mouth Kjeldahl flask of about 1000 c.c. capacity, rinsing mortar and neck of flask with distilled water to make about 400 c.c. Add 5 c.c. of 10 per cent KOH solution and about 2 c.c. of paraffin to decrease foaming. Distill with steam using ordinary Kjeldahl distillation apparatus with good stream of water in the condenser. Heat carefully for a few minutes until danger of foaming is past and then allow to boil vigorously. Distill over 500 c.c. of liquid, bringing the volume of the fecal suspension down to about 100 c.c. toward the end of the distillation.

¹ Ehrenpfordt: *Zeit. exp. Path. Ther.*, 7, 455, 1909.

² In later work (see Blatherwick and Hawk: *Biochem. Bull.*, 3, 28, 1913) it was found advantageous to centrifugalize with alcohol and ether in succession before transferring the bacterial cells to Kjeldahl flasks.

³ Herter and Foster: *Jour. Biol. Chem.*, 1, 257, 1906. Bergeim: *Jour. Biol. Chem.*, 32, 17, 1917.

Transfer the distillate to a clean Kjeldahl flask, add 2 drops of phenolphthalein as an indicator. Make neutral with N sulphuric acid and add 1 c.c. excess. Distill with steam as before, collecting the first 500 c.c. of distillate and bringing the residue finally to about 100 c.c. Mix distillate well by shaking.

Take an aliquot portion of the distillate (100 c.c.); add 1 c.c. of a 2 per cent solution of β -naphthaquinone sodium monosulphonate solution. Then add 2 c.c. of 10 per cent KOH. Shake and let stand for 15 minutes. This is best carried out in a 150 c.c. Squibb shape separatory funnel. Extract with chloroform, shaking vigorously, using a 10 c.c. and a 7 c.c. portion which will bring the total volume of the extract to the mark of a 15 c.c. graduated tube. Mix thoroughly. Run at the same time and in the same way a standard using 1 c.c. of a solution of indol 0.1 mg. of indol per c.c. Compare the extract with this standard in a colorimeter, using the standard ordinarily at the 30-mm. mark. Calculate the indol to the basis of milligrams of indol per gram of moist feces.

Indol and naphthaquinone solutions should be freshly prepared or may be kept in the ice-box for some days. Indol distillates should be kept in the ice-box if not used at once, especially in hot weather. The feces must be fresh.

24. Quantitative Determination of Fat in Feces.—Principle.—The determination of fat in dried feces is a more or less tedious process, and one which is somewhat dangerous if applied to pathological feces. Most of the methods for the determination of fat in the moist feces are accurate, but require a long time. Saxon¹ has proposed a method for the determination of fat in moist feces, which is speedy, convenient, and accurate. The soaps of the feces are converted into free fatty acids by means of hydrochloric acid, and the material is then extracted by shaking with ether. The ether removes the neutral fat, the fatty acids which were present as such, the fatty acids derived from the soaps, and the cholesterol. The ether is removed by distillation, the crude fat purified by means of petroleum ether, and the weight of the total fat obtained. The fat is then dissolved in benzol and titrated with tenth-normal sodium alcoholate solution, using phenolphthalein as an indicator. The fatty acid is calculated, from the titration, to stearic acid.

Procedure.—Place about 5 grams (accurately weighed) of the thoroughly mixed feces in a 100 c.c. glass-stoppered graduated cylinder.²

Add 20 c.c. of distilled water, 1 to 2.5 c.c. of concentrated hydrochloric acid (depending upon the amount of the sample) and again, sufficient distilled water to make a total bulk of 30 c.c. Add exactly 20 c.c. of ether, stopper, and shake vigorously for five minutes. Allow to stand for a few seconds, remove the stopper, add exactly 20 c.c. of 95 per cent alcohol, and again shake for five minutes.

Stand the cylinder aside. The ether, containing practically all of the fat, will come to the top as a colored transparent layer. Blow the ether layer off into

¹Saxon: *J. Biol. Chem.*, 17, 99, 1914.

²Care must be taken not to smear the neck of the cylinder. This may be avoided by removing the feces from the weighing bottle by means of a glass rod, the end of which is flattened, and bent in the shape of a hoe, and transferring small bits of the feces from the hoe to the cylinder, using short pieces of glass rod, which are dropped into the cylinder together with the feces.

a tall 150–200 c.c. beaker.¹ The thin layer of ether which remains is diluted with 5 c.c. of ether, the tube slightly agitated, and the ether blown off. This is done in all five times, care being taken each time to wash down the sides of the cylinder. The stopper should also be washed.

Twenty c.c. of ether are again added, and the cylinder shaken for five minutes and set aside. When the ether has nearly stratified, blow it off and wash as before. During the second washing stratification will complete itself.

Evaporate the ether² until no trace of the alcohol, which has been carried over with it, remains. To the residue add 30 c.c. of low-boiling petroleum ether (should boil below 60°C.), and allow to stand over night. Petroleum for this work should be frequently tested for a residue on evaporation. If a residue is left, the ether should be redistilled.

Filter the petroleum ether solution of the fat, catch the filtrate and washings in a tall, weighed, 100 c.c. beaker, evaporate off the solvent, dry the beaker at 90°C., desiccate and weigh.

After weighing, dissolve the contents of the beaker in 50 c.c. of benzol, heat almost to the boiling-point, add 2 drops of a 0.5 per cent solution of phenolphthalein, and titrate with a decinormal solution of sodium alcoholate.³

Calculations.—The weight of total fat is obtained by subtracting the weight of the empty beaker from the weight of the beaker plus the dried fat. The weight of fatty acids (in terms of milligrams of stearic acid) is obtained by multiplying the number of cubic centimeters of decinormal sodium alcoholate solution by the factor 28.4. The difference between the weight of total fat and the weight of fatty acids is the weight of neutral fat in the sample extracted.

A separate determination without the addition of hydrochloric acid may be run upon the sample, for the purpose of determining the weight of neutral fat and free fatty acids. The difference between this weight and the weight of total fat is the weight of fatty acid present in the original sample in the form of soaps.

¹This is accomplished in the same manner that water is blown from a wash bottle. The submerged end of the delivery tube is bent upward, as in the apparatus used for the determination of fat in milk by Meig's method (see Milk). This avoids upward currents which would disturb the subjacent alcohol-ether-feces layer.

²Erlenmeyer flasks of about 200 c.c. capacity may be used, instead of beakers, for the collection of the ether blown from the cylinders. The ether may then be distilled and recovered. The same procedure may be followed in removing the petroleum ether.

³In the preparation of the sodium alcoholate solution, absolute alcohol and freshly cut, bright, metallic sodium are used; otherwise the procedure is the same as that for the standardization and preparation of any alkali solution.

CHAPTER XV

BLOOD AND LYMPH

BLOOD is composed of four types of form-elements (erythrocytes or red blood corpuscles, leucocytes or white blood corpuscles, blood plates or plaques and blood dust or hemoconein) held in suspension in a fluid called *blood plasma*. These form-elements compose about 60 per cent of the blood, by weight. Ordinarily blood is a dark red opaque fluid due to the presence of the red blood corpuscles, but through the action of certain substances, such as water, ether, or chloroform, it may be rendered transparent. Blood so altered was formerly said to be *laked*. The term *hemolysis* is now used in this connection and substances which cause such action are spoken of as *hemolytic agents*. The hemolytic process is simply a liberation of the hemoglobin from the stroma of the red blood corpuscle. Normal blood is alkaline in reaction to litmus, the alkalinity being due principally to sodium carbonate. When examined according to physico-chemical methods the blood is found to be very faintly alkaline ($P_H = 7.35$). In other words it has a hydrogen ion concentration less than that of water. Even in cases of the most pronounced *acidosis* the reaction of the blood is but slightly altered (see Chapter XVII). The specific gravity of the blood of adults ordinarily varies between 1.045 and 1.075. It varies somewhat with the sex, the blood of males having a rather higher specific gravity than that of females of the same species. Under pathological conditions also the density of the blood may be very greatly altered. The freezing-point (Δ) of normal blood is about -0.56°C . Variations between -0.51° and -0.62°C . may be due entirely to dietary conditions, but if any marked variation is noted it can in most cases be traced to a disordered kidney function. The total amount of blood in the body has been variously estimated at from one-twelfth to one-fourteenth of the body weight. Perhaps $1/13.5$ is the most satisfactory figure. Abderhalden and Schmidt¹ have suggested a unique method for the determination of this value. It is based upon the change in the optical activity of the blood upon injection of a body of known optical activity, such, for example, as dextrin. Keith, Rowntree and Geraghty² have recently made use of a dye in the determination of blood volume.

Among the most important constituents of blood plasma are the four

¹ Abderhalden and Schmidt: *Zeit. physiol. chem.*, 66, 120, 1910.

² Keith, Rowntree and Geraghty: *Arch. Int. Med.*, 16, 509, 1915.

protein bodies, *fibrinogen*, *nucleoprotein*, *serum globulin* (euglobulin and pseudo-globulin) and *serum albumin*. Plasma contains about 8.2 per cent of solids of which the protein constituents named above constitute approximately 84 per cent and the inorganic constituents (mainly chlorides, phosphates and carbonates) approximately 10 per cent. Among the inorganic constituents sodium chloride predominates. To prevent coagulation, blood plasma is ordinarily studied in the form of an oxalated or salted plasma. The former may be obtained by allowing the blood to flow from an opened artery into an equal volume of 0.2 per cent ammonium oxalate solution, whereas in the preparation of a salted plasma 10 per cent sodium chloride solution may be used as the diluting fluid.

Fibrinogen is perhaps the most important of the protein constituents of the plasma. It is also found in lymph and chyle as well as in certain exudates and transudates. Fibrinogen possesses the general properties of the globulins, but differs from serum globulin in being precipitated upon half-saturation with sodium chloride. In the process of coagulation of the blood the fibrinogen is transformed into fibrin. This fibrin is one of the principal constituents of the ordinary blood clot. It is claimed¹ that fibrin has the same percentage composition irrespective of the source of the blood, *e.g.*, cattle, sheep, swine, etc.

The nucleoprotein of blood possesses many of the characteristics of serum globulin. In common with this body it is easily soluble in sodium chloride, and is completely precipitated from its solutions upon saturation with magnesium sulphate. It is much less soluble in dilute acetic acid than serum globulin, and its solutions coagulate at 65°–69°C.

The body formerly called serum globulin is probably not an individual substance. Recent investigations seem to indicate that it may be resolved into two individual bodies called *euglobulin* and *pseudo-globulin*. The euglobulin is practically insoluble in water and may be precipitated in the presence of 28–36 per cent of saturated ammonium sulphate solution. The pseudo-globulin, on the contrary, is soluble in water and is only precipitated by ammonium sulphate in the presence of from 36 to 44 per cent of saturated ammonium sulphate solution.

In common with serum globulin the body known as serum albumin seems also to consist of more than a single individual substance. The so-called serum albumin may be separated into at least two distinct bodies, one capable of crystallization, the other an amorphous body. The solution of either of these bodies in water gives the ordinary albumin reactions. The coagulation temperature of the serum albumin mixture as it occurs in serum or plasma varies from 70° to 85°C. according to

¹ Gortner and Wurtz: *Jour. Am. Chem. Soc.*, 39, 2239, 1917.

the reaction of the solution and its content of inorganic material. Serum albumin differs from egg albumin in being more levorotatory, in being rendered less insoluble by alcohol, and in the fact that when precipitated by hydrochloric acid it is more easily soluble in an excess of the reagent.

When blood coagulates and the usual clot forms, a light yellow fluid exudes. This is blood *serum*. It differs from blood plasma in containing a large amount of *fibrin ferment*, a body of great importance in the coagulation of the blood, and also in possessing a lower protein content. The protein material present in plasma and not found in serum is the fibrinogen which is transformed into fibrin in the process of coagulation and removed. The specific gravity of the serum of human blood varies between 1.026 and 1.032. If blood be drawn into a vessel and allowed to remain without stirring or agitation of any sort the major portion of the red corpuscles will sink away from the upper surface, causing this portion of the clot to assume a lighter color due to the predominance of leucocytes. This light-colored portion of the clot is called the "buffy coat."

Beside the protein constituents already mentioned, other bodies which are found in both the plasma and serum are the following: *Sugar (glucose), uric acid (urates), urea, fat, amino-acids, enzymes, lecithin, creatine, carbamic acid, cholesterol* and its esters, *nucleoprotein, acetone bodies, paralactic acid, gases, ammonia, coloring-matter (lutein or ipochrome)* and *mineral substances*. In addition to the substances just named the blood doubtless contains a class of substances called *hormones* of which *adrenaline* is the only one thus far definitely identified. Some of the *pathological constituents* of blood are *proteoses, biliary constituents* and *purine bodies*. In many pathological conditions certain normal constituents are present in increased amount.

Normal human blood contains slightly less than 0.1 per cent of *glucose* on the average. Strouse,¹ in a very recent series of tests, places the average glucose content at 0.084 per cent. That the diet influences the sugar content is shown by the fact that two and one-half to four hours after a meal the sugar content has been found to equal 0.18 per cent.² In case of *glycosuria* the blood sugar may increase (*hyperglycemia*) to 0.3-1.0 per cent. For the quantitative determination of blood sugar see page 283.

The determination of the *cholesterol* content of the blood is assuming clinical importance. Normal blood contains 140-180 mg. per 100 grams of blood, or about 0.15 per cent. This value has been found to be increased (*hypercholesterolemia*) in *gall stones, pregnancy, nephritis,*

¹ Strouse: *Bull. Johns Hop. Hosp.*, 26, 211, 1915.

² Hirsch: *Zeit. physiol. Chem.*, 93, 355, 1915.

diabetes, arteriosclerosis, and syphilis. (See page 290 for quantitative method.)

Uric acid is present in normal blood to the extent of about 1-2 mg per 100 c.c. of blood. In *gout* this value may be increased to 3-4 mg. The quantitative determination of the uric acid content of blood is of importance as an aid in differentiating *gout* and certain other disorders exhibiting similar clinical symptoms (for methods see page 279).

The *non-protein nitrogen* of normal blood amounts to about 25-35 mg. per 100 c.c. of blood. The *urea* forms about 50 per cent of this, *creatinine* 2 per cent, *uric acid* 2 per cent, *ammonia* 0.3 per cent, *and amino-acids*, etc., about 46 per cent. In *nephritis* the non-protein nitrogen of the blood is much increased. Myers and Fine¹ report a fatal case of *uremia* in which the non-protein nitrogen reached 300

Amino-acids are always present in the blood. They result for most part from the digestion of protein material in the intestine.

Creatinine occurs in normal blood to the extent of about 0.7-1.3 per 100 c.c. of blood. In *uremia* the amount is increased.² Various investigators report the values as ranging from 4 to 33 mg. per 100

The *creatinine* content of normal blood averages about 3 mg. per 100 c.c. of blood. The creatinine values have no important pathological significance as far as known at the present time.

The acetone (acetone and acetoacetic acid) content of normal blood ranges from 0 to 1 mg. per 100 c.c. of blood. In mild *diabetes mellitus* the value rises to 5-12 mg., whereas in severe *diabetes mellitus* (coma) as much as 20-45 mg. per 100 c.c. of blood serum has been found.

Normal blood contains about 20 per cent of *solids* and 3 per cent of *total nitrogen*, whereas *chlorides* are present to the extent of about 0.65 per cent. In severe *diabetes* the chlorides are *decreased* because of the accompanying diuresis.

Abel³ and associates have devised a method by which diffusible substances may be removed from the blood of a living animal. The process is termed *vividdiffusion* and is brought about by permitting the blood from an artery to flow through collodion tubes surrounded by physiological salt solution. The dialyzable substances, except sodium chloride, are removed and the dialyzed blood is returned to the body of the animal by means of a vein. The apparatus has been modified by McGuigan and von Hess.⁴

¹ Myers and Fine: *Chemical Composition of the Blood in Health and Disease*, 1915.

² Folin and Denis: *Jour. Biol. Chem.*, 17, 487, 1914.

³ Myers and Fine: *Jour. Biol. Chem.*, 20, 391, 1915.

⁴ Abel, Rowntree and Turner: *Transactions of the Ass'n of American Physicians*, 1913; also *Jour. of Pharm. and Exp. Therap.*, 5, 275, 1914.

⁵ McGuigan and Von Hess: *Jour. Pharm. and Exp. Therap.*, vol. 6, 1914.

With the standard set at 20 mm., 10 divided by the reading of the unknown (in mm.) gives the amount of uric acid (in mg.) in the volume of urine taken.

The discarded blue solution should be poured as directly as possible into the drain pipes of sinks on account of the cyanide.

$$\frac{20 \times 10}{\text{reading of unknown}} = \text{mgm of uric acid in volume taken}$$

~~diabetes arteriosclerosis and cathelicin~~

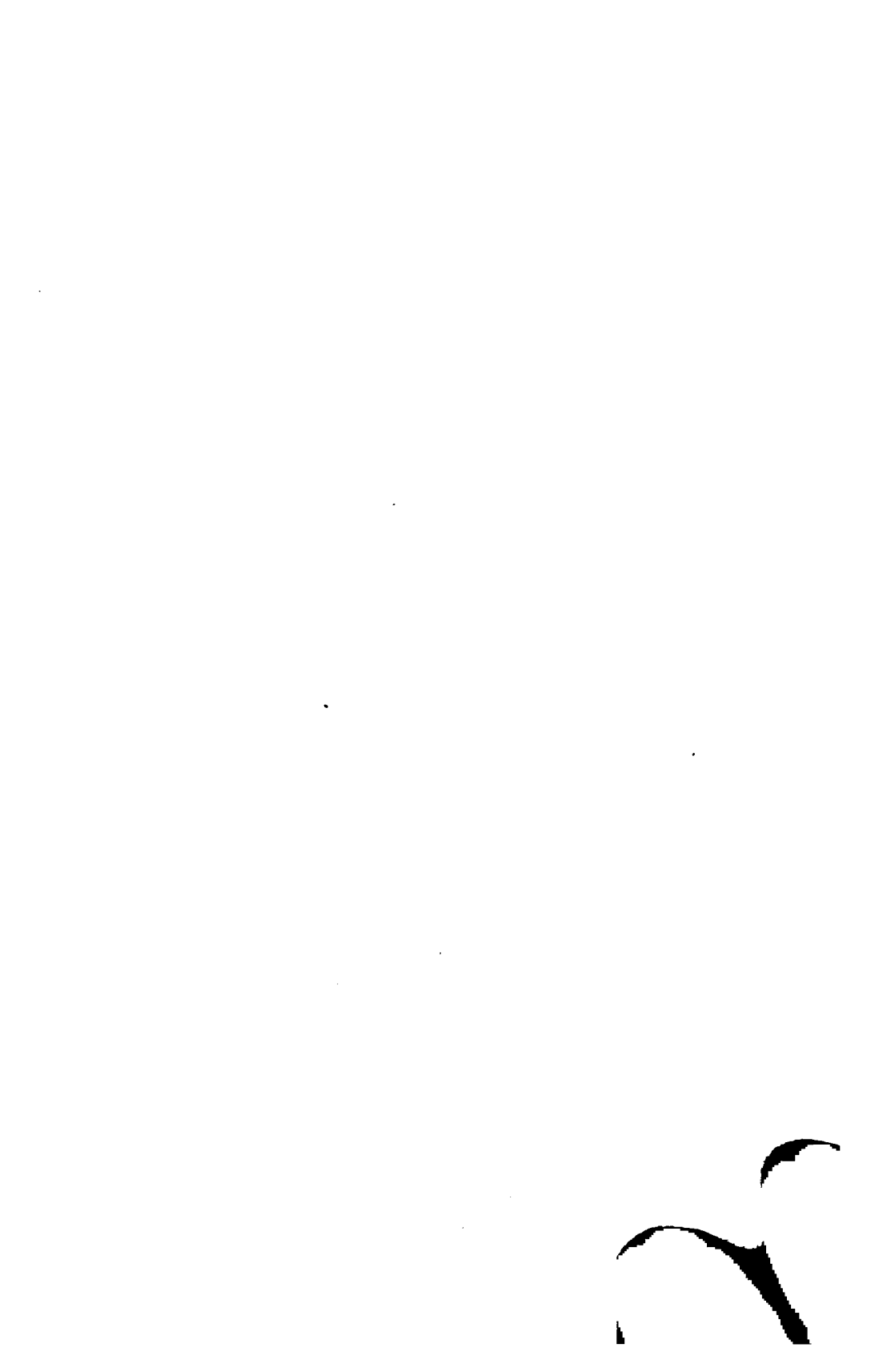
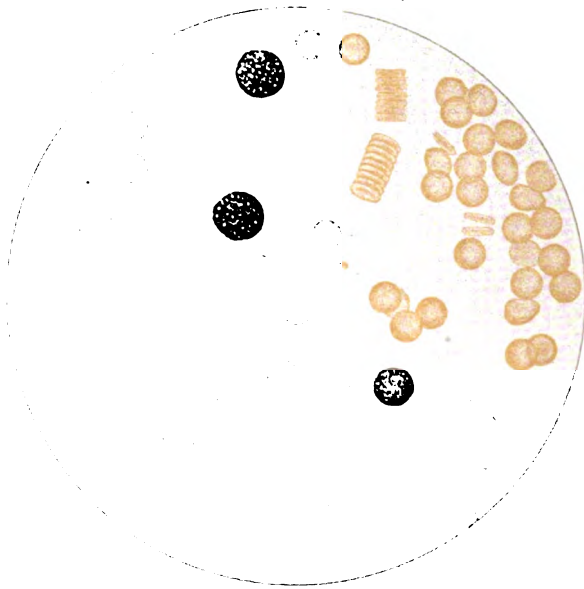

PLATE IV.



NORMAL ERYTHROCYTES AND LEUCOCYTES.

In the application of blood-letting or venesection it has been customary to discard both the corpuscles and plasma of the withdrawn blood. Abel¹ and associates have found it possible to separate the corpuscles from the removed blood by centrifugation and to return them to the body suspended in Locke's solution. They name the procedure *plasmapheresis*. By this means blood-letting can be carried out repeatedly during a short interval of time without endangering the life of the animal.

There has been considerable controversy regarding the form of the erythrocytes or red blood corpuscles of human blood. It is claimed by some investigators that the cells are *bell-shaped* or *cup-shaped*. As the erythrocytes occur normally *in the circulation*, however, they are probably thin, non-nucleated, biconcave discs.²

The blood of most mammals contains erythrocytes similar in form to those of human blood. In the blood of birds, fishes, amphibians and reptiles the erythrocytes are ordinarily more or less elliptical, biconvex and possess a nucleus. The erythrocytes vary in size with the different animals. The average diameter of the erythrocytes of blood from various species is given in the following table:³

Elephant.....	$\frac{1}{1758}$ of an inch.
Guinea-pig.....	$\frac{1}{3833}$ of an inch.
Man.....	$\frac{1}{3250}$ of an inch.
Monkey.....	$\frac{1}{3372}$ of an inch.
Dog.....	$\frac{1}{1681}$ of an inch.
Rat.....	$\frac{1}{3667}$ of an inch.
Rabbit.....	$\frac{1}{665}$ of an inch.
Mouse.....	$\frac{1}{1728}$ of an inch.
Lion.....	$\frac{1}{414}$ of an inch.
Ox.....	$\frac{1}{419}$ of an inch.
Horse.....	$\frac{1}{228}$ of an inch.
Pig.....	$\frac{1}{168}$ of an inch.
Cat.....	$\frac{1}{377}$ of an inch.
Sheep.....	$\frac{1}{491}$ of an inch.
Goat.....	$\frac{1}{818}$ of an inch.
Musk-deer.....	$\frac{1}{1218}$ of an inch.

The erythrocytes, from whatever source obtained, consist essentially of two parts, the *stroma* or protoplasmic tissue and its enclosed pigment, *hemoglobin*. For human blood the number of erythrocytes present in the fluid as obtained from well-developed males in good physical condition is about 5,500,000 per cubic millimeter.⁴ The normal content of the blood of adult females is from 4,000,000 to 4,500,000 per cubic

¹ Abel, Rowntree, Turner, Marshall and Lamson (see Abel's Mellon Lecture," 1915); also Abel: *Science*, 42, 135, 1915.

² When examined singly under the microscope, they possess a pale greenish-yellow color (see Plate IV, opposite), whereas when grouped in large masses a reddish tint is noted.

³ Wormley's *Micro-Chemistry of Poisons*, second edition, p. 733.

⁴ This statement is based upon observations made upon the blood of athletes in training. See Hawk: *Amer. Jour. Physiol.*, 10, 384, 1904. It is generally stated in text-books that the blood of males contains about 5,000,000 per cubic millimeter.

millimeter. The number of erythrocytes varies greatly under different conditions. For instance, the number may be increased after the transfusion of blood of the same species of animals; by residing in a high altitude; or as a result of strenuous physical exercise continued over a short period of time. An increase is also noted in starvation; after partaking of food; after cold or hot baths; after massage, in partial asphyxia, and after fright, as well as after the administration of certain drugs and accompanying certain diseases, such as cholera, diarrhea, dysentery and yellow atrophy of the liver. A decrease in the number occurs in the different forms of anemia. The number has been known to increase to 7,040,000 per cubic millimeter as a result of physical exercise, while 11,000,000 per cubic millimeter have been noted in cases of polycythemia and increases nearly as great in cyanosis. The number has been known to decrease to 500,000 per cubic millimeter or lower in pernicious anemia.

Erythrocytes possess the property, when properly treated, of "clumping" together in masses and precipitating, producing so-called *agglutination*. Cells other than erythrocytes (e.g., bacteria) possess this property. When spoken of in connection with the blood such action is termed *hemagglutination*. A substance which will bring about hemagglutination is said to contain *hemagglutinins*. These hemagglutinins are particularly abundant in the vegetable kingdom.¹ For a demonstration of hemagglutination see page 266.

Oxyhemoglobin, the coloring matter of the blood, is a conjugated protein. Through treatment with hydrochloric acid it may be split into a protein body called *globin*, and *hemochromogen*, an iron-containing pigment. The latter body is rapidly transformed into *hematin* in the presence of oxygen, and this in turn gives place to hematin-hydrochloride or *hemin* (Figs. 84 and 85, page 269). The pigment of arterial blood is for the most part loosely combined with oxygen and is termed *oxyhemoglobin*, whereas the pigment of venous blood is principally hemoglobin (so-called *reduced hemoglobin*). Oxyhemoglobin is the oxygen carrier of the body and belongs to the class of bodies known as respiratory pigments. It is held within the stroma of the erythrocyte. The reduction of oxyhemoglobin to form hemoglobin (so-called *reduced hemoglobin*) occurs in the capillaries. Oxyhemoglobin may be crystallized and a specific form of crystal obtained from the blood of each individual species (see Figs. 76 to 82, pages 255 to 258). This fact seems to indicate that there are many varieties of oxyhemoglobin. The interesting findings of Reichert and Brown are of great value in this connection. These investigators prepared oxyhemoglobin crystals from the blood

¹ Mendel: *Archivio di fisiologia*, 7, 168, 1909; also Schneider: *Journal of Biological Chem.*, 11, 47, 1912.

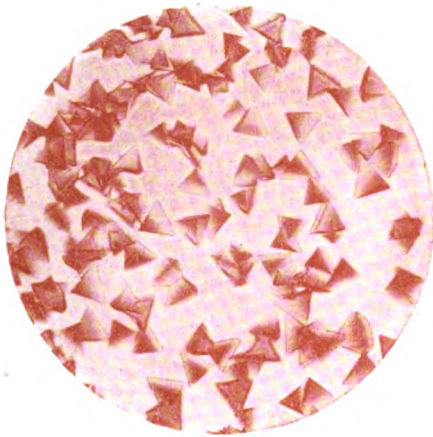

FIG. 76.—OXYHEMOGLOBIN CRYSTALS FROM BLOOD OF THE GUINEA-PIG.
Reproduced from a micro-photograph furnished by Prof. E. T. Reichert, of the University
of Pennsylvania.

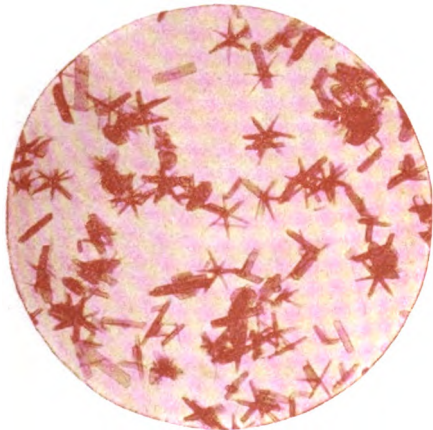

FIG. 77.—OXYHEMOGLOBIN CRYSTALS FROM BLOOD OF THE RAT.
Reproduced from a micro-photograph furnished by Prof. E. T. Reichert, of the University
of Pennsylvania.

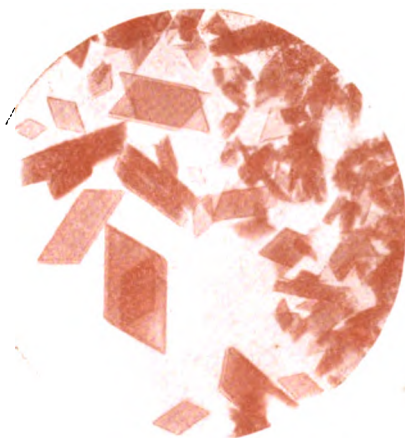

FIG. 78.—OXYHEMOGLOBIN CRYSTALS FROM BLOOD OF THE HORSE.
Reproduced from a micro-photograph furnished by Prof. E. T. Reichert, of the University of Pennsylvania.

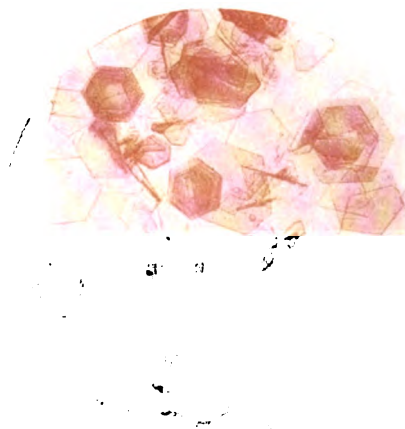

FIG. 79.—OXYHEMOGLOBIN CRYSTALS FROM BLOOD OF THE SQUIRREL.
Reproduced from a micro-photograph furnished by Prof. E. T. Reichert, of the University of Pennsylvania.

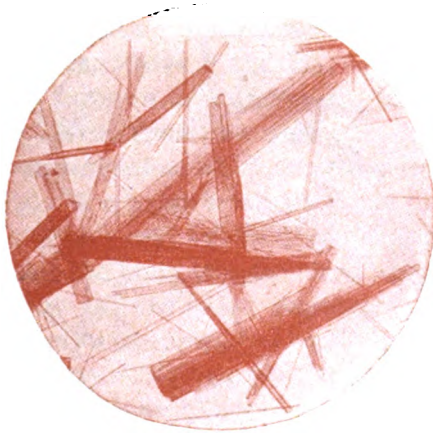

FIG. 80.—OXYHEMOGLOBIN CRYSTALS FROM BLOOD OF THE DOG.
Reproduced from a micro-photograph furnished by Prof. E. T. Reichert, of the University of Pennsylvania.

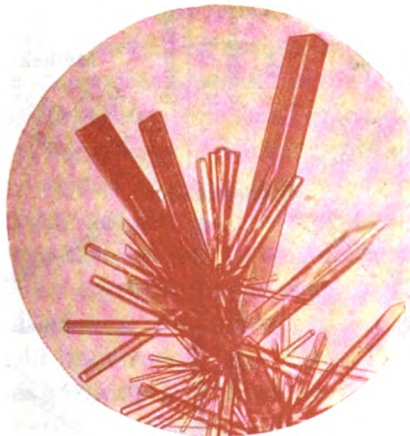

FIG. 81.—OXYHEMOGLOBIN CRYSTALS FROM BLOOD OF THE CAT.
Reproduced from a micro-photograph furnished by Prof. E. T. Reichert, of the University of Pennsylvania.

of over *one hundred* species of animal and subsequently studied the characteristics of the crystals very minutely from the standpoint of crystallography. Their findings may prove of importance from the standpoint of heredity and the origin of species.

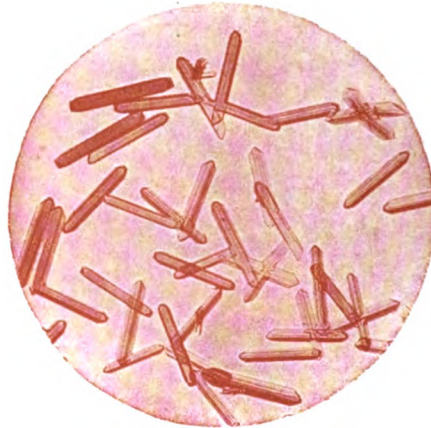
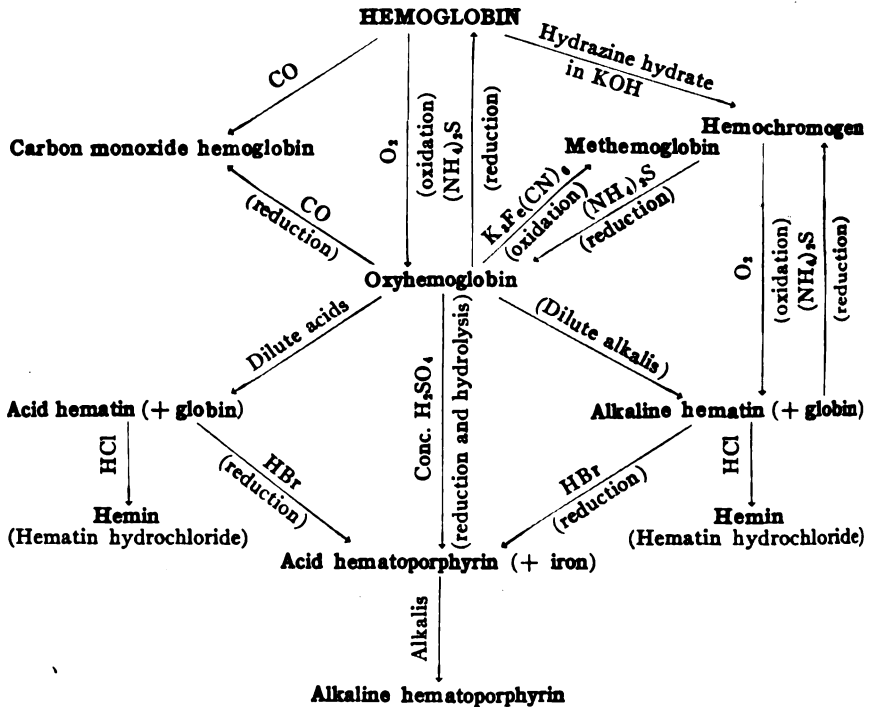

FIG. 82.—OXYHEMOGLOBIN CRYSTALS FROM BLOOD OF THE NECTURUS. Reproduced from a micro-photograph furnished by Prof. E. T. Reichert, of the University of Pennsylvania.¹



¹ The micro-photographs of oxyhemoglobin (see pages 255-258) and hemin (see page 269) are reproduced through the courtesy of Professors E. T. Reichert and Amos P. Brown, of the University of Pennsylvania, who have investigated the crystalline forms of biochemical substances.

The following bodies may be derived from hemoglobin, and each possesses a specific absorption spectrum which serves as an aid in its detection and identification: Oxyhemoglobin, methemoglobin, carbon-monoxide hemoglobin, nitric-oxide hemoglobin, hemochromogen, hematin, acid-hematin, alkali-hematin and hematoporphyrin (see Absorption Spectra, Plates I and II).

The relationship between hemoglobin and its derivatives may be represented by the scheme shown on page 258.

The chemical transformations which occur in the blood during *respiration* are complicated and of great importance. In brief the exchange of oxygen and carbon dioxide may be described as follows: Oxygen from the air passes through the lungs into the blood where it is appropriated for the most part by the red blood corpuscles. The hemoglobin of these corpuscles possesses the property of uniting with oxygen, forming *oxyhemoglobin*. This oxyhemoglobin possesses a red color and imparts to the *arterial blood* its bright appearance. The oxygen is thus borne by these blood cells in the circulating blood to all parts of the body. As the blood passes through the capillaries it gives up the major part of its oxygen which is used by the tissues in their varied activities. As the blood loses its oxygen it becomes darker in color due to the fact that the oxyhemoglobin has been transformed into hemoglobin (or reduced hemoglobin). At the same time in the tissue capillaries the blood takes up excretory products from the tissues, the chief of which is *carbon dioxide*. This carbon dioxide is present in the blood mainly as carbonic acid and sodium acid carbonate; a small amount is probably combined with the proteins of the plasma. We now have so-called venous blood. This is, in turn, carried to the lungs where the carbon dioxide is exchanged for oxygen and the cycle is repeated.

The white corpuscles (or leucocytes) of human blood differ from the red corpuscles (or erythrocytes) in many particulars, such as being somewhat larger in size, in containing at least a single nucleus and in possessing ameboid movement (see Plate IV, opposite page 253). They are typical animal cells and therefore contain the following bodies which are customarily present in such cells: *Proteins, fats, glycogen, purine bodies, enzymes, phosphatides, lecithin, cholesterol, inorganic salts, and water*. Compound proteins make up the chief part of the protein quota of leucocytes, the nucleoproteins predominating. Of the enzymes present the proteolytic are the most important. It is claimed¹ that there are two proteolytic enzymes in leucocytes, one active in alkaline solution and present in the polynuclear cells,² and the other

¹Opie: *Jour. of Experimental Med.*, 8; Opie and Barker: *Ibid.*, 9.

²For discussion of different types of leucocytes see "Da Costa's Clinical Hematology" or some similar volume.

active in acid medium and present in mononuclear cells. It is claimed that the granular leucocytes originate in the bone marrow, whereas the non-granular leucocytes (lymphocytes) have a lymphatic origin (lymph glands or lymphoid tissue); this matter of origin is uncertain. The normal number of leucocytes in human blood varies between 5000 and 10,000 per cubic millimeter. The ratio between the leucocytes and erythrocytes is about 1 : 350-500. A *leucocytosis* is said to exist when the number of leucocytes is increased for any reason. Leucocytoses may be divided into two general classes, the *physiological* and the *pathological*. Under the physiological form would be classed those leucocytoses accompanying pregnancy, parturition and digestion, as well as those due to mechanical and thermal influences. The leucocytoses spoken of as pathological are the inflammatory, infectious, post-hemorrhagic, toxic and experimental forms, as well as the type of leucocytosis which accompanies malignant disease.

The blood plates (platelets or plaques) are round or oval colorless discs which possess a diameter about one-third as great as that of the erythrocytes. Upon treatment with certain reagents, *e.g.*, artificial gastric juice, they may be separated into a homogeneous, non-refractive portion and a granular, refractive portion. The blood plates are associated with the coagulation of the blood. This relationship is not completely understood at present.

The hemoconcin or so-called "blood dust" is made up of round granules which usually have a diameter somewhat less than 1 micron. The serum of normal as well as of pathological blood contains these granules. They were first described by Müller to whom they appeared as highly refractile granules possessed of Brownian movement. The "blood dust" is apparently not concerned with the coagulation of the blood. The granules are insoluble in alcohol, ether and acetic acid and are not blackened by osmic acid. According to Müller, the granules making up the so-called "blood dust" constitute a new organized constituent of the blood, whereas other investigators believe them to be merely free granules from certain of the forms of leucocytes. They appear to possess no clinical significance.

The processes involved in the coagulation of the blood are not fully understood. Several theories have been advanced and each has its adherents. The theory which appears to be fully as firmly founded upon experimental evidence as any is the following: Blood contains a zymogen called *prothrombin* which combines with the calcium salts present to form an enzyme known as *thrombin* or *fibrin-ferment*. When blood is drawn from a vessel the fibrin-ferment at once acts upon the fibrinogen present and gives rise to the formation of *fibrin*.

This fibrin forms in shreds throughout the blood mass and, holding the form elements of the blood within its meshes, serves to produce the typical *blood clot*. The fibrin shreds gradually contract, the clot assumes a jelly-like appearance and the yellowish serum exudes. If, immediately upon the withdrawal of blood from the body, the fluid be rapidly stirred or thoroughly "whipped" with a bundle of coarse strings, twigs or a specially constructed beater, the fibrin shreds will not form in a network throughout the blood mass but instead will cling to the device used in beating. In this way the fibrin may be removed and the remaining fluid is termed *defibrinated* blood. The above theory of the coagulation of the blood may be stated briefly as follows:

I. Prothrombin + Calcium Salts = Thrombin (or Fibrin-ferment).

II. Thrombin (or Fibrin-ferment) + Fibrinogen = Fibrin.

Howell¹ has suggested an ingenious modification of the above theory. He says: "In the circulating blood we find as constant constituents *fibrinogen, prothrombin, calcium salts* and *antithrombin*. The last-named substance holds the prothrombin in combination and thus prevents its conversion or activation to thrombin. When the blood is shed, the disintegration of the corpuscles (platelets) furnishes material (thromboplastin) which combines with the antithrombin and liberates the prothrombin; the latter is then activated by the calcium and acts on the fibrinogen. According to this view the actual process of coagulation involves only three factors, fibrinogen, prothrombin and calcium. These three factors exist normally in the circulating blood but are prevented from reacting by the presence of antithrombin."

The question as to whether *menstrual blood* coagulates has caused much discussion. The most recent investigations seem to show that it *does not coagulate* because of the *removal of fibrin-ferment and fibrinogen* from such blood by the endometrium or lining membrane of the uterus.²

Among the medico-legal tests for blood are the following: (1) Microscopical identification of the erythrocytes, (2) spectroscopic identification of blood solutions, (3) the guaiac test, (4) the benzidine reaction, (5) preparation of hemin crystals, (6) Bordet reaction ("biological" blood test). This last test is the most satisfactory medico-legal test for blood.

Up to within recent times it has been impossible to make an absolute differentiation of human blood. The so-called "biological" blood test has, however, made such a differentiation possible. This test, known as the Bordet reaction, is founded upon the fact that the blood serum of an

¹ Howell: *American Journal of Physiology*, 29, 187, 1911.

² Bell: *Jour. Path. and Bact.*, 18, No. 4, 1914.

animal into which has been injected the blood of another animal of different species develops the property of agglutinating and dissolving erythrocytes *similar to those injected*, but exerts this influence upon the blood from *no other species*. The antiserum used in this test is prepared by injecting rabbits with 5-10 c.c. of human defibrinated blood, at intervals of about four days, until a total of between 50 and 80 c.c. has been injected. After a lapse of one or two weeks the animal is bled, the serum collected, placed in sterile tubes and preserved for use as needed. In examining any specific solution for human blood it is simply necessary to combine the antiserum and the solution under examination in the proportion of 1:100 and place the mixture at 37°C. If human blood is present in the solution a turbidity will be noted and this will change within three hours to a distinctly flocculent precipitate. This antiserum will react thus with no other known substance.

Of the other five blood tests mentioned the last two named are generally considered to be the most satisfactory. They give equally reliable results with fresh blood and with blood from clots or stains of long standing, provided the latter have not been exposed to a high temperature or to the rays of the sun for a long period. The technic of the tests is simple and the formation of the dark brown or chocolate-colored crystals of hemin or the production of the green or blue color with benzidine is indisputable proof of the presence of blood in the fluid, clot or stain examined. The weak point of the tests, medico-legally, lies in the fact that they do not differentiate between human blood and that of certain other species of animal.

The guaiac test (see page 266), although generally considered less accurate than the hemin test, is held by some to be a more delicate test than the hemin test, if properly performed. One of the most common mistakes in the manipulation of this test is the use of a guaiac solution which is too concentrated and which, when brought into contact with the aqueous blood solution, causes the separation of a voluminous precipitate of a resinous material which may obscure the blue coloration; this is particularly true of the test when used for the examination of blood stains. A solution of guaiac made by dissolving 1 gram of the resin in 60 c.c. of 95 per cent alcohol is very satisfactory for general use. The test is frequently objected to upon the ground that various other substances, *e.g.*, milk, pus, saliva, etc., respond to the test and that it cannot therefore be considered a specific test for blood and is of value only in a negative sense. We have demonstrated to our own satisfaction, however, that many samples of milk give the blue color upon the addition of an alcoholic solution of guaiac resin without the addition of

hydrogen peroxide or old turpentine. It has also been shown¹ that those milks which respond positively, fail to do so after boiling. In the case of blood the test is positive both before and after boiling the blood for 15–20 seconds. Pus does not respond after boiling. Old, partly putrified pus gives the test even without the addition of hydrogen peroxide or old turpentine, whereas fresh pus responds upon the addition of hydrogen peroxide. Saliva gives a positive reaction only in case blood or pus is present. Certain plant extracts give the test before but not after boiling for 15–20 seconds. Buckmaster has advocated the use of an alcoholic solution of guaiaconic acid instead of an alcoholic solution of guaiac resin. He claims that he was able to produce the blue color upon the addition of the guaiaconic acid to milk *only* when the sample of milk tested was brought from the country in *sterile bottles*, and further, that no sample of London milk which he examined responded to the test. In the application of the guaiac test to the detection of blood, he states that he was able to detect *laked blood* when present in the ratio 1:5,000,000 and *unlaked blood* when present in the ratio 1:1,000,000. This author considers the guaiac test to be far more trustworthy than is generally believed.

Lymph may be considered as the “middle man” in the transactions between blood and tissues. It is the medium by which the nutritive material and oxygen transported by the blood for the tissues is brought into intimate contact with those tissues and thus utilized. In the further fulfillment of its function, the lymph bears from the tissues water, salts and the products of the activity and catabolism of the tissues and passes these into the blood. Lymph, therefore, exercises the function of a “go-between” for blood and tissues. It bathes every active tissue of the animal body, and is believed to have its origin partly in the blood and partly in the tissues.

In chemical characteristics, lymph resembles blood plasma. In fact, it has been termed “blood without its red corpuscles.” Lymph from the thoracic duct of a fasting animal or from a large lymphatic vessel of a well-nourished animal is of a variable color (colorless, yellowish or slightly reddish) and alkaline in reaction to litmus. It contains fibrinogen, fibrin-ferment and leucocytes and coagulates slowly, the clot being less firm and bulky than the blood clot. Serum albumin and serum globulin are both present in lymph, the albumin predominating in a ratio of about 3 or 4:1. The principal inorganic salts are sodium salts (chloride and carbonate), whereas the phosphates of potassium, calcium, magnesium and iron are present in smaller amount.

Substances which stimulate the flow of lymph are termed *lympho-*

¹Leary: Private communication.

gogues. Such substances as sugar, urea, certain salts (especially sodium chloride), peptone, egg albumin, extracts of dogs' liver and intestine, crab muscles and blood leeches are included in this class.

In a fasting animal, the lymph coming from the intestine is a clear, transparent fluid possessing the characteristics already outlined. After a meal containing fat has been ingested, this intestinal lymph is white or "milky." This is termed *chyle* and is essentially lymph possessing an abnormally high (5-15 per cent) content of emulsified fat. This chyle is absorbed by the lacteals of the intestine and transported to the lower portion of the thoracic duct. Apart from the fat value, the composition of lymph and chyle are similar.

EXPERIMENTS ON BLOOD

I. Defibrinated Ox-blood

1. Reaction.—Moisten red and blue litmus papers with 10 per cent sodium chloride solution and test the reaction of the defibrinated blood. Test by Congo paper also.

2. Microscopical Examination.—Examine a drop of defibrinated blood under the microscope. Compare the objects you observe with Plate IV, opposite page 253. Repeat the test with a drop of your own blood.

3. Specific Gravity.—Determine the specific gravity of defibrinated blood by means of an ordinary specific gravity spindle. Compare this result with the specific gravity as determined by Hammerschlag's method in the next experiment.

4. Specific Gravity by Hammerschlag's Method.—Fill an ordinary urinometer cylinder about one-half full of a mixture of chloroform and benzene, having a specific gravity of approximately 1.050. Into this mixture allow a drop of the blood under examination to fall from a pipette or directly from the finger in case fresh blood is being examined. Care must be taken not to use too large a drop of blood and to keep the drop from coming into contact with the walls of the cylinder. If the blood drop sinks to the bottom of the vessel, thus showing it to be of higher specific gravity than the surrounding fluid, add chloroform until the blood drop remains suspended in the mixture. Stir carefully with a glass rod after adding the chloroform. If the blood drop rises to the surface upon being introduced into the mixture, thus showing it to be of lower specific gravity than the surrounding fluid, add benzene until the blood drop remains suspended in the mixture. Stir with a glass rod after the benzene is added. After the blood drop has been brought to a suspended position in the mixture by means of one or more additions of chloroform and benzene this final mixture should be filtered through muslin and its specific gravity accurately determined. What is the specific gravity of the blood under examination?

5. Tests for Various Constituents.—Place 10 c.c. of defibrinated blood in an evaporating dish, dilute with 100 c.c. of water and heat to boiling. Is there any coagulation, and if so what bodies form the coagulum? At the boiling-point acidulate slightly with dilute acetic acid. Filter. The filtrate should be clear and the coagulum dark brown. Reserve this coagulum. What body gives the coagulum this color? Evaporate the filtrate to about 25 c.c., filtering off any

precipitate which may form in the process. Make the following tests upon the filtrate :

(a) **Fehling's Test.**—To 5 c.c. of the neutralized filtrate add 5 drops of Fehling's solution and boil one minute.

(b) **Chlorides.**—To a small amount of the filtrate in a test-tube add a few drops of nitric acid and a little silver nitrate. In the presence of chloride, a white precipitate of silver chloride will form.

(c) **Phosphates.**—Test for phosphates by nitric acid and molybdate solution according to directions given on page 59.

(d) **Proteose and Peptone.**—Test a small amount of the solution for proteose and peptone by saturating with ammonium sulphate according to directions given on page 120.

(e) **Crystallization of Sodium Chloride.**—Place the remainder of the filtrate in a watch glass and evaporate it on a water-bath. Examine the crystals under the microscope and compare them with those in Fig. 86, page 271.

6. **Test for Iron.**—Incinerate a small portion of the coagulum from the last experiment (5) in a porcelain crucible. Cool, dissolve the residue in dilute hydrochloric acid and test for iron by potassium ferrocyanide or ammonium thiocyanate. Which of the constituents of the blood contains the iron?

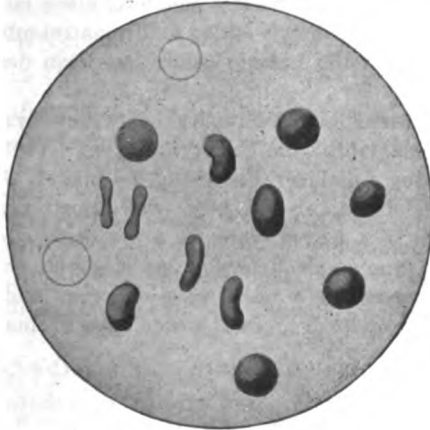

FIG. 83.—EFFECT OF WATER ON ERYTHROCYTES.

7. **Hemolysis ("Laky Blood").**—Note the opacity of ordinary defibrinated blood. Place a few cubic centimeters of this blood in a test-tube and add water, a little at a time, until the blood is rendered transparent. Hemolysis has taken place. How does the water act in causing this transparency? Examine a drop of hemolyzed blood under the microscope. How does its microscopical appearance differ from that of unaltered blood? What other agents may be used to bring about hemolysis?

8. **Osmotic Pressure.**—Place a few cubic centimeters of blood in each of three test-tubes. Hemolyze the blood in the first tube according to directions given in the last experiment (7): add an equal volume of isotonic (0.9 per cent) sodium chloride to the blood in the second tube, and an equal volume of 10 per cent sodium chloride to the blood in the third tube. Mix thoroughly by shaking and after a few moments examine a drop from each of the three tubes under the

microscope (see Figs. 83 and 165, pages 265 and 502). . What do you find and what is your explanation from the standpoint of osmotic pressure?

9. Hemagglutination.—The common garden bean, such as the Scarlet Runner,¹ contains a protein substance which exhibits the interesting property of causing a clumping or agglutination of red blood corpuscles.²

Dilute defibrinated blood³ ten times with physiological sodium chloride solution (0.9 per cent) and place 1 c.c. in each of three small test-tubes.

Grind three beans in a coffee mill, or with mortar and pestle to a fine meal and extract for a few minutes with 0.9 per cent sodium chloride solution. Filter and add 0.05 c.c. (about 2–3 drops) of the filtered extract to the first of the blood tubes; 0.01 c.c. to the second; and 0.05 c.c. of 0.9 per cent sodium chloride to the third.

Invert each tube to mix the contents thoroughly, and note the rapid agglutination and precipitation of the blood corpuscles in the first tube, a less rapid agglutination in the second, while the third or control tube remains unaltered. In one-half hour the corpuscles in the first tube often are packed solid and one is able to pour off perfectly clear serum.

If the remainder of the bean extract is boiled for a few minutes, the coagulum filtered out and 0.05 c.c. of the filtrate added to the control tube, still no agglutination occurs, indicating that the hemagglutinin has been destroyed or removed by the boiling.

10. Diffusion of Hemoglobin.—Prepare some hemolyzed (“laky”) blood, thus liberating the hemoglobin from the erythrocytes. Test the diffusion of the hemoglobin by preparing a dialyzer like one of the models shown in Fig. 2, page 24. How does hemoglobin differ from other well-known crystallizable bodies?

11. Guaiac Test.—To 5 c.c. of water in a test-tube add 2 drops of blood. By means of a pipette drop an alcoholic solution of guaiac (strength about 1:60)⁴ into the resulting mixture until a turbidity is observed and add old turpentine or hydrogen peroxide, drop by drop, until a blue color is obtained.

In the detection of *small* amounts of blood the quantity of guaiac used should also be decreased. Do any other substances respond in a similar manner to this test? Is a positive guaiac test a sure indication of the presence of blood? (See discussion on page 262.)

12. Schumm's Modification of the Guaiac Test.—To about 5 c.c. of the solution under examination⁵ in a test-tube add about 10 drops of freshly prepared alcoholic solution of guaiac. Agitate the tube gently, add about 20 drops of old turpentine, subject the tube to a thorough shaking and permit it to stand for about

¹ The Scarlet Runner is a familiar variety purchasable in every seed store. It occurs in two varieties, the *white* and the *red*. Ricin, a protein constituent of the castor bean, also possesses pronounced agglutinating properties. Because of its poisonous nature it is, however, not suitable for use in class experiments.

² Mendel: *Archivio di fisiologia*, 7, 168, 1909; Schneider: *Journal Biol. Chem.*, 11, 47, 1912.

³ Rabbit's blood is especially desirable (Mendel: *loc. cit.*) and may be obtained for the purpose by bleeding from a small cut on the animal's ear and defibrinating.

⁴ Buckmaster advises the use of an alcoholic solution of guaiacetic acid instead of an alcoholic solution of guaiac resin.

⁵ Alkaline solutions should be made slightly acid with acetic acid, as the blue end-reaction is very sensitive to alkali.

two to three minutes. A blue color indicates the presence of blood in the solution under examination. In case there is insufficient blood to yield a blue color under these conditions, a few cubic centimeters of alcohol should be added and the tube gently shaken, whereupon a blue coloration will appear in the upper alcohol-turpentine layer.

A control test should always be made, using water in place of the solution under examination. In the detection of very minute traces of blood only 3-5 drops of the guaiac solution should be employed.

13. Ortho-tolidin Test (Ruttan and Hardisty).¹—To 1 c.c. of a 4 per cent glacial acetic acid solution of o-tolidin² in a test-tube add 1 c.c. of the solution under examination and 1 c.c. of 3 per cent hydrogen peroxide. In the presence of blood a bluish color develops (sometimes rather slowly) and persists for some time (several hours in some instances).

This test is said to be as sensitive for the detection of occult blood in feces and stomach contents as is the benzidine reaction. It is also claimed to be more satisfactory for urine than any other blood test. The acetic acid solution may be kept for one month with no reduction in delicacy.

14. Benzidine Reaction.—This is one of the most delicate of the reactions for the detection of blood. Different benzidine preparations vary greatly in their sensitiveness, however. Inasmuch as benzidine solutions change readily upon contact with light it is essential that they be kept in a dark place.

The test is performed as follows: To a saturated solution of benzidine in alcohol or glacial acetic acid add an equal volume of 3 per cent hydrogen peroxide and 1 c.c. of the solution under examination. If the mixture is not already acid render it so with acetic acid, and note the appearance of a green or blue color. A control test should be made substituting water for the solution under examination.

The hemoglobin decomposes the hydrogen peroxide (catalysis) and the liberated oxygen oxidizes the benzidine. The sensitiveness of the benzidine reaction is greater when applied to aqueous solutions than when applied to the urine. According to Ascarelli³ the benzidine reaction serves to detect blood when present in a dilution of 1:3,000,000. Walter⁴ has also shown the test to be very delicate, and claims it to be more satisfactory than the guaiac test.

Lyle, Curtman and Marshall⁵ have investigated the benzidine

¹ Ruttan and Hardisty: *Canadian Medical Ass'n Journal*, Nov., 1912; also *Biochemical Bull.*, 2, 225, 1913.

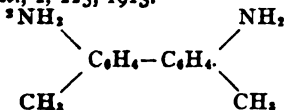

² Ascarelli: *Il policlin ses. prat.*, 1909.

³ Walter: *Deut. med. Woch.*, 36, p. 309.

⁴ Lyle, Curtman and Marshall: *Jour. Biol. Chem.*, 19, 445, 1914.

reaction very carefully. They suggest a new procedure in preparing the reagent¹ and in conducting the test.

The test follows: Into a perfectly clean dry test-tube introduce 1.4 c.c. benzidine solution,¹ add 0.2 c.c. of water or glacial acetic acid, then 1 c.c. of the fluid to be tested and finally 0.4 c.c. of 3 per cent hydrogen peroxide. Note the appearance of a blue color, which reaches its maximum in five to six minutes.

The acetic acid keeps the benzidine in solution. An excess diminishes the delicacy of the reagent.

Hydrogen peroxide supplies oxygen for the reaction and also bleaches the blue color. An excess of peroxide interferes with the reaction by destroying the catalytic power of the blood and by reacting with the benzidine itself, with the formation of products which appear to have an inhibitory action. It is very essential that the peroxide be added *last*.

The benzidine solution should be *dilute*. Such solutions are exceedingly sensitive and permit the detection of blood when present in ratio 1:5,000,000.

15. Hemin Test.—(a) Teichmann's Method.—Place a very small drop of blood on a microscopic slide, add a minute grain of sodium chloride² and carefully evaporate to dryness over a low flame. Put a cover-glass in place, run underneath it a drop of glacial acetic acid and warm gently until the formation of gas bubbles is noted. Add another drop of glacial acetic acid, cool the preparation, examine under the microscope and compare the crystals with those shown in Figs. 84 and 85.

The hemin crystals result from the decomposition of the hemoglobin of the blood. What are the steps involved in this process? The hemin crystals are also called Teichmann's crystals. Is this an *absolute* test for blood? Is it possible to differentiate between human blood and the blood of other species by means of the hemin test?

(b) Nippe's Method.³—Spread a small drop of blood on a slide in the form of a film and evaporate to dryness over a low flame. Now add 2 drops of a solution containing 0.1 gram each of potassium chloride, iodide and bromide in 100 c.c. of glacial acetic acid. Place a cover-glass in position and heat gently over a low flame until gas bubbles form and the solution boils. Run 1-2 drops of the reagent underneath the cover-glass and examine under a microscope. Compare the crystals with those shown in Figs. 84 and 85.

This method is more rapid than Teichmann's method and crystals

¹ Benzidine solution may be prepared as follows: Place 4.33 c.c. of glacial acetic acid in a small Erlenmeyer flask, warm to 50° and add 0.5 gram of benzidine. Heat the flask for eight to ten minutes in water at 50°. To the resultant solution add 19 c.c. of distilled water. This solution may be kept for several days without deterioration.

² Buckmaster considers the use of potassium chloride preferable.

³ Nippe: *Deut. med. Woch.*, 38, 2222, 1912.

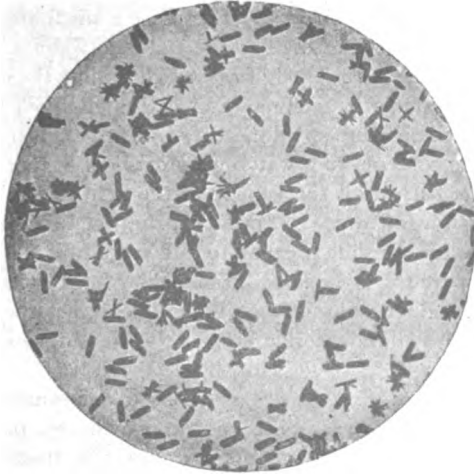

FIG. 84.—HEMIN CRYSTALS FROM HUMAN BLOOD.

Reproduced from a micro-photograph furnished by Prof. E. T. Reichert, of the University of Pennsylvania.



FIG. 85.—HEMIN CRYSTALS FROM SHEEP BLOOD.

Reproduced from a micro-photograph furnished by Prof. E. T. Reichert, of the University of Pennsylvania.

of inorganic chlorides are not formed. In Teichmann's method crystals of sodium chloride often obscure the hemin crystals.

(c) *Atkinson and Kendall's Method.*—Introduce a small amount of the solution under examination into a tube closed at one end, add sodium chloride and glacial acetic acid as in Teichmann's method,¹ fuse or tightly plug the open end of the tube and heat for fifteen minutes in a boiling water-bath.² Remove the tube and permit it to cool to room temperature spontaneously. When the tube has cooled, break it open, transfer the contents to a watch glass or small evaporating dish and concentrate on a water-bath until the volume of the fluid in the watch glass or dish has been reduced to a few drops. Transfer a drop of this fluid to a slide, cover with a cover slip, allow the slide to stand for a few minutes and examine it under a microscope. Compare the crystals with those shown in Figs. 84 and 85, page 269. In case crystals of sodium chloride (see Fig. 86) obstruct the view of the hemin crystals, dissolve the sodium chloride crystals by running a drop of water under the cover slip.

(d) *v. Zeynek and Nencki's Method.*—To 10 c.c. of defibrinated blood add acetone until no more precipitate forms. Filter off the precipitated protein and extract it with 10 c.c. of acetone made acid with 2-3 drops of hydrochloric acid. Place a drop of the resulting colored extract on a slide, immediately place a cover-glass in position and examine under the microscope. Upon the evaporation of the acetone, crystals of hemin will form. Larger crystals may be obtained by evaporating the acetone extract about one-half, transferring it to a stoppered vessel and allowing it to remain overnight.

(e) *Schalfjew's Method.*—Place 20 c.c. of glacial acetic acid in a small beaker and heat to 80°C. Add 5 c.c. of strained defibrinated blood, again bring the temperature to 80°C., remove the flame and allow the mixture to cool. Examine the crystals under the microscope and compare them with those reproduced in Figs. 84 and 85, page 269.

16. **Catalytic Action.**—To about 10 drops of blood in a test-tube add twice the volume of hydrogen peroxide, without shaking. The mixture foams. What is the cause of this phenomenon?

17. **Crystallization of Oxyhemoglobin.** *Reichert's Method.*—Add to 5 c.c. of the blood of the dog, horse, guinea-pig, or rat, before or after laking, or defibrinating, from 1 to 5 per cent of ammonium oxalate in substance. Place a drop of this oxalated blood on a slide and examine under the microscope. The crystals of oxyhemoglobin will be seen to form at once near the margin of the drop, and in a few minutes the entire drop may be a solid mass of crystals. Compare the crystals with those shown in Figs. 76 to 82, pages 255 to 258.

18. **Preparation of Hematin.**—Place 100 c.c. of *hemolyzed (laked)* blood in a beaker and add 95 per cent alcohol until precipitation ceases. What bodies are precipitated? Transfer the precipitate to a flask and boil with 95 per cent alcohol previously acidulated with sulphuric acid. Through the action of the acid the hemoglobin is split into hematin and a protein body called globin. Later the "sulphuric acid ester of hematin" is formed, which is soluble in the alcohol. Continue heating until the precipitate is no longer colored, then filter. Partly saturate the filtrate with sodium chloride and warm. In this process the "hydrochloric acid

¹ Care should be taken not to add too great an excess of these reagents.

² This process insures constancy of temperature and strength of reagents.

ester of hematin" is formed. Filter and dissolve on the filter paper by sodium carbonate. Save this alkaline solution of hematin and make a spectroscopic examination later after becoming familiar with the use of the spectroscope. How does the spectrum of oxyhemoglobin differ from that of the derived *alkali-hematin*?

19. Preparation of Thrombin (Howell).¹—Prepare fibrin from pig's blood according to directions given on page 272. Wash the fibrin thoroughly in water to remove hemoglobin. Squeeze out the water, mince the fibrin and cover with an 8 per cent sodium chloride solution and allow to stand in the cold for 48 hours. Filter. Precipitate the thrombin (and other proteins) from the filtrate by adding an equal volume of acetone. Filter the mixture rapidly through a number of small (25–50 c.c.) filters. Spread out filter papers and precipitate and dry rapidly in a current of cold air. Cut the dried papers into small pieces and treat with a volume of water equivalent to 66 per cent of the 8 per cent NaCl previously used. Allow to stand one-half hour and filter. Shake the filtrate with chloroform (10–15 c.c. per 100 c.c. filtrate) until on settling no opalescence is developed by

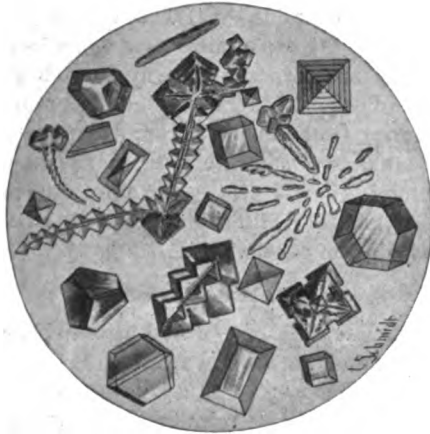

FIG. 86.—SODIUM CHLORIDE.

heating a portion of the supernatant fluid. Decant the liquid and evaporate on watch glasses (2 c.c. to a watch glass) in a current of air. Thrombin so prepared may be kept indefinitely in a desiccator.

20. Variation in Size of Erythrocytes.—Prepare two small funnels with filter papers such as are used in quantitative analysis. Moisten each paper with physiological (isotonic) salt solution. Into one funnel introduce a small amount of defibrinated ox blood and into the other funnel allow blood to drop directly from a decapitated frog. Note that the filtrate from the ox blood is colored, whereas that from the frog blood is colorless. What deduction do you make regarding the relative size of the erythrocytes in ox and frog blood? Does either filtrate clot? Why?

II. Blood Serum²

1. Coagulation Temperature.—Place 5 c.c. of undiluted serum in a test-tube and determine its temperature of coagulation according to the method described

¹ Howell: *Am. Jour. Physiol.*, 32, 264, 1913.

² For directions as to preparation of serum, see "Reagents and Solutions." (Page 621.)

on page 105. Note the temperature at which a cloudiness occurs as well as the temperature at which coagulation is complete.

2. Precipitation by Alcohol.—To 5 c.c. of serum in a test-tube add twice the amount of 95 per cent alcohol and thoroughly mix by shaking. What is this precipitate? Make a confirmatory test. Test the alcoholic filtrate for protein. Explain the result.

3. Proteins of Blood Serum.—Place about 10 c.c. of serum in a small evaporating dish, dilute with 5 c.c. of water and heat to boiling. At the boiling-point acidify slightly with dilute acetic acid. Of what does this coagulum consist? Filter off the coagulum (reserve the filtrate) and test it as follows:

(a) Millon's Reaction.—Make the test according to directions given on page 98.

(b) Hopkins-Cole Reaction.—Make the test according to directions given on page 99.

4. Sugar in Serum.—To 5 c.c. of the neutralized filtrate from Experiment 3 add 5 drops of Fehling's solution and boil one minute. What do you conclude?

5. Detection of Sodium Chloride.—(a) Test a little of the filtrate from Experiment 3 for chlorides, by the use of nitric acid and silver nitrate. (b) Evaporate 5 c.c. of the filtrate from Experiment 3 in a watch glass on a water-bath. Examine the crystals and compare them with those reproduced in Fig. 86, p. 271.

6. Separation of Serum Globulin and Serum Albumin.—Place 10 c.c. of blood serum in a small beaker and saturate with magnesium sulphate. What is this precipitate? Filter it off and acidify the filtrate slightly with acetic acid. What is this second precipitate? Filter this precipitate off and test the filtrate by the biuret test. What do you conclude?

III. Blood Plasma

1. Preparation of Oxalated Plasma.—Allow arterial blood to run into an equal volume of 0.2 per cent ammonium oxalate solution.

2. Preparation of Fibrinogen.—To 25 c.c. of oxalated plasma add an equal volume of saturated sodium chloride solution. Note the precipitation of fibrinogen. Filter off the precipitate (reserve the filtrate) and test it by a protein color test (see page 98).

3. Effect of Calcium Salts.—Place a small amount of oxalated plasma in a test-tube and add a few drops of a 2 per cent calcium chloride solution. What occurs? Explain it.

4. Preparation of Salted Plasma.—Allow arterial blood to run into an equal volume of a saturated solution of sodium sulphate or a 10 per cent solution of sodium chloride. Keep the mixture in a cool place for about 24 hours.

5. Effect of Dilution.—Place a few drops of salted plasma in a test-tube and dilute it with 10–15 volumes of water. What do you observe? Explain it.

IV. Fibrin

1. Preparation of Fibrin.—Allow blood to flow directly from the animal into a vessel and rapidly whip it by means of a bundle of twigs, a mass of strong cords, or a specially constructed beater. If a pure fibrin is desired it is not best to attempt to manipulate a large volume of blood at one time. After the fibrin has been collected it should be freed from any adhering blood clots and washed in water to remove further traces of blood. The pure product should be very light in color. It may be preserved under glycerol, dilute alcohol, or chloroform water.

2. Solubility.—Try the solubility of small shreds of freshly prepared fibrin in water, dilute acid and alkali.
3. Millon's Reaction.—Make the test according to directions given on page 98.
4. Glyoxylic Acid Reaction (Hopkins-Cole).—Make the test according to directions given on page 99.
5. Biuret Test.—Make the test according to directions given on page 100.

V. Detection of Blood in Stains on Cloth, Etc.

1. Identification of Corpuscles.—If the stain under examination is on cloth a portion should be extracted with a few drops of glycerol or physiological (0.9 per cent) sodium chloride solution. A drop of this solution should then be examined under the microscope to determine if corpuscles are present.

2. Tests on Aqueous Extract.—A second portion of the stain should be extracted with a small amount of water and the following tests made upon the aqueous extract:

(a) Hemochromogen.—Make a small amount of the extract alkaline by potassium hydroxide or sodium hydroxide, and heat until a brownish-green color results. Cool and add a few drops of ammonium sulphide or Stokes' reagent (see page 301) and make a spectroscopic examination. Compare the spectrum with that of hemochromogen (see Absorption Spectra, Plate II). Hankin¹ has suggested a test based upon the formation of cyanhemochromogen and the microspectroscopical demonstration of the spectrum of this compound.

(b) Hemin Test.—Make this test upon a small drop of the aqueous extract according to the directions given on page 268.

(c) Guaiac Test.—Make this test on the aqueous extract according to the directions given on page 266. The guaiac solution may also be applied directly to the stain without previous extraction in the following manner: Moisten the stain with water, and after allowing it to stand several minutes, add an alcoholic solution of guaiac (strength about 1:60) and a little hydrogen peroxide or old turpentine. The customary blue color will be observed in the presence of blood.

(d) Benzidine Reaction.—Make this test according to directions given on page 267.

(e) Acid Hematin.—If the stain fails to dissolve in water extract with acid alcohol and examine the spectrum for absorption bands of acid hematin (see Absorption Spectra, Plate II).

¹ Hankin: *Brit. Med. Jour.*, p. 1261, 1906.

Sutherland and Mitra: *Biochemical Journal*, 8, 128, 1914.

CHAPTER XVI

BLOOD ANALYSIS

THE study of the composition of the blood under various normal and pathological conditions has received great impetus from the development of methods for blood analysis which require but small amounts of material and yet give accurate results. Many facts of physiological as well as clinical importance have thus been made available. Some typical examples of data obtained in this way are given in the table on

COMPOSITION OF NORMAL BLOOD AND OF THE BLOOD IN CERTAIN PATHOLOGICAL CONDITIONS¹

	Normal	Chronic nephritis	Uremia	Early diabetes	Severe diabetes	Moderate acidosis	Severe acidosis	Gout	Lipemia	Cholelithiasis	Arthritis
Total solids, per cent.	20.0	13-19	12-18	17-20	19-21			
Total N, per cent.	3.0	2.5-3.0	1.7-2.7	1.8-2.9						
Non-protein N.....	25-35	35-90	90-350					25-35			60-100
Urea N.....	12-23	16-70	70-300								
Uric acid.....	1-3	1-4	4-27				3-6			3-8
Creatinine.....	0.7-1.3	1-3	4-33								
Creatine.....	3	5-30								
Amino-acidN.	6-8	8-16.0								
Ammonia N..	0.1-0.2	0.1-0.2	0.2-1.0								
Sugar, percent	0.08-0.11	0.1-0.2	0.15-0.30	0.3-0.8						
Acetone + Acetoacetic acid.....	0-1.0	2-25	1.5-12	10-40						
β -hydroxybutyric acid.	0-3.0	5-25	5-15	10-100						
Alkali reserve (c.c. CO ₂ in 100 c.c. plasma.....)	77-53	40-30	Below 30				
Cholesterol...	140-180	170-350	170-350	150-300	500-3600	280-950		
Chlorides as NaCl, per cent	0.65	0.55-0.75	0.45-0.65	0.60						
Acid soluble phosphorus..	2-6	3-7	7-21								
Lipoid phosphorus.....	6-12	8-13	8-30								
Fat, per cent.	0.1-0.7 ²	3-18	3-29		

¹ Results are expressed as milligrams per 100 c.c. of blood unless otherwise indicated. Some of the figures given are based upon but few analyses and may not be entirely characteristic.

² A short time after a meal rich in fat the blood may contain considerably more fat.

p. 274. The data there tabulated have been compiled from the work of many observers.¹

It will be noted that in chronic nephritis the principal change is in the urea and non-protein nitrogen of the blood which may increase considerably. In severe cases associated with uremia the retention of these forms of nitrogen may be very great and there is a consequent rise in the blood content which may amount to 1000 per cent or more. In uremia there is likewise a great increase in other individual nitrogenous components of the blood such as uric acid, creatinine, creatine; amino-acid nitrogen, and even of ammonia. The increase in creatinine has been shown by Myers and Fine and others to be significant, inasmuch as this increase does not appear to occur in other types of nephritis. Uric acid is greatly increased in uremia and may be very much higher than in gout. Associated with uremia there is ordinarily an acidosis. There may be an increase in the sugar of the blood and a very great increase of the acetone bodies present. An increase is also generally found in cholesterol and in the various forms of phosphorus of the blood.

In diabetes the most noteworthy changes are in the content of glucose and of acetone bodies. Glucose may be increased above the normal (about 0.1 per cent) to 0.15–0.80 per cent. The increase in acetone, diacetic acid and hydroxybutyric acid is very marked in comparison with the minute amounts found in normal blood. There may also be an increase in fat and other lipoids in severe diabetes.

In moderate acidosis the "alkali reserve" measured in terms of carbon dioxide may range from 40 to 30 volumes per cent, whereas values below 30 are met with in severe acidosis (see Chapter XVII).

In gout the characteristic change is in the uric acid content which is almost always considerably increased. Other forms of nitrogen are affected but little. In arthritis the blood may also be high in uric acid but in this case ordinarily there is a rise in non-protein nitrogen also.

Lipemia is usually associated with an increased sugar content of the blood. The fat content in this condition has been found as high as 29 per cent. There is a correspondingly large increase in the cholesterol of the blood.

In cholelithiasis there appears generally to be a fairly marked

¹ The following may be particularly mentioned: Myers and Fine: *Jour. Biol. Chem.*, 20, 391, 1915; *Post-Graduate*, 1914-15; reprinted as "Chemical Composition of the Blood in Health and Disease," New York, 1915; Folin and Denis: *Jour. Biol. Chem.*, 14, 29, 1913; 13, 469, 1913; 17, 487, 1914; *Arch. Int. Med.*, 16, 33, 1915; Christian, Frothingham and Wood: *Am. J. Med. Sci.*, 150, 655, 1915; Greenwald: *Jour. Biol. Chem.*, 21, 29, 1915; Van Slyke and Meyer: *Jour. Biol. Chem.*, 12, 399, 1912; Bloor: *Jour. Biol. Chem.*, 23, 317, 1915; Marriott: *Jour. Biol. Chem.*, 16, 293, 1913; 18, 507, 1914; Gettler and Baker: *Jour. Biol. Chem.*, 25, 211, 1916; Bock: *Jour. Biol. Chem.*, 29, 191, 1917; Wilson and Plass: *Jour. Biol. Chem.*, 29, 413, 1917; Barnett: *Jour. Biol. Chem.*, 29, 459, 1917; Hunter and Campbell: *Jour. Biol. Chem.*, 33, 169, 1918; Stillman, Van Slyke, Cullen and Fitz: *Jour. Biol. Chem.*, 30, 405, 1917.

increase in the cholesterol content of the blood and this determination is thus of diagnostic aid. Some increase may also be found in other disorders as in nephritis, severe diabetes, pregnancy, arteriosclerosis and syphilis.

METHODS

Non-protein Nitrogen.—(a) *Colorimetric Method of Folin and Denis.*¹
—*Principle.*—This method, which is simple and convenient, depends upon the removal of the proteins from a sample of blood by precipitation with methyl alcohol, and the estimation of nitrogen in the methyl-alcohol solution (after the removal of the proteins) by means of oxidation and Nesslerization. The details of the procedure are carried out in the following manner:

Method of Drawing Blood.—Attach, by means of a short piece of pure gum tubing, an hypodermic needle about 1 mm. in diameter and 25 mm. in length (previously sterilized and paraffined) to the tip of a 2 or 5 c.c. pipette. Introduce into the upper end of the pipette (which must be perfectly clean and dry) a small pinch of powdered potassium oxalate, and allow it to run down into the tip and the needle. Attach a piece of rubber tubing to the upper end of the pipette, and to this a mouthpiece consisting of a short tapering glass tube. Place a pinchcock over the rubber tube near the top of the pipette. To draw the blood, insert the needle into the vein or artery and regulate the flow by means of the pinchcock and suction. The exact quantity of blood desired is thus obtained without any waste or clotting.

Method of Isolating Non-protein Nitrogen Constituents.—Methyl alcohol and zinc chloride are employed as precipitants for the protein materials of the blood, and the determination of the non-protein nitrogen is then carried out upon a portion of the methyl alcohol extract. The procedure is as follows: Transfer the blood, as soon as drawn, to a measuring flask which is half filled with pure methyl alcohol (must be acetone free). Fill to the mark with methyl alcohol and shake thoroughly. (If 2 c.c. of blood are taken, 25 c.c. flasks are used for the precipitation, while for 5 c.c. of blood 50 c.c. flasks are used.) Allow the flask to stand for at least two hours and at the end of that time, or later, filter the contents through dry filter paper. Add 2–3 drops of a saturated alcoholic solution of zinc chloride to the filtrate and filter again through a dry filter paper after a few minutes. The zinc chloride brings down an appreciable precipitate and the last traces of coloring matter, so that the second filtrate obtained is perfectly colorless and clear. This filtrate is used for the determination of non-protein nitrogen.

Trichloroacetic Acid Modification.—Greenwald² has suggested the use of trichloroacetic acid as the precipitant for the proteins of the blood, as being more satisfactory than the methyl alcohol and zinc chloride. The objection to the methyl alcohol is that some of the amino-acids (creatine, asparagine, and tyrosine) are insoluble in it and hence pre-

¹ Folin and Denis: *J. Biol. Chem.*, 11, 527, 1912.

² Greenwald: *J. Biol. Chem.*, 21, 61, 1915.

cipitated along with the proteins. These acids are not removed by the trichloroacetic acid. Certain nitrogenous lipoid substances are precipitated by the trichloroacetic acid and not by the methyl alcohol. Greenwald suggests that these substances, even though non-protein in character, should not be included with the non-protein nitrogen of the amino-acids and urea.

Procedure.—Dilute the blood to ten times its original volume with 2.5 per cent trichloroacetic acid solution. Let stand 30 minutes and then filter. Shake the filtrate with about 4 grams of kaolin per 100 c.c. and filter again. An aliquot of this final filtrate is taken, digested with sulphuric acid and nitrogen determined in the usual way.

Determination of Total Non-protein Nitrogen.—Transfer 5 c.c. of the alcoholic or trichloroacetic acid filtrate to a large Jena test-tube of the same kind as is used in urine analysis (see page 514). Add 1 drop of concentrated sulphuric acid, 1 drop of kerosene, and a small pebble or glass bead to prevent bumping. Immerse the test-tube in a beaker of boiling water for five or ten minutes to drive off the methyl alcohol. When the alcohol is removed add 1 c.c. of concentrated sulphuric acid, 1 gram of potassium sulphate and 1 drop of copper sulphate solution. Boil, cool, dilute and aerate the solution as described in the determination of total nitrogen in urine (see page 514), except that the ammonia is collected in a large test-tube instead of the 100 c.c. flask. Nesslerize the solution, using 7 to 8 c.c. of diluted Nessler reagent (dilution 1:5), dilute to 25 or 50 c.c. according to the amount of color, and compare with a standard solution containing 1 mg. of ammonia nitrogen, Nesslerized and diluted to 100 c.c. and the colorimeter prism set at 20 mm.

Calculations.—If 5 c.c. of blood are diluted to 50 c.c. and 10 c.c. of the alcoholic or trichloroacetic acid extract (equivalent to 1 c.c. of blood) are used for the determination, the amount of non-protein nitrogen (as milligrams per 100 c.c. of the blood) can be obtained by use of the formula $\frac{20}{R} \times D$, in which R stands for the reading of the unknown and D represents the volume to which its ammonia has been diluted. If the equivalent of 0.4 c.c. of blood has been taken for the determination the formula $\frac{50}{R} \times D$ is used, and if the equivalent of 0.5 c.c. of blood has been taken the formula becomes $\frac{40}{R} \times D$.

(b) *Colorimetric Method for Finger Blood.*—*Principle.*—Taylor and Hulton¹ have suggested a modification for the determination of non-protein nitrogen using from 4 to 8 drops of blood. It is based upon the observation of Gulick² that the presence of small amounts of potassium sulphate does not appreciably interfere with the Nesslerization of solutions containing ammonium salts. The Nesslerization is accordingly carried out directly upon the oxidized material without removal of the ammonia by aspiration or distillation. The authors use a mixture of ether and alcohol for the precipitation of proteins. The authors claim

¹ A. E. Taylor and F. Hulton: *J. Biol. Chem.*, 22, 63, 1915.

² Gulick: *J. Biol. Chem.*, 18, 541, 1914.

only approximate accuracy for the method and the small amount of lipid nitrogen included with the other non-protein nitrogen may be disregarded.

Procedure.—Place 10 c.c. of a mixture of absolute alcohol and ether (3:1) in a small Erlenmeyer flask. Stopper and weigh the flask with its contents. Remove the stopper and allow from 4 to 8 drops of blood (depending upon the amount of non-protein nitrogen) to drop from the finger which has been cleaned and pricked with a sharp lance. The blood should drop freely when the hand is held down. Insert the stopper and weigh the flask and contents. The increase in weight is of course the weight of blood. Within a half-hour filter the mixture into the digestion flask and wash the filter with 5 c.c. of alcohol-ether. The filtrate is clear and practically free from protein, although it probably contains traces of nitrogen-containing lipoids. The Kjeldahl digestion is carried out in a 25 c.c. long-necked, round-bottomed Kjeldahl flask, the neck of which has a crook near the top. Add a small piece of acid potassium sulphate, several glass beads, and drive off the alcohol-ether by heating on a hot plate. When the flask is nearly dry add 1 c.c. of concentrated sulphuric acid and not more than 300 or 400 mg. of potassium sulphate. Then place the flask over the direct flame of a micro-burner (resting the bottom of the flask upon an asbestos board which has a circular perforation a little smaller than the circle of 1 c.c. of sulphuric acid in the digestion flask) and heat until the mixture is colorless. Transfer the digestion mixture to a 100 c.c. flask, neutralize the sulphuric acid with about 3 c.c. of a 30 per cent solution of sodium hydroxide, fill the flask to over three-quarters full with ammonia-free water, and add 5 c.c. of Winkler's modification of Nessler's solution (see page 626). Dilute to mark with water and compare the color in the Duboscq colorimeter (see Fig. 168, p. 515) against a standard solution of ammonium sulphate.

2. Urea.—The Urease Method.—Van Slyke and Cullen's¹ Modification of Marshall's Method.²

Principle.—See Urease Method, Chapter XXVII.

Procedure.—Run 3 c.c. of fresh blood (carefully measured with an accurate pipette) into a 100 c.c. test-tube containing 1 c.c. of a 3 per cent solution of potassium citrate (to prevent clotting). Add 0.5 c.c. of the urease solution³ and 2 or 3 drops of caprylic alcohol (to prevent foaming).⁴ After ten minutes add 15 c.c. of a saturated solution of potassium carbonate, and drive off the ammonia by aspiration into another tube containing 15 c.c. of hundredth-normal hydrochloric or sulphuric acid. Titrate the excess of acid with hundredth-normal sodium hydroxide or potassium hydroxide,⁵ using methyl red or alizarin as indicator.

Calculations.—Each cubic centimeter of acid neutralized indicates 0.01 gram of urea per 100 c.c. of blood, or 0.00467 gram of urea nitrogen per 100 c.c. of blood. In case the blood should be one of the rare samples containing over 0.15 per cent of urea, all the acid will be neutralized, and it will be necessary to repeat the

¹ Van Slyke and Cullen: *J. Am. Med. Ass'n*, 62, 1558, 1914.

² Marshall: *Jour. Biol. Chem.*, 15, 487, 1913.

³ The enzyme solution is prepared as described under "Reagents and Solutions," p. 632.

⁴ Lee (*St. Luke's Hosp. Med. and Surg. Rep.*, 4, 1917) suggests the use of a mixture containing 70 per cent phenyl ether and 30 per cent amyl alcohol as a substitute for caprylic alcohol, while Hammett (*Jour. Biol. Chem.*, 33, 381, 1918) uses a mixture of equal parts of amyl alcohol, toluene and ethyl alcohol.

⁵ Rose and Coleman (*Biochem. Bull.*, 3, 411, 1914) suggest the colorimetric determination of the ammonia (see page 521).

determinations, using in the determination only 1 c.c. of blood. Fresh blood contains so little ammonia that it may be disregarded. For further discussion of the urease method see Chapter XXVII.

3. Uric Acid.—*Colorimetric Microchemical Method.*—*Principle.*—Folin and Denis¹ were the first to apply the technic of their method for the determination of small quantities of uric acid to the quantitative estimation of uric acid in blood. (For a discussion of the principle of the color reaction see the determination of uric acid in urine, page 534.) The procedure necessary for the determination in blood is somewhat different from that used for the determination in urine because of the presence of proteins in the blood. These must be removed first, and then the uric acid may be determined in the protein-free extract, according to the procedure used for the determination in urine. The proteins are removed from the blood by precipitation with hot dilute acetic acid in the following manner:

(a) Folin-Denis Procedure.—The blood is drawn into small, wide-mouthed bottles previously weighed and containing a small amount (about 0.1 gram) of finely powdered potassium oxalate. From the subsequent weight of each bottle is obtained the weight of the blood. Five times this weight of N/100 acetic acid solution² is transferred to an ordinary 1000 c.c. flask and heated to boiling. The oxalated blood is then poured into this boiling acetic acid solution, stirring constantly, and the heating is continued until the solution has again begun to boil. The mixture is filtered while still hot. The coagulated material on the filter paper is transferred back into the flask (by means of a small spoon or a spatula), about 200 c.c. of boiling water³ are poured over it and it is allowed to stand for five minutes. This mixture is then filtered through the same filter as was used for the first filtration. The filtrate in the receiving flask should be very nearly as clear as water, and will be found to be so if the original blood was promptly shaken with the oxalate, so that no clotting has taken place.

If clotting has occurred, the coagulation and washing of the blood is a little more complicated. The clot leads to so much bumping in the boiling acetic acid solution that it is not practical or safe to try to heat the mixture to boiling. The filtration is, therefore, made earlier. The partially coagulated clot is then broken up with a glass rod, transferred to a mortar and there ground into a paste in the presence of hot water. This suspension is then poured on the filter. The protein material on the filter is then washed, as before, with about 200 c.c. of hot water. In this case the combined filtrates are, however, never colorless but more or less reddish. On being heated to boiling a second small coagulum will be obtained and the filtrate will then be practically as clear as water.

The combined filtrate and washings, containing the uric acid and other soluble materials, is further acidified by the addition of 5 c.c. of 50 per cent acetic

¹ Folin and Denis: *J. Biol. Chem.*, 13, 469, 1913.

² Prepared by diluting 0.6 c.c. of glacial acetic acid to 1 liter.

³ For this washing, water is used rather than N/100 acetic acid, because if the latter is used the coagulum will give off more or less of the blood pigment and the filtrates are less clear.

acid and is evaporated, over a free flame in a suitable dish,¹ to a very small volume (about 3 c.c.). The liquid is then poured into an ordinary centrifuge tube and the dish washed with two successive portions of 0.1 per cent lithium carbonate solution, using about 2 c.c. for each rinsing. Any solid material adhering to the sides of the dish is removed by rubbing with a rubber-tipped stirring rod. This solid material can be removed by centrifuging and pouring the supernatant liquid into another tube, washing the sediment with lithium carbonate solution (Smith).

The liquid in the centrifuge tube, which at this stage should not be more than 10 c.c. in volume, is then treated as in the method for urine.

(b) **Benedict Procedure.**—Benedict² has suggested that the precipitation of proteins by the method of Folin and Denis is incomplete, and proposes the use of colloidal iron for the completion of precipitation after coagulation in dilute acetic acid. Myers and Fine³ suggest the use of aluminium hydroxide cream for this purpose. Benedict's procedure is as follows:

To 100 c.c. of boiling N/100 acetic acid in a casserole, 20 c.c.⁴ of oxalated blood are added, and the mixture is heated to boiling for a moment. Remove the casserole from the flame and add 200 c.c. of boiling distilled water. Pour the mixture upon a folded filter and wash the residue with 50 c.c. of boiling water (heated in the same casserole in which the original coagulation took place). Transfer the whole filtrate to a casserole and boil down rapidly to a volume of about 25 c.c. Pour this solution into a small flask roughly marked to indicate a volume of 50 c.c. Transfer the contents of the casserole to the flask quantitatively, with the help of two or three portions of water, heating vigorously to boiling and rubbing the sides of the casserole with a rubber-tipped stirring rod each time. The total volume in the flask should not exceed 50 c.c. after the addition of the washings. Thoroughly cool the turbid solution in the flask under running water, and add 2 c.c.⁵ of colloidal iron solution (Merck's "Dialyzed Iron," 5 per cent solution) while the flask is being gently rotated. Filter the mixture through a small folded filter into a 100 c.c. Jena Florence flask, and wash the residue twice with distilled water. The filtrate obtained here should be as clear and colorless as distilled water. Boil the solution down to a volume of from 1 to 2 c.c. (care being taken in the early stages to prevent bumping), then carefully pour into a small centrifuge tube and wash out the flask with three portions of water (1 or 2 c.c. each), heating each to boiling in the flask and shaking thoroughly prior to transferring it to the centrifuge tube. The volume of liquid in the tube at this point should be from 5 to 10 c.c. Cool the liquid, add 20 drops of the

¹ Deep (half globular) dishes 10 cm. in diameter and having a capacity of 250 c.c. are very good for this purpose. While free flames are the most convenient for concentrating the uric acid solutions, care must, of course, be taken not to char the contents toward the end of the operation. Unless the solution can be watched carefully at this stage, it is safer to finish the concentration on the water-bath.

² Benedict: *J. Biol. Chem.*, 20, 629, 1915.

³ Myers and Fine: "Blood in Health and Disease," 1915, p. 14.

⁴ Smaller amounts of blood may be employed, and the quantity of acetic acid and water correspondingly reduced. Unless the quantity of uric acid present is very large, the results are far more accurate when 20 c.c. of blood are used.

⁵ With old samples of blood it may be necessary to add 3 or 4 c.c. of the iron solution and a little 10 per cent sodium chloride solution. When the precipitate separates in large flocculent masses the right amount of iron has been added. Any excess of iron must be avoided, as it would oxidize some of the uric acid later on in the process.

ammoniacal silver magnesium solution and proceed with the determination as described under Urine (Chapter XXVII). If the amount of uric acid present is very small the addition of 1 drop of cyanide solution, 1 c.c. of uric acid reagent, 5 c.c. of 20 per cent sodium carbonate solution, and dilution to 25 c.c. are carried out rather than using the larger quantities given for the determination in the urine.

4. **Creatine and Creatinine.**¹ *Methods of Folin.—Preformed Creatinine.*—Measure 10 c.c. of blood into a 50 c.c. volumetric flask or, better, into a 50 c.c. shaking cylinder which can be closed with a glass stopper. Fill to the 50 c.c. mark with saturated picric acid solution and shake a few times. Add about 1 gram of dry picric acid to the mixture and shake for five minutes. Transfer the mixture to centrifuge tubes, throw down the sediment and precipitate and pour the supernatant liquid through a filter. This is the most economical process where but little blood is available. If desired, however, double quantities of blood and reagents may be taken and filtration carried out without preliminary centrifugation. This process removes the protein materials and leaves the creatine and creatinine in the filtrate which is a saturated picric acid solution. The preformed creatinine is then determined colorimetrically. For this purpose a standard solution of creatinine for comparison is necessary. Prepare this from the standard creatinine stock solution as used in the analysis of urine (see chapter on Quantitative Analysis of Urine) by diluting an amount of this solution equivalent to 1 mg. of creatinine to 500 c.c. with saturated picric acid solution. We have then a standard solution containing 0.2 mg. of creatinine in 100 c.c. of saturated picric acid solution.

Take 20 c.c. portions each of the filtrate and of the standard solution. To each solution then add exactly 1 c.c. of 10 per cent NaOH from a burette. (If the blood filtrate becomes turbid on addition of alkali it must be centrifuged or filtered.) Allow to stand for 10 minutes and compare the colors directly in the colorimeter without further dilution. The standard creatinine solution may be set advantageously at 20 mm., although this is not necessary.

Calculation.—Since the blood was diluted five times in the precipitation procedure and as the standard for comparison contains 0.2 mg. of creatinine per 100 c.c., it is merely necessary to divide the reading of the standard by the reading of the unknown to obtain without further calculation the number of milligrams of creatinine in 100 c.c. of blood.

Creatine Plus Creatinine.—For determining the total creatinine plus creatine in the blood carry out the preliminary precipitation with picric acid just as in the determination of creatinine above. Take 10 c.c. of this filtrate for the determination. Transfer it to a small Erlenmeyer flask or large test-tube. Cover the flask or test-tube with tin foil, transfer to an autoclave and heat to about 120°C. for about 20 minutes. The autoclave should not be opened until the temperature has fallen below 100°C. Cool the solution to room temperature, rinse into a 25 c.c. volumetric flask with saturated picric acid solution. Add 1.25 c.c. of 10 per cent NaOH for the development of the color.

On account of the variations in the creatine content of normal blood two standard creatinine solutions are used. In working on pathological cases a third standard is desirable. These standards contain 0.5, 1, and 2 mg. of creatinine respectively per 100 c.c. of saturated picric acid solution. To 20 c.c. of each of these solutions in measuring cylinders add 1 c.c. of 10 per cent NaOH and allow

¹ Folin: *Jour. Biol. Chem.*, 17, 475, 1914.

to stand for 10 minutes. By inspection determine which standard corresponds most nearly in color with the unknown and use this for comparison. The standard is usually set at 10 mm. in the Duboscq colorimeter.

Calculation.—Multiply the reading of the standard by 125 and by 0.5, 1, or 2, according to which standard is used, and divide by the reading of the unknown in millimeters. The result gives the number of milligrams of creatine + creatinine in 100 c.c. of the blood examined.

5. Amino-acid Nitrogen. (a) *Method of Van Slyke and Meyer.*¹—*Principle.*—The protein of the blood is removed by precipitation with alcohol and the amino-acid nitrogen determined in the filtrate by the nitrous acid method.

Procedure.—Thirty to 50 c.c. of freshly drawn blood are mixed with 9 or 10 volumes of 95 per cent alcohol to precipitate the proteins. The volume of the alcohol-blood mixture must be known, but in case it is not convenient to use a graduated cylinder for the mixture, its volume can be taken as the sum of the volumes of the alcohol and blood without essentially affecting the results. The alcohol and blood are thoroughly mixed, the vessel containing them is closed and 24 hours are allowed for precipitation of the proteins to become complete. The solution is filtered through a dry folded filter into a measuring cylinder without washing the precipitate. The volume of filtrate is noted and is taken for analysis as an aliquot part of the total blood-alcohol mixture. The filtrate is then concentrated to a volume of 3–5 c.c. and used for determination of amino nitrogen by the Van Slyke nitrous acid method (see Chapter IV on Proteins). The use of a few drops of caprylic alcohol to prevent foaming is advisable.

(b) *Method of Constantino.*²—This is based on the formol titration procedure. One hundred c.c. of blood or serum is mixed with a measured (500 c.c.) volume of 2 per cent mercuric chloride solution containing 0.8 per cent hydrochloric acid. The mixture is shaken vigorously in a stoppered flask and allowed to stand a few hours. Centrifugate for 10 minutes, pour the supernatant liquid through a dry filter into a graduated cylinder. An aliquot of the filtrate is taken, the mercury is removed with hydrogen sulphide and the latter by a current of air. The liquid is exactly neutralized and concentrated on the water-bath, or better, at 50° in a vacuum, MgO added, and the mixture distilled in a vacuum at 45° to get rid of ammonia. The volume should now be about 30 c.c. A little solid barium chloride and barium hydroxide are added and 1.5 c.c. of 0.5 per cent solution of phenolphthalein. Filter. Neutralize accurately to sensitive litmus paper. Add neutral formalin solution and titrate with N/5 NaOH as described in the chapter on quantitative analysis of urine (page 528).

6. Ammonia.—*Method of Folin and Denis.*—The determination of ammonia in blood is attended with considerable difficulty because of the fact that it is present only in very small amounts, and owing to the fact that blood very readily and quickly undergoes changes which are accompanied by the formation of ammonia from the nitrogenous compounds present in the fresh blood.

Of the methods proposed for its quantitative estimation that of Folin and Denis³ is perhaps least unsatisfactory. More recently Barnett⁴ has suggested a method for the determination of ammonia in small amounts of fluid of low ammonia content.

Principle.—The method is based upon the liberation of the ammonia from fresh

¹ Van Slyke and Meyer: *Jour. Biol. Chem.*, 12, 399, 1912.

² Constantino: *Bioch. Zeit.*, 55, 419, 1913.

³ Folin and Denis: *J. Biol. Chem.*, 11, 532, 1915.

⁴ Barnett: *Jour. Biol. Chem.*, 29, 459, 1917.

blood by aspiration after adding sodium carbonate solution, and the Nesslerization of the solution into which the ammonia is aspirated.

Procedure.—Place 10 c.c. of systemic blood or 5 c.c. of portal or mesenteric blood¹ in a large Jena test-tube. Add 2 or 3 c.c. of a solution composed of 15 per cent potassium oxalate and 10 per cent sodium carbonate, and about 5 c.c. of toluene. Connect the tube for aspiration as in the method for urea in blood; start the air current, and run as fast as the apparatus will stand for 20 to 30 minutes. Collect the ammonia in another test-tube containing 1 c.c. of water and 5 or 6 drops of tenth-normal acid.

At the end of the aspiration Nesslerize in the usual manner (see method for non-protein nitrogen, page 276) but more cautiously, adding in all not over 1 c.c. of the previously diluted Nessler reagent (dilution 1 : 5). Transfer the contents of the receiver to a 10 c.c. volumetric flask, fill to the mark with ammonia-free water, and mix. Fill a 100 mm. polariscope tube with the mixture and close as for ordinary polariscope work.

Prepare two standard solutions, one containing 0.5 mg. and the other 1.0 mg. of nitrogen, these being Nesslerized simultaneously with the unknown solution and made up to volume (100 c.c.). Use the standard possessing a tint most similar to that of the unknown. Compare in a Duboscq colorimeter, using the ordinary cylinder for the standard and replacing the other cylinder and prism by the polariscope tube, containing the unknown, which usually fits properly in place in the colorimeter.

The unknown solution remains stationary (100 mm.) and the standard is adjusted until the colors match. An iris diaphragm, such as is used in microscopical work, must be attached to the side of the colorimeter holding the standard to reduce the light passing through the standard solution. This is necessary in order to obtain two fields of the same tint. The calculation is made in the usual manner for colorimetric determinations, the amount of ammonia in the unknown being directly proportional to the reading of the standard and its concentration.

7. Total Nitrogen.—The total nitrogen of the blood may be readily determined by the regular Kjeldahl method (see Chapter XXVII). One c.c. of the blood accurately measured is used in this method. The microchemical method of Folin and Farmer, as outlined in the same chapter, may also be employed. In this case transfer 1 c.c. of the well-mixed blood to a 25 c.c. flask, make up to the mark with distilled water, mix thoroughly and take 1 c.c. of this diluted blood for the digestion and determination as there given.

8. Sugar. (a) Benedict² Modification of the Method of Lewis and Benedict.³—*Principle.*—The red color obtained by heating a glucose solution with picric acid and sodium carbonate is employed as the basis of the colorimetric determination. The blood protein is removed by precipitation with picric acid.

Procedure.—Two c.c. of blood are aspirated through a hypodermic needle⁴

¹ The blood must be *freshly drawn*. For method of obtaining blood, see page 276.

² Benedict: *Jour. Biol. Chem.*, 34, 203, 1918.

³ Lewis and Benedict: *Jour. Biol. Chem.*, 20, 61, 1915. For other modifications see Pearce: *Jour. Biol. Chem.*, 22, 525, 1915, and Myers & Bailey: *Jour. Biol. Chem.*, 24, 147, 1916.

⁴ It may be more convenient to draw about 5 c.c. of blood directly into a test-tube containing a little finely powdered potassium oxalate and removing 2 c.c. portions of this with the Ostwald pipette.

and a piece of rubber tubing into an Ostwald pipette, a little powdered potassium oxalate in the tip of the pipette preventing clotting. The blood is drawn up a little above the mark and the end of the pipette is closed with the finger. After the rubber tubing and needle are disconnected, the blood is allowed to flow back to the mark and is discharged at once into a 25 c.c. volumetric flask, or into a large test-tube graduated at 12.5 c.c. and at 25 c.c. The pipette is twice rinsed with distilled water, these washings being added to the blood. The contents of the flask are shaken to insure thorough mixing and a consequent laking or hemolysis of the blood, which is practically complete after a minute or two. A solution of sodium picrate and picric acid¹ is added to the 25 c.c. mark (using a few drops of alcohol to dispel foam if necessary) and the mixture thoroughly shaken. After a minute or two (or longer) the mixture is poured upon a dry filter, and the clear filtrate collected in a dry beaker. Exactly 8 c.c. of the filtrate are measured into a large test-tube bearing graduations at the 12.5 c.c. and 25 c.c. mark, and 1 c.c. of 20 per cent (anhydrous) sodium carbonate solution is added. The tube is plugged with cotton and immersed in boiling water for 10 minutes.² It is then removed, and the contents are cooled under running water and diluted to 12.5 c.c. or to 25 c.c. depending on the depth of color.³ At any time within a half an hour the colored solution is compared in a colorimeter with a suitable standard solution, the standard being set at a height of 15 mm.

The standard solution may be simultaneously prepared from pure glucose by treating 0.64 mg. of glucose in 4 c.c. of water with 4 c.c. of the picrate-picric acid solution and 1 c.c. of the carbonate, and heating for 10 minutes in boiling water and then diluting to 12.5 c.c. A permanent standard solution may be prepared from picramic acid or from potassium dichromate as mentioned below.⁴ The potassium dichromate standard does not match the unknown with absolute exactness, but can be employed with satisfactory results when pure picramic acid is not obtainable.

Calculation.—If directions are followed exactly the calculation is as follows:

$$\frac{\text{Reading of standard}}{\text{Reading of unknown}} \div 10 = \text{per cent of sugar in the original blood.}$$

Where the final dilution of the unknown is made to 25 c.c. instead of 12.5 c.c. the final figure is, of course, multiplied by two.

(c) **Epstein's⁵ Modification of Lewis and Benedict's Method.**—Principle.—This method is a modification of the Lewis and Benedict procedure, being based

¹ To prepare the picrate-picric acid solution, place 36 gm. of dry powdered picric acid in a liter flask or stoppered cylinder, add 500 c.c. of 1 per cent sodium hydroxide solution, and 400 c.c. of hot water. Shake occasionally until dissolved. Cool and dilute to 1 liter.

² Longer heating up to half an hour makes no change in the color.

³ Occasionally the final filtrates in this or other picric acid methods develop a little turbidity during heating. Unless such turbidity is fairly marked it is of no account. When desired, the final colored solution may be filtered through a small folded filter into the colorimeter cup.

⁴ **Permanent Standard.**—The picramic acid standard is best prepared from a stock solution containing 100 mg. of picramic acid and 200 mg. of sodium carbonate per liter. One hundred twenty-six c.c. of this solution are treated with 1 c.c. of the 20 per cent carbonate solution and 15 c.c. of the picrate-picric acid solution, and diluted to 300 c.c. with distilled water. This solution matches exactly the color obtained by treating 0.64 mg. of glucose, as in the above method and diluting to 12.5 c.c. A satisfactory preparation of picramic acid may be obtained from the J. T. Baker Chemical Co., Phillipsburg, N. J.

The standard prepared from potassium dichromate contains 800 mg. of pure potassium dichromate in a liter of water.

⁵ Epstein: *J. Am. Med. Assn.*, 63, 1667, 1914; Janney and Isaacson: *Jour. Amer. Med. Ass'n*, 70, 1131, 1918.

on the same principle but making possible the determination of reducing sugar in finger blood (0.1–0.2 c.c.) with a sufficient degree of accuracy for clinical purposes, and with little expenditure of time. Instead of a Duboscq colorimeter the less expensive Sahli-Gower hemoglobin colorimeter is recommended.

Procedure.—The apparatus¹ shown in the illustration (Fig. 87) and the following reagents are necessary:

1. Picric acid, saturated solution.
2. Sodium carbonate, 10 per cent solution.
3. Sodium fluorid or potassium oxalate, 2 per cent solution.

Put one or two drops of the fluorid or oxalate solution into the graduated test-tube (see illustration). By means of the blood pipette 0.2 c.c. of blood is obtained from the tip of the finger or the lobe of the ear and is discharged into the tube containing the fluorid solution. The pipette is rinsed two or three times with distilled water and the washings added to the blood in the tube. Distilled water is then added to the 1.0 c.c. mark. After laking of the blood has taken place, picric acid is added to this (a few drops at a time) up to the 2.5 c.c. mark, shaking

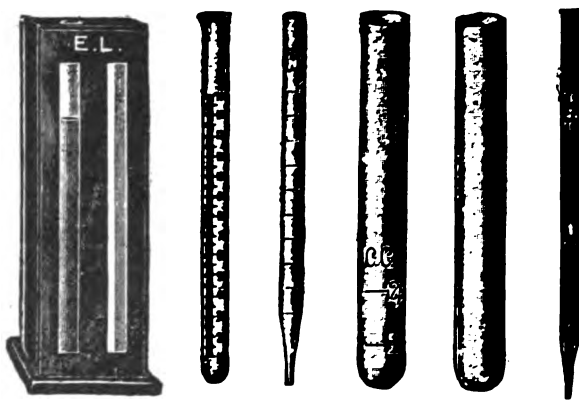

FIG. 87.—APPARATUS FOR EPSTEIN'S SUGAR METHOD.

the tube gently with each addition of the acid. Precipitation of the blood-proteins takes place; the sugar, together with an excess of picric acid sufficient for the reaction, stays in solution. The tube is finally shaken vigorously (covering the end of the tube with the finger) and the contents filtered through a small filter, or, better still, centrifuged for one or two minutes.

One c.c. of the filtrate or the clear supernatant fluid obtained on centrifugalization is withdrawn, put into the plain test-tube, and heated carefully over the naked flame. The contents of the tube are boiled until all but 2 or 3 drops of the solution is evaporated. One-half c.c. of the 10 per cent sodium carbonate solution is then added and the tube heated again until the contents are concentrated to

¹ The tubes belonging to this hemoglobinometer are not all equally calibrated. With some the 50 per cent mark represents a volume of 1.0 c.c.; with others, 1.0 c.c. of fluid reaches up to the 43, 45, 46 or 47 per cent mark. The error in the calibration is generally below the 10 per cent mark; the graduations above this mark are usually correct. By means of the standard 1.0 c.c. pipette one can readily determine whether or not a given tube is properly calibrated. In order to facilitate a direct reading of the percentage of sugar on these hemoglobinometer tubes, it is essential to have 1.0 c.c. of fluid stand at mark 50. To overcome a discrepancy (if any exists) in the calibration of a given tube, one may put one, two or three small glass beads in the bottom of the tube, of such size as to raise the meniscus of 1.0 c.c. of fluid up to the 50 per cent mark.

a small volume equal to about 2 or 3 drops. The color of the fluid changes from yellow to deep red or reddish brown and the reaction is completed.

Three or 4 drops of distilled water are added and the tube warmed gently. The contents are then transferred to the graduated tube of the hemoglobinometer. The boiling tube is rinsed several times with water (using only 3 or 4 drops at a time). The tube is warmed with each rinsing before transferring the contents to the graduated tube. The volume of fluid is then made up to the mark 50 on the scale.

The color of the resulting solution is compared with that of the two standard tubes, *A* and *B* which accompany the instrument. (A solution of picramic acid of the proper strength, prepared as described on p. 284, may be used as a standard.) If it is darker than standard *A* (representing 0.05 per cent of sugar) and lighter than standard *B* (representing 0.1 per cent), the first standard is used for comparison. In either case the solution in the graduated tube is diluted gradually with water (just as is usually done in hemoglobin estimations) until the colors match.

The percentage of sugar in the blood is then computed thus: Using the lighter standard *A* the figure on the scale, divided by 1000 represents the percentage of sugar in the blood. For example, the tube reads 86; then the result is

$$\frac{86}{1000} = 0.086 \text{ per cent}$$

When Standard *B* is used for comparison, the figure on the scale is multiplied by 2 and divided by 1000. For example, the tube reads 73; then the percentage of sugar is

$$\frac{73 \times 2}{1000} = 0.146 \text{ per cent}$$

With the instructions given, the above formulas may be used for direct computation of the percentage of sugar only, when 0.2 c.c. of blood is used in the determination. When, however, only 0.1 c.c. of blood is used, the formulas apply as well, but the value obtained must be multiplied by 2.

It is better, in cases in which a high sugar content in the blood is suspected (in diabetes for example) to use only 0.1 c.c. of blood for the determination. In all other cases 0.2 c.c. of blood should be used.

(d) **Micro-method of Bang.**—**Principle.**—Two or 3 drops of blood are transferred to a small weighed piece of blotting paper and the paper again weighed to determine the amount of blood. The paper is then treated with a boiling acidified KCl solution which coagulates the protein and allows the sugar to diffuse out. The sugar solution thus obtained is boiled with alkaline cupric chloride solution. The amount of cuprous chloride solution formed by the reducing action of the sugar is determined by titration with standard iodine solution.

Procedure.—Small pieces of good absorbent paper, about 16×28 mm. in size,¹ weighing about 100 mg. and held by a small spring clip, are used. To one

¹ Suitable pieces of paper, weighed, ready for use, and with clip attached, may be obtained from Warmbrunn and Quilitz, Berlin. A suitable paper may also be obtained from Griffin and Sons, London, or Grave of Stockholm. Unless specially prepared, the paper should be repeatedly washed with large volumes of hot water acidified with acetic acid to remove impurities.

of these previously weighed¹ transfer 2–3 drops (about 120 mg.) of blood obtained by piercing the cleansed finger. Weigh again immediately and determine by subtraction the weight of blood taken.

Coagulation of Blood Protein.—Transfer the piece of paper to a test-tube and add 6.5 c.c. of boiling acid-potassium chloride solution² and let stand half an hour. The clear solution containing the sugar is poured into a 50 c.c. Jena flask the flange of which has been removed. Wash the paper and tube again with 6.5 c.c. of hot salt solution and transfer washings to the flask. Cool.

Reduction of Cupric Chloride.—Attach to the mouth of the flask a piece of tight-fitting rubber tubing about 2 inches long (see Fig. 88), provided with a clamp which permits of shutting off the contents of the flask from the outside air. Now add to the flask 1 c.c. of the cupric chloride solution.³ Heat so that the solution is brought to a boil in one minute and 30 seconds (an error of five seconds may be disregarded). Allow to boil for exactly two minutes; at the end of this time tighten the clamp over the mouth of the flask. At the same time remove from the flame and cool at once under the tap for about a minute.

Titration of Cuprous Chloride Formed.—The titration is made with N/200 iodine solution⁴ run in from a very accurate burette (preferably a 2 c.c. burette graduated in 1/50 c.c.). Two or 3 drops of starch solution (preferably soluble starch⁵) are added as an indicator. During the titration air must be excluded to prevent re-oxidation. This is done by running a slow stream of carbon dioxide from a generating bottle through a small tube which extends nearly to the bottom of the flask. The titration should be carried out against a white background and the end point taken when the blue color persists for 20–30 seconds.



FIG. 88.—
BANG REDUC-
TION FLASK.

Calculation.—The copper and other solutions used in the test bind about 0.12 c.c. of the iodine solution. This amount must hence be subtracted from the reading. The corrected reading is then divided by 4 to obtain the number of milligrams of glucose in the sample.

Example.—If 0.68 c.c. of N/200 I solution were required, $\frac{0.68 - 0.12}{4} = 0.14$ mg. glucose in the amount of blood used. If 140 mg. of blood were taken for analysis the per cent of glucose in the blood would be $\frac{1000}{140} \times 0.14$ mg. = 0.1 per cent glucose.

¹ The weighing is preferably made on a special torsion micro-balance which, as well as the other apparatus used in this method, may be obtained from either of the firms mentioned in Note 1, page 286. The weighing must be made in a few seconds and with an accuracy of about 1 mg.

² Consisting of 1360 c.c. of saturated KCl to which is added 640 c.c. of water and 1.5 c.c. of 25 per cent HCl.

³ Copper solution. Introduce into a 1000 c.c. flask 700 c.c. of boiled and cooled water. Warm to about 30°C. and add 160 grams of pure potassium bicarbonate in powder form. When dissolved add 66 grams of pure KCl. Cool and then add 100 grams potassium carbonate. Finally add 100 c.c. of 4.4 per cent solution of pure crystalline copper sulphate. Let stand a short time, then make to mark with boiled water. Allow to stand a day or so before using.

⁴ N/200 I solution, made fresh each day. Dilute N/10 I solution 20 times, or make as follows: Introduce into a 100 c.c. flask 2 grams KI, 1–2 c.c. of 2 per cent KIO₃ solution and 5 c.c. of N/10 HCl. Make to mark with boiled and cooled distilled water.

⁵ A 1 per cent solution of Kahlbaum's soluble starch in a saturated KCl solution.

The results obtained by this method are a little higher than those obtained by other reliable methods due to the presence of certain I-binding substances in blood. As these appear to be nearly constant in amount a correction may be applied. To obtain true values for glucose of the blood therefore subtract 0.015 per cent from the value obtained as above. $0.1 \text{ per cent} - 0.015 \text{ per cent} = 0.085 \text{ per cent glucose}$.

To secure accurate results the method of Bang must be rigidly controlled, all new solutions and absorbent papers being checked up against pure 0.2 per cent glucose solutions. Taylor and Hulton¹ also suggest the following precautions. A blank check must be made on the reagents each day an estimation is made. 0.10–0.15 gram of blood should be taken and must spread smoothly on the paper. The proteins are best coagulated by heating of the blood-impregnated papers in the hot air oven at 100° (as recommended by Gardner and McLean)² for five minutes with corks of flasks inverted. The solution should be boiled four minutes for complete reduction. The iodine solution must be fresh each day and checked each day. Determinations should be made in triplicate. Results cannot be depended upon to be more accurate than to 0.005 gram glucose in 100 c.c. blood. Other authors have recommended that an hour instead of half an hour be allowed for the diffusion of the blood sugar, the fluid being brought to the boiling-point twice during this period or kept in a bath at 40°C.

9. Acetone Bodies³ (Acetone, Acetoacetic Acid and β -Hydroxybutyric Acid).—Marriott-Scott-Wilson Method.⁴—(a) Acetone and Acetoacetic Acid.—Draw 10 c.c. of blood from a superficial vein by a sterile graduated syringe and run it into about 40 c.c. of 0.5 per cent potassium oxalate solution. Fit up a Kjeldahl distillation apparatus using an 800 c.c. flask, provided with a dropping funnel, the delivery tube of the condenser dipping beneath the surface of the water in a receiving flask. Introduce into the Kjeldahl flask 100 c.c. of water and 1 c.c. of glacial acetic acid. Bring the acidified water to a boil and then run the diluted blood in slowly through the dropping funnel.

Boil for 30 minutes after the last blood is run in.⁵ To the distillate add a little dilute sulphuric acid and redistil. To this distillate add 20 c.c. of hydrogen peroxide solution and a slight excess of alkali and redistil again. The final distillate is caught in small Erlenmeyer flasks containing an excess of the Scott-Wilson "acetone reagent" which has been recently filtered.⁶ The delivery tube must dip under the surface of the liquid. It is not necessary to distil more than 10 minutes to get off all the acetone. Allow to stand for 10–15 minutes. Filter

¹ Taylor and Hulton: *Jour. Biol. Chem.*, 22, 63, 1915.

² Gardner and McLean: *Biochem. J.*, 8, 391, 1914.

³ For nephelometric method see p. 299.

⁴ Scott-Wilson: *Jour. of Physiol.*, 42, 444, 1911.

Marriott: *Jour. Biol. Chem.*, 16, 295, 1913.

⁵ If β -oxybutyric acid is to be determined the residue in the Kjeldahl flask should be kept and treated as outlined in the latter part of this procedure.

⁶ The reagent is made up as follows: Mercuric cyanide, 10 grams; sodium hydroxide, 180 grams; water, 1200 c.c. The solution is agitated in a flask and 400 c.c. of a 0.7268 per cent solution of silver nitrate slowly run in. At least 30 c.c. of the reagent must be taken for each milligram of acetone present.

through an asbestos mat¹ in a separable bottom Gooch crucible. Clear filtrates are more readily obtained if the pores of the filter have been partly closed by filtering through it a suspension of talcum powder in water. If the first portions of the filtrate are turbid, refilter. Wash the precipitate with cold water until the washings are free from silver.

With the aid of a pointed hooked glass rod transfer the precipitate, mat and crucible bottom to a 50 c.c. beaker, any adhering particles of precipitate being washed into the beaker with the aid of about 10 c.c. of "acid mixture."² Add 1 c.c. of N/5 potassium permanganate, cover the beaker with a watch glass and boil until the liquid is colorless. Add more permanganate, a few drops at a time, until a persistent brown color is obtained which does not disappear on boiling for a couple of minutes. The brown color is then discharged by the addition of a few drops of strong yellow nitric acid. The greater the amount of acetone present the more permanganate is required, and it is essential to the accuracy of the method that an excess be added as indicated above, otherwise the results are too low.

Cool the beaker under the tap, add 2 c.c. of saturated ferric alum solution and run in from a burette a standard solution of potassium sulphocyanate (approximately 0.1 per cent)¹ until a very faint pinkish-brown color is obtained throughout the solution. The end point which consists in the faintest trace of color, can be detected only when the titration is performed on a pure white surface. A control beaker with 1 drop excess of sulphocyanate should be on hand for comparison. A whole cubic centimeter of sulphocyanate may be run in after the end point is reached without very greatly darkening the shade.

Calculation.—By this procedure acetone preformed and from diacetic acid are determined together. The amount of acetone and diacetic acid combined, in terms of acetone, may then be calculated by multiplying the number of cubic centimeters of the KSCN solution used by the equivalent of 1 c.c. of this solution in acetone as determined by standardization.³ To obtain the amount of acetone and diacetic acid in 100 c.c. of blood the result must of course be multiplied by 10.

(b) Determination of β -Hydroxybutyric Acid.—The residue in the Kjeldahl flask from the above determination is used in the determination of β -hydroxybutyric acid. While still hot, precipitate it with about 8 c.c. of 10 per cent sodium carbonate, boil a moment, filter on a Büchner funnel and wash with hot water. To the clear filtrate add 15 c.c. of basic lead acetate (U.S.P.) and 10 c.c. of strong ammonia and make to definite volume (150 c.c.) with water. Allow the precipitate to settle and then filter off on a dry, folded filter. Take an aliquot of the clear filtrate (about 125 c.c.) and boil it to expel the greater part of the ammonia. Cool and add dilute sulphuric acid to precipitate the excess of lead as sulphate and filter. Add 10 c.c. of 50 per cent sulphuric acid and transfer the whole to a Kjeldahl flask provided with a dropping funnel. The contents of the flask are distilled and a solution of potassium bichromate is run in from the dropping funnel at such a rate that the liquid always retains some yellow color and the volume remains at about 100 c.c. It is rarely necessary to add more than about 0.1 gram

¹ Filter paper cannot be used as the strong alkali quickly attacks it.

² "Acid mixture:" Nitric acid 40 parts; sulphuric acid 5 parts; water 55 parts.

³ The sulphocyanate solution should be standardized against pure acetone treated in the same manner as the final distillate above. According to Scott-Wilson it may also be standardized against a pure solution of mercuric nitrate and the equivalent of 1 c.c. of the KSCN solution in milligrams of Hg determined. According to this author 1 mg. of Hg is equivalent to 0.058 mg. of acetone.

The results obtained by this method are a little high by other reliable methods due to the presence of certain blood. As these appear to be nearly constant in amount applied. To obtain true values for glucose of the 0.015 per cent from the value obtained as above. $0.015 \times 1.08 = 0.085$ per cent glucose.

To secure accurate results the method of F... controlled, all new solutions and absorbent p... against pure 0.2 per cent glucose solution... also suggest the following precautions. A... on the reagents each day an estimation i... blood should be taken and must spread s... proteins are best coagulated by heating... papers in the hot air oven at 100° (as re... McLean)² for five minutes with corks... tion should be boiled four minutes... iodine solution must be fresh each day... minations should be made in triplicate... upon to be more accurate than to 0.00... Other authors have recommended that... be allowed for the diffusion of the bl... to the boiling-point twice during thi...

9. Acetone Bodies³ (Acetone, Aceto... —Marriott-Scott-Wilson Method.⁴—(a... 10 c.c. of blood from a superficial veir... into about 40 c.c. of 0.5 per cent potas... distillation apparatus using an 800 c... the delivery tube of the condenser d... a receiving flask. Introduce into th... of glacial acetic acid. Bring the... diluted blood in slowly through the... Boil for 30 minutes after the las... dilute sulphuric acid and redistil... peroxide solution and a slight ex... tillate is caught in small Erlenm... Wilson "acetone reagent" which... must dip under the surface of th... 10 minutes to get off all the ac...

¹ Taylor and Hulston: *Jour. Biol. Chem.*

² Gardner and McLean: *Biochem. Jour.*

³ For nephelometric method see...

⁴ Scott-Wilson: *Jour. of Physiol.*

Marriott: *Jour. Biol. Chem.*

⁵ If β -oxybutyric acid is to be... kept and treated as outlined in...

⁶ The reagent is made up... 180 grams; water, 1200 c.c.

per cent solution of silver nit... taken for each milligram of a...

continued for... every tube... Add... again... the Scott-... and de... ing method... in terms of

of Aulen-... with strong... extracted with... purified, dried... uric acid and... color of the... obtained. The... produced by a

whole blood, serum... a straight tube reflux... 10 c.c. of a 25 per cent... shaking frequently... greenish and contains... substances. This usually... mixture to a separatory... usily for fifteen minutes... portions of chloroform... combined chloroform... may be greenish or brown)... with 15 c.c. portions of... of the chloroform layer into... as sodium sulphate, bring... a 100 c.c. volumetric flask... washing and treatment with... important as they bring about... the subsequent comparison... transfer 10 c.c. of this extract... capacity, add 4 c.c. of pure... uric acid and shake. Place

ification... 43, 1913). A slight modification... by Bloor, *Jour. Biol. Chem.*,

yellowish satisfactory results are... color. When such discoloration... led before using. The anhydride... between 134° and 140°C . may be

38°C. and allow to stand 15 minutes in the same time a series of standards is prepared. The color of the unknown is compared with the most similar of the standards. Readings should be taken. Such readings should be taken. Four standards are kept, 10 c.c. portions of chloroform: (1) 2 mg. of pure cholesterol.¹ In preparing 10 c.c. portions of each of the above standard solutions glass-stoppered bottles and treated with the same as the unknown. The standards then are made up in various dilutions, cholesterol concentrations of 0.2 mg. respectively, in 100 c.c. of the original solution. A 0.2 mg. standard solution is usually satisfactory, and the cholesterol content the other standards should

Unknown reading

Reading \times Cholesterol Equivalent of standard
= milligrams of cholesterol in 100 c.c. of whole

*McLean and Van Slyke.*²—The determination re-
quires (1) removal of proteins and (2) titration of chlorides.

The removal of the proteins³ may be accomplished in two
ways. Results are identical by both methods, but
the former is simpler. For coagulation 2 c.c. of oxalated plasma (1 c.c. may
be used) are drawn into a 2 c.c. pipette which has been cali-
brated. From the pipette the plasma is run into a 20 c.c.
flask which contains 10 c.c. of a 10 per cent magnesium sul-
fate is rinsed twice by drawing up into it the solution from
the pipette. 50 per cent acetic acid are added, the flask is filled to the
contents are mixed by inverting the flask, and heated in a
water bath for 5 minutes. By keeping the stopper loosely in place evaporation
will occur and when cool the contents return to their original volume. Ten
minutes in a water bath are sufficient to coagulate the albumin and to distribute
the precipitate between the fluid and precipitated albumin. The flask is then
inverted and the contents are poured upon about 0.3 gram of blood char-
coal, and mixed. After a few minutes the liquid is filtered
through a Whatman No. 1 filter, and a water-clear filtrate obtained.

The Protein-free Filtrate.—In brief, the chlorides are precipitated in
the filtrate with nitric acid by standard silver nitrate solution, the silver chloride is
precipitated, and the excess silver titrated with standard potassium

chromate. Convenient to make up a stock solution of pure cholesterol containing 100 mg. in
100 c.c. pure chloroform, diluting this as required to make up the four standards
as above.

McLean and Van Slyke: Jour. Biol. Chem., 21, 361, 1915.

Because of the difficulty or impossibility of obtaining Merck's blood charcoal, two
variations of this method have been suggested for the removal of protein. Harding
and Johnson (*Jour. Biol. Chem., 31, 55, 1917*) precipitate the protein by adding copper
sulfate and alkali, while Foster (*Jour. Biol. Chem., 31, 483, 1917*) proposes the use of
phosphoric acid. The McLean and Van Slyke procedure is followed after the protein
is removed in each case.

¹Merck's "Blood Charcoal Reagent," purified by acid and free from chloride, is used.

iodide.¹ The titration is performed in the presence of nitrous acid and starch, so that the first drop of iodide in excess of the silver present is changed to free iodine and gives the blue starch-iodine color. The optimum acidity for the end point is fixed by the addition of trisodium citrate in amount equivalent ($\frac{1}{2}$ mol.) to the free nitric acid present. Under these conditions 1 drop of excess N/50 iodide gives a color perceptible in 150 c.c. of solution.

In detail, the titration of the protein-free plasma filtrate is carried out as follows: Either 10 c.c. of the filtrate, containing the chlorides of 1 c.c. of plasma, are taken in a pipette for titration or the filtrate is collected directly in a certified 25 c.c. graduated cylinder, where it is measured, so that the entire amount may be taken for titration. In this way 13 to 14 c.c. of filtrate, corresponding to 1.3 to 1.4 c.c. of plasma, may be obtained for titration.

After either measuring 10 c.c. of the filtrate into a 25 c.c. volumetric flask or recording the amount of filtrate obtained in the cylinder, 5 c.c. of the acidified *M*/29.25 silver nitrate solution (Solution I) are added, and the whole is made to the 25 c.c. mark with water. This will precipitate up to 10 mg. of NaCl. In samples with high percentage of chloride, only enough filtrate is taken to keep within this limit of 10 mg. Two drops of octyl (caprylic) alcohol are added, and the vessel is stoppered and shaken gently by inverting it several times. Immediate coagulation of the silver chloride occurs. After allowing five minutes for complete precipitation to occur, the solution is filtered through a dry folded filter, and a perfectly clear and colorless filtrate again obtained. An aliquot part of the filtrate (20 c.c.) is now taken with a pipette for titration.

Just before titration with the potassium iodide solution (Solution II) one adds a volume of the citrate solution (Solution III) equal to the volume of Solution I represented in the filtrate to be titrated. If, as is usually the case, one has used 5 c.c. of Solution I diluted to 25 c.c., and taken 20 c.c. of the filtrate for titration, one has the equivalent of 4 c.c. of Solution I present, and must accordingly add

¹ The following solutions are required:

I. An acid *M*/29.25 solution of silver nitrate, 1 c.c. of which is equivalent to 2 mg. of NaCl.

AgNO ₃	5.812	grams
HNO ₃ (sp. gr. 1.42).....	250	c.c.
Water to.....	1000	c.c.

II. A solution of *M*/58.5 potassium iodide, 1 c.c. of which is equivalent to 1 mg. of NaCl.

KI.....	3.0	grams
Water to.....	1000	c.c.

This solution is standardized against the silver solution by adding 5 c.c. of the latter to 5 c.c. of Solution III, and titrating with the iodide solution to the blue end-point. The iodide solution is then diluted to such a degree that 10 c.c. are exactly equivalent to 5 c.c. of the silver solution.

III. A solution, for use in the final titration, containing sodium citrate, sodium nitrite, and starch, which substances respectively regulate the acidity, provide an oxidizing agent for the iodide, and serve as indicator.

Sodium citrate (Na ₃ C ₆ H ₅ O ₇ + 5 $\frac{1}{2}$ H ₂ O).....	446	grams
Sodium nitrite.....	20	grams
Soluble starch.....	2.5	grams
Water to.....	1000	c.c.

The starch is first dissolved with the aid of heat in about 500 c.c. of water. The citrate and nitrite are then added, and the mixture is heated until all is dissolved. The solution, while still hot is filtered through cotton, the filter washed with hot water, the filtrate allowed to cool, and made up to 1000 c.c. Filtration removes insoluble substances occurring chiefly in the nitrite, and cotton filters more rapidly than filter paper. The solution keeps indefinitely. It becomes cloudy on standing, but its efficacy is not impaired.

4 c.c. of Solution III. On adding Solution III a slight turbidity appears, which in no way interferes with the end point.

The potassium iodide solution is then run in from a burette until the blue end point appears. The first definite blue color is taken as the end point, and with slight practice is unmistakable. An additional drop, which may be used as a control, causes such a deep blue color that it is impossible to make an error of more than one drop in titration. Should the end point be accidentally passed, one may add 1 c.c. of Solution I, 1 c.c. of Solution III and retitrate, allowing in the calculation for the extra silver nitrate.

The result may be calculated from the following formula, which applies only when 20 c.c. of the filtrate from silver chloride are titrated:

$$\text{Grams NaCl per liter} = \frac{12.5 (8 - \text{c.c. KI solution used})}{\text{c.c. blood filtrate taken}}$$

Thus, if 13 c.c. of filtrate are obtained and titrated after precipitation of plasma protein, and 1.60 c.c. of KI are used in the final titration,

$$\text{Grams NaCl per liter} = \frac{12.5 (8 - 1.60)}{13} = 6.15.$$

In case only 1 c.c. of plasma instead of 2 c.c. has been used, the factor 25 replaces 12.5 in the numerator. The error should be within a limit of 1 per cent.¹

11. Calcium. Method of Halverson and Bergeim.²—Principle.—The method depends upon, (1) the removal of protein by means of sodium picrate and heat, (2) the precipitation of calcium from the protein free material as the oxalate, and (3) titration of the calcium oxalate with very dilute standard potassium permanganate solution.

Procedure.—*A. Removal of Protein.*—Whole blood is preserved with powdered sodium citrate to make approximately 1.5 per cent. An additional 1 per cent of citrate should be added to plasma if this is not to be analyzed at once. Directions given below are for serum or plasma. Twice the quantity of whole blood should be employed and reagents increased proportionately.

Pipette 5 c.c. of serum or plasma into a 50 c.c. volumetric flask containing exactly 20 c.c. of distilled water. Rinse by once drawing the solution up into the pipette. While rotating the flask add from a pipette 5 c.c. (1 c.c. per c.c. of plasma or serum) of a 4 per cent solution of sodium picrate.³ In the same manner add slowly 5 c.c. of hydrochloric acid (1:2). Heat in a boiling water-bath with occasional rotation for 15 minutes. Cool to a little below room temperature in cold water. Pour onto a folded calcium-free filter paper and allow to drain well.

¹ The exactness of the method depends directly on the care with which measurements are made and on the purity of the reagents used. All reagents must, of course, be free from substances precipitated by silver, and are easily tested. As the volumes measured are not large, however, small absolute errors in measurement may cause considerable percentage error in the final result. All glassware must therefore be carefully calibrated by either the weight of water contained (flasks, cylinders, 2 c.c. pipettes) or the weight delivered (other pipettes, burettes), and burettes should be used which are capable of being read to 0.02 c.c. and which deliver small drops. If these precautions are followed, one should uniformly obtain results, which are well within a limit of error of 1 per cent.

² Halverson and Bergeim: *Jour. Biol. Chem.*, 32, 159, 1917. For colorimetric method see Marriott and Howland: *Jour. Biol. Chem.*, 32, 233, 1917 and for nephelometric method see Lyman: *Jour. Biol. Chem.*, 29, 169, 1917.

³ *Sodium Picrate Solution, 4 Per Cent.*—To 40 gm. of dry purified picric acid add a little calcium-free water and 10 gm. of highest purity anhydrous sodium carbonate (calcium-free) dissolved in 50 c.c. of water. Dilute to 1 liter. Shake until the picric acid is completely dissolved. Add concentrated hydrochloric acid until a slight permanent precipitate of picric acid forms. Filter through highest grade filter paper.

B. Precipitation of Calcium.—Measure an aliquot (usually 25 c.c.) of the filtrate into a 50 c.c. Erlenmeyer flask (Pyrex). Neutralize cautiously with concentrated ammonium hydrate added drop by drop from a burette, using one or two drops of alizarin indicator solution (0.2 per cent). Titrate back until faintly acid with approximately 0.5/N hydrochloric acid. McCrudden's method is then followed. Add from a burette 2.5 c.c. of the hydrochloric acid 0.5/N mentioned above and then the same amount of 2.5 per cent oxalic acid. To the boiling solution add dropwise in two portions 2.5 c.c. of 3 per cent ammonium oxalate. Digest at near boiling for 15 minutes.

Cool in ice water to room temperature or lower. Add another drop of alizarin and also dropwise from a burette 2.5 c.c. of 20 per cent sodium acetate solution while rotating the flask, or if found necessary add until the alizarin just *begins* to change color. Allow to stand over night (or at least 4 hours after 10 minutes' shaking).

Transfer completely to a 50 c.c. round bottom centrifuge tube with the aid of a little water and whirl for about 3 minutes at 1500 revolutions per minute. With an automatic siphon draw off the supernatant liquid at first rapidly and then gently to within a drop or two. Wash with cold distilled water (15–20°C.) first adding about 20 c.c., washing down the sides and rotating the tube. Then add more water from the wash bottle to within about 1.75 cm. of the top of the tube (approximately 50 c.c.). Placing the metacarpal portion of the palm of the hand at the thumb over the mouth of the tube shake vigorously for 5 to 10 seconds. Centrifuge again. Siphon off to within one or two drops and titrate.

C. Titration.—To the precipitates in 50 c.c. centrifuge tubes add, with shaking, 4 c.c. of 5 per cent sulphuric acid (very faintly tinged with potassium permanganate). Place in a water-bath at 65°C. until the tubes approach the temperature of the bath. Remove and titrate rapidly with an approximately 0.0133/N potassium permanganate solution,¹ with moderate shaking using a white background. A burette of 10 c.c. capacity with which readings can be readily estimated to 0.01 c.c. is desirable.

The end point is attained when a faint but definite pink color persists for a minute or longer on gentle shaking and standing. If the precipitate has not been contaminated the end point will be sharp to 0.01 c.c. The sulphuric acid must be brought in contact with all parts of the tube as far up as the original solution extended. The burette reading should be corrected for the small amount of permanganate required to titrate 4 c.c. of the sulphuric acid to the same end point.

D. Calculation.—1 c.c. of 0.0133/N potassium permanganate is equivalent to 0.267 mg. of calcium. The exact factor for a given solution must be determined by standardization. Multiply the number of c.c. used by this factor to obtain the amount of calcium in the 25 c.c. of filtrate. If blank on reagents is not negligible deduct. Multiply by 28 to get mg. of Ca per 100 c.c. of serum or plasma.

12. Total Solids.—The total solids of the blood are most readily determined by using a type of weighing bottle differing from the usual form merely in having a glass loop attached to the under side of the stopper.² A block of filter paper is suspended from this loop by means of a small wire hook. The bottle and filter block are dried and weighed. From a small pipette 0.3–0.6 gram of the well-mixed

¹ For the method of preparing this dilute standard permanganate solution see Halverson and Bergeim: *Jour. Ind. Eng. Chem.*, 10, 110, 1918.

² Myers and Fine: "Chemical Composition of the Blood in Health and Disease," 1915. The weighing bottles may be obtained from Eimer and Amend, N. Y.

blood is allowed to flow rapidly upon the filter block. The stopper is quickly inserted and the bottle weighed. The stopper is then tilted and the bottle placed in the drying oven at 105° over night. When convenient the bottle is cooled and again weighed. The total solids are calculated from the loss of moisture.

13. The Determination of Epinephrin (Adrenalin) in the Adrenal Glands.¹—*Principle.*—It has not yet been found possible to determine adrenalin in the blood by chemical methods. In the adrenals it may be determined by the method given below.

The method is based upon the quantitative production of blue color when a solution of adrenalin is treated with phosphotungstic acid. Uric acid and other substances likewise give the reaction but can be disregarded when the determination is made upon adrenal glands.

Procedure.—Rub the weighed gland thoroughly in a mortar with fine sand and N/10 hydrochloric acid. The mixture is then rinsed into an Erlenmeyer flask with more N/10 acid and water, using in all about 15 c.c. of the acid for each 2 grams of gland and about three times as much water. Heat to boiling to dissolve the epinephrine. Then add 5 c.c. of 10 per cent sodium acetate solution for each 15 c.c. of hydrochloric acid present and heat again to boiling. Transfer the whole mixture (except the sand) to a volumetric flask (capacity 100 c.c. for each 2 grams of gland) and make to mark with water. Filter. Pipette 5 c.c. of the clear extract into a 100 c.c. measuring flask and 1 c.c. of a fresh uric acid solution containing 1 mg. of uric acid into another 100 c.c. flask. To each flask add 2 c.c. of uric acid reagent (see Folin and Denis' method for uric acid, page 279) and 20 c.c. of saturated sodium carbonate solution. Allow to stand for two to three minutes, dilute to the mark, shake thoroughly, and compare in the usual manner in a Duboscq colorimeter with the uric acid standard set at 20 mm. Calculate as if the solution contained uric acid, and divide the result by three to obtain the equivalent in epinephrine which gives three times as much color as an equal weight of uric acid.

Nephelometric Methods

The Nephelometer.—The nephelometer is an instrument for measuring the density of precipitates and thus determining the amount of any substance which can be obtained in the form of a suitable suspension. It is somewhat similar in form and principle to a colorimeter. It differs from the latter in that the light which reaches the eye is not transmitted light, which, on the contrary, is excluded, but light reflected from the particles of the suspension. The brightness of the two fields is compared instead of their colors. It is adapted particularly for the determination of substances that in very dilute solution may be precipitated in the form of suspensions which do not agglutinate appreciably in the time required for making readings (10–20 minutes). The method has been adapted to the determination

¹ Folin, Cannon, and Denis: *Jour. Biol. Chem.*, 13, 477, 1913.

of proteins in digestion mixtures, milk, urine, etc.;¹ nucleic acids;² chlorides,³ phosphates, and phosphatides in blood, etc.;⁴ fats in milk, blood, etc.;⁵ acetone bodies in urine and blood;⁶ uric acid and purine bases;⁷ ammonia;⁸ calcium;⁹ silver, etc., and is continually finding new applications. It is possible to determine very minute amounts of substances, entirely outside of the range of gravimetric methods of analysis, and hence the procedure may be used where the amount of material is very limited. If properly carried out the limits of error

of the method are not greater than those of the colorimetric methods commonly used. Below will be found descriptions of and figures representing two satisfactory types of nephelometer.

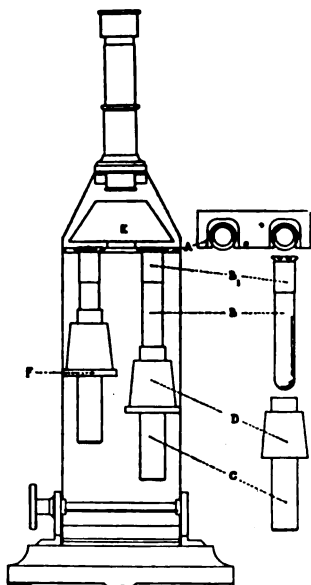

FIG. 89.—BLOOR'S NEPHELOMETER.

The Duboscq colorimeter has been adapted for nephelometric purposes by Kober¹⁰ and by Bloor.¹¹ Bloor's nephelometer is illustrated in Figs. 89 and 90. The brass plate carrying the colorimeter plungers is replaced by the plate *A* with two slots in which are supported the nephelometer tubes *B* with their flanges resting on the edges of the slots. The slots are so cut that the center lines of the tubes are exactly in line with the centers of the lower openings of the prism case *E*. If desired they may be countersunk to receive the flanges. The colorimeter cups

are replaced by the jackets *C* which project through the holes in the cup supports *F* and are supported on them by the collars *D*. They move when the cup supports move. The mirror is turned to the horizontal position so that it reflects no light. The light in the nephelometer comes from in front and not from below (see Fig. 90). The nephelometer tubes are small test-tubes 100×15 mm., preferably

¹ Kober: *Jour. Biol. Chem.*, 13, 485, 1913; *Jour. Am. Ch. Soc.*, 35, 1585, 1913; Folin and Denis: *Jour. Biol. Chem.*, 18, 273, 1914.

² Kober and Graves: *Jour. Am. Chem. Soc.*, 36, 1304, 1914.

³ Richards: *Zeitschr. f. anorg. Chem.*, 7, 269, 1895.

⁴ Greenwald: *Jour. Biol. Chem.*, 21, 29, 1915; Bloor: *Jour. Biol. Chem.*, 22, 133, 1915; Kober and Egerer: *Jour. Am. Chem. Soc.*, 37, 2373, 1915.

⁵ Bloor: *Jour. Biol. Chem.*, 17, 377, 1914; *J. Am. Chem. Soc.*, 36, 1300, 1914.

⁶ Folin and Denis: *Jour. Biol. Chem.*, 18, 263, 1914; Marriott: same, 16, 289, 1913.

⁷ Graves and Kober: *Jour. Am. Chem. Soc.*, 37, 2430, 1915.

⁸ Graves: *J. Am. Chem. Soc.*, 37, 1181, 1915.

⁹ Lyman: *Jour. Biol. Chem.*, 21, 551, 1915.

¹⁰ Kober: *Jour. Biol. Chem.*, 13, 485, 1913; *Jour. Am. Chem. Soc.*, 35, 1585, 1913.

¹¹ Bloor: *Jour. Biol. Chem.*, 22, 145, 1915.

made from the same sample of colorless glass tubing so that they are of exactly the same bore. The flanges at the top should be well made so that the tubes rest firmly and evenly in the slots. The glass should be as free as possible from imperfections and striations. After the tubes are made and fitted into place the jackets are moved up on each tube by means of the rack and pinion until the indicator on the scale is exactly at zero. Marks are made on each tube at the point reached by the top of the jacket and the portion of the tube above that point is made opaque by a ring B1 of black paper or paint. Tubes and jackets are then marked right and left and always used on the same side. Since it is rare to find two tubes which when filled with the same solution give exactly the same readings it is necessary to take this fact into account and correct accordingly.

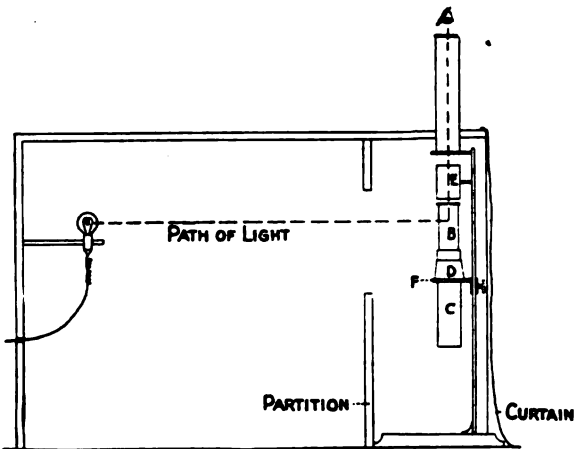

FIG. 90.—NEPHELOMETER IN POSITION, SHOWING RELATION TO SOURCE OF LIGHT.

The jackets *C* are made of tubing (metal or glass) a little larger than the tubes and about the same length (they should clear the mirror when it is turned horizontal), closed at the bottom and made light tight by black paint or paper. The collars *D* supporting the jackets may be made of cork or more permanently of metal. A little cotton wool in the bottom of the jackets will prevent breakage if the tubes should fall into the jackets.

The openings in the prism case, particularly the lower ones, should be protected against accidental splashing by thin glass plates (thick cover slips) which are held in place by a little glue.

Artificial light is necessary and the lamp should be enclosed in a tight box into one end of which the nephelometer fits snugly. A partition extending part way up the box as shown in the diagram

(Fig. 90) serves the double purpose of shutting off the light from the lower part of the instrument and of providing a stop against which the instrument is pushed, so that its distance from the light is kept constant. The box is conveniently made without a bottom and the end closed with a dark curtain after the nephelometer is pushed into place. The inside of the box should be painted black.

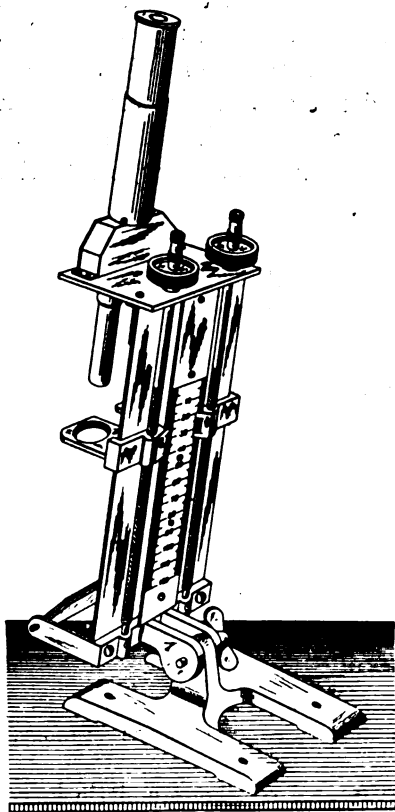

FIG. 91.—KOBBER'S NEPHELOMETER COLORIMETER.

(From *Journal of Biological Chemistry*, 29, 155, 1917.)

A dark room is desirable but not necessary, as the instrument may be used satisfactorily in a room darkened by a dark shade or even in a dark corner of the laboratory.

The relations of the nephelometer and the light source may be seen in the diagram, Fig. 90. The lamp used is an ordinary 50-watt tungsten ("Mazda") supported by a bracket about 30 cm. from the nephelometer and at the height of the nephelometer tubes. The change from one instrument to the other can be made in one or two minutes, since it consists essentially only in unscrewing the brass plate carrying the plungers and screwing on the plate to carry the nephelometer tubes. The extra parts needed, plate, tubes, and jackets, are few and can be made if necessary from material at hand in any laboratory and by anyone with a slight degree of mechanical skill.¹

The above description applies only to the later type of colorimeter where the cups move and the prisms are stationary. The changes required to convert the older type of instrument are more complicated and scarcely to be advised unless the instrument is to have fairly continuous use as a nephelometer. If the change is desired the nephelometer tubes are to be supported in the same way as above, but the jackets must be carried on special brackets which are made to replace

¹ The extra parts necessary for the conversion of the colorimeter into the nephelometer may be obtained from the International Instrument Co. of Cambridge, Mass.

the brackets carrying the plungers. The *nephelometer tubes must be stationary*, the jackets being the movable parts.

Kober¹ has devised a combined colorimeter and nephelometer less expensive than the Duboscq apparatus and which may be obtained in this country.² A cut of this nephelometer-colorimeter is given in Fig. 91, page 298.

Nephelometric Calculations.—The amounts of precipitate in solutions examined nephelometrically is not exactly inversely proportional to the readings of the scale. When the concentration of the unknown and of the standard are within 10 per cent of each other (or within about 20 per cent if the readings are made at depths as great as 50–60 mm.) accurate results may however be obtained directly. If the variations are greater than this a correction is necessary. Kober³ has proposed an equation to supply this correction and thus make possible very accurate work under conditions of moderate variations of concentration. The equation is as follows:

$$y = \frac{s}{x} - \frac{(1-x)sk}{x^2}$$

or

$$x = \frac{s + sk + \sqrt{(s + sk)^2 - 4sky}}{2y}$$

where y = height of unknown solution, on the left side of the instrument, when standard solution is kept on the right side at a definite height, s = height of standard solution on the left side and x = the ratio of the concentrations of the two solutions.

$k = \frac{K}{s}$ where K = a constant, obtained by substitution of standardization values of s , y , and x . The instrument should be checked up for each series of analyses by reading the standard against itself and determining the potential height of the standard solution by reading the scale on the left side when the solution on the right side is kept at a definite height, and the two are matched.

1. Acetone Bodies.—*Nephelometric Methods of Marriott.*⁴—*Principle.*—Acetone in very small amounts forms a cloudy solution with the Scott-Wilson reagent which may be read nephelometrically. By this method it is possible to make a complete analysis for acetone and diacetic acid and hydroxybutyric acid in from 2–5 c.c. of blood.

¹ Kober: *Jour. Ind. and Eng. Chem.*, 7, 843, 1915; *Jour. Biol. Chem.*, 29, 155, 1917.

² The instrument is manufactured by the Klett Manufacturing Co., 202 E. 46th St., New York City.

³ Kober: *J. Am. Chem. Soc.*, 37, 2379, 1915; *Jour. Biol. Chem.*, 13, 485, 1913.

⁴ Marriott: *Jour. Biol. Chem.*, 16, 289 and 293, 1913.

Procedure.—Two to 5 c.c. of blood drawn from a superficial arm vein by means of a sterile syringe are run into a small weighed flask containing 50 c.c. of 0.5 per cent potassium oxalate solution. The flask is reweighed. The diluted blood is run into 100 c.c. of boiling water acidified with 1 c.c. of glacial acetic acid¹ contained in an 800 c.c. Kjeldahl distilling flask and the procedure is then carried out as described in the Marriott-Scott-Wilson methods for (a) acetone and diacetic acid and (b) β -hydroxybutyric acid as outlined on page 288. The precipitate in the mercury reagent is however estimated nephelometrically. In this case the distillate which should measure 75–100 c.c. is allowed to stand half an hour, then transferred to a graduated cylinder and diluted until an opalescence that can be conveniently read is obtained. The turbidity occasioned by 0.05 mg. of acetone diluted to 100 c.c. is a convenient strength for this purpose, although considerably larger or smaller amounts give good results. With heavy opalescence it is desirable after diluting to a certain volume, say 250 c.c. to remove an aliquot portion with a pipette and dilute this appropriately. A solution containing a known amount of acetone² is distilled into an excess of reagent³ and this distillate which is to be used as the standard is diluted as above. Read in the nephelometer against this standard, taking the readings as quickly as possible after filling the tubes as the suspension settles slowly.

If the unknown suspension is diluted so as to be not more than 20 per cent different from the standard and if comparisons are made in considerable depths of solution (50–60 mm.) no corrections are necessary. If the two agree within 10 per cent accurate comparison may be made at less depths. If divergences are greater and accurate results are desired, Kober's correction equation must be used (see discussion of nephelometer p. 299).

2. **Fat.**—*Nephelometric Method of Bloor.*⁴—*Principle.*—The protein is precipitated with alcohol and ether and the fatty acid in the extract determined nephelometrically after saponification.

Procedure.—*Extraction.*—About 2 c.c. of blood are drawn from the vein with a graduated syringe and run at once with stirring into a weighed graduated flask containing about 40 volumes of a mixture of 3 parts alcohol and 1 part ether. After again weighing to find the weight of blood added, the solution is raised to boiling in a water-bath, cooled under the tap, made to volume with alcohol-ether mixture, mixed and filtered. The filtrate is water clear and almost colorless.

Determination.—From 5–20 c.c. of the extract (containing about 2 mg. of fat) are measured with a pipette into a small beaker and saponified by evaporating nearly but not quite to dryness with 2 c.c. of N/1 sodium ethylate. The residue is heated just to boiling after the addition of 5 c.c. of alcohol-ether, and 50 c.c. of distilled water are added.

A similar solution of the standard is prepared by adding 5 c.c. of the standard fatty acid solution from a pipette with stirring to 50 c.c. of distilled water. To

¹ Commercial varieties of acetic acid frequently contain substances which behave like acetone. Blank determinations should always be made and corrections made accordingly.

² A convenient stock solution contains about 0.03 mg. acetone per c.c. The strength of such a solution is determined by titration of 200 c.c. by the Messinger-Huppert method (see Chapter XXVII).

³ The solution cannot be added directly to the reagent as a lower result is obtained than when distilled.

⁴ Bloor: *Jour. Biol. Chem.*, 17, 377, 1914; 23, 317, 1915.

⁵ The standard solution used is an alcohol-ether solution of pure oleic acid of which 5 c.c. contain about 2 mg. of the acid. The alcohol and ether used for the standard are freshly redistilled absolute alcohol and pure dry ether.

the standard and to the test solutions are added simultaneously from pipettes and with stirring 10 c.c. portions of dilute (1:3) hydrochloric acid and the solutions allowed to stand for five minutes, after which they are transferred to the comparison tubes of the nephelometer (see Fig. 89, p. 296). Several readings should be taken and averaged. The standard tube should always be on the same side. See discussion of nephelometer (page 295) for details as to reading. The results represent the amount of total fat (fatty acids and cholesterol) in the blood, expressed as oleic acid. The fat of the corpuscles is not completely extracted, and it should be borne in mind that other lipoids as cholesterol are included in the results. Cholesterol may be determined separately and subtracted from the result for total fat. It may also be determined in a part of the blood extract as prepared above by a modified Autenrieth-Funk procedure.¹ Methods have also been devised for the determination of the phosphatides of blood.²

Instruments Used in the Examination of the Blood

Spectroscope.³—Either the *angular*-vision spectroscope (Figs. 93 and 94) or the *direct*-vision spectroscope (Fig. 92) may be used in making the spectroscopic examination of the blood. For a complete description of these instruments the student is referred to any standard text-book of physics.



FIG. 92.—DIRECT-VISION SPECTROSCOPE.

1. **Oxyhemoglobin.**—Examine dilute (1:50) defibrinated blood spectroscopically. Note the broad absorption band between D and E. Continue the dilution until this single broad band gives place to two narrow bands, the one nearer the D line being the narrower. These are the typical absorption bands of oxyhemoglobin obtained from dilute solutions of blood. Now dilute the blood very freely and note that the bands gradually become more narrow and, if the dilution is sufficiently great, they finally entirely disappear.

2. **Hemoglobin (so-called Reduced Hemoglobin).**—To blood which has been diluted sufficiently to show well-defined oxyhemoglobin absorption bands add a small amount of Stokes' reagent.⁴ The blood immediately changes in color from a bright red to violet-red. The oxyhemoglobin has been reduced through the action of Stokes' reagent and hemoglobin (so-called reduced hemoglobin) has been formed. This has been brought about by the removal of some of the loosely

¹ Bloor: *Jour. Biol. Chem.*, 23, 317, 1915.

² Greenwald: *Jour. Biol. Chem.*, 21, 29, 1915.

Bloor: *Jour. Biol. Chem.*, 22, 133, 1915, 23, 317, 1915.

Kober and Egerer: *J. Am. Chem. Soc.*, 37, 2373, 1915.

Taylor and Miller: *Jour. Biol. Chem.*, 18, 215, 1914.

For other nephelometric methods see Chapters XVIII and XXVII.

³ For Absorption Spectra see Plates I and II.

⁴ Stokes' reagent is a solution containing 2 per cent ferrous sulphate and 3 per cent tartaric acid. When needed for use a small amount should be placed in a test-tube and ammonium hydroxide added until the precipitate which forms on the first addition of the hydroxide has entirely dissolved. This produces *ammonium ferrotartrate* which is a reducing agent.

combined oxygen from the oxyhemoglobin. Examine this hemoglobin spectroscopically. Note that in place of the two absorption bands of oxyhemoglobin we now have a single broad band lying almost entirely between D and E. This is

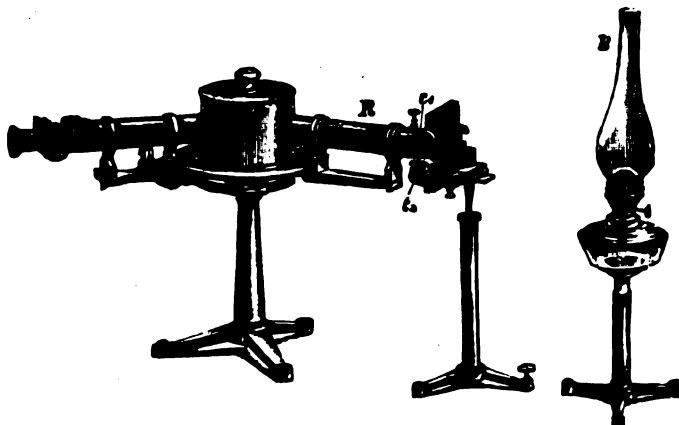

FIG. 93.—ANGULAR-VISION SPECTROSCOPE ARRANGED FOR ABSORPTION ANALYSIS.

the typical spectrum of hemoglobin. If the solution showing this spectrum be shaken in the air for a few moments it will again assume the bright red color of oxyhemoglobin and show the characteristic spectrum of that pigment.

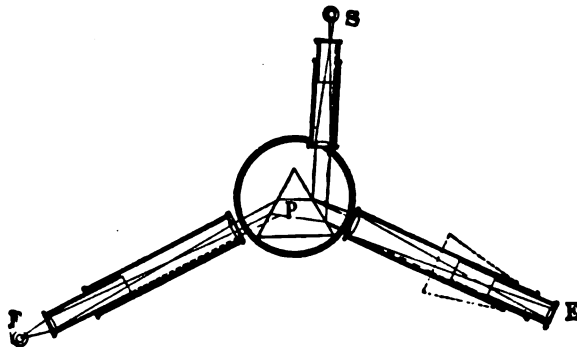

FIG. 94.—DIAGRAM OF ANGULAR-VISION SPECTROSCOPE. (Long.)

The white light *F* enters the collimator tube through a narrow slit and passes to the prism, *P*, which has the power of refracting and dispersing the light. The rays then pass to the double convex lens of the ocular tube and are deflected to the eyepiece *E*. The dotted lines show the magnified virtual image which is formed. The third tube contains a scale whose image is reflected into the ocular and shown with the spectrum. Between the light *F* and the collimator slit is placed a cell to hold the solution undergoing examination.

3. Carbon Monoxide Hemoglobin.—The preparation of this pigment may be easily accomplished by passing ordinary illuminating gas¹ through defibrinated ox-blood. Blood thus treated assumes a brighter tint (carmine) than that im-

¹ The so-called water gas with which ordinary illuminating gas is diluted contains usually as much as 20 per cent of carbon monoxide (CO).

parted by oxyhemoglobin. In very dilute solution oxyhemoglobin appears yellowish red whereas carbon monoxide hemoglobin under the same conditions appears bluish red. Examine the carbon monoxide hemoglobin solution spectroscopically. Observe that the spectrum of this body resembles the spectrum of oxyhemoglobin in showing two absorption bands between D and E. The bands of carbon monoxide hemoglobin, however, are somewhat nearer the violet end of the spectrum. Add some Stokes' reagent to the solution and again examine spectroscopically. Note that the position and intensity of the absorption bands remain unaltered.

The following is a delicate chemical test¹ for the detection of carbon monoxide hemoglobin:

Tannin Test.—Divide the blood to be tested into two portions and dilute each with 4 volumes of distilled water. Place the diluted blood mixtures in two small flasks or large test-tubes and add 20 drops of a 10 per cent solution of potassium ferricyanide.² Allow both solutions to stand for a few minutes, then stopper the vessels and shake one vigorously for 10–15 minutes, occasionally removing the stopper to permit air to enter the vessel.³ Add 5–10 drops of ammonium sulphide (yellow) and 10 c.c. of a 10 per cent solution of tannin to each flask. The contents of the shaken flask will soon exhibit the formation of a dirty olive-green precipitate, whereas the flask which was not shaken and which, therefore, still contains carbon monoxide hemoglobin, will exhibit a bright red precipitate, characteristic of carbon monoxide hemoglobin. This test is more delicate than the spectroscopic test and serves to detect the presence of as low a content as 5 per cent of carbon monoxide hemoglobin.

4. Neutral Methemoglobin.—Dilute a little defibrinated blood (1:10) and add a few drops of a freshly prepared 10 per cent solution of potassium ferricyanide. Shake this mixture and observe that the bright red color of the blood is displaced by a brownish red. Now dilute a little of this solution and examine it spectroscopically. Note the single, very dark absorption band lying to the left of D, and, if the dilution is sufficiently great, also observe the two rather faint bands lying between D and E in somewhat similar positions to those occupied by the absorption bands of oxyhemoglobin. Add a few drops of Stokes' reagent to the methemoglobin solution while it is in position before the spectroscope and note the immediate appearance of the oxyhemoglobin spectrum which is quickly followed by that of hemoglobin.

5. Alkaline Methemoglobin.—Render a neutral solution of methemoglobin, such as that used in the last experiment (4), slightly alkaline with a few drops of ammonia. The solution becomes redder in color, due to the formation of alkaline methemoglobin and shows a spectrum different from that of the neutral body. In this case we have a band on either side of D, the one nearer the red end of the spectrum being much the fainter. A third band, darker than either of those mentioned, lies between D and E somewhat nearer E.

6. Alkali Hematin.—Observe the spectrum of the alkali hematin prepared in Experiment 18 on page 270. Also make a spectroscopic examination of a freshly

¹ Sand (*Ugeskrift for Læger*, 76, 1721, 1914; *Abst. J. A. M. A.*, Nov. 21, 1914) proposes a potassium iodide test for carbon monoxide hemoglobin in blood. He claims 0.125 per cent may be detected by his test.

² This transforms the oxyhemoglobin into methemoglobin.

³ This is done to free the blood from carbon monoxide hemoglobin.

prepared alkali hematin.¹ The typical spectrum of alkali hematin shows a single absorption band lying across D and mainly toward the red end of the spectrum.

7. Reduced Alkali Hematin or Hemochromogen.—Dilute the alkali hematin solution used in the last experiment (6) to such an extent that it shows no absorption band. Now add a few drops of Stokes' reagent or ammonium sulphide and note that the greenish-brown color of the alkali hematin solution is displaced by a bright red color. This is due to the formation of hemochromogen or reduced alkali hematin. Examine this solution spectroscopically and observe the narrow, dark absorption band lying midway between D and E. If the dilution is not too great a faint band may be observed in the green extending across E and b.

8. Acid Hematin.—To some defibrinated blood add half its volume of glacial acetic acid and an equal volume of ether. Mix thoroughly. The acidified ethereal solution of hematin rises to the top and may be poured off and used for the spectroscopic examination. If desired it may be diluted with acidified ether in the ratio of one part of glacial acetic acid to two parts of ether. A distinct absorption band will be noted in the red between C and D and lying somewhat nearer C than the band in the methemoglobin spectrum. Between D and F may be seen a rather indistinct broad band. Dilute the solution until this band resolves itself into two bands. Of these the more prominent is a broad, dark absorption band lying in the green between b and F. The second, a narrow band of faint outline, lies in the light green to the red side of E. A fourth very faint band may be observed lying on the violet side of D.

9. Acid Hematoporphyrin.—To 5 c.c. of concentrated sulphuric acid in a test-tube add 2 drops of blood, mixing thoroughly by agitation after the addition of each drop. A wine-red solution is produced. Examine this solution spectroscopically. Acid hematoporphyrin gives a spectrum with an absorption band on either side of D, the one nearer the red end of the spectrum being the narrower.

10. Alkaline Hematoporphyrin.—Introduce the acid hematoporphyrin solution just examined into an excess of distilled water. Cool the solution and add potassium hydroxide slowly until the reaction is but slightly acid. A colored precipitate forms which includes the principal portion of the hematoporphyrin. The presence of sodium acetate facilitates the formation of this precipitate. Filter off the precipitate and dissolve it in a small amount of dilute potassium hydroxide. Alkaline hematoporphyrin prepared in this way forms a bright red solution and possesses four absorption bands. The first is a very faint, narrow band in the red, midway between C and D; the second is a broader, darker band lying across D, principally to the violet side. The third absorption band lies principally between D and E, extending for a short distance across E to the violet side, and the fourth band is broad and dark and lies between b and F. The first band mentioned is the faintest of the four and is the first to disappear when the solution is diluted.

11. Fleischl's Hemometer (Fig. 95, p. 305).—This is an instrument used quite extensively clinically, for the quantitative determination of hemoglobin. The instrument consists of a small cylinder which is provided with a fixed glass bottom and a movable glass cover, and which is

¹ Alkali hematin may be prepared by mixing one volume of a concentrated potassium hydroxide or sodium hydroxide solution and two volumes of dilute (1 : 5) defibrinated blood. This mixture should be heated gradually almost to boiling, then cooled and shaken for a few moments in the air before examination.

divided, by means of a metal septum, into two compartments of equal capacity. This cylinder is supported in a vertical position by means of a mechanism which resembles the base and stage of an ordinary microscope. Underneath the stage is placed a colored glass wedge (see Fig. 97), so arranged as to run immediately beneath the glass bottom of one of the compartments of the cylinder and ground in such a manner that each part of the wedge corresponds in color to a solution of hemoglobin of some definite percentage. The glass wedge is held in a metal frame and may be moved backward or forward by means of a rack and pinion arrangement. A scale along the side of this frame indicates the percentage of the normal amount of hemoglobin which each particular variation in the depth of color of the ground wedge represents, taking the normal hemoglobin content as 100.¹ In a position corresponding to the position of the mirror on the ordinary microscope is attached a light-colored opaque plate which serves to reflect the light upward through the colored wedge and the cylinder to the eye of the observer.

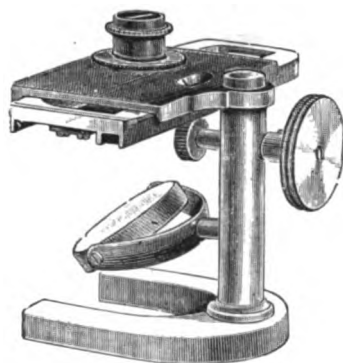

FIG. 95.—FLEISCHL'S HEMOMETER.
(*Da Costa.*)

In making a determination of the percentage of hemoglobin by this instrument the procedure is as follows: Fill each compartment about three-fourths full of distilled water. Puncture the finger-tip or lobe of the ear of the subject by means of a sterile needle or scalpel and, as soon as a drop of blood appears, place one end of the capillary pipette (Fig. 96), which accompanies the instrument, against the drop and allow it to fill by capillary attraction. To prevent the blood from adhering to the exterior of the tube, and so render the determination inaccurate, it is customary to apply a very thin coating of mutton fat to the outer surface before using or to wrap the tube in a piece of oily chamois when not in use. As soon as the tube has been accurately filled with blood it should be dipped into the water of one of the compartments of the cylinder and all traces of the blood washed out with water by means of a small dropper which accompanies the instrument. If the blood is not well distributed throughout the compartment and does not form a homogeneous solution the contents of the compartment should be mixed thoroughly by means of the metal handle of the capillary measuring pipette. When this has been done each compartment should be completely filled with distilled water and the glass cover adjusted, care being taken that the contents of the two compartments do not mix. Now adjust the cylinder so that the compartment containing the pure distilled water is immediately above the colored glass wedge. By means of the rack and pinion arrangement manipulate the colored wedge until a portion of it is found which corresponds in color with the diluted blood. When this agreement in color has been secured the point on the scale cor-

¹ The scale of the ordinary instrument is usually too high.

responding to this particular color should be read and the actual percentage of hemoglobin computed. For instance, if the scale reading is 90 it means that the blood under examination contains 90 per cent of the normal quantity of hemoglobin, i.e., 90 per cent of 14 per cent.

2. Fleischl-Miescher Hemometer.—The apparatus of Fleischl has been modified by Miescher. If all precautions are taken, the margin of error in the absolute quantity of hemoglobin determined by this instrument does not exceed 0.15–0.22 per cent by weight of the



FIG. 96.—PIPETTE OF FLEISCHL'S HEMOMETER.

blood. Detailed directions for the manipulation of the Fleischl-Miescher hemometer accompany the instrument. In brief Miescher modified the instrument as follows: (1) The scale of each instrument is supplied with a caliber table of *absolute* hemoglobin values, expressed in milligrams: the scale of Fleischl's hemometer shows the percentage of hemoglobin in relation to an average selected somewhat arbitrarily. Thus many errors arising from the irregular coloring of the glass wedge of the older apparatus are avoided in the instrument as modified. (2) Each instrument is accompanied by a measuring pipette (*melangeur*) which allows of a more accurate measurement of the blood than was possible with the capillary tubes of the older apparatus. (3) With the aid of the measuring pipette mentioned above blood of varying degrees of concentration may be compared. In this way the individual examinations are controlled and a check upon the accuracy of the graduation in the color of the glass wedge is also afforded. This wedge is much more evenly and accurately colored than in the unmodified apparatus of Fleischl. (4) Before reading the percentage as indicated by the scale, the chamber is covered with a glass and a diaphragm which sharply define the field on all sides without the formation of a meniscus.

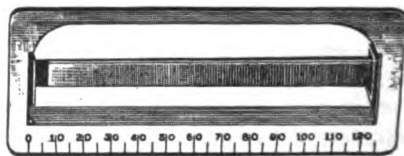

FIG. 97.—COLORED GLASS WEDGE OF FLEISCHL'S HEMOMETER. (Da Costa.)

The measuring pipette is constructed essentially the same as the pipettes which accompany the Thoma-Zeiss apparatus (see page 310). The capillary portion, however, is graduated, 1, $\frac{2}{3}$ and $\frac{1}{2}$ which enables the observer to dilute the blood sample in the proportion of 1:200, 1:300 or 1:400 as he may desire. If there is difficulty in drawing in the blood exactly to one of the graduations just mentioned the amount of blood above or below the volume indicated by the graduation may be determined by means of certain delicate cross-lines which

are placed directly above and below the graduation. Each cross-line corresponds to $1/100$ of the volume of the capillary tube from the tip to the 1 graduation.

A 0.1 per cent solution of sodium carbonate is used to dissolve the stroma of the erythrocytes and so render the blood solution perfectly clear. If this is not done the color of the blood solution invariably appears darker in tone than that of the colored glass wedge. A freshly prepared sodium carbonate solution should be used in order that the clearness of the solution may not be marred by the presence of sodium bicarbonate.

3. Dare's Hemoglobinometer (Fig. 98).—This instrument, as the name signifies, is used for the determination of hemoglobin. In using either Fleisch's hemometer or the instrument as modified by Miescher the blood is diluted for examination, whereas with the Dare instrument *no dilution* is required. This probably allows of rather more accurate determinations than are possible with the old Fleisch apparatus.

The instrument consists essentially of the following parts: (1) A capillary observation cell, (2) a semicircular colored glass wedge, (3) a milled wheel for manipulating the wedge, (4) a candle used to illuminate portions of the capillary observation cell and the colored wedge, (5) a small telescope used in the examination of the areas illuminated by the candle flame, (6) a scale graduated in percentages of the normal amount of hemoglobin, (7) a hard-rubber case, (8) a movable screen attached to the case.

The capillary observation cell is formed of two small, polished rectangular plates of glass, one being transparent and the other opaque. When held in position on the instrument, by means of a small metal bracket, the opaque portion of the cell is nearer the candle and thus serves to soften the glare of light when an observation is being made.

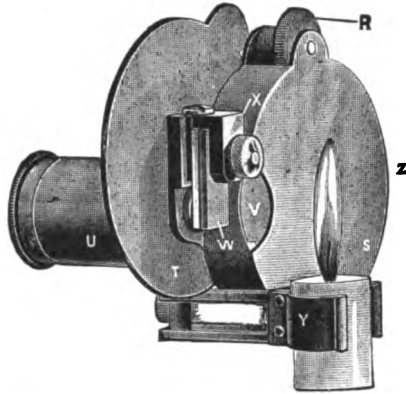

FIG. 98.—DARE'S HEMOGLOBINOMETER.
(*Da Costa's Hematology.*)

R, Milled wheel acting by a friction bearing on the rim of the color disc; S, case inclosing color disc, and provided with a stage to which the blood chamber is fitted; T, movable wing which is swung outward during the observation, to serve as a screen for the observer's eyes, and which acts as a cover to inclose the color disc when the instrument is not in use; U, telescoping camera tube, in position for examination; V, aperture admitting light for illumination of the color disc; X, capillary blood chamber adjusted to stage of instrument, the slip of opaque glass, W, being nearest to the source of light; Y, detachable candle-holder; Z, rectangular slot through which the hemoglobin scale indicated on the rim of the color disc is read.

The transparent portion of the cell is directly over a circular opening in the case, through which the blood specimen is viewed by means of the small telescope.

The semicircular colored glass wedge is so ground that each particular shade of color corresponds to that possessed by fresh blood which contains some definite percentage of hemoglobin. It is mounted upon a disc which may be manipulated by the milled wheel in such a manner as to bring successive portions of the wedge in position to be viewed through a circular opening contiguous to the opening through which the blood specimen is viewed. For a further description of the instrument see Figs. 98, 99, and 100.

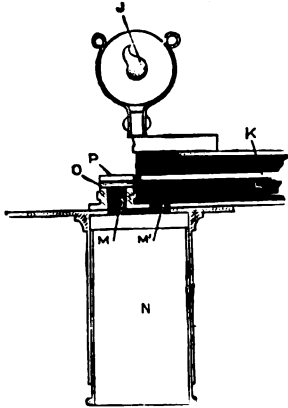

FIG. 99.—HORIZONTAL SECTION OF DARE'S HEMOGLOBINOMETER. (*Da Costa.*)

In using the Dare hemoglobinometer proceed as follows: Puncture the finger-tip or lobe of the ear of the subject by means of a needle or scalpel and, after a drop of blood of good proportions has formed, place the flat capillary observation cell in contact with the drop and allow it to fill by capillary attraction (Fig. 100). Replace the cell in its proper place on the instrument. When in position, a portion of this cell may be observed through a small telescope attached to the apparatus. It is viewed through a circular opening and near this circle is a second one through which a portion of a semicircular colored glass wedge is visible. These two circles are illuminated simultaneously by means of the flame of a candle. The colored glass

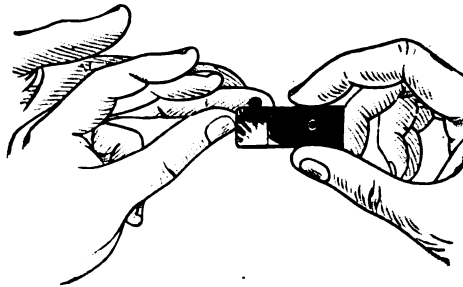

FIG. 100.—METHOD OF FILLING THE CAPILLARY OBSERVATION CELL OF DARE'S HEMOGLOBINOMETER. (*Da Costa.*)

may be rotated by means of a milled wheel and the point of agreement of the color of the adjoining discs may be determined in the same way as in Fleischl's hemometer. The scale reading gives the percentage of the normal quantity of hemoglobin which the blood sample under examination contains. Compute the actual hemoglobin content in the same manner as from the scale reading of the Fleischl hemometer (see page 304).

4. Tallquist's Hemoglobin Scale.—This consists essentially of a series of ten colors corresponding to stains produced by blood containing varying percentages of hemoglobin.

In using this scale a drop of blood is allowed to fall on a small section of filter paper and the resulting color is compared with the ten colors of the scale. When the color in the scale is found which corresponds to the color of the blood stain the accompanying hemoglobin value is read off directly.

This is a very convenient method for determining hemoglobin at the bedside. There is a possibility of the colors being inaccurately printed, however, and even if originally correct in tint, under the continued influence of air and light they must eventually alter somewhat.

Hemoglobin.—Carbon Monoxide Hemoglobin Method (Palmer).¹—Blood is obtained in the usual manner by pricking the finger or lobe of the ear. A 1 per cent solution of blood is made by drawing 0.05

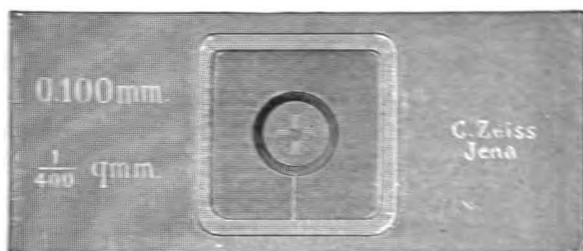

FIG. 101.—THOMA-ZEISS COUNTING CHAMBER. (De Costa.)

c.c. into a special pipette and transferring into 5 c.c. of 0.4 per cent ammonia solution—accurately measured with a calibrated pipette or burette into a 12 × 120 mm. test-tube. The blood pipette is rinsed out by drawing into it two or three times the ammonia solution. Ordinary illuminating gas is bubbled rapidly through the ammonia blood solution for 30 seconds, after which, it is compared in a Duboscq colorimeter with a standard carbon monoxide hemoglobin solution set at 10. The average of at least four readings is taken. The calculation is simple,

$$\frac{10}{R} \times 100 = \text{per cent hemoglobin.} \quad \text{The method is accurate.}$$

5. Thoma-Zeiss Hemocytometer.²—This is an instrument used in “blood counting,” *i.e.*, in determining the number of erythrocytes and leucocytes. The instrument consists of a microscopic slide constructed of heavy glass and provided with a central counting cell (see Fig. 101,

¹ Palmer: *Jour. Biol. Chem.*, 33, 119, 1918.

² The American Standard Hemocytometer with Levy Counting Chamber may be substituted for this instrument. It may be obtained from Arthur H. Thomas Co., Philadelphia.

below). This cell, with the cover glass in position, is exactly 0.1 mm. deep. The floor of the cell is divided by delicate lines into squares each of which is $\frac{1}{400}$ sq. mm. in area (see Fig. 103, page 311). The volume of blood, therefore, between any particular square and the cover glass above must be $\frac{1}{4000}$ cu. mm. Accompanying each instrument are two capillary pipettes (Fig. 102), each constructed with a mixing bulb in its upper portion. Each bulb is further provided with an enclosed

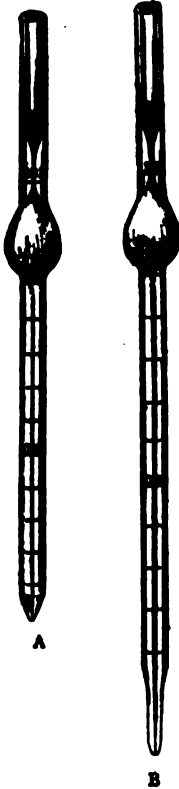

FIG. 102.—THOMAZ
ZEISS CAPILLARY
PIPETTES.
A, Erythrocytometer;
B, Leucocytometer.

glass bead which is of great assistance in mixing the contents of the chamber. The stem of each pipette is graduated in tenths from the tip to the bulb. The final graduation at the upper end of the bulb is 101 on the pipette used in mixing the blood sample in which the erythrocytes are counted (erythrocytometer, see Fig. 102), and 11 on the pipette used in mixing the blood sample for the leucocyte count (leucocytometer, see Fig. 102). In making "blood counts" with the hemocytometer it is necessary to use some diluting fluid. Two very satisfactory forms of fluid for this purpose are Toison's and Sherrington's solutions.¹ When either of these solutions is used as the diluting fluid it is possible to make a very satisfactory count of both the erythrocytes and leucocytes from the same preparation, since the leucocytes are stained by the methyl-violet or methylene-blue.

In counting the erythrocytes by means of the hemocytometer, proceed as follows: Thoroughly cleanse the tip of the finger or lobe of the ear of the subject by the use of soap and water, alcohol and ether applied in the sequence just given. Puncture the skin by means of a needle or scalpel and allow the blood drop to form without pressure. Place the tip of the pipette in contact with the blood drop, being careful to avoid touching the skin, and draw blood into the pipette up to the point marked 0.5 or 1 according to the desired dilution. Rapidly wipe the tip of the pipette and immediately fill it to the point marked 101 with Toison's or Sherrington's solution. Now thoroughly mix the blood and diluting fluid within the mixing

¹Toison's solution has the following formula:

Methyl-violet.....	0.025 gram.
Sodium chloride.....	1 gram.
Sodium sulphate.....	8 grams.
Glycerol.....	30 grams.
Distilled water.....	160 grams.

Sherrington's solution has the following formula:

Methylene-blue.....	0.1 gram.
Sodium chloride.....	1.2 gram.
Neutral potassium oxalate...	1.2 gram.
Distilled water.....	300.0 grams.

chamber by tapping the pipette gently against the finger, or by shaking it while held securely with the thumb at one end and the middle finger at the other. After the two fluids have been thoroughly mixed the diluting fluid contained in the capillary-tube below the bulb should be discarded in order to insure the collection of a drop of the thoroughly mixed blood and diluting solution for examination. Transfer a drop from the pipette to the ruled floor of the counting chamber and, after placing the cover-glass firmly in position,¹ allow an interval of a few minutes to elapse for the corpuscles to settle before making the count. Now place the slide under the microscope and count the number of erythrocytes in a number of squares, counting the corpuscles which are in contact with the upper and the right-hand boundaries of the square as belonging to that square. Take the squares in some definite sequence in order that the re-counting of the same corpuscles may be avoided. A satisfactory procedure is to begin in the upper right-hand corner and proceed from left to right count-

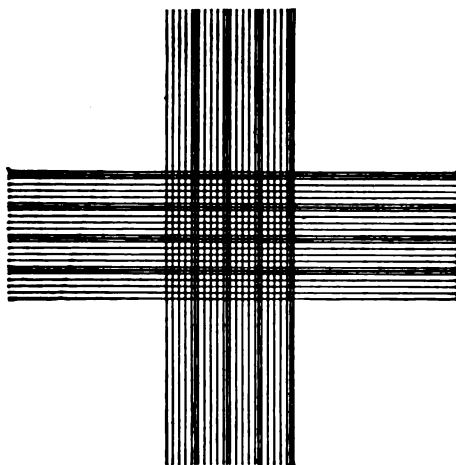

FIG. 103.—ORDINARY RULING OF THOMA-ZEISS COUNTING CHAMBER. (Da Costa.)

ing the cells in each individual square. Take the next lower row of squares and count from left to right and so on (see Fig. 107, page 317). Of course, all things being equal, the greater the number of squares examined the more accurate the count. It is considered essential under all circumstances, where an accurate count is desired, that the counting chamber shall be filled, at least twice, and the individual counts made in each instance, as indicated above, before the data are deemed satisfactory. Under no conditions should less than 200 squares be examined.

¹ If the cover-glass is in accurate apposition to the counting cell Newton's rings may be plainly observed. Eustis (*Jour. Am. Med. Ass'n*, 61, 1984, 1913) suggests the following technic: "After the usual shaking of the pipette, and expulsion of a few drops of the suspension, a good sized drop is placed on the counting chamber, no particular attention being paid to its size. The cover-glass, which has been previously cleaned, is then rapidly grasped between the thumb and index-finger of the right hand, while the slide is steadied on the table with the left hand. While firm pressure is exerted on the cover-glass it is rapidly slid across the counting chamber, through the drop of suspension on it. The cover-glass will cut through the drop at exactly 0.1 mm. The excess from the drop will rise on top of the cover-glass and jump across the moat. Newton's rings will be obtained in each instance. The drop on top of the edge of the cover-glass is wiped or soaked up with the point of a towel or blotting-paper and the preparation is completed."

To calculate the number of erythrocytes per cubic millimeter of undiluted blood proceed as follows: Determine the number of corpuscles in any given number of squares and divide this total by the number of squares, thus obtaining the average number of erythrocytes per square. Multiply this average by 4000 to obtain the number of erythrocytes per cubic millimeter of *diluted* blood, and multiply this product by 100 or 200, according to the dilution, to obtain the number of erythrocytes per cubic millimeter of *undiluted* blood. Thus:

$$\text{Average number of erythrocytes per square} \times 4000 \times 200 \text{ (or 100)} = \text{Number of erythrocytes per cubic millimeter.}$$

Great care should be taken to see that the capillary pipette is properly cleaned. After using, it should be immediately rinsed out with the diluting fluid, then with water, alcohol, and ether in the sequence given. Finally dry air should be drawn through the capillary and a horsehair inserted to prevent the entrance of dust particles.

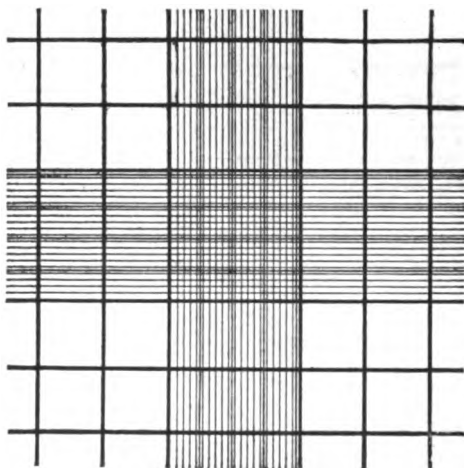

FIG. 104.—ZAPPERT'S MODIFIED RULING OF THOMA-ZEISS COUNTING CHAMBER. (*Da Costa.*)

In counting leucocytes by means of the hemocytometer proceed as follows: As mentioned above, if the diluting fluid is either Toison's or Sherrington's solution the leucocytes may be counted in the same specimen of blood in which the erythrocytes are counted. When this is done it is customary to use a slide provided with Zappert's modified ruling (Fig. 104). This method is rather more accurate than the older one of counting the leucocytes in a separate specimen of blood. Furthermore, it is obviously preferable to count both the erythrocytes and the leucocytes from the same blood sample. To insure accuracy the number of leucocytes within the whole ruled region should be determined in duplicate blood samples. This includes the examination of an area eighteen times as great as the old style Thoma-Zeiss central ruling. This region then would correspond to 3600 of the small squares and, if duplicate examinations were made, the total number of small squares examined would aggregate 7200.

The calculation would be as follows:

$$\frac{\text{Number of leucocytes in } 7200 \text{ squares}}{\times 200 \times 4000 + 7200} = \text{Number of leucocytes per cubic millimeter.}$$

If a Zappert slide is not available, a good plan to follow is to place a diaphragm in the tube of the ocular of the microscope consisting of a circle of black cardboard or metal¹ having a square hole in the center of such a size as to allow of the examination of exactly 100 squares or one-fourth of a square millimeter at one time. With this arrangement any portion of the specimen may be examined and counted whether within or without the ruled area. In counting by means of this device it is, of course, helpful if the microscope is provided with a mechanical stage, but even without this arrangement, if the observer is careful to see that the leucocytes at the extreme boundary of one field move to the opposite boundary when the position of the slide is changed, the device may be very satisfactorily employed. The leucocytes should be counted in 36 of the diaphragm-fields in *duplicate* specimens and the calculation made in the same manner as explained above.

If the leucocytes are counted in a separate specimen of blood ordinarily the diluting fluid is 0.3–0.5 per cent acetic acid, a fluid in which the leucocytes alone remain visible. Under these conditions the dilution is customarily made in the pipette having 11 as the final graduation. The capillary portion is of larger caliber and so requires a greater amount of blood to fill it to the 0.5 or 1 mark than is required in the use of the other form of pipette. In counting the leucocytes according to this method it is customary to draw blood into the pipette up to the 1 mark and immediately fill the remaining portion of the apparatus to the 11 graduation with the 0.3–0.5 per cent acetic acid. It then remains to count the number of leucocytes in the whole central ruled portion of 400 squares. This should be done in *duplicate* samples and the calculation made as follows:

$$\frac{\text{Number of leucocytes in } 800 \text{ squares}}{\times 4000 \times 10 + 800} = \text{Number of leucocytes per cubic millimeter.}$$

6. **Bürker's Hemocytometer.**²—This is an improved apparatus³ for the more accurate counting of erythrocytes than is possible by the Thoma-Zeiss apparatus. The principles involved are somewhat different from those in force with the latter apparatus. For example, the blood is diluted in a separate vessel, not in the pipette with which the sample is drawn, and furthermore the cover-glass is applied to the counting chamber and *clamped* in place *before* the diluted blood is applied to the

¹ Ehrlich's mechanical eyepiece with iris diaphragm is also very satisfactory for this purpose.

² Bürker: *Pflüger's Archiv.*, 142, 337, 1911; *Münch. med. Woch.*, 59, pp. 14 and 89, 1912.

³ Manufactured by C. Zeiss, Jena.

ruled area. Hayem's solution¹ is used as the diluting fluid. Toison's solution is not satisfactory for use with the Bürker counting chamber as its viscosity is too great. The corpuscles settle rapidly in Hayem's fluid as the specific gravity of the fluid is 1015 whereas that of the erythrocytes is 1090.

The pipette for measuring the quantity of blood (Fig. 105, upper pipette) has a point which is not ground dull but is polished. This allows of better judgment in deciding whether the column of blood extends to the very tip. The volume of the pipette between tip and mark is 25 cu. mm. The mark extends all the way around the tube so that errors of parallax may be avoided.

The pipette for measuring the diluting fluid (Fig. 105, middle pipette) also has a polished point and circular mark and delivers 4975 cu. mm. This volume of

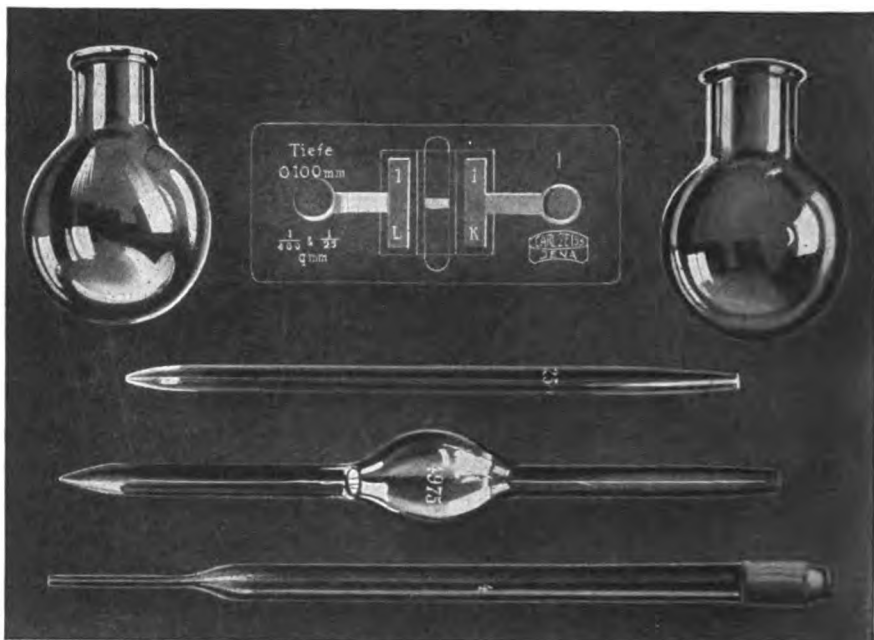

FIG. 105.—BÜRKER'S PIPETTES, MIXING FLASKS AND COUNTING CHAMBER.

diluting fluid with 25 cu. mm. of blood gives a dilution of 1:200. Both pipettes are provided with a piece of rubber tubing and mouthpiece.

For transferring the diluted blood from the diluting flask to the chamber a plain pipette provided with a rubber cap is used (Fig. 105, lower pipette). It is filled by pressing the cap slowly with the index-finger, inserting the tip into the liquid and then releasing the pressure.

The diluting is done in a small round-bottomed flask as shown in Fig. 105. Several of these flasks should be kept on hand in a wooden rack which will hold them in an upright position. Each flask is provided with a paraffined, or smooth cork stopper.

¹ Hayem's solution has the following formula:

Mercuric chloride.....	0.25 gram.
Sodium chloride.....	0.5 gram.
Sodium sulphate.....	2.5 grams.
Distilled water.....	100.0 grams.

In the older counting chambers the floor of the chamber is circular and the counting is done in the center of this space. The corpuscles are therefore counted in the center of a capillary, circular film where on account of surface tension their number is slightly greater than elsewhere. This source of error is avoided in the new counting chamber (Fig. 108) in which the floor is represented by the upper surface of a piece of glass 25 mm. long and 5 mm. wide which is rounded off at both ends and divided into two portions by a groove 1.5 mm. wide through the center. At each side of this floor piece, separated from it by a groove is a glass plate (7.5 mm. \times 21 mm.) of such height that the space between the floor of the cell and a cover-glass placed across the plates is 0.100 mm. A cover-glass 23 mm. long and 21 mm. wide with rounded polished edges is used so that the rounded ends of the floor piece project beyond it. The chamber is provided with clamps to press the cover-glass firmly upon both plates (Fig. 105).

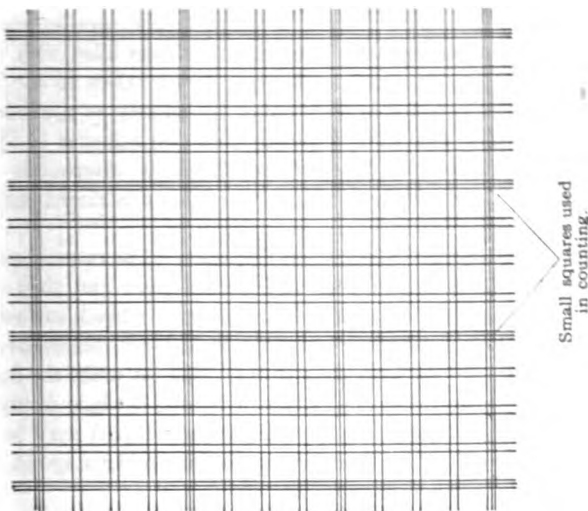

FIG. 106—RULING OF BÜRKER COUNTING CHAMBER.

The ruling on each portion of the floor piece is that shown in Fig. 106, which will be explained below.

Measuring the Diluting Fluid.—Four thousand nine hundred and seventy-five cu. mm. of diluting fluid (*Hayem's*) are measured out into the diluting flask. To do this the pipette is filled by suction to slightly above the mark and the rubber tube is carefully clamped off. Then with a soft piece of linen the tip is wiped dry. The meniscus is then accurately adjusted to the mark by lightly touching the point of the pipette to the cleaned tip of the finger. The pipette is then inserted into the diluting flask and with the tip nearly touching the bottom of the flask the fluid is allowed to run out. The time of the flow should be about forty seconds and is controlled by placing the tip of the index-finger loosely upon the mouthpiece. The pipette is emptied completely by alternately blowing through it and touching it to the wall of the flask slightly above the level of the liquid. The drops clinging to the wall are united with the bulk of the liquid by a suitable motion of the flask. The flask is then stoppered, care being taken from now on that none of the liquid ever touches the neck of the flask or the stopper.

Taking the Blood Sample.—Usually the best time to draw the blood is before breakfast. For a single determination the author prefers to draw it from the tip of the fourth finger of the left hand. For repeated determinations it is well to change off between third, fourth and fifth fingers of left hand. The temperature of the room should not be below 17°C. to prevent an undue contraction of the cutaneous vessels. The instrument used to puncture the finger should have a chisel-shaped point which is preferable to the ordinary lancet-shaped point. The first drop of blood is wiped off. Into the second one the tip of the pipette is inserted and blood is drawn in until the meniscus is even with or a little beyond the mark. The tip is then wiped off without touching the capillary opening and the observer assures himself that the column of blood extends to the very end of the capillary. The meniscus is then accurately adjusted to the mark.

Mixing of the Blood and Diluting Fluids.—The tip of the pipette is now dipped into the diluting fluid which has been measured into the flask and the blood is slowly blown out. The blood having a much higher specific gravity than the Hayem's fluid sinks to the bottom. The pipette is then filled with the pure supernatant diluting fluid and emptied again, care being taken to avoid air bubbles. This is repeated until the blood is removed as completely as possible. To mix the blood and diluting fluid the flask is rotated for two minutes in spiral curves of continually decreasing radius. The motion should be alternately clockwise and counterclockwise. After complete mixing the pipette is rinsed out several times with the diluted blood.

Transferral of the Diluted Blood to the Chamber.—The counting chamber which has been cleaned with distilled water and alcohol-ether and then wiped dry with a soft cloth as free from lint as possible is placed upon a black surface and carefully brushed with a camel's hair brush. The cover-glass is now placed over the chamber by sliding it over the two glass plates with both thumbs while the index-fingers are pressing it down. By means of the clamps it is held in place firmly so that Newton's rings (if possible of the first order: brown and black) may be seen over the entire area of the plates. The chamber is placed upon the stage of the microscope and is brought into a horizontal position.

Before transferring the diluted blood to the chamber the flask must be shaken for two minutes as described before. The liquid shows a cloudy appearance and must be allowed to stand until the turbidity has become uniform.

One of the plain pipettes described above is now inserted into the diluted blood while slight pressure is being exerted on the rubber cap. The pressure is released slowly and the liquid rises into the pipette. The point of the pipette is now immediately placed upon one of the projecting ends of the floor plate and very slight pressure is exerted on the rubber cap until the liquid coming from the pipette just reaches the cover-glass when the pressure is released. An instantaneous filling of the capillary space results. The pipette should be emptied immediately, rinsed with distilled water and placed in an upright position in a beaker of water. The other portion of the counting chamber is now filled in the same way with a second pipette and about one minute is allowed for the settling of the corpuscles. During this time the pipettes may be washed with distilled water and ether-alcohol and dried by suction. Occasionally, the pipettes should be cleaned with a horse hair and with concentrated H_2SO_4 containing a little $K_2Cr_2O_7$.

To see whether the distribution of the corpuscles has been uniform the chamber is illuminated with a wide-open diaphragm and viewed at an angle. If the opacity

is not uniform in either of the portions of the chamber, that one should not be used for counting. If the counting must be interrupted or requires a long time a moist chamber¹ should be used to prevent evaporation of the diluting fluid. The diluted

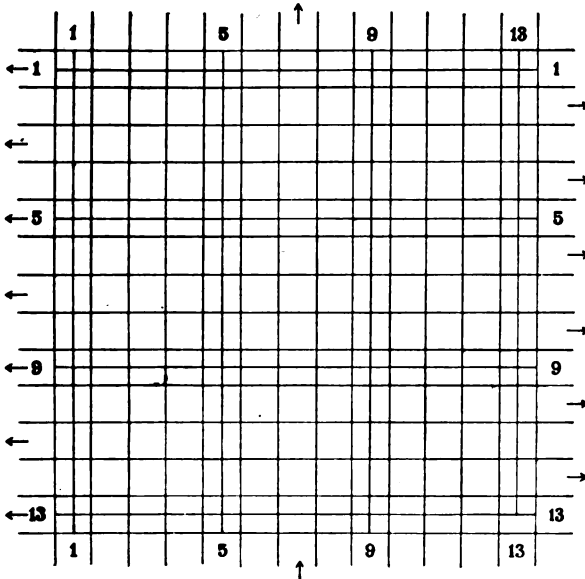

FIG. 107.—SCHEMA.

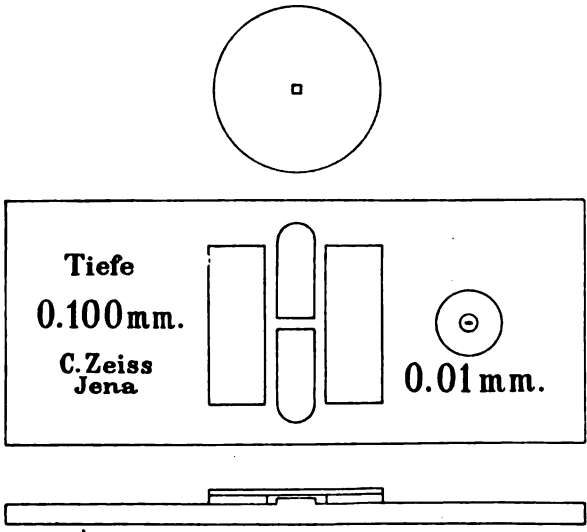

FIG. 108.—BÜRKER COUNTING CHAMBER.

blood may be retained in the mixing flasks and duplicate countings obtained after the lapse of twenty-four hours or more according to Bürker.

Counting and Calculation.—A mechanical stage movable in two directions is indispensable. With a magnification of 320 diameters the counting is begun in

¹ Bürker: *Pflüger's Archiv*, 118, 465, 1907.

the left upper corner of the ruling. Proceed from left to right along one row then move from right to left along the next lower row, and so on. Only the small squares are used for counting (see Fig. 106) and the figures are recorded in the *schema*¹ (see Fig. 107) in which the squares crossed by horizontal or vertical lines correspond to the small squares used for counting. Usually 80 squares are counted and by recording the figures in the *schema* the count may be verified and an idea of the uniformity of the distribution may be formed. Half of the counted squares should be in the one, half in the other portion of the counting chamber. For more accurate measurements more squares may be counted.

The observer will do well not to attempt counting each individual corpuscle in a square. After some practice each typical group of corpuscles will immediately suggest a number. A very common form of grouping is one corpuscle surrounded by four others. This should immediately suggest the number five. In this way the counting will become more rapid and also more reliable.

The calculation is very simple. The number of corpuscles in 80 squares divided by 100 will give the number of millions per cubic millimeter. If, for example, 536 corpuscles have been counted in 80 squares then with a dilution of 1:200 the number of corpuscles per cubic millimeter is 5,360,000. Thus, $\frac{536}{80} \times 4000 \times 200 = 5,360,000$ erythrocytes per cubic millimeter. More than two decimal places are without significance.

¹ The firm of H. Laupp in Tübingen has put this schema on the market (in packs of 100).

CHAPTER XVII

ACIDOSIS

Acidosis may be considered as a condition brought about by the excessive withdrawal of bases through the formation of acids within the body. Such an acidosis may occur in diabetes mellitus, in certain kidney disorders, *e.g.*, severe nephritis, in childrens disorders such as diarrhea, recurrent vomiting, food intoxication, etc. The acids known to be produced are acetoacetic acid and β -hydroxybutyric acid. These along with acetone are classed together as the "acetone bodies." Not only may an excessive acid formation or retention in the body accompany the various disorders mentioned, but an acidosis may be produced in any normal person by proper changes in diet. Thus the feeding of a diet which contains no carbohydrate will generally be followed within 24 hours by indications of acidosis. The following table (von Noorden) indicates the extent to which such a "physiological" acidosis may develop. Such acidosis will not result if carbohydrate to the extent of 50-150 grams per day is included in the diet. The feeding of a "salt-free" diet or of a diet containing a large excess of acid-forming foods such as meats, fish, cereals and eggs may also cause acidosis. In the latter case (*i.e.*, acid-forming foods) however, the acidosis is not associated with the formation of acetone bodies.

ACIDOSIS ACCOMPANYING CARBOHYDRATE WITHDRAWAL

Day	Diet	Excretion of acetone bodies calculated as β -hydroxybutyric acid (grams)
1	Protein, fat and carbohydrate.....	none
2	Protein and fat.....	0.8
3	Protein and fat.....	1.9
4	Protein and fat.....	8.7
5	Protein and fat.....	20.0
6	Protein, fat and carbohydrate.....	2.2

Of the acetone bodies, the acetoacetic acid is considered to be the most important. This acid has its origin principally in fats, and to a minor degree in certain amino acids resulting from protein cleavage. It has been demonstrated that acetoacetic acid may be formed in the body through the oxidation of butyric acid, and that the administration of fats containing butyryl to diabetics causes an increased produc-

tion of acetoacetic acid. Furthermore, it is believed that fatty acids higher than butyric acid in the series also yield acetoacetic acid by oxidation. In this change the oxidation occurs at the β -carbon, two carbon atoms at a time being involved. As soon as the oxidation proceeds to the butyric acid stage this acid is transformed into acetoacetic acid. In diabetes the body either does not possess the normal power of oxidizing acetoacetic acid or else this acid is produced in excessive amount. At any rate, we find it in blood and urine in abnormal quantity. The relationship of acetoacetic acid to fatty acids may be expressed as follows:

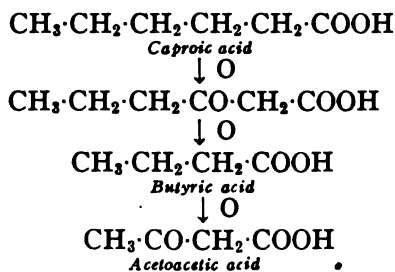

The β -hydroxybutyric acid is formed from acetoacetic acid by *reduction*. It was originally believed that this procedure was reversed and that the acetoacetic acid was formed from the β -hydroxybutyric acid by *oxidation*. However, it has been shown that the introduction of β -hydroxybutyric acid into the body is not followed by an increased acetoacetic acid formation, whereas, β -hydroxybutyric acid is formed when acetoacetic acid is introduced. Therefore, it seems clear that the acetoacetic acid is the original substance from which the β -hydroxybutyric acid is formed by a process of reduction. The relationship between the acetone bodies may be indicated in this way:

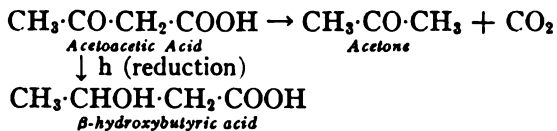

In the normal body it is probable that the bulk of the acetoacetic acid is oxidized to acetic acid and carbonic acid in turn and thence to carbon dioxide and water, whereas, in the diabetic organism this does not occur, at least not to any great extent. Likewise in the absence of carbohydrate in the diet, the oxidation is not complete and acetone bodies are increased in amount in both blood and urine.

The appearance of the "acetone bodies," *i.e.*, acetone, acetoacetic acid and β -hydroxybutyric acid *in the urine* in appreciable quantity was originally taken as the index of an acidosis and the extent of the acidosis

was judged by the estimation of the amount of these bodies present in the urine. That this is not a reliable index is shown by the occasional observation of a pronounced acidosis with no appreciable increase in urinary acetone bodies. A high urinary ammonia coefficient (ammonia N:total N) was also early looked upon as an indication of acidosis. However, this factor is not very useful in diagnosis in spite of the fact that the majority of acidosis cases show a high urinary ammonia value. Certain dietetic changes may produce high urinary ammonia, therefore, it is not necessarily indicative of acidosis. It is also true that fatal acidosis has been observed in uremia, and in nutritional disorders of infants, with no pronounced increase in the ammonia coefficient.

With the development of blood analysis the content of these acetone bodies in blood plasma was looked to as an aid in the determination of the extent of acidosis. But here again the hope of the clinician failed to materialize. Notwithstanding the fact that acidosis may truthfully be considered as that state of metabolism of which the most constant characteristic is the production of abnormal quantities of acetone bodies, nevertheless, it is the consensus of the best opinion at the present time that acidosis can be best diagnosed and its course followed not by the determination of acetone bodies in either urine or blood but by the determination of certain other factors which are more or less typical of acidosis. These include the following:

1. The determination of the "alkali reserve" of the blood.
2. The determination of the alkali tolerance of the patient.
3. The determination of the carbon dioxide tension of the alveolar air.
4. The determination of the hydrogen-ion concentration of the blood.

It must be at once apparent that the development of acidosis with its excessive acid formation will tend toward a change in the reaction of the various body fluids, particularly the blood. However, *even in the most severe acidosis there is but slight alteration in the reaction of the blood* since the ability of the body to protect itself against the acid production is very remarkable. The normal reaction of the blood is slightly alkaline. If there be but slight deviation from the normal reaction, health rapidly departs and death may ensue. It is therefore of first importance that the reaction of the blood be kept as nearly normal as possible. In fact the conditions are somewhat similar to those which surround the temperature regulation of the body. Here again the body attempts to maintain a normal temperature. A given man before a blast furnace, for example, shows a body temperature very similar to that exhibited by the same man in the ice floes of the north.

Any considerable deviation from normal in the temperature of our body is associated with failing health and possible death.

The popular conception of water is that of a fluid which is neutral in reaction. As a matter of fact, however, in ordinary tap water we have a solution more alkaline than blood, whereas, distilled water, which is our standard of neutrality, is considerably more acid than is the blood. A change in the reaction of the blood equivalent to the very slight difference between the reaction of tap water and distilled water would be fatal to the organism.

Just a word in review as to the physico-chemical methods of expressing the reaction of a solution. A neutral solution is, of course, one which contains equal numbers of hydrogen and hydroxyl ions while an acid solution contains an excess of hydrogen ions and an alkaline solution contains an excess of hydroxyl ions. The extent to which an acid ionizes or liberates hydrogen ion determines the efficiency of that acid in altering the reaction of a solution. Thus tenth normal solutions of hydrochloric and acetic acids, for example, each contain the same amount of reacting hydrogen per liter. However, 91 per cent of the hydrogen of the hydrochloric acid dissociates and forms hydrogen ion whereas only 1.3 per cent of the reacting hydrogen of acetic acid is thus dissociated. Therefore, the decinormal hydrochloric acid is 70 times as strong as the decinormal acetic acid.

Pure water is a $1/10,000,000$ N acid and a $1/10,000,000$ N alkali as well. If we take a normal solution of an acid and an alkali we may dilute each until the hydrogen and hydroxyl ion concentrations are the same as that of water. Instead of expressing the hydrogen ion concentration of water as $1/10,000,000$ N it is customary to use the logarithmic notation and express it as 10^{-7} N or rather better to drop the 10^{-} and express it as pH_7 or P_{H7} or $P_H - 7$. This then represents the hydrogen ion concentration of a neutral solution. Exponents above 7 indicate alkaline solutions whereas exponents below 7 indicate acid solutions.

Thus P_{H1} is the hydrogen ion concentration of N/10 acid.
 P_{H6} is the hydrogen ion concentration of N/1,000,000 acid.
 P_{H7} is a *neutral* solution.
 P_{H8} is the hydroxyl ion concentration of N/1,000,000 alkali.
 $P_{H13.2}$ is the hydroxyl ion concentration of N/10 alkali.

The reaction of blood serum is about $P_{H7.35}$. The maximum variations are P_{H7} to P_{H8} . The former value (*i.e.*, neutrality) may be

reached in very severe acidosis whereas the maximum alkaline value of P_{H8} may be reached by alkali administration. The average value for normal urine is P_{H6} and for gastric juice $P_{H1.77}$.

Even under normal conditions the human body is continually forming acids as a result of oxidations taking place in intermediary metabolic changes. For example, the sulphur of the proteins we eat is oxidized to sulphuric acid, whereas, carbonic acid results from the transformation not only of proteins but of fats and carbohydrates as well. Moreover, there are small amounts of various organic acids produced and ultimately oxidized with the formation of carbon dioxide and water, although a certain quantity of some of these acids, notably lactic and uric, is excreted as such.

Let us examine into the factors which the blood calls to its aid in maintaining its accustomed reaction in the face of normal or abnormal acid production. In this connection we must consider (1) sodium bicarbonate and carbon dioxide which are present in proper quantity to yield a nearly neutral reaction, (2) the *acid* monosodium hydrogen phosphate and the *alkaline* disodium hydrogen phosphate which also are present in proper proportion to yield a similar nearly neutral reaction as that formed by the sodium bicarbonate and carbon dioxide, (3) the proteins which are amphoteric and, therefore, combine with acids or alkalis without change in reaction. The carbonates of the blood are of prime importance in maintaining the constancy of reaction and have been termed the "first line of defense." Carbon dioxide is being constantly formed in the tissues. This is carried by the blood to the lungs and eliminated in respiration as carbon dioxide. Every 24 hours an average adult eliminates in this way acid equivalent to several hundred cubic centimeters of concentrated hydrochloric acid. Owing to the operation of laws which govern the reaction of solutions of weak acids and the salts of such acids, the blood is able to take up a quantity of the acid carbon dioxide without undergoing any appreciable change in reaction. In this way large amounts of acid are daily eliminated from the body, and the mechanism is so nicely adjusted that the organism is subjected to no strain of any sort.

If we could hold our breath for a sufficiently long time while the circulation continued normally we would finally reach a point where the carbon dioxide concentration would be the same in the alveolar air as in the blood and tissues. The process of respiration lowers the concentration of carbon dioxide in the lungs. This in turn permits the entrance of carbon dioxide from the blood into the alveoli of the lungs and the consequent lowering of the blood carbon dioxide permits the entrance into the blood of carbon dioxide from the tissues where the

concentration of carbon dioxide is the highest. In acidosis the carbon dioxide concentration of the alveolar air is lowered because of hyperpnea and because of the fact that the power of the blood to carry carbon dioxide has been lowered.

When acids such as β -hydroxybutyric, lactic and hydrochloric are added to the blood they react with the sodium bicarbonate and disodium phosphate forming a sodium salt which is neutral in reaction, monosodium phosphate which is slightly acid, and free carbonic acid. The carbonic acid and acid phosphate ionize to but a small degree and therefore the hydrogen ion concentration of the blood is but slightly altered. We have here a very efficient factor in the regulation of blood reaction following an influx of acid or alkali. The regulatory mechanism is further aided by the rapid elimination of the acid phosphate and carbonic acid, the former by way of the urine and the latter by way of the lungs in the form of carbon dioxide. The following equations represent what takes place when an excess of acid (HCl) enters the blood.

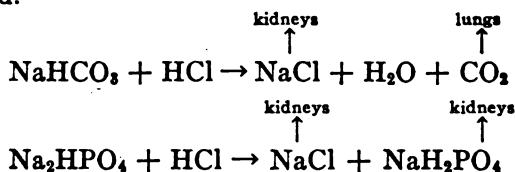

The name "buffer substances" has been given to the sodium phosphate and sodium bicarbonate of the blood in view of their protective rôle in preventing pronounced changes in blood reaction after acid or alkali introduction. If large amounts of acids are continually poured into the blood these buffer substances decrease in amount and finally when the body can no longer replace the destroyed buffers acidosis results. In fact we may consider that acidosis is any condition in which the buffer substances of the blood are reduced below normal. Hence acidosis is "lowering of the alkali reserve" of the body. When such a reduction occurs the capacity of the blood to transport acids is lowered. We have seen that carbonic acid is the acid most abundantly produced in the body hence the "buffer" depletion lowers the power of the blood to carry this acid. In case this depletion is sufficiently pronounced carbonic acid accumulates in the tissues. It is well known that the respiratory center is very susceptible to acid stimulation such, *e.g.*, as that afforded by carbonic acid. Hence a more thorough ventilation of lungs and blood results and the more rapid removal of carbon dioxide prevents its further accumulation in the tissues. This hyperpnea resulting from a stimulated respiratory center is one of the clinical symptoms of acidosis. Furthermore one of the laboratory procedures

for establishing the extent of the acidosis is the estimation of the amount of the reduction in the carbon dioxide concentration of the alveolar air which accompanies the hyperpnea. This indirect index of acidosis may be determined in a few minutes. (For methods see page 332.)

A rather more satisfactory method for the study of acidosis is the direct determination of the "buffer value" or "alkali reserve" of the blood. This consists in saturating a given volume of blood plasma with carbon dioxide and in measuring the volume of carbon dioxide given off from this blood plasma when acid is added. A decrease in the carbon dioxide indicates a depletion of the bicarbonate of the blood and hence a lowering of the blood's "buffer value" or "alkali reserve."

The alkali reserve may also be determined by administering sodium bicarbonate. Normal urine is acid in reaction. When bicarbonate is given to a normal person in small amount the reaction of the urine becomes alkaline. In acidosis, however, an increased amount of carbonate is necessary to produce a change in the urinary reaction. The amount of alkali needed to cause the urine to become alkaline is an index of what is commonly called the "tolerance to alkalies."

Because of the fact that it varies so little from the normal under any circumstances, the determination of the hydrogen ion concentration of the blood is of less value in the diagnosis of acidosis than either the determination of the "alkali reserve" of the blood, the "carbon dioxide tension" of the alveolar air or the "alkali tolerance" of the patient.

METHODS

1. Alkali Reserve.—Direct Method. Carbon dioxide capacity of the plasma. (Van Slyke and Cullen.¹)

Principle.—The plasma from oxalated blood is shaken in a separatory funnel filled with an air mixture whose carbon dioxide tension approximates that of normal arterial blood, by which treatment it combines with as much carbon dioxide as it is able to hold under normal tension. A known quantity of the saturated plasma is then acidified within a suitable pipette, and its carbon dioxide is liberated by the production of a partial vacuum. The liberated carbon dioxide is then placed under atmospheric pressure, its volume carefully measured, and the volume corresponding to 100 c.c. of plasma calculated.

Apparatus.—The apparatus² used in the estimation of the carbon

¹ Van Slyke & Cullen: *Jour. Biol. Chem.*, 30, 289, 1917; Van Slyke: *Jour. Biol. Chem.*, 30, 347, 1917.

² The apparatus is manufactured by the Emil Greiner Company, 55 Fulton Street, New York.

dioxide content of the plasma is illustrated in Fig. 109. It is made of strong glass in order to stand the weight of mercury without danger of breaking, and is held in a strong screw clamp the jaws of which are lined with thick pads of rubber. In order to prevent accidental slipping of the apparatus from the clamp, an iron rod of 6 or 8 mm. diameter should be so arranged as to project under cock *f* between *c* and *d*.

Three hooks or rings at the levels 1, 2, and 3 serve to hold the levelling bulb at different stages of the analysis. The bulb is connected with the bottom of the apparatus by a heavy walled rubber tube.

It is necessary, of course, that both stop cocks should be properly greased and air tight, and it is also essential that they (especially *f*) shall be held in

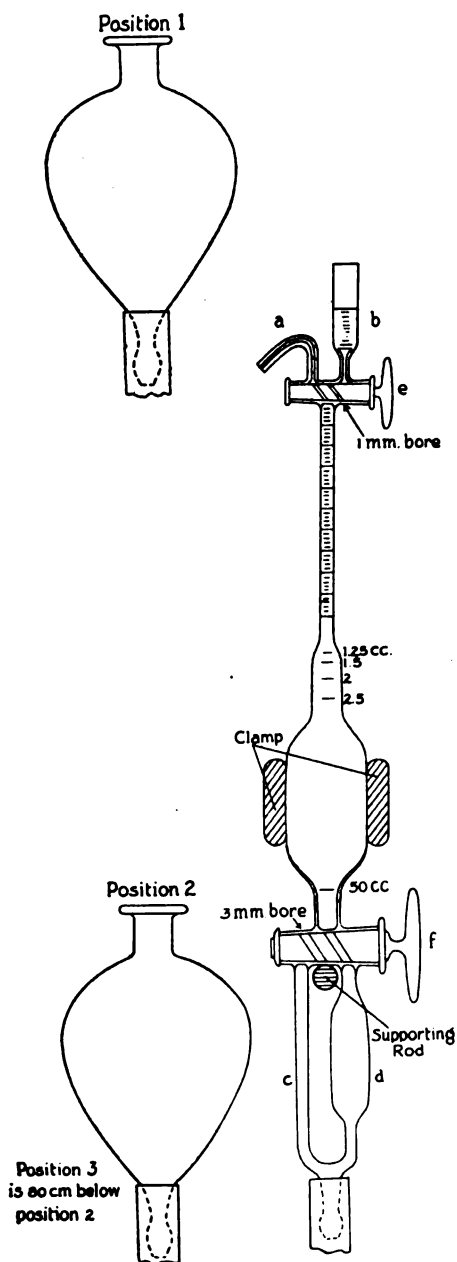

FIG. 109.—VAN SLYKE CARBON DIOXIDE APPARATUS. (*Journal Biological Chemistry*, 30, 289, 1917; 30, 347, 1917.)

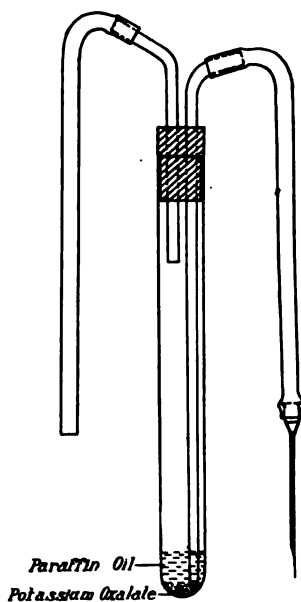

FIG. 110.—TUBE USED IN COLLECTING BLOOD. (*Journal Biological Chemistry*, 30, 289, 1917.)

place so that they cannot be forced out by pressure of the mercury. Rubber bands may be used for this purpose but it is suggested that elastic cords of fine wire spirals, applied in the same manner as rubber bands, are stronger and more durable.

After a determination has been finished, the levelling bulb is lowered without opening the upper cock, and most of the mercury is withdrawn from the pipette through *c*. The water solution from *d* is readmitted and the levelling bulb being raised to position 1, the water solution, together with a little mercury, is forced out of the apparatus through *a*.¹

Procedure.—Drawing the blood.² About six or seven c.c. of venous blood are aspirated into a centrifuge tube (see Fig. 110) which contains a little powdered

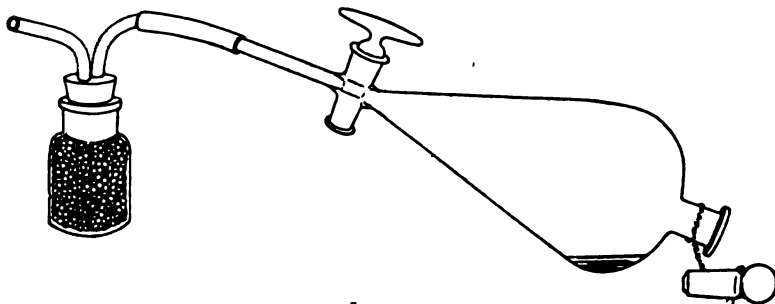

FIG. 111.—SEPARATORY FUNNEL USED IN SATURATING BLOOD PLASMA WITH CARBON DIOXIDE. (*Journal Biological Chemistry*, 30, 289, 1917.)

potassium oxalate and some paraffin oil. The tube is subjected to a minimum of agitation after the blood is in it. The slight amount of agitation necessary to assure mixture with the oxalate is accomplished by stirring with the inlet tube, rather than by inverting or shaking. The tube and contents are then centrifuged.

Saturation of Plasma with Carbon Dioxide.—After centrifugation about 3 c.c. of the plasma³ are transferred to a 300 c.c. separatory funnel, arranged as in Fig. 111, and the air within the funnel is displaced by either alveolar air from the lungs of the operator or a 5.5 per cent carbon dioxide-air mixture from a tank. In either case the gas mixture must be passed over moist glass beads before it enters the funnel.

When alveolar air is used the operator, without inspiring more deeply than normal, expires as quickly and as completely as possible through the glass beads

¹ It is well to have a funnel draining into a special vessel to catch the water residues and mercury overflow from *a*. A considerable amount of mercury is thus regained if many analyses are run. It requires only straining through cloth or chamois skin to prepare it for use again.

² For at least an hour before the blood is drawn the subject should avoid vigorous muscular exertion as this, presumably because of the lactic acid formed lowers the bicarbonate of the blood. (Christiansen, Douglas & Haldane: *J. Physiol.*, 48, 246, 1914; Morawitz & Walker: *Biochem. Zeit.*, 60, 395, 1914.)

³ If it is desired to keep the plasma for the estimation of carbon dioxide at a later time it should be transferred to a paraffined tube, covered with a layer of paraffin oil, stoppered and kept cold; under which conditions it is claimed that, if sterile, it may be kept for over a week without alteration of its carbon dioxide capacity.

and separatory funnel. The stopper of the funnel should be inserted just before the expiration is finished, so that there is no opportunity for air to be drawn back into the funnel. In order to saturate the plasma the separatory funnel is turned end over end for 2 minutes, the plasma being distributed in a thin layer as completely over the surface of the funnel's interior as is possible. After saturation is completed the funnel is placed upright and allowed to stand for a few minutes until the fluid has drained from the walls and gathered in the contracted space at the bottom of the funnel.

Determination of Carbon Dioxide.—A sample of 1 c.c. (or 0.5 c.c. in case the amount of plasma available is very small) accurately pipetted, is allowed to run into the cup *b* in the apparatus represented in Fig. 109, the tip of the pipette remaining below the surface of the plasma as it is added. The cup should have been previously washed out with carbonate-free ammonia, and together with the entire apparatus should have been filled with mercury to the top of the capillary tube by placing the levelling bulb of mercury in position 1.

With the mercury bulb at position 2 and the cock *f* in the position shown in the figure the plasma is admitted from the cup into the 50 c.c. chamber, leaving just enough above the cock *e* to fill the capillary so that no air is introduced when the next solution is added. The cup is washed with two portions of about 0.5 c.c. of water, each portion being added to the pipette in turn. A small drop¹ of caprylic alcohol is then added to the cup and is permitted to flow entirely into the capillary above *e*. Finally 0.5 c.c. of 5 per cent sulphuric acid is run in.

It is not necessary that exactly 1 c.c. of wash water and 0.5 c.c. of acid shall be taken, but the total volume of the water solution introduced must extend exactly to the 2.5 c.c. mark on the apparatus, if the table on page 330 is to be used.

If the amount of plasma available is small a little more than 0.5 c.c. are saturated in a 50 c.c. funnel, and exactly 0.5 c.c. used for the estimation of carbon dioxide. In this case the volume of distilled water and acid used to wash the plasma into the apparatus is halved, so that the total volume of water solution introduced is only 1.25 c.c., and in the calculation the observed volume of gas is multiplied by 2.

After the acid has been added a drop of mercury is placed in *b* and allowed to run down the capillary as far as the cock in order to seal the latter. Whatever excess of sulphuric acid remains in the cup is washed out with a little water.

The mercury bulb is now lowered and hung at position 3 and the mercury in the pipette is allowed to run down to the 50 c.c. mark, producing a Torricellian vacuum in the apparatus. When the mercury (not the water) meniscus has fallen to the 50 c.c. mark the lower cock is closed and the pipette is removed from the clamp. Equilibrium of the carbon dioxide between the 2.5 c.c. of water solution and the 47.5 c.c. of free space in the apparatus is obtained by turning the pipette upside down fifteen or more times, thus thoroughly agitating the contents. The pipette is then replaced in the clamp.

By turning the cock *f* the water solution is now allowed to flow from the pipette completely into *d* without, however, allowing any of the gas to follow

¹ It is desirable to keep the amount of caprylic alcohol small, as larger amounts may appreciably increase results. With plasma 0.02 c.c. is sufficient to prevent foaming and is measured most conveniently from a burette made by fusing a capillary stopcock to a pipette graduated into 0.01 c.c. divisions.

it. The levelling bulb is then raised in the left hand while with the right the cock is turned so as to connect the pipette with *c*. The mercury flowing in from *c* fills the body of the pipette, and as much of the calibrated stem at the top as is not occupied by the gas extracted from the solution. A few hundredths of a c.c. of water which could not be completely drained into *d* float on top of the mercury in the pipette, but the error caused by reabsorption of carbon dioxide into this small volume of water is negligible if the reading is made at once. The mercury bulb is placed at such a level that the gas in the pipette is under atmospheric pressure¹ and the volume of the gas is read on the scale.

Calculation.—By means of the table on page 330 the readings on the apparatus can be directly transposed into c.c. of carbon dioxide chemically bound by 100 c.c. of plasma. The barometer reading and room temperature are taken at the time of the determination. For convenience in the calculation values are given below for the ratio $\frac{B}{760}$ over the range usually encountered.

Barometer	$\frac{B}{760}$	Barometer	$\frac{B}{760}$
732	0.963	756	0.995
734	0.966	758	0.997
736	0.968	760	1.000
738	0.971	762	1.003
740	0.974	764	1.006
742	0.976	766	1.008
744	0.979	768	1.011
746	0.981	770	1.013
748	0.984	772	1.016
750	0.987	774	1.018
752	0.989	776	1.021
754	0.992	778	1.024

In case the volume of plasma taken for estimation of carbon dioxide content was 0.5 c.c. the observed volume of gas is multiplied by 2 before it is used to calculate the volume per cent of carbon dioxide bound.

Interpretation.—The carbon dioxide capacity of the plasma as determined by this method appears to indicate not only the alkaline reserve of the blood but also that of the entire body. The average normal value for man is 65 volume per cent of carbon dioxide. The table, page 331, shows the range of results obtained with normal and pathological plasma, as well as the relationship of the plasma bicarbonate to acid excretion, alkali tolerance, and alveolar carbon dioxide tension.

¹ In order to have the column in the pipette exactly balanced by that outside, the surface of the mercury in the levelling bulb should be raised until it is level with the mercury meniscus in the pipette, and then, for entire accuracy, raised above the latter meniscus by a distance equal to $\frac{1}{4}$ the height of the column of water above the mercury in the pipette. As the water column is as a rule, only about 10 mm. high, the correction that has to be estimated is less than 1 mm. of mercury, *i. e.*, the entire correction for the water column is not enough to influence results appreciably.

TABLE FOR CALCULATION OF CARBON DIOXIDE COMBINING POWER OF PLASMA¹

Observed vol. gas B × 760	C.c. of CO ₂ reduced to 0° 760 mm. bound as bicar- bonate by 100 c.c. of plasma				Observed vol. gas B × 760	C.c. of CO ₂ reduced to 0° 760 mm. bound as bicar- bonate by 100 c.c. of plasma			
	15°	20°	25°	30°		15°	20°	25°	30°
0.20	9.1	9.9	10.7	11.8	0.60	47.7	48.1	48.5	48.6
1	10.1	10.9	11.7	12.6	1	48.7	49.0	49.4	49.5
2	11.0	11.8	12.6	13.5	2	49.7	50.0	50.4	50.4
3	12.0	12.8	13.6	14.3	3	50.7	51.0	51.3	51.4
4	13.0	13.7	14.5	15.2	4	51.6	51.9	52.2	52.3
5	13.9	14.7	15.5	16.1	5	52.6	52.8	53.2	53.2
6	14.9	15.7	16.4	17.0	6	53.6	53.8	54.1	54.1
7	15.9	16.6	17.4	18.0	7	54.5	54.8	55.1	55.1
8	16.8	17.6	18.3	18.9	8	55.5	55.7	56.0	56.0
9	17.8	18.5	19.2	19.8	9	56.5	56.7	57.0	56.9
0.30	18.8	19.5	20.2	20.8	0.70	57.4	57.6	57.9	57.9
1	19.7	20.4	21.1	21.7	1	58.4	58.6	58.9	58.8
2	20.7	21.4	22.1	22.6	2	59.4	59.5	59.8	59.7
3	21.7	22.3	23.0	23.5	3	60.3	60.5	60.7	60.6
4	22.6	23.3	24.0	24.5	4	61.3	61.4	61.7	61.6
5	23.6	24.2	24.9	25.4	5	62.3	62.4	62.6	62.5
6	24.6	25.2	25.8	26.3	6	63.2	63.3	63.6	63.4
7	25.5	26.2	26.8	27.3	7	64.2	64.3	64.5	64.3
8	26.5	27.1	27.7	28.2	8	65.2	65.3	65.5	65.3
9	27.5	28.1	28.7	29.1	9	66.1	66.2	66.4	66.2
0.40	28.4	29.0	29.6	30.0	0.80	67.1	67.2	67.3	67.1
1	29.4	30.0	30.5	31.0	1	68.1	68.1	68.3	68.0
2	30.3	30.9	31.5	31.9	2	69.0	69.1	69.2	69.0
3	31.3	31.9	32.4	32.8	3	70.0	70.0	70.2	69.9
4	32.3	32.8	33.4	33.8	4	71.0	71.0	71.1	70.8
5	33.2	33.8	34.3	34.7	5	71.9	72.0	72.1	71.8
6	34.2	34.7	35.3	35.6	6	72.9	72.9	73.0	72.7
7	35.2	35.7	36.2	36.5	7	73.9	73.9	74.0	73.6
8	36.1	36.6	37.2	37.4	8	74.8	74.8	74.9	74.5
9	37.1	37.6	38.1	38.4	9	75.8	75.8	75.8	75.4
0.50	38.1	38.5	39.0	39.3	0.90	76.8	76.7	76.8	76.4
1	39.1	39.5	40.0	40.3	1	77.8	77.7	77.7	77.3
2	40.0	40.4	40.9	41.2	2	78.7	78.8	78.7	78.2
3	41.0	41.4	41.9	42.1	3	79.7	79.6	79.6	79.2
4	42.0	42.4	42.8	43.0	4	80.7	80.5	80.6	80.1
5	42.9	43.3	43.8	43.9	5	81.6	81.5	81.5	81.0
6	43.9	44.3	44.7	44.9	6	82.6	82.5	82.4	82.0
7	44.9	45.3	45.7	45.8	7	83.6	83.4	83.4	82.9
8	45.8	46.2	46.6	46.7	8	84.5	84.4	84.3	83.8
9	46.8	47.1	47.5	47.6	9	85.5	85.3	85.2	84.8
0.60	47.7	48.1	48.5	48.6	1.00	86.5	86.2	86.2	85.7

¹ The temperature figures at the heads of columns represent the room temperature at which the samples of plasma are saturated with alveolar carbon dioxide and analyzed. It is assumed that both operations are performed at the same temperature. The figures have been so calculated that, regardless of the room temperature at which saturation and analysis are performed, the table gives the volume (reduced to 0°, 760 mm.) of carbon dioxide that 100 c.c. of plasma are capable of binding when saturated at 20° with carbon dioxide at approximately 41 mm. tension. If the figures in the table are multiplied by 0.94 they give, within 1 or 2 per cent of the carbon dioxide bound at 37°.

THE RELATIONSHIP OF THE PLASMA BICARBONATE TO ACID EXCRETION, ALKALI TOLERANCE, AND ALVEOLAR CARBON DIOXIDE TENSION*

Condition of subject	Corresponding results of indirect tests for acidosis				
	24-hour excretion† of NH ₄ acid + NH ₃		Carbon dioxide of alveolar air		Sodium bicarbonate required to turn urine alkaline
	(a) C.c. per kg. (b) Approximate c.c. per 60 kg. person	Reliability in diabetes	(a) Mm. tension. (b) Approximate per cent	Reliability in diabetes	(a) Gm. per kg.‡ (b) Approximate gm. for a 60 kg. person
Actual bicarbonate reserve Plasma bicarbonate CO ₂ reduced to 0.760 mm.					
Normal resting adult.†	C.c. (a) 0-27 (b) 0-1600	Good	(a) 53-35 mm. (b) 6.8-4.7 per cent	May indicate some acidosis in its absence	(a) 0-0.5 (b) 0-30
Extreme limits of bicarbonate reserve.					
Mild acidosis, no pronounced symptoms.	(a) 27-65 (b) 1600-4000	Good‡	(a) 35-27 mm. (b) 4.7-3.6 per cent	May indicate more acidosis than is present	(a) 0.5-0.8 (b) 30-50
Moderate to severe acidosis. Symptoms may be apparent.	(a) 65-100 (b) 4000-6000	Liable to considerable error in either direction‡	(a) 27-20 mm. (b) 3.6-2.7 per cent	Good	(a) 0.8-1.1 (b) 50-65
Severe acidosis. Symptoms of acid intoxication.	(a) Over 100 (b) Over 6000		(a) Below 20 mm. (b) 2.7 per cent	Good	(a) Over 1.1 (b) Over 65

* D. D. Van Slyke: *Jour. Biol. Chem.*, 33, 271, 1918.

† Measured either in 24-hour urine or on specimen from shorter period calculated to 24-hour basis.

‡ After bicarbonate administration likely to indicate more acidosis than is present.

§ The figures tabulated in this column also indicate the doses of bicarbonate necessary to restore the alkali reserve to normal from acidosis of the severity indicated by the corresponding plasma CO₂ figures in the first column.

† Schloss (*Am. Jour. Dis. Child.*, 13, 218, 1917) finds values of 63-46 in the plasma of normal infants, i.e., about 10 c.c. lower than in adults.

2. Alkali Reserve.—Indirect Method. Alveolar Carbon Dioxide Tension. Fridericia's Method.¹

Principle.—The method of determination is based upon the absorption, by means of potassium hydroxide, of the carbon dioxide from a known amount of alveolar air. The apparatus is so graduated that the decrease in volume may be read in per cent.

Procedure.—The subject must sit quietly in a chair and breathe naturally,² holding the apparatus (shown in Fig. 112) in front of him with the cock *a* open and *b* in a position connecting *x* with *y*. After taking a normal inspiration he places the mouthpiece *m* into his mouth and blows as hard and as quickly as possible through the apparatus thus washing it out and leaving it filled with alveolar air. The cock *a* is at once closed and the whole apparatus is immersed in water for 5 minutes. By this means the alveolar air in *x* and *y* is cooled to a temperature which remains constant throughout the experiment, and the contraction in volume causes the alveolar air in the lower part of *y* to be drawn back into *x*.³ At the end of 5 minutes the cock *b* is turned so as to connect *y* with *c*, thus closing *x* which then contains exactly 100 c.c. of alveolar air at atmospheric pressure and at the temperature of the water in which the apparatus is immersed, this temperature remaining constant throughout the determination. The apparatus is removed from the water, the tube *c* is placed beneath the surface of some 10 per cent sodium hydroxide solution, some of the alkali is drawn up into *y*, the apparatus is held in such a position that *y* is rather depressed in order to prevent the escape of small bubbles of gas from *x*, the cock is turned so as to connect *y* with *x*, and some of the alkali is forced

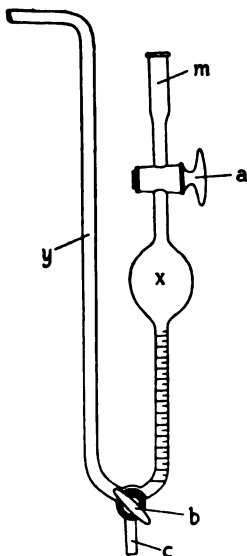

FIG. 112.—FRIDERICIA APPARATUS.

into *x*. The cock *b* is at once turned, closing *x* and connecting *y* with *c* through which the remainder of the alkali is allowed to flow. The apparatus is inverted several times during the course of half a minute which is sufficient time for the absorption of all the carbon dioxide. It is then returned to the water which rises through *c* into *y*, after which *b* is turned to connect *y* and *x* and the whole is allowed to remain for 5 minutes to again equalize the temperature. It is then raised rapidly until the water in the graduated portion of *x* is at the same level as the water outside the apparatus, i.e., when the gas within the tube *x* is under atmospheric pressure.

Calculation.—The reading of the bottom of the meniscus of the fluid in *x* is taken and represents, without any further calculation or correction, the per-

¹ Fridericia: *Hospitalsidende*, Copenhagen, 57, 585, 1914; Poulton: *Brit. Med. Jour.*, 2, 392, 1915.

² It is especially important to caution the subject against the very natural inclination to take an abnormally deep inspiration just before blowing through the apparatus, and also to see that, in seeking to avoid this fault, the breath is not held just before the sample is taken.

³ Any diffusion with the outside air at the top of *y* will not reach to the bottom of the tube owing to its length.

centage of carbon dioxide in the alveolar air. If it is desired to express this percentage as the partial pressure of CO₂ in millimeters of mercury¹ it is multiplied by a figure 40 mm. less than the prevailing barometric pressure; e.g., if the reading of the apparatus is 5.5 then the calculation will be as follows: 5.5 per cent CO₂ or $0.055 \times (760 - 40)$. This 40 mm. is the tension of water vapor in the lungs at body temperature. It is sufficient for clinical purposes to use the mean barometric pressure of the locality, neglecting the daily variations.

Interpretation.—The sample of air obtained by this method (if properly taken) represents more nearly air whose CO₂ tension is the same as that of arterial blood, *i.e.*, true alveolar air, than does air obtained by “rebreathing.” The results obtained by this method, then, are from 5 to 10 per cent lower than those obtained by the Marriott method below. The average normal value for men² is about 5.5 volumes per cent of carbon dioxide. In women and children the normal value is somewhat lower. In acidosis the carbon dioxide falls and in diabetic coma may go as low as 1 or 2 per cent. A value of 2 per cent means that coma may supervene within 24 hours. A value of 3 per cent or 4 per cent is less dangerous; in the worst event coma will not come on for at least two or three days. For detailed data as to alveolar carbon dioxide tension under different conditions see table on page 331.

3. Alkali Reserve. Indirect Method. Alveolar Carbon Dioxide Tension. Marriott's Method.³—While this method is open to criticism because of the liability of error in the collection of the sample and, more fundamentally, because of various factors (psychical, etc.) other than acidosis which may influence the carbon dioxide tension, nevertheless, it is of considerable value and has been rather widely adopted for clinical use.

Principle.—By rebreathing air under certain definite conditions a sample is obtained whose carbon dioxide tension is virtually that of venous blood. The method of analysis of this sample depends on the fact that if a current of air containing carbon dioxide is passed through a solution of sodium carbonate or bicarbonate until the solution is saturated, the final solution will contain sodium bicarbonate and dissolved carbon dioxide. The reaction of such a solution will depend on the relative amounts of the alkaline bicarbonate and the acid carbon dioxide present. This, in turn, will depend on the tension of carbon dioxide in the air with which the mixture has been saturated and will be independent of the volume of air blown through, provided saturation has once been attained. High tensions of carbon dioxide change the reaction of the solution toward the acid side. Low tensions have the reverse effect; hence the reaction of such a solution is a measure of the tension of carbon dioxide in the air with which it has been saturated. A suitable indicator is added to the solution and its reaction (after the passage of the alveolar air) is determined by comparison with a set of suitable standards.

¹ Henderson and Morriss: *Jour. Biol. Chem.*, 31, 217, 1917.

² Beddard, Pembrey, and Spriggs: *Brit. Med. Jour.*, 2, 389, 1915.

³ Marriott: *Jour. Am. Med. Ass'n*, 66, 1594, 1916.

Apparatus.—The complete apparatus, including rubber bag for collection of sample, standardized phosphate mixture sealed in tubes, the standard bicarbonate solution, tubes, color comparison box and other accessories may be obtained from Hynson, Westcott and Dunning, Baltimore, Maryland.

Procedure.—Collection of the alveolar air. The method of collection is essentially that of Plesch,¹ as modified by Higgins.² A rubber bag of approximately 1500 c.c. capacity³ is connected by means of a short rubber tube to a glass mouthpiece.⁴ About 600 c.c. of air are blown into the bag with an atomizer bulb, and the rubber tube clamped off by a pinchcock. The subject should be at rest and breathing naturally.⁵ At the end of a normal expiration, the subject takes the tube in his mouth; the pinchcock is released and the subject's nose closed by the observer. The subject breathes back and forth from the bag 4 times in 20 seconds, emptying the bag at each inspiration. The observer should indicate when to breathe in and out. Breathing more frequently will not greatly alter the results. At the end 20 seconds, the tube is clamped off and the air analyzed. The analysis should be carried out within 3 minutes' time, as carbon dioxide rapidly escapes through rubber.

The foregoing procedure applies to patients who are capable of cooperating to some extent. In the case of comatose patients, the initial amount of air in the rubber bag must be greater (1000 c.c. at least), and the period of rebreathing prolonged to 30 seconds.⁶ This is necessary, as it is not feasible that the bag be completely emptied of air at each inspiration; and therefore a longer time is required for the carbon dioxide tension in the bag and in the lungs to become equal. The initial amount of air in the bag should be such that it is at least one-half and preferably as much as two-thirds emptied at each inspiration. Since comatose patients cannot hold the mouthpiece, some form of mask is necessary. This may be a gas anesthetic mask⁷ or such a device as described below for use with infants.

A special mask has been devised for the collection of alveolar air from infants.⁸ It is made from the nipple of a wide-mouth (Hygeia) nursing bottle and a piece of thin rubber tissue (dental dam). A sheet of the tissue (8 by 10 inches) is perforated in the center by a piece of hot metal or glass tubing of large bore. The hole is stretched and pulled over the nipple and slipped down to the lower rim. A small amount of rubber cement is applied to hold the tissue and nipple together. A strip of adhesive plaster $\frac{3}{8}$ inch wide is applied around the rim of the nipple

¹ Plesch: *Ztschr. f. exper. Path. u. Therap.*, 380, vi, 1909.

² Higgins: *Pub. 203, Carnegie Institution of Washington*, 1915, p. 168.; Boothby, W. M., and Peabody, F. W.: A comparison of Methods of Obtaining Alveolar Air, *Arch. Int. Med.*, March, 1914, p. 497.

³ A basket ball bladder or a hot water bag answers very well. If the latter is used, the neck may be closed by a rubber stopper carrying a short glass tube $\frac{3}{8}$ inch in internal diameter.

⁴ An ordinary piece of glass tubing with rounded edges, $1\frac{1}{2}$ inch long and $\frac{3}{8}$ inch in internal diameter.

⁵ Especially to be guarded against is a deep, voluntary inspiration just before the collection begins, as this causes too low a determination.

⁶ The bag is clamped at the end of that expiration occurring nearest to 30 seconds, as no great error is introduced by prolonging the time of rebreathing by 2 or 3 seconds.

⁷ Some advantage may be gained by inserting a large three-way stopcock of metal or glass between the mask and the bag. When such a stopcock is used, the mask is first put in place on the patient's face with the cock so turned that he breathes the outside air for a few respirations. At the end of an expiration the cock is quickly turned so as to bring the bag and the mask into connection.

⁸ Howland and Marriott: *Am. Jour. Dis. Child.*, May, 1916.

so as to overlap the rubber tissue and hold it firmly in place. The extreme tip of the nipple is cut off and a short glass tube, $\frac{3}{8}$ inch in diameter, inserted.

"In making a collection of alveolar air from infants a rubber bag of 500 c.c. capacity is connected with the mask and partially filled with air by means of an aspirator bulb. The neck of the bag is closed off by a pinchcock or with the fingers, the mask placed over the nose and mouth of the infant and the rubber tissue closely drawn around the face so as to prevent the escape of air. The mask should, if possible, be placed over the face just at the end of expiration. Respirations are allowed to continue for from 28 to 32 seconds, and at the end of an expiration the neck of the bag is closed off and the mask removed from the face. We have found that it is necessary that the infant should be breathing quietly for 1 minute previous to the collection of the air sample, as vigorous crying, just before the mask is put on, leads to a lowering of the carbon dioxide tension, as determined, by several millimeters. Crying during the collection of the sample almost invariably occurs and facilitates mixing of the gases. The effect is to raise the tension somewhat if crying is very vigorous, but not to such an extent as to be significant. The initial amount of air in the bag must be such that during inspiration the bag is from one-half to two-thirds empty, but never completely collapsed. The amount of air required for infants under 1 year of age varies from 250 c.c. to 400 c.c."

The mask described above for use with infants may be very conveniently used for the collection of alveolar air samples from dogs. The animal's nose is inserted into the mask and the rubber tissue drawn closely around the muzzle. The time of a collection need not exceed 25 seconds.

Analysis of Sample.—In analyzing a sample of air, about 2 or 3 c.c. of the standard bicarbonate solution are poured into a clean test-tube of the same diameter as the tubes containing standard phosphate solutions, but from 100 to 150 mm. long. Air from the bag is then blown through the solution by means of a glass tube drawn out to a fine capillary point, until the solution is saturated, as shown by the fact that no further color change occurs.¹ The tube is stoppered and the color immediately compared with that in the standard tubes. By interpolation, one can readily read to millimeters. Color changes are not quite so sharp above 35 mm. as at the lower end of the scale, but here changes are of less significance. In making the color comparisons the solution being compared is placed between the two standards which it most nearly matches. When there is doubt as to whether the color of the solution is higher or lower than one of the standards, changing the order in which the tubes are placed in the comparison box will generally make the relationship clear.

The standard solutions described are so prepared as to give correct results when the determination is carried out at a temperature of from 20° to 25°C. (from 68° to 77°F.). When the room temperature is considerably higher or lower than these points it is advisable to immerse the tubes in water at approximately 25°C. during the blowing. They may be removed from the water for the color compari-

¹ If the operator first blows his own breath through the solution so as to bring it into approximate equilibrium with alveolar air, saturation may be accomplished with as little as 100 c.c. of air from the bag, blown through during 30 seconds. The same bicarbonate solutions may be used for repeated determinations.

son, however, provided this is quickly made. The differences due to ranges of temperature occurring under ordinary circumstances are practically negligible.¹

Calculation.—The standard tubes are marked to indicate the carbon dioxide tension in millimeters of mercury, and the readings can be estimated to about 2 mm.

Interpretation.—In normal adults at rest the carbon dioxide tension in the alveolar air, determined and described above, varies from 40 to 45 mm. Tensions between 30 and 35 mm. are indicative of a mild degree of acidosis. When the tension is as low as 20 mm., the individual may be considered in imminent danger. In coma, associated with acidosis, the tension may be as low as 8 or 10 mm. In infants, the tension of carbon dioxide is from 3 to 5 mm. lower than in adults.

Conditions other than acidosis may affect the carbon dioxide tension. Stimulation of the respiratory center leads to increased pulmonary ventilation and a consequent lowering of the alveolar carbon dioxide tension. Such stimulation may be brought about by caffeine² and possibly also by intracranial lesions. The respiratory center may be depressed by morphin, and as the result of certain³ infections. This leads to an increased carbon dioxide tension. Changes in the excitability of the respiratory center, however, are but rarely great enough to affect significantly the composition of the alveolar air.

"Alveolar" air collected as described above is essentially air which has come in equilibrium with the venous blood in the pulmonary capillaries. The tension of carbon dioxide is approximately that in the venous blood. "Alveolar" air collected by the Haldane or Fridericia methods is air which has come in approximate equilibrium with the arterial blood, and hence is of a carbon dioxide tension from 10 to 20 per cent lower.

Changes in the pulmonary epithelium such as would prevent the air in the lungs from coming in equilibrium with the blood in the capillaries would, of necessity, affect the composition of the alveolar air. Since very little is known as yet regarding the exact effect of such changes, one is hardly justified in drawing conclusions regarding acidosis from the composition of the alveolar air in patients with pulmonary affections.³

4. Alkali Reserve. Indirect Method. Index of Acid Excretion in Urine. Method of Fitz and Van Slyke.⁴ Principle.—The method depends upon the determination of the rate of excretion of acid (NH_3 + titratable acid) from which the plasma carbon dioxide capacity is calculated.

Procedure.—Collect the urine for 24 hours (or if desired for a period of 1 or 2 hours during which the subject ingests neither food nor water). In the latter case the urine collection should not be too soon after a meal. Measure, carefully, the volume of the urine and determine its ammonia content according to the method given on page 523 and the titratable acid according to the method given on page 508. Obtain the body weight of the patient.

¹ No correction for barometric pressure is required as from the nature of the determination, barometric fluctuations are self-corrective. Variations in the temperature of the subject are never great enough to affect the value as much as 1 mm. and therefore may be neglected.

² Higgins and Means: *Jour. Pharmacol. and Exper. Therap.*, 1915, vii, 1.

³ Means, Newburgh and Porter: *Boston Med. and Surg. Jour.*, 1915, clxxiii, 742.

⁴ Fitz and Van Slyke: *Jour. Biol. Chem.*, 30, 389, 1917; Van Slyke: *Ibid.*, 33, 271, 1918; Barnett: *Jour. Biol. Chem.*, 33, 267, 1918.

Calculation.—The plasma bicarbonate may be calculated by substitution in the following equation.

$$\text{Plasma Carbon Dioxide Capacity} = 80^1 - 5\sqrt{\frac{D}{W}}$$

D = Rate of excretion per 24 hours.

W = Body weight in kilograms.

The value D is equal to the product VC, in which V is the 24 hour volume² expressed in liters, and C the sum of the ammonia (expressed as c.c. of N/10 NH₃ per liter of urine) plus the titratable acid (expressed as c.c. of N/10 acid per liter of urine). For practical purposes the acid excretion may, without going through the calculation of the formula, be interpreted directly into terms of clinical severity of acidosis, as indicated in the table on page 331, e.g., an excretion exceeding 27 c.c. of N/10 ammonia plus titratable acid per kilo indicates acidosis, which usually becomes critical in severity if the excretion approaches 100 c.c. per kilo.

Interpretation.—After careful investigation in which the relationship between the carbon dioxide capacity of plasma and the excretion rate and concentration of total urinary acid excreted in excess of mineral bases was determined, Fitz and Van Slyke concluded that no other equation including excretion rate and concentration was so satisfactory as the above simplification of that used by Ambard for urea and chloride.

The value $80 - 5\sqrt{\frac{D}{W}}$ indicates, with an error which is usually less than 10 volumes per cent, the level of the plasma carbon dioxide capacity. Diabetics receiving bicarbonate administrations are exceptions, the blood bicarbonate in such cases being, as a rule, much higher than indicated by the urine.

Of the two indirect measures of alkali reserve the alveolar carbon dioxide determination appears the more accurate in measuring the more severe stages of diabetic acidosis, such as are encountered in threatened coma, while the index of acid excretion is the more accurate in measuring the more common intermediate stages.⁴

In nephritis, acidosis (lowered blood bicarbonate) may occur without increase in acid excretion or even with decrease of the latter. Consequently the excretion cannot be used as an indicator of acidosis when nephritis is present.

For values of the acid index under different conditions see table, page 331.

¹ The value 80 represents the maximum normal value of plasma bicarbonate. Under such a condition the titratable acid and ammonia excretion tend to approach zero.

² If the urine is collected for only 1 or 2 hours its volume is, of course, multiplied by 24 or 12 as the case may be.

³ Ambard: *Physiologie normale et pathologique des reins*, Paris, 1914.

⁴ Stillman, Van Slyke, Cullen, and Fitz: *Jour. Biol. Chem.*, 30, 405, 1917.

5. Alkali Tolerance.¹—This method is quite reliable for proving the absence of acidosis, but is not particularly dependable for showing either the presence or the degree of acidosis when it exists. This seems to be due in part at least to the fact that in conditions associated with acidosis the power of the kidney for excretion of alkalis may be markedly impaired.

Principle.—Sodium bicarbonate is administered in small amounts, either by mouth or intravenously until the reaction of the urine changes from acid to alkaline. The amount of bicarbonate is then noted.

Procedure.—Give (by mouth) 5 grams of sodium bicarbonate in 100 c.c. of water to the subject under examination. Repeat every half hour until the total bicarbonate administration is equivalent to 0.5 gram per kilogram of body weight unless the urine becomes alkaline before that time. In case the urine does not become alkaline with the above bicarbonate ingestion, continue the administration of the alkali until the urine shows an alkaline reaction.² The urine should be voided by the subject before each administration of bicarbonate. Test each specimen of urine with litmus, boiling those samples which are only faintly acid so that any bicarbonate present will be converted to carbonate. Note the number of grams of bicarbonate necessary to produce an alkaline urine.

Interpretation.—Normally the administration of from 5 to 10 grams of bicarbonate is generally sufficient to produce an alkaline reaction in the urine,³ while in patients suffering from acidosis a greater amount is required. In general a maximum ingestion of 0.5 gram of bicarbonate per kilogram body weight will produce an alkaline urine in a normal person. In mild acidosis this value may be increased to a maximum of 0.8 gram, whereas, moderate acidosis may show a value of 1.1 grams. In severe acidosis with symptoms of acid intoxication the bicarbonate value may exceed 1.1 grams per kilogram body weight. If an alkaline urine is obtained after the administration of 0.5 gram or less of bicarbonate per kilogram body weight one is safe in saying that no acidosis exists. When higher values are obtained, however, they should be confirmed by blood analysis before being accepted. For data as to alkali tolerance under different conditions see table on page 331.

6. Relative Hydrogen Ion Concentration of the Blood. *Method of Levy, Rowntree, and Marriott.*⁴ *Principle.*—The blood is dialyzed against normal salt solution and the H ion concentration of the protein-free dialyzate is determined by the indicator method, using phenolsulphonephthalein.

¹ Sellards: *Bull. Johns Hopkins Hosp.*, 23, 289, 1912; Palmer and Henderson: *Arch. Int. Med.*, 12, 153, 1913; Palmer and Van Slyke: *Jour. Biol. Chem.*, 32, 499, 1917.

² Because of the likelihood of producing a condition of alkalosis it is advisable not to continue the administration of bicarbonate without evidence from blood analysis showing an alkali deficit.

³ Henderson & Palmer: *Jour. Biol. Chem.* 14, 81, 1913.

⁴ Levy, Rowntree and Marriott: *Arch. Int. Med.*, 16, 389, 1915.

Procedure.—One to 3 c.c. of clear serum or of blood is run, by means of a blunt-pointed pipette, into a dialyzing sac¹ which has been washed outside and inside with salt solution.² The sac is lowered into a small test-tube (100×10 mm., inside measurements), containing 3 c.c. of salt solution, until the fluid on the outside of the sac is as high as on the inside. From 5–10 minutes are allowed for dialysis. The collodion sac is removed and 5 drops of the indicator (0.01 per cent solution of phenolsulphonephthalein) are thoroughly mixed with the dialyzate. The tube is then compared with the standards³ until the corresponding color is found, which indicates the hydrogen ion concentration present in the dialyzate. Readings should be made immediately against a white background. Results are expressed in logarithmic notation.

Oxalated blood from normal individuals gives a dialyzate with a P_H varying from 7.4 to 7.6, while that of serum ranges from 7.6 to 7.8. In clinical acidosis figures from 7.55 to 7.2 have been noted by this method for serum and for oxalated blood from 7.3 to 7.1. A rise in the H ion concentration of the blood is significant because it indicates a failure on the part of the protective mechanism of the body to preserve the proper reaction.

7. Acetone Bodies. *Nephelometric Methods of Marriott.*—(See Nephelometric Methods, p. 295.)

¹ *Preparation of Sacs.*—One ounce of celloidin is dissolved in 500 c.c. of a mixture of equal quantities of ether and ethyl alcohol. The solid swells up and dissolves with occasional gentle shakings, in 48 hours. As a small amount of brown sediment separates out at first, the solution should stand for at least three or four days, after which the clear supernatant solution is ready for use. A small test-tube (120 by 9 mm., inside measurement) is filled with this mixture, inverted, and half the contents poured out. The tube is then righted, and the collodion allowed to fill the lower half again. A second time it is inverted and rotated on its axis, the collodion being drained off. Care must be taken to rotate the tube, in order to secure a uniform thickness throughout. The tube is clamped in the inverted position and allowed to stand for ten minutes, until the odor of ether finally disappears. It is filled five or six times with cold water, or it is allowed to soak five minutes in cold water. A knife blade is run around the upper rim, so as to loosen the sac from the rim of the test-tube, and a few cubic centimeters of water are run down between the sac and the glass tube. By gentle pulling the tube is extracted, after which it is preserved by complete immersion in water.

² *The Salt Solution.*—The blood or serum is dialyzed against an 0.8 per cent sodium chloride solution.

Before applying the test, it is necessary to ascertain that the solution is free from acids other than carbonic. To determine this, a few cubic centimeters of the salt solution are placed in a Jena test-tube and 1 or 2 drops of the indicator added, whereupon a yellow color appears. On boiling, carbon dioxide is expelled, and the solution loses its lemon color and takes on a slightly brownish tint. In the absence of this change other acids are present, and the salt solution is therefore not suitable. If, on the other hand, on adding the indicator pink at once appears, the solution is alkaline and hence cannot be used.

³ *Preparation of Standard Colors.*—Standard phosphate mixtures are prepared according to Sørensen's directions as follows:

$\frac{1}{5}$ mol. acid or primary potassium phosphate. 9.078 grams of the pure recrystallized salt (KH_2PO_4) is dissolved in freshly distilled water and made up to 1 liter.

$\frac{1}{5}$ mol. alkaline or secondary sodium phosphate. The pure recrystallized salt ($Na_2HPO_4 \cdot 12H_2O$) is exposed to the air for from ten days to two weeks, protected from dust. Ten molecules of water of crystallization are given off and a salt of the formula $Na_2HPO_4 \cdot 2H_2O$ is obtained. 11.876 grams of this is dissolved in freshly distilled water and made up to 1 liter. The solution should give a deep rose-red color with phenolsulphonephthalein. If only a faint pink color is obtained, the salt is not sufficiently pure.

The solutions are mixed in the proportions indicated below to obtain the desired P_H .

TABLE FOR PREPARATION OF STANDARD COLORS

pH	6.4	6.6	6.8	7.0	7.1	7.2	7.3	7.4	7.5	7.6	7.7	7.8	8.0	8.2	8.4
Primary potassium phosphate c.c.	73	63	51	37	32	27	23	19	15.8	13.2	11.0	8.8	5.6	3.2	2.0
Secondary sodium phosphate c.c.	27	37	49	63	68	73	77	81	84.2	86.8	89.0	91.2	94.4	96.8	98.0

CHAPTER XVIII

MILK

MILK is the most satisfactory individual food material elaborated by nature. It contains the three nutrients, protein, fat, and carbohydrate and inorganic salts in such proportion as to render it a very acceptable dietary constituent. It is a specific product of the secretory activity of the mammary gland. It contains, as the principal solids, *olein, palmitin, stearin, butyryn, casein, lact-albumin, lacto-globulin, lactose, phosphates of calcium, potassium and magnesium, citrates of sodium and potassium and chloride of calcium*. The calcium phosphate of milk is the *neutral calcium phosphate*, CaHPO_4 .¹ Milk also contains some *iron* but not enough for the needs of the body if milk is the only source of the iron. It also contains at least traces of lecithin, cholesterol, urea, creatine, creatinine, and the tri-glycerides of caproic, lauric, and myristic acids. According to Osborne and Wakeman² milk contains two *phosphatides*, one being probably *stearyl-oleyl-lecithin*. These same investigators³ have also shown milk to contain an *alcohol-soluble* protein.

Recent investigations indicate the presence in milk of some substance or substances of *unknown character* which are of great nutritional importance. The presence of a *growth-promoting substance* (vitamine) in *butter fat* has been demonstrated by McCollum and Davis and by Osborne and Mendel.⁴ (For discussion of vitamins, see Experiment 1, page 585.)

By passing milk through a special form of earthenware filter Van Slyke and Bosworth⁵ have obtained a separation of the constituents in milk which are in true solution from those insoluble in water or in suspension. The soluble constituents and the water constitute the *milk serum*. They suggest the following classification of milk constituents:

CONSTITUENTS OF MILK

In true solution in milk serum.	Partly in solution and partly in suspension or colloidal solution.	Entirely in suspension or colloidal solution.
1. Lactose.	1. Albumin.	1. Fat.
2. Citric acid.	2. Inorganic phosphate.	2. Casein.
3. Potassium.	3. Calcium.	
4. Sodium.	5. Magnesium.	
5. Chlorine.		

¹ Van Slyke and Bosworth: *Jour. Biol. Chem.*, 20, 135, 1915.

² Osborne and Wakeman: *Jour. Biol. Chem.*, 21, 539, 1915; 28, 1, 1916.

³ Osborne and Wakeman: *Jour. Biol. Chem.*, 33, 243, 1918.

⁴ McCollum and Davis: *Jour. Biol. Chem.*, 15, 167, 1913; Osborne and Mendel: *ibid.*, 15, 311, 1913; 24, 37, 1916 (previous references cited in this article).

⁵ Van Slyke and Bosworth: *Jour. Biol. Chem.*, 20, 135, 1915.

The milk-curdling enzymes of the gastric and the pancreatic juice have the power of splitting the casein of the milk, through a process of hydrolytic cleavage, into *soluble paracasein* and a *peptone-like* body. This soluble paracasein then forms a combination with the soluble calcium salts of the milk and an *insoluble* curd of *paracasein* results. The clear fluid surrounding the curd is known as *whey*. This action of rennin may be represented by the following scheme:

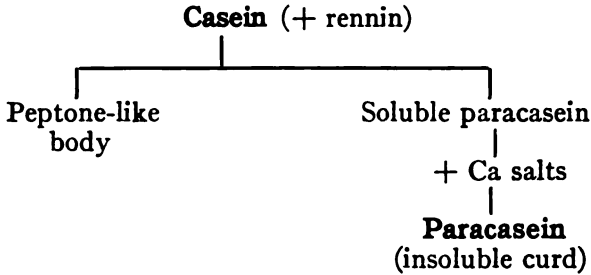

FIG. 113.—NORMAL MILK AND COLOSTRUM.
a, Normal milk; b, Colostrum.

There is still considerable confusion of terms when different authorities discuss milk proteins and the action of milk curdling enzymes upon them. The English scientists¹ quite uniformly call the principal protein of milk *caseinogen* whereas the insoluble curd formed by rennin is termed *casein*. On the other hand, the Germans and many Americans give the name *casein* to the milk protein and *paracasein* to the product of the action of rennin upon this protein. The confusion of terms may be represented thus:

<i>English.</i>	=	<i>German.</i>
Caseinogen.	=	Casein.
Casein.	=	Paracasein.

¹ Halliburton: *Journal of Physiology*, 11, 448, 1900

The most important difference between human milk and cow's milk is in the protein content, although there are also differences in the



FIG. 114.

FIG. 114.—CURD OF HUMAN MILK 5 MINUTES AFTER INGESTION OF 75 C.C. MILK (Beginning of curd formation, $\frac{1}{2}$ actual size).¹



FIG. 115.

FIG. 115.—CURD OF HUMAN MILK 10 MINUTES AFTER INGESTION OF 75 C.C. MILK. (Maximum curd formation, $\frac{1}{2}$ actual size).¹

carbohydrate and ash and likewise striking biological differences difficult to define chemically. It has been shown that the casein of human

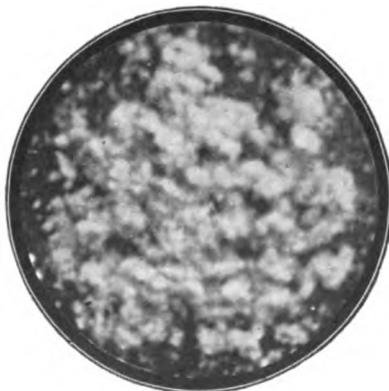

FIG. 116.

FIG. 116.—CURD OF COW'S MILK 10 MINUTES AFTER INGESTION OF 500 C.C. WHOLE MILK. (Curds $\frac{1}{2}$ actual size).²



FIG. 117.

FIG. 117.—CURD OF COW'S MILK 25 MINUTES AFTER INGESTION OF 500 C.C. WHOLE MILK. (Curds $\frac{1}{2}$ actual size).²

FIGS. 114 TO 117—PHOTOGRAPHS REPRESENTING TYPICAL CURDS FROM HUMAN AND COW'S MILK.

milk differs from the casein of cow's milk in being more difficult to precipitate by acid or coagulate by gastric rennin. The casein curd

¹ Unpublished photographs from the thesis of Dr. Robert A. Lichtenthaler.

² Unpublished photographs from investigations by Bergeim, Evvard, Rehfuess and Hawk.

(paracasein) also forms in much looser and more flocculent manner than that from cow's milk and is for this reason much more easily digested than the latter. (For illustrations of milk curds, see Figs. 114 to 117, page 344.) Both human and cow's milk contain important non-nitrogenous substances of an unknown character. Human milk contains the greater quantity of these substances.¹

The relative composition of human and cow's milk is shown in the following table which embraces data reported by Meigs and Marsh.

COMPOSITION OF MILK (PER CENT OF WHOLE MILK) NORMAL VARIATIONS FROM BEGINNING OF SECOND MONTH OF LACTATION

Constituent	Cow	Human
Water (Avg.).....	87.0	87.5
Solids (Avg.).....	13.0	12.5
Protein.....	4-2.5 ²	1.5-0.7
Fat.....	2-4	2-4
Sugar.....	3.5-5 ²	6-7.5
Ash.....	0.6-0.7	0.2-0.3

The above data indicate that *human milk contains less protein, more sugar and much less ash than cow's milk.* The percentage composition of human milk at different periods is represented in the following table.³

PERCENTAGE COMPOSITION OF HUMAN MILK BY PERIODS

Period	Fat	Sugar	Protein	Casein	Albumin	Ash	Total solids
Colostrum (1-12 days).....	2.83	7.59	2.25	0.31	13.4
Transition (12-30 days).....	4.37	7.74	1.56	0.24	13.4
Mature (1-9 mos.).....	3.26	7.50	1.15	0.43	0.72	0.21	12.2
Late (10-20 mos.).....	3.16	7.47	1.07	0.32	0.75	0.20	12.2

¹ Meigs and Marsh: *Jour. Biol. Chem.*, 16, 147, 1913.

² Note: Protein starts high and decreases whereas sugar starts low and increases.

³ Holt, Courtney and Fales: *Am. Jour. Dis. Children*, 10, 229, 1915.

The composition of the ash of milk is shown in the following table reported by Holt, Courtney and Fales.¹

PERCENTAGE COMPOSITION OF THE ASH OF MILK

	CaO	MgO	P ₂ O ₅	Na ₂ O	K ₂ O	Cl
Human milk.....	23.3	3.7	16.6	7.2	28.3	16.5
Cow's milk.....	23.5	2.8	26.5	7.2	24.9	13.6

It will be observed that the composition of the ash of the two varieties of milk is about the same except for phosphorus. The higher phosphorus content in the case of cow's milk is due principally to the fact that the milk contains a higher percentage of *casein* or *phosphoprotein*. It should be borne in mind that cow's milk contains on the average over *three times* as much ash as human milk. Therefore unless cow's milk has been diluted with more than twice its volume, there is still present as high a concentration of the inorganic constituents as are present in normal human milk. Hence there is no necessity for the addition of any of these constituents in infant feeding.

Interesting data relative to the composition of milk from various sources may be gathered from the following table which was compiled mainly from the results of investigations by Pröscher² and by Abderhalden³ in Bunge's laboratory. It will be noted that the composition of the milk varies directly with the length of time needed for the young of the particular species to double in weight.

Species	Period in which weight of the newborn is doubled (days)	100 Parts of milk contain			
		Proteins	Salts	Calcium	Phosphoric acid
Man.....	180	1.6	0.2	0.033	0.047
Horse.....	60	2.0	0.4	0.124	0.131
Cow.....	47	3.5	0.7	0.160	0.197
Goat.....	22	3.7	0.8	0.197	0.284
Sheep.....	15	4.9	0.8	0.245	0.293
Pig.....	14	5.2	0.8	0.249	0.308
Cat.....	9.5	7.0	1.0
Dog.....	9	7.4	1.3	0.455	0.508
Rabbit.....	6	10.4	2.5	0.891	0.997

The secretion of the mammary glands of the newborn of both sexes is called "witches' milk." The name is centuries old and evidently

¹ Holt, Courtney and Fales: *Am. Jour. Dis. Children*, 10, 229, 1915.

² Pröscher: *Zeit. f. physiol. Chemie*, 24, 285, 1898.

³ Abderhalden: *Ibid.*, 26, 487, 1899; and 27, pp. 408 and 457, 1899.

refers to the mystery of the useless secretion. Basch¹ has recently suggested that this secretion of "witches' milk" is brought about by the passage of *hormones* (see Chapter on Pancreatic Digestion) from the blood of the mother to the fetus.

Lactose, the principal carbohydrate constituent of milk, is an important member of the disaccharide group. It occurs only in milk, except as it is found in the urine of women during pregnancy, during the nursing period, and soon after weaning; it also occurs in the urine of normal persons after the ingestion of a very large amount of lactose in the food. It is not derived directly from the blood, but is a specific product of the cellular activity of the mammary gland. It has strong reducing power, is dextro-rotatory and forms an osazone with phenylhydrazine. Lactose is *not* fermentable by the ordinary baker's yeast. For changes

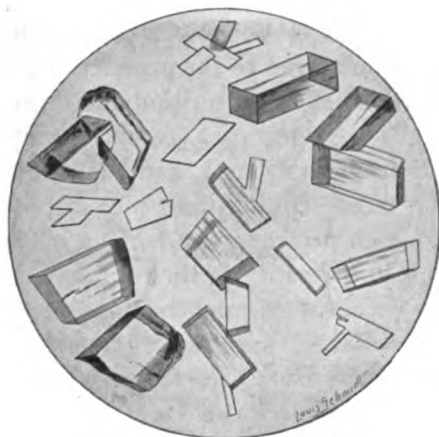

FIG. 118.—LACTOSE.

which lactose undergoes in *lactic acid fermentation* see page 342. The crystalline form of lactose is shown in Fig. 118.

Casein, the principal protein constituent of milk, belongs to the group of phosphoproteins and contains 0.7 per cent of phosphorus.² It has acidic properties and combines with bases to produce salts.³ It is probably present in milk in the form of *neutral calcium caseinate* (Casein Ca₄).⁴ It is not coagulable upon boiling and is precipitated from its neutral solution by certain metallic salts as well as upon saturation with sodium chloride or magnesium sulphate. Its acid solution is precipitated by mineral acid.

Lactalbumin and lactoglobulin, the protein constituents of milk,

¹ Basch: *Munch. med. Woch.*, 58, 2266, 1911.

² Bosworth and Van Slyke: *Jour. Biol. Chem.*, 19, 67, 1914.

³ Van Slyke and Bosworth: *Jour. Biol. Chem.*, 14, 207-227, 1914.

⁴ Van Slyke and Bosworth: *Jour. Biol. Chem.*, 20, 135, 1915.

next in importance to casein, closely resemble serum albumin and serum globulin in their general properties.

Butter (milk fat) consists in large part of *olein* and *palmitin*. Stearin, butyrin, caproin and traces of other fats are also present. An important growth-promoting substance (vitamine) called "Fat Soluble A" is also present in butter fat.¹ When butter becomes rancid through the cleavage of certain of its constituent fats by bacteria the odors of caproic and butyric acids are in evidence.

The pigment of the fat of cow's milk is made up of *carotin* and *xanthophylls*. The principal pigment is carotin, an unsaturated hydrocarbon pigment which is widely distributed in plants.² The pigment of the fat of *human* milk is made up of carotin and xanthophylls in about equal proportions. Carotin is also probably the pigment of human fat. The pigment of body fat, blood serum, corpus luteum and skin secretions of the cow is principally carotin.

Colostrum is the name given to the product of the mammary gland secreted for a short time before parturition and during the early period of lactation (see Fig. 113, page 343). It is yellowish in color, contains more solid matter than ordinary milk, and has a higher specific gravity (1.040-1.080). The most striking difference between colostrum and ordinary milk is the high percentage of lactalbumin and lactoglobulin in the former. This abnormality in the protein content is responsible for the coagulation of colostrum upon boiling.

Such enzymes as lipase, amylase, galactase, catalase, oxidases, peroxidases, and reductases have been identified in milk, but not all of them in milk of the same species of animal.

Among the principal preservatives used in connection with milk are formaldehyde, hydrogen peroxide, boric acid, borates, salicylic acid, and salicylates. The use of milk preservatives is illegal in most states.

EXPERIMENTS ON MILK

1. Reaction.—Test the reaction of fresh cow's milk to litmus, phenolphthalein and Congo red.

2. Biuret Test.—Make the biuret test according to directions given on page 100.

3. Microscopical Examination.—Examine fresh whole milk, skimmed or centrifugated milk, and colostrum under the microscope. Compare the microscopical appearance with Fig. 117, page 344.

4. Specific Gravity.—Determine the specific gravity of both whole and skimmed milk (see page 353). Which possesses the higher specific gravity? Explain why this is so.

5. Film Formation.—Place 10 c.c. of milk in a small beaker and boil a few minutes. Note the formation of a film. Remove the film and heat again. Does

¹ See Experiment 1, page 585.

² Palmer and Eckles: *Jour. Biol. Chem.*, 17, 191, 1914.

the film now form? Of what substance is this film composed? The biuret test was positive; why do we not get a coagulation here when we heat to boiling?

6. Coagulation Test.—Place about 5 c.c. of milk in a test-tube, acidify slightly with dilute acetic acid and heat to boiling. Do you get any coagulation? Why?

7. Action of Hot Alkali.—To a little milk in a test-tube add a few drops of potassium hydroxide and heat. A yellow color develops and gradually deepens into a brown. To what is the formation of this color due? (See Moore's Test, Chapter II.)

8. Test for Chlorides.—To about 5 c.c. of milk in a test-tube add a few drops of very dilute nitric acid to form a precipitate. Filter off this precipitate and test the filtrate for chlorides. Does milk contain any chlorides?

9. Guaiac Test.—To about 5 c.c. of water in a test-tube add 3 drops of milk and enough alcoholic solution of guaiac (strength about 1:60)¹ to cause turbidity. Thoroughly mix the fluids by shaking and observe any change which may gradually take place in the color of the mixture. If no blue color appears in a short time, heat the tube gently below 60°C. and observe whether the color reaction is hastened. In case a blue color does not appear in the course of a few minutes, add hydrogen peroxide or old turpentine, drop by drop, until the color is observed.

Fresh milk will frequently give this blue color when treated with an alcoholic solution of guaiac without the addition of hydrogen peroxide or old turpentine. Those milks which respond positively, fail to do so after boiling 15–20 seconds. What substances beside milk respond to this test? See discussion on page 262.

10. Differentiation of Human and Cow's Milk (Modification of Bauer's Test).²—Introduce 2 c.c. of fresh human milk into a 50 c.c. test-tube and 2 c.c. of fresh cow's milk into another similar tube. Add to the contents of each tube 1 drop of a 0.25 per cent aqueous solution of Nile-blue sulphate (Grübler). Shake the tubes gently and permit them to stand undisturbed for 10–30 minutes. The milk assumes a bluish cast in each case. At the end of the 10-minute interval add 10 c.c. of ether to the contents of each tube and shake very thoroughly for one minute. The ether extracts the pigment from the human milk, leaving the milk white. In the case of cow's milk the ether does not extract the dye and the milk remains bluish in color.

11. Tests to Differentiate between Raw Milk and Heated Milk.—

(a) *Tricresol Peroxidase Reaction (Kastle)*.—The peroxidase reaction of milk is founded upon the fact that small amounts of *raw* milk will induce the oxidation of various leuco compounds by hydrogen peroxide. This reaction has been used in a practical way as the most convenient means of differentiating between *raw milk* and *heated milk*. Many substances have been employed for this purpose, e.g., guaiac, parphenylenediamine, ortol, amidol, etc. Kastle has found that a dilute

¹ Buckmaster advises the use of an alcoholic solution of guaiacetic acid instead of an alcoholic solution of guaiac resin. Guaiacetic acid is a constituent of guaiac resin.

² Bauer: *Monatssch. f. Kinderheil.*, 11, 474, 1912–13.

solution of "trícresol"¹ acts as a sensitizing agent in the peroxidase reaction and offers the following test which is based upon this fact.

Procedure.—To 2–5 c.c. of raw milk in a test-tube add 0.1–0.3 c.c. of M/10 hydrogen peroxide and 1 c.c. of a 1 per cent solution of "trícresol." A slight though unmistakable yellow color will be observed to develop throughout the solution. Repeat the test using milk which has been boiled or heated to 80°C. for 10–20 minutes and cooled, and note that no yellow color is produced.

The color reaction in the case of the raw milk probably results from the oxidation of the cresols by the hydrogen peroxide. The first product of this oxidation² then oxidizes the leuco compound, when such is present, and causes the color observed.

(b) *Benzidine Peroxidase Reaction (Wilkinson and Peters).*³—To 10 c.c. of the milk to be tested add 2 c.c. of a 4 per cent alcoholic solution of benzidine, sufficient acetic acid to coagulate the milk (usually 2–3 drops) and finally 2 c.c. of a 3 per cent solution of hydrogen peroxide. Raw milk yields an immediate blue color. In adding the peroxide it is best to permit it to flow slowly down the wall of the vessel containing the mixture instead of allowing it to mix with the milk. Milk which has been heated to 78°C. or above remains unchanged.

12. **Saturation with Magnesium Sulphate.**—Place about 5 c.c. of milk in a test-tube and saturate with solid magnesium sulphate. What is this precipitate?

13. **Influence of Gastric Rennin on Milk.**—Prepare a series of five tubes as follows:

(a) 5 c.c. of fresh milk + 0.2 per cent HCl (add drop by drop until a precipitate forms).

(b) 5 c.c. of fresh milk + 5 drops of rennin solution.⁴

(c) 5 c.c. of fresh milk + 10 drops of 0.5 per cent Na₂CO₃.

(d) 5 c.c. of fresh milk + 10 drops of ammonium oxalate.

(e) 5 c.c. of fresh milk + 5 drops of 0.2 per cent HCl.

Now to each of the tubes (c), (d) and (e) add 5 drops of rennin solution. Place the whole series of five tubes at 40°C. and after 10–15 minutes note what is occurring in the different tubes. Give a reason for each particular result.

14. **Preparation of Casein.**—Fill a large beaker one-third full of skimmed (or centrifugated) milk and dilute it with an equal volume of water. Add dilute hydrochloric acid until a flocculent precipitate forms. Stir after each acidification and do not add an excess of the acid as the precipitate would dissolve. Allow the precipitate to settle, decant the supernatant fluid, and reserve it for use in later (15–18) experiments. Filter off the precipitate of casein and remove the excess of moisture by pressing it between filter papers. Transfer the casein to a small beaker, add enough 95 per cent alcohol to cover it and stir for a few moments. Filter, and press the precipitate between filter papers to remove the alcohol. Transfer the casein again to a small dry beaker, cover the precipitate with ether and heat on a water-bath for ten minutes, stirring con-

¹ "Tríkresol" is the trade name of an antiseptic which contains the three cresols in approximately equal proportions.

² Probably some organic peroxide or quinoid compound.

³ Wilkinson and Peters: *Z. Nahr-Genussm.*, 16, No. 3, p. 172.

⁴ Any commercial rennin or rennet preparation or an extract of the gastric mucosa of the pig may be employed.

tinuously. Filter (reserve the filtrate), and press the precipitate as dry as possible between filter papers. Open the papers and allow the ether to evaporate spontaneously. Grind the precipitate to a powder in a mortar. Upon the casein prepared in this way make the following tests:

(a) Solubility.—Try the solubility in water, sodium chloride, dilute acid and alkali.

(b) Millon's Reaction.—Make the test according to the directions given on page 98.

(c) Biuret Test.—Make the test according to directions given on page 100.

(d) Glyoxylic Acid Reaction (Hopkins-Cole).—Make the test according to the directions given on page 99.

(e) Unoxidized Sulphur.—Test for unoxidized sulphur according to the directions given on page 108. The sulphur content of casein is rather low, e.g., about 0.7 per cent.

(f) Fusion Test for Phosphorus.—Test for phosphorus by fusion according to directions given on page 129. Casein contains 0.7 per cent of phosphorus.

15. Coagulable Proteins of Milk.—Place the filtrate from the original casein precipitate in a casserole and heat, on a wire gauze, over a free flame. As the solution concentrates, a coagulum consisting of lactalbumin and lactoglobulin will form. Continue to concentrate the solution until the volume is about one-half that of the original solution. Filter off the coagulable proteins (reserve the filtrate) and test them as follows:

(a) Millon's Reaction.—Make the test according to the directions given on page 98.

(b) Biuret Test.—Make the test according to the directions given on page 100.

(c) Glyoxylic Acid Reaction (Hopkins-Cole).—Make the test according to the directions given on page 99.

16. Detection of Calcium Phosphate.—Evaporate the filtrate from the coagulable proteins, on a water-bath, until crystals begin to form. It may be necessary to concentrate to 15 c.c. before any crystallization will be observed. Cool the solution, filter off the crystals (reserve the filtrate), and test them as follows:

(a) Microscopical Examination.—Examine the crystals and compare them with those in Fig. 119.

(b) Dissolve the crystals in nitric acid. Test part of the acid solution for phosphates. Render the remainder of the solution slightly alkaline with ammonia, then acidify with acetic acid and add ammonium oxalate. Examine the crystals under the microscope and compare them with those in Fig. 149, page 488.

17. Detection of Lactose.—Concentrate the filtrate from the calcium phosphate until it is of a syrup-like consistency. Allow it to stand over night and observe the formation of crystals of lactose. Make the following experiments.

(a) Microscopical Examination.—Examine the crystals and compare them with those in Fig. 118, page 347.

(b) Fehling's Test.—Try Fehling's test upon the mother liquor.

(c) Phenylhydrazine Test.—Apply the phenylhydrazine test to some of the mother liquor according to the directions given on page 22.



FIG. 119.—CALCIUM PHOSPHATE.

18. Milk Fat.—(a) Evaporate the ether filtrate from the casein (Experiment 13) and observe the fatty residue. The milk fat was carried down with the precipitate of casein and was removed when the latter was treated with ether. If centrifugated milk was used in the preparation of the caseinogen the amount of fat in the ether filtrate may be very small. To secure a larger yield of fat proceed according to directions given under (b) below.

(b) To 25 c.c. of whole milk in an evaporating dish add a little sand or filter paper and evaporate the fluid to dryness on a water-bath. Grind or break up the residue after cooling and extract with ether in a flask. Filter and remove the ether from the filtrate by evaporation. How can you identify fats in the ethereal residue?

19. Saponification of Butter.—Dissolve a small amount of butter in alcohol made strongly alkaline with potassium hydroxide. Place the alcoholic-potash solution in a casserole, add about 100 c.c. of water and boil for 10–15 minutes or until the odor of alcohol cannot be detected. Place the casserole in a hood and neutralize the solution with sulphuric acid. Note the odor of volatile fatty acids, particularly butyric acid. Under certain conditions the odor of ethyl butyrate may also be detected.

20. Detection of Preservatives.—(a) Formaldehyde.—In these tests *two* controls should be run, one with *pure milk* and one with milk to which a very small amount of formaldehyde has been added.

I. Leach's Hydrochloric Acid Test.—Mix 10 c.c. of milk and 10 c.c. of concentrated hydrochloric acid containing about 0.002 gram of ferric chloride in a small porcelain evaporating dish or casserole and gradually raise the temperature of the mixture, on a water-bath, nearly to the boiling-point, with occasional stirring. If formaldehyde is present a violet color is produced, while a brown color develops in the absence of formaldehyde. In case of doubt the mixture, after having been heated nearly to the boiling-point for about one minute, should be diluted with 50–75 c.c. of water, and the color of the diluted fluid carefully noted, since the violet color if present will quickly disappear. Formaldehyde may be detected by this test when present in the proportion 1 : 250,000.

II. Gallic Acid Test.—Acidify 30 c.c. of milk with 2 c.c. of normal sulphuric acid and distil. Add 0.2–0.3 c.c. of a saturated alcoholic solution of gallic acid to the *first* 5 c.c. of the distillate, then incline the test-tube and slowly introduce 3–5 c.c. of concentrated sulphuric acid, allowing it to run slowly down the side of the tube. A green ring, which finally changes to blue, is formed at the juncture of the fluids. This is claimed, by Sherman, to be twice as delicate as either the sulphuric acid or the hydrochloric acid test for formaldehyde.

(b) *Salicylic Acid and Salicylates*.—Remont's Method.¹—Acidify 20 c.c. of milk with sulphuric acid, shake well to break up the curd, add 25 c.c. of ether, mix thoroughly, and allow the mixture to stand. By means of a pipette remove 5 c.c. of the ethereal extract, evaporate it to dryness, boil the residue with 10 c.c. of 40 per cent alcohol, and cool the alcoholic solution. Make the volume 10 c.c., filter through a *dry* paper if necessary to remove fat, and to 5 c.c. of the filtrate, which represents 2 c.c. of milk, add 2 c.c. of a 2 per cent solution of ferric chloride. The production of a *purple* or *violet* color indicates the presence of salicylic acid.

¹ For other tests see Sherman's Organic Analysis, Second Edition, p. 378

This test may form the basis of a quantitative method by diluting the final solution to 50 c.c. and comparing this with standard solutions of salicylic acid. The colorimetric comparisons may be made in a Duboscq colorimeter.

(c) *Hydrogen Peroxide*.—Add 2–3 drops of a 2 per cent aqueous solution of para-phenylenediamine hydrochloride to 10–15 c.c. of milk. If hydrogen peroxide is present a blue color will be produced immediately upon shaking the mixture or after allowing it to stand for a few minutes. It is claimed that hydrogen peroxide may be detected by this test when present in the proportion 1 : 40,000.

(d) *Boric Acid and Borates*.—To the ash, obtained according to the directions given in Experiment 4, page 356, add 2 drops of dilute hydrochloric acid and 1 c.c. of water. Place a strip of turmeric paper in the dish and after allowing it to soak for about one minute remove it and allow it to dry in the air. The presence of boric acid is indicated by the production of a deep red color which changes to green or blue upon treatment with a dilute alkali. This test is supposed to show boric acid when present in the proportion 1 : 8000.

Quantitative Analysis of Milk

1. **Specific Gravity**.—This may be determined conveniently by means of a Soxhlet, Veith, or Quevenne lactometer. A lactometer reading of 32° denotes a specific gravity of 1.032. The determination should be made at about 60°F . and the lactometer reading corrected by adding or subtracting 0.1° for every degree F. above or below that temperature.

2. **Fat**.—(a) *Babcock's Centrifugal Method*.¹—*Principle*.—The principle of this method is the destruction of organic matter other than fat by sulphuric acid and the centrifugation of the acid solution in the special tube shown in Fig. 120 and the subsequent reading of the percentage of fat by means of the tube's graduated neck. The method is one of the most satisfactory in common use and is accurate to within 0.5 per cent.

Procedure.—By means of a special narrow pipette introduce milk into the tube up to the 5 c.c. mark. Now add sufficient sulphuric acid (sp. gr. 1.83–1.834) to fill the body of the tube and rotate the tube to secure a homogeneous acid-milk solution. Fill the neck of the tube with an acid-alcohol mixture.²

¹ A modification of this method for use with sweetened dairy products, e.g., ice cream, and entailing the use of a different type of centrifuge tube has been proposed by Halverson (*Jour. Ind. and Eng. Chem.*, 5, 403, 1913). A more recent modification involving the use of mixtures of glacial acetic, sulphuric and nitric acids instead of sulphuric acid alone has been proposed by Francis and Morgan (*Jour. Ind. and Eng. Chem.*, 9, 861, 1917). These authors use the regulation Babcock tube, and the method is applicable to the analysis of ice cream, and evaporated, malted and dried milk.

² This mixture consists of equal volumes of amyl alcohol and concentrated hydrochloric acid.

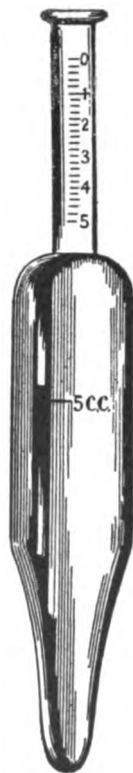

FIG. 120.—BABCOCK TUBE.

Centrifuge the tube and contents for one to two minutes and read off the percentage of fat by means of the graduated neck of the tube. If the top of the fat column is not at zero it may be brought there by the addition of water and a moment's recentrifugation.

In case very rich milk (over 5 per cent fat) is under examination, it may be diluted with an equal volume of water before examination and the fat percentage multiplied by 2. In the examination of cream it is customary to dilute the sample with four volumes of water and multiply the resultant fat value by 5.

(b) Quantitative Determination of Fat in Milk by the Meigs¹ Method with Modification and Improved Apparatus by Croll.²—The method as stated by Dr.

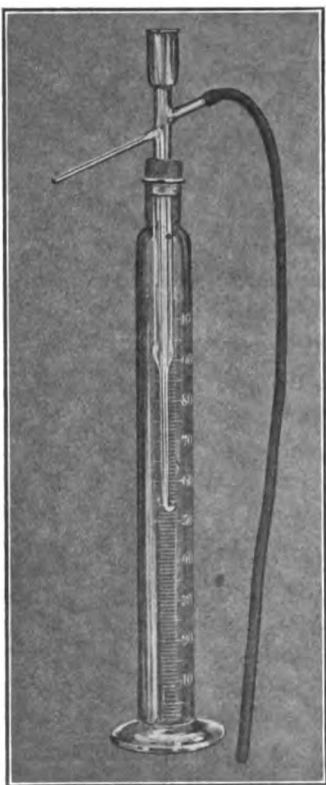

FIG. 121.—CROLL'S FAT APPARATUS.

Meigs is: Approximately 10 c.c. of milk is carefully weighed and transferred to an ordinary 100 c.c. glass-stoppered graduated cylinder. Twenty c.c. each of distilled water and ether (0.720) are added, the ground-glass stopper tightly inserted in the bottle, and the whole shaken vigorously for five minutes. Then the bottle is carefully unstoppered, 20 c.c. 95 per cent alcohol added, the stopper reinserted and again shaken for five minutes. The bottle is now placed on a table and the contents will separate into two distinct strata, the upper of which contains practically all the fat. This stratum is carefully removed by a small pipette and transferred to a carefully weighed glass evaporating dish. The thin ether layer remaining is washed by the addition of 5 c.c. of ether. This is removed by pipetting off. This washing is repeated four times. On each addition the sides of the bottle should carefully be washed down by the fresh ether. Finally, the pipette is rinsed with a little ether. The evaporating dish with contents is now placed on a safety water-bath and the ether evaporated. The drying is continued in a hot-air oven at a temperature below 100°C. and finally completed in a desiccator to constant weight.

Croll's modification consists of subsequent repeated extraction of the end-product of evaporation with absolute ether. The combined extracts are filtered and the small filter paper is washed repeatedly with absolute ether. The combined extracts and washings are evaporated and dried as before and then weighed.

The piece of apparatus shown in Fig. 121, above was also devised by Croll to do away with the use of the pipette.³ On closing the top with a finger and blowing into the mouthpiece, the upper stratum is forced out into the dish. The

¹ Original paper by Dr. Arthur V. Meigs in *Philadelphia Medical Times*, July 1, 1882

² Croll: *Biochem. Bull.*, 2, 509, 1913.

³ If desired a cork with two tubes may be substituted for this somewhat complicated apparatus.

bottle is washed by simply pouring the ether into the tube. This lessens the possibility of accidental loss.

The accuracy of the method compared with that of the Soxhlet method, using the paper-coil modification and extracting until fresh portions of absolute ether gave no further trace of extractive material, is shown by the average difference on twelve samples of human milk being only 0.017 per cent less than by the Soxhlet and on seven samples cow's milk being only 0.019 per cent less. The extreme differences in case of the human milk were—0.004 per cent and—0.044 per cent and in case of the cow's milk—0.006 per cent and—0.068 per cent.

(c) *Adams' Paper-coil Method.*—Introduce about 5 c.c. of milk into a small beaker, quickly ascertain the weight to centigrams, stand a fat-free coil¹ in the beaker and incline the vessel and rotate the coil in order to hasten the absorption of the milk. Immediately upon the complete absorption of the milk remove the coil and again quickly ascertain the weight of the beaker. The difference in the weights of the beaker at the two weighings represents the quantity of milk absorbed by the coil. Dry the coil carefully at a temperature below 100°C. and extract it with ether for 3–5 hours in a Soxhlet apparatus (Fig. 122). Using a safety water-bath, heat the flask containing the fat to constant weight at a temperature below 100°C.

Calculation.—Divide the weight of fat, in grams, by the weight of milk, in grams. The quotient is the *percentage of fat* contained in the milk examined.

(d) *Nephelometric Method of Bloor.*²—This method is exactly similar in principle and procedure to the method given for the determination of fat in blood. (See page 300.) One c.c. of milk is ordinarily taken.

FIG. 123.—FESER'S LACTOSCOPE.

(e) *Approximate Determination by Feser's Lactoscope.*—Milk is opaque mainly because of the suspended fat globules and therefore by means of the estimation of this opacity we may obtain data as to the *approximate* content of fat. Feser's lactoscope (Fig. 123) may be used for this purpose. Proceed as follows: By means of the graduated pipette accompanying the instrument introduce 4 c.c. of milk into the lactoscope. Add water gradually, shaking after each addition, and note the point at which the black lines upon the

¹ Very satisfactory coils are manufactured by Schleicher and Schüll.

² Bloor: *J. Am. Chem. Soc.*, 36, 1300, 1914.

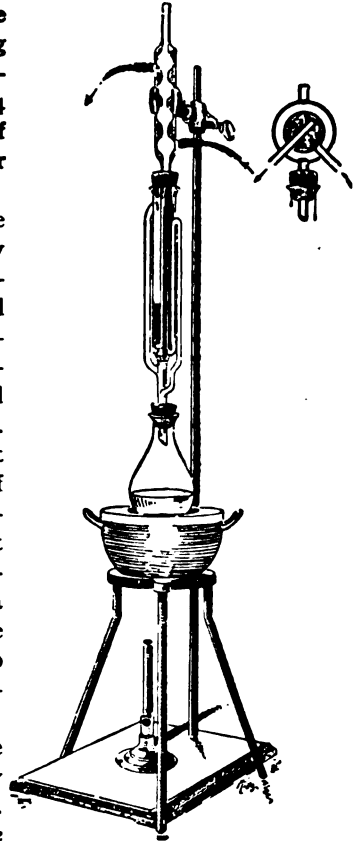

FIG. 122.—SOXHLET APPARATUS.



inner white glass cylinder are *distinctly* visible. Observe the point on the graduated scale of the lactoscope which is level with the surface of the diluted milk. This reading represents the *percentage of fat present in the undiluted milk*. Pure milk should contain at least 3 per cent of fat.

3. Total Solids.¹—Introduce 2–5 grams of milk into a weighed flat-bottomed platinum dish² and quickly ascertain the weight to milligrams. Expel the major portion of the water by heating the open dish on a water-bath and continue the heating in an air-bath or water oven at 97°–100°C. until the weight is constant. (If platinum dishes are employed this residue may be used in the determination of ash according to the method described below.)

Calculation.³—Divide the weight of the residue, in grams, by the weight of milk used, in grams. The quotient is the percentage of solids contained in the milk examined.

4. Ash.—Heat the dry solids from 2–5 grams of milk, obtained according to the method just given, over a very low flame⁴ until a white or light gray ash is obtained. Cool the dish in a desiccator and weigh. (This ash may be used in testing for borates according to directions on page 353.)

5. Proteins: *Nephelometric Determination of Proteins, Casein, Globulin, and Albumin in Milk. Method of Kober.*⁵—*Principle.*—The proteins are precipitated with sulphosalicylic acid and the precipitate estimated nephelometrically (see discussion of nephelometric methods, page 295).

Procedure.—Five c.c. of milk are carefully measured into a 250 c.c. flask and after adding 200 c.c. of distilled water and 10 c.c. of decinormal sodium hydroxide solution, water is added to the mark and the mixture shaken. Ten c.c. are put with exactly 2 c.c. of ether in a centrifuge tube which is then tightly stoppered with a cork and vigorously shaken. Allow to separate and withdraw 5 c.c. of the aqueous layer without contamination with ether. Dilute to 50 c.c. Take 10 c.c. of this solution and add 10 c.c. of 3 per cent sulphosalicylic acid. A suspension of casein is obtained which can be matched accurately with the following standard: 1 volume (5 c.c.) of a 0.01 per cent casein solution⁶ to which is added 2 volumes (10 c.c.) of 3 per cent sulphosalicylic acid.

The protein obtained with this reagent is not all casein, and in order to obtain the exact amount of casein the casein is precipitated according to the "official

¹ Shackell's method for the vacuum desiccation of frozen preparations may be used where great accuracy is desired (see *American Journal of Physiology*, 24, 325, 1909).

² Lead foil dishes, costing only about one dollar per gross, make a very satisfactory substitute for the platinum dishes.

³ The percentage of total solids may be calculated from the *specific gravity* and *percentage of fat* by means of the following formula which has been proposed by Richmond:

$$S = 0.25 L + 1.2 F + 0.14$$

S = total solids.

L = lactometer reading.

F = fat content.

⁴ Great care should be used in this ignition, the dish at no time being heated above a faint redness, as chlorides may volatilize.

⁵ Kober: *J. Am. Chem. Soc.*, 35, 1585, 1913.

⁶ *Standard Casein Solution.*—Dissolve with stirring 0.1 gram of casein or its equivalent in 1 c.c. of 0.1 N NaOH, add 95 c.c. of distilled water, add 2 c.c. of toluene, shake thoroughly and make up to 100 c.c. This is the stock solution which keeps three or four days or longer. The standard solution is made up fresh every day by making 10 c.c. of the stock solution up to 100 c.c. with water. The standard is controlled by total nitrogen estimations using the factor 6.38 for casein.

method" or the method of Hart given below and the amount of precipitate obtained in an aliquot portion of the filtrate, by adding 4 volumes of the reagent, is determined nephelometrically. This fraction, for want of a better name called the "globulin and albumin fraction," is subtracted from the gross casein, to give the amount of casein precipitated by the "official method."

The ether used in extracting the fat increases the volume of the solution and hence a factor allowing for this must be used. For 10 c.c. of diluted milk and 2 c.c. of ether the factor is 0.910.

6. Proteins.—Introduce a known weight of milk (5–10 grams) into a 500 c.c. Kjeldahl digestion flask and add 20 c.c. of concentrated sulphuric acid and about 0.2 gram of copper sulphate. Expel the major portion of the water by heating over a low flame and finally use a full flame and allow the mixture to boil one to two hours. Complete the determination according to the directions given under Kjeldahl Method, page 512.

Calculation.—Multiply the total nitrogen content by the factor 6.37¹ to obtain the protein content of the milk examined.

7. Hart's Casein Method.²—Introduce 10.5 c.c. of milk into a 200 c.c. Erlenmeyer flask and add 75 c.c. of distilled water and 1–1.5 c.c. of 10 per cent acetic acid.³ Mix the contents by giving the flask a vigorous rotary motion. The precipitated casein is now filtered off upon a 9–11 cm. filter paper.⁴ Wash out the adsorbed and loosely combined acetic acid by means of cold water. Continue the washing of both the casein on the filter and that adhering to the flask, until the wash water has reached a volume of at least 250 c.c.

Now return the precipitate and paper to the original Erlenmeyer flask, add 75–80 c.c. of neutral (carbon dioxide-free) water, 10 c.c. of N/10 potassium hydroxide and a few drops of phenolphthalein. Stopper the flask and shake it vigorously, by hand or machine, until the casein has been brought into solution.⁵ Rinse the stopper with neutral (carbon dioxide-free) water and titrate the alkaline casein solution at once with N/10 hydrochloric acid until there is a disappearance of all red color.⁶

Calculation.—Subtract the corrected⁶ acid reading from the 10 c.c. of alkali used. The difference is the percentage of casein in the milk. For example, if it takes 6.7 c.c. of N/10 hydrochloric acid to titrate the alkaline solution to the end point and the check test was equivalent to 20 c.c. N/10 acid the casein value would be obtained as follows:

$$10 - (6.7 + 0.2) = 3.1 \text{ per cent casein}$$

¹ The usual factor employed for the calculation of protein from the nitrogen content is 6.25 and is based on the assumption that proteins contain on the average 16 per cent of nitrogen. This special factor of 6.37 is used to calculate the protein content from the total nitrogen, since the principal protein constituents of milk, *i.e.*, casein and lactalbumin, contain about 15.7 per cent of nitrogen.

² Hart: *Jour. Biol. Chem.*, 6, 445, 1909.

³ In general 1.5 c.c. of acetic acid gives a clear solution which filters nicely but occasionally, when the milk has a low casein value it is advisable to use less acetic acid.

⁴ The process of filtration may be retarded through the packing of the casein mass upon the filter paper. In this case conduct a fine stream of cold water against the upper point of contact of filter paper and casein. By this means the casein precipitate is loosened and gathers in the apex of the filter. This procedure is very essential. It is not necessary to remove the casein which adheres to the interior of the flask.

⁵ Solution is indicated by the disappearance of the white casein particles which would otherwise settle to the bottom of the flask.

⁶ A check test should be run parallel with the entire determination. Even with special precautions as to neutrality, it is generally found that an acid check of 0.2–0.3 will be obtained. This check titration should be added to the volume of acid used in titration.

8. **Casein.**—Mix about 20 grams of milk with 40 c.c. of a saturated solution of magnesium sulphate and add the salt in substance until no more will dissolve. The precipitate consists of casein admixed with a little fat and lacto-globulin. Filter off the precipitate, wash it thoroughly with a saturated solution of magnesium sulphate,¹ transfer the filter paper and precipitate to a Kjeldahl digestion flask, and determine the nitrogen content according to the directions given in a previous experiment (6).

Calculation.—Multiply the *total nitrogen* by the factor 6.37 to obtain the casein content.

9. **Lactalbumin.**—To the filtrate and washings from the determination of casein, in Experiment 8, add Almén's² reagent until no more precipitate forms. Filter off the precipitate and determine the nitrogen content according to the directions given under Proteins, page 357.

Calculation.—Multiply the *total nitrogen* by the factor 6.37 to obtain the lactalbumin content.

10. **Lactose.**—To about 350 c.c. of water in a beaker add 20 grams of milk, mix thoroughly, acidify the fluid with about 2 c.c. of 10 per cent acetic acid and stir the acidified mixture continuously until a flocculent precipitate forms. At this point the reaction should be distinctly acid to litmus. Heat the solution to boiling for one-half hour, filter, rinse the beaker thoroughly, and wash the precipitated proteins and the adherent fat with hot water. Combine the filtrate and wash water and concentrate the mixture to about 150 c.c. Cool the solution and dilute it to 200 c.c. in a volumetric flask. Titrate this sugar solution according to directions given under Fehling's Method, page 546, or Benedict's Method, page 545.

Myers³ recommends the following procedure for the determination of lactose in milk. One part of milk is mixed with an equal volume of phosphotungstic acid solution (70.0 grams acid and 200 c.c. conc. HCl in 1 liter of water) and 2-3 parts of water. Mix well, filter until clear, and titrate the clear filtrate against Benedict's solution (25 c.c. reducing 67 mg. of lactose).

The milk may also be clarified for the lactose determination by means of aluminum hydroxide⁴ or dialyzed iron.⁵ The dialyzed iron procedure is as follows: Dilute 10 gm. of milk to 25 c.c. and add about 3 c.c. of 10 per cent colloidal iron solution adding the last portion drop by drop to determine the exact amount necessary. Filter and wash with water to make the clear filtrate 100 c.c. Titrate using Benedict's method (see page 545).

The preparation of aluminum hydroxide cream and its use in protein removal are described under Nitrogen Partition, p. 514, Chapter XXVII.

Calculation.—Make the calculation according to directions given under Fehling's Method, page 546, bearing in mind that 100 c.c. of Fehling's solution is completely reduced by 0.0676 gram of lactose.⁶

¹ Preserve the filtrate and washings for the determination of lactalbumin (Expt. 9).

² Almén's reagent may be prepared by dissolving 5 grams of tannic acid in 240 c.c. of 50 per cent alcohol and adding 10 c.c. of 25 per cent acetic acid.

³ Myers: *Munch. med. Woch.*, 59, 1494, 1912.

⁴ Welker and Marsh: *J. Am. Chem. Soc.*, 35, 823, 1913.

⁵ Hill: *Jour. Biol. Chem.*, 20, 175, 1915.

⁶ In case Benedict's method is used it should be remembered that 25 c.c. of the reagent is reduced by 0.067 gram of lactose.

CHAPTER XIX

EPITHELIAL AND CONNECTIVE TISSUES

EPITHELIAL TISSUE (KERATIN)

THE albuminoid *keratin* constitutes the major portion of hair, horn, hoof, feathers, nails, and the epidermal layer of the skin. There is a group of keratins the members of which possess very similar properties. The keratins as a group are insoluble in the usual protein solvents and are not acted upon by the gastric or pancreatic juices. They all respond to the xanthoproteic and Millon reactions and are characterized by containing large amounts of sulphur. Keratin from any of its sources may be prepared in a pure form by treatment, in sequence, with artificial gastric juice, artificial pancreatic juice, boiling alcohol, and boiling ether, from twenty-four to forty-eight hours being devoted to each process.

The percentage composition of some typical keratins is given in the following table:

Source		Percentage composition				
		S	N	C	H	O
Nails ¹		2.80	17.51	51.00	6.94	21.75
Horn ²		3.20	50.86	6.94
Human Hair, ³	Indian.....	4.82	15.40	44.06	6.53	29.19
	Japanese.....	4.96	14.64	42.99	5.91	31.50
	Negro.....	4.84	14.90	43.85	6.37	30.04
	Caucasian (adults).....	5.22	15.79	44.49	6.44	28.66
	Caucasian (children).....	4.93	14.58	43.23	6.46	30.80

The composition of human hair is influenced by its *color* and by the *race, sex, age* and *purity of breeding* of the individual.³ It may be dif-

¹ Mulder: *Versuch einer allgem. physiol. Chem.*, Braunschweig, 1844-51.

² Horbaczewski: *Ladenburg's Handwörterbuch d. Chem.*, 3.

³ Rutherford and Hawk: *Jour. Biol. Chem.*, 3, 459, 1907.

ferentiated from all other animal hair or wool by its high content of *cystine*. Human hair may yield nearly 12 per cent of this amino-acid.¹

EXPERIMENTS ON EPITHELIAL TISSUE

Keratin

Horn shavings or nail parings may be used in the experiments which follow:

1. Solubility.—Test the solubility of keratin in water, dilute and concentrated acid and alkali.
2. Millon's Reaction.
3. Xanthoproteic Reaction.
5. Glyoxylic Acid Reaction (Hopkins-Cole).
6. Test for Unoxidized Sulphur.

CONNECTIVE TISSUE

I. WHITE FIBROUS TISSUE

The principal solid constituent of white fibrous connective tissue is the albuminoid collagen. This body is also found in smaller percentage in cartilage, bone, and ligament, but the collagen from the various sources is not identical in composition. In common with the keratins, collagen is insoluble in the usual protein solvents. It differs from keratin in containing less sulphur. One of the chief characteristics of collagen is, according to Hofmeister, the property of being hydrolyzed by boiling acid or water with the formation of *gelatin*. Emmett and Gies² claim that under these conditions there is an intramolecular rearrangement of collagen and the resultant gelatin is consequently not the product of hydrolysis. The liberation of ammonia from the collagen during the process apparently confirms this view. Collagen gives Millon's reaction as well as the xanthoproteic and biuret tests.

The form of white fibrous tissue most satisfactory for general experiments is the *tendo Achillis* of the ox. According to Buerger and Gies³ the fresh tissue has the following composition:

Water.....	62.87%
Solids.....	37.13
Inorganic matter.....	0.47
Organic matter.....	36.66
Fatty substance (ether-soluble).....	1.04
Coagulable protein.....	0.22
Mucoid.....	1.28
Elastin.....	1.63
Collagen.....	31.59
Extractives, etc.....	0.90

¹ Buchtala: *Zeit. physiol. Chem.*, 85, 246, 1913.

² Emmett and Gies: *Jour. Biol. chem.*, 3, xxxiii (Proceedings), 1907.

³ Buerger and Gies: *Am. Jour. Physiol.*, 6, 219, 1901.

The mucoid just mentioned is called *tendomucoid*¹ and is a glycoprotein. It possesses properties similar to those of other connective-tissue mucoids, e.g., osseomucoid and chondromucoid.

Gelatin, the body which results from the hydrolysis of collagen (see statement of Emmett and Gies, p. 360), is sometimes classed as an albuminoid (see Chapter V). It responds to nearly all the protein tests. It differs from the keratins and collagen in being easily digested and absorbed. Gelatin is not a satisfactory substitute for the protein constituents of a normal diet, however, since a certain portion of its nitrogen is not available for the uses of the organism. Gelatin from cartilage differs from gelatin from other sources in containing a lower percentage of nitrogen. Tyrosine and tryptophane are not numbered among the decomposition products of gelatin, hence it does not respond to Millon's reaction or the glyoxylic acid reaction. Cystine is also absent.

EXPERIMENTS ON WHITE FIBROUS TISSUE

The *tendo Achillis* of the ox may be taken as a satisfactory type of the white fibrous connective tissue.

1. Preparation of Tendomucoid.—Dissect away the fascia from about the tendon and cut the clean tendon into small pieces. Wash the pieces in running water, subjecting them to pressure in order to remove as much as possible of the soluble protein and inorganic salts. This washing is very important. Transfer the washed pieces of tendon to a flask and add 300 c.c. of half-saturated lime water.² Shake the flask at intervals for twenty-four hours. Filter off the pieces of tendon and precipitate the mucoid with dilute hydrochloric acid. Allow the mucoid precipitate to settle, decant the supernatant fluid and filter the remainder. Test the mucoid as follows:

(a) Solubility.—Try the solubility in water, sodium chloride, dilute and concentrated acid and alkali.

(b) Biuret Test.—First dissolve the mucoid in potassium hydroxide solution and then add a dilute solution of copper sulphate.

(c) Test for Unoxidized Sulphur.

(d) Hydrolysis of Tendomucoid.—Place the remainder of the mucoid in a small beaker, add about 30 c.c. of water and 2 c.c. of dilute hydrochloric acid and boil until the solution becomes dark brown. Cool the solution, neutralize it with concentrated potassium hydroxide, and test by Fehling's test. With a reduction of Fehling's solution and a positive biuret test what do you conclude regarding the nature of tendomucoid?

2. Collagen.—This substance is present in the tendon to the extent of about 32 per cent. Therefore in making the following tests upon the pieces of

¹ Cutter and Gies: *Am. Jour. Physiol.*, 6, 155, 1901.

² Made by mixing equal volumes of saturated lime water and water from the faucet.

tendon from which the mucoid, soluble protein, and inorganic salts were removed in the last experiment, we may consider the tests as being made upon collagen.

(a) Solubility.—Cut the collagen into very fine pieces and try its solubility in water and dilute and concentrated acid and alkali.

(b) Millon's Reaction.

(c) Biuret Test.

(d) Xanthoproteic Reaction.

(e) Glyoxylic Acid Reaction (Hopkins-Cole).

(f) Test for Unoxidized Sulphur.—Take a large piece of collagen in a test-tube and add about 5 c.c. of potassium hydroxide solution. Heat until the collagen is partly decomposed, then add 1-2 drops of lead acetate and again heat to boiling.

(g) Formation of Gelatin from Collagen.—Transfer the remainder of the pieces of collagen to a casserole, fill the vessel about two-thirds full of water and boil for several hours, adding water at intervals as needed. By this means the collagen is transformed and a body known as gelatin is produced (see page 361).

3. Gelatin.—On the gelatin formed from the transformation of collagen in the above experiment (g), or on gelatin furnished by the instructor make the following tests:

(a) Solubility.—Try the solubility in the ordinary solvents (see page 21) and in hot water.

(b) Millon's Reaction.

(c) Glyoxylic Acid Reaction (Hopkins-Cole).—Conduct this test according to the modification given on page 107.

(d) Test for Unoxidized Sulphur.

Make the following tests upon a solution of gelatin in hot water:

(a) Precipitation by Mineral Acids.—Is it precipitated by strong mineral acids such as concentrated hydrochloric acid?

(b) Salting-out Experiment.—Saturate a little of the solution with solid ammonium sulphate. Is the gelatin precipitated? Repeat the experiment with sodium chloride. What is the result?

(c) Precipitation by Metallic Salts.—Is it precipitated by metallic salts such as copper sulphate, mercuric chloride, and lead acetate?

(d) Coagulation Test.—Does it coagulate upon boiling?

(e) Precipitation by Alkaloidal Reagents.—Is it precipitated by such reagents as picric acid, tannic acid, and trichloroacetic acid?

(f) Biuret Test.—Does it respond to the biuret test?

(g) Precipitation by Alcohol.—Fill a test-tube one-half full of 95 per cent alcohol and pour in a small amount of concentrated gelatin solution. Do you get a precipitate? How would you prepare pure gelatin from the tendo Achillis of the ox?

II. YELLOW ELASTIC TISSUE (ELASTIN)

The *ligamentum nuchæ* of the ox may be taken as a satisfactory type of the yellow elastic connective tissue. The principal solid constituent of this tissue is *elastin*, a member of the albuminoid group.

In common with the keratins and collagen, elastin is an insoluble body and gives the protein color reactions. It differs from keratin principally in the fact that it may be digested by enzymes and that it contains a very small amount of sulphur.

It has been demonstrated that elastin has the property of absorbing pepsin from the gastric juice and thus protecting it so the enzyme can function later in the intestine¹ (see Chapter on Gastric Digestion).

Yellow elastic tissue also contains mucoïd and collagen but these are present in much smaller amount than in white fibrous tissue, as may be seen from the following percentage composition of the fresh *ligamentum nucha* of the ox as determined by Vandegrift and Gies.²

Water.....	57.57%
Solids	42.43
Inorganic matter.....	0.47
Organic matter.....	41.96
Fatty substance (ether-soluble).....	1.12
Coagulable protein.....	0.62
Mucoïd.....	0.53
Elastin.....	31.67
Collagen.....	7.23
Extractives, etc.....	0.80

EXPERIMENTS ON ELASTIN

1. Preparation of Elastin (Richards and Gies).³—Cut the ligament into fine strips, run it through a meat chopper and wash the finely divided material in cold, running water for 24–48 hours. Add an excess of half-saturated lime water, (see note at the bottom of page 361) and allow the hashed ligament to extract for 48–72 hours. Decant the lime water, remove all traces of alkali by washing in water and then boil in water with repeated renewals until only traces of protein material can be detected in the wash water. Decant the fluid and boil the ligament in 10 per cent acetic acid for a few hours. Treat the pieces with 5 per cent hydrochloric acid at room temperature for a similar period, extract again in hot acetic acid and in cold hydrochloric acid. Wash out traces of acid by means of water and then thoroughly dehydrate by boiling alcohol and boiling ether in turn. Dry in an air-bath and grind to a powder in a mortar.

2. Solubility.—Try the solubility of the finely divided elastin, prepared by yourself or furnished by the instructor, in the ordinary solvents (see page 21). How does its solubility compare with that of collagen?

3. Millon's Reaction.

4. Xanthoproteic Reaction.

5. Biuret Test.

6. Glyoxylic Acid Reaction (Hopkins-Cole).—Conduct this test according to the modification given on page 107.

7. Test for Unoxidized Sulphur.

¹ Abderhalden and Meyer: *Zeit. physiol. Chem.*, 74, 67, 1911.

² Vandegrift and Gies: *Am. Jour. Physiol.*, 5, 287, 1901.

³ Richards and Gies: *Am. Jour. Physiol.*, 7, 93, 1902.

III. CARTILAGE

The principal solid constituents of the matrix of cartilaginous tissue are *chondromucoid*, *chondroitin-sulphuric acid*, *chondroalbumoid* and *collagen*. Chondromucoid differs from the mucoids isolated from other connective tissues in the large amount of chondroitin-sulphuric acid obtained upon decomposition. Besides being an important constituent of all forms of cartilage, chondroitin-sulphuric acid has been found in bone, ligament, the mucosa of the pig's stomach, the kidney of the ox, the inner coats of large arteries and in human urine. It may be decomposed through the action of acid and yields a nitrogenous body known as *chondroitin* and later this body yields *chondrosin*. Chondrosin is also a nitrogenous body and has the power of reducing Fehling's solution more strongly than dextrose. Levene and La Forge¹ claim the reducing action of chondrosin to be due to an *hexosamine isomeric with glucosamine*. Sulphuric acid is a by-product in the formation of chondroitin, and acetic acid is a by-product in the formation of chondrosin.

Chondroalbumoid is similar in some respects to elastin and keratin. It differs from keratin in being soluble in gastric juice and in containing considerably less sulphur than any member of the keratin group. It gives the usual protein color reactions.

EXPERIMENTS ON CARTILAGE

1. Preparation of the Cartilage.—Boil the trachea of an ox in water until the cartilage rings may be completely freed from the surrounding tissue. Use the cartilage so obtained in the following experiments:

2. Solubility.—Cut one of the rings into very small pieces and try the solubility of the cartilage in water and dilute and concentrated acid and alkali.

3. Millon's Reaction.

4. Xanthoproteic Reaction.

5. Glyoxylic Acid Reaction (Hopkins-Cole).—Conduct this test according to the modification given on page 107.

6. Test for Unoxidized Sulphur.

7. Preparation of Cartilage Gelatin.—Cut the remaining cartilage rings into small pieces, place them in a casserole with water and boil for several hours. Filter while the solution is still hot. Observe that the filtrate soon becomes more or less solid. What is the reason for this? Bring a portion of the material into solution by heat and try the following tests:

(a) Biuret Test.

(b) Test for Unoxidized Sulphur.

(c) To about 5 c.c. of the solution in a test-tube add a few drops of barium chloride. Do you get a precipitate, and if so to what is the precipitate due?

¹ Levene and La Forge: *Proc. Soc. ep. Biol. and Med.*, 11, 124, 1914.

(d) To about 5 c.c. of the solution in a test-tube add a few drops of dilute hydrochloric acid and boil for a few moments. Now add a little barium chloride to this solution. Is the precipitate any larger than that obtained in the preceding experiment? Why?

(e) To the remainder of the solution add a little dilute hydrochloric acid and boil for a few moments. Cool the solution, neutralize with solid potassium hydroxide, and try Fehling's test. Explain the result.

IV. OSSEOUS TISSUE

Of the solids of bone about equal parts are organic and inorganic matter. The organic portion, called *ossein*, may be obtained by removing the inorganic salts through the medium of dilute acid. Ossein is practically the same body which is termed collagen in the other connective tissues, and in common with collagen yields gelatin upon being boiled with dilute mineral acid.

In common with the other connective tissues bone contains a mucoïd and an albuminoid. Because of their origin these bodies are called *osseomucoïd* and *osseoalbumoid*. Osseomucoïd, when boiled with hydrochloric acid, yields sulphuric acid and a substance capable of reducing Fehling's solution. The composition of osseomucoïd is very similar to that of tendomucoïd and chondromucoïd (see page 113).

The inorganic basis of the dry, fat-free bone is a chemical substance, not a mixture. This fact is indicated by the uniform composition of the bones of fasting animals as well as by the definite relationship existing between the elements present. Bones of normal and fasting animals of the same species present no profound differences in percentage composition. The percentage composition of the dry, fat-free femurs of two dogs¹ after the animals had fasted for 104 and 14 days respectively was as follows:

Dog No.	Length of fast	Ash	N	CaO	MgO	P ₂ O ₅
1.	104 days	61.50	4.6	33.3	0.8	12.80
2.	14 days	61.65	4.1	33.1	0.9	12.90

The marked uniformity in composition notwithstanding the wide variation in the fasting periods is significant. The tensile strength of the femur of the dog has been found to be at least 25,000 pounds to the square inch¹ whereas that of oak is 10,000 and that of cast iron 20,000 pounds to the square inch.

¹ Johnston and Hawk: Unpublished data. For data on a 117-day fast by dog No. 1. see Howe, Mattill and Hawk: *Jour. Biol. Chem.*, 11, 103, 1912.

EXPERIMENT ON OSSEOUS TISSUE

The *percentage* composition of *normal* human bone and of bone from a case of *osteomalacia* is given in the following table:¹

Constituent	Kind of bone	
	Normal	Osteomalacia
Calcium (CaO).....	28.85	15.44
Magnesium (MgO).....	0.14	0.57
Phosphorus (P ₂ O ₅).....	19.55	12.01
Sulphur (S).....	0.14	0.55

Qualitative Analysis of Bone Ash.—Take 1 gram of bone ash in a small beaker and add a little dilute nitric acid. What does the effervescence indicate? Stir thoroughly and when the major portion of the ash is dissolved add an equal volume of water and filter. To the acid filtrate add ammonium hydroxide to alkaline reaction. A heavy white precipitate of phosphates results. (What phosphates are precipitated here by the ammonia?) Filter and test the filtrate for chlorides, sulphates, phosphates, and calcium. Add dilute acetic acid to the precipitate on the paper and test a little of this filtrate for calcium and phosphates. Heat the remainder of the filtrate to boiling and add (NH₄)₂CO₃ and NH₄Cl slowly to this hot solution as long as a precipitate forms. Filter off the precipitate of CaCO₃ and wash with hot water until free from alkali.² To the filtrate add a solution of Na₂HPO₄, make strongly alkaline with NH₄OH, and note the formation of a white precipitate of ammonium magnesium phosphate (NH₄MgPO₄). Examine the crystals under the microscope and compare with those shown in Fig. 143, page 436. To the precipitate on the filter paper, which was insoluble in acetic acid add a little dilute hydrochloric acid and test this last filtrate for phosphates and iron.

Reference to the following scheme may facilitate the analysis.

¹ McCrudden: *Jour. Biol. Chem.*, 7, 199, 1910.

² Magnesium is not precipitated here because of presence of NH₄Cl.

BONE ASH.

Add dilute nitric acid, stir thoroughly and after the major portion of the ash has been brought into solution add a little distilled water and filter.

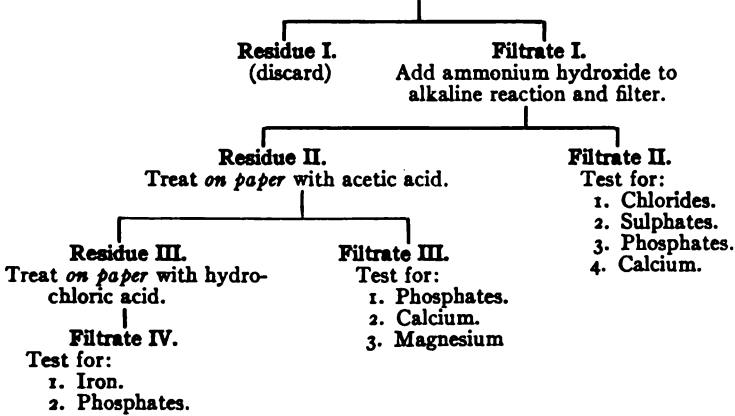

V. ADIPOSE TISSUE

Adipose tissue consists almost entirely of a mixture of fats. For discussion and experiments see chapter on Fats, page 180.

an accurate separation by this method is somewhat doubtful. It is well established that para-myosinogen is a globulin since it responds to certain of the protein precipitation tests and is insoluble in water. Myosinogen, on the contrary, is not a typical globulin since it is soluble in water. It has been called a *pseudo-globulin*. Myosin possesses the globulin characteristics. It is insoluble in water but soluble in the other protein solvents and is precipitated from its solution upon saturation with sodium chloride.

Our ideas concerning the cause of *rigor mortis* have undergone an important revision in recent years. A very attractive theory has been advanced by Meigs¹ and experimental confirmation has been accorded it by von Fürth and Lenk.² According to this theory, *rigor* has no connection with the coagulation of the muscle proteins and may even be hindered or prevented by such coagulation. The cause of *rigor*, from this new viewpoint, lies in the *imbibition of water by the muscle colloids*. It is well known that colloids possess the property of absorbing whatever fluid may be in contact with them. Moreover, the capacity of the colloid for water is increased if the fluid is slightly acid in reaction. Therefore the postmortem production of lactic acid facilitates the imbibition of muscle fluid by the muscle colloids. Under such conditions, the fibers swell, become rigid and the condition known as *rigor mortis* results. The disappearance of *rigor* is believed to be due to the coagulation of the muscle protein through the agency of the accumulated lactic acid. This change is accompanied by a release of the imbibed water by the colloids, inasmuch as the capacity of a colloid for retaining fluid is lowered by coagulation.

There is a difference of opinion as to whether true *rigor* ever occurs in connection with non-striated (smooth)³ muscle.

Under the name *extractives* we class a number of muscle constituents which occur in traces in the tissue and may be extracted by water, alcohol, or ether. There are two classes of these extractives, the *non-nitrogenous extractives* and the *nitrogenous extractives*. Grouped under the non-nitrogenous bodies we have *glycogen*, *dextrin*, *sugars*, *lactic acid*, *inositol*, $C_6H_6(OH)_6$, and *fat*. In the class of nitrogenous extractives we have *creatine*, *creatinine*, *xanthine*, *hypoxanthine*, *uric acid*, *urea*, *carnine*, *guanine*, *phosphocarnic acid*, *inosinic acid*, *carnosine*, *taurine*, *carnitine*, *novaine*, *ignotine*, *neosine*, *oblitine*, *carnomuscarine*, and *methylguanidine* (see formulas on pp. 127 and 375). Not all of these extractives are present in the muscles of all species of animals.

¹ Meigs: *American Journal of Physiology*, 26, 191, 1910.

² von Fürth and Lenk: *Wiener klinische Wochenschrift*, 24, 1079, 1911.

³ Saxl: *Beiträge zur chemischen Physiologie und Pathologie*, 9, 1, 1907.

Other extractives besides those enumerated above have been described and there are undoubtedly still others whose presence remains undetermined. A detailed consideration would, however, be unprofitable in this place.

Glycogen is an important constituent of muscle. The content of this polysaccharide in muscle varies and is markedly decreased by intense muscular activity. It is transformed into sugar and used as fuel. The liver is the organ which stores the reserve supply of glycogen and transforms it into glucose which is passed into the blood stream and so carried to the working muscle where it is synthesized into glycogen. The glycogen thus formed is then changed into glucose as the working muscle may need it.

Glycogen is a polysaccharide and has the same percentage composition as starch and dextrin. It resembles starch in forming an opalescent solution and resembles dextrin in being very soluble, in giving reddish color with iodine and in being dextro-rotatory. Glycogen may be prepared from muscle by extracting with boiling water and then precipitating the glycogen from the aqueous solution by alcohol; dilute or concentrated potassium hydroxide may also be used to extract the glycogen. Glycogen may be prepared in the form of a white, tasteless, amorphous powder. It is completely precipitated from its solution by saturation with solid ammonium sulphate, but is not precipitated by saturation with sodium chloride. It may also be precipitated by alcohol, tannic acid, or ammoniacal basic lead acetate. It has the power of holding cupric hydroxide in solution in alkaline fluids but cannot reduce it. It may be hydrolyzed with the formation of glucose by dilute mineral acids and is readily digested by amylolytic enzymes.

Mendel and Leavenworth have drawn the conclusion, from the examination of embryo pigs, that embryonic structures do not contain exceptionally large amounts of glycogen. The distribution of the glycogen was not observed to differ from that in the adult animal except that the liver of the embryo does not assume its glycogen-storing function early. They further draw the conclusion that the metabolic transformations of glycogen in the embryo and the adult are entirely analogous.

The lactic acid occurring in the muscular tissue of vertebrates is *paralactic or sarcolactic acid*,¹

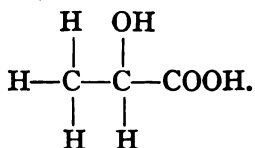

¹ This is *dextro-rotatory*, whereas *fermentation lactic acid (d-l-lactic acid)* is optically inactive.

The reaction of an inactive living muscle is alkaline, but upon the death of the muscle, or after the continued activity of a living muscle, the reaction becomes acid, due to the formation of lactic acid. There is a difference of opinion regarding the origin of this lactic acid. Some investigators claim it to arise from the carbohydrates of the muscle, while others ascribe to it a protein origin. The strongest evidence favors a carbohydrate source.¹

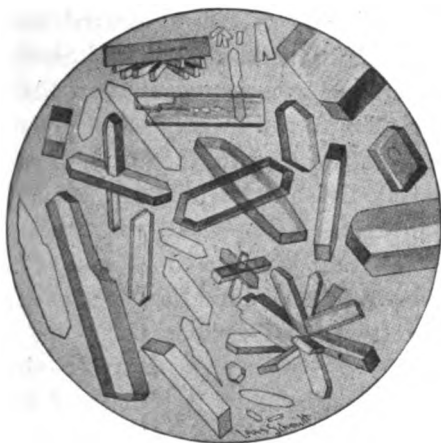

FIG. 124.—CREATINE.

Among the nitrogenous extractives of muscle, those which are of the most interest in this connection are creatine and the purine bases, xanthine and hypoxanthine. Creatine is found in varying amounts in the muscles of different species, the muscles of birds having shown the largest amount. It has also been found in the blood, the brain, in transudates and in the thyroid gland. Creatine may be crystallized and forms colorless rhombic prisms (Fig. 124) which are soluble in warm water and practically insoluble in alcohol and ether. Upon boiling a solution of creatine with dilute hydrochloric acid it is dehydrolyzed and its anhydride creatinine is formed. The theory that the creatine of ingested meat is transformed into creatinine and excreted in the urine has been proven untenable through the researches of Folin, Klercker, and Wolf and Shaffer. It is now known that under normal conditions the ingestion of creatine in no way influences the excretion of creatinine. In the case of Eck fistula dogs, however, London and Bolyarski² found ingested creatine to increase the output of creatinine in the urine. This finding is of importance as throwing light upon the

¹Levene and Meyer: *Jour. Biol. Chem.*, 11, 361, 1912.

²London and Bolyarskii: *Zeit. phys. chem.*, 62, 465, 1909.

rôle of the liver in creatine and creatinine metabolism. In this connection it is important to note that there is no *normal* excretion of *endogenous* (see page 406) creatine, a statement proven by the fact that if no creatine be ingested none will be excreted. Folin¹ has shown that the main bulk of ingested creatine is retained in the body, unless the diet contains a large amount of protein material. In fasting the urine contains considerable creatine, *i.e.*, 120 mg. or more per day. Under certain *pathological* conditions, *e.g.*, fevers, the urine may contain *endogenous* creatine which is probably derived from the catabolism of muscular tissue, as Benedict, Mellanby, and Shaffer have suggested. Benedict and Osterberg² believe we may have a high creatine elimination which has no relation to the catabolism of muscle.

McCrudden³ reports creatine in the urine in cases of infantilism, achondroplasia and cretinism the amount present being increased when the carbohydrate ingestion was increased.

It has been stated that creatine does not occur in non-striated muscle. It has, however, been found in the non-striated muscles of the *lamprey* the lowest form of vertebrates.⁴

Amberg and Morrill,⁵ Sedgwick,⁶ Rose⁷ and Folin⁸ have shown that creatine is a normal constituent of the urine of infants and children (10–15 mg. per day). Folin explains this phenomenon on the basis of the relatively high protein intake, whereas Rose believes it is due to a peculiar carbohydrate metabolism.

Besides being a normal constituent of muscle, xanthine has been found in the brain, spleen, pancreas, thymus, kidneys, testicles, liver, and in the urine. It may be obtained in crystalline form (Fig. 125, p. 373), but ordinarily it is amorphous. Xanthine is easily soluble in alkalis, less soluble in water and dilute acids, and entirely insoluble in alcohol and ether.

Hypoxanthine occurs ordinarily in those tissues and fluids which contain xanthine. It has been found, unaccompanied by xanthine, in bone marrow and in milk. Unlike xanthine it may be easily crystallized in the form of small, colorless needles. It is readily soluble in alkalis, acids, and boiling water, less soluble in cold water and practically insoluble in alcohol and ether.

The predominating inorganic salt of muscle is potassium phosphate

¹ Folin: *Hammarsten Festschrift*, p. 15.

² Benedict and Osterberg: *Jour. Biol. Chem.*, 18, 195, 1914.

³ McCrudden: *Jour. Expt. Med.*, 15, 457, 1912.

⁴ Mellanby: *Jour. of Physiol.*, 36, 472, 1908. Wilson: *Jour. Biol. Chem.*, 18, 17, 1914.

⁵ Amberg and Morrill: *Jour. Biol. Chem.*, 3, 311, 1907.

⁶ Sedgwick: *Jour. Am. Med. Ass'n*, 55, 1178, 1910.

⁷ Rose: *Jour. Biol. Chem.*, 10, 265, 1911.

⁸ Folin: *Ibid.*, 11, 253, 1912.

Besides this salt we have present chlorides and salts of sodium, calcium, magnesium, and iron. Sulphates are present in *traces*.

Mendel and Saiki have made some interesting observations upon the chemical composition of *non-striated* or *smooth* (involuntary) mammalian muscle, such as the urinary bladder and the muscular coat of the stomach of the pig. Hypoxanthine was found to be the predominant purine base present. Creatine and paralactic acid were also isolated. These investigators were unable to demonstrate, definitely, the presence of glycogen in the non-striated muscles studied, but state that "the tissues possess the property of transforming glycogen in the char-



FIG. 125.—XANTHINE.

After the drawings of Horbaczewski, as represented in Neubauer and Vogel. (*Ogden*.)

acteristic enzymatic way." The most important part of their investigation consists in a rather complete analysis of the inorganic constituents of these muscles. A notable difference in the relative distribution of the various inorganic constituents was observed, a difference which, according to the authors, "can be accounted for in part only by an admixture of lymph." The comparative composition of the inorganic portion of striated and non-striated muscle and of blood serum for comparison is shown in the following table:

	Per 100 parts of fresh muscle							
	K ₂ O	Na ₂ O	Fe ₂ O ₃	CaO	MgO	Cl	P ₂ O ₅	H ₂ O
Non-striated muscle (Mendel and Saiki)	0.081	0.328	0.011	0.044	0.007	0.171	0.184	80.6
Skeletal muscle (Katz)	0.306	0.210	0.008	0.011	0.047	0.048	0.487	72.9
Blood serum (Abderhalden)	0.027	0.425	0.012	0.004	0.363	0.020	91.8

An interesting comparative study of the ash of the smooth muscle of

the stomach of the frog and the striated muscle from the same animal was very recently reported by Meigs and Ryan.¹ Their data indicate "that smooth muscle contains somewhat less potassium and phosphorus and somewhat more sodium and chlorine than the striated muscle of the same animal, but that the differences in these respects between the two tissues are not by any means so marked as has sometimes been supposed." Their average figures for each type of muscle follow:

Muscle	Per 100 parts of fresh muscle									
	K	Na	Fe	Ca	Mg	P	Cl	S	Solids	H ₂ O
Striated.....	0.350	0.054	0.010	0.028	0.030	0.155	0.066	0.141	20.13	79.87
Smooth.....	0.325	0.073	0.0007	0.004	0.013	0.137	0.120	0.161	17.70	82.30

The preparation from which the above data for smooth muscle were obtained were shown by histological examination to consist in large part of smooth muscle fibers.

Muscular tissue is said to contain a reddish pigment called *myohematin*, which is a derivative of hemoglobin.

The so-called "fatigue substances" of muscle are carbon dioxide, paralactic acid, and potassium dihydrogen phosphate.

The ordinary commercial "meat extract" is composed principally of the water-soluble constituents of muscle and *contains practically nothing of nutritive value*. The protein material to which meat owes its value as an article of diet is ordinarily practically all removed in the preparation of the extract. Occasionally some preparations are found to contain proteose, which is formed from the meat proteins in the process of preparation.

Lusk² has shown that Liebig's extract is without influence upon the metabolism (energy) in spite of the glandular activity it is known to induce.

The structural formulas of some of the nitrogenous extractives of muscle are as follows:

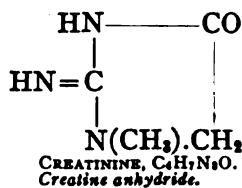
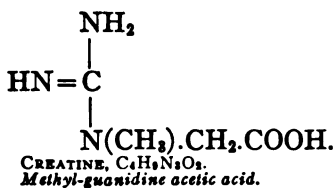

¹ Meigs and Ryan: *Journal of Biological Chemistry*, 11, 401, 1912.

² Lusk: *Jour. Biol. Chem.*, 13, 155, 1912.

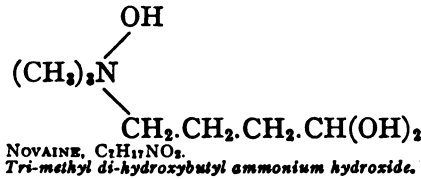
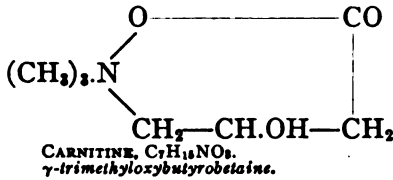
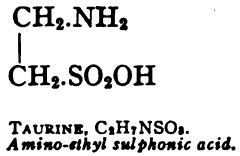
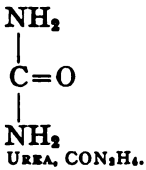

Carnosine, $\text{C}_9\text{H}_{14}\text{N}_4\text{O}_3$.

Neosine, $\text{C}_6\text{H}_{17}\text{NO}_2$.

Ignotine, $\text{C}_9\text{H}_{14}\text{N}_4\text{O}_3$.

Phosphocarnic acid, $\text{C}_{10}\text{H}_{17}\text{N}_3\text{O}_5$ or $\text{C}_{10}\text{H}_{15}\text{N}_3\text{O}_5$.

Inosinic acid, $(\text{HO})_2\text{.PO.O.CH}_2(\text{CHOH})_3\text{.CH:(C}_5\text{H}_3\text{N}_4\text{O)}$.

Purine Bodies.¹—

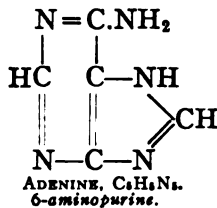
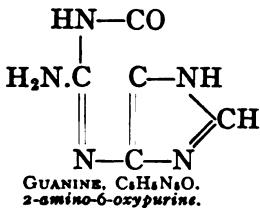
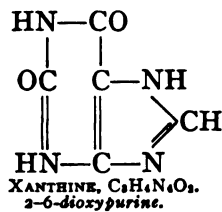
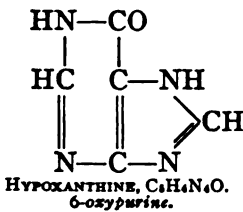

EXPERIMENTS ON MUSCULAR TISSUE

I. Experiments on "Living" Muscle

1. Preparation of Muscle Plasma (Halliburton).—Wash out the blood vessels of a freshly killed rabbit with 0.9 per cent sodium chloride. This can best be

¹ For discussion of the *purine bodies* which are found as muscle extractive see Chapter VI on Nucleic Acids.

done by opening the abdomen and inserting a cannula into the aorta. Now remove the skin from the lower limbs, cut away the muscles and divide them into very small pieces by means of a meat chopper. Transfer the pieces of muscle to a mortar and grind them with clean sand and a little ice cold 5 per cent magnesium sulphate. Place in an ice-box over night. Filter off the salted muscle plasma and make the following tests:

(a) Reaction.—Test the reaction to litmus, phenolphthalein, and Congo red. What is the reaction of this fresh muscle plasma?

(b) Fractional Coagulation.—Place a little muscle plasma in a test-tube and arrange the apparatus for fractional coagulation as explained on page 105. Raise the temperature very carefully from 30°C. and note any changes which may occur and the exact temperature at which such changes take place. When the first protein (para-myosinogen) coagulates filter it off and then heat the clear filtrate as before, being careful to note the exact temperature at which the next coagulation (myosinogen) occurs. There will probably be a preliminary opalescence in each case before the real coagulation occurs. Therefore do not mistake the real coagulation-point and filter at the wrong time. What are the coagulation temperatures of these two proteins? Which protein was present in greater amount?

(c) Formation of the Myosin Clot.—Dilute a portion of the plasma with 3 or 4 times its volume of water and place it on a water-bath or in an incubator at 35°C. for several hours. A typical myosin clot should form. Note the muscle serum surrounding the clot. Now test the reaction. Has the reaction changed, and if so to what is the change due? Make a test for lactic acid. What do you conclude?

2. Preparation of Muscle Plasma (v. Fürth).—Remove the blood-free muscles of a rabbit as explained above. Finely divide by means of a meat chopper and grind in a mortar with a little clean sand and some 0.9 per cent. sodium chloride. Wrap portions of the muscle in muslin and press thoroughly by means of a tincture press or lemon squeezer. Filter and make the tests according to the directions given in the last experiment.

3. "Fuchsin-frog" Experiment.—Inject a saturated aqueous solution of Fuchsin "S" into the lymph spaces of a frog two or three times daily for one or two days, in this way thoroughly saturating the tissues with the dye. Pith the animal (insert a heavy wire or blunt needle through the occipito atlantoid membrane), remove the skin from both hind legs and expose the sciatic nerve in one of them. Insert a small wire hook through the jaws of the frog and suspend the animal from an ordinary clamp or iron ring. Pass electrodes under the exposed sciatic nerve, and after tying the other leg to prevent any muscular movement, stimulate the exposed nerve by means of make and break shocks from an induction coil. The stimulated leg responds by pronounced muscular contractions, whereas the tied leg remains inactive. Continue the stimulation until the muscles are fatigued. The muscular activity has caused the production of lactic acid and this in turn has reacted with the injected fuchsin to cause a pink or red color to develop. The muscles of the inactive leg still remain unchanged in color.

The normal color of the Fuchsin "S" when injected was red, but upon being absorbed it became colorless through the action of the alkalinity of the blood. Upon stimulating the muscles, however, as above explained, lactic acid was

formed and this acid reacted with the fuchsin and again produced the original color of the dye.

II. Experiments on "Dead" Muscle

1. Preparation of Myosin.—Take 25 grams of finely divided lean beef which has been carefully washed to remove blood and lymph constituents and place it in a beaker with 10 per cent sodium chloride. Stir occasionally for several hours. Strain off the meat pieces by means of cheese cloth, filter the solution and saturate it with sodium chloride in substance. Filter off the precipitate of myosin and make the tests as given below. This filtration will proceed very slowly. Myosin collects as a film on the sides of the filter paper and may be removed and tested before the entire volume of fluid has been filtered. If this precipitate remains for any length of time on the paper in contact with the air it will become transformed into the protean myosan. Test the myosin precipitate as follows:

(a) Solubility.—Try its solubility in water sodium chloride, dilute acid and alkali. Is myosin an albumin or a globulin?

(b) Xanthoproteic Reaction.—See page 99.

(c) Coagulation Test.—Suspend a little of the myosin in water in a test-tube and heat to boiling for a few minutes. Now remove the suspended material and try its solubility in 10 per cent sodium chloride. What property does this experiment show myosin to possess?

Test the filtrate from the original myosin precipitate as follows:

(a) Biuret Test.—What does this show?

(b) Place a little of the solution in a test-tube and heat to boiling. At the boiling-point add a drop of dilute acetic acid and filter. Test this filtrate for proteose with picric acid. Is any proteose present? Saturate another portion of the filtrate with ammonium sulphate and test for peptone in the usual way (see page 120). Do you find any peptone?

From your experiments on "living" and "dead" muscle what are your ideas regarding the proteins of muscle?

2. Preparation of Glycogen.—Grind a few oysters or scallops¹ in a mortar with sand. Transfer to an evaporating dish, add water, and boil for 20 minutes. Note the opalescence of the solution. At the boiling-point faintly acidify with acetic acid. Why is this acid added? Filter, and divide the filtrate into two parts. Test one part of the filtrate as follows:

(a) Iodine Test.—To 5 c.c. of the solution in a test-tube add 5-10 drops of iodine solution and 2-3 drops of 10 per cent sodium chloride. What do you observe? Is this similar to the iodine test upon any other body with which we have had to deal?

If difficulty is experienced in securing a satisfactory iodine test proceed as follows: Make equal volumes of glycogen solution acid in reaction with hydrochloric acid. Boil one solution to hydrolyze the glycogen. Add equal volumes

¹ Glycogen may also be prepared from the liver of an animal which has been fed a high carbohydrate diet for 1-2 days previously. The best yield of glycogen can, however, generally be obtained from scallops. To secure best yield of glycogen the liver, scallops or oysters should be *fresh*. Canned oysters or scallops may be used if fresh ones are not available. If permitted to stand some glycogen will be converted into glucose.

of iodine solution to each and note the more pronounced iodine reaction in the unhydrolyzed solution.

(b) Reduction Test.—Does the solution reduce Fehling's solution?

(c) Hydrolysis of Glycogen.—Add 10 drops of concentrated hydrochloric acid to 10 c.c. of the solution and boil for 10 minutes. Cool the solution, neutralize with solid potassium hydroxide and test with Fehling's solution. Does it still fail to reduce Fehling's solution? If you find a reduction how can you prove the identity of the reducing substance?

(d) Influence of Saliva.—Place 5 c.c. of the solution in a test-tube, add 5 drops of saliva and place on the bath-water at 40°C. for 10 minutes. Does this now reduce Fehling's solution?

To the second part of the glycogen filtrate add 3-4 volumes of 95 per cent alcohol. Allow the glycogen precipitate to settle, decant the supernatant fluid, and filter the remainder. Heat the glycogen on a water-bath to remove the alcohol, then subject it to the following tests:

(a) Solubility.—Try its solubility in water and 10 per cent sodium chloride solution.

(b) Iodine Test.—Place a small amount of the glycogen in a depression of a test-tablet and add 2-3 drops of dilute iodine solution and a trace of a sodium chloride solution. The same wine-red color is observed as in the iodine test upon the glycogen solution.

3. Testing for Inorganic Constituents.—(a) Examination of Ash of Muscle.—Incinerate a small amount of muscular tissue, dissolve the ash in dilute hydrochloric acid. Test for potassium, phosphates, magnesium, calcium and chlorides.

(b) Demonstration of Phosphates and Magnesium in Muscle (Hürthle's Experiment).—Tease a very small piece of frog's muscle on a microscopical slide. Expose the slide to ammonia vapor for a few moments, then adjust a cover-glass, and examine the muscle fibers under the microscope. Note the large number of crystals of ammonium magnesium phosphate, distributed every-

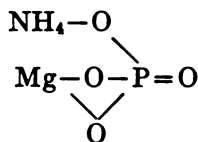

where throughout the muscle fiber, thus demonstrating the abundance of phosphates and magnesium in the muscle (Fig. 143, page 436).

Separation of Extractives from Muscles

1. Creatine.—Dissolve about 10 grams of a commercial extract of meat in 200 c.c. of warm water. (Test for Protein by Biuret and Coagulation Tests, see Chapter V.) Precipitate the inorganic constituents by neutral lead acetate, being careful not to add an excess of the reagent. Write the equations for the reactions taking place here. Allow the precipitate to settle, then filter and remove the excess of lead in the warm filtrate by hydrogen sulphide. Filter while the solution is yet warm, evaporate the clear filtrate to a syrup, and allow it to stand at least 48 hours in a cool place. Crystals of creatine should form at this point. Examine under the microscope (Fig. 124, page 371). Treat the syrup with 200

c.c. of 88 per cent alcohol, stir well with a glass rod to bring all soluble material into solution, and then filter. The purine bases have been dissolved and are in the filtrate, whereas the creatine crystals were insoluble in the 88 per cent alcohol and remain on the filter paper. Wash the crystals with 88 per cent alcohol, then remove them and bring them into solution in a little hot water. Decolorize the solution by animal charcoal and concentrate it to a small volume. Allow the solution to cool and note the separation of colorless crystals of creatine.¹

Make the following tests on the crystals:

(a) **Microscopical Examination.**—Examine some crystals under the microscope and compare the form with those reproduced in Fig. 124, page 371.

(b) **Transformation of Creatine into Creatinine.**—Dissolve the crystals in about 30 c.c. of hot water. To one-half of the solution in a flask add an equal volume of normal hydrochloric acid and heat on a boiling water-bath for five hours with reflux condenser. The creatine has been changed into creatinine. Apply tests for creatinine as given in Chapter XXIII to the original solution as well as to the acidified solution.

Diacetyl Reaction.—To 5 c.c. of a dilute creatine solution add an equal volume of saturated sodium carbonate solution and a few drops of a solution of diacetyl. A pink color should develop. This test has been made the basis of a method for the quantitative determination of creatine.²

2. **Hypoxanthine.**—Evaporate the alcoholic filtrate from the creatine to remove the alcohol. Make the solution ammoniacal and add ammoniacal silver nitrate until precipitation ceases. The precipitate consists principally of hypoxanthine silver and xanthine silver. Collect these silver salts on a filter paper and wash them with water. Place the precipitate and paper in an evaporating dish and boil for one minute with nitric acid having a specific gravity of 1.1. Filter while hot through a double paper, wash with the same strength of nitric acid and allow the solution to cool. By this treatment with nitric acid hypoxanthine silver nitrate and xanthine silver nitrate have been formed. The former is insoluble in the cold solution and separates on standing. After standing several hours filter off the hypoxanthine silver nitrate and wash with water until the wash water is only slightly acid in reaction. Examine the crystals of hypoxanthine silver nitrate under the microscope and compare them with those in Fig. 126. Now wash the crystals from the paper into a beaker with a little water and warm the liquid. Remove the silver by hydrogen sulphide and filter. By this means hypoxanthine nitrate has been formed and is present in the filtrate. (For crystalline form of hypoxanthine nitrate see Fig. 40, p. 136.) Concentrate on a water-bath to drive off hydrogen sulphide, and render the solution slightly alkaline with ammonia. Warm for a time, to remove the free ammonia, filter, concentrate the filtrate to a small volume and allow it to stand in a cool place. Hypoxanthine should crystallize in small colorless needles. Examine the crystals under the microscope.

3. **Xanthine.**—To the filtrate from the above experiment containing the xanthine silver nitrate add ammonia in excess. (The crystalline form of xanthine silver nitrate is shown in Fig. 127.) A brownish-red precipitate of xanthine silver forms. Filter off precipitate, suspend in water and treat with

¹ For an improved method of preparing pure creatine from creatinine see chapter on Physiological Constituents of the Urine.

² Walpole: *Jour. Physiol.*, 42, 301, 1911.

hydrogen sulphide (do not use an excess of hydrogen sulphide) then warm the mixture for a few moments and filter while hot. Concentrate the filtrate

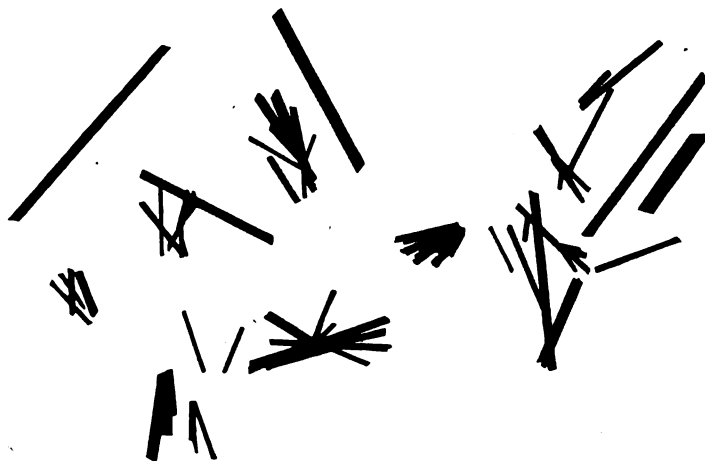

FIG. 126.—HYPOXANTHINE SILVER NITRATE.
(Drawn from a student preparation by Dr. E. F. Hirsch.)

to a small volume and put away in a cool place for crystallization (Fig. 125, page 373). To obtain xanthine in crystalline form special precautions are

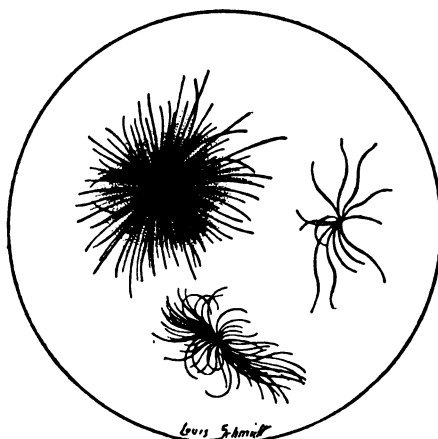

FIG. 127.—XANTHINE SILVER NITRATE

generally necessary. Evaporate the solution to dryness and test according to directions given in Chapter VI on Nucleic Acids.

CHAPTER XXI

NERVOUS TISSUE

IN common with the other solid tissues of the body, nervous tissue contains a large amount of water. The percentage of water present depends upon the particular form of nervous tissue but in all forms it is invariably greater in the gray matter than in the white. Embryonic nervous tissues also contain a larger percentage of water than the tissues of adult life. The gray matter of the brain of the foetus, for instance, contains about 92 per cent of water, whereas the gray matter of the brain of the adult contains but 83-84 per cent of the fluid.

Among the solid constituents of nervous tissue are *proteins, cholesterol, cerebrosides* (cerebrin, etc.), *lecithin, kephalin, protagon* (?), *para-nucleoprotagon, nuclein, neurokeratin, collagen, extractives, and inorganic salts*. The proteins are present in the greatest amount and comprise about 50 per cent of the total solids. Three distinct proteins, two globulins, and a nucleoprotein, have been isolated from the nervous tissue. The globulins coagulate at 47°C. and 70-75°C., respectively, while the nucleoprotein coagulates at 56-60°C. This nucleoprotein contains about 0.5 per cent of phosphorus (Halliburton, Levene). Nervous tissue is composed of a relatively large quantity of a variety of compounds which collectively may be grouped under the term "lipoid"—substances resembling the fats in some of their physical properties and reactions but distinct in their composition. We will class cholesterol, the cerebrosides and the phosphorized fats as lipoids.

The consideration of lipoids (or *lipins*¹) is assuming added importance. These substances constitute one of the two great groups of *tissue colloids*, the proteins being the remaining group. So far as structure and chemical properties are concerned the various classes of lipoids are entirely unlike.

The group of *phosphorized fats* are very important constituents of nervous tissue. The best known members of this group are *lecithin protagon* (?) and *kephalin*. Lecithin occurs in larger amount than the other members of the group, has been more thoroughly studied than the others and is apparently of greater importance. Upon decomposition lecithin yields *fatty acids, glycerophosphoric acid*, and

¹ Rosenbloom and Gies: *Biochemical Bulletin*, 1, 51, 1911. The term lipoid was introduced by Overton (Studien über die Narkose, Jena, 1901, Gustav Fischer).

is said by some investigators to yield cerebrin and the decomposition products of lecithin. It has been shown by Posner and Gies¹ as well as by Rosenheim and Tebb² that protagon is a mixture and has no existence as a chemical individual. Koch³ reported data obtained from purified preparations which indicate that protagon contains at least three substances: a "phosphatide containing cholin, a cerebroside containing sugar, a complex combination of a cholin-free phosphatide with a cerebroside to which an ethereal sulphuric acid group is attached." On the basis of his data, he believed the term protagon to have no chemical significance. He proposed the term sulphatide. Koch's preparation analyzed as follows (per cent):

Choline	Sugar	Nitrogen	Phosphorus	Sulphur
1.0	12.0	2.3	1.7	1.9

He suggested the following structure:

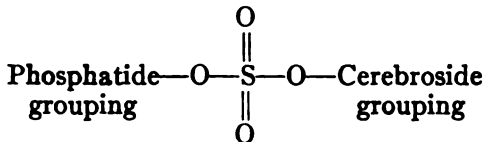

Kephalin is the third member of the group of phosphorized fats. It is precipitated from its acetone-ether extract by alcohol. It contains about 4 per cent of phosphorus and has been given the formula $C_{42}H_{79}NPO_{12}$. Kephalin may be a stage in lecithin metabolism.

The cerebroside is a substance containing nitrogen but no phosphorus, and are important constituents of the white matter of nervous tissue. Certain ones have also been found in the spleen, pus, and in egg yolk. They may be extracted from the tissue by boiling alcohol and are insoluble in cold alcohol, cold and hot ether, and in water and dilute alkalis. The cerebroside termed cerebrin is a mixture containing phrenosin (pseudo-cerebrin or cerebrin), a body yielding the carbohydrate galactose on decomposition.

Cholesterol, one of the primary cell constituents, is present in fairly large amount in nervous tissue. It occurs in two forms, *i.e.*, free and combined as an *ester*. It is claimed⁴ that 99 per cent of the cholesterol of brain tissue (boy) is in the free state. It is a mon-atomic alcohol containing at least *one* double bond and possesses the formula $C_{27}H_{44}OH$ or $C_{27}H_{42}OH$. There is still some uncertainty as to the exact structure of cholestêrol. It may possess a terpene structure. It

¹ Posner and Gies: *Journal of Biological Chemistry*, 1, 59, 1905-06.

² Rosenheim and Tebb: *Journal of Physiology*, 36 and 37, 1907-08.

³ Koch: *Journal Biological Chemistry*, 11, March, 1912, Proceedings.

⁴ Lapworth: *Jour. Path. Bact.*, 1911, p. 256.

was formerly called a "non-saponifiable fat" but since it is not changed in any way by boiling alkalis it is not a fat. It is soluble in ether, chloroform, benzene, and hot alcohol. It crystallizes in the form of thin, colorless, transparent plates (Fig. 63, page 214). Cholesterol is present in bile, and occurs abundantly in one form of biliary calculus. It is also present in blood and its quantitative determination is of clinical importance (see Chapter XVI). It has been found in feces, wool fat, egg yolk, and milk, frequently in the form of its esters of higher fatty acids. It is generally believed that the cholesterol present in the animal body has its origin in the vegetable kingdom. Some evidence has been submitted¹ indicating a synthesis of cholesterol under certain conditions in the animal body. However, it is probable that cholesterol is not *readily* synthesized in the body.²

Paranucleoprotagon is a phosphorized substance originally isolated from brain tissue by Ulpiani and Lelli and recently reinvestigated by Steel and Gies. It is said to possess lecithoprotein characteristics.

Nervous tissue yields about 1 per cent of ash which is made up in great part of alkaline phosphates and chlorides.

EXPERIMENTS ON THE LIPOIDS OF NERVOUS TISSUE³

1. Preparation of Lecithin.⁴—Treat the finely divided brain of a sheep with ether and allow it to stand in the cold for 48–72 hours. The cold ether will extract lecithin and cholesterol. Filter and add acetone to the filtrate to precipitate the lecithin. Filter off the lecithin and test it as follows:

(a) Microscopical Examination.—Suspend a small portion in a drop of water on a slide and examine under the microscope.

(b) Osmic Acid Test.⁵—Treat a small portion with osmic acid. What happens?

(c) Acrolein Test.—Make the acrolein test according to directions on page 184.

(d) Test for Phosphorus.—See page 129, Chapter VI.

2. Preparation of Cholesterol.—Place a small amount of finely divided brain tissue under ether and stir occasionally for one hour. Filter, evaporate the filtrate to dryness on a water-bath, and test the cholesterol according to directions given below. (If it is desired, the ether extract from the so-called protagon,

¹ Klein: *Biochem. Zeit.*, 30, 465, 1910.

² Gardner and Lander: *Proc. Royal Soc., London (B)*, 87, 229, 1913.

³ Preparation of So-called Protagon.—Divide the brain of a sheep into small pieces, treat with 85 per cent alcohol and warm on a water-bath 45°C. for two hours. Filter *hot* into a bottle or strong flask and cool to 0°C. for one-half hour by means of a freezing mixture. By this procedure both protagon and cholesterol are caused to precipitate. Filter the cold solution rapidly and treat the precipitate on the paper with ice cold ether to dissolve out the cholesterol. The protagon may now be redissolved in warm 85 per cent alcohol from which solution it will precipitate upon cooling.

⁴ For the preparation of lecithin in purer form see MacLeon: *Jour. Path. Bact.*, 18, 490, 1914.

⁵ Osmic acid serves to detect fats which contain *unsaturated fatty acid radicals*, e.g., *oleic acid*, in their molecule.

or the ether-acetone filtrate from the lecithin may be used for the isolation of cholesterol. In these cases it is simply necessary to evaporate the solution to dryness on a water-bath.) Upon the cholesterol prepared by either of the above methods make the following tests:

(a) **Microscopical Examination.**—Examine the crystals under the microscope and compare them with those in Fig. 63, page 214.

(b) **H₂SO₄ Test (Salkowski).**—Dissolve a few crystals of cholesterol in a little chloroform and add an equal volume of concentrated sulphuric acid. A play of colors from bluish-red to cherry-red and purple is noted in the chloroform, while the acid assumes a marked green fluorescence.

(c) **Acetic Anhydride-H₂SO₄ Test (Liebermann-Burchard).**—Dissolve a few crystals of cholesterol in 2 c.c. of chloroform in a dry test-tube. Now add 10 drops of acetic anhydride and 1-3 drops of concentrated sulphuric acid. The solution becomes red, then blue, and finally bluish-green in color.

(d) **Iodine-sulphuric Acid Test.**—Place a few crystals of cholesterol in one of the depressions of a test-tablet and treat with a drop of concentrated sulphuric acid and a drop of a very dilute solution of iodine. A play of colors, consisting of violet, blue, green, and red, results.

(e) **Schiff's Reaction.**—To a little cholesterol in an evaporating dish add a few drops of a reagent made by adding 1 volume of 10 per cent ferric chloride to 3 volumes of concentrated sulphuric acid. Evaporate to dryness over a low flame and observe the reddish-violet residue which changes to a bluish-violet.

(f) **Phosphorus.**—Test for phosphorus according to directions given in Chapter VI, page 129. Is phosphorus present?

3. **Preparation of Cerebrin.**—Treat 100 grams of finely divided brain tissue, in a flask, with 200 c.c. of 95 per cent alcohol and boil on a water-bath for one-half hour, keeping the volume constant by adding fresh alcohol as needed or by the use of a reflux condenser. Filter the solution hot and stand the cloudy filtrate away for 24 hours. (If the filtrate is not cloudy concentrate it upon the water-bath until it is so.) Filter off the cerebrin (cerebrin, lecithin, kephalin, cholesterol) and test it as follows:

(a) **Microscopical Examination.**—Suspend a small portion in a drop of water on a slide and examine under the microscope.

(b) **Solubility.**—Try the solubility of cerebrin in water, 10 per cent sodium chloride and in dilute acid and alkali, and in hot and cold alcohol and hot and cold ether.

(c) **Phosphorus.**—Test for phosphorus according to directions in Chapter VI, page 129. How does the result compare with that on lecithin?

(d) Place a little cerebrin on platinum foil and warm. Note the odor.

(e) **Hydrolysis of Cerebrin.**—Place the remaining cerebrin in a small evaporating dish, add equal volumes of water and dilute hydrochloric acid, and boil for one hour. Cool, neutralize with solid potassium hydroxide, filter, and test with Fehling's solution. Is there any reduction, and if so how do you explain it?

4. **Tests for Choline.**—(a) **Rosenheim's Periodide Test.**—Prepare an alcoholic extract of the fluid under examination, and after evaporation apply Rosenheim's iodo-potassium iodide solution¹ to a little of the residue. In a short time dark

¹ Prepared by dissolving 2 grams of iodine and 6 grams of potassium iodide in 100 c.c. water.

brown plates and prisms of *choline periodide* begin to form and may be detected by means of the microscope. Occasionally they are large enough to be visible to the naked eye. They somewhat resemble crystals of hemin (see page 269). If the slide be permitted to stand, thus allowing the fluid to evaporate, the crystals will disappear and leave brown oily drops. They will reappear, however, upon the addition of fresh iodine solution. v. Staněk claims that this choline compound has the formula $C_8H_{14}NOI.I_5$.

(b) *Rosenheim's Bismuth Test*.—Extract the fluid under examination with absolute alcohol, evaporate, and reextract the residue. Repeat the extraction several times. Dissolve the final residue in 2–3 c.c. of water and add a drop of Kraut's reagent.¹ Choline is indicated by the appearance of a bright brick-red precipitate.

¹ Dissolve 272 grams of potassium iodide in water and add 80 grams of bismuth subnitrate dissolved in 200 grams of nitric acid (sp. gr. 1.18). Permit the potassium nitrate to crystallize out, then filter it off and make the filtrate up to 1 liter with water.

CHAPTER XXII

URINE: GENERAL CHARACTERISTICS OF NORMAL AND PATHOLOGICAL URINE

Volume.—The volume of urine excreted by normal individuals during any definite period fluctuates within very wide limits. The average output for twenty-four hours is placed by German writers between 1500 and 2000 c.c. This value is not strictly applicable to conditions in America, however, since it has been found that the average normal excretion of the adult male American falls within the lower values of 1000–1200 c.c. The volume-excretion is influenced greatly by the diet, particularly by the ingestion of fluids.

Certain pathological conditions cause the output of urine for any definite period to depart very decidedly from the normal output. Among the pathological conditions in which the volume of urine is *increased* above normal are the following: Diabetes mellitus, diabetes insipidus, certain diseases of the nervous system, contracted kidney, amyloid degeneration of the kidney, and in convalescence from acute diseases in general. Many drugs such as calomel, digitalis, acetates, and salicylates also increase the volume of the urine excreted. A *decrease* from the normal is observed in the following pathological conditions: Acute nephritis, diseases of the heart and lungs, fevers, diarrhœa, and vomiting.

Color.—Normal urine ordinarily possesses a yellow tint, the depth of the color being dependent in part upon the density of the fluid. The color of normal urine is due principally to a pigment called *urochrome*,¹ traces of *hematoporphyrin*, *urobilin*, and *uroerythrin* have also been detected. Under pathological conditions the urine is subject to pronounced variations in color and may contain many varieties of pigments. Under such circumstances the urine may vary in color from an extremely light yellow to a very dark brown or black. Vogel has constructed a color chart which is of some value for purposes of comparison. The nature and origin of the chief variations in the urinary color are set forth in tabular form by Halliburton as follows:

¹ Urochrome is believed to be identical with the yellow pigment (lactochrome) of milk whey (Palmer and Coolidge: *Jour. Biol. Chem.*, 17, 251, 1914).

Color	Cause of coloration	Pathological condition
Nearly colorless.....	Dilution, or diminution of normal pigments.	Nervous conditions: hydruria, diabetes insipidus, granular kidney.
Dark yellow to brown-red.	Increase of normal, or occurrence of pathological, pigments. Concentrated urine.	Acute febrile diseases.
Milky.....	Fat globules.....	Chyluria.
	Pus corpuscles.....	Purulent diseases of the urinary tract.
Orange.....	Excreted drugs.....	Santonin, crysophanic acid.
Red or reddish.....	Hematoporphyrin..... Unchanged hemoglobin.....	Hemorrhages, or hemoglobinuria.
	Pigments in food (logwood, madder, bilberries, fuchsin).	
Brown to brown black....	Hematin.....	Small hemorrhages.
	Methemoglobin.....	Methemoglobinuria.
	Melanin.....	Melanotic sarcoma.
	Hydrochinol and catechol...	Carbolic-acid poisoning.
Greenish yellow, greenish brown, approaching black.	Bile-pigments.....	Jaundice.
Dirty green ¹ or blue.....	A dark blue scum on surface, with a blue deposit, due to an excess of indigo-forming substances.	Cholera, typhus; seen especially when the urine is putrefying.
Brown-yellow to red-brown, becoming blood-red upon adding alkalis.	Substances contained in senna, rhubarb and chelidonium which are introduced into the system.	

Transparency.—Normal urine is ordinarily perfectly clear and transparent when voided. On standing for a variable time, however, a cloud (nubecula) consisting principally of nucleoprotein or mucoid (see page 424) and epithelial cells forms. A turbidity due to the precipitation of phosphates is normally noted in urine passed after a hearty

¹ This dirty green or blue color also occurs after the use of methylene blue in the organism.

meal. The urine obtained 2–3 hours after a meal or later is ordinarily free from turbidity. Permanently turbid urines ordinarily arise from pathological conditions.

Odor.—The odor of normal urine is of a faint, aromatic type. The bodies to which this odor is due are not well known, but it is claimed by some investigators to be due, at least in part, to the presence of minute amounts of certain volatile organic acids. Dehn and Hartman¹ have recently succeeded in isolating from urine a neutral ill-smelling substance which they call *urinod*. Its empirical formula is C_6H_8O . Urinod occurs in urine to the extent of only 1–2 parts in 100,000 parts of urine. When the urine undergoes decomposition, *e.g.*, in alkaline fermentation, a very unpleasant ammoniacal odor is evolved. All urines are subject to such decomposition if allowed to stand for a sufficiently long time. Under normal conditions the urine very often possesses a peculiar odor due to the ingestion of some certain drug or vegetable. For instance, cubebs, copaiba, myrtol, saffron, tolu, and turpentine each imparts a somewhat specific odor to the urine. After the ingestion of asparagus, the urine also possesses a typical odor due to the formation of *methyl mercaptan* ($CH_3\cdot SH$) in the intestine.

Frequency of Urination.—The frequency of urination varies greatly in different individuals, but in general is dependent upon the amount of fluid in the bladder. In pathological conditions an inflammatory affection of the urinary tract or any disturbance of the innervation of the bladder will influence the frequency. Affections of the spinal cord which lead to an increased irritability of the bladder or a weakening of the sphincter, or any condition lowering the residual capacity of the bladder, will result in increasing the frequency of urination.

Reaction.—The mixed 24-hour urinary excretion of a normal individual ordinarily possesses an acid reaction to litmus. This acidity in normal cases is represented on the average by a hydrogen ion concentration of 10×10^{-7} , although it may vary from 0.40 to 150×10^{-7} . The reaction of the urine represents an equilibrium between a large number of acid and basic constituents, both organic and inorganic, which it contains. Organic acids and bases play a part in producing the normal reaction, but this is probably, in the main, dependent upon the relative amounts of the mono- and dibasic sodium and potassium phosphates. The monobasic sodium phosphate (NaH_2PO_4) is acid in reaction, while the dibasic phosphate (Na_2HPO_4) is alkaline in reaction. The excretion of acid or alkaline phosphate by the kidneys is one of the factors in the regulation of the neutrality of the blood and of the organism in general. The acidity of the urine as determined by titration runs

¹ Dehn and Hartman: *Jour. Am. Chem. Soc.*, 36, 2136, 1914.

in general parallel with the hydrogen ion concentration and seems to be dependent upon the same factors, and in more acid urines mainly on the phosphate content. (For further discussion of acidity see Chapter VIII on Gastric Analysis.)

The mean acidity in cardio-renal diseases is high—about 50×10^{-7} as compared with 10×10^{-7} , the normal mean. In general the acidity tends to be increased in the greater number of pathological disorders.

The composition of the food is perhaps the most important factor in determining the reaction of the urine (see Chapter XXVIII on Metabolism for influence of base-forming and acid-forming foods). The reaction ordinarily varies considerably according to the time of day the urine is passed. For instance, for a variable length of time after a meal the urine may be neutral or even alkaline in reaction to litmus,



FIG. 128.—DEPOSIT IN AMMONIACAL FERMENTATION.
a, Acid ammonium urate; *b*, ammonium magnesium phosphate; *c*, bacteria.

owing to the claim of the gastric juice upon the acidic radicals to further the formation of hydrochloric acid for use in carrying out the digestive secretory function. This change in reaction is known as the *alkaline tide* and is common to perfectly healthy individuals. The urine may also become temporarily alkaline in reaction to litmus, as the result of ingesting alkaline carbonates or certain salts of tartaric and citric acids which may be transformed into carbonates within the organism. Normal urine upon standing for some time becomes alkaline in reaction to litmus, owing to the inception of alkaline or ammoniacal fermentation through the agency of micro-organisms. This fermentation has no especial diagnostic value except in cases where the urine has undergone this change *within the organism* and is voided in the decomposed state. Ammoniacal fermentation is ordinarily due to cystitis or occurs as the result of infection in the process of catheterization. A microscopical

examination of such urine (Fig. 128) shows the presence of *ammonium magnesium phosphate* crystals, *amorphous phosphates*, and not infrequently *ammonium urate*.

Ingestion of *acid* fruits (oranges, lemons, peaches, etc.) causes the formation of *alkaline* urine. This is due to the fact that the ash of such fruits is alkaline and when the fruits are combusted in the body *carbonates are formed*. On the other hand, bread, cereals, etc., yield an *acid ash* and an acid urine.

Occasionally a urine which possesses a normal acidity when voided, upon standing instead of undergoing ammoniacal fermentation as above described, will become more strongly acid in reaction. Such a phenomenon is termed *acid fermentation*. Accompanying this increased acidity there is ordinarily a deepening of the tint of the urinary color.

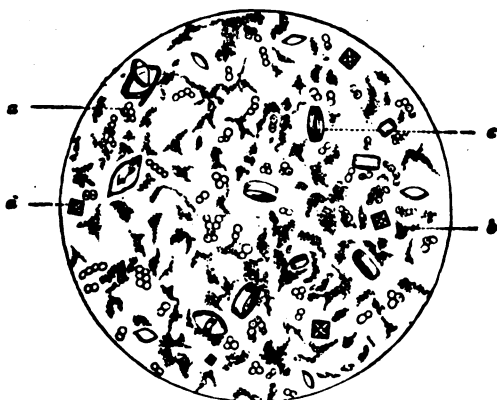

FIG. 129.—DEPOSIT IN ACID FERMENTATION.

a, Fungus; b, amorphous sodium urate; c, uric acid; d, calcium oxalate.

Such urines may contain *acid urates*, *uric acid*, *fungi*, and *calcium oxalate* (Fig. 129, above). On standing for a sufficiently long time any urine which exhibits acid fermentation will ultimately change in reaction, due to the inception of alkaline fermentation, and will show the microscopical deposits characteristic of such a urine.

Specific Gravity.—The specific gravity of the urine of normal individuals varies ordinarily between 1.015 and 1.025. This value is subject to wide fluctuations under various conditions. For instance, following copious water- or beer-drinking the specific gravity may fall to 1.003 or lower, whereas in cases of excessive perspiration it may rise as high as 1.040 or even higher. Where a very accurate determination of the specific gravity is desired, use is commonly made of the *pycnometer* or of the *Westphal hydrostatic balance*. These instruments, however, are not suited for clinical use. The clinical method of deter-

mining the specific gravity is by means of a *urinometer* (Fig. 130). This affords a very rapid method and at the same time is sufficiently accurate for clinical purposes. The urinometer is always calibrated for use at a specific temperature and the observations made at any other temperature must be subjected to a certain correction to obtain the true specific gravity. In making this correction *one unit of the last order is added* to the observed specific gravity for every three degrees *above*



FIG. 130.—URINOMETER AND CYLINDER.

the normal temperature and *subtracted* for every three degrees *below* the normal temperature. For instance, if in using a urinometer calibrated for 15°C. the specific gravity of a urine having a temperature of 21°C. is determined as 1.018 it is necessary to add to the observed specific gravity two units of the third order to obtain the real specific gravity of the urine. Therefore the true specific gravity, at 15°C., of a urine having a specific gravity of 1.018 at 21°C. is $1.018 + 0.002 = 1.020$.

Pathologically, the specific gravity may be subjected to very wide variations. This is especially true in diseases of the kidneys. In acute nephritis ordinarily the urine is concentrated and of a high specific gravity, whereas in chronic nephritis the reverse conditions are more apt to prevail. In fact, under most conditions, whether physiological or pathological, the specific gravity of the urine is inversely proportional to the volume excreted. This is not true of diabetes mellitus, however, where the volume of urine is large and the specific gravity is also high, owing to the sugar contained in the urine.

The amount of solids eliminated in the excretion for twenty-four hours may be roughly calculated by means of *Long's coefficient*, *i.e.*, 2.6. The solid content of 1000 c.c. of urine is obtained by multiplying the last two figures of the specific gravity observed at 25°C. by 2.6. To determine the amount of solids excreted in twenty-four hours if the volume was 1120 c.c. and the specific gravity was 1.018 the calculation would be as follows:

$$(a) 18 \times 2.6 = 46.8 \text{ grams of solid matter in 1000 c.c. of urine.}$$

$$(b) \frac{46.8 \times 1120}{1000} = 52.4 \text{ grams of solid matter in 1120 c.c. of urine.}$$

The coefficient of Häser (2.33) which has been in use for years probably gives values that are inaccurate for conditions existing in America.

This coefficient was calculated on the basis of the specific gravity determined at a temperature of 15°C .

Freezing-point (Cryoscopy).—The freezing-point of a solution depends upon the total number of molecules of solid matter dissolved in it. The determination of the osmotic pressure by this method has come to be of some clinical importance, particularly as an aid in the diagnosis of kidney disorders. In this connection it is best to collect the urine from each kidney separately and determine the freezing-point in the individual samples so collected. By this means considerable aid in the diagnosis of renal diseases may be secured. The fluids most frequently examined cryoscopically are the blood (see page 249) and the urine. The freezing-point is denoted by Δ . The value of Δ for normal urine varies ordinarily between -1.3° and -2.3°C ., the freezing-point of pure water being taken as 0° . Δ is subject to very wide fluctuations under unusual conditions. For instance, following copious water- or beer-drinking Δ may have as high a value as -0.2°C ., whereas on a diet containing much salt and deficient in fluids the value of Δ may be lowered to -3°C . or even lower. The freezing-point of normal blood is generally about -0.56°C . and is not subject to the wide variations noted in the urine, because of the tendency of the organism to maintain the normal osmotic pressure of the blood under all conditions. Variations between -0.51° and -0.62°C . may be due entirely to dietary conditions, but if any marked variation is noted it can, in most cases, be traced to a disordered kidney function.

Freezing-point determinations may be made by means of the Beckmann-Heidenhain apparatus (Fig. 131) or the Zikel pektoscope. The Beckmann-Heidenhain apparatus consists of the following parts: A strong battery jar or beaker (C) furnished with a metal cover which is provided with a circular hole in its center. This strong glass vessel serves to hold the freezing mixture by means

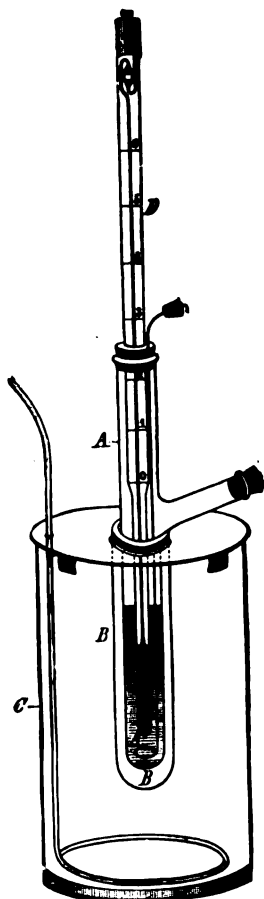

FIG. 131.—BECKMANN-HEIDENHAIN FREEZING-POINT APPARATUS. (Long.)

D, a delicate thermometer; *C*, the containing jar; *B*, the outside or air mantle tube; *A*, the tube in which the mixture to be observed is placed. Two stirrers are shown, one for the cooling mixture in the jar and one for the experimental mixture.

of which the temperature of the fluid under examination is lowered. A large glass tube (B) designed as an air-jacket, and formed after the manner of a test-tube is introduced through the central aperture in the metal cover and into this air-jacket is lowered a smaller tube (A) containing the fluid to be tested. A very delicate thermometer (D), graduated in hundredths of a degree is introduced into the inner tube and is held in place by means of a cork so that the mercury bulb is immersed in the fluid under examination but does not come into contact with any glass surface. A small platinum wire stirrer serves to keep the fluid under examination well mixed while a larger stirrer is used to manipulate the freezing mixture. (Rock salt and ice in the proportion 1:3 form a very satisfactory freezing mixture.)

In making a determination of the freezing-point of a fluid by means of the Beckmann-Heidenhain apparatus proceed as follows: Place the freezing mixture in the battery jar and add water (if necessary) to secure a temperature not lower than 3°C. Introduce the fluid to be tested into tube A, place the thermometer and platinum wire stirrer in position, and insert the tube into the air-jacket which has previously been inserted through the metal cover of the battery jar. Manipulate the two stirrers in order to insure an equalization of temperature and observe the course of the mercury column of the thermometer very carefully. The mercury will *gradually fall* and this gradual lowering of the temperature will be followed by a *sudden rise*. The point at which the mercury rests *after this sudden rise* is the *freezing-point*. This rise is due to the fact that previous to freezing, a fluid is always more or less *over-cooled* and the thermometer temporarily registers a temperature somewhat *below the freezing-point*. As the fluid freezes, however, there is a very *sudden* change in the temperature of the liquid and this change is imparted to the thermometer and causes the rise as indicated. It occasionally occurs that the fluid under examination is very much over-cooled and *does not freeze*. Under such circumstances a small piece of ice is introduced into it by means of the side tube noted in the figure. This so-called "inoculation" causes the fluid to freeze instantaneously. (For details of the method of determining the freezing-point consult standard works on physical or organic chemistry.)

Electrical Conductivity.—The electrical conductivity of the urine is dependent upon the number of *inorganic* molecules or ions present, and in this differs from the freezing-point which is dependent upon the total number of molecules both *inorganic* and *organic* which are in solution. The conductivity of the urine has been investigated but slightly, but from the data secured it seems that the value generally falls below $\kappa = 0.03$. The conductivity of blood serum has been de-

terminated as $\kappa = 0.012$. Up to the present time the determination of the electrical conductivity of any of the fluids of the body has been put to very slight clinical use. Experience may show the conductivity value to be a more important aid to diagnosis than it is now considered, particularly if it is taken in connection with the determination of the freezing-point. By a combination of these two methods the portion of the osmotic pressure due respectively to electrolytes and non-electrolytes may be determined. For a discussion of electrical conductivity, the method by which it is determined, and the principles involved consult standard works on physical or electro-chemistry.

Collection and Preservation of the Urine Sample.—If any dependable data are desired regarding the *quantitative* composition of the urine the examination of the mixed excretion for twenty-four hours is *absolutely necessary*. In collecting the urine the bladder may be emptied at a given hour, say 8 A. M., the urine discarded and all the urine from that hour up to and including that passed the next day at 8 A. M., saved, thoroughly mixed, and a sample taken for analysis. Until recently it was believed that powdered thymol (*para-iso propylmetacresol*)

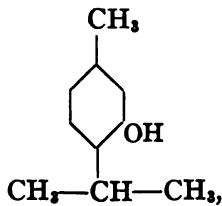

was a very satisfactory preservative since the excess might be removed by filtration, if desired, and it was believed that the small amount which went into solution would have no appreciable influence upon the determination of any of the urinary constituents. It appears however that thymol is not such a satisfactory urinary preservative as was believed. Evidence has been presented showing it to be unsatisfactory for the preservation of urines which contain sugar, acetone or diacetic acid, and in which it is desired to estimate the quantitative content of these constituents. Claim has also been made that thymol is not a satisfactory preservative for urines that are to be examined quantitatively for phosphates or magnesium. Thymol being a phenol will cause an inaccuracy when phenols are being determined quantitatively. Urines preserved by thymol will also give a confusing white ring when subjected to the nitric acid test for albumin (see Chapter XXIV).

Toluene is a very satisfactory preservative for urine. In using this preservative simply overlay the urine with the toluene. Rosenbloom¹

¹ Rosenbloom: *New York Medical Journal*, 99, 735, 1914.

claims that camphor is a very satisfactory urine preservative which does not interfere with the tests for important urinary constituents.

In certain pathological conditions it is desirable to collect the urine passed during the *day* separately from that passed during the *night*. When this is done the urine voided between 8 A. M. and 8 P. M. may be taken as the *day sample* and that voided between 8 P. M. and 8. A. M. as the *night sample*.

The *qualitative* testing of urine samples collected at *random*, except in a few specific instances, is of no particular value so far as giving us any accurate knowledge as to the exact urinary characteristics of the individual is concerned. In the great majority of cases the qualitative as well as the quantitative tests should be made upon the mixed excretion for a twenty-four-hour period as well as upon a *night sample* as above described.

CHAPTER XXII

URINE : PHYSIOLOGICAL CONSTITUENTS¹

i. Organic Physiological Constituents

Urea.

Uric acid.

Creatinine.

Creatine.²

Ethereal sulphuric acids..... {
Indoxyl-sulphuric acid.
Phenol- and *p*-cresol-sulphuric acids.
Pyrocatechol-sulphuric acid.
Skatoxyl-sulphuric acid.

Hippuric acid.

Oxalic acid.

Neutral sulphur compounds... {
Cystine.
Chondroitin-sulphuric acid.
Thiocyanates.
Taurine derivatives.
Oxyproteic acid.
Alloxyproteic acid.
Uroferric acid.

Allantoin.

Aromatic oxyacids..... {
Para-oxyphenyl-acetic acid.
Para-oxyphenyl-propionic acid.
Homogentisic acid.
Uroleucic acid.
Oxymandelic acid.
Kynurenic acid.

Amino-acids.

Peptides.

Benzoic acid.

Nucleoprotein.

Oxaluric acid.

Glucose.

¹ It is impossible to make any *absolute* classification of the physiological and pathological constituents of the urine. A substance may be present in the urine in small amount physiologically and be sufficiently increased under certain conditions as to be termed a pathological constituent. Therefore it depends, in some instances upon the *quantity* of a constituent present whether it may be correctly termed a physiological or a pathological constituent.

² Normal constituent of urine of adults but found in larger amount in urine of infants and children (see p. 533).

Enzymes.....	{ Pepsin. Gastric rennin. Amylase.
Volatile fatty acids.....	{ Acetic acid. Butyric acid. Formic acid.
Paralactic acid.	
Phenaceturic acid.	
Urocanic acid.	
Phosphorized compounds.....	{ Glycerophosphoric acid. Phosphocarnic acid.
Pigments.....	{ Urochrome. Urobilin. Uroerythrin.
Ptomaines and leucomaines.	
Purine Bases.....	{ Adenine. Guanine. Xanthine. Epiguanine. Episarkine. Hypoxanthine. Paraxanthine. Heteroxanthine. 1-Methylxanthine.

2. Inorganic Physiological Constituents

Ammonia.
Sulphates.
Chlorides.
Phosphates.
Sodium and potassium.
Calcium and magnesium.
Carbonates.
Iron.
Fluorides.
Nitrates.
Silicates.
Hydrogen peroxide.

Normal urine varies widely in composition, being influenced by *diet* and other factors. The following table represents the composition of a normal urine.¹

¹ Vierordt: Daten und Tabellen. Jena, 1906, p. 330.

COMPOSITION OF A NORMAL URINE¹
Volume (24 hours) 1500 c.c.

Constituent	Absolute weight, grams	Approximate percentage
Water.....	1440.00	96.0
Solids.....	60.0	4.0
Urea.....	35.0	2.33
Uric acid.....	0.75	0.05
Hippuric acid.....	0.7	0.05
Oxalic acid.....	0.015	0.001
Aromatic oxyacids.....	0.06	0.004
Creatinine.....	1.0	0.07
Thiocyanic acid (as KSCN).....	0.15	0.01
Indican.....	0.01	0.001
Ammonia.....	0.65	0.04
Sodium chloride.....	16.5	1.1
Phosphoric acid.....	2.5	0.15
Total sulphuric acid ²	2.5	0.15
Silicic acid.....	0.45	0.03
Potassium (K ₂ O).....	2.5	0.15
Sodium (Na ₂ O).....	5.0	0.3
Calcium (CaO).....	0.25	0.015
Magnesium (MgO).....	0.30	0.02
Iron.....	0.005	0.0004

¹ The values in this table were obtained from the analysis of a *single specimen* of urine and are not to be confused with *normal averages* which are based on the analysis of many normal urines.

² For data as to "partition" of sulphur and nitrogen, see Chapter XXVIII on Metabolism.

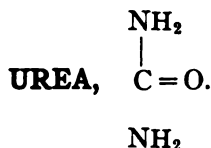

Urea is the principal end-product of the metabolism of protein substances. It was formerly believed that about 90 per cent of the total nitrogen of the urine was present as urea. Folin, however, has shown that the distribution of the nitrogen of the urine among urea and the other nitrogen-containing bodies present depends entirely upon the absolute amount of the total nitrogen excreted. He found that a decrease in the total nitrogen excretion was always accompanied by a decrease in the percentage of the total nitrogen excreted as urea, and that after so regulating the diet of a normal person as to

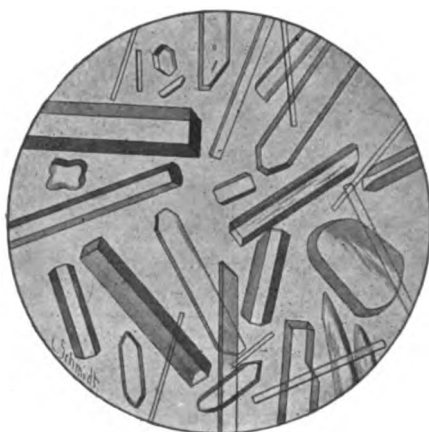

FIG. 132.—UREA.

cause the excretion of total nitrogen to be reduced to 3-4 grams in 24 hours, *only about 60 per cent of this nitrogen appeared in the urine as urea.* His experiments also seem to show urea to be the only one of the nitrogenous excretions which is relatively as well as absolutely decreased as a result of decreasing the amount of protein metabolized. This same investigator reports a hospital case in which only 14.7 per cent of the total nitrogen was present as urea and about 40 per cent was present as ammonia. Mörner had previously reported a case in which but 4.4 per cent of the total nitrogen of the urine was present as urea, and 26.7 per cent was present as ammonia.

Urea occurs most abundantly in the urine of man and carnivora and in somewhat smaller amount in the urine of herbivora; the urine of fishes, amphibians, and certain birds also contains a small amount of

the substance. Urea is also found in nearly all the fluids and in many of the tissues and organs of mammals. The amount excreted, under normal conditions, by an adult man in 24 hours is about 30–35 grams. The excretion is greatest in amount after a diet of meat, and least in amount after a diet consisting of non-nitrogenous foods; this is due to the fact that the urea output is regulated by the protein ingestion. It is true also that a non-nitrogenous diet has a tendency to decrease the metabolism of the tissue proteins and thus cause the output of urea under these conditions to fall below the output of urea observed during starvation. The output of urea is also increased after copious water- or beer-drinking. The increase is probably due *primarily* to the washing out of the tissues of the urea previously formed, but which had not been removed in the normal processes, and *secondarily* to a stimulation of protein catabolism.

Urea may be formed in the organism from amino-acids such as leucine, glycocoll, and aspartic acid: it may also be formed from ammonium carbonate $(\text{NH}_4)_2\text{CO}_3$ or ammonium carbamate, $\text{H}_4\text{N.O.CO.NH}_2$.

There are differences of opinion regarding the transformation of the substances just named into urea, but there is rather conclusive evidence that at least a part of the urea is formed in the liver; it may be formed in other organs or tissues as well.

Urea crystallizes in long, colorless, four- or six-sided, anhydrous, rhombic prisms (Fig. 132), which melt at 132°C . and are soluble in water or alcohol and insoluble in ether or chloroform. If a crystal of urea is heated in a test-tube, it melts and decomposes with the liberation of ammonia. The residue contains *cyanuric acid*,

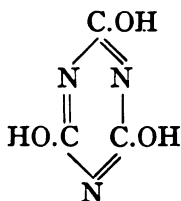

and *biuret*,

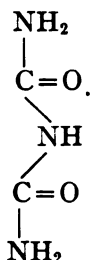

The biuret may be dissolved in water and a reddish-violet color obtained by treating the aqueous solution with copper sulphate and potassium hydroxide (see Biuret Test, page 100). Certain hypochlorites or hypobromites in alkaline solution have the power of decomposing urea into nitrogen, carbon dioxide, and water. Sodium hypobromite brings about this decomposition, as follows:

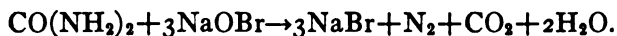

This property forms the basis for a clinical quantitative determination of urea which was formerly in use, but which has been discarded because of inaccuracies.

The soy bean has been shown to contain an enzyme called *urease* which has the power to decompose urea with the liberation of ammonia.¹ This fact is made use of in the quantitative determination of urea (see Chapter XXVII).

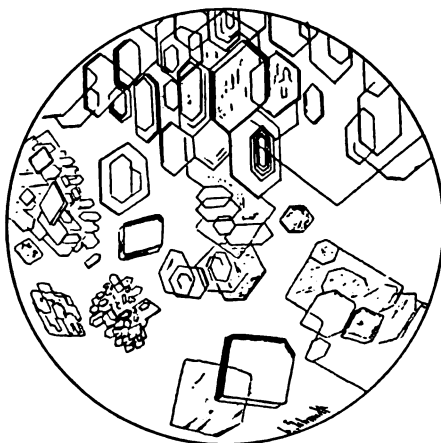

FIG. 133.—UREA NITRATE.

Urea has the power of forming crystalline compounds with certain acids; urea nitrate and urea oxalate are the most important of these compounds. *Urea nitrate*, $\text{CO}(\text{NH}_2)_2 \cdot \text{HNO}_3$, crystallizes in colorless, rhombic or six-sided tiles (Fig. 133, above), which are easily soluble in water. *Urea oxalate*, $[\text{CO}(\text{NH}_2)_2]_2 \cdot \text{H}_2\text{C}_2\text{O}_4$, crystallizes in the form of rhombic or six-sided prisms or plates (Fig. 135, page 404): the oxalate differs from the nitrate in being somewhat less soluble in water. The formation of the nitrate and oxalate and the decomposition of urea by the enzyme urease are the most satisfactory methods for the detection of urea.

A decrease in the excretion of urea is observed in many diseases in which the diet is much reduced and in some disorders as a result of

¹ Takeuchi: *Jour. College of Agr., Tokyo, 1909, Part I.*

alterations in metabolism, *e.g.*, myxedema, and in others as a result of changes in excretion, as in severe and advanced kidney disease. A pathological increase is found in a large proportion of diseases which are associated with a toxic state. In marked acidosis it may be considerably decreased relative to the total nitrogen (§see Ammonia).

EXPERIMENTS ON UREA

1. Isolation from the Urine.¹—Place 800 c.c. of urine in a precipitating jar add 250 c.c. of baryta mixture,² and stir thoroughly. Filter off the precipitate of phosphates, sulphates, urates, and hippurates and evaporate the filtrate on a water-bath to a thick syrup. This syrup contains chlorides, creatinine, organic salts, pigments, and urea. Extract the syrup with warm 95 per cent alcohol and filter again. The filtrate contains the urea contaminated with pigment. Decolorize the filtrate by boiling with animal charcoal, filter again, and stand the filtrate away in a cold place for crystallization. Examine the crystals under the microscope and compare them with those shown in Fig. 132, page 400.

2. Solubility.—Test the solubility of urea, prepared by yourself or furnished by the instructor, in water and in alcohol and ether.

3. Melting-point.—Determine the melting-point of some pure urea furnished by the instructor. Proceed as follows: Into an ordinary melting-point tube, sealed at one end, introduce powdered urea. Fasten the tube to the bulb of a thermometer as shown in Fig. 134, and suspend the bulb and its attached tube in a small beaker containing sulphuric acid. Gently raise the temperature of the acid by means of a low flame, stirring the fluid continually, and note the temperature at which the urea begins to melt.

4. Crystalline Form.—Dissolve a crystal of pure urea in a few drops of 95 per cent alcohol and place 1–2 drops of the alcoholic solution on a microscopic slide. Allow the alcohol to evaporate spontaneously, examine the crystals under the microscope, and compare them with those reproduced in Fig. 132, page 400. Recrystallize a little urea from water in the same way and compare the crystals with those obtained from the alcoholic solution.

5. Formation of Biuret.—Place a small amount of urea in a dry test-tube and heat carefully in a low flame. The urea melts at 132°C. and liberates ammonia. Continue heating until the fused mass begins to solidify. Cool the

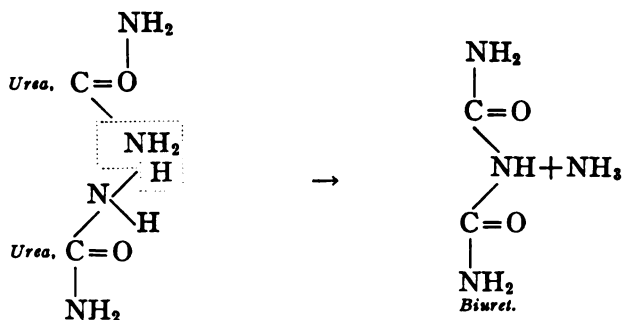

FIG. 134.—MELTING-POINT TUBES FASTENED TO BULB OF THERMOMETER.

¹ The method based upon the precipitation by nitric acid is also satisfactory (see Hoppe-Seyler's *Handbuch der Physiol. und Pathol. Chem. Anal.*, Eighth edition, 1909, p. 145).

² Baryta mixture consists of a mixture of 1 volume of a saturated solution of $\text{Ba}(\text{NO}_3)_2$ and 2 volumes of a saturated solution of $\text{Ba}(\text{OH})_2$.

tube, dissolve the residue in dilute potassium hydroxide solution, and add very dilute copper sulphate solution (see page 100). The purplish-violet color is due to the presence of biuret which has been formed from the urea through the application of heat as indicated. This is the reaction:



6. Urea Nitrate.—Prepare a concentrated solution of urea by dissolving a little of the substance in a few drops of water. Place a drop of this solution on a microscopic slide, add a drop of concentrated nitric acid, and examine under the microscope. Compare the crystals with those reproduced in Fig. 133, page 402.

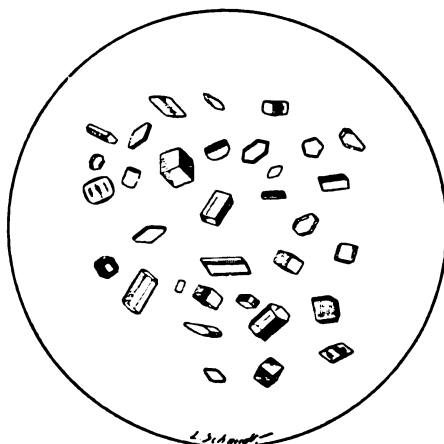

FIG. 135.—UREA OXALATE.

7. Urea Oxalate.—To a drop of a concentrated solution of urea, prepared as described in the last experiment (6), add a drop of a saturated solution of oxalic acid. Examine under the microscope and compare the crystals with those shown in Fig. 135, above.

8. Decomposition by Sodium Hypobromite.—Into a mixture of 3 c.c. of concentrated sodium hydroxide solution and 2 c.c. of bromine water in a test-tube introduce a crystal of urea or a small amount of concentrated solution of urea. Through the influence of the sodium hypobromite, NaOBr , the urea is decomposed and carbon dioxide and nitrogen are liberated. The carbon dioxide is absorbed by the excess of sodium hydroxide, while the nitrogen is evolved and causes the marked effervescence observed. This property forms the basis for

urea, ammonia, and creatinine are the chief end-products of nitrogenous metabolism. It is generally said that the relation existing between uric acid and urea in human urine under normal conditions varies on the average from 1:40 to 1:100 and is subject to wider variations under pathological conditions; and further that because of the high content of uric acid in the urine of newborn infants the ratio may be reduced to 1:10 or even lower. We now know that this ratio of uric acid to urea is of little significance under any conditions.

In man, uric acid probably results principally from the destruction of nuclein material. It may arise from nuclein or other purine material ingested as food or from the disintegrating cellular matter of the organism. The uric acid resulting from the first process is said to be of *exogenous* origin, whereas the product of the second form of activity is said to be of *endogenous* origin. As a result of experimentation, Sivéń, and Burian and Schur, and Rockwood claim that the amount of endogenous uric acid formed in any given period is fairly constant for each individual under normal conditions, and that it is entirely independent of the total amount of nitrogen eliminated. Folin has taken exception to the statements of these investigators and claims that, following a pronounced decrease in the amount of protein metabolized, the absolute quantity of uric acid is decreased but that this decrease is relatively smaller than the decrease in the total nitrogen excretion and that the per cent of the uric acid nitrogen, in terms of the total nitrogen, is therefore decidedly increased. According to Mareš,¹ food-stuffs act to increase the endogenous uric acid output by stimulating the digestive glands to activity. That a portion of the endogenous uric acid may arise in this way has recently been shown by Mendel and Stehle.²

In birds the formation of uric acid is analogous to the formation of urea in man. In these organisms it is derived principally from the protein material of the tissues and the food and is formed through a process of synthesis which occurs for the most part in the liver; a comparatively small fraction of the total uric acid excretion of birds may result from nuclein material.

When pure, uric acid may be obtained as a white, odorless, and tasteless powder, which is composed principally of small, transparent, crystalline, rhombic plates. Uric acid as it separates from the urine is invariably pigmented, and crystallizes in a large variety of characteristic forms, *e.g.*, dumb-bells, wedges, rhombic prisms, irregular rectangular or hexagonal plates, whetstones, prismatic rosettes, etc. Uric acid is insoluble in alcohol and ether, soluble with difficulty in boiling

¹ Mareš: *Arch. f. d. ges. Physiol.*, 134, 59, 1910.

² Mendel and Stehle: *Jour. Biol. Chem.*, 22, 215, 1915.

water (1 : 1800) and practically insoluble in cold water (1 : 39,480, at 18°C.). It is soluble in alkalis, alkali carbonates, boiling glycerol, concentrated sulphuric acid, and in certain organic bases such as ethylamine and piperidine. It is claimed that the uric acid is held in solution in the urine by the urea and disodium hydrogen phosphate present. Uric acid possesses the power of reducing cupric hydroxide in alkaline solution and may thus lead to an erroneous conclusion in testing for sugar in the urine by means of Fehling's or Trommer's test. A white precipitate of cuprous urate is formed if only a small amount of cupric hydroxide is present, but if enough of the copper salt is present the characteristic red or brownish-red precipitate of cuprous oxide is obtained. Uric acid does not possess the power of reducing bismuth in alkaline solution and therefore does not interfere in testing for sugar in the urine by means of Boettger's or Nylander's tests.

In addition to being an important urinary constituent uric acid is present in small amounts in normal human blood as well as in the blood of birds. It is also normally present in the brain, heart, liver, lungs, pancreas, and spleen.

Pathologically, the excretion of uric acid is subject to wide variations, but the experimental findings are rather contradictory. It may be stated with certainty, however, that in leukemia, because of the destruction of nuclein material, the uric acid output is increased absolutely as well as relatively to the urea output; under these conditions the ratio between the uric acid and urea may be as low as 1 : 9, whereas the normal ratio, as we have seen, is 1 : 50 or higher. An actual output of 12 grams of uric acid per day has been reported in leukemia. In the study of the influence of X-ray on metabolism Edsall and others have reached some interesting conclusions. Edsall found that the excretion of uric acid is usually increased and that in some conditions, particularly in leukemia, it may be *greatly* increased. The excretion of total nitrogen, phosphates, and other substances may also be considerably increased.

In gout the kidney is said to lose the power of properly eliminating uric acid and it collects in the blood in abnormally high concentration.

Normal = 1-3 mg. uric acid per 100 grams of blood.

Gout = 3-6 mg. uric acid per 100 grams of blood.

In gout the uric acid content of the urine is generally low preceding an attack and increases during the attack. Atophan has been found to increase the uric acid output in gout, apparently due to increased kidney activity.

The uric acid content of the urine is of importance in relation to the formation of uric acid calculi. The administration of alkali carbonates

and citrates, or the feeding of base-forming foods, by decreasing the acidity of the urine increases its solvent power for uric acid and decreases the liability of formation of this type of calculus.¹

EXPERIMENTS ON URIC ACID

1. Isolation from the Urine.—Place about 200 c.c. of filtered urine in a beaker, render it acid with 2–10 c.c. of concentrated hydrochloric acid, stir thoroughly, and stand the vessel in a cold place for 24 hours. Examine the pigmented crystals of uric acid under the microscope and compare them with those shown in Fig. 151, page 490, and Pl. V, opposite.

2. Solubility.—Try the solubility of pure uric acid, furnished by the instructor, in water, dilute acid and alkali and in alcohol, ether and concentrated sulphuric acid.

3. Crystalline Form of Pure Uric Acid.—Place about 100 c.c. of water in a small beaker, render it distinctly alkaline with potassium hydroxide solution and

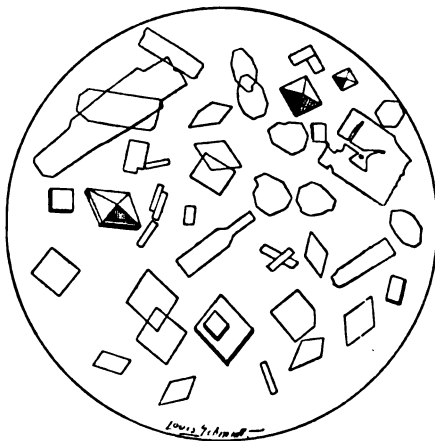

FIG. 136.—PURE URIC ACID.

add a small amount of pure uric acid, stirring continuously. Cool the solution, render it distinctly acid with hydrochloric acid and allow it to stand in a cool place for crystallization. Examine the crystals under the microscope and compare them with those reproduced in Fig. 136.

4. Murexide Test.—To a small amount of pure uric acid in a small evaporating dish add 2–3 drops of concentrated nitric acid. Evaporate to dryness carefully on a water-bath or over a very low flame. A red or yellow residue remains which turns purplish red after cooling the dish and adding a drop of very dilute ammonium hydroxide. The color is due to the formation of murexide. If potassium hydroxide is used instead of ammonium hydroxide a purplish violet color due to the production of the potassium salt is obtained. The color disappears upon warming; with certain related bodies (purine bases) the color persists under these conditions.

¹ Blatherwick: *Arch. Int. Med.*, 14, 409, 1914.

PLATE V.



URIC ACID CRYSTALS. NORMAL COLOR. (From Purdy, after Peyer.)

In this reaction the uric acid is oxidized to dialuric acid and alloxan. These two substances condense to form alloxantin. This alloxantin reacts with ammonium hydroxide to form purpuric acid. The purple color is due to the formation of *ammonium purpurate* or *murexide*.

5. **Phosphotungstic Acid Reaction (Folin).**—To 20 c.c. of saturated sodium carbonate solution in a small beaker add a small amount of uric acid. Stir the solution until the uric acid has dissolved, then add 1 c.c. of Folin's uric acid reagent (see Chapter XXVII). A blue color results.

6. **Silver Reduction Test (Schiff).**—Dissolve a small amount of pure uric acid in sodium carbonate solution and transfer a drop of the resulting mixture to a strip of filter paper saturated with silver nitrate solution. A yellowish-brown or black coloration due to the formation of reduced silver is produced.

It is claimed that chlorides interfere with this test.

7. **Ganassini's Test.**¹—Dissolve a small amount of uric acid in sodium carbonate. Precipitate the dissolved uric acid by means of zinc chloride, filter off the precipitate, and permit it to stand in contact with the air. A sky-blue color will develop, a color change which may be hastened by sunlight. A similar reaction may be obtained by treating the original precipitate with $K_2S_2O_8$.

8. **Influence upon Fehling's Solution.**—Dilute 1 c.c. of Fehling's solution with 4 c.c. of water and heat to boiling. Now add slowly, a few drops at a time, 1–2 c.c. of a concentrated solution of uric acid in potassium hydroxide, heating after each addition. From this experiment what do you conclude regarding the possibility of arriving at an erroneous decision when testing for sugar in the urine by means of Fehling's test?

9. **Reduction of Nylander's Reagent.**—To 5 c.c. of a solution of uric acid in potassium hydroxide add about one-half a cubic centimeter of Nylander's reagent and heat to boiling for a few moments. Do you obtain the typical black end-reaction signifying the reduction of the bismuth?

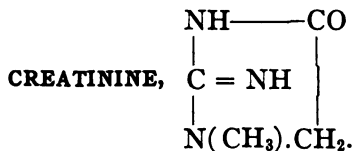

Creatinine is the anhydride of creatine and is a constituent of normal human urine. The theory that creatinine is derived from the creatine of ingested muscular tissue as well as from the creatine of the muscular tissue of the organism has been proven to be incorrect by Folin, Klercker, and Wolf and Shaffer. Shaffer believes that creatinine is the result of some special process of normal metabolism which takes place to a large extent, if not entirely, in the muscles, and further that the amount of such creatinine elimination, expressed in *milligrams per kilogram body weight*, is an index of this special process.² He further

¹ Ganassini: *Boll. soc.*, 1908, No. 1.

² He proposes to designate as the "creatinine coefficient" the excretion of *creatinine-nitrogen* (mg.) per kilogram of body weight.

states that the muscular efficiency of the individual depends upon the intensity of this process. Under normal conditions about 1-1.25 grams of creatinine is excreted by an adult man in 24 hours,¹ the exact amount depending in great part upon the nature of the food and decreasing markedly in starvation. Very little that is important is known regarding the excretion of creatinine under pathological conditions. The creatinine content of the urine is said to be increased in typhoid fever, typhus, tetanus, and pneumonia, and to be decreased in anæmia, chlorosis, paralysis, muscular atrophy, advanced degeneration of the kidneys, and in leukemia (myelogenous, lymphatic and pseudo). An increase



FIG. 137.—CREATININE.

of creatinine was also noted in diabetes, an increase probably due to the creatinine content of the meat eaten. The greater part of the data, however, relating to the variation of the creatinine excretion under pathological conditions are not of much value since in nearly every instance the diet was not sufficiently controlled to permit the collection of reliable data. And further, until the advent of the Folin method (see page 530) there was no accurate method for the quantitative determination of creatinine. Shaffer has called attention to the fact that a low excretion of creatinine is found in the urine of a remarkably large number of pathological subjects, representing a variety of conditions, and that it is therefore evident that the excretion of an abnormally small amount of this substance is by no means peculiar to any one disease. A considerable increase in the creatinine content of the blood has been observed in uremia.²

¹ According to Shaffer the amount excreted by strictly normal individuals is between 7 and 11 mg. of creatinine-nitrogen per kilogram of body weight.

² Folin and Denis: *Jour. Biol. Chem.*, 17, 487, 1914.

Myers and Fine: *Jour. Biol. Chem.*, 20, 391, 1914.

Creatinine crystallizes in colorless, glistening monoclinic prisms (Fig. 137, page 410) which are soluble in about 12 parts of cold water; they are more soluble in warm water and in warm alcohol. It forms salts only with strong mineral acids. One of the most important and interesting of the compounds of creatinine is *creatinine-zinc chloride*, $(C_4H_7N_3O)_2 \cdot ZnCl_2$, which is formed from an alcoholic solution of creatinine upon treatment with zinc chloride in acid solution. Creatinine has the power of reducing cupric hydroxide in alkaline solution and in this way may interfere with the determination of sugar in the urine. In the reduction by creatinine the blue liquid is first changed to a yellow, and the formation of a brownish-red precipitate of cuprous oxide is brought about only after continuous boiling with an excess of the copper salt. Creatinine does not reduce alkaline bismuth solutions and therefore does not interfere with Nylander's and Boettger's tests.

It has recently been shown by Folin that the absolute quantity of creatinine eliminated in the urine on a meat-free diet is a constant quantity different for different individuals, but wholly independent of quantitative changes in the total amount of nitrogen eliminated. Shaffer has very recently confirmed these findings and has shown that the output of creatinine under these conditions is constant from hour to hour as well as from day to day.

EXPERIMENTS ON CREATININE

1. **Preparation of Pure Creatinine from Urine (Folin-Benedict¹).**—To 10 liters² of undecomposed urine in a large precipitating jar add with stirring a hot solution of 180 grams of picric acid in 450 c.c. of boiling alcohol. Allow to stand over night and syphon off the supernatant fluid. Pour the residue upon a large Buchner funnel, drain with suction, wash once or twice with cold saturated picric acid and suck dry. Treat the dry or nearly dry picrate in a large mortar or evaporating dish with enough concentrated HCl to form a moderately thin paste (about 60 c.c. of acid for each 100 grams of picrate) and stir the mixture thoroughly with the pestle for 3–5 minutes. Filter with suction on a hardened paper, and wash the residue twice with enough water to cover it, sucking as nearly dry as possible each time. Transfer the filtrate to a large flask and neutralize with an excess of solid magnesium oxide (the "heavy" variety is best). Add this oxide in small portions with cooling of the flask under running water between the additions. Neutralization of the acid will be indicated by a bright yellow color of the mixture, or litmus paper may be used to test it. Filter with suction. Wash the residue twice with water. Immediately add a few cubic centimeters of glacial acetic acid to the filtrate to make it strongly acid. Pay no attention to any precipitate that may form, but dilute the solution with about 4 volumes of 95 per

¹ Benedict: *Jour. Biol. Chem.*, 18, 182, 1914.

Folin: *Ibid.*, 17, 463, 1914.

² If it is simply desired to demonstrate the presence of creatinine, 1 liter may be employed and the various reagents reduced accordingly.

cent alcohol. After 15 minutes filter off the slight precipitate which forms. Treat the final filtrate with 30-40 c.c. of 30 per cent zinc chloride. Stir and let stand over night in a cool place. Pour off the supernatant liquid and collect the creatinine zinc chloride on a Buchner funnel, wash once with water, then thoroughly with 50 per cent alcohol, finally with 95 per cent alcohol and dry. A nearly white, light crystalline powder should be obtained. The yield should be 90-95 per cent of the original creatinine (usually about 1.5-1.8 grams of creatinine zinc chloride per liter of urine).

Recrystallize the creatinine-zinc chloride by treating 10 grams with 100 c.c. of water and about 60 c.c. of normal sulphuric acid, heating the mixture until a clear solution is obtained. Add about 4 grams of purified animal charcoal, continue boiling for about a minute, filter with suction through a small Buchner funnel, pouring the filtrate back on the filter three or four times until it runs through perfectly colorless. Wash residue with hot water and transfer the total filtrate to a beaker and while hot treat with a little strong zinc chloride solution (3 c.c.) and with about 7 grams of potassium acetate dissolved in a little water. After ten minutes dilute with an equal volume of alcohol, and allow to stand in a cold place for some hours. Filter off the crystalline product and examine under microscope (see Fig. 124). To remove the small amount of potassium sulphate which it contains stir up with twice its weight of water, filter, wash with a little water and then with alcohol. The preparation should be snow white. Yield, 85-90 per cent.

Place the finely powdered recrystallized creatinine zinc chloride in a dry flask and treat with seven times its weight (by volume) of concentrated aqueous ammonia. Warm slightly and agitate gently until a clear solution is obtained, care being taken to drive off no more ammonia during the warming than is necessary to obtain a clear solution. Stopper the flask, allow to cool, place in the ice-box for an hour or more. Pure creatinine crystallizes out. It may be recrystallized from boiling alcohol or concentrated ammonia, but this is usually unnecessary. The product is perfectly pure and can be used as a standard in the quantitative determination of creatine and creatinine. See chapters on Quantitative Analysis of Urine and Blood.

1. Preparation of Creatine.—Creatine may be prepared from creatinine zinc chloride by decomposition with calcium hydrate, the process being one of hydrolysis (Benedict).

One hundred grams of creatinine zinc chloride are treated with about 700 c.c. of water in a large casserole and the mixture heated to boiling; 150 grams of pure powdered calcium hydrate are then added, with stirring, and the mixture boiled gently for 20 minutes (with occasional stirring). The hot mixture is then filtered with suction, the residue being washed with hot water. The filtrate is then treated with hydrogen sulphide gas for a few minutes and poured through a folded filter to remove the zinc. The filtrate is acidified by the addition of about 5 c.c. of glacial acetic acid and boiled down rapidly to a volume of about 200 c.c. This solution is allowed to stand over night, preferably in a cool place. The next day the crystallized creatine is filtered off with suction, washed with a very little cold water, and then thoroughly washed with alcohol and dried.¹ This product is then recrystallized by dissolving in about seven times its weight of boiling water and allowing

¹ The filtrate obtained at this point should be diluted with alcohol and treated with zinc chloride (50 c.c. of a 30 per cent solution) for recovery of the unconverted creatinine.

the solution to cool slowly and stand for some hours. This product should be perfectly pure creatine. If necessary it can be recrystallized with very little loss. The crystallized product should be filtered off, washed with alcohol and ether and dried in air for about half an hour. Thus obtained the creatine contains water of crystallization which it loses very readily upon exposure to air. To prepare creatine which can be weighed with absolute exactness it is necessary to dehydrate this product by heating for some hours at about 95° .

The yield in this process is about 18 grams of recrystallized creatine, and about 55 grams of creatinine zinc chloride recovered. Longer boiling with lime does not bring about a greater yield, as after the 20-minute point creatine is decomposed almost exactly as fast as it is formed.

Examine the crystals of creatine under the microscope and compare with illustration in Chapter XX on Muscular Tissue. For other creatine tests see Chapter XX.

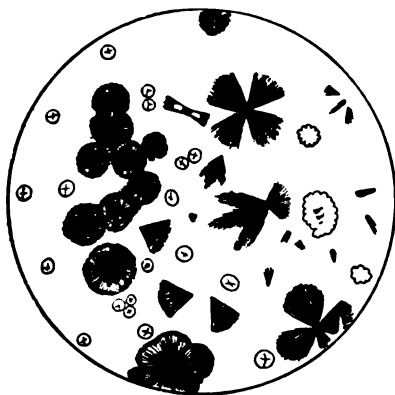

FIG. 138.—CREATININE-ZINC CHLORIDE. (Salkowski.)

3. Nitro-prusside Test (Weyl).—Take 5 c.c. of urine in a test-tube, add a few drops of sodium nitro-prusside and render the solution alkaline with potassium hydroxide solution. A ruby-red color results which soon turns yellow. See Legal's test for acetone, page 465.

4. Nitro-prusside-acetic Acid Test (Salkowski).—To the yellow solution obtained in Weyl's test above add an excess of acetic acid and apply heat. A green color results and is in turn displaced by a blue color. A precipitate of Prussian blue may form.

5. Picric Acid Reaction (Jaffe).—Place 5 c.c. of urine in a test-tube, add an aqueous solution of picric acid and render the mixture alkaline with potassium hydroxide solution. A red color is produced which turns yellow if the solution be acidified. Glucose gives a similar red color but only upon the application of heat. This color reaction observed when creatinine in alkaline solution is treated with picric acid is the basic principle of Folin's colorimetric method for the quantitative determination of creatinine (see page 530).

ETHEREAL SULPHATES

The most important of the ethereal sulphates found in the urine are *phenol-sulphuric acid*, *p-cresol-sulphuric acid*, *indoxyl-sulphuric*

acid, and *skatoxyl-sulphuric acid*. Pyrocatechol-sulphuric acid also occurs in traces in human urine. The total output of ethereal sulphuric acid (as SO_3) varies ordinarily from 0.1 gram to 0.25 gram for 24 hours and comprises 5–15 per cent of the total sulphur. In health the ratio of ethereal sulphuric acid to inorganic sulphuric acid is about 1:10. These ethereal sulphuric acids originate in part from the phenol, cresol, indole and skatole formed in the putrefaction of protein material in the intestine. The phenol passes to the liver where part of it is conjugated to form phenol potassium sulphate and appears in this form in the urine whereas the indole and skatole undergo a preliminary oxidation to form *indoxyl* and *skatoxyl* respectively before their conjugation and elimination.

It was formerly generally considered that each of the ethereal sulphuric acids was formed principally in the putrefaction of protein material in the intestine and that therefore a determination of the total ethereal sulphuric acid content of the urine was an index of the extent to which these putrefactive processes were proceeding within the organism. Folin, however, conducted a series of experiments which seemed to show that the ethereal sulphuric acid content of the urine did *not* afford an index of the extent of intestinal putrefaction, since these bodies arise only in part from putrefactive processes. He claims that the ethereal sulphuric acid excretion represents a form of sulphur metabolism which is more in evidence upon a diet containing a very small amount of protein or upon a diet containing absolutely no protein. The ethereal sulphuric acid content of the urine diminishes as the total sulphur content diminishes but the *percentage decrease* is much less. Therefore when considered from the standpoint of the total sulphuric acid content the ethereal sulphuric acid content is not diminished but is *increased*, although the total sulphuric acid content is *diminished*. Folin's experiments also seem to show that the indoxyl sulphuric acid (indoxyl potassium sulphate or indican) content of the urine does not originate to any degree from the metabolism of protein material but that it arises in great part from intestinal putrefaction and that the excretion of indoxyl sulphuric acid may *alone* be taken as a rough index of the extent of putrefactive processes within the intestine. Indoxyl sulphuric acid,

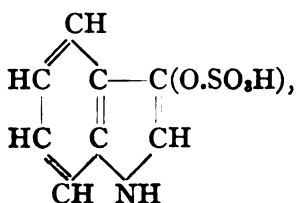

therefore, which occurs in the urine as indoxyl potassium sulphate or indican,

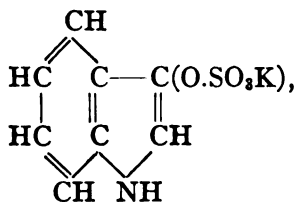

is clinically the most important of the ethereal sulphuric acids. Under normal conditions from 4 to 20 mg. of indican are excreted per day. The variations are due mainly to diet, a high meat diet causing an increase and a carbohydrate diet a decrease. Pathologically the greatest increases are found in disorders involving increased putrefaction and stagnation of intestinal contents. Bacterial decomposition of body protein as in gangrene, putrid pus formation, etc., gives rise to an increased indican excretion.

It was formerly believed that the *phenol* was excreted practically quantitatively in the conjugated form. Recent work of Folin and Denis¹ seems to indicate that this is not true. Only *part* of the phenols formed in intestinal putrefaction are excreted in the conjugated form, the remainder being excreted as free phenol. The phenol output tends to vary directly but not proportionally with the protein ingestion. The total phenol excretion of normal men on an ordinary mixed diet averages around 0.4 gram per day.

TESTS FOR INDICAN²

1. **Jaffe's Test.**—Nearly fill a test-tube with a mixture composed of equal volumes of concentrated HCl and the urine under examination. Add 2–3 c.c. of chloroform and a few drops of a calcium hypochlorite solution, place the thumb over the end of the test-tube and shake the tube and contents thoroughly. The chloroform is colored more or less, according to the amount of indican present. Ordinarily a blue color due to the formation of indigo-blue is produced; less frequently a red color due to indigo-red may be noted.

Repeat this test on some of this same urine to which formaldehyde has been added. Is there any variation in the reaction from what you previously obtained?

The following represents the reaction (see also pages 216–217):

¹ Folin and Denis: *Jour. Biol. Chem.*, 22, 309, 1915.

² The urine should always be examined *fresh* if this is possible. In any event formaldehyde should never be used as a preservative for such urines as are to be examined for indican by means of any test involving hypochlorite or potassium permanganate. The formaldehyde through its reducing power lowers the oxidizing efficiency of the mixture. The formation of formic acid from the aldehyde may also interfere.

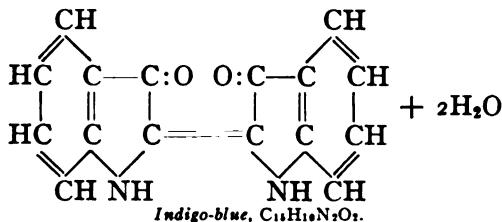
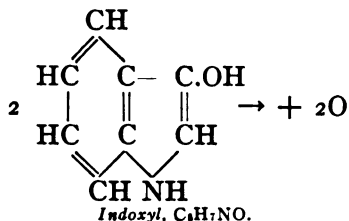

2. Obermayer's Test.—Nearly fill a test-tube with a mixture composed of equal volumes of Obermayer's reagent¹ and the urine under examination. Add 2–3 c.c. of chloroform, place the thumb over the end of the test-tube and shake thoroughly. How does this compare with Jaffe's test?

3. Jolles' Reaction.²—To 10 c.c. of urine add 1 c.c. of a 5 per cent¹ alcoholic thymol solution and shake. Add about 10 c.c. of fuming HCl containing 5 grams of ferric chloride per liter. Shake again carefully and let stand for 15 minutes. Add about 4 c.c. of chloroform and extract the pigment by repeated gentle shaking. The chloroform becomes intensely violet. 0.0032 mg. of indican can be detected in 10 c.c. of urine. It is much the most delicate test for indican.

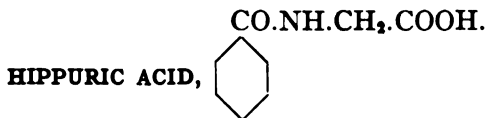

This acid occurs normally in the urine of both the carnivora and herbivora but is much more abundant in the urine of the latter. It is formed by a synthesis of benzoic acid and glycocholl which takes place in the kidneys and elsewhere.³ The glycocholl comes from decomposition of protein. The benzoic acid thus utilized may come from (1) preformed benzoic acid of fruits and vegetables; (2) other aromatic compounds of fruits and vegetables; (3) aromatic amino-acids (tyrosine and phenylalanine) from the alimentary tract. The average excretion of hippuric acid by an adult man for 24 hours under normal conditions is about 0.7 gram. Hippuric acid crystallizes in needles or rhombic prisms (see Fig. 139, p. 417) the particular form depending upon the

¹ Obermayer's reagent is prepared by adding 2–4 grams of ferric chloride to a liter of concentrated HCl (sp. gr. 1.19).

² *Zeit. physiol. Chem.*, 94, 79, 1915.

³ Kingsbury and Bell: *Jour. Biol. Chem.*, 21, 297, 1915.

rapidity of crystallization. Pure hippuric acid melts at 187°C . The most satisfactory method for the isolation of hippuric acid from the urine in crystalline form is that proposed by Roaf (see below). It is easily soluble in alcohol or hot water, and only slightly soluble in ether. The output of hippuric acid is increased in diabetes owing probably to the ingestion of much protein and fruit. Plums, prunes and cranberries in particular increase the hippuric acid output considerably due to their relatively high content of benzoic acid. Hippuric acid is decreased in fevers and in certain kidney disorders where the synthetic



FIG. 139.—HIPPURIC ACID.

activity of the renal cells is diminished. It may be determined quantitatively by methods given in Chapter XXVII.

EXPERIMENTS ON HIPPURIC ACID

1. Separation from the Urine.—(a) First Method.—Render 500–1000 c.c. of urine of the horse or cow¹ alkaline with milk of lime, boil for a few moments and filter while hot. Concentrate the filtrate, over a burner, to a small volume. Cool the solution, acidify it strongly with concentrated hydrochloric acid and stand it in a cool place for 24 hours. Filter off the crystals of hippuric acid which have formed and wash them with a little cold water. Remove the crystals from the paper, dissolve them in a very small amount of hot water and percolate the hot solution through thoroughly washed animal charcoal, being careful to wash out the last portion of the hippuric acid solution with hot water. Filter, concentrate

¹ If urine of the horse or cow is not available human urine may serve the purpose fully as well provided means are taken to increase its content of hippuric acid. This may be conveniently accomplished by ingesting 2 grams of ammonium benzoate at night. (See chapter on Metabolism.) The fraction of urine passed in the morning will be found to have a high content of hippuric acid. The ammonium benzoate is in no way harmful. In case ammonium benzoate is not available sodium benzoate may be substituted.

the filtrate to a small volume and stand it aside for crystallization. Examine the crystals under the microscope and compare them with those in Fig. 139, page 417. This method is not as satisfactory as Roaf's method (see below).

(b) Roaf's Method.—Place 500 c.c. of urine of the horse or cow in a casserole or precipitating jar and add an equal volume of a saturated solution of ammonium sulphate¹ and 7.5 c.c. of concentrated sulphuric acid. Permit the mixture to stand for 24 hours and remove the crystals of hippuric acid by filtration. Purify the crystals by recrystallization according to the directions given above under First Method. Examine the crystals under the microscope and compare them with those given in Fig. 139, page 417.

If sufficient urine is not available to permit the use of 500 c.c. a smaller volume may be used inasmuch as it is possible, by the above technic, to isolate hippuric acid in crystalline form from as small a volume as 25–50 c.c. of herbivorous urine. The greater the amount of ammonium sulphate added the more rapid the crystallization until at the saturation point the crystals of hippuric acid sometimes form in about ten minutes.

2. Melting-point.—Determine the melting-point of the hippuric acid prepared in the above experiment (see page 403).

3. Solubility.—Test the solubility of hippuric acid in hot and cold water and in alcohol, and ether.

4. Formation of Nitro-Benzene (Lücke's Reaction).—To a little hippuric acid in a small porcelain dish add 1–2 c.c. of concentrated HNO₃ and evaporate to dryness on a water-bath. Transfer the residue to a dry test-tube, apply heat, and note the odor of the artificial oil of bitter almonds (nitrobenzene).

5. Spiro's Reaction.²—Warm the hippuric acid with acetic anhydride, anhydrous sodium acetate and benzaldehyde. After one-half hour permit the solution to cool. Note the formation of crystals of the lactimide of phenylaminocinnamic acid, melting-point 165–166°. Heat some of the crystals with concentrated sodium hydroxide until ammonia is given off. Acidify and note the formation of phenylpyrrolic acid (C₆H₅CH₂.CO.CO₂H). This acid is soluble in ether.

6. Sublimation.—Place a few crystals of hippuric acid in a dry test-tube and apply heat. The crystals are reduced to an oily fluid which solidifies in a crystalline mass upon cooling. When stronger heat is applied the liquid assumes a red color and finally yields a sublimate of benzoic acid and the odor of hydrocyanic acid.

7. Formation of Ferric Salt.—Render a small amount of a solution of hippuric acid neutral with dilute potassium hydroxide. Now add 1–3 drops of neutral ferric chloride solution and note the formation of the ferric salt of hippuric acid as a cream-colored precipitate.

8. Synthesis of Hippuric Acid.—To some of the glycocholl prepared in the last experiment or furnished by the instructor, add a little water, about 1 c.c. of benzoyl chloride and render alkaline with potassium hydroxide solution. Stopper the tube and shake it until no more heat is evolved. Now render strongly alkaline with potassium hydroxide and shake the mixture until no odor of benzoyl chloride can be detected. Cool, acidify with hydrochloric acid, add an equal volume of petroleum ether, and shake thoroughly to remove the benzoic acid. (Evaporate this solution and note the crystals of benzoic acid. Compare them with those shown in Fig. 141, page 424.) Decant the ethereal solution into a porcelain dish and extract again

¹ 125 grams of solid ammonium sulphate may be substituted.

² Spiro: *Zeit. physiol. Chem.*, 28, 174, 1899.

with ether. The hippuric acid remains in the aqueous solution. Filter it off and wash it with a small amount of cold water while still on the filter. Remove it to a small, shallow vessel, dissolve it in a small amount of hot water and set it aside for crystallization. Examine the crystals microscopically and compare them with those in Fig. 139, page 417.

The chemistry of the synthesis is represented thus:

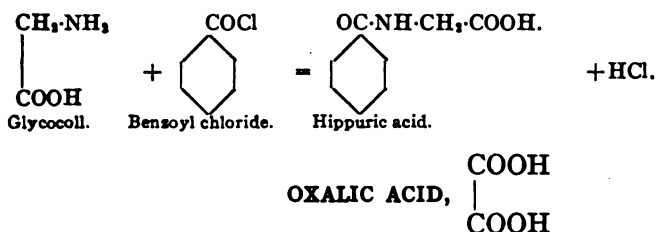

Oxalic acid is a constituent of normal urine, about 15–20 mg. being eliminated in 24 hours. It is present in the urine as calcium oxalate which is kept in solution through the medium of the acid phosphates. The origin of the oxalic acid content of the urine is not well understood. When ingested it is eliminated, at least in part, unchanged, therefore since many of the common articles of diet, *e.g.*, asparagus, apples, cabbage, grapes, lettuce, rhubarb, spinach, tomatoes, etc., contain oxalic acid (oxalates) it seems probable that the ingested food supplies a portion of the oxalic acid found in the urine. There is also experimental evidence that part of the oxalic acid of the urine is formed within the organism in the course of protein and fat metabolism. It has also been suggested that oxalic acid may arise from an incomplete combustion of carbohydrates, especially under certain abnormal conditions. Pathologically, oxalic acid is found to be increased in amount in diabetes mellitus, in organic diseases of the liver, and in various other conditions which are accompanied by a derangement of the oxidation mechanism. An abnormal increase of oxalic acid is termed *oxaluria*. A considerable increase in the content of oxalic acid may be noted unaccompanied by any other apparent symptom. Calcium oxalate crystallizes in at least two distinct forms, *dumb-bells* and *octahedra* (Fig. 149, page 488).

EXPERIMENTS

Preparation of Calcium Oxalate.—First Method.—Place 200–250 c.c. of urine in a beaker, add 5 c.c. of a saturated solution of calcium chloride, make the urine slightly acid with acetic acid, and stand the beaker aside in a cool place for 24 hours. Examine the sediment under the microscope and compare the crystalline forms with those shown in Fig. 149, page 488.

Second Method.—Proceed as above, replacing the acetic acid by an excess of ammonium hydroxide and filtering off the precipitate of phosphates.

NEUTRAL SULPHUR COMPOUNDS

Under this head may be classed such bodies as cystine (see page 75), chondroitin-sulphuric acid, oxyproteic acid, alloxyproteic acid, uroferric acid, methyl mercaptan, ethyl sulphide, thiocyanates and taurine derivatives. The sulphur content of the bodies just enumerated is generally termed unoxidized or neutral sulphur in order that it may not be confused with the acid or oxidized sulphur which occurs in the inorganic sulphuric acid and ethereal sulphuric acid forms. Ordinarily the neutral sulphur content of normal human urine is 5-25 per cent of the total sulphur content (see "Sulphur Partition" in chapter on Metabolism). The actual amount excreted may be 0.2-0.4 grams



FIG. 140.—ALLANTOIN, FROM CAT'S URINE.

a and *b*, Forms in which it crystallized from the urine; *c*, recrystallized allantoin. (Drawn from micro-photographs furnished by Prof. Lafayette B. Mendel of Yale University.)

per day, calculated as SO_3 . Its origin is mainly endogenous. The excretion is fairly constant for any given individual in spite of dietary changes. In tuberculosis, cancer, cystinuria, etc., the amount may be relatively or absolutely increased.

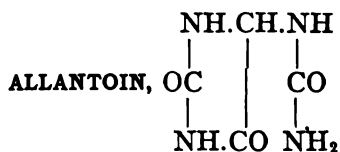

Allantoin is found in the urine of practically all mammals including man. In human urine it occurs in very small amount (5-15 mg. per day) whereas in the case of all other mammals investigated except anthropoid apes, it is the principal end-product of purine metabolism

and may constitute 90 per cent or over of the total purine output.¹ Allantoin is formed by the oxidation of uric acid and the output is increased by the feeding of thymus or pancreas to lower animals. When pure it crystallizes in prisms (Fig. 140, page 420) and when impure in granules and knobs. Pathologically, it has been found increased in diabetes insipidus and in hysteria with convulsions (Pouchet). Mendel and Dakin² have shown that allantoin is optically inactive notwithstanding the fact that it contains an asymmetric carbon atom. This phenomenon they believe to be due to tautomeric change. Wiechowski has suggested an excellent method for the quantitative determination of allantoin. (See Chapter XXVII.)

EXPERIMENTS

1. Separation from the Urine.³—Meissner's Method.—Precipitate the urine with baryta water. Neutralize the filtrate carefully with dilute sulphuric acid, filter immediately, and evaporate the filtrate to incipient crystallization. Completely precipitate this warm fluid with 95 per cent alcohol (reserve the precipitate). Decant or filter and precipitate the solution by ether. Combine the ether and alcohol precipitates and extract with cold water or hot alcohol; allantoin remains undissolved. Bring the allantoin into solution in hot water and recrystallize.

2. Preparation from Uric Acid.—Dissolve 4 grams of uric acid in 100 c.c. of water rendered alkaline with potassium hydroxide. Cool and carefully add 3 grams of potassium permanganate. Filter, immediately acidulate the filtrate with acetic acid and allow it to stand in a cool place over night. Filter off the crystals and wash them with water. Save the wash water and filtrate, unite them and after concentrating to a small volume stand away for crystallization. Now combine all the crystals and recrystallize them from hot water. Use these crystals in the experiments which follow.

3. Microscopical Examination.—Examine the crystals made in the last experiment and compare them with those shown in Fig. 140.

4. Solubility.—Test the solubility of allantoin in cold and hot water, cold and hot alcohol and in ether.

5. Reaction.—Dissolve a crystal in water and test the reaction to litmus.

6. Furfural Test (Schiiff).—Place a few crystals of allantoin on a test-tablet or in a porcelain dish and add 1-2 drops of a concentrated aqueous solution of furfural and 1-2 drops of concentrated hydrochloric acid. Observe the formation of a yellow color which turns to a light purple if allowed to stand. This test is given by urea but not by uric acid.

7. Murexide Test.—Try this test according to the directions given on page 408. Note that allantoin fails to respond.

8. Reduction of Fehling's Solution.—Make this test in the usual way (see page 444) except that the boiling must be prolonged and excessive. Ultimately

¹ Wiechowski: "Die Purinstoffe und das Allantoin" in Neubauer and Huppert's "Analyse des Harns," Wiesbaden, 1913.

² Mendel and Dakin: *Jour. Biol. Chem.*, 7, 153, 1910.

³ The urine of the dog after thymus, pancreas, or uric acid feeding may be employed.

the allantoin will reduce the solution. Compare with the result on uric acid, page 409.

AMINO-ACIDS¹

Certain of these acids are always present in normal urine. The excretion of total amino-acid nitrogen by a normal adult averages 0.4-1.0 gram per day or about 2-6 per cent of the total nitrogen. Free amino-acid nitrogen (see van Slyke procedure, Chapter IV) is considerably less than this, and ordinarily constitutes 0.5-1 per cent of the total nitrogen. The amount may be largely increased in disorders associated with tissue waste, *e.g.*, typhoid, acidosis, pronounced atrophy of the liver, etc. For tests on amino-acids see Chapter IV.

AROMATIC OXYACIDS

Two of the most important of the oxyacids are *parahydroxy-phenyl-acetic acid*,

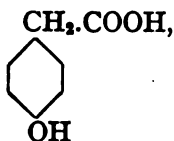

and *parahydroxy-phenyl-propionic acid*,

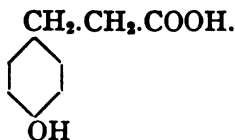

They are products of the putrefaction of protein material and tyrosine is an intermediate stage in their formation. Both these acids for the most part pass unchanged into the urine where they occur normally in very small amount. The content may be increased in the same manner as⁴the phenol content, in particular by acute phosphorus poisoning. A fraction of the total aromatic oxyacid content of the urine is in combination with sulphuric acid, but the greater part is present in the form of salts of sodium and potassium.

Homogentistic Acid or di-hydroxyphenyl-acetic acid,

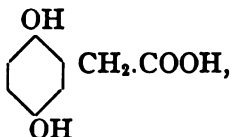

¹For a full discussion see Underhill's "The Physiology of the Amino Acids," Yale University Press, November, 1915.

is another important oxyacid sometimes present in the urine. Under the name *glycosuric acid* it was first isolated from the urine by Prof. John Marshall of the University of Pennsylvania; subsequently Baumann isolated it and determined its chemical constitution. It occurs in cases of *alcaptonuria*. A urine containing this oxyacid turns greenish-brown from the surface downward when treated with a little sodium hydroxide or ammonia. If the solution be stirred the color very soon becomes dark brown or even black. Homogentisic acid reduces alkaline copper solutions but not alkaline bismuth solutions. Uro-leucic acid is similar in its reaction to homogentisic acid.

Hydroxymandelic Acid or parahydroxyphenyl-glycolic acid,

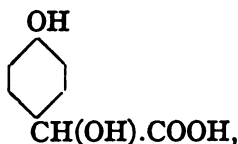

has been detected in the urine in cases of yellow atrophy of the liver.

Kynurenic Acid or γ -hydroxy- β -quinoline carboxylic acid,

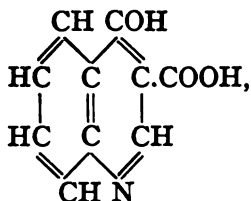

is present in the urine of the dog and has recently been detected by Swain in the urine of the coyote. To isolate it from the urine proceed as follows: Acidify the urine with hydrochloric acid in the proportion 1:25. From this acid fluid both the uric acid and the kynurenic acid separate in the course of 24-48 hours. Filter off the combined crystalline deposit of the two acids, dissolve the kynurenic acid in dilute ammonia (uric acid is insoluble), and reprecipitate it with hydrochloric acid. If a solution containing kynurenic acid be evaporated to dryness with hydrochloric acid and potassium chlorate, a reddish residue is obtained which becomes first brownish green and then emerald green on adding ammonia (Jaffé).

Kynurenic acid may be quantitatively determined by Capaldi's method.¹

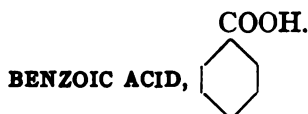

¹ *Zeitschrift für physiologische Chemie*, 23, 92, 1897.

Benzoic acid has been detected in the urine of the rabbit and dog. It is also said to occur in human urine accompanying renal disorders. The benzoic acid probably originates from a fermentative decomposition of the hippuric acid of the urine. Benzoic acid and glycocholl are synthesized in the kidney and elsewhere¹ to form hippuric acid (see page 609). Certain fruits and berries contain considerable benzoic acid; *e.g.*, *cranberries* have been shown to contain 0.06 per cent.²

EXPERIMENTS

1. Solubility.—Test the solubility of benzoic acid in water, alcohol, and ether.
2. Crystalline Form.—Recrystallize some benzoic acid from hot water, examine the crystals under the microscope, and compare them with those reproduced in Fig. 141.



FIG. 141.—BENZOIC ACID.

3. Sublimation.—Place a little benzoic acid in a test-tube and heat over a flame. Note the odor which is evolved and observe that the acid sublimes in the form of needles.
4. Dissolve a little sodium benzoate in water and add a solution of neutral ferric chloride. Note the production of a brownish-yellow precipitate (salicylic acid gives a reddish-violet color under the same conditions). Add ammonium hydroxide to some of the precipitate. It dissolves and ferric hydroxide is formed. Add a little hydrochloric acid to another portion of the original precipitate and stand the vessel away over night. What do you observe?

NUCLEOPROTEIN

The nubecula of normal urine has been shown by one investigator to consist of a mucoïd containing 12.7 per cent of nitrogen and 2.3 per cent of sulphur. This body evidently originates in the urinary

¹ Kingsbury and Bell: *Jour. Biol. Chem.*, 21, 297, 1915.

² Radin [quoted by Blatherwick (*Arch. Int. Med.*, 14, 409, 1914) from unpublished data].

passages. It is probably slightly soluble in the urine. Some investigators believe that the body forming the nubecula of normal urine is nucleoprotein and not a mucin or mucoid as stated above. A discussion of nucleoprotein and related bodies occurring in the urine under pathological conditions will be found on page 456.

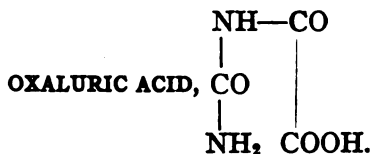

Oxaluric acid is not a constant constituent of normal human urine, and when found occurs only in traces as the ammonium salt. Upon boiling oxaluric acid it splits into oxalic acid and urea.

GLUCOSE

This sugar occurs in *traces* in normal urine. It is, however, not present in sufficient concentration to be detected by any of the ordinary tests used in urine analysis. In certain pathological conditions (pp. 440 and 546) the sugar in the urine is notably increased. Folin has recently modified Benedict's sugar test (see Chapter XXIV) so it may be used to demonstrate the sugar content of normal urine.¹

ENZYMES

Various types of enzymes produced within the organism are excreted in both the feces and the urine. In this connection it is interesting to note that *pepsin*, *rennin*, *lipase* and an *amylase* have been positively identified in the urine. The occurrence of trypsin in the urine, at least under normal conditions, is questioned.

VOLATILE FATTY ACIDS

Acetic, butyric, and formic acids have been found under normal conditions in the urine of man and of certain carnivora as well as in the urine of herbivora. Normally they arise principally from the fermentation of carbohydrates and the putrefaction of proteins. The acids containing the fewest carbon atoms (formic and acetic) are found to be present in larger percentage than those which contain a larger number of such atoms. The volatile fatty acids occur in normal urine in traces, the total output for 24 hours according to older investigators varying from 0.008 gram to 0.05 gram.

Pathologically, the excretion of volatile fatty acids is increased in

¹ Folin: *Jour. Biol. Chem.*, 22, 327, 1915.

diabetes, fevers, and in certain hepatic diseases in which the parenchyma of the liver is seriously affected. Under other pathological conditions the output may be diminished. These variations, however, in the excretion of the volatile fatty acids possess very little diagnostic value.

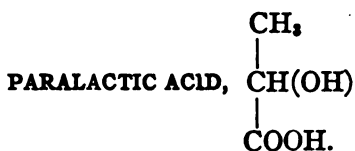

Paralactic acid is supposed to pass into the urine when the supply of oxygen in the organism is diminished through any cause, *e.g.*, in eclampsia, acute yellow atrophy of the liver, carbon-monoxide poisoning, acute phosphorus poisoning, or epileptic attacks. This acid has also been found in the urine of healthy persons following the physical exercise incident to prolonged marching. Paralactic acid has been detected in the urine of birds after the removal of the liver. Underhill reports the occurrence of this acid in the urine of a case of pernicious vomiting of pregnancy.

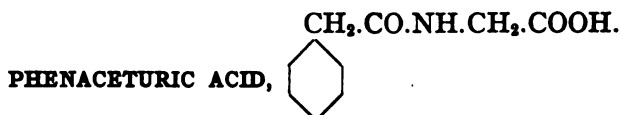

Phenaceturic acid occurs principally in the urine of herbivorous animals. It may be isolated from the urine of the dog after feeding phenylacetic acid.¹ It is produced in the organism through the synthesis of glycocholl and phenylacetic acid. It is doubtful if it occurs in normal human urine even after the ingestion of phenylacetic acid. It may be decomposed into its component parts by boiling with dilute mineral acids. The crystalline form of phenaceturic acid (small rhombic plates with rounded angles) resembles one form of uric acid crystal.

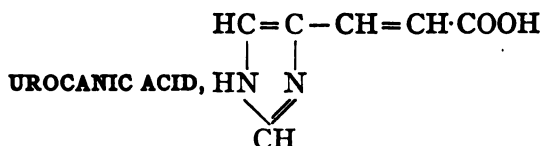

This acid has been found in the urine of dogs, but not in human urine. It is *imidazolyl-acrylic acid*. Hunter² found it among the pancreatic digestion products of casein. It crystallizes as sickle-shaped crystals.

¹ Sherwin: Dissertation, Tübingen, 1915.

² Hunter: *Jour. Biol. Chem.*, 11, 537, 1913.

PHOSPHORIZED COMPOUNDS

Phosphorus in organic combination has been found in the urine in such bodies as glycerophosphoric acid, which may arise from the decomposition of lecithin, and phosphocarnic acid. It is claimed that on the average about 2.5 per cent of the total phosphorus elimination is in organic combination.

PIGMENTS

There are at least three pigments normally present in human urine. These pigments are *urochrome*, *urobilin*, and *uroerythrin*.

A. UROCHROME

This is the principal pigment of normal urine and imparts the characteristic yellow color to that fluid. It is apparently closely related to its associated pigment urobilin since the latter may be readily converted into urochrome through evaporation of its aqueous-ether solution. Urochrome may be obtained in the form of a brown, amorphous powder which is readily soluble in water and 95 per cent alcohol. It is less soluble in absolute alcohol, acetone, amyl alcohol and acetic ether, and insoluble in benzene, chloroform, and ether. Urochrome is said to be a nitrogenous body (4.2 per cent nitrogen), free from iron. Urochrome is believed to be identical with the yellow pigment, *lactochrome*, of milk whey.¹ The chromogen of urochrome, *i.e.*, *urochromogen* is present in the urine in pulmonary tuberculosis. Its presence is said to be of prognostic value (see page 481).

B. UROBILIN

Urobilin, which was at one time considered to be the principal pigment of urine, in reality contributes little toward the pigmentation of this fluid. It is claimed that no urobilin is present in freshly voided normal urine but that its precursor, a chromogen called *urobilinogen*, is present and gives rise to urobilin upon decomposition through the influence of light. It is claimed by some investigators that there are various forms of urobilin, *e.g.*, normal, febrile, physiological, and pathological. Urobilin is said to be very similar to, if not absolutely identical with, hydrobilirubin (see page 226).

Urobilin may be obtained as an amorphous powder which varies in color from brown to reddish-brown, red and reddish-yellow, depending upon the way in which it is prepared. It is easily soluble in ethyl alcohol, amyl alcohol, and chloroform, and slightly soluble in ether, acetic ether, and in water. Its solutions show characteristic absorption

¹ Palmer and Coolidge: *Jour. Biol. Chem.*, 17, 251, 1914.

bands (see Absorption Spectra, Plate II). Under normal conditions urobilin is derived from the bile pigments in the intestine.

Urobilin is increased in most acute infectious diseases such as *erysipelas*, *malaria*, *pneumonia*, and *scarlet fever*. It is also increased in *appendicitis*, *carcinoma of the liver*, *catarrhal icterus*, *pernicious anemia*, in cases of poisoning by antifebrin, antipyrin, pyridin, and potassium chlorate and quite commonly after salvarsan injections. In general it is usually increased when blood destruction is excessive and in disturbances of the liver. It is markedly decreased in phosphorus poisoning.

In liver disease, of any type, *urobilinogen* occurs in the urine. Its detection is the basis of a specific test for *functional liver incapacity*.

EXPERIMENTS

1. **Ammoniacal-zinc Chloride Test.**—Render some of the urine ammoniacal by the addition of ammonium hydroxide, and after allowing it to stand a short time filter off the precipitate of phosphates and add a few drops of zinc chloride solution to the filtrate. Observe the production of a greenish fluorescence. Examine the fluid by means of the spectroscope and note the absorption band which occupies much the same position as the absorption band of urobilin in acid solution (see Absorption Spectra, Plate II).

2. **Ether-absolute Alcohol Test.**—Mix urine and pure ether in equal volumes and shake gently in a separatory funnel. Separate the ether extract, evaporate it to dryness, and dissolve the residue in 2-3 c.c. of absolute alcohol. Note the greenish fluorescence. Examine the solution spectroscopically and observe the characteristic absorption band (see Absorption Spectra, Plate II).

3. **Ring Test.**—Acidify 25 c.c. of urine with 2-3 drops of concentrated hydrochloric acid, add 5 c.c. of chloroform and shake the mixture. Separate the chloroform, place it in a test-tube, and add carefully 3-5 c.c. of an alcoholic solution of zinc acetate. Observe the formation of a green ring at the zone of contact of the two fluids. If the tube is shaken a fluorescence may be observed.

4. **Spectroscopic Examination.**—Acidify the urine with hydrochloric acid and allow it to remain exposed to the air for a few moments. By this means if any urobilinogen is present it will be transformed into urobilin. The urine may now be examined by means of the spectroscope. If urobilin is present in the fluid the characteristic absorption band lying between *b* and *F* will be observed (see Absorption Spectra, Plate II). It may be found necessary to dilute the urine with water before a distinct absorption band is observed. This test may be modified by acidifying 10 c.c. of urine with hydrochloric acid and shaking it gently with 5 c.c. of amyl alcohol. The alcoholic extract when examined spectroscopically will show the characteristic urobilin absorption band. (Note the spectroscopic examination in experiment (1) above.)

5. **Iodine Test (Gerhardt).**—To 20 c.c. of urine add 3-5 c.c. of chloroform and shake well. Separate the chloroform extract and add to it a few drops of iodine solution (I in KI). Render the mixture alkaline with dilute solution of potassium hydroxide and note the production of a yellow or yellowish-brown color. The solution ordinarily exhibits a greenish fluorescence.

6. Alcoholic-zinc Chloride Test (Wirring).—To 20 c.c. of urine add 3-5 c.c. of chloroform and shake gently. Separate the chloroform extract and add to it a drop of an alcoholic solution of zinc chloride. Note the rose-red color and the greenish fluorescence. If the solution is turbid it may be rendered clear by the addition of a few cubic centimeters of absolute alcohol.

C. UROERYTHRIN

This pigment is frequently present in small amount in normal urine. The red color of urinary sediments is due in great part to the presence of uroerythrin. It is easily soluble in amyl alcohol, slightly soluble in acetic ether, absolute alcohol, or chloroform, and nearly insoluble in water. Dilute solutions of uroerythrin are pink in color while concentrated solutions are orange red or bright red; none of its solutions fluoresce. Uroerythrin is increased in amount after strenuous physical exercise, digestive disturbances, fevers, certain liver disorders, and in various other pathological conditions.

PTOMAINES AND LEUCOMAINES

These toxic substances are said to be present in small amount in normal urine. Very little is known definitely, however, about them. It is claimed that five different poisons may be detected in the urine, and it is further stated that each of these substances produces a specific and definite symptom when injected intravenously into a rabbit. The resulting symptoms are narcosis, salivation, mydriasis, paralysis, and convulsions. The day urine is principally narcotic and is 2-4 times as toxic as the night urine which is chiefly productive of convulsions.

PURINE BASES

The purine bases found in human urine are adenine, carnine, epiguanine, episarkine, guanine, xanthine, heteroxanthine, hypoxanthine, paraxanthine, and 1-methylxanthine. The main bulk of the purine base content of the urine is made up of *paraxanthine*, *heteroxanthine* and *1-methylxanthine*, which are derived for the most part from the caffeine, theobromine, and theophylline of the food. The total purine base content is made up of the products of two distinct forms of metabolism, *i.e.*, metabolism of ingested nucleins and purines and metabolism of tissue nuclein material. Purine bases resulting from the first form of metabolism are said to be of *exogenous* origin, whereas those resulting from the second form of metabolism are said to be of *endogenous* origin. The daily output of purine bases by the urine is extremely small and varies greatly with the individual (16-60 mg.). The output is increased after the ingestion of nuclein material as well as after the increased de-

struction of leucocytes. A well-marked increase accompanies leukemia. Edsall and others have shown that the output of purine bases by the urine is increased as a result of X-ray treatment. The purine bases form a higher percentage of the total purine excretion in the case of the monkey, sheep and goat than in man.

EXPERIMENT

1. **Formation of the Silver Salts.**—Add an excess of magnesia mixture¹ to 25 c.c. of urine. Filter off the precipitate and add ammoniacal silver solution² to the filtrate. A precipitate composed of the silver salts of the various purine bases is produced. The purine bases may be determined quantitatively by means of Krüger and Schmidt's method (see page 537), or Welker's method (see page 539).

2. Inorganic Physiological Constituents

Ammonia

Next to urea, ammonia is the most important of the nitrogenous end-products of protein metabolism. Ordinarily about 2.5-4.5 per cent of the total nitrogen of the urine is eliminated as ammonia and on the average this would be about 0.7 gram per day. Under normal conditions the ammonia is present in the urine in the form of the *chloride, phosphate, or sulphate*. This is due to the fact that combinations of this sort are not oxidized in the organism to form urea, but are excreted as such. This explains the increase in the output as ammonia which follows the administration of the ammonium salts of the mineral acids or of the acids themselves. On the other hand, when ammonium acetate and many other ammonium salts of certain organic acids are administered no increase in the output of ammonia occurs since the salt is oxidized and its nitrogen ultimately appears in the urine as urea. Acid-forming foods (see page 603) also increase the ammonia output, whereas the administration of alkalis or of base-forming foods decreases the excretion of ammonia.

Experiments³ indicate that the nitrogen in food protein may in part be replaced by ammonium salts.

Copious water drinking increases the ammonia output. This fact has been interpreted as indicating a stimulation of the gastric secretion.⁴

¹ Magnesia mixture may be prepared as follows: Dissolve 175 grams of $MgSO_4$ and 350 grams of NH_4Cl in 1400 c.c. of distilled water. Add 700 grams of concentrated NH_4OH , mix very thoroughly and preserve the mixture in a glass-stoppered bottle.

² Ammoniacal silver solution may be prepared according to directions given on page 617.

³ Grafe and Schläpfer: *Zeit. physiol. chem.*, 77, 1, 1912, experiments by Abderhalden in same journal.

⁴ Wills and Hawk: *Jour. Am. Chem. Soc.*, 36, 158, 1914.

The acids formed during the process of protein destruction within the body have an influence upon the excretion of ammonia similar to that exerted by acids which have been administered. Therefore a pathological increase in the output of ammonia is observed in such diseases as are accompanied by an increased and imperfect protein metabolism, and especially in diabetes, in which disease acetoacetic acid and β -hydroxybutyric acid are found in the urine in combination with the ammonia.

Folin claims that a pronounced decrease in the extent of protein metabolism, as measured by the total nitrogen in the urine, is frequently accompanied by a decreased elimination of ammonia. The ammonia elimination is therefore probably determined by other factors than the total protein catabolism as such. Furthermore, he believes that a decided decrease in the total nitrogen excretion is always accompanied by a *relative increase* in the ammonia-nitrogen, provided the food is of a character yielding an alkaline ash.

The quantitative determination of ammonia must be made upon the fresh urine, since upon standing the normal urine will undergo ammoniacal fermentation (see page 390).

EXPERIMENTS

(See Experiment 2 under Phosphates, page 436.)

Sulphates

Sulphur in combination is excreted in two forms in the urine: first, as *unoxidized, loosely combined* or *neutral sulphur*, and second, as *oxidized* or *acid sulphur*. The *unoxidized* or *neutral sulphur* is excreted mainly as a constituent of such bodies as cystine, cysteine, taurine, hydrogen sulphide, ethyl sulphide, thiocyanates, sulphonic acids, oxyproteic acid, alloxypoteic acid, and uroferric acid. The amount of *neutral sulphur* eliminated is in great measure independent of the extent of protein decomposition or of the total sulphur excretion. In this characteristic it is somewhat similar to the excretion of creatinine. The *oxidized sulphur* is eliminated in the form of sulphuric acid, principally as salts of sodium, potassium, calcium, and magnesium; a relatively small amount occurs in the form of *ethereal sulphuric acid, i.e.*, sulphuric acid in combination with such *aromatic* bodies as phenol, indole, skatole, cresol, pyrocatechol, and hydroquinol. Sulphuric acid in combination with Na, K, Ca or Mg is sometimes termed *inorganic* or *preformed sulphuric acid*, whereas the ethereal sulphuric acid is sometimes called *conjugate sulphuric acid*. The greater part of the sulphur is eliminated in the

oxidized form, but the absolute percentage of sulphur excreted as the preformed, ethereal or loosely combined type depends upon the total quantity of sulphur present; *i.e.*, there is no definite ratio between the three forms of sulphur which will apply under all conditions. The preformed sulphuric acid may be precipitated directly from acidified urine with BaCl_2 , whereas the ethereal sulphuric acid must undergo a preliminary boiling in the presence of a mineral acid before it can be so precipitated.

The sulphuric acid excreted in the urine arises principally from the oxidation of protein material within the body; a relatively small amount is due to ingested sulphates. Under normal conditions about 2.5 grams of sulphuric acid (SO_3) are eliminated daily, about 75–95 per cent of this being in the form of sulphates. About 90 per cent of this sulphate excretion is in the form of *inorganic* sulphate and 10 per cent as *ethereal* sulphates. Since the sulphuric acid content of the urine has, for the most part, a protein origin and since one of the most important constituents of the protein molecule is nitrogen, it would be reasonable to suppose that a fairly definite ratio might exist between the excretion of these two elements. However, when we appreciate that the percentage content of N and S present in different proteins is subject to rather wide variations, the fixing of a ratio which will express the exact relation existing between these two elements as they appear in the urine as end-products of protein metabolism is practically impossible. It has been suggested that the ratio 5:1 expresses this relation in a general way.

Pathologically, the excretion of sulphuric acid by the urine is increased in acute fevers and in all other diseases marked by a stimulated metabolism, whereas a decrease in the sulphuric acid excretion is observed in those diseases which are accompanied by a loss of appetite and a diminished metabolic activity.

EXPERIMENTS

1. **Detection of Inorganic Sulphuric Acid.**—Place about 10 c.c. of urine in a test-tube, acidify with acetic acid and add some barium chloride solution. A white precipitate of barium sulphate forms.

2. **Detection of Ethereal Sulphuric Acid.**—Filter off the barium sulphate precipitate formed in the above experiment, add 1 c.c. of hydrochloric acid and a little barium chloride solution to the filtrate and heat the mixture to boiling for 1–2 minutes. Note the appearance of a turbidity due to the presence of sulphuric acid which has been separated from the ethereal sulphates and has combined with the barium of the BaCl_2 to form BaSO_4 .

3. **Detection of Unoxidized or Neutral Sulphur.**—Place about 10 c.c. of urine in a test-tube, introduce a small piece of zinc, add sufficient hydrochloric acid

to cause a gentle evolution of hydrogen, and over the mouth of the tube place a filter paper saturated with lead acetate solution. In a short time the portion of the paper in contact with the vapors within the test-tube becomes blackened due to the formation of lead sulphide. The nascent hydrogen has reacted with the loosely combined or neutral sulphur to form hydrogen sulphide, and this gas coming in contact with the lead acetate paper has caused the production of the black lead sulphide. Sulphur in the form of inorganic or ethereal sulphuric acid does not respond to this test.

4. Calcium Sulphate Crystals.—Place 10 c.c. of urine in a test-tube, add 10 drops of calcium chloride solution and allow the tube to stand until crystals form. Examine the calcium sulphate crystals under the microscope and compare them with those shown in Fig. 142.

Chlorides

Next to urea, the chlorides constitute the chief *solid* constituent of the urine. The principal chlorides found in the urine are those of sodium, potassium, ammonium, and magnesium, with sodium chloride predominating. The excretion of chloride is dependent, in great part, upon the nature of the diet, but on the average, the daily output is about 10–15 grams, expressed as sodium chloride. Copious water drinking increases the output of chlorides considerably. Because of their solubility, chlorides are never found in the urinary sediment.

Since the amount of chlorides excreted in the urine is due primarily to the chloride content of the food ingested, it follows that a decrease in the amount of ingested chloride will likewise cause a decrease in the chloride content of the urine. In cases of actual fasting the chloride content of the urine may be decreased to a *slight trace* which is derived from the body fluids and tissues. Under these conditions, however, an examination of the blood of the fasting subject will show the percentage of chlorides in this fluid to be approximately normal. This forms a very striking example of the care nature takes to maintain the normal composition of the blood. There is a limit to the power of the body to maintain this equilibrium, however, and if the fasting organism be subjected to the influence of diuretics for a time, a point is reached where the normal composition of the blood can no longer be maintained and a gradual decrease in its chloride content occurs which finally results in death. Death is supposed to result not so much because of a lack of chlorine as from a *deficiency of sodium*. This is shown from the fact that potassium chloride, for instance, cannot replace the sodium chloride



FIG. 142.—CALCIUM SULPHATE.
(Hensel and Weil.)

of the blood when the latter is decreased in the manner above stated. When this substitution is attempted the potassium salt is excreted at once in the urine, and death follows as above indicated.

Pathologically the excretion of chlorides may be decreased in some fevers, chronic nephritis, croupous pneumonia, diarrhoea, certain stomach disorders, and in acute articular rheumatism. Any condition accompanied by the formation of an exudate (*e.g.*, pneumonia) will cause a diminished chloride output. In convalescence and with resolution of the exudate the chloride excretion rises again.

EXPERIMENT

Detection of Chlorides in Urine.—Place about 5 c.c. of urine in a test-tube, render it acid with nitric acid and add a few drops of a solution of silver nitrate. A white precipitate, due to the formation of silver chloride, is produced. This precipitate is soluble in ammonium hydroxide.

Phosphates

Phosphoric acid exists in the urine in two general forms: First, that in combination with the alkali metals, sodium and potassium, and the radical ammonium; second, that in combination with the alkaline earth metals, calcium and magnesium. Phosphates formed through a union of phosphoric acid with the alkali metals are termed *alkaline phosphates*, or phosphates of the alkali metals, whereas phosphates formed through a union of phosphoric acid with the alkaline earth metals are termed *earthy phosphates* or phosphates of the alkaline earth metals.

Three series of salts are formed by phosphoric acid: *Normal*, M_3PO_4 ,¹ *mono-hydrogen*, M_2HPO_4 , and *di-hydrogen*, MH_2PO_4 . The di-hydrogen salts are acid in reaction, and it is claimed that about 60 per cent of the total phosphate content of the urine is in the form of this type of salt, and that the acidity of the urine is due in great part to the presence of *sodium di-hydrogen phosphate* (see page 389). Henderson² maintains that "determinations of hydrogen ionization in urine and its behavior toward indicators both support the view that in urine there exists a mixture of *mono-* and *di-hydrogen* phosphates of sodium, ammonium and other bases."

In bones the phosphates occur principally in the form of the normal salts of calcium and magnesium. The mono-hydrogen salts as a class are alkaline in reaction to litmus, and it is to the presence of di-sodium

¹ M may be occupied by any of the alkali metals or alkaline earth metals.

² Henderson: *Am. Jour. Physiol.*, 15, 257, 1906.

hydrogen phosphate, Na_2HPO_4 , that the greater part of the alkalinity of the saliva is due.

The excretion of phosphoric acid is extremely variable, but on the average the total output for 24 hours is about 2.5 grams, expressed as P_2O_5 . Ordinarily the total output is mainly in the form of phosphates and is distributed between alkaline phosphates and earthy phosphates approximately in the ratio 2:1. The organic phosphorus of the urine constitutes only 1-4 per cent of the total phosphorus content. The greater part of this phosphoric acid arises from the ingested food, either from the preformed phosphates or more especially from the phosphorus in organic combination such as we find it in *phospho-proteins*, *nucleo-proteins* and *lecithins*; the phosphorus-containing tissues of the body also contribute to the total output of this element. Alkaline phosphates ingested with the food have a tendency to increase the phosphoric acid content of the urine to a greater extent than the earthy phosphates so ingested. This is due, in a measure, to the fact that a portion of the earthy phosphates, under certain conditions, may be precipitated in the intestine and excreted in the feces; this is especially to be noted in the case of herbivorous animals. Since the extent to which the phosphates are absorbed in the intestine depends upon the form in which they are present in the food, under ordinary conditions, there can be no absolute relationship between the urinary output of nitrogen and phosphorus. If the diet is constant; however, from day to day, thus allowing of the preparation of both a nitrogen and a phosphorus balance,¹ a definite ratio may be established. In experiments upon dogs which were fed an exclusive meat diet, the ratio of nitrogen to phosphorus, in the urine and feces, was found to be 8.1:1.

It has been demonstrated by recent investigation that the ingestion of *inorganic* phosphorus compounds may give rise to *organic* phosphorus compounds such as lecithin, phosphatides, nucleoproteins and phosphoproteins. This is an instance of an organic substance synthesized from an inorganic substance. The experiments have been made principally on ducks² and hens.³

Pathologically the excretion of phosphoric acid is increased in such diseases of the bones as diffuse periostosis, osteomalacia, and rickets; according to some investigators, in the early stages of pulmonary tuberculosis, in acute yellow atrophy of the liver, in diseases which are accompanied by an extensive decomposition of nervous tissue, and after

¹ In metabolism experiments, a statement showing the relation existing between the nitrogen content of the food on the one hand and that of the urine and feces on the other, for a definite period, is termed a *nitrogen balance* or a "balance of the income and outgo of nitrogen" (see chapter on Metabolism, p. 615).

² Fingerling: *Biochem. Zeit.*, 38, 448, 1912.

³ McCollum and Halpin: *Jour. Biol. Chem.*, 11, 47 (Proceedings), 1912.

sleep induced by potassium bromide or chloral hydrate (Mendel). It is also increased after copious water drinking. A decrease in the excretion of phosphates is at times noted in febrile affections, such as the acute infectious diseases, in pregnancy, in the period during which the fetal bones are forming, and in diseases of the kidneys, because of non-elimination.

The so-called "phosphaturias" many times represent decreased acidity and not increased phosphate content of the urine. Such conditions are, however, significant as indicating a possible tendency to the formation of phosphatic calculi.

EXPERIMENTS

1. Formation of "Triple Phosphate."—Place some urine in a beaker, render it alkaline with ammonium hydroxide, add a small amount of magnesium sul-



FIG. 143.—"TRIPLE PHOSPHATE." (Ogden.)

phate solution and allow the beaker to stand in a cool place over night. Crystals of ammonium magnesium phosphate, "triple phosphate," form under these conditions. Examine the crystalline sediment under the microscope and compare the forms of the crystals with those shown in Fig. 143, above.

2. Ammoniacal Fermentation.—Stand some urine aside in a beaker for several days. Ammoniacal fermentation will develop and "triple phosphate" crystals will form.

(a) Examine the sediment under the microscope and compare the crystals with those shown in Fig. 143.

(b) Hold a glass rod dipped in concentrated hydrochloric acid near the surface of the urine. Note the fumes of ammonium chloride.

(c) Insert a strip of red litmus paper in the urine. Permit the paper to dry. Note the gradual restoration of red color, due to volatilization of ammonia (volatile alkali). Run a control test using 0.5 per cent Na_2CO_3 (fixed alkali).

3. Detection of Earthy Phosphates.—Place 10 c.c. of urine in a test-tube and render it alkaline with ammonium hydroxide. Warm the mixture and note the separation of a precipitate of earthy phosphates.

4. **Detection of Alkaline Phosphates.**—Filter off the earthy phosphates as formed in the last experiment, and add a small amount of magnesia mixture (see page 625) to the filtrate. Now warm the mixture and observe the formation of a white precipitate due to the presence of alkaline phosphates. Note the difference in the size of the precipitates of the two forms of phosphates from this same volume of urine. Which form of phosphates was present in the larger amount, earthy or alkaline?

5. **Influence upon Fehling's Solution.**—Place 2 c.c. of Fehling's solution in a test-tube, dilute it with 4 volumes of water and heat to boiling. Add a solution of sodium dihydrogen phosphate, NaH_2PO_4 , a small amount at a time, and heat after each addition. What do you observe? What does this observation force you to conclude regarding the interference of phosphates in the testing of diabetic urine by means of Fehling's test?

Sodium and Potassium

The elements sodium and potassium are always present in the urine. Usually they are combined with such acidic radicals as Cl^- , CO_3^{--} , SO_4^- and PO_4^- . The amount of potassium, expressed as K_2O , excreted in 24 hours by an adult, subsisting upon a mixed diet, is on the average 2-3 grams, whereas the amount of sodium, expressed as Na_2O , under the same conditions, is ordinarily 4-6 grams. The ratio of K to Na is generally about 3:5. The absolute quantity of these elements excreted depends, of course, in large measure upon the nature of the diet. Because of the non-ingestion of NaCl and the accompanying destruction of potassium-containing body tissues, the urine during fasting contains more potassium salts than sodium salts.

Pathologically the output of potassium, in its relation to sodium, may be increased during fever; following the crisis, however, the output of this element may be decreased. It may also be increased in conditions associated with acidosis.

Calcium and Magnesium

The greater part of the calcium and magnesium excreted in the urine is in the form of phosphates. The daily output of calcium, which depends principally upon the nature of the diet, aggregates on the average about 0.1-0.4 gram (expressed as CaO) per day. The percentage of calcium salts present in the urine at any one time (10-40 per cent of total calcium output) forms no dependable index as to the absorption of this class of salts, since they are again excreted into the intestine after absorption. It is therefore impossible to draw any satisfactory conclusions regarding the excretion of calcium unless we obtain accurate analytical data from both the feces and the urine.

Very little is known positively regarding the actual course of the excretion of the calcium under pathological conditions. An excess is found in some diseases of the bones, *e.g.*, osteomalacia. In others as in rickets the urinary excretion may be very low.

The daily excretion of *magnesium* by way of the urine usually amounts to between 0.1 and 0.3 gram, expressed as MgO. The amount depends mainly on the diet. About 50 per cent or more of the excreted magnesium is usually eliminated by the kidneys, the remainder passes out in the feces. There may be a retention of magnesium in certain bone disorders accompanying a loss of calcium; in osteomalacia for example. Thus the excretion of calcium and magnesium do not necessarily run parallel.

Carbonates

Carbonates generally occur in small amount in the urine of man and carnivora under normal conditions, whereas much larger quantities are ordinarily present in the urine of herbivora. The alkaline reaction of the urine of herbivora is dependable in great measure upon the presence of carbonates. In general a urine containing carbonates in appreciable amount is turbid when passed or becomes so shortly after. These bodies ordinarily occur as alkali or alkaline earth compounds and the turbid character of urine containing them is usually due principally to the latter class of substances. The carbonates of the alkaline earths are often found in amorphous urinary sediments.

Iron

Iron is present in small amount in normal urine. It probably occurs partly in inorganic and partly in organic combination. The iron contained in urinary pigments or chromogens is in organic combination. According to different investigators the iron content of normal urine will probably not average more than 1-5 mg. per day. After splenectomy there is an increased loss of iron from the body particularly by way of the feces (Asher).

EXPERIMENT

Detection of Iron in Urine.—Evaporate a convenient volume (10-15 c.c.) of urine to dryness. Incinerate and dissolve the residue in a few drops of iron-free hydrochloric acid and dilute the acid solution with 5 c.c. of water. Divide the acid solution into two parts and make the following tests: (a) To the first part add a solution of ammonium thiocyanate; a red color indicates the presence of iron. (b) To the second part of the solution add a little potassium ferrocyanide solution; a precipitate of Prussian blue forms upon standing.

Fluorides, Nitrates, Silicates and Hydrogen Peroxide

These substances are all found in traces in human urine under normal conditions. Nitrates are undoubtedly introduced into the organism in the water and ingested food. The average excretion of nitrates is about 0.5 gram per day, the output being the largest upon a vegetable diet and smallest upon a meat diet. Nitrites are found only in urine which is undergoing decomposition and are formed from nitrates in the course of ammoniacal fermentation. Hydrogen peroxide has been detected in the urine, but its presence is believed to possess no pathological importance.

CHAPTER XXIV

URINE: PATHOLOGICAL CONSTITUENTS¹

Glucose.

Proteins	{	Serum albumin. Serum globulin. Proteoses. Peptone. Nucleoprotein. Fibrin. Oxyhemoglobin.	{	Deutero-proteose. Hetero-proteose. "Bence-Jones' protein."
----------	---	--	---	--

Blood	{	Form elements. Pigment.
-------	---	----------------------------

Pus.

Bile.	{	Pigments. Acids.
-------	---	---------------------

Creatine.²

Acetone.

Acetoacetic acid

β -Hydroxybutyric acid.

Conjugate glycuronates.

Pentoses:

Fat.

Hematoporphyrin.

Lactose.

Galactose.

Fructose.

Arsenic.

Mercury.

Inositol.

Laiose.

Melanin.

Urorosein.

Nephrorosein.

Urochromogen.

Unknown substances.

¹ See note at the bottom of page 397.

² Normal constituent of urine of infants and children.

GLUCOSE

Traces of this sugar occur in normal urine, but the amount is not sufficient to be readily detected by the ordinary simple qualitative tests. There are two distinct types of *pathological glycosuria*, *i.e.*, transitory glycosuria and persistent glycosuria. The transitory type may follow the ingestion of an excess of sugar, causing the *assimilation limit* to be exceeded, or it may accompany any one of several disorders which cause impairment of the power of assimilating sugar. In the persistent type large amounts of sugar are excreted daily in the urine for long periods of time. Under such circumstances a condition known as diabetes mellitus exists. In this disorder the urine may contain 10 per cent of glucose and the average sugar content is 3-5 per cent. Ordinarily, diabetic urine which contains a high percentage of sugar possesses a faint yellow color, a high specific gravity, and a volume which is above normal. Over 100 grams of sugar are daily eliminated in some severe cases of diabetes mellitus.

EXPERIMENTS

The various tests for glucose in the urine which are embraced in the experiments given herewith are based upon one of the following properties of this sugar:

- (1) Its power to *reduce the oxides of certain metals in alkaline solution*.
- (2) Its power to *rotate the plane of polarized light*.
- (3) Its power to *form crystalline osazones with phenylhydrazine*.
- (4) Its ability to *ferment with ordinary yeast*.

1. **Phenylhydrazine Reaction.**—Test the urine according to one of the following methods: (a) To a small amount of phenylhydrazine mixture (enough to fill the rounded portion of a small test-tube), furnished by the instructor,¹ add 5 c.c. of the urine, shake well, and heat on a boiling water-bath for one-half to three-quarters of an hour. Allow the tube to cool slowly (not under the tap) and examine the crystals microscopically (Plate III, opposite page 22). If the solution has become too concentrated in the boiling process it will be light red in color and no crystals will separate until it is diluted with water.

In case doubtful results are obtained by this test owing to the presence of interfering substances, the urine should be clarified and the test repeated. To clarify the urine introduce 10 c.c. into a test-tube, add 1 gram of pure blood charcoal, heat to boiling and allow to stand with occasional shaking for five minutes. Use the filtrate in the test.

Yellow crystalline bodies called *osazones* are formed from certain sugars under these conditions, in general each individual sugar giving

¹ This mixture is prepared by combining two parts of phenylhydrazine-hydrochloride and three parts of sodium acetate, by *weight*. These are thoroughly mixed in a mortar.

rise to an osazone of a definite crystalline form which is typical for that sugar.

It is important to remember in this connection that, of the simple sugars of interest in physiological chemistry, glucose and fructose yield the same osazone, with phenylhydrazine. Each osazone has a definite melting-point, and as a further and more accurate means of identification it may be recrystallized and identified by the determination of its melting-point and nitrogen content. The reaction taking place in the formation of *phenylglucosazone* is as follows:

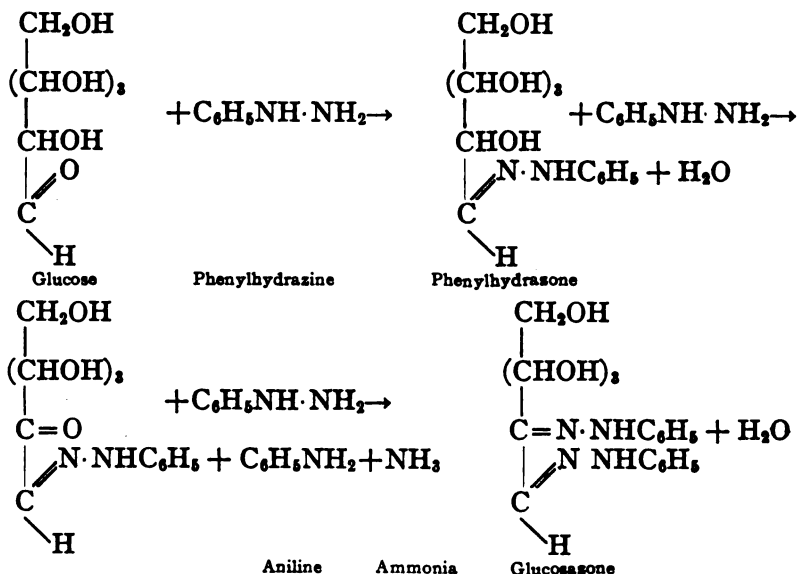

(b) Place 5 c.c. of the urine in a test-tube, add 1 c.c. of phenylhydrazine-acetate solution furnished by the instructor,¹ and heat on a boiling water-bath for one-half to three-quarters of an hour. Allow the liquid to cool slowly and examine the crystals microscopically (Plate III, opposite page 22).

The phenylhydrazine test has been so modified by Cipollina as to be of use as a *rapid clinical test*. The directions for this test are given in the next experiment.

2. **Cipollina's Test.**—Thoroughly mix 4 c.c. of urine, 5 drops of phenylhydrazine (the base) and 0.5 c.c. of glacial acetic acid in a test-tube. Heat the mixture for about one minute over a low flame, shaking the tube continually to prevent loss of fluid by bumping. Add 4–5 drops of potassium hydroxide or sodium hydroxide (sp. gr. 1.16), being certain that the fluid in the test-tube remains acid; heat the mixture again for a moment and then cool the contents of the tube. Ordinarily the crystals form at once, especially if the urine possesses a low specific gravity. If they do not appear immediately allow the tube to stand at least 20 minutes before deciding upon the absence of sugar.

¹ This solution is prepared by mixing one part by *volume*, in each case of glacial acetic acid, one part of water and two parts of phenylhydrazine (the base).

Examine the crystals under the microscope and compare them with those shown in Plate III, opposite page 22.

3. **Riegler's Reaction.**¹—Introduce 0.1 gram of phenylhydrazine-hydrochloride and 0.25 gram of sodium acetate into a test-tube, add 20 drops of the urine under examination, and heat the mixture to boiling. Now introduce 10 c.c. of a 3 per cent solution of potassium hydroxide and gently shake the tube and contents. If the urine under examination contains glucose the liquid in the tube will assume a red color. One per cent glucose yields an immediate color whereas 0.05 per cent yields the color only after the lapse of a period of one-half hour from the time the alkali is added. If the color appears after the 30-minute interval the color change is without significance inasmuch as sugar-free urines will respond thus. The reaction is given by all aldehydes and therefore the test cannot be safely employed in testing urines preserved by formaldehyde. Albumin does not interfere with the test.

4. **Bottu's Test.**²—To 8 c.c. of Bottu's reagent³ in a test-tube add 1 c.c. of the urine under examination and mix the liquids by gentle shaking. Now heat the upper portion of the mixture to boiling, add an additional 1 c.c. of urine and heat the mixture again immediately. The appearance of a blue color accompanied by the precipitation of small particles of indigo blue indicates the presence of glucose in the urine under examination. The test will serve to detect the presence of 0.1 per cent of glucose and is uninfluenced by creatinine or by ammonium salts.

5. **Reduction Tests.**—To their aldehyde or ketone structure, many sugars owe the property of readily reducing the alkaline solutions of the oxides of metals like copper, bismuth, and mercury; they also possess the property of reducing ammoniacal silver solutions with the separation of metallic silver. Upon this property of reduction the most widely used tests for sugars are based. When whitish-blue cupric hydroxide in suspension in an alkaline liquid is heated it is converted into insoluble black cupric oxide, but if a reducing agent like certain sugars be present the cupric hydroxide is reduced to insoluble yellow or red cuprous oxide. These changes are indicated as follows:

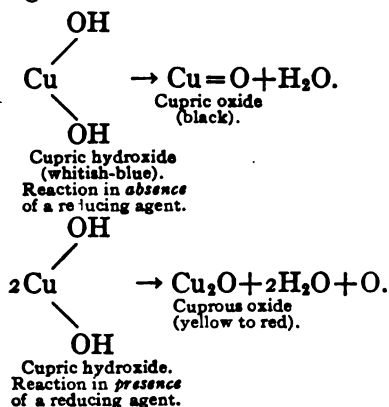

¹ Riegler: *Compt. rend. soc. biol.*, 66, p. 795.

² Bottu: *Compt. rend. soc. biol.*, 66, p. 972.

³ This reagent contains 3.5 grams of *o*-nitrophenylpropionic acid and 5 c.c. of a freshly prepared 10 per cent solution of sodium hydroxide per liter.

The chemical equations here discussed are exemplified in Trommer's and Fehling's tests.

(a) *Trommer's Test*.—To 5 c.c. of urine in a test-tube add one-half its volume of KOH or NaOH. Mix thoroughly and add, drop by drop, agitating after the addition of each drop, a *very dilute* solution of copper sulphate. Continue the addition until there is a slight permanent precipitate of cupric hydroxide and in consequence the solution is slightly turbid. Heat, and the cupric hydroxide is reduced to yellow or brownish-red cuprous oxide.

If the solution of copper sulphate used is too strong, a small brownish-red precipitate, produced in the presence of a low percentage of glucose, may be entirely masked. On the other hand, if too little copper sulphate is used, a light-colored precipitate, formed by uric acid and purine bases, may obscure the brownish-red precipitate of cuprous oxide. The action of KOH or NaOH in the presence of an excess of sugar and insufficient copper will produce a brownish color. Phosphates of the alkaline earths may also be precipitated in the alkaline solution and be mistaken for cuprous oxide. Trommer's test is not very satisfactory.

Salkowski¹ has proposed a modification of the Trommer procedure which he claims is a very accurate sugar test.

(b) *Fehling's Test*.—To about 1 c.c. of Fehling's solution² in a test-tube add about 4 c.c. of water, and boil.³ [The cupric hydroxide is held in solution by the sodium potassium tartrate (Rochelle salt).] This is done to determine whether the solution will of itself cause the formation of a precipitate of brownish-red cuprous oxide. If such a precipitate forms, the Fehling's solution must not be used. Add urine⁴ to the hot Fehling's solution, a few drops at a time, and heat the mixture to boiling after each addition (never add more urine than the original volume of Fehling's solution). The production of yellow or brownish-red cuprous oxide indicates that reduction has taken place. The yellow precipitate is more likely to occur if the urine is added rapidly and in large amount, whereas with a less rapid addition of smaller amounts of urine the brownish-red precipitate is generally formed. The differences in color of the cuprous oxide precipitates under different conditions are apparently due to differences in the size of the particles, the more finely divided precipitates having a yellow color, while the coarser ones are red. In the presence of protective colloidal substances the yellow precipitate is usually formed.⁵

This is a much more satisfactory test than Trommer's, but even this test is not entirely reliable when used to detect sugar in the urine.

¹ Salkowski: *Zeit. physiol. Chem.*, 79, 164, 1912.

² Fehling's solution is composed of two definite solutions—a copper sulphate solution and an alkaline tartate solution, which may be prepared as follows:

Copper sulphate solution = 34.65 grams of copper sulphate dissolved in water and made up to 500 c.c.

Alkaline tartrate solution = 125 grams of potassium hydroxide and 173 grams of Rochelle salt dissolved in water and made up to 500 c.c.

These solutions should be preserved separately in rubber-stoppered bottles and mixed in equal volumes when needed for use. This is done to prevent deterioration.

³ More dilute Fehling's solution should be used in testing urines containing small amounts of sugar. In case of urines containing a high concentration of sugar it may sometimes be desirable to use a larger volume of Fehling's solution.

⁴ In case doubtful results are obtained by this test owing to the presence of interfering substances the urine should be clarified and the test repeated. To clarify the urine introduce 10 c.c. into a test-tube, add 1 gram of pure blood charcoal, heat to boiling and allow to stand with occasional shaking for five minutes. Use the filtrate in the test.

⁵ Fischer and Hooker: *Science*, N. S. XLV, 505, 1917.

Such bodies as *conjugate glycuronates*, *uric acid*, *nucleoprotein*, and *homogentisic acid*, when present in sufficient amount, may produce a result similar to that produced by sugar. *Phosphates of the alkaline earths* may be precipitated by the alkali of the Fehling's solution and in appearance may be mistaken for the cuprous oxide. Cupric hydroxide may also be reduced to cuprous oxide and this in turn be dissolved by *creatinine*, a normal urinary constituent. This will give the urine under examination a greenish tinge and may obscure the sugar reaction even when a considerable amount of sugar is present. According to Laird¹ even small amounts of creatinine will *retard the reaction velocity* of reducing sugars with Fehling's solution.

Conjugate glycuronates are formed after the ingestion of such substances as chloral hydrate, camphor, menthol, thymol, antipyrin, phenol, etc. The chloral hydrate is excreted in the urine as *trichloroethylglycuronic acid*, $C_2Cl_3H_2.C_6H_9O_7$. This compound reduces Fehling's solution and is *levorotatory*, whereas glucose also reduces but is *dextrorotatory*. Therefore by means of a polariscopic test we may differentiate between a "chloral urine" and a "sugar urine."

In testing urine preserved by *chloroform* a positive test may be obtained in the absence of sugar. This is due to the fact that the hot alkali produces *formic acid* (a reducing fatty acid) from the chloroform.

Ammonium salts also interfere with Fehling's test. If present in excess the urine should be made alkaline and boiled in order to decompose the ammonium salts.

(c) **Benedict's Modifications of Fehling's Test.—First Modification.**—To 2 c.c. of Benedict's solution² in a test-tube add 6 c.c. of distilled water and 7-9 drops (not more) of the urine under examination. Boil the mixture vigorously for about 15-30 seconds and permit it to cool to room temperature spontaneously. (If desired this process may be repeated, although it is ordinarily unnecessary.) If sugar is present in the solution a precipitate will form which is often bluish-green or green at first, especially if the percentage of sugar is low, and which usually becomes yellowish upon standing. If the sugar present exceeds 0.06 per cent this precipitate generally forms at or below the boiling-point, whereas if less than 0.06 per cent of sugar is present the precipitate forms more slowly and generally only after the solution has cooled. The greenish precipitate obtained with urines containing small amounts of sugar may be a compound of copper with the sugar or a compound of some constituent of the urine with reduced copper

¹ Laird: *Journ. Path. and Bact.*, 16, 398, 1912.

² Benedict's modified Fehling's solution consists of two definite solutions—a copper sulphate solution and an alkaline tartrate solution, which may be prepared as follows:

Copper sulphate solution = 34.65 grams of copper sulphate dissolved in water and made up to 500 c.c.

Alkaline tartrate solution = 100 grams of anhydrous sodium carbonate and 173 grams of Rochelle salt dissolved in water and made up to 500 c.c.

These solutions should be preserved separately in rubber-stoppered bottles and mixed in equal volumes when needed for use. This is done to prevent deterioration.

oxide instead of being a precipitate of cuprous hydroxide or oxide as is the case when the original Fehling solution is reduced.

Benedict claims that, whereas the original Fehling's test will not serve to detect sugar when present in a concentration of less than 0.1 per cent, that the above modification will serve to detect sugar when present in as small quantity as 0.015-0.02 per cent. This claim has been corroborated by Harrison.¹ The modified solution used in the above test differs from the original in that 100 grams of sodium carbonate is substituted for the 125 grams of potassium hydroxide ordinarily used, thus forming a Fehling solution which is considerably *less alkaline* than the original. This alteration in the composition of the Fehling solution is of advantage in the detection of sugar in the urine inasmuch as the strong alkalinity of the ordinary Fehling solution has a tendency, when the reagent is boiled with a urine containing a small amount of glucose, to decompose sufficient of the sugar to render the detection of the remaining portion exceedingly difficult by the usual technic. Benedict claims that for this reason the use of his modified solution permits the detection of smaller amounts of sugar than does the use of the ordinary Fehling solution.

Second Modification.²—Benedict has further modified his solution and has succeeded in obtaining one which does not deteriorate upon long standing.³ The following is the procedure for the detection of glucose in the urine: To 5 c.c. of the reagent in a test-tube add 8 (not more) drops of the urine to be examined. The fluid is then boiled vigorously for from one to two minutes and then allowed to cool spontaneously. In the presence of glucose the entire body of the solution will be filled with a precipitate, which may be red, yellow, or green in color, depending upon the amount of sugar present. If no glucose is present, the solution will either remain perfectly clear, or will show a very faint turbidity, due to precipitated urates.

Even very small quantities of glucose in urine (0.1 per cent) yield precipitates of surprising bulk with this reagent, and the positive reaction for glucose is the filling of the entire body of the solution with a precipitate, so that the solution becomes opaque. Since *amount*

¹ Harrison: *Pharm. Jour.*, 87, 746, 1911.

² Benedict: *Jour. Am. Med. Ass'n*, 57, 1193, 1911.

³ Benedict's new solution has the following composition:

Copper sulphate.....	17.3 gm.
Sodium citrate.....	173.0 gm.
Sodium carbonate (anhydrous).....	100.0 gm.
Distilled water to.....	1000.0 c.c.

With the aid of heat dissolve the sodium citrate and carbonate in about 600 c.c. of water. Pour (through a folded filter if necessary) into a glass graduate and make up to 850 c.c. Dissolve the copper sulphate in about 100 c.c. of water and make up to 150 c.c. Pour the carbonate-citrate solution into a large beaker or casserole and add the copper sulphate solution slowly, with constant stirring. The mixed solution is ready for use, and does not deteriorate upon long standing.

rather than color of the precipitate is made the basis of this test, it may be applied, even for the detection of small quantities of glucose, as readily in artificial light as in daylight. Chloroform does not interfere with this test nor do uric acid or creatinine interfere to such an extent as in the case of Fehling's test.

(d) **Haines' Test.**—This is a copper reduction test similar in many respects to the Fehling and Benedict reactions. In Haines' solution¹ the cupric hydroxide is held in solution by glycerol instead of Rochelle salt as in Fehling's solution.

Perform the test as follows: Introduce about 5 c.c. of Haines' solution¹ into a test-tube and heat to boiling. If no reduction occurs add 6–8 drops of the urine and again bring to a boil. If glucose is present an abundant yellow (cuprous hydroxide) or brownish-red (cuprous oxide) precipitate is thrown down. This test is about as delicate as Fehling's test.

(e) **Allen's Modification of Fehling's Test.**—The following procedure is recommended: "From 7 to 8 c.c. of the sample of urine to be tested is heated to boiling in a test-tube, and, without separating any precipitate of albumin which may be produced, 5 c.c. of the solution of copper sulphate used for preparing Fehling's solution is added. This produces a precipitate containing uric acid, xanthine, hypoxanthine, phosphates, etc. To render the precipitation complete, however, it is desirable to add to the liquid, *when partially cooled*, from 1 to 2 c.c. of a saturated solution of sodium acetate having a feebly acid reaction to litmus.² The liquid is filtered and to the filtrate, which will have a bluish-green color, 5 c.c. of the alkaline tartrate mixture used for preparing Fehling's solution is added, and the liquid boiled for 15–20 seconds. In the presence of more than 0.25 per cent of sugar, separation of cuprous oxide occurs before the boiling-point is reached; but with smaller quantities precipitation takes place during the cooling of the solution, which becomes greenish, opaque, and suddenly deposits cuprous oxide as a fine brownish-red precipitate."

Mercuric Oxide Reduction Test (Cramer).³—This test depends on the reduction of mercuric oxide in a weakly alkaline solution with the formation of metallic mercury. The degree of alkalinity is an important factor, as the test becomes more sensitive but less specific the greater the alkalinity of the reagent.

Apply the test as follows:

Introduce 3 c.c. of Cramer's "2.5 standard reagent"⁴ into a test-tube and heat to boiling. The reagent remains clear but becomes slightly yellow. Add 3 c.c. of urine and heat the mixture to boiling. Remove the tube from the flame, and

¹ Haines solution may be prepared by dissolving 8.314 grams of copper sulphate in 400 c.c. of water adding 40 c.c. of glycerol and 500 c.c. of 5 per cent potassium hydroxide solution.

² Sufficient acetic acid should be added to the sodium acetate solution to render it feebly acid to litmus. A saturated solution of sodium acetate keeps well, but weaker solutions are apt to become mouldy, and then possess the power of reducing Fehling's solution. Hence it is essential in all cases of importance to make a blank test by mixing equal measures of copper sulphate solution, alkaline tartrate solution and water, adding a little sodium acetate solution, and heating the mixture to boiling.

³ Cramer: *Bioch. Jour.*, 9, 156, 1915.

⁴ See Chapter II, page 28.

after 30 seconds acidify with a few drops of acetic acid. Hold the tube over ordinary print. If the urine is normal, a slight but distinct turbidity remains but the print is clearly readable. If sugar is present in the urine above the normal concentration, the contents of the tube darken and on standing a finely divided precipitate of mercury settles to the bottom of the tube. The amount of the precipitate depends upon the concentration of reducing sugar in the urine.

It is claimed that this test is free from fallacies inherent in Fehling's test as the result of the reducing action of uric acid and creatinine. The test is said to be more sensitive than Fehling's test or the bismuth reduction tests, and is particularly suitable for the examination of urines in which the amount of sugar present exceeds the normal amount only slightly.

If the reagent be made more alkaline than indicated, it ceases to be specific for reducing sugars.

(f) **Bismuth Reduction Test (Boettger).**—To 5 c.c. of urine in a test-tube add 1 c.c. of KOH or NaOH and a very small amount of bismuth subnitrate, and boil. The solution will gradually darken and finally assume a black color due to reduced bismuth. If the test is made with urine containing albumin this must be removed, by boiling and filtering, before applying the test, since with albumin a similar change of color is produced (bismuth sulphide).

(g) **Bismuth Reduction Test (Nylander).**—To 5 c.c. of urine in a test-tube add one-tenth its volume of Nylander's reagent¹ and heat for five minutes in a boiling water-bath.² The mixture will darken if reducing sugar is present and upon standing for a few moments a black color will appear.

This color is due to the precipitation of bismuth. If the test is made on urine containing albumin this must be removed, by boiling and filtering, before applying the test, since with albumin a similar change of color is produced. Glucose when present to the extent of 0.08 per cent may be easily detected by this reaction (Rabe³ claims that 0.01 per cent may be so detected). Uric acid and creatinine which interfere with the Fehling test do not interfere with the Nylander's reaction. It is claimed by Bechold that the bismuth reduction tests give a negative reaction with solutions containing sugar when mercuric chloride or chloroform is present. Other observers⁴ have failed to verify the inhibitory action of the mercuric chloride and have shown that the inhibitory influence of chloroform may be overcome by raising

¹ Nylander's reagent is prepared by digesting 2 grams of bismuth subnitrate and 4 grams of Rochelle salt in 100 c.c. of a 10 per cent potassium hydroxide solution. The reagent is then cooled and filtered.

² Hammarsten suggests that the solution be boiled for 2-5 minutes (according to the sugar content) over a free flame and the tube then permitted to stand five minutes before drawing conclusions.

³ Rabe: *Apoth. Ztg.*, 29, 554, 1914.

⁴ Rehfuss and Hawk: *Jour. Biol. Chem.*, 7, 267, 1910; also Zeidlitz: *Uppsala Lakäroforen Forh.*, N. F., 11, 1906.

the temperature of the urine to the boiling-point for a period of five minutes previous to making the test.

Urines rich in *indican*, *uroerythrin*, *urochrome* or *hematoporphyrin*, as well as urines excreted after the ingestion of large amounts of certain *medicinal substances*, may give a darkening of the Nylander's reagent similar to that of a true sugar reaction. It is a disputed point whether the urine after the administration of urotropin will reduce the Nylander reagent.¹

Strausz² has recently shown that the urine of diabetics to whom "Iothion" (diiodohydroxypropane) has been administered will give a negative Nylander's reaction and respond positively to the Fehling and polarization tests. "Iothion" also interferes with the Nylander test *in vitro* whereas KI and I do not.

According to Rustin and Otto the addition of PtCl₄ increases the delicacy of Nylander's reaction. They claim that this procedure causes the sugar to be converted *quantitatively*. No quantitative method has yet been devised, however, based upon this principle.

A positive bismuth reduction test is probably due to the following reactions:

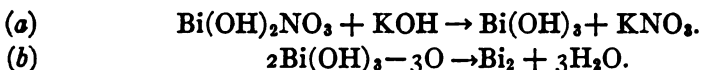

Bohmansson,³ before testing the urine under examination treats it (10 c.c.) with $\frac{1}{5}$ volume of 25 per cent hydrochloric acid and $\frac{1}{2}$ volume of boneblack. This mixture is shaken one minute, then filtered, and the neutralized filtrate tested by Nylander's reaction. Bohmansson claims that this procedure removes certain interfering substances, notably urochrome.

6. Fermentation Test.—Rub up in a mortar about 15 c.c. of the urine with a small piece of compressed yeast. Transfer the mixture to a saccharometer (Fig. 5, page 31) and stand it aside in a warm place for about 12 hours. If glucose is present, alcoholic fermentation will occur and carbon dioxide will collect as a gas in the upper portion of the tube. On the completion of fermentation, introduce, by means of a bent pipette, a little KOH solution into the graduated portion, place the thumb tightly over the opening in the apparatus and invert the saccharometer. Remembering that KOH has the power to absorb CO₂, how do you explain the result?⁴

7. Polariscopic Examination.—For directions as to the use of the polariscope see Chapter II.

¹ Abt: *Archives of Pediatrics*, 24, 275, 1907; also Weitbrecht: *Schweiz. Woch.*, 47, 577, 1909.

² Strausz: *Munch. med. Woch.*, 59, 85, 1912.

³ Bohmansson: *Biochem. Zeit.*, 19, p. 281.

⁴ The findings of Neuberg and associates indicate that the liberation of carbon dioxide by yeast is not necessarily a criterion of the presence of sugar. The presence of an enzyme called carboxylase has been demonstrated in yeast which has the power of splitting off CO₂ from the carboxyl group of amino- and other aliphatic acids.

PROTEINS

Normal urine contains a trace of protein material, but the amount present is so slight as to escape detection by any of the simple tests in general use for the detection of protein urinary constituents. The following are the more important forms of protein material which have been detected in the urine under pathological conditions:

- (1) Serum albumin.
- (2) Serum globulin.
- (3) Proteoses

{	Deutero-proteose.
{	Hetero-proteose.
{	"Bence-Jones' protein."
- (4) Peptone.
- (5) Nucleoprotein.
- (6) Fibrin.
- (7) Oxyhemoglobin.

ALBUMIN

Normal urine contains a trace of albumin which is too slight to be detected by the usual procedures.

Albuminuria is a condition in which serum albumin or serum globulin appears in the urine. There are two distinct forms of albuminuria, *i.e.*, *renal* albuminuria and *accidental* albuminuria. Sometimes the terms "true" albuminuria and "false" albuminuria are substituted for those just given. In the renal type the albumin is excreted by the kidneys. This is the more serious form of the malady and at the same time is more frequently encountered than the accidental type. Among the causes of renal albuminuria are altered blood pressure in the kidneys, altered kidney structure, or changes in the composition of the blood entering the kidneys, thus allowing the albumin to diffuse more readily. In the accidental form of albuminuria the albumin is *not* excreted by the kidneys as is the case in the renal form of the disorder, but arises from the blood, lymph, or some albumin-containing exudate coming into contact with the urine at some point below the kidneys. It has been suggested¹ that albuminurias may be classed as *pre-renal*, *renal* and *post-renal*. The pre-renal type is illustrated by the albuminuria of heart disease, whereas the post-renal form corresponds to what we have called "accidental" albuminuria.

The determination of albumin may be of assistance in following the course of kidney disturbances, but the results can only be interpreted in the light of other clinical findings.

¹ Bruce: *Lancet*, May 6, 1911, p 1205.

EXPERIMENTS

(The urine should be filtered before performing these tests.)

Nitric Acid Ring Test (Heller).—Place 5 c.c. of concentrated HNO_3 in a test-tube, incline the tube, and by means of a pipette allow the urine to flow slowly down the side. The liquids should stratify with the formation of a white zone of precipitated albumin at the point of juncture.

If the albumin is present in very small amount the white zone may not form until the tube has been allowed to stand for several minutes. If the urine is quite concentrated a white zone, due to uric acid or urates, will form upon treatment with nitric acid as indicated. This ring may be easily differentiated from the albumin ring by repeating the test after diluting the urine with 3 or 4 volumes of water, whereupon the ring, if due to uric acid or urates, will not appear. It is ordinarily possible to differentiate between the albumin ring and the uric acid ring without diluting the urine, since the ring, when due to uric acid, has ordinarily a less sharply defined upper border, is generally broader than the albumin ring and frequently is situated in the urine *above* the point of contact with the nitric acid. Concentrated urines also occasionally exhibit the formation, at the point of contact, of a *crystalline* ring with very sharply defined borders. This is urea nitrate and is easily distinguished from the “fluffy” ring of albumin. If there is any difficulty in differentiation a simple dilution of the urine with water, as above described, will remove the difficulty. Various colored zones, due either to the presence of indican, bile pigments, or to the oxidation of other organic urinary constituents, may form in this test under certain conditions. These colored rings should never be confounded with the *white* ring which alone denotes the presence of albumin.

After the administration of certain drugs a white precipitate of *resin acids* may form at the point of contact of the two fluids and may cause the observer to draw wrong conclusions. This ring, if composed of resin acids, will dissolve in alcohol, whereas the albumin ring will not dissolve in this solvent.

Weinberger has shown that a ring closely resembling the albumin ring is often obtained in urines preserved for a considerable time by thymol when subjected to the nitric acid test. The ring is due to the formation of nitrosothymol and possibly nitrothymol. If the thymol is removed from the urine by extraction with petroleum ether¹ previous to adding nitric acid, the ring does not form.

An instrument called the *albumoscope* (*horismascope*) has been de-

¹ Accomplished readily by gently agitating equal volumes of petroleum ether and the urine under examination for *two minutes* in a test-tube before applying the test.

vised for use in this test and has met with considerable favor. The method of using the albumoscope is described below.

Use of the Albumoscope.—This instrument is intended to facilitate the making of “ring” tests such as Heller’s and Roberts’. In making a test about 5 c.c. of the solution under examination is first introduced into the apparatus through the larger arm (see Fig. 144), and the reagent used in the particular test is then introduced through the capillary arm and allowed to flow down underneath the solution under examination. If a reasonable amount of care is taken there is no possibility of mixing the two solutions and a definitely defined white “ring” is easily obtained at the zone of contact.

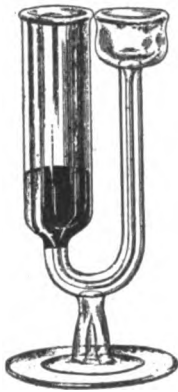

FIG. 144.—ALBUMOSCOPE.

2. **Nitric Acid and Magnesium Sulphate Ring Test (Roberts).**—Place 5 c.c. of Roberts’ reagent¹ in a test-tube, incline the tube, and by means of a pipette allow the urine to flow slowly down the side. The liquids should stratify with the formation of a white zone of precipitated albumin at the point of juncture.

This test is a modification of Heller’s ring test and is rather more satisfactory than that test, since the colored rings never form and the consequent confusion is avoided. The *albumoscope* (see above) may also be used in making this test.

3. **Spiegler’s Ring Test.**—Place 5 c.c. of Spiegler’s reagent² in a test-tube, incline the tube and, by means of a pipette, allow 5 c.c. of urine, acidified with acetic acid, to flow *slowly* down the side. A white zone will form at the point of contact. This is an exceedingly delicate test, in fact too delicate for ordinary clinical purposes, since it serves to detect albumin when present in the merest trace (1:250,000) and hence most normal urines will give a positive reaction for albumin when this test is applied. Proteose and peptone are also said to respond to this test.

4. **Coagulation or Boiling Test.**—(a) Heat 5 c.c. of urine to boiling in a test-tube. (If the urine is not clear it should be filtered.) A precipitate forming at this point is due either to albumin or to phosphates. Acidify the urine slightly by the addition of 3–5 drops of very dilute acetic acid, adding the acid drop by drop to the hot solution. If the precipitate is due to phosphates it will disappear under these conditions, whereas if it is due to albumin it will not only fail to disappear but will become more flocculent in character, since the reaction of a

¹ Roberts’ reagent is composed of 1 volume of concentrated HNO₃ and 5 volumes of a saturated solution of MgSO₄.

² Spiegler’s reagent has the following composition:

Tartaric acid.....	20 grams.
Mercuric chloride.....	40 grams.
Sodium chloride.....	50 grams.
Glycerol.....	100 grams.
Distilled water.....	1000 grams.

fluid must be acid to secure the complete precipitation of the albumin by this coagulation process.

Too much acid should be avoided since it will cause the albumin to go into solution. Certain *resin acids* may be precipitated by the acid, but the precipitate due to this cause may be easily differentiated from the albumin precipitate by reason of its solubility in alcohol.

(b) A modification of this test in quite general use is as follows: Fill a test-tube two-thirds full of urine and gently heat the upper half of the fluid to boiling, being careful that this fluid does not mix with the lower half. A turbidity indicates albumin or phosphates. Acidify the urine slightly by the addition of 3-5 drops of dilute acetic acid, when the turbidity, if due to phosphates, will disappear.

Nitric acid is often used in place of acetic acid in these tests. In case nitric acid is used ordinarily 1-2 drops is sufficient.

5. Acetic Acid and Potassium Ferrocyanide Test.—To 5 c.c. of urine in a test-tube add 5-10 drops of acetic acid. Mix well and add potassium ferrocyanide drop by drop, until a precipitate forms.

This is a very delicate test. Schmiedl claims that a precipitate of $\text{Fe}(\text{CN})_6\text{K}_3\text{Zn}$ or $\text{Fe}(\text{CN})_6\text{Zn}_2$ is formed when urines containing zinc are subjected to this test and that this precipitate resembles the precipitate secured with protein solutions. In the case of human urine a reaction was obtained when 0.000022 gram of zinc per cubic centimeter was present. Schmiedl further found that the urine collected from rabbits housed in zinc-lined cages possessed a zinc content which was sufficient to yield a ready response to the test.

Proteoses may also be detected by this test. To differentiate albumin from proteose perform the coagulation test (see page 452).

6. Tanret's Test.—To 5 c.c. of urine in a test-tube add Tanret's reagent¹ drop by drop until a turbidity or precipitate forms. This is an exceedingly delicate test. Sometimes the urine is stratified upon the reagent as in Heller's or Roberts' ring test. According to Repton, urates interfere with the delicacy of this test. Tanret, however, claims that urates do not interfere inasmuch as any precipitate due to urates may be brought into solution by heat, whereas an albumin precipitate under the same conditions will persist. Tanret further states that *mucin* interferes with the delicacy of the test and that it should therefore be removed from the urine under examination by acidification with acetic acid and filtration before testing for albumin. This test also serves to detect proteoses.

7. Sodium Chloride and Acetic Acid Test.—Mix two volumes of urine and one volume of a saturated solution of sodium chloride in a test-tube, acidify with acetic acid, and heat to boiling. The production of a cloudiness or the formation of a precipitate indicates the presence of albumin. The resin acids may interfere here

¹ Tanret's reagent is prepared as follows: Dissolve 1.35 grams of mercuric chloride in 25 c.c. of water, add to this solution 3.32 grams of potassium iodide dissolved in 25 c.c. of water, then make the total solution up to 60 c.c. with water and add 20 c.c. of glacial acetic acid to the mixture.

as in the ordinary coagulation test (page 452), but they may be easily differentiated from albumin by means of their solubility in alcohol.

GLOBULIN

Serum globulin is not a constituent of normal urine but frequently occurs in the urine under pathological conditions and is ordinarily associated with serum albumin. In albuminuria globulin in varying amounts often accompanies the albumin, and the clinical significance of the two is very similar. Under certain conditions globulin may occur in the urine unaccompanied by albumin.

EXPERIMENTS

Globulin will respond to all the tests just outlined under Albumin. If it is desirable to differentiate between albumin and globulin in any urine the following processes may be employed:

1. **Saturation with Magnesium Sulphate.**—Place 25 c.c. of neutral urine in a small beaker and add pulverized magnesium sulphate in substance to the point of saturation. If the protein present is globulin it will precipitate at this point. If no precipitate is produced acidify the saturated solution with acetic acid and warm gently. Albumin will be precipitated if present.

The above procedure may be used to separate globulin and albumin if present in the same urine. To do this filter off the globulin after it has been precipitated by the magnesium sulphate, then acidify the clear solution and warm gently as directed. Note the formation of the albumin precipitate.

2. **Half-saturation with Ammonium Sulphate.**—Place 25 c.c. of neutral urine in a small beaker and add an equal volume of a saturated solution of ammonium sulphate. Globulin, if present, will be precipitated. If no precipitate forms add ammonium sulphate *in substance* to the point of saturation. If albumin is present it will be precipitated upon saturation of the solution as just indicated. This method may also be used to separate globulin and albumin when they occur in the same urine.

Frequently in urine which contains a large amount of urates a precipitate of ammonium urate may occur when the ammonium sulphate solution is added to the urine. This urate precipitate should not be confounded with the precipitate due to globulin. The two precipitates may be differentiated by means of the fact that the urate precipitate ordinarily appears only after the lapse of several minutes whereas the globulin generally precipitates at once.

PROTEOSE AND PEPTONE

Proteoses, particularly deutero-proteose and hetero-proteose, have frequently been found in the urine under various pathological conditions, such as diphtheria, pneumonia, intestinal ulcer, carcinoma,

dermatitis, osteomalacia, atrophy of the kidneys, and in sarcomata of the bones of the trunk. The presence of proteose in the urine may frequently be demonstrated in any pathological condition in which there is absorption of partially digested pus. "Bence-Jones' protein," a proteose-like substance, is of interest in this connection and its appearance in the urine is believed to be of great diagnostic importance in cases of multiple myeloma or myelogenic osteosarcoma. By some investigators this protein is held to be a variety of hetero-proteose, whereas others claim that it possesses albumin characteristics. The origin of "Bence-Jones' protein" is unknown. Its origin has at various times been ascribed to the blood proteins, the bones or to abnormal metabolism of protein material in the body. It occurs in the urine in about 80 per cent of the cases of multiple myeloma. If its presence is unaccompanied by multiple myeloma it is nearly always associated with some disease of the blood-forming organs or of the bones. When "Bence-Jones' protein" is hydrolyzed it is found to contain all the amino-acids which are characteristic of typical proteins.

Peptone certainly occurs much less frequently as a constituent of the urine than does proteose, in fact most investigators seriously question its presence under any conditions. There are many instances of peptonuria cited in the early literature, but because of the uncertainty in the conception of what really constituted a peptone it is probable that in many cases of so-called peptonuria the protein present was really proteose.

EXPERIMENTS

1. **Phosphotungstic Precipitation Test (v. Aldor).**—Acidify 10 c.c. of urine with hydrochloric acid, add phosphotungstic acid until no more precipitate forms and centrifugate¹ the solution. Decant the supernatant fluid, add some absolute alcohol to the precipitate, and centrifugate again. This washing with alcohol is intended to remove the urobilin and hence should be continued so long as the alcohol exhibits any coloration whatever. Now suspend the precipitate in water and add potassium hydroxide to bring it into solution. At this point the solution may be blue in color, in which case decolorization may be secured by gently heating. Apply the biuret test to the cool solution. A positive biuret test indicates the presence of proteoses.

2. **Boiling Test.**—Make the ordinary coagulation test according to the direction given under Albumin, page 452. If no coagulable protein is found allow the boiled urine to stand and note the gradual appearance, in the cooled fluid, of a flaky precipitate of proteose. Spiegler's reaction may also be applied at this point. A precipitate indicates proteose.

3. **Schulte's Method.**—Acidify 50 c.c. of urine with dilute acetic acid and filter off any precipitate of nucleoprotein which may form. Now test a few cubic centi-

¹ If not convenient to use a centrifuge the precipitate may be filtered off and washed on the filter paper with alcohol.

meters of the urine for coagulable protein, by tests 2 and 4 under Albumin, page 452. If coagulable protein is present remove it by coagulation and filtration before proceeding. Introduce 25 c.c. of the urine, freed from coagulable protein, into 150 c.c. of absolute alcohol and allow it to stand for 12–24 hours. Decant the supernatant fluid and dissolve the precipitate in a small amount of hot water. Now filter this solution, and after testing again for nucleoprotein with *very dilute* acetic acid, try the biuret test. If this test is positive the presence of proteose is indicated.¹

Urobilin does not ordinarily interfere with this test since it is almost entirely dissolved by the absolute alcohol when the proteose is precipitated.

4. **Detection of "Bence-Jones' Protein."**—Heat the suspected urine very gently, carefully noting the temperature. At as low a temperature as 40°C. a turbidity may be observed, and as the temperature is raised to about 60°C. a flocculent precipitate forms and clings to the sides of the test-tube. If the urine is now acidified *very slightly* with acetic acid and the temperature further raised to 100°C. the precipitate at least partly disappears; it will return upon cooling the tube.

This property of precipitating at so low a temperature and of dissolving at a higher temperature is typical of "Bence-Jones' protein" and may be used to differentiate it from all other forms of protein material occurring in the urine.

NUCLEOPROTEIN

There has been considerable controversy as to the proper classification for the protein body which forms the "nubecula" of normal urine. By different investigators it has been called *mucin*, *mucoïd*, *phosphoprotein*, *nucleoalbumin*, and *nucleoprotein*. Of course, according to the modern acceptance of the meanings of these terms they cannot be synonymous. Mucin and mucoïd are glycoproteins and hence contain no phosphorus (see page 112), whereas phosphoproteins and nucleoproteins are phosphorized bodies. It may possibly be that both these forms of protein, *i.e.*, the glycoprotein and the phosphorized type, occur in the urine under certain conditions (see page 424). In this connection we will use the term *nucleoprotein*. The pathological conditions under which the content of nucleoprotein is increased includes all affections of the urinary passages and in particular pyelitis, nephritis, and inflammation of the bladder.

EXPERIMENTS

1. **Detection of Nucleoprotein.**—Place 10 c.c. of urine in a small beaker, dilute it with three volumes of water to prevent precipitation of urates, and make the reaction very strongly acid with acetic acid. If the urine becomes turbid it is an indication that nucleoprotein is present.

¹ If it is considered desirable to test for peptone the proteose may be removed by saturation with $(\text{NH}_4)_2\text{SO}_4$ according to the directions given on p. 120 and the filtrate tested for peptone by the biuret test.

If the urine under examination contains albumin the greater portion of this substance should be removed by boiling the urine before testing it for the presence of nucleoprotein.

2. **Tannic Acid Precipitation Test (Ott).**—Mix 25 c.c. of the urine with an equal volume of a saturated solution of sodium chloride and slowly add Almén's reagent.¹ In the presence of nucleoprotein a voluminous precipitate forms.

BLOOD

The pathological conditions in which blood occurs in the urine may be classified under the two divisions *hematuria* and *hemoglobinuria*. In hematuria we are able to detect not only the hemoglobin but the unruptured corpuscles as well, whereas in hemoglobinuria the pigment alone is present. Hematuria is brought about through blood passing into the urine because of some lesion of the kidney or of the urinary tract below the kidney. Hemoglobinuria is brought about through hemolysis, *i.e.*, the rupturing of the stroma of the erythrocyte and the liberation of the hemoglobin. This may occur in scurvy, typhus, pyemia, purpura, and in other diseases. It may also occur as the result of a burn covering a considerable area of the body, or may be brought about through the action of certain poisons or by the injection of various substances having the power of dissolving the erythrocytes. Transfusion of blood may also cause hemoglobinuria.

Even in true hematuria the erythrocytes may escape detection if the urine is ammoniacal inasmuch as the cells disintegrate under these conditions.

EXPERIMENTS

1. **Potassium Hydroxide Test (Heller).**—Render 10 c.c. of urine strongly alkaline with potassium hydroxide solution and heat to boiling. Upon allowing the heated urine to stand a precipitate of phosphates, colored red by the contained hematin, is formed. It is ordinarily well to make a "control" experiment using normal urine, before coming to a final decision.

Certain substances, such as cascara sagrada, rhubarb, santonin, and senna, cause the urine to give a similar reaction. Reactions due to such substances may be differentiated from the true blood reaction by the fact that both the precipitate and the pigment of the former reaction disappear when treated with acetic acid, whereas if the color is due to hematin the acid will only dissolve the precipitate of phosphates and leave the pigment undissolved.

2. **Teichmann's Hemin Test.**—Place a small drop of the suspected urine or a small amount of the moist sediment on a microscopic slide, add a minute grain of sodium chloride and carefully evaporate to dryness over a low flame. Put a cover-glass in place, run underneath it a drop of glacial acetic acid, and warm gently until the formation of gas bubbles is observed. Cool the preparation, examine under the microscope, and compare the form of the crystals with those

¹ Dissolve 5 grams of tannic acid in 240 c.c. of 50 per cent alcohol and add 10 c.c. of 25 per cent acetic acid.

reproduced in Figs. 84 and 85, page 269. (See Atkinson and Kendall's and Nippe's modifications, pages 268 and 270.)

3. **Heller-Teichmann Reaction.**—Produce the pigmented precipitate according to directions given in Heller's test above. If there is a copious precipitate of phosphates and but little pigment the phosphates may be dissolved by treatment with acetic acid and the residue used in the formation of the hemin crystals according to directions in Experiment 2, above.

4. **v. Zeynek and Nencki's Hemin Test.**—To 10 c.c. of the urine under examination add acetone until no more precipitate forms. Filter off the precipitate and extract it with 10 c.c. of acetone rendered acid with 2-3 drops of hydrochloric acid. Place a drop of the resulting colored extract on a slide, immediately place a cover-glass in position, and examine under the microscope. Compare the form of the crystals with those shown in Figs. 84 and 85, page 269. Hemin crystals produced by this manipulation are sometimes very minute, thus rendering it difficult to determine the exact form of the crystal.

6. **Guaiac Test.**—Place 5 c.c. of urine in a test-tube and by means of a pipette introduce a freshly prepared alcoholic solution of guaiaac (strength about 1:60) into the fluid until a turbidity results, then add old turpentine or hydrogen peroxide, drop by drop, until a blue color is obtained.

This is a very delicate test when properly performed. Buckmaster has suggested the use of guaiaconic acid instead of the solution of guaiaac. The test is positive both before and after boiling the blood for 15-20 seconds. Pus does not respond after boiling. *Old*, partly putrefied pus gives the test even without the addition of hydrogen peroxide or old turpentine whereas *fresh* pus responds upon the addition of hydrogen peroxide. See discussion on page 262 and test on page 266.

7. **Schumm's Modification of the Guaiac Test.**—To about 5 c.c. of urine¹ in a test-tube add about 10 drops of a freshly prepared alcoholic solution of guaiaac. Agitate the tube gently, add about 20 drops of old turpentine, subject the tube to a thorough shaking, and permit it to stand for about 2-3 minutes. A blue color indicates the presence of blood in the solution under examination. In case there is not sufficient blood to yield a blue color under these conditions, a few cubic centimeters of alcohol should be added and the tube gently shaken, whereupon a blue coloration will appear in the upper alcohol-turpentine layer.

A control test should always be made using water in place of urine. In the detection of very minute traces of blood only 3-5 drops of the guaiaac solution should be employed.

8. **Ortho-Tolidin Test (Ruttan and Hardisty).**²—To 1 c.c. of a 4 per cent glacial acetic acid solution of o-tolidin³ in a test-tube add 1 c.c. of the solution

¹ Alkaline urine should be made slightly acid with acetic acid as the blue end-reaction is very sensitive to alkali.

² Ruttan and Hardisty: *Canadian Medical Assn. Journal*, Nov., 1912, also *Biochemical Bull.*, 2, 225, 1913.

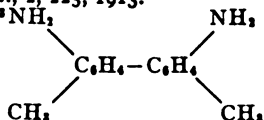

under examination and 1 c.c. of 3 per cent hydrogen peroxide. In the presence of blood a bluish color develops (sometimes rather slowly) and persists for some time (several hours in some instances).

This test is said to be as sensitive for the detection of occult blood in feces and stomach contents as is the benzidine reaction. It is also claimed to be more satisfactory for urine than any other blood test. The acetic acid solution may be kept for one month with no reduction in delicacy.

9. Benzidine Reaction.—This is one of the most delicate of the reactions for the detection of blood. Different benzidine preparations vary greatly in their sensitiveness, however. Inasmuch as benzidine solutions change readily upon contact with light, it is essential that they be kept in a dark place.

The test is performed as follows: To a saturated solution of benzidine in alcohol or glacial acetic acid add an equal volume of 3 per cent hydrogen peroxide and 1 c.c. of the urine under examination. If the mixture is not already acid, render it so with acetic acid, and note the appearance of a blue color. A control test should be made substituting water for the urine.

Often when urines containing a small amount of blood are tested by this reaction, the mixture is rendered so turbid as to make it difficult to decide as to the presence of a faint green color. Such urines should be washed with water before the test is applied to it. The sensitiveness of the benzidine reaction is greater when applied to aqueous solutions than when applied to the urine.

For a modification of this test and further discussion see Chapter XV on Blood and Lymph.

9. Spectroscopic Examination.—Submit the urine to a spectroscopic examination according to the directions given on page 301, looking especially for the absorption bands of oxyhemoglobin and methemoglobin (see Absorption Spectra, Plate I).

PUS

Pus may be present in the urine in inflammatory affections of various types. Such a condition is termed *pyuria*. Albumin always accompanies the pus. In catarrh of the bladder and in inflammation of the urethra or of the pelvis of the kidney pus is particularly apt to be present in the urine. If a urine of high pus concentration is voided it may indicate the rupturing of an abscess in some part of the genitourinary tract. Pus may be detected by one of the procedures given below.

EXPERIMENTS

1. Microscopical Detection of Pus.—The characteristic form elements of pus are leucocytes. They may occur in very small number in normal urine. Examine the

urine (centrifugated if necessary) under the microscope. Any considerable number of pus corpuscles indicates a pathological urine. In *acid urine* the pus corpuscles appear as round, colorless cells, composed of refractive, granular protoplasm. Sometimes they may exhibit amœboid movements, particularly if the slide containing them be warmed slightly. They are nucleated (one or more nuclei), the nuclei being clearly visible only upon treating the cells with water, acetic acid or some other suitable reagent. In *alkaline urine* the pus corpuscles are often degenerated. They may occur as swollen, transparent cells, which exhibit no granular structure. If the degeneration has proceeded far enough the nuclei fade and the cell disintegrates and only débris remains.

Sometimes it is almost impossible to differentiate between pus corpuscles and certain types of epithelial cells. In such a case apply one of the following chemical tests.

2. **Guaic Test.**—This test is not specific for pus, but is given by certain other substances and particularly by blood (see Chapter XV). Perform the test as follows: Acidify the urine (if alkaline) with acetic acid, filter,¹ and add tincture of guaiac to the sediment on the paper. If the pus is old, and partly putrefied it will give a blue color. If no blue color is secured, add old turpentine, or hydrogen peroxide, drop by drop. A blue color formed only under these conditions indicates fresh pus.

As a control test boil some of the urine (or sediment) for 15–20 seconds and repeat the test. Pus does not respond after boiling. In the case of blood the test is positive both before and after boiling.

3. **Potassium Hydroxide Test (Donné).**—Separate the sediment from the urine (by decantation, filtration or centrifugation); place a small piece of solid potassium hydroxide on the sediment and stir. If pus is present (and particularly if it be fresh pus and not disintegrated) the sediment will become slimy and tough. If the sediment is mucus it will more or less pass into solution in the concentrated alkali.

BILE

Both the pigments and the acids of the bile may be detected in the urine under certain pathological conditions. Of the pigments, bilirubin is the only one which has been positively identified in fresh urine; the other pigments, when present, are probably derived from the bilirubin. A urine containing bile may be yellowish-green to brown in color and when shaken foams readily. The staining of the various tissues of the body through the absorption of bile due to occlusion of the bile duct is a prominent symptom of the condition known as icterus or jaundice. Bile is always present in the urine under such conditions unless the amount of bile reaching the tissues is extremely small.

EXPERIMENTS

Tests for Bile Pigments

Practically all of these tests for bile pigments are based on the oxidation of the pigment by a variety of reagents with the formation

¹ If desired, the urine may be centrifuged and the sediment used in the test.

of a series of colored derivatives, *e.g.*, biliverdin (green), bilicyanin (blue), choletelin (yellow).

1. **Gmelin's Test.**—To about 5 c.c. of concentrated nitric acid in a test-tube add an equal volume of urine carefully so that the two fluids do not mix. At the point of contact note the various colored rings; green, blue, violet, red, and reddish-yellow.

2. **Rosenbach's Modification of Gmelin's Test.**—Filter 5 c.c. of urine through a small filter paper. Introduce a drop of concentrated nitric acid into the cone of the paper and observe the succession of colors as given in Gmelin's test.

3. **Nakayama's Reaction.**—To 5 c.c. of urine in a test-tube add an equal volume of a 10 per cent solution of barium chloride. Centrifugate the mixture, pour off the supernatant fluid, and heat the precipitate with 2 c.c. of Nakayama's reagent.¹ In the presence of bile pigments the solution assumes a blue or green color.

3. **Huppert's Reaction.**—Thoroughly shake equal volumes of urine and milk of lime in a test-tube. The pigments unite with the calcium and are precipitated. Filter off the precipitate, wash it with water, and transfer to a small beaker. Add alcohol acidified slightly with hydrochloric acid and warm upon a water-bath until the solution becomes colored an emerald green.

According to Steensma, this procedure may give negative results even in the presence of the pigments, owing to the fact that the acid-alcohol is not a sufficiently strong oxidizing agent. He therefore suggests the addition of a drop of a 0.5 per cent solution of sodium nitrite to the acid-alcohol mixture before warming on the water-bath. Try this modification also.

4. **Salkowski's Test.**—Render 5 c.c. of urine alkaline with a few drops of a 10 per cent sodium carbonate solution and add a 10 per cent solution of calcium chloride, drop by drop, until the supernatant fluid exhibits the normal urinary color when the contents of the test-tube are thoroughly mixed. Filter off the precipitate, and after washing it place it in a second tube with 95 per cent alcohol. Acidify the alcohol with hydrochloric acid and, if necessary, shake the tube to bring the precipitate into solution. Heat the solution to boiling and observe the appearance of a green color which changes through blue and violet to red; if no bile is present the solution does not undergo any color change. This test will frequently exhibit greater delicacy than Gmelin's test. Steensma's suggestions mentioned under Huppert's Reaction, above, apply in connection with this test also.

5. **Hammarsten's Reaction.**—To about 5 c.c. of Hammarsten's reagent² in a small evaporating dish add a few drops of urine. A green color is produced. If more of the reagent is now added the play of colors as noted in Gmelin's test may be obtained.

6. **Smith's Test.**—To 2–3 c.c. of urine in a test-tube add carefully about 5 c.c. of dilute tincture of iodine (1:10) so that the fluids do not mix. A green ring is observed at the point of contact.

7. **Salkowski-Schippers Reaction.**—Neutralize the acidity of 10 c.c. of the urine under examination with a few drops of a dilute solution of sodium carbonate, and add 5 drops of a 20 per cent solution of sodium carbonate and 10 drops of a 20 per cent solution of calcium chloride. Filter off the resultant precipitate upon a

¹ Prepared by combining 99 c.c. of alcohol and 1 c.c. of fuming hydrochloric acid containing 4 grams of ferric chloride per liter.

² Hammarsten's reagent is made by mixing one volume of 25 per cent nitric acid and 19 volumes of 25 per cent hydrochloric acid and then adding 1 volume of this acid mixture to 4 volumes of 95 per cent alcohol.

hardened filter paper and wash it with water. Remove the precipitate to a small porcelain dish, add 3 c.c. of an acid-alcohol mixture¹ and a few drops of a dilute solution of sodium nitrite and heat. The production of a green color indicates the presence of bile pigments.

8. **Bonanno's Reaction.**²—Place 5–10 c.c. of the urine under examination in a small porcelain evaporating dish and add a few drops of Bonanno's reagent.³ If bile is present an emerald-green color will develop. Bonanno says the reaction is not interfered with by any known normal or pathological urinary constituent.

[Tests for Bile Acids]

1. **Sucrose—H₂SO₄ Test (Pettenkofer).**—To 5 c.c. of urine in a test-tube add 5 drops of a 5 per cent solution of sucrose. Now incline the tube, run about 2–3 c.c. of concentrated sulphuric acid carefully down the side and note the red ring at the point of contact. Upon slightly agitating the contents of the tube the whole solution gradually assumes a reddish color. As the tube becomes warm, it should be cooled in running water in order that the temperature may not rise about 70°C.

It is claimed that this test is not satisfactory in the presence of protein and chromogenic substances which yield interfering colors with sulphuric acid.

2. **Furfural—H₂SO₄ Test (Mylius).**—To approximately 5 c.c. of urine in a test-tube add 3 drops of a very dilute (1 : 1000) aqueous solution of furfural,

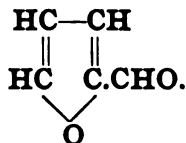

Now incline the tube, run about 2–3 c.c. of concentrated sulphuric acid carefully down the side and note the red ring as above. In this case also, upon shaking the tube, the whole solution is colored red. Keep the temperature below 70°C. as before.

3. **Foam Test (v. Udránsky).**—To 5 c.c. of urine in a test-tube add 3–4 drops of a very dilute (1 : 1000) aqueous solution of furfural. Place the thumb over the top of the tube and shake until a thick foam is formed. By means of a small pipette add 2–3 drops of concentrated sulphuric acid to the foam and observe the dark pink coloration produced.

4. **Surface Tension Test (Hay).**—This test is based upon the principle that bile acids have the property of reducing the surface tension of fluids in which they are contained. The test is performed as follows: Cool about 10 c.c. of urine in a test-tube to 17°C. or lower, and sprinkle a little finely pulverized sulphur upon the surface of the fluid. The presence of bile acids is indicated if the sulphur sinks to the bottom of the liquid, the rapidity with which the sulphur sinks depending upon the amount of bile acids present in the urine. The test is said to react with bile acids when the latter are present in the proportion 1 : 120,000.

¹ Made by adding 5 c.c. of concentrated hydrochloric acid to 95 c.c. of 96 per cent. alcohol.

² Il Tommasi, 2, No. 21.

³ This reagent may be prepared by dissolving 2 grams of sodium nitrite in 100 c.c. of concentrated hydrochloric acid.

Allen¹ has recently suggested the quantitative determination of bile acids by a surface tension method. Urines preserved with thymol may respond positively to this test.

5. **Neukomm's Modification of Pettenkofer's Test.**—To a few drops of urine in an evaporating dish add a trace of a dilute sucrose solution and one or more drops of dilute sulphuric acid. Evaporate on a water-bath and observe the development of a *violet* color at the edge of the evaporating mixture. Discontinue the evaporation as soon as the color is observed.

6. **Peptone Test (Oliver).**—To 5 c.c. of urine add 2–3 drops of acetic acid, filtering if necessary. Add an equal volume of a 1 per cent solution of Witte's peptone to the acid solution. A precipitate is formed which is insoluble in an excess of acetic acid. This precipitate is a compound of protein and bile acids.

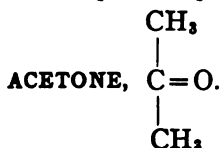

It was formerly very generally believed that acetone appeared in the urine under pathological conditions because of increased protein decomposition. It is now generally thought that, in man, the output of acetone arises principally from the breaking down of fatty tissues or fatty foods within the organism. The quantity of acetone eliminated has been shown to increase when the subject is fed an abundance of fat-containing food as well as during fasting, whereas a replacement of the fat with carbohydrates is followed by a marked decrease in the acetone excretion. If no carbohydrate food is fed the output of acetone bodies increases at once, producing a *physiological acidosis* (see Chapter XXVIII on Metabolism).

Acetone and the closely related bodies, β -hydroxybutyric acid and acetoacetic acid, are generally classified as the *acetone bodies*. They are all associated with a deranged metabolic function and may appear in the urine together or separately, depending upon the conditions. Acetone and diacetic acid may occur alone in the urine but β -hydroxybutyric acid is never found except in conjunction with one or the other of these bodies. Both acetone and β -hydroxybutyric acid may be formed from acetoacetic acid. The relation existing between these three bodies is as follows:²

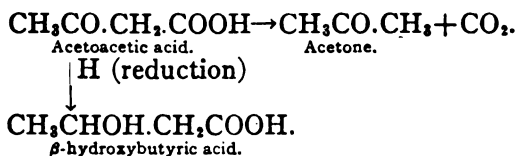

¹ Allen: *Jour. Biol. Chem.*, 22, 505, 1915.

² Maase: *Med. Klinik*, 61, 445, 1910.

Blum: *Munch. med. Woch.*, 57, 683, 1910.

Dakin: *Jour. Biol. Chem.*, 8, 97, 1910.

Marriott: *Jour. Biol. Chem.*, 18, 241, 1914.

Mathews: *Physiological Chemistry*, 2d Ed., 1916, p. 756.

Allen: *Am. Jour. Med. Sci.*, 153, 313, 1917.

Acetone, chemically considered, is a ketone, *di-methyl ketone*. When pure it is a liquid which possesses a characteristic aromatic fruit-like odor, boils at 56–57°C. and is miscible with water, alcohol, or ether in all proportions. Acetone is a *physiological* as well as a pathological constituent of the urine and under normal conditions the daily output (preformed acetone + acetoacetic acid) is about 3–15 mg.

Pathologically, the elimination of acetone is often greatly increased and at such times a condition of *acetonuria* is said to exist. Values from 0.02–6 grams or higher have been obtained for preformed acetone plus acetone derived from acetoacetic acid. This pathological acetonuria may accompany diabetes mellitus, scarlet fever, typhoid fever, pneumonia, nephritis, phosphorus poisoning, grave anemias, fasting, and a deranged digestive function; it also frequently accompanies auto-intoxication and chloroform and ether anesthesia. The types of acetonuria most frequently met with are those noted in febrile conditions and in advanced cases of diabetes mellitus. The *blood* in diabetic comas has been found to contain as high as 45 mg. of total acetone (acetone + acetoacetic acid) for 100 c.c. of blood serum.

EXPERIMENTS

1. **Isolation from the Urine.**—In order to facilitate the detection of acetone in the urine, the specimen under examination should be distilled and the tests as given below applied to the resulting distillate. If it is not convenient to distil the urine, the tests may be conducted upon the undistilled fluid. To obtain an acetone distillate proceed as follows: Place 100–250 c.c. of urine in a distillation flask or retort and render it acid with acetic acid. Collect about one-third of the original volume of fluid as a distillate, add 5 drops of 10 per cent hydrochloric acid and redistil about one-half of this volume. With this final distillate conduct the tests as given below.

2. **Gunning's Iodoform Test.**—To about 5 c.c. of the urine or distillate in a test-tube add a few drops of Lugol's solution¹ or ordinary iodine solution (I in KI) and a few drops of dilute NH_4OH to form a black precipitate (nitrogen iodide). Allow the tube to stand (the length of time depending upon the content of acetone in the fluid under examination) and note the formation of a yellowish sediment consisting of iodoform. Examine the sediment under the microscope and compare the form of the crystals with those shown in Fig. 4, page 31.

If the crystals are not well formed recrystallize them from ether and examine again. The crystals of iodoform should not be confounded with those of calcium phosphate (Fig. 119, page 351) which may be formed in this test, particularly if made upon the undistilled urine. This test is preferable to Lieben's test (4) since no substance other than acetone will produce iodoform when treated according to the directions for

¹ Lugol's solution may be prepared by dissolving 4 grams of iodine and 6 grams of potassium iodide in 100 c.c. of distilled water.

this test; both alcohol and aldehyde yield iodoform when tested by Lieben's test.

Gunning's test is rather satisfactory for the detection of acetone, and has been used with good results even upon the undistilled urine. Protein material apparently interferes with the reaction, and when present the urine should be distilled and the distillate used.¹ In some instances where the amount of acetone present is very small it is necessary to allow the tube to stand 24 hours before making the examination for iodoform crystals. This test serves to detect acetone when present in the ratio 1:100,000.

3. Sodium Nitroprusside Test (Legal).—Introduce about 5 c.c. of the urine or distillate into a test-tube, add a few drops of freshly prepared aqueous solution of sodium nitroprusside and render the mixture alkaline with potassium hydroxide. (Be sure to add the nitroprusside before the solution is rendered alkaline.) A ruby-red color, due to creatinine, a normal urinary constituent, is produced (see Weyl's test, page 413). Add an excess of acetic acid and if acetone is present the red color will be intensified, whereas in the absence of acetone a yellow color will result. Make a control test upon normal urine to show that this is so.

A similar red color may be produced by paracresol in urines containing no acetone.

Two hypotheses have been proposed to explain the color reaction between acetone and nitroprusside: (1) The formation of a complex ion of ferropentacyanide with the isonitroso compound of the ketone, or (2) the formation of such an ion with the isonitroamine derivative of the ketone.²

4. Iodoform Test (Lieben).—Introduce 5 c.c. of the urine or distillate into a test-tube, render it alkaline with potassium hydroxide and add 1-2 c.c. of iodine solution drop by drop. If acetone is present a yellowish precipitate of iodoform will be produced. Identify the iodoform by means of its characteristic odor and its typical crystalline form (see Fig. 4, page 31).

While fully as delicate as Gunning's test (2) this test is not as accurate since, by means of the procedure involved, either alcohol or aldehyde will yield a precipitate of iodoform. This test is especially liable to lead to erroneous deductions when urines from the advanced stages of diabetes are under examination, because of the presence of alcohol formed from the sugar through fermentative processes.³ If protein is present in the urine to be tested it may prevent the acetone from responding to the above reaction. It is therefore advisable to use

¹ Rosenbloom: *Jour. Am. Med. Ass'n*, 59, 445, 1912.

² Cambi: *Atti. accad. Lincei*, 22, 376, 1913.

³ Welker reports the production of a pink or red color during the application of this test to the distillates from pathological urines which had been preserved with powdered thymol. He found the color to be due to an iodothymol compound which had been previously prepared synthetically by Messinger and Vortmann.

the distillate to secure most accurate results.¹ Sobel² has suggested a quantitative method for acetone based on Lieben's test.

5. Reynolds-Gunning Test.—This test depends upon the solubility of mercuric oxide in acetone and is performed as follows: To 5 c.c. of the urine or distillate add a few drops of mercuric chloride, render the solution alkaline with potassium hydroxide and add an equal volume of 95 per cent alcohol. Shake thoroughly in order to bring the major portion of the mercuric oxide into solution and filter. Render the *clear* filtrate faintly acid with hydrochloric acid and stratify some ammonium sulphide (NH₄)₂S upon this acid solution. At the zone of contact a blackish-gray ring of precipitated mercuric sulphide, HgS, will form. Aldehyde also responds to this test. Aldehyde, however, has never been detected in the urine and could be present in this instance only if the acidified urine was distilled too far.

6. Rothera's Reaction.³—To 5–10 c.c. of urine or distillate in a test-tube add a little solid ammonium sulphate, 2–3 drops of a freshly prepared 5 per cent solution of sodium nitroprusside and 1–2 c.c. of concentrated ammonium hydroxide. The development of a *permanganate* color indicates the presence of acetone.

Hunter⁴ claims that this reaction serves to detect acetoacetic acid rather than acetone. Others claim it detects both acetone and acetoacetic acid.

8. Salicylaldehyde Reaction (Frommer).—Render 10 c.c. of urine strongly alkaline with potassium hydroxide, add 10–12 drops of a 10 per cent solution of salicylaldehyde in absolute alcohol and warm the mixture to about 70°. If acetone be present the fluid becomes yellow, then red, reddish-purple and dark red in turn. The color of the urine is practically unchanged if no acetone is present.

This color is due to the formation of dihydroxydibenzoylacetone through the interaction of salicylaldehyde and acetone.

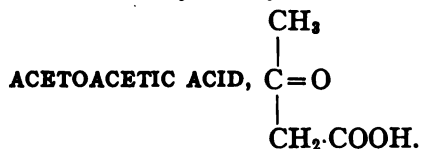

Acetoacetic or diacetic acid occurs in traces in normal urine. The sum of the acetone and the acetoacetic acid excreted in normal urine per day ranges from 3 to 15 mg. and ordinarily three-quarters of this is acetoacetic acid. Under certain pathological conditions it occurs in larger quantities and is rarely found except associated with acetone. In the human body it yields β -hydroxybutyric acid by reduction and upon decomposition yields acetone and carbon dioxide. Acetoaceturia occurs ordinarily under the same conditions as the pathological acetonuria, *i.e.*, in fevers, diabetes, etc. (pp. 463 and 560). If very little acetoacetic acid is formed it may be transformed into acetone, whereas if a larger quantity is produced both

¹ Rosenbloom: *Jour. Am. Med. Ass'n*, 59, 445, 1912.

² Sobel: *Schweiz. A. polh. Zig.*, 52, 62, 1914.

³ Rothera: *Jour. Physiol.*, 37, 491, 1908.

⁴ Hunter: *Quart. Jour. Exp. Physiol.*, 8, 13, 1914.

acetone and acetoacetic acid may be present in the urine. Acetoaceturia is most frequently observed in children, especially accompanying fevers and digestive disorders; it is perhaps less frequently observed in adults, but when present, particularly in fevers and diabetes it is frequently followed by fatal coma.

Acetoacetic acid is a colorless liquid which is miscible with water, alcohol and ether, in all proportions. It differs from acetone in giving a violet-red or Bordeaux-red color with a dilute solution of ferric chloride.

EXPERIMENTS¹

1. **Le Nobel Reaction.**²—Make 10 c.c. of urine acid with acetic acid, add a few drops of a dilute aqueous solution of sodium nitroprusside and stratify concentrated ammonium hydroxide upon the mixture. In the presence of acetoacetic acid a violet ring forms at once.

Acetone also responds to this test, but the test is more delicate for acetoacetic acid and the response is more prompt.

2. **Ferric Chloride Test (Gerhardt).**—To 5 c.c. of urine in a test-tube add ferric chloride solution, drop by drop, until no more precipitate forms. In the presence of acetoacetic acid a Bordeaux-red color is produced; this color may be somewhat masked by the precipitate of ferric phosphate, in which case the fluid should be filtered.

A positive result from the above manipulation simply indicates the possible presence of acetoacetic acid. Before making a final decision regarding the presence of this body make the two following control experiments:

(a) Place 5 c.c. of urine in a test-tube, small beaker, or Erlenmeyer flask and boil it vigorously for 3–5 minutes. Cool the vessel and, with the boiled urine, make the test as given above. As has been already stated, acetoacetic acid yields acetone upon decomposition and acetone does not give a Bordeaux-red color with ferric chloride. By boiling as indicated above, therefore, any acetoacetic acid present would be decomposed into acetone and carbon dioxide and the test upon the resulting fluid would be negative. If positive, the color is due to the presence of bodies other than acetoacetic acid.

(b) Place 5 c.c. of urine in a test-tube, acidify with H_2SO_4 , to free acetoacetic acid from its salts, and carefully extract the mixture with ether by shaking. If acetoacetic acid is present it will be extracted by the ether. Now remove the ethereal solution, evaporate it to dryness, dissolve the residue in 1–2 c.c. of water and add 3–5 drops of 3 per cent ferric chloride. Acetoacetic acid is indicated by the production of the characteristic Bordeaux-red color.

This color disappears spontaneously in 24–48 hours. Such substances as antipyrin, kairin, phenacetin, salicylic acid, salicylates, sodium acetate, thiocyanates, and thallin yield a similar red color

¹ To prepare a diacetic acid solution which may be added to urine, if urines containing this acid are not available, proceed as follows: Treat 13 grams of ethyl acetoacetate with 500 c.c. of N/5 sodium hydroxide. Allow to stand for 48 hours to hydrolyze the ester. In preparing urine for tests add 1 part of this solution to 10 parts of urine.

² Harding and Ruttan: *Biochem. Jour.*, 6, 445, 1912; also *Biochem. Bull.*, 2, 223, 1913.

under these conditions, but when due to the presence of any of these substances the color does not disappear spontaneously but may remain permanent for days. Many of these disturbing substances are soluble in benzene or chloroform and may be removed from the urine by this means before extracting with ether as above. Acetoacetic acid is insoluble in benzene or chloroform.

3. Sodium Nitrite—Ferrous Sulphate Reaction (Hurtley).—Place 10 c.c. of urine in a large test-tube, add 2.5 c.c. of concentrated hydrochloric acid and 1 c.c. of fresh 1 per cent sodium nitrite. Shake the tube and permit it to stand for two minutes. Add 15 c.c. of concentrated ammonium hydroxide and 5 c.c. of 10 per cent ferrous sulphate. Shake the tube and permit it to stand. Note the slow development of a violet or purple color in the presence of acetoacetic acid.

This test serves to detect acetoacetic acid when present in a dilution of 1 to 50,000. The concentration of the acetoacetic acid regulates the speed at which the color develops. If the concentration be very low an interval of five hours may elapse before the color appears. The test is believed to be specific for acetoacetic acid.

4. Arnold-Liplawsky Reaction.—This reaction is somewhat more delicate than Gerhardt's test (2) and serves to detect acetoacetic acid when present in the proportion of 1 : 25,000. It is also negative toward acetone, β -hydroxybutyric acid and the interfering drugs mentioned as causing erroneous deductions in the application of Gerhardt's test. If the urine under examination is highly pigmented it should be partly decolorized by means of animal charcoal before applying the test as indicated below.

Place 5 c.c. of the urine under examination and an equal volume of the Arnold-Liplawsky reagent¹ in a test-tube, add a few drops of concentrated ammonia and shake the tube vigorously. Note the production of a brick-red color. Take 1-2 c.c. of this colored solution, add 10-20 c.c. of hydrochloric acid (sp. gr. 1.19), 3 c.c. of chloroform, and 2-4 drops of ferric chloride solution and carefully mix the fluids. Acetoacetic acid is indicated by the chloroform assuming a violet or blue color; if acetoacetic acid is absent the color may be yellow or light red.

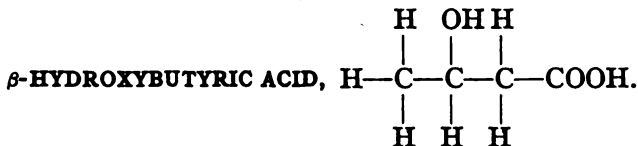

This acid occurs in normal urine in traces, *e.g.*, 20-30 mg. per day.² It is found under certain pathological conditions in larger quantities

¹ This reagent consists of two definite solutions which are ordinarily preserved separately and mixed just before using. The two solutions are prepared as follows:

(a) One per cent aqueous solution of potassium nitrite.

(b) One gram of *p*-amino-acetophenon dissolved in 100 c.c. of distilled water and enough hydrochloric acid (about 2 c.c.) added, drop by drop, to cause the solution, which is at first yellow, to become entirely colorless. An excess of acid must be avoided.

Before using, *a* and *b* are mixed in the ratio 1 : 2.

² Shaffer and Marriott: *Jour. Biol. Chem.*, 16, 265, 1913.

and then always in conjunction with either acetone or acetoacetic acid. It is present in especially large amount in severe cases of diabetes and has also been detected in digestive disturbances, continued fevers, scurvy, measles, and in fasting. It is probable that, in man, β -hydroxybutyric acid, in common with acetone and acetoacetic acid, arises principally from the breaking down of fatty tissues within the organism. Any condition in which large amounts of acetone and acetoacetic acid, and in severe cases β -hydroxybutyric acid also, are excreted in the urine is known as an "acidosis." In diabetes the deranged metabolic conditions cause the production of great quantities of these substances which lead to an acid intoxication and ultimately to diabetic coma. In severe diabetes 50-100 grams or over per day may be excreted. In such conditions the β -hydroxybutyric acid may constitute 60-80 per cent of the *total acetone bodies*. In rare cases we may have an excretion of large amounts of β -hydroxybutyric acid with a low acetone output. An acidosis may also occur under certain *physiological* conditions (see Chapter XVII on Acidosis and Chapter XXVIII on Metabolism).

Ordinarily β -hydroxybutyric acid is an odorless, transparent syrup which is levorotatory and easily soluble in water, alcohol, and ether; it may be obtained in crystalline form.

EXPERIMENTS

1. **Black's Reaction.**¹—Inasmuch as the urinary pigments as well as any contained sugar or acetoacetic acid will interfere with the delicacy of this test when applied to the urine directly, the following preliminary procedure is necessary: Concentrate 10 c.c. of the urine under examination to one-third or one-fourth of its original volume in an evaporating dish at a gentle heat. Acidify the residue with a few drops of concentrated hydrochloric acid, add sufficient plaster of Paris to make a thick paste and allow the mixture to stand until it begins to "set." It should now be stirred and broken up in the dish by means of a stirring rod with a blunt end. Extract the porous meal thus produced twice with ether by stirring and decantation. Any β -hydroxybutyric acid present will be extracted by the ether. Evaporate the ether extract spontaneously or on a water-bath, dissolve the residue in water, and neutralize it with barium carbonate. To 5 to 10 c.c. of this neutral fluid in a test-tube add 2 to 3 drops of ordinary commercial acid hydrogen peroxide. Mix by shaking and add a few drops of Black's reagent.² Permit the tube to stand and note the gradual development of a rose color which increases to its maximum intensity and then gradually fades.³

In carrying out the test care should be taken to see that the solution is *cold* and *approximately neutral* and that a *large excess* of hydrogen

¹ Black: *Jour. Biol. Chem.*, 5, 207, 1908.

² Made by dissolving 5 grams of ferric chloride and 0.4 gram of ferrous chloride in 100 c.c. of water.

³ This disappearance of color is due to the further oxidation of the acetoacetic acid.

peroxide and Black's reagent are not added. In case but little β -hydroxybutyric acid is present the color will fail to appear or will be but transitory if the oxidizing agents are added in *too great excess*. It is preferable to add a few drops of the reagent and at intervals of a few minutes repeat the process until the color undergoes no further increase in intensity. One part of β -hydroxybutyric acid in 10,000 parts of the solution may be detected by this test.

2. **Polariscopic Examination.**—Subject some of the urine (free from protein) to the ordinary fermentation test (see page 469). This will remove glucose and fructose, which would interfere with the polariscopic test. Now examine the fermented fluid in the polariscope and if it is levorotatory the presence of β -hydroxybutyric acid is indicated. This test is not absolutely reliable, however, since conjugate glycuronates are also levorotatory after fermentation.

CONJUGATE GLYCURONATES

Glycuronic acid does not occur free in the urine, but is found, for the most part, in combination with phenol. Much smaller quantities are excreted in combination with indoxyl and skatoxyl. The total content of conjugate glycuronates seldom exceeds 0.004 per cent under normal conditions. The output may be very greatly increased as the result of the administration of antipyrin, borneol, camphor, chloral hydrate, menthol, morphine, naphthol, turpentine, etc. The glycuronates as a group are levorotatory whereas glycuronic acid is dextrorotatory. Most of the glycuronates reduce alkaline metallic oxides and so introduce an error in the examination of urine for sugar. Conjugate glycuronates often occur associated with glucose in glycosuria, diabetes mellitus, and in some other disorders. As a class the glycuronates are non-fermentable.

EXPERIMENTS

1. **Naphthoresorcinol Reaction (Tollens).**—Introduce 5 c.c. of urine in a test-tube and add 0.5-1 c.c. of a 1 per cent solution of naphthoresorcinol in 95 per cent alcohol, and 5 c.c. of concentrated hydrochloric acid. Raise the temperature gradually to the boiling-point and boil for one minute, shaking the tube continuously. Stand the tube aside four minutes, then cool under the tap. Extract with an equal volume of ether. Glycuronates are indicated by the ether extract assuming a violet-red color. The spectroscope shows this extract to possess two absorption bands, one on the D line and one to the right of this line.

2. **Polariscopic-Fermentation Test.**—If glucose is present in the urine tested

for glycuronates the urine may first be subjected to a polariscopic examination, then fermented and a second polariscopic examination made. The sugar being dextrorotatory and fermentable and the glycuronates being levorotatory and non-fermentable the second polariscopic test will show a levorotation indicative of conjugate glycuronates.

3. Reduction-Polariscopic Test.—Test the urine by Fehling's test. If positive try the Resorcinol-HCl reaction for fructose. If negative test the optical activity. Levorotation indicates glycuronates.

PENTOSES

We have two distinct types of pentosuria, *i.e.*, *alimentary pentosuria*, resulting from the ingestion of large quantities of pentose-rich vegetables

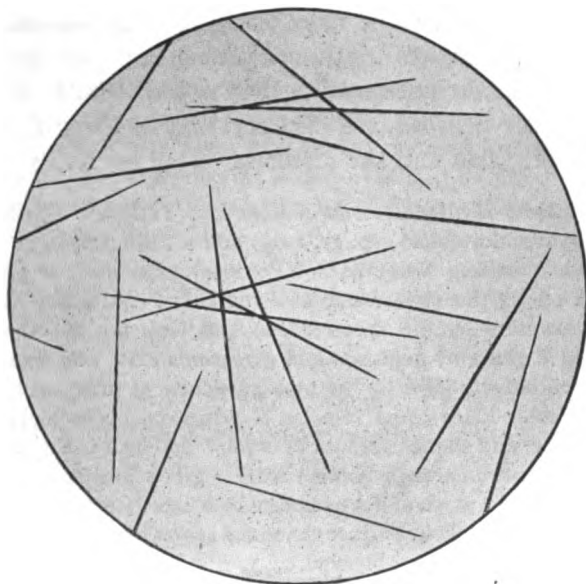

FIG. 145.—PENTOSAZONE CRYSTALS.

Isolated and purified in the author's laboratory by Mr. B. L. Fleming. From the urine of a patient in the service of Dr. S. Solis Cohen, Jefferson Hospital, Phila. For color of crystals see Plate III, opposite page 22.

such as prunes, cherries, grapes, or plums, and fruit juices, in which condition the pentoses appear only *temporarily* in the urine; and the *chronic* form of pentosuria, in which the output of pentoses bears no relation whatever to the quantity and nature of the pentose content of the food eaten. In occurring in these two forms, pentosuria resembles glycosuria (see page 441), but it is definitely known that pentosuria bears no relation to diabetes mellitus and there is no generally accepted theory to account for the occurrence of the chronic form of pentosuria. The pentose detected most frequently in the urine is arabinose, the inactive form generally occurring in chronic pentosuria

although active forms have been more or less frequently reported. Levene and La Forge¹ as well as Zerner and Waltuch² report *d*-xylose, and Hiller³ found *d*-xyloketose in one case of pentosuria. The levorotatory variety occurs in the alimentary type of the disorder. For pentosazone crystals (see Fig 145).

EXPERIMENTS

1. Orcinol-Hydrochloric Acid Reaction (Bial).⁴—To 5 c.c. of Bial's reagent⁴ in a test-tube add 2–3 c.c. of urine and heat the mixture gently until the first bubbles rise to the surface.⁵ Immediately or upon cooling the solution becomes green and a flocculent precipitate of the same color may form.

This test is believed to be more accurate than the original orcinol test. It is claimed that urines containing *menthol*, *kreosotal*, etc., respond to the old orcinol reaction, but not to Bial's. If so desired the osazone of the pentose (see Fig. 145) may be formed, then distilled with hydrochloric acid and the distillate tested by Bial's test (Jolles).

2. Phloroglucinol-Hydrochloric Acid Reaction (Tollens).—To equal volumes of urine and hydrochloric acid (sp. gr. 1.09) add a little phloroglucinol and heat the mixture on a boiling water-bath. Pentose, galactose, or glycuronic acid will be indicated by the appearance of a red color. To differentiate between these bodies examine by the spectroscope and look for the absorption band between D and E given by pentoses and glycuronic acid, and then differentiate between the two latter bodies by the melting-points of their osazones.

3. Orcinol Test.—Place equal volumes of urine and hydrochloric acid (sp. gr. 1.09) in a test-tube, add a small amount of orcinol, and heat the mixture to boiling. Color changes from red through reddish-blue to green will be noted. When the solution becomes green it should be shaken in a separatory funnel with a little amyl alcohol, and the alcoholic extract examined spectroscopically. An absorption band between C and D will be observed.

FAT

When fat finds its way into the urine through a lesion which brings some portion of the urinary passages into communication with the lymphatic system a condition known as *chyluria* is established. The turbid or milky appearance of such urine is due to its content of chyle. This disease is encountered most frequently in tropical countries, but

¹ Levene and La Forge: *Jour. Biol. Chem.*, 18, 319, 1914.

² Zerner and Waltuch: *Monatsh. Chem.*, 34, 1639, 1913; 35, 1025, 1914.

³ Hiller: *Jour. Biol. Chem.*, 30, 135, 1917.

⁴ Bial: *Deut. med. Woch.*, 28, 252, 1902.

⁵ Orcinol..... 15 grams.

Fuming HCl..... 500 grams.

Ferric chloride (10 per cent)..... 20–30 drops.

⁶ The test may also be performed by adding the urine to the *hot* reagent. No further heating should be necessary if pentose is present.

is not entirely unknown in more temperate climates. Albumin is a constant constituent of the urine in chyluria. Upon shaking a chylous urine with ether the fat is dissolved by the ether and the urine becomes clearer or entirely clear.

HEMATOPORPHYRIN

Urine containing this body is occasionally met with in various diseases, but more frequently after the use of quinine, tetronal, trional, and especially sulphonal. Such urines ordinarily possess a reddish tint, the depth of color varying greatly under different conditions.

EXPERIMENTS

1. **Spectroscopic Examination.**—To 100 c.c. of urine add about 20 c.c. of a 10 per cent solution of potassium hydroxide or ammonium hydroxide. The precipitate which forms consists principally of earthy phosphates to which the hematoporphyrin adheres and is carried down. Filter off the precipitate, wash it and transfer to a flask and warm with alcohol acidified with hydrochloric acid. By this process the hematoporphyrin is dissolved and on filtering will be found in the filtrate and may be identified by means of the spectroscope (see page 301, and Absorption Spectra, Plate II).

2. **Acetic Acid Test.**—To 100 c.c. of urine add 5 c.c. of glacial acetic acid and allow the mixture to stand 48 hours. Hematoporphyrin deposits in the form of a precipitate.

LACTOSE

Lactose is rarely found in the urine except as it is excreted by women during pregnancy, during the nursing period, or soon after weaning. It is rather difficult to show the presence of lactose in the urine in a satisfactory manner, since the formation of the characteristic lactosazone is not attended with any great measure of success under these conditions. It is, however, comparatively easy to show that it is not glucose, for, while it responds to reduction tests, it does not ferment with *pure* yeast and does not give a glucosazone. An absolutely conclusive test, of course, is the isolation of the lactose in crystalline form (Fig. 118, page 347) from the urine.

On oxidation with nitric acid lactose and galactose yield *mucic acid*. This test is frequently used in urine examination to differentiate lactose and galactose from other reducing sugars. To differentiate lactose from pentose, since neither ferments, we may apply the Orcinol—HCl test of Bial, see page 472.

EXPERIMENTS

1. **Mucic Acid Test.**—Treat 100 c.c. of the urine under examination with 20 c.c.¹ of concentrated nitric acid and evaporate the mixture in a broad, shallow

¹ If the specific gravity of the urine is 1020 or over, it is necessary to use 25–35 c.c. of nitric acid. Under these conditions the mixture should be evaporated until the remaining volume is approximately equivalent to that of the nitric acid added.

glass vessel, upon a boiling water-bath until the volume of the solution is only about 20 c.c. At this point the fluid should be clear and a fine white precipitate of mucic acid should separate.

If the percentage of lactose in the urine is low it may be necessary to cool the solution and permit it to stand for some time before the precipitate will form. It is impossible to differentiate between galactose and lactose by means of this test, but the reaction does serve to differentiate these two sugars from all other reducing sugars. A satisfactory differentiation between lactose and galactose in pure solution may be made by means of Barfoed's test, page 30. This test is, however, not suited for urine examination. To differentiate galactose and lactose in urine use the Phloroglucinol-Hydrochloric Acid Reaction of Tollens, see pages 38 and 472.

2. **Rubner's Test.**—To 10 c.c. of urine in a small beaker add some lead acetate, in substance, heat to boiling, and add NH_4OH until no more precipitate is dissolved. In the presence of lactose a brick-red or rose-red color develops, whereas glucose gives a coffee-brown color, maltose a light yellow color, and fructose no color at all under the same conditions.

3. **Compound Test.**—Try the Nylander reaction. If positive try the phenylhydrazine test. If negative (the lactosazone is not readily formed in urine) apply the fermentation test. If this test is also negative, differentiate between lactose and pentose by Orcinol-HCl reaction (Bial) and mucic acid tests.

GALACTOSE

Galactose has occasionally been detected in the urine, and in particular in that of nursing infants afflicted with a deranged digestive function. Lactose and galactose may be differentiated from other reducing sugars which may be present in the urine by means of the mucic acid test. This test simply consists in the production of mucic acid through oxidation of the sugar with nitric acid.

EXPERIMENTS

1. **Mucic Acid Test.**—Treat 100 c.c. of the urine under examination with 20 c.c.¹ of concentrated nitric acid and evaporate the mixture in a broad, shallow glass vessel, upon a boiling water-bath, until the volume of the solution is only 20 c.c. At this point the fluid should be clear and a fine, white precipitate of mucic acid should separate.

If the percentage of galactose present in the urine is low it may be necessary to cool the solution and permit it to stand for some time

¹ If the specific gravity of the urine is 1020 or over it is necessary to use 25–35 c.c. of nitric acid. Under these conditions the mixture should be evaporated until the remaining volume is approximately equivalent to that of the nitric acid added.

before the precipitate will form. It is impossible to differentiate between galactose and lactose by means of this test, but the reaction does serve to differentiate these two sugars from all other reducing sugars. A satisfactory differentiation between galactose and lactose may be made by the Phloroglucinol-Hydrochloric Acid Test of Tollens, below.

2. **Phloroglucinol-Hydrochloric Acid Reaction (Tollens).**—To equal volumes of the urine and hydrochloric acid (sp. gr. 1.09) add a little phloroglucinol and heat the mixture on a boiling water-bath. Galactose, pentose, and glycuronic acid will be indicated by the appearance of a red color. Galactose may be differentiated from the two latter substances in that its solutions exhibit no absorption bands upon spectroscopical examination.

FRUCTOSE

Diabetic urine frequently possesses the power of rotating the plane of polarized light to the left, thus indicating the presence of a levorotatory substance. The levorotation is sometimes due to the presence of fructose, although not necessarily confined to this carbohydrate, since conjugate glycuronates and β -hydroxybutyric acid, two other levorotatory bodies, are frequently found in the urine of diabetics. Fructose is invariably accompanied by glucose in diabetic urine, but *fructosuria* has been observed as a separate anomaly. The presence of fructose may be inferred when the percentage of sugar, as determined by the titration method, is greater than the percentage indicated by the polariscopic examination.

EXPERIMENTS

1. **Borchardt's Reaction.**—To about 5 c.c. of urine in a test-tube add an equal volume of 25 per cent hydrochloric acid and a few crystals of resorcinol. Heat to boiling and after the production of a red color, cool the tube under running water and transfer to an evaporating dish or beaker. Make the mixture slightly alkaline with solid potassium hydroxide, return it to a test-tube, add 2-3 c.c. of acetic ether, and shake the tube vigorously. In the presence of fructose the acetic ether is colored yellow.

The only urinary constituents which interfere with the test are *nitrites* and *indican* and these interfere only when they are *simultaneously present*. Under these conditions, the urine should be acidified with acetic acid and heated to boiling for one minute to remove the nitrites. In case the indican content is *very large*, it will impart a *blue* color to the acetic ether, thus masking the yellow color due to fructose. When such urines are to be examined, the indican should first be re-

moved by Obermayer's test (see page 416). The chloroform should then be discarded, the acid-urine mixture diluted with one-third its volume of water, and the test applied as described above. The urine of patients who have ingested *santonin* or *rhubarb* responds to the test. The test will serve to detect fructose when present in a dilution of 1 : 2000, *i.e.*, 0.05 per cent.

2. **Resorcinol-Hydrochloric Acid Reaction (Seliwanoff).**—To 5 c.c. of Seliwanoff's reagent¹ in a test-tube add a few drops of the urine under examination and heat the mixture to boiling. The presence of fructose is indicated by the production of a red color and the separation of a red precipitate. The latter may be dissolved in alcohol to which it will impart a striking red color.

If the boiling be *prolonged* a similar reaction may be obtained with urines containing glucose. This has been explained² in the case of glucose as due to the transformation of the glucose into fructose by the catalytic action of the hydrochloric acid. The precautions necessary for a positive test for fructose are as follows: The concentration of the hydrochloric acid must not be more than 12 per cent. The reaction (red color) and the precipitate must be observed after not more than 20–30 seconds of boiling. Glucose must not be present in amounts exceeding 2 per cent. The precipitate must be soluble in alcohol with a bright red color.

3. **Phenylhydrazine Test.**—Make the test according to directions under Glucose, 3, page 22.

4. **Polariscopic Examination.**—A simple polariscopic examination, when taken in connection with other ordinary tests, will furnish the requisite data regarding the presence of fructose, provided fructose is not accompanied by other levorotatory substances, such as conjugate glycuronates and β -hydroxybutyric acid.

ARSENIC

When any soluble form of arsenic is introduced into the body in any way, it is quickly absorbed and distributed by the blood and lymph. The absorption is influenced by the quantity and quality of the food in the stomach, and the activity of the circulation of the part in contact with the poison. Some of the absorbed arsenic may be returned to the alimentary canal by way of the bile and gastro-intestinal mucous membrane. After absorption it may be deposited in the liver, kidneys, brain, bone, muscles, and walls of the stomach and intestines. It is eliminated in all of the excretions, but chiefly by the kidneys and through the feces. It does not appear very promptly in

¹ Seliwanoff's reagent may be prepared by dissolving 0.05 gram of resorcinol in 100 c.c. of dilute (1 : 2) hydrochloric acid.

² Koenigsfeld: *Bioch. Zeit.*, 38, 311, 1912.

the urine but continues to be excreted in the urine over a long period of time, in some cases for several months. The urine may be examined for arsenic by the following methods.

1. Marsh and Marsh-Berzelius Method.—This method has the advantage of serving as a qualitative and quantitative determination, and is a very delicate test; it is, however, long and tedious. The various steps in the analysis are: (1) the destruction of the organic matter in the urine; (2) treatment with sulphuric acid to drive off excess nitric acid and break up nitro-compounds; and (3) application of independent test to the resultant solution. Proceed as follows: The urine, to which is added one-third its volume of nitric acid, is placed in a casserole or evaporating dish and evaporated at 65° – 70° C. to a syrupy consistency. The mass is then allowed to cool and 5 c.c. concentrated sulphuric acid added, and gentle heat applied. The heating must be done cautiously, or deflagration takes place and

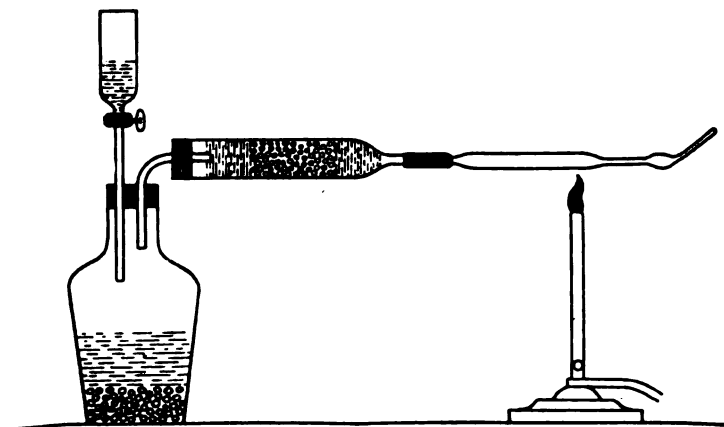

FIG. 146.—MARSH APPARATUS.

some of the arsenic is sure to be lost. The mass will liquefy and finally darken, indicating organic matter. Cool and add concentrated nitric acid, 1 c.c., and apply very gentle heat; copious reddish-brown fumes are evolved. Gradually raise the temperature until darkening of the solution occurs, then cool, add 1 c.c. concentrated nitric acid and again apply gentle heat, and repeat the process until the solution fails to darken. Now raise the temperature until white fumes begin to come off. At this temperature excess nitric acid will have been removed and all nitro-compounds broken up. The solution at this point is clear and at most a pale straw color. Cool and add a mixture of 10 c.c. concentrated sulphuric acid and 40 c.c. water, and test for arsenic using a Marsh apparatus. The apparatus (see Fig. 146, above) consists of a wide-mouth flask—250 c.c. capacity—fitted with a two-hole stopper. Through one hole is passed the stem of a separatory funnel of 50 to 60 c.c. capacity. Through the other hole a piece of glass tube bent at right angles, which is fitted to a calcium chloride tube, and this in turn to a narrow quartz tube, the distal end of which is drawn to a fine bore and bent up almost at a right angle. All joints must be air-tight.

Introduce 30 to 40 grams of arsenic-free granulated zinc into the flask, insert the stopper and through the funnel introduce 50 c.c. dilute sulphuric acid (1 part

to 4 parts water). After a few minutes collect a test-tube of gas by inverting a test-tube over the end of the quartz tube, and test it by igniting. When the gas in the test-tube ignites quietly, light the gas issuing from the quartz tube.

Hold a clean porcelain crucible lid in the flame and note whether any deposit occurs. This precaution must be taken to insure that the chemicals and apparatus are not contaminated with arsenic.

Now introduce the prepared urine solution into the funnel and adjust the flow so that 6 to 8 drops are introduced into the flask per minute. Immediately hold a clean porcelain crucible lid in the flame and at the first evidence of a dark deposit apply heat, using a wing-top burner, to the quartz tube. The arsenic if present will deposit in the quartz tube beyond the flame. Now test the spot on the lid to see if it is arsenic; it should dissolve readily in sodium hypochlorite solution. Continue the operation for two hours, remove the Bunsen burner and again hold the lid in the flame. If no more deposits on the lid, the arsenic has all come over and is deposited in the quartz tube; if deposition occurs, apply the Bunsen again and repeat.

When complete, remove the quartz tube, weigh it after cooling, then dissolve out the arsenic with nitric acid, wash, dry, and weigh again. The difference in weight is the weight of metallic arsenic in the volume of urine taken.

2. **Reinsch's Test.**—This test is very much simpler, but not so delicate. It has the advantage of application in the presence of organic matter. The test is performed as follows: The urine, acidified with one-fifth its volume of pure hydrochloric acid, is placed in a beaker. A piece of bright copper foil free from arsenic is then introduced, and the urine heated almost to the boiling-point. It is then set aside for six to eight hours. The arsenic is deposited on the copper foil, bluish-gray color. The foil is then removed, washed successively in pure water, alcohol, ether, and dried without heat. The foil is then rolled into a scroll and inserted into a 3 mm. bore glass tube 4 inches long, about 1 inch from the end. The tube is then held in the Bunsen flame at an angle of 20 to 25 degrees applying heat where the copper foil is situated. The arsenic volatilizes and is oxidized, and deposits as octahedral crystals of arsenic trioxide on the cooler part of the tube. The crystals can readily be recognized by the microscope and sometimes with a simple magnifying lens.

MERCURY

The rapidity of absorption of mercury depends upon a number of conditions such as, mode of administration, the nature of the compound and its physical state, the state and condition of the stomach and intestines, the quantity and quality of the food in the stomach and the state of the circulation of the portal of entrance. There is no definite knowledge as to the form in which it is absorbed. Elimination depends upon the state of the excretory organs. It is eliminated as an albuminate in all the excretions of the body, urine, feces, saliva, sweat, tears, and milk. Elimination begins about two hours after introduction. Depending upon the amount introduced and absorbed, the time required for its complete elimination varies from 24 hours to many weeks. Mercury may be detected in the urine by the following methods.

1. **Reinsch's Test**.—The procedure is carried out in the same manner as for arsenic (see above). A piece of arsenic-free copper foil is introduced into the urine acidified with one-fifth its volume of pure hydrochloric acid. The urine is, however, not heated to boiling, but warmed to 50° or 60° and set aside for 12 hours or preferably 24 hours. Metallic mercury is deposited on the foil as a bright lustrous mirror. The foil is then washed with pure water, alcohol, ether, and dried without heat, rolled into a scroll, inserted into a glass tube and heated in the same manner as under arsenic. The mercury is deposited in the metallic state in the form of globules readily distinguished with the microscope.

2. **Amalgamation Test**.—A more rapid method than the above is by amalgamation with zinc. Add 5 grams of zinc dust to the urine and heat for 15 minutes, stirring continuously. Allow the amalgamated zinc to settle and decant the urine. Then wash by decantation several times with pure water, then with alcohol, and finally with ether and dry in air. Now introduce the dry zinc into a narrow dry glass tube sealed at one end. With the Bunsen soften the tube about 2 inches above the zinc and constrict the tube by pulling the ends apart. Introduce a small bit of glass wool or asbestos sufficient to support a small piece of iodine. Introduce the iodine supported by the asbestos at the constriction. Apply heat to the zinc amalgam, and then gently to the region holding the iodine to gently volatilize it, and immediately reapply heat to the zinc. The mercury volatilizes and meeting the iodine vapor unites with it, and is deposited as the red iodide of mercury.

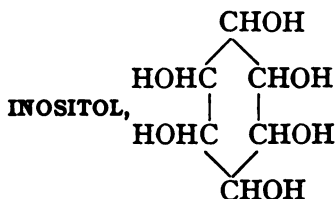

Inositol occasionally occurs in the urine in albuminuria, diabetes mellitus, and diabetes insipidus. It is claimed also that copious water-drinking causes this substance to appear in the urine. Inositol was at one time considered to be a sugar but is now known to be hexahydroxybenzene, as the above formula indicates. It is an example of a non-carbohydrate in whose molecule the H and O are present in the proportion to form water. In other words it has the formula of the hexoses, *i.e.*, $C_6H_{12}O_6$. Inositol occurs widely distributed in the vegetable kingdom, and because of this fact the theory has been voiced that it represents one of the first stages in the conversion of a carbohydrate into the benzene ring. It is found in the liver, spleen, lungs, brain, kidneys, suprarenal capsules, muscles, leucocytes, testes, and urine under normal conditions.

EXPERIMENT

1. **Detection of Inositol (Scherer)**.—Acidify the urine with concentrated nitric acid and evaporate nearly to dryness. Add a few drops of ammonium hydroxide

and a little calcium chloride solution to the moist residue and evaporate the mixture to dryness. In the presence of inositol (0.001 gram) a bright red color is obtained.

For a more satisfactory test, which is also more time-consuming, see Salkowski's¹ modification of Scherer's test.

LAIOSE

This substance is *occasionally* found in the urine in severe cases of diabetes mellitus. By some investigators laiose is classed with the sugars. It resembles fructose in that it has the property of reducing certain metallic oxides and is levorotatory, but differs from fructose in being amorphous, non-fermentable, and in not possessing a sweet taste.

MELANINS

These pigments never occur normally in the urine, but are present under certain pathological conditions, their presence being especially associated with melanotic tumors. Ordinarily the freshly passed urine is clear, but upon exposure to the air the color deepens and may at last be very dark brown or black in color. The pigment is probably present in the form of a chromogen or melanogen and upon coming into contact with the air oxidation occurs, causing the transformation of the melanogen into melanin and consequently the darkening of the urine.

It is claimed that melanuria is proof of the formation of a visceral melanotic growth. In many instances, without doubt, urines rich in indican have been wrongly taken as diagnostic proof of melanuria. The pigment melanin is sometimes mistaken for indigo and melanogen for indican. It is comparatively easy to differentiate between indigo and melanin through the solubility of the former in chloroform.

In rare cases melanin is found in urinary sediment in the form of fine amorphous granules.

EXPERIMENTS

1. **Ferric Chloride Reaction (von Jaksch-Pollak).**—Add a few drops of ferric chloride solution to 10 c.c. of urine in a test-tube and note the formation of a gray color. Upon the further addition of the chloride a dark precipitate forms, consisting of phosphates and adhering melanin. An excess of ferric chloride causes the precipitate to dissolve.

This is the most satisfactory test for the identification of melanin in the urine.

2. **Bromine Test (Zeller).**—To 50 c.c. of urine in a small beaker add an equal volume of bromine water. In the presence of melanin a yellow precipitate will form and will gradually darken in color, ultimately becoming black.

¹ Salkowski: *Zeit. physiol. chem.*, 69, 478, 1910.

UROROSEIN

This is a pigment which is not present in normal urine but may be detected in the urine in various diseases, such as pulmonary tuberculosis, typhoid fever, nephritis, and stomach disorders. Urorosein, in common with various other pigments, does not occur preformed in the urine, but is present in the form of a chromogen, which is transformed into the pigment upon treatment with a mineral acid. Herter¹ showed this chromogen to be indole acetic acid,

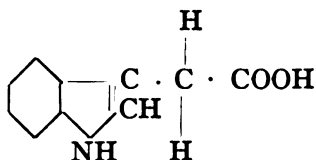

Normal urine responds to the urorosein reaction (see below) if nitrites are present.

EXPERIMENTS

1. **Nitrite-Hydrochloric Acid Test (Urorosein Reaction).**—To 10 c.c. of urine in a test-tube add 2 c.c. of concentrated hydrochloric acid and a few drops of a 1 per cent solution of potassium nitrite. A rose-red color indicates urorosein.

The chromogen (indole acetic acid) has been changed into urorosein by oxidation.

2. **Robin's Reaction.**—Acidify 10 c.c. of urine with about 15 drops of concentrated hydrochloric acid. Upon allowing the acidified urine to stand, a rose-red color will appear if urorosein is present.

3. **Nencki and Sieber's Reaction.**—To 100 c.c. of urine in a beaker add 10 c.c. of 25 per cent sulphuric acid. Allow the acidified urine to stand and note the appearance of a rose-red color. The pigment may be separated by extraction with amyl alcohol.

NEPHROROSEIN

This pigment is closely related to urorosein² and like urorosein it is produced from a chromogen when the urine is treated with nitric acid or with concentrated hydrochloric acid and a little sodium nitrite solution. It is sometimes called β -urorosein to differentiate it from the true urorosein which is termed α -urorosein. Nephrorosein occurs only in pathological urines.

UROCHROMOGEN

This is the chromogen of urochrome, the normal urinary pigment (see Chapter XXII). It is claimed that the *urochromogen reaction* of the

¹ Herter: *Jour. Biol. Chem.*, 4, 253, 1908.

² Arnold: *Zeit. physiol. Chem.*, 71.

urine is an aid to prognosis and diagnosis of pulmonary tuberculosis. Urochromogen is not present in normal urine. Its presence in pathological urine is due probably to faulty oxidation, *i.e.*, failure to oxidize the chromogen to urochrome. Urochromogen may be detected by oxidizing it to urochrome by means of potassium permanganate. In this process a certain antecedent of urochromogen is also oxidized to urochrome. Whereas the diazo reaction (see page 483) is also given by urines containing urochromogen, it is claimed that the diazo reaction does not show the presence of the precursor of urochromogen. Hence the urochromogen reaction is said to be more constant and uniform in its appearance.

EXPERIMENT

Urochromogen Reaction (Weisz).¹—Fill a test-tube a little less than one-third full of urine, dilute it with 2 volumes of distilled water and mix thoroughly. Pour one-half the diluted urine into another tube and to one of the tubes add 3 drops of a 1 per cent solution of potassium permanganate. Shake the tube thoroughly. In the presence of urochromogen a yellow tint will appear in the tube to which permanganate was added.

The reaction is due to the oxidation of urochromogen to urochrome, and is believed to be of value as an aid in prognosis and diagnosis of pulmonary tuberculosis. The presence of sugar, albumin or urobilin in low concentration does not interfere with the test. The test often runs parallel with the diazo reaction (see below). The test is supposed to be positive when the focus of the lung is so active or extensive as to flood the blood with toxins or to break down the defensive forces of the body. It is claimed, therefore, that this test will differentiate the cases in which the tuberculosis is beyond help from the tuberculin from those in which the body is liable to respond favorably to its action.² Some investigators claim the test is not specific and that a positive reaction will be obtained in many disorders other than tuberculosis.³

¹ Weisz: *Munch. med. Woch.*, 58, 1348, 1911.

Vitri: *Semana Medica*, 20, No. 28, 1913.

Hefebower: *Am. Jour. Med. Sci.*, 143, 221, 1912.

Metzger and Watson: *Jour. Am. Med. Ass'n*, 62, 1886, 1914.

Pignacca: *Gazetta d. Osp. e delle Clin.*, 25, 353, 1914.

Ferrannini: *Riforma med.*, 31, 479, 1915.

² M. and A. Weisz: *Wien. klin. Woch.*, 25, 1183, 1912.

Dozzi: *Gazetta d. Osp. e delle Clin.*, 34, 815, 1914.

Burgess: *Jour. Am. Med. Ass'n*, 66, 82, 1916.

³ Tuliato: *Gazetta d. Osp. e delle Clin.*, 35, 1914.

Martelli and Pizzetti: *Policlinico*, 21, April 1, 1914.

UNKNOWN SUBSTANCES

1. Ehrlich's Diazo Reaction.—Place equal volumes of urine and Ehrlich's diazobenzenesulphonic acid reagent¹ in a test-tube, mix thoroughly by shaking, and quickly add ammonium hydroxide in excess. The test is positive if both the fluid and the foam assume a red color. If the tube is allowed to stand a precipitate forms, the upper portion of which exhibits a blue, green, greenish-black, or violet color. Normal urine gives a brownish-yellow reaction with the above manipulation.

The exact nature of the substance or substances upon whose presence in the urine this reaction depends is not well understood. Some investigators claim that a positive reaction indicates an abnormal decomposition of protein material, whereas others assume it to be due to an increased excretion of alloxypoteic acid, oxyproteic acid, or uroferic acid. Weisz² claims that urochromogen is the principal urinary substance which causes a positive diazo reaction.

The reaction may be taken as a metabolic symptom of certain disorders, which is of value diagnostically *only* when taken in connection with the other symptoms. The reaction appears principally in the urine in febrile disorders and in particular in the urine in typhoid fever, tuberculosis, and measles. The reaction has also been obtained in the urine in various other disorders such as carcinoma, chronic rheumatism, diphtheria, erysipelas, pleurisy, pneumonia, scarlet fever, syphilis, typhus, etc. The administration of alcohol, chrysarobin, creosote, cresol, dionin, guaiacol, heroin, morphine, naphthalene, opium, phenol, tannic acid, etc., will also cause the urine to give a positive reaction.

The following chemical reactions take place in this test:

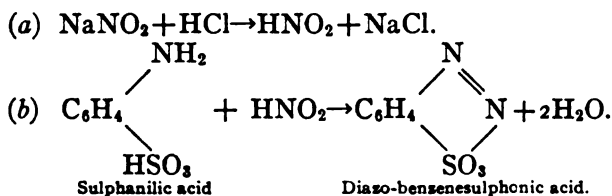

¹ Two separate solutions should be prepared and mixed in definite proportions when needed for use:

(a) Five grams of sodium nitrite dissolved in 1 liter of distilled water.

(b) Five grams of sulphanilic acid and 50 c.c. of hydrochloric acid in 1 liter of distilled water.

Solutions *a* and *b* should be preserved in well-stoppered vessels and mixed in the proportion 1:50 when required. Green asserts that greater delicacy is secured by mixing the solutions in the proportion 1:100. The sodium nitrite deteriorates upon standing and becomes unfit for use in the course of a few weeks.

² Weisz: *Munch. med. Woch.*, 58, 1348, 1911.

2. **Methylene Blue Reaction (Russo).**¹—To 5 c.c. of urine add 4 drops of a 0.1 per cent solution of methylene blue. In cases of typhoid fever, measles, smallpox and certain other disorders there will be a change in color from blue to green. In normal urine the blue color persists. The test is sometimes used as a substitute for the diazo reaction (see p. 483).

PHENOLSULPHONEPHTHALEIN TEST FOR KIDNEY EFFICIENCY

This test for renal function was devised by Rowntree and Geraghty.² It depends upon the injection into the tissues of a dyestuff which is eliminated rapidly by the normal kidneys, and can be easily estimated quantitatively in the urine.

This dyestuff, phenolsulphonephthalein, is non-irritative to the body either when taken by mouth or when injected into the tissues,³ so that it does no harm to an already weakened kidney.

The patient upon whom the test is to be performed is given 300–400 c.c. of water 20–30 minutes previously, in order to assure a free flow of urine.

The procedure is as follows: One c.c. of a solution containing 6 mg. of phenolsulphonephthalein⁴ is injected intramuscularly in the lumbar region, the time of injection being noted. The patient is then catheterized and the urine as it forms thereafter allowed to drop into a beaker containing 2 drops of 25 per cent NaOH. The appearance of a red color in the alkalized urine indicates beginning excretion of the drug, the normal time being within 5 to 10 minutes after its injection. Urine is now collected in one-hour samples. In patients with obstruction to the flow of urine from the bladder the retention catheter is stoppered and the urine drawn off at the end of each hour. Other patients may simply be allowed to urinate at the hourly periods.

To each hour sample of urine is added 25 per cent NaOH, drop by drop, until the maximum intensity of color appears. This color will remain constant for an indefinite period of time. Each sample is then placed in a 1000 c.c. volumetric flask and diluted to the mark with distilled water.

Comparison is made in a Duboscq (Hellige or Sargent) colorimeter (see p. 514) with a standard consisting of 3 mg. of phenolsulphonephthalein in 1000 c.c. of solution. The cylinder containing the standard may conveniently be placed at the 10 mm. mark. Since the volume of each urine sample is the same as that of the standard, the percentage elimination of phenolsulphonephthalein in each may be easily calculated as follows:

¹ Russo: *Riforma med.*, No. 19, 1905.

Peskow: *Semaine med.*, 103, 1912.

da Pozzo: *Gaz. Osp. Clin.*, 35, 865, 1914.

² Rowntree and Geraghty: *Jour. Pharm. and Exper. Therap.*, 1, 579, 1910; also *Arch. Int. Med.*, March, 1912, p. 284.

³ Abel and Rowntree: *Jour. Pharm. and Exper. Therap.*, 1, 231, 1910.

⁴ This solution is prepared by adding 0.6 gram phenolsulphonephthalein and 0.84 c.c. of 2/N NaOH to enough 0.75 per cent NaCl solution to make 100 c.c. This gives the monosodium or acid salt which is slightly irritant locally when injected. It is necessary to add 2–3 drops more 2/N NaOH which changes the color to a bordeaux red. This preparation is non-irritant.

Reading of Urine:Reading of Standard::100:X.

The amount of the drug eliminated normally is 40-60 per cent during the first hour and 20-25 per cent during the second hour, or a total of 60-85 per cent for two hours. The amount of the drug excreted has been found to be independent of the quantity of urine obtained. In case of delayed excretion the collection of hourly samples may be continued until practically all of the drug has been recovered in the urine.

If it is desired to test the function of each kidney separately, ureteral catheterization must be resorted to, the experiment otherwise being performed as above described.

The phenolsulphonophthalein test may be used to indicate the amount of derangement in quantitative functional disturbance of the kidneys, as in chronic interstitial and chronic parenchymatous nephritis or uremia.

McLean¹ has very recently suggested a method for studying kidney function which is based upon the relationship between the urea content of the blood and the rate at which the urea is excreted by the kidney. It gives similar values to the phenolsulphonophthalein test. It has an advantage in that it enables one to measure kidney function by a study of an actual normal function of the organ, *i.e.*, urea excretion. The method, however, is more or less complex.

¹ McLean: *Jour. Am. Med. Ass'n*, 66, 415, 1916.

CHAPTER XXV

URINE: ORGANIZED AND UNORGANIZED SEDIMENTS

THE data obtained from carefully conducted microscopical examinations of the sediment of certain pathological urines are of very great importance diagnostically. Too little emphasis is sometimes placed upon the value of such findings.

The sedimentary constituents may be divided into two classes, *i.e.*, *organized* and *unorganized*. The sediment is ordinarily collected



FIG. 147.—THE PURDY ELECTRIC CENTRIFUGE.



FIG. 148.—SEDIMENT TUBE FOR THE
PURDY ELECTRIC CENTRIFUGE.

for examination by means of the centrifuge (Fig. 147). An older method, and one still in vogue in some quarters, is the so-called *gravity* method. This simply consists in placing the urine in a conical glass and allowing the sediment to settle. The collection of the sediment by means of the centrifuge, however, is much preferable, since the process of sedimentation may be accomplished by the use of this instrument in a few minutes, and far more perfectly, whereas when the other method is used it is frequently necessary to allow the urine to remain in the con-

ical glass 12–24 hours before sufficient sediment can be secured for the microscopical examination.

(a) Unorganized Sediments

Ammonium magnesium phosphate (“triple phosphate”).

Calcium oxalate.

Calcium carbonate.

Calcium phosphate.

Calcium sulphate.

Uric acid.

Urates.

Cystine.

Cholesterol.

Hippuric acid.

Leucine (?) and tyrosine.

Hematoidin and bilirubin.

Magnesium phosphate.

Indigo.

Xanthine.

Melanin.

Ammonium Magnesium Phosphate (“Triple Phosphate”).—

Crystals of “triple phosphate” are a characteristic constituent of the sediment when alkaline fermentation of the urine has taken place either *before* or *after* being voided. They may even be detected in amphoteric or *slightly* acid urine provided the ammonium salts are present in large enough quantity. This substance may occur in the sediment in two forms, *i.e.*, prisms and the feathery type. The prismatic form of crystals (Fig. 143, page 436) is the one most commonly observed in the sediment; the feathery form (Fig. 143, page 436) predominates when the urine is made ammoniacal with ammonia.

The sediment of the urine in such disorders as are accompanied by a retention of urine in the lower urinary tract contains “triple phosphate” crystals as a characteristic constituent. The crystals are frequently abundant in the sediment during paraplegia, chronic cystitis, enlarged prostate, and chronic pyelitis.

Calcium Oxalate.—Calcium oxalate is found in the urine in the form of at least two distinct types of crystals, *i.e.*, the *dumb-bell* type and the *octahedral* type (Fig. 149, page 488). Either form may occur in the sediment of neutral, alkaline, or acid urine, but both forms are found most frequently in urine having an acid reaction. Occasionally, in alkaline urine, the octahedral form is confounded with “triple phos-

phate" crystals. They may be differentiated from the phosphate crystals by the fact that they are insoluble in acetic acid.

The presence of calcium oxalate in the urine is not of itself a sign of any abnormality, since it is a constituent of normal urine. It is increased above the normal, however, in such pathological conditions as diabetes



FIG. 149.—CALCIUM OXALATE. (Ogden.)

mellitus, in organic diseases of the liver, and in various other conditions which are accompanied by a derangement of digestion or of the oxidation mechanism, such as occurs in certain diseases of the heart and lungs.

Calcium Carbonate.—Calcium carbonate crystals form a typical constituent of the urine of herbivorous animals. They occur less fre-

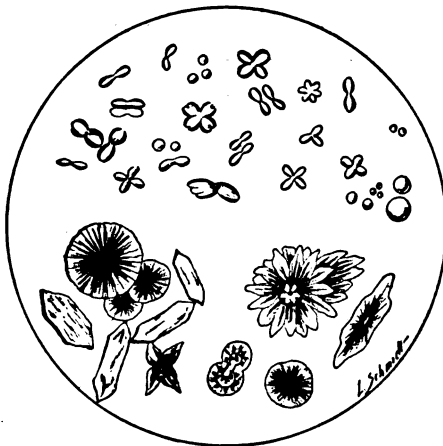

FIG. 150.—CALCIUM CARBONATE.

quently in human urine. The reaction of urine containing these crystals is nearly always alkaline, although they may occur in amphoteric or in *slightly* acid urine. It generally crystallizes in the form of granules, spherules, or dumb-bells (Fig. 150). The crystals of calcium carbonate may be differentiated from calcium oxalate by the

fact that they dissolve in acetic acid with the evolution of carbon dioxide gas.

Calcium Phosphate (Stellar Phosphate).—Calcium phosphate may occur in the urine in three forms, *i.e.*, amorphous, granular, or crystalline. The crystals of calcium phosphate are ordinarily pointed, wedge-shaped formations which may occur as individual crystals or grouped together in more or less regularly formed rosettes (Fig. 119, page 351). Acid sodium urate crystals (Fig. 152, page 491) are often mistaken for crystals of calcium phosphate. We may differentiate between these two crystalline forms by the fact that acetic acid will readily dissolve the phosphate, whereas the urate is much less soluble and when finally brought into solution and recrystallized one is frequently enabled to identify uric acid crystals which have been formed from the acid urate solution. The clinical significance of the occurrence of calcium phosphate crystals in the urinary sediment is similar to that of "triple phosphate" (see page 436).

Calcium Sulphate.—Crystals of calcium sulphate are of quite rare occurrence in the sediment of urine. Their presence seems to be limited in general to urines which are of a decided acid reaction. Ordinarily it crystallizes in the form of long, thin, colorless needles or prisms (Fig. 142, page 433) which may be mistaken for calcium phosphate crystals. There need be no confusion in this respect, however, since the sulphate crystals are insoluble in acetic acid, which reagent readily dissolves the phosphate. As far as is known their occurrence as a constituent of urinary sediment is of very little clinical significance.

Uric Acid.—Uric acid forms a very common constituent of the sediment of urines which are acid in reaction. It occurs in more varied forms than any of the other crystalline sediments (Plate V, opposite page 408, and Fig. 151), some of the more common varieties of crystals being rhombic prisms, wedges, dumb-bells, whetstones, prismatic rosettes, irregular or hexagonal plates, etc. Crystals of pure uric acid are always colorless (Fig. 136, page 408), but the form occurring in urinary sediments is impure and under the microscope appears pigmented, the depth of color varying from yellow to a dark reddish-brown according to the size and form of the crystal.

The presence of a considerable uric acid sediment does not, of necessity, indicate a pathological condition or a urine of increased uric acid content, since this substance very often occurs as a sediment in urines whose uric acid content is diminished from the normal merely as a result of changes in reaction, etc. Pathologically, uric acid sediments occur in gout, acute febrile conditions, chronic interstitial nephritis, etc. If the microscopical examination is not conclusive, uric acid may be

differentiated from other crystalline urinary sediments from the fact that it is soluble in alkalis, alkali carbonates, boiling glycerol, concentrated sulphuric acid, and in certain organic bases such as ethylamine and piperidin. It also responds to the murexide test (see page 408), Schiff's reaction (see page 409) and to Folin's phosphotungstic acid reaction (see page 409).

Urates.—The urate sediment may consist of a mixture of the urates of ammonium, calcium, magnesium, potassium, and sodium. The ammonium urate may occur in neutral, alkaline, or acid urine, whereas the other forms of urates are confined to the sediments of acid urines. Sodium urate occurs in sediments more abundantly than the other



FIG. 151.—VARIOUS FORMS OF URIC ACID.

1, Rhombic plates; 2, whetstone forms; 3, 3, quadrate forms; 4, 5, prolonged into points; 6, 8, rosettes; 7, pointed bundles; 9, barrel forms precipitated by adding hydrochloric acid to urine.

urates. There are two sodium urates, the *mono* and the *di*, which may be expressed thus $\text{Na}^+ \text{H}^+ \rangle \text{C}_5\text{H}_2\text{N}_4\text{O}_3^-$ and $\text{Na}^+ \text{Na}^+ \rangle \text{C}_5\text{H}_2\text{N}_4\text{O}_3^-$. Both salts dissociate with the production of an alkaline reaction, the alkalinity being stronger in the case of the di-sodium urate. The so-called *quadriurate* or *hemiurate* have no existence as chemical units.¹ The urates of calcium, magnesium, and potassium are amorphous in character, whereas the urate of ammonium is crystalline. Sodium urate may be either amorphous or crystalline. When crystalline it forms groups of fan-shaped clusters or colorless, prismatic needles (Fig.

¹ Taylor: *Jour. Biol. Chem.*, 1, 177, 1905.

1111
1111
1111
1111
1111

1111
1111
1111
1111
1111



)

1111
1111

1111
1111
1111
1111
1111
1111
1111
1111
1111
1111

PLATE VI.

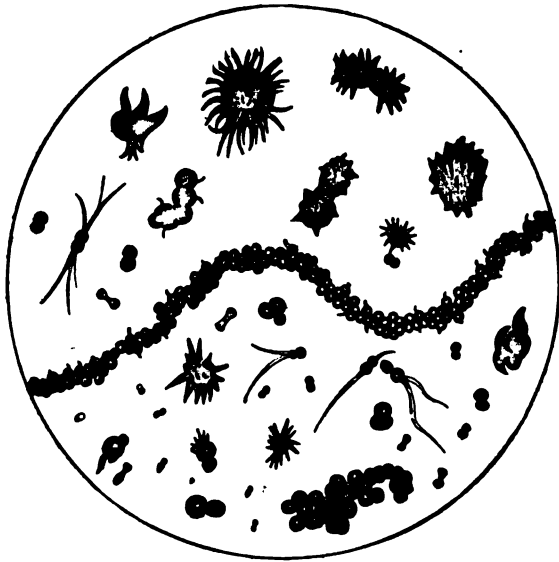

AMMONIUM URATES, SHOWING SPHERULES AND THORN-APPLE-SHAPED CRYSTALS.
(From *Ogden*, after *Peyer*.)

152). Ammonium urate is ordinarily present in the sediment in the burr-like form of the "thorn-apple" crystal, *i.e.*, yellow or reddish-brown spheres, covered with sharp spicules or prisms (Plate VI, opposite). The urates are all soluble in hydrochloric acid or acetic acid and their acid solutions yield crystals of uric acid upon standing. They also respond to the murexide test. The clinical significance of



FIG. 152.—ACID SODIUM URATE.

urate sediments is very similar to that of uric acid. A considerable sediment of amorphous urates does not necessarily indicate a high uric acid content, but ordinarily signifies a concentrated urine having a very strong acidity.

Cystine.—Cystine is one of the rarer of the crystalline urinary sediments. It has been claimed that it occurs more often in the urine of

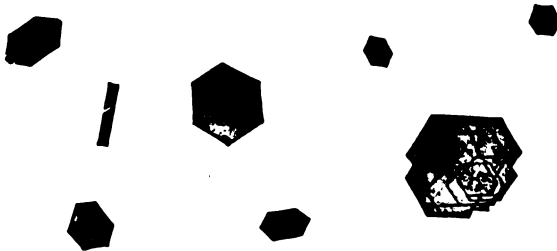

FIG. 153.—CYSTINE. (*Ogden.*)

men than of women. Cystine crystallizes in the form of thin, colorless, hexagonal plates (Fig. 26, page 76, and Fig. 153) which are insoluble in water, alcohol, and acetic acid, and soluble in mineral acids, alkalis, and especially in ammonia. Cystine may be identified by burning it upon platinum foil, under which condition it does not

melt but yields a bluish-green flame. For preparation of Cystine see Chapter IV.

Cholesterol.—Cholesterol crystals have been but rarely detected in urinary sediments. When present they probably arise from a pathological condition of some portion of the urinary tract. Crystals of cholesterol have been found in the sediment in cystitis, pyelitis, chyluria, and nephritis. Ordinarily it crystallizes in large regular and irregular colorless, transparent plates, some of which possess notched corners (Fig. 63, page 214). Frequently, instead of occurring in the sediment, it is found in the form of a film on the surface of the urine.

Hippuric Acid.—This is one of the rare sediments of human urine. It deposits under conditions similar to those which govern the formation

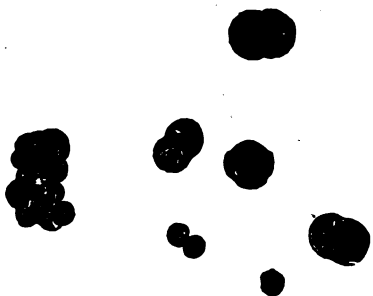

FIG. 154.—CRYSTALS OF IMPURE LEUCINE. (Ogden.)

of uric acid sediments. The crystals, which are colorless needles or prisms (Fig. 139, page 417) when pure, are invariably pigmented in a manner similar to the uric acid crystals when observed in urinary sediment and because of this fact are frequently confounded with the rarer forms of uric acid. Hippuric acid may be differentiated from uric acid from the fact that it does not respond to the murexide test and is much more

soluble in water and in ether. The detection of crystals of hippuric acid in the urine has very little clinical significance, since its presence in the sediment depends in most instances very greatly upon the nature of the diet. It is particularly prone to occur in the sediment after the ingestion of certain fruits as well as after the ingestion of benzoic acid (see pages 416 and 609).

Leucine and Tyrosine.—Leucine and tyrosine have frequently been detected in the urine, either in solution or as a sediment. Neither of them occurs in the urine ordinarily except in association with the others, *i.e.*, whenever leucine is detected it is more than probable that tyrosine accompanies it. They have been found pathologically in the urine in acute yellow atrophy of the liver, in acute phosphorus poisoning, in cirrhosis of the liver, in severe cases of typhoid fever and small-pox, and in leukemia. In urinary sediments leucine ordinarily crystallizes in characteristic spherical masses which show both radial and concentric striations and are highly refractive (Fig. 154). Some investigators claim that these crystals which are ordinarily called leucine are, in reality, generally urates. This view point has become more general in recent years. For the crystalline form of pure leucine

obtained as a decomposition product of protein see Fig. 28, page 80. Tyrosine crystallizes in urinary sediments in the well-known sheaf or tuft formation (Fig. 25, page 76). For other tests on leucine and tyrosine see pages 86 and 87.

Hematoidin and Bilirubin.—There are divergent opinions regarding the occurrence of these bodies in urinary sediment. Each of them crystallizes in the form of tufts of small needles or in the form of small plates which are ordinarily yellowish-red in color (Fig. 62, page 209). Because of the fact that the crystalline form of the two substances is identical many investigators claim them to be one and the same body. Other investigators claim, that while the crystalline form is the same in each case, there are certain chemical differences which may be brought out very strikingly by properly testing. For instance, it has been claimed that hematoidin may be differentiated from bilirubin through the fact that it gives a momentary color reaction (blue) when nitric acid is brought into contact with it, and, further, that it is not dissolved on treatment with ether or potassium hydroxide. Pathologically, typical crystals of hematoidin or bilirubin have been found in the urinary sediment in jaundice, acute yellow atrophy of the liver, carcinoma of the liver, cirrhosis of the liver, and in phosphorus poisoning, typhoid fever, and scarlatina.

Magnesium Phosphate.—Magnesium phosphate crystals occur rather infrequently in the sediment of urine which is neutral, alkaline, or *feebly* acid in reaction. It ordinarily crystallizes in elongated, highly refractive, rhombic plates which are soluble in acetic acid.

Indigo.—Indigo crystals are frequently found in urine which has undergone alkaline fermentation. They result from the breaking down of indoxyl-sulphates or indoxyl-glycuronates. Ordinarily indigo deposits as dark blue stellate needles or occurs as amorphous particles or broken fragments. These crystalline or amorphous forms may occur in the sediment or may form a blue film on the surface of the urine. Indigo crystals generally occur in urine which is alkaline in reaction, but they have been detected in acid urine.

Xanthine.—Xanthine is a constituent of normal urine but is found in the sediment in crystalline form very infrequently, and then only in pathological urine. When present in the sediment xanthine generally occurs in the form of whetstone-shaped crystals somewhat similar in form to the whetstone variety of uric acid crystal. They may be differentiated from uric acid by the great ease with which they may be brought into solution in dilute ammonia and on applying heat. Xanthine may also form urinary calculi. The clinical significance of xanthine in urinary sediment is not well understood.

Melanin.—Melanin is an extremely rare constituent of urinary sediments. Ordinarily in melanuria the melanin remains in solution; if it separates it is generally held in suspension as fine amorphous granules.

(b) Organized Sediments

Epithelial cells.

Pus cells.

Casts.	}	Hyaline.
		Granular.
		Epithelial.
		Blood.
		Fatty.
		Waxy.
		Pus.

Cylindroids.

Erythrocytes.

Spermatozoa.

Urethral filaments.

Tissue débris.

Animal parasites.

Micro-organisms.

Fibrin.

Foreign substances due to contamination.

Epithelial Cells.—The detection of a certain number of these cells in urinary sediment is not, of itself, a pathological sign, since they occur in normal urine. However, in certain pathological conditions they are greatly *increased* in number, and since different areas of the urinary tract are lined with different forms of epithelial cells, it becomes necessary, when examining urinary sediments, to note not only the relative number of such cells, but at the same time to carefully observe the shape of the various individuals in order to determine, as far as possible, from what portion of the tract they have been derived. Since the different layers of the epithelial lining are composed of cells different in form from those of the associated layers, it is evident that a careful microscopical examination of these cells may tell us the particular layer which is being desquamated. It is frequently a most difficult undertaking, however, to make a clear differentiation between the various forms of epithelial cells present in the sediment. If skillfully done, such a microscopical differentiation may prove to be of very great diagnostic aid.

The principal forms of epithelial cells met with in urinary sediments are shown in Fig. 155, page 495.

Pus Cells.—Pus corpuscles or leucocytes are present in extremely small numbers in normal urine. Any considerable increase in the number, however, ordinarily denotes a pathological condition, generally an acute or chronic inflammatory condition of some portion of the urinary tract. The sudden appearance of a large amount of pus in a sediment denotes the opening of an abscess into the urinary tract. Other form elements, such as epithelial cells, casts, etc., ordinarily accompany pus corpuscles in urinary sediment and a careful examination of these associated elements is necessary in order to form a correct diagnosis as to the origin of the pus. Protein is always present in urine which contains pus.

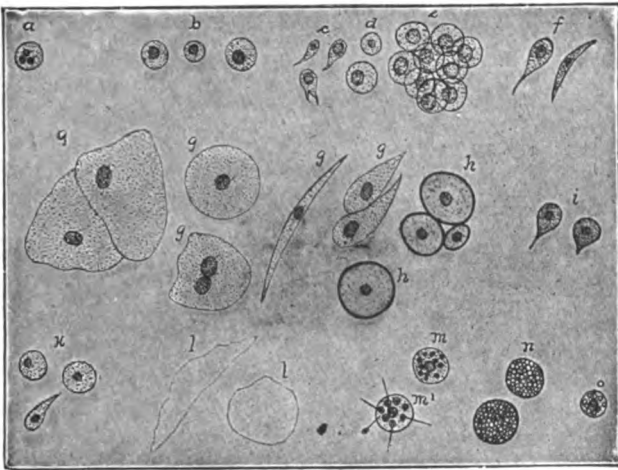

FIG. 155.—EPITHELIUM FROM DIFFERENT AREAS OF THE URINARY TRACT.

a, Leucocyte (for comparison); *b*, renal cells; *c*, superficial pelvic cells; *d*, deep pelvic cells; *e*, cells from calices; *f*, cells from ureter; *g*, *g*, *g*, *g*, squamous epithelium from the bladder; *h*, *h*, neck-of-bladder cells; *i*, epithelium from prostatic urethra; *k*, urethral cells; *l*, *l*, scaly epithelium; *m*, *m'*, cells from seminal passages; *n*, compound granule cells; *o*, fatty renal cell. (*Ogden*.)

The appearance which pus corpuscles exhibit under the microscope depends greatly upon the reaction of the urine containing them. In acid urine they generally present the appearance of round, colorless cells composed of refractive, granular protoplasm, and may frequently exhibit ameboid movements, especially if the slide containing them be warmed slightly. They are nucleated (one or more nuclei), the nuclei being clearly visible only upon treating the cells with water, acetic acid, or some other suitable reagent. In urine which has a decided alkaline reaction, on the other hand, the pus corpuscles are often greatly degenerated. They may be seen as swollen, transparent cells, which exhibit no granular structure and as the process of degeneration con-

tinues the cell outline ceases to be visible, the nuclei fade, and finally only a mass of débris containing isolated nuclei and an occasional cell remains.

It is frequently rather difficult to make a differentiation between pus corpuscles and certain types of epithelial cells which are similar in form. Such confusion may be avoided by the addition of iodine solution (I in KI), a reagent which stains the pus corpuscles a deep mahogany-brown and transmits to the epithelial cells a light yellow tint. The test proposed by Vitali often gives very satisfactory results. This simply consists in acidifying the urine (if alkaline) with acetic acid, then filtering, and treating the sediment on the filter paper with freshly prepared tincture of guaiac. The presence of pus in the sediment is indicated

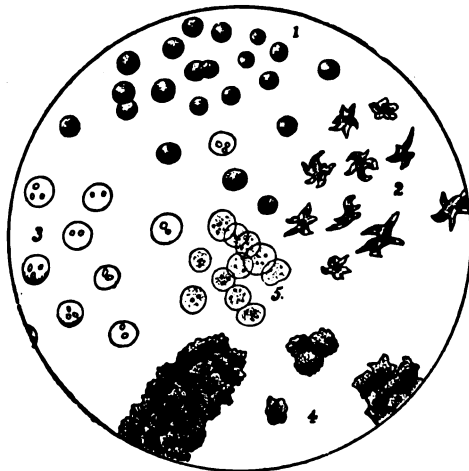

FIG. 156.—PUS CORPUSCLES. (After *Ullmann*.)

1, Normal; 2, showing amoeboid movements; 3, nuclei rendered distinct by acetic acid; 4, as observed in chronic pyelitis; 5, swollen by ammonium carbonate.

if a *blue* color is observed. Large numbers of pus corpuscles are present in the urinary sediment in gonorrhœa, leucorrhœa, chronic pyelitis, and in abscess of the kidney. In addition to the usual constituents found in leucocytes Mandel and Levene¹ claim that pus cells contain *gluathionic acid*. See Pus tests, page 459.

Casts.—These are cylindrical formations, which originate in the uriniferous tubules and are forced out by the pressure of the urine. They vary greatly in size, but in nearly every instance they possess parallel sides and rounded ends. The finding of casts in the urine is very important because of the fact that they *generally indicate* some kidney disorder; if albumin accompanies the casts the indication is

¹ Mandel and Levene: *Biochemische Zeitschrift*, 4, 78, 1907.

much accentuated. Casts have been classified according to their microscopical characteristics as follows: (a) hyaline, (b) granular, (c) epithelial, (d) blood, (e) fatty, (f) waxy, (g) pus.

(a) *Hyaline Casts*.—These are composed of a basic material which is transparent, homogeneous, and very light in color (Fig. 157). In fact, chiefly because of these physical properties, they are the most difficult form of renal casts to detect under the microscope. Frequently such casts are impregnated with deposits of various forms, such as erythrocytes, epithelial cells, fat globules, etc., thus rendering the form of the cast more plainly visible. Staining is often resorted to



FIG. 157.—HYALINE CASTS.
One cast is impregnated with four renal cells.

in order to render the shape and character of the cast more easily determined. Ordinary iodine solution (I in KI) may be used in this connection; many of the aniline dyes are also in common use for this purpose, e.g., gentian-violet, Bismarck-brown, methylene-blue, fuchsin, and eosin. Generally, but not always, albumin is present in urine containing hyaline casts. Hyaline casts are common to all kidney disorders, but occur particularly in the earliest and recovering stages of parenchymatous nephritis and interstitial nephritis.

(b) *Granular Casts*.—The common hyaline material is ordinarily the basic substance of this form of cast. The granular material generally consists of albumin, epithelial cells, fat, or disintegrated erythrocytes or

leucocytes, the character of the cast varying according to the nature and size of the granules (Fig. 158, and Fig. 159, page 499). Thus we have casts of this general type classified as *finely granular* and *coarsely granular* casts. Granular casts, and in particular the finely granular types, occur in the sediment in practically every kidney disorder but are probably especially characteristic of the sediment in inflammatory disorders.

(c) *Epithelial Casts*.—These are casts bearing upon their surface epithelial cells from the lining of the uriniferous tubules (Fig. 160, page 499). The basic material of this form of cast may be hyaline or

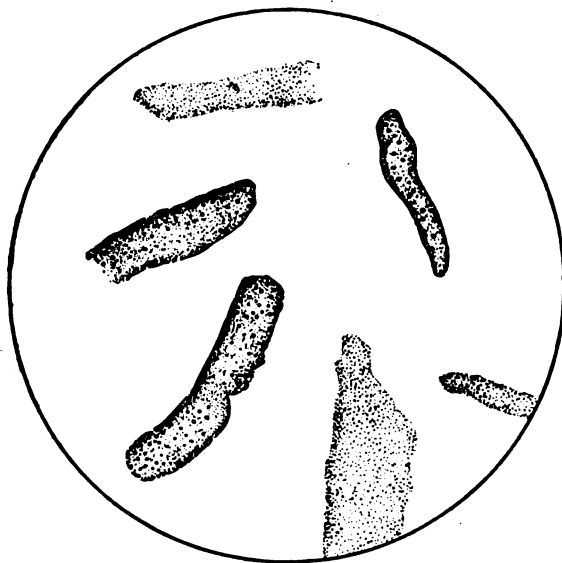

FIG. 158.—GRANULAR CASTS. (After Peyer.)

granular in nature. Epithelial casts are particularly abundant in the urinary sediment in *acute* nephritis.

(d) *Blood Casts*.—Casts of this type may consist of erythrocytes borne upon a hyaline or a fibrinous basis (Fig. 161, page 499). The occurrence of such casts in the urinary sediment denotes renal hemorrhage and they are considered to be especially characteristic of acute diffuse nephritis and acute congestion of the kidney.

(e) *Fatty Casts*.—Fatty casts may be formed by the deposition of fat globules or crystals of fatty acid upon the surface of a hyaline or granular cast (Fig. 162, page 500). In order to constitute a true fatty cast the deposited material must cover the greater part of the surface area of the cast. The presence of fatty casts in urinary sediment in-

dicates fatty degeneration of the kidney; such casts are particularly characteristic of subacute and chronic inflammation of the kidney.



FIG. 159.—GRANULAR CASTS.
a, Finely granular; b, coarsely granular.

FIG. 160.—EPITHELIAL CASTS.

(f) *Waxy Casts*.—These casts possess a basic substance similar to that which enters into the foundation of the hyaline form of cast. In

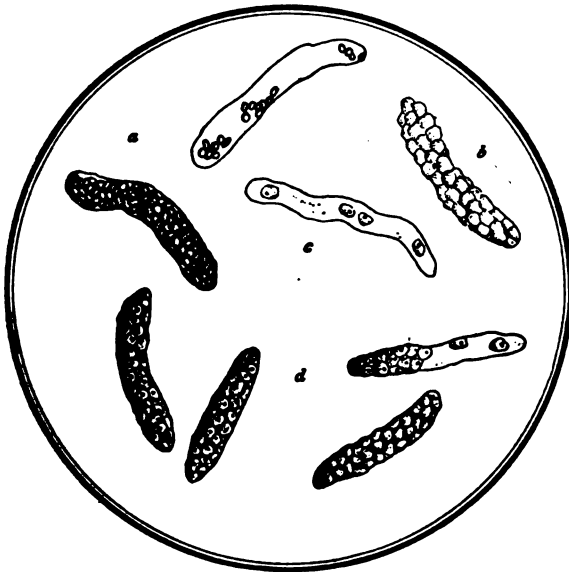

FIG. 161.—BLOOD, PUS, HYALINE AND EPITHELIAL CASTS.
a, Blood casts; b, pus cast; c, hyaline cast impregnated with renal cells; d, epithelial casts.

common with the hyaline type they are colorless, refractive bodies, but differ from this form of cast in being, in general, of greater length and diameter and possessing sharper outlines and a light yellow color

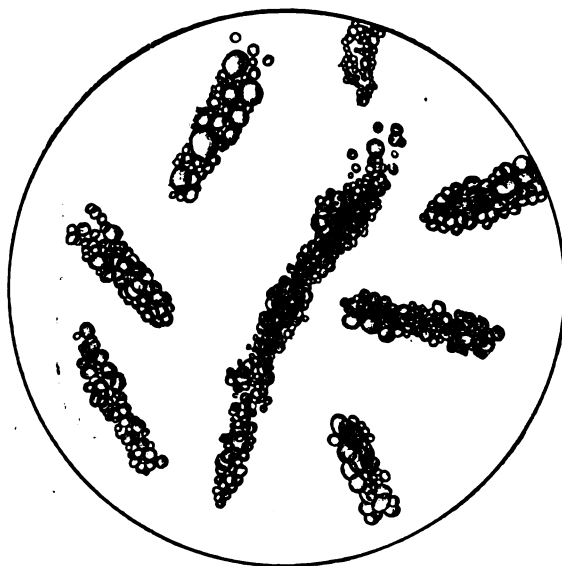

FIG. 162.—FATTY CASTS. (After Peyer.)

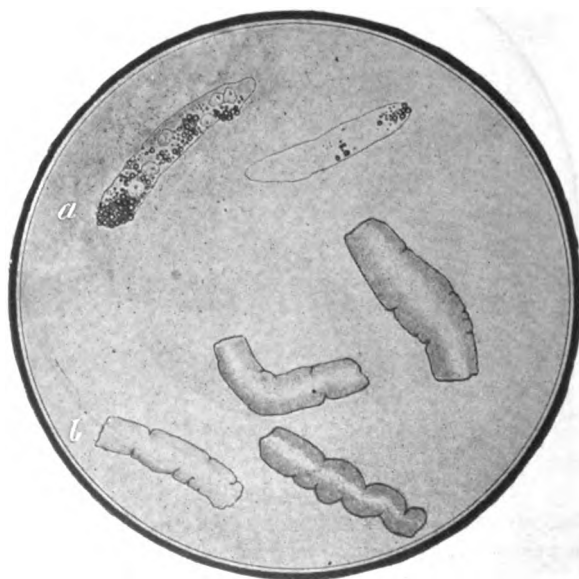

FIG. 163.—FATTY AND WAXY CASTS.
a, Fatty casts; *b*, waxy casts.

(Fig. 163, page 500). Such casts occur in several forms of nephritis, but do not appear to characterize any particular type of the disorder except *amyloid disease*, in which they are rather common.

(g) *Pus Casts*.—Casts whose surface is covered with pus cells or leucocytes are termed *pus casts* (Fig. 161, p. 499). They are frequently mistaken for epithelial casts. The differentiation between these two types is made very simple, however, by treating the cast with acetic acid which causes the nuclei of the leucocytes to become plainly visible. The true pus cast is quite rare and indicates renal suppuration.

Cylindroids.—These formations may occur in normal or pathological urine and have no particular clinical significance. They are frequently

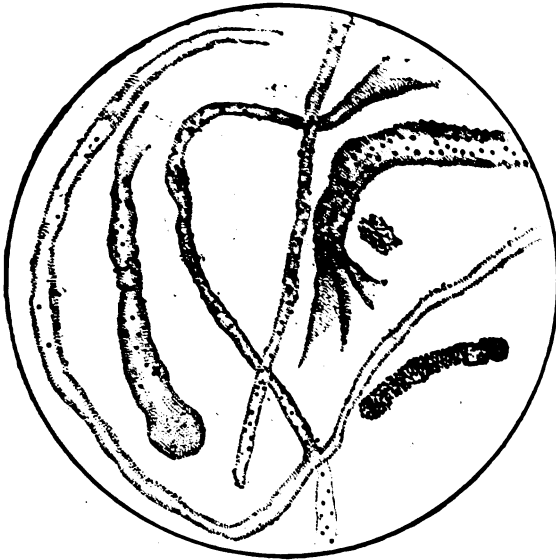

FIG. 164.—CYLINDROIDS. (After Peyer.)

mistaken for true casts, especially the hyaline type, but they are ordinarily *flat* in structure with a rather smaller diameter than casts, may possess forked or branching ends, and are not composed of homogeneous material as are the hyaline casts. Such "false casts" may become coated with urates, in which event they appear granular in structure. The basic substance of cylindroids is often the nucleoprotein of the urine (Fig. 164, above).

Erythrocytes.—These form elements are present in the urinary sediment in various diseases. They appear as the normal biconcave, yellow erythrocyte (Plate IV, opposite page 253) or may exhibit certain modifications in form, such as the crenated type (Fig. 165) which is often seen in concentrated urine. Under different condi-

tions they may become swollen sufficiently to entirely erase the biconcave appearance and may even occur in the form of colorless spheres having a smaller diameter than the original disc-shaped corpuscles. Erythrocytes are found in urinary sediment in hemorrhage of the kidney or of the urinary tract, in traumatic hemorrhage, hemorrhage from congestion, and in hemorrhagic diathesis.

Spermatozoa.—Spermatozoa may be detected in the urinary sediment in diseases of the genital organs, as well as after coitus, nocturnal emissions, epileptic, and other convulsive attacks, and sometimes in severe febrile disorders, especially in typhoid fever. In form they consist of an oval body, to which is attached a long, delicate tail (Fig.

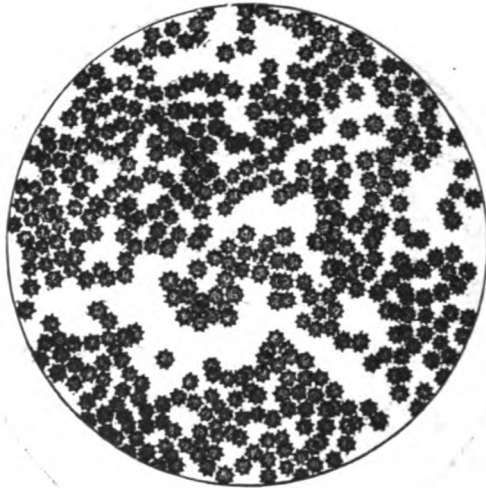

FIG. 165.—CRENATED ERYTHROCYTES.

166, page 503). Upon examination they may show motility or may be motionless.

Urethral Filaments.—These are peculiar thread-like bodies which are sometimes found in urinary sediment. They may occasionally be detected in normal urine and pathologically are found in the sediment in acute and chronic gonorrhœa and in urethrorrhœa. The ground-substance of these urethral filaments is, in part at least, similar to that of the cylindroids (see page 472). The urine first voided in the morning is best adapted for the examination for filaments. These filaments may ordinarily be removed by a pipette since they are generally macroscopic.

Tissue Débris.—Masses of cells or fragments of tissue are frequently found in the urinary sediment. They may be found in the sediment in tubercular affections of the kidney and urinary tract or in tumors of these organs. Ordinarily it is necessary to make a histological ex-

amination of such tissue fragments before coming to a final decision as to their origin.

Animal Parasites.—The cysts, hooklets, and membrane shreds of *echinococci* are sometimes found in the urinary sediments. Other animal organisms which are more rarely met with in the urine are embryos of the *Filaria sanguinis* and eggs of the *Distoma hematobium* and *Ascarides*. Animal parasites in general occur most frequently in the urine in tropical countries.

Micro-organisms.—Bacteria as well as yeasts and moulds are frequently detected in the urine. Both the pathogenic and non-pathogenic forms of bacteria may occur. The non-pathogenic forms most frequently observed are *micrococcus ureæ*, *bacillus ureæ*, and *staphylococcus ureæ liquefaciens*. Of the pathogenic forms many have been

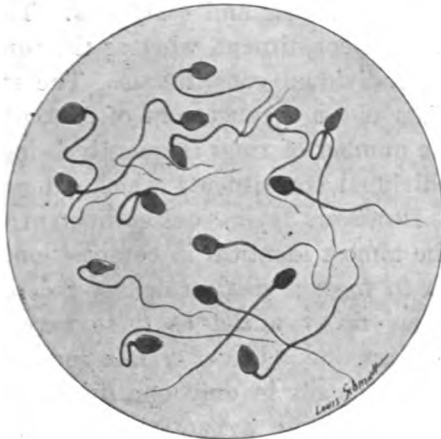

FIG. 166.—HUMAN SPERMATOOA.

observed, e.g., *Bacterium Coli*, *typhoid bacillus*, *tubercle bacillus*, *gonococcus*, *bacillus pyocyaneus*, and *proteus vulgaris*. Yeast and moulds are most frequently met with in diabetic urine.

Fibrin.—Following hematuria, fibrin clots are occasionally observed in the urinary sediment. They are generally of a semi-gelatinous consistency and of a very light color, and when examined under the microscope they are seen to be composed of bundles of highly refractive fibers which run parallel.

Foreign Substances Due to Contamination.—Such foreign substances as fibers of silk, linen, or wool; starch granules, hair, fat, and sputum, as well as muscle fibers, vegetable cells, and food particles, are often found in the urine. Care should be taken that these foreign substances are not mistaken for any of the true sedimentary constituents already mentioned.

CHAPTER XXVI

URINE: CALCULI

URINARY *calculi*, also called *concretions*, or *concrements* are solid masses of urinary sediment formed in some part of the urinary tract. They vary in shape and size according to their location, the smaller calculi, termed *sand* or *gravel*, in general arising from the kidney or the pelvic portion of the kidney, whereas the large calculi are ordinarily formed in the bladder. There are two general classes of calculi as regards composition, *i.e.*, *simple* and *compound*. The simple form is made up of but a single constituent, whereas the compound type contains two or more individual constituents. The structural plan of most calculi consists of an arrangement of concentric rings about a central nucleus, the number of rings frequently being dependent upon the number of individual constituents which enter into the structure of the calculus. However, layers quite different in macroscopical appearance may be almost identical in composition. In case two or more calculi unite to form a single calculus the resultant body will obviously contain as many nuclei as there were individual calculi concerned in its construction. Under certain conditions the growth of a calculus will be principally in only one direction, thus preventing the nucleus from maintaining a central location. The qualitative composition of urinary calculi is dependent, in great part, upon the reaction of the urine, *e.g.*, if the reaction of the urine is acid the calculi present will be composed, in great part at least, of substances that are capable of depositing in acid urine, *e.g.*, uric acid, urates and calcium oxalate.

According to Ultzmann, out of 545 cases of urinary calculus, uric acid and urates formed the nucleus in about 81 per cent of the cases; earthy phosphates in about 9 per cent; calcium oxalate in about 6 per cent; cystine in something over 1 per cent, while in about 3 per cent of the cases some foreign body comprised the nucleus.

More recent analyses¹ of twenty-four calculi showed the nucleus in 75 per cent of them to be calcium oxalate (60 per cent) and in 25 per cent to be phosphate (56 per cent). All of the calculi contained some uric acid and urates, but only three gave more than 10 per cent.

¹ Kahn and Rosenbloom: *Jour. Am. Med. Ass'n*, 59, 2252, 1913.

In the chemical examination of urinary calculi the most valuable data are obtained by subjecting each of the concentric layers of the calculus to a separate analysis. Material for examination may be conveniently obtained by sawing the calculus carefully through the nucleus, then separating the various layers, or by scraping off from each layer (without separating the layers) enough powder to conduct the examination as outlined in the scheme (see page 506).

Varieties of Calculus

Uric Acid and Urate Calculi.—Uric acid and urates constitute the nuclei of a large proportion of urinary concretions. Such stones are always colored, the tint varying from a pale yellow to a brownish-red. The surface of such calculi is generally smooth but it may be rough and uneven.

Phosphatic Calculi.—Ordinarily these concretions consist principally of "triple phosphate" and other phosphates of the alkaline earths, with very frequent admixtures of urates and oxalates. The surface of such calculi is generally rough but may occasionally be rather smooth. The calculi are somewhat variable in color, exhibiting gray, white, or yellow tints under different conditions. When composed of earthy phosphates the calculi are characterized by their friability.

Calcium Oxalate Calculi.—This is the hardest form of calculus to deal with, and is rather difficult to crush. They ordinarily occur in two general forms, *i.e.*, the small, smooth concretion which is characterized as the *hemp-seed calculus*, and the medium-sized or large stone possessing an extremely uneven surface, which is generally classed as a *mulberry calculus*. This roughened surface of the latter form of calculus is due, in many instances, to protruding calcium oxalate crystals of the octahedral type.

Calcium Carbonate Calculi.—Calcium carbonate concretions are quite common in herbivorous animals, but of exceedingly rare occurrence in man. They are generally small, white, or grayish calculi, spherical in form and possess a hard, smooth surface.

Cystine Calculi.—The cystine calculus is a rare variety of calculus. Ordinarily they occur as small, smooth, oval, or cylindrical concretions which are white or yellow in color and of a rather soft consistency.

Xanthine Calculi.—This form of calculus is somewhat more rare than the cystine type. The color may vary from white to brownish-yellow. Very often uric acid and urates are associated with xanthine in this type of calculus. Upon rubbing a xanthine calculus it has the property of assuming a wax-like appearance.

On Heating the Powder on Platinum Foil, It					
Does not burn		Does burn			
The powder when treated with HCl		With flame	Without flame		
Does not effervesce		<p>Flame pale blue, burns a short time. Peculiar sharp odor. The powder dissolves in ammonia, and six-sided plates separate on the spontaneous evaporation of the ammonia.</p> <p>Flame yellow, pale, continuous. Odor of resin or shellac on burning. Powder soluble in alcohol and ether.</p> <p>Flame yellow, continuous. Odor of burnt feathers. Insoluble in alcohol and ether. Soluble in potassium hydroxide with heat. Precipitated herefrom by acetic acid and generation of hydrogen sulphide.</p>	<p>Does not give murexide test. The powder dissolves in nitric acid without effervescence. The dried yellow residue becomes orange with alkali, beautiful red on warming.</p>	<p>The powder gives the murexide test</p>	
The powder gently heated, then treated with HCl				<p>The powder when treated with KOH gives</p>	<p>No noticeable ammonia reaction</p>
The powder when moistened with a little KOH				<p>Strong ammonia reaction</p>	<p>Ammonium urate</p>
<p>Abundant ammonia. The powder dissolves in acetic acid or HCl. This solution is precipitated by ammonia (amorphous)</p>				<p>Effervesces</p>	<p>Uric acid.</p>
<p>Effervesces</p>		<p>Effervesces</p>	<p>Calcium carbonate.</p>		
<p>Effervesces</p>		<p>Effervesces</p>	<p>Calcium oxalate.</p>		
<p>Bone-earth (magnesium and calcium phosphate).</p>		<p>Urostealith.</p>	<p>Fibrin.</p>		
<p>“Triple phosphate” (mixed with unknown amount of earthy phosphate).</p>		<p>Cystine.</p>	<p>Xanthine.</p>		

Urostealith Calculi.—This form of calculus is extremely rare. Such concretions are composed principally of fat and fatty acid. When moist they are soft and elastic, but when dried they become brittle. Urostealiths are generally light in color.

Fibrin Calculi.—Fibrin calculi are produced in the process of blood coagulation within the urinary tract. They frequently occur as nuclei of other forms of calculus. They are rarely found.

Cholesterol Calculi.—An extremely rare form of calculus somewhat resembling the cystine type.

Indigo Calculi.—Indigo calculi are extremely rare, only two cases having been reported. One of these indigo calculi is on exhibition in the museum of Jefferson Medical College of Philadelphia.

The scheme, proposed by Heller and given on page 506, will be found of much assistance in the chemical examination of urinary calculi.

CHAPTER XXVII

URINE: QUANTITATIVE ANALYSIS

IN analyzing a normal or pathological urine quantitatively for any of its constituents it is particularly necessary that the complete and exact 24-hour sample be obtained. For directions with regard to the collection and preservation of urine for analysis see Chapter XXII on General Characteristics of Normal and Pathological Urine. Methods for the determination of the specific gravity of the urine are also there described. Before any urine is taken for analysis its total volume should be measured, using a large graduated cylinder, and this volume is thereafter taken as a basis for the calculations of the daily output of the individual constituents determined. If the urine be pathological it is of course necessary to precede its quantitative analysis by qualitative tests for the pathological constituents.

Acidity by Titration

Folin's Method.—*Principle.*—The urine is titrated with standard sodium hydroxide solution, using phenolphthalein as an indicator. Potassium oxalate is added to precipitate the calcium which would otherwise interfere with the end-point due to the precipitation of calcium phosphate on neutralization of the urine. The acidity of the urine as determined in this way is not a correct measure of the true acidity, which is dependent upon the concentration of hydrogen ions. The results obtained do, however, ordinarily show a certain parallelism with the hydrogen ion concentration and are of value for comparative purposes.

Procedure.—Place 25 c.c. of urine in a 200 c.c. Erlenmeyer flask and add 15–20 grams of finely pulverized potassium oxalate and 1–2 drops of a 1 per cent phenolphthalein solution to the fluid. Shake the mixture vigorously for 1–2 minutes and titrate it immediately with N/10 sodium hydroxide until a faint but unmistakable pink remains permanent on further shaking. Take the burette reading and calculate the acidity of the urine under examination.

Calculation.—If y represents the number of cubic centimeters of N/10 sodium hydroxide used and y' represents the volume of urine excreted in 24 hours, the total acidity of the 24-hour urine specimen may be calculated by means of the following proportion:

25:y::y':x (acidity of 24-hour urine expressed in cubic centimeters of N/10 sodium hydroxide).

Each cubic centimeter of N/10 sodium hydroxide contains 0.004 gram of sodium hydroxide, and this is equivalent to 0.0063 gram of oxalic acid. Therefore, in order to express the total acidity of the 24-hour urine specimen in equivalent grams of sodium hydroxide, multiply the value of x, as just determined, by 0.004, or multiply the value of x by 0.0063 if it is desired to express the total acidity in grams of oxalic acid.

Interpretation.—(Under the heading “*Interpretation*” there will be found, in connection with the various quantitative methods which follow, brief notes as to the possible significance of the results obtained. For some further points (and reference to literature) see the chapters on the Normal and Pathological Constituents of Urine and on Metabolism. Consult text-books on physiological chemistry and clinical diagnosis for complete discussion). The acidity of the urine expressed in cubic centimeters N/10 alkali required to neutralize the 24-hour output varies ordinarily from 200 to 500 under normal conditions with an average of perhaps 350. It is dependent almost entirely upon the diet, being low on a vegetable (base-forming) diet and high on a diet containing much meat, rice, whole wheat products, fruits containing benzoic acid, as prunes and cranberries, etc. (acid-forming foods). On the administration of 15 grams of sodium bicarbonate it may go down to 100; the ingestion of much acid-forming food may increase it to 600. In fasting it may rise in a few days to 800. It must be borne in mind that acidities of less than 250 usually indicate a true *alkalinity* of the urine inasmuch as phenolphthalein changes in an alkaline solution. Samples of urine collected shortly after a meal may be alkaline due to the so-called “alkaline tide.”

Bacterial decomposition of the urea of the urine occurring in the urinary tract will increase the amount of ammonia and decrease the acidity of the urine. The same change usually occurs in urine left in contact with the air. The acidity of the urine is increased in acidosis, cardio-renal and certain other disorders. The acidity of the urine may be somewhat increased by administration of mineral acids, acid phosphates, or benzoates, but it is much more difficult to increase than to decrease this acidity.

Hydrogen Ion Concentration or True Acidity

Indicator Method (Henderson and Palmer's Adaptation of Sørensen's Method).¹—*Principle.*—The reaction of the urine is estimated

¹ Henderson and Palmer: *Jour. Biol. Chem.*, 13, 393, 1913.

by matching the colors produced when a few drops of indicator are added respectively to the diluted urine and to standard solutions of known reaction similarly diluted. Similar hydrogen ion concentrations are indicated by similar colors. The indicator must be properly chosen.

Standard Solutions.—A series of standard solutions of known hydrogen ion concentration must be prepared. The solutions as indicated in Table I (page 511) are satisfactory for urine analysis. The table also indicates the H ion concentration of each solution, the figure given being the logarithm of this concentration (P_{H+}). It is more convenient and rational to express the concentration by this logarithmic notation. True H ion concentrations corresponding to the logarithmic figures are given in Table II (page 511).

The 13 solutions indicated are made up by mixing equal volumes of their ingredient solutions of the composition indicated. Solutions 4 to 12 are all that are ordinarily required as the normal urinary H ion concentrations lie between 4.80 and 7.50 and pathological variations are usually within these limits. The mean normal value is almost exactly 6.00.

Procedure.—Select eleven 250 c.c. flasks of good glass and indistinguishable in color and form. Into each of ten of these introduce 10 c.c. of the various standard solutions. Make up to 250 c.c. with distilled water and add to each exactly the same amount of an aqueous solution of sodium alizarine sulphonate (10–15 drops). Mix well by inverting. Introduce 10 c.c. of the urine to be tested into a similar 250 c.c. flask, dilute and add indicator in exactly the same way as before. Match the color of the diluted urine solution with one of the standard solutions. By consulting Table II (page 511) determine to what H ion concentration this corresponds. This table points out the indicators to be used for different ranges of acidity. From 5.3–6.7 *p*-nitrophenol is satisfactory and is used in the same way as alizarin except that it must be present in concentration of 0.08 per cent. Neutral red is used in the same way for acidities from 6.7–7.5 about 1.5 c.c. of the 1 per cent solution being required. For acidities greater than 5.5 methyl red is used in the following way: 10 c.c. portions of the standard solutions are introduced into carefully selected colorless test-tubes and 10 c.c. of urine is introduced into another tube. The standard solutions are then colored to match the urine by the addition of small amounts of *p*-nitrophenol, methyl orange, alizarine or bismark brown. Then to standard solutions and urine add 0.15 c.c. of a saturated solution in 50 per cent alcohol, of methyl red and match the colors. For concentrations of 7.5–9.27 or less undiluted urine is matched in test-tubes against undiluted standard solutions, using phenolphthalein as an indicator (without previous coloration of standard solution). In all cases estimations are made in duplicate.

TABLE I

No.	NaH ₂ PO ₄ '	Na ₂ HPO ₄	P _H +	Indicator	
1		0.1000 N	9.27	Phenolphthalein	
2	0.0001 N	0.0480 N	8.7		
3	0.0001 N	0.0120 N	8.0		
4	0.0166 N	0.0833 N	7.48		Neutral red
5	0.0010 N	0.0060 N	7.38		
6	0.0010 N	0.0023 N	6.90		Sodium alizarine sulphonate.
	CH ₃ COOH	CH ₃ COONa			
7	0.0009 N	0.0920 N	6.70		
8	0.0023 N	0.0920 N	6.30	Nitrophenol	
9	0.0046 N	0.0920 N	6.00		
10	0.0092 N	0.0920 N	5.70	Methyl red	
11	0.0230 N	0.0920 N	5.30		
12	0.0460 N	0.0920 N	4.90		
13	0.0920 N	0.0920 N	4.70		

TABLE II

Log	H	Log	H
4.6	250 × 10 ⁻⁷	6.4	4.0 × 10 ⁻⁷
4.8	160 × 10 ⁻⁷	6.6	2.5 × 10 ⁻⁷
5.0	100 × 10 ⁻⁷	6.8	1.6 × 10 ⁻⁷
5.2	63 × 10 ⁻⁷	7.0	1.0 × 10 ⁻⁷
5.4	40 × 10 ⁻⁷	7.2	0.63 × 10 ⁻⁷
5.6	25 × 10 ⁻⁷	7.4	0.40 × 10 ⁻⁷
5.8	16 × 10 ⁻⁷	7.6	0.25 × 10 ⁻⁷
6.0	10 × 10 ⁻⁷	7.8	0.16 × 10 ⁻⁷
6.2	6.3 × 10 ⁻⁷	8.0	0.10 × 10 ⁻⁷

Interpretation.—The H ion concentration of the urine is influenced by the same factors as the titratable acidity (see page 508). The normal values lie between 4.80 and 7.50 with a mean value of almost exactly 6.00. For vegetarians the mean value is about 6.64. In cardio-renal disorders the mean is 5.3. In most pathological conditions the hydrogen ion concentration is increased.

Total Solids

1. Drying Method.—Place 5 c.c. of urine in a weighed shallow dish, acidify very slightly with acetic acid (1–3 drops), and dry it *in vacuo* in the presence of sulphuric acid to constant weight. Calculate the percentage of solids in the urine sample and the total solids for the 24-hour period.

Interpretation.—The average excretion of total solids by a normal adult man is about 70 grams. It is largely dependent upon the protein and salts of the diet. It may be decreased in severe nephritis due to impaired excretion, and greatly increased in diabetes with high sugar elimination.

Practically all the methods the technic of which includes evaporation at an increased temperature, either under atmospheric conditions or *in vacuo*, are attended with error.

Shackell's method¹ which entails the vacuum desiccation of the frozen sample is extremely satisfactory and should be used in all biological work where the greatest accuracy is desired.

¹Shackell: *American Journal of Physiology*, 24, 325, 1909.

2. **Calculation by Long's Coefficient.**—The quantity of solid material contained in the urine excreted for any 24-hour period may be approximately computed by multiplying the second and third decimal figures of the specific gravity by 2.6. This gives us the *number of grams of solid matter in 1 liter of urine*. From this value the total solids for the 24-hour period may easily be determined.

Calculation.—If the volume of urine for the 24 hours was 1120 c.c. and the specific gravity 1.018, the calculation would be as follows:

$$(a) 18 \times 2.6 = 46.8 \text{ grams of solid matter in 1 liter of urine.}$$

$$(b) \frac{46.8 \times 1120}{1000} = 52.4 \text{ grams of solid matter in 1120 c.c. of urine.}$$

Long's coefficient was determined for urine whose specific gravity was taken at 25°C. and is probably more accurate, for conditions obtaining in America, than the older coefficient of Haeser, 2.33.

Interpretation.—See above.

Total Nitrogen

1. **Kjeldahl Method.**¹—*Principle.*—The principle of this method is the conversion of the various nitrogenous bodies of the urine into ammonium sulphate by boiling with concentrated sulphuric acid, the subsequent decomposition of the ammonium sulphate by means of a fixed alkali (NaOH) and the collection of the liberated ammonia in an acid of known strength. Finally, this partly neutralized acid solution is titrated with an alkali of known strength and the nitrogen content of the urine under examination computed.

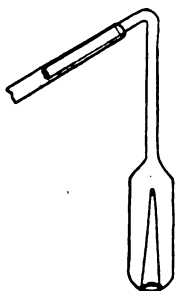

FIG. 167.—FOLIN FUME ABSORBER.

Procedure.—Place 5 c.c. of urine in a 500 c.c. long-necked Jena glass Kjeldahl flask, add 20 c.c. of concentrated sulphuric acid and about 0.2 gram of copper sulphate and boil the mixture for some time after it is colorless (about one hour). If a suitable hood or fume chamber is not available the sulphuric acid vapors may be carried away by suction. Connect the outlet tube of a 2–3 liter wash bottle filled with caustic soda solution with a suction pump. The inlet tube is connected with a Folin fume absorption tube such as illustrated in Fig. 167. If such a tube is not at hand a small funnel may be attached. The absorption tube is placed loosely over the mouth of the digestion flask and a constant current of air drawn through the apparatus.

Allow the flask to cool and dilute the contents with about 200 c.c. of ammonia-free water. Add a little more of a concentrated solution of NaOH than is necessary to neutralize the sulphuric acid² and introduce into the flask a little coarse pumice stone or a few pieces of granulated zinc,³ to prevent bumping, and a

¹ There are numerous modifications of the original Kjeldahl method; the one described here, however, has given excellent satisfaction and is recommended for the determination of the nitrogen content of urine.

² This concentrated sodium hydroxide solution should be prepared in quantity and "check" tests made to determine the volume of the solution necessary to neutralize the volume (20 c.c.) of concentrated sulphuric acid used.

³ Powdered zinc may be substituted.

small piece of paraffin to lessen the tendency to froth. By means of a safety-tube connect the flask with a condenser so arranged that the delivery-tube passes into a vessel containing a known volume (the volume used depending upon the nitrogen content of the urine) of N/10 sulphuric acid, using care that the end of the delivery-tube reaches beneath the surface of the fluid.¹ Mix the contents of the distillation flask very thoroughly by shaking and distil the mixture until its volume has diminished about one-half. Titrate the partly neutralized N/10 sulphuric acid solution by means of N/10 sodium hydroxide, using congo red as indicator, and calculate the content of nitrogen of the urine examined.

Calculation.—Subtract the number of cubic centimeters of N/10 sodium hydroxide used in the titration from the number of cubic centimeters of N/10 sulphuric acid taken. The remainder is equivalent to the number of cubic centimeters of N/10 sulphuric acid, neutralized by the ammonia of the urine. One c.c. of N/10 sulphuric acid is equivalent to 0.0014 gram of nitrogen. Therefore, if y represents the volume of urine used in the determination, and y' the number of cubic centimeters of N/10 sulphuric acid neutralized by the ammonia of the urine, we have the following proportion:

$y : 100 :: y' \times 0.0014 : x$ (percentage of nitrogen in the urine examined).

Calculate the quantity of nitrogen in the 24-hour urine specimen.

Interpretation.—An adult of medium size on a mixed diet will usually excrete 12–18 grams of nitrogen per day. It varies, however, almost directly with the protein ingestion and hence usually runs parallel to the excretion of urea (see page 522). In a normal adult the total nitrogen of the feces and of the urine will often be almost exactly equal to the total nitrogen of the food. Such a condition is called “nitrogen equilibrium.” The feces usually contain very little nitrogen. (See also Ammonia, Creatinine, etc.)

Calculation of Percentage Nitrogen Distribution.—In modern metabolism studies where the various forms of nitrogen are determined, in addition to the total nitrogen as yielded by the Kjeldahl method, it is customary to indicate what portion of the total nitrogen was present in the form of each of the individual nitrogenous constituents. These percentage values are secured by dividing the weight (grams) of nitrogen excreted for the day in the form of each individual nitrogenous constituent by the weight of the total nitrogen output for the same period. For example, if the total nitrogen excretion is 9.814 grams and the excretion of urea-nitrogen is 8.520 grams and the excretions of nitrogen in the forms of ammonia and creatinine are 0.271 gram and 0.639 gram respectively, the percentage distribution for these forms of nitrogen would be calculated as follows:

8.520 grams urea-nitrogen	÷ 9.814 grams total nitrogen	= 84.3 per cent
0.271 gram ammonia-nitrogen	÷ 9.814 grams total nitrogen	= 2.7 per cent
0.639 gram creatinine-nitrogen	÷ 9.814 grams total nitrogen	= 6.5 per cent

Nitrogen Partition in Urines Containing Albumin.—If the urine to be tested contains albumin this must be removed before an attempt at

¹ This delivery-tube should be of large caliber in order to avoid the “sucking back” of the fluid.

a nitrogen partition is made. This may be done by heating to boiling, acidifying with acetic acid to coagulate the protein, filtering and making up the filtrate to the original volume of the urine. If very small amounts of albumin are present this is attended with difficulty. In these cases Tracy and Welker¹ have suggested the use of aluminium hydroxide cream. It apparently removes none of the nitrogenous constituents of normal urine.

Procedure.—One liter of urine (containing not over 1 per cent of albumin) is mixed with one liter of aluminium hydroxide cream² and filtered.

2. Folin-Farmer Microchemical Method.³—*Principle.*—This method belongs with the so-called microchemical methods inasmuch as it is adapted to the determination of amounts of nitrogen in the neighborhood of 1 mg. while in the ordinary Kjeldahl procedure 30–100 mg. of nitrogen are generally manipulated. One c.c. of diluted urine is decomposed with sulphuric acid as in the Kjeldahl method, the ammonia formed is set free by the addition of alkali and carried over into an acid solution by means of a current of air. The ammonia solution is then treated with the Nessler-Winkler reagent and the color produced compared with that of a standard solution of an ammonium salt treated in the same way.

Colorimeter.—For this method as well as for a number of other methods commonly used in urinary and blood analysis an instrument known as a colorimeter is required. Through its aid we are able accurately to measure the respective depths of color in two solutions and hence to calculate the comparative amounts of substances which form colored compounds in a quantitative manner. The most satisfactory instrument for this purpose is the Duboscq colorimeter (see Fig. 168, page 515). This enables the two colored solutions to be compared in the same optical field and with a degree of accuracy of about 1 per cent. The later type of the Duboscq colorimeter with cylinders instead of prisms movable is to be preferred, particularly as this type may be readily adapted to the comparison of cloudy solutions or suspensions, the instrument thus modified being called a nephelometer (see Fig. 89, page 296). In this later form of colorimeter the depths of the colored solutions through which the light passes are regulated by raising or lowering the cups and are accurately indicated in millimeters on a vernier scale at the back of the instrument. The standard solution is

¹ Tracy and Welker: *Jour. Biol. Chem.*, 22, 55, 1915. For other applications of aluminium hydroxide precipitation of colloids, see Welker and Marshall, *J. Am. Chem. Soc.*, 25, 820, 1913.

² *Aluminium Hydroxide Cream.*—To a 1 per cent solution of ammonium alum at room temperature add a slight excess of a 1 per cent solution of ammonium hydroxide. Wash by decantation until the wash water shows only the faintest trace of residue on evaporation. Stronger solutions should not be used.

³ Folin and Farmer: *Jour. Biol. Chem.*, 11, 493, 1912.

placed at any convenient depth and the color of the solution to be examined is matched with it by raising or lowering cups. When the color is of the same intensity as the standard the depth of the solution is read. The amounts of the colored substance in solution are inversely proportional to the depths of the columns of fluid. Thus if the standard is set at 10 mm. and the solution under examination has the same color density at 20 mm. the latter has just one-half the concentration of the standard.

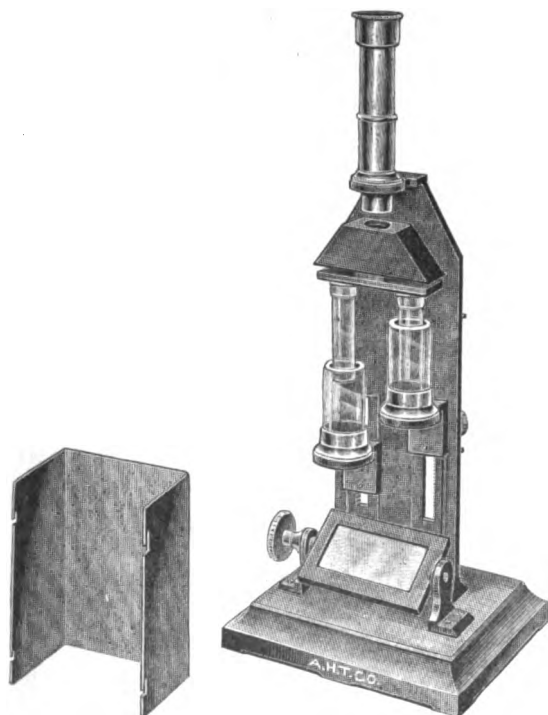

FIG. 168.—DUBOSCQ COLORIMETER.

A large number of other colorimeters have been devised and may be used in place of the Duboscq. Most of these though less expensive than this instrument are also less accurate. The Hellige colorimeter has been recommended, particularly for clinical determinations by Myers and Fine.¹ A simple colorimeter, costing only about one dollar, has been devised and used with considerable success by Peebles and Lewis.² It is claimed to compare favorably in accuracy with other colorimeters and to be applicable to clinical and student use. Another accurate colorimeter has been developed by Bock and Benedict³ in which the place of costly and difficultly obtainable prisms

¹ Myers and Fine: *Post-graduate*, 1914-1915.

² Peebles and Lewis: *J. Am. Med. Assn.*, 70, 679, 1918.

³ Bock and Benedict: *Jour. Biol. Chem.*, 33, xix, 1918; 35, 227, 1918.

is taken by mirrors. Kober has devised a combined colorimeter and nephelometer which may be obtained in this country (see page 298). For merely approximate determinations the color comparisons may be made directly with a series of colored standards of varying strengths made up in exactly similar test-tubes or small flasks.

Procedure.—Introduce 5 c.c. of urine into a 50 c.c. volumetric flask if the specific gravity of the urine is over 1018, or into a 25 c.c. flask if the specific gravity is less than 1018.¹ Fill the flask to the mark with distilled water and invert it several times in order to guarantee thorough mixing. Transfer 1 c.c.² of the diluted urine to a large (20–25 mm. × 200 mm.) Jena-glass test-tube. Add to this 1 c.c. of concentrated sulphuric acid, 1 gram of potassium sulphate, 1 drop of 5 per cent copper sulphate solution and a small, clean, quartz pebble or

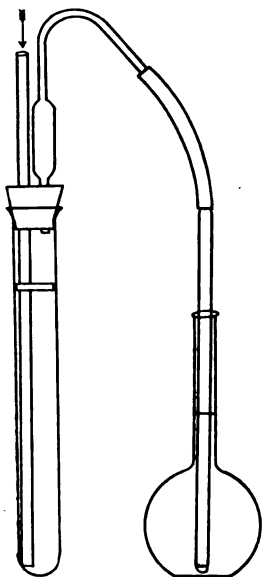

FIG. 169.

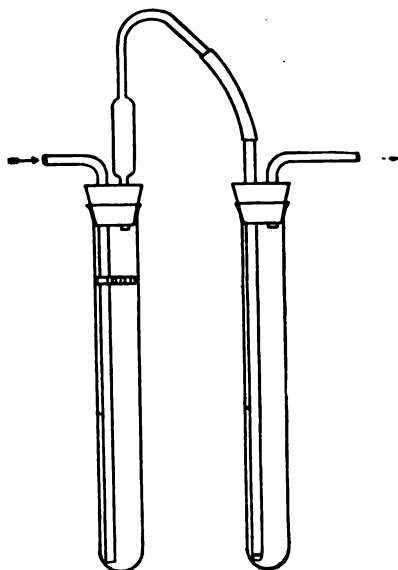

FIG. 170.

FIGS. 169 AND 170.—FORMS OF APPARATUS USED IN METHODS OF FOLIN AND ASSOCIATES FOR DETERMINATION OF TOTAL NITROGEN, UREA AND AMMONIA. (From *Jour. Biol. Chem.* vol. 11, 1912.)

glass bead. (The pebble or bead is added to prevent bumping.) Boil the mixture over a micro-burner³ for about six minutes, i.e., about two minutes after the mixture has become colorless. Allow to cool until the digestion mixture begins to become viscous. This ordinarily takes about three minutes, but in any event the mixture must not be permitted to solidify. Add about 6 c.c. of water (a few drops at a time, at first, then more rapidly) to prevent solidification. To this acid solution add an excess of sodium hydroxide (3 c.c. of a saturated solution is

¹ The purpose is to so dilute the urine that 1 c.c. of the diluted fluid shall contain 0.75–1.5 mg. of nitrogen.

² This measurement should be made by means of a modified Ostwald pipette (see Ostwald-Luther: *Physiko-Chemische Messungen*, 2d. ed., p. 135). Such pipettes may be obtained from Eimer and Amend, New York.

³ A type of burner which has proven satisfactory is Eimer and Amend's No. 2587.

sufficient) and aspirate the liberated ammonia by means of a rapid air current¹ into a volumetric flask (100 c.c.) containing about 20 c.c. of ammonia-free water and 2 c.c. of N/10 hydrochloric acid (see Figs. 169 and 170, page 516). The air current should be only moderately rapid for the first two minutes but at the end of this two-minute period the current should be run at its maximum speed for an interval of eight minutes.

Disconnect the flask, dilute the contents to about 60 c.c. with ammonia-free water and dilute similarly 1 mg. of nitrogen in the form of ammonium sulphate² in a second volumetric flask. Nesslerize both solutions as nearly as possible at the same time with 5 c.c. of Nessler-Winkler solution³ diluted, immediately before using, with about 25 c.c. of ammonia-free water to avoid turbidity. Immediately fill the two flasks to the mark with ammonia-free water, mix well and determine the relative intensity of the two colors by means of a Duboscq colorimeter.⁴

The color of the unknown should be adjusted to that of the standard both from above and below the level of the latter. The matching of the colors is ordinarily very easy. It is desirable to make the readings by diffused daylight if possible. If electric light must be used, a sheet of smooth white paper should be interposed between the colorimeter and the source of light.

Calculation.—The reading of the standard divided by the reading of the unknown gives the nitrogen in milligrams in the volume of the urine taken. Calculate the total nitrogen output for the 24-hour period.

Interpretation.—See page 513.

3. Bock and Benedict's Modification of the Folin-Farmer Procedure.—Bock and Benedict⁵ have found distillation of the ammonia more accurate than

¹ Either a vacuum pump or compressed air or a force pump may be used. The compressed air method is rather the more convenient inasmuch as the ammonia may be collected directly in a volumetric flask. Inasmuch as the necks of such flasks (100 c.c.) are not large enough to permit of the use of a two-hole rubber stopper when suction is used, the ammonia should be collected in one of the Jena test-tubes previously described which contains 2 c.c. of N/10 hydrochloric acid and about 5 c.c. of ammonia-free water. The ammonium salt is then transferred to the volumetric flask with 40–50 c.c. of water and Nesslerized as described.

² Care should be taken to secure the pure salt. All ammonium salts contain pyridine bases which titrate like ammonia but do not react with Nessler's reagent. Pure ammonium sulphate may be prepared by decomposing a high-grade ammonium salt with sodium hydroxide and passing the liberated ammonia into pure sulphuric acid. The salt is then precipitated by means of alcohol, then brought into solution in water and re-precipitated by alcohol. The final product should be dried in a desiccator over sulphuric acid. Dr. H. L. Emerson of Boston prepares a salt which is very satisfactory for use in this method. According to Bock and Benedict, Kahlbaum's "Zur Analyse" ammonium chloride is satisfactory.

³ *Chem. Zeit.*, 1899, p. 541. The Nessler-Winkler solution has the following formula:

Mercuric iodide.....	10 grams.
Potassium iodide.....	5 grams.
Sodium hydroxide.....	20 grams.
Water.....	100 c.c.

The mercuric iodide is rubbed up in a small porcelain mortar with water, then washed into a flask and the potassium iodide added. The sodium hydroxide is dissolved in the remaining water and the cooled solution added to the above mixture. The solution cleared by standing is preserved in a dark bottle.

The 25 c.c. portion of the diluted reagent should be added about one-third at a time to the contents of the flask. It is very essential that the dilution of the reagent takes place *immediately preceding its use*, inasmuch as the diluted reagent deteriorates in a few minutes as is indicated by the formation of a brick-red precipitate. Fortunately the reagent does not decompose in this manner in the presence of the ammonium salt.

⁴ The standard may be set at any desired depth but a very satisfactory depth is 20 mm. The depth should be uniform throughout any series of comparative tests.

⁵ Bock and Benedict: *Jour. Biol. Chem.*, 20, 47, 1915.

aspiration. They connect the large Jena test-tube in which the digestion was carried out with a small Liebig condenser (made from a piece of glass tubing 30 by 150 mm. with two-hole rubber stoppers at each end through which pass the inlet and outlet tubes and the condenser tube itself). See Fig. 171. The lower end of the condenser is connected with a glass tube (or better an old pipette, to prevent back suction) which reaches nearly to the bottom of the volumetric flask used as a receiver. The distillation tube also has a two-hole rubber stopper. It is connected with the condenser and also carries a long straight tube which reaches nearly to the bottom of the test-tube, and is closed above with a piece of rubber tubing and a pinch-cock. The digestion is carried out just as in the Folin-Farmer method (see page 514) and when partially cool 7 c.c. of water are added. Into the long tube passing through the stopper suck 3 c.c. of saturated sodium hydroxide solution and close the pinch-cock. Insert the stopper,

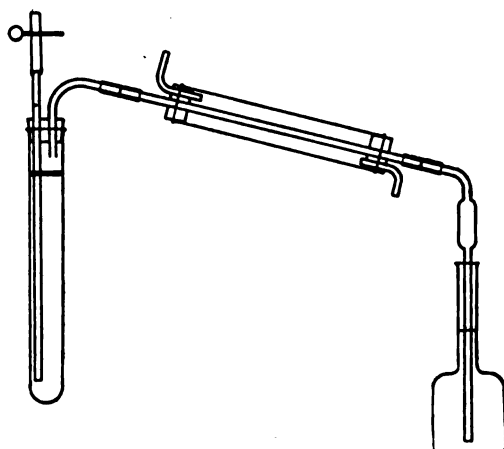

FIG. 171.—BOCK AND BENEDICT APPARATUS.

connect with the condenser and allow the alkali to run into the test-tube. The fluids are mixed by blowing a few bubbles of air through the apparatus. The test-tube is then heated to vigorous boiling (over a large free flame), the distillation being continued until a separation of salts occurs in the test-tube and the mixture begins to bump. This distillation requires about two minutes. The test-tube is then disconnected from the condenser and the latter washed down with a few cubic centimeters of water. The liquid in the receiving flask is diluted and Nesslerized as in the Folin-Farmer method (see page 514).

Bock and Benedict, while holding the distillation procedure to be more accurate than aspiration, do not consider that the colorimetric method is equivalent to the standard Kjeldahl procedure in accuracy or reliability, although usually it agrees with the latter method within about 2–3 per cent, and is indispensable where very small amounts of nitrogen are to be determined. According to Folin¹ and others the method is capable of greater accuracy than this, and the aspiration

¹ Folin: *Jour. Biol. Chem.*, 21, 195, 1915.

procedure gives satisfactory results. The method should be checked up carefully by each new learner of the method, using pure solutions. Outside air is better than laboratory air for aspiration purposes. Care is needed in using the pipettes, which should be of the Ostwald type and accurate. In using them allow the pipette to drain against the side of the vessel for 10 seconds and then blow out clean so that nothing is left behind in the tip. The reagents used must be as free as possible from ammonia and must be checked up, particularly the sulphuric acid and potassium sulphate. Those who have trouble in using a colorimeter may substitute titration with N/50 hydrochloric acid using alizarin, or better methyl red, as an indicator.

4. Gulick's Modification of the Folin-Farmer Colorimetric Method.¹—*Principle.*—By using small amounts of sulphuric acid and potassium sulphate it is possible to Nesslerize the products of the digestion directly without the necessity of previous aspiration of the ammonia.

Procedure.—Dilute the sample of urine to an exact multiple of its original volume (about 4–10 times) with acid mixture,² so that 0.5 c.c. of the dilution will contain between 0.4 and 0.7 mg. of nitrogen. With an Ostwald pipette introduce 0.5 c.c. of this mixture into the bulb of a micro-oxidation flask. The type illustrated in Fig. 172, with a bulb capacity of about 15 c.c., is the most convenient. Add also a small spherical glass bead or scrap of platinum or, better, a piece of platinum wire 4–5 mm. long bent into a tight spiral. Agitate continually while boiling off the water over a micro-burner (about one minute). Set up to heat over a very small flame well guarded against the wind. A luminous flame 6–7 mm. high coming from a burner tube of about 3 mm. outside diameter may be used. The digestion bulb is set at a slant so that the mouth is directed upward and the heat applied at the tip. Heat for at least one minute after the acid becomes clear white. The boiling and oxidation require about 6–10 minutes. As soon as the glass is cool enough to bear water add sufficient ammonia-free water to dissolve the contents, and rinse quantitatively into a 50 c.c. volumetric flask.

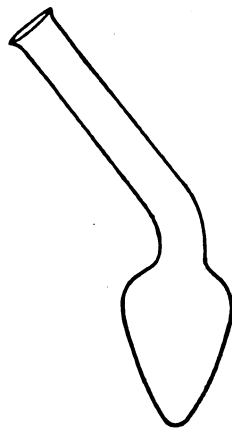

FIG. 172.—GULICK MICRO-OXIDATION FLASK.

Introduce into a second 50 c.c. flask 0.5 mg. of nitrogen in the form of pure ammonium sulphate. Fill both flasks to about 40 c.c. with ammonia-free water. Into each of the flasks then inject 5 c.c. of the modified Winkler solution³ in a vigorous stream from a pipette. Fill to the mark and mix thoroughly. Compare

¹ Gulick: *Jour. Biol. Chem.*, 18, 541, 1914.

² *Acid Oxidizing Mixture.*—To 125 c.c. of ammonia-free water add 40 c.c. of sulphuric acid, 5 c.c. of a saturated solution of mercuric chloride and 20 gm. of potassium sulphate. Then make up to 200 c.c. with ammonia-free water.

³ *Modified Winkler Solution.*—Dissolve 40 grams of sodium hydroxide in about 200 c.c. of ammonia-free water. Mix 15 grams of mercuric iodide and 10 grams of potassium iodide and dissolve in about 15 c.c. of water. Transfer with the aid of the alkali to a 500 c.c. volumetric flask and make up to 500 c.c. with ammonia-free water. Transfer to an Erlenmeyer flask and let stand 24 hours to settle.

at once or at least within an hour in a colorimeter, using a depth of standard of 20-30 mm.

Urea

1. Urease Methods.—*Principle.*—These methods depend upon the principle that the enzyme *urease* is able, at ordinary temperatures, to transform urea, quickly and completely, into ammonium carbonate. Takeuchi¹ in 1909 discovered the presence of this enzyme in the soja or soy bean. The application of this enzyme to the determination of urea in urine, blood, etc., was first proposed by Marshall,² whose methods have been modified by Van Slyke and Cullen.³ These latter investigators prepared a permanent preparation of the enzyme, in a water-soluble form, the use of which makes more convenient the rapid and accurate determination of urea in urine, blood and other biological fluids.

The urease method is probably the most satisfactory of all methods for the determination of urea. Other nitrogenous constituents such as allantoin are not decomposed by urease. The method involves no carefully regulated heating procedures, and is applicable to diabetic urines.

The procedure for the determination in urine consists in treating the urine sample with urease, aerating the ammonia formed into fiftieth-normal acid, and titrating the excess of acid with fiftieth-normal alkali. (For colorimetric procedure see page 521.)

Preparation of Solid Urease.⁴—Digest one part of soy bean meal with five parts of water at room temperature, with occasional stirring, for an hour, and clear the solution by filtration through paper pulp or centrifugation. Pour this extract slowly, with stirring, into at least 10 volumes of acetone. The acetone dehydrates the enzyme preparation. Filter, dry in vacuum, and powder. The activity of the preparation is retained indefinitely. Thus prepared it is not perfectly soluble in water, but this fact interferes in no way with its use.

Standardization of the Enzyme Preparation.—Make up accurately a 3 per cent solution of pure urea. Treat this solution exactly as the urine is treated in the following method, using $\frac{1}{2}$ c.c. of the solution. The ammonia formed should neutralize 25 c.c. of N/50 acid. If it does so the preparation is of sufficient strength to use as indicated. If not, more of the preparation must be used for a determination.

The ground soy bean may also be used directly in this determination. It should pass through a 20-mesh sieve. Rose and Coleman for their micro-procedure

¹ Takeuchi: *Journ. Coll. Agr.*, Tokyo, 1909, Part 1.

² Marshall, E. K., Jr.: *J. Biol. Chem.*, 14, 283, 1913; 15, 495, 1913; 15, 487, 1913; 17, 351, 1914.

³ Van Slyke, D. D., and Cullen, G. E.: *J. Am. Med. Ass'n*, 62, 1558, 1914. See, also, *J. Biol. Chem.*, 19, 141, 1914.

⁴ Van Slyke and Cullen: *Jour. Biol. Chem.*, 19, 211, 1914. Satisfactory preparations of Urease in powder or tablet form may be obtained from the Arlington Chemical Company, Yonkers, N. Y., and from Hynson, Westcott and Dunning, Baltimore.

(see below) use 0.2–0.4 gram of bean flour acting in a water-bath at 50–60° for five minutes. In their macro-method, using 5 c.c. of urine they dilute with 30 c.c. of water warmed to 50–60° and then add 5 grams of the soy bean flour and let stand for 30 minutes. They then add 5 c.c. of saturated sodium carbonate solution and aerate as usual.

(a) Procedure of Van Slyke and Cullen.—Dilute 5 c.c. of urine to 50 c.c. with ammonia-free water. Measure 5 c.c. of the diluted urine into Tube "A" (see Fig. 173), add 1 drop of caprylic alcohol (to prevent frothing), and 1 c.c. of enzyme solution.¹ Close "A" with stopper shown in figure, and let the tube stand 15 minutes for the enzyme to act. Measure into Tube "B" 25 c.c. of N/50 HCl or H₂SO₄. Add 1 drop of caprylic alcohol and 1 drop of a 1 per cent alizarin solution,² as indicator. Connect "A" and "B" as shown in the figure. At the end of 15 minutes aspirate for about one-half minute to remove any ammonia present in the free condition in "A." After this aspiration, open "A" and introduce 5 c.c. of saturated potassium carbonate. Close "A" at once and aspirate until all the ammonia has been removed from "A" and carried over into the acid in "B." The time needed for the aspiration varies for different pumps from 5 to 30 minutes, and should be determined by trial for the particular apparatus used. At the end of the time needed for the aeration,³ the pump is disconnected (care being taken to avoid back suction) and the excess acid in "B" is titrated by means of fiftieth-normal alkali.

Calculations.—The number of cubic centimeters of fiftieth-normal acid neutralized is multiplied by the factor 0.056 to give the number of grams of urea-plus ammonia-nitrogen in 100 c.c. of the urine. The ammonia alone may be determined at the same time as the ammonia plus urea, using the same technic except that 5 c.c. of the undiluted urine, no urease, and the factor 0.0056 are used for the determination of ammonia alone. The ammonia tubes are run in the same series as those for the urea determination, using the same air current for all.

(b) Colorimetric Modification.—Rose and Coleman⁴ suggest the colorimetric determination of the ammonia which is carried over by the aspiration, rather than titration of the excess of acid. They Nesslerize the solution in "B," and compare the color produced with the color of a Nesslerized solution of known ammonia content, as in the Folin-Farmer method for total nitrogen. If this procedure is followed, the amount of urea and ammonia nitrogen in the solution acted upon by the

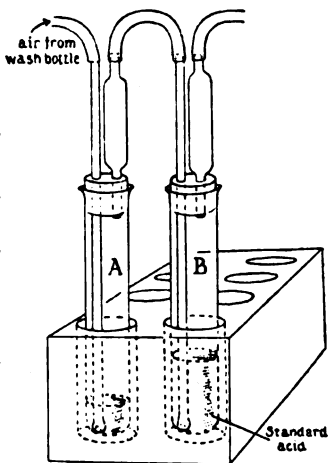

FIG. 173.—VAN SLYKE AND CULLEN APPARATUS.

¹ The enzyme solution is prepared by dissolving 2 grams of the enzyme preparation, 0.6 gram of dipotassium-hydrogen phosphate, and 0.4 gram of monopotassium-dihydrogen phosphate in 10 c.c. of water. Solution is aided by stirring with a glass rod. The slightly opalescent solution should be covered with toluol and may be kept for two weeks without losing activity.

² Folin states that methyl red is preferable to alizarin for ammonia titrations.

³ See Fiske (*Jour. Biol. Chem.*, 23, 455, 1915) and Van Slyke and Cullen (*Jour. Biol. Chem.*, 24, 117, 1916) for discussion of details of method.

⁴ Rose and Coleman: *Biochem. Bull.*, 3, 411, 1914.

urease must not exceed 2 mg. This procedure has been found useful where small quantities of urea are to be estimated.

Interpretation.—The mean average daily excretion of urea by normal adults is usually placed at about 30–35 grams but is very closely dependent upon the protein ingestion and hence may vary widely. It is of significance only when the amount of nitrogen ingested is known with some degree of accuracy. In disorders associated with increased tissue catabolism as in fevers, the excretion of urea is increased. It may be decreased in pronounced kidney and liver disorders due to decreased formation and decreased power of elimination, but these findings are not constant.

The per cent of the total nitrogen of the urine occurring as urea varies on the average from 80–90. On a high protein diet it is nearer 90 per cent; on a very low nitrogen but high calorie diet it may not be over 60 per cent. In marked acidosis it may be considerably decreased relative to the total nitrogen (see ammonia).

(c) **Marshall's Urease Method.**¹—*Principle.*—This is a simple clinical method for the determination of urea in urine. It differs from the preceding method in that instead of aspirating off the ammonia formed from the urea by the action of the urease, it is titrated directly in the urine mixture, thus simplifying the procedure. The method is nearly as accurate as the preceding, for normal urine the error being only about 2 per cent which is very satisfactory for a rapid clinical procedure. For diabetic urines the aeration procedure should be used as such urines contain substances which render the titration inaccurate.

Procedure.—Two 5 c.c. portions of the urine are measured into flasks of 200–300 c.c. capacity and diluted with distilled water to about 100–125 c.c. One c.c. of a 10 per cent solution of urease² prepared as described on page 520 is added to one flask, a few drops of toluene to each and the solution allowed to remain, well stoppered, at room temperature over night (or five hours). The fluid in each flask is titrated to a distinct pink color with N/10 hydrochloric acid using methyl orange as an indicator. A few cubic centimeters of the enzyme solution used should also be titrated to determine the amount of N/10 hydrochloric acid required to neutralize 1 c.c.

Calculation.—The amount of hydrochloric acid required for the contents of the flask containing the urine and enzyme solution, less the amount used for 5 c.c. of urine alone and that previously determined for 1 c.c. of enzyme solution, corresponds to the urea originally present in the sample of urine. Since 1 c.c. of N/10 HCl is equivalent to 3 mg. of urea, the number of cubic centimeters required, multiplied by 0.6 gives the value of urea expressed in grams per liter of urine.

Interpretation.—See above.

¹ Marshall: *Jour. Biol. Chem.*, 14, 283, 1913.

² In this particular method urease free from phosphate should be used as the presence of these salts interferes with the production of a satisfactory end-point.

Ammonia

I. Folin's Method.—Principle.—The ammonia of the urine is set free by the addition of an alkali and this ammonia is then carried over by an air current into a flask containing a measured amount of standard acid. The excess acid is then titrated. The necessity for distillation is avoided.

Procedure.—Place 25 c.c. of urine in an aerometer cylinder, 30–40 cm. in height (Fig. 174, p. 523), add about 1 gram of dry sodium carbonate and introduce some crude petroleum to prevent foaming. Insert into the neck of the cylinder a rubber stopper provided with two perforations, into each of which passes a glass tube, one of which reaches below the surface of the liquid. The shorter tube (10 cm. in length) is connected with a calcium chloride tube filled with cotton, and this tube is in turn joined to a glass tube extending to the bottom of a 500 c.c.

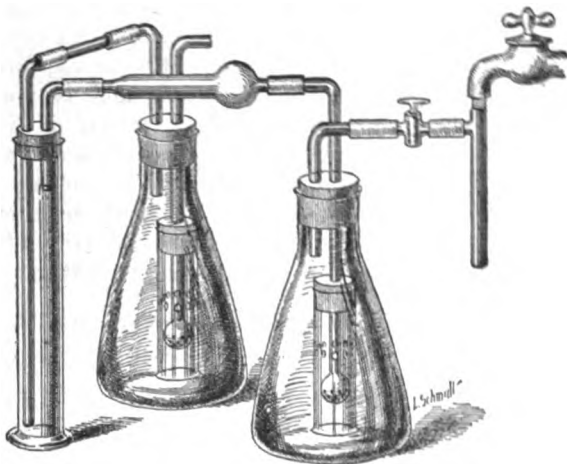

FIG. 174.—FOLIN AMMONIA APPARATUS.

wide-mouthed flask which is intended to absorb the ammonia and for this purpose should contain 20 c.c. of N/10 sulphuric acid, 200 c.c. of ammonia-free distilled water and a few drops of an indicator (alizarin red or Congo red). To insure the complete absorption of the ammonia the absorption flask is provided with a Folin improved absorption tube (Fig. 175), which is very effective in causing the air passing from the cylinder to come into intimate contact with the acid in the absorption flask. In order to exclude any error due to the presence of ammonia in the air a similar absorption apparatus to the one just described is attached to the other side of the aerometer cylinder, thus insuring the passage of ammonia-free air into the cylinder. With an ordinary filter pump and good water pressure the last trace of ammonia should be removed from the cylinder in about one and one-half hours.¹ The number of cubic

¹ With any given filter pump a "check" test should be made with urine or, better, with a solution of an ammonium salt of known strength to determine how long the air current must be maintained to remove all the ammonia from 25 c.c. of the solution.

centimeters of the N/10 sulphuric acid neutralized by the ammonia of the urine may be determined by direct titration with N/10 sodium hydroxide.

Steele¹ has suggested a modification for use on urines containing triple phosphate sediments. In this modification 0.5–1.0 gram of NaOH and about 15 grams of NaCl are substituted for the Na₂CO₃ of the Folin method. The use of sodium hydroxide and chloride instead of carbonate has also been recommended by other workers² as a general procedure, inasmuch as triple phosphate crystals are almost always formed on adding sodium carbonate and these are decomposed with some difficulty by sodium carbonate but readily by the hydroxide. It has not been shown that the use of sodium hydroxide in this manner brings about the decomposition of any other urinary nitrogen compounds.



FIG. 175.—FOLIN IMPROVED ABSORPTION TUBE.

Calculation.—Subtract the number of cubic centimeters of N/10 sodium hydroxide used in the titration from the number of cubic centimeters of N/10 sulphuric acid taken. The remainder is the number of cubic centimeters of N/10 sulphuric acid neutralized by the NH₃ of the urine. One c.c. of N/10 sulphuric acid is equivalent to 0.0017 gram of NH₃. Therefore if y represents the volume of urine used in the determination and y' the number of cubic centimeters of N/10 sulphuric acid neutralized by the NH₃ of the urine, we have the following proportion:

$$y':100 :: y' \times 0.0017 : x \text{ (percentage of NH}_3 \text{ in the urine examined).}$$

Calculate the quantity of NH₃ in the 24-hour urine specimen.

Interpretation.—The average daily output of ammonia in the urine is about 0.7 gram, amounting to 2.5–4.5 per cent of the total nitrogen excretion.

It is increased by the ingestion of acids or acid-forming foods and decreased by the ingestion of alkalis or base-forming foods. In acidosis it may be very greatly increased, being excreted in combination with hydro-oxybutyric and other acids. Values of 5 grams have been noted. It is at the same time increased relative to total nitrogen and urea. In pronounced liver disorders the same thing is noted, as ammonia is not so completely transformed into urea before excretion.

¹ Steele: *Jour. Biol. Chem.*, 8, 365, 1910.

² Benedict and Osterberg: *Biochem. Bull.*, 3, 41, 1913.

Shulansky and Gies: *Biochem. Bull.*, 3, 45, 1913.

2. Micro-chemical Method of Folin and MacCallum.¹—*Principle.*—

This method is a combination of the aeration procedure for ammonia with its colorimetric determination by means of Nessler-Winkler solution. It gives satisfactory results, but is probably not as accurate as the regular Folin procedure where the amount of substance for analysis is not limited.

Procedure.—By means of Ostwald pipettes introduce 1–5 c.c. of urine² into a Jena test-tube (20–25 mm. by 200 mm.) and add to the urine a few drops of a solution containing 10 per cent of potassium carbonate and 15 per cent of potassium oxalate. To prevent foaming add a few drops of kerosene or heavy, crude machine oil. Pass a strong air current (see page 523) through the mixture until the ammonia has been entirely removed.³ Collect the ammonia in a 100 c.c. volumetric flask containing about 20 c.c. of ammonia-free water and 2 c.c. of N/10 acid.

Nesslerize as described in the method for total nitrogen, page 517, and compare with 1 mg. of nitrogen obtained from a standard ammonium sulphate solution and similarly Nesslerized.

It has been noted that a trace of something capable of giving a color with the Nessler-Winkler solution continues to come long after all the ammonia has been removed from the urine. The nature of this substance has not yet been determined. In actual determinations by this method, the influence of this unknown substance, because of the small volume of urine used, is entirely negligible.

3. Formol Titration Method (Malfatti).⁴—*Principle.*—This method is based on the reaction taking place when formalin solution is added to a solution containing ammonium salts (see Amino-acid Nitrogen, below). An acid reaction is produced in the mixture, which is then titrated with standard alkali using phenolphthalein as an indicator. Amino-acids give the same reaction so that the result of the titration represents ammonia + amino-acid nitrogen. This method may be used for the rapid clinical estimation of these forms of nitrogen as a substitute for an ammonia determination, but the results do not represent ammonia as is sometimes stated.

Procedure.—To 25 c.c. of urine in a 200 c.c. Erlenmeyer flask add 15–20 grams of finely pulverized potassium oxalate, a few drops of phenolphthalein, and titrate to a faint but permanent pink color with N/10 NaOH. (The urine mixture just after neutralization in the urinary acidity determination (see page 508) may be used.) Then add 10 c.c. of neutral formalin solution (see amino-

¹ Folin and MacCallum: *Jour. Biol. Chem.*, 11, 523, 1912.

² The volume of urine taken should contain 0.75–1.5 mg. of ammonia nitrogen. With normal urines 2 c.c. will generally yield the desired amount. With very dilute urines 5 c.c. may be required, while with diabetic urines rich in ammonium salts 1 c.c. may be excessive, thus requiring dilution.

³ Ordinarily a period of ten minutes is sufficiently long.

⁴ Malfatti: *Z. anal. Chem.*, 47, 273, 1908.

acid nitrogen), mix well and titrate with N/10 sodium hydroxide to a permanent pink color.

Calculation.—One c.c. of N/10 sodium hydroxide is equivalent to 1.7 mg. of ammonia. Multiply the number of cubic centimeters of N/10 alkali used by 1.7 and by 4 to get the number of milligrams of ammonia + amino-acid nitrogen (expressed as ammonia) in 100 c.c. of the urine examined.

4. Direct Nesslerization Methods.—Two methods for the determination of ammonia in urine by direct Nesslerization have been proposed. Folin and Bell¹ absorb the ammonia from a small amount of urine by means of permutit, liberate the absorbed ammonia by treatment with alkali, and Nesslerize the resultant mixture.

Sumner² uses copper sulphate and sodium hydroxide to precipitate creatinine and other substances which interfere with Nesslerization. The mixture is filtered and the filtrate Nesslerized. A rapid procedure is described for estimating the amount of ammonia present before diluting and treating with Nessler solution.

Amino-acid Nitrogen

1. Henriques-Sørensen Formol Titration Method.³—Principle.—

A solution containing amino-acids is nearly neutral in reaction. If formaldehyde be added, however, the following reaction takes place with the formation of methylene derivatives which are more strongly acid in reaction due to the destruction of the basic properties of the amino groups. The carboxyl groups may then be titrated using phenolphthalein as an indicator.

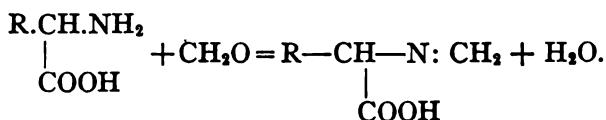

The acidity as shown by the titration is a measure of the amount of amino-acid nitrogen present. Ammonia likewise reacts with formaldehyde in a similar manner as is shown in the following equation:

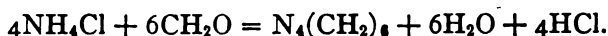

Hence the formol titration in the presence of ammonia gives results which include both amino-acid and ammonia nitrogen. Ammonia

¹ Folin and Bell: *Jour. Biol. Chem.*, 29, 329, 1917.

² Sumner: *Jour. Biol. Chem.*, 34, 37, 1918.

³ Henriques and Sørensen: *Zeit. physiol. chem.*, 64, 120, 1909.

may be determined and a correction applied, or the ammonia may be removed by means of phosphotungstic acid. Phosphates also interfere by obscuring the end-point and are removed by the addition of barium salts.

It must be borne in mind that polypeptides and still more complex protein derivatives likewise react with formol to a certain degree so that the results do not strictly represent "amino-acid nitrogen."

The method is, with some modifications involving the preparation of the solution to be titrated, applicable in the determination of amino-acids in any medium, *e.g.*, urine, protein digests, etc. When poorly dissociated acids, *e.g.*, some fatty acids, are present, these will in part be included in the result and lead to values which are too high. Certain of the amino-acids when present in large amounts will give erroneous results, but in the ordinary urine or digest these errors are either negligible or compensate each other. In the titration of colored solutions the control solution which is necessary in this method must be colored to correspond with the color of the unknown solution.

Procedure.—The determination of the amino-acids is carried out as follows: The solution to be analyzed, if carbonates, phosphates and ammonia are absent, is made neutral to litmus (paper) and the solution titrated with formaldehyde as below.¹ In case carbonates, phosphates or ammonia are present a preliminary treatment is necessary which will vary according to the quantity of ammonia present.

(a) For Small Amounts of Ammonia.—Applicable to most urines. Fifty c.c. of the material under examination is pipetted into a 100 c.c. measuring flask and 1 c.c. phenolphthalein solution² and 2 grams of solid barium chloride are added; the whole is shaken, to saturate the solution with barium chloride; saturated barium hydroxide solution is added until the red color of the phenolphthalein develops and then an excess of 5 c.c. is added. The flask is filled to the graduation mark with water, shaken and permitted to stand for 15 minutes, after which it is filtered through a dry filter. Eighty c.c. of the clear red filtrate (which corresponds to 40 c.c. of the liquid under examination) are placed in a 100 c.c. measuring flask, neutralized to litmus and diluted to 100 c.c. with freshly boiled water. Equal portions of this solution, 40 c.c. (equivalent to 16 c.c. of the original solution), may be taken for analysis, one for the formol titration and the other for the determination of ammonia nitrogen.³

(b) For Large Amounts of Ammonia.—After the treatment with phenolphthalein, barium chloride, and barium hydroxide, and the solution has been diluted to 100 c.c. as in (a) above, the ammonia is distilled off, *in vacuo*.⁴

¹ As a standard of comparison the litmus paper used for neutralization is contrasted with a similar piece dipped in a phosphate solution having a neutral reaction ($M/15$ KH_2PO_4 and $M/15$ Na_2HPO_4).

² A solution of 0.5 gram of phenolphthalein in 50 c.c. of alcohol and 50 c.c. of water.

³ The determination of ammonia may be dispensed with in case a separate determination is made.

⁴ For particulars with regard to the distillation, etc., see Henriques and Sørensen: *Zeit. physiol. Chem.*, 64, 137, 1909.

In case the solution is deeply colored, as in protein digests, it may be necessary to decolorize¹ before the titration is attempted.

Final Titration.—For the final titration a volume of from 20–40 c.c. which contains approximately 0.025 gram of nitrogen is the most desirable. A control solution is run composed of an equal volume of boiled distilled water and 20 c.c. of the formaldehyde mixture.² This control solution is colored³ so that its tint matches that of the solution to be titrated.

To this control is added about half the volume of N/5 alkali which will be used in the titration of the solution under investigation and it is then titrated with N/5 acid to a faint red (first stage).⁴

An additional drop of N/5 alkali is added, which imparts a distinct red to the solution (second stage).

The solution to be analyzed is now titrated to the color produced in the second stage of the control. The formaldehyde mixture is now added; 10 c.c. for each 20 c.c. of the solution, and the mixture again titrated to the second stage with N/5 alkali.⁵

Two drops of the N/5 alkali are now added to the control solution which assumes a deep red color (third stage). Fifth normal alkali is now added to the solution under examination until it assumes a color corresponding to the third stage of the control. This completes the titration.

Calculation.—The calculations are similar to those which pertain to any acidimetry procedure. Each cubic centimeter of an N/5 alkali or acid solution is equivalent to 0.0028 gram of nitrogen. An example will illustrate the procedure: 40 c.c. of solution (16 c.c. of urine) required 5.10 c.c. N/5 NaOH; control, 0.10 c.c. N/5 NaOH; total required for amino-acids 5.00 c.c. equivalent to 0.014 gram of nitrogen. Ammonia nitrogen in 16 c.c. of urine 0.007 gram N. Then $0.014 - 0.007 = 0.007$ gram amino-acid nitrogen in 16 c.c. of urine.

Interpretation.—The excretion of total amino-acid nitrogen by a normal adult averages between 0.4 to 1.0 gram per day or from 2 to 6 per cent of the total nitrogen. Free amino-acid nitrogen (see Van Slyke procedure) is considerably less than this, ordinarily 0.5 to 1.0 per cent of the total nitrogen. The amount may be largely increased in disorders associated with tissue waste as typhoid, in pronounced atrophy of the liver, acidosis, etc.

2. Benedict-Murlin Modification.⁶—**Principle.**—In this method the ammonia is removed by means of phosphotungstic acid, and excess acid as well as carbonates and phosphates carried down with barium.

¹ For methods see Jessen-Hansen, *Abderhalden's Arbeits Methoden*, vol. 6, p. 262, 1912.

² The formaldehyde solution is freshly prepared for each set of determinations as follows: to 50 c.c. of commercial formaldehyde (formol) (30–40 per cent) add 1 c.c. of the phenolphthalein solution. N/5 alkali is then added until the mixture acquires a faint red color. The volume of the formaldehyde used will vary with the volume of the solution to be analyzed; approximately 10 c.c. of the formalin solution are added for each 20 c.c. of the unknown solution.

³ Solution of Bismark brown is very satisfactory for urines. Tropæolin O, Tropæolin OO, *p*-nitro-phenol, methyl orange or alizarin sulphonate, may be used.

⁴ This procedure is recommended in order that the final volume of the control and the unknown solutions shall be approximately the same when the process is complete.

⁵ This is best accomplished by adding alkali until the color is deeper than that of the control, then acid again until lighter and finally alkali to the desired color.

⁶ Benedict and Murlin: *Jour. Biol. Chem.*, 16, 385, 1913.

Procedure.—Measure into a 500 c.c. Erlenmeyer flask 200 c.c. of a 24-hour urine which has been diluted to 2000 c.c. (or its equivalent). Add an equal volume of 10 per cent phosphotungstic acid (Merck)¹ in 2 per cent HCl. Let stand at least three hours, better over night. Pour off 250 c.c. of the clear fluid, add 1 c.c. of a 0.5 per cent solution of phenolphthalein and then barium hydroxide in substance until the whole fluid turns decidedly pink. The barium hydroxide should be added a very little at a time. Let stand one hour. Filter off two 100 c.c. samples (= 50 c.c. urine). Neutralize these samples to litmus (using good quality litmus paper) with N/5 HCl. Add at once 10–20 c.c. of neutral formalin² and titrate cautiously to a deep red color, *i.e.*, until the drop produces no additional color with N/10 NaOH. Deduct from the result thus obtained the amount of N/10 NaOH necessary to produce the same depth of color in an equal quantity of water, freed from carbon dioxide by boiling and cooling, and to which an equal volume of neutral formalin has been added.

Calculation.—One c.c. of N/10 NaOH is equivalent to 1.4 mg. of amino-acid nitrogen. Multiply the number of cubic centimeters of N/10 NaOH used (after deducting for control as indicated above) by 1.4 and by 2 (as the equivalent of 50 c.c. of urine was used) to obtain the number of milligrams of amino-acid nitrogen in 100 c.c. of the urine.

Interpretation.—See page 528.

3. Method of Frey-Gigon.³—**Principle.**—The ammonia is removed from the urine by aspiration after treatment with barium hydroxide and the formol titration performed in the usual manner.

Procedure.—Treat 50 c.c. of urine in an aerometer cylinder such as used in the Folin ammonia method, with 20 c.c. of saturated barium hydroxide solution and 15 c.c. of alcohol. Aspirate for two or three hours, using a slow current of air. The ammonia is carried off. (It may be collected in standard acid solution and determined as in the Folin method (see page 523) if desired.) Transfer the urine mixture quantitatively to a 250 c.c. flask and make to mark with distilled water. Shake well, allow to settle, filter. Take 100 c.c. of the filtrate and just neutralize with N/5 hydrochloric acid, using rosolic acid as an indicator. Then to another 100 c.c. portion of the filtrate add an amount of the standard acid equal to that added to the first portion. Next add 10 c.c. of neutral formalin solution, a few drops of phenolphthalein and titrate in the usual manner to a red-violet color. Calculate as in the preceding method.

The amino-acid nitrogen may also be approximately determined by carrying out the titration for ammonia + amino-acid nitrogen as given under Ammonia, page 525, making a separate determination of ammonia, and subtracting the latter result from the former.

4. Van Slyke's Method for Total Amino-Acid Nitrogen.⁴—Take 25 c.c. of urine⁵ and mix with 1 c.c. of concentrated sulphuric acid and heat in an autoclave at 180° (oil bath temperature) for one and one-half hours. Transfer to a 50 c.c. flask and add 2 grams powdered calcium hydroxide. Shake thoroughly, make up to 50 c.c. and filter through a dry folded filter. Transfer 20 c.c. of the

¹ Kahlbaum's preparation is a very different substance.

² To 50 c.c. commercial formalin solution (30–40 per cent) add 1 c.c. of phenolphthalein solution and then N/5 NaOH to a very faint pink color. The solution should be freshly prepared.

³ Frey and Gigon: *Biochem. Zeit.*, 22, 309, 1909.

⁴ Van Slyke: *Jour. Biol. Chem.*, 16, 125, 1913.

⁵ See (Van Slyke: *Proc. Soc. Exp. Biol. and Med.*, 13, 63, 1915) for treatment of urines containing glucose or albumin.

filtrate to a Jena glass evaporating dish and concentrate to dryness on the water-bath. This requires about half an hour. The residue is moistened with 1 c.c. of 50 per cent acetic acid to bring the calcium hydroxide and carbonate into solution, and is then washed into a 10 c.c. flask and filled up to the mark. One can use the entire solution for determination of the amino-nitrogen in the large amino-apparatus, or use 2 c.c. portions for the micro-apparatus. (See Van Slyke Apparatus, Figs. 34 and 35, p. 88 in Chapter IV on Proteins.)

The length of time which the nitrous acid solution should be shaken in order to drive off all the amino-nitrogen depends somewhat on the temperature. When the latter is 15–20° the time should be five to four minutes; for 20–25° it is three minutes, for 25–30°, two and a half to two minutes. It is preferable that the solution should be shaken vigorously with a motor and the time kept down to these limits, for the sake not only of rapidity but of accuracy.

Van Slyke's Method for Free Amino-Acid Nitrogen.—To 25 c.c. of urine¹ in a 50 c.c. flask add urease solution and allow to stand for one and one-half times the interval which has been found necessary to effect the maximum decomposition of urea, as observed by titration of the ammonia. The last traces of urea are decomposed. At the end of the digestion period 10 c.c. of a 10 per cent suspension of calcium hydroxide are added, the mixture shaken and made up to 50 c.c. Then filter, evaporate, and complete the determination according to the method outlined under total amino-acid nitrogen, above.

Creatinine

Folin's Colorimetric Method.—*Principle.*—This method is based upon the characteristic property possessed by creatinine, of yielding a certain definite color-reaction in the presence of picric acid in alkaline solution.

Procedure.—Place 10 c.c. of urine in a 500 c.c. volumetric flask, add 15 c.c. of a saturated solution of picric acid and 5 c.c. of a 10 per cent solution of sodium hydroxide, shake thoroughly and allow the mixture to stand for five minutes. During this interval pour a little $N/2$ potassium bichromate solution² into each of the two cylinders of the colorimeter (Duboscq's, see Fig. 168, p. 515) and carefully adjust the depth of the solution in one of the cylinders to the 8 mm. mark. A few preliminary colorimetric readings may now be made with the solution in the other cylinder, in order to insure greater accuracy in the subsequent examination of the solution of unknown strength. Obviously the two solutions of potassium bichromate are identical in color and in their examination no two readings should differ more than 0.1–0.2 mm. from the true value (8 mm.). Four or more readings should be made in each case and an average taken of all of them exclusive of the first reading, which is apt to be less accurate than the succeeding readings. In time as one becomes proficient in the technic it is perfectly safe to take the average of the first two readings.

At the end of the five-minute interval already mentioned, the contents of the 500 c.c. flask are diluted to the 500 c.c. mark, the bichromate solution is thoroughly rinsed out of one of the cylinders and replaced with the solution thus prepared and a number of colorimetric readings are immediately made.

¹ See note 5, page 529.

² This solution contains 24.55 grams of potassium bichromate to the liter. A pure creatinine standard is to be preferred, see p. 531.

Ordinarily 10 c.c. of urine is used in the determination by this method, but if the content of creatinine is above 15 mg. or below 5 mg. the determination should be repeated with a volume of urine selected according to the content of creatinine. This variation in the volume of urine according to the content of creatinine is quite essential, since the method loses in accuracy when more than 15 mg. or less than 5 mg. of creatinine is present in the solution of unknown strength.

Calculation.—By experiment it has been determined that 10 mg. of pure creatinine, when brought into solution and diluted to 500 c.c. as explained in the above method, yields a mixture 8.1 mm. of which possesses the same colorimetric value as 8 mm. of a $N/2$ solution of potassium bichromate. Bearing this in mind the computation is readily made by means of the following proportion in which y represents the number of millimeters of the solution of unknown strength equivalent to the 8 mm. of the potassium bichromate solution :

$$y:8.1::10:x \text{ (mg. of creatinine in the quantity of urine used).}$$

This proportion may be used for the calculation no matter what volume of urine (5, 10, or 15 c.c.) is used in the determination. The 10 represents 10 mg. of creatinine which gives a color equal to 8.1 mm., whether dissolved in 5, 10, or 15 c.c. of fluid.

Calculate the quantity of creatinine in the 24-hour urine specimen.

Interpretation.—The daily excretion of creatinine by an adult of medium weight averages about 1.25 grams. The value is nearly constant from day to day for a given individual being influenced by the diet hardly at all unless this contains much preformed creatinine (as in case of a heavy meat diet). The excretion of creatinine is to a certain extent a measure of muscular efficiency and of the amount of active muscle tissue in the body. Relative to body weight less creatinine is excreted by obese persons.

Creatinine excretion is decreased in disorders associated with muscular atrophy and muscular weakness. It increases with increased tissue catabolism as in fever.

By the "creatinine coefficient" is meant the number of milligrams of creatinine—*nitrogen* excreted daily per kilo of body weight. This varies under normal conditions from 7-11.

Use of Pure Creatinine Standards.—Instead of using as a standard a potassium dichromate solution as above indicated, a solution of pure creatinine is to be recommended. By using this certain arbitrary factors are eliminated and the method becomes of more general applicability. The standard need not be set at a definite mark as is necessary in the case of dichromate and temperature and time have less influence on the accuracy of the results. A stock solution of pure creatinine (made according to Benedict's directions; see Chapter XXIII in *Physiological Constituents of Urine*) is made by dissolving 1 gram of the substance in sufficient $N/10$ HCl to make a liter. This solution contains 1 mg. of creatinine per cubic centimeter. In carrying out the determination treat 10 c.c. of the stock solution in the same way and at the same time as the 10 c.c. sample of urine. Compare in the colorimeter. The calculation is simple. The reading of the standard divided by the reading of the

urine gives directly the number of milligrams of creatinine per cubic centimeter of urine.

Folin's Microchemical Modification.¹—*Principle.*—The principle is the same as that of the original colorimetric method (see page 530). This procedure is to be recommended particularly where only small amounts of material are available.

Procedure.—One c.c. of the standard creatinine (see above) solution (1 mg. per c.c.) is measured into a 100 c.c. volumetric flask and 1 c.c. of urine into another; 20 c.c. of saturated picric acid solution (measured with a cylinder) are added to each and then 1.5 c.c. of a 10 per cent solution of sodium hydroxide. At the end of ten minutes the flasks are filled up to the mark with tap water and the color of the unknown is determined. The reading of the standard divided by the reading of the unknown gives directly the number of milligrams of creatinine in the amount of urine taken for analysis.

3. Shaffer's Modification for the Determination of Creatinine in Very Dilute Solutions.²—The regular Folin procedure is not accurate when applied to urines containing less than 20 mg. of creatinine per 100 c.c. By a slight modification it becomes applicable to creatinine solutions containing as little as 1 mg. or less per 100 c.c.

Procedure.—To the solution under examination add an equal volume of saturated picric acid solution and one-tenth this volume of 10 per cent sodium hydroxide solution. After standing 6–10 minutes the liquid is diluted to a definite volume depending upon the intensity of the color developed. With very dilute solutions one may add solid picric acid equivalent to half saturation (0.6 per cent) and when dissolved, one-twentieth the volume of sodium hydroxide. Provided the creatinine solution itself has not sufficient color to interfere, the results by this method appear to be as accurate as the original procedure. The colorimetric readings and calculations are made in the same way as in the preceding methods.

Creatine

Folin-Benedict Method.³—*Principle.*—Creatine on boiling with acid is transformed into creatinine. By determining the content of creatinine before and after the acid treatment we are able to calculate the amount of creatine originally present in the urine. The Folin colorimetric method (page 530) is used for determining the creatinine in both cases. The method is not applicable to diabetic urines.

Procedure.—Introduce into a small flask or beaker 10 c.c. of the urine to be examined. (If 10 c.c. contains more than 12 or less than 7 mg. of total creatinine use a correspondingly smaller or larger volume of urine.) Add from 10–20 c.c. of normal HCl, and a pinch or two of powdered or granulated lead. Boil the mixture over a free flame as slowly or as rapidly as may be desired, until very nearly down to dryness, when the heating should be continued to dryness either on the water-bath or very easily by simply holding the vessel in the hand and heating carefully for a moment or two. Let the residue stand on the water-bath for a few minutes until most of the excess of hydrochloric acid gas has been expelled, after which dissolve it in about 10 c.c. of hot water and rinse the solu-

¹ Folin: *Jour. Biol. Chem.*, 17, 469, 1914.

² Shaffer: *Jour. Biol. Chem.*, 18, 525, 1914.

³ Benedict: *Jour. Biol. Chem.*, 18, 191, 1914.

tion quantitatively through a plug of cotton or glass wool (to remove all metallic lead) into a 500 c.c. volumetric flask. Add 20–25 c.c. of a saturated picric acid solution and about 7–8 c.c. of a 10 per cent NaOH solution, which contains 5 per cent of Rochelle salt.¹ At the end of five minutes fill to the mark with water and read in the colorimeter just as in the case of creatinine (see page 530).

Calculation.—Calculate the creatinine content of the solution in the same manner as given under Creatinine (page 531). From the value thus obtained subtract the value for the creatinine content of the urine before dehydration. The difference will be the creatine content of the original urine in terms of creatinine.

Interpretation.—Creatine occurs only in very small amounts in the urine of normal adults, but is found in larger amounts in that of children (10 to 50 mg. per day). Creatine ingestion in adults has little effect on the urinary excretion. In fasting, the amount is markedly increased (it may amount to 100 mg. or more per day). Creatine also appears in the urine after high water ingestion. It is found in many pathological conditions associated with malnutrition and disintegration of muscular tissue, in fever, etc. Very large amounts have been found in cases of carcinoma of the liver.

2. Folin-Benedict and Myers Method.²—To 20 c.c. of urine in a 50 c.c. volumetric flask, add 20 c.c. of normal hydrochloric acid and place the flask in an autoclave at a temperature of 117–120°C. for one-half hour. Add distilled water until the volume of the acid-urine mixture is exactly 50 c.c., close the flask by means of a stopper, and shake it thoroughly. Approximately neutralize 25 c.c. of this mixture, introduce it into a 500 c.c. volumetric flask and determine its creatinine content according to Folin's Colorimetric Method (see page 530).

For calculation and interpretation see the foregoing method.

3. Method of Folin.³—*Water-bath Procedure.*—Heat 10 c.c. of urine with 5 c.c. of normal hydrochloric acid on the boiling water-bath or at 90°C. for three hours. The creatine is transformed into creatinine. Some darkening takes place but this does not interfere because of the subsequent dilution. The mixture is made up to 50 c.c., 25 c.c. of this is taken, neutralized, and creatinine plus creatine determined just as in the case of creatinine alone. The creatine is obtained by difference. This procedure may be used for diabetic urines which is not the case with the autoclave procedure nor with the Benedict modification. It is perhaps not quite so accurate as the autoclave procedure.

4. Microchemical Modification of Folin.⁴—By greatly diluting the urine the time required for the conversion of creatine to creatinine is decreased, and picric acid can be substituted for mineral acid.

Procedure.—Enough urine to give 0.7–1.5 mg. of creatinine is measured into a weighed Erlenmeyer Jena flask (capacity 200 c.c.); 20 c.c. of saturated picric acid solution, about 130 c.c. of water, and a few very small pebbles to promote even boiling are added and the mixture is gently boiled, preferably over a micro-burner for about one hour. At the end of this time the heat is increased and the solution

¹ The Rochelle salt should be present to prevent any formation of turbidity, which otherwise may occur, due to the presence of traces of dissolved lead.

² Benedict and Myers: *Am. J. Phys.*, 18, 397, 1907.

³ Folin: *Zeitschr. f. physiol. Chem.*, 41, 222, 1904.

⁴ Folin: *Jour. Biol. Chem.*, 17, 469, 1914.

is boiled down to rather less than 20 c.c. The flask is transferred to the scales and enough water is added to make the total solution equal to 20-25 grams. The solution is cooled in running water, 1.5 c.c. of 10 per cent sodium hydroxide are added, and the total creatinine is determined as in the preformed creatinine determination using 1 mg. of creatinine as a standard. The method has been found to give good results in the presence of glucose and other sugars.

Morris¹ has suggested that in the case of diabetic urines the total creatinine be determined after precipitation of the creatine and creatinine with picric acid. The method is not recommended as a regular procedure.

Uric Acid

1. Microchemical Colorimetric Method.—*Benedict and Hitchcock Modification of the Folin-Macallum-Denis Procedure.*—The principle of the method depends upon the fact, first noted by Folin and Macallum² and further investigated by Folin and Denis,³ that uric acid gives, with phosphotungstic acid and alkali, a deep blue color the depth of which is proportional to the amount of uric acid present. Since certain other substances present in urine produce a similar blue color with the phosphotungstic acid, it is necessary to separate the uric acid from them. This is accomplished by precipitation as the silver salt. The silver urate is subsequently dissolved and treated with the uric acid reagent.

Benedict and Hitchcock⁴ have examined the method of Folin and Denis and have suggested a number of important modifications.

Procedure.—Measure such an amount of urine as will contain from 0.7 to 1.3 mg. of uric acid (2 to 4 c.c. is usually the correct amount) into a centrifuge tube, dilute with water to about 5 c.c., and add 15 to 20 drops of an ammoniacal silver magnesium solution.⁵ Mix the contents of the tube with a small stirring rod and centrifuge the tube for one or two minutes. Pour off the supernatant liquid, as completely as possible, by inverting the tube, allowing it to drain a moment, and then touching the inside of the lip of the tube with a towel or piece of filter paper. Add to the residue in the tube two drops of a 5 per cent solution of potassium cyanide to dissolve the silver urate, stir the mixture thoroughly with a thin rod, for half a minute, add a few drops (0.5 to 1.0 c.c.) of water, and stir again.⁶ Two c.c. of the uric acid reagent⁷ are added and the mixture stirred

¹ Morris: *Jour. Biol. Chem.*, 21, 201, 1915.

² Folin and Macallum: *J. Biol. Chem.*, 13, 363, 1912.

³ Folin and Denis: *J. Biol. Chem.*, 14, 95, 1913; *ibid.*, 13, 469, 1913.

⁴ Benedict and Hitchcock: *J. Biol. Chem.*, 20, 619, 1915; Benedict: *ibid.*, 20, 629, 1915.

⁵ This solution has the following composition:

3 per cent silver lactate solution	70 c.c.
Magnesia mixture	30 c.c.
Concentrated ammonium hydroxide solution.....	100 c.c.

⁶ At this point perfectly clear solutions are obtained with pure uric acid solutions in phosphate mixture or in pyridin. With urines some magnesium ammonium phosphate is precipitated with the uric acid, which does not dissolve in the cyanide. After adding the two subsequent reagents, however, a perfectly clear solution is obtained.

⁷ **Preparation of the Uric Acid Reagent.**—Boil together 100 grams of sodium tungstate, 30 c.c. of 85 per cent phosphoric acid, 20 c.c. of concentrated hydrochloric acid, and 750 c.c. of distilled water under a reflux condenser for 1½ hours. Cool and make up to 1 liter. This modified solution shows less tendency to develop turbidity than does the original Folin-Denis reagent.

again, after which¹ add 10 c.c. of 20 per cent sodium carbonate solution,² transfer quantitatively to a 50 c.c. flask, and at the end of about one-half minute, dilute to mark. Compare this solution in the Duboscq colorimeter (page 515) with a simultaneously prepared solution obtained by treating 5 c.c. of the standard uric acid solution,³ contained in a 50 c.c. flask, with 2 drops of the potassium cyanide solution, 2 c.c. of the uric acid reagent, 10 c.c. of 20 per cent sodium carbonate solution, and diluting to the mark at the end of about one-half minute. The standard solution is best set at a height of 15 mm. in the colorimeter.

Calculation.—The reading of the standard divided by the reading of the urine gives the number of milligrams of uric acid in the amount of sample taken.

Interpretation.—For adults on a mixed diet the average excretion of uric acid is about 0.7 gram. It arises from the purines of ingested food (exogenous uric acid) and from purines derived from the body tissues by disintegration of nuclein material (endogenous uric acid). Exogenous uric acid depending entirely upon the diet is greatly increased by the ingestion of purine-rich foods (meat, liver, sweetbreads, etc.) and reduced to a very low level on purine-free foods, e.g., milk, eggs, etc. (see Chapter XXVIII). Endogenous uric acid is influenced by exercise and by the diet (protein foods particularly giving rise to increases). It appears to be partly the result of gastro-intestinal secretory activity. On a purine-free diet the average excretion is 0.1–0.5 gram. On a high purine diet the uric acid output may be 2 grams per day.

In gout the uric acid content of the urine is low preceding an attack and increases during the attack, this fall and rise being more or less characteristic. The excretion rises after atophan administration apparently due to increased kidney activity. In leukemia the excretion is extremely high due to nuclear destruction. The uric acid content of the urine is of importance in relation to the formation of uric acid calculi. The administration of alkali carbonates and citrates by decreasing the acidity of the urine increases its solvent power for uric acid, and decreases the liability of the formation of this type of calculus.

¹ Bogert (*Jour. Biol. Chem.*, 31, 165, 1917) advocates transferring the mixture to the volumetric flask by washing with 20 to 30 c.c. of water before adding the sodium carbonate, as a means of preventing turbidity.

² Sodium Carbonate Solution.—Dissolve 200 grams of anhydrous sodium carbonate in warm water and make up to 1 liter.

³ Standard Uric Acid Solution.—The solution of uric acid in phosphate solution is very readily prepared, does not need to be standardized, and appears to keep indefinitely. It is prepared in the following manner: Dissolve 9 grams of pure crystallized disodium hydrogen phosphate, together with 1 gram of crystallized sodium dihydrogen phosphate, in 200 to 300 c.c. of hot water, and filter if the solution is not perfectly clear. Make this filtrate up to about 500 c.c. with hot water, and pour this hot or warm (and perfectly clear) solution upon exactly 200 mg. of pure uric acid suspended in a few cubic centimeters of water in a liter volumetric flask. Agitate the mixture for a few minutes until the uric acid completely dissolves. Cool, add *exactly* 1.4 c.c. of glacial acetic acid, dilute to the mark, and mix. Add about 5 c.c. of chloroform to prevent the growth of bacteria or moulds in the solution. Five c.c. of this solution contains exactly 1 mg. of uric acid.

Curtman and Freed (*Jour. Biol. Chem.*, 28, 89, 1916) suggest that the deterioration of the above standard due to crystallization of uric acid may be prevented by replacing the 1.4 c.c. of glacial acetic acid of the standard by 25 c.c. of 4 per cent boric acid solution.

3. **Folin-Shaffer Method.**¹—*Principle.*—The uric acid is precipitated as ammonium urate by the addition of ammonia, the precipitate filtered off, washed and titrated with potassium permanganate. A preliminary treatment with an ammonium sulphate-uranium acetate solution is for the purpose of removing interfering organic substances. The method gives accurate results.

Procedure.—Introduce² 100 c.c. of urine into an Erlenmeyer flask, add 25 c.c. of the Folin-Shaffer reagent³ and after shaking the flask to thoroughly mix the fluids allow the mixture to stand,⁴ with or without further stirring, until the precipitate has settled (5–10 minutes). Filter, transfer 100 c.c. of the filtrate to a 200 c.c. Erlenmeyer flask, add 5 c.c. of concentrated ammonium hydroxide and allow the mixture to stand for 24 hours. Transfer the precipitated ammonium urate quantitatively to a filter paper,⁵ using 10 per cent ammonium sulphate to remove the final traces of the urate from the flask. Wash the precipitate approximately free from chlorides by means of 10 per cent ammonium sulphate solution,⁶ remove the paper from the funnel, open it, and by means of hot water rinse the precipitate back through the funnel into the flask in which the urate was originally precipitated. The volume of fluid at this point should be about 100 c.c. Cool the solution to room temperature, add 15 c.c. of concentrated sulphuric acid and titrate at once with N/20 potassium permanganate, $K_2Mn_2O_8$, solution. The first tinge of pink color which extends throughout the fluid after the addition of two drops of the permanganate solution, while stirring with a glass rod, should be taken as the end-reaction. Take the burette reading and compute the percentage of uric acid present in the urine under examination.

Calculation.—Each cubic centimeter of N/20 potassium permanganate solution is equivalent to 3.75 mg. (0.00375 gram) of uric acid. The 100 c.c. from which the ammonium urate was precipitated is equivalent to only four-fifths of the 100 c.c. of urine originally taken; therefore we must take five-fourths of the burette reading in order to ascertain the number of cubic centimeters of the permanganate solution required to titrate 100 c.c. of the original urine to the correct end point. If y represents the number of cubic centimeters of the permanganate solution required, we may make the following calculation:

$$y \times 0.00375 = \text{weight of uric acid in 100 c.c. of urine.}$$

Because of the solubility of the ammonium urate a correction of 3 mg. should be added to the final result.

Calculate the quantity of uric acid in the 24-hour urine specimen.

5. **Krüger-Schmidt Method.**—Krüger and Schmidt have devised a method for the combined determination of uric acid and the other purine bodies of urine. This procedure is described under Purine Bases, below. A modification of this method by Hunter is also given.

¹ Folin and Shaffer: *Zeit. physiol. Chem.*, 32, 552, 1901.

² It is preferable to use more than 100 c.c. of urine if the fluid has a specific gravity less than 1.020.

³ The Folin-Shaffer reagent consists of 500 grams of ammonium sulphate, 5 grams of uranium acetate and 60 c.c. of 10 per cent acetic acid in 650 c.c. of distilled water.

⁴ The mixture should not be allowed to stand for too long a time at this point, since uric acid may be lost through precipitation.

⁵ The Schleicher and Schüll *hardened* papers or the Baker and Adamson *washed, askless* variety are very satisfactory for this purpose.

⁶ This washing may be conveniently done by *decantation* if desired, thus retaining the major portion of the precipitate in the flask.

6. Ruhemann's Uricometer Method.—*Principle.*—When iodine solution is added to urine an amount of iodine is absorbed roughly proportional to the amount of the uric acid present. A special graduated tube is required and carbon disulphide is used to indicate the presence of excess iodine.

Procedure.—Fill the tube (see Fig. 176) to the lowest mark S with carbon disulphide (the bottom of the meniscus should rest on the line). Then add iodine solution (1.5 grams iodine, 1.5 grams potassium iodide, 15 grams absolute alcohol, and 185 grams distilled water) to the mark J. Add urine to mark 2.45 (2.6 c.c.). Insert the glass stopper and shake. The carbon disulphide will show the dark brown color of iodine. Add more urine gradually with continued shaking until only a violet-pink color remains in the disulphide after shaking. Then add drop by drop with vigorous shaking until the disulphide becomes colorless. Read on the scale the amount of uric acid in parts per thousand of urine.

When the uric acid content of the urine is low this method gives reasonably accurate results from the clinical standpoint.¹ At a level of 0.3 gram per day the probable error will not exceed 10–15 per cent. Above 1 gram no limit can safely be placed on the degree of error in pathological cases especially where albumin, diacetic acid, purine bases and certain drugs are likely to be present. The results by this method are ordinarily high.

Purine Bases

1. Krüger and Schmidt's Method.—*Principle.*—This method serves for the determination of both uric acid and the purine bases. The principle involved is the precipitation of both the uric acid and the purine bases in combination with copper oxide and the subsequent decomposition of this precipitate by means of sodium sulphide. The uric acid is then precipitated by means of hydrochloric acid and the purine bases are separated from the filtrate in the form of their copper or silver compounds. The nitrogen content of the precipitates of uric acid and purine bases is then determined by means of the Kjeldahl method (see page 512) and the corresponding values for uric acid and purine bases calculated.

Procedure.—To 400 c.c. of albumin-free urine² in a liter flask,³ add 24 grams of sodium acetate, 40 c.c. of a solution of sodium bisulphite⁴ and heat the mixture to boiling. Add 40–80 c.c.⁵ of a 10 per cent solution of copper sulphate and main-

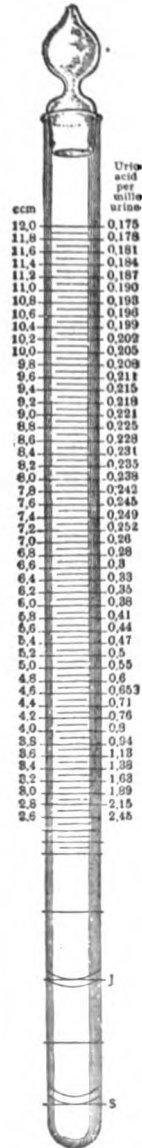

FIG. 176.—RUHEMANN'S URICOMETER.

¹ Bradley and Bunta: *Jour. Am. Med. Ass'n*, Jan. 4, 1913.

² If albumin is present, the urine should be heated to boiling, acidified with acetic acid and filtered.

³ The total volume of urine for the 24 hours should be sufficiently diluted with water to make the total volume of the solution 1600–2000 c.c.

⁴ A solution containing 50 grams of Kahlbaum's commercial sodium bisulphite in 100 c.c. of water.

⁵ The exact amount depending upon the content of the purine bases.

tain the temperature of the mixture at the boiling-point for at least three minutes. Filter off the flocculent precipitate, wash it with hot water until the wash water is colorless, and return the washed precipitate to the flask by puncturing the tip of the filter paper and washing the precipitate through by means of hot water. Add water until the volume in the flask is approximately 200 c.c., heat the mixture to boiling and decompose the precipitate of copper oxide by the addition of 30 c.c. of sodium sulphide solution.¹ After decomposition is complete, the mixture should be acidified with acetic acid and heated to boiling until the separating sulphur collects in a mass. Filter the hot fluid by means of a filter-pump, wash with hot water, add 10 c.c. of 10 per cent hydrochloric acid and evaporate the filtrate in a porcelain dish until the total volume has been reduced to about 10 c.c. Permit this residue to stand about two hours to allow for the separation of the uric acid, leaving the purine bases in solution. Filter off the precipitate of uric acid, using a small filter paper, and wash the uric acid, with water made acid with sulphuric acid, until the total volume of the original filtrate and the wash water aggregates 75 c.c. Determine the nitrogen content of the precipitate by means of the Kjeldahl method (see page 512), and calculate the uric acid equivalent.²

Render the filtrate from the uric acid crystals alkaline with sodium hydroxide, add acetic acid until faintly acid and heat to 70°C. Now add 1 c.c. of a 10 per cent solution of acetic acid and 10 c.c. of a suspension of manganese dioxide³ to oxidize the traces of uric acid which remain in the solution. Agitate the mixture for one minute, add 10 c.c. of the sodium bisulphite solution⁴ and 5 c.c. of a 10 per cent solution of copper sulphate and heat the mixture to boiling for three minutes. Filter off the precipitate, wash it with hot water, and determine its nitrogen content by means of the Kjeldahl method (see page 512). Inasmuch as the composition and proportion of the purine bases present in urine is variable, no factor can be applied. The result as regards these bases must therefore be expressed in terms of nitrogen.

Benedict and Saiki⁵ report cases in which the total purine nitrogen by this method was less than the uric-acid nitrogen as determined by the Folin-Shaffer method. The inaccuracy was found to lie in the Krüger and Schmidt method. To obviate this they advise the addition of 20 c.c. of glacial acetic acid for each 300 c.c. of urine employed, the acid being added before the first precipitation.

Interpretation.—The amount of purine bases excreted by a normal man is small and variable. Values from 16–60 mg. have been found. The purine base nitrogen is of course only a fraction of this. The amount excreted is influenced by the diet somewhat in the same way as is the excretion of uric acid being also increased in disorders asso-

¹ This is made by saturating a 1 per cent solution of sodium hydroxide with hydrogen sulphide gas and adding an equal volume of 1 per cent sodium hydroxide.

Ordinarily the addition of 30 c.c. of this solution is sufficient, but the presence of an excess of sulphide should be *proven* by adding a drop of lead acetate to a drop of the solution. Under these conditions a dark brown color will show the presence of an excess of sodium sulphide.

² This may be done by multiplying the nitrogen value of three and adding 3.5 mg. to the product as a correction for the uric acid remaining in solution in the 75 c.c.

³ Made by heating a 0.5 per cent solution of potassium permanganate with a little alcohol until it is decolorized.

⁴ To dissolve the excess of manganese dioxide.

⁵ Benedict and Saiki: *Jour. Biol. Chem.*, 7, 27, 1909.

ciated with increased uric acid excretion such as leukemia. The purine bases form a higher percentage of the total purine excretion in the case of the monkey, sheep, and goat than in the case of man.

2. Hunter and Givens' Modification of Krüger-Schmidt Method.¹—

Principle.—The Krüger-Schmidt process is combined with the microchemical colorimetric method for uric acid (see page 534).

Procedure.—The first copper-purine precipitate as obtained in the Krüger-Schmidt procedure is suspended in about 200 c.c. of water, to which there is added about 1 c.c. of concentrated hydrochloric acid. The mixture is vigorously boiled, whereupon the whole or greater part of the precipitate goes into solution. Removal of the copper is effected by treatment with hydrogen sulphide in the heat, and excess of the sulphide is completely expelled by renewed boiling. Filtration under suction, and thorough washing of flask and filter result in a filtrate which is perfectly clear and nearly colorless. This is concentrated if necessary, and made up to a convenient volume which must of course be sufficiently large to retain, when cool, the uric acid in solution. Of this an aliquot part is utilized directly for the colorimetric determination of uric acid. In the remainder the residual uric acid is destroyed and bases determined according to the regular Krüger-Schmidt procedure. This modification is recommended particularly where the amount of uric acid present is minute.

3. Welker's Modification of the Methods of Arnstein and of Salkowski.²—

Principle.—The phosphates are removed by treatment with magnesia mixture. The purine bases and uric acid are then thrown down as their silver salts and the nitrogen content of this precipitate determined.

Procedure.—Four hundred c.c. of urine, free from protein, are treated with 100 c.c. of magnesia mixture and 600 c.c. of water. This is then filtered and of the clear filtrate a measured quantity (600–800 c.c.) is treated with an excess (10 c.c.) of a 3 per cent silver nitrate solution. Concentrated ammonium hydroxide is added in small quantities, with stirring, until all the chlorides have dissolved. Allow the flocculent precipitate of the silver purine compounds to settle to the bottom, then pass the supernatant liquid through the filter before disturbing the precipitate. Finally transfer the precipitate quantitatively to the paper which must be of known nitrogen content. The precipitate is washed with dilute (1 per cent) ammonium hydroxide. The paper with the precipitate is then transferred to a Kjeldahl flask and about 100 c.c. of water and a small quantity (about 0.1 gram) of magnesium oxide are added. The water is then boiled until all the ammonia has been driven off. Test the steam with litmus paper.

The material in the flask is then digested by means of the usual Kjeldahl method (see page 512). The digestion must be watched carefully at the time the sulphuric acid reaches sufficient concentration to affect the filter paper, inasmuch as the SO₂ produced causes considerable frothing. The total nitrogen (purine base, uric acid and filter-paper nitrogen) is now determined in the usual way (see Kjeldahl Method, page 512). This result *minus* the uric acid and filter-paper nitrogen will give the figure for the purine-base nitrogen.

Purine Nitrogen

Hall's Purinometer.³—By means of the instrument shown in Fig. 177, urine may be examined for total purine nitrogen, *i.e.*, nitrogen in the form of purine bases,

¹ Hunter and Givens: *Jour. Biol. Chem.*, 17, 37, 1914.

² Dittman and Welker: *New York Med. Jour.*, May–June, 1909.

³ Hall: *The Purine Bodies*, Philadelphia, 1904.

urates and uric acid. The method does not give an absolutely accurate measure of the purine values. It is, however, of considerable service clinically. The principle of the method is the preliminary precipitation of the phosphates present followed by the precipitation of the purine bodies in the form of their silver compounds by means of an ammoniacal silver nitrate solution. The volume of this silver precipitate is then determined and its nitrogen value interpolated by means of a table of equivalent values.

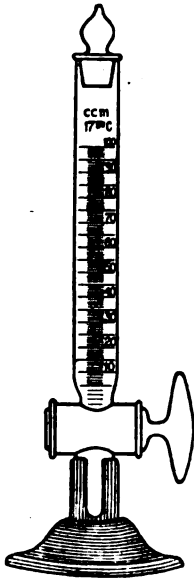

FIG. 177.—HALL'S PURINOMETER.

Procedure.—Collect the 24-hour urine and mix it thoroughly. Take 100 c.c. of the urine and if albumin is present make slightly acid with acetic acid and boil and filter. Close the stopcock of the instrument and introduce 90 c.c. of urine and 20 c.c. of a modified magnesia mixture.¹ Turn the stopcock and permit the precipitated phosphates to pass into the lower chamber of the instrument. After an interval of ten minutes has elapsed the stopcock should be closed and sufficient ammoniacal silver nitrate solution² added to make the total volume in the upper chamber 100 c.c. The precipitate of the silver compounds of the purine bodies should be pale yellow. Any silver chloride present may be brought into solution in the strong ammoniacal solution by the repeated inversion of the purinometer. In case the chloride does not dissolve it should be brought into solution by the addition of further ammonium hydroxide. Place the purinometer in a dark room for 24 hours and at the end of this time read the volume of the purine precipitate. Inter-

polate the value in terms of purine nitrogen by means of the following table:

Precipitate, c.c.	Purine nitrogen, per cent (grams in 100 c.c.)
4.....	0.0078
5.....	0.0097
6.....	0.0117
7.....	0.0136
8.....	0.0156
9.....	0.0175
10.....	0.0185
11.....	0.0195
12.....	0.0205
13.....	0.0218
14.....	0.0225
15.....	0.0234
16.....	0.0249
17.....	0.0260
18.....	0.0265
19.....	0.0270

¹ This is prepared as follows: Dissolve 10 grams of magnesium chloride in about 75 c.c. of water and add 10 grams of ammonium chloride. Introduce 100 c.c. of concentrated ammonium hydroxide into this mixture. If a precipitate forms add ammonium hydroxide until a clear solution is obtained. Make the volume 200 c.c. by means of water and add 10 grams of purified talcum.

² This solution has the following formula:

Silver nitrate.....	1 gram.
Ammonium hydroxide (sp. gr. 0.90).....	100 c.c.
Talcum.....	5 grams.
Distilled water.....	100 c.c.

Precipitate, c.c.	Purine nitrogen, per cent (grams in 100 c.c.)
20.....	0.0275
21.....	0.0283
22.....	0.0286
23.....	0.0299
24.....	0.0312
25.....	0.0325

Calculation.—Multiply the purine nitrogen percentage by the total volume of urine and divide by 100 to obtain the total purine nitrogen value. For example, if the precipitate was found to be 12 c.c. and the total volume of the 24-hour urine was 1300 c.c. the calculation would be as follows:

$$12 \text{ c.c.} = 0.0205 \text{ per cent purine nitrogen.}$$

$$0.0205 \times 13.0 = 0.2665 \text{ gram purine nitrogen.}$$

Interpretation.—The endogenous purine nitrogen excretion (on purine-free diet) averages about 0.15 gram per day, though variations are considerable. As uric acid makes up about nine-tenths of this the amount varies much as uric acid varies. The exogenous purine nitrogen excretion may be largely influenced by the methyl purines of tea, coffee, and cocoa which are excreted unchanged, as well as by the purine bases which are normally oxidized to uric acid (see Uric Acid, page 405).

Allantoin

1. Method of Wiechowski-Handovsky.¹—**Principle.**—The urine is precipitated with phosphotungstic acid and lead acetate and in the presence of chlorides with silver acetate. The heavy metals are removed with hydrogen sulphide. The allantoin is then precipitated as a mercuric compound and the amount of mercury and hence of allantoin in the precipitate determined by titration with ammonium thiocyanate. This method, though rather tedious, is probably the most accurate method for the determination of allantoin.

Procedure.—The urine is diluted to about 1 per cent urea. As rabbit urine contains in the day's output about 2-4 grams of urea, and that of other herbivora usually forms about a 4 per cent urea solution, it is usually desirable to dilute 3-4 times. A greater dilution is not desirable. The urine is treated with 1 per cent of sulphuric acid and about 3 c.c. of acetic acid for each day's volume. Test a small quantity of the urine to determine the amount of 50 per cent phosphotungstic acid required to completely precipitate it. The bulk of the urine is then treated on this basis with sufficient solid phosphotungstic acid to precipitate it completely. Stir to dissolve the acid and allow to stand for several hours. Filter with suction, first lining the filter with infusorial earth by rubbing up a little of the substance with some of the urine mixture and filtering with suction. To some ordinary lead oxide in a mortar add a small amount of the filtrate and stir until it becomes warm, then add the rest of the filtrate and stir, adding more oxide if necessary until the solution reacts alkaline due to the formation of basic lead acetate.

Filter again. The filtrate should give no precipitate with basic lead acetate. A measured volume of the filtrate is then treated with measured volumes of acetic acid and silver nitrate solution to completely precipitate any chlorides present. Filter again preferably through infusorial earth. Pass hydrogen sulphide through

¹ Handovsky: *Zeit. physiol. Chem.*, 90, 211, 1914.

Wiechowski: Neubauer-Huppert: *Analyse des Harns*, Wiesbaden, 1913, p. 1076.

the filtrate until the heavy metals are completely precipitated. Filter again. Pass a current of air through the filtrate to remove all hydrogen sulphide (test with lead acetate paper). Neutralize this final filtrate with calcium carbonate and remove the carbon dioxide with a current of air.

The neutral filtrate is then treated with an amount of allantoin reagent in excess of that required to precipitate the allantoin as indicated by a preliminary test. (The allantoin reagent is a solution containing 5 per cent mercuric acetate and 20 per cent of sodium acetate. The reagent when used must be clear.)

Allow to stand for half an hour (not too long) and then filter. A measured amount of the filtrate is taken and treated with about 10 c.c. of iron-ammonium alum and the red solution decolorized with dilute sulphuric acid. (The solution is not completely decolorized but retains a faint greenish tint.) Any calcium sulphate precipitate formed at this point may be disregarded. Titrate with N/10 ammonium thiocyanate solution to a yellow color, which increases in intensity on the addition of 1-2 drops more of solution. The titration should not be carried out in artificial light and some practice is required to get the exact end point. The thiocyanate solution should be standardized occasionally against standard silver nitrate solution.

Calculation.—One c.c. of N/10 NH_4SCN solution corresponds to 0.00436 gram of allantoin. The limit of error of the method is about 5 mg. for the daily output of allantoin. In the calculation of course all losses through filtration, etc., must be considered.

For the considerable modifications required in carrying out the determination on human urine with its very low content of allantoin see the section by Wiechowski in Neubauer-Huppert.¹

Interpretation.—Allantoin may be found in very small amounts in human urine (5-15 mg. per day), appearing to be mainly, though not entirely, exogenous in origin. It forms, however, the principal end-product of the purine metabolism of practically all mammals other than man and the anthropoid apes. Thus over 90 per cent of the purine-allantoin nitrogen excretion of the dog, the cow, and the pig occurs in this form. In these animals its origin is from exogenous and endogenous purines, and its excretion is influenced by much the same factors as is that of uric acid in man.

2. Determination by Difference.—Method of Plimmer and Skelton.²—Allantoin is transformed into urea and determined as such by the acid-magnesium chloride method of Folin for urea in urine.³ Urease, however, has no effect upon allantoin. Therefore, determine the urea + allantoin of the urine according to Folin's procedure, and also determine the true urea according to the urease method (see Urea). The difference between the results thus obtained represents allantoin. If sugar is present it must be removed before applying Folin's procedure.

Hippuric Acid

1. Method of Folin and Flanders.⁴—*Principle.*—The hippuric acid is hydrolyzed to benzoic acid in alkaline solution and then the solution is boiled with strong nitric acid to remove pigments and emulsifying

¹ Wiechowski: Neubauer-Huppert: *Analyse des Harns*, Wiesbaden, 1913, p. 1076.

² Plimmer and Skelton: *Bioch. J.*, 8, 70 and 641, 1914.

³ Mathews *Physiological Chemistry*, 2d. Ed., p. 953.

⁴ Folin and Flanders: *Jour. Biol. Chem.*, 11, 257, 1912.

substances. The benzoic acid is extracted with chloroform and titrated with sodium ethylate.

Procedure.—Measure 100 c.c. of urine into a porcelain evaporating dish by means of a pipette. Add 10 c.c. of 5 per cent NaOH and evaporate to dryness on the steam-bath. Transfer the residue to a 500 c.c. Kjeldahl flask by means of 25 c.c. of water and 25 c.c. of concentrated HNO₃. Add 0.2 gram of copper nitrate, a couple of pebbles or glass pearls and boil very gently for four and one-half hours over a micro-burner. Fit the necks of the flasks with condensers of the Hopkins type made from large test-tubes fitted with two-hole rubber stoppers, the inlet tubes extending near the bottom of the test-tubes while the outlet tube is shorter. These condensers should fit rather loosely. A good current of water flowing through the condensers prevents loss of benzoic acid or change in concentration of the nitric acid.

After cooling, rinse the condensers down with 25 c.c. of water and transfer the contents of the flask to a 500 c.c. separatory funnel, with the aid of 25 c.c. more of water. The total volume of the solution is now 100 c.c. Add to the solution sufficient ammonium sulphate to just saturate it (about 55 grams). Make four extractions with freely washed chloroform, using 50, 35, 25, and 25 c.c. portions. The first two portions may be used to further rinse out the Kjeldahl flask.

Collect the successive portions of chloroform in another separatory funnel. Add to the combined extracts 100 c.c. of a saturated solution of pure sodium chloride, to each liter of which has been added 0.5 c.c. of concentrated HCl. Shake well, draw the chloroform into a dry 500 c.c. Erlenmeyer flask and titrate with N/10 sodium alcoholate,¹ using 4 or 5 drops of phenolphthalein as an indicator. The first distinct end point should be taken, although it may fade on standing a short time.

Calculation.—Multiply the number of cubic centimeters of alcoholate used by the factor for hippuric acid as determined by standardization to obtain the amount of hippuric acid in the 100 c.c. of urine used. One c.c. of exactly N/10 sodium alcoholate is equivalent to 0.0179 gram of hippuric acid. Calculate the daily output of hippuric acid from the 24-hour volume.

Interpretation.—The average excretion of hippuric acid by a normal adult man is about 0.7 gram per day. The amount is increased by the ingestion of benzoic acid or fruits containing it (plums, prunes, cranberries). It arises in part apparently from putrefaction products formed in the intestine. In herbivora it is often the most abundant nitrogenous constituent of the urine.

2. Dakin's Methods.²—Preliminary Procedure.—Place 150 c.c. (or more) of the urine under examination in a porcelain evaporating dish and evaporate almost to dryness upon a water-bath. Add about 1 gram of sodium dihydrogen phosphate,

¹ The sodium alcoholate is made by dissolving 2.3 grams of cleaned metallic sodium in 1 liter of absolute alcohol. It is advisable that it be slightly weaker rather than stronger than tenth-normal. It may be standardized against pure benzoic acid in washed chloroform. It may also be standardized against N/10 HCl provided the alcoholate solution contains not more than traces of carbonate.

² Private communication to the author from Dr. H. D. Dakin.

about 25 grams of gypsum ($\text{CaSO}_4 \cdot 2\text{H}_2\text{O}$) and rub up with a pestle and stir with a spatula until a uniform mixture results. Dry the powder thus produced in a water-oven for about two hours, at the end of which period it should be rubbed up a second time, to remove lumps, and transferred to a Schleicher and Schüll "extraction shell" and extracted in a Soxhlet apparatus in the usual way (see page 355). The extraction medium is ethyl acetate and the flask containing the acetate should be strongly heated over a *sand-bath*¹ for about two hours. The ethyl acetate extract is now transferred to a separatory funnel, and the original flask rinsed with sufficient fresh ethyl acetate to make the total volume in the separatory funnel² about 100 c.c. Wash the ethyl acetate solution *five times* with a saturated solution of sodium chloride, using 8 c.c. of the sodium chloride solution at each extraction, shaking vigorously and removing the sodium chloride extract in each case before adding fresh sodium chloride solution. The sodium chloride *removes the urea completely* and the hippuric acid is then determined in the urea-free solution by the following volumetric or gravimetric procedure:

1. *Volumetric Determination*.—Transfer the urea-free ethyl acetate solution, prepared as described above, to a Kjeldahl flask, add about 25 c.c. of water, a small piece of pumice stone to prevent bumping, attach a condenser and distil off the acetate³ over a free flame. After practically all of the ethyl acetate has been distilled off, the nitrogen in the remaining solution should be determined by means of the Kjeldahl method (see page 512).

The main source of error in this method is the fact that any nitrogen present in the form of *phenaceturic acid* or *indole acetic acid* is determined as hippuric acid nitrogen. The error from this source is, however, usually trifling.

Calculation.—Calculate as usual for nitrogen determinations, remembering that 1 c.c. of N/10 sulphuric acid is equivalent to 0.0179 gram hippuric acid.

Interpretation.—See page 543.

2. *Gravimetric Determination*.—The urea-free ethyl acetate solution contained in the separatory funnel, after washing with sodium chloride solution, as described under Preliminary Procedure, page 543, is washed with 5 c.c. of distilled water to remove the major portion of the sodium chloride. Transfer the solution from the separatory funnel to a round-bottomed flask and subject it to a steam distillation in the usual way. A *slow* current of steam should be used while the ethyl acetate is being distilled off and later a more rapid current may be employed. The distillation should be continued for 20 minutes. Now add about 0.1 gram of charcoal to the aqueous solution which is heated to boiling and filtered *hot*. Evaporate the solution in a *weighed* Jena glass dish on a water-bath until the volume of the solution is reduced to about 3 c.c. Stand the dish in a warm place until evaporation is complete and a crystalline residue remains. Wash the residue, in turn, with 2 c.c. of dry ether and 1 c.c. of water, dry it in an air-bath at 100°C. and weigh. If it is so desired the residue may be recrystallized from a little *hot* water and the melting-point determined. Pure hippuric acid melts at 187°C. Contamination with phenaceturic acid may be detected both by the melting-point and the microscopical characteristics.

¹ A water-bath cannot be substituted inasmuch as the resultant extraction would be *too slow*.

² This ethyl acetate solution contains hippuric acid, urea, and other substances.

³ The ethyl acetate after separation from the watery layer of the distillate may be dried over calcium chloride and used again.

Glucose

1. Benedict's Method.¹—*Principle.*—Benedict's reagent for the estimation of reducing sugars contains potassium thiocyanate as well as copper sulphate, and in the presence of the former a white precipitate of cuprous thiocyanate is formed on reduction instead of the usual red precipitate of cuprous oxide. The small amount of potassium ferrocyanide also aids in keeping cuprous oxide in solution. As the precipitate formed is white the loss of all blue tint in the solution, indicating complete reduction of the copper, is readily observed. The alkali used is sodium carbonate, which has the advantage over the hydroxides in that there is less danger of destruction of small amounts of sugar. The solution also has the great advantage of being stable for an indefinite length of time. The method is recommended for simplicity and accuracy.

Procedure.—The urine, 10 c.c. of which should be diluted with water to 100 c.c. (unless the sugar content is believed to be low, when it may be used undiluted), is poured into a 50 c.c. burette up to the zero mark. Twenty-five c.c. of the reagent² are measured with a pipette into a porcelain evaporation dish (25–30 cm. in diameter), 10 to 20 grams of crystallized sodium carbonate (or one-half the weight of the anhydrous salt) are added, together with a small quantity of powdered pumice stone or talcum, and the mixture heated to boiling over a free flame until the carbonate has entirely dissolved. The diluted urine is now run in from the burette, rather rapidly, until a chalk-white precipitate forms and the blue color of the mixture begins to lessen perceptibly, after which the solution from the burette must be run in a few drops at a time, until the disappearance of the last trace of blue color, which marks the end point. The solution must be kept vigorously boiling throughout the entire titration. If the mixture becomes too concentrated during the process, water may be added from time to time to replace the volume lost by evaporation.

Calculation.—The calculation of the percentage of sugar in the original sample of urine is very simple. The 25 c.c. of copper solution are reduced by exactly 50 mg. of glucose. Therefore the volume run out of the burette to effect the reduction contained 50 mg. of the sugar. When the urine is diluted 1:10, as in the

¹ Benedict: *Jour. Am. Med. Ass'n*, 57, 1193, 1911.

² Copper sulphate (crystallized).....	18.0 grams.
Sodium carbonate (crystallized, one-half the weight of the anhydrous salt may be used).....	200.0 grams.
Sodium or potassium citrate.....	200.0 grams.
Potassium thiocyanate.....	125.0 grams.
Potassium ferrocyanide (5 per cent solution).....	5.0 c.c.
Distilled water to make a total volume of.....	1000.0 c.c.

With the aid of heat dissolve the carbonate, citrate and thiocyanate in enough water to make about 800 c.c. of the mixture and filter if necessary. Dissolve the copper sulphate separately in about 100 c.c. of water and pour the solution slowly into the other liquid, with constant stirring. Add the ferrocyanide solution, cool and dilute to exactly 1 liter. Of the various constituents, the copper salt only need be weighed with exactness. Twenty-five c.c. of the reagent are reduced by 50 mg. of glucose.

usual titration of diabetic urines, the formula for calculating the per cent of the sugar is the following:

$$\frac{0.050}{X} \times 1000 = \text{per cent in original sample, wherein } X$$

is the number of cubic centimeters of the diluted urine required to reduce 25 c.c. of the copper solution.

In the use of this method chloroform must not be present during the titration. If used as a preservative in the urine it may be removed by boiling a sample for a few minutes, and then diluting to its original volume.

Interpretation.—Sugar in the urine in amounts sufficient to be detected by the commonly employed qualitative tests indicates a pathological condition, unless very large amounts of sugar have been ingested just previously, in which case the condition is spoken of as an alimentary glycosuria. Persistent glycosuria thus indicates diabetes mellitus, a disorder in which the amount of sugar may rise as high as 10 per cent and averages 3–5 per cent. The volume of urine excreted per day is usually also large and the absolute sugar excretion may thus be very great (100 grams of glucose per day are not uncommon). The quantitative methods for the estimation of sugar in urine enable us to determine the severity of the disorder as well as to follow its course under treatment, etc.

2. Fehling's Method.—*Principle.*—Diluted urine is run into a measured amount of Fehling's solution at the boiling-point until all of the copper it contains is reduced as indicated by the loss of blue color. This method has several disadvantages over Benedict's method. The end point is difficult to determine and the mixed solution is unstable. It gives less accurate results.

Procedure.—Place 10 c.c. of the urine under examination in a 100 c.c. volumetric flask and make the volume up to 100 c.c. with distilled water. (If the urine contains less than 0.5 per cent of sugar it may be used without dilution. A concentration of about 0.5 per cent is the most satisfactory for this titration.) Thoroughly mix this diluted urine by pouring it into a beaker and stirring with a glass rod, then transfer a portion of it to a burette which is properly supported in a clamp.

Now place 10 c.c. of Fehling's solution¹ in a small beaker, dilute it with approximately 40 c.c. of distilled water, heat to boiling, and observe whether decomposition of the Fehling's solution itself has occurred as indicated by the production of a turbidity. If such turbidity is produced the Fehling's solution is unfit for use. Clamp the burette containing the dilute urine immediately over the beaker and carefully allow from 0.5–1 c.c. of the diluted urine to flow into the boiling Fehling's solution. Bring the solution to the boiling-point after each addition of urine and continue running the urine from the burette, 0.5–1 c.c. at a time, as indicated, until the Fehling's solution is completely reduced, i.e., until all the cupric

¹ Directions for the preparation of Fehling's solution are given in a note at the bottom of p. 25.

oxide in solution has been precipitated as cuprous oxide. This point will be indicated by the absolute disappearance of all blue color. When this end point is reached note the number of cubic centimeters of diluted urine used in the process and calculate the percentage of dextrose present, in the sample of urine analyzed, according to the method given below.

This is a satisfactory method, the main objection to its use being the uncertainty attending the determination of the end-reaction, i.e., the difficulty with which the exact point where the blue color finally disappears is noted. Several means of accurately fixing this point have been suggested, but they are practically all open to objection. As good a "check" as any, perhaps, is to filter a few drops of the solution through a double paper, after the blue color has apparently disappeared, acidify the filtrate with acetic acid and add potassium ferrocyanide. If the copper of the Fehling's solution has been completely reduced, there will be no color reaction, whereas the production of a brown color indicates the presence of unreduced copper. Harrison has recently suggested the following procedure to determine the exact end point: To about 1 c.c. of a starch iodide solution¹ in a test-tube add 2-3 drops of acetic acid and introduce into the acidified mixture 1-2 drops of the solution to be tested. Unreduced copper will be indicated by the production of a purplish-red or blue color due to the liberation of iodine.

It is ordinarily customary to make at least three determinations by Fehling's method before coming to a final conclusion regarding the sugar content of the urine under examination.

Calculation.—Ten c.c. of Fehling's solution is completely reduced by 0.05 gram of dextrose.² If y represents the number of cubic centimeters of undiluted urine (obtained by dividing the burette reading by 10) necessary to reduce the 10 c.c. of Fehling's solution, we have the following proportion:

$$y : 0.05 :: 100 : x \text{ (percentage of dextrose).}$$

Interpretation.—See page 546.

3. Bang's Method.³—*Principle.*—The solution to be tested is boiled with alkaline cupric chloride solution containing thiocyanate and potassium chloride. The cupric salt under these conditions is reduced to the cuprous form without any precipitation taking place. The reduced copper is titrated with standard iodine solution using starch as an indicator. The titration reaction is as follows:

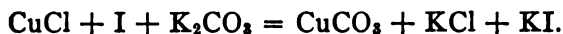

Procedure.—A 100 c.c. Jena flask with a straight neck, the flange of which has been cut off, is used for the boiling procedure. Over the neck of the flask place

¹ The starch-iodide solution may be prepared as follows: Mix 0.1 gram of starch with cold water in a mortar and pour the suspended starch granules into 75-100 c.c. of boiling water, stirring continuously. Cool the starch paste, add 20-25 grams of potassium iodide and dilute the mixture to 250 c.c. This solution deteriorates upon standing, and therefore must be freshly prepared as needed.

² The values for certain other sugars are as follows:

Lactose.....	0.0676 gram.
Maltose.....	0.074 gram.
Invert sugar.....	0.0475 gram.

³ Bang: *Biochem. Zeit.*, 49, 1, 1913.

a piece of tight fitting rubber tubing sufficiently long (about 2 inches), so that it may be provided with a pinch cock or clamp to shut off the contents of the flask from the outside air (see Fig. 88, page 287).

Introduce into the flask 0.1 to 2.0 c.c. (or more) of the sugar solution containing not more than 10 mg. of glucose. Then add 55 c.c. of the diluted copper solution.¹ Heat over an asbestos gauze with a flame standardized to bring the solution to the boiling-point in from 3 1/2-3 3/4 minutes. Boil for exactly 3 minutes, being prepared to close the flask with the pinch-cock at the end of the 3 minutes. Remove from the flame and at once cool under the tap to room temperature. Remove the rubber tubing, add to the contents of the flask 0.5-1 c.c. of the starch solution (1 gram of soluble starch in 100 c.c. of saturated KCl solution, which keeps indefinitely). Titrate with the standard iodine solution¹ run in from an accurate burette with a glass stopcock. When the iodine starch color appears throughout the solution rotate gently and let stand a few seconds. The end point is reached when the blue color endures for 10-20 seconds. It is preferable to carry out the titration in an atmosphere of carbon dioxide, maintained by means of a delivery tube hung over the side of the flask. Otherwise the titration must be carried out rapidly to prevent reoxidation by the oxygen of the air.

Calculation.—Divide the number of cubic centimeters of N/100 iodine solution used in the titration by 2.7 to obtain the number of milligrams of glucose in the amount of solution used.

This method is suitable for urine analysis. The urine must however be free from albumin and as urine contains substances reacting slowly with iodine the end point must be taken when the blue color persists for about 10 seconds and any slow decolorization disregarded.

Interpretation.—See page 546.

4. Peters' Method.²—*Principle.*—The sugar solution is boiled with an alkaline copper solution under rigidly standardized conditions and after filtration the un-reduced copper is determined by adding potassium iodide and titrating the liberated iodine with standard thiosulphate solution.

Procedure.—*A. The Heating Power.*—It is necessary to standardize the heating power of the flame used in the reduction process. A 200 c.c. Erlenmeyer flask of Jena glass and of about 6 cm. basal diameter is used. This bears a two-hole rubber stopper, one hole of which carries a thermometer. The lower end of the thermome-

¹ *Copper Solution.*—*Stock Solution.*—Dissolve first 160 grams potassium bicarbonate, 100 grams potassium carbonate and 66 grams of potassium chloride with about 700 c.c. of distilled water in a liter flask. Pure salts must be used in each case. As the bicarbonate is difficultly soluble it should be finely powdered and brought into solution first, preferably with warming to 30°C. The KCl is then dissolved and finally, with cooling, the carbonate. Then add 100 c.c. of a 4.4 per cent solution of pure crystalline $\text{CuSO}_4 \cdot 5\text{H}_2\text{O}$. Fill to the mark with distilled water. Mix without strong shaking and let stand for 24 hours before using.

Dilute Copper Solution.—Dilute 300 c.c. of the stock solution to 1000 c.c. Mix with only gentle shaking. Allow to stand for several hours before using.

Standard Iodine Solution.—The N/100 iodine solution is made by dilution of N/10 iodine solution (see appendix) with boiled out distilled water. The solution is stable for three months if kept in a dark bottle. It may also be prepared daily from KI and KIO_3 . Introduce into a 100 c.c. flask about 1 c.c. of 2 per cent KIO_3 , and 2-2.5 grams of KI and then exactly 10 c.c. of N/10 HCl. The HCl liberates an equivalent amount of iodine (sulphuric acid is less desirable). Make to 100 c.c. with distilled water and mix.

² Peters: *J. Am. Chem. Soc.*, 34, 928, 1912; 34, 422, 1912.

ter should extend to about 2 mm. from the bottom of the flask and the 35° mark on the thermometer stem should be visible above the stopper. The flask is placed on an asbestos gauze supported by an adjustable ring stand. A Bunsen or Méker burner is used and is placed at from 3–5 cm. beneath the lower surface of the asbestos gauze. Use a large flame and allow the ring and gauze to become thoroughly heated. Then place the flask, into which 60 c.c. of distilled water has been introduced, in the center of the gauze and observe the time required for the temperature in the flask to rise from 35 to 95°C. By several trials the flame and position of the gauze are so adjusted that it requires (within a few seconds either way) just 120 seconds for the temperature to rise from 35–95°C. This standard flame is then used in the determinations which follow.

B. The Reduction Process.—Into a 200 c.c. Jena Erlenmeyer flask fitted as above, introduce 20 c.c. of alkaline tartrate solution,¹ 20 c.c. of the copper sulphate solution¹ and the sugar solution to be analyzed which should first be made up to 20 c.c. so that the total volume of the fluid in the reduction flask is always 60 c.c. Place the flask over the standard flame and note when the temperature of the mixture reaches 95°C. Allow to boil for exactly 20 seconds after the temperature reaches 95°. Then the flask is promptly removed with the stopper still in place and held under the tap for a moment to stop the reduction but not to cool the mixture more than a few degrees below the boiling-point. Filter hot through a previously prepared Gooch crucible with a heavy asbestos mat through which sufficient of a suspension of talcum has been filtered so that with suction, not a stream but a rapid succession of drops comes through the filter. (A calcium chloride tube packed with glass wool and asbestos may also be used.) The suction flask should have a capacity of about 200 c.c. so that the titration may be carried out in it directly. Wash the filter with a fine stream of water using not more than 15–20 c.c. of water in all. To the filtrate add 4 c.c. of concentrated sulphuric acid and cool to 20°C. Add 6–7 c.c. of a saturated solution of potassium iodide. Titrate the liberated iodine with standard thiosulphate solution,² adding a few drops of a solution of soluble starch as an indicator near the close of the titration. The “spot test” may be used in determining the end point. As long as a drop of thiosulphate produces a perceptible white area in falling upon the quiet solution the end point has not been reached. The chocolate-brown color of the mixture changes to a light cream white as the last necessary drop of thiosulphate is added.

A blank should be run in exactly the same way but with the omission of the sugar solution.

Calculation.—Subtract the number of cubic centimeters of thiosulphate required for the titration of unreduced copper from the number of cubic centimeters required for the blank. This gives the amount of thiosulphate equivalent to copper

¹ **Copper Solution.**—Dissolve 34.639 grams of highest purity crystallized copper sulphate (Kahlbaum's “zur Analyse mit Garantieschein”) in water to make 500 c.c.

Alkaline Tartrate Solution.—Dissolve 173 grams of sodium potassium tartrate and 125 grams of potassium hydroxide in water to make 500 c.c.

² **N/5 Sodium Thiosulphate.**—Dissolve about 50 grams of ordinary c.p. sodium thiosulphate or exactly 40.66 grams of the pure, dry, recrystallized salt, in enough boiled-out distilled water to make a liter. Allow to stand for several days. The solution should be standardized against the copper solution prepared as above. For this purpose introduce 20 c.c. of the copper solution into a 200 c.c. Erlenmeyer flask, add 20 c.c. of 30 per cent acetic acid and 40 c.c. of water. Add about 7 grams of a saturated solution of KI and titrate with the thiosulphate using starch as an indicator. Calculate the equivalent of 1 c.c. of thiosulphate in Cu. One c.c. of the copper sulphate solution contains 17.647 mg. of Cu. The thiosulphate remains constant for some months. It should be kept in a dark bottle.

reduced. Multiply this result by the value of 1 c.c. of thiosulphate expressed as Cu, and obtain the number of milligrams of copper reduced. Then by consulting the table of values (below) determine the weight of glucose equivalent to this amount of copper.

Cole¹ has determined the copper values for lactose using this method exactly as outlined. He has also suggested the following empirical formula which agrees well with the values derived from his table:

$$\text{Mg. anhydrous lactose} = 1.25 + 0.778 \times \text{mg. Cu.}$$

Interpretation.—See page 546.

TABLE FOR THE DETERMINATION OF GLUCOSE

According to Peters

Glucose	Copper, mg.	Glucose Cu ratio	Glucose	Copper, mg.	Glucose Cu ratio
1	1.2	0.833	60	115.5	0.522
2	2.8	0.714	70	134.4	0.522
5	8.2	0.610	80	152.9	0.522
8	13.8	0.580	90	171.0	0.522
10	17.4	0.575	100	191.6	0.522
15	27.7	0.542	110	208.9	0.527
20	37.1	0.539	120	228.1	0.526
25	48.1	0.522	135	255.0	0.529
30	57.3	0.522	150	280.8	0.534
35	67.6	0.522	165	306.8	0.538
40	76.2	0.522	180	330.5	0.545
45	86.0	0.522	200	349.6	0.572
50	96.0	0.522			

5. **Bertrand's Method.**² *Principle.*—The sugar is boiled with alkaline copper sulphate solution and the precipitated cuprous oxide filtered off, dissolved in an acid solution of ferric sulphate and the resultant ferrous salt titrated with potassium permanganate. This method of titrating cuprous oxide may be conveniently used where other reduction procedures such as that of Peters or of Munson and Walker,³ have been employed. In this case the tables corresponding to the particular method and not the Bertrand tables must be consulted in calculating the sugar equivalent.

The following reactions are involved in the Bertrand titration:

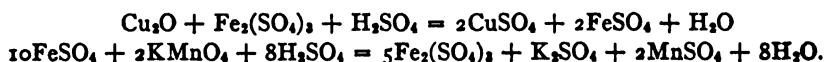

Procedure.—Introduce into an Erlenmeyer flask of 150 c.c. capacity, 20 c.c. of the sugar solution (of a concentration of 0.5 per cent or less), 20 c.c. of the copper

¹ Cole: *Biochem. J.*, 8, 134, 1914.

² Bertrand: *Bull. Soc. Chim. de France*, 35, 1285, 1906.

³ Munson and Walker: *Bull.*, 107, U. S. Dept. of Agriculture.

TABLE FOR THE DETERMINATION OF REDUCING SUGARS

According to Bertrand

Sugar in mg.	Glucose Cu	Invert sugar Cu	Galactose Cu	Maltose Cu	Lactose Cu
10	20.4	20.6	19.3	11.2	14.4
11	22.4	22.6	21.2	12.3	15.8
12	24.3	24.6	23.0	13.4	17.2
13	26.3	26.5	24.9	14.5	18.6
14	28.3	28.5	26.7	15.6	20.0
15	30.2	30.5	28.6	16.7	21.4
16	32.2	32.5	30.5	17.8	22.8
17	34.2	34.5	32.3	18.9	24.2
18	36.2	36.4	34.2	20.0	25.6
19	38.1	38.4	36.0	21.1	27.0
20	40.1	40.4	37.9	22.2	28.4
21	42.0	42.3	39.7	23.3	29.8
22	43.9	44.2	41.6	24.4	31.1
23	45.8	46.1	43.4	25.5	32.5
24	47.7	48.0	45.2	26.6	33.9
25	49.6	49.8	47.0	27.7	35.2
26	51.5	51.7	48.9	28.9	36.6
27	53.4	53.6	50.7	30.0	38.0
28	55.3	55.5	52.5	31.1	39.4
29	57.2	57.4	54.4	32.2	40.7
30	59.1	59.3	56.2	33.3	42.1
31	60.9	61.1	58.0	34.4	43.4
32	62.8	63.0	59.7	35.5	44.8
33	64.6	64.8	61.5	36.5	46.1
34	66.5	66.7	63.3	37.6	47.4
35	68.3	68.5	65.0	38.7	48.7
36	70.1	70.3	66.8	39.8	50.1
37	72.0	72.2	68.6	40.9	51.4
38	73.8	74.0	70.4	41.9	52.7
39	75.5	75.9	72.1	43.0	54.1
40	77.5	77.7	73.9	44.1	55.4
41	79.3	79.5	75.6	45.2	56.7
42	81.1	81.2	77.4	46.3	58.0
43	82.9	83.0	79.1	47.4	59.3
44	84.7	84.8	80.8	48.5	60.6
45	86.4	86.5	82.5	49.5	61.9
46	88.2	88.3	84.3	50.6	63.3
47	90.0	90.1	86.0	51.7	64.6
48	91.8	91.9	87.8	52.8	65.9
49	93.6	93.6	89.5	53.9	67.2
50	95.4	95.4	91.2	55.0	68.5
51	97.1	97.1	92.9	56.1	69.8
52	98.9	98.8	94.6	57.1	71.1
53	100.6	100.6	96.3	58.2	72.4
54	102.3	102.3	98.0	59.3	73.7
55	104.1	104.0	99.7	60.3	74.9
56	105.8	105.7	101.5	61.4	76.2

TABLE FOR THE DETERMINATION OF REDUCING SUGARS.—(Continued)

According to Bertrand

Sugar in mg.	Glucose Cu	Invert sugar Cu	Galactose Cu	Maltose Cu	Lactose Cu
57	107.6	107.4	103.2	62.5	77.5
58	109.3	109.2	104.9	63.5	78.8
59	111.1	110.9	106.6	64.6	80.1
60	112.8	112.6	108.3	65.7	81.4
61	114.5	114.3	110.0	66.8	82.7
62	116.2	115.9	111.6	67.9	83.9
63	117.9	117.6	113.3	68.9	85.2
64	119.6	119.2	115.0	70.0	86.5
65	121.3	120.9	116.6	71.1	87.7
66	123.0	122.6	118.3	72.2	89.0
67	124.7	124.2	120.0	73.3	90.3
68	126.4	125.9	121.7	74.3	91.6
69	128.1	127.5	123.3	75.4	92.8
70	129.8	129.2	125.0	76.5	94.1
71	131.4	130.8	126.6	77.6	95.4
72	133.1	132.4	128.3	78.6	96.6
73	134.7	134.0	130.0	79.7	97.9
74	136.3	135.6	131.5	80.8	99.1
75	137.9	137.2	133.1	81.8	100.4
76	139.6	138.9	134.8	82.9	101.7
77	141.2	140.5	136.4	84.0	102.9
78	142.8	142.1	138.0	85.1	104.2
79	144.5	143.7	139.7	86.1	105.4
80	146.1	145.3	141.3	87.2	106.7
81	147.7	146.9	142.9	88.3	107.9
82	149.3	148.5	144.6	89.4	109.2
83	150.9	150.0	146.2	90.4	110.4
84	152.5	151.6	147.8	91.5	111.7
85	154.0	153.2	149.4	92.6	112.9
86	155.6	154.8	151.1	93.7	114.1
87	157.2	156.4	152.7	94.8	115.4
88	158.8	157.9	154.3	95.9	116.6
89	160.4	159.5	156.0	96.9	117.9
90	162.0	161.1	157.6	98.0	119.1
91	163.6	162.6	159.2	99.0	120.3
92	165.2	164.2	160.8	100.1	121.6
93	166.7	165.7	162.4	101.1	122.8
94	168.3	167.3	164.0	102.2	124.0
95	169.9	168.8	165.6	103.2	125.2
96	171.5	170.3	167.2	104.2	126.5
97	173.1	171.9	168.8	105.3	127.7
98	174.6	173.4	170.4	106.3	128.9
99	176.2	175.0	172.0	107.4	130.2
100	177.8	176.5	173.6	108.4	131.4

solution¹ and 20 c.c. of the alkaline tartrate solution.¹ Heat to boiling over an asbestos gauze and boil gently for exactly three minutes. Let stand a moment that the copper oxide may settle and then filter with suction through a Gooch crucible with a heavy asbestos mat (or a calcium chloride tube with successive layers of glass wool, coarse asbestos and fine asbestos wool) into a flask of about 150 c.c. capacity. Wash the residue in the flask twice by decantation with a little hot water pouring the supernatant liquid through the filter. Throw away the clear filtrate, rinse the flask and replace it. To the flask containing the cuprous oxide add 5–20 c.c. of the acid ferric sulphate solution.¹ A green solution containing ferrous sulphate is formed. Pour through the filter together with a little more of the acid solution if necessary to completely dissolve the copper oxide. Wash flask and filter with a little water. Titrate the filtrate with standard potassium permanganate solution¹ to a rose color. The procedure should be carried out as rapidly as possible.

Calculation.—Multiply the number of cubic centimeters of permanganate used by its copper equivalent as determined by standardization, and from the table (page 551–552) obtain the corresponding value for the sugar under examination.

Interpretation.—See page 546.

6. Fermentation Method.—*Principle.*—This method consists in the measurement of the volume of carbon dioxide evolved when the dextrose of the urine undergoes fermentation with yeast. None of the various methods whose manipulation is based upon this principle is *absolutely* accurate. The method in which Einhorn's saccharometer (Fig. 5, page 31) is the apparatus employed is perhaps as satisfactory as any for clinical purposes.

Procedure.—Place about 15 c.c. of urine in a mortar, add about 1 gram of yeast (1/16 of the ordinary cake of compressed yeast) and carefully crush the latter by means of a pestle. Transfer the mixture to the saccharometer, being careful to note that the graduated tube is completely filled and that no air bubbles gather at the top. Allow the apparatus to stand in a warm place (30°C.) for 12 hours and observe the percentage of dextrose as indicated by the graduated scale of the instrument. Both the percentage of dextrose and the number of cubic centimeters of carbon dioxide are indicated by the graduations on the side of the saccharometer tube.

The fermentation method becomes a much more accurate procedure if the saccharometer of Lohnstein is used.²

¹ (a) *Copper Sulphate Solution.*—Forty grams of pure crystallized copper sulphate are dissolved in water to make a liter.

(b) *Alkaline Tartrate Solution.*—Dissolve 200 grams of Rochelle salts and 150 grams of NaOH in water to make 1000 c.c.

(c) *Acid Ferric Sulphate Solution.*—Dissolve 50 grams of ferric sulphate in about 200 c.c. of water and pour into this a mixture of 200 c.c. of concentrated sulphuric acid diluted with about 400 c.c. of water. Mix and make up to 1000 c.c.

(d) *Potassium Permanganate Solution.*—Dissolve 5 grams of potassium permanganate in water to make 1000 c.c. *Standardization.*—Dissolve 0.250 gram of ammonium oxalate in 50–100 c.c. of water, add 1–2 c.c. of concentrated sulphuric acid and titrate with the permanganate to a rose color. About 22 c.c. will be required. Multiply the number of grams of oxalate used by 0.895 to get the equivalent in Cu of the number of cubic centimeters of permanganate used. Calculate the Cu value of 1 c.c.

² Lohnstein: *Münch. med. Woch.*, 1899, 1671.

The availability of the fermentation procedure as a quantitative aid has been appreciably lowered through the important findings of Neuberg and Associates.¹ They show that yeast has the property of *splitting off carbon dioxide from the carboxyl group of amino- and other aliphatic acids*. The active agent in this "sugar-free fermentation" is an enzyme called *carboxylase*. Inasmuch as amino-acids are always present in the urine, the error from this source is apparent.

7. Polariscopic Examination.—Before subjecting urine to a polariscopic examination the slightly acid fluid should be decolorized as thoroughly as possible by the addition of a little basic lead acetate. The urine should be well stirred and then filtered through a filter paper which has not been previously moistened. In this way a perfectly clear and almost colorless liquid is obtained.

In determining dextrose by means of the polariscope it should be borne in mind that this carbohydrate is often accompanied by other optically active substances, such as proteins, fructose, β -hydroxybutyric acid, and conjugate glycuronates which may introduce an error into the polariscopic reading; the method is, however, sufficiently accurate for practical purposes.

For directions as to the manipulation of the polariscope see page 32.

Below are given the specific rotations of some physiologically important sugars as well as of certain other optically active substances the possible presence of which must be borne in mind in determining glucose polarimetrically in urine.

	Specific Rotation		Specific Rotation
Glucose	+52.49	Fructose	-92.25
Maltose	+136.5	β -Hydroxybutyric acid.	-24.12
Isomaltose	+68.0	Conjugated Glycuronic Acids.	Levorotatory in varying degrees.
Lactose	+52.53		
Pentose (i-arabinose).	0.0		

Protein

1. Scherer's Coagulation Method.—The content of coagulable protein may be accurately determined as follows: Place 50 c.c. of urine in a small beaker and raise the temperature of the fluid to about 40°C. upon a water-bath. Add dilute acetic acid, drop by drop, to the warm urine, to precipitate the protein which will separate in a flocculent form. Care should be taken not to add too much acid; ordinarily less than 20 drops is sufficient. The temperature of the water in the water-bath should now be raised to the boiling-point and maintained there for a few minutes in order to insure the complete coagulation of the protein present. Now filter the urine² through a previously washed, dried, and weighed

¹ Neuberg and Associates: *Biochem. Zeitschr.*, vol. 31 and 36, 1911.

² If it is desired the precipitate may be filtered off on an *unweighed* paper, and its nitrogen content determined by the Kjeldahl method (see p. 512). In order to arrive at correct figures for the protein content it is then simply necessary to multiply the total nitrogen content by 6.25 (see p. 357). Correction should be made for the nitrogen content of the filter paper used unless this factor is negligible.

filter paper, wash the precipitated protein, in turn, with hot water, 95 per cent alcohol, and with ether, and dry the paper and precipitate, to constant weight, in an air-bath at 110°C. Subtract the weight of the filter paper from the combined weight of the paper and precipitate and calculate the percentage of protein in the urine specimen.

Calculation.—To determine the percentage of protein present in the urine under examination, multiply the weight of the precipitate, expressed in grams, by 2.

Interpretation.—The amount of albumin occurring in the urine is not necessarily an index of the severity or type of the disorder giving rise to it. Hence no significant figures can be given. Normal human urine probably contains a trace of albumin which is too slight to be detected or determined by the usual procedures. The determination of albumin may be of assistance in following the course of kidney disturbances, but the results can be interpreted only in the light of other clinical findings.

2. Esbach's Method.—This method depends upon the precipitation of protein by Esbach's reagent¹ and the apparatus used in the estimation is Esbach's albuminometer (Fig. 178). In making a determination fill the albuminometer to the point U with urine, then introduce the reagent until the point R is reached. Now stopper the tube, invert it slowly several times in order to insure the thorough mixing of the fluids, and stand the tube aside for 24 hours. Creatinine, resin, acids, etc., are precipitated in this method, and for this and other reasons it is not as accurate as the coagulation method. It is, however, extensively used clinically. According to Sahli² the method is "accurate approximately to one part per 1000," whereas Pfeiffer³ claims it is not accurate for less than one-half or for more than five parts per 1000.

Calculation.—The graduations on the albuminometer indicate grams of protein per liter of urine. Thus, if the protein precipitate is level with the figure 3 of the graduated scale, this denotes that the urine examined contains 3 grams of protein to the liter. To express the amount of protein in per cent simply move the decimal point one place to the left. In the case under consideration the urine contains 0.3 per cent protein.

Interpretation.—See above.

3. Kwilecki's Modification of Esbach's Method.⁴—Add 10 drops of a 10 per cent solution of FeCl₃ to the acid urine before introducing the Esbach's reagent.

¹ Esbach's reagent is prepared by dissolving 10 grams of picric acid and 20 grams of citric acid in 1 liter of water.

² Sahli: *Lehrbuch d. klin. Untersuchungs-Methoden*, 5th Aufl., 1909.

³ Pfeiffer: *Berl. klin. Woch.*, 49, 114, 1912.

⁴ Kwilecki: *Munch. med. Woch.*, 56, p. 1330.

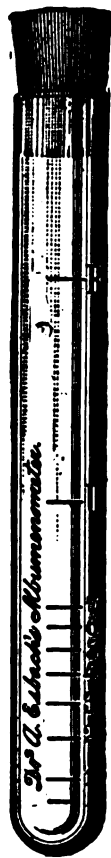

FIG. 178.—
ESBACH'S ALBU-
MINOMETER.

Warm the tube and contents in a water-bath at 72°C. for 5-6 minutes and make the reading.

4. **Turbidity Method of Folin and Denis.**¹—*Principle.*—The albumin of the urine is precipitated with sulphosalicylic acid and the turbidity produced compared with that of a standard protein solution.

Procedure.—To about 75 c.c. of water in each of two 100 c.c. volumetric flasks is added 5 c.c. of a 25 per cent solution of sulphosalicylic acid. To one flask is then added 5 c.c. of the standard protein solution containing 10 mg. of albumin and to the other is added the albuminous urine 1 c.c. at a time (by means of an Ostwald pipette) until the turbidity obtained seems to be reasonably near that of the standard. The two flasks are then filled up to the mark with water, cautiously inverted a few times to secure mixing, and are then ready for the quantitative comparison just as in colorimetric work. The standard must invariably be read against itself. The standard² containing 10 mg. of protein is set at 20 mm. The unknown must not read less than 10 nor more than 30.

Calculation.—Dividing 200 by the product of the reading of the unknown and the number of cubic centimeters of urine taken gives the albumin in milligrams per cubic centimeter of urine. The albuminous suspensions must not be shaken but mixed very carefully. The method is fairly accurate and requires but a few minutes if a standard solution is at hand. The method is not applicable to urines deeply colored with blood or bile but may be used for albuminous fluids other than urine if such fluids are not highly pigmented. It must be borne in mind that different proteins, as serum albumin and serum globulin, may give markedly different degrees of turbidity under the same conditions.³

Interpretation.—See page 555.

Bence-Jones Protein. Method of Folin and Denis.⁴—*Principle.*—A known volume of urine is heated at 60°, the coagulated Bence-Jones protein is then thrown down by centrifugation, washed with 50 per cent. alcohol, dried and weighed.

Procedure.—Place 10 c.c. of the urine containing Bence-Jones protein in a previously weighed, conical centrifuge tube, add 1 c.c. of 5 per cent. acetic acid,⁵ and allow to stand overnight⁶ in a water bath at 60°C. The next morning remove the tube from the bath, centrifuge for a few minutes and pour off the supernatant liquid. Stir the sediment well with about 10 c.c. of 50 per cent. alcohol, centrifuge, pour off the alcohol, dry at 100°C. to constant weight, cool, and weigh.

Calculation.—Subtract the weight of the empty tube from that of the tube and protein to obtain the weight of Bence-Jones protein contained in 10 c.c. of urine. Calculate, from this figure, the percentage and 24-hour output.

¹ Folin and Denis: *Jour. Biol. Chem.*, 18, 273, 1914.

² Standard Albumin solution. *Fresh* blood serum free from hemoglobin is used. 25-35 c.c. of the serum are diluted with a 15 per cent solution of chemically pure sodium chloride to about 1500 c.c. The solution is mixed and filtered. By means of nitrogen determinations the protein content of the filtrate is determined (protein = N × 6.25) and on the basis of the figure obtained the solution is diluted with 15 per cent sodium chloride solution so that it contains 2 mg. of protein per cubic centimeter. It is best to saturate the albumin solution with chloroform. The solution keeps for months.

³ Marshall and Banks: *Proceedings of the American Philosophical Society*, 54, 176, 1915.

⁴ Folin and Denis: *Jour. Biol. Chem.*, 18, 277, 1914.

⁵ Taylor and Miller (*Jour. Biol. Chem.*, 25, 281, 1916) suggest the use of only a trace of acetic acid.

⁶ From 6 P. M. until 8 A. M. is suggested as convenient.

Interpretation.—For a discussion of the significance of Bence-Jones proteinuria see p. 455.

Acetone Bodies

Van Slyke's Methods.¹—*Principle.*—The method is based on a combination of Shaffer's oxidation of β -hydroxybutyric acid to acetone, and Denigè's precipitation of acetone as a basic mercuric sulphate compound. Glucose and certain other interfering substances are removed by precipitation with copper sulphate and calcium hydroxide. Preservatives other than toluene or copper sulphate should not be used.

Procedure.—**Removal of Glucose and other Interfering Substances from Urine.**

Place 25 c.c. of urine in a 250 c.c. measuring flask. Add 100 c.c. of water, 50 c.c. of copper sulphate solution² and mix. Then add 50 c.c. of 10 per cent calcium hydroxide suspension, shake, and test with litmus. If not alkaline, add more calcium hydroxide. Dilute to the mark and let stand at least one-half hour for glucose to precipitate. Filter through a dry folded filter. This procedure will remove up to 8 per cent of glucose. Urine containing more should be diluted enough to bring the glucose down to 8 per cent. The copper treatment is depended upon to remove interfering substances other than glucose, and should therefore never be omitted, even when glucose is absent. The filtrate may be tested for glucose by boiling a little in a test-tube. A precipitate of yellow cuprous oxide will be obtained if the removal has not been complete. A slight precipitate of white calcium salts always forms, but does not interfere with the detection of the yellow cuprous oxide.

Determination of Total Acetone Bodies (Acetone, Acetoacetic Acid, and β -hydroxybutyric Acid.)—Place in a 500 c.c. Erlenmeyer flask 25 c.c. of urine filtrate. Add 100 c.c. of water, 10 c.c. of 50 per cent sulphuric acid, and 35 c.c. of the 10 per cent mercuric sulphate. Or in place of adding the water and reagents separately, add 145 c.c. of the "combined reagents." Connect the flask with a reflux condenser having a straight condensing tube of 8 or 10 mm. diameter and heat to boiling. After boiling has begun, add 5 c.c. of the 5 per cent dichromate through the condenser tube. Continue boiling gently 1 1/2 hours. The yellow precipitate which forms consists of the mercury sulphate-chromate compound³ of the preformed acetone, and the acetone which has been formed

¹ Van Slyke: *Jour. Biol. Chem.*, 32, 455, 1917.

² *Solutions Required.*—20 per cent copper sulphate—200 grams of $\text{CuSO}_4 \cdot 5\text{H}_2\text{O}$ dissolved in water and made up to 1 liter.

10 per cent mercuric sulphate—73 grams of pure red mercuric oxide dissolved in 1 liter of H_2SO_4 of 4 N. concentration.

50 volume per cent sulphuric acid—500 c.c. of sulphuric acid of 1.835 specific gravity, diluted to 1 liter with water. Concentration of H_2SO_4 must be readjusted if necessary to make it 17.0 N by titration.

10 per cent calcium hydroxide suspension—mix 100 grams of Merck's fine light "reagent" $\text{Ca}(\text{OH})_2$ with 1 liter of water.

5 per cent potassium dichromate—50 grams $\text{K}_2\text{Cr}_2\text{O}_7$ dissolved in water and made up to 1 liter.

Combined reagents for total acetone body determination—1 liter of the above 50 per cent sulphuric acid, 3.5 liters of the mercuric sulphate, 10 liters of water.

³This contains about 77 per cent mercury and in the absence of chromate has approximately one of the following formulas: $3\text{HgSO}_4 \cdot 5\text{HgO} \cdot 2(\text{CH}_3)_2\text{CO}$ or $2\text{HgSO}_4 \cdot 3\text{HgO} \cdot (\text{CH}_3)_2\text{CO}$.

by decomposition of acetoacetic acid and by oxidation of the β -hydroxybutyric acid. It is collected in a Gooch or "medium density" alundum crucible, washed with 200 c.c. of cold water, and dried for an hour at 110° . The crucible is allowed to cool in room air (a desiccator is unnecessary and undesirable) and weighed. Several precipitates may be collected, one above the other, without cleaning the crucible. As an alternative to weighing, the precipitate may be dissolved and titrated as described below.

Determination of Acetone and Acetoacetic Acid.—The acetone plus the acetoacetic acid, which completely decomposes into acetone and CO_2 on heating, is determined without the β -hydroxybutyric acid exactly as the total acetone bodies, except that (1) no dichromate is added to oxidize the β -hydroxybutyric acid and (2) the boiling must continue for not less than 30 nor more than 45 minutes. Boiling for more than 45 minutes splits off a little acetone from β -hydroxybutyric acid even in the absence of chromic acid.¹

Determination of β -hydroxybutyric Acid.—The β -hydroxybutyric acid alone is determined exactly as total acetone bodies except that the preformed acetone and that from the acetoacetic acid are first boiled off. To do this the 25 c.c. of urine filtrate plus 100 c.c. of water are treated with 2 c.c. of the 50 per cent sulphuric acid and boiled in the open flask for 10 minutes. The volume of solution left in the flask is measured in a cylinder. The solution is returned to the flask, and the cylinder washed with enough water to replace that boiled off and restore the volume of the solution to 127 c.c. Then 8 c.c. of the 50 per cent sulphuric acid and 35 c.c. of mercuric sulphate are added. The flask is connected under the condenser and the determination is continued as described for total acetone bodies.

Titration of the Precipitate in the Above Methods.—Instead of weighing the precipitate, one may wash the contents of the Gooch, including the asbestos, into a small beaker with as little water as possible, and add 15 c.c. of normal HCl. The mixture is then heated, and the precipitate quickly dissolves. In case an alundum crucible is used, it is set into the beaker of acid until the precipitate dissolves, and then washed with suction, the washings being added to the beaker. In place of using either a Gooch or alundum crucible one may, when titration is employed, wash the precipitate without suction on a small quantitative filter paper, which is transferred with the precipitate to the beaker and broken up with a rod in 15 c.c. of normal HCl.

In order to obtain a good end-point in the subsequent titration it is necessary to reduce the acidity of the solution. For this purpose it has been found that the addition of excess sodium acetate is the most satisfactory means. Six to 7 c.c. of 3 M acetate are added to the cooled solution of redissolved precipitate. Then

¹ *Blank Determination of Precipitate from Substances in Urine Other than the Acetone Bodies.*—The 25 c.c. aliquot of urine filtrate is treated with sulphuric acid and water and boiled 10 minutes to drive off acetone. The residue is made up to 175 c.c. with the same amounts of mercuric sulphate and sulphuric acid used in the above determinations, but without chromate, and is boiled under the reflux for 45 minutes. Longer boiling splits off some acetone from β -hydroxybutyric acid, and must therefore be avoided. The weight of precipitate obtained may be subtracted from that obtained in the above determination.

The blank is so small that it appears to be relatively significant only when compared with the small amounts of acetone bodies found in normal or nearly normal urines. In routine analyses of diabetic urines it is not determined.

Tests of Reagents.—When the complete total acetone bodies determination, including the preliminary copper sulphate treatment, is performed on a sample of distilled water instead of urine no precipitate whatever should be obtained. This test must not be omitted.

the 0.2 M KI is run in rapidly from a burette with constant stirring. If more than a small amount of mercury is present, a red precipitate of HgI_2 , at once forms, and redissolves as soon as 2 or 3 c.c. of KI in excess of the amount required to form the soluble K_2HgI_4 , have been added. If only a few mg. of mercury are present, the excess of KI may be added before the HgI_2 , has had time to precipitate so that the titrated solution remains clear. In this case not less than 5 c.c. of the 0.2 M KI are added, as it has been found that the final titration is not satisfactory if less is present. The excess of KI is titrated back by adding 0.05 M $HgCl_2$, from another burette until a permanent red precipitate forms. Since the reaction utilized is $HgCl_2 + 4KI = K_2HgI_4 + 2KCl$, 1 c.c. of 0.05 M $HgCl_2$, is equivalent in the titration to 1 c.c. of the 0.2 M KI.

In preparing the two standard solutions the 0.05 M $HgCl_2$, is standardized by the sulphide method, and the iodine is standardized by titration against it. A slight error appears to be introduced if the iodide solution is gravimetrically standardized and used for checking the mercury solution, instead of vice versa.

In standardizing the mercuric chloride the following procedure has been found convenient: 25 c.c. of 0.05 M $HgCl_2$, are measured with a calibrated pipette, diluted to about 100 c.c., and H_2S is run in until the black precipitate flocculates and leaves a clear solution. The HgS , collected in a Gooch crucible and dried at 110° , should weigh 0.2908 gram if the solution is accurate.

Both by gravimetric analyses of the basic mercuric sulphate-acetone precipitate and by titration, the mercury content of the precipitate has been found to average 76.9 per cent. On this basis, each c.c. of 0.2 M KI solution, being equivalent to 10.0 mg. of Hg, is equivalent to 13.0 mg. of the mercury acetone precipitate.

Titration is not quite so accurate as weighing, but, except when the amounts determined are very small, the titration is satisfactory.

Calculation.—1 mg. of β -hydroxybutyric acid yields 8.45 mg. of precipitate. 1 mg. of acetone yields 20.0 mg. of precipitate. 1 c.c. of 0.2 M KI solution is equivalent to 13 mg. of precipitate in titration of the latter.

Special Factors for Calculation of Results when 25 c.c. of Urine Filtrate, Equivalent to 2.5 c.c. of Urine, are used for the Determination.

Determination performed	Acetone bodies, calculated as gm. acetone per liter of urine, indicated by	
	1 gm. of prec.	1 c.c. of 0.2 M KI sol.
Total acetone bodies ¹	24.8	0.322
β -Hydroxybutyric acid.....	26.4	0.344
Acetone ² + acetoacetic acid.....	20.0	0.260

¹ The "total acetone bodies" factor is calculated on the assumption that the molecular proportion of them in the form β -hydroxybutyric acid is 75 per cent of the total, which proportion is usually approximated in acetonuria. Because β -hydroxybutyric acid yields only 0.75 molecule of acetone, the factors are strictly accurate only when this proportion is present, but the error introduced by the use of the approximate factors is for ordinary purposes not serious. The actual errors in percentage of the amounts determined are as follows: molecular proportion of acetone bodies as β -acid 0.50, error 6.5 per cent; β -acid 60.0, error 3.8 per cent; β -acid 0.80, error 1.3 per cent.

² For the determination of preformed acetone see method p. 561.

In order to calculate the acetone bodies as β -hydroxybutyric acid rather than acetone, use the above factors multiplied by the ratio of the molecular weights $\frac{\beta\text{-acid}}{\text{acetone}} = \frac{104}{58} = 1.793$. In order to calculate the acetone bodies in terms of molecular concentration, divide the factors in the table by 58. To calculate c.c. of 0.1 M acetone bodies per liter of urine use the above factors multiplied by $\frac{10,000}{58} = 172.4$.

Interpretation.—Normal adults on a mixed diet excrete on the average 3–15 mg. of combined acetone and acetoacetic acid per day and anything over 20 mg. is usually pathological. Usually about one-fourth of this total is acetone although the proportion varies considerably. The amount is considerably increased in fasting and on a carbohydrate-free diet due to the development of acidosis. In severe diabetic acidosis values up to 6 grams per day or even higher may be noted. It is sometimes found in large amounts in intoxications associated with pregnancy. It may be found in increased amounts in the urine in a great variety of pathological conditions. Quantative estimation enables us to follow the course of the acidosis. Ammonia excretion is also largely increased in these conditions, being used in the neutralization of the excess acids formed in the body. Usually about three-quarters of the combined acetone and acetoacetic acid excretion is in the form of acetoacetic acid, but the proportion is not constant.

β -hydroxybutyric acid may occur in normal human urine to the extent of 20–30 mg. per day. In fasting or on a carbohydrate-free diet very large amounts may be excreted (up to 20 grams per day). In severe diabetes mellitus the largest amounts are found, and excretions of 50 or even 100 grams or over per day have been noted. In this condition it is usually the most abundant of the acetone bodies making up from 60–80 per cent of the total. The ratio is, however, by no means constant and it should be borne in mind that in rare cases large amounts of β -hydroxybutyric acid may be eliminated although the acetone excretion is very low. It is always present in the urine when large amounts of acetone are present.

Acidosis is due mainly to a disturbance in the metabolism of fats. The fatty acids are ordinarily oxidized to acetoacetic acid, which is either oxidized through formic and acetic acids to carbon dioxide and water, or by reduction forms β -hydroxybutyric acid. When fat catabolism is increased to such an extent that the body cannot bring about complete oxidation of the products formed, a considerable portion of the acetoacetic acid instead of being oxidized in this way is transformed into acetone and in more severe cases into β -hydroxybutyric acid which will then be eliminated to varying degrees in the urine.

The relation of the acetone bodies is indicated in the following scheme.

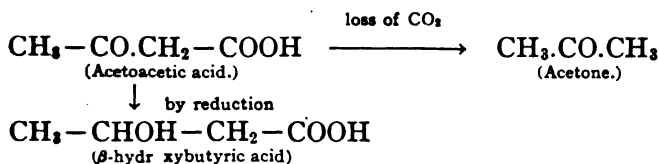

In fasting the decomposition of fat is increased due to the lack of carbohydrate material and acidosis develops. The same holds true for a carbohydrate-free diet. Apparently, also, fat is much less readily oxidized in the presence of a carbohydrate deficiency.

Acetone

Folin's Method.—Principle.—The preformed acetone is aspirated from the urine mixture at room temperature to prevent decomposition of acetoacetic acid. The acetone is collected in alkaline hypoiodite solution as in the Folin-Hart method. Iodoform is formed quantitatively and the excess of iodine is titrated with sodium thio-sulphate.

Procedure.—The same type of apparatus is used in this method as that described in Folin's method for the determination of ammonia (see page 523). Introduce 20–25 c.c. of the urine under examination into the aerometer cylinder and add 10 drops of 10 per cent phosphoric acid,¹ 8–10 grams of sodium chloride,² and a little petroleum. Introduce into an absorption flask,³ such as is used in the ammonia determination (see page 523), 150 c.c. of water, 10 c.c. of a 40 per cent solution of potassium hydroxide, and an excess of a N/10 iodine solution. Connect the flask with the aerometer cylinder, attach a Chapman pump, and permit an air current, slightly less rapid than that used for the determination of ammonia, to be drawn through the solution for 20–25 minutes. All of the acetone will, at this point, have been converted into iodoform in the absorption flask. Add 10 c.c. of concentrated hydrochloric acid (a volume equivalent to that of the strong alkali originally added), to the contents of the latter and titrate the excess of iodine by means of N/10 sodium thiosulphate solution until a light yellow color is obtained. At this point add a few cubic centimeters of starch paste and titrate the mixture until no blue color is visible. This is the end reaction.

Calculation.—Subtract the number of cubic centimeters of N/10 thiosulphate solution used from the volume of N/10 iodine solution employed. Since 1 c.c. of the iodine solution is equivalent to 0.067 mg. of acetone, and since 1 c.c. of the

¹ Oxalic acid (0.2–0.3 gram) may be substituted if desired.

² Acetone is insoluble in a saturated solution of sodium chloride.

³ Folin's improved absorption tube (see Fig. 175, p. 524) should be used in this connection inasmuch as the original type embracing the use of a rubber stopper is unsatisfactory because of the solvent action of alkaline hypoiodite on rubber.

thiosulphate solution is equivalent to 1 c.c. of the iodine solution, if we multiply the remainder from the above subtraction by 0.967 we will obtain the number of milligrams of acetone in the volume of urine employed.

Calculate the quantity of acetone in the twenty-four-hour urine specimen.

Interpretation.—See Van Slyke's Methods, page 560.

Folin has further made suggestions regarding the *simultaneous* determination of acetone and ammonia by the use of the same air current.¹ This is an important consideration for the clinician inasmuch as urines which contain acetone and acetoacetic acid are generally those from which the ammonia data are also desired. The procedure for the combination method is as follows: Arrange the ammonia apparatus as usual (see page 523), and to the aerometer of the ammonia apparatus attach the acetone apparatus set up as described above. Regulate the air current with special reference to the determination of acetone and at the end of 20–25 minutes disconnect the acetone apparatus and complete the determination of the acetone as just described. The air current is not interrupted, and after having run one and one-half hours the ammonia apparatus is detached and the ammonia determination completed as described on page 523.

If data regarding acetoacetic acid are desired, the result obtained by Folin's method may be subtracted from the result obtained by the Van Slyke method for acetone and acetoacetic acid. Under all conditions the determination of acetone should be as expeditious as possible. This is essential, not only because of the fact that any acetoacetic acid present in the urine will become transformed into acetone, but *also* because of the rapid spontaneous decomposition of the alkaline hypiodite solution used in the determination of the acetone. It has been claimed that alkaline hypiodite solutions are almost completely converted into iodate solutions in *one-half hour*. Folin states, however, that the transformation is not so rapid as this, but he nevertheless emphasizes the necessity of rapidity of manipulation. At the same time it should be remembered that the air current must not be as rapid as for ammonia, inasmuch as the alkaline hypiodite solution will not absorb all the acetone under those conditions.

Indican

Ellinger's Method.—*Principle.*—This method for the quantitative determination of indican is based upon the principle underlying Jaffe's qualitative test for indican. The urine after removal of interfering substances with basic lead acetate is treated with Obermayer's reagent to oxidize the indican to indigo. The indigo is extracted with chloroform, the chloroform evaporated off and the residue titrated with potassium permanganate. The method is not very accurate but is as satisfactory as any.

Procedure.—To 50 c.c. of urine² in a small beaker or casserole add 5 c.c. of basic lead acetate solution,³ mix thoroughly, and filter. Transfer 40 c.c. of

¹ These determinations may even be made on the *same sample* of urine if the sample is too small for the double determination.

² If the urine under examination is neutral or alkaline in reaction it may be made faintly acid with acetic acid before adding the basic lead acetate.

³ For preparation of basic lead acetate solution see p. 679.

the filtrate to a separatory funnel, add an equal volume of Obermayer's reagent (see page 416) and 20 c.c. of chloroform, and extract in the usual manner. This extraction with chloroform should be repeated until the chloroform solution remains colorless. Shake up the combined chloroform extracts two or three times with distilled water in a separating funnel and complete the purification by extracting with very dilute sodium hydroxide (1:1000). Remove all traces of alkali by washing with water. Now filter the combined chloroform extracts through a dry filter paper into a dry Erlenmeyer flask. Distil off the chloroform, heat the residue on a boiling water-bath for five minutes in the open flask, and wash the dried residue with hot water.¹ Add 10 c.c. of concentrated sulphuric acid to the washed residue, heat on the water-bath for five to ten minutes, dilute with 100 c.c. of water, and titrate the blue solution with a very dilute solution of potassium permanganate.² The end point is indicated by the dissipation of all the blue color from the solution and the formation of a pale yellow color.

Beautiful plates of indigo blue sometimes appear in the chloroform extract of urines containing abundant indican. In urines preserved by thymol the determination of indican is interfered with unless great care is taken in washing the chloroform extract with dilute alkali. Care should be taken, therefore, to make the indican determination upon fresh urine, before the addition of the preservative.

Plasencia³ has suggested a method which is shorter than Ellinger's and according to its sponsor, just as accurate.

Calculation.—One cubic centimeter of the diluted permanganate solution is equivalent to about 0.15 mg. of indigo. Ellinger claims that one-sixth of the amount determined must be added to the value obtained by titration in order to secure accurate data. This correction should always be made.

Interpretation.—From 4–20 mg. of indican are excreted per day by normal men. In normal individuals the variations are dependent mainly upon the diet. A meat diet increases the indican excretion, while a milk or carbohydrate-rich diet decreases it. Pathologically the greatest increases are found in disorders involving increased putrefaction and stagnation of intestinal contents. Bacterial decomposition of body protein as in gangrene, putrid pus formation, etc., gives rise to increases.

Phenols

Colorimetric Method of Folin and Denis.⁴—*Principle.*—This method is based upon the fact that phenols yield with a solution of phospho-

¹ The washing should be continued until the wash water is no longer colored. Ordinarily two or three washings are sufficient. If a separation of indigo particles takes place during the washing process, the wash water should be filtered, the indigo extracted with chloroform, and the usual method applied from this point.

² A "stock solution" of potassium permanganate containing 3 grams per liter should be prepared, and when needed for titration purposes a suitable volume of this solution should be diluted with 40 volumes of water. The potassium permanganate solution may be standardized with pure indigo.

³ Plasencia: *Revista de Medicina y Cirugia.*, 17, 1, 1912.

⁴ Folin and Denis: *J. Biol. Chem.*, 22, 305, 1915.

tungstic-phosphomolybdic acid and alkali a deep blue color the depth of which is proportional to the amount of such substances present. Traces of protein, which may be present in the urine, and uric acid give a blue color with the reagent and are removed by precipitation with an ammoniacal silver solution and colloidal iron as a preliminary to the determination of the phenols.

Procedure.—Removal of Interfering Substances.—Place 10 c.c. of ordinary urine, or 20 c.c. of a dilute urine in a 50 c.c. volumetric flask. To this add an acid silver lactate solution (from 2 to 20 c.c. of a 3 per cent solution of silver lactate in 3 per cent lactic acid) until no further precipitate is obtained. Add a few drops of colloidal iron, shake the flask, dilute to mark with distilled water, shake again, and filter the contents through a dry filter. Phenols are not precipitated by this procedure but are recovered quantitatively in the filtrate. Transfer 25 c.c. of the filtrate to a 50 c.c. volumetric flask, and add a sufficient quantity of saturated sodium chloride solution, containing 10 c.c. of strong hydrochloric acid per liter, to precipitate all the silver. Fill the flask to the mark with distilled water, mix thoroughly, and filter through a dry filter. This filtrate, which contains half the phenol from the urine taken for analysis, is used for the determination of free and total phenols.

Free Phenols.—Place 20 c.c. of the filtrate mentioned above in a 50 c.c. volumetric flask, add 5 c.c. of the phosphotungstic-phosphomolybdic acid reagent¹ and 15 c.c. of a saturated solution of sodium carbonate. Dilute to volume with luke warm water (30–35°C.), mix thoroughly and after allowing to stand for 20 minutes compare the deep blue color in the Duboscq colorimeter (see Fig. 168, page 515) against a standard solution of phenol (see below) similarly treated.

Total Phenols (Free and Conjugated).—Place 20 c.c. of the same filtrate used for the determination of free phenols in a large test-tube, add 10 drops of concentrated hydrochloric acid, cover the tube with a small funnel, heat rapidly to boiling over a free flame, and then place in a boiling water-bath for ten minutes. This process serves to decompose the conjugated phenols. At the end of the ten minutes, remove the tube, cool, and transfer the contents to a 100 c.c. volumetric flask. Add 10 c.c. of the phosphotungstic-phosphomolybdic reagent, 25 c.c. of saturated sodium carbonate solution, dilute to mark with luke warm water (30–35°C.), mix thoroughly, allow to stand for 20 minutes, and read in the Duboscq colorimeter (see page 515) against a standard solution of phenol (see below).

Standard Solution of Phenol.—The standard used is a solution of pure phenol in N/100 hydrochloric acid containing 1 mg. of phenol in 10 c.c., standardized by means of the iodometric titration. The preparation is carried out as follows: Make a phenol solution in N/10 hydrochloric acid, which contains approximately 1 mg. of crystallized phenol per cubic centimeter. Transfer 25 c.c. of this solution to a 250 c.c. flask, add 50 c.c. of N/10 sodium hydroxide, heat to 65°C., add 25 c.c. of N/10 iodine solution, stopper the flask, and let stand at room temperature 30 or

¹ This reagent is prepared as follows: Boil together for two hours (using a reflux condenser) 100 grams of sodium tungstate, 20 grams of phosphomolybdic acid (or an equivalent of molybdic acid), 50 c.c. of phosphoric acid (85 per cent), and 75 c.c. of distilled water. After the period of heating, cool, dilute to 1 liter with distilled water, and filter if necessary.

40 minutes. Add 5 c.c. of concentrated hydrochloric acid and titrate the excess of iodine with N/10 thiosulphate solution. Each cubic centimeter of N/10 iodine solution corresponds to 1.567 mg. of phenol. On the basis of the result dilute the phenol solution so that 10 c.c. contain 1 mg. of phenol. Five c.c. of this solution (equivalent to 0.5 mg. of phenol), when 10 c.c. of the phosphotungstic phosphomolybdic reagent and 25 c.c. of saturated sodium carbonate solution are added, and the whole made up with water at about 30°C. to 100 c.c., give when set in the colorimeter at 20 mm. a convenient standard.

Calculation.—The filtrate used for the determination of free and total phenols contains the phenols from one-half the amount of urine analyzed. The actual determination of phenols, both free and total, is made upon a two-fifths portion of this filtrate and this amount of filtrate contains the phenols from one-fifth of the amount of urine analyzed. In the determination of free phenols the colored solution is diluted to only half that of the standard while in the determination of total phenols the dilution is the same as that of the standard.

Hence,

$$\frac{R_1}{R_2 \times 4} = \text{milligrams of free phenol}$$

and

$$\frac{R_1}{R_2 \times 2} = \text{milligrams of total phenol}$$

in 2 c.c. or 4 c.c. of urine according to whether 10 c.c. or 20 c.c. of urine was taken for analysis, when R_1 is taken as the reading obtained with the standard solution, and R_2 is taken as the reading obtained with the unknown.

Interpretation.—By this method total phenol excretions of from 0.2–0.5 gram per day have been noted in normal individuals. These results are much higher than figures previously obtained by other methods. The free phenols varied from 0.1–0.3 gram per day. The total phenol excretion appears to vary directly but not proportionately with the protein intake. The amount of conjugated phenol indicates the extent to which the phenols have been detoxicated. The excretion of phenols is increased in gastro-intestinal disorders associated with increased putrefaction. It is increased by the ingestion of phenols or of benzene.

Oxalic Acid

Salkowski-Autenreith and Barth Method.—*Principle.*—The oxalic acid is precipitated by means of CaCl_2 . From the solution of this precipitate in hydrochloric acid the oxalic acid is extracted with ether and reprecipitated as calcium oxalate.

Procedure.—Place the 24-hour urine specimen in a precipitating jar, add an excess of calcium chloride, render the urine strongly ammoniacal, stir it well, and allow it to stand 18–20 hours. Filter off the precipitate, wash it with a small amount of water and dissolve it in about 30 c.c. of a hot 15 per cent solution of hydrochloric acid. By means of a separatory funnel extract the solution with 150 c.c. of ether which contains 3 per cent of alcohol, repeating the extraction four or five times with fresh portions of ether. Unite the ethereal extracts, allow them to stand for an hour in a flask, and then filter through a dry filter paper. Add 5 c.c. of water to the filtrate, to prevent the formation of diethyl oxalate when the solu-

tion is heated, and distil off the ether. If necessary, decolorize the liquid with animal charcoal and filter. Concentrate the filtrate to 3-5 c.c., add a little calcium chloride solution, make it ammoniacal, and after a few minutes render it slightly acid with acetic acid. Allow the acidified solution to stand several hours, collect the precipitate of calcium oxalate on a washed filter paper,¹ wash, incinerate strongly (to CaO), and weigh in the usual manner.

Calculation.—Since 56 parts of CaO are equivalent to 90 parts of oxalic acid, the quantity of oxalic acid in the volume of urine taken may be determined by multiplying the weight of CaO by the factor of 1.6071.

Interpretation.—From 15-20 mg. of oxalic acid are excreted by a normal adult on an ordinary mixed diet. It arises from oxalates of the food ingested and from fat and protein metabolism. It is increased by the ingestion of apples, grapes, cabbage, etc., although most of the ingested oxalate is destroyed. It is increased in disturbances of metabolism associated with decreased oxidation, according to certain observers. The term "oxaluria" has been largely a misnomer.

Sulphur

(a) Gravimetric Procedures

1. Total Sulphates.—*Folin's Method.*—**Principle.**—The sulphuric acid of the conjugated sulphates is set free by boiling with acid. The total sulphates are then precipitated with barium chloride.

Procedure.—Place 25 c.c. of urine in a 200-250 c.c. Erlenmeyer flask, add 20 c.c. of dilute hydrochloric acid² (1 volume of concentrated HCl to 4 volumes of water) and gently boil the mixture for 20-30 minutes. To minimize the loss of water by evaporation the mouth of the flask should be covered with a small watch glass during the boiling process. Cool the flask for 2-3 minutes in running water, and dilute the contents to about 150 c.c. by means of cold water. Add 10 c.c. of a 5 per cent solution of barium chloride slowly, drop by drop, to the cold solution.³ The contents of the flask should not be stirred or shaken during the addition of the barium chloride. Allow the mixture to stand at least one hour, then shake up the solution and filter it through a weighed Gooch crucible.⁴

Wash the precipitate of BaSO₄ with about 250 c.c. of cold water, dry it in an air-bath or over a very low flame, then ignite,⁵ cool and weigh.

¹ Schleicher and Schüll, No. 589, is satisfactory.

² If it is desired, 50 c.c. of urine and 4 c.c. of concentrated acid may be used instead.

³ A dropper or capillary funnel made from an ordinary calcium chloride tube and so constructed as to deliver 10 c.c. in 2-3 minutes is recommended for use in adding the barium chloride.

⁴ If a Gooch crucible is not available, the precipitate of BaSO₄ may be filtered off upon a washed filter paper (Schleicher & Schüll's, No. 589, blue ribbon), and after washing the precipitate with about 250 c.c. of cold water the paper and precipitate may be dried in an air-bath or over a low flame. The ignition may then be carried out in the usual way in the ordinary platinum or porcelain crucible. In this case correction must be made for the weight of the ash of the filter paper used.

⁵ Care must be taken in the ignition of precipitates in Gooch crucibles. The flame should never be applied directly to the perforated bottom or to the sides of the crucible, since such manipulation is invariably attended by mechanical losses. The crucibles should always be provided with lids and tight bottoms during the ignition. In case porcelain Gooch crucibles, whose bottoms are not provided with a non-perforated cap, are used, the crucible may be placed upon the lid of an ordinary platinum crucible during ignition. The lid should be supported on a triangle, the crucible placed upon the lid and the flame applied to the improvised bottom. Ignition should be complete in 10 minutes if no organic matter is present.

Calculation.—Subtract the weight of the Gooch crucible from the weight of the crucible and the BaSO_4 precipitate to obtain the weight of the precipitate. The weight of SO_2 ,¹ in the volume of urine taken may be determined by means of the following proportion.

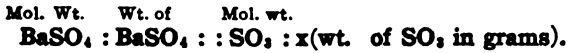

Representing the weight of the BaSO_4 precipitate by y and substituting the proper molecular weights, we have the following proportion:

$$233.43 : y : : 80.06 : x \text{ (wt. of SO}_2 \text{ in grams in the quantity of urine used).}^1$$

Calculate the quantity of SO_2 in the twenty-four-hour specimen of urine.

To express the result in percentage of SO_2 , simply divide the value of x , as just determined, by the quantity of urine used.

Interpretation.—The total sulphate excretion (ethereal and inorganic sulphates) by a normal adult on a mixed diet is usually between 1.5 and 3.0 gram of SO_2 with an average of about 2.0 gram. The sulphuric acid is derived but to a slight extent ordinarily from ingested sulphates, being mainly dependent on the sulphur of the protein ingested and will consequently vary widely with the protein content of the diet. From 75 to 95 per cent of the total sulphur of the urine is ordinarily found as sulphate, the proportion being greatest on a high protein diet. The sulphate excretion is increased in all conditions associated with increased decomposition of body protein as in acute fevers and decreased whenever there is a decrease in metabolic activity.

2. Inorganic Sulphates.—Folin's Method.—Place 25 c.c. of urine and 100 c.c. of water in a 200–250 c.c. Erlenmeyer flask and acidify the diluted urine with 10 c.c. of dilute hydrochloric acid (1 volume of concentrated HCl to 4 volumes of water). In case the urine is dilute 50 c.c. may be used instead of 25 c.c. and the volume of water reduced proportionately. Add 10 c.c. of 5 per cent barium chloride slowly, drop by drop, to the cold solution and from this point proceed as indicated in the method for the determination of Total Sulphates, page 566.

Calculate the quantity of inorganic sulphates, expressed as SO_2 , in the twenty-four-hour urine specimen.

Calculation.—Calculate according to the directions given under Total Sulphates, above.

Interpretation.—On an average about 90 per cent of the total sulphates of the urine exists as inorganic sulphates but the proportion of the sulphates existing in this form varies widely, being greater on a high protein diet than on a very low protein diet. The amount varies with the total sulphates (which see).

3. Ethereal Sulphates.—Folin's Method.—Principle.—The inorganic sulphates are removed with barium chloride and the conjugated sulphates then determined after hydrolysis.

¹ It is considered preferable by many investigators to express all sulphur values in terms of S rather than SO_2 .

Procedure.—Place 125 c.c. of urine in an Erlenmeyer flask of suitable size, dilute it with 75 c.c. of water and acidify the mixture with 30 c.c. of dilute hydrochloric acid (1 volume of concentrated HCl to 4 volumes of water). To the cold solution add 20 c.c. of a 5 per cent solution of barium chloride, drop by drop.¹ Allow the mixture to stand about one hour, then filter it through a dry filter paper.² Collect 125 c.c. of the filtrate and boil it gently for at least one-half hour. Cool the solution, filter off the precipitate of BaSO₄, wash, dry and ignite it according to the directions given on page 566.

Calculation.—The weight of the BaSO₄ precipitate should be multiplied by 2 since only one-half (125 c.c.) of the total volume (250 c.c.) of fluid was precipitated by the barium chloride. The remaining calculation should be made according to directions given under Total Sulphates, page 567.

Calculate the quantity of ethereal sulphates, expressed as SO₃, in the twenty-four-hour urine specimen.

Interpretation.—The excretion of ethereal sulphates (expressed as SO₃) varies ordinarily from 0.1 to 0.25 gram per day comprising from 5 to 15 per cent of the total sulphur excretion. The absolute amount of ethereal sulphate increases with increase in the protein of the diet and particularly with increase of putrefactive processes in the intestine or elsewhere. The amount excreted cannot however be taken as an index of the extent of intestinal putrefaction.

4. Total Sulphur.—Benedict's Method.³—Principle.—The urine is evaporated and ignited with a solution of copper nitrate and potassium chlorate. Organic matter is thus destroyed and all unoxidized sulphur is oxidized to the sulphate form and can be readily precipitated with barium chloride in the usual manner. The method is very convenient and accurate.

Ten c.c. of urine are measured into a small (7–8 cm.) porcelain evaporating dish and 5 c.c.⁴ of Benedict's sulphur reagent⁵ added. The contents of the dish are evaporated over a free flame which is regulated to keep the solution just below the boiling-point, so that there can be no loss through spattering. When dryness is reached the flame is raised slightly until the entire residue has blackened. The

¹ See note (3) at the bottom of p. 566.

² This precipitate consists of the inorganic sulphates. If it is desired, this BaSO₄ precipitate may be collected in a Gooch crucible or on an ordinary quantitative filter paper and a determination of inorganic sulphates made, using the same technic as that suggested above. In this way we are enabled to determine the inorganic and ethereal sulphates in the same sample of urine.

³ Benedict: *Journal of Biological Chemistry*, 6, 363, 1909.

⁴ If the urine is concentrated the quantity should be slightly increased.

⁵ Crystallized copper nitrate, sulphur-free or of known sulphur content..... 200 grams.
Sodium or potassium chlorate..... 50 grams.
Distilled water to..... 1000 c.c.

Denis has suggested the use of the following solution:

Copper nitrate.....	25 grams.
Sodium chloride.....	25 grams.
Ammonium nitrate.....	10 grams.
Water to make.....	100 c.c.

The procedure is the same as the above except that 25 c.c. of urine and 5 c.c. of reagent are taken. It gives accurate results.

flame is then turned up in two stages to the full heat of the bunsen burner and the contents of the dish thus heated to redness for ten minutes after the black residue (which first fuses) has become dry. This heating is to decompose the last traces of nitrate (and chlorate). The flame is then removed and the dish allowed to cool more or less completely. Ten to 20 c.c. of dilute (1 : 4) hydrochloric acid is then added to the residue in the dish, which is then warmed gently until the contents have completely dissolved and a perfectly clear, sparkling solution is obtained. This dissolving of the residue requires scarcely two minutes. With the aid of a stirring rod the solution is washed into¹ a small Erlenmeyer flask, diluted with cold, distilled water to 100–150 c.c., 10 c.c. of 10 per cent barium chloride solution added drop by drop, and the solution allowed to stand for about an hour. It is then shaken up and filtered as usual through a weighted Gooch crucible. Controls should be run on the oxidizing mixture.

Calculation.—Make the calculation according to directions given under Total Sulphates, page 567. Calculate the quantity of sulphur expressed as SO_2 or S, present in the twenty-four-hour urine specimen.

Interpretation.—The total sulphur (SO_2) excretion averages about 2.5 grams per day. It runs more or less parallel with the decomposition of endogenous and exogenous protein and a definite ratio between the excretion of total N and total S might be expected. It has been suggested that the ratio 5 : 1 expresses this relation in a general way but no constant value can be given. See Total Sulphates.

5. Total Sulphur.—Osborne-Folin Method.—Principle.—This method depends on the destruction of organic matter by means of sodium peroxide. It is employed particularly for the determination of sulphur in foods and feces. Benedict's procedure (see above) is simpler and fully as satisfactory for urine.

Place 25 c.c. of urine² in a 200–250 c.c. nickel crucible and add about 3 grams of sodium peroxide. Evaporate the mixture to a syrup upon a steam water-bath and heat it carefully over an alcohol flame until it solidifies (15 minutes). Now remove the crucible from the flame and allow it to cool. Moisten the residue with 1–2 c.c. of water,³ sprinkle about 7–8 grams of sodium peroxide over the contents of the crucible and fuse the mass over an alcohol flame for about 10 minutes. Allow the crucible to cool for a few minutes, add about 100 c.c. of water to the contents and heat at least one-half hour over an alcohol flame to dissolve the alkali and decompose the sodium peroxide. Next rinse the mixture into a 400–450 c.c. Erlenmeyer flask, by means of hot water, and dilute it to about 250 c.c. Heat the solution nearly to the boiling-point and add concentrated hydrochloric acid slowly until the nickelic oxide, derived from the crucible, is just brought into solution.⁴ A few minutes' boiling should now yield a clear solution. In case too little peroxide or too much water was added for the final fusion a clear solution will not be obtained. In this event cool the solution and remove the insoluble matter by filtration.

¹ Sometimes the porcelain glaze cracks during heating, in which case the solution should be filtered into the flask.

² If the urine is very dilute 50 c.c. may be used.

³ This moistening of the residue with a small amount of water is very essential and should not be neglected.

⁴ About 18 c.c. of acid are required for 8 grams of sodium peroxide.

To the clear solution add 5 c.c. of very dilute alcohol (about 18–20 per cent) and continue the boiling for a few minutes. The alcohol is added to remove the chlorine which was formed when the solution was acidified. Add 10 c.c. of a 10 per cent solution of barium chloride, slowly, drop by drop,¹ to the liquid. Allow the precipitated solution to stand in the cold two days and then filter and continue the manipulation according to the directions given under Total Sulphates, page 566.

Calculation.—Make the calculation according to directions given under Total Sulphates, page 567. Calculate the quantity of sulphur, expressed as SO_2 or S, present in the twenty-four-hour urine specimen.

Interpretation.—See page 569.

(b) Volumetric Procedures

6. Volumetric Determination of Ethereal and Inorganic Sulphates.
—Method of Rosenheim and Drummond.²—*Principle.*—The sulphates of the urine are precipitated by means of benzidine solution, the precipitate of benzidine sulphate being filtered off and the sulphuric acid of the compound titrated with $\text{N}/10$ KOH using phenolphthalein as an indicator. This is possible because the benzidine is a very weak base and its sulphate readily dissociates. It is necessary that excess of HCl be avoided in the precipitation process.

Procedure.—(a) Inorganic Sulphates.—Preparation of the benzidine solution. Rub 4 grams of benzidine (Kahlbaum) into a fine paste with about 10 c.c. of water and transfer to a 2-liter flask with the aid of about 500 c.c. of water. Add 5 c.c. of concentrated HCl (sp. gr. 1.19) and make up to 2 liters with distilled water. One hundred and fifty c.c. of this solution, which keeps indefinitely, are sufficient to precipitate 0.1 gram H_2SO_4 .

Measure 25 c.c. of urine into a 250 c.c. Erlenmeyer flask and acidify with dilute hydrochloric acid (1 : 4) until the reaction is distinctly acid to Congo red paper. Usually 1–2 c.c. of dilute acid are required. One hundred c.c. of the benzidine solution, as prepared above, are then run in and the precipitate, which forms in a few seconds, allowed to settle for ten minutes. Filter with suction and wash the precipitate with 10–20 c.c. of water saturated with benzidine sulphate.³ Transfer the precipitate and filter paper to the original precipitation flask with about 50 c.c. of water and titrate hot with $\text{N}/10$ KOH, after first adding a few drops of saturated alcoholic solution of phenolphthalein.

Calculation.—One c.c. of $\text{N}/10$ KOH corresponds to 4.9 mg. H_2SO_4 or 4.0 mg. of SO_2 . Multiply the number of cubic centimeters of $\text{N}/10$ KOH required by 4.9 and by 4 to get the amount of H_2SO_4 in 100 c.c. of the urine analyzed.

¹ See note (3) at the bottom of p. 566.

² Rosenheim and Drummond: *Biochem. J.*, 8, 143, 1914.

³ In order to obtain accurate results it is most important that the precipitate should be finely suspended in water before titration and this again entails certain precautions during filtration so as to prevent the caking together of the precipitate. The authors use a funnel of 6 cm. diameter and a perforated porcelain plate (5–7 mm.) covered either with paper pulp or with a well-fitting filter paper. Do not allow the precipitate to be sucked dry on the filter. The final filtrate should show no acid reaction to Congo red.

(b) **Total Sulphates (Inorganic and Ethereal).**—Measure 25 c.c. of urine into an Erlenmeyer flask, add 2–2.5 c.c. of dilute HCl (1:4) and 20 c.c. of water and boil for 15–20 minutes. The ethereal sulphates are hydrolyzed.¹ Allow the solution to cool and then precipitate the sulphate with benzidine as in the determination of inorganic sulphates. The titration and calculation are also carried out in the same way.

(c) **Ethereal Sulphates.**—Determine the total sulphates and inorganic sulphates as indicated above. Subtract the amount of inorganic sulphate from that of the total sulphate and obtain the amount of ethereal sulphate present.

(d) **Total Sulphur.**—According to Rosenheim and Drummond² the benzidine method may be employed for the estimation of total sulphur in the solution obtained on the oxidation of urine by the Wolf-Osterberg³ modification of Benedict's method. This modification involves the use of larger quantities of urine than the Benedict method or a reduction in accuracy and hence probably has no advantages over Benedict's original procedure. See below for modification of Raiziss and Dubin.

(e) **Neutral Sulphur.**—Neutral sulphur is most readily determined by difference. Subtract from the total sulphur as determined by one of the methods given above the amount of total sulphates. The difference corresponds to the neutral sulphur of the urine sample examined.

Interpretation.—The neutral sulphur of the urine is made up of cystine and related bodies, thiocyanate, oxyproteic acids, etc. It makes up ordinarily from 5–25 per cent of the total sulphur of the urine, or on the average 0.2 to 0.4 gram per day calculated as SO_2 . The absolute amount is fairly constant for a given individual through wide variations of protein intake, indicating that its origin is mainly endogenous, that is, that it arises principally from the decomposition of tissue protein. On this account the percentage of the total sulphur excretion existing in the neutral form may rise to 25 per cent on a very low protein diet and decrease to 5 per cent on a high protein diet, the absolute amount remaining nearly constant. In fasting percentages as high as 70 have been noted. In many disorders as tuberculosis, cancer, cystinuria, etc., the amount may be relatively and in some cases absolutely increased but no fixed relations have been determined for the various conditions.

7. Total Sulphur.—Method of Raiziss and Dubin.⁴—*Principle.*—The urine is oxidized by Benedict's method (page 568) the sulphur precipitated as benzidine sulphate and the benzidine titrated with N/10 permanganate solution. Very small amounts of sulphur may be determined in this way.

Procedure.—To 2 c.c. of urine in an 8 cm. porcelain dish, add 0.5 c.c. of Benedict's reagent (page 568) and evaporate to dryness on the water-bath. Heat the dish

¹ A larger amount of HCl may be used (20 c.c. of the dilute acid) if desired. In this case it is necessary to neutralize the solution carefully after boiling and again add dilute HCl until the reaction is acid to Congo red.

² Rosenheim and Drummond: *Bioch. Jour.*, 8, 143, 1914.

³ Wolf and Osterberg: *Bioch. Zeit.*, 29, 429, 1910.

⁴ Raiziss and Dubin: *Jour. Biol. Chem.*, 18, 297, 1914.

carefully over a small flame till the contents are black, and then heat to redness for only two minutes. Cool, add 2 c.c. of hydrochloric acid (1:4) and warm. Neutralize the clear solution with NaOH (10 per cent) and again acidify with 1 drop of HCl (1:4). Add 25 c.c. of a solution of benzidine hydrochloride¹ with stirring. Let stand 15 minutes and then filter off on an asbestos filter. Transfer the precipitate to the filter by means of the filtrate and wash with 5 c.c. of cold water, drop by drop. Put the filter into a 500 c.c. Erlenmeyer flask, add 1 c.c. of NaOH (10 per cent) and 200 c.c. of water. Boil the suspension for five minutes and then cool to room temperature. Add 20 c.c. concentrated sulphuric acid and titrate the warm solution at once with N/10 potassium permanganate solution till a distinct pink coloration is obtained, which should last 12 seconds. In titrating at first add only about 0.5 c.c. at a time and toward the end only 2 drops at a time, waiting till the color disappears before further addition of permanganate solution. As the titration progresses it will be noticed that the yellow color gradually disappears, the solution turning practically colorless. It is at this stage of the titration that care should be taken in adding only 2 drops of permanganate at a time.

Calculation.—One c.c. of N/10 potassium permanganate is equivalent to 0.099 mg. of sulphur. Multiply the number of cubic centimeters of permanganate used by 0.099 and divide by 2 in order to obtain the weight of sulphur in 1 c.c. of urine. Calculate the day's sulphur output.

Interpretation.—See page 569.

Phosphorus

1. Total Phosphates.—*Uranium Acetate Method.*—*Principle.*—Standard uranium acetate is run into a measured quantity of urine until all of the phosphate has been precipitated as insoluble uranium phosphate. An excess of uranium is indicated by a reddish coloration with potassium ferrocyanide. This method is accurate and gives practically the total phosphorus of urine inasmuch as the latter exists generally almost entirely as phosphates.

Procedure.—To 50 c.c. of urine in a small beaker or Erlenmeyer flask add 5 c.c. of a special sodium acetate solution² and heat the mixture to the boiling-point. From a burette, run into the hot mixture, drop by drop, a standard solution of uranium acetate³ until a precipitate ceases to form and a drop of the mixture when removed by means of a glass rod and brought into contact with a

¹ Six and seven-tenths grams of benzidine (Merck reagent) are put in a 1-liter flask, 20 c.c. of hydrochloric acid (sp. gr. 1.12) added and the solution diluted up to the mark.

² The sodium acetate solution is prepared by dissolving 100 grams of sodium acetate in 800 c.c. of distilled water, adding 100 c.c. of 30 per cent acetic acid to the solution, and making the volume of the mixture up to 1 liter with water.

³ *Uranium Acetate Solution.*—Dissolve about 35.0 grams of uranium acetate in 1 liter of water with the aid of heat and 3-4 c.c. of glacial acetic acid. Let stand a few days and filter. Standardize against a phosphate solution containing 0.005 gram of P_2O_5 per cubic centimeter. For this purpose dissolve 14.721 grams of pure air-dry sodium ammonium phosphate ($NaNH_4HPO_4 \cdot 4H_2O$) in water to make a liter. To 30 c.c. of this phosphate solution in a 100 c.c. beaker add 30 c.c. of water and 5 c.c. of sodium acetate solution (see above) and titrate with the uranium solution to the correct end reaction as indicated in the method above. If exactly 20 c.c. of uranium solution are required 1 c.c. of the solution is equivalent to 0.005 gram P_2O_5 . If stronger than this dilute accordingly and check again by titration.

drop of a solution of potassium ferrocyanide on a porcelain test-tablet produces instantaneously a brownish-red coloration.¹ Take the burette reading and calculate the P_2O_5 content of the urine under examination.

Calculation.—Multiply the number of cubic centimeters of uranium acetate solution used by 0.005 to determine the number of grams of P_2O_5 in the 50 c.c. of urine used. To express the result in percentage of P_2O_5 , multiply the value just obtained by 2, e.g., if 50 c.c. of urine contained 0.074 gram of P_2O_5 , it would be equivalent to 0.148 per cent.

Calculate, in terms of P_2O_5 , the total phosphate content of the 24-hour urine specimen.

Interpretation.—The excretion of phosphoric acid is extremely variable but on the average the total output for the 24 hours is about 2.5 grams expressed as P_2O_5 . Ordinarily the total output is mainly in the form of phosphates and is distributed between alkaline and earthy phosphates in the ratio of 2:1 but this is likewise inconstant. The greater part of the phosphate excretion arises from the ingested food, either from the preformed phosphates or more especially from the organic combinations as phospho- and nucleoproteins. The excretion is consequently very largely dependent upon the phosphorus content of the diet. Some of the phosphoric acid results from the breakdown of the tissues of the body, and this endogenous phosphoric acid excretion is increased in conditions of increased metabolism as in fevers. The findings in pathological conditions have been somewhat contradictory due to lack of control of diet. The so-called "phosphaturias" nearly always represent decreased acidity and not increased phosphate content of the urine. Such conditions are, however, significant as indicating a possible tendency to the formation of phosphatic calculi.

2. Earthy Phosphates.—**Principle.**—The earthy phosphates are precipitated by making the urine alkaline. The precipitate is filtered off, dissolved in acid and titrated with uranium acetate.

Procedure.—To 100 c.c. of urine in a beaker add an excess of ammonium hydroxide and allow the mixture to stand 12–24 hours. Under these conditions the phosphoric acid in combination with the alkaline earths, calcium and magnesium, is precipitated as phosphates of these metals. Collect the precipitate on a filter paper and wash it with very dilute ammonium hydroxide. Pierce the paper, and remove the precipitate by means of hot water. Bring the phosphates into solution by adding a small amount of dilute acetic acid to the warm solution. Make the volume up to 50 c.c. with water, add 5 c.c. of sodium acetate solution, and determine the P_2O_5 content of the mixture according to the directions given under the previous method.

Calculation.—Multiply the number of cubic centimeters of uranium acetate solution used by 0.005 to determine the number of grams of P_2O_5 in the 100 c.c.

¹ A 10 per cent solution of potassium ferrocyanide is satisfactory.

of urine used. Since 100 c.c. of urine was taken this value also expresses the percentage of P_2O_5 present.

Calculate the quantity of earthy phosphates, in terms of P_2O_5 , present in the 24-hour urine specimen.

The quantity of phosphoric acid present in combination with the alkali metals may be determined by subtracting the content of earthy phosphates from the total phosphates.

Interpretation.—Ordinarily the earthy phosphates make up from 30–40 per cent of the total phosphate excretion. The amount varies with the excretion of calcium and magnesium (which see).

3. Total Phosphorus.—(a) *Volumetric Procedure.*—*Principle.*—The organic matter is destroyed by digestion with a mixture of sulphuric and nitric acids or some other oxidizing agent. The phosphorus is then precipitated as the phosphomolybdate and determined gravimetrically or volumetrically.

Preparation of the Solution.—Pipette 10 c.c. of urine (or an amount of substance containing about 20 mg. of P_2O_5) into a Kjeldahl flask. Add 10 c.c. of a mixture of equal parts of concentrated H_2SO_4 and concentrated HNO_3 . Digest over a low flame until red fumes cease to come off. If the mixture darkens due to the charring action of the sulphuric acid, add nitric acid from a separatory funnel a few drops at a time and continue the digestion. When the mixture remains clear on evaporation to the point where white sulphuric fumes come off the digestion is completed by heating for 10–15 minutes longer. Cool and transfer the solution to a 400 c.c. Erlenmeyer flask with the aid of enough water to make a total volume of about 75 c.c.¹

Instead of oxidizing the material as described above it may be ignited with magnesia to destroy organic matter. About 2 grams of the solid substance or 25 c.c. of urine (previously evaporated nearly to dryness) are mixed with a little more than an equal bulk of magnesium oxide in a porcelain dish of about 30 c.c. capacity. Five c.c. of magnesium nitrate solution (see Reagents and Solutions, page 626) are added and the mixture heated very gently at first, then gradually to bright redness. The mixture is cooled and transferred with water to a 250 c.c. flask. An excess (20–30 c.c.) of HCl are added and the mixture boiled a few minutes. Remove from the flame and add at once enough barium chloride solution to precipitate any sulphate present. Cool, make to mark, filter and take an aliquot for analysis.

Precipitation of the Phosphomolybdate.—Neutralize the solution with ammonia, make slightly acid with nitric acid, and add 15 grams of ammonium nitrate in substance (or 25 c.c. of a 60 per cent solution). Heat on a water-bath to 60–65°C. (not higher) and add 30–40 c.c. of molybdate solution,² stir and let

¹ In the case of urine it is possible to neutralize this acid solution with ammonia, make it acid with acetic acid and titrate with uranium acetate as in the preceding method.

² Made by adding 5 c.c. of concentrated HNO_3 to 100 c.c. of the ordinary molybdate solution (see Reagents and Solutions, page 617).

stand for about 15 minutes at 60–65°. Filter at once through a small paper,¹ washing the precipitate twice by decantation with 1 per cent potassium nitrate solution using about 25 c.c. each time, stirring up the precipitate well in each case, and allowing to settle. Transfer the precipitate to the filter and wash with 1 per cent potassium nitrate solution until two fillings of the filter (collected separately) do not greatly diminish the color produced with phenolphthalein by 1 drop of the standard alkali.

Titration of the Phosphomolybdate.—Transfer the precipitate and filter back to the original beaker and dissolve in a small excess of N/5 NaOH (about 2–3 c.c. more than required to completely dissolve the yellow precipitate). Add about 100 c.c. of boiled and cooled water and a few drops of phenolphthalein as an indicator (a red color should be observed indicating excess of NaOH) and titrate the excess of NaOH with N/10 acid.

Calculation.—Divide the number of cubic centimeters of N/10 acid required by 2 and subtract from the number of cubic centimeters of N/5 NaOH used. This gives the number of cubic centimeters of N/5 NaOH required. Multiply by 0.618 (the equivalent of 1 c.c. of N/5 NaOH in P_2O_5) and obtain the number of milligrams of P_2O_5 in 10 c.c. of the urine analyzed. Calculate the daily output of P_2O_5 in this case from the 24-hour volume.

Interpretation.—Nearly all of the phosphorus of the urine exists as alkali and earthy phosphates. Consequently the total phosphorus varies in the same way as the total phosphates (which see). A small portion of the phosphorus of the urine may exist in organic combination though never in a reduced form. This organically bound phosphate may amount to from 1–4 per cent of the total phosphorus excretion. Little is known with regard to the compounds in which it occurs. Possibly some glycerophosphoric acid may occur either free or as lecithin.

Gravimetric Modification.—The phosphorus may be determined somewhat more accurately by substituting a gravimetric procedure for the above titration. In this case the washed phosphomolybdate precipitate is dissolved on the filter paper with ammonium hydroxide and hot water to make a volume of not more than 100 c.c. Nearly neutralize with HCl, cool, and add about 10 c.c. of magnesia mixture (see Appendix) from a burette. Add slowly (about 1 drop per second) stirring vigorously. After 15 minutes add 12 c.c. of ammonium hydroxide solution (sp. gr. 0.90). Let stand for some time (two hours is usually enough) then filter and wash the precipitate with 2.5 per cent ammonia until practically free from chlorides. Ignite to whiteness or to a grayish-white ash and weigh. Multiply the weight of magnesium pyrophosphate thus obtained by 0.637 to get the weight of P_2O_5 .

Calculation.—Calculate as explained above.

¹ It is better to use a special filter tube of about $1\frac{1}{4}$ inches diameter (similar to a Gooch filtering tube) in which is placed a perforated porcelain plate $1\frac{1}{8}$ inches in diameter, covered with a layer of asbestos $\frac{1}{8}$ inch thick. Filtration is carried out with suction and is very rapid. Ordinary Gooch crucibles lined with asbestos may also be used but are not so satisfactory. The asbestos used should be specially prepared (see Appendix). For a good discussion of the details of procedure and sources of error of this volumetric method see Hibbard: *J. Ind. Eng. Chem.*, 5, 998, 1913.

Chlorides

1. Volhard-Arnold Method.—*Principle.*—The urine is acidified with nitric acid and the chlorides precipitated with a measured excess of standard silver nitrate solution. The silver chloride formed is filtered off and in the filtrate the excess silver nitrate is titrated back with standard ammonium thiocyanate solution. Ferric ammonium sulphate is used as an indicator. A red color due to the formation of ferric thiocyanate indicates that an excess of thiocyanate is present and that the end point has been reached.

Procedure.—Place 10 c.c. of urine in a 100 c.c. volumetric flask, add 20–30 drops of nitric acid (sp. gr. 1.2) and 2 c.c. of a cold saturated solution of ferric alum. If necessary, at this point a few drops of 8 per cent solution of potassium permanganate may be added to dissipate the red color. Now slowly run in a known volume of the standard silver nitrate¹ solution (20 c.c. is ordinarily used) in order to precipitate the chlorine and insure the presence of an excess of silver nitrate. The mixture should be continually shaken during the addition of the standard solution. Allow the flask to stand 10 minutes, then fill it to the 100 c.c. graduation with distilled water and thoroughly mix the contents. Now filter the mixture through a dry filter paper, collect 50 c.c. of the filtrate and titrate it with standardized ammonium thiocyanate solution.² The first permanent tinge of red-brown indicates the end point. Take the burette reading and compute the weight of sodium chloride in the 10 c.c. of urine used.

Calculation.—The number of cubic centimeters of ammonium thiocyanate solution used indicates the excess of standard silver nitrate solution in the 50 c.c. of filtrate titrated. Multiply this reading by 2, inasmuch as only one-half of the filtrate was employed, and subtract this product from the number of cubic centimeters of silver nitrate (20 c.c.) originally used, in order to obtain the actual number of cubic centimeters of silver nitrate utilized in the precipitation of the chlorides in the 10 c.c. of urine employed.

To obtain the weight in grams of the sodium chloride in the 10 c.c. of urine used, multiply the number of cubic centimeters of the standard silver nitrate solution, actually utilized in the precipitation, by 0.010. If it is desired to express the result in percentage of sodium chloride move the decimal point one place to the right.

In a similar manner the weight, or percentage of chlorine may be computed using the factor 0.006 instead of 0.010.

¹ Standard silver nitrate solution may be prepared by dissolving 29.042 grams of silver nitrate in 1 liter of distilled water. Each cubic centimeter of this solution is equivalent to 0.010 gram of sodium chloride or to 0.006 gram of chlorine.

² This solution is made of such a strength that 1 c.c. of it is equal to 1 c.c. of the standard silver nitrate solution used. To prepare the solution dissolve 13 grams of ammonium thiocyanate, NH_4SCN , in a little less than a liter of water. In a small flask place 20 c.c. of the standard silver nitrate solution, 5 c.c. of the ferric alum solution and 4 c.c. of nitric acid (sp. gr. 1.2), add water to make the total volume 100 c.c. and thoroughly mix the contents of the flask. Now run in the ammonium thiocyanate solution from a burette until a permanent red-brown tinge is produced. This is the end-reaction and indicates that the last trace of silver nitrate has been precipitated. Take the burette reading and calculate the amount of water necessary to use in diluting the ammonium thiocyanate in order that 10 c.c. of this solution may be exactly equal to 10 c.c. of the silver nitrate solution. Make this dilution and titrate again to be certain that the solution is of the proper strength.

Calculate the quantity of sodium chloride and chlorine in the 24-hour urine specimen.

Interpretation.—From 10–15 grams of chlorine, expressed as sodium chloride, are excreted per day, on the average, by normal adults. The amount is, however, closely dependent upon the chloride content of the food ingested. In fasting, the chloride excretion falls rapidly to a very minimal quantity. On high water ingestion it is increased. In pneumonia and certain other acute infectious diseases the excretion of chlorides may be markedly diminished particularly during the periods in which exudates are forming. In convalescence and with resolution of the exudates the chlorine excretion rises again. A decrease has also been noted in nephritis associated with edema.

2. Volhard-Harvey Method.¹—*Principle.*—This procedure differs from the Volhard-Arnold method in that the excess of silver nitrate is titrated directly without filtering and hence in the presence of the silver chloride. The procedure is thus more rapid but the exact end point is more difficult to determine.

Procedure.—Introduce 5 c.c. of urine into a small porcelain evaporating dish or casserole and dilute with about 20 c.c. of distilled water. Precipitate the chlorides by the addition of 10 c.c. of standard silver nitrate solution² and add 2 c.c. of acidified indicator.³ Now run in a standard ammonium thiocyanate solution⁴ from a burette until a faint red-brown tint is visible throughout the mixture. This point may be determined readily by permitting the precipitate to settle somewhat. Calculate the sodium chloride value as indicated below.

(If a red tint is produced when the first drop of thiocyanate is added an additional 10 c.c. of the standard silver nitrate solution must be introduced. The titration should then proceed as above described and proper allowance made in the calculation for the extra volume of silver nitrate employed.)

Calculation.—Since 2 c.c. of the ammonium thiocyanate solution is equivalent to 1 c.c. of the silver nitrate solution, divide the burette reading by 2 and subtract the quotient from 10 c.c., the quantity of silver nitrate solution taken. This value is the number of cubic centimeters of silver nitrate solution actually

¹ Harvey: *Archives of Internal Medicine*, 6, 12, 1910.

² See p. 576.

³ This is prepared as follows: To 30 c.c. of distilled water add 70 c.c. of 33 per cent nitric acid (sp. gr. 1.2) and dissolve 100 grams of crystalline ferric ammonium sulphate in this dilute acid solution. Filter and use the filtrate which is a saturated solution of the iron salt. This single reagent takes the place of the nitric acid and ferric alum as used in Volhard-Arnold method, and insures the use of the proper quantity of acid.

⁴ This is a solution of ammonium thiocyanate of such a strength that 2 c.c. is equivalent to 1 c.c. of the silver nitrate solution. First make a concentrated solution by dissolving 13 grams in 1 liter of water. To determine the requisite dilution to make such a solution that 2 c.c. shall be equivalent to 1 c.c. of the silver nitrate solution proceed as follows: Introduce 10 c.c. of the silver nitrate solution into a small porcelain evaporating dish or casserole, add 30–50 c.c. of distilled water, 2 c.c. of the acid indicator and titrate as described above with the ammonium thiocyanate solution. The total volume of the concentrated thiocyanate solution excluding that used in this titration is divided by 10, and the result multiplied by the difference between this burette reading and 20 c.c. This will give the volume of distilled water which must be added to the concentrated thiocyanate solution to render 2 c.c. equivalent to 1 c.c. of the silver nitrate solution.

used in the precipitation of the chlorides. As 1 c.c. of the silver nitrate solution is equivalent to 0.01 gram of sodium chloride, the number of cubic centimeters of silver nitrate solution used multiplied by 0.01 gram will give the weight of sodium chloride in the 5 c.c. portion of urine used. The weight of chlorine may be computed by using the factor 0.006 instead of 0.01.

Calculate the weight of sodium chloride and chlorine in the 24-hour urine specimen.

A "short cut" method of calculating the 24-hour output of sodium chloride consists in subtracting the burette reading from 20 c.c., multiplying this value by the total urine volume and pointing off three places.

Interpretation.—See above.

3. Dehn-Clark Method.¹—*Principle.*—In this method any organic matter which may interfere with the titrimetric determination of the chlorides is destroyed by oxidation with sodium peroxide. The chlorides are then determined by the Volhard-Arnold titration procedure.

Procedure.—To 10 c.c. of urine in a 75–100 c.c. casserole, add 1.0–1.2 grams of sodium peroxide and evaporate the mixture to dryness on a boiling water-bath. In case the residue is not pure white, thus indicating that insufficient sodium peroxide has been added, the residue should be moistened with distilled water, additional sodium peroxide added, and the mixture again evaporated to dryness. When the oxidation is complete, treat the mass with 10–20 c.c. of distilled water and stir until it has practically all been brought into solution. Then introduce a bit of litmus paper and add dilute nitric acid (1:1) until the litmus paper turns red and *all effervescence ceases*. Now place the casserole on a hot plate or on a gauze and heat the contents almost to the boiling-point.² To the hot solution add a standard solution of silver nitrate (see page 576) in slight excess.³ Filter off the silver chloride while the solution is still hot and wash the precipitate thoroughly with distilled water. To the filtrate, add 1 c.c. of a saturated solution of ferric ammonium sulphate and then titrate with a standard solution of ammonium thiocyanate (see page 576) until the clear, slightly yellow fluid (or the opalescent, milky fluid, in case there is much excess of silver nitrate) changes to a slight reddish-brown color. The color of the end point varies with the individual. The exact end point reached is not so important as is the securing of the *same* end point in a series of determinations as that obtained in the standardization of the standard solutions used.

Calculation.—The standard solution of silver nitrate should be made up so that 1 c.c. equals 0.010 gram of sodium chloride and 1 c.c. of the ammonium thiocyanate should be equivalent to 1 c.c. of the silver nitrate solution. The calculation is then exactly the same as in the Volhard-Arnold method (page 577) except that the burette reading is not multiplied by 2.

Interpretation.—See page 577.

4. Mohr's Method.—*Principle.*—The organic matter of the urine is destroyed by ignition with potassium nitrate. To the solution of the ash potassium chromate is added and then standard silver nitrate solution run in from a burette. The first

¹ Private communication to the author from Mr. S. C. Clark.

² If there is a slight precipitate, due to silicic acid from the casserole, this is filtered off and the filtrate collected in a 200 c.c. beaker.

³ This point is most easily recognized by keeping the solution hot and in constant agitation while adding the silver nitrate so that the silver chloride formed coagulates and sinks, leaving a clear, supernatant fluid.

excess of silver nitrate over that necessary to precipitate the chlorides reacts with the chromate to form red silver chromate (Ag_2CrO_4). This indicates the end point. The method is accurate when applied to the ash of urine in this manner.

Procedure.—To 10 c.c. of urine in a small platinum or porcelain crucible or dish add about 2 grams of chlorine-free potassium nitrate and evaporate to dryness at 100°C . (The evaporation may be conducted over a low flame provided care is taken to prevent loss by spurling.) By means of crucible tongs hold the crucible or dish over a free flame until all carbonaceous matter has disappeared and the fused mass is slightly yellow in color. Cool the residue somewhat and bring it into solution in a small amount (15–25 c.c.) of distilled water acidified with about 10 drops of nitric acid. Transfer the solution to a small beaker, being sure to rinse out the crucible or dish very carefully. Test the reaction of the fluid, and if not already acid in reaction to litmus, render it slightly acid with nitric acid. Now neutralize the solution by the addition of calcium carbonate¹ in substance, add 2–5 drops of neutral potassium chromate solution to the mixture, and titrate with a standard silver nitrate solution:

This standard solution should be run in from a burette, stirring the liquid in the beaker after each addition. The end-reaction is reached when the yellow color of the solution changes to a slight *orange-red*. At this point take the burette reading and compute the percentage of chlorine and sodium chloride in the urine examined.

Calculation.—The calculation is made exactly as in the Volhard-Arnold method, page 577, except that the reading is not multiplied by two.

Calculate the quantity of sodium chloride and chlorine in the twenty-four-hour urine specimen.

Interpretation.—See page 577.

Calcium and Magnesium

McCrudden's Methods.²—*Principle.*—Urine contains magnesium, phosphates and a small amount of iron, each of which will interfere with the accurate determination of its calcium content if proper conditions of acidity are not maintained during the precipitation. In the following method the proper acidity is attained through the use of sodium acetate and hydrochloric acid, and this with slow addition of the ammonium oxalate reduces the danger of occlusion of magnesium oxalate, calcium phosphate, or ferric phosphate in the calcium oxalate precipitate.

The calcium oxalate precipitate is either ignited and weighed as CaO or determined volumetrically by titration with potassium permanganate. Magnesium is determined in the filtrate from the calcium determination after destruction of the organic matter. It is determined in the usual way by ignition of the magnesium ammonium phosphate precipitate and weighing as the pyrophosphate.

¹ The cessation of effervescence and the presence of some undecomposed calcium carbonate at the bottom of the vessel are the indications of neutralization.

² McCrudden: *Jour. Biol. Chem.*, 7, 83, 1910; 10, 187, 1911.

Lyman has suggested a nephelometric method for the determination of calcium in urine and feces.¹

Procedure for Calcium.—If the urine is alkaline make it neutral or slightly acid and filter. Take 200 c.c. of the filtered urine for analysis. If it is only faintly acid to litmus paper add 10 drops of concentrated hydrochloric acid (sp. gr. 1.20). If the urine is strongly acid it may be made just alkaline with ammonia and then just acid with hydrochloric acid after which the 10 drops of concentrated hydrochloric acid are added. Then add 10 c.c. of 2.5 per cent oxalic acid. Run in slowly with stirring 8 c.c. of 20 per cent sodium acetate. Allow to stand over night at room temperature or shake vigorously for ten minutes. Filter off the precipitate of calcium oxalate on a small paper and wash free from chlorides with 0.5 per cent ammonium oxalate solution. The precipitate may then be dried, ignited to constant weight and weighed as calcium oxide or it may be manipulated volumetrically as described below.

Volumetric Procedure.—If free from uric acid the calcium oxalate precipitate may be washed three times with distilled water, filling the filter about two-thirds full and allowing it to drain completely before adding more. A hole is made in the paper and the calcium oxalate washed into the flask. The volume of the fluid is brought up to about 50 c.c. and 10 c.c. of concentrated sulphuric acid added. Titrate with standard potassium permanganate solution to a pink color which endures for at least a minute.

Calculation.—One c.c. of N/10 permanganate solution is equivalent to 2.8 mg. of CaO. Calculate the daily output of calcium expressed as CaO.

Interpretation.—The average urinary excretion of calcium by normal adults lies between 0.1 to 0.4 gram (expressed as CaO) per day. It is dependent very largely upon the amount of calcium in the diet. From 10 to 40 per cent of the ingested calcium ordinarily is excreted by this channel, the greater part being eliminated by the feces. The proportion is dependent particularly on the amount of calcium in the food. If the calcium ingestion is very high the per cent of the total excretion taking place by way of the kidneys will be low, and *vice versa*. As excretion takes place by way of the intestine as well as by the kidneys no conclusions can be drawn from urinary analyses alone. The excretion of calcium may be greatly increased in certain bone disorders as osteomalacia. In others as in rickets the urinary excretion may be very low.

Procedure of Magnesium.—Transfer the filtrate from the determination of calcium as above to a porcelain dish, add about 20 c.c. of concentrated nitric acid and evaporate to dryness. Heat the residue over a free flame until the ammonium salts are destroyed and the residue fuses. After cooling take the residue up with water and a little hydrochloric acid and filter if necessary. Dilute to about 80 c.c., nearly neutralize with ammonia and cool. Add a slight excess of sodium acid phosphate and then ammonia drop by drop with constant stirring until the solution is alkaline and then add enough more slowly with

¹ Lyman: *Jour. Biol. Chem.*, 21, 551, 1915.

constant stirring to make the solution contain one-fourth its bulk of dilute ammonia (sp. gr. 0.96). Allow to stand over night. Filter and wash free from chlorides with alcoholic ammonia solution (1 part alcohol, 1 part dilute ammonia, 3 parts water). The precipitate with filter paper is incinerated slowly and carefully with good supply of air to prevent reduction, in the usual manner, and ignited and weighed as the pyrophosphate.

Calculation.—To obtain the weight of MgO multiply the weight of magnesium pyrophosphate by 0.3624.

Interpretation.—The daily excretion of magnesium by way of the urine usually amounts to between 0.1 and 0.3 gram (expressed as MgO). The amount depends mainly upon the diet. Usually 50 per cent or more of the excreted magnesium is eliminated by the kidneys, the remainder passing out in the feces. The proportion varies, however, and it is impossible to draw any conclusions from the urinary output alone. There may be a retention of magnesium in certain bone disorders accompanying a loss of calcium; in osteomalacia for example. Thus the excretions of calcium and magnesium do not necessarily run parallel.

Determination of Calcium in Ash of Foods or Feces.—Ignite the material in a crucible to a white ash and dissolve the ash with the aid of a little hydrochloric acid. Bring the volume of the ash solution to 75–150 c.c. Make just alkaline with strong ammonia added drop by drop (using litmus paper or alizarin as an indicator). Add concentrated HCl drop by drop until just acid to litmus. Then add 10 drops of concentrated HCl (sp. gr. 1.20), and 10 c.c. of 2.5 per cent oxalic acid. Either of two procedures may then be followed. (a) The solution is boiled until the precipitated calcium oxalate is coarsely crystalline, and then an excess of 3 per cent ammonium oxalate is slowly added to the boiling solution and the boiling continued until the precipitate is coarsely crystalline. (If but little calcium is present nothing will precipitate at this point and it is not necessary to add oxalate.) Or (b) the flask closed with a rubber stopper is shaken vigorously for ten minutes. An excess of 3 per cent ammonium oxalate is then added. Cool to room temperature. Add 8 c.c. of 20 per cent sodium acetate solution. (In case of ash of feces add 15 c.c.) The solution may either be (a) allowed to stand over night or (b) stoppered and vigorously shaken for ten minutes. The calcium oxalate is filtered off on a small ash-free paper and washed free from chlorides with 0.5 per cent ammonium oxalate solution. Either of two procedures may next be followed. (a) The precipitate and filter are dried, burned in a platinum or porcelain crucible to constant weight as CaO. (b) The precipitate is washed three times with cold distilled water, as given under the method for urine and the oxalate titrated with potassium permanganate.

Magnesium is determined in the filtrate from calcium just as given above.

Sodium and Potassium

Determination of Combined Sodium and Potassium.—From 50 to 100 c.c. of urine, depending upon the specific gravity, are oxidized in a Kjeldahl flask with nitric and sulphuric acids as in the Neumann procedure for total phosphorus (see page 574). To remove the sulphuric acid as completely as possible transfer with

the aid of a little water to a platinum dish and evaporate to dryness over a free flame. (The alkalis are in the form of sulphate and do not volatilize.) Dissolve the residue in hot water with the aid of a little dilute hydrochloric acid. Heat to boiling and add barium chloride solution until no more precipitate forms. While still hot add an excess of ammonia and ammonium carbonate. The barium chloride precipitates the sulphates and part of the phosphates; the ammonia in the presence of excess barium precipitates the rest of the phosphates, and the carbonate precipitates the calcium and most of the magnesium, as well as the excess barium. Filter and wash the precipitate well with hot water containing a few drops of ammonia. Evaporate filtrate and washings to dryness and heat the residue to dull redness for a moment. Redissolve in water and treat again with ammonia and ammonium carbonate to remove any remaining alkaline earth metals. Filter and wash as before. Transfer filtrate and washings to a weighed platinum dish, add a few drops of hydrochloric acid and evaporate to dryness. Heat the residue gently to remove ammonium salts and then to dull redness for a moment. Desiccate and weigh. Reheat to constant weight which represents the combined chlorides of sodium and potassium. The reagents used in the determination must be tested and found free from alkali metals or a correction made for the alkali metals present in the reagents used. The sodium is determined by difference after potassium has been estimated by the method given below.

Potassium.—Dissolve the alkali chlorides from the preceding determination in a little water and add a slight excess of 10 per cent platonic chloride over that necessary to precipitate all of the alkali present calculated as sodium chloride (about 17 c.c. being required for each gram of sodium chloride). Evaporate to a syrupy consistency on the water-bath and add about 50 c.c. of 80 per cent alcohol. Stir occasionally for a few minutes. This operation must be carried out in the absence of ammonia vapors. Filter through a weighed Gooch crucible, washing the precipitate with 80 per cent alcohol first thoroughly by decantation and then on the filter, for some time after the filtrate is colorless. Dry at 110–115°C. and weigh.

Calculation.—Multiply the weight of potassium platonic chloride by 0.1941 to obtain the amount of K_2O present. Express as KCl by using instead of this factor the factor 0.30712. Subtract from the weight of total alkali chlorides as determined in the preceding method, the weight of potassium chloride as calculated and obtain the amount of sodium chloride present.

Interpretation.—The average alkali excretion of an adult on a mixed diet is about 2–3 grams of potassium expressed as K_2O and 4–6 grams of sodium expressed as Na_2O . The ratio of Na to K is thus about 5:3. Both the ratio and the absolute amounts of these elements excreted are, however, largely dependent upon the salt content of the diet. Because of the non-ingestion of sodium chloride and the accompanying destruction of potassium-containing body tissues, the urine during fasting contains more potassium than sodium salts. The excretion of the bases, particularly K , may be increased in fevers and in acidosis.

Iron

Method of Wolter.¹—**Principle.**—The urine is ashed, the ash dissolved, and the iron present oxidized to the ferric form by means of hydrogen peroxide. The iron is then determined iodometrically.

¹ Wolter: *Bioch. Zeit.*, 24, 108, 1910.

Procedure.—The 24-hour specimen of urine is treated with 30 c.c. of concentrated iron-free nitric acid and then evaporated to low volume in a large evaporating dish on the water-bath. Transfer to a small evaporating dish. Heat to dryness on the sand bath and then char, using a small flame. Transfer the charred mass by means of a glass spatula to a crucible. The remaining material in the evaporating dish is transferred with the aid of a little hot water and a rubber "policeman" to a second crucible. Evaporate to dryness on the water-bath and then ash the material in both crucibles. Dissolve the ash in about 30 c.c. of iron-free hydrochloric acid, transfer to an Erlenmeyer flask, add 2 c.c. of hydrogen peroxide and boil for three-quarters of an hour. After cooling, 2 grams of potassium iodide and a few drops of fresh starch paste are added. The liberated iodine is titrated with N/100 thiosulphate solution. Controls should be run on reagents. A correction of 0.32 mg. is usually necessary for the undecomposed hydrogen peroxide. The thiosulphate solution is made up as needed from an N/10 stock solution by dilution. It is standardized against an iron solution containing 2 mg. of iron in 10 c.c. The number of cubic centimeters of thiosulphate used in titration of the iodine set free from the ash solution is multiplied by the iron equivalent of 1 c.c. of the thiosulphate (about 0.2 mg.) to obtain the total amount of iron in the 24-hour specimen of urine. From 1-5 mg. of iron are usually excreted per day.

CHAPTER XXVIII

METABOLISM

Metabolism is a part of that complex series of processes grouped together under the head of *Nutrition*. It embraces a consideration of those changes taking place in the body other than those customarily classified as secretion, digestion, excretion, etc. *Metabolism* may be defined as *all chemical and physical changes which occur in living matter and which constitute the basis of the material phenomena of life*. This conception of metabolism holds for the simple individual cell of the amoeba as well as for the complex mechanism of the human body. There are two types of metabolism, one constructive, the other destructive. The constructive metabolism is termed *anabolism*; the destructive metabolism is termed *catabolism*.

Thus:

$$\textit{Metabolism} \begin{cases} \textit{Anabolism} \text{ (constructive metabolism).} \\ \textit{Catabolism} \text{ (destructive metabolism).} \end{cases}$$

In general we may say that the main bulk of the food-stuffs of the diet, *i.e.*, protein, fat and carbohydrate, is transformed in the gastro-intestinal tract and that the end-products of this transformation are carried to the cells of the body and there built up by *anabolic* (synthetic) *processes* into cell structure or stored as a reserve to be used as required. All living cells undergo wear and tear in the course of their life cycle. By *catabolic* (cleavage) *processes* therefore a portion of the living cell substance or of the stored material is reduced to simpler fragments and these are eliminated from the body after having yielded the bulk of their energy in the form of heat or mechanical work. It is apparent, therefore, that the chemical side of metabolism is closely associated with the physical side. Each of the three types of food-stuffs (protein, fat and carbohydrate) is concerned with the upkeep of the tissues and with the liberation of energy. It is true, however, that the main burden of the upkeep falls upon the proteins whereas the combustion of fats and carbohydrates yields the major portion of the required energy. The above facts are embraced in the following scheme:

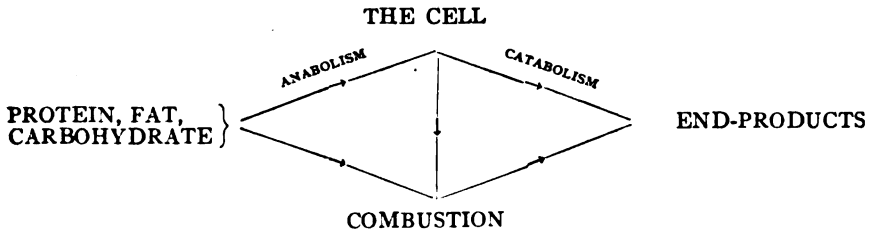

Without doubt both anabolic and catabolic processes are going on incessantly within every individual living cell. At one time the anabolic phase will be more prominent; at another the catabolic activity will be in the ascendency. It should also be borne in mind that *metabolism implies a transformation of energy as well as an exchange of materials.*

For further brief discussions of certain phases of metabolism see the following experiments. A detailed discussion being out of place in this volume, the reader is referred to the following books:

- (1) Taylor's "Digestion and Metabolism," Lea and Febiger, 1912.
- (2) Sherman's "Chemistry of Food and Nutrition," Macmillan.
- (3) Osler & McCrae's "Modern Medicine," Vol. II, Second Edition, 1914, Lea and Febiger. The author's section on "General Consideration of Metabolism," pages 549-673.

METABOLISM EXPERIMENTS

I. Metabolism Procedures Involving the Determination of Body Weight

1. **Influence of Accessory Food Substances (Vitamines).**—As a result of the work of different experimenters,¹ certain "accessory food substances," "growth promoting substances" or vitamines as they are variously termed, have been shown to be of great importance in nutrition. The exact character of these substances has not been established. There are two distinct accessory food substances, one soluble in fats and called "Fat Soluble A," the other soluble in water and called "Water Soluble B." The substances have a rather wide distribution.² The fat soluble vitamine is present in milk fat, egg yolk fat, beef fat, cod liver oil, "oleo oil" margarines, cabbage and alfalfa

¹ Funk: *Jour. of Physiology*, 43, 395, 1911.

Hopkins: *Jour. of Physiology*, 44, 425, 1912.

McCullum and Davis: *Jour. Biol. Chem.*, 15, 167, 1913.

McCullum and Simmonds: *Jour. Biol. Chem.*, 33, 303, 1918.

McCullum, Simmonds and Parsons: *Jour. Biol. Chem.*, 33, 411, 1918.

Osborne and Mendel: *Jour. Biol. Chem.*, 15, 311, 1913; 24, 37, 1916 (other references cited here); 34, 17, 1918.

² Osborne and Mendel: *Jour. Biol. Chem.*, 32, 309, 1917.

leaves, rye, and the seeds of flax, hemp, millet, and sunflower. The water soluble vitamine occurs in milk, rice (unpolished), yeast, peanuts, pancreas, and kidney bean. Certain animal and vegetable products contain both the vitamins. Among these are whole milk, cotton seed, soy bean, the kernel of maize and oat, and the kernel and embryo of wheat.

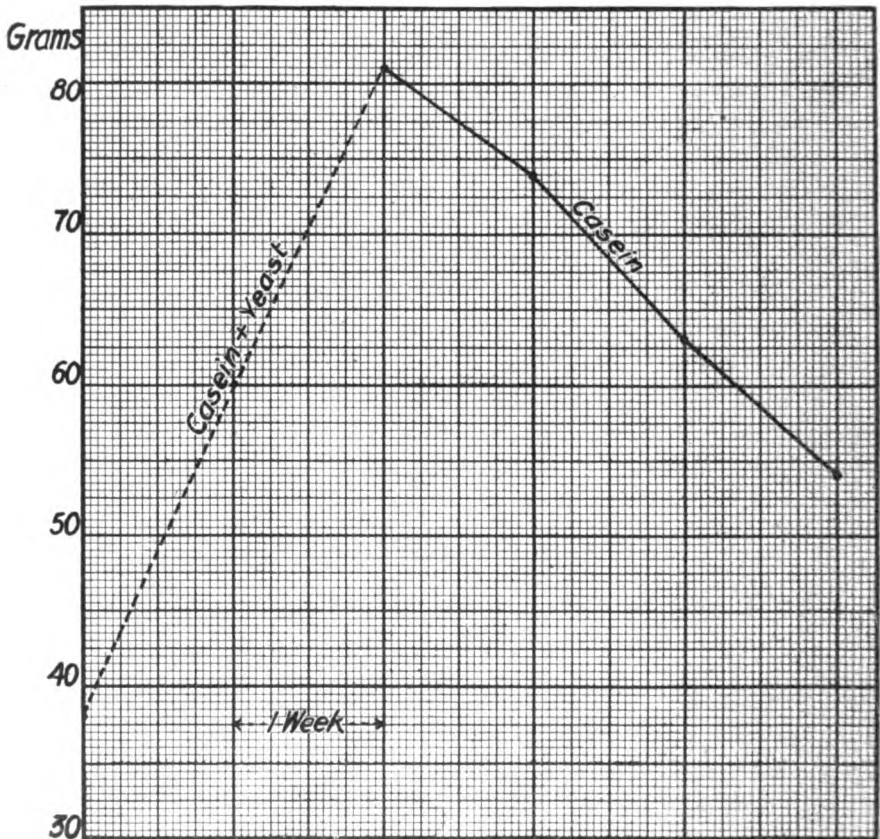

FIG. 179.—GROWTH CURVE OF ALBINO RAT SHOWING IMPORTANCE OF WATER-SOLUBLE "B".

(From unpublished data collected by Fishback, Bergeim and Hawk in the Author's laboratory).

In order that a diet may be adequate for growth it must contain a satisfactory quota of these accessory food substances in addition to protein, proper in kind and amount, suitable inorganic matter and enough fat and carbohydrate to yield the required energy. The influence of the water soluble vitamine upon growth may be shown by the following experiment.

Experiment.—Take two white rats from one to two months old and weighing

30-60 grams each and feed them daily upon a diet adequate from every standpoint. Such a diet may consist of casein (20 per cent), butter fat (15 per cent), starch (56 per cent), salt mixture (4 per cent¹) and yeast (5 per cent²). The yeast furnishes the "Water Soluble B" whereas the "Fat Soluble A" is furnished by the butter fat. On the above diet the rats will about double their

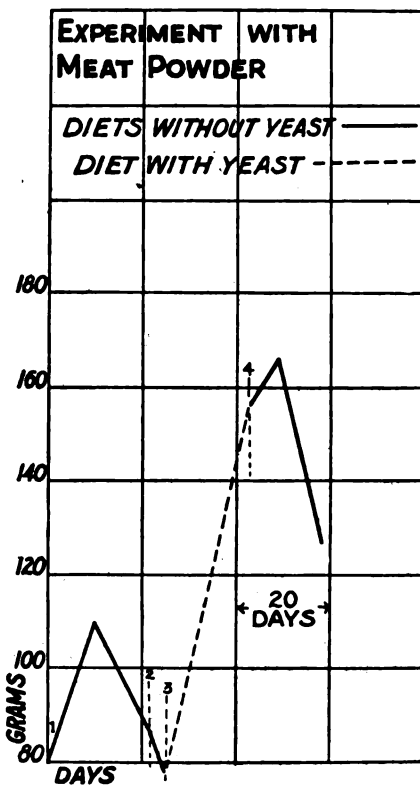

FIG. 180.—GROWTH CURVE OF ALBINO RAT SHOWING IMPORTANCE OF WATER-SOLUBLE "B".

(Osborne and Mendel: *Journal Biological Chemistry*, 32, 309, 1917).

weight in two weeks.³ The animals should be weighed at intervals of one week. At the end of two weeks eliminate the yeast from the diet leaving the diet unchanged in all other respects. The diet now lacks the water soluble vitamins and the animals will not only fail to grow but will show an actual loss of weight. A period of two weeks on this diet will be sufficient to demonstrate this fact.

¹The salt mixture should have the following composition:

CaCO ₃134.8 gm.	K ₂ CO ₃141.3 gm.	H ₂ SO ₄9.2 gm.
MgCO ₃ 24.2 gm.	H ₃ PO ₄103.2 gm.	Citric acid + H ₂ O.....111.1 gm.
Na ₂ CO ₃ 34.2 gm.	HCl..... 53.4 gm.	Fe citrate + 1½H ₂ O 6.34 gm.
KI..... 0.020 gm.	MnSO ₄ 0.079 gm.	NaF..... 0.248 gm.
		K ₂ Al ₂ (SO ₄) ₂ 0.0245 gm.

²Fleischmann's Compressed Yeast dried in an air current at about 100°C.

³For normal growth curves of albino rats see "The Rat," by Henry H. Donaldson, Wistar Institute, Philadelphia, Pa.

The curve shown in Fig. 179, page 586, is the growth curve of a white rat fed as just described.¹

An experiment similar to the above may be made by replacing the casein by "meat powder" prepared from fresh lean beef, ground and dried in a current of air at about 100°C. A typical growth curve from such an experiment² is shown in Fig. 180, page 587.

II. Metabolism Procedures Involving the Manipulation of the Urine

2. Collection and Preservation of the Urine.—In metabolism tests, such as those given in this chapter the accurate collection of the urine for the *exact* 24-hour period is of the *utmost importance*. Proceed as follows: Empty the bladder at a given hour, *e.g.*, 8 a.m. and *discard the urine*. Prepare a *thoroughly clean* bottle of proper size, introduce into it sufficient toluene to cover the bottom of the bottle and use this bottle for the collection of all urine voided from 8 a.m. until 8 a.m. the next day. During the day, when not actually in use for the introduction of a urine fraction, the bottle should be kept in a refrigerator or cold room in order that the sample may not deteriorate before it is examined. Measure the volume of the sample and determine its specific gravity (see Chapter XXII) and reaction before proceeding to the quantitative estimation of any specific urinary constituents.

3. Complete Analysis of Urine.—Ingest an ordinary mixed diet (or any special diet) and collect the urine accurately for a 24-hour period (see above). Measure the volume of the sample, determine the specific gravity and preserve the urine (see above) until the following constituents have been determined (for Methods of Analysis, see Chapter XXVII). Total solids, titratable acidity, hydrogen ion concentration, total nitrogen, amino-acid nitrogen, ammonia, urea, uric acid, creatinine, total sulphur, ethereal sulphates, inorganic sulphates, neutral sulphur (by difference) total phosphates and sodium chloride.

Calculate the nitrogen and sulphur "partitions," *i.e.*, the percentage of the total nitrogen and sulphur which occur in the different forms and tabulate the data from the complete analysis. Compare your results with those listed in the table on pages 399 and 601.

4. Hyperglycemia Produced by Carbohydrate Ingestion.—The average glucose content of normal blood is somewhat less than 0.1 per cent. This is increased (hyperglycemia) on the ingestion of carbohydrate food. The increase is noted more quickly after the ingestion of monosaccharides than after the ingestion of the more complex carbohydrates. After the ingestion of 100 grams of glucose or starch an increase in the sugar of the blood sometimes occurs in five minutes.³ (See Fig. 181.)

¹ Fishback, Bergeim and Hawk: Unpublished data. See also Osborne and Mendel: *Jour. Biol. Chem.*, 31, 149, 1917; 32, 309, 1917; Funk and Macallum: *Jour. Biol. Chem.*, 23, 413, 1915; 27, 51, 1916.

² Osborne and Mendel: *Jour. Biol. Chem.*, 32, 309, 1917.

³ Jacobson: *Bioch. Zeit.*, 56, 471, 1913.

(a) **Influence of Glucose.**—In the morning before breakfast, or three to five hours after breakfast, determine the normal sugar content of your blood by means of some accurate micromethod. (See Chapter XVI.) Ingest 100 grams of glucose dissolved in 250 c.c. of water, and again determine the blood sugar level at intervals of 5, 15 and 30 minutes and one, two and three hours. (Plot a curve similar to the one shown in Fig. 181. The urine may also be examined for sugar at intervals of one hour after the sugar ingestion.

Repeat the experiment on another day using 250 grams of glucose and compare the results with those obtained after the ingestion of 100 grams. Explain your findings. If desired this experiment may be combined with the ones on "Alimentary Glycosuria," and "Carbohydrate in Feces," see pages 591 and 614.

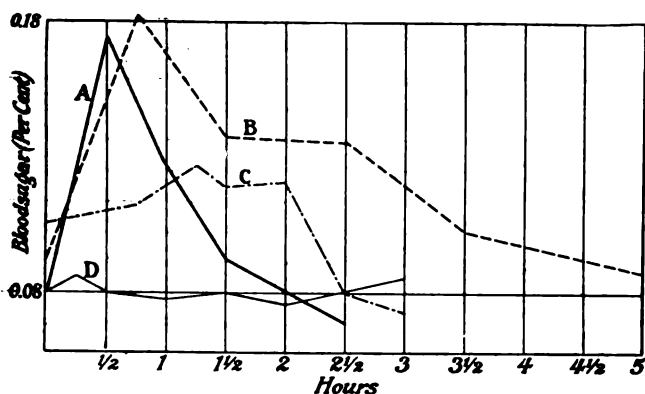

FIG. 181.—BLOOD SUGAR AS INFLUENCED BY DIET.

A = glucose; B = starch;
C = starch and fat; D = fat.

(b) **Influence of Starch.**—Repeat the experiment as given above for glucose except that 170 grams of white bread or 100 grams of starch made into a paste¹ are substituted for the 100 grams of glucose.

The experiment may be repeated as described above using an increased amount of starch.

The various experiments may be conducted on patients suffering from diabetes mellitus if such are available and instructive data collected. The alimentary hyperglycemia will generally be slower in reaching its maximum and will be more prolonged than in the case of normal subjects. In some instances (see Fig. 182, p. 590) after the diabetic has ingested 100 grams of glucose the blood sugar does not reach its maximum until a period of two hours has elapsed.² The blood sugar also returns to its former level more slowly than in the case of normal individuals.

¹ In making starch paste, rub up the dry starch in a mortar with cold water and pour the suspended starch granules into boiling water and stir.

² Martin and Mason: *American Journal of Medical Sciences*, 153, 50, 1917.

5. **Influence of Physical Exercise upon Blood Sugar.**—After strenuous physical exertion by a normally nourished individual there is an increase in the sugar concentration of the blood.¹ Similar increases are not shown by resting individuals similarly nourished nor by fasting individuals after strenuous physical exercise. This point is illustrated in the following protocol:



FIG. 182.—BLOOD SUGAR CURVE OF DIABETIC AFTER GLUCOSE INGESTION.
(Martin and Mason: *American Journal of Medical Sciences*, 153, 50, 1917.)

INFLUENCE OF PHYSICAL EXERCISE ON BLOOD SUGAR (Normal Man)

Day	Experimental conditions	Blood examined, hour	Blood sugar, per cent
1	Normal.	7 A. M.	0.043
	Marched 8 miles in 2 hours; ate 200 grams sucrose.	12 A. M.	0.080
2	Normal.	7 A. M.	0.045
	Complete rest; ate 200 grams sucrose.	12 A. M.	0.055
3	Fasting and complete rest.	7 A. M.	0.047
	Fasting and complete rest.	12 A. M.	0.045
4	Fasting.	7 A. M.	0.047
	Fasting and 2-hour march (8 miles).	12 A. M.	0.052

¹ Moraczewski: *Bioch. Zeit.*, 71, 268, 1915.

The increase in blood sugar under the influence of exercise occurs rather sooner in the diabetic organism. Typical data follow:

Experiment.—Ingest a simple uniform diet. (see Experiment 35, page 615) for five days taking the first meal after 12 o'clock (noon) and the last one before 10 P. M. On the morning of the second day (7 A. M.) determine the sugar in your blood (see methods, Chapter XVI). About three hours later take a brisk walk for 8 miles covering the distance in about two hours and consume 200 grams sucrose during the walk. Make a second analysis of the blood sugar. On the third day analyze your blood for sugar at 7 A. M. and again at noon, remaining quiet in the meantime. The fourth day should be passed without physical exertion whereas on the second day between 10 A. M. and 12 M. a brisk 8-mile walk is taken but no sucrose ingested. Sugar analyses should be made at 7 A. M. and 12 M. each day.

INFLUENCE OF EXERCISE ON BLOOD SUGAR (Diabetes Patient)

Day	Blood examined, hour	Blood sugar, per cent	Experimental conditions
1	8 A. M.	0.062	Rest. Diet consisting of 2500 grams milk, 300 grams bread, 50 grams fat.
2	8 A. M.	0.120	Eight-mile march (2 hours). Diet as above.
	3 P. M.	0.085	
3	8 A. M.	0.055	Rest. Diet as on first day.
	3 P. M.	0.050	Rest. Diet as on first day.
4	8 A. M.	0.050	Rest. Diet as on first day.
	3 P. M.	0.055	Rest. Diet as on first day.
5	8 A. M.	0.084	Eight-mile march (2 hours). Diet as on first day.

Calculate your results, tabulate them and compare them with those given above.

6. Alimentary Glycosuria.—Normal urine contains a trace of glucose but not enough to permit detection by the ordinary tests used in urinary analysis. If more glucose is ingested than can be absorbed and assimilated by the body the excess will be eliminated in the urine. The "assimilation limit" for the glucose has been exceeded, and a transient alimentary glycosuria results. To demonstrate this, glycosuria proceed as follows: Before breakfast or luncheon empty the bladder and test the urine for sugar by any reliable test (see Chapter XXIV). If the test is negative, ingest along with the other articles of diet, 250 grams of glucose, sucrose, or lactose dissolved in water. Empty the bladder at the end of every hour for a period of three hours and test the urine for reducing sugar and the sugar ingested.

Was there any glycosuria and if so how soon after the sugar ingestion did it appear? If no glycosuria resulted repeat the test on a subsequent day using a larger quantity of sugar. If desired, the sugar in the urine may be determined quantitatively by one of the methods given in Chapter XXVII.

This experiment may be made more complete by making determinations of blood sugar at short intervals as described in Experiment 4, page 588. If desired, data on glycosuria, hyperglycemia and carbohydrate in feces (page 614) may be collected from one experiment.

7. **Absorption of Carbohydrate as Influenced by Fat Ingestion.**—When fat is eaten along with carbohydrate food the absorption of the latter is somewhat delayed. This has been shown experimentally.¹ To demonstrate the point proceed as follows: Determine the content of sugar in the blood at various intervals after the ingestion of 170 grams of white bread as described in Experiment 4(b), page 589. Plot a curve for these values similar to the one shown in Fig. 181, page 589. On a later day repeat the experiment and ingest 170 grams of white bread and 85 grams of butter. Plot the curve for these blood sugar concentrations along with blood sugar values obtained after the ingestion of white bread as described above. Has the fat exerted any influence upon the absorption of the carbohydrate? Repeat the above experiment on a case of diabetes mellitus if such is available and note that fat exerts the same influence upon carbohydrate absorption as it exerts in the normal human body.

8. **Time Relations of Protein Metabolism.**—It is a well-known physiological fact that an interval elapses between the ingestion of protein food and the appearance in the urine of certain products representing the complete catabolism of this food. For example, if one ingests an excess of protein material an interval elapses before the urine gives evidence of the complete excretion of certain products representative of the catabolism of the protein. Urea is the chief of these. The term "nitrogen lag" has been used to designate the period elapsing between the ingestion of protein and the excretion in the urine of a quantity of nitrogen equivalent to that contained in the protein.

Experiment.—Ingest a simple uniform diet whose exact composition has been determined by analysis or whose approximate composition has been estimated.

COMPOSITION OF COMMON FOODS²

Food		Water	Protein (N × 6.25)	Fat	Carbo- hydrates	Ash	Calories per pound
		Per cent	Per cent	Per cent	Per cent	Per cent	
Beef	Loin	61.3	19.0	19.1	1.0	1125
	Ribs	57.0	17.8	24.6	0.9	1338
	Round	67.8	20.9	10.6	1.1	812
Mutton	Loin	50.2	16.0	33.1	0.8	1642
	Leg	67.4	19.8	12.4	1.1	865
	Shoulder	67.2	19.5	12.9	1.0	905
Sweetbreads		70.9	16.8	12.1	1.6	800
Liver		65.6	20.2	3.1	2.5	1.3	539
Heart		62.6	16.0	20.4	1.0	1125
Tongue		70.8	18.9	9.2	1.0	719
Brain		80.6	8.8	9.3	1.1	540
Ham		49.2	22.5	21.0	5.8	1266

¹ Jacobson: *Bioch. Zeit.*, 56, 471, 1913.

² Sherman's "Food Products," Macmillan, 1914.

Food		Water	Protein (N×6.25)	Fat	Carbo- hydrates	Ash	Calories per pound
Chicken	Broilers Fowl	Per cent	Per cent	Per cent	Per cent	Per cent	
		74.8	21.5	2.5	1.1	492
		63.7	19.3	16.3	1.0	1016
Fish	Halibut Salmon	75.4	18.6	5.2	1.0	550
		64.6	22.0	12.8	1.4	922
Cereals	Oatmeal (boiled)	84.5	2.8	0.5	11.5	0.7	280
	Rice (boiled)	72.5	2.8	0.1	24.4	0.2	498
	Shredded Wheat	8.1	10.5	1.4	77.9 ¹	2.1	1660
Crackers	Graham	5.4	10.0	9.4	73.8 ¹	1.4	1904
	Oatmeal	6.3	11.8	11.1	69.0 ¹	1.8	1920
	Soda	5.9	9.8	9.1	73.1 ¹	2.1	1875
Bread	White Graham	35.3	9.2	1.3	53.1 ¹	1.1	1182
		35.7	8.9	1.8	52.1 ¹	1.5	1189
Potatoes	Boiled Mashed Chips Sweet	75.5	2.5	0.1	20.9 ¹	1.0	429
		75.1	2.6	3.0	17.8	1.5	493
		2.2	6.8	39.8	46.7	4.5	2598
		51.9	3.0	2.1	42.1	0.9	903
Eggs (hen)	White Yolk Entire edible por- tion	86.2	12.3	0.2	0.6	231
		49.5	15.7	33.3	1.1	1643
		73.7	13.4	10.5	1.0	672
Milk		87.0	3.3	4.0	5.0	0.7	314
Butter		12.7	1.3	84.0	1.9 ²	3450
Peanut butter		2.1	29.3	46.5	17.1	5.0	2741
Soups	Consommé Tomato Pea Celery (cream)	96.0	2.5	0.4	1.1	53
		90.0	1.8	1.1	5.6	1.5	179
		86.9	3.6	0.7	7.6	1.2	232
		88.6	2.1	2.8	5.0	1.5	243
Tapioca pudding		64.5	3.3	3.2	28.2	0.8	702
Doughnuts		18.3	6.7	21.0	53.1 ¹	0.9	1942
Ginger snaps		6.3	6.5	8.6	76.0 ¹	2.6	1848
Peas (cooked)		73.8	6.7	3.4	14.6	1.5	525
Lettuce		94.7	1.2	0.3	2.9 ¹	0.9	87
Apples		84.6	0.4	0.5	14.2 ¹	0.3	285
Oranges		86.9	0.8	0.2	11.6	0.5	233
Bananas		75.3	1.3	0.6	22.0 ¹	0.8	447
Figs		79.1	1.5	18.8	0.6	368
Sandwiches	Egg Chicken	41.4	9.6	12.7	34.5	1.8	1319
		48.5	12.3	5.4	32.1	1.7	1026
Cheese (American)		30.0	28.8	35.9	0.3	5.0 ³	1990

(See table above.) Continue this diet from one to four days. Collect the urine in two-hour periods from 7 A. M. to 11 P. M. and in an eight-hour period between 11 P. M. and 7 A. M. Analyze each specimen for total nitrogen or urea. At the end of this preliminary period add to the uniform diet, at one meal, a weighed quantity (150-250 grams) of lean meat specially prepared and analyzed. Collect the urine in periods as before and determine total nitrogen or urea. Calculate the total nitrogen or urea excretion; tabulate the data and plot curves

¹ Percentage of fiber, included under carbohydrate: shredded wheat (1.7), Graham crackers (1.5), oatmeal crackers (1.9), soda crackers (0.3), white bread (0.5), Graham bread (1.1), boiled potatoes (0.6), doughnuts (0.7), ginger snaps (0.7), lettuce (0.7), apples (1.2), bananas (1.0).

² Including salt.

³ Including salt and sugar.

showing the course of the nitrogen excretion on the various days of the experiment. How long was the "nitrogen lag?"

A less accurate experiment than the above but one which yields interesting data may be carried out as follows:

Ingest a simple diet whose nitrogen content can be estimated with some degree of accuracy (see table above). Collect the urine in two-hour periods from 7 A. M. to 11 P. M. and in an eight-hour period from 11 P. M. to 7 A. M. and analyze for total nitrogen or urea. The next day ingest the same diet plus 150–250 grams of lean meat whose nitrogen content has been determined by analysis or estimated. Collect the urine as upon the previous day and determine its total nitrogen or urea content. Plot curves showing the course of the nitrogen or urea excretion on each of the days. How soon after the ingestion of the large quantity of meat did you note an increase in the nitrogen or urea excretion? How many hours after the meal was the maximum quantity of nitrogen or urea excreted?

9. Influence of Purine-free and High Purine Diets.—The uric acid of the body has a two-fold origin, *i.e.*, it may arise from the metabolism of the purine (nuclein) material of body tissue (glandular organs in particular) or it may arise from the ingestion of purine (nuclein) material. That uric acid which arises from the first source is called *endogenous* while that which arises from the second source is termed *exogenous*. Secretory activity may also act to increase the endogenous uric acid output. The urine will therefore contain uric acid even though no precursor of the acid be ingested. We may also increase the uric acid output markedly by ingesting a high purine diet. However, no matter how much purine material is eaten, only a small part of this purine material reappears in the urine as uric acid. In gout it is claimed there is an accumulation of uric acid in the blood due to the fact that the kidney has lost the ability to maintain the normal blood uric acid level. In this disease the excretion of uric acid may be low before an attack and increase considerably during an attack. The excretion of exogenous uric acid in gout is also much slower than normal.

Experiment.—Ingest a purine-free diet containing about 16 grams of nitrogen and consisting of egg, cheese, milk, starch, fruit, sugar and water for a period of two days (for purine content of foods, see table, page 595). Determine or estimate the nitrogen content (see table, page 592) and during the next two days substitute sweetbreads, thymus or liver for all the nitrogen of the diet maintaining the calorific value of the diet the same as before. Return to the original purine-free diet for a third interval of two days. During the final period of two days feed a diet of sweetbreads or liver containing 50 per cent more nitrogen than that of the first sweetbread period. Collect the urine for each of the eight days of the experiment and determine uric acid, and total nitrogen or urea. Note the rise in the uric acid output during the sweetbread periods. The uric acid output on the purine-free diet is endogenous in origin. Tabulate your results. The following data were secured by Taylor and Rose¹ in a similar but much more carefully controlled test than that just outlined.

¹ Taylor and Rose: *Jour. Biol. Chem.*, 14, 419, 1913.

INFLUENCE OF PURINE-FREE AND HIGH PURINE DIETS

Nitrogen ingestion 10 grams daily
(Daily Output)

Urinary constituents determined (grams)	Purine-free diet	Purine diet (medium)	Purine diet (increased)	Purine-free diet
Uric acid N.....	0.09	0.14	0.24	0.07
Total nitrogen.....	8.9	8.7	9.1	8.8
Urea N (+NH ₂).....	7.3	7.1	7.1	7.05
Creatinine.....	1.57	1.49	1.51	

PURINE CONTENT OF FOODS¹
(Percentage purine base nitrogen)

Food	Analyzed by			Food	Analyzed by		
	Vogel ²	Hall ³	Bessau and Schmid ⁴		Vogel ²	Hall ³	Bessau and Schmid ⁴
Beef.....	0.059	0.052	0.037	Lettuce.....			0.003
Liver.....	0.099	0.110	0.093	Cucumbers.....			None.
Mutton.....			0.026	Rye bread.....	0.014		Trace.
Tongue.....			0.055	White bread...	0.008	None.	None.
Chicken.....			0.029	Milk.....	0.0002	0.0002	None.
Thymus.....	0.398	0.403	0.330	Eggs.....	None.	None.	None.
Cod fish.....	0.040	0.023	0.038	Cheese.....	0.0004		None.
Potatoes.....	0.001	0.0007	0.009	Rice.....	0.0004	None.	None.
Celery.....			0.005	Tapioca.....			None.
Peas.....	0.016	0.016	0.018	Oatmeal.....			None.
Spinach.....	0.022		0.024	Onions.....			None.
Hominy.....	0.004			Tomatoes.....	None.		None.

¹ Other purine-free foods not listed here are *fruits, butter, cream and starch.*

² Vogel: *Munch. med. Woch.*, 58, 2433, 1911.

³ Hall: "The Purine Bodies," Philadelphia, 1904.

⁴ Bessau and Schmid: *Therap. Monatsch.*, March, 1910.

10. A Study of Endogenous Uric Acid Output.—The uric acid in the urine is said to have two sources, *i.e.*, from the purine material of the tissues and from the purine material ingested. The former is *endogenous* uric acid, the latter *exogenous* uric acid.¹ The output of uric acid on the purine-free diet in Experiments 571 and 574 is *endogenous*.

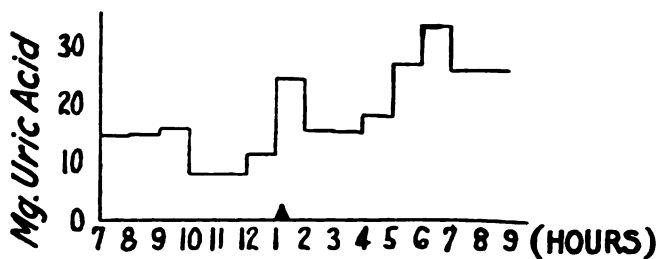

FIG. 183.—INFLUENCE OF PROTEIN INGESTION ON ENDOGENOUS URIC ACID OUTPUT. GLUTEN (130 GRAMS) INGESTED AT 1 P.M. (*Mendel & Stehle: Jour. Biol. Chem.*, 22, 215, 1915.)

Mares² claims that food-stuffs act to increase the endogenous uric acid output by stimulating the digestive glands to activity. A similar finding is reported by Mendel and Stehle.³ The food-stuff having the most pronounced influence was protein. *Pilocarpine* which stimulates the digestive glands was found to increase the endogenous uric acid output whereas *atropine* which inhibits secretory activity was found to decrease the output of endogenous uric acid.

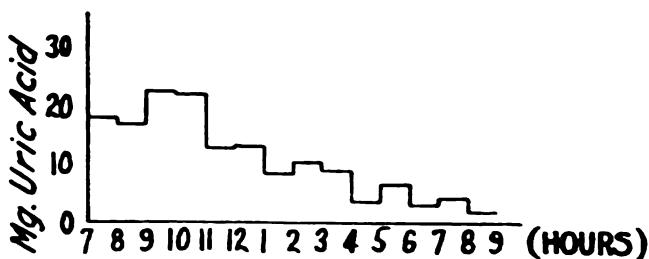

FIG. 184.—THE ENDOGENOUS URIC ACID OUTPUT DURING FASTING. (*Mendel & Stehle: Jour. Biol. Chem.*, 22, 215, 1915.)

The influence of protein upon the endogenous uric acid excretion is shown by the chart in Fig. 183. The fasting output by the same individual is shown, for comparison, in Fig. 184.

Experiment.—Ingest a purine-free diet consisting of milk, egg, fruit, cheese, butter, sugar and bread for one day. Continue the diet for breakfast and luncheon the next day but eat nothing after 12 o'clock noon, until 12 o'clock noon the

¹ Burian and Schur: *Zeit. physiol. Chem.*, 43, 532, 1904-5.

² Mares: *Arch. f. d. ges. Physiol.*, 134, 59, 1910.

³ Mendel and Stehle: *Jour. Biol. Chem.*, 22, 215, 1915.

following day, i.e., the third day of the experiment. At that time ingest 125-150 grams of gluten or some other purine-free protein preparation. On the fourth day of the experiment eat nothing until 9 P. M.

Collect the urine each day in hour periods from 7 A. M. to 9 P. M. and analyze for uric acid (see methods in Chapter XXVII). Chart your data similarly to those shown in Figs. 183 and 184, page 596, and compare them with the findings there recorded.

11. The Rate of Purine Excretion.—The purine material ingested by the average normal person and which is not transformed in the body will be eliminated in about 24 hours. In the case of persons afflicted with gout the purine elimination is delayed. The establishment of this delayed purine elimination is often of diagnostic assistance.

Demonstrate the rate of purine excretion as follows: Ingest a purine-free diet consisting of egg, milk, cheese, starch, sugar, fruit and water for two days and follow this by a day in which sweetbreads, thymus or liver is substituted for one of the meals of the day (see table page 595 for purine content of foods). Finish the experiment by ingesting the original purine-free diet for two days. Collect each day's urine and analyze for uric acid. How soon after the sweetbread ingestion was the original plane of endogenous uric acid elimination reestablished? If one desires to locate this time more definitely the urine may be collected in short periods (one to two hours) and the uric acid content of each specimen determined. Particularly instructive data may be collected by performing the above experiment on a gout patient and upon a normal person for comparison.

12. A Study of Creatinine Elimination.—It has been established that a normal person ingesting a creatinine-free diet will excrete a uniform quantity of creatinine from day to day. The daily excretion of an adult man of average weight ranges from 1-1.5 grams. For data as to creatinine excretion of a 60 kg. man see Taylor and Rose's figures in table on page 595. The creatinine excretion depends primarily on the active mass of protoplasmic tissue, and therefore, it is generally true that a fat man will show a lower creatinine output than a lean man of like body weight. For further discussion of creatinine see Chapter XXIII.

Experiment.—Ingest an ordinary mixed diet (non-meat) for a period of three days varying the character of the diet daily. Collect the urine and analyze for creatinine. (See Chapter XXVII for methods of analysis.)

Did the creatinine elimination change with the change in diet?

13. Influence of Water.—It has been demonstrated that increased water ingestion influences many of the functions and activities of the human body.¹ The increase in protein catabolism which accompanies high-water intake is shown in the following data collected from

¹ Hawk: The relationship of water to certain life processes and more especially to nutrition. Read before *American Philosophical Society*, Philadelphia, Feb., 1914. (See *Bioch. Bull.*, 3, 420, 1914.)

an experiment upon a normal man.¹ In this experiment the water ingestion *at meals* was increased 3 liters per day during the Water Period.

INFLUENCE OF HIGH-WATER INTAKE UPON URINE VOLUME AND NITROGEN PARTITION

Day of experiment	Urine volume	Nitrogen	Urea-nitrogen	Ammonia-nitrogen	Creatinine-nitrogen	Creatine-nitrogen
Preliminary Period						
	c.c.	grams	grams	grams	grams	grams
4	830	12.987	11.338	0.288	0.629
5	920	12.084	11.476	0.305	0.619
6	880	13.183	11.568	0.369	0.651
Water Period						
7	3440	14.161	12.596	0.486	0.610	0.063
8	3840	13.491	11.583	0.499	0.616	0.024
9	3670	12.981	11.212	0.553	0.589	0.102
10	3610	12.976	11.455	0.485	0.608	0.055
11	4020	13.138	11.879	0.456	0.589	0.128

The above data indicate an increased catabolism of protein material as is shown by an increased output of total nitrogen upon the first and second days (days 7 and 8) of the Water Period. Part of this increase may, however, have been due to a "flushing" of the tissues rather than to increased catabolism of protein structures.

Experiments—(a) Relation of Water Intake to Volume and Specific Gravity of the Urine.—Ingest an ordinary mixed diet for two days. Collect the urine in 24-hour periods. During the first day ingest very little fluid of any kind either at meals or between meals. On the second day ingest as much water as you can without physical inconvenience. A person of average size should have no difficulty in drinking 5–6 quarts per day.

Measure the volume of each day's urine and take the specific gravity. Note the pronounced increase in volume and the low specific gravity of the urine under the influence of high-water ingestion.

(b) Influence on Protein Catabolism.—That water stimulates protein catabolism may easily be demonstrated as follows: Ingest a uniform diet (milk, crackers, butter, peanut butter and water) for a period of four days. During the first two days ingest your customary volume of water per day. During the last two days increase the water ingestion to 5–6 liters per day. Collect urine in 24-hour periods and analyze for total nitrogen by Kjeldahl method (see Chapter XXVII and note on page 612). Note the increased excretion of nitrogen under the influence of high-water intake. If time permits other nitrogenous urinary constituents may be determined (see table above).

¹ Fowler and Hawk: *Jour. Expt. Med.*, 12, 388, 1910.

14. **"Salt-free" Diet.**—In order to be properly nourished we must ingest a certain amount of inorganic matter daily. If we fail to do this our metabolic processes become abnormal and the urine is one index of this abnormality.¹

Experiment.—Ingest an ordinary mixed diet containing an ample salt content for a period of two days. Follow this period by the ingestion of a diet which has had its salt content reduced to a very low value.² Sugar and olive oil or non-salted butter may supply the bulk of the calorific part of the diet and dialyzed egg white or casein or commercial protein preparations, e.g., plasmon, gluten or glidine may supply the protein. Ingest such a diet for three days. (This is an "acid-forming" diet, see page 603.) Collect the urine and analyze for sodium chloride, acidity, ammonia and total nitrogen. Compare the data from the normal days with those obtained when the "salt-free" diet was ingested. Test the urine (Chapter XXVII) and blood (Chapter XVI) for acetone. An acidosis follows the ingestion of a salt-free diet for a sufficient length of time.

Did you feel perfectly normal during the interval you were ingesting the "salt-free" diet?

15. **Salt-rich Diet.**—On an ordinary mixed diet a normal adult will daily excrete 10–15 grams of chloride, expressed as sodium chloride, in the urine. On a salt-free diet this excretion decreases, whereas if the diet contains an excessive quantity of sodium chloride this excess will be promptly excreted in the urine. Normal feces contain very little sodium chloride even after excessive sodium chloride ingestion (see Experiment 34).

Experiment.—Ingest an ordinary mixed diet for two days. On each of the following two days take a similar diet plus a weighed amount (e.g., 10 grams) of sodium chloride. Collect the urine for the four days in 24-hour samples, preserve and analyze for sodium chloride (for methods see Chapter XXVII). What proportion of the added chloride was recovered?

If it is desired to make the experiment quantitative in character ingest a uniform diet (see Experiment, page 615) each day instead of the ordinary mixed diet, and examine urine and feces (see Experiment 34) for chloride.

16. **Acidosis.**—Acidosis may be induced in a normal person by the ingestion of a "salt-free" diet such as described in Experiment 13, above, or by the ingestion of a carbohydrate-free diet. The acidosis appears somewhat earlier under the latter conditions. The non-carbohydrate diet is rather better suited for the demonstration of acidosis because of its greater palatability. When carbohydrates are ingested there is an oxidation of fatty acids to carbon dioxide and water. When no carbohydrates are ingested a portion of the fatty acids are converted into *acetone bodies*. These are difficult to oxidize and are excreted as such. The *ketonuria* (excretion of acetone and

¹ Taylor: University of California Publications, Pathology, 1.

² It is practically impossible to secure an absolutely "salt-free" diet.

diacetic acid) is particularly pronounced. The following table shows the data obtained in an actual case of the withdrawal of carbohydrate food from the diet of a normal man (von Noorden).

ACIDOSIS ACCOMPANYING CARBOHYDRATE WITHDRAWAL

Day	Diet	Excretion of acetone bodies calculated as β -hydroxybutyric acid (grams)
1	Protein, fat and <i>carbohydrate</i> .	None.
2	Protein and fat.	0.8
3	Protein and fat.	1.9
4	Protein and fat.	8.7
5	Protein and fat.	20.0
6	Protein, fat and <i>carbohydrate</i> .	2.2

Experiment.—Ingest an ordinary mixed diet for one day. Follow this by a period of two to four days in which no digestible carbohydrate is eaten. (A diet of meat, eggs, butter, agar-agar and water has a very low digestible carbohydrate value.) Collect the urine for each day of the experiment, examine it qualitatively for acetone bodies (see tests in Chapter XXIV). If present, determine the total acetone bodies quantitatively (for methods see Chapter XXVII). The blood may also be examined (see Chapter XVI). Did the withdrawal of carbohydrate food cause an acidosis or ketonuria? How did it compare with the acidosis in the above table?

17. **“Alkaline Tide.”**—For a time after a meal the normal acid reaction of the urine may be changed to neutral or alkaline. This has been explained as due to the withdrawal of hydrogen ions to manufacture the hydrochloric acid of the gastric juice.

Experiment.—Ingest an ordinary mixed diet. Urinate just before dinner and note the reaction of the urine to litmus. If acid, determine the hydrogen ion concentration by the method given in Chapter XXVII. (If alkaline, discard the urine and make the test on another day.) After eating a heavy dinner (meats) collect the urine at intervals of a half-hour and take the reaction to litmus and determine the hydrogen ion concentration as before. Did your urine change in reaction after the meal and if so how long a period elapsed between the meal and the occurrence of the maximum change in reaction?

18. **The “Partition” of Urinary Nitrogen and Sulphur as Influenced by Diet.**—It was first shown by Folin¹ that the percentage of the total nitrogen and total sulphur of the urine which appeared in the form of any particular nitrogenous constituent or in any particular form of

¹ Folin: *Amer. Jour. Physiol.*, 13, 118, 1905.

sulphur was regulated directly by the extent of the total nitrogen and sulphur elimination. This point is well illustrated in the following table which contains data regarding the so-called "partition" or "distribution" of the urinary nitrogen and sulphur.

THE NITROGEN AND SULPHUR "PARTITIONS" AS INFLUENCED BY DIET¹

Constituent of the urine	Normal protein diet			Starch-cream diet		
	Weight, grams	Nitrogen, grams	Per cent of total N or S	Weight, grams	Nitrogen, grams	Per cent of total N or S
Urea.....	31.6	14.7	87.5	4.72	2.2	61.7
Ammonia.....	0.6	0.49	3.0	0.51	0.42	11.3
Creatinine.....	1.55	0.58	3.6	1.61	0.60	17.2
Uric acid.....	0.54	0.18	1.1	0.27	0.09	2.5
Undetermined.....		0.85	4.9		0.27	7.5
Total N.....		16.8	100.0		3.6	100.0
Inorganic SO ₂	3.27		90.0	0.46		60.5
Ethereal SO ₂	0.19		5.2	0.10		13.2
Neutral SO ₂	0.18		4.8	0.20		26.3
Total SO ₂	3.64		100.0	0.76		100.0

It will be observed from an examination of this table that a normal protein diet which gave 16.8 grams of urinary nitrogen yielded 87.5 per cent of this nitrogen as urea, 3 per cent as ammonia, 3.6 per cent as creatinine and 1.1 per cent as uric acid; whereas a "non-protein diet" (starch and cream containing about 1 gram of nitrogen) which gave only 3.6 grams of urinary nitrogen yielded only 61.7 per cent of this nitrogen as urea but gave a greatly *increased percentage output* in the case of each of the other nitrogenous constituents mentioned, e.g., 11.3 per cent as ammonia, 17.2 per cent as creatinine and 2.5 per cent as uric acid. The *percentage output* of neutral sulphur was also *greatly increased*.

It will furthermore be observed that the *actual daily output* of

¹ Folin: *Am. Journ. Physiol.*, 13, 118, 1905.

certain of the constituents is uninfluenced by the amount of protein ingested. Among these are creatinine and neutral sulphur. On the other hand the output of inorganic sulphur and urea is more or less directly proportional to the protein ingestion. The observation of such facts as these led Folin to formulate his theory of protein metabolism.¹

Experiment.—During a period of two or three days ingest an ordinary mixed diet containing 100–125 grams of protein (16–20 grams of nitrogen) per day. Collect the urine accurately in 24-hour periods (page 588) preserve it and analyze the urine of the second and third days for total nitrogen, urea, creatinine, total sulphur, inorganic sulphates, ethereal sulphates and neutral sulphur (by difference). For methods of analysis see Chapter XXVII. Follow this period by one of three days in which a diet of starch and cream having a similar calorific value is ingested. Analyze the urine for the second and third days as indicated above. Calculate your results and tabulate as shown in the table on page 601. How did the change in the diet alter the metabolism of nitrogen and sulphur?

In calculating the calorific value of a diet make use of the following values:

1 gram protein.....	4.1 large calories
1 gram fat.....	9.3 large calories
1 gram carbohydrate.	4.1 large calories.

19. Protein-Sparing Action of Carbohydrate and Fat.—The non-nitrogenous nutrients, carbohydrate and fat, have the power to diminish the extent of the catabolism of protein in the normal human body. In other words they are said to “spare” protein. This point is illustrated in data reported by von Noorden and Dieters, which are tabulated below.

PROTEIN-SPARING ACTION OF CARBOHYDRATE AND FAT

Nitrogen ingested	Nitrogen in urine	
12.6 grams.	10.4 grams.	
12.6 grams + 200 grams sucrose.	9.0 grams.	13 per cent reduction in protein catabolism.

It will be observed that the addition of 200 grams of sucrose to the diet was accompanied by a decrease of 13 per cent in the amount of protein catabolized. It has been established that carbohydrates are more efficient “protein spacers” than are the fats. For example Voit found carbohydrate to produce a 9 per cent decrease in protein catabolism whereas fats produced only a 7 per cent decrease.

Experiment.—Ingest a uniform diet of known or estimated nitrogen content for a period of four days. Collect and preserve the urine accurately (see page 588) in 24-hour samples and analyze the excretion of the *third and fourth days* for total nitrogen. On the fifth day *add 200 grams of sucrose to the diet*. Analyze this urine

¹ The author's article on “General Considerations of Metabolism” in “Modern Medicine” (Osler and McCrae) 2nd Edition, 1914, p. 594. See also Folin: *American Journal Physiol.*, 13, 118, 1905.

also for total nitrogen. Calculate your results and tabulate the data as shown in table on page 601.

Did the sucrose influence the catabolism of protein in your body?

20. Hydrogen Ion Concentration of the Urine as Influenced by the Ingestion of Acid-Forming and Base-Forming Foods.—It has been demonstrated by Sherman and Gettler¹ that vegetables and fruits, on burning, leave an ash in which the basic elements (sodium, potassium, calcium and magnesium) predominate, whereas cereals, meats and fish foods leave an ash in which the acid-forming elements (chlorine, sulphur and phosphorus) predominate. A list of acid-forming and base-forming foods is given in the following table.

EXCESS OF ACID-FORMING OR BASE-FORMING ELEMENTS IN FOODS
(Sherman and Gettler)

Article of Food	Excess acid or base in terms of normal solutions. Per 100 grams	
	Acid (c.c.)	Base (c.c.)
Apples.....		3.76
Asparagus.....		0.81
Bananas.....		5.56
Beans (dried).....		23.87
Beans (lima, dried).....		41.65
Beets.....		10.86
Cabbage.....		4.34
Cantaloup.....		7.47
Carrots.....		10.82
Cauliflower.....		5.33
Celery.....		7.78
Crackers.....	7.81	
Eggs.....	11.10	
Egg-white.....	5.24	
Egg-yolk.....	26.69	
Fish (haddock).....	16.07	
Lemons.....		5.45
Lettuce.....		7.37
Meat (lean beef).....	13.91	
Milk (cow's).....		2.37
Oatmeal.....	12.93	
Oranges.....		5.61
Potatoes.....		7.19
Prunes.....		24.40 ²
Raisins.....		23.68
Rice.....	8.10	
Wheat (entire).....	9.66	

¹ Sherman and Gettler: *Jour. Biol. Chem.*, 11, 323, 1912.

² Prunes, plums and cranberries yield an alkaline ash but serve to increase the hydrogen ion concentration of the urine because of their benzoic acid content, this acid being synthesized with glycocholic acid in the kidney and elsewhere to form hippuric acid.

The above data indicate that potatoes, oranges, raisins, apples, bananas and cantaloups are important base-forming foods. Among the most important acid-forming foods are found rice, whole wheat bread, oatmeal, meats and eggs. Certain fruits, *e.g.*, cranberries,¹ prunes and plums yield a basic ash but are acid-forming foods.

This is due to the fact that they contain benzoic acid which is synthesized with glycocholic acid in the body to produce hippuric acid (see page 609). It is worthy of note that some plant foods are base-formers and others are acid-formers. It is also an important fact that *acid* fruits yield a *basic* ash (see page 603).

The normal diet should contain sufficient base-forming elements to neutralize the acids formed. If these acids are not neutralized by the basic elements in the diet they will be neutralized by the fixed bases of the tissues of the body and a seriously deranged metabolism may result. (See experiment on "salt-free diet," page 599.) Organic salts of the alkalis (*e.g.*, sodium bicarbonate or sodium acetate) are often given therapeutically. They reduce the H ion concentration of the urine: the same result so far as urine reaction is concerned may be secured by feeding properly selected base-forming foods. The ingestion of sodium dihydrogen phosphate (NaH_2PO_4) will increase the acidity of the urine: a like result may be produced by feeding properly selected acid-forming foods. Anything which produces an increase in the H ion concentration of the urine will produce an increase in the ammonia output.

On a mixed diet the H ion concentration of the urine² has been found to average about 6.0.³ In nephritis the H ion concentration of the urine may be increased to 5.3 or higher. Alkalis have been used with apparent success in the treatment of nephritis.⁴ It is evident that base-forming foods properly selected should be suitable dietary articles for nephritics.⁴ For a detailed discussion of acid-forming and base-forming foods see article by Blatherwick.⁵

Experiment.—Ingest a uniform diet consisting of milk, crackers, butter, peanut butter, and water in desired quantities for a period of three days. Follow this by a period of six days during the first three of which considerable quantities of acid-forming foods (see table page 603) are added to the diet. During the second

¹ Radin reports this berry to contain 0.06 per cent benzoic acid (Blatherwick: *Arch. Int. Med.*, 14, 409, 1914).

² Henderson and Palmer: *Jour. Biol. Chem.*, 13, 393, 1913; 14, 81, 1913.

³ H ion concentration may be expressed as gram of ionized H per liter of water. A neutral solution has a H ion concentration of 1×10^{-7} , or 0.000,000,1 gram per liter. It is often customary to express the H ion concentration according to Sørensen's logarithmic notation. For example instead of expressing the H ion concentration of a neutral solution as 1×10^{-7} he expresses it as 7.00. An increasing H ion concentration decreases this value and an increasing OH ion concentration increases the value.

⁴ Fisher: *Nephritis*, New York, 1912.

⁵ Blatherwick: *Arch. Int. Med.*, 14, 409, 1914.

half of the period (days four to six) add an abundance of base-forming foods to the diet. Distilled water should be used for drinking purposes and a uniform volume should be ingested daily. Collect the urine in 24-hour periods, preserve and analyze for H ion concentration, titratable acidity and ammonia (for methods see Chapter XXVII). Compare your results with those tabulated in the table below.

REACTION OF URINE AS INFLUENCED BY DIET¹

Determination.	Basal diets ²		1 Baked potatoes (750 grams per day) + basal diet No. 1 (6 days)	2 Rice (210 grams per day) + basal diet No. 1 (4 days)	3 Cranberry sauce (300-600 grams per day) + basal diet, No. 1 (6 days)	4 Bread ³ (whole wheat) 450 grams for 1 day + basal diet, No. 1	5 Prunes (330-550 grams per day) + basal diet, No. 2 (3 days)	6 Cantaloup ⁴ (260 grams per day) + basal diet, No. 2 (5 days)
	No. 1	No. 2						
	5 days	5 days						
H ion concentration.	7.19	5.57	7.74	7.48-6.90 7.14	6.30-5.70 6.19	6.80 (Previous day 6.90)	5.30-4.80 5.07	5.30-7.38 6.70
Titratable acidity (c.c. N/10)	275	474	196-216 203	166-297 233	391-488 407	350 (Previous day 297)	570-540-578 563	466-250 328
Ammonia N (grams)	0.310	0.464	0.221-0.248 0.238	0.166-0.251 0.198	0.219-0.391 0.305	0.280 (Previous day 0.251)	0.602-0.729 0.654	0.513-0.220 0.310

21. Hydrogen Ion Concentration of the Urine as Influenced by Alkali and Acid Ingestion.—The ingestion of certain organic salts of the alkalis, e.g., sodium citrate and sodium bicarbonate will cause a decrease in the hydrogen ion concentration of the urine. The ingestion of acids

INFLUENCE OF INGESTED SODIUM BICARBONATE ON H ION CONCENTRATION OF URINE

Experiment Number	Sodium Bicarbonate, Grams	Hydrogen Ion Concentration before Bicarbonate Ingestion	Time of Collection of Specimen of Urine and H Ion Concentration				
			11.00 A. M.	12.00 noon	1.00 P. M.	2.00 P. M.	3.00 P. M.
			1	4	7.40	8.30	7.48
2	8	5.40	8.50	8.30	6.50	6.50	7.40
3	12	5.30	8.70	8.70	8.70	8.70	8.70
4	8	7.40	8.50	8.70	8.50	8.50	8.50
5	8	5.85	8.70	8.70	8.30
6	8	6.70	7.48	8.70	8.50	8.70	8.50

¹ Tabulated from data reported by Blatherwick (*Arch. Int. Med.*, 14, 409, 1914). Experiments all made on the same subject (B).

² Basal diet No. 1 contained 100 grams Graham crackers, 25 grams butter, 400 c.c. whole milk ingested at each of the three daily meals. One apple and one soft boiled egg added at supper. In diet No. 2 whole wheat crackers were substituted for the Graham crackers.

³ This day was preceded by NaHCO₃ ingestion for three days and by rice ingestion for four days.

⁴ This diet followed immediately after the diet of prunes (see 5).

(either organic or inorganic) or acid salts, *e.g.*, sodium dihydrogen phosphate will increase the hydrogen ion concentration of the urine. The alkalis are much more effective in producing changes in reaction than are the acids. The influence of ingested alkali (sodium bicarbonate) is shown in the foregoing table containing data submitted by Henderson and Palmer.¹

Blatherwick² reports a decrease in ammonia nitrogen output from 0.256 gram to 0.072 gram, and an accompanying decreased acidity under the influence of bicarbonate ingestion (25 grams in two days).

The influence of ingested acid (benzoic) is shown in the following data reported by Blatherwick.³

INFLUENCE OF BENZOIC ACID INGESTION³

Day	Titrateable acidity (c.c. N/10)	H ion concentration	Ammonia N (grams)
1	392	6.15	0.292
2	410	6.15	0.374
3	443	6.00	0.422
4	434	6.00	0.408
5	468	5.70	0.418

(For further discussion of dietary alterations of urine reaction see preceding experiment.)

Experiments.—(a) **Influence of Alkali.**—Ingest a uniform diet consisting of milk, crackers, butter, peanut butter and distilled water for a period of two days. During the next two days take the same diet and ingest 24 grams of sodium bicarbonate between meals (12 in A. M. and 12 in P. M.). Collect the urine in 24-hour periods and analyze it for titrateable acidity, H ion concentration and ammonia. Compare your results with those shown in table on page 605.

If desired the bicarbonate may be given in one dose of 8-12 grams and the urine collected in hourly specimens for the next five hours and each specimen analyzed. Data from such experiments are shown in table on page 605.

(b) **Influence of Acid.**—Proceed as above except that 1 gram of benzoic acid (in capsule) is ingested before each meal of the experimental period.

The experiment may also be varied by ingesting 10 grams of sodium dihydrogen phosphate early in the day and collecting the urine in hourly fractions or in one 24-hour sample.

¹ Henderson and Palmer: *Jour. Biol. Chem.*, 14, 81, 1913.

² See p. 604.

³ One gram of benzoic acid in a capsule before each meal. Basal diet No. 1 described on page 605 was used.

From your experiments what do you conclude as to the relative efficiency of acid and alkali in altering the reaction of the urine?

22. Influence of a High Calorie Non-Nitrogenous Diet.—If an individual fasts there is a combustion of a certain amount of protein tissue each day of the fast. The destruction of such tissue is rather low on the first day due to the fact that the glycogen stores of the body are being utilized to furnish the necessary energy. If an individual

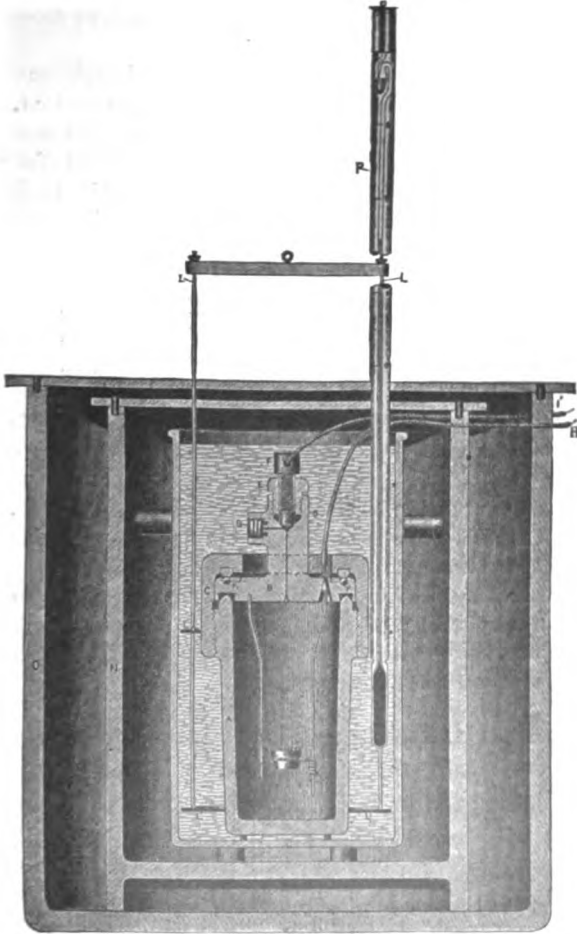

FIG. 185.—BERTHELOT-ATWATER BOMB CALORIMETER.

instead of fasting, ingests a diet of high calorific value and very low in nitrogen the output of nitrogen in the urine of the third or fourth day will be less than on the third or fourth day in fasting. This is due to the fact that the body derives sufficient energy from the high calorie diet and there is less destruction of protein body tissues than occurs in

fasting. For a discussion of energy value of foods see "Determination of Fuel Value of Foods," below, and the table on page 592.

Experiment.—Ingest a high calorie diet which is very low in nitrogen or actually non-nitrogenous. A satisfactory diet may include sugar, butter, starch, cream, agar-agar and water. (For energy values see below and table, page 592.) Ingest such a diet for three days. Collect the urine in 24-hour periods, preserve and analyze it for total nitrogen, acidity and ammonia. Note the low nitrogen excretion on the third day as compared with the nitrogen output of the third day of fasting. If so desired, you may (at some later date) fast for three days and repeat the above analyses for comparison.

Determination of Fuel Value of Food.—When organic substances are oxidized or burned in the human body they liberate a certain amount of heat. This calorific energy or heat value varies according to the type of organic matter undergoing oxidation. Thus the proteins, fats and carbohydrates of the diet when they are burned in the body yield different quantities of heat per unit of substance than do organic acids, alcohol, etc. The energy values of pure protein fat and carbohydrate are the following:

Protein	= 4.1 large calories per gram.
Fat	= 9.3 large calories per gram.
Carbohydrate	= 4.1 large calories per gram.

In arriving at the energy value of any given diet it is customary to burn weighed samples of the various foods in an oxygen atmosphere in an apparatus called a bomb calorimeter (see Fig. 185, page 607). By this means we may determine how much heat is liberated when the ingested food is oxidized in the body. A correction must be made for the incompletely oxidized substances of the urine and feces. A large mass of data concerning the heat value of foods has been collected and tabulated, and it is therefore possible to arrive at an approximate idea of the energy value of a diet by calculation (see table, page 592). The bomb calorimeter shown in Fig. 185, page 607, is one of the most satisfactory for actual determination of the heat of combustion of organic substances.

23. Metabolism in Fasting.—The metabolism of a fasting man is entirely different from the metabolism of a well-nourished person. The collection and analysis of the urine during a short fast (three to seven days) will demonstrate many important facts. The following table, which contains data from fasting tests made in the author's laboratory,¹ illustrates some of the points in which fasting metabolism differs from normal metabolism:

Abstinence from food for a few days can in no way operate to the disadvantage of a normal person. In fact individuals affected with certain types of gastro-intestinal disorders are benefited by fasting.

¹ The chloride, phosphate and acidity determinations were collected during one seven-day fast and the other data collected during a different fast on the same man. (See Howe, Mattill and Hawk: *Jour. Amer. Chem. Soc.*, 33, 568, 1911; and Wilson and Hawk: *Jour. Amer. Chem. Soc.*, 36, 137, 1914.)

METABOLISM IN FASTING

Day of period	Body weight, kg.	Total N grams	Ammonia N grams	Creatine N grams	Acidity. c.c. N/10 NaOH	P ₂ O ₅ grams	Chloride grams, NaCl
Preliminary Feeding Period							
1-4	Av. 74.16	10.430	0.112	None	238.6	2.768	9.007
Fasting Period							
1	73.32	10.072	0.288	0.269	328.9	2.616	5.035
2	71.98	15.072	0.642	0.073	677.1	2.509	3.231
3	70.92	14.463	0.862	0.089	770.4	2.851	2.539
4	70.24	13.080	1.201	0.068	664.2	2.490	1.253
5	69.61	11.801	1.266	0.033	525.0	2.376	1.474
6	69.12	11.214	1.373	0.022	462.4	1.186	1.132
7	68.70	10.734	1.371	0.003	438.9	0.955	1.137

The *fasting treatment*¹ is also being used with success in cases of diabetes mellitus and in the treatment of obesity.²

In order to determine experimentally how the fasting metabolism differs from normal metabolism proceed as follows: Ingest an ordinary mixed diet and collect your urine (see page 588) for a day. Measure the volume and analyze the sample for total nitrogen, ammonia, creatine, sodium chloride, total phosphates and acidity³ (for methods see Chapter XXVII). For the next few days (three to seven as desired) ingest nothing but water and collect the urine accurately and analyze for the constituents enumerated above. Tabulate your results and compare them with those given in the table above.

24. Synthesis of Hippuric Acid in Human Body.—Hippuric Acid is present in human urine in small amount, about 0.7 gram being excreted per day. The urine of herbivorous animals contains much larger quantities. This acid is formed in the animal body, by synthesis from benzoic acid and glycocholic acid which takes place in the kidneys and elsewhere.⁴

Experiment.—Ingest 2 grams of sodium benzoate or ammonium benzoate before retiring at night. Collect the first fraction of urine voided the next morning. The benzoate has been synthesized with glycocholic acid to form hippuric acid. The urine will therefore be found to contain much more of this acid than is normally present. Isolate the hippuric acid by one of the following methods:

(a) *First Method.*—Render the urine alkaline with milk of lime, boil for a few moments and filter while hot. Concentrate the filtrate, over a burner, to a small volume. Cool the solution, acidify it strongly with concentrated hydrochloric acid and stand it in a cool place for 24 hours. Filter off the crystals of hippuric acid

¹ Allen: *Amer. Jour. Med. Sci.*, 150, 480, 1915.

² Folin and Denis: *Jour. Biol. Chem.*, 21, 183, 1915.

³ A more accurate experiment may be carried out by ingesting a uniform diet of known composition (see page 592) for a few days before the fast.

⁴ Kingsbury and Bell: *Jour. Biol. Chem.*, 21, 297, 1915.

which have formed and wash them with a little cold water. Remove the crystals from the paper, dissolve them in a very small amount of hot water and percolate the hot solution through thoroughly washed animal charcoal, being careful to wash out the last portion of the hippuric acid solution with hot water. Filter, concentrate the filtrate to a small volume and stand it aside for crystallization. Examine the crystals under the microscope and compare them with those in Fig. 139, page 417. This method is not as satisfactory as Roaf's method (see below).

(b) *Roaf's Method*.—Place the urine in a casserole or precipitating jar and add an equal volume of a saturated solution of ammonium sulphate and 1.5 c.c. of concentrated sulphuric acid per 100 c.c. of urine. Permit the mixture to stand for twenty-four hours and remove the crystals of hippuric acid by filtration. Purify the crystals by recrystallization according to the directions given above under First Method. Examine the crystals under the microscope and compare them with those given in Fig. 139, page 417.

It is possible, by the above technic, to isolate hippuric acid in crystalline form from as small a volume as 25–50 c.c. of herbivorous urine. The greater the amount of ammonium sulphate added the more rapid the crystallization until at the saturation point the crystals of hippuric acid sometimes form in about *ten minutes*.

III. METABOLISM PROCEDURES INVOLVING THE MANIPULATION OF THE FECES¹

25. "Separation" of Feces.—In order to differentiate the feces which correspond to the food ingested during any given interval it is customary to cause the person under observation to ingest some substance, at the beginning and end of the period in question, which shall sufficiently differ in color and consistency from the surrounding feces as to render such differentiation comparatively easy. Two "markers" very widely used in such tests are *wood charcoal* and *carmine*. In making an actual separation of feces in a metabolism experiment proceed as follows: Just preceding or in the early part of the first meal (usually breakfast) of the metabolism test, ingest a gelatine capsule (No. 00) containing 0.2–0.3 gram of carmine or charcoal. From this time collect all stools in *flat-bottom* porcelain dishes and examine for the presence of the "marker." All fecal matter containing portions of the marker may be considered as representing the diet in question. This fecal matter should be retained and preserved (see page 611). Just before or in the early part of the first meal (usually breakfast) following the end of the metabolism test a second "marker" in a gelatine capsule should be ingested. The feces should be carefully inspected until the marker makes its appearance. Retain all fecal matter uncolored by the marker, reject the remainder. Frequent difficulties are encountered in the practical separation of feces, but the character of such difficulties will be most satisfactorily impressed by the performance of actual separations.

¹ For other practical work on feces see Chapter XIV.

26. Collection and Preservation of Feces and the Mixing and Weighing for Analysis.—The older methods in vogue in metabolism work embraced the analysis of *dried* feces. Various investigators later demonstrated that the drying of feces was accompanied by losses and changes of some of the organic constituents of the feces.¹ Therefore the chemical examination of all stools wherever possible should be made on the *fresh* feces. If a study is being made which extends over several days and it is desired to economize time and effort in the chemical examination the daily fecal output or an aliquot portion of each stool may be collected in a friction-top can or pail of suitable size and preserved by thymol and refrigeration.² This method has been found satisfactory when the feces are to be examined for inorganic constituents or total nitrogen. For the determination of fat, carbohydrate, etc., the *fresh* stool should be employed.

In the preservation of feces for the determination of total nitrogen the following simple procedure may be used: Introduce each stool into a weighed friction-top can or pail and place the vessel in a cold room or refrigerator.³ At the end of the period mix the feces thoroughly and analyze weighed portions. In case individual stools are analyzed, the stool should be collected in a *weighed* flat-bottom porcelain dish.⁴ After mixing the feces *very thoroughly* the weight of dish, spatula and feces is determined and the weight of the feces secured by difference.⁵ A portion of the well-mixed feces is then introduced into a large weighing bottle containing a glass hoe. Desired amounts of feces are then removed for analysis and the exact weight of such amounts obtained by difference.

27. Bacterial Nitrogen in Feces.—About 50 per cent of the total nitrogen of the feces is made up of bacterial cells (see Chapter XIV on Feces). To demonstrate this point proceed as follows:

(a) Ingest an ordinary mixed diet. Collect a representative stool from this diet and after mixing it thoroughly separate the bacterial cells from a weighed portion as described in Chapter XIV. After examining some of the suspension under the microscope and noting the bacterial cells determine the bacterial nitrogen in

¹ Zaitschek: *Pflügers Arch.*, 98, 595, 1903.

Schimidzu: *Bioch. Zeit.*, 28, 237, 1911.

König: *Landw. Vers. Stat.*, 38, 230.

Frear and Holter: *Report, Penn. State College*, p. 123, 1891.

Emmett and Grindley: *Jour. Am. Chem. Soc.*, 31, 570, 1909.

³ Howe, Rutherford and Hawk: *Jour. Amer. Chem. Soc.*, 32, 1683, 1910. This procedure is not satisfactory if fat is to be determined (Smith, Miller and Hawk: *Jour. Biol. Chem.*, 21, 395, 1915). Such feces shows an hydrolysis of fat to fatty acid and a decrease in total fat.

² The author uses a brine tank at -12°C . in which the feces are quickly frozen.

⁴ The spatula for mixing the feces should be weighed with the dish.

⁵ In case it is desired an *aliquot part* of each stool may be placed in a friction-top can or pail and preserved as a "composite sample" for the period.

the entire volume of suspension by the Kjeldahl method¹ (see Chapter XXVII). Also determine the total nitrogen in weighed portions of the original feces by the Kjeldahl method. What percentage of the total nitrogen of the feces is bacterial nitrogen?

(b) If it is desired to determine the actual *amount* of nitrogen which is excreted daily in the feces in the form of bacterial cells, proceed as follows: Ingest an ordinary mixed diet for a period of three days. Separate the feces for this period according to directions given on page 610, using charcoal for the first separation and carmine for the second or *vice versa*. Preserve the feces for the period according to directions given on page 611. Mix the weighed feces thoroughly and analyze for bacterial nitrogen and total nitrogen according to directions given elsewhere (see Chapters XIV and XXVII). Calculate the actual output of bacterial nitrogen per day and the percentage of the total nitrogen of the feces which was excreted per day in the form of bacterial nitrogen.

28. "Metabolic Product" Nitrogen in Feces.—A certain quota of the fecal nitrogen is due to the presence of residues of digestive secretions, epithelial cells, bacteria, etc. The nitrogen in these forms has been called "metabolic nitrogen." To determine this form of nitrogen one method² of procedure is as follows: Ingest a non-nitrogenous diet for a period of two days. The diet may include desired quantities of *starch, cream, sugar, butter, water and sodium chloride*. About 15 grams of *agar-agar* should be added to the diet to prevent constipation and to insure the evacuation of approximately the normal quantity of feces. (For influence of *agar-agar* see Experiment 29.) To separate the feces properly ingest a capsule of carmine at the beginning of the test and one of charcoal at the end (see page 610). Preserve the feces as described on page 611. After mixing the feces thoroughly determine the nitrogen in weighed quantities by the Kjeldahl method³ according to directions given in Chapter XXVII. Calculate the quantity of nitrogen eliminated per day. Inasmuch as no nitrogen was ingested the nitrogen present in the feces is of metabolic origin, *i.e.*, it is made up principally of nitrogen in the form of cells, digestive secretions and bacteria.

29. Influence of Indigestible Non-Nitrogenous Material upon Fecal Output.—This may be demonstrated by *agar-agar* ingestion. This indigestible hemicellulose has the property of absorbing water readily and therefore when ingested it increases the bulk of the feces considerably. This fact is made use of in some forms of constipation and in the determination of metabolic product nitrogen (see Experiment 27).

Experiment.—Ingest a uniform diet for four days. Divide the interval into periods of two days each,⁴ and "separate" the feces by charcoal or carmine (see Experiment 25). On the third and fourth days ingest 10 grams of *agar-agar* at each meal. Collect the feces for each two-day period (see Experiment 25, page 610), and note the increase in the daily excretion under the influence of the *agar* ingestion. What was the increase per gram of *agar*?

¹ More accurate results will be secured if the bacterial nitrogen is determined on each individual stool in the fresh condition.

² For a discussion of other methods of estimating metabolic product nitrogen see Forbes, Mangels, and Morgan: *Jour. Agr. Res.*, 9, 405, 1917.

³ In the oxidation process use 10 grams of potassium sulphate instead of the copper sulphate. The remainder of the procedure is the same as for urine.

⁴ Longer periods are desirable where great accuracy is desired.

30. Protein Utilization.—By “protein utilization” is meant the percentage of the ingested protein which is actually absorbed and assimilated.

This may be determined by the following procedure: Ingest any diet of known nitrogen content for a period of three days¹ (see table, page 592). Collect all feces from the diet making the “separations” as directed on page 610, using carmine as the initial “marker” and charcoal as the final “marker” or vice versa. Preserve the feces as directed on page 611. Mix the total feces thoroughly and determine the nitrogen by the Kjeldahl method (see Chapter XXVII and note on page 612). The approximate nitrogen utilization may be calculated as follows:

$$\frac{(\text{Food nitrogen} - \text{Feces nitrogen}) \times 100}{\text{Food nitrogen}} = \text{Approximate percentage nitrogen utilization.}$$

If it is desired to ascertain the actual percentage of the ingested nitrogen which has been utilized by the body we must make a correction for metabolic nitrogen. In doing this proceed as follows: Ingest a non-nitrogenous diet as described on page 612 for a period of two days, using sufficient agar-agar to insure a daily fecal output which shall approximate in weight that obtained when the regular protein diet was ingested.² Separate and preserve the feces as directed on page 610. Mix thoroughly and analyze for nitrogen according to the Kjeldahl method (see Chapter XXVII and note on page 612). Calculate the actual percentage utilization of the diet as follows:

$$\frac{[\text{Food Nitrogen} - (\text{Fecal nitrogen} - \text{metabolic nitrogen})] \times 100}{\text{Food nitrogen}} = \text{Actual percentage nitrogen utilization.}$$

If urinary nitrogen is determined the above data enable us to prepare a nitrogen balance (see Experiment 35, page 615).

31. Influence of Defective Mastication on Food Residues in Feces.—Rapid eating accompanied by defective mastication leads to the appearance of relatively large macroscopic food residues in the feces. Under some conditions, however, *protein utilization* (see above) may be as satisfactory during food “bolting” as when the food is very thoroughly masticated.³ This problem may be studied by the following method:

(a) Ingest a diet containing meat and be certain to masticate the diet very thoroughly. Collect a stool, examine macroscopically; mix carefully and examine microscopically (see page 233).

(b) Ingest a diet similar to that employed in above experiment (a). “Bolt” the food, *i.e.*, ingest it practically without mastication. Examine the feces as above. Note the difference in the macroscopical and microscopical findings under (a) and (b).

If the nitrogen of food and feces is determined we may calculate the protein utilization (see Experiment 30). By the additional determination of urinary nitrogen, we may prepare a nitrogen balance (see Experiment 35, page 615).

¹ See note 4, p. 612.

² It is frequently difficult to so regulate the agar-agar intake as to secure the proper fecal output. In such an event the proper value for metabolic nitrogen must be obtained by calculation. For example if 89.1 grams of feces were excreted per day on the protein diet, and 166.5 grams per day (with a nitrogen value of 0.5 gram) when agar was employed, the actual value for metabolic product nitrogen may be obtained by the following proportion, assuming that the content of metabolic nitrogen is proportional to the weight of feces excreted: 89.1 : 166.5 :: x : 0.5. $x = 0.268$ gram metabolic nitrogen per day.

³ Foster and Hawk: *Jour. Amer. Chem. Soc.*, 37, 1347, 1915.

32. Fat in Feces.—A normal adult will digest and absorb at least 90 per cent of the fat in the diet when the amount ingested does not exceed 100 grams. If the diet contains an excessive amount of fat, e.g., 300 grams per day, considerable appears in the feces. In pancreatic diseases and such conditions as are accompanied by a decrease in bile flow the digestion and assimilation of fat is lessened.

Experiments.—(a) Ingest an ordinary mixed diet containing an average amount of fat per day, e.g., 75–100 grams. Collect a stool and examine it microscopically as directed in Chapter XIV. (b) Now ingest a diet containing an excessive quantity of fat, e.g., 300 grams per day. Separate the feces and subject a representative sample of the feces from the high fat diet to microscopical examination. (c) If it is desired the fat may be extracted from some of the stool by applying the principle involved in the quantitative determination of fat in the Saxon method (see Chapter XIV). Evaporate the ether extract and identify the fat in the residue by tests given in Chapter IX.

33. Carbohydrate in Feces.—Under normal conditions the great bulk of the soluble carbohydrate in the food is absorbed from the intestine even when the ingestion is high. Hence the content of soluble carbohydrate in feces is low. To demonstrate this proceed as follows:

(a) Ingest for three days an ordinary mixed diet to which 100 grams of glucose or sucrose is daily added. Separate and preserve the feces (see page 610) and when the final "marker" appears extract an aliquot portion of the total mixed feces¹ with water, decolorize with boneblack, filter, and after making the filtrate up to a known volume determine the sugar by Benedict's method (see page 545). Calculate the soluble carbohydrate content of the feces for the three-day interval. (b) Proceed as above with the exception that at least 250 grams of sugar should be added to the diet instead of 100 as in (a).

How did the daily excretion of soluble carbohydrate in (a) compare with that in (b)? Why is this so? If a diet of known carbohydrate content is fed this experiment will give us accurate data as to soluble carbohydrate utilization (see Protein Utilization, page 613). If it is desired this experiment may be combined with the hyperglycemia and glycosuria experiments on pages 588 and 591. See also Experiment 37, page 616.

34. Inorganic Elements in the Feces.—The salts of sodium and potassium being very soluble are almost completely absorbed from the intestine. The same is true of the chlorides including that of sodium which is of greatest importance. Hence the alkali metals and chlorides are excreted mainly in the urine and are found only in very small amounts in the feces even when large amounts are ingested. With calcium, magnesium, iron and phosphate conditions are different. Not only are salts of calcium, magnesium and iron less readily absorbed but they are excreted to a large extent by way of the intestinal mucosa rather than by the kidneys. Ordinarily about 90 per cent of ingested calcium is

¹If time permits it is more satisfactory to analyze each individual stool in *fresh* condition.

eliminated by way of the feces and a little less than half of the magnesium. From 20-30 per cent of the phosphorus ingested is usually found in the feces.

Experiments.—(a) Ingest for a period of three days an ordinary mixed diet without added salt and containing no milk. Separate the feces for the period (see page 610) and retain a portion of the well-mixed feces for analysis.

(b) Proceed as above with the exception that there is added to the mixed diet 10 grams of common salt and a quart of milk (containing about 1.6 grams of CaO, 0.2 gram MgO, 1.4 grams of chloride expressed as sodium chloride, and 2.2 grams P₂O₅). Mix feces well and reserve part for analysis.

Ash 10 gram samples of the feces from the above diets. Dissolve with the aid of a little dilute nitric acid, filter and make up to 100 c.c. Determine in aliquot portions of this solution: (1) Chlorides by Volhard method. (2) Calcium and magnesium by McCrudden's method. (3) Phosphorus by uranium titration. (For details of analytical methods see Chapter XXVII.) Calculate the percentages of the added Ca, Mg, P, and Cl which are recovered from the feces.

For a more detailed study of chloride excretion combine this experiment and Experiment 15 (see Experiment 14).

IV. METABOLISM PROCEDURES INVOLVING THE MANIPULATION OF BOTH URINE AND FECES

35. Preparation of a Metabolic Balance.—This test entails the analysis of the food ingested and of the urine and feces excreted, *i.e.*, a study of the *income* and *outgo*. Proceed as follows:

Select a diet which is simple, *i.e.*, consists of few constituents, and which lends itself readily to accurate chemical analysis. A good type of diet for ordinary metabolism experiments of this sort consists of crackers (graham or soda),

BALANCE OF CALCIUM, MAGNESIUM, PHOSPHORUS, SULPHUR, AND NITROGEN IN ACROMEGALY

	Calcium oxide	Magnesium oxide	Phosphoric anhydride	Sulphur	Nitrogen
	Grams				
Ingestion (daily).....	1.494	0.486	3.192	1.190	18.84
Excretion (urine).....	0.159	0.160	1.701	1.006	17.60
Excretion (feces).....	1.093	0.226	1.002	0.135	1.10
Excretion (total).....	1.252	0.386	2.703	1.141	18.70
Retention (daily).....	0.242	0.100	0.489	0.049	0.14
Retention (per cent).....	16.2	20.6	15.3	4.1	0.7

milk, butter, water and agar-agar (to prevent constipation). Meat specially prepared in quantity sufficient for an entire experiment may also be utilized. Ingest uniform quantities of these dietary constituents each day for a period of three days.¹ Make an accurate collection of the urine passed during this interval (see page 588). Separate the feces representing the three-day period (see page 610), and analyze foods, urine and feces. The balances ordinarily prepared are those for nitrogen, sulphur, phosphorus and calcium. Analytical methods for the determination of these elements may be found in Chapter XXVII.

The foregoing table includes balances obtained in a metabolism test on acromegaly.²

36. Excretion of Urinary and Fecal Chloride after a High Chloride Ingestion.—Combine the procedures outlined under Experiments 15 and 34, pages 599 and 614.

37. A Study of the Elimination of Carbohydrate in Urine and Feces after Excessive Carbohydrate Ingestion.—Combine the procedures outlined in Experiments 6 and 33, pages 591 and 614.

¹ See note 4, p. 612.

² Bergeim, Stewart and Hawk: *Jour. Expt., Med.*, 20, 218, 1914.

REAGENTS AND SOLUTIONS

Alizarin.¹—A 1 per cent solution of alizarin mono-sodium sulphonate in water.

Almen's Reagent.²—Dissolve 5 grams of tannic acid in 240 c.c. of 50 per cent alcohol and add 10 c.c. of 25 per cent acetic acid.

Aluminium Hydroxide Cream.³—To a 1 per cent solution of ammonium alum at room temperature add a slight excess of a 1 per cent solution of ammonium hydroxide. Wash by decantation until the wash water shows only the faintest trace of residue on evaporation.

Ammoniacal Silver Solution.⁴—Dissolve 26 grams of silver nitrate in about 500 c.c. of water, add enough ammonium hydroxide to redissolve the precipitate which forms upon the first addition of the ammonium hydroxide and make the volume of the mixture up to 1 liter with water.

Ammonium Thiocyanate Solution.⁵—This solution is made of such a strength that 1 c.c. of it is equal to 1 c.c. of the standard silver nitrate solution mentioned below. To prepare the solution dissolve 12.9 grams of ammonium thiocyanate, NH_4SCN , in a little less than a liter of water. In a small flask place 20 c.c. of the standard silver nitrate solution, 5 c.c. of a cold saturated solution of ferric alum and 4 c.c. of nitric acid (sp. gr. 1.2), add water to make the total volume 100 c.c., and thoroughly mix the contents of the flask. Now run in the ammonium thiocyanate solution from a burette until a permanent *red-brown* tinge is produced. This is the end-reaction and indicates that the last trace of silver nitrate has been precipitated. Take the burette reading and calculate the amount of water necessary to use in diluting the ammonium thiocyanate in order that 10 c.c. of this solution may be exactly equal to 10 c.c. of the silver nitrate solution. Make the dilution and titrate again to be certain that the solution is of the proper strength.

Arnold-Lipliawsky Reagent.⁶—This reagent consists of two definite solutions which are ordinarily preserved separately and mixed just before using. The two solutions are prepared as follows:

(a) One per cent aqueous solution of potassium nitrate.

¹ Indicator in various procedures, pp. 178 and 510.

² Ott's precipitation test, p. 457. Determination of lactalbumin, p. 358.

³ Removal of protein in various methods, pp. 358, 514.

⁴ Purine base precipitant, p. 130.

⁵ Volhard-Arnold method, p. 576, and Dehn-Clark method, p. 578.

⁶ Arnold-Lipliawsky reaction, p. 468.

(b) One gram of *p*-amino-acetophenon dissolved in 100 c.c. of distilled water and enough hydrochloric acid (about 2 c.c.) added drop by drop, to cause the solution, which is at first yellow, to become entirely colorless. An excess of acid must be avoided.

Asbestos for Suction Filters.¹—The asbestos is shredded, placed in a wide mouth flask and covered with 10 per cent HCl. Heat on water-bath for five hours. Filter on Buchner funnel, wash free from acid, return to the flask, cover with 5 per cent NaOH and heat on water-bath for three hours. Filter, wash free from alkali, then with dilute acid and finally with water until free from acid. Suspend in a large volume of water, allow to settle for five minutes. Pour off the upper two-thirds and discard. Repeat the washing of the desired coarse portion several times until the supernatant liquid remains nearly clear.

Bang's Sugar Reagents.²—(a) *Acid KCl Solution.*—Consisting of 1360 c.c. of saturated KCl to which is added 640 c.c. of water and 1.5 c.c. 25 per cent HCl.

(b) *Stock Copper Solution.*—Introduce into a 1000 c.c. flask 700 c.c. of boiled and cooled water. Warm to about 30°C. and add 160 grams of pure potassium bicarbonate in powder form. When dissolved add 66 grams of pure KCl. Cool and then add 100 grams potassium carbonate. Finally add 100 c.c. of 4.4 per cent solution of pure crystalline copper sulphate. Let stand a short time, then make to mark with boiled water. Allow to stand a day or so before using.

(c) *N/200 I Solution.*—Made fresh each day. Dilute N/10 I solution 20 times. Or make as follows: Introduce into a 100 c.c. flask 2 grams KI, 1–2 c.c. of 2 per cent KIO₃ solution and 5 c.c. of N/10 HCl. Make to mark with boiled and cooled distilled water.

(d) *Starch Solution.*—A 1 per cent solution of Kahlbaum's soluble starch in a saturated KCl solution.

(e) *Dilute Copper Solution.*—Dilute 300 c.c. of the stock solution to 1000 c.c. Mix with only gentle shaking. Let stand several hours before using.

Barfoed's Solution.³—Dissolve 9 grams of neutral, crystallized copper acetate in 100 c.c. of water and add 1.2 c.c. of 50 per cent acetic acid.

Baryta Mixture.⁴—A mixture consisting of 1 volume of a saturated solution of barium nitrate and 2 volumes of a saturated solution of barium hydroxide.

¹ See methods entailing use of Gooch crucibles.

² Determination of sugar, pages 286 and 527.

³ Barfoed's test, p. 30.

⁴ Isolation of urea from urine, p. 403.

Basic Lead Acetate Solution.¹—This solution possesses the following formula:

Lead acetate.....	180 grams.
Lead oxide (Litharge).....	110 grams.
Distilled water to make.....	1000 grams.

Dissolve the lead acetate in about 700 c.c. of distilled water, with boiling. Add this hot solution to the finely powdered lead oxide and boil for one-half hour with occasional stirring. Cool, filter and add sufficient distilled water to the filtrate to make the weight 1 kg.

Benedict's Solutions.²—*First Modification.*—Benedict's modified Fehling solution consists of two definite solutions—a copper sulphate solution and an alkaline tartrate solution, which may be prepared as follows:

Copper sulphate solution = 34.65 grams of copper sulphate dissolved in water and made up to 500 c.c.

Alkaline tartrate solution = 100 grams of anhydrous sodium carbonate and 173 grams of Rochelle salt dissolved in water and made up to 100 c.c.

These solutions should be preserved separately in rubber-stoppered bottles and mixed in equal volumes when needed for use. This is done to prevent deterioration.

Second Modification.—Benedict has further modified his solution and has succeeded in obtaining one which does not deteriorate upon long standing. It has the following composition:

Copper sulphate.....	17.3 grams.
Sodium citrate.....	173.0 grams.
Sodium carbonate..	100.0 grams.
Distilled water to make 1 liter.	

With the aid of heat dissolve the sodium citrate and carbonate in about 600 c.c. of water. Pour (through a folded filter paper if necessary) into a glass graduate and make up to 850 c.c. Dissolve the copper sulphate in about 100 c.c. of water and make up to 150 c.c. Pour the carbonate-citrate solution into a large beaker or casserole and add the copper sulphate solution slowly, with constant stirring. The mixed solution is ready for use and does not deteriorate upon long standing.

Benedict's Sugar Reagent.³

Copper sulphate (crystallized).....	18.0 grams.
Sodium carbonate (crystallized, one-half the weight of the anhydrous salt may be used).....	200.0 grams.
Sodium or potassium citrate.....	200.0 grams.
Potassium thiocyanate.....	125.0 grams.
Potassium ferrocyanide (5 per cent solution).....	5.0 c.c.
Distilled water to make a total volume of.....	1000.0 c.c.

¹ Indican determination, p. 562.

² Benedict's modifications of Fehling's test, pp. 26 and 445.

³ Quantitative determination of sugar, p. 545.

With the aid of heat dissolve the carbonate, citrate and thiocyanate in enough water to make about 800 c.c. of the mixture and filter if necessary.

Dissolve the copper sulphate separately in about 100 c.c. of water and pour the solution slowly into the other liquid, with constant stirring. Add the ferrocyanide solution, cool and dilute to exactly 1 liter. Of the various constituents, the copper salt only need be weighed with exactness. Twenty-five c.c. of the reagent are reduced by 50 mg. of glucose.

Benedict's Sulphur Reagent.

Crystallized copper nitrate, sulphur-free or of known sulphur content.....	200 grams.
Sodium or potassium chlorate.....	50 grams.
Distilled water to.....	1000 c.c.

Benzidine Solutions for Volumetric Sulphur Determinations.

(a) *Rosenheim and Drummond*.—Rub 4 grams of benzidine (Kahlbaum) into a fine paste with about 10 c.c. of water and transfer to a 2-liter flask with the aid of about 500 c.c. of water. Add 500 c.c. of concentrated HCl (sp. gr. 1.19) and make up to 2 liters with distilled water. 150 c.c. of this solution, which keeps indefinitely, are sufficient to precipitate 0.1 gram H_2SO_4 .

(b) *Raiziss and Dubin*.—Put 6.7 grams of benzidine (Merck Reagent) in a 1-liter flask, add 29 c.c. of hydrochloric acid (sp. gr. 1.12) and dilute up to the mark.

Bertrand Sugar Reagents.¹—(a) *Copper Sulphate Solution*.—Forty grams of pure crystallized copper sulphate are dissolved in water to make a liter.

(b) Dissolve 200 grams of Rochelle salts and 150 grams of NaOH in water to make 1000 c.c.

(c) *Acid Ferric Sulphate Solution*.—Dissolve 50 grams of ferric sulphate in about 200 c.c. of water and pour into this a mixture of 200 c.c. of concentrated sulphuric acid diluted with about 400 c.c. of water. Mix and make to 1000 c.c.

(d) *Potassium Permanganate Solution*.—Dissolve 5 grams of potassium permanganate in water to make 1000 c.c. *Standardization*.—Dissolve 0.250 gram of ammonium oxalate in 50–100 c.c. of water, add 1–2 c.c. of concentrated sulphuric acid and titrate with the permanganate to a rose color. Multiply the number of grams of oxalate used by 0.895 to get the equivalent in Cu of the number of cubic centimeters of permanganate used. Calculate the Cu value of 1 c.c.

¹ Determination of sugar, p. 550.

Bial's Reagent.¹

Orcinol.....	1.5 grams.
Fuming HCl.....	500.00 grams.
Ferric chloride (10 per cent).....	20-30 drops.

Biuret Reagent, Gies.²—This reagent consists of 10 per cent KOH solution to which 25 c.c. of 3 per cent CuSO₄ solution per liter has been added. This imparts a slight though distinct blue color to the clear liquid.

Biuret Paper (Kantor and Gies).²—Immerse filter paper in Gies' Biuret Reagent (above) then dry and cut into strips.

Black's Reagent.³—Made by dissolving 5 grams of ferric chloride and 0.4 gram of ferrous chloride in 100 c.c. of water.

Blood Serum.—This may easily be obtained in quantity by the procedure described under Hemagglutination in the chapter on Blood.

Boas' Reagent.⁴—Dissolve 5 grams of resorcinol and 3 grams of sucrose in 100 c.c. of 50 per cent alcohol.

Bonnano's Reagent.—Dissolve 2 grams of sodium nitrite in 100 c.c. of concentrated hydrochloric acid.

Bottu's Reagent.—To 3.5 grams of *o*-nitrophenylpropionic acid add 5 c.c. of a freshly prepared 10 per cent solution of sodium hydroxide and make the volume of the solution 1 liter with distilled water.

Carmine-Fibrin.⁵—Prepared by running fibrin through a meat chopper, washing carefully and placing in 0.5 per cent ammoniacal carmine solution (very little excess ammonia should be present) until the maximum coloration of the fibrin (dark red) is obtained. The fibrin is then washed in water and in water acidified with acetic acid. It is preserved under glycerol.

Chloride Reagents for Blood Analysis.⁶—(a) An acid M/29.25 solution of silver nitrate, 1 c.c. of which is equivalent to 2 mg. of NaCl.

AgNO ₃	5.812 grams.
HNO ₃ (sp. gr. 1.42).....	250 c.c.
Water to.....	1000 c.c.

(b) A solution of M/58.5 potassium iodide, 1 c.c. of which is equivalent to 1 mg. of NaCl.

KI.....	3.0 grams.
Water to.....	1000 c.c.

This solution is standardized against the silver solution by adding 5 c.c. of the latter to 5 c.c. of solution (c) and titrating with the iodide solution

¹ Test for pentose, p. 38.

² Protein tests, p. 100.

³ Black's reaction, p. 469.

⁴ Test for free acid, p. 159.

⁵ Tests on proteases, p. 12.

⁶ Method of McLean and Van Slyke, p. 291.

to the blue end point. The iodide solution is then diluted to such a degree that 10 c.c. are exactly equivalent to 5 c.c. of the silver solution.

(c) A solution used as an indicator, to regulate acidity, and provide an oxidizing agent.

Sodium citrate ($\text{Na}_3\text{C}_6\text{H}_5\text{O}_7 + 5.5\text{H}_2\text{O}$).....	446.0 grams.
Sodium nitrite	20.0 grams.
Soluble starch.....	2.5 grams.
Water to.....	1000.0 c.c.

The starch is first dissolved with the aid of heat in about 500 c.c. of the water. The citrate and nitrite are then added, and the mixture is heated until all is dissolved. The solution while still hot is filtered through cotton, the filter washed with hot water, the filtrate allowed to cool, and made up to 1000 c.c. The solution keeps indefinitely.

Combined Hydrochloric Acid (Protein Salt).—To prepare so-called *combined* hydrochloric acid simply add a soluble protein such as Witte's peptone to *free* hydrochloric acid of the desired strength until it no longer responds to free acid tests (see chapter on Gastric Digestion). For example, if 0.2 per cent combined acid is required the protein would be added to 0.2 per cent *free* hydrochloric acid.

Strictly speaking there is no such thing as "combined" acid in this sense. When the protein is added a *protein salt* of the acid is formed which ionizes differently from the free acid.

Congo Red.¹—Dissolve 0.5 gram of Congo red in 90 c.c. of water and add 10 c.c. of 95 per cent alcohol.

Congo Red-Fibrin.—This may be prepared by placing fibrin in faintly alkaline Congo red solution and heating to 80°C. The fibrin is then washed and preserved under glycerol.

Creatinine, Standard Solution for Colorimetric Method.²—Dissolve 1 gram of pure creatinine in 1000 c.c. of N/10 HCl. The solution contains 1 mg. of creatinine per cubic centimeter.

Cross and Bevan's Reagent.—Combine *two* parts of concentrated hydrochloric acid and *one part* of zinc chloride *by weight*.

Ehrlich's Diazo Reagent.³—Two separate solutions should be prepared and mixed in definite proportions when needed for use.

(a) Five grams of sodium nitrite dissolved in 1 liter of distilled water.

(b) Five grams of sulphanic acid and 50 c.c. of hydrochloric acid in 1 liter of distilled water.

Solutions (a) and (b) should be preserved in well-stoppered vessels and mixed in the proportion 1:50 when required. Green asserts that

¹ Test for free acid, p. 157.

² Determination of creatinine, p. 530.

³ Ehrlich's diazo reaction, p. 483.

greater delicacy is secured by mixing the solutions in the proportion 1:100. The sodium nitrite deteriorates upon standing and becomes unfit for use in the course of a few weeks.

Esbach's Reagent.¹—Dissolve 10 grams of picric acid and 20 grams of citric acid in 1 liter of water.

Fehling's Solution.²—Fehling's solution is composed of two definite solutions—a copper sulphate solution and an alkaline tartrate solution, which may be prepared as follows:

Copper sulphate solution = 34.65 grams of copper sulphate dissolved in water and made up to 500 c.c.

Alkaline tartrate solution = 125 grams of potassium hydroxide and 173 grams of Rochelle salt dissolved in water and made up to 500 c.c.

These solutions should be preserved separately in rubber-stoppered bottles and mixed in equal volumes when needed for use. This is done to prevent deterioration.

Ferric Alum Solution.³—A cold saturated solution.

Folin-Shaffer Reagent.⁴—This reagent consists of 500 grams of ammonium sulphate, 5 grams of uranium acetate, and 60 c.c. of 10 per cent acetic acid in 650 c.c. of distilled water.

Formalin Solution (Neutral).⁵—To 50 c.c. of commercial formaldehyde solution (30–40 per cent) add 1 c.c. of phenolphthalein solution and then standard alkali solution until the mixture assumes a faint red color. The solution should be freshly prepared for each set of determinations.

Furfural Solution.⁶—Add 1 c.c. of furfural to 1000 c.c. of distilled water.

Gallic Acid Solution.⁷—A saturated alcoholic solution.

Guaiac Solution.⁸—Dissolve 0.5 gram of guaiac resin in 30 c.c. of 95 per cent alcohol.

Gulick's Acid Oxidizing Mixture.⁹—To 125 c.c. of ammonia-free water add 40 c.c. of sulphuric acid, 5 c.c. of a saturated solution of mercuric chloride, and 20 grams of potassium sulphate. Then make up to 200 c.c. with ammonia-free water.

Gulick's Modified Winkler Solution.¹⁰—Dissolve 40 grams of sodium

¹ Esbach's method, p. 555.

² Fehling's method, p. 546. Fehling's test, pp. 25 and 444.

³ Volhard-Arnold method, p. 576.

⁴ Folin-Shaffer method, p. 536.

⁵ Formol titration procedure, p. 525.

⁶ Mylius's modification of Pettenkofer's test, pp. 212 and 462; v. Udránsky's test, pp. 212 and 462.

⁷ Gallic acid test, p. 352.

⁸ Guaiac test, pp. 15, 239, 266, and 458.

⁹ Determination of total nitrogen, p. 512.

¹⁰ Determination of total nitrogen, p. 512.

hydroxide in about 200 c.c. of ammonia-free water. Mix 15 grams of mercuric iodide and 10 grams of potassium iodide and dissolve in about 15 c.c. of water. Transfer with the aid of the alkali to a 500 c.c. volumetric flask and make up to 500 c.c. with ammonia-free water. Transfer to an Erlenmeyer flask and let stand 24 hours to settle.

Günzberg's Reagent.¹—Dissolve 2 grams of phloroglucinol and 1 gram of vanillin in 100 c.c. of 95 per cent alcohol.

Haines' Solution.²—This solution may be prepared by dissolving 8.314 grams of copper sulphate in 400 c.c. of water adding 40 c.c. of glycerol and 500 c.c. of 5 per cent potassium hydroxide solution.

Hammarsten's Reagent.³—Mix 1 volume of 25 per cent nitric acid and 19 volumes of 25 per cent hydrochloric acid and add 1 volume of this acid mixture to 4 volumes of 95 per cent alcohol. It is preferable that the acid mixture be prepared in advance and allowed to stand until yellow in color before adding it to the alcohol.

Hayem's Solution.—This solution has the following formula:

Mercuric chloride.....	0.25 gram.
Sodium chloride.....	0.5 gram.
Sodium sulphate.....	2.5 grams.
Distilled water.....	100.0 grams.

Hopkin's-Cole Reagent.⁴—To 1 liter of a saturated solution of oxalic acid add 60 grams of sodium amalgam and allow the mixture to stand until the evolution of gas ceases. Filter and dilute with 2-3 volumes of water.

Hopkin's-Cole Reagent (Benedict's Modification).—Ten grams of powdered magnesium are placed in a large Erlenmeyer flask and shaken up with enough distilled water to liberally cover the magnesium. Two hundred and fifty c.c. of a cold, saturated solution of oxalic acid is now added slowly. The reaction proceeds very rapidly and with the liberation of much heat, so that the flask should be cooled under running water during the addition of the acid. The contents of the flask are shaken after the addition of the last portion of the acid and then poured upon a filter, to remove the insoluble magnesium oxalate. A little wash water is poured through the filter, the filtrate acidified with acetic acid to prevent the partial precipitation of the magnesium on long standing, and made up to a liter with distilled water. This solution contains only the magnesium salt of glyoxylic acid.

Hypobromite Solution.⁵—The ingredients of this solution should

¹ Test for free acid, p. 154.

² Haines' test, p. 447.

³ Hammarsten's reaction, pp. 211 and 461.

⁴ Hopkins-Cole reaction, p. 99.

⁵ Used for determination of urea.

be prepared in the form of *two* separate solutions which may be united as needed.

(a) Dissolve 125 grams of sodium bromide in water, add 125 grams of bromine and make the total volume of the solution 1 liter.

(b) A solution of sodium hydroxide having a specific gravity of 1.25. This is approximately a 22.5 per cent solution.

Preserve both solutions in rubber-stoppered bottles and when needed for use mix 1 volume of solution (a), 1 volume of solution (b), and 3 volumes of water.

Iodine Solutions (N/10).¹—Weigh out 12.685 grams of pure resublimed iodine into a small weighing bottle using a porcelain spatula. Dissolve 18 grams of pure KI in about 150 c.c. of water. Transfer the iodine to a liter flask washing out the last traces with some of the KI solution, which is then poured into the flask. Stopper and shake occasionally until dissolved. If necessary a few more crystals of KI may be added to aid solution. Dilute to the mark and mix well. Keep in glass-stoppered bottle in cool dark place. Standardize at once against N/10 sodium thiosulphate solution. Measure out accurately 25 c.c. of the iodine solution into an Erlenmeyer flask, run in sodium thiosulphate until the color is pale yellow, then add a few cubic centimeters of a 1 per cent solution of starch (preferably soluble starch) and titrate to disappearance of blue color. Care should be taken near the end point.

Iodine Solution.²—Prepare a 2 per cent solution of potassium iodide and add sufficient iodine to color it a deep yellow.

Iodine-Zinc Chloride Reagent.³—Dissolve 20 grams of zinc chloride in 8.5 c.c. of water. Cool, and introduce iodine solution (3 grams KI + 1.5 gram I in 60 c.c. of water) drop by drop until iodine begins to precipitate.

Kraut's Reagent.⁴—Dissolve 272 grams of potassium iodide in water and add 80 grams of bismuth subnitrate dissolved in 200 grams of nitric acid (sp. gr. 1.18). Permit the potassium nitrate to crystallize out, then filter it off and make the filtrate up to 1 liter with water.

Lead Acetate, Basic. (See Basic Lead Acetate.)

Lugol's Solution.⁵—Dissolve 4 grams of iodine and 6 grams of potassium iodide in 100 c.c. of distilled water.

Magnesia Mixture.⁶—Dissolve 175 grams of magnesium sulphate and 350 grams of ammonium chloride in 1400 c.c. of distilled water.

¹ Determination of acetone, p. 561.

² Iodine test, p. 45.

³ Amyloid formation, p. 49.

⁴ Rosenheim's bismuth test for choline, p. 386.

⁵ Gunning's iodoform test, p. 464.

⁶ Method for determination of total phosphorus, p. 575.

Add 700 grams of concentrated ammonium hydroxide, mix thoroughly, and preserve the mixture in a glass-stoppered bottle.

Magnesium Nitrate Solution for Ignition.¹—Dissolve 320 grams of calcined magnesia in nitric acid, avoiding an excess of the latter; then add a little calcined magnesia in excess; boil; filter from the excess of magnesia, ferric oxide, etc., and dilute with water to 2 liters.

Methyl Red.²—Saturated solution in 50 per cent alcohol.

Millon's Reagent.³—Digest 1 part (by weight) of mercury with 2 parts (by weight) of nitric acid (sp. gr. 1.42) and dilute the resulting solution with 2 volumes of water.

Molisch's Reagent.⁴—A 15 per cent alcoholic solution of α -naphthol.

Molybdate Solution.⁵—Dissolve 100 grams of molybdic acid in 144 c.c. of ammonium hydroxide (sp. gr. 0.90) and 271 c.c. of water; slowly and with constant stirring pour the solution thus obtained into 489 c.c. of nitric acid (sp. gr. 1.42) and 1148 c.c. of water. Keep the mixture in a warm place for several days, or until a portion heated to 40°C. deposits no yellow precipitate of ammonium phosphomolybdate. Decant the solution from any sediment and preserve in glass-stoppered bottles.

Mörner's Reagent.⁶—Thoroughly mix 1 volume of formalin, 45 volumes of distilled water, and 55 volumes of concentrated sulphuric acid.

Nakayama's Reagent.⁷—Prepared by combining 99 c.c. of alcohol and 1 c.c. of fuming hydrochloric acid containing 4 grams of ferric chloride per liter.

α -Naphthol Solution.⁸—Dissolve 1 gram of α -naphthol in 100 c.c. of 95 per cent alcohol.

Nessler-Winkler Solution.

Mercuric iodide.....	10 grams.
Potassium iodide.....	5 grams.
Sodium hydroxide.....	20 grams.
Water.....	100 c.c.

The mercuric iodide is rubbed up in a small porcelaine mortar with water, then washed into a flask and the potassium iodide added. The sodium hydroxide is dissolved in the remaining water and the cooled solution added to the above mixture. The solution cleared by standing is preserved in a dark bottle.

¹ Determination of phosphorus, p. 574.

² Determination of H ion concentration, pp. 159 and 510.

³ Millon's reaction, p. 98.

⁴ Molisch's reaction, p. 21.

⁵ Detection and determination of phosphorus, pp. 129 and 574

⁶ Mörner's test, p. 86.

⁷ Nakayama's reaction, pp. 211 and 461.

⁸ Oxidases p. 15. For other α -naphthol solution see *Molisch reaction*.

Neutral Olive Oil.¹—Shake ordinary olive oil with a 10 per cent solution of sodium carbonate, extract the mixture with ether, and remove the ether by evaporation. The residue is *neutral* olive oil.

Neutral Red.¹—A 1 per cent solution in 50 per cent alcohol.

p-Nitrophenol.²—A 1 per cent solution in 50 per cent alcohol.

Nylander's Reagent.³—Digest 2 grams of bismuth subnitrate and 4 grams of Rochelle salt in 100 c.c. of a 10 per cent solution of potassium hydroxide. The reagent should then be cooled and filtered.

Obermayer's Reagent.⁴—Add 2–4 grams of ferric chloride to a liter of hydrochloric acid (sp. gr. 1.19).

Oxalated Plasma.⁵—Allow arterial blood to run into an equal volume of 0.2 per cent ammonium oxalate solution.

Para-dimethylaminobenzaldehyde Solution.⁶—This solution is made by dissolving 5 grams of para-dimethylaminobenzaldehyde in 100 c.c. of 10 per cent sulphuric acid.

Para-phenylenediamine Hydrochloride Solution.⁷—Two grams dissolved in 100 c.c. of water.

Peters' Sugar Reagents.⁸—(a) *Copper Solution.*—Dissolve 34.639 grams of highest purity crystallized copper sulphate (such as Kahlbaum's "zur analyse mit garantieschein") in water to make 500 c.c.

(b) *Alkaline Tartrate Solution.*—Dissolve 173 grams of sodium potassium tartrate and 125 grams of potassium hydroxide in water to make 500 c.c.

(c) *N/5 Sodium Thiosulphate.*—Dissolve about 50 grams of ordinary c.p. sodium thiosulphate or exactly 49.66 grams of the pure, dry, recrystallized salt, in enough boiled out distilled water to make a liter. Allow to stand for several days. The solution should be standardized against the copper solution prepared as above. For this purpose introduce 20 c.c. of the copper solution into a 200 c.c. Erlenmeyer flask, add 20 c.c. of strong acetic acid (30 per cent) and 40 c.c. of water. Add about 7 grams of a saturated solution of KI and titrate with the thiosulphate using starch as an indicator. Calculate the equivalent of 1 c.c. of thiosulphate in Cu. One c.c. of the copper sulphates solution contains 17.647[mg. of Cu. The thiosulphate remains constant for some months. It should be kept in a dark bottle.

¹ Emulsification of fats, p. 184.

² Determination of H ion concentration, pp. 159 and 509.

³ Nylander's test, pp. 29 and 448.

⁴ Obermayer's test, p. 416.

⁵ Experiments on blood plasma, p. 272.

⁶ Herter's para-dimethylaminobenzaldehyde reaction, p. 223.

⁷ Detection of hydrogen peroxide, p. 353.

⁸ Determination of sugar, p. 548.

Phenolphthalein.¹—Dissolve 1 gram of phenolphthalein in 100 c.c. of 95 per cent alcohol.

Potassium Permanganate Solution (Alkaline) for Van Slyke Method.²—The alkaline potassium permanganate solution contains 50 grams of potassium permanganate and 25 grams of potassium hydroxide per liter.

Potassium Permanganate Standard (N/10) Solution.—Dissolve 3.162 grams of pure potassium permanganate in a liter of distilled water, allow to stand a few days, and filter through glass wool. Standardize against N/10 oxalic acid solution or against pure dry sodium or potassium oxalate. One c.c. of N/10 permanganate is equivalent to 7.0 mg. of sodium oxalate.

Phenylhydrazine Mixture.³—This mixture is prepared by combining 2 parts of phenylhydrazine-hydrochloride and 3 parts of sodium acetate *by weight*. These are thoroughly mixed in a mortar.

Phenylhydrazine-Acetate Solution.⁴—This solution is prepared by mixing 1 volume of glacial acetic acid, 1 volume of water, and 2 volumes of phenylhydrazine (the base.)

Picramic Acid.—*Permanent Standard for Lewis-Benedict Blood Sugar Method.*⁵—A solution of picramic acid makes a very satisfactory permanent standard. The color is identical in quality with that formed in the method and its solution keeps perfectly. The formula of the permanent standard is:

Picramic acid	0.064 gram.
Sodium carbonate (anhydrous)	0.100 gram.
Water to make.....	1000.0 c.c.

Dissolve the picramic acid with the aid of heat in 25–50 c.c. of distilled water which has been made alkaline with sodium carbonate. Cool and dilute to 1 liter. This solution has the same intensity of color as that obtained by the proposed method with 0.64 mg. of sugar when the final volume of the reaction fluid is made 10 c.c. The solution should be standardized against pure glucose. A satisfactory preparation of picramic acid may be obtained from the J. T. Baker Chemical Co., Phillipsburg, N. J.

Roberts' Reagent.⁶—Mix 1 volume of concentrated nitric acid and 5 volumes of a saturated solution of magnesium sulphate.

Rosenheim's Iodo-Potassium Iodide Solution.⁷—Dissolve 2 grams of iodine and 6 grams of potassium iodide in 100 c.c. of water.

¹ Töpfer's method, p. 178.

² Determination of amino-acid nitrogen, p. 88.

³ Phenylhydrazine reaction, pp. 22 and 441.

⁴ Phenylhydrazine reaction, pp. 22 and 441.

⁵ Determination of sugar in blood, p. 283.

⁶ Roberts' ring test, pp. 104 and 452.

⁷ Rosenheim's periodide test, p. 385.

Sahli's Reagent.¹—This reagent consists of a mixture of equal parts of a 48 per cent solution of potassium iodide and an 8 per cent solution of potassium iodate.

Salted Plasma.²—Allow arterial blood to run into an equal volume of a saturated solution of sodium sulphate or a 10 per cent solution of sodium chloride. Keep the mixture in the cold room for about 24 hours.

Schweitzer's Reagent.³—Add potassium hydroxide to a 5 per cent solution of copper sulphate which contains 5 per cent ammonium chloride. Filter off the precipitate of cupric hydroxide, wash it, and bring 3 grams of the moist cupric hydroxide into solution in a liter of 20 per cent ammonium hydroxide.

Scott-Wilson Acetone Reagents.⁴—(a) *Mercury Reagent.*—This reagent is made up as follows: Mercuric cyanide 10 grams, sodium hydroxide 180 grams, water 1200 c.c. The solution is agitated in a flask and 400 c.c. of a 0.7268 per cent solution of silver nitrate slowly run in. Let stand three days and decant supernatant liquid. The silver nitrate solution is made by taking 1 part of standard silver nitrate solution (1 c.c. = 10 mg. NaCl) and 3 parts of water.

(b) *Standard Potassium Thiocyanate Solution.*—Make up an approximately 0.1 per cent solution of potassium thiocyanate and standardize it against mercuric nitrate or silver nitrate. It is convenient to have the solution of such strength that 1 c.c. = 1 mg. of Hg.

(c) *Acid Mixture.*—Nitric acid 40 parts, sulphuric acid 5 parts, and water 55 parts.

(d) *Permanganate N/5 Solution.*—Dissolve 6.324 grams of potassium permanganate in water and make up to a liter.

Seliwanoff's Reagent.⁵—Dissolve 0.05 gram of resorcinol in 100 c.c. of dilute (1:2) hydrochloric acid.

Sherrington's Solution.⁶—This solution possesses the following formula:

Methylene-blue.....	0.1 gram.
Sodium chloride.....	1.2 grams.
Neutral potassium oxalate.....	1.2 grams.
Distilled water.....	300.0 grams.

Silver Nitrate Solution.⁷—Dissolve 29.042 grams of silver nitrate in 1 liter of distilled water. Each cubic centimeter of this solution is

¹ Determination of free acid, p. 168.

² Experiments on blood plasma, p. 272.

³ Schweitzer's solubility test, p. 49.

⁴ Determination of acetone and acetoacetic acid.

⁵ Seliwanoff's reaction, pp. 35 and 476.

⁶ "Blood-counting," p. 309.

⁷ Volhard-Arnold method, p. 576, Mohr's method, p. 578, and Dehn-Clark method, p. 578.

equivalent to 0.01 gram of sodium chloride or to 0.006 gram of chlorine.

Sodium Acetate Solution.¹—Dissolve 100 grams of sodium acetate in 800 c.c. of distilled water, add 100 c.c. of 30 per cent acetic acid to the solution, and make the volume of the mixture up to 1 liter with distilled water.

Sodium Alcoholate (N/10) Solution.²—The sodium alcoholate is made by dissolving 2.3 grams of cleaned metallic sodium in 1 liter of absolute alcohol. It is advisable that it be slightly weaker than stronger than tenth-normal. It may be standardized against pure benzoic acid in washed chloroform. It may also be standardized against N/10 HCl provided the alcoholate solution contains not more than traces of carbonate.

Sodium Alizarin Sulphonate.³—Dissolve 1 gram of sodium alizarin sulphonate in 100 c.c. of water.

Sodium Sulphide Solution.⁴—Saturate a 1 per cent solution of sodium hydroxide with hydrogen sulphide gas and add an equal volume of 1 per cent sodium hydroxide.

Sodium Thiosulphate Standard (N/10) Solution.⁵—Weigh out 25 grams of ordinary c.p. sodium thiosulphate or 24.83 grams of the pure dry recrystallized salt. Dissolve in water and dilute to a liter. Boiled distilled water must be used. Keep in a bottle with a siphon arrangement and carrying a soda lime tube to exclude CO₂.

It is best standardized against acid potassium iodate KH(IO₃)₂. Weigh out accurately 0.3249 gram of acid potassium iodate. Dissolve in 50 c.c. of water, heating gently if necessary. Transfer the solution to a 100 c.c. flask, rinsing the beaker carefully and make to mark with water. This solution is exactly decinormal. Pipette out 25 c.c. into an Erlenmeyer flask, add 1 gram of potassium iodide dissolved in a little water, and a few cubic centimeters of dilute hydrochloric acid. Titrate immediately with the thiosulphate solution. When the solution becomes pale yellow add a few cubic centimeters of 1 per cent solution of soluble starch and titrate to loss of blue color.

Solera's Test Paper.⁶—Saturate a good quality of filter paper with 0.5 per cent starch paste to which has been added sufficient iodic acid to make a 1 per cent solution of iodic acid and allow the paper to dry in the air. Cut it in strips of suitable size and preserve for use.

¹ Uranium acetate method, p. 572.

² Determination of hippuric acid, p. 542.

³ Töpfer's method, p. 178.

⁴ Krüger and Schmidt's method, p. 537.

⁵ Determination of acetone, p. 561.

⁶ Solera's reaction, p. 59.

Spiegler's Reagent.¹—This reagent has the following composition:

Tartaric acid.....	20 grams.
Mercuric chloride.....	40 grams.
Sodium chloride.....	50 grams.
Glycerol.....	100 grams.
Distilled water.....	1000 grams.

Starch Iodide Solution.²—Mix 0.1 gram of starch powder with *cold* water in a mortar and pour the suspended starch granules into 75–100 c.c. of boiling water, stirring continuously. Cool the starch paste, add 20–25 grams of potassium iodide and dilute the mixture to 250 c.c. This solution deteriorates upon standing, and therefore must be freshly prepared as needed.

Starch Paste.—Grind 2 grams of starch powder in a mortar with a small amount of water. Bring 200 c.c. of water to the boiling-point and add the starch mixture from the mortar with continuous stirring. Bring again to the boiling-point and allow it to cool. This makes an approximate 1 per cent starch paste which is a very satisfactory strength for general use.

Stokes' Reagent.³—A solution containing 2 per cent ferrous sulphate and 3 per cent tartaric acid. When needed for use a small amount should be placed in a test-tube and ammonium hydroxide added until the precipitate which forms on the first addition of the hydroxide has entirely dissolved. This produces *ammonium ferrotartrate*, which is a reducing agent.

Suspension of Manganese Dioxide.⁴—Made by heating a 0.5 per cent solution of potassium permanganate with a little alcohol until it is decolorized.

Tanret's Reagent.⁵—Dissolve 1.35 grams of mercuric chloride in 25 c.c. of water, add to this solution 3.32 grams of potassium iodide dissolved in 25 c.c. of water, then make the total solution up to 60 c.c. with distilled water and add 20 c.c. of glacial acetic acid to the mixture.

Tincture of Iodine.⁶—Dissolve 70 grams of iodine and 50 grams of potassium iodide in 1 liter of 95 per cent alcohol.

Toison's Solution.⁷—This solution has the following formula:

Methyl violet.....	0.025 gram.
Sodium chloride.....	1.0 gram.
Sodium sulphate.....	8.0 grams.
Glycerol.....	30.0 grams.
Distilled water.....	160.0 grams.

¹ Spiegler's ring test, pp. 104 and 452

² Fehling's method, p. 546.

³ Hemoglobin, p. 301. Hemochromogen, p. 304

⁴ Krüger and Schmidt's method, p. 537.

⁵ Tanret's test, pp. 104 and 453.

⁶ Smith's test, pp. 212 and 461.

⁷ "Blood counting," p. 309.

Töpfer's Reagent.¹—Dissolve 0.5 gram of di-methylaminoazobenzene in 100 c.c. of 95 per cent alcohol.

Tropæolin OO.²—Dissolve 0.05 gram of tropæolin OO in 100 c.c. of 50 per cent alcohol.

Uffelmann's Reagent.³—Add a 5 per cent solution of ferric chloride to a 1 per cent solution of carbolic acid until an amethyst-blue color is obtained.

Uranium Acetate Solution.⁴—Dissolve about 35.0 grams of uranium acetate in 1 liter of water with the aid of heat and 3–4 c.c. of glacial acetic acid. Let stand a few days and filter. Standardize against a phosphate solution containing 0.005 gram of P_2O_5 per cubic centimeter. For this purpose dissolve 14.721 grams of pure air-dry sodium ammonium phosphate ($NaNH_4HPO_4 + 4H_2O$) in water to make a liter. To 20 c.c. of this phosphate solution in a 200 c.c. beaker add 30 c.c. of water and 5 c.c. of sodium acetate solution (see above) and titrate with the uranium solution to the correct end reaction as indicated in the method proper, page 572. If exactly 20 c.c. of uranium solution are required 1 c.c. of the solution is equivalent to 0.005 gram P_2O_5 . If stronger than this dilute accordingly and check again by titration.

Urease.⁵—(a) *Soy Bean Meal.*—Grind the soy bean to a powder which will pass through a 20-mesh sieve.

(b) *Solid Urease Preparation.*—Digest 1 part of soy bean meal with 5 parts of water at room temperature, with occasional stirring for an hour, and clear the solution by filtration through paper pulp or centrifugation. Pour this extract slowly, with stirring, into at least 10 volumes of acetone. The acetone dehydrates the enzyme preparation. Filter, dry in vacuum and powder. For standardization procedure see the determination of urea in urine.

(c) *Enzyme Solution.*—Dissolve 2 grams of urease, prepared as above, together with 0.6 gram of di-potassium-hydrogen phosphate and 0.4 gram of mono-potassium-dihydrogen phosphate in 10 c.c. of water. The solution may be kept under toluene for two weeks, without losing activity.

Uric Acid Reagents.⁶—(a) *Silver Magnesium Solution.*—

3 per cent silver lactate solution.....	70 c.c.
Magnesia mixture.....	30 c.c.,
Concentrated ammonium hydroxide solution.....	100 c.c.

¹ Töpfer's method, p. 178.

² Test for free acid, p. 159.

³ Uffelmann's reaction, p. 174.

⁴ Phosphate determination, p. 572.

⁵ Determination of urea, p. 520.

⁶ Determination of uric acid p. 279 and p. 534.

(b) *Uric Acid Reagent for Colorimetric Method.*—Place 100 grams of sodium tungstate, 80 c.c. of 85 per cent phosphoric acid, and 750 c.c. of distilled water in a liter flask. Boil the mixture with a reflux condenser for two hours, cool and dilute to 1 liter, filtering if necessary.

(c) *Sodium Carbonate Solution.*—Dissolve 200 grams anhydrous sodium carbonate in warm water and make up to 1 liter.

(d) *Uric Acid Formaldehyde Standard.*—Place 1 gram of uric acid in a liter volumetric flask and dissolve with 200 c.c. of a 0.4 per cent lithium carbonate solution. Add to the solution 40 c.c. of 40 per cent formaldehyde solution, shake the mixture and allow to stand for a few minutes. Acidify the clear solution with 20 c.c. of normal acetic acid and dilute to mark with distilled water. The solution should remain perfectly clear and the next day (not before) may be standardized against a freshly prepared solution of uric acid in lithium carbonate. The color produced by 5 c.c. of this solution corresponds very closely to that produced from 1 mg. of pure uric acid. The colorimeter reading obtained from the solution when thus compared with pure uric acid (1 mg.) is, of course, thereafter used as the standard value corresponding to 1 mg. of uric acid.

(e) *Uric Acid Standard in Phosphate Solution.*—Dissolve 9 grams of pure crystallized disodium hydrogen phosphate, together with 1 gram of crystallized sodium dihydrogen phosphate, in 200 to 300 c.c. of hot water, and filter if the solution is not perfectly clear. Make this filtrate up to about 500 c.c. with hot water, and pour this hot or warm (and perfectly clear) solution upon exactly 200 mg. of pure uric acid suspended in a few cubic centimeters of water in a liter volumetric flask. Agitate the mixture for a few minutes until the uric acid completely dissolves. Cool, add *exactly* 1.4 c.c. of glacial acetic acid, dilute to the mark, and mix. Add about 5 c.c. of chloroform to prevent the growth of bacteria or moulds in the solution. Five c.c. of this solution contain exactly 1 mg. of uric acid.

The solution of uric acid in the phosphate solution is very readily prepared, does not need to be standardized, and appears to keep indefinitely.

INTERNATIONAL ATOMIC WEIGHTS, 1916

		o = 16.			o = 16.
Aluminium.....	Al	27.1	Manganese.....	Mn	54.93
Antimony.....	Sb	120.2	Mercury.....	Hg	200.6
Arsenic.....	As	74.96	Molybdenum.....	Mo	96.0
Barium.....	Ba	137.37	Nickel.....	Ni	58.68
Bismuth.....	Bi	208.0	Nitrogen.....	N	14.01
Boron.....	B	11.0	Osmium.....	Os	190.9
Bromine.....	Br	79.92	Oxygen.....	O	16.00
Cadmium.....	Cd	112.40	Palladium.....	Pd	106.7
Calcium.....	Ca	40.07	Phosphorus.....	P	31.04
Carbon.....	C	12.005	Platinum.....	Pt	195.2
Chlorine.....	Cl	35.46	Potassium.....	K	39.10
Chromium.....	Cr	52.0	Radium.....	Ra	226.0
Cobalt.....	Co	58.97	Selenium.....	Se	79.2
Copper.....	Cu	63.57	Silicon.....	Si	28.3
Fluorine.....	F	19.0	Silver.....	Ag	107.88
Glucinum.....	Gl	9.1	Sodium.....	Na	23.00
Gold.....	Au	197.2	Strontium.....	Sr	87.63
Hydrogen.....	H	1.008	Sulphur.....	S	32.06
Iodine.....	I	126.92	Tantalum.....	Ta	181.5
Iridium.....	Ir	193.1	Tellurium.....	Te	127.5
Iron.....	Fe	55.84	Tin.....	Sn	118.7
Lanthanum.....	La	139.0	Titanium.....	Ti	48.1
Lead.....	Pb	207.20	Tungsten.....	W	184.0
Lithium.....	Li	6.94	Uranium.....	U	238.2
Magnesium.....	Mg	24.32	Zinc.....	Zn	65.37

INDEX

Main references are in heavy-faced type.

- Aberhalden test for pregnancy, principle of, 3
Absorption of carbohydrate as influenced by fat ingestion, 589
Acacia solution, formation of emulsion by, 182
Accessory food substances, 585
 influence on growth, 585
Acetoacetic acid, 274, 288, 299, 440, 466, 557
 Arnold-Lipliawaky test for, 468
 formula for, 466
 Gerhardt's test for, 467
 Hurtley's reaction for, 468
 Le Nobel reaction for, 467
 quantitative determination of, 288, 299, 557
Acetone, 274, 288, 299, 440, 463, 557
 bodies, 274, 288, 463, 557
 determination of in blood, 288
 of in urine, 561
 Van Slyke's methods for, 557
 origin of, 320
 formula for, 463
 Prommer's test for, 466
 Gunning's iodoform test for, 464
 Legal's iodoform test for, 465
 Lieben's test for, 465
 quantitative determination of, 288, 299, 561
 Reynolds-Gunning test for, 466
 Rothera's reaction for, 466
Achol stool, 227
Achroo-dextrins, 43, 56
 α -achroo-dextrin, 56
 β -achroo-dextrin, 56
 γ -achroo-dextrin, 56
Acid, acetic, 364, 398, 425
 acetoacetic, 274, 288, 299, 440, 466, 557
 alloxyproteic, 397, 420
 amino-acetic, 65, 69, 71, 200
 amino-butyric, 218
 amino-ethyl-sulphonic, 208, 375
 α -amino- β -hydroxy-propionic, 69, 73
 α -amino- β -imidazolyl-propionic, 68, 77
 α -amino-iso-butyl-acetic, 69, 79
 α -amino- β -methyl- β -ethyl-propionic, 68, 80
 α -amino-normal glutaric, 69, 82
 α -amino-propionic, 68, 72
 amino-succinic, 69, 82
 amino-valeric, 218
 α -amino-iso-valeric (see Valine), 69, 78
 α -diamino- β -dithiollactyl, 69, 75
 aspartic, 69, 82
 benzoic, 72, 397, 416, 423, 606, 609
 butyric, 8, 348, 352, 398, 425
 caproic, 341, 348
 carbamic, 251
 cholic, 208
 chondroitin-sulphuric, 364, 397, 420
 citric, 341
 Acid, combined hydrochloric (protein salt), 56, 140, 177, 179, 622
 cyanuric, 401
 α - ϵ -diamino-caproic, 68, 80
 diaminotrihydroxydodecanoic, 85
 diao-benzene-sulphonic, 483
 etheral sulphuric, 216, 397, 413
 fatty, 180, 181, 186, 216, 398, 425
 formic, 26, 398, 425
 free hydrochloric, 56, 140, 157, 166, 177, 178
 glucothionic, 496
 glutamic, 69, 82
 glycerophosphoric, 381, 382, 398, 427
 glycocholic, 208
 glycosuric, 423
 glycuronic, 36, 38, 445, 470
 glyoxylic, 99
 guanidine- α -amino-valeric, 68, 79
 hippuric, 72, 397, 416, 424, 492, 542, 609
 homogentisic, 26, 394, 422, 445
 β -hydroxybutyric, 274, 288, 320, 324, 440, 463, 468, 557
 hydroxymandelic, 397, 422
 iminazolylpropionic, 218
 indole- α -amino-propionic, 68, 77
 indolylacetic, 218, 481
 indoxyl-sulphuric, 216, 397, 413
 inosinic, 369, 375
 isovaleric, 218
 kynurenic, 397, 423
 lactic, 40, 140, 163, 173, 342, 369, 370
 lauric, 341
 mucic, 36, 40, 473, 474
 myristic, 341
 nucleic, 94, 123, 124, 130-133
 osmic, 384
 oxalic, 397, 419, 565
 oxaluric, 397, 425
 oxy- α -pyrrolidine-carboxylic, 68, 85
 oxyproteic, 397, 420
 palmitic, 180, 181, 185, 186
 para-cresolesulphuric, 397, 413
 para-hydroxyphenyl-acetic, 216, 218, 397, 422
 para-hydroxy- β -phenyl- α -amino-propionic, 69, 74, 86
 para-hydroxyphenyl-propionic, 216, 218, 397, 422
 paralactic, 251, 342, 370, 398, 426
 phenaceturic, 398, 426
 phenol-sulphuric, 397, 413
 phenylacetic, 218
 phenyl- α -amino propionic, 69, 73
 phenylpropionic, 218
 phosphocarnic, 369, 398, 427
 phosphoric, 434

- Acid, pyrocatechin-sulphuric, 397, 413
 α -pyrrolidine-carboxylic, 68, 85
 sarcolactic, 370
 skatole acetic, 77
 skatole carbonic, 221, 224
 skatoxyl-sulphuric, 397, 413
 stearic, 181, 382
 succinic, 218
 sulphanilic, 483
 tannic, 45, 48, 103
 taurocholic, 208
 trichlorethylglucuronic, 445
 uric, 26, 127, 251, 274, 279, 369, 397, 399, 405, 487, 489, 505, 534
 urocanic, 398, 426
 uroferric, 397, 420
 uroleucic, 397
 volatile fatty, 216, 219, 398, 425
 Acid albuminate. See Acid metaprotein.
 Acid excretion in urine, determination of index of, 336
 Acid-forming foods, influence of on hydrogen ion concentration of urine, 603
 Acid-hematin, 258, 273, 299, 304
 Acid infraprotein. See Acid metaprotein.
 Acid metaprotein, 95, 115, 116
 coagulation of, 116
 experiments on, 116
 precipitation of, 116
 preparation of, 116
 solubility of, 116
 sulphur content of, 116
 Acidity of gastric juice, quantitative determination of, 151, 163, 166
 urine, cause of, 389, 434
 quantitative determination of, by hydrogen ion concentration, 509
 by titration, 508
 Acidosis, 319, 463, 599
 blood in, 274
 general discussion of, 319
 metabolism in, 599
 Acrolein, formation of, from olive oil, 184
 from glycerol, 187
 Activation, 6, 191
 Activation of calcium salts, 191
 Adam's paper coil method for determination of fat in milk, 355
 Adaptation, 57
 Adenase, 4, 187
 Adenine, 4, 125, 126, 127, 132, 375, 398, 429
 Adipocere, 183
 Adrenalin, determination of in adrenals, 295
 Agar-agar, 20, 50, 228, 608, 612
 Al glutination, 254, 266
 Alanine, 68, 72, 218
 Albino rats, experiments on, 585
 Albumin, egg, 94, 106, 107
 crystallized, preparation of, 106
 powdered, preparation of, 107
 tests on, 107
 serum, 93, 422, 249, 272, 440, 450
 solution, preparation of, 98
 Albumin in urine, 440, 450
 acetic acid and potassium ferrocyanide test for, 453
 coagulation or boiling test for, 452
 determination of, 554
 Albumin in urine, Heller's ring test for, 451
 Roberts' ring test for, 452
 sodium chloride and acetic acid test for, 453
 Spiegler's ring test for, 452
 Tanret's test for, 453
 tests for, 451
 Albumins, 93, 95, 96
 Albuminates. See Metaproteins.
 Albuminates, formation of, by metallic salts, 102
 Albuminoids, 93, 112, 359
 Albumoscope, 104, 452
 Albumoses (see Proteoses, p. 118)
 Alcaptonuria, 423
 Alcohol, aldehyde test for, 31
 iodoform test for, 31
 Alcohol-soluble proteins (see Prolamins, p. 111)
 Alcoholic-zinc chloride test for urobilin, 429
 Aldehyde, 25, 42
 Aldehyde group, 39
 Aldehyde test for alcohol, 31
 v. Aldor's method of detecting proteose in urine, 455
 Aldose, 19
 Aliphatic nucleus, 65, 68
 Alizarin yellow R, use of, as indicator, 161, 162
 Alkali albuminate. See Alkali metaprotein.
 Alkali-hematin, 258, 303
 Alkali metaprotein, 95, 115, 116
 experiments on, 116
 precipitation of, 116
 preparation of, 116
 sulphur content of, 116
 Alkaline tide, 390, 600
 demonstration of, 600
 "Alkali reserve," determination of, 325
 Alkali tolerance, determination of, 338
 Allantoin, 397, 420
 crystalline form of, 420
 experiments on, 421
 formula for, 420
 preparation of, from uric acid, 421
 quantitative determination of, by Wieschowski-Handovsky method, 541
 by difference, 542
 separation of, from urine, 421
 Allen's modification of Fehling's test, 447
 Alloxyproteic acid, 397, 420
 Almén's reagent, preparation of, 457
 Aloin-turpentine test for "occult blood," 239
 Aluminium hydroxide, use of, in removal of protein, 280, 358
 Alveolar air, carbon dioxide tension of, 332
 Amalgamation test for mercury, 479
 Amandin, 94
 American standard hemocytometer, 309
 Amide nitrogen, 64
 Amino acids, 65, 67, 68, 190, 199, 251, 274, 397, 422
 preparation of, in crystalline form, 85, 87
 α -amino- β -hydroxy-propionic acid, 69, 73
 α -amino- β -imidazol-propionic acid, 68, 77
 α -amino-iso-butyl-acetic acid, 69, 78
 α -amino-normal-glutaric acid, 69, 82
 Amino-butyric acid, 218
 Amino group, 65, 88, 100
 Amino-nitrogen, quantitative determination of, 88, 91, 282, 526
 Amino-succinic acid, 69, 82

- Amino-valeric acid, 218
 α -amino-iso-valeric acid, 69, 78
 Ammonia, 64, 67, 71, 107, 251, 274, 282, 398, 430, 523, 598
 in blood, 251, 274
 quantitative determination of, 282
 in urine, 398, 430, 523, 598
 quantitative determination of, 523
 Ammoniacal cupric hydroxide, solubility test, 49
 Ammoniacal silver solution, preparation of, 617
 Ammoniacal-sinc chloride test for urobilin, 428
 Ammonium benzoate, synthesis of, to form hippuric acid, 609
 Ammonium magnesium phosphate ("Triple phosphate"), 391, 436
 in urinary sediments, 487
 Ammonium purpurate, 128, 409
 Ammonium urate, 391, 405, 490, 536
 crystalline form of, Plate VI, opposite p. 491
 Amphopeptone, 96, 119
 Amygdalin, 4
 Amylase, pancreatic, 4, 11, 191, 195
 digestion of dry starch by, 192, 196
 inulin by, 196
 experiments on, 11, 195
 influence of bile upon action of, 196
 most favorable temperature for action of, 196
 salivary, 4, 10, 55, 140
 activity of, in stomach, 57, 140
 experiments on, 10, 59
 inhibition of activity of, 57, 61
 nature of action of, 56, 61
 products of action of, 56, 60
 vegetable, 4, 11
 Amylases, 4, 10, 55, 191
 experiments on, 10, 59, 195, 243
 Amylocellulose, 43
 Amyloid, 49, 113
 Amyolytic enzymes. See Amylases.
 quantitative determination of activity of, 196, 243
 Amylopectin, 43
 Amylose, 43
 Anabolism, 584
 Animal parasites in feces, 231
 in urinary sediments, 494, 503
 Anti-enzymes, 9
 experiments on, 17
 Antimony pentachloride as cellulose solvent, 50
 Antimony trichloride as cellulose solvent, 49
 Antipepsin, 9, 17
 Antipeptone, 96, 119
 Antirennin, 9
 Antithrombin, 261
 Antitrypsin, 9, 18
 Aporrhemas, 218
 Arabinose, 19, 37, 471
 Bial's reaction for, 38, 472
 orcinol test on, 38, 472
 phenylhydrazine test on, 38
 Tollens' reaction on, 38, 472
 Arginase, 4
 Arginine, 4, 67, 68, 79, 190
 Arnold-Lipliawsky reaction for acetoacetic acid, 468
 reagent, preparation of, 468
 Aromatic oxyacids, 397, 422
 Arsenic in urine, detection of, 476
 determination of, 476
 Arthritis, blood in, 274
 Ascaris, 17, 18
 Ash of milk, quantitative determination of, 356
 Asparagine, 82
 formula for, 82
 Aspartic acid, 65, 67, 69, 82
 crystalline form of, 81
 formula for, 82
 Assimilation limit, 21
 Assimilation limit of dextrose, 21, 441, 591
 Atkinson and Kendall's hemin test, 270
 Atomic weights, table of, 634
 Autolytic enzymes, 3
 Automatic regulation of gastric acidity, 150
 Azolitmin, use of, as indicator, 162

 Babcock fat method, 353
 tube, 353
 Bacteria in feces, 225, 228, 229, 245, 611
 quantitative determination of, 245
 Bacterial nitrogen in feces, 230, 611
 determination of, 245
 Balance, metabolic, preparation of, 615
 calcium, 615
 magnesium, 615
 nitrogen, 615
 phosphorus, 615
 sulphur, 615
 Bang reduction flask, 287
 Bang's method for estimation of sugar in blood, 286
 Bang's method for estimation of sugar in urine, 547
 Barfoed's reagent, preparation of, 30, 204, 618
 Barfoed's test for monosaccharides, 30
 Baryta mixture, preparation of, 403, 618
 Base-forming foods, influence of on hydrogen ion concentration of urine, 390, 603
 Basic lead acetate solution, 562, 619
 Bayberry tallow, saponification of, 185
 source of, 185
 Bayberry wax. See Bayberry tallow, 185
 Bead test (Einhorn), 242
 Beckmann-Heidenhain apparatus, 393
 "Bence-Jones' protein," detection of, 456
 quantitative determination of, 556
 Benedict creatine preparation, 412
 Benedict and Bock's method for quantitative determination of total nitrogen, 517
 Benedict-Polin creatinine preparation, 411
 Benedict-Polin method for creatine in urine, 532
 Benedict-Hitchcock method for uric acid in urine, 534
 Benedict-Murlin method for amino-acid nitrogen in urine, 528
 Benedict's method for quantitative determination of sugar, 545
 Benedict's method for quantitative determination of sulphur, 568
 Benedict's method for uric acid in blood, 280
 Benedict's modification of Benedict and Lewis method for sugar in blood, 283
 Benedict's modifications of Fehling's test, 26, 445
 solution, for use in quantitative determination of sugar, preparation of, 545, 619
 solutions, preparation of, 26, 445, 619
 sulphur reagent, preparation of, 620

- Benzidine peroxidase reaction** (Wilkinson and Peters), 350
- Benzidine reaction for blood**, 175, 237, 267, 459
- Benzoic acid**, 72, 397, 416, 423, 606, 609
 crystalline form of, 424
 experiments upon, 424
 formula for, 423
 solubility of, 424
 sublimation of, 424
- Bergeim's intragastric conductance apparatus**, 153
- Bergeim's modification of the Herter-Foster method for indole in feces**, 246
- Bergeim's phosphonuclease theory for the origin of hydrochloric acid of gastric juice**, 141
- Berthelot-Atwater bomb calorimeter**, 607
- Bertrand's method for sugar determination**, 550
- Bial's reaction for pentoses**, 38, 472
- Bial's reagent, preparation of**, 38, 472
- Bile**, 175, 206, 440, 460
 analysis of, 207
 constituents of, 207
 daily secretion of, 207
 freezing-point of, 207
 influence on digestion, gastric, 147
 pancreatic, 195, 197
 inorganic constituents of, 207, 211
 nucleoprotein of, 207, 211
 reaction of, 206, 211
 secretion of, 206
 specific gravity of, 207
- Bile acids**, 208, 212
 Hay's test for, 213
 Mylius's test for, 212
 Neukomm's test for, 213
 Oliver's test for, 213
 Pettenkofer's test for, 212
 tests for, 212
 v. Udránsky's test for, 212
- Bile acids in feces, detection of**, 240
- Bile acids in urine**, 440, 462
 Hay's test for, 462
 Mylius's test for, 462
 Neukomm's test for, 463
 Oliver's test for, 463
 Pettenkofer's test for, 462
 tests for, 462
 v. Udránsky's test for, 462
- Bile pigments**, 207, 208, 211
 Gmelin's test for, 211
 Hammarsten's reaction for, 211
 Huppert's reaction for, 211
 Nakayama's reaction for, 211
 Rosenbach's test for, 211
 Salkowski-Schipper's reaction for, 212
 Smith's test for, 212
 tests for, 211
- Bile pigments in urine**, 440, 460
 Gmelin's test for, 461
 Hammarsten's reaction for, 461
 Huppert's reaction for, 461
 Nakayama's reaction for, 461
 Rosenbach's test for, 461
 Salkowski-Schipper's reaction for, 461
 Salkowski's test for, 461
 Smith's test for, 461
 tests for, 460
- Bile salts**, 208, 462
 crystallization of, 208, 213
- Biliary calculi**, 210, 213
 analysis of, 213
- Bilicyanin**, 208
- Bilifuscin**, 208
- Bilihumin**, 208
- Biliprasin**, 208
- Bilirubin**, 208
 crystalline form of, 290
 in urinary sediments, 487, 493
- Biliverdin**, 208, 210
 "Biological" blood test, 261
- Bismuth, influence on color of feces**, 226, 242
- Bismuth reduction tests**, 29, 448
- Bismuth test for choline**, 386
- Biuret**, 100, 401, 403
 formation of, from urea, 100, 401
- Biuret paper of Kantor and Gies**, 101
- Biuret potassium cupric hydroxide**. See **Cupri-potassium biuret**, 100
 test, 100
 Posner's modification of, 101
- Biuret reagent (Gies), preparation of**, 101
- Black's reaction for β -hydroxybutyric acid**, 469
 reagent, preparation of, 469
- Blood**, 174, 229, 237, 249, 274, 440, 457
 acetoacetic acid in, 274, 288
 acetone in, 251, 274, 288
 agglutination of, 254, 266
 amino-acid nitrogen in, 274, 282
 amino-acids in, 251, 252
 ammonia in, 274, 282
 benzidine test for, 175, 237, 267, 459
 Bordet test for, 261
 cholesterol in, 251, 274, 290
 coagulation of, 261
 Howell's theory of, 261
 composition of normal and pathological, 274
 constituents of, 251, 252
 creatine in, 252, 274, 281
 creatinine in, 252, 274, 281
 crystallisation of oxyhemoglobin of, 254, 270
 defibrinated, 261, 264
 detection of, 174, 237, 267, 457
 determination of acetone in, 288, 299
 acetoacetic acid in, 288, 299
 amino-acid nitrogen in, 282
 ammonia in, 282
 chlorides in, 291
 cholesterol in, 290
 creatine in, 281
 creatinine in, 281
 fat in, 300
 β -hydroxybutyric acid in, 288, 299
 hydrogen ion concentration in, 338
 non-protein nitrogen in, 276
 sugar in, 274, 283
 total nitrogen in, 274, 283
 total solids in, 274, 294
 urea in, 274, 278
 uric acid in, 274, 279
 erythrocytes of, 253, 265, 501
 experiments on, 264, 274
 fat in, 251, 300
 form elements of, 253
 guaiac test for, 239, 262, 266, 458
 hemin test for, 268, 457

- Blood, β -hydroxybutyric acid in, 274, 288
 in arthritis, 274, 275
 in cholelithiasis, 251, 274, 275
 in diabetes, 274, 275
 in gout, 252, 274, 275, 407
 in lipemia, 274, 275
 in nephritis, 274, 275
 in uremia, 274, 275
 in urine, 440, 457
 leucocytes of, 259
 medico-legal tests for, 261, 267
 menstrual, 261
 microscopic examination of, 253, 264, 273
 non-protein nitrogen of, 274
 determination of, 276
 nucleoprotein of, 250, 251
 "occult," in feces, 229, 237
 ortho-tolidin test for, 174, 237, 267, 458
 oxyhemoglobin of, 254, 301
 pigment of, 254, 258
 plaques, 260
 plasma, 249, 272
 platelets, 260
 plates, 260
 preparation of hematin from, 270
 preparation of "laky," 249, 265
 reaction of, 249, 264
 serum, 251, 271
 specific gravity of, 249, 264
 spectroscopic examination of, 301
 sugar in, 251, 272, 274, 283
 test for iron in, 265
 total amount of, 249
 v. Zeynek and Nencki's hemin test for, 270, 458
- Blood analysis, 274
 Blood casts in urine, 494, 498
 Blood corpuscles, 253, 259, 265, 494, 501
 "counting," 309, 313
 Blood dust, 249, 260
 Blood in urine, 440, 458
 benedidine reaction for, 459
 guaiac test for, 458
 Heller's test for, 457
 Heller-Teichmann reaction for, 458
 ortho-tolidin test for, 458
 Schumm's modification of guaiac test for, 458
 spectroscopic examination of, 459
 Teichmann's hemin test for, 457
 tests for, 457
 v. Zeynek and Nencki's hemin test for, 458
- Blood plasma, 249, 272
 constituents of, 249
 effect of calcium on oxalated, 272
 experiments on, 272
 preparation of fibrinogen from, 272
 oxalated, 272
 salted, 272
- Blood serum, 251, 271
 coagulation temperature of, 271
 constituents of, 251, 272
 experiments on, 271
 precipitation of proteins of, 272
 separation of albumin and globulin of, 272
- Blood serum, sodium chloride in, 271
 sugar in, 271
- Blood stains, examination of, 273
 Bloor's nephelometer, cut of, 296
 Boas' reagent, as indicator, 159
 preparation of, 159, 621
 Bock and Benedict's apparatus, cut of, 518
 Bock and Benedict's microchemical method for total nitrogen in urine, 517
 Boettger's test for sugar, 28, 448
 "Bolting" of food, influence of, on food residues in feces, 613
 Bomb calorimeter, Berthelot-Atwater, 607
 Bonanno's reaction, 212, 462
 Bonanno's reagent, preparation of, 212, 462
 Bone, constituents of, 365-367
 ossein of, preparation of, 365
 quantitative composition of, 365, 366
 Bone ash, scheme for analysis of, 367
 Borchart's reaction for fructose, 36, 475
 Bordet test, detection of human blood by, 257
 Boric acid and borates in milk, detection of, 353
 Bottu's reagent, preparation of, 443
 Bottu's test, 443
 Bromelin, 5
 Bromine test for melanin, 480
 for tryptophane, 193
- Buccal glands, 54
 "Buffer substances" of the blood, 324
 Buffy coat, formation of, 251
 Bunge's mass action theory, 140
 Bürker's hemocytometer, 313
 Butter, composition of, 348
 Butyric acid, 8, 348, 352, 398, 425
 Butyrin, 181, 341, 348
 Bynin, 94, 111
- Cadaverin, 81, 216
 Calcium in urine, 398, 437, 487-9, 579
 quantitative determination of, 579
 balance, preparation of, 615
 carbonate in urinary sediments, 487, 488
 caseinate, 347
 in bone, detection of, 365-7
 in feces, estimation of, 615
 oxalate, 419, 487
 in urinary sediments, 487
 paracasein, 143, 343
 phosphate in urinary sediments, 487, 489
 in bone, detection of, 366-7
 in milk, 341, 351
 sulphate in urinary sediments, 487, 489
- Calculi, biliary, 210, 213
 urinary, 504
 calcium carbonate in, 505
 cholesterol in, 507
 cystine in, 505
 fibrin in, 507
 indigo in, 507
 oxalate in, 505
 phosphates in, 505
 uric acid and urates in, 505
 urostealthis in, 507
 xanthine in, 505
- Calliphora, larvæ of, formation of fat from protein by, 180
 Calomel, influence on color of stool, 226, 242
 Cambogia, influence of, on color of feces, 242

- Camphor as urine preservative, 396
 Cane sugar (see Sucrose, p. 41)
 Canton silk, 69
 Caproic acid, 341, 348
 Carbamic acid, 251
 Carbocyclic nucleus, 65, 68-9
 Carbohydrases, 4
 Carbohydrates, 19
 absorption of, as influenced by fat ingestion, 589
 classification of, 19
 composition of, 19
 control of putrefaction by, 217
 in feces, estimation of, 614 |
 protein-sparing action of, 602
 review of, 51
 scheme for detection of, 53
 variation in solubility of, 20
 Carbonates in urine, 398, 438
 Carbon dioxide capacity of plasma, 325
 tension of alveolar air, 332
 Carbon moiety of protein molecule, 183
 Carbon monoxide, hemoglobin, 258, 302
 spectroscopic test for, 303
 tannin test for, 303
 Carboxylase, 4, 19, 32, 449
 Carmine-fibrin, preparation of, 12, 621
 Carmine, use in feces separation, 239, 610
 Carnine, 369
 Carnitine, 369
 formula for, 375
 Carnomuscarnine, 369
 Carnosine, 369, 375
 Carotin, 348
 Cartilage, 364
 constituents of, 364
 experiments on, 364
 Hopkins-Cole reaction on, 364
 Millon's reaction on, 364
 preparation of gelatin from, 364
 solubility of, 364
 unoxidised sulphur in, 364
 xanthoproteic test on, 364
 Casein, 67, 143, 341, 343, 347
 action of rennin upon, 143, 343
 biuret test on, 351
 decomposition of, 67
 Millon's test on, 351
 precipitation of, 350
 preparation of, 350
 quantitative determination of, 357-8
 quantitative determination of, Hart's method for, 357
 solubility of, 351
 soluble, 143
 test for phosphorus in, 351
 test for unoxidized sulphur in, 351
 Caseinate, calcium, 347
 Caseinogen. See Casein.
 Casts, 494, 496
 blood, 494, 498
 epithelial, 494, 498
 fatty, 494, 498
 granular, 494, 497
 hyaline, 494, 497
 pus, 494, 501
 waxy, 494, 499
 Casts in urinary sediments, 494, 496
 Catabolism, 584
 Catalase, 5, 15
 animal, 16
 experiments on, 16
 quantitative determination of, 16
 vegetable, 16
 Catalysis, 2
 Cat gut, 147
 Cell, 585
 Cellulose, 20, 48
 action of Schweitzer's reagent on, 49
 hydrolysis of, 49
 iodine test on, 49
 solubility of, 49
 solvents, 49
 utilisation by animals, 48
 Cellulose group, 20
 Cerebrin (cerebroside), 381, 383, 385
 experiments on, 385
 hydrolysis of, 385
 microscopical examination of, 385
 preparation of, 385
 solubility of, 385
 Cerebrosides, 381, 383
 Cerebro-spinal fluid, choline in, 382
 Charcot-Leyden crystals, 229
 form of, 229
 Chlorides in blood, 274, 291
 quantitative determination of, 291
 in urine, 398, 433, 576
 detection of, 434
 quantitative determination of, 576
 Cholecyanin, 210
 Cholelithiasis, blood in, 274
 Choleprasin, 208
 Cholera-red reaction for indole, 222
 Cholesterol, 207, 214, 251, 274, 275, 290, 341, 381, 383
 crystalline form of, 214
 formula for, 383
 in blood, 251, 274, 275, 290
 determination of, 290
 iodine-sulphuric acid test for, 214, 385
 isolation of, from biliary calculi, 213
 Liebermann-Burchard test for, 214, 385
 occurrence of, in urinary sediments, 487, 492
 origin of, 383
 preparation of, from nervous tissue, 384
 Salkowski's test for, 214, 385
 Schiff's reaction for, 214, 385
 tests for, 214, 385
 Choletelin, 208
 Choline, 216, 382, 385
 as putrefaction product, 216
 formula for, 382
 tests for, 385
 Chondrigen, 113
 Chondroalbumoid, 364
 Chondroitin, 364
 Chondroitin-sulphuric acid, 364, 398, 420
 Chondromucoid, 113, 364
 Chondrosin, 364
 reducing action of, 364
 Chromoproteins (see Hemoglobins), 113
 Chyle, 264
 Cipollina's test, 23, 442
 Clark's modification of Dehn's method for determination of chlorides, 578

- Cleavage products of protein (see Decomposition products), 64, 68-69
- Clupeine, 67, 95
- Coagulases, 4
- Coagulated proteins, 96, 116
 biuret test on, 118
 digestion of, 118
 formation of, 117
 Hopkins-Cole reaction on, 118
 Millon's reaction on, 118
 solubility of, 118
 xanthoproteic reaction on, 118
- Coagulation of blood, 260
 Howell's theory of, 261
- Coagulation of proteins, 116
 changes in composition during, 117
 fractional, 105, 117
- Coagulation temperature of proteins, 105, 117
 apparatus used in determining, 106
 method employed in determining, 105
- Cochineal, use of, 161, 162
- Co-enzyme, 7
- Collagen, 94, 112, 360, 361
 experiments on, 361
 percentage of, in ligament, 363
 in tendon, 360
 production of gelatin from, 361, 362
 solubility of, 362
 transformation of, 361, 362
- Collection and preservation of feces in metabolism experiments, 611
 of urine in metabolism experiments, 395, 588
- Collodion dialyzer, 24
- Colloidal solution, 341
- Colloids, 341, 369
 tissue, 369
- Colostrum, 343, 345, 348
 microscopic appearance of, 343
- Combined hydrochloric acid (protein salt), 56, 140, 177, 179, 622
 preparation of, 622
 tests for, 179
- Combustion of foodstuffs, 608
- Composition of common foods (Table), 592
- Compound test for lactose in urine, 474
- Congeaing-point of fat, 188
- Congo red, as indicator, 157, 158
 preparation of, 622
- Congo-red fibrin, preparation of, 12, 622
- Conjugated proteins, 95, 112
 classes of, 95, 112
 nomenclature of, 95, 112
 occurrence of, 95, 112
- Conjugate glycuronates, 26, 445, 470
 naphthoresorcinol reaction for, 470
 polariscopic-fermentation test for, 470
 reduction-polariscopic test for, 471
- Connective tissue, 359
- Constipation, aid in, 51, 227
- Cowie's guaiac test, 239
- Cramer's mercuric oxide test for reducing sugar, 28, 447
- Creatine, 251, 252, 274, 281, 371, 374, 378, 397, 412, 440, 532
 crystalline form of, 371
 diacetyl reaction for, 379
 formula for, 374
- Creatine, quantitative determination of, 281, 532
 separation of, from meat extract, 378
 transformation into creatinine, 379
- Creatinine, 26, 252, 274, 398, 409
 coefficient, definition of, 409, 531
 crystalline form of, 410
 daily excretion of, 410
 elimination, a study of, 597
 experiments on, 411
 formula for, 409
 from creatine, 379
 Jaffe's reaction for, 413
 quantitative determination of, 281, 530
 Salkowski's test for, 413
 separation of, from urine, 411
 Weyl's test for, 413
- Creatinine-zinc chloride, formation of, 411, 413
- Cresol, para, 216
 tests for, 223
- Croll's fat apparatus, 354
- Cross and Bevan's reagent, 49
 preparation of, 49
 solubility test, 49
- Cryoscopy, 393
- Cul-de-sac, 139
- Cupri-potassium biuret, formation of, 100
 formula for, 100
- Cyanuric acid, 401
 formula for, 401
- Cylindroids in urinary sediments, 494, 501
- α -Cyprinine, 67
- Cystine, 65, 67-69, 75, 87, 487, 491
 crystalline form of, 76, 491
 detection of, 87, 491
 formula for, 76
 in hair, 87
 in urinary sediments, 487, 491
 preparation of, in crystalline form, 87
- Cytosine, 125, 126, 128, 133
 Wheeler-Johnson reaction for, 133
- Dakin's methods for quantitative determination of hippuric acid, 543
- Dare's hemoglobinometer, 307
 description of, 307
 determination of hemoglobin by, 307
- Deaminases, 4
- Decomposition products of proteins, 64, 67, 68, 69, 71
 crystalline forms of, 72-84
 experiments on, 85-87
 isolation of, 85-87
- Defensive enzymes, 3
- Degradation products of protein (see Decomposition products), 64, 67-69, 71
- Dehn-Clark method for chlorides, 578
- Delusive feeding experiments, 138
- Derived proteins, 94, 114
- Detection of preservatives in milk, 352
 boric acid and borates, 353
 formaldehyde, 352
 hydrogen peroxide, 353
 salicylic acid and salicylates, 352
- Determination of acetoacetic acid in blood, 288, 299
 in urine, 557
 acetone in blood, 288, 299
 in urine, 557, 561

- Determination of acetone and diacetic in blood, 288, 299
 in urine, 557
 acetone bodies in urine, 557
 acidity of urine, by titration, 508
 by hydrogen ion concentration, 509
 albumin in urine, 554
 "alkali reserve" of the blood, 325
 alkali tolerance, 338
 allantoin in urine, 541
 amino acid nitrogen, 88, 91, 282, 526
 in blood, 282
 in protein hydrolysis, 64, 88, 91
 in urine, 526
 ammonia in blood, 282
 ammonia in urine, 523
 amyolytic activity, 196, 243
 ash of milk, 356
 calcium in urine, 579
 carbon dioxide tension of alveolar air, 332
 casein of milk, 357-8
 catalase, 16
 chlorides in blood, 291
 in urine, 576
 cholesterol in blood, 290
 creatine in blood, 281
 in urine, 532
 creatinine in blood, 281
 in urine, 530
 diacetic acid (see Acetoacetic acid).
 fat in blood, 300
 in feces, 247
 in milk, 357
 fecal amylase 243
 fecal bacteria, 245
 glucose in urine, 545
 hippuric acid in urine, 542
 hydrogen ion concentration of blood, 338
 of urine, 509
 β -hydroxybutyric acid in blood, 289, 299
 in urine, 557
 index of acid excretion in urine, 336
 indican in urine, 562
 indol in feces, 246
 iron in urine, 582
 lactalbumin in milk, 358
 lactose in milk, 358
 magnesium in urine, 579
 nitrogen in urine, 512
 partition in urine, 513, 600
 oxalic acid in urine, 565
 β -oxybutyric acid in blood, 288, 299
 in urine, 557
 peptic activity, 169
 phenols in urine, 563
 phosphorus in urine, 572
 potassium in urine, 582
 protein in milk, 356, 357
 protein in urine, 554
 purine bases in urine, 537
 purine nitrogen in urine, 539
 sodium in urine, 581
 sulphur in urine, 566
 total solids in milk, 356
 total solids in urine, 511
 tryptic activity, 172
 urea in blood, 278
 in urine, 520
- Determination of uric acid in blood, 279
 in urine, 534
 Deuteroproteose, 95, 119
 Dextrin, 20, 43, 47, 56
 achroo-, 43, 56
 α -achroo-, 56
 β -achroo-, 56
 γ -achroo-, 56
 action of tannic acid on, 48
 diffusibility of, 48
 erythro-, 43, 56
 Fehling's test on, 48
 hydrolysis of, 48
 iodine test on, 47
 solubility of, 47
 Dextrosazone, crystalline form of, Plate III,
 opposite p. 22
 Dextrose (see Glucose).
 Diabetes, blood in, 274
 Diacetic acid (see Acetoacetic acid), 274, 288,
 440, 466, 557
 Dialysis, 24
 Dialyzers, preparation of, 24
 Diamino acid nitrogen, 64
 Diaminotrihydroxydodecanoic acid, 85
 α -di-amino-caproic acid, 68, 80
 Diastase (see Vegetable amylase), 4, 10
 Diao-benzene-sulphonic acid, 483
 reagent, preparation of, 483
 Diao reaction (Ehrlich's), 483
 Differentiation between pepsin and pepsinogen,
 141, 146
 Digestion, gastric, 138
 intestinal, 199
 pancreatic, 189
 salivary, 54
 Di-iodo-hydroxypropane (Iothion), 30, 449
 Di-methyl-amino-asobenzene (see Töpfer's re-
 agent), 178
 2, 5-dinitrohydroquinol use of, 162
 Dipeptides, 66, 96
 Disaccharides, 19, 38
 classification of, 19
 Dissociation products of protein (see Decom-
 position products, 64).
 Donné's pus test, 460
 Drying method for determination of total solids
 in urine, 511
- Earthy phosphates in urine, 434, 436, 573
 quantitative determination of, 573
 Edestan, 95, 114
 experiments on, 115
 Edestin, 67, 94, 109
 coagulation of, 109
 crystalline forms of, 109
 decomposition of, 67
 microscopical examination of, 109
 Millon's test on, 109
 preparation of, 109
 solubility of, 109
 tests on crystallized, 109
 filtrate of, 110
 Ehrlich's diazo-benzene-sulphonic acid reagent,
 preparation of, 483
 Ehrlich's diazo reaction, 483
 Ehrlich's mechanical eye-piece, use of, 313

- Einhorn's bead test, 242
 Einhorn's saccharometer, 31
 Elastin, 94, 360, 362, 363
 absorption of pepsin by, 363
 experiments on, 363
 preparation of, 363
 solubility of, 363
 Electrical conductivity of urine, 394
 Electrolytes, influence on enzyme activity, 7, 192
 Embryos, glycogen in, 370
 Emulsin, 4
 Energy metabolism, 584, 608
 Enterokinase, 191, 200, 201
 demonstration of, 201
 Enzymes, 1
 activation of, 6
 adsorption of, 6
 classification of, 4
 defensive, 3
 definition of, 2
 experiments on, 10
 influence of electrolytes, 7, 192
 list of, 4
 preparation of, 5, 11, 13, 14
 properties of, 6
 reference books, 10
 Epiguanine, 397, 429
 Epinephrin, determination of in adrenal glands, 295
 Episarkine, 397, 429
 Epithelial cells in urinary sediments, 494
 casts in urinary sediments, 494, 498
 Epithelial tissue, 359
 experiments on, 360
 Epstein's sugar method, 284
 apparatus for, 285
 Erepsin, 5, 199, 202
 experiments on, 202
 Erythrocytes, 253, 265, 501
 counting the, 309, 313
 diameter of, 253
 form of, 253
 Erythrocytes, influence of osmotic pressure on, 265
 in urinary sediments, 494, 501
 number of, per cubic millimeter, 253, 254
 of different species, 253
 stroma of, 253
 variation in number of, 254
 Erythro-dextrin, 43, 56
 Esbach's albuminometer, 555
 method for determination of albumin, 555
 reagent, preparation of, 555
 Ester, definition of, 180
 hydrochloric acid, of hematin, 270
 sulphuric acid, of hematin, 270
 Etheral sulphates, 397, 413
 quantitative determination of, 567, 571
 Etheral sulphuric acid, 216, 397, 413
 Ethyl butyrate test for pancreatic lipase, 198
 sulphide, 420
 Euglobulin, 250
 Excelsin, 110
 crystalline form of, 110
 Extractives of muscular tissue, 369
 nitrogenous, 369
 non-nitrogenous, 369
 Farmer-Polin microchemical method for nitrogen in urine, 514
 Fasting, feces in, 231
 metabolism in, 608
 Fatigue substances of muscle, 374
 Fats, 180
 absorption of, 182, 192
 apparatus for determination of melting-point of, 187
 chemical composition of, 180, 181
 congealing-point of, 188
 crystallisation of, 182, 185
 digestion of, 182, 192
 emulsification of, 182, 184
 experiments on, 184
 formation of, from protein, 183
 formation of acrolein from, 184
 hydrogenation of, 181
 hydrolysis of, 181
 influence of, on carbohydrate absorption, 589
 in milk, 341, 345, 348, 352, 353
 in urine, 440, 472, 494, 498
 melting-point of, 182, 187
 nomenclature of, 180, 181
 occurrence of, 180
 permanent emulsions of, 182, 184
 protein-sparing, action of, 602
 quantitative determination of, in milk, 353
 rancid, 182
 reaction of, 182
 saponification of, 181, 185, 186
 solubility of, 182, 184
 transitory emulsions of, 182, 184
 Fat-soluble "A," influence of on growth, 585
 occurrence of, 585
 Fat-splitting enzymes (see Lipases 5, 13, 182, 192, 197)
 Fatty acid, 180, 182, 186, 216, 398, 425
 Fatty casts in urinary sediments, 494, 498
 Fatty degeneration, 183
 Fecal amylase, quantitative determination of, 243
 Fecal bacteria, 225, 228, 229, 245, 611
 quantitative determination of, 245
 Feces, 225, 610, 615
 agar-agar, influence of, 228, 608, 612
 albumin and globulin in, 241
 bacteria in, 225, 228, 229, 245, 611
 bacterial nitrogen in, demonstration of, 611
 bile acids in, 240
 bilirubin in, 226, 240
 blood in, 229, 237
 carbohydrate in, estimation of, 614
 casein in, 240
 cholesterol in, 228, 236
 collection and preservation in metabolism experiments, 611
 color of, influence of drugs and foods upon, 242
 daily excretion of, 225, 611
 enzymes of, 230, 243
 experiments on, 233, 610, 615
 "fasting," 231
 fat in, determination of, 247
 food residues in, 231, 613
 form and consistency of, 227
 hydrobilirubin in, 226, 239
 hydrogen ion concentration of, 227

- Feces, indole in, 227, 241
 determination of, 246
 influence of defective mastication on, 613
 inorganic constituents of, 229, 241, 614
 elements of, demonstration of, 614
 macroscopic constituents of, 228, 233
 metabolic product, nitrogen in, 231, 612
 microscopic constituents of, 228
 microscopical examination of, 233
 nitrogen of, 231, 612
 nucleoprotein in, 240
 odor of, 227
 parasites and ova in, 231
 pigment of, 226
 proteose and peptone in, 241
 reaction of, 227
 Scybala form of, 227
 separation of, importance of, 228, 243, 610
 separation of, experiment on, 243, 610
 weighing of, 611
- Fehling's method for determination of glucose in urine, 546
 Benedict's modifications of, 545
 solution, preparation of, 619
 test, 26, 445
 Allen's modification of, 447
 Benedict's modifications of, 26, 445
- Fermentation, lactic acid, 173, 342
 "sugar-free," 10, 32, 449
- Fermentation method for determination of glucose, 553
- Fermentation test, 31, 449
- Ferments, classification of, 4
- Ferric chloride test for thiocyanate in saliva, 59
 for melanin in urine, 480
- Fibrin, 250, 260, 272, 494, 503
 carmine, preparation of, 12
 congo-red, preparation of, 12
 in urinary sediments, 494, 503
 separation of, from blood, 251, 260
 solubility of, 272
- Fibrin ferment, 251, 260
- Fibrin-heteroproteose, 68
- Fibrinogen, 251, 260, 261, 272
- Fibroin, Tussah silk, 68
- Fischer apparatus, 75
 photograph of, 75
- Fleischl's hemometer, 305
 description of, 304
 determination of hemoglobin by, 305
- Fleischl-Miescher hemometer, 306
- Fluorides in urine, 398, 439
- Fly-maggots, experiments on, 183
- Foam test for bile acids, 212, 462
- Folin's method for determination of acetone in urine, 561
 acidity of urine, by titration, 508
 ammonia, 523
 creatinine, in blood, 276
 in urine, 530, 532
 ethereal sulphates, 567
 inorganic sulphates, 567
 total sulphates, 566
 of preparing cystine, 87
 test for uric acid, 409
 theory of protein metabolism, 602
- Folin and Bell's method for determination of ammonia in urine, 526
- Folin and Denis' method for determination of uric acid in blood, 279
- Folin and Denis' method for determination of uric acid in urine, modification of, 534
- Folin and Denis' method for phenols in urine, 563
- Folin and Denis' method for Bence-Jones protein, 556
- Folin and Denis' nephelometric method for albumin in urine, 556
- Folin and Flanders' method for hippuric acid in urine, 542
- Folin and Macallum's microchemical method for ammonia, 525
- Folin, Benedict and Myers' method for determination of creatine, 533
- Folin-Benedict method for determination of creatine, 532
- Folin-Farmer microchemical method for total nitrogen in urine, 514
 Bock and Benedict's modification of, 517
 Gulick's modification of, 519
- Folin-Shaffer method for determination of uric acid, 536
- Foods, composition of, 592
 purine content of, 595
- Foreign substances in urinary sediment, 494, 503
- Form elements of blood, 249
- Formaldehyde, as milk preservative, 352
 reaction (Konto), 222
- Formaldehyde-H₂SO₄ test (Mörner), 86
- Formation of methyl-phenylfructosazone, 36
- Formic acid, 26, 398, 425
- Formol titration method of Benedict-Murlin, 528
 of Malfatti, 525
 of Sørensen, 526
- Fractional coagulation of proteins, 105, 117
 method of gastric analysis, 151, 163
- Free hydrochloric acid, 57, 140, 157, 168
 tests for, 157
- Freezing-point of bile, 207
 blood, 249
 milk, 342
 pancreatic juice, 190
 urine, 393
- Frey-Gigon method for amino-acid nitrogen in urine, 529
- Fridericia apparatus, 332
- Fridericia's method for determination of alkali reserve, 332
- Fructose, Borchardt's reaction for, 36, 475
 in urine, 475
 methyl-phenylhydrazine test for, 36
 Seliwanoff's reaction for, 35
- Fuchsin-frog experiment, 376
- Fundus glands, 139
- Furfural, formation of, 22
 solution, preparation of, 623
- Fusion mixture, preparation of, 129
- Galactans, 20, 50, 51
- Galactase, 348
- Galactose, 19, 36, 342, 474
 experiments on, 36
- Gallic acid test for formaldehyde, 352
- Ganassini's test, 409
- Gastric acidity and the use of indicators, 155
 automatic regulation of, 150, 154

- Gastric analysis**, 151, 177
 detection of bile in, 175
 of blood in, 174
 of food rests in, 176
 of lactic acid in, 173
 of mucus in, 176
 determination of free acidity in, 168
 of peptic activity in, 169
 of total acidity in, 166
 of tryptic activity in, 172
 examination of samples in, 166
 fractional method of, 151, 163
 introduction of the tube in, 163
 Rehfuß tube, use of in, 151, 163
 retention meal in, 165
 test meals in, 165
 use of indicators in, 155
- Gastric digestion**, 138
 conditions essential for, 145
 general experiments on, 145
 influence of bile on, 147
 influence of different temperatures on, 146
 influence of water on, 138, 144
 most favorable acidity for, 146
 power of different acids in, 147
 products of, 141, 145
- Gastric fistula**, 138
- Gastric juice**, 139, 145
 acidity of, 140, 151
 automatic regulation of, 150
 influence of water on, 138, 144
 of regurgitation on, 140, 144, 150, 154
 analysis of, 151, 177
 artificial, preparation of, 145
 collection of, 144
 composition of, 139, 155
 enzymes of, 139
 human, collection of, 144
 experiments on, 148
 lactic acid in, test for, 173
 origin of hydrochloric acid of, 140
 quantitative analysis of, 151, 177
 quantity of, 138
 reaction of, 139
 secretion of, 138, 139
 influence of meat extractives on, 148
 of psychical factors on, 149
 of water on, 138, 144
 specific gravity of, 139
- Gastric lipase**, 139, 143
- Gastric protease**, 12
- Gastric rennin**, 139, 143, 148, 343, 350
 action of, upon casein, 143, 148, 343, 350
 experiments on, 148, 350
 influence of, upon milk, 148, 350
 in gastric juice, absence of, 143
 nature of action of, 143, 343
 occurrence of, 143
- Gastric residuum**, 155, 164
 analysis of, 165
 composition of, 155
 removal of, 165
- Gelatin**, 67, 68, 361, 362
 coagulation of, 362
 decomposition of, 67, 68
 experiments on, 362
 formation of, 361, 362
 Hopkins-Cole reaction on, 362
 Millon's reaction on, 362
 precipitation of, by alcohol, 362
 alkaloidal reagents, 362
 metallic salts, 362
 by mineral acids, 362
 preparation of, from cartilage, 364
 from collagen, 361, 362
 salting-out of, 362
 solubility of, 362
- Gerhardt's test for acetoacetic acid**, 467
- Gerhardt's test for urobilin**, 428
- Giss' biuret reagent**, preparation of, 101
- Gliadin**, 67, 94, 111, 112
 decomposition of, 67
 preparation of, 112
 tests on, 112
- Globin**, 67, 94, 113, 354
 decomposition of, 67
- Globulins**, 93, 108
 experiments on, 109
 preparation of, 109
 serum, 94, 250, 440, 454
 in urine, 440, 454
 tests for, 454
 vegetable, 109
- Glucoproteins** (see Glycoproteina, pp. 95, 112, 361)
- Glucosazone**, crystalline form of, Plate III, opposite p. 22
- Glucose**, 19, 21
 alcoholic fermentation of, 30
 Allen's modification of Fehling's test for, 447
 assimilation limit of, 21, 591
 Barfoed's test on, 30
 Benedict's modification of Fehling's test, 26, 445
 Benedict's modification of Lewis-Benedict method, in blood, 283
 bismuth tests, 28, 448
 Boettger's test on, 28, 448
 Bottu's test on, 23, 443
 Cipollina's test on, 23, 442
 Cramer's mercuric oxide test on, 28, 447
 diffusibility of, 23
 experiments on, 21, 441
 Fehling's test on, 25, 444
 fermentation of, 31, 449
 formation of caramel from, 32
 formula for, 21
 glycosuria produced by, 591
 Haines test on, 447
 hyperglycemia produced by, 588
 iodine test on, 23
 Molisch's reaction on, 21
 Moore's test on, 24
 Nylander's test on, 29, 448
 optical activity of, 32, 33
 phenylhydrazine test on, 22, 441
 picric acid test, 30
 polariscopic tests, 449
 precipitation by alcohol, 23
 quantitative determination of, 283, 545
 in blood, 283
 in urine, 545
 reduction tests on, 24, 443
 Riegler's reaction on, 23, 443
 solubility of, 21

- Melting-point apparatus, 187
of fats, determination of, 187
- Mercuric oxide test for reducing sugar, 28, 447
- Mercury in urine, 478
detection of, 479
- Metabolic product nitrogen, 231, 612
- Metabolism, 584
experiments, 585
balance of income and outgo in, preparation of, 615
collection and preservation of feces in, 611
separation of feces in, 610
urine in, 395, 588
- Polin's theory of, 602
in acidosis, 319, 599
in fasting, 608
in gout, 594, 597
influence of acids on, 324, 605, 606
of alkalis on, 324, 605, 606
of defective mastication on, 613
of digestion on, 600
of fats and carbohydrates as protein spacers in, 602
of high calorie, non-nitrogenous diet on, 607
indigestible, non-nitrogenous material on, 612
of water on, 597
of acid-forming and base-forming foods, 603
of ammonium benzoate, 609
of carbohydrates, 588-592, 602
of energy, 602, 607, 608
of fat, 592, 602
of inorganic elements, 614, 615
of nitrogen and sulphur as influenced by diet, 600
of proteins, 592
time relations of, 592
of purines, 594-597
on "salt-free" diet, 599
on salt-rich diet, 599
relation of bacterial nitrogen of feces to, 611
of metabolic product nitrogen of feces to, 612
study of creatinine elimination in, 597
time relations of protein, 592
- Menstrual blood, 261
- Metaproteins, 95, 115
acid, 95, 115, 116
alkali, 95, 115, 116
experiments on, 116
precipitation of, 116
sulphur content of, 116
- Methemoglobin, 258, 303
- Methylene blue, 147
reaction (Russo), 484
- Methyl-mercaptan, 216
- Methyl orange, use of, as indicator, 162
red, use of, as indicator, 162
violet, use of, as indicator, 162
- Methyl-pentose (see Rhamnose, p. 19)
- Methylphenylfructosazone, formation of, 36
- Methylphenylhydrazine, 36
- 1-methylxanthin, 398, 429
- Mett's method for determination of peptic activity, 169
- Mett's tubes, preparation of, 170
- Micro-organisms in urinary sediments, 494, 503
in feces, 225, 229
in intestine, 225, 229
- Milk, 341
ash of human and cow's, 346
casein of, 341, 343, 347, 350
citrates in, 341
composition of human and cow's, 345, 346
curds, photographs of, 344
detection of calcium phosphate in, 351
lactose in, 351
preservatives in, 352
difference between human and cow's, 344, 345, 346, 349
experiments on, 348
formation of film on, 342, 348
freezing-point of, 342
guaiac test on, 349
human and cow's, differentiation, 345, 349
influence of rennin on, 143, 148, 343
isolation of fat from, 352, 353
Kastle's peroxidase reaction on, 349
lactose in, 341, 342, 347, 351
crystalline form of, 347
fermentation of, 342
microscopical appearance of, 343, 348
preparation of casein from, 350
properties of casein of, 343, 347, 351
quantitative analysis of, 353
reaction of, 342, 348
separation of coagulable proteins of, 351
serum, 341
specific gravity of, 342, 348
unknown constituents of, 341
- Millon's reaction, 98
reagent, preparation of, 98
- Mohr's method for determination of chlorides, 378
- Molisch's reaction, 21
- Molybdate solution, preparation of, 626
- Monamino acid nitrogen, 64
- Monosaccharides, 19, 20
Barfoed's test for, 30
classification of, 19
- Mörner's reagent, preparation of, 86
test for tyrosine, 86
- Motor and functional activities of the stomach, 147
- Mucic acid, 37, 41, 473, 474
test, 37, 41, 473, 474
- Mucin, 55, 58, 95, 113
biuret test on, 59
hydrolysis of, 59
isolation of, from saliva, 59
Millon's reaction on, 59
- Mucins, 55, 58, 95, 113
- Mucoid, 95, 113, 360, 361
experiments on, 361
hydrolysis of, 361
in urine, 424, 456
preparation of, from tendon, 361
- Mucoida, 95, 113, 360, 361
- Murexide test, 408
- Muscle plasma, 368, 375
formation of myosin clot in, 368, 376
fractional coagulation of, 368, 376
preparation of, 375
reaction of, 371, 376

- Muscular tissue**, 368
 ash of, smooth and striated, 374
 commercial extracts of, 374
 experiments on "dead," 377
 "living," 375
 extractives of, 369, 378
 fatigue substances of, 374
 formulas of nitrogenous extractives of,
 375
 glycogen in, 369, 370, 377
 involuntary, 368
 lactic acid in, 369, 370, 376
 magnesium in, demonstration, 378
 nonstriated, 368
 phosphate in, demonstration of, 378
 pigment of, 374
 preparation of glycogen from, 377
 muscle plasma from, 375
 proteins of, 368, 375, 376, 377
 reaction of living, 371, 376
 rigor mortis of, 368, 369
 separation of extractives from, 378
 striated, 368
 voluntary, 368
- Myohematin**, 374
- Myosan**, 95, 377
 formation of, 377
- Mysin**, 368, 377
 biuret test on, 377
 coagulation of, 377
 preparation of, 377
 solubility of, 377
- Myosinogen**, 368, 376
- Myristic acid**, 341
- Myristin**, 181
- Myrtle wax** (see Bayberry tallow, 185)
- Nakayama's reaction** for bile pigments, 211, 461
 reagent, preparation of, 211, 461
- α -Naphthol reaction**, 21
- Naphthorescinol reaction** for glycuronates
 (Tollens), 470
- Nencki and Sieber's reaction** for uroscosin, 481
- Neosmine**, 369, 375
 formula for, 375
- Nephelometer**, Bloor, cut of, 296
 description of, 296
 Kober, cut of, 298
- Nephelometric**, determination of, acetone bodies
 in blood, 299
 fat in blood, 300
 in milk, 355
 proteins in milk, 356
 in urine, 556
- Nephelometric methods**, 295, 300, 355, 356
- Nephritis**, blood in, 252, 274, 275
- Nephroscosin** in urine, 481
- Nervous tissue**, 381
 constituents of, 381
 experiments on lipoids of, 384
 lipoids of, 381, 384
 percentage of water in, 381
 phosphorized fats of, 381
 proteins of, 381
- Nessler-Winkler solution**, 626
- Neurine**, 216
- Neumann's method** for total phosphorus, 574
- Neurokeratin**, 381
- Neutral fats**, 181, 182, 184
- Neutral olive oil**, preparation of, 184
- Neutral red**, use of, 162
- Neutral sulphur compounds**, 397, 420
- Ninhydrin reaction**, 101
- Nippe's hemin test**, 268
- Nitrates** in urine, 398, 439
- Nitric acid test** (Heller), 103, 451
 for phenol, 224
- Nitric acid-MgSO₄ test** (Roberts), 104, 452
- Nitrilase**, 8
- Nitrilase**, 8
- Nitrites** in saliva, test for, 59
- Nitrogen**, 63, 64
 forms of, in protein molecule, 64
 importance of, in sustaining life, 64
 in urine, quantitative determination of, 512
- Nitrogen distribution**, calculation of, 513
- Nitrogen iodide**, formation of, 64
- Nitrogen "lag"**, 592
 metabolic product, 231, 612
 "partition," 513, 598, 600
- Nitrogenous extractives** of muscular tissue, 369
 378
 formulas for, 375
- p*-Nitrophenol**, use of, as indicator, 162
- Nitroprusside reaction** for indole (Legal), 222
- Nitroprusside test** for creatinine (Weyl), 413
- Nitroprusside-acetic acid test** for creatinine
 (Salkowski), 413
- Nitroso-indole nitrate test**, 223
- Nitrosothymol**, formation of in Heller's test, 451
- Non-nitrogenous extractives** of muscular tissue,
 369
- Non-protein nitrogen** of blood, 252, 274, 275, 276
- Normal urine**, 387, 397, 399
 characteristics of, 387
 constituents of, 397, 399
 experiments on, 413-439
- Novaine**, 369
 formula for, 375
- Nubecula**, 425, 456
- Nucleases**, 5
 experiments on, 134
- Nucleic acid**, 124-128, 131-137
 decomposition of, 124-126
 experiments on, 131-137
 from yeast, formula for, 125
- Nucleicacidase**, 5, 126
- Nucleins**, 123, 124, 145, 594
- Nucleoproteins**, 95, 112, 123, 128-131, 207, 211,
 240, 381, 397, 424, 440, 456
 decomposition of, 123-124
 experiments on, 128-131
 from yeast, 128
 preparation of, 128
 protein, carbohydrate and phosphoric
 radicals in, 130
 tests on, 129
 thymus, preparation of, 130
 experiments on, 130
- in bile, 207, 211
 in feces, 240
 in nervous tissue, 381
 in urine, 397, 424, 440, 456
 test for, 456
 occurrence of, 123
 Ott's precipitation test for, 456

- Nucleosidase, 5, 126
 Nucleoside, 125
 Nucleotidase, 5, 126
 Nucleotide, 125
 Nylander reaction, 29, 448
 Nylander reagent, preparation of, 29, 448
 Obermayer's test for indican, 416
 reagent, preparation of, 416
 Oblitine, 369
 "Occult" blood in feces, 229, 237
 tests for, 237
 Olein, 181, 341
 Olive oil, 184
 emulsification of, 184
 neutral, preparation of, 184
 Oliver's peptone test for bile acids, 213, 463
 Optical methods, 31-34
 Orcinol-HCl reaction (Bial), 38, 472
 Orcinol test, 38, 472
 Organic physiological constituents of urine, 397
 Organized ferments, 1
 Organized urinary sediments, 486, 494
 Ornithine, 65, 218
 Ortho-tolidin test for blood, 174, 237, 267, 458
 Osborne-Folin method for determination of total sulphur in urine, 569
 Ossein, 365
 preparation for, 365
 Ossealbumoid, 365
 Osseomucoid, 95, 113, 365
 chemical composition of, 113
 Osseous tissue, 365
 experiment on, 366
 Ott's precipitation test for detection of nucleoprotein in urine, 456
 Ovalbumin, 93
 Ovoglobulin, 94
 Oxalated plasma, preparation of, 272
 Oxalic acid, 397, 419, 565
 experiments on, 419
 formula for, 419
 in urine, 397, 419
 quantitative determination of, 565
 Oxaluria, 419
 Oxaluric acid, 397, 425
 Oxamide, 100
 Oxidases, 5, 14, 348
 experiments on, 14
 Oxyacids, 216, 224, 397, 422
 tests for, 224
 β -Oxybutyric acid (see β -hydroxybutyric acid, 274, 288, 320, 324, 440, 463, 468, 557)
 Oxyhemoglobin, 64, 254, 258, 259, 270
 crystalline forms of, 255-258
 quantitative determination of, 304-309
 Reichert's method for crystallisation of, 270
 Oxymandelic acid (see Hydroxymandelic acid, 397, 423)
 Oxyproline, 65, 67, 85
 Oxyproteic acid, 397, 420, 483
 Palmer's method for determination of hemoglobin, 309
 Palmitic acid, 180, 181, 185, 186
 crystalline form of, 186
 experiments on, 186
 formula for, 181
 preparation of, 186
 Palmitin, 181
 Pancreatic amylase, 4, 11, 191, 196
 digestion of dry starch by, 192, 196
 inulin by, 196
 experiments on, 11, 195
 influence of bile upon action of, 196
 most favorable temperature for action of, 196
 Pancreatic digestion, 189
 general experiments on, 194
 products of, 190, 193
 Pancreatic insufficiency, Schmidt's nuclei test for, 241
 Pancreatic juice, 123, 189, 190, 191, 193
 artificial, preparation of, 193
 daily secretion of, 190
 enzymes of, 190
 freezing-point of, 190
 mechanism of, secretion of, 189
 reaction of, 190
 solid content of, 190
 specific gravity of, 190
 Pancreatic lipase, 5, 13, 182, 192
 ethyl-butyrate test for, 197
 experiments on, 13, 197
 litmus-milk test for, 197
 Pancreatic protease (see Trypsin, pp. 5, 12, 190)
 Pancreatic rennin, 5, 190, 193, 198
 experiments on, 198
 Papain, 5, 13
 Papayotin (see Papain)
 Paracasein, 343
 Para-cresol-sulphuric acid, 397, 413
 Paradimethylamino benzaldehyde solution, preparation of, 627
 Paralactic acid, 251, 342, 370, 398, 426
 Paramyosinogen, 368
 Paranucleoprotagon, 381, 384
 Paraoxyphenylacetic acid, 216, 218, 397, 423
 Paraoxy- β -phenyl- α -amino-propionic acid, 69, 74, 86
 Paraoxyphenylpropionic acid, 216, 218, 397, 422
 Paraphenylenediamine hydrochloride, 353
 Parasites, 231, 494, 503
 Paraxanthine, 398, 429
 Parietal cells, 139
 Parotid glands, characteristics of saliva secreted by, 54
 Pathological constituents of urine, 440
 Pathological urine, 387, 440
 constituents of, 440
 experiments on, 441
 "Partition" of nitrogen and sulphur in urine, 600
 Pektoscope, 393
 Pentamethylenediamine, 218
 Pentapeptides, 66, 95
 Pentosans, 20, 36, 50, 51
 Pentosazone, crystals of, 471
 Pentoses, 19, 37
 experiments on, 37
 in urine, 440, 471
 tests for, 471
 Pepsin (see Gastric Protease), 5, 12, 141, 145-147, 169
 action of, influence of bile upon, 147
 influence of different acids upon, 147
 influence of metallic salts upon, 147
 temperature upon, 146

- Pepsin**, conditions essential for action of, 145
 differentiation of, from pepsinogen, 141, 146
 digestive properties of, 141
 formation of, 141
 most favorable acidity for action of, 146
 presence of, in intestine, 142
 proteolytic action of, 141
- Pepsin-hydrochloric acid**, 146
- Pepsin-rennin controversy**, 143
- Pepsinogen**, 6, 141, 145, 146
 differentiation of, from pepsin, 141, 146
 extract of, preparation of, 145
 formation of, 141
- Peptases**, 5
- Peptic activity**, Given's modification of Rose's
 method for determination of, 172
 Mett's method for the determination of,
 169
 Rose's method for determination of, 171
- Peptic proteolysis**, 141
 products of, 141
 relation of, to tryptic proteolysis, 142
- Peptides**, 66, 70, 96, 120
- Peptone**, 65, 71, 96, 118
 amphi, 95, 119
 anti, 119
 differentiation of, from proteoses, 119
 experiments on, 119, 120
 in urine, 440, 454
 tests for, 455
 separation of, from proteoses, 120
- Peptone test for bile acids** (Oliver), 213, 463
- Periodide test for cholins**, 385
- Permutit**, use of in determining ammonia, 526
- Peroxidase reaction**, Kastle's, for milk, 349
- Peroxidases**, 5, 14, 15, 321
- Peters' method for sugar determination**, 548
- Pettenkofer's test for bile acids**, 212, 462
 Mylius's modification of, 212,
 462
 Neukomm's modification of,
 213, 463
- Phenaceturic acid**, 398, 426
- Phenol**, 217, 223, 414, 563, 565
 excretion of, 414, 565
 quantitative determination of, in urine, 563
 tests for, 223
- Phenolphthalein as indicator**, 157, 158, 161, 162,
 166, 508
 preparation of, 162, 628
 test for blood in feces, 238
- Phenolsulphonephthalein test for kidney effi-
 ciency**, 484
- Phenol-sulphuric acid**, 397, 413
- Phenylacetic acid**, 218
- Phenyl- α -amino propionic acid**, 69, 73
- Phenylalanine**, 65, 67, 69, 73
- Phenylethylamine**, 218
- Phenylglucosazone**, 22 and Plate III opposite
- Phenylhydrazine**, 22
 acetate solution, preparation of, 22
 mixture, preparation of, 22
 reaction, 22, 23, 441
 Cipollina's modification of, 23, 442
- Phenylmaltosazone**, crystalline form of, Plate III,
 opposite p. 22
- Phenylmaltosazone**, crystalline form of Plate III,
 opposite p. 22
- Phenylpotassium sulphate**, 414
- Phenylpropionic acid**, 218
- Phloroglucinol-HCl reaction**, 36, 38, 472, 475
- Phosphate solutions and hydrogen ion concen-
 tration**, 158, 160, 161, 163, 319, 389, 509
- Phosphates in urine**, 389, 434, 572
 detection of, 434
 experiments on, 434
 quantitative determination of, 572
- Phosphatase**, 9
- Phosphatase**, 9
- Phosphatides**, 207, 301, 381
- Phosphocarnic acid**, 369, 375, 398, 427
- Phosphonuclease**, 136
- Phosphoproteins**, 95, 96, 113, 342
- Phosphorized compounds in urine**, 398, 427
- Phosphorus in urine**, determination of, 572
 organic, test for, 129
- Phosphotungstic acid reaction** (Polin), 409
 precipitation test for protease
 (v. Aldor), 435
- Physiological constituents of urine**, 397
- Phytase**, 5
- Phytin**, 5
- Picric acid reaction for creatinine** (Jaffe), 413
 test for glucose, 30
- Pigments of urine**, 387, 398, 427, 480
- Pine wood test for indole**, 223
- Piria's test for tyrosine**, 86
- Plasma of blood**, 249, 279
 of muscle, 368, 375
- Plasmapheresis**, 253
- Polariscope**, use of, 32
 in detection of conjugate glycuronates,
 471
 in determination of glucose, 32, 554
 β -hydroxybutyric acid, 470
- Polypeptides**, 66, 70, 96
- Polysaccharides**, 20, 43
 classification of, 20
 properties of, 43
- Posner's modification of biuret test**, 101
- Potassium hydroxide test for blood in urine**
 (Heller), 457
 indoxyl-sulphate (see Indican, pp. 216, 415,
 562)
 determination of, 562
 formula for, 216, 415
 origin of, 216, 416
 tests for, 415, 416
- Potassium in urine**, 398, 437, 581
 quantitative determination of, 581
- Primary protein derivatives**, 65, 95, 114
- Primary proteoses**, 119
- Products of protein hydrolysis**, 65, 67, 68, 69, 71,
 190
- Prolamins**, 94, 111
 classification of, 94
 preparation of, 112
 tests on, 112
- Prolin**, 65, 67, 68, 83, 111, 142, 190
 crystalline form of copper salt of, 84
 crystalline form of *levo*- α -, 84
- Prosecretin**, 189
- Protagon**, 381, 382
 preparation of, 384
 structure of, 383
- Protamines**, classification of, 94, 96

- Proteans**, 95, 114
Protease, gastric, 5, 12, 141, 145
 experiments on, 12, 145
 pancreatic, 5, 12, 190
 experiments on, 12, 193
 vegetable, 5, 13
Proteases, 5, 12
 experiments on, 12
Protective enzymes (see *Defensive Enzymes*), 3
Proteid, (see *Proteins*)
Protein content of foods, 592
 derivatives, primary, 65, 95, 114
 secondary, 65, 96, 118
 metabolism, time relations of, 592
 influence of water on, 597
 utilization, determination of, 613
Protein-coagulating enzymes, 5, 143, 193, 260, 343
Protein-cystine, 77
Protein-sparing action of fat and carbohydrate, 602
Proteins, 63, 92, 440, 450
 acetic acid and potassium ferro-cyanide test for, 104
 action of alkaloidal reagents on, 103
 of metallic salts on, 103
 mineral acids, alkalis and organic acids on, 103
 biuret test on, 100
 chart for use in review of, 121
 chemical composition of, 63
 classification of, 94, 96
 coagulated, 96, 116
 biuret test on, 118
 formation of, 116
 Hopkins-Cole reaction on, 118
 Millon's reaction on, 118
 quantitative determination of, 554
 solubility of, 118
 xanthoproteic reaction on, 118
 coagulation, influence of salts upon, 117
 coagulation or boiling test for, 105
 color reactions of, 98
 conjugated, 95, 96, 112, 123
 classes of, 95, 112
 experiments on, 59, 128, 270, 301, 350
 nomenclature of, 95, 112
 occurrence of, 95, 112
 decomposition of, 64, 67, 68
 by hydrolysis, 65
 by oxidation, 64
 products of, 64, 67, 68, 71
 experiments on, 85
 separation of, 85
 study of, 64, 67, 85
 derived, 95, 114
 formation of fat from, 183
 formulas of, 64
 Heller's ring test on, 103
 Hopkins-Cole reaction on, 99
 importance of, to life, 63
 in urine, 440, 450, 554
 determination of, 554
 test for, 451
 Millon's reaction on, 98
 of milk, 315, 318
 molecular weights of, 64
 ninhydrin reaction on, 101
 Posner's reaction on, 101
 Proteins, precipitation of, by alcohol, 106
 alkaloidal reagents, 103
 metallic salts, 103
 mineral acids, 103
 precipitation reactions of, 102
 quantitative determination of, in milk, 356
 review of, 121
 Robert's ring test on, 104
 salting-out experiments on, 105
 salts of, 102
 scheme for separation of, 122
 simple, 94, 96, 97
 synthesis of, 66, 70
 xanthoproteic reaction on, 99
 Proteolysis, peptic, 142
 tryptic, 142, 190
 Proteolytic enzymes (see *Proteases*, p. 12)
 Proteose, 64, 94, 96, 118
 v. Aldor's method for detection of, 455
 biuret test on, 120
 coagulation test on, 120
 deutero, 94, 96, 120
 differentiation of, from peptone, 120
 experiments on, 119, 120
 hetero, 95, 120
 in urine, 440, 454
 test for, 455
 potassium ferrocyanide and acetic test on, 120
 powder, preparation of, 120
 precipitation of, by nitric acid, 120
 by picric acid, 120
 by potassium-mercuric iodide, 120
 by trichloroacetic acid, 120
 primary, 120
 proto, 95, 96, 120
 Schulte's method for detection of, 455
 secondary, 120
 separation of, from peptones, 120
 Protoproteose, 95, 96, 120
 Proteoses and peptones, 95, 96, 119, 120
 separation of, 120
 tests on, 120
 Proteose-peptone, 119
 Proteose-peptone, coagulation test on, 120
 experiments on, 119
 Millon's reaction on, 119
 precipitation of, by nitric acid, 120
 by picric acid, 120
 Prothrombin, 260, 261
 Pseudo-globulin, 250
 Psychical stimulation of gastric secretion, 149
 Ptomaines and leucomaines in urine, 398, 421
 Ptyalin (see *Salivary amylase*, I, 4, 10, 55, 191)
 Purinases, 127, 134
 experiments on, 134
 Purine bases, 125, 126, 132, 369, 375, 394, 429, 537, 597
 formulas for, 127, 375
 in urine, quantitative determination of, 537
 tests on, 132, 133
 content of foods, 595
 excretion, rate of, 597
 oxidases, 5, 127, 134
 oxy, 127, 132
 Purine-free and high purine diets, influence of, 594
 Pus casts in urinary sediments, 494, 501

- Pus cells in urinary sediments, 494, 495
 in urine, 459
 tests for, 459, 460
- Putrefaction, control of, by carbohydrate, 217
 indican as an index of, 216, 414
- Putrefaction mixture, preparation of a, 218
 products, 216
 experiments on, 218
 most important, 216
 tests for, 222
- Putrescine, 216
- Pyloric glands, 138
- Pyrimidine bases, 125, 126, 128
 experiments on, 133
 formulas for, 128
- Pyrocatechol-sulphuric acid, 397, 414
- α -pyrrolidine-carboxylic acid (see Proline, pp. 65,
 67, 68, 83, 111, 142, 190)
- Pyuria, 459
- Quadriurate, 490
- Qualitative analysis of the products of salivary
 digestion, 60
- Quantitative analysis of blood, 274
 of gastric juice, 151
 of milk, 353
 of urine, 508
- Quevenne lactometer, determination of specific
 gravity of milk by, 353
- Raffinose, 19, 42
- Raisiss and Dubin's volumetric methods for total
 sulphur, 571
- Rancid fat, 182
- Rats, white, experiments on, 585
- Raw and heated milk tests, 349
- Reaction of the urine, 389, 434, 508, 603
- Reagents and solutions, 617-633
- Reduced alkali-hematin, 303
- Reduced hemoglobin, 301
- Reductases, 348
- Regurgitation, automatic regulation of gastric
 acidity by, 150
- Rehflus stomach tube, cut of, 152
 use of, 152, 163
- Reichert's method for crystallisation of oxy-
 hemoglobin, 270
- Reinsch test for arsenic, 478
 for mercury, 479
- Remont's method for detection of salicylic acid
 and salicylates, 352
- Rennin, gastric, 139, 143, 148, 343, 350
 action of, upon casein, 143, 148, 343, 350
 experiments on, 148, 350
 influence of, upon milk, 148, 350
 in gastric juice, absence of, 143
 nature of action of, 143, 343
 occurrence of, 143
- Rennin, pancreatic, 5, 193, 198
 experiments on, 198
- Rennin-pepsin controversy, 143
- Resorcinol-HCl reaction, 35, 476
- Respiration, chemistry of, 259
- Retention meal in gastric analysis, 165
- Reticulin, 112
- Reversibility of enzyme action, 8, 57
- Reynolds-Gunning test for acetone, 466
- Rhamnose, 19, 38
- Rhubarb, influence of, on color of feces, 242
- Ricin, 13, 266
- Riegler's reaction, 443
- Rigor mortis, 368, 369
- Ring test for urobilin, 428
- Roaf's method for crystallizing hippuric acid, 418,
 608
- Robert's ring test for protein, 104, 452
 reagent, preparation of, 104, 452
- Robin's reaction for uroscopin, 481
- Rosenheim's bismuth test for choline, 386
- Rosenheim's periodide test for choline, 385
- Rosenheim and Drummond's volumetric methods
 for sulphates and total sulphur, 570, 571
- Rose's method for determination of pepsin, 171
- Rosolic acid, use of, as indicator, 157, 162
- Rothera's reaction for acetone, 466
- Rubner's test for lactose in urine, 474
- Ruhemann's uricometer, cut of, 537
 use of, 537
- Russo's reaction, 484
- Ruttan and Hardisty's ortho-tolidin test for blood,
 174, 237, 267, 458
- Saccharide group, 20
- Saccharose (see Sucrose, 19, 41)
- Sahli's desmoid reaction, 147
 reagent, 168
- Salicylaldehyde reaction for acetone (Frommer),
 466
- Saliva, 54
 alkalinity of, 55
 amount of, 55
 bacteria in, 58
 biuret test on, 58
 calcium in, 59
 chlorides in, 59
 constituents of, 55
 digestion of dry starch by, 60
 digestion of inulin by, 60
 digestion of starch paste by, 56, 59
 dilution of, influence on digestion, 60
 enzymes contained in, 55
 excretion of potassium iodide in, 61
 inorganic matter in, tests for, 59
 Millon's reaction on, 58
 mucin from, preparation of, 59
 nitrites in, test for, 59
 phosphates in, test for, 59
 potassium thiocyanate in, 59
 reaction of, 55, 58
 secretion of, 54
 specific gravity of, 55, 58
 sulphates in, test for, 59
 tests on, 58
 thiocyanates in, 55, 59
 tripeptide-splitting enzymes in, 57
- Salivary amylase, 1, 4, 10, 55, 191
 activity of, in stomach, 57, 192
 inhibition of activity of, 57
 nature of action of, 56, 57
 products of action of, 56
 scheme showing, 56
- Salivary digestion, 54
 graphic representation of, 56
 influence of acids and alkalis on, 56, 61,
 dilution on, 57, 60
 metallic salts on, 61
 temperature on, 60

- Salivary digestion, nature of action of acids and alkalis on, 61
 qualitative analysis of products of, 60
- Salivary digestion in stomach, 57, 192
 glands, 54
 stimuli, 54
- Salkowski-Autenrieth-Barth method for determination of oxalic acid in urine, 565
- Salkowski-Schippers reaction for bile pigments, 212, 461
- Salkowski's test for cholesterol, 214, 385
 for creatinine, 413
- Salmine, 67, 68, 69, 95, 96
- "Salt-free" diet, metabolism on a, 599
- Salted plasma, preparation of, 272
- Salting-out experiments on proteins, 105, 122
- Santonin, influence of, on color of feces, 242
- Saponification, 181, 185, 186
 of bayberry tallow, 185
 of lard, 186
- Sarcosolactic acid, 370
- Scallops, preparation of glycogen from, 377
- Schalfjew's method for preparation of hemin, 270
- Schema for "blood counting," 317
- Scheme for analysis of biliary calculi, 213
 bone ash, 367
 stomach contents, 163
 urinary calculi, 506
 separation of carbohydrates, 53
 of proteins, 122
- Scherer's coagulation method for determination of albumin in urine, 554
- Schiff's reaction for cholesterol, 214, 385
 for uric acid, 409
- Schmidt diet, composition of, 222
- Schmidt's nuclei test for pancreatic insufficiency, 241
- Schmidt's test for hydrobilirubin, 239
- Schulte's method for detection of proteose in urine, 455
- Schumm's modification of the guaiac test, 266
- Schütz's law, statement of, 9, 170
- Schweitzer's reagent, action of, on cellulose, 49
 preparation of, 49
- Scleroproteins (see Albuminoids), 94, 112
- Scombrine, 67, 95
- Scombrone, 94, 96
- Scott-Wilson method for acetone and diacetic acid in blood, 288
 reagent, 629
- Scybala, 50, 227
- Secondary protein derivatives, 65, 96, 118
- Secondary proteoses, 120
- Secretin, 189
- Seliwanoff's reaction, 35, 476
 reagent, preparation of, 35, 476
- Senna, influence of, on color of feces, 242
- Separation of feces, importance of, in nutrition and metabolism experiments, 228, 610
- Serine, 65, 67, 69, 73
 crystalline form of, 73
 formula for, 73
- Serum albumin, 94, 250, 271, 440, 450
 in urine, 440, 450
 test for, 451
- Serum, blood, 250, 271
 milk, 341
- Serum globulin, 94, 250, 440, 450
 in urine, 440, 450
 test for, 454
- Shackell's method for vacuum desiccation, 511
- Sherrington's solution, preparation of, 310
- Silicates in urine, 398, 439
- Silver reduction test for uric acid (Schiff), 409
- Skatole, 216, 217, 218, 223
 tests for, 223
- Skatole-carbonic acid, 221, 224
 test for, 224
- Smith's test for bile pigments, 212, 461
- Soap, salting-out of, 185
 insoluble, preparation of, 186
- Sodium and potassium in urine, 398, 437, 581
 quantitative determination of, 581
- Sodium alisarin sulphonate as indicator, 157, 158, 161, 178, 511
- Sodium alisarin sulphonate, preparation of, 158
- Sodium chloride, crystalline form, 271
- Sodium chloride in urine, 433, 576, 599
- Sodium hypobromite solution, preparation of, 624
- Sodium nitrite-ferrous sulphate reaction for acetoacetic acid (Hurtley), 468
- Sodium nitroprusside test for acetone, 465
- Sodium sulphide solution, preparation of, 630
- Solera's reaction for detection of thiocyanate in saliva, 59
 test paper, preparation of, 59
- Soluble starch, 11, 43, 56
 as indicator, 169, 287, 547, 561
- Sørensen's formol titration method for amino nitrogen, 526
 indicator method for hydrogen ion concentration, 161, 509
- Soxhlet apparatus for extraction of fat, 355
- Soxhlet lactometer, determination of specific gravity of milk by, 254
- Specificity of enzyme action, 7
- Spectroscope, use of in detection of blood, 301
- Spermatozoa in urinary sediments, 494, 502
 microscopical appearance of human, 503
- Spiegler's ring test for protein, 104, 452
 reagent, preparation of, 104, 452
- Spiro's reaction for hippuric acid, 418
- Spongion, 69
- Standard ammonium thiocyanate solution, preparation of, 617
 creatinine solution, 622
 iodine solution, 625
 potassium permanganate, 628
 picramic acid, 628
 silver nitrate solution, preparation of, 629
 sodium alcoholate, 630
 sodium thiosulphate, 630
 uranium acetate solution, preparation of, 632
 uric acid solution, 632
- Starch, 20, 43
 action of alcohol on iodide of, 45
 action of alkali on iodide of, 45
 heat on iodide of, 45
 dry, digestion of, by pancreatic amylase, 192, 196
 dry, digestion of, by salivary amylase, 60
 experiments on, 43
 hyperglycemia produced by, 589
 iodine test for, 45
 microscopical characteristics of, 43, 44

- Starch, microscopical examination of, 45
 potato, preparation of, 43
 soluble, 11, 43, 56
 soluble starch as indicator, 169, 287, 547, 561
 solubility of, 43, 45
 various forms of, 44
- Starch group, 20
- Starch paste, action of tannic acid on, 45
 diffusibility of, 45
 digestion of, by pancreatic amylase, 192, 195
 by salivary amylase, 10, 56, 59
 Fehling's test on, 45
 hydrolysis of, 45
 iodic acid paper, 59
 preparation of, 45
- Steapsin (see Pancreatic lipase, 5, 13, 182, 192, 197)
- Stearic acid, 181, 382
- Stearin, 181, 182, 341
- Stellar phosphate, 351, 489
- Stercobilin, 226
- Stokes' reagent, action of, 301
 preparation of, 301
- Stomach contents, lactic acid in, tests for, 173
 examination of, 163
 peptid-splitting enzyme in, 142, 203
 removal of, 165
 tube, Rehfuess, 151, 152
- Stomach, motor and functional activities of, 147, 163
- Stone-cystine, 77
- Sturine, 67, 68, 94
- Sublingual glands, characteristics of saliva secreted by, 54
- Submaxillary glands, characteristics of saliva secreted by, 54
- Substrate, 3
- Succinic acid, 218
- Sucrase, 4, 14, 199, 203
 experiments on, 14, 203
 vegetable, 14
- Sucrose, 19, 41
 experiments on, 42
 inversion of, 42
 structure of, 42
- Sucrose-H₂SO₄ test (Pettenkofer), 212, 462
- Sugar (see Glucose and Sucrose)
- Sulphanilic acid, 483
- Sulphates in saliva, test for, 59
- Sulphates in urine, 398, 431, 566
 ethereal, 413, 567
 quantitative determination of, 567
 experiments on, 415, 432
 inorganic, 431, 567
 quantitative determination of, 567
 total, quantitative determination of, 566, 571
- Sulphocyanides (see Thiocyanates, 55, 59, 397, 420)
- Sulphur in protein, 63, 108
 acid, 108
 in urine, gravimetric determination of, 566
 volumetric determination of, 570
 lead blackening, 108, 431
 loosely combined, 108, 431
 mercaptan, 108, 431
- Sulphur, neutral, 108, 431
 oxidized, 108, 431
 "partition," in urine, 600
 tests for, 108
 unoxidized, 108, 431
- Sulphuric acid test (Piria), 86
- Sumner's method for determination of ammonia in urine, 526
- Surface tension test for bile acids (Hay), 213, 462
- Suspension of manganese dioxide, 631
- Synthesis of hippuric acid, 609
 demonstration of, 609
- Tallow bayberry, saponification of, 186
- Tallquist's hemoglobin scale, determination of hemoglobin by, 309
- Tannic acid, influence of, on dextrin, 48
 on starch, 45
 precipitation test for proteose (Ott), 456
- Tannin test for carbon monoxide hemoglobin, 303
- Tanret's reagent, preparation of, 104, 453, 631
- Tanret's test, 104, 453
- Tartar, formation of, 55
- Taurine, 208, 214, 369, 375, 397, 420
 derivatives, 397, 420
 formula for, 208, 375
 microscopical appearance, 215
 preparation of, 214
- Taurocholic acid, 208
 group, 208
- Teichmann's crystals, form of (see Hemin crystals, p. 268)
 test, 268, 270, 457
- Tendomuroid, 95, 113, 360
 biuret test on, 361
 chemical composition of, 113
 hydrolysis of, 361
 loosely combined sulphur in, test for, 361
 preparation of, 361
 solubility of, 361
- Test meals, 163, 165
 Ewald, 163, 165
 retention, 163, 165
 water, 163, 165
- Tetrapeptides, 66, 96
- Tetramethylene-diamine, 218
- Tetranucleotide, 125
- Thiocyanates in saliva, significance of, 55
 ferric chloride test for, 59
 Solera's reaction for, 59
- Thiocyanates in urine, 397, 420
- Thiophene reaction, 174
- Thoma-Zeiss hemocytometer, 309
- Thrombin, 251, 260, 261
- Thromboplastin, 261
- Thymine in nucleic acids, 125, 126, 133
- Thymol, formula for, 395
 interference in Heller's ring test, 451
 determination of sugar, acetone bodies, phosphates and magnesium in urine, 395
 interference of, in Lieben's acetone test, 465
 use of, as preservative, 395
- Thymolphthalein, use of, as indicator, 162
- Thymus histone, 94

- Thymus nucleic acid, 124, 131
 preparation of, 131
 tests on, 132
- Time relations of protein metabolism, 592
- Tincture of iodine, preparation of, 631
- Tissue, adipose, experiments on, 180, 367
 connective, 359, 360
 white fibrous, 360
 composition of, 360
 experiments on, 361
 yellow elastic, 362
 composition of, 362
 experiments on, 363
- epithelial, 359
 experiments on, 360
- muscular, 368
 experiments on, 375
- nervous, 381
 experiments on, 384
- osseous, 365
 experiments on, 366
- Tissue débris in urinary sediments, 494, 502
- Titanium tetrachloride as cellulose solvent, 50
- Toison's solution, preparation of, 310
- o-Tolidin test for blood, 174, 237, 267, 458
- Tollen's reaction for conjugate glycuronates, 470
 arabinose, 38
 galactose, 36, 475
 pentoses in urine, 472
- Töpfer's method for quantitative analysis of gastric juice, 177
- Töpfer's reagent, as indicator, 157, 158, 168, 177, 178
 preparation of, 178
- Total nitrogen, of urine, quantitative determination of, 512
- Total solids, of milk, quantitative determination of, 356
 of urine, quantitative determination of, 511
- Total sulphur of urine, quantitative determination of, 566
 phosphorus of urine, quantitative determination of, 574
- Trichloroacetic acid, precipitation of protein by, 103, 120, 276
- Tricresol-peroxidase reaction (Kastle), 349
- Triketohydrindene hydrate (ninhydrin) reaction, 101
- Trimethyl-oxyethyl-ammonium hydroxide (see Choline, 216, 382, 385)
- Trioses, 19
- Tripeptides, 66, 96
- Triple phosphate, 390, 391, 487, 505, 524
 crystalline form of, 436
 formation of, 436
- Trisaccharides, 19, 42
- Trommer's test, 25, 444
- Tropæolin O, use of, as indicator, 162
 preparation of, 162
- Tropæolin OO, use of, as indicator, 157, 158, 159, 161, 162
 preparation of, 159, 161
- Tropæolin OOO, use of, as indicator, 162
 preparation of, 162
- Trypsin (see also Pancreatic protease, 5, 12, 190)
 action of, upon proteins, 66, 190, 193
 experiments on, 193-4
- Trypsin, influence of alkalis and mineral acids upon, 194
 in stomach, 154, 155, 172
 determination of, 172
 nature of, 190
 quantitative determination of, 172, 195
- Trypsinogen, 6, 190
 activation of, 6, 190, 200, 201
- Tryptic digestion, 66, 190
 influence of bile on, 195
 most favorable reaction for, 194
 temperature for, 194
 products of, 66, 190, 193
- Tryptic proteolysis, 142, 190
- Tryptophane, 65, 67, 68, 77, 99, 190, 193
 bromine water test for, 193
 formula for, 77
 group in the protein molecule, 99
 Hopkins-Cole reaction for, 99
 mercury compound of, preparation of, 193
 occurrence of, as a decomposition product of protein, 65, 67, 68, 77
 occurrence of, as an end-product of pancreatic digestion, 190, 193
- Tuberculosis, urochromogen reaction for, 481
- Tussah silk fibroin, 68
- Tyrosinase, 5
- Tyrosine, 5, 65, 67, 69, 74, 86, 98, 190, 487, 492
 crystalline form of, 76
 experiments on, 86
 formula for, 77
 Hoffmann's reaction for, 86
 in urinary sediments, 487, 492
 microscopical examination of, 86
 Mörner's test for, 86
 occurrence of, 65, 67, 69, 190
 Piria's test for, 86
 salts of, 77
 separation of, from leucine, 85
 solubility of, 86
 sublimation of, 86
- Tyrosine-sulphuric acid, 86
- v. Udrányi's test for bile acids, 212, 462
- Uffelmann's reagent, preparation of, 174, 632
 reaction for lactic acid, 174
- Unknown substances in urine, 483
- Unorganised ferments, 1
 sediments in urine, 486, 487
- Unsaturated acids, 181
- Uranium acetate method for determination of total phosphates in urine, 572
- Uracil, 125, 128, 133
 Wheeler-Johnson reaction for, 133
- Urate, ammonium, crystalline form of, Plate VI, opposite p. 491
 sodium, crystalline form of, 490
- Urates in urinary sediments, 487, 490
- Urea, 251, 252, 274, 278, 369, 397, 399, 400, 520
 crystalline form of, 400
 decomposition of, by sodium hypobromite, 402, 404
 excretion of, 400, 402
 experiments on, 403
 formation of, 401
 formula for, 400
 furfural test for, 405
 isolation of, from the urine, 403

- Urea**, melting-point of, 403
 quantitative determination of, in blood, 278,
 in urine, 530
- Urea nitrate**, 402, 404
 crystalline form of, 402
 formula for, 402
- oxalate**, 402, 404
 crystalline form of, 404
 formula for, 402
- Urease**, 4, 278, 402, 520
 decomposition of urea by, 520
 preparation of, 520
 quantitative determination of urea by, 278,
 520
- Uremia**, blood in, 274, 275
- Urethral filaments in urinary sediments**, 494, 502
- Uric acid**, 26, 127, 133, 137, 252, 274, 279, 369,
 397, 405, 487, 489, 505, 534, 595, 596
 calculi, 505
 crystalline form of, pure, 408
 endogenous, 406, 594, 596
 exogenous, 406, 594, 596
 experiments on, 408
 formula for, 405
 Ganassini's test, 409
 in blood, 251, 252, 274, 279
 in gout, 274, 407, 594, 597
 in leukaemia, 407
 in urinary sediments, 487-489
 crystalline form of, Plate V, oppo-
 site p. 408, 490
 isolation of, from the urine, 408
 metabolism, 594-597
 murexide test for, 408
 origin of, 406
 quantitative determination of, in blood,
 Benedict's method, 280
 Folin-Denis method, 279
 in urine, microchemical colo-
 rimetric method, 534
 Folin-Shaffer method, 536
 Krüger-Schmidt method,
 536
 Uricometer method, 537
 quantitative determination of, Krüger
 and Schmidt's method for, 536
 reducing power of, 26, 407, 409, 445
 Ruhemann's uricometer method for, 537
 Schiff's reaction for, 409
- Uricase**, 5, 127, 137
 experiments on, 137
- Uricolytic enzymes**, 3, 5, 127, 137
 experiments on, 137
- Urinary calculi**, 504
 calcium carbonate in, 505
 cholesterol in, 507
 compound, 504
 cystine in, 505
 fibrin in, 507
 indigo in, 507
 oxalate in, 505
 phosphates in, 505
 scheme for chemical analysis of, 506
 simple, 504
 uric acid and urates in, 505
 urostealiths in, 507
 xanthine in, 505
- Urinary concretions** (see Urinary calculi, p. 504)
- Urinary sediments**, 486
 ammonium magnesium phosphate in,
 487
 animal parasites in, 494, 503
 calcium carbonate in, 487, 488
 oxalate in, 487
 phosphate in, 487, 489
 sulphate in, 487, 489
 casts in, 494, 496
 cholesterol in, 487, 492
 collection of, 486
 cylindroids in, 494, 501
 cystine in, 487, 491
 epithelial cells in, 494
 erythrocytes in, 494, 501
 fibrin in, 494, 503
 foreign substances in, 494, 503
 hematoidin and bilirubin in, 487, 493
 hippuric acid in, 487, 492
 indigo in, 487, 493
 leucine and tyrosine in, 487, 492
 magnesium phosphate in, 487, 493
 melanin in, 487, 494
 micro-organisms in, 494, 503
 organized, 486, 494
 pus cells in, 494, 495
 spermatozoa in, 494, 502
 tissue debris in, 494, 502
 unorganized, 486, 487
 urates in, 487, 490
 urethral filaments in, 494, 502
 uric acid in, 487, 489
 xanthine in, 487, 493
- Urination**, frequency of, 389
- Urine**, 387
 acetoacetic acid in, 440, 466, 557
 acetone in, 440, 463, 557
 acidity of, 389, 434, 508, 509, 603, 605
 acid fermentation of, 391
 albumin in, 440, 450, 554
 alkaline fermentation of, 390, 436
 allantoin in, 397, 420, 541
 amino-acids in, 397, 422, 526
 ammonia in, 398, 430, 523, 598
 aromatic oxyacids in, 397, 422
 benzoic acid in, 397, 416, 423, 606, 609
 bile in, 440, 462
 blood in, 440, 457
 calcium in, 398, 437, 487, 579
 carbonates in, 398, 438
 chlorides in, 398, 433, 576
 collection of, 395, 588
 collection and preservation of, in metabolism
 tests, 395, 588
 color of, 387
 complete analysis of, 399, 588
 conjugate glycuronates in, 445, 470
 creatine in, 371, 374, 378, 397, 412, 440, 532
 creatinine in, 398, 409, 530, 597
 dextrose in (see Glucose, 440, 441, 545)
 diacetic acid in (see Acetoacetic acid, 440, 466,
 557)
 electrical conductivity of, 394
 enzymes in, 398, 425
 ethereal sulphuric acid in, 397, 413, 567, 571
 fat in, 440, 472, 494, 498
 fluorides in, 398, 439
 freezing-point of, 393

- White fibrous connective tissue, 300
 experiments on, 302
 White test, experiments on, 398
 Wiesmann-Handovsky method for determi-
 nation of albumin in urine, 341
 Wilkerson and Peters test, 350
 Wintrow's test for uric acid, 449
 Witke milk, 340
 Wohlgenant method for quantitative deter-
 mination of amylolytic activity, 190
 Author's modification of, 144
 Woiters method for determination of iron in
 urine, 382

 Xanthine, 120, 127, 132, 306, 373, 375, 379, 429
 tests (see Purine bases, pp. 120, 375, 429)
 crystalline form of, 373
 oxonine form, 127, 375
 in urinary sediments, 187, 408
 solution of, from meat extract, 379
 silver nitrate, 380
 crystalline form of, 380
 test, 379
 tests for, 132
 Weidel's reaction for, 132
 Xanthoxylin, 348
 Xanthopterin reaction, 39
 Xanthoxylinase, 5
 X-ray vision, 472
 Xyloam, 20, 38, 472

 Xyloam, orange reaction of, 19
 preparation of, 19
 Tollens' reaction of, 19

 Yeast, enzymes of, 7
 fermentation of, 19, 27
 growth-producing substances of, 225
 nutrients on growth of, 225
 preparation of, 110
 fermentation of, 110
 test of, 119
 nutrient salts of, 22, 119
 fermentation of, 119
 preparation of, 119
 test of, 119
 water-soluble vitamins of, 225
 Yellow crystals, qualitative tests, 294
 preparation of, 295
 preparation of, 295

 Zappert's test, 314
 Zinn, 17, 19, 24, 26, 114
 preparation of, 17, 18
 Zeller's test for uric acid, 104
 Z. Zeyher's alkaline reaction of uric acid, 104, 105
 Ziken pectocoupe, 104
 Zymase, preparation of, 110
 preparation of, 110
 Zymase-ester, 7
 Zymograph, 2, 90

