

---

**U.S. ARMY MEDICAL DEPARTMENT CENTER AND SCHOOL  
FORT SAM HOUSTON, TEXAS 78234-6100**

---

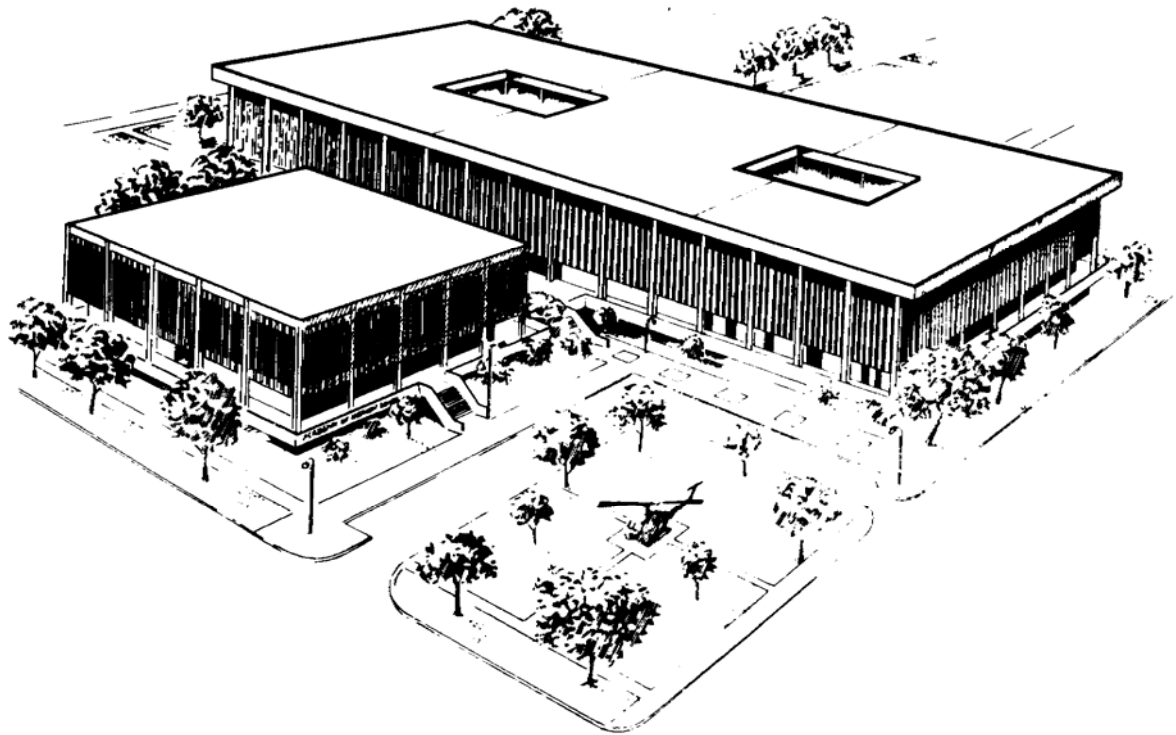

# **IMMUNOHEMATOLOGY AND BLOOD BANKING I**

**SUBCOURSE MD0845**

**EDITION 100**

## **DEVELOPMENT**

This subcourse is approved for resident and correspondence course instruction. It reflects the current thought of the Academy of Health Sciences and conforms to printed Department of the Army doctrine as closely as currently possible. Development and progress render such doctrine continuously subject to change.

## **ADMINISTRATION**

Students who desire credit hours for this correspondence subcourse must enroll in the subcourse. Application for enrollment should be made at the Internet website: <http://www.atrrs.army.mil>. You can access the course catalog in the upper right corner. Enter School Code 555 for medical correspondence courses. Copy down the course number and title. To apply for enrollment, return to the main ATRRS screen and scroll down the right side for ATRRS Channels. Click on SELF DEVELOPMENT to open the application; then follow the on-screen instructions.

For comments or questions regarding enrollment, student records, or examination shipments, contact the Nonresident Instruction Branch at DSN 471-5877, commercial (210) 221-5877, toll-free 1-800-344-2380; fax: 210-221-4012 or DSN 471-4012, e-mail [accp@amedd.army.mil](mailto:accp@amedd.army.mil), or write to:

NONRESIDENT INSTRUCTION BRANCH  
AMEDDC&S  
ATTN: MCCS-HSN  
2105 11TH STREET SUITE 4191  
FORT SAM HOUSTON TX 78234-5064

Be sure your social security number is on all correspondence sent to the Academy of Health Sciences.

## **CLARIFICATION OF TERMINOLOGY**

When used in this publication, words such as "he," "him," "his," and "men" are intended to include both the masculine and feminine genders, unless specifically stated otherwise or when obvious in context.

## **USE OF PROPRIETARY NAMES**

The initial letters of the names of some products may be capitalized in this subcourse. Such names are proprietary names, that is, brand names or trademarks. Proprietary names have been used in this subcourse only to make it a more effective learning aid. The use of any name, proprietary or otherwise, should not be interpreted as endorsement, deprecation, or criticism of a product; nor should such use be considered to interpret the validity of proprietary rights in a name, whether it is registered or not.

## TABLE OF CONTENTS

<u>Lesson</u>		<u>Paragraphs</u>
	INTRODUCTION	
1	BLOOD COLLECTION, PROCESSING, STORAGE, AND SHIPMENT	
	Section I. Blood Collection and Processing	1-1 -- 1-16
	Section II. Blood Storage and Shipment	1-17 -- 1-25
	Exercises	
2	IMMUNOGENETICS	
	Section I. Blood Group Immunogenetics	2-1 -- 2-7
	Section II. The ABO System	2-8 -- 2-15
	Section III. The Rh System	2-16 -- 2-28
	Section IV. Other Blood Group Systems	2-29 -- 2-37
	Exercises	

**CORRESPONDENCE COURSE OF  
UNITED STATES ARMY MEDICAL DEPARTMENT CENTER AND SCHOOL**

**SUBCOURSE MD0845**

**IMMUNOHEMATOLOGY AND BLOOD BANKING I**

**INTRODUCTION**

Blood for transfusion is a biologically active, therapeutic substance. It has specific effects on the human organism and dosage requirements just as any other therapeutic substance. Blood differs, however, from other biologicals in that it must be obtained from healthy individuals of the human race. At our present state of knowledge, human whole blood is a perishable substance, and being derived from human beings, must be collected in thousands of widely spread laboratories rather than being produced in a handful of qualified and well regulated laboratories. The responsibilities of those who collect, process, and issue whole blood for transfusion are tremendous.

Subcourse MD0845, Immunohematology and Blood Banking I, will give you a basic background and provide you with information concerning blood collection, processing, storage and shipment, and immunogenetics.

It is necessary for you to master the contents of this subcourse before you proceed to the next. If you already have a background in these areas, then use this subcourse as a refresher before starting your study of Subcourse MED846.

Subcourse Components:

This subcourse consists of two lessons:

- Lesson 1. Blood Collection, Processing, Storage, and Shipment.
- Lesson 2. Immunogenetics.

Credit Awarded:

Upon successful completion of this subcourse, you will be awarded 13 credit hours.

Procedures for Subcourse Completion:

You are encouraged to complete the subcourse lesson by lesson. When you have completed all of the lessons to your satisfaction, fill out the examination answer sheet and mail it to the Academy along with the Student Comment Sheet in the envelope provided. Be sure that your name, rank, social security number, and return address is on all correspondence sent to the Academy. You will be notified by return mail of the examination results. Your grade on the exam will be your rating for the subcourse.

### Study Suggestions:

Here are some suggestions that may be helpful to you in completing this subcourse:

--Read and study each lesson carefully.

--Complete the subcourse lesson by lesson. After completing each lesson, work the exercises at the end of the lesson, marking your answers in this booklet.

--After completing each set of lesson exercises, compare your answers with those on the solution sheet which follows the exercises. If you have answered an exercise incorrectly, check the reference cited after the answer on the solution sheet to determine why your response was not the correct one.

--As you successfully complete each lesson, go on to the next. When you have completed all of the lessons, complete the examination. Mark your answers in this booklet; then transfer your responses to the examination answer sheet using #2 pencil.

### Student Comment Sheet:

You can provide us with your suggestions and criticisms by filling out the Student Comment Sheet (found at the back of the examination), and returning it to us with your examination answer sheet. In this way, you will help us to improve the quality of this subcourse.

## **LESSON ASSIGNMENT**

### **LESSON 1**

Blood Collection, Processing, Storage, and Shipment.

### **TEXT ASSIGNMENT**

Paragraphs 1-1 through 1-25.

### **LESSON OBJECTIVES**

After completing this lesson, you should be able to:

- 1-1. Identify factors in the reception, registration, and selection of blood donors.
- 1-2. List the steps in the two methods of venipuncture preparation, factors in donor care and treatment, and processing requirements for donor blood.
- 1-3. Identify the functions and uses of CPD, CPDA-1 (and their components), and heparin.
- 1-4. Identify the requirements for the refrigeration of blood in storage and shipment.
- 1-5. Select the statement which correctly describes the criteria in the inspection for the storage of blood.
- 1-6. Identify the requirements to reissue blood.

### **SUGGESTION**

After completing the assignment, complete the exercises of the lesson. These exercises will help you to achieve the lesson objectives.

## LESSON 1

### BLOOD COLLECTION, PROCESSING, STORAGE, AND SHIPMENT

#### Section I. BLOOD COLLECTION AND PROCESSING

##### 1-1. BLOOD DONORS

a. Blood banks and transfusion services are dependent on voluntary donors to provide the blood necessary to meet the needs of the patients whom they serve. To attract volunteer donors and to encourage their continued participation, it is essential that everyone concerned with providing safe and efficient products make blood donation as pleasant, safe, and convenient as possible for donors.

b. The donor center should be attractive, well-lighted, comfortably ventilated, clean, and open at convenient hours for donors. Donor center personnel should be highly motivated, friendly, and understanding, as well as professional and well-trained.

c. The medical director of each blood bank must establish the parameters (meeting all requirements of the American Association of Blood Banks (AABB) Standards and Food and Drug Administration (FDA)) used for accepting, deferring, or permanent rejecting prospective donors. This policy must be included in the blood bank's written operating procedures manual, which covers all phases of activity in the donor area.

##### 1-2. BLOOD DONOR REGISTRATION

a. A Donor Record (see figure 1-1) must be recorded on each donor and kept on file in the blood bank for at least 5 years and 6 months. The following demographic information is to be and will make it reasonably possible to identify and recall the donor.

- (1) Date of donation.
- (2) Name: last, first, and middle initial.
- (3) Address: residence and/or business.
- (4) Telephone: residence and/or business.
- (5) Sex.

ALL ENTRIES ON THIS FORM MUST BE COMPLETED IN INK OR TYPEWRITTEN

1. DONOR'S NAME (Last, First, Middle Initial)		2. GRADE		3. SSN			
4. AGE	5. SEX	6. ORGANIZATION/STATION OR ADDRESS AND PHONE					
<b>7. FOR OFFICE USE</b>							
MEDICAL QUESTIONNAIRE		YES	NO	MEDICAL QUESTIONNAIRE		YES	NO
8. Have you donated blood in the past 8 weeks? Date: _____				21. Have you had small pox vaccination/other immunizations in the past 2 weeks?			
9. Have you ever been rejected as a blood donor?				22. Have you been vaccinated for German measles in the past 2 months?			
10. Have you ever been notified that a patient who received your donated blood had hepatitis?				23. Have you ever had convulsions or fainting spells? Donor reactions?			
11. Do you have a cold, flu, grippé or sore throat (URI)? Do you have any illness now?				24. Have you been immunized to human cell/red blood cell antigens?			
12. Are you under a doctor's care now for any reason?				25. Have you received blood or plasma in the past 6 months?			
13. Have you ever coughed up or vomited blood?				26. Have you donated plasma in the past 48 hours? Plasmapheresis within the past 72 hours?			
14. Have you had tuberculosis? Kidney disease? Liver disease?				27. Have you had malaria/taken antimalarial drugs in the past 5 years?			
15. Have you experienced chest pain or shortness of breath?				28. Have you been outside the U. S. in the past 3 years?			
16. Have you had heart trouble? Rheumatic heart disease? Asthma?				29. Have you had surgery or serious illness in the past 6 months?			
17. Have you had lung or stomach disease? Cancer? Diabetes? Ulcers?				30. Have you ever had hepatitis, yellow jaundice or a positive laboratory test for hepatitis?			
18. Have you had lymph gland disease, leukemia, or infectious mononucleosis?				31. Have you been exposed to hepatitis in the past 6 months?			
19. Have you had tooth extraction/dental surgery in the past 3 days?				32. Have you taken any drugs or medications in the past 48 hours?			
20. Have you had rabies vaccination in the past year? Hepatitis Immune Globulin in the past 9 months?				33. Have you taken any habit forming or hallucinogenic drug within the past 48 hours?			
34. Have you had a tattoo/mars pierce/scarification in the past 6 months?				35. Have you ever injected any drugs into your veins or skin?			
36. Have you ever had venereal disease? Ever been treated for syphilis?				37. Have you had a recent unexplained weight loss of over 10 pounds?			
38. Do you have skin infections? Frequent boils?				39. Do you have any illnesses which are not covered by this questionnaire?			
40. (Women) are you pregnant now or have you been during the past 6 weeks?				41. Are you in good health generally? Do you feel well now?			
42. Do you have any abnormal bleeding tendencies?				43. Have you been institutionalized during the past 6 months?			
44. Have you taken aspirin compounds in past 5 days? (applicable to single donor plateletpheresis only)				45. For questions 45 - 50, please read the back of this card.			
46. back of this card.							
DONOR HISTORY REMARKS							
47. WEIGHT		48. TEMPERATURE		49. PULSE		50. BLOOD PRESSURE	
51. HGB/HCT		52. ARMS INSPECTION SATISFACTORY		53. GENERAL APPEARANCE		54. DONOR REJECTED	
55. AUTOLOGOUS DONOR		56. SUITABLE FOR TRANSFUSION TO OTHER PATIENTS		57. SIGNATURE OF INDIVIDUAL RESPONSIBLE FOR DETERMINING DONOR ELIGIBILITY		58. SIGNATURE OF MEDICAL REVIEWER	
<input type="checkbox"/> YES <input type="checkbox"/> NO		<input type="checkbox"/> SAT <input type="checkbox"/> UNSAT		<input type="checkbox"/> NO <input type="checkbox"/> YES <input type="checkbox"/> PERM <input type="checkbox"/> TEMP		<input type="checkbox"/> YES <input type="checkbox"/> NO <input type="checkbox"/> YES <input type="checkbox"/> NO <input type="checkbox"/> N/A	
The answers above are correct to the best of my knowledge and belief, and I understand that my answers are important in determining my individual fitness to donate blood. I am voluntarily donating approximately 450 ML of blood to the Armed Forces for use in any way they may deem advisable. I understand that I should not engage in strenuous exercise or hazardous activity on the day of donation.							
Signature of Donor				Date			

DD FORM 572 1 NOV 78  
 Proponent: DPALS  
 EDITION OF 1 APR 78 MAY BE USED. PREVIOUS EDITIONS ARE OBSOLETE.  
 PRIVACY ACT STATEMENT ON REVERSE SIDE  
 DEPARTMENT OF DEFENSE MILITARY BLOOD PROGRAM  
 BLOOD DONOR RECORD BAMC OP 606  
 1 Mar 89

BLOOD DONOR'S QUESTIONNAIRE

DONOR NUMBER		DATE COLLECTED		DATE EXPIRES		INTEGRAL TUBE NUMBER (optional)		BLOOD GROUP AND RH					
BAG ISSUE <input type="checkbox"/> SINGLE <input type="checkbox"/> DOU <input type="checkbox"/> TRIP <input type="checkbox"/> OTHER		ANTICOAGULANT <input type="checkbox"/> CPD <input type="checkbox"/> CPDA <input type="checkbox"/> OTHER		COLLECTION STARTED (Time)		COLLECTION ENDED (Time)							
BLOOD PRODUCTS PREPARED (Circle if required)													
WHOLE BLOOD (Human)		WHOLE BLOOD (Human) MODIFIED		PLATELET CONCENTRATE (Human)		OTHER _____							
RED BLOOD CELLS (Human)		SINGLE DONOR PLASMA (Human) FRESH FROZEN		LEUCOCYTES (Human)									
RED BLOOD CELLS (Human), FROZEN		SINGLE DONOR PLASMA (Human) FRESH FROZEN PLATELETS REMOVED		CRYOPRECIPITATED ANTIHEMO- PHILIC FACTOR (Human)									
Signature of Phlebotomist													
REMARKS (For local use)					PRIVACY ACT STATEMENT BLOOD DONOR'S QUESTIONNAIRE 1. AUTHORITY. 5 U.S.C. section 301, 10 U.S.C. section 3012, 2. MANDATORY OR VOLUNTARY DISCLOSURE. Voluntary. 3. PRINCIPAL PURPOSES FOR COLLECTING THE INFORMATION. To record time of withdrawal and type of blood, and to determine suitability of voluntary blood donations. 4. ROUTINE USE. This information will be used within the Department of Defense and the civilian medical community to administer the Military Blood Donor Program and, in some cases, may be used to recommend medical treatment based on laboratory findings. 5. EFFECTS OF NOT PROVIDING THE INFORMATION. It may be impossible to accept the donated blood.								
					Signature _____								
TYPING RECHECK													
REASON FOR QUARANTINE		DATE IN	BY	DATE OUT	BY	anti A	anti B	anti Rh	Rh Con	Du			
					Interpretation _____ Date _____ Tech _____								
DATE K-MATCH		LOG NO.	RECIPIENT	WARD	BLOOD ISSUED			BLOOD RETURNED			DATE		
					INSP/ACPT BY	DATE	TIME	REC BY	INSP/ACPT BY	DATE	TIME	GIVEN	OFF RESER

Figure 1-1. Blood donor record card (top--front; bottom--back).



(6) Age or date of birth: blood donors must be at least 17 years of age with the following exceptions:

(a) Donors who are considered minors under local law may be accepted only if written consent to donate blood has been obtained in accordance with local law.

(b) Elderly donors should be evaluated by the blood bank physician and this evaluation should be documented as part of the permanent record of that donation. Elderly individuals may donate with the blood bank physician's permission if they meet other donor criteria.

(c) Autologous donations: There are no age limits for drawing blood for autologous use, though each patient or donor must be evaluated to determine if it is safe to collect blood.

(7) Consent for the blood bank to take and use blood from a prospective donor must be obtained in writing. The consent form is part of the Donor Record and is usually completed at time of registration. A qualified person should explain the procedure in terms the donor understands. The donor must have an opportunity to ask questions and to decide whether or not to give consent by signing the form. The blood bank staff member should then sign as witness to the donor's signature or note refusal (see figure 1-1).

b. The following information is not required but may be useful:

(1) Additional identification such as social security number.

(2) Time of last meal. Fasting is not recommended and donors who have not eaten within the past four to 6 hours should be sent to the refreshment area for a light snack.

(3) Name of intended recipient or donor group.

(a) Full name of patient and hospital or donor group is important to ensure proper credit.

(b) A record of deferred donors may be useful to the patient or to others concerned with donor recruitment or credit accounts.

(4) Hazardous activities. If job duties (or hobbies) include possible hazard to self or responsibility for the safety of others, the consequence of temporary incapacity as a result of fainting, or other delayed reactions should be considered. Donors should be accepted only if adequate time elapses before returning to such activities.

Examples: Operators of cranes, heavy equipment, power machinery, buses, taxicabs, or trains; workers on jobs requiring climbing ladders or scaffolding; scuba or sky divers; 12 hours. Flight crews: 72 hours.

(5) Specific directives regarding blood donation by personnel on flying status have been issued by the military services. In general, such personnel are excused from participation in routine blood-collection programs.

(6) Race. This information may be particularly useful when blood of a specific phenotype is needed to meet the needs of patients with unexpected antibodies. Care should be taken to ensure that minority populations understand the medical importance and scientific applications of this information.

(7) Unique characteristics of the donor, which may enable the blood bank to make optimal use of the donation are recorded (for example, donors who are seronegative for cytomegalovirus (CMV) or who are group O Rh negative are often designated for neonatal patients).

### **1-3. DONOR SELECTION**

a. A limited physical examination and a rather detailed medical history must be done on the day of and prior to each donation to determine whether giving blood will in any way harm the donor or if transfusion of the unit will in any way harm the recipient. Careful donor selection plays a major role in determining whether or not a unit will be therapeutically effective and free of transmissible disease.

b. The order in which questions are asked or examinations performed may be arranged for convenience. The interview must be conducted by qualified personnel, as designated by the medical director, in a manner that assures auditory privacy (visual privacy is also recommended), allays apprehensions, and allows time for any necessary discussion or explanation. Answers to questions must be recorded as "Yes" or "No," with details added as indicated. Results of tests must be recorded.

c. The required procedures with some acceptable methods, guidelines for obtaining accurate, required information and allowable parameters for acceptance, deferment, or permanent rejection are given below. Additional criteria may be indicated in areas with special local health problems.

(1) Weight. Donors weighing 110 lb (50 kg) or more may give 450 plus or minus 45 ml of blood as well as up to 30 ml for processing tubes. Donors weighing less than 110 lb are not normally drawn.

(2) Pulse. The pulse should be counted for at least 15 seconds. It should exhibit no pathologic irregularity and should be between 50 and 100 beats per minute. However, if a prospective donor is an athlete with high exercise tolerance, a lower pulse rate may be acceptable. The blood bank physician should evaluate marked abnormalities of pulse and recommend acceptance, deferral, or referral for additional evaluation.

(3) Blood pressure. The systolic blood pressure should be no higher than 180 mm Hg and the diastolic blood pressure should be no higher than 100 mm Hg.

(4) Skin lesions. The skin at the site of venipuncture must be free of lesions. Both arms must be examined for signs of intravenous drug abuse. The common findings would be needle puncture marks and/or sclerotic veins. Mild skin disorders such as acne, psoriasis, or rash of poison ivy are not necessarily cause for deferment unless present in the antecubital area or are unusually extensive. Donors with boils, purulent wounds, or severe skin infections anywhere on the body should be deferred, as should anyone with purplish-red or hemorrhagic nodules or indurated plaques suggestive of Kaposi's sarcoma.

(5) General appearance. If donor looks ill, appears to be under the influence of drugs or alcohol, or is excessively nervous, it is best to defer temporarily.

(6) Temperature. The oral temperature must not exceed 37.5° C (99.6° F). Use caution. When taking the patient's temperature with a glass thermometer, a thermometer cover is advised.

**CAUTION:** A glass thermometer should never be in the donor's mouth when blood is obtained for a hematocrit or hemoglobin determination. The donor may bite down hard on the thermometer, break, and cut himself or swallow the glass and mercury.

(7) Hematocrit or hemoglobin. These values vary. Depending on the source, refer to the chart for minimum values in Table 1-1.

(a) Copper sulfate method. Test procedures to be used are adapted to the source of the specimen (see Table 1-1). The solutions should be stored at room temperature in tightly capped containers to prevent evaporation. For routine use, dispense 30 ml of solution into an appropriately labeled, clean, dry tube or bottle. Change solution daily and after every 25 tests. This method is based on specific gravity. A drop of blood dropped into the solution is encased in a sac of copper proteinate, which prevents any change in specific gravity for about 15 seconds. If the drop of blood has a satisfactory specific gravity it will sink within 15 seconds. If not, the drop will hesitate, remain suspended, or rise to the top of solution in 15 seconds. This is not a quantitative test and will show only that the hemoglobin is equal to, below, or

Source of Specimen	Test Method	Minimum Value	
		Male	Female
Earlobe	Hgb	13 g/dl	12.5 g/dl
	Hct	39%	38%
	Copper sulfate	1.054	1.053
Finger or vein	Hgb	12.5 g/dl	12.0 g/dl
	Hct	38%	36%
	Copper sulfate	1.053	12.5 g/dl*

\* FDA requires a blood hemoglobin of no less than 12.5 g/dl.

Table 1-1. Copper sulfate method.

above acceptable limits. Test results that indicate satisfactory hemoglobin levels are usually accurate, but some results that indicate low hemoglobin levels are false. Repeating the test by a second method will help resolve this problem.

(b) Test procedure for fingerstick. Clean the site of skin puncture thoroughly with antiseptic solution and wipe dry with sterile gauze. Puncture a finger slightly to the side with sterile disposable lancet. A good free flow of blood is important. Do not squeeze the finger as this may dilute the drop with excess tissue plasma and give false results. Collect blood in a capillary tube without allowing air to enter tube. Let one drop of blood fall gently from the tube at a height of about 1 cm above the surface of the proper sulfate solution. Observe for 15 seconds. Record results less than 12.5 gm or greater than 13.5 gm, and so forth. Spectrophotometric methods--use standard techniques. Hematocrit measurement--use standard techniques.

#### 1-4. MEDICAL HISTORY OF POTENTIAL DONORS

a. Some very specific questions will be necessary but a great deal of pertinent information can be obtained by asking some general or leading questions in simple language that the donor can understand.

b. The examples given below include all requirements and are followed by suggested or required response to information received.

Example 1:

QUESTION: Have you ever donated blood, platelets, or plasma?  
Date of last donation?

EXPLANATION: Interval between donations of whole blood (450 ml plus or minus 45 ml) must be eight weeks except in unusual circumstances and with the written permission of a physician. The interval after hemapheresis before whole blood donation must be at least 48 hours.

Example 2:

QUESTION: Have you ever been deferred as a blood donor? Why?

EXPLANATION: Information regarding prior deferrals should be considered when evaluating current eligibility.

Example 3:

QUESTION: (Women) Are you pregnant?  
Have you been pregnant during the last six weeks?

EXPLANATION: Defer during pregnancy and for six weeks thereafter. Exception may be made if possible autologous or exchange transfusion is anticipated. Donors who have had uncomplicated abortions need not be deferred if they meet other donor criteria.

Example 4:

QUESTION: Do you feel well now?

EXPLANATION: Acute respiratory infection is cause for deferment until all symptoms subside. Pain, cough, sore throat, headache, nausea, dizziness, menstrual cramps, sinusitis, or extreme nervousness may be cause for deferment, depending on severity and medical evaluation.

Example 5:

QUESTION: Are you in good health generally?  
Under a doctor's care now for any reason? Why?  
Ever had a serious illness or operation? When? What?  
Any illness or operation in last six months? When? What?  
Any unexplained weight loss?  
Ever cough up or vomit blood? Explain.  
Suffer from chest pain or shortness of breath? Explain.  
Have you lost weight recently? How much? Why?

EXPLANATION: Donors should be in good health. This group of questions may reveal the presence or history of kidney, lung, heart, stomach or liver disease, or cancer. Be sure all are either denied or explained. Acutely ill donors must be deferred (temporarily or permanently). Chronic conditions should be evaluated by a physician.

A history of rheumatic heart disease or coronary heart disease is cause for deferment (permanent). A single episode of rheumatic fever or pericarditis, a heart murmur, or repair of a congenital defect does not necessarily disqualify a donor.

Active pulmonary tuberculosis is cause for deferment. Donors with a reactive tuberculin skin test, but without other abnormality, may be accepted.

A history of excessive, unexplained weight loss, often defined as 10% or more, should be investigated further and evaluated by a physician prior to acceptance.

Infectious mononucleosis is not cause for deferment if recovery is complete.

Donors who have had major surgery should be deferred for at least six months. Minor surgery is disqualifying only until healing is complete. The determination of "major" and "minor" may have to be made by a physician, but the following common operations are generally classified as minor: closed reduction of fracture, repair of hernia, hemorrhoidectomy, appendectomy, tonsillectomy, minor gynecologic procedures, removal of pilonidal cyst, and varicose vein surgery.

Example 6:

QUESTION: Are you taking any drugs or medications? Why? What?

EXPLANATION: Marijuana (unless presently under the influence), oral contraceptives, mild analgesics, minor tranquilizers or psychic energizers, vitamins, replacement hormones, or weight-reduction pills are not usually cause for deferment.

Aspirin or aspirin-containing compounds depress platelet function for one to three days. A donor who has taken these drugs within 48-72 hours should not be used as the only source of platelet preparations (platelet-pheresis) as per AABB Standards.

NOTE: Guidelines from FDA for the collection of platelets, pheresis state that platelets drawn from a donor 36 hours after ingestion of aspirin will have satisfactory function.

History of recent or present therapy with antibiotics, corticosteroids, digitalis, insulin, quinidine, diphenylhydantoin (Dilantin), diuretics, nitroglycerin, anticoagulants, or other potent drugs should be evaluated by a physician.

Other drugs and medication should be carefully evaluated by the blood bank medical director. Certain drugs and medical conditions may be permitted in blood donors at the discretion of the medical director. The medical director may give this approval as (1) a general approval, which would be included in the facility procedures manual or (2) verbally on a case by case basis, but the approval must be documented on the donor's record. Listed below are the drugs and medical conditions for consideration:

- 1 Tetracyclines and other antibiotics for acne. Use of Isoretinoin disqualifies a donor for 30 days because it may be a teratogen.
- 2 Topical steroid preparations for skin lesions not at the venipuncture site.

Example 6: (continued)

- 3 Blood pressure medications, taken chronically and successfully, so that pressure is at or below allowable limits. The prospective donor taking antihypertensives should be free from side effects of the drug, especially episodes of postural hypotension, and should be free of any cardiovascular symptoms. Asymptomatic patients taking methyldopa (Aldomet) may have a positive, direct antiglobulin test in which case their blood should not be used for transfusion.
- 4 Isoniazid given because the tuberculin skin test has converted but without evidence of tuberculosis.
- 5 Over-the-counter bronchodilators and decongestants.
- 6 Oral hypoglycemic agents in well-controlled diabetics without any vascular complications of the disease.
- 7 Tranquilizers, under most conditions. A physician should evaluate the donor to distinguish between tranquilizers and anti-psychotic medications. Donors taking anti-psychotic agents should be deferred because their mental processes might be sufficiently disordered that it would be difficult to obtain a good, complete medical history from them.
- 8 Hypnotics used at bedtime, or regularly at bedtime.



Example 7:

QUESTION: Have you been vaccinated or had any shots in the past twelve months?  
What? When?

EXPLANATION: Symptom-free donors who have been recently immunized with toxoids or killed vaccines need not be deferred with the following exceptions:

- 1 Smallpox. Donors are acceptable either after the scab has fallen off or two weeks after an immune reaction.
- 2 Measles (rubeola), mumps, yellow fever, oral polio vaccine. Donors are acceptable two weeks after their last immunization.
- 3 German measles (rubella). Donors are acceptable four weeks after their last injection.
- 4 Hepatitis B immune globulin (HBIG). Donors are acceptable 12 months after injection.
- 5 Hepatitis B vaccine. Donors are acceptable provided they would not otherwise be disqualified.
- 6 Rabies, if given following a bite by a rabid animal. Defer for one year.
- 7 Immune serum globulin (for example, Rho GAM). Deferral is not necessary if donor is otherwise acceptable.
- 8 Injections with human pituitary, derived growth hormone (pit-hGH). Deferment is permanent. However, a referral is not necessary if the donor has only been given recombinant growth hormone.

Example 8:

QUESTION: Do you have asthma?

EXPLANATION: Prospective donors with symptomatic bronchial asthma should be deferred.

Example 9:

QUESTION: Have you had convulsions or fainting spells?

EXPLANATION: Donors who have had either one, except in childhood, may have a reaction or seizure if they donate. They should be deferred.

Example 10:

QUESTION: Do you bleed a long time when you have a cut or a tooth pulled?

EXPLANATION: Abnormal bleeding tendency is cause for deferment. The physician should evaluate.

Example 11:

QUESTION: Have you ever had malaria? When?  
Are you a visitor or immigrant to the USA?  
Have you been out of the USA in the past 3 years? Where?  
Have you ever taken any medication to prevent malaria?

EXPLANATION: Travelers in areas considered endemic for malaria by the Malaria Program Center for Disease Control may be accepted as regular blood donors 6 months after return to a non-endemic area, providing they have been free of symptoms and have not taken antimalarial drugs in the interim. (A recent World Health Organization map of endemic areas should be available to interviewing personnel.) Prospective donors who have had malaria shall be deferred for 3 years after becoming asymptomatic and after cessation of therapy. Prospective donors who have taken antimalarial prophylaxis shall be deferred for 3 years after cessation of therapy or after departure from the area if they have been asymptomatic in the interim. Immigrants or visitors from endemic areas are acceptable as blood donors 3 years after departure from the area if they have been asymptomatic in the interim. Donations to be used for the preparation of plasma, plasma components, or fractions devoid of intact red blood cells are exempt from these restrictions.

Example 12:

QUESTION: Have you ever had yellow jaundice or hepatitis?  
Have you had a reactive test for hepatitis (HBsAg)?  
Have you had intimate contact with a person with hepatitis? When?  
Have you received injections of hepatitis B immune globulin (HBIG)?  
When?  
Have you been transfused with blood or blood components? When?  
Have you had a tattoo? When?  
Have you ever injected drugs into your veins or skin? (If ear piercing and/or acupuncture are commonly performed in the area and are not performed by a physician, the donor should be questioned about these procedures.)

EXPLANATION: The possible presence of the agent of viral hepatitis cannot at present be detected with 100 including history, physical examination or laboratory tests (including tests for HBsAg); therefore, strict regulations for donor acceptability must be established and followed.

## 1-5. PERMANENT DEFERMENT OF DONORS

Donors may be permanently deferred for certain reasons. These reasons are as follows:

a. Donors with a history of viral hepatitis at any time (FDA regulations) or after age 10 per AABB Standards.

b. Donors who have ever had a confirmed positive test for HBsAg. HBsAg stands for hepatitis B surface antigen (also called hepatitis-associated antigen (HAA)), the causal viral agent of serum hepatitis.

c. Donors who have or have been a drug addict (involving injection of drugs). Check both arms.

d. Donors with the only unit of blood, blood component, or derivative administered to a recipient who within 6 months developed post transfusion hepatitis.

NOTE: Post transfusion hepatitis after multiple transfusions is not cause or exclusion of all donors.

e. Donors who have present or past clinical or laboratory evidence of infection with hepatitis C or who have had a repeatedly reactive test for anti-HB<sub>c</sub> (hepatitis B Core) on more than one occasion.

f. Donors with AIDS; donors who have experienced any of the symptoms in Example 13, or the donors who fall into one of the categories listed in the explanation for Example 13.

g. Donors who have present or past clinical or laboratory evidence of infection with HIV or HTLV-I/II viruses.

h. Donors that are excluded from donation by current FDA regulations for the prevention of HIV transmission by blood and blood products.

i. Donors who have donated the only unit of blood or blood component transfused to a patient, who developed clinical or laboratory evidence of transfusion associated infection with HIV or HTLV-I/II viruses and who received no other blood component or derivative known to transmit these infections and had no other probable cause of infection.

Example 13:

**QUESTION:** Have you had any of the following: night sweats; unexplained fever above 99° F; persistent cough or shortness of breath; lymph nodes swollen for more than a month; blue or purple spots or lumps on or under the skin or mucous membranes; white patches or unusual lesions in the mouth; persistent diarrhea; or unexpected weight loss?

Are you a member of, or a sexual partner of a category considered at high risk of acquired immune deficiency syndrome (AIDS)?

**EXPLANATION:** Individuals in categories at high risk for acquiring or transmitting AIDS, and their sexual partners, should not donate blood. These include persons with AIDS; persons who have experienced the symptoms listed above; males who have had sex with, or whose male partners have had sex with, more than one male since 1977; past or present abusers of intravenous drugs; Haitian entrants to the US after 1977; hemophiliacs; those having sex with prostitutes (in the past 12 months) and the sexual partners of individuals in these categories, with instruction that such individuals should abstain from donation. Donor room personnel must question all individuals who elect to donate about the signs and symptoms listed, and should be alert to abnormalities on physical examination, especially evidence of IV drug abuse, skin lesions, fever, or evidence of recent weight loss. At some centers, donors unwilling to discontinue the selection process are offered an opportunity to signify confidentially that their blood should not be used for transfusion.

**1-6. TWELVE MONTH DEFERMENT OF DONORS (IN CASE HEPATITIS DEVELOPS)**

a. Donors may be deferred for at least 12 months under the following circumstances:

(1) Recipient of blood, blood components, or derivatives such as fibrinogen, Factor II, VII, IX, or X complex, AHF concentrates, immune vaccines, and so forth. This includes donors who are in blood group immunization programs.

(2) Donor who has had skin allografts and tattoos. (Ear-piercing and acupuncture done under questionable conditions may be considered as reason for deferment.)

(3) Donor who has had close contact with a patient with viral hepatitis. The type of contact that hospital personnel encounter in their routine work is not considered close contact and is not cause for rejection. Hospital personnel in areas where hepatitis is endemic (in renal dialysis units, and so forth) should be deferred for 6 months after employment in such areas.

(4) Inmates of penal or mental institutions until 6 months after release.

b. Any donor with a questionable history or one who has been implicated in more than one case of post-transfusion hepatitis should be referred to the blood bank physician for evaluation.

c. Record of physical examination and medical history must be signed by the examiner. The reason for deferral (temporary or permanent) should be recorded and explained to the donor and referral to a physician made if indicated.

d. Donors who are accepted should be made aware that there is possible risk to recipient and asked to report any illness developing within a few days of donation, and especially to report hepatitis that develops within 6 months.

#### **1-7. SPECIAL DONOR CATEGORIES**

Exceptions to the usual requirements may be made for:

a. **Therapeutic Bleedings.** This term is used when blood is removed for medical indications. The records must include a written order by the patient's physician specifying the amount of blood to be drawn, the frequency of bleeding and/or a hemoglobin or hematocrit level at which the patient should be bled. The blood bank physician may agree to and accept responsibility for having these patients bled in the donor center. In most therapeutic bleedings, it is advisable to bleed at a slower rate than usual and to extend the rest period following donation. If the patient is obviously ill, phlebotomy should be performed in a hospital setting. If the unit is not suitable for homologous transfusion, it must be labeled NOT FOR TRANSFUSION and either discarded or used for research purposes. If the unit is suitable for homologous transfusion (as determined by the blood bank physician), it may be transfused after the usual processing, provided the label indicates a therapeutic bleeding and specifies the donor's disease. The recipient's physician must agree to use the blood for transfusion and a record made of this agreement.

**b. Autologous Transfusion.** The term autologous transfusion describes transfusion of any blood component that was donated by the intended recipient. A recipient who serves as his or her own donor receives the safest possible transfusion in that the risks of transfusion-transmitted infection and all immunization are eliminated. Autologous transfusion provides many benefits to the donor-patient, the blood donor center, and the hospital transfusion service. Four categories of autogous transfusions are generally recognized:

(1) Preoperative. The blood drawn before a planned surgery is stored until needed.

(2) Intraoperatiive hemodilution. The blood is collected at the start of surgery (most often prior to a cardiopulmonary bypass procedure) and then stored for subsequent reinfusion post-bypass.

(3) Intraoperative salvage. The blood is salvaged from the surgical field and infused during or after the surgical procedure.

(4) Post operative salvage. The blood is collected post operatively by salvage of shed mediastinal blood. Although preoperative phlebotomy may be performed only at the written request of the patient's physician, the medical director of the drawing facility is ultimately responsible for determining, prior to each donation, the suitability of drawing blood from a particular patient. Guidelines for acceptable autogous donation criteria should be met prior to accepting the patient for donation. Individuals who fail to meet the criteria may request special permission to enter the autologous program.

**c. Donor Immunization and Hyperimmunization.** The standards are quite clear and the reader is referred to the current edition of the Standards of the AABB.

## **1-8. THE COLLECTION OF BLOOD**

a. Blood shall be collected from donors by trained personnel working under the direction of a qualified, licensed physician. The phlebotomist must sign or initial donor record, whether or not the phlebotomy resulted in a transfusable unit.

b. Blood collection shall be by aseptic methods, utilizing a sterile, closed system, and a single venipuncture. If more than 1 skin puncture is needed, another container and donor set must be used.

**CAUTION:** The donor must never be left unattended during the collection of blood.

## 1-9. MATERIALS AND INSTRUMENTS USED IN BLOOD COLLECTION

Many items are available in sterile, single-use disposable form. Items such as gauze, cotton balls, applicators, forceps, and forcep holders may be adequately sterilized by steam under pressure for at least 30 minutes at 121.5°C, by dry heat for at least 2 hours at 170°C, or by gas sterilization if available. Sterile containers should be labeled and dated when sterilized and when opened. Transfer forceps should have at least the lower third immersed in an effective antiseptic solution (for example, 70 percent isopropyl alcohol) and be resterilized after 1 week. Unopened containers may be stored from 2 to 3 weeks. Open containers may be used for 1 week only.

## 1-10. BLOOD CONTAINERS

The blood container (see figure 1-2) shall be pyrogen-free, sterile, and contain sufficient anticoagulant for the quantity of blood to be collected. The anticoagulant shall be one approved by the Food and Drug Administration (FDA), or 1 that meets its standards, and shall be in the container when it is sterilized. The container shall be sufficiently colorless and transparent to permit visual inspection.

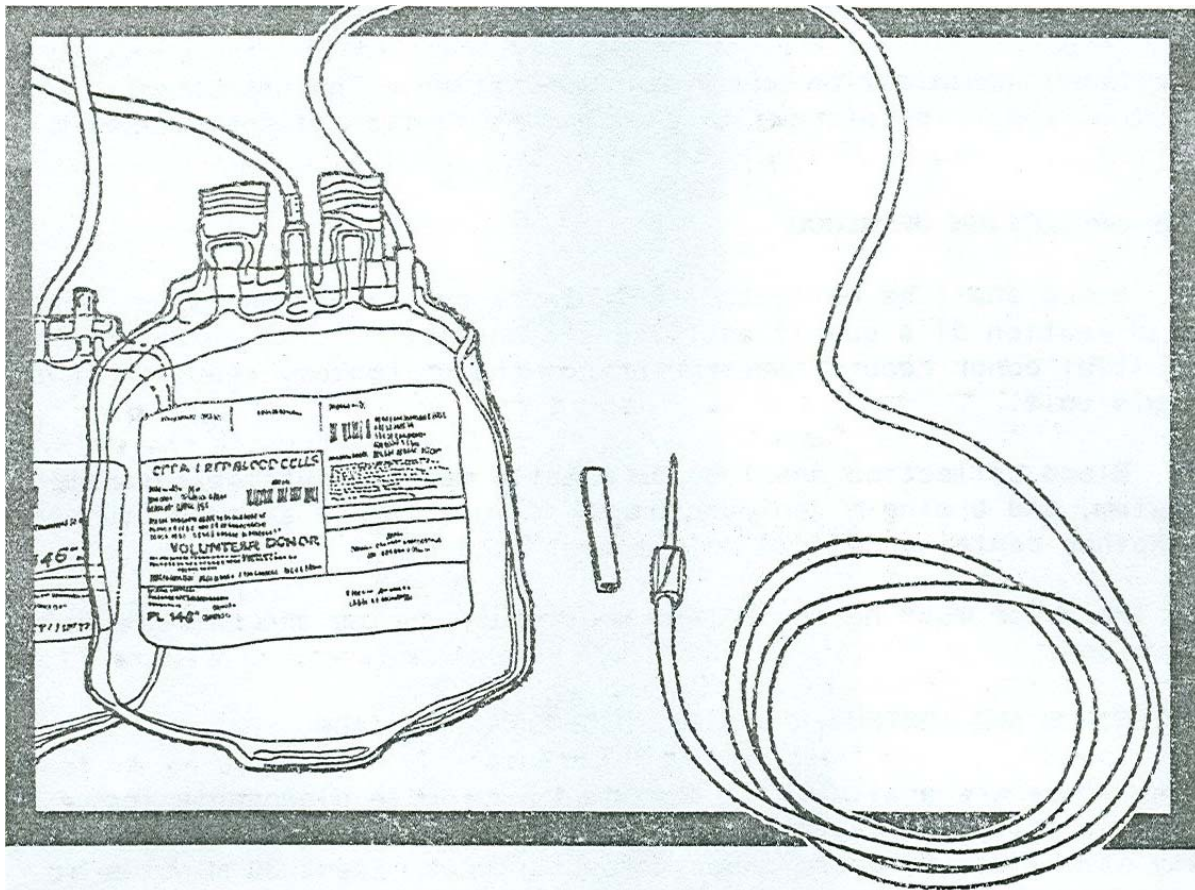

Figure 1-2. Plastic blood pack.



## 1-11. THE IDENTIFICATION OF MATERIALS

In each step from donor to final disposition, a numeric or alpha-numeric system shall be used to identify and relate the donor record, the processing (pilot) tubes, and the container. Extreme caution is necessary to avoid any mix-up in numbers. All cards and labels should be checked for printing errors. Duplicate numbers must be discarded and voided numbers recorded. A separate work table by each donor chair will decrease the possibility of errors. Prior to starting the phlebotomy:

NOTE: Phlebotomy means the incision of a vein. It is used in this text to indicate the procedure for letting blood.

a. Ensure that the donor card is completely filled out and any question answered "yes" must be resolved and the donation approved by the blood bank physician.

b. Identify the donor record with the donor by name.

c. Attach identically numbered labels to donor the record, container, and processing tubes.

d. Processing tubes are for laboratory tests other than compatibility testing and must accompany the container during collection of blood. They may be attached in any convenient manner to assure correct identification. (Segments must be used for compatibility testing.)

e. Re-check all numbers.

## 1-12. PREPARATION OF THE VENIPUNCTURE SITE

a. Select a large firm vein in an area that is free of skin lesions. It is often helpful to inspect both arms and to use either a tourniquet or a blood-pressure (BP) cuff inflated to 40 mmHg to 60 mmHg to make the veins more prominent. Having the donor open and close his hand a few times is also helpful. Release tourniquet and prepare site.

b. There is no way to prepare a completely aseptic site for venipuncture; however, a state of surgical cleanliness can be achieved to provide maximum assurance of a sterile product, and two recommended procedures follow. Other procedures may be equally satisfactory.

c. General instructions for both methods: Prepare an area at least 1 1/2 inches in all directions from intended site of venipuncture; use sterile materials and instruments; after the initial scrub, apply other solutions starting at site of venipuncture and moving outward in a concentric spiral.

NOTE: Check with donor to determine if he/she is allergic to iodine. If the answer is "yes," use method 2.

### Method 1

STEP 1: Scrub vigorously with 15 percent aqueous (not alcoholic) soap or detergent solution for at least 30 seconds to clean away fat, oils, dirt, and so forth.

STEP 2: Remove soap, and so forth, with 10 percent acetone in 70 percent ethyl alcohol and allow to dry.

STEP 3: Apply tincture of iodine (3 percent to 3 ½ percent in 70 percent ethyl alcohol) and allow to dry.

STEP 4: Remove the iodine with 10 percent acetone in 70 percent isopropyl alcohol. (The iodine has served its purpose and will rarely cause any skin reactions if properly removed.) Allow the solution to dry.

STEP 5: Cover the site with a sterile gauze if venipuncture is not done immediately.

NOTE: Keep the tincture of iodine bottle tightly capped to prevent evaporation of alcohol. Higher concentrations of iodine may cause skin reactions. In situations in which iodine is not feasible (such as collection of blood for chemical control use), 1 of the organic mercurials may be used as an antiseptic (FDA).

### Method 2

STEP 1: Scrub area for 30 seconds with 0.75 percent aqueous scrub solution of iodophor compound (for example, PVP-iodine or poloxameriodine complex). Excess foam must be removed but the arm need not be dry before proceeding to the next step.

STEP 2: Apply iodophor complex solution (that is, 10 percent PVP-iodine and let stand for 30 seconds. This solution contains 1 percent free iodine and need not be removed before completing venipuncture. It has the advantages of less odor and stain than tincture of iodine and seldom causes skin reactions even in iodine-sensitive individuals. Iodophor complexes may be substituted for tincture of iodine in Method one, step three

STEP 3: Cover the areas with sterile gauze if venipuncture is not done immediately. After the skin has been prepared, it must not be touched again. Do not repalpate vein.

NOTE: For donors sensitive to iodine (tincture or PVP), another method, such as green soap scrub followed by acetone-alcohol, should be designated by the blood bank physician.

### 1-13. PHLEBOTOMY AND COLLECTION OF SAMPLES FOR PROCESSING AND COMPATIBILITY TESTS

In order to obtain a clot-free full collection of blood, it is most important to do a clean, skillful venipuncture.

a. STEP 1: Inspect bag for any defects. Apply pressure to check for leaks. The anticoagulant solution must be clear.

b. STEP 2: Position bag carefully. Determine and do the following:

(1) If balance system is used, be sure counterbalance is level and adjusted for the amount to be drawn. Unless metal clips and a hand sealer are used, make a very loose overhand knot in tubing. Hang the bag and route tubing through the pinch clamp.

(2) If balance system is not used, position bag low enough to allow gravity collection. The bag may be hung upside down so blood flows through the anticoagulant. There must be a means to monitor the amount of blood drawn.

(3) If a vacuum-assist device (see figure 1-3) is being used, the manufacturer's instructions should be followed.

(4) Quality assurance--For accuracy, balance system (see figure 1-4) or vacuum-assist devices and scales must be checked upon receipt and periodically.

c. STEP 3: Reapply tourniquet or BP cuff (40 mmHg). Have donor open and close hand until previously selected vein is again prominent.

d. STEP 4: Uncover sterile needle and do venipuncture immediately (see figure 1-5). Tape the tubing to hold needle in place and cover site with sterile gauze.

e. STEP 5: Open the temporary closure between the interior of the bag and the tubing following manufacturer's instructions (see figure 1-6).

f. STEP 6: Instruct donor to open and close hand, squeeze a rubber ball or other resilient object, slowly every 10-12 seconds during collection.

g. STEP 7: Mix the blood and anticoagulant gently and periodically (approximately every 30 seconds) during collection. Mixing may be done manually, by placing bag on a rotator, or by using a vacuum-assist device.

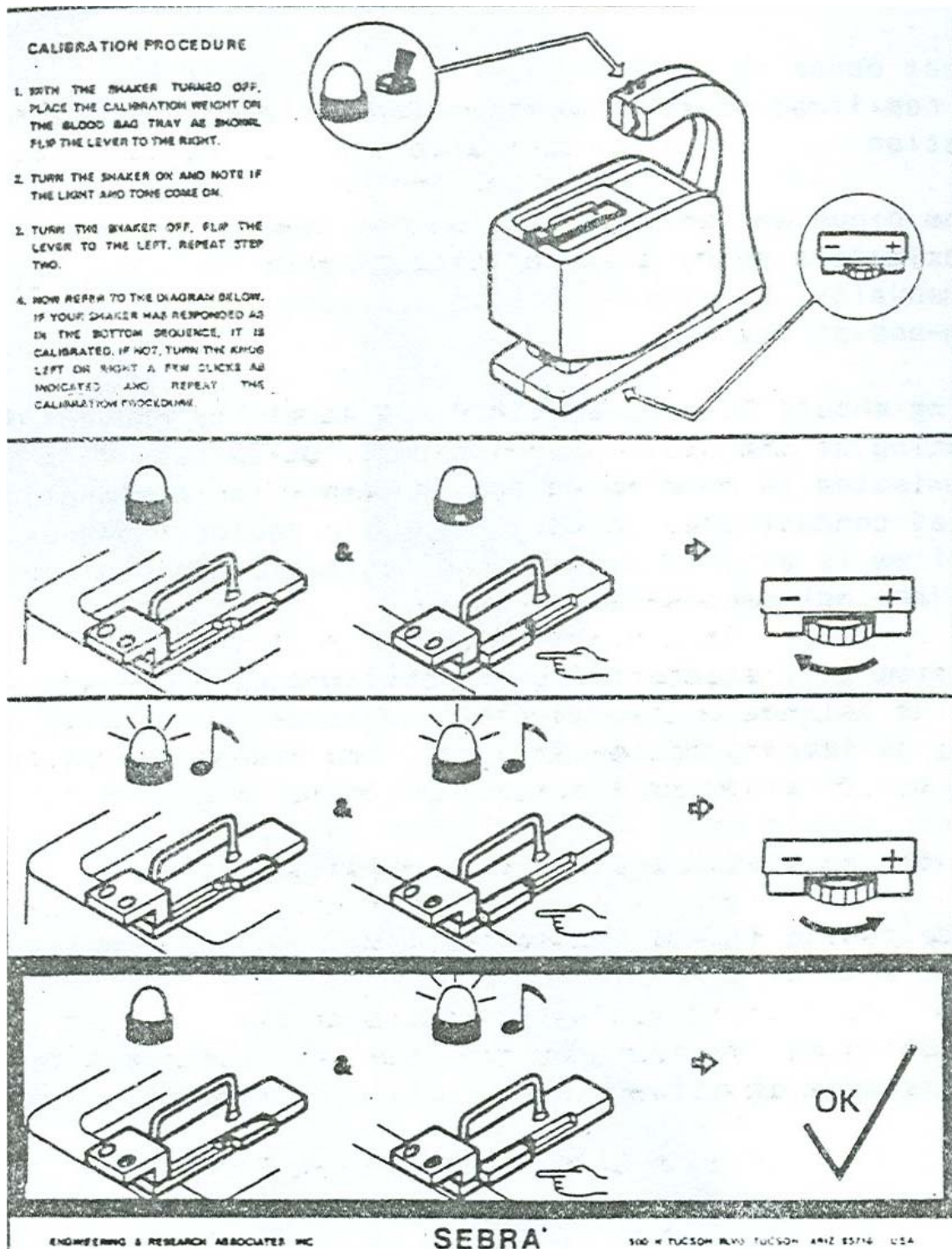

Figure 1-3. A vacuum-assist device.

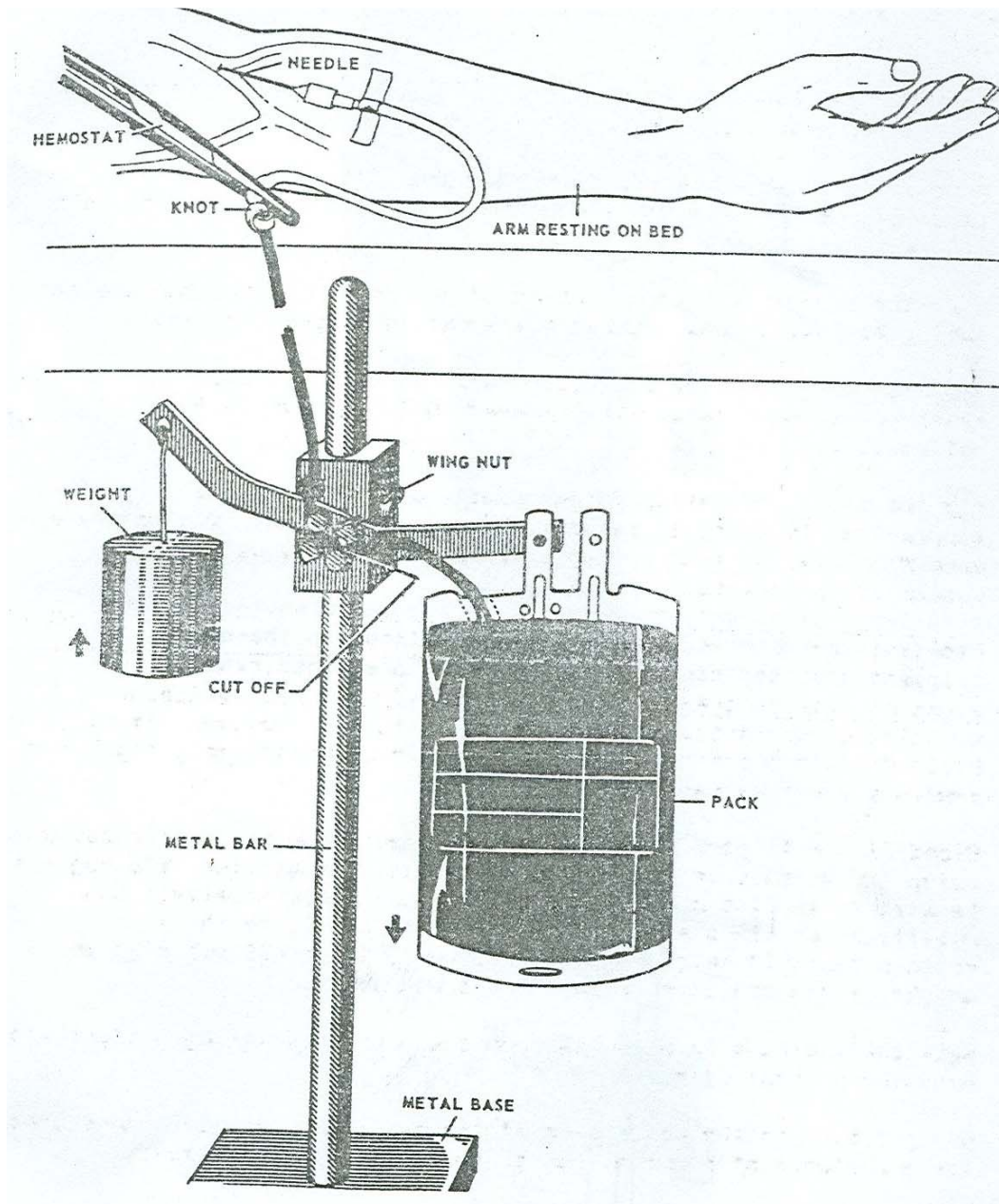

Figure 1-4. Automatic shut/cut-off blood collecting balance. Apparatus rests at a lower level than the patient's arm. Adjustable height is controlled by a wing nut attached to sliding metal rectangle which moves vertically on the metal bar.

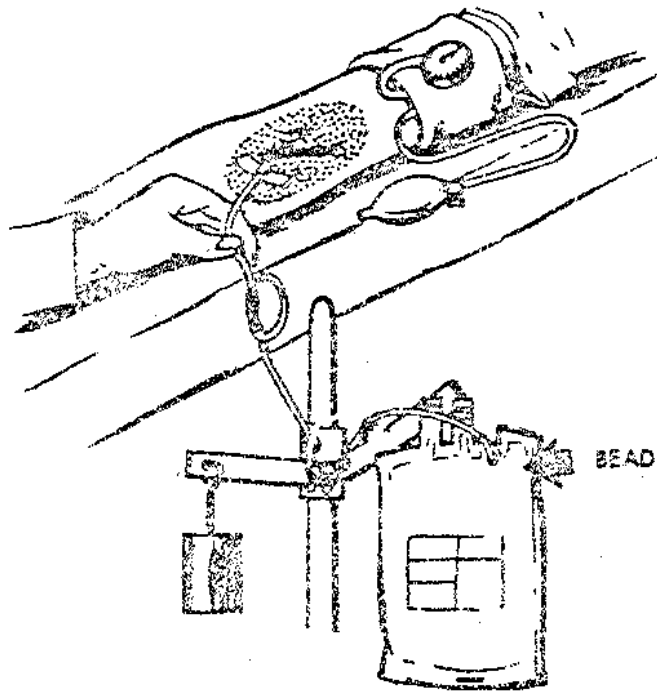

Figure 1-5. Blood pack mounted on the automatic shut-off blood collecting balance. (Note the loose knot in the donor tubing and the bead of blood entering the blood pack.)

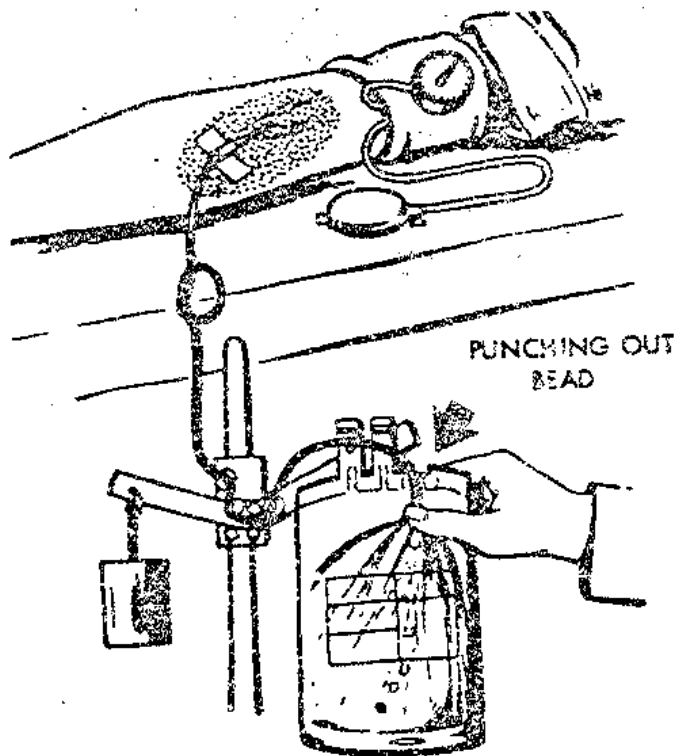

Figure 1-6. Opening the temporary closure between the interior of the bag and the tubing.

h. STEP 8: Bleeding should be completed fairly rapidly to prevent the triggering of the clotting mechanism. Units requiring more than eight minutes to draw may not be suitable for preparation of platelet concentrates or antihemophilic factor; however, if adequate blood flow is assured and constant agitation maintained, rigid time limits are not warranted.

i. STEP 9: Blood flow will stop after the proper amount has been collected when using the balance or vacuum-assist methods. Otherwise, the bag must be weighed (spring scales) and the flow stopped manually. One milliliter of blood equals 1.053 gm to 1.055 gm, so the final container should weigh 425 gm to 520 gm (405 to 495 ml) plus the weight of the container with its anticoagulant.

j. STEP 10: Seal the tubing 4 to 5 inches from the needle by making a tight knot or using a metal clip.

k. STEP 11: Grasp tubing on the donor side of the seal and press to remove blood for a distance of no more than an inch. Clamp with hemostat.

l. STEP 12: Cut tubing between seal and hemostat. To fill processing tubes for laboratory tests, other than compatibility testing, remove stopper from tubes, release hemostat, and allow blood to flow directly from vein (see figure 1-7). Re-identify tubes with container after filling.

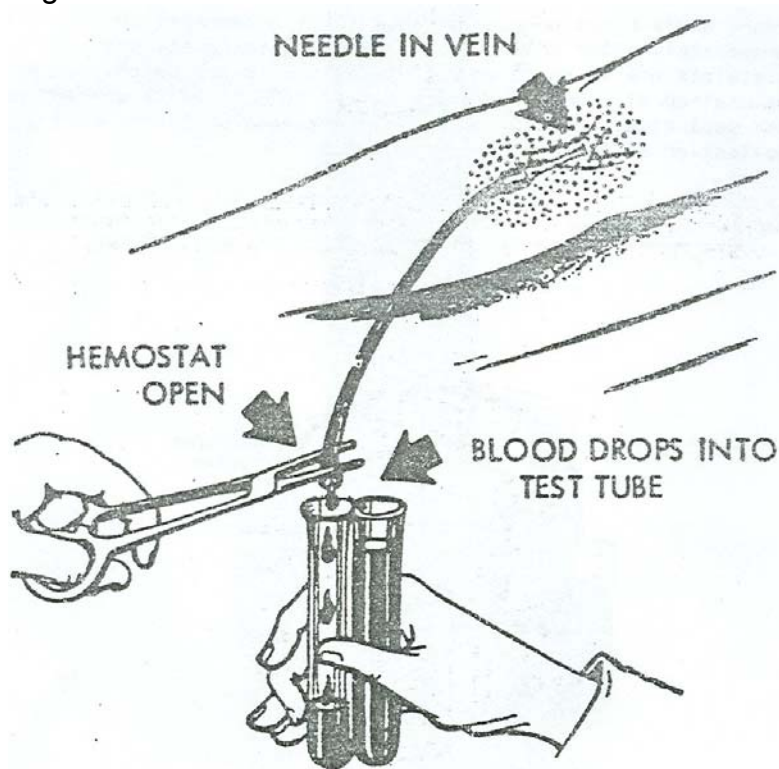

Figure 1-7. Filling tubes for laboratory tests.

m. STEP 13: Deflate and remove tourniquet. Remove needle from arm. Apply pressure with a sterile sponge and have donor raise arm (elbow straight) and hold gauze firmly over phlebotomy site with other hand.

n. STEP 14: Discard needle assembly into special container designed to prevent accidental contamination to personnel.

o. STEP 15: Strip donor tubing as completely as possible, starting at the seal going into the bag. It is important to work quickly before initiation of coagulation occurs.

p. STEP 16: Invert bag several times to mix thoroughly; then allow tubing to refill with anticoagulated blood from the bag.

q. STEP 17: Keep the tubing attached to the bag and sealed into sterile segments, suitable for compatibility testing, using knots, metal clips, or a dielectric sealer (see figure 1-8). A final double seal should be made within 2 inches of the bag. It must be possible to separate segments from container without breaking sterility of container.

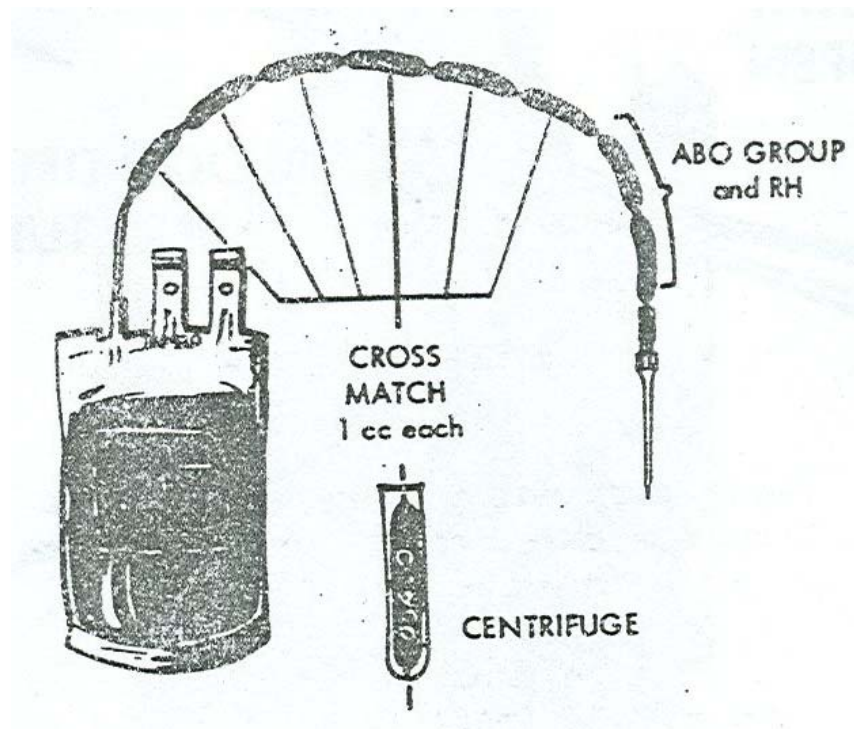

Figure 1-8. Procedure for collecting pilot tube specimens.



- r. STEP 18: Reinspect container for defects.
- s. STEP 19: Recheck numbers on container, processing tubes, and donor record.
- t. STEP 20: Store whole blood or red blood cells at a temperature of 1° C to 6° C immediately after collecting or removing the platelets. If platelets are to be harvested, blood should not be chilled but maintained at room temperature (about 20° C to 24° C) until platelets are separated. Platelets must be separated within 8 hours after collection of the unit of whole blood.

#### **1-14. START CARE OF THE DONOR AFTER PHLEBOTOMY**

Follow these steps after phlebotomy.

- a. STEP 1: Check arm and apply bandage after bleeding stops.
- b. STEP 2: Instruct donor to remain reclined on the bed or in the donor chair under close observation by staff.
- c. STEP 3: Allow donor to sit up when a satisfactory condition is noted.

**CAUTION:** DO NOT LEAVE DONOR. The donor could faint, fall, and/or have some type of reaction.

d. STEP 4: Give the donor some simple instructions. The medical director may wish to include some of the following suggestions:

- (1) Do not smoke for a half-hour.
- (2) Eat and drink something before leaving.
- (3) Do not leave until released by a staff member.
- (4) Drink more fluids than usual in next four hours.
- (5) It is probably better not to have any alcohol until you have eaten something.
- (6) If there is bleeding from phlebotomy site, raise arm and apply pressure.
- (7) If you feel faint or dizzy, either lie down or sit down with head between your knees.
- (8) Remove bandage after a few hours.

(9) If any symptoms persist, either return to blood bank or see a doctor.

(10) You may resume all normal activities after about a 1/2 if you feel well.

(11) It is probably best not to ride in fast elevators, to do strenuous work or exercise, or to visit a patient in the hospital until after you have eaten.

(12) Your blood volume returns to normal very rapidly (normal volume ranges from 4,000 ml (8 pints) to 5,500 ml (11 pints), depending on size and weight).

e. STEP 5: Advise the donor to remain for a few minutes. Thank the donor for an important contribution, encourage repeat donation after proper interval, and escort donor to the refreshment area. The person on duty in this area should be friendly and qualified to observe for any signs of delayed reaction, competent to interpret instructions and answer questions, and responsible for releasing donor in good condition.

f. STEP 6: Record on the donor's card if he leaves against advice to stay. The medical director of the blood bank must establish a mechanism to notify donors if he considers that any clinically significant abnormalities have been detected in either pre-donation evaluation or in post-donation laboratory tests, especially confirmed positive tests for hepatitis or syphilis.

## **1-15. DONOR REACTIONS**

Most donors tolerate donating very well, but occasionally an adverse reaction may occur. Personnel must be trained to recognize and treat reactions, and suitable equipment must be available.

### **a. Causes and Symptoms.**

(1) Syncope (fainting or vasovagal syndrome) may be caused by the sight of blood, blood donation by another individual, and by individual or group excitement. Whether caused by pre-donation psychologic factors or a neurophysiologic response to blood donation, the various symptoms may include: weakness, diaphoresis (perspiration), dizziness, pallor, nausea, loss of consciousness, convulsions, and involuntary bowel or urinary passage. The skin feels cold, there is a fall in blood pressure (systolic level of 50 mmHg or 60 mmHg), or the blood pressure may become un-recordable. The pulse rate may slow to as low as 40 beats per minute.

(2) Convulsions may occur during blood donation, and several considerations are involved; for example, they may occur in a donor who is an epileptic; another aspect is deep or over-breathing, in which the excited donor loses an excess of CO<sub>2</sub> resulting in alkalosis and hyperventilation tetany.

(3) The fall of peripheral resistance in the normal individual results in adrenergic stimulation, an increase in heart rate, and increases in peripheral resistance (skin, muscles, kidney, and gut). In the donor reaction, circulating blood volume loss results in a fall of peripheral resistance, which appears to be related to a sudden dilatation of the vascular beds in widespread areas of the body, particularly the voluntary muscles.

b. **Treatment.** The blood bank physician must provide written instructions for handling donor reactions. This must include a procedure for obtaining emergency medical help.

NOTE: Immediate action is needed if the donor has a reaction.

(1) General.

(a) At the first sign of reaction during the phlebotomy, **REMOVE THE TOURNIQUET AND WITHDRAW THE NEEDLE FROM THE ARM.**

(b) If the treatment listed in the items below does not result in rapid recovery, call the blood bank physician or the physician designated for such purposes.

(2) Fainting.

(a) Place the donor on his back and raise his feet above the level of his head.

(b) Loosen tight clothing.

(c) Be sure the donor has an adequate airway.

(d) Administer aromatic spirits of ammonia by inhalation. Test the ammonia on yourself before passing it under the donor's nose, as it may be too strong or too weak. Strong ammonia may injure the nasal membranes; weak ammonia is not effective. The donor should respond by coughing, which rapidly elevates the blood pressure.

(e) Check and record the blood pressure, pulse, and respiration periodically until the donor recovers.

(f) Apply cold compresses to the donor's forehead or the back of his neck if this seems desirable.

(3) Nausea and vomiting.

(a) Make the donor as comfortable as possible.

(b) Instruct the donor to breathe slowly and deeply if he is only nauseated.

(c) Apply cold compresses to the donor's forehead.

(d) Provide a suitable receptacle if the donor vomits, and have cleansing tissues or a damp towel ready.

**CAUTION:** Do not leave donor in a head-down position because of the dangers of aspiration.

(e) Give the donor a paper cup of water to rinse out his mouth.

(4) Twitching or muscular spasms. Extremely nervous donors may hyperventilate, causing faint muscular twitching or tetanic spasm of their hands or face. Donor room personnel should watch closely for these symptoms during the phlebotomy. Diverting the donor's attention by engaging him in conversation can interrupt the hyperventilation pattern. However, if symptoms are apparent, having the donor re-breathe into a paper bag will usually bring prompt relief.

**CAUTION:** DO NOT ADMINISTER OXYGEN FOR TWITCHING/MUSCULAR SPASMS.

(5) Hematoma.

(a) Remove the tourniquet and the needle from the donor's arm.

(b) Place 3 or 4 sterile gauze squares over the hematoma and apply firm digital pressure for 7 to 10 minutes with the donor's arm held above the heart level.

(6) Convulsions.

(a) **CALL SOMEONE TO HELP YOU IMMEDIATELY.** Prevent the donor from injuring himself. During severe seizures, some people exhibit great muscular power and are difficult to restrain.

1 If possible, place tongue blades wrapped with adhesive tape between the back teeth of the donor to prevent him from chewing his tongue. Keep the blades in place until the donor recovers.

2 If possible, hold the donor on the chair or bed; if not possible, place the donor on the floor. Do not restrain the movements of the donor's extremities completely, but try to prevent him from injuring himself or you.

(b) Be sure the donor has an adequate airway.

(c) If the donor does not recover in a short time, call for medical aid.

(7) Cardiac or respiratory difficulties.

(a) Call for medical aid and/or an emergency care unit immediately.

(b) If the donor is in cardiac arrest, **begin CPR immediately** and continue until medical aid and/or an emergency care unit arrives.

NOTE: The nature and treatment of all reactions should be recorded on the donor's record or a special incident form. This should include a notation as to whether the donor should be accepted or rejected as a donor in the future.

c. **Emergency Supplies.** Supplies and drugs selected by the medical director should be readily available. A suggested list is given below. Some of these should be at the donor bleeding station. Others may not be necessary if the hospital emergency room or similar facility is nearby.

(1) Oropharyngeal airway, plastic or hard rubber.

(2) Oxygen and mask.

(3) Administration sets for:

(a) Intravenous fluids.

(b) Blood.

(4) Needle, sterile, both 20-gauge 2-inch and 25-gauge 3/4-inch.

(5) Sodium chloride injection USP (normal saline).

(6) Hypodermic syringes, sterile, 1 or 2 ml.

(7) Emesis basin or equivalent.

(8) Towels.

(9) Emergency drugs. Drugs are seldom required to treat a donor who has had a reaction. If the medical director wishes to have such drugs available, the kind and amount to be kept on hand must be specified in writing. Suggested drug classifications for consideration are: vasopressors, cardiac stimulants, coronary vasodilators, anticonvulsants, sedatives, bronchodilators, and antiemetics.

(10) A tray of sterile instruments and materials for treatment of minor lacerations, and so forth, may be useful, especially if the bleeding facility is not in a hospital.

## 1-16. PROCESSING REQUIREMENTS FOR DONOR BLOOD

a. **ABO Group.** ABO group shall be determined by testing the red blood cells with Anti-A, Anti-B, and Anti-A,B serums which meet FDA standards and by testing the serum or plasma with a pool of known group A<sub>1</sub> cells and known group B cells. The blood shall not be labeled unless the tests are in agreement and any discrepancy resolved.

b. **Rh Type.** The Rh group must be determined with Anti-Rh<sub>o</sub> (D) typing serum. Units that appear to be Rh<sub>o</sub> (D) negative must be tested for Rh<sub>o</sub> variants (D<sup>u</sup>). Units that are D-positive or D<sup>u</sup>-positive must be labeled as Rh-positive. Routine testing for additional red blood cell antigens is not recommended or encouraged.

### c. **Detection of Antibodies.**

(1) Blood from donors with a history of prior transfusion or pregnancy should be tested for unexpected antibodies before the cross-match, preferably at the time of processing. Most blood banks test all donor blood for unexpected antibodies--regardless of their history of transfusions or pregnancies--because of the difficulties in determining the donor's past histories and/or attempting to segregate those to be tested from those not to be tested.

(2) Methods for testing unexpected antibodies must be those that will demonstrate clinically significant antibodies. Blood in which such antibodies are found should be processed into components that contain only minimal amounts of plasma.

d. **Test for Identification of Units Possibly Transmitting Disease.** All donor blood must be tested to detect units which might transmit diseases. Currently required tests include hepatitis B surface antigen (HBsAg), hepatitis C virus (HCV), anti-hepatitis B core (anti-HBc), alanine aminotransferase (ALT), anti-human immunodeficiency virus-1 (anti-HIV-1), and anti-Human T-cell lymphotropic virus type I (anti-HTLV-I). All donor blood shall be tested for HBsAg, HCV, anti-HBc, ALT, anti-HIV-1 and anti-HTLV-I with reagents and techniques specified by the FDA, or approved equally sensitive and specified techniques. The blood component or unit of blood must not be used for transfusion unless the tests are negative or in the normal range. In an emergency situation, blood or components may be issued before the testing is performed but this fact must be conspicuous on the blood label. If the test is subsequently reactive, the recipient's physician must be notified.

e. **Test for Syphilis.** The FDA requires a serological test for syphilis. The blood or blood components must be non-reactive to be transfused.

f. **Labeling.** Prior to issue, each unit must be appropriately labeled. As a minimum, each unit should include the proper name of the component; the kind and amount of anticoagulant; the volume of the unit; the required storage temperature; the name and address of the collecting facility; whether the donor is a volunteer, autologous, or paid; the expiration date and the unique donor number; and required statements indicating "this product may transmit infectious agents" and "properly identify intended recipient." Depending on the component, various test results such as ABO, Rh, and antibody screening are required.

g. **Repeat Testing.** The facility performing the compatibility test must confirm the ABO group on donor cells, obtained from the integral segment, of all units of whole blood or red blood cells and the Rh type (D and D<sup>u</sup>) of all Rh<sub>o</sub> (D)-negative units of whole blood or red blood cells. Discrepancies shall be reported to the collecting facility and resolved before the unit is issued for transfusion. Repeating other tests is neither required nor recommended.

h. **Previous Records.** A donor's previous record of ABO group and Rh type shall not serve for identification of units of blood subsequently given by the same donor; new determinations shall be made for each collection.

i. **Retention of Blood Samples.** Processing samples shall be stored at 1°C to 6°C for at least 7 days after transfusion. When the blood is discarded, the processing sample need not be saved.

j. **Laboratory Records.** The actual results of each test observed must be recorded immediately, and the final interpretation must be recorded upon completion of testing. The record system must make it possible to trace any unit of blood or blood component from source (donor or shipping facility) to final disposition (transfused, shipped, discarded), and to recheck the laboratory records applying to the specific product, and to investigate adverse reactions manifested by the recipient. All records must be retained for at least 5 years and 6 months. Legal requirements for retention of records vary in different states.

k. **Maintenance Details.** Details for maintenance and storage including daily inspection, refrigeration temperatures, bacteriological procedures, are included in the next section. Techniques for performing the required laboratory tests, labeling requirements, and methods of component preparation are given in detail in the appropriate lessons of this subcourse.

I. **Quarantined Blood.** Blood collected from a donor later found to have, or to be at high risk of AIDS should be quarantined immediately, and the Office of Biologics Research and Review (Division of Blood and Blood Products) should be notified. Each facility's procedures manual should make it clear that such blood and all components, products, or samples prepared from it, is potentially infectious and should be labeled, stored, or shipped with standard precautions for infectious material. Such donor units may be held in quarantine pending clarification of the donor's diagnosis; used for investigative use related to AIDS; or disposed of by autoclaving or controlled incineration. Units should be over wrapped, to protect personnel in case of breakage.

## **Section II. BLOOD STORAGE AND SHIPMENT**

### **1-17. BACKGROUND INFORMATION**

a. The human erythrocyte is a living cell that requires energy to remain viable and carry out its primary function of delivering oxygen to the tissues. The major purpose of transfusing whole blood and red blood cells is to provide the recipient with the means of delivering oxygen to the tissues. Storage conditions, therefore, should be devised to maintain hemoglobin function and viability of the stored red blood cell mass.

b. Proper maintenance of red blood cell hemoglobin function and viability during cold storage is accomplished primarily by collecting the blood into an appropriate, sterile anticoagulant-preservative solution that prevents the blood from clotting and provides proper nutrients for continuing metabolism in the red blood cell. As with other living systems, the continued integrity of the stored red blood cell mass is dependent on a delicate biochemical balance of certain elements such as glucose, pH, ATP (adenosine triphosphate), and 2,3-DPG (diphosphoglycerate). This balance is further influenced by the storage temperature of 1°C to 6°C for whole blood and stored liquid red blood cells.

c. In addition to anticoagulant-preservative requirements, there are rather rigid regulations for the actual refrigeration of blood at 1°C to 6°C and 1°C to 10°C during transportation. To assure the continued sterility of blood during storage, regulations for routine inspection of stored blood, for bacteriologic studies of blood in open systems, and for re-issuance of blood have been instituted.



## 1-18. ANTICOAGULANT PRESERVATIVES

### a. CPD and CPDA-1.

(1) Citrate phosphate dextrose (CPD) is an anticoagulant-preservative approved by the FDA for 21-day storage of red blood cells maintained at 1°C to 6°C. Blood collected in CPDA-1 may be stored for up to 35 days at 1°C to 6°C. Maintenance of ATP levels correlates with viability during storage. The low storage temperature, 1°C to 6°C, slows glycolytic activity enough that the dextrose substrate is not rapidly consumed, and intermediary metabolites that may inhibit glycolysis are not generated excessively. CPD contains enough dextrose to support continuing ATP generation by glycolytic pathways. The added adenine in CPDA-1 provides a substrate from which red cells can synthesize ATP during storage, resulting in improved viability when compared with CPD without adenine.

(2) The quantity of citrate in CPD and CPDA-1 solutions is more than sufficient to bind the ionized calcium present in the volume of whole blood for which the bag is designed. Citrate prevents coagulation by inhibiting the several calcium-dependent steps of the coagulation cascade. Additionally, it retards glycolysis. The amount of anticoagulant-preservative in commercially available containers is suitable for 450 ml plus or minus 10 percent of blood that is, 405 to 495 ml).

(3) Currently approved by the FDA for extended storage of red blood cells are two systems in which a second preservative solution is added for red cell storage in addition to the anticoagulant solution used for whole blood collection. Both require that the plasma be separated from the red cells before additional preservative solution is combined with the red cells. This combination should take place as soon as possible but no later than 72 hours after phlebotomy.

(a) One system consists of a primary collection bag containing CPD. To this bag are attached satellite bags, one of which contains 100 ml of additive solution consisting of saline, dextrose, mannitol, and adenine.

(b) The second system consists of a primary collection bag containing citrate phosphate double dextrose (CP2D), a CPD solution with additional dextrose. A satellite bag contains 100 ml of additive solution consisting of saline, dextrose, and adenine.

(4) Maximum allowable storage time, referred to as shelf-life, is defined by the requirement for 70 percent recovery at 24 hours, for example, at least 70 percent of the transfused cells remain in the recipient's circulation 24 hours after transfusion. Transfused red blood cells that circulate after 24 hours will have a normal survival curve in the recipient. Blood collected in CPD may be stored for 21 days. Blood collected in CPDA-1 may be stored up to 35 days. The additive solution systems, approved only for red cell storage and not whole blood, permit a 35-day and a 49-day dating period respectively.

(5) The auxiliary preservative solutions in the additive systems are not approved for whole blood, plasma components, platelets, or for use in plasma-pheresis procedures. The anticoagulant CP2D has been approved for the preparation of routine blood components including single donor plasma, cryo-precipitated antihemophilic factor, and platelet concentrate.

(6) Certain measurable biochemical changes occur when blood is stored at 1°C to 6°C. These changes, some of which are reversible, are known as the "storage lesion" of blood. These changes are tabulated for CPD and CPDA-1 stored blood in table 1-2 and additive systems in Table 1-3. Except for oxygen-transporting discussed below, these rarely have clinical significance because transfusion volumes are small and the recipient's compensatory homeostatic mechanisms reverse these changes. Even in massive transfusion, the adverse effects of the red cell storage lesion are usually inconsequential unless the recipient is already severely compromised.

(7) In red cell storage and preservation, it is important to maintain oxygen-carrying and oxygen-releasing capacities of hemoglobin. The concentration of red cell 2,3-DPG influences the release of oxygen to the tissues. If 2,3-DPG levels are high, more oxygen is released at a given PO<sub>2</sub>. Lower red cell levels of 2,3-DPG cause greater affinity of hemoglobin for oxygen so that less oxygen is released at the same PO<sub>2</sub>.

(8) Concentrations of 2,3-DPG are affected by pH. The initial pH of blood collected in CPD and measured at the temperature of storage is approximately 7.4 to 7.5. As stored red blood cells metabolize glucose to lactate, hydrogen ions accumulate, plasma pH falls, and 2,3-DPG declines. Table 1-2 tabulates these changes for CPD and CPDA-1. During the second week of storage, the pH of CPD stored blood falls below 7.0. As pH drops, there is a fall in red cell 2,3-DPG. Concentrations of 2,3-DPG are normal in CPD-stored blood for about 10 days. When blood is stored in CPDA-1, 2, 3-DPG levels initially fall slightly more rapidly than in CPD, but near normal levels are maintained for 12 to 14 days.

(9) Following transfusion, stored red blood cells regenerate ATP and 2,3-DPG, resuming normal energy metabolism and hemoglobin function as they circulate in the recipient. It usually takes from 3 to 8 hours for severely depleted cells to regenerate half of their 2,3-DPG levels and approximately 24 hours for complete restoration of 2,3-DPG and normal hemoglobin function. In red cell storage, maintaining cell viability is unclear. On theoretical grounds, recipients likely to be most affected by low 2,3-DPG levels in transfused blood are those receiving massive quantities of stored blood in a short time, and those particularly vulnerable to the effects of tissue hypoxia; examples include newborns undergoing exchange transfusion, patients with small blood volume who receive large volumes of blood, and patients undergoing coronary artery bypass surgery. Such patients usually receive blood less than 7 to 10 days old.

Variable Days of Storage	CPD		Whole Blood	Red Blood Cells	CPDA-1	
	Whole Blood	Whole Blood			Whole Blood	Red Blood Cells
	0	21	0	0	35	35
% viable cells (24hr posttransfusion)	100.0	80.0	100.0	100.0	79.0	71.0
pH (measured at 37°C) <sup>o</sup>	7.2	6.84	7.6	7.55	6.98	6.71
ATP (% initial value)	100.0	86.0	100.0	100.0	56.0 (+/-16)	45.0 (+/-12)
2,3-DPG (% of initial value)	100.0	44.0	100.0	100.0	<10.0	<10.0
Plasma K <sup>+</sup> (mEq/l)	3.9	21.0	4.2	5.1	27.3	78.5*
Plasma Na <sup>+</sup> (mEq/l)	168.0	156.0	169.0	169.0	155.0	111.0
Plasma hemoglobin (mg/dl)	1.7	19.1	8.2	7.8	46.1	658*

\* Values for plasma hemoglobin and potassium concentrations may appear somewhat high in 35-day stored red blood cell units; the total plasma in these units is only about 70 ml.

Table 1-2. Biochemical changes of blood stored in CPD and CPDA-1.

(10) Stored red cells, even those at the end of their allowable shelf-life, can be rejuvenated with FDA-approved solutions containing pyruvate, inosine, phosphate, adenine, and in some cases, glucose. The rejuvenated red cells have increased levels of 2,3-DPG and ATP. Rejuvenated red cells can be frozen and stored in the same manner as fresh red cells and demonstrate normal oxygen transport when transfused.

b. **Heparin.** Heparin exerts its anticoagulant effect by potentiating the action of the endogenous plasma protein, antithrombin III (AT III). Synthesized in the liver, AT III is an inhibitor of most serine esterase clotting factors. Because it lacks dextrose, heparin serves only as an anticoagulant, not as a preservative. Heparinized blood must be transfused within 48 hours, preferably within 24 hours. Heparin is not recommended for routine blood collection.

Variable	AS-3*		(ADsal) AS-1**
Days of shortage	42	49	49
% viable cells (24-hours posttransfusion)	83 (+or-10)	72 (+or-9)	76 (64-85)
ATP (% of initial value)	58	45	64
2,3- DPG (% of initial value)	<10	<15	<5.0
Plasma K <sup>+</sup> (mEq/l)	NA	NA	6.5
pH	6.5	6.4	6.6
% Hemolysis	0.8	0.9	0.5
Based on manufacturer's submission to FDA, 1983.			
* Simon TL			
** Fenwal Laboratories			

Table 1-3. Biochemical changes of red cells stored in additive systems for 35 days.

## 1-19. REFRIGERATION OF BLOOD

a. Blood-storage refrigerators should contain only blood, blood components, reagents for blood bank tests, and blood samples from patients and donors. All samples in test tubes should be stoppered or sealed with parafilm. The temperature must be maintained in all areas of the refrigerator between 1°C and 6°C. Blood storage refrigerators should be designed with adequate fans and circulating spaces so that the designated temperature is maintained throughout the refrigerator. Separate areas in blood storage refrigerators should be clearly designated and labeled for: (1) unprocessed blood, (2) labeled blood, (3) cross-matched blood, (4) rejected or quarantined blood. Separate shelves or areas should be labeled for the various blood groups and types.

b. The interior of the blood storage refrigerator must be clean and adequately lighted to facilitate the inspection of the blood, the refrigerator and the thermometers.

c. All refrigerators in which blood is stored should have recording thermometers and must have audible and/or visual alarms to warn continuously of abnormal temperatures. The sensor for the temperature-recording system should be in fluid (10 percent glycerol in water) in a container with heat characteristics of the blood containers being used and a volume no greater than the least donor blood or component in storage. The sensor for the visual and audible alarm signals should be in the same container. The alarm should be activated when the temperature falls outside the acceptable 1°C to 6°C range. The electrical source for the alarm system should be separate from that of the refrigerator, using either a continuously rechargeable battery or a separate electrical house circuit. Finally, two mercury-type thermometers are recommended for monitoring temperatures: 1 immersed with the sensors of the recorder and alarm system and 1 in a similar container on the lowest shelf on which blood is stored. The temperatures of these two thermometers must be 1°C to 6°C at all times. A daily check should show the temperature of the thermometer at the top to be within 1°C of that shown on the automatic recorder. It is sufficient to record the temperatures from the two mercury thermometers on the recorder chart when it is changed weekly. In large walk-in refrigerators, it is recommended that such thermometer containers be placed in areas determined to reflect the range of temperatures and efficiency of the cool air distribution.

d. Temperature charts from 7-day mechanical recording devices must be changed weekly, dated inclusively, and labeled for proper identification of the refrigerator. Any temperature variation from normal should be explained in writing on the chart beside the tracing; but if the tracing is habitually a perfect circle, the recorder may not be functioning properly. The person responsible for changing the charts should sign them. All temperature records must be kept as part of the blood bank records a minimum of 5 years.

e. Refrigerator thermometers and alarms should be checked periodically to ascertain that they are functioning properly. The high temperature may be checked by slowly adding warm water to the vessel in the refrigerator which contains the sensor of the recording system and the calibrated thermometer. Stir constantly as the warm water is added. Note the temperature on the thermometer and on the chart at which the alarm sounds. The alarm should be activated just above 6°C. The low temperature may be checked by adding chipped ice slowly to the vessel containing the sensor of the alarm system and the calibrated thermometer.

f. Surfaces of refrigerators, charts, and working areas should be regularly cleaned with a germicidal solution. Phenolic compounds, such as O-phenyl phenol, are in many of the better cleaning solutions. Some combination products have soaps which greatly increase the germicidal activity of the phenols. These have to be carefully combined, however, because some soaps interfere with the germicidal activity of phenols. For cleaning areas that might be contaminated with the hepatitis agent, 5 percent to 10 percent sodium hypochlorite solutions are recommended.

g. Blood should never be left unnecessarily at room temperature. When units are removed from the refrigerator for processing or labeling, the length of time that they can be left un-refrigerated can be estimated by having an extra 300-ml container with a mercury thermometer in the blood bank refrigerator removed with the units to be processed. When the temperature in this container rises to near 6°C, the blood must be returned to the refrigerator without delay.

h. When issued for transfusion, blood should not be allowed to stand unnecessarily at room temperature. Delayed delivery to the floor, delayed arrival of equipment or personnel to begin a transfusion, and delays during infusion are all undesirable. Transfusion therapy teams of specially trained people have been effective in reducing the mishandling of donor blood.

i. If blood is stored in surgical or obstetrical suites, refrigerators that meet the previously discussed standards must be used. Temperature records are required for such refrigerators during periods of blood storage. Donor blood must never be stored in unmonitored refrigerators.

## **1-20. TRANSPORTATION OF BLOOD**

a. During transport, the temperature of blood must be kept between 1°C and 10°C. Sturdy, well-insulated cardboard or styrofoam shipping containers for maintaining these temperatures should be used.

b. The refrigerant during shipment from one facility to another is ordinarily wet ice in waterproof containers. Wet ice from ordinary commercial ice-making machines is satisfactory. Direct contact of the blood with the ice should be assured during long hot trips. Cubed wet ice is required rather than chipped or broken ice for shipments of blood at 1°C to 10°C. A layer of cardboard or an air space between ice and units may result in exceeding the upper limits of temperature acceptability (10°C) in summer months. The ice should have wet, glistening surfaces, indicative of melting (2°C to 3°C), and should not be super-cooled, in a low temperature freezer before using. Neither super-cooled, canned ice nor dry ice may be used in shipping or storing whole blood or red blood cells. Ice should be at least twice the volume of blood in the box when shipping a long distance or at high environmental temperatures. For blood recently drawn from a donor, a larger volume of ice may be necessary.

c. Some form of temperature indicator or monitoring is desirable periodically when shipping blood over a regular route. An easy method that every blood bank can employ to ascertain the temperature in a shipping box upon receipt is as follows: remove two bags of blood, position labels out, place a quality-assured mercury thermometer bulb end between the bags, and secure the "sandwich" with 2 rubber bands; after a few minutes, read the temperature. If the temperature exceeds 10°C, even though some ice is still present, such blood must be quarantined. Regular temperature monitoring of whole blood and red blood cells may uncover a need for better insulated containers or larger amounts of ice. Record forms, packaged in each carton for completion and return by recipient blood bank personnel, provides written evidence of sufficient ice and insulation. These records of shipping to usual recipients can be used as guides for shipments to unusual recipients.

d. Other suitable methods for monitoring shipments are:

(1) Use time/temperature tags that indicate whether, at anytime during the shipping process, the temperature has exceeded 10°C.

(2) Place a "high-low" mercury thermometer in the shipping box. These simple reusable thermometers record the highest and lowest temperatures achieved during a time period.

(3) Use a temperature indicator in which the location of glass beads in an ampule filled with wax-like material indicates whether or not the wax has reached its 10°C melting point.

(4) Use other monitoring devices shown to be satisfactory. The accuracy of any temperature-indicating device should be checked before it is placed in routine use and periodically thereafter.

e. Local transport of blood or red blood cells from the blood bank to other parts of the hospital must be controlled so that unused blood is returned within a set period of time. Because blood stored at 1°C to 6°C will exceed 10°C in approximately 30 minutes at room temperature, blood or red blood cells should be used or returned within 30 minutes. When transportation will require a slightly longer time, each unit may be placed in an insulated paper bag pre-cooled to 1°C to 6°C. Blood required by remote facilities such as surgical operating theaters can be delivered in this manner, or monitored refrigerators can be installed. Small styrofoam buckets with lids are useful for a few hours storage in operating rooms. A bag of ice water blanketing the blood bag assures a 1°C to 6°C temperature.

f. Whether blood is removed from the facility for transport or for remote holding, as in a surgical suite, it must be maintained at less than 10°C. Finally, it is the responsibility of the shipping or issuing facilities to ascertain that the shipping container is satisfactory with respect to its ability to maintain the temperature of the blood or red blood cells below 10°C during the time of transportation.

## **1-21. TRANSPORTATION OF FROZEN COMPONENTS**

Packing must assure that the component being transported is maintained at or below its required storage temperature. For example, if fresh-frozen plasma (required to be stored below 18°C) is to be packed for a 10-hour trip, enough dry ice must be used to assure that the plasma stays below 18°C. The insulation qualities of a clean, plastic air bubble packaging material have been useful in maintaining temperatures of frozen components and protecting them from mechanical damage. Small pieces of styrofoam (disc, peanut-shape, and so forth) are useful. Too much distance between dry ice and components must be avoided. Careful sealing with masking tape of an inner and outer container is most important. Adequate quantities of dry ice and insulating characteristics of the container must be determined for each situation.

## **1-22. DONOR BLOOD INSPECTION**

a. All units in the storage refrigerator must be examined periodically during storage (daily inspection is recommended) and immediately before issue. Records of these inspections must be maintained and the date shown; donor number and description of any abnormal units, action taken, and personnel identities must be given. Blood should be rejected for transfusion if the color or other physical appearance is abnormal. Contamination is suspected if the red blood cell mass has a purple color, if a zone of hemolysis is observed just above the cell mass, or if clots are visible. Other obvious features that can make blood unsuitable for transfusion are purple, brown, or red plasma. Green plasma may be a harmless manifestation of the use of oral contraceptives. Inadequate sealing or closure, sometimes indicated by blood or plasma at sealing joints in the tubing or ports, renders the unit suspect and possibly unsuitable for transfusion.

b. Blood units that are questionable for any of the above reasons should be quarantined until their disposition is decided. The unit should be gently inverted a few times to mix the cells and plasma since a great deal of undetected hemolysis, clotting, and so forth, may have taken place within the red blood cell mass. If, after sedimentation, the blood no longer appears abnormal, it may be returned to the available blood supply. Appropriate records should be completed by the responsible persons.

c. Abnormal blood that cannot be released for transfusion should be investigated and the abnormality recorded before it is destroyed. Results of the investigation may indicate the need for improvement in donor techniques, screening of donors, handling of blood units during processing, or notification of the donor, local health department, or both. Disposal procedures must conform to the local public health codes. Autoclaving, then incineration, are recommended.



## **1-23. BACTERIOLOGIC PROCEDURES**

a. Routine sterility testing is no longer required. Culturing may be desirable when inspections reveal abnormal donor bloods/components, or when patients have adverse reactions suspected to have resulted from contaminated donor blood. A good blood culture technique is: the test shall be performed with a total sample of no less than 10 ml of blood and a total volume of fluid thioglycollate or thioglycollate broth medium 10 times the volume of the sample of blood. The test sample shall be inoculated into one or more test vessels in a ratio of blood to medium of 1 to 10 for each vessel, mixed thoroughly, incubated for 7 to 9 days at a temperature of 30°C to 32°C, and examined for evidence of growth of microorganisms every workday throughout the test period. On the third, fourth, and fifth day, at least 1 ml of material from each test vessel shall be subcultured in additional test vessels containing the same culture medium and in such proportion as will permit significant visual inspection, mixed thoroughly, incubated for 7 to 9 days at a temperature of 30°C to 32°C, and examined for evidence of growth of microorganisms every workday throughout the test period. Subcultures are important because the original culture is usually slightly turbid from the blood, but the subculture is not. Turbidity is the earliest indication of growth of bacteria. Subcultures are usually clear if there is no growth.

b. If the sterility studies are done in another laboratory or institution, the medical director of the blood bank must assure himself that they have been done and reported to the blood bank adequately. Positive cultures should arouse suspicion of the donor arm preparation technique and/or component preparation if done using an open system. If growth is observed in any test vessel, the unit and any components made from it should be quarantined until additional cultures can be made to rule out faulty culturing procedures. All positive cultures should be recorded and the blood destroyed.

c. Records of these bacteriologic studies, like other records, must be retained for at least 5 years and 6 months. Legal requirements for retention of records vary in different states and the local statutes must be followed if these are longer than 5 years and 6 months.

## **1-24. REQUIREMENTS FOR REISSUANCE OF BLOOD**

Blood that has been returned to the blood bank shall not ordinarily be reissued for transfusion until the following conditions have been assured:

a. The container closure has not been penetrated or entered in any manner. This is to be certain that sterility is maintained.

b. The blood has been continuously refrigerated between 1°C and 10°C, preferably 1°C to 6°C. Warming the blood beyond these limits, even with subsequent cooling, tends to accelerate red cell metabolism, produce hemolysis, and may permit bacterial growth in the unit.

c. If the blood was issued, the pilot tube (or sealed segment of integral donor tubing) has remained attached to the container. If the blood has remained on the premises of the issuing facility, a removed pilot tube may be re-identified with the original container.

d. Records must indicate that the unit has been reissued.

### **1-25. TRANSPORTATION OF INFECTED REAGENTS**

Transportation of liquids or tissues known to contain hepatitis B surface antigen (HBsAg) is governed by an amendment of section 72.25 of part 72-Title 42, Code of Federal Regulations, containing important instructions for packaging precautions and procedures for damaged packages, and labeling requirements.

**Continue with Exercises**

## EXERCISES, LESSON 1

**INSTRUCTIONS:** Answer the following exercises by marking the lettered response that best answers the exercise, by completing the incomplete statement, or by writing the answer in the space provided at the end of the exercise.

After you have completed all the exercises, turn to "Solutions to Exercises" at the end of the lesson and check your answers. For each exercise answered incorrectly, reread the material referenced with the solution.

1. The age of blood donors must be at least what age?
  - a. 17.
  - b. 18.
  - c. 21.
  - d. 25.
  
2. A blood donor should NOT fast prior to withdrawal of blood.
  - a. True.
  - b. False.
  
3. Military personnel on flying status are generally excused from participation in routine blood collection programs.
  - a. True.
  - b. False.

4. The blood donor's oral temperature should be no greater than \_\_\_\_\_, the pulse from \_\_\_\_\_ beats per minute, the systolic blood pressure not greater than \_\_\_\_\_ mm of mercury, and the diastolic blood pressure no greater than \_\_\_\_\_ mm of mercury.
- a. 37°C (98.6°F); 62-82; 140 mm; 90 mm.
  - b. 38°C (100.4°F); 52-92; 130 mm; 80 mm.
  - c. 37.5°C (99.6°F); 50-100; 180 mm; 100 mm.
  - d. 38.5°C (101.3°F); 67-77; 125 mm; 110 mm.
5. The minimum acceptable specific gravity of blood from a female donor is:
- a. 1.043.
  - b. 1.053.
  - c. 1.055.
  - d. 1.065.
6. For how long after termination of a full term pregnancy must blood donation be deferred?
- a. 10 days.
  - b. 6 months.
  - c. 6 weeks.
  - d. 1 year.

7. A cause for deferral or exclusion of a potential donor is:
- a. Acute illness.
  - b. Coronary heart disease.
  - c. Rheumatic heart disease.
  - d. Active pulmonary tuberculosis.
  - e. Major surgery within the last six months.
  - f. All of the above.
8. A donor should NOT be used as the only source for a platelet preparation if he has taken \_\_\_\_\_ within the last 48 hours.
- a. Aspirin.
  - b. Minor tranquilizer.
  - c. Oral contraceptive.
  - d. Weight reduction drug.
9. How long must blood a donor be deferred after ingesting an oral polio vaccine or an immune reaction with smallpox vaccine?
- a. 2 weeks.
  - b. 24 hours.
  - c. 72 hours.
  - d. 3 months.

10. Which of the following is sufficient to defer blood donation for at least 12 months?
- a. Tattoo.
  - b. Receipt of blood transfusion.
  - c. Ear piercing, if procedure is suspect.
  - d. Confinement in penal or mental institution.
  - e. Close contact with a patient with viral hepatitis.
  - f. All the above.
11. Blood must be collected by aseptic methods.
- a. True.
  - b. False.
12. How much time is required for steam pressure (121.5<sup>0</sup>C) and dry heat (170<sup>0</sup>C) sterilization, respectively when such items as cotton balls and forceps are used?
- a. 15 minutes; 1 hour.
  - b. 1 hour; 15 minutes.
  - c. 30 minutes; 2 hours.
  - d. 2 hours; 30 minutes.
13. What type of vein must be selected for venipuncture?
- a. Aseptic.
  - b. Superficial.
  - c. Small and thin.
  - d. Firm and large.

14. What liquid is used first to remove soap and then iodine in Method 1 (as described in TM 8-227-3) to prepare the site for a venipuncture?
- a. Detergent.
  - b. Ethyl alcohol.
  - c. Distilled water.
  - d. Ten
15. After the skin has been prepared for venipuncture, DO NOT:
- a. Cover site.
  - b. Touch site.
  - c. Reapply tourniquet.
  - d. Perform venipuncture.
16. Why must the portion of tubing remaining attached to the bag be stripped into the bag and then refilled after the tubing has been cut?
- a. Avoid air bubbles.
  - b. Concentrate cells within the bag.
  - c. Assure even distribution of cells.
  - d. Avoid clotting the blood in the tubing.
17. Ordinarily, about how long after leaving the donor chair or bed may the donor resume most normal, non-hazardous activities?
- a. One day.
  - b. Half day.
  - c. Half hour.
  - d. Three days.

18. How may hyperventilation tetany be treated?
- Elevate the donor's feet.
  - Administer aromatic spirits of ammonia.
  - Have the donor re-breathe into a paper bag.
  - Place padded tongue blades between back teeth.
19. For what must the donor's blood be tested?
- Syphilis.
  - ABO group.
  - Hepatitis B surface antigen.
  - Rh type (and weak Rh<sub>o</sub> variant (D<sup>u</sup>) if Rh<sub>o</sub> (D) negative).
  - Unexpected antibodies.
  - HTLV-III.
- II, V.
  - II, III.
  - I, II, III, V.
  - II, III, IV, V, VI.
20. What two natural components in red blood cells are essential for cell viability and help to maintain the normal hemoglobin function?
- ACD; CPD.
  - CPD; ACD.
  - 2,3-DPG; ATP.
  - ATP; 2,3-DPG.



21. The purpose of the citrate ion in CPD and CPD-1 is to prevent clotting by binding:
- Calcium.
  - Platelets.
  - Fibrinogen.
  - Prothrombin.
22. What environment allows for 2,3-DPG levels to be initially maintained better and ATP levels maintained better throughout?
- ACD.
  - CPD.
  - CPD-1.
  - Heparin.
23. How long is it before the recipient's hemoglobin function is restored to normal and red blood cells are regenerated following transfusion?
- 12 hours.
  - 24 hours.
  - 48 hours.
  - 3 days.
24. A 5 to 10 percent solution of \_\_\_\_\_ is to be used for cleaning areas that might be contaminated with hepatitis agent.
- Iodine.
  - Formaldehyde.
  - Isopropyl alcohol.
  - Sodium hypochlorite.

25. Donor blood should be stored in monitored refrigerators.
- True.
  - False.
26. Blood units should never reach a temperature higher than \_\_\_\_\_ during blood shipment.
- 20°C.
  - 0°C.
  - 4°C.
  - 10°C.
27. How long does it take the blood to exceed 10°C if it has been stored at 1°C to 6°C at room temperature?
- 10 minutes.
  - 20 minutes.
  - 30 minutes.
  - 40 minutes.
28. A unit of blood is suspected of being contaminated if it has:
- Visible clots.
  - A purple color.
  - A zone of hemolysis just above the cells.
  - All the above.

29. Which of the following is acceptable for blood to be reissued for transfusion?
- a. Settling.
  - b. Warming above 10<sup>0</sup>C.
  - c. Missing pilot tube.
  - d. Previous penetration of container.

**Check Your Answers on Next Page**

## SOLUTIONS TO EXERCISES, LESSON 1

1. a (para 1-2a(6)(a))
2. a (para 1-2b(2))
3. a (para 1-2b(5))
4. c (para 1-3c)
5. b (para 1-3c(7)(a))
6. c (para 1-4b Example 3)
7. f (para 1-4b)
8. a (para 1-4b Example 6: Second Explanation)
9. a (para 1-4b Example 7: First and Second Explanations)
10. f (para 1-6)
11. a (para 1-8b)
12. c (para 1-9)
13. d (para 1-12a)
14. d (para 1-12c Method 1: Step 2)
15. b (para 1-12c Method 2: Step 3)
16. d (para 1-13 Step 15)
17. b (para 1-14 Step 4j)
18. c (para 1-15b(4))
19. d (para 1-16; figure 1-1)
20. d (paras 1-17b, 1-18a(1) and (7))
21. a (para 1-18a(2))
22. b (Table 1-1)

- 23. b (para 1-18a(9))
- 24. d (para 1-19f)
- 25. a (para 1-19i)
- 26. d (para 1-20a)
- 27. c para 1-20e)
- 28. d (para 1-22a)
- 29. a (para 1-24)

End of Lesson 1

## LESSON ASSIGNMENT

### LESSON 2

Immunogenetics.

### TEXT ASSIGNMENT

Paragraphs 2-1 through 2-37.

### LESSON OBJECTIVES

After completing this lesson, you should be able to:

- 2-1. Select the statements which correctly describe the procedures for ABO cell grouping and interpretation of the results.
- 2-2. Select the statements that best describe the causes of discrepancies for ABO cell grouping and means of resolving said discrepancies.
- 2-3. Identify the important interactions of the ABO, Hh, Lele, and Sese gene systems.
- 2-4. Select the statements that best describe the Fisher-Race and Wiener nomenclatures and translation of common symbols from one nomenclature to the other.
- 2-5. Select the statement which correctly describes the most probable Rh genotype that Rh-positive individual would have if the Rh phenotype were known.
- 2-6. Identify the procedures for Rh typing and interpret results.
- 2-7. Select the statement that correctly identifies the other important blood group systems.

### SUGGESTION

After completing the assignment, complete the exercises of the lesson. These exercises will help you to achieve the lesson objectives.

## LESSON 2

### IMMUNOGENETICS

#### Section I. BLOOD GROUP IMMUNOGENETICS

##### 2-1. BACKGROUND

a. Although prior workers established the heritability of the blood group antigens, the origin of immunogenetics as a discrete subject is usually credited to Little, Cole, and Irwin, who not only established the genetic determination of blood group antigens of fowl but also went further to use these antigens as markers in carefully controlled matings.

b. Formerly, geneticists were limited to investigations of traits such as body color or wing shape in fruit flies, or clinical disorders in man. These, however, are usually difficult to analyze on a molecular level and often suffer from pleiotropism, that is, multiple effects of a single gene. For this reason, the emergence of immunogenetics gave promise of more closely approaching the action of the gene. In fact, early papers went so far as to state that antigens were direct gene products, a hypothesis codified in the dictum "one-gene-one antigen." It is apparent now, however, that only protein antigens or those in which the antigenic site resides in protein, such as the Rh antigens, are closely related to an RNA messenger coded by nuclear DNA.

##### 2-2. GENETIC TERMINOLOGY

a. Genes are the basic units of heredity. There has been little doubt since the description of the double helix by Watson and Crick in 1953 that the information necessary to encode biologic structures and processes resides in deoxyribonucleic acid (DNA), a high molecular weight polymer containing the sugar 2-deoxy-ribose, phosphate, and 4 nucleotide bases (adenine, thymine, guanine, and cytosine). For our purpose, it is sufficient to conceptualize genes as linearly arranged units on chromosomes, arrayed in the nucleus as strings of beads. Any particular gene, however, will be situated normally at a fixed position or locus on a particular chromosome. Because chromosomes occur in pairs (in humans, there are 23 pairs), gene loci must also be paired. One exception to this rule in mammals and other sexually reproducing animals is lack of paired material between portions of the sex chromosomes, X and Y. The Y chromosome is generally much shorter than the X and lacks most of the gene loci of the X chromosome such as the locus for the Xg<sup>a</sup> blood group.

b. Alternative forms of a gene occurring at a single locus are called alleles (or, rarely, allelomorphs); for example, the Kell blood group system includes two alleles, K (Kell) and k (Cellano). Any cell, including the fertilized egg or zygote, in which the alleles at a paired locus are identical is called a homozygote. Using the example given above, two homozygous allelic pairs are possible, KK and kk. The remaining combination, Kk, contains non-identical or heterozygous alleles.

c. The term phenotype refers to the expressed characteristics or traits of an individual which are due to genetic factors (for example, the appearance of the organism--such as eye color). The term genotype, on the other hand, refers to the specific genetic makeup of an organism. To be homozygous, an organism must have like genes at corresponding loci on a specific pair of homologous chromosomes. To be heterozygous, the organism must have dissimilar genes at the corresponding loci.

### 2-3. GENE ACTION

a. Blood group antigens fall into three general chemical classes as shown in Table 2-1. Glycoprotein and glycolipid antigens owe their specificity to the carbohydrate portion of the molecule, while specificity resides in the protein moiety of lipoproteins.

<u>Chemical Class</u>	<u>Antigens</u>	<u>Location</u>
Glycoprotein (sugar + polypeptide)	A, B, H	Mucous secretions
	Le <sup>a</sup> , Le <sup>b</sup>	Mucous secretions
	P <sub>1</sub>	Cell membranes
	M, N	Cell membranes
	I, i	Serum
	Oncofetal (CEA)	Serum, G.I. tract,
Glycolipid (sugar + fatty acids)	A, B, H	Cell membranes
	Le <sup>a</sup> , Le <sup>b</sup>	Serum lipoproteins
	I, i	Cell membrane
Lipoprotein (fatty acids + polypeptide)	Rh	Red blood cell membrane

Table 2-1. Chemistry of cellular antigens.

b. According to the central dogma, information coded in the nucleotide bases of DNA is transcribed to messenger ribonucleic acid (mRNA), and subsequently, through numerous, events translation into structural proteins is accomplished. There is no place for the synthesis of carbohydrate in this scheme. It is interesting to note however, that the carbohydrate specificities of so many blood group antigens are inherited precisely in accord with the traditional rules of genetics.



c. The ABO system consists of a series of possible alleles located on chromosome nine. These multiple alleles ( $A_1$ ,  $A_2$ ,  $A_3$ ,  $A_m$ ,  $A_x$ ,  $B$ ,  $B_m$ ,  $B_x$ ,  $O$  and others) at a single locus constitute a genetic system.

d. Figure 2-1, based on extensive biochemical and genetic data, illustrates the synthesis of antigens of the ABO and H systems. Similar mechanisms underlie the assembly of other carbohydrate specificities.

e. In this scheme, the end product of gene action is not an antigen but 1 of a group of enzymes called glycosyltransferases. These enzymes are not involved in sugar synthesis but rather in the assembly of sugar chains by the addition of 1 sugar to another. Each transferase accomplishes the transfer of a specific sugar--the donor sugar--to another specified sugar--the acceptor sugar. The carbohydrate antigens reflect the activity of a series of enzymes which, given the raw materials, can act "in vitro" in the absence of DNA or other genetic material. These resulting carbohydrate chains, attached to protein (polypeptide) or lipid (fatty acids) provide antigenic specificity for chain blood groups, for example, ABO, Lewis.

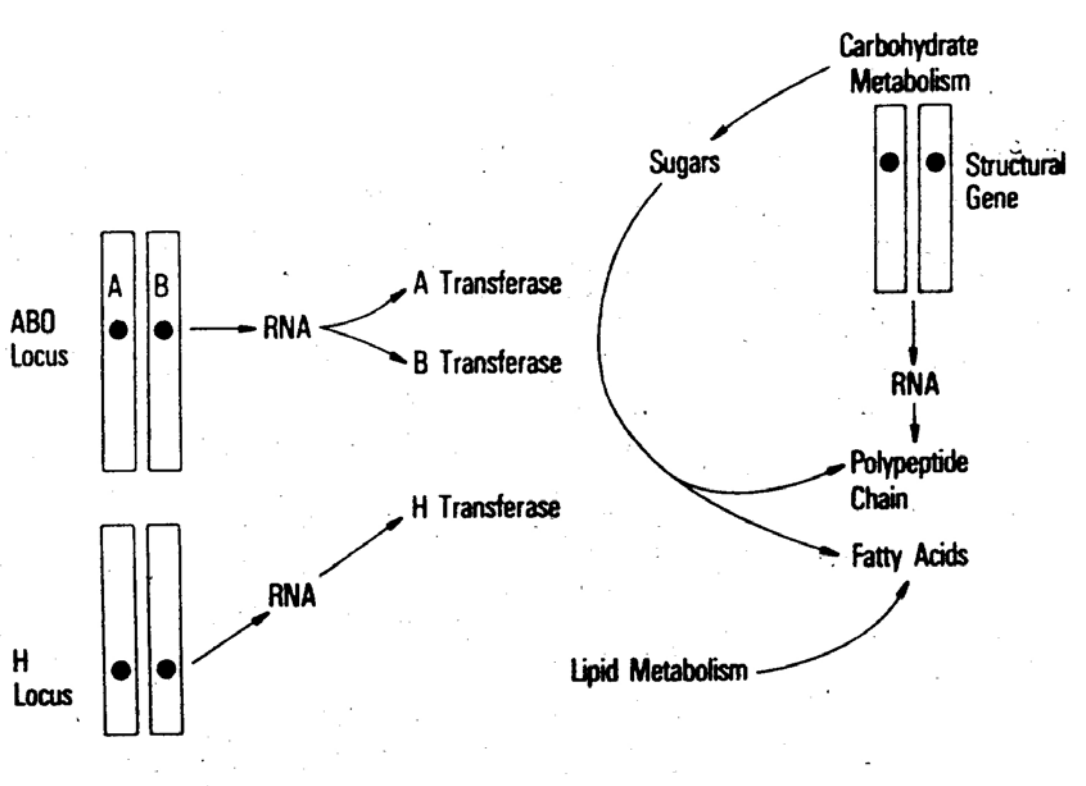

Figure 2-1. Blood group antigen synthesis.

## 2-4. DOMINANT AND RECESSIVE TRAITS

a. Genes are responsible for producing the various manifestations of structure and form which we call traits. A trait which is manifested when the alleles are heterozygous is called dominant. A recessive trait is revealed only when the responsible allele is present in double dose (homozygous). It is important to note that these terms, dominant and recessive, are properly applied in describing only traits. Their use in labeling genes or alleles is improper. For example, serologically, the  $A_1$  antigen, an observable trait, is dominant to the  $A_2$  antigen. Given an  $A_1A_2$  individual, only the  $A_1$  antigen would be detected; while the  $A_2$  antigen would not be observed. In an individual with the genotype  $A_2O$ , however, the  $A_2$  antigen (an observable trait) would be detected over the product of the O gene.

b. Although in this discussion it has been shown that the observable traits  $A_1$ ,  $A_2$ , O may be dominant or recessive depending on an individual's genotype, it is important to realize that the gene action does not demonstrate dominance or recessivity. In the  $A_1A_2$  genotype, for example, the  $A_1$  gene and the  $A_2$  gene produce their appropriate glycosyltransferase, with subsequent development of BOTH antigens. The same is true as well of the  $A_2O$  genotype.

c. In the examples given in Table 2-2, the genetic formulae  $A_1A_2$  and  $A^2O$  constitute the genotype of the individuals. Based on these three alleles only, there are six possible genotypes. The traits which they determine are called phenotypes.

<u>Alleles</u>	<u>Genotypes</u>	<u>Phenotypes</u>
$A_1$	$A_1A_1$	$A_1$
$A_2$	$A_1A_2$	$A_1$
O	$A_1O$	$A_1$
	$A_2A_2$	$A_2$
	$A_2O$	$A_2$
	$O^2O$	O

Table 2-2. Alleles, genotypes, and phenotypes.

d. In most blood group systems, if the allele directly or indirectly determines an antigen, it will be expressed. The K and k antigens, referred to earlier, are good examples of antigens determined by allelic genes in which both antigens are serologically detectable in the heterozygote. Such traits are referred to as co-dominant.

e. To demonstrate that dominance is a property of traits rather than a manifestation of gene activity, consider again the  $A_1$  and  $A_2$  traits. Based upon serologic evidence, an  $A_1A_2$  heterozygote is phenotypically  $A_1$ , for example, the  $A_1$  trait is dominant to  $A_2$ ; however, analysis of the serum transferases reveals that the  $A_1A_2$  heterozygote possesses both the  $A_1$  transferase and the  $A_2$  transferase. In respect to transferase activity, then, the  $A_1$  and  $A_2$  traits are co-dominant; or to simplify matters, let's consider the blood group AB. Both the A and B genes are inherited as heterozygote genes, but both will be expressed, because they are co-dominant.

## 2-5. MODES OF INHERITANCE

a. **Background.** The pattern of inheritance exhibited by blood group antigens depends upon the distribution of their alleles among the paired chromosomes. Most blood group alleles are located on 1 of the 22 pairs of autosomes, those chromosomes other than the sex chromosomes, X and Y. No blood group genes have been discovered on the Y chromosome and only the  $Xg$  and  $K^x$  loci have thus far been ascribed to the X chromosome.

b. **Autosomal Dominant or Codominant Inheritance.** An autosomal dominant or codominant trait shows a very characteristic pattern that is easy to recognize. The trait never skips a generation, and occurs with equal frequency in males and females. Most blood group and histocompatibility antigens fit into this category.

c. **Autosomal Recessive Inheritance.** Traits inherited in autosomal recessive fashion will also occur with equal frequency in males and females. To manifest the trait, the individual must be homozygous for the gene (allele). The parents may or may not display the trait. However, if the parent does not display the trait, they must be carriers of the gene (heterozygous) for the gene whose presence is not phenotypically apparent. When the recessive trait is rare, it typically is manifested in members of one generation and not manifested in members of the preceding or successive generation. Blood relatives are more likely to carry the same rare gene than unrelated people. It is easily understood, therefore, that when offspring are homozygous for a rare gene and display the trait, the parents are usually blood relatives (a consanguineous mating).

d. **Sex-Linked Dominant or Codominant Inheritance.** Sex-linked dominant or codominant pedigrees show affected males with normal wives transmitting the trait to daughters only. Some sex-linked dominants of interest in immunogenetics are the  $Xg^a$  blood group, which is present on the X chromosome.

e. **Sex-Linked Recessive Inheritance.** A much larger number of affected males than females is the first thing to look for. Affected males do not come from affected fathers but from carrier mothers, who may often be recognized by having affected brothers, fathers, or uncles. A good example of this is hemophilia A.

## 2-6. GENE INTERACTION

a. Quite often genes at far distant loci must interact to produce a given trait. Such interactions are quite common and, in fact, no gene ever really acts wholly by itself. Among the blood groups, the best example of gene interaction involves the interaction between the H, Le (Lewis), or transferases, and the effects of the Se (Secretor) gene which give rise to the 3 red cell phenotypes of the Lewis blood group system.

b. Genes that affect the expression of other genes are described as suppressor or modifier genes. The exact mechanisms of these gene interactions are not fully understood. One phenomenon seen in blood group serology that has been explained by gene interaction, is weakening of the D antigen when the C gene is in the trans position.

## 2-7. IMMUNOGENETIC SYSTEMS

In general, when a gene or set of allelic genes can be shown to segregate independently of all other genes responsible for other antigens, the set is designated a system. Most of the time an immunogenetic system may be defined as a series of alleles which act to produce chemically related but serologically distinct antigens. Occasionally, the situation is less clear as in the Lewis blood group system where the Le<sup>a</sup> antigen is a product of the Le gene but the antigen Le<sup>b</sup> results from interaction of at least 4 genes (ABO, Le, Se, H). Except for the Le gene, none of the remaining 3 genes is considered a member of the Lewis system! Hence, be aware that there are inconsistencies in the naming of systems.

## Section II. THE ABO SYSTEM

### 2-8. BACKGROUND

a. In 1900, Landsteiner discovered that human red blood cells could be classified as A,B, or O, according to the presence or absence of highly reactive antigens on the red blood cell surface. Several years later, an associate of Dr. Landsteiner discovered a fourth ABO blood group AB. First to be discovered; these antigens remain first in significance for transfusion practice.

b. Of all red blood cell antigens, the A and B are the only ones for which the corresponding antibodies consistently and predictably exist in the blood of normal individuals. Because of this, compatibility of ABO group is the essential foundation on which all other pre-transfusion testing rests.

## 2-9. GENETIC AND BIOCHEMICAL CONSIDERATIONS

a. **Nature of A and B Antigens.** The red blood cell membrane is crowded with antigenically active molecules. Prominent among these are large, complex, sugar-and-lipid-containing molecules which carry peripheral chains of sugars attached to a backbone that inserts into the membrane. Specific sugars, in specific linkage conformations, determine the antigenic activities called A and B. The presence of 1 sugar, N-acetylgalactosamine, gives the molecule A activity; a different sugar, D-galactose, determines B activity. These sugars, when present, occupy a predetermined location, attached to D-galactose, which resides at the end of a chain containing other sugars in an unvarying order. The D-galactose that anchors the N-acetylgalactosamine (for A) or D-galactose (for B) must also have a second sugar, L-fucose, attached in a specific configuration. Without the L-fucose, the other 2 sugars cannot attach. The D-galactose-plus-L-fucose configuration, without added D-galactose or N-acetylgalactosamine, has antigenic activity called H (see figure 2-2).

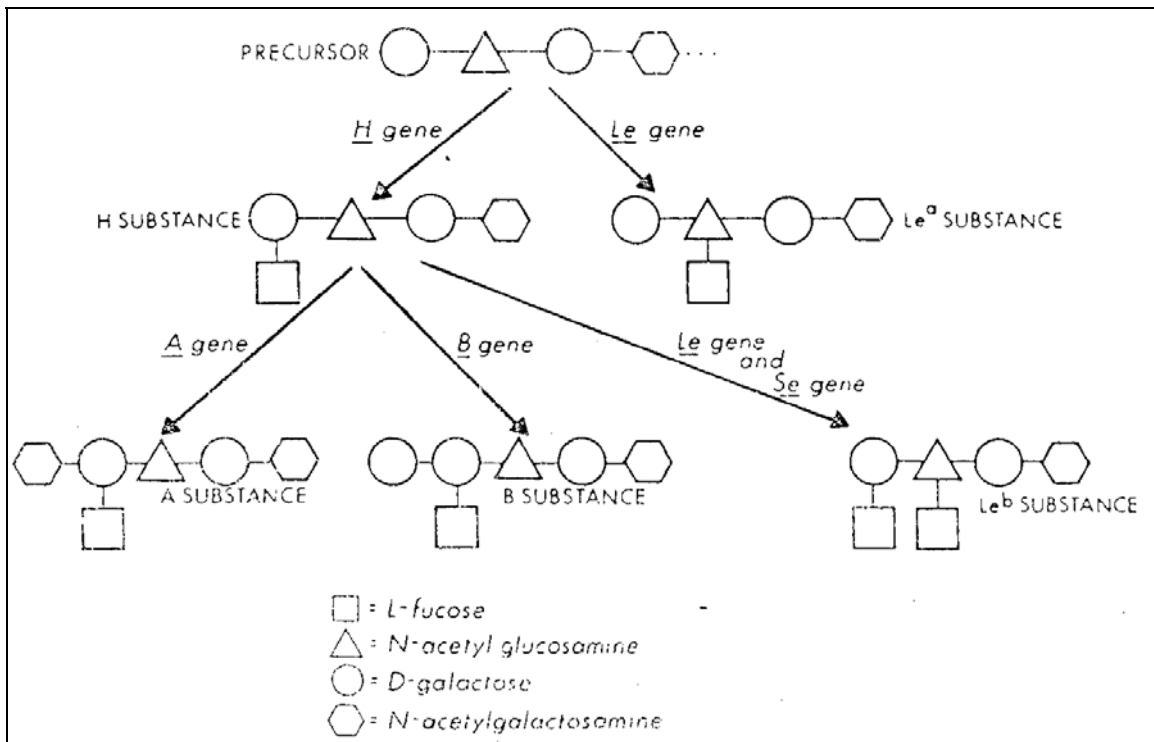

Figure 2-2. Development of H, AB, and Lewis antigens.

## **b. Antigen Loci.**

(1) The presence or absence of ABO antigens on red blood cells is dependent on two gene sites located on separate chromosome pairs. At one locus, on an unidentified chromosome, is the gene H. The second gene locus is found on chromosome 9; this is the locus for ABO determining genes. At the H locus there are only two recognized alleles, the active H gene and the h gene. No product has been demonstrated for the h gene; therefore, it is considered an amorph.

(2) At the ABO locus, there are three major alleles; A, B, and O. However, as stated earlier, phenotypic expression of the A and B antigens are dependent on activity at the H locus. The H gene produces a transferase essential for the expression of A and B antigens on red blood cells. This transferase is responsible for the attachment of the sugar L-fucose to the terminal D-galactose of some carbohydrate chains (oligosaccharide chains) on the red blood cell membrane. Without L-fucose being present on the terminal D-galactose, other sugars may still be attached to these chains. The A transferase (N-acetyl-galactosaminyl transferase) and the B transferase (galactosyl transferase) attach immunodominant sugars to the carbohydrate chain where L-fucose has been added. If the individual is group O, there are no A or B specified transferases and the H activity remains unchanged. The O gene does control production of a protein which can be immunologically detected, but this protein has not been shown to have impact on red blood cell antigenicity.

## **c. Difference Between Genotype and Phenotype.**

(1) Phenotypes are those observable characteristics whether that particular gene is present in a single dose (heterozygous) or in a double dose (homozygous). The reactions seen when testing with antiseras are considered observable characteristics.

(2) The H gene must be present for the expression of the A or B gene. H substance (antigen) is acted upon by the A or B gene and the majority of the H substance (antigen) is converted to A or B antigen. In rare instances, a person lacks the H gene and is homozygous h/h. As a result, these persons will test as group O even though the A and B gene may be present. This blood group is known as Bombay.

(3) The O gene is an allele to the A and B genes. The O gene produces no observable effect so it is said to be amorphic. When a person inherits the O gene with an A or B gene, the A or B will be expressed, indicating that at least one A or B gene is present. However, antisera testing will not demonstrate whether the person is homozygous or heterozygous. Family studies are used to determine zygosity.

Genotype H/H or H/h	ABO Genotype	Antigens present
	0	H
	A <sub>2</sub>	A <sub>2</sub> , H
	B <sub>2</sub>	B <sub>2</sub> , H
	A <sub>1</sub>	A <sub>1</sub> , H
	A <sub>1</sub> B	A <sub>1</sub> B, H
	A <sub>2</sub> B	A <sub>2</sub> B, H
h/h	A, B or 0	- - - - (0, Bombay)

Table 2-3. Conversion of H substance (antigen) to blood groups.  
(In order of most amounts of residual H substance to least amounts.)

(4) The second principal subgroups of A are A<sub>1</sub> and A<sub>2</sub>. RBCs of both react strongly with anti-A reagents. The serologic distinction between these subgroups is based upon results obtained using anti-A<sub>1</sub> reagents agglutinate A<sub>1</sub>-but not A<sub>2</sub> cells. Approximately 80 percent of group A RBCs are agglutinated with anti-A<sub>1</sub>, while the remaining 20 percent of group A RBCs are not agglutinated. Some of the lesser subgroups may, however, cause problems. Lesser subgroups of A (A<sub>3</sub>, A<sub>m</sub>, A<sub>x</sub>) produce the A antigen, but in a much smaller quantity than A<sub>1</sub> and A<sub>2</sub> individuals. This can cause a problem when performing cell grouping by being mistaken for a Group O. A second problem occurs with persons with lesser subgroups who may produce Anti-A<sub>1</sub>. If transfused with regular group A blood, they may experience a reaction. Table 2-4 lists the genotypes that can be responsible for the commonly observed red blood cell ABO phenotypes.

<u>ABO Phenotypes</u>	<u>Possible Genotypes</u>
A <sub>1</sub>	A <sub>1</sub> A <sub>1</sub> , A <sub>1</sub> A <sub>2</sub> , A <sub>1</sub> O, A <sub>1</sub> A weak subgroup
A <sub>2</sub>	A <sub>2</sub> A <sub>2</sub> , A <sub>2</sub> O, A <sub>2</sub> A weak subgroup
B	BB, BO
A <sub>1</sub> B	A <sub>1</sub> B
A <sub>2</sub> B	A <sub>2</sub> B
O	OO

Table 2-4. Genotypic basis for common ABO phenotypes.

#### d. **Secretor and Lewis Genes.**

(1) Secretor (Se) genes. Products of two other independent gene loci interact with products of the ABO and Hh alleles. The Se gene acts upon cells involved in watery secretions, like saliva, tears, and milk, enabling them to secrete glycoproteins with blood group activity. The A, B, and H substances of red blood cells are glycolipids, which are soluble in organic solvents but not in water. Blood-group-active glycoproteins have the sugar– linkages that control antigenic identity, but the parent molecule is water-soluble. Persons homozygous or heterozygous for Se have H substance and either A or B substance in their saliva, depending, of course, on the presence of an H gene and the ABO genotype. Homozygotes for sese have perfectly normal red blood cell antigens, but lack blood group activity in their secretions. Approximately 80% of the population is secretors, while 20 percent is nonsecretors.

(2) The Lewis gene. The third Lewis phenotype occurs when the Le gene is absent and the amorphic le gene is present in the homozygous state giving rise to the Le<sup>a-b-</sup> phenotype. These persons lack the Le<sup>a</sup> and Le<sup>b</sup> antigens. The Le gene product acts upon the sugar chain that also determines A, B, and H activity, but its inheritance and its effects are independent of ABO and Hh. The Le gene directs addition of a fucose to the sugar (N-acetylglucosamine) adjacent to the terminal galactose. See figure 2-2. When the fucose is present, the molecule has Lewis<sup>a</sup> activity, abbreviated Le<sup>a</sup>. The presence or absence of H-determining fucose on the adjacent galactose has no effect on Le<sup>a</sup> activity. Another form of Lewis activity develops if the H, Se, and Le genes are all present. In the presence of a Se gene, an active molecule is produced with fucose on the terminal galactose and another fucose on the adjacent N-acetylglucosamine, creating the antigenic activity called Lewis<sup>b</sup> (Le<sup>b</sup>). Without the Se gene, Le<sup>b</sup> activity does not develop, even if Le and H genes are present. Lewis substances are unusual because they confer red blood cell antigenic activity without being part of the red cell membrane. Both water-soluble and alcohol-soluble forms of Lewis are produced. The water-soluble form exists in saliva and other secretions. The alcohol-soluble form absorbs onto the lipid-rich red blood cell membrane, conferring antigenic activity on these surfaces and allowing agglutination by appropriate Lewis antibodies. With suitable manipulations, the antigens can be eluted off the cells, leaving the cells free of Lewis activity.



## 2-10. CELL AND SERUM ACTIVITY

a. **Background.** Serum antibodies are not directly determined by gene activity, but are important phenotypic characteristics in the ABO system. Under most circumstances, most individuals possess antibodies directed against the ABH antigens absent from their own cells. This predictable complementary relationship is the basis for using both serum and cell tests in blood grouping. The cells are observed for the presence or absence of agglutination by known anti-A and anti-B. Cell-testing is sometimes called direct-or forward-testing. The unknown serum is tested against known A and B cells, sometimes called reverse- or back-testing. Since the genetically determined cellular antigens are rarely altered by environmental modification, cell-testing alone is more reliable than serum-testing alone. Both should be routinely performed, partly because the tests serve to verify each other, and partly because investigation of discrepancies usually reveals a medically or serologically significant etiology. Table 2-5 shows the phenotypic products that develop when different genes from these independent but interacting systems are present.

<u>Genes</u>	<u>Red Blood Cell Antigens</u>	<u>Saliva Antigens</u>
A, B, H, Le, Se See paragraph 2-29b for Le <sup>e</sup> and Le <sup>d</sup> antigenic determinants.	H, A, B, Le <sup>b*</sup>	A, B, H, Le <sup>a*</sup> , Le <sup>b*</sup>
A, B, H, Le, esse	H, A, B, Le <sup>a</sup>	Le <sup>a</sup>
A, B, H, lele, Se	H, A, B,	A, B, H
A, B, H, lele, sese	H, A, B	None
A, B, hh, Le, Se or sese	Le <sup>a</sup>	Le <sup>a</sup>
A, B, hh, lele, Se or sese	None	None

\* Persons whose red blood cells have only Le<sup>b</sup> activity characteristically have both Le<sup>a</sup> and Le<sup>b</sup> in their saliva.

Table 2-5. Red blood cell and salivary antigens determined by ABO, Hh, sese, and lele genes.

**b. Development of Antibodies.** The sugar-sugar linkages that confer A, B, and H activity on molecules in the red blood cell membrane also occur in other biologic materials. Many bacteria have structural products with the same sugar groups; the antigenic properties of these bacterial materials are similar to those of human red blood cells. Bacteria are everywhere in the environment, and it appears that dust, foodstuffs, and other widely distributed agents constitute a powerful, continuing antigenic stimulus. Persons with normal immune systems react to these stimuli by producing antibodies against those antigens foreign to their own system. Thus, anti-A occurs in serum from persons of group O or B, and anti-B in group O or A serum. AB persons, having both antigens, lack both antibodies. Except for the rare hh persons who lack H, everyone has some element of H in his cellular makeup. Anti-H appears regularly in the serum of hh individuals, but rarely in other serums. A few persons with strongly active A<sub>1</sub>, or A<sub>1</sub> and B, transferases convert virtually all their H substance to A, or to A and B. These people may have a weak anti-H in their serum, but it never achieves the strength of the anti-H in hh persons, or of anti-A or anti-B.

(1) Time of appearance. Antibody production does not normally begin until after birth. Newborns have their mother's IgG antibodies, but these are passively received through placental transfer, not actively produced. Anti-A and anti-B production begins in the first few months of life, with titers rising for the first 5 or 6 years, and then remaining functionally the same until late in adult life. In very old people, levels of anti-A and anti-B are significantly lower than in young adults.

(2) Antibody behavior. Agglutination is the most conspicuous "in vitro" serologic effect of anti-A and anti-B. Other effects can and do occur under appropriate circumstances. Hemolysis, an important "in vitro" effect, sometimes occurs under "in vitro" conditions, and should be sought in observing every serum test. ABH antibodies sometimes coat cells without causing agglutination. When coating and agglutinating antibodies of the same specificity are present in a serum, only agglutination is apparent, unless the agglutinating antibodies are neutralized or inactivated. Coating antibodies are usually IgG. They are clinically important in hemolytic disease of the newborn since, like all IgG antibodies, they readily cross the placenta. Small amounts of IgG anti-A or anti-B can be found in group B or group A serum, but they are seldom of clinical significance. Hemolytic disease of the newborn occurs primarily in the A or B offspring of group O mothers or, rarely, the B offspring of A<sub>2</sub> mothers.

(3) Group O serum. In addition to separable anti-A and anti-B, serum from group O subjects may contain an antibody that reacts with either A cells or B cells. The two antibody specificities cannot be separated by differential absorption. Either A or B cells can be used for absorption, and the eluate from either will react with both A and B cells. This antibody has been called inseparable anti-A and B or anti-A, B. Anti-A, B from group O serum reacts more strongly with some variant examples of A and B antigens than does either individual anti-A or anti-B. Blood banks use an anti-A, B reagent, prepared from group O serum, to detect weakly reacting cells that are not agglutinated by anti-A or anti-B, and might otherwise be classified as group O.

(4) "Immune" antibodies. Agglutinating anti-A and anti-B develop so regularly after environmental exposure that they are considered naturally occurring; for example, no recognizable immunizing event leads to their appearance. A person exposed to a specific immunizing event may produce antibodies of the same specificity but different biologic behavior. Immunizing events include pregnancy with an ABO-incompatible fetus; transfusion of incompatible red blood cells or of plasma containing blood group substances; injection of purified blood group substances; or inoculation with viral or bacterial products containing blood-group-active materials. After immunization, the subject's antibody may increase in titer or avidity; develop powerful hemolyzing properties; become more difficult to neutralize with soluble blood-group substances; or become more active at 37°C. These changes are more common in group O subjects, but may occur in group A or B persons as well. Although the distinction is not always complete, naturally occurring antibodies tend to be IgM and "immune" activity is more often IgG. Serologic characteristics of IgG and IgM Anti-A and Anti-B are as follows:

(a) Properties in Common

Agglutinate red blood cells in saline suspension  
React well at room temperature  
Present in serum of group O persons  
May cause hemolysis in "in-vitro" testing

(b) Distinguishing Features

IgM

Antibody titer can be enhanced by use of enzymes,  
cold temperature  
Readily neutralized by soluble blood-group substances  
Inactivated by two-mercaptoethanol or dithiothreitol  
Predominant isoagglutinin in group A and B persons

IgG

Antibody titer can be enhanced by warm temperature  
and use of antiglobulin technique  
Only partially neutralized by soluble blood group substances  
Unaffected by two-mercaptoethanol or dithiothreitol  
Seldom conspicuous in unimmunized A or B persons

## 2-11. GENERAL PRINCIPLES FOR ALL SEROLOGIC TESTING

a. Document the strength, specificity, and behavioral characteristics of all reagents by a regular quality assurance program.

b. Label all tubes, slides, and so forth, completely enough that there can be no confusion about the identity of the unknown sample or the reagents in use.

c. Calibrate each centrifuge for the optimal time and speed needed for each type of procedure. Record these data on the centrifuge and follow the instructions for each test.

d. Record results immediately after observation.

e. Report interpretation, where appropriate, separately from recorded results.

f. Record the identity of the person performing each test.

## 2-12. ROUTINE TESTING FOR ABO

a. **Background.** Antibodies of the ABO system cause agglutination of saline-suspended cells at room temperature or below. A high-protein medium does not interfere with agglutination, but does not enhance it. Heating to 37°C weakens the reaction. Reagent antibodies agglutinate most cell samples when tested on a slide or tile, without centrifugation to enhance the end point. For this reason, cell-testing can be done either on a slide or in test tubes. Natively occurring antibodies may or may not be strong enough to agglutinate cells without centrifugation; therefore, testing serum or plasma for the presence of anti-A or anti-B is more reliably done in test tubes than on a slide or tile.

b. **Cell-Testing in Tubes.** Each manufacturer has detailed instructions for its own antisera. Consult the local SOP for details. The following instructions are listed in the current Technical Manual 8-227-2, Method 2.2.

- (1) Place one drop of anti-A into a clean, labeled tube.
- (2) Place one drop of anti-B into a second clean, labeled tube.
- (3) Place one drop of anti-A, B into a third tube.
- (4) Add to each tube one drop of a 2-5 tested.
- (5) Mix contents gently and centrifuge approximately 900-1000 g.
- (6) Gently re-suspend the RBC buttons and examine for agglutination.
- (7) Record test results.

c. **Cell-Testing on a Slide.** Slide tests should be done according to the directions for the specific anti-serum used. Some manufacturers recommend using whole blood; others specify a 10% suspension of the cells in serum, plasma, or saline. Instructions that apply to all slide tests are:

- (1) Label the sections of the slide to identify the antiserums.
- (2) Mix cells and antiserums gently but thoroughly over an area about 1 inch in diameter.
- (3) Use a separate, clean stick to mix cells with each antiserum. Do not place slide on or over a warmed view box.
- (4) Keep cell-serum mixture in continuous, gentle motion and observe for 2 minutes before concluding that agglutination is absent. Do not confuse drying around the edges with agglutination. Avoid touching the cell-serum mixture with fingers.

d. **Serum Tests in Tubes.** Most serums have antibodies strong enough to cause prompt agglutination. The cells for serum-testing should either be commercial cells that meet Bureau of Biologics (BOB) requirements, or a 2 to 5 percent suspension of washed cells in saline, prepared freshly each day.

- (1) Place two drops of serum into each of two properly identified tubes.
- (2) Add one drop of A cells to the A tube, and one drop of B cells to the B tube.

NOTE: Use cells known to be A<sub>1</sub> or a pool of at least five randomly selected A donors.

- (3) Mix by gentle shaking. To enhance agglutination, tubes may be incubated five minutes or more at room temperature.
- (4) Centrifuge at speed and time determined to be optimal.
- (5) Observe supernatant fluid against a well-lighted white back-ground, for presence of hemolysis.
- (6) Gently disperse cell button and inspect for agglutination, using a well-lighted background.

e. **Interpretation of Routine ABO Tests.** Table 2-6 gives the results and interpretations of routine ABO serum and cell-testing. Note the different frequencies of ABO groups in different segments of the US population.

Reaction of Cells Tested With		Reaction of Serum Tested Against			Interpretation ABO Group	Frequency (%) in U.S. Population*			
		A Cells	B Cells	O Cells		Whites	Blacks	Indians	Oriental
0	0	+	+	0	O	45	49	79	40
+	0	0	+	0	A	40	27	16	28
0	+	+	0	0	B	11	20	4	27
+	+	0	0	0	AB	4	4	1	5

+ agglutination; 0, no agglutination.  
\* Composite figures, calculated from Mourant, et al.

Table 2-6. Routine ABO grouping.

## 2-13. LESS COMMON PHENOTYPES

### a. Difference Between A<sub>1</sub> and A<sub>2</sub>.

(1) The most common variation within the standard categories of A, B, AB, and O is the A<sub>2</sub> phenotype. In approximately 20 percent of A and AB persons, the red blood cells have A<sub>2</sub> reactivity. With present-day reagents, there is virtually no difference in the strength of the agglutination observed with commercial anti-A. Quantitative evaluation, however, reveals that A<sub>2</sub> cells have only one-third to one-quarter the number of A antigenic sites that A<sub>1</sub> cells have. A<sub>2</sub> cells have substantially more H reactivity than A<sub>1</sub> cells. A<sub>2</sub> individuals who have the secretor gene have A substance in their saliva.

(2) It appears that qualitative as well as quantitative difference exists between A<sub>1</sub> and A<sub>2</sub> cells. A few A<sub>2</sub> individuals, and as many as 20A<sub>2</sub>B individuals, have anti-A<sub>1</sub> activity in their serum. This reacts, usually weakly, with A<sub>1</sub> or A<sub>1</sub>B cells and not with A<sub>2</sub> or A<sub>2</sub>B cells. Similarly, the anti-A in serum from a group B individual contains some antibodies that react with both A<sub>1</sub> and A<sub>2</sub> cells, and some which react only with A<sub>1</sub> cells. Absorbing group B serum with A<sub>2</sub> cells leaves anti-A<sub>1</sub> activity in the supernatant. Saline extracts of seeds of Dolichos biflorus agglutinate A<sub>1</sub> cells, but not A<sub>2</sub> cells.

### b. Weak Subgroups of A<sup>12,13</sup>.

(1) Much rarer than A<sub>2</sub> are subgroups of A with still fewer A sites on the red blood cells. These result from the action of mutant genes, comprising less than 1 percent of the total pool of A genes. Of these rare types, the most common (perhaps 0.1 percent or less of group A) is A<sub>3</sub>, in which the red blood cells characteristically give a mixed-field agglutination pattern when tested with anti-A. Small clumps of agglutinated cells are present among large numbers of cells which adsorb the antibody to their surface but are not agglutinated by it. A<sub>3</sub> cells are not agglutinated by Dolichos biflorus extract or anti-A<sub>1</sub>. They react more strongly with anti-H than A<sub>2</sub> cells do. A few A<sub>3</sub> persons have anti-A<sub>1</sub> in their serum, but this is rare. ABH secretors who are A<sub>3</sub> have A substance in their saliva.

(2) A great many variations of A reactivity have been identified. In general, these follow a spectrum of declining numbers of A antigen sites, and increasing strength of H reactivity. Variants of A differ from one another in the presence or absence of anti-A<sub>1</sub> or anti-A activity in the serum; in the presence or absence of salivary A substance; and in the degree to which they are agglutinated by the inseparable, or cross-reacting, anti-A,B serum or by anti-A serums boosted by specific immunization. Different workers employ slightly differing terminology to describe variants.

(3) The problem of selecting appropriate blood for transfusion of a patient with variant A antigens or antibodies is addressed in paragraph 1-47 of Subcourse MD0846.

c. **Weak Subgroups of B.** No allele analogous to A<sub>2</sub> has been found for B. There are, however, very rare genes that affect the expression of red blood cells and salivary B in manners somewhat comparable to the effect of A<sub>x</sub>, A<sub>m</sub>, and other variants of A activity.

d. **The Bombay Phenotype.** Individuals homozygous for the rare gene h have red cells devoid of A, B, or H antigens. On initial testing the cells appear to be from group O, and the phenotype is called O<sub>h</sub>. The O<sub>h</sub> phenotype is popularly called "Bombay" because it was first discovered in Bombay and seems to occur more often in India than elsewhere. In routine testing, O<sub>h</sub> bloods may appear to be group O since the red cells are not agglutinated by anti-A or anti-B and the serum agglutinates both A and B red cells. Because O<sub>h</sub> persons lack H substance on their red cells, their serum contains anti-H that is as strong as the anti-A and anti-B.

## 2-14. SPECIAL PROCEDURES-TEST FOR HEMOLYSINS

If whole blood is to be given to a recipient of another blood type (group O to A or B; group A to AB), the donor blood must be free of hemolysins. It is far preferable not to give whole blood; give red blood cells instead.

a. STEP 1: Use complement-containing serum, not plasma or aged or inactivated serum.

b. STEP 2: Place two drops of serum in each of two tubes labeled A and B.

c. STEP 3: Add two drops of 2 to 5 percent saline suspension of washed fresh A1 cells to tube A and 2 drops of B cells to tube B.

NOTE: Use of a weaker cell suspension or larger amounts of serum will increase incidence of hemolytic activity.

d. STEP 4: Mix gently and incubate at 37°C for 10 to 15 minutes.

e. STEP 5: Centrifuge and examine supernatant against a well-lighted white background to detect hemolysis. Any shade of pink or red indicates hemolysis.

f. STEP 6: Record results as negative or as a quantitative estimate on positives.

## 2-15. DISCREPANCIES BETWEEN CELL AND SERUM RESULTS

a. **Background.** When the results of cell and serum tests for ABO do not agree, the discrepancy must be investigated. If the blood is from a donor unit, the unit must not be released for transfusion until the discrepancy is resolved. When the blood is from a potential recipient, it may be necessary to administer group O red cells of the appropriate Rh type before investigations are complete. It is important to obtain enough of the patient's blood before transfusion so that testing can be continued on a sample free of transfused cells.

b. **Sources of Discrepancies.** Discrepancies in ABO testing may result from technical errors, from intrinsic properties of the red cells, or from intrinsic properties of the serum.

### c. **Technique.**

#### (1) Errors in technique.

- (a) Dirty glassware may cause false positives.
- (b) Improper concentration of cells to serum may cause a false positive or false negative.
- (c) Failure to identify hemolysis as a positive reaction causes a false negative.
- (d) Over-centrifugation or under-centrifugation causes a false positive or negative.
- (e) Carelessness on reading may cause a false negative.
- (f) Warming cell-serum mixture may cause a false negative.
- (g) Contamination or inactivation of reagent serums may cause a false negative, or occasionally, false positive.
- (h) Incorrect identification of specimen, materials, or incorrect recording of results or interpretation causes false positives, false negatives, and total disaster.



(2) Resolving errors in technique.

(a) Check identification of all samples and materials. If a blood sample is found to be incorrectly labeled, immediately begin efforts to find out why. Often two samples will have been switched, so look for another sample drawn, received, or processed at the same time and place.

(b) Repeat tests, using clean glassware and different reagents, with careful attention to timing of centrifugation or tilting slide and to use of positive and negative controls.

(c) Thoroughly wash patient's cells before making cell suspension.

**d. Problems with Red Blood Cells.**

(1) The cells may appear to be agglutinated because something in the patient's serum (Wharton's jelly or serum proteins causing rouleaux) remains in the cell suspension tested.

(2) The patient may have antibody-coated cells, which agglutinate in a high-protein medium.

(3) The patient may have received transfused cells and the sample is a mixture of cell types.

(4) The A or B antigens may be weakly expressed because of an unusual genotype.

(5) The A or B antigens may be weakened by the effects of leukemia or non-hematologic malignant conditions.

(6) The cells may have genetic or acquired surface abnormalities that render them polyagglutinable.

(7) There may be acquired "B-like" activity, usually resulting from action of gram-negative organisms.

**e. Problems with Serum.**

(1) High concentrations of fibrinogen or of abnormal proteins, or altered proportions of globulins, may cause rouleaux formation, which resembles agglutination.

(2) There may be an unexpected antibody reacting with A, B, or H antigens. The most common are anti-A<sub>1</sub> in A<sub>2</sub> or A<sub>2</sub>B serums, and anti-H in A<sub>1</sub> or A<sub>1</sub>B serums.

(3) There may be an unexpected antibody in some other blood group system reacting with antigens on the A or B cells used for serum-testing. Anti-I is probably the most common trouble-maker.

(4) The patient may have been given dextran, intravenously injected contrast materials, or drugs that cause cellular aggregation that resembles agglutination.

(5) The patient may have an immunodeficiency disease and lack expected antibodies because of low overall immunoglobulin levels.

(6) The patient may be an infant who has not begun producing his own antibodies, or who has antibodies passively received from the mother.

(7) The patient may be an elderly person whose antibody levels have declined severely.

(8) The patient may have antibodies against elements of the preservatives, suspending mediums, or reagent solutions used in testing.

f. **Resolving Discrepancies.** Many problems can be resolved by repeating the tests and washing the cells thoroughly before testing them. Obtaining a new sample of blood from the patient corrects difficulties introduced by contaminated specimens. The most frequent causes for persisting problems are the presence of rouleaux-producing factors in serum; the presence of unexpected antibodies; the presence of anti-I, which reacts with nearly all cells, including the patient's own cells; and the presence of antibodies coating the cells (positive antiglobulin test). In handling a persistent problem, be sure to:

(1) Look at results of an antibody-screening test. If test is positive, identify the antibody. For serum-testing, use A and B cells that lack the antigen involved, if these can be obtained.

(2) Determine subject's age, diagnosis, previous medications, or transfusions, and serum protein findings.

(3) Perform antiglobulin test on patient's cells.

(4) Perform an autologous control test, using patient's serum and suspension of the patient's cells. Both rouleaux factors and auto-anti-I will cause autoagglutination. It is usually possible to autoabsorb anti-I. Rouleaux formation can often be diminished by adding additional saline to the cell-serum mixture.

**NOTE:** If the patient has been transfused with red blood cells in the preceding 4 weeks or thereabouts, autoabsorption should not be performed because the antigens on the transfused cells may adsorb a developing isoantibody of clinical significance.

**g. Specific Procedures.**

(1) To diagnose anti-A<sub>1</sub>, anti-H, or anti-I, test subject's serum against carefully selected cells.

(2) To delineate weak examples of A or B, whether genetic or acquired, a number of procedures may have to be used. Table 2-7 shows serologic characteristics of several variant A phenotypes that may be encountered. To diagnose rarer A and B phenotypes, see Race and Sanger.

(a) Test cells with many different samples of anti-A and anti-B, including those from subjects whose antibodies have been stimulated by injection of A or B substances.

(b) Perform anti-A and anti-B testing with incubation at 18°C or 4°C.

Cell Phenotype	Reaction of Cells to Antisera					Reaction of Serum Against Red Blood Cells				Saliva of Secretors Contains
	A	B	A,B	H	A <sub>1</sub>	A <sub>1</sub>	A <sub>2</sub>	B	O	
A <sub>1</sub>	++++	0	++++	0	++++	0	0	++++	0	A & H
A <sub>int</sub>	++++	0	++++	+++	++	0	0	++++	0	A & H
A <sub>2</sub>	++++	0	++++	++	0	0/+	0	++++	0	A & H
A <sub>3</sub>	+mf	0	++mf	+++	0	0/+	0	++++	0	A & H
A <sub>m</sub>	0/+	0	0/+	++++	0	0	0	++++	0	A & H
A <sub>x</sub>	0/+	0	+//+	++++	0	0/+	0	++++	0	H

+ to +++++, agglutination of increasing strength;  
 +, weak agglutination;  
 mf, mixed field pattern of agglutination;  
 0, no agglutination.

**NOTE:** The occurrence of anti-A<sub>1</sub> is variable in these phenotypes. A<sub>x</sub> persons frequently have anti-A<sub>1</sub>; A<sub>3</sub> persons usually do not, but a few A<sub>3</sub> serums with Anti-A<sub>1</sub> have been found. Anti-A<sub>1</sub> is more common in A<sub>2</sub>B serum than in A<sub>2</sub> serum.

Table 2-7. Serologic reactions of A phenotypes. (Adapted from Race and Sanger)

(c) Test cells for ability to adsorb antibody even if agglutination does not occur.

(d) Test eluate from adsorbing cells for agglutinating activity against cells of other unusual activities.

(e) Test saliva for presence of H and A or B.

(f) Study blood and saliva from blood relatives to determine heritability of the abnormality.

(3) If polyagglutinability is suspected, various lectins can be used to delineate the different types. The condition can arise from genetically determined antigenic activity; from activation of the T receptor or the Tn receptor by bacterial enzymes; or from bacterial action associated with the acquired B antigen.

Polyagglutinable red blood cells are:

(a) Agglutinated by many typing serums of human and rabbit origin.

(b) Agglutinated by serum from all adults, regardless of ABO type.

(c) Not agglutinated by cord serum.

(d) Not usually agglutinated by the individual's own serum.

(e) Variably agglutinated by lectins, as shown in Table 2-8.

<u>Seed Extract</u>	<u>Type of Polyagglutinable Cell</u>		
	<u>I</u>	<u>Tn</u>	<u>Cad</u>
Arachis hypogaea	+	0	0
Salvia sclarea	0	+	0
Salvia horminum	0	+	+

+, agglutination; 0, no agglutination.

Table 2-8. Reactions of polyagglutinable cells with lectins.

## Section III. THE Rh SYSTEM

### 2-16. BACKGROUND

The Rh system is so complex and aspects of its genetics, nomenclature, and antigenic interactions are so unsettled that any attempt for complete coverage in this subcourse would be futile. Except for those working in highly specialized laboratories, however, the body of essential information is relatively compact. This section will concentrate on commonly encountered observations, problems, and solutions, without exhaustive theoretical considerations.

### 2-17. Rh-POSITIVE AND Rh-NEGATIVE

a. The unmodified descriptive terms Rh-positive and Rh-negative refer to the presence or absence of a single red blood cell antigen. This antigen was first characterized, in 1939, by Levine and Stetson, who found the identifying antibody in the serum of a woman whose fetus had fatal hemolytic disease of the newborn. It received its name in 1940, when Landsteiner and Wiener immunized rabbits with red blood cells from rhesus monkeys and found that the rabbit anti-rhesus antibody agglutinated approximately 85 percent of human red blood cells tested. They gave the name "Rh" to this determinant present on all rhesus monkey cells and apparently present on 85 percent of human red blood cells. Levine and his co-workers found several other postpartum women with similar antibodies, at least one of which gave reactions parallel to rabbit anti-Rh, and Weiner and Peters observed human examples of anti-Rh in Rh-negative patients who had received ABO-compatible, Rh-positive transfusions.

b. Now called  $Rh_0(D)$ , this antigen is, after A and B, the most important antigen in transfusion practice. Unlike the situation with ABO, persons whose cells lack the antigen do not routinely have the antibody in their serum. Formation of the antibody almost always results from exposure, either through transfusion or pregnancy, to immunizing red blood cells containing the antigen; and such exposure elicits antibody production in a high proportion of Rh-negative subjects. As transfusions became more frequent in the 1940s there were increasing opportunities for immunization to occur and for the antibody, once developed, to become apparent. Investigation and discoveries have continued apace.

c. The immunogenicity of  $Rh_0(D)$ , that is, its likelihood of provoking an antibody if transfused into a negative recipient, is greater than that of virtually all other antigens studied. In routine transfusion practice,  $Rh_0(D)$  is the only antigen for which red blood cells are tested (outside of A and B), so that Rh-negative recipients can be identified and given Rh-negative blood. Of the Rh-negative recipients of Rh-positive blood, 50 to 75 percent can be expected to develop the antibody.

d. Family studies very early showed that Rh<sub>o</sub>(D) was genetically determined and that the gene controlling its production behaved like an autosomal dominant. The Rh gene has recently been shown to reside on chromosome. With only a few fascinating exceptions, persons who have the gene for Rh<sub>o</sub>(D) will have the antigen directly detectable on their cells.

## 2-18. OTHER MAJOR ANTIGENS

a. Further investigation of patients with transfusion reactions, and more frequent and sophisticated pretransfusion testing, soon revealed antibodies that identified other antigens associated with Rh<sub>o</sub>(D). By the mid-1940s, 4 additional antigens had been recognized as belonging to what we now call the Rh system. Despite the many new discoveries, these four additional antigens and the original Rh factor, Rh<sub>o</sub>(D), remain the object of more than 99 percent of clinical work in the Rh field.

b. The four additional antigens are rh'(C), rh"(E), hr'(c), and hr"(e). The association of these factors suggests that immunologic activity of Rh arises from surface material with several different determinant areas. Some antigenic associations include Rh<sub>o</sub>(D) and some do not. Antigenic packages that do not include Rh<sub>o</sub>(D) nonetheless have activity at the other sites. The constitution of these antigenic groups is genetically determined. In terms of the five major antigens under discussion, a single gene or gene complex will determine presence or absence of Rh<sub>o</sub>(D), and the production of rh'(C) or hr'(c), and rh"(E) or hr"(e). Many variations, combinations, and permutations have been characterized, but these five antigens, and the readily available antibodies that characterize them, are the backbone of clinical Rh work.

## 2-19. INHERITANCE AND NOMENCLATURE

a. **General.** Certain combinations of Rh antigens are transmitted inseparably. The chemistry of Rh activity has not been delineated, so it is not clear how genetic information is translated into serologically demonstrable characteristics. The most ambitious conceptual model of the Rh system is that of Rosenfield and other people, but the material that follows is given in terms either through transfusion or pregnancy, to immunizing red blood cells and concepts far simpler than theirs. A single gene or complex determines the presence on the red blood cell of a specific combination of antigens. An individual inherits two such genes or complexes, one from each parent. These may be the same, in which case the person is homozygous for the gene, or different, making him heterozygous for each of two genes or gene complexes. Rh genes, like nearly all other blood group genes, are co-dominant, meaning that all genetic information is translated into detectable red blood cell antigens. The homozygous individual will have a single set of antigenic determinants; the heterozygote will have two sets, although one or more individual antigenic specificities may be common to both sets.

**b. Rh-Hr, CDE, and Numerical Terms.**

(1) Two nomenclatures are currently used to express genetic and serologic information. The Rh-Hr terminology derives from Wiener's work. He distinguished genes from the observed antigenic specificities, asserting that the immediate gene product is a single entity called an agglutino-gen (haplotype), which is, in turn, characterized by various serologic specificities. The CDE terminology was introduced by English workers Fisher and Race, and reflects the original concept that individual genes determine each antigen; the same letter designation is used for both gene and gene product. It is important to be familiar with both nomenclatures. Figure 2-3 shows the comparison of the Fisher-Race and Wiener systems. Table 2-9 shows the most common frequencies or combinations of antigens, which are determined by allelic genes or gene complexes.

FISHER-RACE			WIENER				
Gene Combination	Antigens	Corresponding Antibodies	Gene	Agglutino-gen	Blood Factors	Corresponding Antibodies	
D	→ D	anti-D	R <sup>1</sup>	Rh <sub>0</sub>	Rh <sub>0</sub>	anti-D	
C	→ C	anti-C			Rh <sub>1</sub>	rh'	anti-C
e	→ e	anti-e				hr''	anti-e
WIENER GENE (FISHER-RACE GENE COMBINATION)		WIENER AGGLUTINOGEN	WIENER ANTIGENIC DETERMINANT (FISHER-RACE ANTIGEN)				
R <sup>0</sup> (cDe)		R <sup>0</sup>	hr'(c), Rh <sub>0</sub> (D), hr''(e)				
r(cde)		r	hr'(c), hr''(e)				
R <sup>1</sup> (CDe)		R <sup>1</sup>	rh'(C), Rh <sub>0</sub> (D), hr''(e)				
r'(Cde)		r'	rh'(C), hr''(e)				
R <sup>2</sup> (cDE)		R <sup>2</sup>	hr'(c), Rh <sub>0</sub> (D), rh''(E)				
r''(cdE)		r''	hr'(c), rh''(E)				
R <sup>3</sup> (CDE)		R <sup>3</sup>	rh'(C), Rh <sub>0</sub> (D), rh''(E)				
r <sup>3</sup> (CdE)		r <sup>3</sup>	rh'(C), rh''(E)				

Figure 2-3. Comparison of the Fisher-Race and Wiener systems.

WIENER		FISHER-RACE		Frequency in USA			
Allele	Major Antigenic Specificities	Gene Combination	Major Antigenic Specificities	Whites*	Blacks	American Indians	Oriental
R <sup>1</sup>	Rh <sub>0</sub> , rh' hr''	CDe	C,D,e	0.42	0.17	0.44	0.70
r	hr', hr''	cde	c,e	0.37	0.26	0.11	0.03
R <sup>2</sup>	Rh <sub>0</sub> ,hr',rh''	cDE	c,D,E	0.14	0.11	0.34	0.21
R <sup>0</sup>	Rh <sub>0</sub> ,hr',hr''	cDe	c,D,e	0.04	0.44	0.02	0.03
r'	rh',hr''	Cde	C,e	0.02	0.02	0.02	0.02
r''	hr',rh''	cdE	c,E	0.01	0.00	0.06	0.00
R <sup>3</sup>	Rh <sub>0</sub> ,rh',rh''	CDE	C,D,E	0.00	0.00	0.06	0.01

\* 12,719 Whites; figures averaged from 8 series.  
4,479 Blacks; figures averaged from 9 series.  
American Indians; figures averaged from 15 series (averages are highly misleading because large regional variations exist).  
1,504 Orientals; figures averaged from 4 series.  
All figures were calculated from Mourant et al.

Table 2-9. Frequencies of some Rh genes.

(2) Rosenfield, et al. have proposed a nomenclature based entirely on phenotypic observations. Antigens are numbered and their presence or absence on red blood cells is designated by positive and negative numbers. Table 2-10 shows reaction patterns for various cells tested with the five major antisera, and the phenotypic descriptive terms used in the three nomenclature systems.

**c. Phenotype and Genotype.**

(1) In clinical practice, only five reagent antisera are readily available. For most pre-transfusion studies, tests are performed only for Rh<sub>0</sub>(D), while the other antisera are used principally in family studies or investigation of commonly encountered antibodies. The assortment of antigens detectable on an individual's cells is his phenotype. Since any individual antigen may be part of several different genetic packages, it is not always possible to deduce which combination of genes has produced a given phenotype.



Anti-Rh <sub>0</sub> (D)	Anti-rh'(C)	Anti-rh''(E)	Anti-hr'(c)	Anti-hr''(e)	Rh-Hr	CDE	Numerical
+	+	0	+	+	R <sup>1</sup> r	CcDee	Rh: 1, 2, -3, 4, 5
+	+	0	0	+	R <sup>1</sup> R <sup>1</sup>	CCDee	Rh: 1, 2-3, -4, 5
+	+	+	+	+	R <sup>2</sup> R <sup>2</sup>	CcDEe	Rh: 1, 2, 3, 4, 5
+	0	0	+	+	R <sup>2</sup>	ccDee	Rh: 1, -2-3, 4, 5
+	0	+	+	+	R <sup>2</sup> r	ccDEe	Rh: 1, -2, 3, 4, 5
+	0	+	+	0	R <sup>2</sup> R <sup>2</sup>	ccDEE	Rh: 1, -2, 3, 4, -5
+	+	+	0	+	R <sup>2</sup> R <sup>1</sup>	CCDEe	Rh: 1, 2, 3, -4, 5
+	+	+	+	0	R <sup>2</sup> R <sup>2</sup>	CcDEE	Rh: 1, 2, 3, 4, -5
+	+	+	0	0	R <sup>2</sup> R <sup>2</sup>	CCDEE	Rh: 1, 2, 3, -4, -5
0	0	0	+	+	r	ccee	Rh: -1, -2, -3, 4, 5
0	+	0	+	+	r'r	Ccee	Rh: -1, 2, -3, 4, 5
0	0	+	+	+	r''r	ccEe	Rh: -1, -2, 3, 4, 5
0	+	+	+	+	r'r''	CcEe	Rh: -1, 2, 3, 4, 5

Table 2-10. Determination of some Rh phenotypes from typing results.

(2) Using the phenotype and knowledge of how frequently particular antigenic combinations derive from a single allele or gene complex, one can make useful assumptions about presumed genotypes. This is important in population studies, in studies to assign parentage, and in evaluating hemolytic disease of the newborn resulting from anti-Rh<sub>0</sub>(D). There is no simple serologic technique for distinguishing among persons with two genes which code for Rh<sub>0</sub>(D) (homozygous Rh-positive) and those with one gene that codes for Rh<sub>0</sub>(D) and one gene whose product lacks Rh<sub>0</sub>(D) (heterozygous Rh-positive), since the Rh<sub>0</sub>(D) antigen is fully expressed even when there is only one gene present that determines the trait. There is no antiserum that specifically reacts with the product of the "Rh-negative" gene. (This would be anti-d, but the d antigen has never been shown to exist.) The person whose cells are Rh-negative obviously has two genes which code for a surface configuration that lacks Rh<sub>0</sub>(D).

#### d. **Zygoty of Rh-Positives.**

(1) Assumptions about Rh genotype are based on knowledge of how frequently individual genes occur in the population (see Table 2-10). The Rh-negative trait is most often a result of the gene that also specifies  $hr'(c)$  and  $hr''(e)$ ; much less often  $rh'(C)$  or  $rh''(E)$  may accompany this trait. A person with positive cells that have only  $Rh_o(D)$ ,  $rh'(C)$ , and  $hr''(e)$  is most likely to have the genotype  $R^1R^1$  ( $CDe/CDe$ ). He could be heterozygous, with the genotype  $R^1r'$  ( $CDe/Cde$ ), but this is less likely, because  $r'$  is infrequent in most populations. A White person whose cells have  $Rh_o(D)$ ,  $hr'(c)$ , and  $hr''(e)$  would probably be heterozygous ( $R^0r$ ) because  $r$  is so much more common than  $R^0$  in Whites; but a Black with that phenotype would probably be homozygous ( $R^0R^0$ ).

(2) A person with cells which react with all five major antisera (see line 3 in Table 2-11) could have any one of a variety of genotypes. He would probably be homozygous Rh-positive, meaning that his two genes, although different from each other, both code for Rh-positive. The most probable genotype in any population group is  $R^1R^2$  ( $CDe/cDE$ ). Genotypes heterozygous for  $Rh_o(D)$  require that 1 or 2 uncommon alleles be present, for example  $R^1r''$  ( $CDe/cdE$ ),  $R^2r'$  ( $cDE/Cde$ ), or  $R^2r$  ( $CDE/cde$ ). Table 2-11 gives the frequency of the more common Rh-positive genotypes in the White population. In other racial groups, there is less likelihood that Rh-positive phenotypes result from heterozygous genotypes, because Rh-negative genes are less frequent.

#### **2-20. Rh VARIANT ( $D^u$ )**

##### a. **General.**

(1) Not every Rh-positive cell sample reacts equally with every anti- $Rh_o(D)$  serum. Most specimens show clear-cut agglutination after immediate spin, and can easily be categorized as Rh-positive. Cells which are not immediately agglutinated cannot so readily be categorized as Rh-negative, because some  $Rh_o(D)$ -containing cells react to a variable degree with the antiserum, but are not agglutinated. Since the antigen is present, the cells are indeed Rh-positive, and additional testing is necessary to demonstrate it. These types of reactivity are called  $D^u$ .

(2) The  $D^u$  phenotype can arise from several different genetic circumstances. Some genes for  $Rh_o(D)$  seem to code for a weakly reactive antigen, and this trait can be shown to follow regular patterns of inheritance. In Blacks, the trait is fairly common, often appearing as part of the gene  $R^0$  ( $cDe$ ).  $D^u$  is considerably less common in Whites. When it occurs, it more often is found as a variant of the  $R^1$  ( $CDe$ ) or  $R^2$  ( $cDE$ ) genes, which are more common in the White population than  $R^0$  ( $cDe$ ). Some of these genetically determined  $D^u$  may react weakly with most anti- $Rh_o(D)$  sera.

Phenotype		Genotype		Genotype	Likelihood of Zygosity (%)*	
Rh-Hr	CDE	Rh-Hr	CDE	(% total population)	Homo-zygous	Hetero-zygous
Rh <sub>1</sub> rh	CcDee	R <sup>1</sup> r	CDe/cde	32.0	6	94
		R <sup>1</sup> R <sup>o</sup>	CDe/cDe	2.0		
Rh <sub>1</sub> Rh <sub>1</sub>	CCDee	R <sup>1</sup> R <sup>1</sup>	CDe/CDe	17.0	96	4
		R <sup>1</sup> r <sup>1</sup>	CDe/Cde	0.8		
Rh <sub>2</sub> rh	ccDEe	R <sup>2</sup> r	cDE/cde	11.0	6	94
		R <sup>2</sup> R <sup>o</sup>	cDE/cDe	0.7		
Rh <sub>2</sub> Rh <sub>2</sub>	ccDEE	R <sup>2</sup> R <sup>2</sup>	cDE/cDE	2.0	86	14
		R <sup>2</sup> r <sup>2</sup>	cDE/cdE	0.3		
Rh <sub>2</sub>	CcDEe	R <sup>1</sup> R <sup>2</sup>	CDe/cDE	12.0	89	11
		R <sup>1</sup> r	CDE/cde	1.0		
		R <sup>2</sup> r <sup>1</sup>	cDE/Cde	0.3		
		R <sup>2</sup> r	CDE/cde	0.2		
Rh <sub>o</sub>	cDe	R <sup>o</sup> r	cDe/cde	2.0	3	97
		R <sup>o</sup> R <sup>o</sup>	cDe/cDe	0.07		

Figures given are for random White population. In Blacks, gene R<sup>o</sup>(cDe) is more common, a fact to be borne in mind in estimating genotype likelihood, particularly in phenotypes R<sup>1</sup>r and R<sup>2</sup>r. For the rare phenotypes and genotypes not included in this table, consult Race and Sanger.

From Huestis, Bove, and Busch. Used with permission of Little Brown and the authors.

Table 2-11. Frequencies of the more common Rh-positive genotypes.

(3) In some heterozygous individuals, the  $D^u$  phenotype seems to result from suppression of a perfectly normal gene by the other allele. The gene  $r'$  (Cde) sometimes affects the expression of Rh-positive genes present on the chromosome, TRANS. (This is known as TRANS positioning.) When this occurs, the cell may have weakened  $Rh_o(D)$  activity, but it is usually stronger than on cells whose  $D^u$  is controlled by a specific gene. This phenotypic trait is not transmitted genetically, and not every Rh-positive individual with a  $r'$  (Cde) gene will show this effect.

b. **Subunits of  $Rh_o(D)$  -  $D^{mosaic}$ .** Observations that the  $Rh_o(D)$  antigen includes numerous genetically determined subunits explained the behavior of some  $D^u$  bloods and some hitherto inexplicable cases of Rh-positive persons producing anti- $Rh_o(D)$ . Wiener and Unger have shown that normal Rh-positive cells include all the subunits, to which they give the designation  $Rh_o$  associated cognate specificities:  $Rh^A$ ,  $Rh^B$ ,  $Rh^C$ , and  $Rh^D$ ; in rare examples of Rh-positive blood, 1 or more cognate specificities may be absent. Some cells lacking aspects of the  $Rh_o(D)$  spectrum may react weakly with anti- $Rh_o(D)$ , and be classified as  $D^u$ . As many as 50 percent of  $D^u$  bloods may have this basis. Other deficient cells may give unremarkable Rh-positive reactions, but if such patients receive Rh-positive blood, they will be exposed to an antigen absent from their own cells. Should they produce antibody to the missing subunit, it would react with nearly all Rh-positive cells but their own, and would appear to be anti- $Rh_o(D)$ . Tippett has classified such persons into six numbered groups. Although arrived at by different criteria, the classifications of Race and Sanger and Wiener need not be incompatible.

c. **Significance of  $D^u$ .**

(1) Since  $D^u$  cells are Rh-positive, it is important that they not be given to Rh-negative recipients. Although much less antigenic than standard Rh-positives, such cells are capable of eliciting an anti- $Rh_o(D)$  antibody, and if transfused into an Rh-negative patient who already has an antibody, they may suffer accelerated destruction. All donor bloods must be fully tested to exclude  $D^u$  reactivity before they are classified as Rh-negative.

(2) More controversy exists about the status of the  $D^u$  transfusion recipient. Theoretically, such a patient, being Rh-positive, can receive Rh-positive blood with impunity. Some workers believe that those individuals whose  $D^u$  is a result of missing subunits have increased risk of developing antibodies, which, although directed against a particular cognate specificity, are effectively anti- $Rh_o(D)$ . This happening is rare. In some transfusion centers,  $D^u$  recipients are routinely given Rh-positive blood. A different consideration influences other workers, who fear that careless or incorrect interpretation of the  $D^u$  test might lead some Rh-negative patients to be incorrectly typed as  $D^u$  and thus inappropriately to receive Rh-positive blood. The AABB Standards requires that donor bloods, but not recipient bloods, be tested for  $D^u$ . Many workers believe that giving Rh-negative blood routinely to a patient whose cells are not immediately agglutinated by anti- $Rh_o(D)$  is the safest, most efficient, and most economical way to handle this issue.

## 2-21. OTHER Rh ANTIGENS

a. **Background.** The number of identified Rh antigens has now exceeded 40. Except for the rare individuals and laboratories involved, most have primarily theoretical importance. Table 2-12 lists most of the antigens sufficiently well characterized to have names and/or numbers. The advantages of the numerical nomenclature are obvious at these esoteric levels. A few antigens deserve additional comment.

**NOTE:** No specific references are given. The reader is referred to Race and Sanger, Issitt and Issitt, and to the papers by Rosenfield and colleagues.

Numerical Designation (prefixed by Rh)				Numerical Designation (prefixed by Rh)			
	CDE	Rh-Hr	Other		CDE	Rh-Hr	Other
1	D	Rh <sub>0</sub>		24	E <sup>T</sup>		
W1	D <sup>W</sup>	h <sub>0</sub>		25			LW
2	C	rh <sup>?</sup>		26	"C-Like"		Deal
3	E	rh <sup>+</sup>		27	cE		
4	c	hr <sup>+</sup>		28		hr <sup>M</sup>	Hernandez
5	e	hr <sup>-</sup>		29			"Total Rh"
6	f, ce	hr		30	D <sup>ce</sup>		Go <sup>ce</sup>
7	Ce	rh		31	hr <sup>ce</sup>		
8	C <sup>W</sup>	rh <sup>W1</sup>		32		R <sup>N</sup>	Troll
9	C <sup>X</sup>	rh <sup>X</sup>		33	R <sup>ce</sup>		Hill
10	V, ce <sup>+</sup>	hr <sup>V</sup>		34			Bastiaan
11	E <sup>W</sup>	rh <sup>W2</sup>		35			1114
12	G	rh <sup>G</sup>		36			Be <sup>G</sup>
13		Rh <sup>A</sup>		37			S
14		Rh <sup>B</sup>		39	C-Like		
15		Rh <sup>C</sup>		40			Targett
16		Rh <sup>D</sup>		41	Ce-Like		
17		Hr		42	Ce <sup>+</sup>	rh <sup>A</sup>	Thornton
18		Hr <sub>0</sub>		43			Crawford
19		hr <sup>A</sup>		44			Nou
20	e <sup>A</sup>		VS	45			Riv
21	C <sup>G</sup>			46			Sec
22	CE		Jarvis	47			DAV
23	D <sup>W</sup>		Wiel				

**NOTE:** The antigens designated Rh:32 and Rh:33 have not been given names. The symbols shown are for the genes. The antigens are the products of these genes.

Table 2-12. Equivalent notations in the Rh system.

## b. Compound Antigens and Spatial Configuration.

(1) The material on the red blood cell surface that displays Rh activity has numerous possible antigenic subdivisions. Each gene or gene complex determines a single surface structure, of which some portions are more likely to elicit antibodies than others. The product of the gene  $R^1$  (CDe) has antigenic activity defined as  $Rh_o(D)$ ,  $rh'(C)$ , and  $hr''(e)$ . It also has  $Rh:7$ ,  $rhi(Ce)$ , the "compound" product of  $rh'(C)$ , and  $hr''(e)$  together in the same gene product. Cells that have  $rh'(C)$  and  $rh''(e)$  determined by separate genes (for example, from an  $R^{2r}$  [CDE/cde] person) do not have the antigen  $rhi(Ce)$ . Similar compound antigens exist for  $hr'(c)$  and  $hr''(e)$  determined by the same gene (the antigen called  $Rh:6$ ,  $hr$ ,  $f$ , or  $ce$ );  $hr'(c)$  and  $rh''(E)$  determined by the same gene ( $Rh:27$ ,  $cE$ ); and  $rh'(C)$  and  $rh''(E)$  determined by the same gene ( $Rh:22$ ,  $CE$ ).

(2) These compound antigens elicit antibodies less often than the single specificities. The fact that they are rarely immunogenic does not mean that they are absent. Antibodies specific for the compound antigen are very useful in determining genotype. Anti- $hr(f,ce)$  will agglutinate cells from an  $R^{2r}$  (CDE/cde) person but not from an  $R^1R^2$  (CDe/cDE) person, even though their phenotypes with the 5 standard antisera appear the same.

(3) The existence of compound antigens provides a clue to the structure of Rh-active material. Whatever the overall configuration of the material produced by each gene or gene complex, it appears that the  $rh'/hr'$  (C/c) and  $rh''/hr''$  (E/e) activities are in close spatial association. No compound antigens have been found that reflect the presence of the  $Rh_o(D)$  and  $rh''(E)$  or  $hr''(e)$  determinants on the same gene. Some workers find it more logical to write the gene product of  $R^1$  (CDe) as  $DcE$ , or of  $R^2$  (cDE) as  $DcE$  to reflect this seeming spatial contiguity.

c. **Deletions.** Rare genes exist that appear to code for Rh material which lacks any activity at the  $rh''/hr''$  (E/e) site, or at the sites for both  $rh'/hr'$  (C/c) and  $rh''/hr''$  (E/e). (See discussion in Race and Sanger, pp 210-216.) It is as if smaller or larger parts of the surface configuration were lopped off or compressed, leaving  $Rh_o(D)$  as the only remaining site. Cells which lack any Rh antigens other than  $Rh_o(D)$  have exceptionally strong  $Rh^o(D)$  activity an observation that may allow such cells to be identified in routine testing.

d. **The Antigen  $rh^G$  and Cross-Reactions.** The  $rh^G$  (or G) antigen cannot be neatly fitted into the concept of 3 antigenic regions; rather, it appears to be a cross-reaction between  $Rh_o(D)$  and  $rh'(C)$ . It almost always accompanies  $Rh_o(D)$  or  $rh'(C)$ , and antibodies against  $rh^G$  superficially appear to be anti- $Rh_o(D)$  plus anti- $rh'(C)$ . The anti- $rh^G(G)$  activity cannot, however, be separated into anti- $rh'(C)$  and anti- $Rh_o(D)$ . Rare cells have been found which display  $rh^G$  but lack  $Rh_o(D)$  and a reasonable expression of  $rh'(C)$ ; and there are even rarer cells that have at least part of  $Rh_o(D)$  but lack  $rh^G$ . Such antibody specificity explains how Rh-negative persons who receive cells positive for

rh'(C) but negative for Rh<sub>o</sub>(D) can develop an antibody apparently directed against Rh<sub>o</sub>(D). Such an antibody, in most cases, is really anti-rh<sup>G</sup>. Rh-negative persons rarely receive Rh<sub>o</sub>(D)-containing blood, but, if exposed through pregnancy or transfusion to Rh<sub>o</sub>(D)-positive, rh'(C)-negative cells, they could form antibody with apparent anti-rh'(C) activity. Other cross-reactions may occur between rh'(C) and rh"(E), and between rh'(C) and hr"(e).

**e. "Variant" Antigens.**

(1) There must be innumerable subtle differences in composition among various Rh gene products. Although red cells from most people give straightforward reactions with common antibodies, those from some give atypical reactions, and others stimulate the production of antibodies that do not react with red cells of common Rh phenotypes. It has been convenient to consider C and c, and E and e, as antithetical activities at specific surface sites. This scheme can be expanded to include alternative antigenic activities that seem to reside at the same site, but are determined by genes coding for activity distinct from the common Rh determinants.

(2) Atypical activity at the e site is fairly common in Blacks. Several distinct patterns have been identified, such as hr<sup>s</sup>- and hr<sup>d</sup>-. Diminished c and markedly diminished e activity are among the features of products of the R<sup>N</sup> gene, which also determines a low-frequency antigen, Rh32. Among Whites, a weakened e antigen is among the products of genes that determine the Rh33 (R<sub>o</sub> H<sup>ar</sup>) and the Be<sup>a</sup> (Berrens) antigens.

(3) Antigens that behave on most occasions as if they had an antithetical relationship to C/c or E/e have been found, mainly in Whites. The most common is C<sup>w</sup>, which occurs in 2 Table 2-12 lists many of the separate antigens that have been found to belong to the Rh system and have contributed to the advancing complexity of the system and its nomenclature.

**2-22. THE LANDSTEINER and WIENER ( PROBLEM**

a. As work in the Rh system progressed, evidence accumulated that the antigen identified by the rabbit antiserum of Landsteiner and Wiener (LW) was not, after all, the same as the antigen present on 85 percent of human blood cells. Similarities exist, but numerous absorption, elution, agglutination, and immunization studies have demonstrated two different activities. The antigens identified on rhesus monkey cells are present on nearly all human cells, both Rh-positive and Rh-negative. Adult Rh-negative cells have rather weak activity. Cord blood cells, both Rh-positive and Rh-negative, have abundant activity. Since the term Rh was so firmly entrenched, Levine proposed that the newly characterized activity universal in rhesus monkeys and extremely common in human subjects be called LW, in honor of Landsteiner and Wiener. Rare persons exist whose cells have normal Rh antigens, either with or without Rh<sub>o</sub>(D), but whose red cells have so little LW activity that they are able to form allo-anti-LW.

b. The genes determining LW activity are not part of the Rh system. Genetic independence has been shown in families whose LW–negative trait segregates separately from the Rh genes. Phenotypically, however, the gene products are related. This is confirmed both through the original observation that LW activity is always weak in adult Rh-negative cells, and more conclusively, through observation that all the rare persons who lack Rh activity of any kind also lack LW activity. The basis for this interaction is not clear. The LW gene appears to require, for its expression, some product of Rh gene activity.

c. The clinical significance of LW is that there are persons with cells that are LW-variant and these persons can produce anti-LW. If they are Rh-positive but LW-negative, the resulting antibody may appear to be anti-Rh<sub>o</sub>(D) occurring in an Rh-positive. Anti-LW activity has been documented as an autoantibody, and possibly as part of early development of anti-Rh<sub>o</sub>(D).

### 2-23. Rh<sub>null</sub> SYNDROME

a. At least 22 persons have been found, in 14 families, whose cells have no Rh antigens at all. Numerous elegant studies have revealed that at least two genetic mechanisms may produce this phenotype. Most such individuals possess perfectly normal Rh genes whose expression seems to be blocked if an independently segregating gene is present in homozygous state. The term regulator type of Rh<sub>null</sub> is applied to this event. It appears that before Rh genes can act, some action must be taken by a very common gene referred to as X<sup>1</sup>r. Homozygotes for the very rare amorphic allele X<sup>0</sup>r are unable to express the activity of Rh genes. The parents and offspring of such individuals have normal Rh genotypes; in some cases, overall Rh reactivity is depressed, a finding consistent with heterozygosity for an amorphic regulator gene. Thus, Rh<sub>null</sub> persons of the regulator type have normal Rh genes which are unable to function. These persons transmit normal Rh genes to their offspring, in a manner analogous to the transmission of A or B genes by someone of the Bombay phenotype.

b. Rarer still is the Rh<sub>null</sub> phenotype in persons homozygous for an amorphic gene at the Rh locus. The homozygote is unable to manufacture any Rh antigens. The parents and offspring all possess a single dose of the amorphic gene, so each presents a phenotype with only one set of Rh antigens.

c. Whatever the genetic cause, red blood cells lacking Rh antigens have membrane abnormalities that shorten cell survival, although the severity varies among affected individuals. Shortened red blood cell survival and variably altered activity of the MNSsU and En<sup>a</sup> antigens have been consistently observed, but the degrees of hemolysis and anemia differ in different subjects. Since Rh antigenic activity appears to reside on lipoprotein molecules integrally enmeshed in the red blood cell membrane, it is not surprising that cells deficient in Rh activity have defective membrane function.



d. A third type of defective Rh gene expression is found in patients of the Rh<sub>mod</sub> phenotype, which seems to arise from the homozygous occurrence of another recessive "suppressor" gene. These patients have congenital hemolytic anemia and much reduced, but not completely absent, Rh activity. Rh<sub>null</sub> cells consistently lack the LW antigen despite the fact that the individual has normal LW genes; Rh<sub>mod</sub> cells do have LW activity.

e. Most Rh<sub>null</sub> individuals came to medical attention because their serum contained antibodies, but this is not universal. Transfusion seems to be highly sensitizing, but not all parous Rh<sub>null</sub> women have developed pregnancy-related antibodies, and one never-transfused man developed antibody without known stimulation. Although all are within the Rh system, the antibodies have a spectrum of reactivity, from identifiable anti-e and anti-C to the serum called anti-Rh29, which reacts with all cells tested except other Rh<sub>null</sub> cells.

## 2-24. Rh ANTIBODIES

a. With the exception of occasional examples of anti-rh"(E) and anti-C<sup>w</sup> occurring without known stimulus, most Rh antibodies result from immunization by pregnancy or transfusion. Rh<sub>o</sub>(D) is far and away the most potent antigen, followed by hr'(c) and rh"(E). Although strong reactions may be seen in saline agglutinating systems, most Rh antibodies react best by enzyme or anti-globulin techniques. Even serums with strong saline-active anti-Rh<sub>o</sub>(D) usually react at far higher dilutions in anti-globulin tests. Some workers find enzyme techniques especially useful for detecting weak or developing Rh antibodies. Sensitization tends to persist for many years, and even if circulating antibody is no longer detectable, subsequent antigenic exposure produces rapid secondary response.

b. Anti-Rh<sub>o</sub>(D) usually reacts in an all-or-nothing fashion, without distinguishing between red blood cells from homozygous and heterozygous individuals. Dosage effect can often be demonstrated in antibodies against rh"(E), hr'(c) and hr"(e), while anti-rh'(C) sometimes behaves this way. Detecting antigen strength by tube-testing with agglutinating antibodies provides data that are quantitatively poor. Accurate quantitation of antigenic sites requires methods such as radioisotope labeling, immunoferritin localization, or automated procedures.

c. Virtually all the Rh antigens have been discovered because of human antibodies. The complexity of the Rh system testifies to the diversity of Rh antigen activity and to the remarkable discriminatory capacity of the human immune response. It is not known why some antigens evoke antibodies after a given antigenic challenge while others do not.

## 2-25. PREVENTION OF Rh<sub>o</sub>(D) IMMUNIZATION

a. Very few Rh-negative women form anti-Rh<sub>o</sub>(D) after an Rh-positive pregnancy nowadays because the women are given antepartum (at 28 weeks gestation) and postpartum (within 72 hours of delivery) injections of Rh immune globulin (RhIG), which provides specific, effective immunosuppression. Rh immune globulin is also effective in suppressing immunization after inadvertent or deliberate transfusion of Rh-positive blood. The recommended immunosuppressive dose is 300 ug of immune globulin for each 15 ml of Rh-positive cells transfused. Manufacturers state that a single vial of RhIG provides adequate immunosuppression for up to 15 ml of Rh-positive cells. Note that this dose refers to the red blood cells, not whole blood. To calculate the number of vials of RhIG needed, the volume of transfused red blood cells should be divided by 15.

Example: A Rh-negative person is inadvertently given a unit of Rh-positive whole blood. Transfusion is discontinued when the error is discovered, after 175 ml has been transfused.

QUESTION: How many Rh-positive cells have been given?

EXPLANATION: It is not necessary to calculate red cell volume precisely. A generous rule-of-thumb is to consider that the whole blood is 50 percent red cells and that the red cell concentrates are 100 percent red blood cells. maximum volume of red blood cells received by the above patient is  $(175 \text{ ml}/2) = 88 \text{ ml}$ .

QUESTION: How much RhIG to give?

EXPLANATION:  $88 \text{ ml red blood cells divided by } 15 \text{ ml/vial} = 6 \text{ vials}$ .

NOTE: Giving excess RhIG will not harm the Rh-negative patient, whereas giving too little and allowing immunization to occur is certainly harmful. In calculating the dose of RhIG, it is better to err by overestimating the volume of Rh-positive cells given, than by underestimating.

b. Rh immune globulin shortens the life span of transfused Rh-positive cells, but does not usually cause clinical findings more severe than transient temperature rise, muscle pain, and splenomegaly. Since Rh-positive cells continue to circulate for at least 7 days after anti-Rh<sub>o</sub>(D) has been given, giving immune globulin does not abolish the immediate therapeutic benefit of the transfusion. The recipient's direct antiglobulin test will be positive for as long as the Rh-positive cells continue to circulate. The bilirubin may rise within hours to days of injection, with increments as high as 2 to 6 mg/dl. Passively administered antibody remains detectable up to five months after

treatment, so the success or failure of immunosuppression cannot be evaluated until at least 6 months after the transfusion. Rh immune globulin should be given as soon as possible after Rh-positive cells have been transfused, but successful immunosuppression has been reported with delay as long as 72 hours before beginning injections. When large amounts of globulin must be given intramuscularly, divided doses over a period of several days can be therapeutically effective.

## 2-26. Rh-TYPING

a. **General.** Routine cell-typing for patients and donors alike involves only Rh<sub>o</sub>(D) with techniques to demonstrate D<sup>u</sup> being required for donor bloods. Tests for other Rh antigens are performed when there are specific reasons for detailed testing, such as parentage determination or other family studies, or attempts to distinguish between homozygous or heterozygous Rh-positives. Potential donor bloods should always be tested for the relevant antigen if the recipient has an antibody. In selecting blood for the recipient with an antibody, testing with reagent antisera gives more reliable results than relying merely on a negative cross-match. Except for clearly defined indications, routine testing for Rh antigens other than Rh<sub>o</sub>(D) is not recommended.

b. **Anti-Rh<sub>o</sub>(D) Serum for Slide or Rapid Tube Test.** This reagent gives rapid, reproducible results when used according to manufacturer's directions, provided the cells are not antibody-coated or otherwise abnormal. Since false positive agglutination readily occurs, a control with immunologically inert reagents must accompany each test. If cells are agglutinated in the control procedure, the results of the anti-Rh<sub>o</sub>(D) test are invalid, and the cells must be tested with a reagent unaffected by protein abnormalities. (See section below on saline-agglutinating reagents.)

(1) The control. False positives are caused by interaction between the red blood cells under test and the non-antibody materials in the reaction mixture. Not only the macromolecular nature of the medium, but specific substances in the reagents may cause cellular aggregation that resembles antibody-mediated agglutination. The best control medium to detect these events is the material used in the antiserum, which lacks only the specific antibody. Many manufacturers offer immunologically inert high-protein mediums that resemble the reagent in all other ways. The Rh<sub>o</sub>(D) test should be controlled with this material, if it is available. In the absence of inert serum diluent, 22 percent or 30 percent bovine albumin can be used. The serum diluent used for Rh-testing should not be used as the high-protein additive for cross-matching or antibody-screening or identification procedures.

(2) Slide testing.

(a) This requires a high concentration of cells and protein and an optimum temperature of 37°C. The viewing surface should be kept lighted at all times to preserve a temperature of 45°C to 50°C. Reagents placed on a glass slide in contact with the surface should reach 37°C within 2 minutes.

- 1 STEP 1: Place one drop of reagent anti-Rh<sub>o</sub>(D) on a labeled slide.
- 2 STEP 2: Place one drop of albumin or other control medium on another labeled slide.
- 3 STEP 3: To each slide add two drops of well mixed 40 to 50 percent suspension of cells in plasma or serum.
- 4 STEP 4: Thoroughly mix the cell suspension and reagent, using a clean stick for each slide, and spread the mixture evenly over most of the slide.
- 5 STEP 5: Place both slides on the viewing surface simultaneously, and tilt gently and continuously to observe for agglutination.
- 6 STEP 6: After no longer than 2 minutes, interpret and record the results of the reactions on both sides.

**NOTE:** Do not allow cell mixture to come in contact with hands.

(b) Interpretation. A positive test has agglutination with anti-Rh<sub>o</sub>(D) and a smooth suspension of cells in the control. Drying around the edges should not be confused with agglutination. If there is agglutination or irregularity in the control, a saline test must be performed (see below).

(c) Du testing cannot be done on a slide. To confirm Rh-negative results, a tube test should supplement the slide findings.

(d) False positives.

1 If albumin control is positive, disregard results and repeat test with saline-active reagents.

2 Small fibrin clots may give the appearance of agglutination.

3 Blood incompletely anti-coagulated may clot on the heated slide.

(e) False negatives.

1 Too weak a cell suspension may agglutinate poorly. Whole blood from a severely anemic patient may not be a sufficiently concentrated cell suspension.

2 Cells in a saline suspension react poorly or not at all.

3 Weakly active cells may take the full 2 minutes to agglutinate. Do not expect reactions to be as rapid as with ABO reagents.

4 Failure to identify reagents at time of use may allow albumin, anti-globulin serum, or some other colorless reagent to be added instead of anti-Rh<sub>o</sub>(D).

(3) Capillary testing. See special methods section.

(4) Tube testing.

(a) Most slide and rapid tube anti-Rh<sub>o</sub>(D) serums can be used with saline-suspended cells or with cells in serum, but this should be confirmed by reading the manufacturer's instructions before use. Table 2-13 illustrates the kinds of differences that exist in manufacturer's instructions for use of anti-Rh<sub>o</sub>(D).

1 STEP 1: Place one drop of antiserum in labeled tube for test.

2 STEP 2: Place one drop of albumin or control medium in labeled tube for control.

	A	B	C	D	E
Drops of antiserum	1 or 2	1	1 or 2	1	1
Drops of cell suspension	1	1	1 or 2	1	1
Suspension (%)	4	2-4	2-5	5	5
Saline suspension	Yes	*	Yes	Yes	Yes
Serum suspension	*	Yes	*	Yes	Yes
Plasma suspension	*	Yes	*	Yes	Yes
Centrifugation	1 min at 1,500 rpm or 30 sec at 3,400 rpm	1 min at 1,500 rpm or 30 sec at 3,400 rpm	2 min at 1,500 rpm or 30 sec at 3,400 rpm	1 min at 1,500 rpm or 15-30 sec at 3,400 rpm	30 sec at 9-1,100 rcf
Incubation for D <sub>u</sub> -testing	10 min at 37°C	15-30 min at 37°C	15-30 min at 37°C	15-30 min at 37°C	15 min at 37°C
* Not mentioned as either permissible or forbidden. Relative centrifugal force.					

Table 2-13. Variables in manufacturer's instructions for Rh<sub>o</sub>(D)-testing.

3 STEP 3: Add one or two drops of 2 to 5 percent cell suspension in serum or saline to each tube OR use clean, separate applicator stick to dislodge sufficient cells from clot to approximate cell volume in one drop of 5 percent suspension in each tube.

4 STEP 4: Mix gently and centrifuge.

5 STEP 5: Gently resuspend cell button and observe for agglutination. If stick was used to transfer cells, adding one drop of saline to the tube before resuspending cell button will provide more fluid and make resuspension and reading easier.

6 STEP 6: Record test and control results.

(b) Interpretation. A positive result is agglutination in the anti-Rh<sub>o</sub>(D) tube and a smooth suspension in the control. If the anti-Rh<sub>o</sub>(D) tube is not agglutinated, the test can be continued immediately for D<sup>u</sup>. If there is agglutination or irregularity in the control tube, a saline test must be performed (see below).

(c) False positives.

1 If cells and serum remain together too long before test is read, the high-protein medium may produce rouleaux which resemble agglutinates.

2 If a combined antibody (for example, anti-Rh<sub>o</sub>rh'(DC)) is used instead of anti-Rh<sub>o</sub>(D), cells which lack Rh<sub>o</sub>(D) but contain the other antigen may be agglutinated.

3 Some specificity other than anti-Rh<sub>o</sub>(D) may be present in the serum.

(d) False negatives.

1 If cells and serum remain together too long before tests are read, antibody may elute from weakly reactive cells, and small agglutinates may disperse.

2 Failure to identify reagents at time of use may result in albumin, antiglobulin serum, or some other colorless reagent being added instead of anti-Rh<sub>o</sub>(D).

3 Inadvertent failure to add reagent (as, for example, in one of the long row of tubes) will give smooth suspension of cells.

(5) Testing for D<sup>u</sup>.

(a) Cells classified as D<sup>u</sup> possess the Rh<sub>o</sub>(D) antigen but are not agglutinated by some or all anti-Rh<sub>o</sub>(D) serums used. The antigen can most conveniently be demonstrated by showing antibody attachment to the cell surface. Antiglobulin serum demonstrates whether or not this attachment has occurred after cells and anti-Rh<sub>o</sub>(D) serum have been incubated together.

(b) Not every anti-Rh<sub>o</sub>(D) serum can be subjected to anti-globulin-testing, since antiglobulin-reactive antibodies of other specificities may be present. Check manufacturer's instructions.

1 STEP 1: Place one drop of anti-Rh<sub>o</sub>(D) serum in a labeled test tube.

2 STEP 2: Add one or two drops of 2 to 5 percent cell suspension.

NOTE: If the initial anti-Rh<sub>o</sub>(D) test was done in a tube, this tube can be used directly for D<sup>u</sup> testing.

3 STEP 3: Prepare a control tube. Either of two procedures may be used. Add one or two drops of the original cell suspension to the labeled control tube OR use the albumin or reagent control tube from anti-Rh<sub>o</sub>(D) testing.

4 STEP 4: Mix gently and incubate 15 to 30 minutes at 37°C (according to manufacturer's instruction). Following incubation gently re-suspend cell/serum mixture: centrifuge and examine for agglutination. If strong agglutination of test RBCs is observed (with no agglutination in the control tube), record the test sample as Rh positive. If test RBCs are not agglutinated, or show doubtful agglutination, continue with step 5.

5 STEP 5: Wash cells in both tubes three or four times with large volumes of saline.

6 STEP 6: Decant thoroughly and blot rim of tubes dry after final wash.

7 STEP 7: Add one or two drops of antiglobulin serum (follow manufacturer's instruction) to each tube.

8 STEP 8: Mix gently and centrifuge.

9 STEP 9: Re-suspend cell button gently and observe for agglutination.

10 STEP 10: Add known sensitized cells as a control for antiglobulin procedures.

11 STEP 11: Record results.

(c) Interpretation.

1 A positive result is agglutination in the anti-Rh<sub>o</sub>(D) tube and none in the control tube. This indicates Rh<sub>o</sub>-variant activity, and the blood should be classified as Rh<sub>o</sub>-positive. A negative result is absence of agglutination in both tubes. This means the cells do not have Rh<sub>o</sub>(D) activity and should be classified as Rh negative.

2 Cells which are agglutinated by antiglobulin serum in the absence of added reagent antiserum have a positive antiglobulin test. If the control is positive, the antiglobulin results of the anti-Rh<sub>o</sub>(D) tube cannot be interpreted. If the cells are from a patient needing a transfusion, he should be given Rh-negative blood. If the cells are from a donor, the blood should not be used for transfusion.

3 Occasionally, when the albumin or the reagent control tube is used for antiglobulin-testing, globulins in the medium may coat the cells during incubation. To distinguish this from a truly positive direct antiglobulin test, repeat the antiglobulin test on well-washed unincubated cells. If this is negative, the reagents used for incubation should be investigated for the presence of immunologically active protein.

4 For false positives and false negatives refer to Subcourse MD0846, Lesson 1, Section II.

**c. Anti-Rh<sub>o</sub>(D), Saline-Reactive.**

(1) Saline-agglutinating Rh antibodies are useful for testing cells that agglutinate spontaneously or form rouleaux when suspended in a high-protein medium. Sometimes cells that are coated by anti-Rh<sub>o</sub>(D) (as, for example, in hemolytic disease of the newborn) or other antibodies (as, for example, in autoimmune hemolytic anemia) can successfully be typed with saline-reactive antisera, when antiserum for slide or rapid tube test gives equivocal results. Saline-agglutinating Rh antibodies are processed from pooled human serum and consist of human immunoglobulins.

(2) Since saline-reactive anti-Rh<sub>o</sub>(D) agglutinates saline-suspended cells, high-protein medium should not be used, and an albumin control is not indicated. If this reagent is used only occasionally, the test should be accompanied by known positive and negative controls. If the test is done frequently, the reagent should be tested as part of the regular quality assurance program.



- (a) STEP 1: Place one drop of saline-reactive anti-Rh<sub>o</sub>(D) in properly labeled tube.
- (b) STEP 2: Add one drop of 2 to 5 percent saline suspension of well-washed red cells.
- (c) STEP 3: Mix gently and incubate at 37°C for 15 to 60 minutes, according to manufacturer's direction.
- (d) STEP 4: Centrifuge and gently resuspend to look for agglutination. For controls, use a saline suspension of known Rh-positive cells and one of known Rh-negative cells. Be sure the concentration is comparable to that of the test cells. Test all three tubes, suitably labeled, at the same time.
- (e) STEP 5: Interpret the results. Agglutination indicates that the cells are Rh-positive. Du cells will not ordinarily be agglutinated, and the saline reagent cannot be used for Du-testing. This test is done only on patient's cells; any seemingly negative recipient should be given Rh-negative blood. Blood from a potential donor whose cells cannot satisfactorily be tested with slide or rapid tube test anti-Rho(D) should not be used for transfusion.

d. **Rho(D)-Typing in Hemolytic Disease of the Newborn.** Occasionally, an infant's cells may be so heavily coated with maternal anti-Rho(D) that no sites are left to react with the antiserum. Some such cells can be successfully typed with saline anti-Rho(D) but many cannot. This should be suspected if cells with a strongly positive antiglobulin test are negative on anti-Rho(D)-testing. To resolve this discrepancy, antibody can be eluted from the cells at 45°C (see Subcourse MD08460846 para 1-40). Usually, enough sites will be liberated so that anti-Rho(D)-testing can be done. The specificity of the eluate should be determined to confirm that the antibody coating the cells is indeed antiRho(D), and also to see if there are additional antibodies present.

## **2-27. TESTS FOR ANTIGENS OTHER THAN Rho(D)**

Both saline-reactive and slide or rapid tube test antisera are available for the other 4 major Rh antigens, rh'(C), rh"(E), hr'(c), and hr"(e). High-protein sera for slide or rapid tube test are more common, and the same kind of high-protein control should be used for these tests as for anti-Rho(D). The manufacturer's instructions should be followed for whatever serum is used. Contamination with antiglobulin-reactive antibodies other than those specified on the label is more common with these Rh antibodies than with anti-Rho(D). Unless the instructions clearly indicate their suitability, these reagents should not be used with antiglobulin serum. If a blood bank uses these reagents only rarely, positive and negative control cells should be tested along with the test cells.

## 2-28. GENERAL CONSIDERATIONS IN Rh-TESTING

a. The following problems may cause false positive results in Rh-testing:

(1) Serum-suspended cells from patients with abnormal serum proteins may form rouleaux which resemble agglutination. This will occur in both test and control tube, since the same suspension is in both. To resolve, use a well-washed saline suspension and test with saline-agglutinating reagents.

(2) Polyagglutinable cells may be agglutinated by any human protein reagent, because the antibodies that agglutinate these surface-altered cells are present in all adult serums. All reagent Rh antibodies derive from human serum. The control tube may not agglutinate if bovine albumin is used as the protein. Except for group AB cells, this situation would become obvious when cell and serum ABO tests disagree. Both ABO and Rh discrepancies should be resolved before transfusing the patient. In an emergency, group O, Rh-negative packed cells should be given. Polyagglutinable cells cannot be used as donor cells.

(3) Contaminating antibody with specificity other than that indicated by the label could cause agglutination. Agglutinating antibodies are rare with well-standardized, licensed serum, but antiglobulin-active antibodies are not uncommon. Quality assurance techniques might not detect the problem if the cell used as the negative control were also negative for the antigen recognized by the contaminating antibody. Many blood banks prefer to perform duplicate tests, with different lots of antiserum, so that discrepant results of this sort can be detected.

b. The following problems may cause false negative results in Rh-testing:

(1) If an antibody recognizes only a compound antigen, it will not react with cells which carry the individual specificities as separate gene products. For example: A supposed anti-hr<sup>(e)</sup> serum that was anti-hr (f or ce), would give negative results against R<sup>1</sup>R<sup>2</sup> (CDe/cDE) cells, or any other cells on which the hr<sup>(e)</sup> antigen was part of a gene product that did not include the compound antigen. This problem is difficult to detect in testing individual samples, unless complete phenotypic testing allows one to make an accurate estimate of probable genotype. Well-defined quality assurance procedures in antibody processing should obviate the problem.

(2) Cells with variant antigens like C<sup>w</sup> or ce<sup>s</sup> may fail to react with standard antisera. This is especially difficult to detect because the results of duplicate testing will be similar. Discrepant results in family studies are the usual clue that further investigation is needed. Sometimes blood "negative" for an antigen elicits antibody which reacts with both the variant and the normal antigen, and the variant is discovered in investigating the immunization.

## Section IV. OTHER BLOOD GROUP SYSTEMS

### 2-29. BACKGROUND

a. In addition to the antigens described in the ABO and Rh blood group systems, there are over 300 more that can be detected on human red blood cells by specific antibodies. The more important of these additional groups, as far as practical blood transfusion is concerned, are the Lewis, I, Kell, P, Duffy, Kidd, MNSs, and Lutheran. Others, such as the only X-linked blood group Xg<sup>a</sup>, contribute to the understanding of human genetics, but are rarely clinically important.

b. Many antigens are not apparently related to any known genetic system. Some, which occur on the red blood cells of almost all persons, are known as high-incidence or "public" antigens. Others have a low incidence and are sometimes referred to as "private" antigens. Some of these antigens are mentioned briefly in the tables at the end of this lesson; more detailed information can be obtained from the reference books listed.

### 2-30. LEWIS SYSTEM

a. The relationship of the Lewis genes, Le and le, to the ABO, Hh, and Se se genes has been described. Although Le<sup>a</sup> and Le<sup>b</sup> antigens are not produced by red blood cells, they are absorbed onto cell membranes as glyco-sphingolipids from the plasma. Table 2-14 shows the Lewis red blood cell phenotypes.

Reactions with Anti-		Phenotype	Frequency in Adults (%)	
Le <sup>a</sup>	Le <sup>b</sup>		Whites	Blacks
+	0	Le(a+b-)	22	23
0	+	Le(a-b+)	72	55
0	0	Le(a-b-)	6	22

**IMPORTANT NOTE:** The notation Le(a-b+) refers to a negative test for the antigen Le<sup>a</sup> and a positive test for the antigen Le<sup>b</sup>. Likewise, the notation Le(a+b-) is used to indicate a positive test for Le<sup>a</sup> and a negative test for Le<sup>b</sup>. Le(a-b-) means a negative test for both Le<sup>a</sup> and Le<sup>b</sup>.

Table 2-14. Lewis red blood cell phenotypes.

b. Red blood cells from newborn infants give unreliable reactions with anti-Le<sup>a</sup> and are usually negative with anti-Le<sup>b</sup>. In subjects destined to be Le(a-b+), the red blood cells go through an intermediate Le(a+b+) phase during the first few years of life.

c. Two other antigenic determinants, Le<sup>c</sup> and Le<sup>d</sup>, have been described. The rare antibodies detecting these determinants react with Le(a-b-), but not Le(a+) or Le(b+) red cells. The biochemical structure of these antigens has not yet been determined.

d. Lewis antibodies usually occur without known antigenic stimulus in Le(a-b-) individuals. Anti-Le<sup>a</sup> and anti-Le<sup>b</sup> may occur separately or together in the same serum, virtually always as IgM molecules; they are capable of fixing complement, but not crossing the placenta.

e. Most examples of anti-Le<sup>b</sup> react best with 0 and A<sub>2</sub> red blood cells and are designated anti-Le<sup>bH</sup>. Those examples which react equally well with cells of all ABO phenotypes that are Le(b+) are classified as anti-Le<sup>bL</sup>. The latter antibodies are not neutralized by saliva from 0 Le(a-b-) secretors, whereas the former are.

f. Serum containing both anti-Le<sup>a</sup> and -Le<sup>b</sup> activity often react with cord cells. As cord cells do not usually react with anti-Le<sup>a</sup> or -Le<sup>b</sup> separately, it has been suggested that this reaction is detecting a determinant other than Le<sup>a</sup> or Le<sup>b</sup>, called Le<sup>x</sup>.

g. As shown in Table 2-15, most Lewis antibodies agglutinate saline-suspended red blood cells; however, the agglutination is often fragile and easily broken up if the button of red blood cells is not re-suspended very gently following centrifugation. Albumin does not usually enhance agglutination by Lewis antibodies. Many of these antibodies react at 37°C by the antiglobulin test. They are almost always IgM complement-binding antibodies and are not detected if complement is absent from the incubation mixture or if the antiglobulin serum has poor anti-complement activity.

		Anti-		
		Le <sup>a</sup>	Le <sup>b</sup>	Le <sup>x</sup> + Le <sup>b</sup>
Saline	22°C	Most	Most	Most
	37°C	Most	Some	Most
	AGT	Many	Some	Many
Enzymes	Hemolysis	Many	Few	Many
	37°C	Most	Most	Most
	AGT	Most	Some	Most
	Hemolysis	Many	Some	Many

Table 2-15. Serologic behavior of Lewis system antibodies.

h. Since glycosphingolipids with Lewis antigenic activity are poorly developed at birth, and since antibodies of the IgM class do not cross the placenta, neither anti-Le<sup>a</sup> nor anti-Le<sup>b</sup> causes hemolytic disease of the newborn. Since Lewis antibodies are readily neutralized by Lewis blood group substances present in plasma, and Lewis-positive red blood cells lose their Lewis antigens when transfused into Lewis-negative recipients, "in vivo" reactions, are rare. No hemolytic transfusion reactions have been proven to be caused by anti-Le<sup>b</sup>, but anti-Le<sup>a</sup> has been implicated. Le(a-) blood is easily found for patients having anti-Le<sup>a</sup> present in their serum. To obtain blood for a patient with anti-Le<sup>b</sup>, some workers have neutralized Lewis antibodies successfully "in vivo" by transfusing plasma containing Lewis blood-group substances before carrying out compatibility-testing and transfusion of Lewis-positive blood, however, for most recipients, it is quite acceptable to use Le(a-b+) blood for transfusing, since anti-Le<sup>b</sup> is so rarely capable of red blood cell destruction.

### 2-31. I BLOOD GROUP SYSTEM

a. The I system differs from most of the other blood group systems in several ways. Fetal red cells are rich in an antigen known as i and have very poorly developed I antigen. At birth, the I antigen is still poorly developed but there is a gradual development of I antigen and a loss of i antigen during the first 2 years; thus, the normal adult's red blood cells react strongly with anti-I but weakly with anti-i. The strength of I antigen varies considerably among normal adults. Rare adults exist who have even less I antigen and more i antigen on their red blood cells than cord red blood cells, the so-called i(adult). No cells completely lack either the I or i antigens. In some conditions associated with bone marrow stress (for example, thalassemia, congenital dyserythropoietic anemia, and so forth), adults may have greatly increased i antigen on their red blood cells without a concomitant decrease of I antigen.

b. An antibody whose reaction is strong against cord cells, weaker against adult cells and, in contrast to anti-i, weaker still against the rare i (adult) phenotype, has been described. It was suggested that the antigen it detected, I<sup>T</sup>, was transitional between i and I. Table 2-16 shows the relative amounts of these antigens on various red blood cells.

	I	Antigen i	I <sup>T</sup>
I adult	Much	Trace	Moderate
i cord	Little	Much	Much
i adult	Trace	Much	Trace

Table 2-16. Amounts of I system antigens on different red blood cells.

c. Additional antigenic determinants such as IA, IB, IH, iH, IP<sub>1</sub>, IP, iP<sub>1</sub>, I<sup>T</sup>P<sub>1</sub>, and A<sub>1</sub>Le<sup>b</sup> are recognized by antibodies with distinct specificities. Thus, although anti-IP<sub>1</sub> reacts only with red blood cells having both I and P<sub>1</sub> antigens, it is reacting with a separate IP<sub>1</sub> determinant; it is not a mixture of anti-I and anti-P<sub>1</sub>.

d. At 4°C, low-titer (that is, less than 64) auto-anti-I can be demonstrated in the serum of most individuals. Such auto-anti-I usually has a narrow thermal range and is not clinically significant. Nevertheless, because it sometimes reacts at room temperature, it is the most common cause of difficulty in compatibility testing (see Subcourse MD0846 Lesson 1, Sections II and III). It may agglutinate red blood cells only weakly at room temperature but unless prewarmed techniques are used, complement components may become bound to the red blood cells, leading to a false-positive indirect antiglobulin test at 37°C.

e. High-titer auto-anti-I with a wide thermal range is encountered as the causative antibody of "cold antibody" autoimmune hemolytic anemia.

f. Anti-I can be encountered as an allo-antibody in the serum of individuals of the very rare i (adult) phenotype.

g. Although anti-i is rarely encountered in routine blood bank investigations, it is commonly found in the serum of patients with infectious mononucleosis; usually, it is present as a weak antibody reacting only at 4°C. On rare occasions, it may be present to high titer and be the cause of "cold antibody" autoimmune hemolytic anemia. Helpful hints in testing I system antibodies are as follows:

(1) Strong examples of the antibodies may not show the clear-cut differences shown in Table 2-17. Titration studies at different temperatures to determine the specificity may be necessary.

		Anti		
		I	i	I <sup>T</sup>
4°C	I adult	4+	0-1+	1+ -3+
	i cord	0-2+	3+	4+
	i adult	0-1+	4+	0-1+
22°C	I adult	2+	0	1+
	i cord	0	2+	3+
	i adult	0	3+	0

Table 2-17. Some examples illustrating the serologic behavior of I system antibodies (saline cell suspensions).

(2) All I system antibody reactions are enhanced if enzyme-treated red blood cells are used. Many of them are also enhanced in the presence of albumin.

(3) Small amounts of complement may be bound to red blood cells at room temperature, causing a subsequent antiglobulin test at 37°C to be weakly positive.

(4) If interpretation of results at 37°C is to be relied upon, pre-warmed tests should be set up strictly at 37°C, including centrifugation procedures, if possible.

## 2-32. KELL BLOOD GROUP SYSTEM

a. The Kell (K) antigen was first demonstrated by an antibody that caused hemolytic disease of the newborn. Its associated gene (K) is present in approximately 9 confirmed when an antithetical relationship was established between K and k antigens using anti-Cellano (k), which reacted with the red blood cells of over 99% of the population.

b. Subsequently, four additional antigens were found to be related to the Kell system. The first two were shown to be allelic and were termed  $Kp^a$  and  $Kp^b$ . As with K and k,  $Kp^a$  has a low frequency and  $Kp^b$  a high frequency (see Table 2-18).  $Js^a$  is found in about 20 percent of Blacks, but very rarely in Whites or Orientals. In antithetical antigen,  $Js^b$ , has a high frequency. The paired antigens K and k,  $Kp^a$  and  $Kp^b$ , and  $Js^a$  and  $Js^b$  are inherited as if they were controlled by 3 pairs of allelic genes, analogous to the situation in the Rh system; however, unlike the latter system, not all theoretically possible gene complexes have been found for the Kell system.

<u>Phenotype</u>	<u>% Frequency (Approx)</u>	
	<u>Whites</u>	<u>Blacks</u>
K+, k-	0.2	0.1
K+, k+	8.8	3.5
K-, k+	91.0	96.5
$Kp(a+b-)$	0.1	0.1
$Kp(a+b+)$	2.0	0.1
$Kp(a-b+)$	98.0	99.9
$Js(a+b-)$	0.1	1.0
$Js(a+b+)$	0.1	18.5
$Js(a-b+)$	99.9	80.5

Table 2-18. Some phenotype frequencies in the Kell system.

c. There is a numerical system for designating the Kell antigens similar to that used for the Rh-Hr system. Table 2-19 presents this nomenclature and includes some additional antigens that currently are thought to be part of the Kell system.

d. As with most of the other group systems, there are rare individuals whose red blood cells react very weakly or not at all with the antibodies of the Kell system. Red blood cells of the  $K_o$  (or  $K_{null}$ ) phenotype seem to lack all antigens that are produced by the Kell genes. An antigen Kx (K15) is present in large amounts on  $K_o$  cells but very little is detected on other phenotypes. Kx appears to be a precursor in the Kell biosynthetic pathway and its synthesis controlled by an X-linked gene, independent to the Kell locus. Anti-Kx can be found together with anti-KL (K9) in the serum of some rare individuals who have such weak Kell antigens that adsorption and elution techniques may be needed to demonstrate them; such weakly reactive cells are said to have the McLeod phenotype. Individuals with the  $K_o$  phenotype can produce an antibody, anti-Ku (K5), that will react with all cells except those of the  $K_o$  phenotype.

Antigen	Numerical Term	Blood Positive (%)	
		Whites	Blacks
K	K1	9.0	3.5
k	K2	99.8	99.9
$Kp^a$	K3	2.0	1.0
$Kp^b$	K4	99.9	99.9
Ku	K5	99.9	99.0
$Js^a$	K6	0.1	19.5
$Js^b$	K7	99.9	99.0
$K^w$	K8	5.0*	18.0*
KL	K9	99.9	99.9
UI <sup>#</sup>	K10	2.6+	1.0.
Cote	K11	99.9	1.0.
-	K12	99.9	1.0.
-	K13	99.9	1.0.
-	K14	99.9	1.0.
Kx	K15	99.9	1.0.
k-lie	K16	99.9	1.0.
$Wk^a$	K17	0.3	1.0.
	K18	99.9	1.0.

\* Frequencies in Kell-negatives. Frequencies may be higher when K+ blood are  $K^w$  typed. The population of Finland is the only one reported in detail. 1.0. Insufficient data.

Table 2-19. Antigen frequencies in the Kell system.



e. An interesting association between the Kell system and an X-linked disease of childhood, chronic granulomatous disease (CGD), has been described. In this disease, the neutrophils can phagocytize but not kill certain pathogenic organisms. Normal neutrophils and monocytes do not possess any of the antigens that are products of the Kell locus but they do possess the Kx antigen. Leukocytes from boys with CGD have been shown to lack the Kx determinant. Most cases of CGD have red blood cells of common Kell phenotype but a few cases have the McLeod phenotype, and run the risk of forming anti-KL + Kx if transfused with blood of common Kell type.

f. Antibodies in the Kell system usually react optimally by the anti-globulin test (AGT). Table 2-20 shows the usual serologic behavior of the antibodies. The antibodies have been responsible for both fatal transfusion reactions and severe hemolytic disease of the newborn.

g. The K antigen is the most immunogenic after Rh<sub>0</sub>(D). Fortunately, 90 serious problems... Similarly, finding compatible blood for patients with anti-Kp<sup>a</sup>, -Js<sup>a</sup>, -K<sup>w</sup>(K8), -UI<sup>a</sup>(K10), or -K17 presents no real difficulty and is well within the capability of any blood Bank; however, finding blood for a patient with an antibody directed against one of the high-frequency antigens k, Kp<sup>b</sup>, Js<sup>b</sup>, Ku, KL, K11-K16, or K18 is an extremely difficult task and is unlikely to be accomplished by screening several hundred random donors.

	K	k	Kp <sup>a</sup>	Anti- Kp <sup>b</sup>	Ku	Js <sup>a</sup>	Js <sup>b</sup>	K8-18*
Saline	22°C	Few	Few	Some	Few	0	Few	0
	37°C	Some	Some	Some	Few	0	Few	0
	AGT	Most	Most	Most	Most	Most	Most	Most
Albumin	37°C	Some	Few	0	0	0	0	0
	AGT	Most	Most	Most	Most	Most	Most	Most
Enzymes	37°C	Some	Some	Some	Some		Few	Few
	AGT	Some	Some	Some	Some		Few	Few
* very few examples of these described but all react by AGT.								
0 usually no reactions; blank spaces indicate insufficient data available.								

Table 2-20. Serologic behavior of Kell system antibodies.

### 2-33. P BLOOD GROUP SYSTEM

a. The P blood group system is genetically and chemically complex. The P<sub>1</sub> antigen, which is present on the red blood cells of approximately 80 percent of Whites, has been shown to be closely related to antigens in the ABO system. In fact, the P<sub>1</sub> antigen is chemically very similar to the B antigen. Most red blood cell samples that lack P<sub>1</sub> (approximately 20 percent of Whites) are said to be P<sub>2</sub>. Both P<sub>1</sub> and P<sub>2</sub> individuals possess P antigen on their blood cells. Very rare individuals of the phenotype p (previously known as Tj(a-)) lack all known P antigens from their red cells. Other rare individuals who lack P from their red blood cells have the so-called P<sup>k</sup> antigen present.

b. The phenotypes in this system are shown in Table 2-21.

c. The P<sub>1</sub> antigen varies considerably in strength on the cells of different P<sub>1</sub>-positive individuals. The antigen deteriorates rapidly on storage and reliable P<sub>1</sub> typing requires the use of fairly fresh red blood cells with sufficiently active antiserum to detect weak antigens. Cold temperatures enhance this reaction. Anti-P<sub>1</sub> is a commonly encountered, naturally occurring antibody. Some investigators feel it can be detected in all serums from P<sub>2</sub> individuals, if sensitive enough techniques are employed. The antibody reacts optimally at 4°C; relatively fewer examples are detected at 25°C, and it is rare to find examples reacting at 37°C (if 37°C conditions are strictly controlled). Anti-P<sub>1</sub> rarely causes "in vivo" hemolysis, the unusual examples reacting at 37°C being the main cause for concern. Thus, anti-P<sub>1</sub> is of very little clinical importance, causing much unwarranted anxiety in many transfusion laboratories. As anti-P<sub>1</sub> is almost always IgM, it does not cross the placenta and cause hemolytic disease of the newborn.

Phenotype	Reaction with anti-				% Phenotype Frequency	
	P <sub>1</sub>	P	P <sup>k</sup>	PP <sub>1</sub> P <sup>k</sup>	Whites	Blacks
P <sub>1</sub>	+	+	0	+	79	94
P <sub>2</sub>	0	+	0	+	21	6
p	0	0*	0	0	All extremely rare	
P <sub>1</sub> <sup>k</sup>	+	0	+	+		
P <sub>2</sub> <sup>k</sup>	0	0	+	+		

\* Usually negative, occasionally weakly positive.

Table 2-21. P blood group system.

d. The rare individuals of phenotype p, previously called Tj(a-), have anti-PP<sub>1</sub>p<sup>k</sup> (previously called anti-Tj<sup>a</sup>) in their serum. Antibodies with this specificity are nearly always hemolysins capable of causing hemolytic transfusion reactions and hemolytic disease of the newborn. The rare individuals having the P<sup>k</sup> phenotype have anti-P in their serum reacting with P<sub>1</sub> and P<sub>2</sub> cells, but not with p cells. Table 2-22 reviews the serologic behavior of the P system antibodies.

Antibody	Reaction Characteristics
Anti-P <sub>1</sub> (formed by P <sub>2</sub> persons)	Mostly cold agglutinins, optimally reactive at 4°C, some reactive at higher temperatures. A few examples active at 37°C with rare examples active by antiglobulin test (these examples invariably bind complement). Albumin does little to enhance or inhibit, enzymes may enhance some examples.
Anti-P (formed by P <sup>k</sup> persons)	Usually potent antibodies reacting at 4°C, 37°C, and by AGT in saline, albumin, and enzyme methods. Some act as hemolysins. The auto-antibody of paroxysmal cold hemoglobinuria often has anti-P specificity.
Anti-PP <sub>1</sub> P <sup>k</sup> (formed by p persons)	Usually potent antibodies reacting at 4°C, 22°C, 37°C, and by AGT in saline, albumin, and enzyme methods. Frequently present as hemolysins.
Anti-P <sup>k</sup>	Not yet found as a single antibody. Can be prepared by absorbing some examples of anti-PP <sub>1</sub> P <sup>k</sup> with P <sub>1</sub> -positive, P <sup>k</sup> -negative cells.

Table 2-22. Serologic behavior of P system antibodies.

## 2-34. DUFFY BLOOD GROUP SYSTEM

a. Anti-Duffy (Fy<sup>a</sup>) reacts with the red blood cells of about 66Whites. Anti-Fy<sup>b</sup>, specific for the antithetical antigen, reacts with about 80Fy<sup>b</sup>, with a locus on chromosome one. A third "silent" allele at this locus has a high frequency among Black subjects. Table 2-23 shows the phenotypes observed when the two antiserums are used.

b. "In vitro" reactions of Fy<sup>a</sup> and Fy<sup>b</sup> antigens are greatly weakened when red blood cells are treated with proteolytic enzymes. Both anti-Fy<sup>a</sup> and anti-Fy<sup>b</sup> react best in the antiglobulin test; both have caused hemolytic transfusion reactions as well as hemolytic disease of the newborn (see Table 2-24).

Reactions with Anti-		Phenotype	Phenotype Frequency (%)	
Fy <sup>a</sup>	Fy <sup>b</sup>		Whites	Blacks
+	0	Fy(a+b-)	17	9
+	+	Fy(a+b+)	49	1
0	+	Fy(a-b+)	34	22
0	0	Fu(a-b-)	Very rare	68

Table 2-23. Phenotypes and frequencies in the Duffy system.

		Anti-Fy <sup>a</sup>	Anti-Fy <sup>b</sup>
Saline	22°C	Few	Rare
	37°C	Few	Rare
	AGT	Most	Most
Albumin	22°C	0	0
	37°C	0	0
	AGT	Most	Most

Table 2-24. Serologic behavior of the common Duffy system antibodies.

c. Other antigens in this system have been described:

(1) Fy3. An antibody found in serum of one of the rare, White Fy(a-b-) individuals, anti-Fy3, reacts with all Fy(a+) and Fy(b+) but not Fy(a-b-) cell samples. Its apparent anti-Fy<sup>a</sup> + anti-Fy<sup>b</sup> specificities cannot be separated by absorption. Unlike anti-Fy<sup>a</sup> and -Fy<sup>b</sup>, anti-Fy3 reacts strongly with enzyme-treated red blood cells and probably detects a determinant distinct from either Fy<sup>a</sup> or Fy<sup>b</sup>.

(2) Fy4. An antibody also enhanced by proteolytic enzymes was found in an Fy(a+b+) Black subject whose serum reacted with all Fy(a-b-) red blood cells from Blacks, some Fy(a+b-) and Fy(a-b+) red blood cells, but not with Fy(a+b+) cells. The gene corresponding to Fy4 was previously called Fy, being common in Blacks (68% of Blacks are Fy(a-b-)).

(3) Fy5. Anti-Fy5, found in the serum of a transfused Black Fy(a-b-) boy, reacted with Fy(a+) or Fy(b+) cells of common Rh type but not with Fy(a-b-) cells from Blacks, nor with Rh<sub>null</sub> cells. Apart from the aberrant reactions with Rh<sub>null</sub> cells, anti-Fy5 closely resembles anti-Fy3. The loci for both Duffy and Rh systems are on chromosome one.

d. The data in Table 2-23 show that the cells of 66 percent of Whites and ten percent of Blacks will react with anti-Fy<sup>a</sup>, while cells of 85 percent of Whites and 23 percent of Blacks react with anti-Fy<sup>b</sup>. Thus, the cells of almost all Whites react with both anti-Fy<sup>3</sup> and anti-Fy<sup>5</sup>, and 68 percent of Black subjects (who are Fy (a-b-)) are nonreactive with these antibodies. About 96 percent of Blacks are Fy4-positive (based on the calculated frequency of the Fy or Fy4 gene) but virtually all Whites are Fy4-negative. Thus, finding compatible blood for patients with Duffy system antibodies is greatly facilitated by searching for donors among the appropriate ethnic group.

e. Recent reports strongly suggest that there is an association between the Fy(a-b-) phenotype and resistance to malaria. Fy(a-b-) red blood cells have been shown to be resistant to invasion "in vitro" with Plasmodium knowlesi. Of 17 volunteers exposed to the bites of Plasmodium vivax-infected mosquitoes, only the five with the red blood cell phenotype Fy(a-b-) were resistant to erythrocyte infection. It was concluded that the Duffy determinants (Fy<sup>a</sup> or Fy<sup>b</sup> or both) on the erythrocyte membrane are required for invasion by vivax merozoites.

## 2-35. KIDD BLOOD GROUP SYSTEM

a. Anti-Kidd (Jk<sup>a</sup>) was discovered in the serum of a woman who had given birth to an infant with hemolytic disease of the newborn. It reacts with the blood of 77% of Whites. Anti- Jk<sup>b</sup> reacts with the antithetical antigen. These two antibodies define the four phenotypes listed in Table 2-25.

b. The phenotype Jk(a-b-) is very rare, and is apparently a result of a silent Jk allele at the Kidd system locus. The serum of Jk(a-b-) individuals sometimes contains an antibody that reacts with all Jk(a+) and Jk(b+) but not Jk(a-b-) cells. Like anti-Fy<sup>3</sup>, the reaction does not seem to be caused by a mixture of antibodies, since it is not possible to separate anti-Jk<sup>a</sup> from anti-Jk<sup>b</sup> by absorption. It has been suggested that a separate determinant, Jk3, is being detected.

Reactions with Anti-		Phenotype	Phenotype Frequency (%)	
Jk <sup>a</sup>	Jk <sup>b</sup>		Whites	Blacks
+	0	Jk(a+b-)	28	57
+	+	Jk(a+b+)	49	34
0	+	Jk(a-b+)	23	9
0	0	Jk(a-b-)	See below	See below

Table 2-25. Phenotypes and frequencies in the Kidd system.

c. It is difficult to work with the treacherous antibodies of the Kidd system. They are often weak when first detected and, because of complement-dependence, may become undetectable in stored serum. When a fresh serum contains Kidd antibodies, the antiglobulin serums used for their detection should contain optimum levels of anti-complement. Older serums may require addition of fresh complement. Added to these difficulties, the production of Kidd antibodies is evanescent (transient, tending to vanish) and they are frequently accompanied by other blood group antibodies as well.

d. Antibodies of this system are well-known for causing severe transfusion reactions and delayed transfusion reactions. These evanescent antibodies may be undetectable at the time of cross-matching but may attain considerable levels at the time of transfusion. Hemolytic disease of the newborn caused by these antibodies is distinctly rare (see Table 2-26).

Reactions with Anti-		Phenotype	Phenotype Frequency (%)
Lu <sup>a</sup>	Lu <sup>b</sup>		
+	0	Lu(a+b-)	0.15
+	+	Lu(a+b+)	7.5
0	+	Lu(a-b+)	92.35
0	0	Lu(a-b-)	Very rare

Table 2-26. Serologic behavior of Kidd system antibodies.

## 2-36. MNSs BLOOD GROUP SYSTEM

a. The M and N antigens behave in most respects like the products of a pair of allelic genes: the red cells of persons lacking an M gene type as M-N+; those with one M gene type as M+N+; and individuals homozygous for M type as M+N-.

b. M and N antigens show a marked dosage effect. Thus MM and NN cells often react much stronger with anti-M and -N, respectively, than MN cells.

c. There is strong evidence that a complex biochemical pathway is involved in which N represents an intermediate product in the production of M. Individuals of phenotype M+N- can be shown, by sensitive tests, to possess some N antigen.

d. The antigens S and s appear to be produced by another pair of allelic genes closely linked to the MN locus. The gene (or gene complex) producing M and s is more common than the one producing M and S. The complex producing N and s is 5 times more common than the one producing N and S. Most genes (or gene complexes) that cause the production of S or s also cause the production of a high-incidence antigen in this system called U. Some Black individuals have cells which are S-, s-, and U-, while others are S-, s-, U+, showing that anti-U is not anti-Ss in an inseparable form (see Table 2-27).

Reactions with Anti-					Phenotype	Phenotype Frequency (%)	
M	N	S	s	U		Whites	Blacks
+	0				M	28	26
+	+				MN	50	44
0	+				N	22	30
		+	0	+	SU	11	3
		+	+	+	SsU	44	23
		0	+	+	sU	45	69
		0	0	0	S-, s-, U-	0	Rare
		0	0	+	S-, s-, U+	0	Rare

Table 2-27. Phenotypes and frequencies in the MN system.

e. Enzyme treatment of red blood cells denatures M, N, S antigens but not s and U14 (see Table 2-28).

f. Human anti-M and anti-N antibodies are occasionally encountered. They are usually naturally occurring IgM agglutinins, rarely reacting above room temperature. The reactions of some anti-M are enhanced by lowering the pH of the serum. Rabbit anti-M and anti-N reagents, often available commercially, detect similar, but probably not identical, antigens to those detected by human antisera. Lectin reagents may detect yet other determinants, particularly the anti-N made from *Vicia graminea* seeds that appear to detect a product that occurs before N in the antigen production pathway. In spite of this, human, rabbit, or lectin reagents are useful in typing human red blood cells.

		Anti-				
		M	N	S	s	U
Saline	4°C	Most	Most	Few	0	0
	22°C	Most	Most	Some	Few	Very Few
	37°C	Few	Few	Some	Few	Very Few
	AGT	Few	Few	Some	Most	Most
Albumin	4°C	Most	Most	Few	0	0
	22°C	Most	Most	Some	Few	Few
	37°C	Few	Few	Some	Few	Few
	AGT	Few	Few	Some	Most	Most
Enzyme	37°C	0	0	0	Some	Some
	AGT	0	0	0	Most	Most

Table 2-28. Serologic behavior of MNSs system antibodies.

g. Anti-M and N, like anti-I and P<sub>1</sub>, are of little clinical importance. There have only been one or two reports of hemolytic transfusion reactions and hemolytic disease of the newborn caused by MN antibodies since their discovery in 1927. These rare examples of clinically significant anti-M and -N reacted up to 37°C "in vitro".

h. A high incidence of anti-N-like antibodies has been encountered in patients who have undergone renal dialysis. These have occurred in N-positive and N-negative individuals. Failure of kidney grafts has been attributed to such cold agglutinins when a cold donor kidney was transplanted.

i. Anti-S, anti-s, and anti-U are occasionally found in human serum, usually as immune antibodies. They have each caused hemolytic transfusion reactions and hemolytic disease of the newborn.

## 2-37. LUTHERAN BLOOD GROUP SYSTEM

a. Using anti-Lu<sup>a</sup> and anti-Lu<sup>b</sup>, four phenotypes have been described (see Table 2-29).

Reactions with Anti-Lu <sup>a</sup>	Reactions with Anti-Lu <sup>b</sup>	Phenotype	Phenotype Frequency (%)
+	0	Lu(a+b-)	0.15
+	+	Lu(a+b+)	7.5
0	+	Lu(a-b+)	92.35
0	0	Lu(a-b-)	Very rare

Table 2-29. Phenotypes and frequencies of the Lutheran system in Whites.

NOTE: Insufficient data for reliable calculation of frequencies in Blacks.

b. Many high-incidence antigens are associated with the Lutheran system (for example, Lu4, 5, 6, 7, 8, 11, 12, 13, 15). Any one of these may be missing from the cells of a rare person whose other Lutheran antigens appear normal, thus rendering that individual capable of forming the antibody directed against the high-incidence antigen that his cells lack. Lu(a-b-) cells lack all these other high-incidence Lutheran system antigens and the low-incidence antigens (for example, Lu9, 10, and 14) that have been discovered so far.



c. The Lu(a-b-) phenotype can be caused by two different genetic situations. It can be produced by either one independently segregating dominant gene or homozygosity at the Lutheran locus for amorphic genes. The name In(Lu) has been suggested for the rare inhibitor gene that prevents normal expression of the Lutheran genes in the dominant Lu(a-b-) phenotype.

d. Lutheran system antibodies are rare, and there is very little evidence that they have ever caused hemolytic transfusion reactions or hemolytic disease of the newborn. Most examples of anti-Lu<sup>a</sup> and some anti-Lu<sup>b</sup> will agglutinate saline-suspended red blood cells, causing small-to-moderate-sized, loosely agglutinated clumps of cells superimposed on a background of unagglutinated red blood cells. Most anti-Lu<sup>b</sup> and occasional anti-Lu<sup>a</sup> react by the antiglobulin test.

e. Additional information is given in Tables 2-30 through 2-33.

Name of System	Anti-gens	Phenotypes	Phenotype Frequency* (%)	Best Technique for Testing	Implicated in	
					HDN	HTR**
Cartwright	Yt <sup>a</sup>	Yt(a+b-)	91.9	AGT		Yes
	Yt <sup>b</sup>	Yt(a+b+)	7.8			
		Yt(a-b+)	0.3			
Diego	Di <sup>a</sup>	Di(a+b-)	0.1+	AGT	Yes	
	Di <sup>b</sup>	Di(a+b+)	0.1+			
		Di(a-b+)	99.9			
Scianna (Sm-Burrell)	Sc 1	Sc: 1,2	0.1	AGT	Yes	Yes
	Sc 2	Sc: 1,2	0.3			
		Sc: 1,-2	99.7			
Sc: -1,-2		0.1				
Wright	Wr <sup>a</sup>	Wr(a+b-)	0.1	Anti-Wr <sup>a</sup> , many saline aggn. 22°C and 37°C others AGT Anti-Wr <sup>b</sup> , (only example AGT)		
	Wr <sup>b</sup>	Wr(a+b+)	0.1			
		Wr(a-b+)	99.9			
		Wr(a-b-)	0.1			
Colton	Co <sup>a</sup>	Co(a+b-)	89.3	AGT with enzyme treated cells	Yes (mild)	
	Co <sup>b</sup>	Co(a+b+)	10.4			
		Co(a-b+)	0.3			
		Co(a-b-)	0.1			
Dombrock	Do <sup>a</sup>	Do(a+b-)	17.2	AGT with enzyme treated cells	Yes (mild)	
	Do <sup>b</sup>	Do(a+b+)	49.5			
		Do(a-b+)	33.3			
<p>* Frequencies in whites, insufficient data for reliable calculations in blacks.</p> <p>+ The antigen Di<sup>a</sup> has a higher incidence in Orientals and South American Indians.</p> <p>** Hemolytic transfusion reaction.</p>						

Table 2-30. Additional blood group systems in which antithetical antigens are known.

Name of System	Anti-gens	Phenotypes	Phenotype Frequency* (%)	Best Technique for Testing	Implied in HDN
Gerbich+	Ge:1	Ge:1,2,3	99.9	AGT	Yes (mild)
	Ge:2	Ge:-1,2,3	0.1		
	Ge:3	Ge:-1,-2,3	0.1		
	Ge:-1,-2,-3	0.1			
Vel	Vel 1	Vel:1,2	99.92	Some 37°C aggn. or lysis of saline suspended cells, some AGT	
	Vel 2	Vel:1,-2	0.05		
	Vel:-1,-2	0.03			

\* Frequencies in whites, insufficient data for accurate calculations in blacks.

+ The Gerbich-negative phenotypes are more frequent in certain Melanesian populations.

Table 2-31. Additional blood group systems in which more than one antigen is known, but in which no antithetical relationships have been found.

Name and Shorthand Name	Antigen Frequency* (%)	Best Technic for Testing
Augustine, At <sup>a</sup>	99.9	AGT
Chido, Ch <sup>a</sup>	98.0+	AGT
Stirling, Cs <sup>a</sup>	98.0	AGT
En <sup>a</sup>	99.9	AGT
Gn <sup>a</sup>	99.9	AGT
Gregory, Gy <sup>a</sup>	99.9	AGT
Junior, Jr <sup>a</sup>	99.9	AGT
Knops-Helgeson, Kn <sup>a</sup>	99.9	AGT
Sid, Sd <sup>a</sup>	1.0**	Few aggn. 22°C and 37°C, most AGT
York, Yk <sup>a</sup>	88.0	AGT
Can	99.9	AGT

\* Frequencies in whites; insufficient data for accurate calculations in blacks.

+ As determined by inhibition tests using donor plasma as a source of antigen.

\*\* As determined by red cell typing. Tests for presence of Sd<sup>a</sup> substance in urine suggest a higher incidence of this antigen.

Table 2-32. Some apparently unrelated antigens of high incidence.

Name and Shorthand Name	Name and Shorthand Name
Berrens, Be <sup>a</sup>	Lewis II, Ls <sup>a</sup>
Bishop, Bp <sup>a</sup>	Moen, Mo <sup>a</sup>
Box, Bx <sup>a</sup>	Peters, Pt <sup>a</sup>
Griffiths, Gf <sup>a</sup>	Radin, Rd
Good	Stoltzfus, Sf <sup>a</sup>
Hunt, Ht <sup>a</sup>	Torkildsen, To
JN, Jn	Traverse, tr <sup>a</sup>
Levay	Webb, Wb
<p>These antigens have been found with a frequency of less than one in every thousand bloods tested</p>	

Table 2-33. Some apparently unrelated antigens of low incidence.

**Continue with Exercises**

## EXERCISES, LESSON 2

**INSTRUCTIONS:** Answer the following exercises by marking the lettered response that best answers the exercise, by completing the incomplete statement, or by writing the answer in the space provided at the end of the exercise.

After you have completed all the exercises, turn to "Solutions to Exercises" at the end of the lesson and check your answers. For each exercise answered incorrectly, reread the material referenced with the solution.

1. What are genes called that appear at corresponding loci in a pair of homologous chromosomes?
  - a. Haptens.
  - b. Alleles.
  - c. Antigens.
  - d. Antibodies.
  
2. What trait is manifested when the alleles are heterozygous?
  - a. Dominant.
  - b. Recessive.
  - c. Genotypic.
  - d. Penetrant.
  
3. What is the collective term for a series of alleles which act to produce chemically related but serologically distinct antigens?
  - a. A phenotype.
  - b. Co-dominant traits.
  - c. A gene interaction.
  - d. An immunogenetic system.

4. When converting an H to a blood group, ABO genotype  $A_2B$  has more residual of H substance than:
  - a. O.
  - b. B.
  - c.  $A_1$
  - d.  $A_1B$ .
  
5. Which ABO genotype would result in an ABO phenotype (blood group) of  $A_2$ ?
  - a.  $A_1A_2$ .
  - b.  $A_2A_2$ .
  - c.  $A_2A_3$ .
  - d.  $A_2B$ .
  
6. If an individual has the genotype sese, he is a \_\_\_\_\_ of ABH substance.
  - a. Secretor.
  - b. Non-secretor.
  
7. Generally, if an individual's red cells carry the antigen  $Le^a$ , he is a \_\_\_\_\_ of ABH substance.
  - a. Secretor.
  - b. Non-secretor.
  
8. Both IgM and IgG antibodies react well at:
  - a.  $4^\circ\text{C}$ .
  - b.  $37^\circ\text{C}$ .
  - c. Room temperature.

9. The maximum temperature for the reaction mixture of the ABO grouping of cells in the slide method is:
- a. 4°C (39.2°F).
  - b. 15°C (59.0°F).
  - c. 37°C (98.6°F).
  - d. Room temperature.
10. How many minutes should the cell-serum mixture be observed in the slide method for ABO grouping of cells?
- a. 1 minute,
  - b. 2 minutes.
  - c. 5 minutes.
  - d. 10 minutes.
11. Which ABO blood group has the highest frequency in the US?
- a. A.
  - b. B.
  - c. O.
  - d. AB.
12. The anti-A serum from a group B individual will have antibodies that will react with:
- a. Anti-B.
  - b. Anti-O.
  - c. Anti-A, B.
  - d. Anti-A and anti-A<sub>1</sub>.

13. A properly prepared plant hemagglutinin from Dolichos biflorus will agglutinate which ABO phenotype cells?
- A<sub>1</sub>.
  - A<sub>2</sub>.
  - A<sup>3</sup>.
  - All subgroups of A.
14. What is an important difference between the procedures for reverse (serum) ABO grouping and the test for hemolysins?
- Incubation.
  - Centrifuging.
  - Type of specimen.
  - Use of group B cells.
15. Rouleaux formation can often be diminished by:
- Heating.
  - Cooling.
  - Centrifuging.
  - Adding saline.
16. For individuals who lack antigens, the formation of antibodies usually comes from:
- Transfusions.
  - Rh<sup>+</sup> or - recipients.
  - Widespread distribution of Rh<sup>+</sup> donors.



17. Which Rh system has the highest immunogenicity?
- C.
  - c.
  - E.
  - D.
18. What are Fisher-Race equivalents to the three antigenic determinants Rh<sub>0</sub>, rh', and rh" in the Wiener nomenclature?
- d, c, and e.
  - D, c, and e.
  - D, C, and E.
  - D, E, and C.
19. What are Fisher-Race equivalents to the two antigenic determinants hr' and hr" in the Wiener nomenclature?
- c and e.
  - e and c.
  - C and E.
  - E and C.
20. What is the nomenclature of the Fisher-Race two antigenic determinants if their equivalent in the Wiener nomenclature is rh' and hr'?
- c and C.
  - C and c.
  - e and E.
  - E and e.

21. Two antigenic determinants in the Wiener nomenclature are  $rh''$  and  $hr''$ . What are their Fisher-Race equivalents?
- a. c and C.
  - b. C and c.
  - c. e and E.
  - d. E and e.
22. Which gene does the Fisher-Race have in common with the Wiener's  $R^0$ ,  $R^1$ ,  $R^2$ , and  $R^z$  alleles?
- a. C.
  - b. c.
  - c. D.
  - d. d.
  - e. E.
  - f. e.
23. The  $r$ ,  $r'$ , and  $r''$  alleles in the Wiener nomenclature have which gene in common with the Fisher-Race nomenclature?
- a. C.
  - b. c.
  - c. D.
  - d. d.
  - e. E.
  - f. e.

24.  $R^0$  and  $r$  are two alleles in the Wiener nomenclature. According to the Fisher-Race nomenclature, which genes do they have in common?
- a.  $c$  and  $e$ .
  - b.  $C$  and  $e$ .
  - c.  $c$  and  $E$ .
  - d.  $C$  and  $E$ .
25. Which genes do the Wiener  $R^1$  and  $r'$  alleles have in common with the Fisher-Race nomenclature?
- a.  $c$  and  $e$ .
  - b.  $C$  and  $e$ .
  - c.  $c$  and  $E$ .
  - d.  $C$  and  $E$ .
26. Which genes do the Wiener  $R^2$  and  $r''$  alleles have in common with the Fisher-Race nomenclature?
- a.  $c$  and  $e$ .
  - b.  $C$  and  $e$ .
  - c.  $c$  and  $E$ .
  - d.  $C$  and  $E$ .

27. The most probable genotype for phenotype pattern below is:

D	C	E	c	e
+	+	0	0	+

- a.  $R^1r(CDe/cde)$ .
- b.  $R^1r'(CDe/Cde)$ .
- c.  $R^1R^1(CDe/CDe)$ .
- d.  $R^2r(cDE/cde)$ .

28. The most probable genotype for this phenotypic pattern is:

D	C	E	c	e
+	0	+	+	+

- a.  $R^1r'(CDe/Cde)$ .
- b.  $R^1R^1(CDe/CDe)$ .
- c.  $R^2r(cDE/cde)$ .
- d.  $R^2R^0(cDE/cDe)$ .

29. What is the most probable genotype for the following phenotypic pattern?

D	C	E	c	e
+	+	+	+	+

- a.  $R^1R^2(CDe/cDE)$ .
- b.  $R^1r''(CDe/cdE)$ .
- c.  $R^2r(CDE/cde)$ .
- d.  $R^2r'(cDE/Cde)$ .

30. What blood may a recipient with a known D<sup>u</sup>-positive receive?
- D<sup>u</sup>-positive only.
  - Rh-positive only.
  - Rh-negative only.
  - Either Rh-positive or Rh-negative.
31. What should donated blood with a positive test for D<sup>u</sup> be considered?
- Rh-positive.
  - Rh-negative.
  - Neither of the above.
32. The concentration of red cell suspension for a slide test Rh<sub>o</sub>(D) should be:
- 2-5
  - 26-30
  - 40-50
  - 100
33. The concentration of red cell suspension for a tube test Rh<sub>o</sub>(D) should be:
- 2-5
  - 25-30
  - 40-50
  - 100

34. Which is necessary for tube tests Rh<sup>o</sup>(D) but not for slide tests?
- Centrifuge.
  - Albumin control.
  - Anti-Rh<sub>o</sub>(D) serum.
  - Red cell suspension.
35. Which antiserum is used in the test for Rh<sub>o</sub> variant D<sup>u</sup>?
- Anti-Rh<sub>o</sub>(D).
  - Anti-rh'C).
  - Anti-rh"(E).
  - Anti-hr'(c).
36. Blood should not be used for a transfusion if it exhibits a positive:
- D<sup>u</sup> test.
  - Antiglobulin test.
  - Test with slide or rapid tube anti-Rh<sub>o</sub>(D).
  - Test with saline agglutinating anti-Rh<sub>o</sub>(D).
37. Which antigen is present on the red cells of over 50% of the adult population?
- Le<sup>b</sup>.
  - I.
  - k.
  - P<sub>1</sub>.
  - All of the above.

38. The most common cause of difficulty in compatibility testing is:
- a. Anti-A<sub>1</sub>.
  - b. Anti-H.
  - c. Anti-P<sub>1</sub>.
  - d. Auto-anti-I.

**Check Your Answers on Next Page**

## SOLUTIONS TO EXERCISES, LESSON 2

1. b (para 2-2b)
2. a (para 2-4a)
3. d (para 2-7)
4. d (Table 2-3)
5. b (Table 2-4)
6. b (para 2-9d)
7. b (Table 2-5)
8. c (para 2-10b(4)(a))
9. d (para 2-12c(4))
10. b (para 2-12c(5))
11. c (Table 2-6)
12. d (para 2-13a(2))
13. a (para 2-13a(2))
14. a (paras 2-12d(3) and 2-14a(4))
15. d (para 2-15f(4))
16. c (para 2-17b)
17. d (para 2-17c)
18. c (Table 2-9, figure 2-6)
19. a (Table 2-9, figure 2-6)
20. b (figure 2-6)
21. d (figure 2-6)



22. c (Table 2-9, figure 2-6)
23. d (figure 2-6)
24. a (figure 2-6)
25. b (figure 2-6)
26. c (figure 2-6)
27. c (figure 2-6, Table 2-11)
28. c (figure 2-6, Table 2-11)
29. a (figure 2-6, Table 2-11)
30. d (para 2-20c(2))
31. a (para 2-20c(1))
32. c (para 2-26b(2)(a), Step 3)
33. a (para 2-26b(4)(a), Step 3)
34. a (para 2-26b(4)(a), Step 4)
35. a (para 2-26b(5)(b), Step 1)
36. b (paras 2-26b(5)(c)2)
37. e (paras 2-31, 2-32)
38. d (para 2-31d)

**End of Lesson 2**