



# **METEOROLOGY**

**PRACTICAL AND APPLIED**







August 2, 1908

Xcme

# METEOROLOGY

Practical and Applied

BY

JOHN WILLIAM MOORE

M.A., M.D., F.R.S., F.R.M.S., F.R.S.E., F.R.S.M., F.R.S.D.

FRANCIS AND TAYLOR, 25, ABchurch Lane, LONDON, E.C. 4.  
NEW YORK: FRANKLIN AND WINTHROP, 15, NASSAU ST.

LONDON

F. A. FEBMAN, 11, ADAM STREET, STRAND

1894



# METEOROLOGY

PRACTICAL AND APPLIED

BY

JOHN WILLIAM MOORE

B.A., M.D., M.Ch., UNIV. DUBL. ; F.R.C.P.I. ;

FELLOW OF THE ROYAL METEOROLOGICAL SOCIETY ; DIPLOMATE IN STATE  
MEDICINE AND EX-SCHOLAR OF TRINITY COLLEGE, DUBLIN

LONDON

F. J. REBMAN, 11 ADAM STREET, STRAND

1894



*Entered at Stationers' Hall*

2915664

41877  
22 Ap '97

MDC

M78

## PREFACE

THE writing of this book has been to me a labour of love. Should the reader derive some pleasure as well as information from the perusal of its pages, the task set before me will not have been undertaken and completed in vain.

It may be objected that a work on Meteorology should more fitly have been written by an author distinguished for scientific attainments, and whose life-work lay amid the precise sciences. A physician, it may be said—and said with truth—is daily and hourly exposed to distractions of all kinds in the practice of his profession. He is, in consequence, placed at a disadvantage when he discusses a purely scientific topic.

In answer to such an objection it may be urged with some force that the physician of all men has the fullest opportunities of observing the far-reaching influence of weather and climate upon human health, happiness, and longevity. If he utilises these opportunities with intelligence and zeal, he is bound to make of such topics a peculiar study. That this often happens, a reference to the roll of Fellows of the Royal Meteorological Society or of the Scottish Meteorological Society will abundantly prove. In my own case, more than thirty years ago I was already

a systematic observer of the weather, and such I continue to be. My "Second Order Station" and the lessons it has taught through all these years afford the needed foil to my more serious professional studies and pursuits. Hence it happens that I have been able to bring no small practical experience of meteorology to bear in the writing of the pages which follow.

The work is divided into four parts. A brief introduction is succeeded by a full account of the methods which are employed in practical meteorology. The third part treats of climate and weather—necessarily in a somewhat condensed and concise manner. Finally, I have endeavoured to point out, in the fourth and concluding portion of the book, a few of the practical bearings of the subject. In those closing chapters the grave question of the influence of weather and season upon disease is in some measure discussed.

The time seems opportune for the publication of a popular yet scientific Text-book of Meteorology. The marvellous advances of Preventive Medicine within recent years, the institution of a registrable qualification in State Medicine in the United Kingdom of Great Britain and Ireland, the establishment of a new order of public servants drawn from the ranks of the medical profession—I allude to Medical Officers of Health—the vast development of international telegraphy in modern times, the hearty co-operation of the various national Weather Bureaux—all these things have done much within the last quarter of a century to raise Meteorology to the rank of a science, and have given a wonderful impetus to the continuous or the periodic study of the weather. The literature of the subject is

therefore daily increasing, and volume after volume is being added to the list of standard works on Meteorology and Climatology.

Primarily intended for the use of my professional brethren at home and abroad, this book has been so written as to claim the attention of a much wider circle of readers. Its chief object is to convey a clear idea of the science of meteorology to any one of ordinary mental capacity and fair education who had been previously quite unacquainted with so attractive a study. Technical and scientific terms have been as far as possible explained. No pains have been spared to make the description of the different instruments used by meteorological observers as clear as can be. In most instances drawings of these instruments have been interpolated in the text.

Thanks to a generous publisher, and to the great kindness of many scientific friends, the following pages will be found copiously illustrated. For valuable assistance in this direction, I desire to express my grateful acknowledgments to Mr. Greenwood Pim, M.A., for his beautiful photograph of the Matterhorn, which forms the frontispiece to this volume; to Mr. F. J. Rebman, publisher of this book, for the interesting photograph illustrating a burst of sunshine through an early morning mist; to Mr. R. H. Scott, F.R.S., Secretary to the Meteorological Council, Mr. George J. Symons, F.R.S., Editor of *British Rainfall*, and Mr. William Marriott, Secretary of the Royal Meteorological Society, for permission to use various illustrations reproduced in the book. I would also thank MM. Richard Frères, of Paris; Messrs. Negretti and Zambra, of London; Messrs. Yeates and Son, of Dublin; and

especially Mr. L. P. Casella, of London, for the opportunity of illustrating my description of many meteorological instruments either invented by them or manufactured by their respective firms.

Perhaps a distinctive feature of the book is the very full account it contains of the organisation of the Meteorological Office, London, the work done by which is carried on under the auspices of the Meteorological Council; and of the Weather Bureau of the United States, under the able management of its Chief, Mr. Mark W. Harrington. To this gentleman my grateful thanks are due, and hereby given, for the trouble he has been good enough to take in preparing the account of the United States Weather Bureau for publication in my book.

Having said so much, I lay down my pen in the full confidence that the indulgent reader will, in the fascination of the subject, overlook the faults and imperfections of my work, and accept it as the outcome of many years' close observation and attentive study.

JOHN WILLIAM MOORE.

40 FITZWILLIAM SQUARE, WEST, DUBLIN,

*September 20, 1894.*

# CONTENTS

## PART I.—INTRODUCTORY

### CHAPTER I

#### METEOROLOGY

Meaning and History of the Term—Relations of Meteorology to Medicine—  
Buys Ballot's Law—Theory of the Winds—Cyclonic and Anticyclonic  
Systems—Direction and Force, or Velocity, of the Wind—Barometrical  
Gradients—Seasonal Variations of Temperature and Air Move-  
ments—The Claim of Meteorology to be regarded as a Science

Pages 1-9

### CHAPTER II

#### THE PHYSICAL PROPERTIES OF THE ATMOSPHERE

The Atmosphere: what it is, and its Effects—The Inclination of the  
Earth on its Axis—The Revolution of the Earth round the Sun—  
Atmospheric Air is Transparent, but has both Substance and Colour  
—Weight of the Atmosphere—Its Gaseous Condition—It is capable  
of Compression and of Expansion—Professor Dewar's Experiments  
on the Liquefaction of Gases by Cold—Liquid Air—Liquid Oxygen—  
Frozen Air—Boyle's and Mariotte's Law—The Law of Charles, or  
Regnault's Law—Bearing of these Laws of Compression and Expan-  
sion of Gases on Practical Meteorology—Elasticity of the Air—Rare-  
faction of the Atmosphere at great Altitudes—Atmospheric Pressure  
is exerted equally in all Directions—Otto von Guericke's Experiment  
with the Magdeburg Hemispheres—Transparency of the Atmosphere  
—Its Diathermancy and Athermancy . . . . . Pages 10-18

## CHAPTER III

## THE COMPOSITION OF THE ATMOSPHERE

Components of the Atmosphere—A mechanical Mixture of Oxygen and Nitrogen—Nature's cleansing Operations—Volumetric Analysis of Air—Proofs that Air is a Mechanical Mixture and not a Chemical Combination—Sources of the Carbon Dioxide of the Atmosphere—Its Distribution—Action of Chlorophyll upon it—Ozone—Other Gaseous Constituents of the Atmosphere—Graham's Law of the Diffusion of Gases—Mineral Constituents of the Atmosphere—Microorganisms, or Microbes—Permanganate of Potassium Test for Organic Matter in the Air—Aqueous Vapour . . . . . Pages 19-26

## PART II.—PRACTICAL METEOROLOGY

## CHAPTER IV

## BRITISH METEOROLOGICAL OBSERVATIONS

Merle's Journal of the Weather, 1337-1344—Admiral FitzRoy's Charts and Forecasts—Synoptic Weather Charts—Meteorology of the British Isles—Stations of the First Order—Anemographic Stations—Stations of the Second Order—Telegraphic Reporting Stations—"Isobars" and "Isotherms"—Extra Stations—Royal Meteorological Society—Scottish Meteorological Society—Daily Weather Report—Weekly Weather Report—Monthly Summary—Accumulated Temperature—Numerical Scales for Telegraphic Weather Reports—Code System—Meteorological Conditions which influence Disease and the Death-rate—Equipment of a Second Order Station . . . . . Pages 27-38

## CHAPTER V

HISTORY, ORGANISATION, AND WORK OF THE UNITED STATES  
WEATHER BUREAU

Pages 39-48

## CHAPTER VI

HISTORY, ORGANISATION, AND WORK OF THE UNITED STATES  
WEATHER BUREAU (*continued*)

Pages 49-67

## CHAPTER VII

HISTORY, ORGANISATION, AND WORK OF THE UNITED STATES  
WEATHER BUREAU (*continued*)

Pages 68-80

## CHAPTER VIII

HISTORY, ORGANISATION, AND WORK OF THE UNITED STATES  
WEATHER BUREAU (*continued and concluded*)

Pages 81-93

## CHAPTER IX

AIR TEMPERATURE AND ITS MEASUREMENT

Temperature the most important Meteorological Factor—Meaning of the word Thermometer—History of the Instrument—Fahrenheit's Scale—Why Mercury was selected as the Medium for measuring Temperature—Celsius' Scale—The Centigrade Thermometer—Réaumur's Scale—Relations of the three Scales to one another—Rules for reducing Readings of one Scale to those of another—Melting Point of Ice—Freezing Point of Water—Boiling Point of Water varies with Atmospheric Pressure and with Altitude—Definition of a Thermometer—Steps in the Construction of this Instrument . . . Pages 94-99

## CHAPTER X

THERMOMETERS

Standard Thermometers—Ordinary Thermometers—"Displacement of Zero"—Registering Thermometers—Phillips's Maximum Thermometer—Negretti and Zambra's Maximum Thermometer—Rutherford's Minimum Thermometer—Objections to Spirit Thermometers—Six's combined Maximum and Minimum Thermometer—Casella's mercurial Minimum Thermometer—Exposure of Instruments—Stevenson Thermometer Stand and Screen—The "Wall Screen"—Method of Reading the Instruments—The Sling Thermometer (*Thermomètre fronde*)—Self-recording Thermometers, or "Thermographs"—Electrical and Photographic Thermographs—Radiation Thermometers—Mean Temperature—Average Mean Temperature . . . Pages 100-113

## CHAPTER XI

RADIATION

Heat: how transmitted—Conduction—Convection—Radiation—Solar Radiation—Terrestrial Radiation—Effect of Altitude on Temperature:



how brought about—Radiation Thermometers—Black-bulb Thermometer *in vacuo*—Bright-bulb Thermometer *in vacuo*—Southall's Helio-pyrometer—Herschel's Actinometer—Pouillet's Pyrheliometer—Grass Minimum Thermometers—Earth Temperatures—Critical Temperature at depth of 4 feet—Duration of bright Sunshine—Sunshine Recorders . . . . . Pages 114-128

## CHAPTER XII

### ATMOSPHERIC PRESSURE

The Barometer and its Uses—Galileo's Observation—Torricelli's Discovery—The "Torricellian Vacuum"—Principle involved in Nature's abhorrence of a Vacuum—Fluids used in constructing a Barometer: Mercury, Water, Glycerine—Jordan's Glycerine Barometer—Estimation of the Height of the Atmosphere—Pascal's Experiments—Estimation of Mountain Altitudes by means of the Barometer—Scaling and Lettering of the Barometer—The "Weather Glass," or Wheel Barometer, of Robert Hooke—History of the Barometer  
Pages 129-135

## CHAPTER XIII

### THE BAROMETER

The Mercurial Barometer—Extreme Limits of Atmospheric Pressure at Sea-Level—"Torricellian Vacuum"—Attached Thermometer—Mounting of the Mercurial Barometer—Two Difficulties in the Construction of this Instrument—How they are Surmounted—"Error of Capacity"—Capacity Correction—The Fortin Barometer—The Kew Barometer (Adie)—The Siphon Barometer (Gay-Lussac)—The "Gun Barometer" (FitzRoy)—The Wheel Barometer, or "Weather Glass" (Hooke)—Self-registering Barometers, or "Barographs"—King's Mechanical Barograph—Ronalds's Photographic Barograph—Redier's Mercurial Registering Barometer—Wheatstone's Electrical Barograph—Transmission of Barometric Indications by Electricity (J. Joly)—Substitutes for Mercurial Barometers: the Aneroid Barometer—Its Altitude Scale—Bourdon's Metallic Barometer—Measurement of Heights—The "Engineering Aneroid"—Sympiesometer—Hypsometer . . . . . Pages 136-150

## CHAPTER XIV

### BAROMETRICAL READINGS

Attached Thermometer—Mounting of Barometer—Method of taking a Barometrical Observation—"Capillary Action"—Capillarity—The

Vernier—Graduation of British Barometers—Corrections to be applied to Barometrical Readings: Index Error, Capacity, Capillarity, Temperature, Altitude—Verification of a Barometer—The Cathetometer—Kew Certificate—Schumacher's Formula for Reduction of Barometer Readings to 32°—Ordnance Datum for Great Britain—Ordnance Datum for Ireland—Table of Corrections for Altitude controlled by existing Air Temperature and Pressure—Laplace's Formula for finding the difference in Height between two Places—Determination of Mountain Heights by the Barometer . . . . . Pages 151-163

## CHAPTER XV

### BAROMETRICAL FLUCTUATIONS

Periodic and Non-periodic Variations in Atmospheric Pressure—Regular and Irregular Variations—Regular: Diurnal and Annual—Irregular: Cyclonic and Anticyclonic—Distribution of Diurnal Variations—Explanation—Dove's Theory—Mr. Strachan's Objections—Diurnal Range of Pressure—Bibliography—Annual Variations of Pressure—Periodical Anticyclonic and Cyclonic Systems—Explanation of their Formation—Trade Winds—Irregular Variations in Pressure—Isobars: Primary and Secondary Shapes—Cyclonic and Anticyclonic—Secondary or Subsidiary Depression—V-shaped Depression—Straight Isobars—"Wedge" of High Pressure—"Col" of High Pressure—Cyclonic and Anticyclonic Systems contrasted—"Radiation Weather"—"Intensity"—Path of Cyclonic Systems—Weather Changes accompanying their Passage—"Veering," "Hauling," "Backing" of the Wind—Anticyclonic Weather: (1) in Winter; (2) in Summer . . . . . Pages 164-178

## CHAPTER XVI

### THE ATMOSPHERE OF AQUEOUS VAPOUR

Aqueous Vapour, or Water in a Gaseous or Aëriform State—Its Elastic Force or Tension—Influence of Aqueous Vapour on the Barometer, on the Weather—Evaporation—Fogs—Capacity of the Atmosphere for Aqueous Vapour—Atmometry or Atmidometry—Hygrometry—Hyetometry—Determination of the Amount of Evaporation—Evaporimeters, Atmometers, or Atmidometers—Saturation—Heat made latent in Evaporation—Uses of Coolness produced by Evaporation—Amount of Evaporation—Babington's Atmidometer—Von Lamont's Atmometer—De la Rue's Evaporimeter—Richards' Self-recording Evaporation Gauge—Mr. Symons's Evaporimeter—Observations on Evaporation in Ireland by Mr. James Price, M. Eng., Univ. Dubl., C.E. . . . . Pages 179-185

## CHAPTER XVII

THE ATMOSPHERE OF AQUEOUS VAPOUR (*continued*)

Direct and Indirect Hygrometers—Organic and Inorganic Hygrometers—  
 Dew Point—Direct Hygrometers: Daniell's, Regnault's, Dines's—  
 Indirect Hygrometers: Saussure's Hair Hygrometer—Chemical  
 Hygrometer—Mason's Dry and Wet-Bulb Hygrometer—The Psychro-  
 meter—Apjohn's Formula for calculating the maximal Vapour  
 Tension for the Dew Point—Glaisher's Hygrometrical Tables—  
 Greenwich Factors—Examples of their Use—Relative Humidity—  
 Management of the Wet-Bulb Thermometer—Distribution of Aqueous  
 Vapour in the Atmosphere—"Absolute Humidity"—History of  
 Hygrometers . . . . . Pages 186-196

## CHAPTER XVIII

THE ATMOSPHERE OF AQUEOUS VAPOUR (*continued*)

Hyetometry includes Seven Modes of Condensation of the Watery Vapour  
 of the Atmosphere—Dew—Two forms of Dew: "Serein" and  
 "Rosée"—Hoar Frost—Silver Thaw (*Glätteis, Verglas*)—Interference  
 with Formation of Dew—Measurement of Dew—Mist and Fog—  
 "Scotch Mist"—Formation of Fogs, Clouds, and Rain—Mr. John  
 Aitken's Researches—The Influence of Atmospheric Dust—Mr.  
 Aitken's Koniscope—The Number of Dust Particles in the Air—  
 How Fog or Mist forms—Dry Town Fogs—Haze . . . . . Pages 197-212

## CHAPTER XIX

THE ATMOSPHERE OF AQUEOUS VAPOUR (*continued*)

Definition of a "Cloud"—Height of Clouds—The "Cloud Line"—Luke  
 Howard's Classification of Cloud Forms—Upper Clouds: Cirrus,  
 Cirro-cumulus, Cirro-stratus—Pallium (Poëy)—The Mackerel Sky—  
 Lower Clouds: Stratus, Cumulus, Cumulo-stratus, Nimbus—Roll-  
 cumulus—"Pocky" or "Festooned" Cloud—Cloud-slopes in Cumulus  
 —Various meanings of the word "Nimbus"—Scud—Cloud Observa-  
 tions—Scale for the amount of Cloud—Characters of Thunder-clouds  
 —Their rapid changes in Formation, Shape, and Density  
 . . . . . Pages 213-221

## CHAPTER XX

THE ATMOSPHERE OF AQUEOUS VAPOUR (*continued and concluded*)

Relative Amount of Precipitation as Dew and as Rainfall—Excessive Precipitation in the Khasi Hills, Assam—Rainfall Observations in the Seventeenth Century—Weighing the Rainfall—Hooke's Rain Gauge (1695)—Exhibition of Rain Gauges by the Royal Meteorological Society in 1891—Chief Gauges in use: Meteorological Office Gauge, Symons's Snowdon Gauge, the Mountain Gauge, Symons's Storm Gauge, Crosley's Registering Gauge, Yeates's Registering Gauge, Richards' Self-recording Rain Gauge—Measurement of Rain—Time and Method of Observing—Variation of Rainfall with Elevation, how explained—Physical Cause of Rain—Snow—Sleet—Hail—Measurement of Snow—Theory of the Formation of Hail—Examples of Hailstorms—Soft Hail—Relative Size and Weight of Hailstones—Distribution of Rain: (1) Geographical, (2) Seasonal, (3) Diurnal—Weight and Bulk of Rain . . . . . Pages 222-248

## CHAPTER XXI

## ANEMOMETRY AND ANEMOMETERS

Wind: what it is and how produced—Force or Velocity of Wind depends on Barometric Gradients—Estimation of Wind Force—Beaufort Scale—Wind Direction—Bearings should be true—Variation of the Compass—Position of the Pole Star—Equation of Time—A Windrose: how determined—Anemometers: Pendulum, Bridled, Pressure Plate, Pressure on a Fluid, Velocity, Evaporation or Temperature, Suction, Direction, Inclination, Musical, Dines's Helicoid, MM. Richards' Anémo-Cinémographe—Lambert's Formula for determining Mean Direction of the Wind—Mr. Dines's Comparative Experiments with Anemometers—Casella's Self-recording Anemometer Pages 249-275

## CHAPTER XXII

## ATMOSPHERIC ELECTRICITY

Identity of Atmospheric Electricity and that obtained from an Electric Machine—The Electroscope—The Nature of Electricity—Atmospheric Electrical Phenomena—Electrical Density, Force, and Potential—Use of the Electroscope—The Collector—The Electrometer—Coulomb's Torsion Balance—The Electrophorus—The Replenisher—The Diurnal and Annual March of Atmospheric Electricity—Its Distribution—Thunderstorms: Professor Mohn's Classification—Cyclonic and Heat Thunderstorms—Geographical Distribution of Thunderstorms  
Pages 276-289

## CHAPTER XXIII

ATMOSPHERIC ELECTRICITY (*continued and concluded*)

Lightning—Thunder—Varieties of Lightning: zigzag, or forked; diffused, or sheet; globular, or ball lightning—Fulgurites—Rapidity of Lightning—St. Elmo's Fire—Hail—The Aurora: how caused; its height; its colour—Ozone—Lightning-conductors . . . . . Pages 290-303

## PART III.—CLIMATE AND WEATHER

## CHAPTER XXIV

## CLIMATE

Meaning of the term "Climate"—Definition of Climate—Accumulated Temperature—Effect of Temperature on the Animal and Vegetable Kingdoms—Principal Factors of Climate: Latitude, Altitude, Relative Distribution of Land and Water—Presence of Ocean Currents . . . . . Pages 304-315

## CHAPTER XXV

CLIMATE (*continued and concluded*)

Proximity of Mountain Ranges, Soil, Vegetation, Rainfall, Prevailing Winds—Cold Winds: East Wind of Spring in the British Isles, Mistral, Tramontana, Nortes of Gulf of Mexico, Pampéras, Tormentos, Etesian Winds—Hot Winds: Scirocco, Solano, Leveche, Harmattan, Khamseen, Simoom, Hot Wind of Australia, Föhn, Leste . . . . . Pages 316-328

## CHAPTER XXVI

## THE CLIMATE OF THE BRITISH ISLANDS

Division of Climates into (1) Insular, or Moderate; (2) Continental, or Excessive—Distribution of Atmospheric Pressure according to Season—Climate of the British Isles: (1) in Summer; (2) in Winter—Isothermals in July and January—Features in the Climatology of Great Britain and Ireland—Sea Temperatures: in Winter and in

Summer—Air Temperatures: arrangement of the Isotherms in January, April, July, and October—Atmospheric Pressure: its Monthly Distribution—Equinoctial Gales . . . Pages 329–345

## CHAPTER XXVII

### THE CLIMATE OF THE BRITISH ISLANDS (*continued and concluded*)

Distribution of Rainfall in the British Islands—Regions of heaviest Rainfall—How determined: Prevalent Winds, Exposure to these Winds, Mountains—Regions of least Rainfall—Geological Formation—Its Local Influence on Temperature—Permanent Elevation of Surface—Pebble Beds, Sands, and Sandstones—Clays and Shales—Limestones—Crystalline Rocks, whether Slates or Schists—Climatological Tables for Dublin . . . . . Pages 346–356

## PART IV.—THE INFLUENCE OF SEASON AND OF WEATHER ON DISEASE

### CHAPTER XXVIII

#### ACUTE INFECTIVE DISEASES

Introductory Remarks—Dr. William Heberden's Observations on Weather and Disease in 1797—Meteorological Factors which influence the Prevalence and Fatality of Disease: Mean Temperature, Rainfall, Humidity—Acute Infective Diseases: Influenza, Cholera, Diarrhoeal Diseases—Dr. Edward Ballard's Researches—Influence of the Temperature of the Soil—The Critical Subsoil Temperature of 56° F. at a depth of Four Feet—Dr. E. Meinert's Observations on Cholera Infantum—Dr. Ballard's working Hypothesis . . . . . Pages 357–375

### CHAPTER XXIX

#### ACUTE INFECTIVE DISEASES (*continued and concluded*)

Influence on the Prevalence of Enteric Fever of (1) Season; (2) Temperature and Moisture; (3) Soil and Underground Water—Outbreaks at Terling and in Trinity College, Dublin—Seasonal Mortality from Enteric Fever in Dublin for Twenty Years, 1872–91—Typhus Fever a Disease of Winter and Spring—Influence of Season, Overcrowding,

Defective Ventilation, Temperature and Atmospheric Moisture—  
Seasonal Mortality from Typhus in Dublin for Twenty Years, 1872-91  
—Seasonal Prevalence of (1) Smallpox ; (2) Measles ; (3) Scarlatina  
Pages 376-393

## CHAPTER XXX

THE SEASONAL PREVALENCE OF PNEUMONIC FEVER  
Pages 394-406

## APPENDIX I

LIST OF THE REGULAR STATIONS OF THE UNITED STATES  
WEATHER BUREAU  
Pages 407-409

## APPENDIX II

THE MORE IMPORTANT PUBLICATIONS OF THE UNITED STATES  
METEOROLOGICAL SERVICE  
Pages 410-419

## APPENDIX III

HYGROMETRICAL TABLES  
Pages 420, 421

INDEX OF SUBJECTS AND PLACES  
Pages 423-440

INDEX OF PROPER NAMES  
Pages 441-445

## LIST OF ILLUSTRATIONS

PLATE

I. Cloud Formation on the Matterhorn . . . . . *Frontispiece*

PAGE

II. Dispersion of Early Morning Mist. . . . . 212

CHARTS

A. and B. Weather Signals of U.S. Weather Bureau . . . . . 82

C. Distribution of Extreme and Mean Temperature . . . . . 328

FIG.

1. Kew Observatory Thermometer . . . . .	101
2. Phillips's and Negretti and Zambra's Maximum Thermometers	102
3. Rutherford's Minimum Thermometer . . . . .	104
4. Six's Thermometer . . . . .	105
5. Casella's Mercurial Minimum Thermometer . . . . .	107
6. Stevenson's Thermometer Stand . . . . .	108
7. Underground Thermometer . . . . .	115
8.     "                 "                 " . . . . .	115
9. Solar Radiation Thermometer Stand . . . . .	119
10. Richards' Actinometer . . . . .	121
11. Casella's Bifurcated Grass Minimum . . . . .	122
12. Symons's Earth Thermometer . . . . .	123
13. Campbell-Stokes Sunshine Recorder . . . . .	125
14. Whipple-Casella Universal Sunshine Recorder . . . . .	126
15. Jordan Photographic Sunshine Recorder . . . . .	127
16. Improved Jordan Photographic Sunshine Recorder . . . . .	128
17. Torricelli's Experiment . . . . .	130
18. Readings of the Jordan Barometer . . . . .	133
19. Fortin Barometer . . . . .	139
20. Wallis's Arrangement for adjusting the Ivory Point . . . . .	140
21. Kew Barometer . . . . .	141



FIG.	PAGE
22. Gay-Lussac Air-Trap . . . . .	141
23. Siphon Barometer . . . . .	142
24. Alfred King's Barograph . . . . .	144
25. Aneroid Barometer . . . . .	147
26. Aneroid Barometer, extra small, in silver case . . . . .	147
27. Field's Engineering Aneroid Barometer . . . . .	147
28. Extra-sensitive Aneroid Barometer . . . . .	147
29. Adie's Sympiesometer . . . . .	149
30. Portable Leather Case for holding Casella's Hypsometer . . . . .	150
31. Casella's Hypsometer . . . . .	150
32. Method of reading the Vernier (Case 1) . . . . .	154
33. , , (Case 2) . . . . .	154
34. Cathetometer constructed for the Indian Government . . . . .	157
35. Cathetometer, as used at Kew Observatory . . . . .	158
36. Cathetometer, 6½ feet in height . . . . .	158
37. Diurnal Oscillation of the Barometer in Various Latitudes . . . . .	168
38. Cyclonic and Anticyclonic Isobars . . . . .	174
39. Daniell's Hygrometer . . . . .	187
40. Regnault's Hygrometer . . . . .	188
41. Dines's Hygrometer . . . . .	189
42. Vertical View of Dines's Hygrometer . . . . .	189
43. Mason's Hygrometer . . . . .	191
44. Hooke's Rain Gauge . . . . .	224
45. Meteorological Office Rain Gauge . . . . .	226
46. Snowdon Rain Gauge . . . . .	226
47. Mountain Rain Gauge . . . . .	227
48. Symons's Storm Rain Gauge (Second Pattern) . . . . .	228
49. Crosley's Self-registering Rain Gauge . . . . .	229
50. Yeates's Electrical Self-registering Rain Gauge . . . . .	230
51. Registering Part of Yeates's Rain Gauge . . . . .	230
52. Richards' Self-recording Rain Gauge (Float Pattern) . . . . .	231
53. Richards' Self-recording Rain Gauge (Balance Pattern) . . . . .	232
54. Casella's Self-recording Anemometer or Anemograph . . . . .	254
55. Recording Cylinder of Casella's Anemograph . . . . .	255
56. Pressure Plate Anemometer . . . . .	257
57. Lind's Anemometer . . . . .	258
58. Robinson's Anemometer . . . . .	259

*LIST OF ILLUSTRATIONS*

xxi

FIG.	PAGE
59. Negretti and Zambra's Improved Robinson's Anemometer . . . . .	261
60. Air-meter . . . . .	262
61A. Vane of Casella's Altazimuth Anemometer . . . . .	266
61B. Casella's Altazimuth Anemometer . . . . .	267
62. Vane of Richards' Anémo-Cinémographe . . . . .	270
63. Richards' Anémo-Cinémographe . . . . .	271
64. Richards' Anémo-Cinémographe (Second Form) . . . . .	272
65. Anémo-Cinémographe in position . . . . .	273
66. Gold-leaf Electroscope . . . . .	279
67. Thomson's Portable Electrometer . . . . .	288
68. Diagram illustrating the Effect of the perpendicular and the oblique falling of the Sun's rays . . . . .	307
<b>DIAGRAM</b>	
1. Enteric Fever (22 Years, 1869-90) . . . . .	377
2. Smallpox (50 Years, 1841-90) . . . . .	384
3. Measles (50 Years, 1841-90) . . . . .	388
4. Scarlet Fever (30 Years, 1861-90) . . . . .	392



# METEOROLOGY

## PART I.—INTRODUCTORY

### CHAPTER I

#### METEOROLOGY

Meaning and History of the Term—Relations of Meteorology to Medicine—  
Buys Ballot's Law—Theory of the Winds—Cyclonic and Anticyclonic  
Systems—Direction and Force, or Velocity, of the Wind—Barometrical  
Gradients—Seasonal Variations of Temperature and Air Move-  
ments—The Claim of Meteorology to be regarded as a Science.

THE term Meteorology is more than two thousand years old. It was first used by the philosopher Plato four hundred years before Christ, when he described Socrates as “a sage, both a thinker on supra-terrestrial things, and an investigator of all things upon the earth beneath.” (“Σωκράτης, σοφὸς ἀνὴρ, τὰ τε μετέωρα φροντιστής, καὶ τὰ ὑπὸ γῆς ἅπαντα ἀνεζητηκώς.”—*Apologia Socratis*, cap. ii.) In his *Phædrus*, the same author employed the very word ἡ μετεωρολογία in the sense of a discussion of τὰ μετέωρα, that is, things in the air, natural phenomena, the heavenly bodies—Cicero's “supera atque cælestia.” Fifty years later the philosopher Aristotle wrote a treatise which he styled τὰ μετεωρολογικά, in which he discussed the subjects of air, water, and earthquakes, in this way approaching the modern signification of the word. Originally applied

to appearances in the sky, whether atmospheric or astronomical in their character, the term Meteorology is at present used in a much stricter and more scientific sense to denote that branch of natural philosophy which deals with weather and climate. It includes the study of the physical properties of the atmosphere, a description of the instruments of precision employed in that study, and the application of the knowledge so obtained to the elucidation of the problems of Physical Geography, the advancement of Agriculture, and the promotion of Health as well as the prevention of Disease. To the physician the securing of these last-named ends is of course of paramount importance.

From the earliest times the relations existing between medicine and meteorology have been most intimate. The far-seeing Fathers of Medicine were not slow to perceive how sensitive to the changes of the weather the delicate human organism is, and what an important bearing the study of weather-phenomena should exercise on the practice of medicine. Two thousand two hundred years ago Hippocrates wrote: "Whoever wishes to study the healing art properly must do this—first, he must attentively consider the seasons of the year," etc.<sup>1</sup> In his other writings, also, he often recurs to this subject.

Celsus, again, in the second book of his treatise, *De Medicinâ*, says: "Saluberrimum Ver est: proxime deinde ab hoc Hiems, periculosior Æstas, Autumnus longe periculosissimus"—a statement which to this day is true to the letter as regards Southern Italy, where the words were penned. What can be more graphic than his description of the effects of a north wind, or as we may say of a "nor'-easter": "Aquilo tussim movet, fauces exasperat, ventrem adstringit, urinam suppressit, horrores excitat, item dolores lateris et pectoris, sanum tamen corpus spissat, et mobilius atque expeditius reddit!"

<sup>1</sup> Περὶ Ἀέρων, Ἰδάτων, Τόπων.—"Ἱητρικὴν ὄστις βούλεται ὀρθῶς ζητεῖν, τάδε χρὴ ποιεῖν· πρῶτον μὲν ἐνθυμέεσθαι τὰς ὥρας τοῦ ἔτους, κ.τ.λ.

There is reason to believe that the suggestions thrown out by these illustrious Greek and Latin physicians were allowed to remain almost a dead letter. Certain it is that their doctrines as to the close relation of meteorology and of climatology to medicine became dimmed by the rust of time, and were neglected or forgotten.

Within comparatively recent years, however, a keen interest has been awakened in the subject. Every medical man who enters Her Majesty's service is required to study the broad facts relating to meteorological observation, and afterwards is called upon to aid in building up a science of climatology. Men like Edmund A. Parkes and Ballard in England, Stark and Sir Arthur Mitchell in Scotland, Quetelet in Belgium, Pettenkofer and Buhl in Germany, have studied the weather, and published researches on it and upon its bearing upon health. And now meteorology, than which no science is more closely analogous to that of medicine, takes its proper place in the curriculum and in the examination for the Diploma in State Medicine, Public Health, or Sanitary Science, which has been made a registrable qualification under Section 21 of the Medical Act, 1886 (49 and 50 Vict. cap. xlviii.)

In 1854, the Rev. Humphrey Lloyd, D.D., Provost of Trinity College, Dublin, demonstrated the cyclonic character of most of the gales experienced in Ireland,<sup>1</sup> and so foreshadowed what is now universally known as *Buys Ballot's Law*—a law on which the whole of modern meteorology turns. As applicable to the northern hemisphere, except close to the equator, this law may be concisely stated in the following terms: "Stand with your back to the wind, and the barometer will be lower on your left hand than on your right hand." Similarly, for the southern hemisphere, except close to the equator, the rule holds good: "Stand with your back to the wind, and the barometer will be lower on your right hand than on your left hand."

<sup>1</sup> "Notes on the Meteorology of Ireland," *Royal Irish Academy Transactions*, vol. xxii., "Science," 1854.

So long as the atmosphere is in a state of equilibrium the air is, of course, motionless or "calm"; but the moment the equilibrium is disturbed, an aërial current, which we call "wind," is generated—the air moving, or the wind blowing, from the district of greater towards that of less pressure, with the object of restoring absolute equilibrium. This, however, is in nature hardly ever attained. "The prime cause of atmospheric disturbance," says the Rev. W. Clement Ley, M.A., "is found in the unequal distribution of solar heat over the earth's surface; in the changes, diurnal and seasonal, in that distribution; and in the unequal effects thus produced on the tension of the air itself and of the vapour suspended in it."<sup>1</sup>

Experience and reflection have alike proved that air currents flowing in towards an area of low atmospheric pressure do so, not along straight lines, but in curves, so that a gyratory movement is developed round the low-pressure area. The determining cause of this phenomenon is the rotation of the earth upon its axis. A given point on the equator travels round at an infinitely greater speed than a similar point near either of the poles, because the equatorial point has to perform a journey of some 25,000 miles in the same space of time (namely, twenty-four hours) that a circum-polar point takes wherein to leisurely traverse a distance of perhaps only 100 miles. The actual speed at which a point is carried round with the earth as it spins on its axis is—at the equator, 1040 miles an hour (namely, 24,900 miles ÷ twenty-four hours); in latitude 30°, 900 miles an hour; and in latitude 60°, only 520 miles an hour, or but one-half the equatorial velocity.

The result of this is that air flowing northwards from the equator outstrips the earth's surface over which it is blowing because of its greater initial velocity, and accordingly trends towards the north-eastward. In this way a south wind is

<sup>1</sup> *Aids to the Study and Forecast of Weather*, p. 9. London: J. D. Potter. 1880.

deflected into a south-west wind. Conversely, air flowing southwards from the north pole lags behind the earth's surface, which is travelling from west to east with increasing speed according as the latitude diminishes; and so a north wind is deflected into a north-east wind. Supposing, then, an area of low pressure to exist between such south-west and north-east winds, it is evident that these winds must make for that centre so as to fill up its vacuum by curving: the south-west wind through south to south-east and east to the right-hand side, or the eastward, of the low-pressure area; the north-east wind through north to north-west and west to the left-hand side, or the westward of that area. In this way a circulation in a direction *against the hands of a watch* is developed round a low-pressure area, the point of lowest pressure in the *cyclonic system* so formed always lying (in the northern hemisphere) on the left-hand side.

In the case of the southern hemisphere the reverse of all this holds good. Air flowing southwards from the equator, that is, a north wind, travels faster than the surface over which it is blowing, and so it trends towards the south-eastward, becoming a north-west wind. Conversely, air flowing northwards from the south pole lags behind the earth's surface, which, as before stated, is travelling from west to east with ever-increasing speed as the latitude diminishes, and so a south wind is deflected into a south-east wind. These north-west and south-east winds, thus formed, will curve into a vacuum or low-pressure area, in a direction *with the hands of a watch*: the north-west wind through north to north-east and east to the right-hand side, or the eastward, of the low pressure area; the south-east wind through south to south-west and west to the left-hand side, or the westward of that area. Thus, the point of lowest pressure in the *cyclonic system* so formed always lies (in the southern hemisphere) on the right-hand side.

Similar considerations will show that, when air flows out in all directions from an area of high atmospheric pressure



a gyratory movement, or circulation, will be developed, which will be in opposite directions to those just described in the case of each hemisphere north and south of the equator. To these high-pressure systems and circulations the term "anti-cyclonic" is applied, because they are the opposites, or antitheses, of the cyclonic systems already described. "From these considerations," writes R. H. Scott,<sup>1</sup> "we gather that round an area of low pressure in the northern hemisphere the wind will circulate, having the lowest pressure on its left, or in a direction against the hands of a watch. Round an area of high pressure in the same hemisphere it will circulate in the opposite direction, or with watch hands.

"In the southern hemisphere these conditions will be exactly reversed: the wind will move round an area of low barometer readings with watch hands, and round an area of high readings against watch hands."

It is now forty years since Professor Adolf Erman first drew attention, in *Poggendorff's Annalen* (vol. lxxxviii. 1853, p. 260), to these relations between wind and atmospheric pressure. But to the late Professor H. Buys Ballot, Director of the Royal Meteorological Institute of the Netherlands, Utrecht, belongs the credit of having first insisted on their constancy and importance—hence the law which expresses them is called "Buys Ballot's Law."

The application of this law teaches us that, in the northern hemisphere, the wind will be more or less easterly at a given station when the barometer is higher to the north than to the south of it; more or less southerly when the barometer is higher to the east than to the west; more or less westerly when pressure is higher to the south than to the north; and more or less northerly when pressure is higher to the west than to the east. The qualifying words "more or less" are used, because the wind seldom blows directly along, or parallel to, the "isobars" (Greek, *ἴσος*, *equal*; and *βάρος*, *weight*), as the

<sup>1</sup> *Elementary Meteorology*, p. 254. London: Kegan Paul, Trench, and Co. 1883.

lines of equal barometrical pressure are called. To these lines the wind is often inclined at an angle of some 30° or even 40°.

From the foregoing considerations it follows that the *direction* of the wind, or the point from which the wind is blowing, is determined by differences in atmospheric pressure, which are recorded and gauged by differences in the height of the barometer.

But further, the *velocity* or *force* of the wind—measured by the Beaufort scale, which will be afterwards explained—is found to depend mainly on the amount of those differences, or on what are called the “barometrical gradients.” The term “gradient” is borrowed from the language of engineering. Engineers measure the steepness of a slope or “incline” by the relation which its vertical height bears to its horizontal length. If the ground rises or falls one foot in a distance of 60 feet, they speak of the gradient as 1 in 60.

It is to Mr. Thomas Stevenson, C.E., of Edinburgh, that we owe the application of the term “gradient” to differences of atmospheric pressure as measured by barometrical observations at neighbouring or even distant stations. But barometrical gradients differ from engineering gradients in a very important particular, namely, that their vertical and horizontal units of scale are not of the same kind. Their “vertical scale,” says the Hon. Ralph Abercromby, F.R. Met. Soc., “is expressed in units of barometrical readings, and the horizontal scale in units of geographical measurement.”<sup>1</sup> In the Meteorological Office, London, barometrical gradients are now expressed in decimal parts of an inch of mercury per 15 nautical miles, or about 17 statute miles, the line joining the points of barometrical observation necessarily running at right angles to the isobars. This unit of distance—15 nautical miles—was adopted by the Permanent Committee of the International Meteorological Congress, held at Vienna in 1873, in order to secure uniformity between the

<sup>1</sup> *Principles of Forecasting by Means of Weather Charts*, p. 4. London: Edward Stanford. 1885.

gradients of the British scale and those expressed in terms of the metric system. As a hundredth of an inch is nearly equal to a quarter of a millimetre, the English gradient given above corresponds closely with a French gradient expressed in millimetres per 60 nautical miles, or  $1^\circ$  of latitude.

Barometrical gradients are regarded as slight or moderate when they are below  $\cdot 01$  inch, but steep when they exceed  $\cdot 02$  inch. They seldom exceed  $\cdot 04$  inch or  $\cdot 05$  inch in the British Islands. An example of the use of these barometrical gradients may be given: when it is said that on a given day there is between Dublin and Holyhead a gradient of  $\cdot 025$  for northerly winds, it is implied that the isobars run north and south between those stations, and that the barometer stands as nearly as possible a tenth of an inch higher in Dublin than at Holyhead—there being a difference in pressure in favour of Dublin amounting to  $\cdot 025$  inch for each unit of 15 nautical miles between the two stations—( $15 \times 4 = 60$  nautical miles) ( $\cdot 025$  inch  $\times 4 = \cdot 100$  inch, or one-tenth of an inch).

In general, the steeper the gradient, or the closer the isobars are on a weather chart, the greater the velocity or the force of the wind. But the direct relation between these two factors—the gradient and wind force—is often interfered with by inequalities of the earth's surface, variations of temperature and of humidity, the existence of cross-currents in the higher strata of the atmosphere, and probably also the actual height of the barometer.

Buys Ballot's Law, as originally formulated, was supposed to apply only to those ephemeral and varying systems of atmospheric pressure which are called "cyclones" and "anti-cyclones"; but it is found to be equally applicable to the far vaster and more permanent seasonal variations of pressure and wind which depend on the alternate heating and cooling of large continents, and the periodical disturbance of the balance of temperature over their surface and that of neighbouring oceans, such as the Atlantic and the Pacific. This topic will be more fitly considered at length in connec-

tion with the subject of Barometrical Fluctuations (see Chapter XV.)

The foregoing reflections will, I trust, vindicate the claim of Meteorology to be regarded as a science—not, indeed, an exact science in the sense that mathematics and physics are exact sciences. The phenomena with which it deals are too many and too complex for that; our knowledge of those phenomena is so imperfect that we cannot systematise it so as to predict or “forecast” with certainty. But for this very reason, perhaps, the study of the weather and the elucidation of the laws which govern it possess an interest amounting to fascination, which is quite unfelt by the student of the exact sciences.

## CHAPTER II

### THE PHYSICAL PROPERTIES OF THE ATMOSPHERE

The Atmosphere: what it is, and its Effects—The Inclination of the Earth on its Axis—The Revolution of the Earth round the Sun—Atmospheric Air is Transparent, but has both Substance and Colour—Weight of the Atmosphere—Its gaseous Condition—It is capable of Compression and of Expansion—Professor Dewar's Experiments on the Liquefaction of Gases by Cold—Liquid Air—Liquid Oxygen—Frozen Air—Boyle's and Mariotte's Law—The Law of Charles, or Regnault's Law—Bearing of these Laws of Compression and Expansion of Gases on practical Meteorology—Elasticity of the Air—Rarefaction of the Atmosphere at great Altitudes—Atmospheric Pressure is exerted equally in all Directions—Otto von Guericke's Experiment with the Magdeburg Hemispheres—Transparency of the Atmosphere—Its Diathermancy and Athermancy.

THE gaseous or aërial envelope which surrounds the earth is called the Atmosphere (Greek, *ἀτμός, vapour; σφαῖρα, a globe or sphere*). It profoundly influences animal and vegetable life, modifies and retains the heat derived from the sun, facilitates the transmission of sound, causes twilight or the gradual shading of day into night, and is intimately concerned in the production of weather phenomena and geological changes of all kinds.

Before we proceed to pass in review the properties of the atmosphere, it is necessary to remember that the earth's axis of rotation is inclined at an angle of  $23^{\circ}27'44''$  to its orbit of revolution round the sun, or as it is technically called, the plane of the ecliptic, that is, the apparent annual path of the

sun round the heavens, or the real path of the earth as seen from the sun. As the earth revolves round the sun year after year, the plane of the ecliptic cuts the plane of the equator (or the great circle which is equi-distant from the poles and perpendicular to the earth's axis of rotation) at two points which are diametrically opposite to each other. This happens on March 21, when the sun is on the equator and going northwards, and on September 23, when the sun is again on the equator, but going southwards. The points where the ecliptic and the equator intersect are called the *equinoctial points*, and the times when this occurs are called the *equinoxes*, because day and night are then of exactly equal length, the sun being twelve hours above and twelve hours below the horizon.

From March 21 to June 21 the sun is getting farther and farther north of the equator, and remains longer and longer than twelve hours above the horizon at all places in the northern hemisphere. On June 21 the sun appears to traverse the heavens at an angular distance north of the equator, amounting at present to  $23^{\circ}27'44''$ . He "stands still," as it were, at the Tropic of Cancer and at the summer solstice, before beginning a retrograde journey to the equator and ultimately to the southward of it. Hence the terms "solstice" (that is, *solis statio*) and "tropic" (from the Greek *τροπή*, a turning round). On December 21 the sun in like manner reaches his greatest southern declination—in latitude at the Tropic of Capricorn, and, in time, at the winter solstice. The expression *τροπαὶ ἡελίου* occurs both in Homer and in Hesiod, the latter first using the phrase as a note of time—midsummer or midwinter.

The reason why it has been necessary to enter into these particulars about the inclination of the earth on its axis, and the revolution of the earth round the sun, is that the change of seasons on all parts of the earth's surface depends chiefly upon the relations of these two factors to each other. Long days and more or less vertical suns produce summer; short

days and more or less horizontal suns, on the other hand, produce winter. Summer merges into winter through autumn; winter yields to summer through spring.

Although invisible to the eye, owing to its transparency, atmospheric air has both substance and colour. That it has substance is evident from the mechanical effects which it produces when in motion. The windmill, the sailing vessel, and the anemometer alike illustrate this. The pressure anemometer has been called upon, in the gusts of great storms, to bear pressures up to 36 or even 40 lbs. on the square foot; for example, a pressure of 42 lbs. was recorded at Glasgow on January 24, 1868, and one of 53 lbs. at Greenwich on October 14, 1881. The extraordinary pressure of over 70 lbs. per square foot was registered at Bidston Observatory, near Liverpool, on February 1, 1871. This, however, must have been quite a local phenomenon, as a pressure of 49 lbs. equals a velocity of  $110\frac{1}{2}$  miles per hour, and means a "hurricane that tears up trees and throws down buildings" (Rouse).

The principle upon which the parachute is constructed, or the boomerang of the aborigines of Australia, has reference to the substantial nature of air, which is capable of resisting these bodies when passing through it.

Air, again, has weight, and can be weighed. At a temperature of  $32^{\circ}$  F., the barometer standing at 29.92 inches, 100 cubic inches of air weigh 32.6 grains nearly. The weight of a cubic foot of air is 573.5 grains. At a temperature of  $60^{\circ}$  F., and with the barometer at 30.00 inches, the corresponding weights are 30.93 grains, and 534.47 grains respectively. According to Dr. Robert J. Mann,<sup>1</sup> 13 cubic feet, or a quadrangular block measuring 24 inches in two directions and 39 inches in the third, weighs exactly 1 lb.; a room 10 feet square contains 77 lbs. of air; while Westminster Hall holds 75 tons. He adds that air is about 760 times lighter, bulk for bulk, than water.

<sup>1</sup> *Modern Meteorology*, p. 3. London: Edward Stanford. 1879.

Under ordinary circumstances, the atmosphere exists in a gaseous state. A gas may be defined as a body whose molecules are in a constant state of repulsion. It is to Lord Kelvin (Sir William Thomson), the President of the Royal Society, and Professor of Natural Philosophy in the University of Glasgow, that we are particularly indebted for a molecular analysis of air. He believes that the atoms of air are so minute that five hundred millions of them would fit into an inch if arranged in a line. They float at some distance apart from one another, repelling each other very energetically whenever an attempt is made to drive them mechanically together. Like other gases, and, indeed, in consequence of this loose arrangement of the atoms of which it is composed, atmospheric air can be readily compressed to one-half its original volume by doubling the pressure to which it is subjected. This fixed law of compression of gases was discovered in the seventeenth century (1662) by the Hon. Robert Boyle, F.R.S., and afterwards, independently, in 1679, by Edmé Mariotte, a priest who lived at Dijon, in Burgundy. Hence it is known as "Boyle's and Mariotte's Law." It may be concisely stated thus: *The temperature remaining the same, the volume of a given quantity of gas is inversely as the pressure which it bears.*<sup>1</sup> It will be seen, from the statement of this law, that the elastic resistance of air becomes greater and greater the more it is attempted to be compressed, whether mechanically or by means of cold. Notwithstanding this, science has triumphed, and in January, 1893, Professor Dewar, in a discourse on the "Liquefaction of Gases by Cold," delivered at the Royal Institution of Great Britain, demonstrated the liquefaction of atmospheric air. For the purpose of this experiment a temperature of not less than 182° Centigrade (327·6° Fahrenheit) below the melting point of ice (32° F.) is required; in other words, the temperature must be reduced to -295·6° F. If a vessel containing air is

<sup>1</sup> *Essentials of Physics*, p. 61. By Fred. J. Brockway, M.D. Philadelphia: W. B. Saunders. 1892.



chilled to this extent, "the air will condense, trickle down the sides, and accumulate as a liquid at the bottom" (Sir Robert Ball, LL.D., F.R.S.) At this lecture, Professor Dewar actually succeeded in pouring half a pint of liquid air from one vessel to another. The professor's subsequent experiments have been still more marvellous. He has frozen air into a viscid, jelly-like mass, something between a liquid and a solid. It is supposed that frozen air assumes this form because oxygen—an element which appears to resist independent solidification successfully—is probably entangled in a liquid state in the frozen nitrogen of the air.

It is worth noting that liquid oxygen, also shown by Professor Dewar at his lecture, displays a beautiful blue tint, suggesting, according to Sir Robert Ball, a possible explanation of the colour of the sky—that is, of the atmosphere. To this coloration of the air allusion has already been made above.

Not only is atmospheric air capable of compression, but, in common with all gases, it is capable of expansion also. As compression of air takes place in accordance with a fixed law, so also does its expansion. Like other gases, air increases its volume, or expands, by the  $\frac{1}{273}$ rd of its bulk for every degree of the Centigrade thermometer, or the  $\frac{1}{491.1}$ th of its bulk for every degree of Fahrenheit's scale (Regnault). When air is heated from the melting point of ice to the boiling point of water, it is found that 1000 cubic inches become 1366.5 cubic inches. The fraction  $\frac{366.5}{1000}$ , or  $\frac{10.995}{30}$  (nearly  $\frac{11}{30}$ ) therefore represents the amount of the expansion of a volume of air when raised from 32° to 212° F.; that is, through 180°. But, as the expansion is equal for each degree, the amount of the expansion for one degree is  $\frac{10.995}{30 \times 180} = \frac{10.995}{5400}$ , which, when reduced, becomes  $\frac{1}{491.1}$ , as above; or, in decimals, 0.002036 for each degree. It is to be noted that the increase of the unit of volume of a gas for one degree is called its *coefficient of expansion*. Gases are not only the most expansible of all bodies, but they all have the

same coefficient of expansion, namely,  $\frac{1}{273}$  for  $1^{\circ}$  C., or  $\frac{1}{459.1}$  for  $1^{\circ}$  F. Except at very high temperatures their expansion is uniform, no matter what the temperature or the pressure may be.

The fixed formula or law just stated, by which the expanding effect of heat on a gas is expressed, was first laid down in 1787 by M. Charles, then Professor of Physics in the Conservatoire des Arts et Metiers, Paris. It was subsequently arrived at independently by John Dalton, a distinguished meteorologist, physicist, and chemist (1766-1844), whose name is especially identified with the Atomic Theory, which elevated chemistry into a science. In 1802 Louis Joseph Gay-Lussac published a memoir on the subject, and later still Regnault improved upon Gay-Lussac's experiments, so that the law is sometimes spoken of as Regnault's Law as well as the Law of Charles.

The property which air possesses of contracting in bulk when exposed to pressure, and of expanding again on the removal of that pressure, constitutes what is called *elasticity*—a property which air possesses in no ordinary degree.

These laws of the compression and expansion of gases have a most important and direct bearing upon meteorology. According to the law of Charles a volume of air at a constant pressure is proportional to its absolute temperature. According to the law of Boyle and Mariotte the density of air varies inversely as its volume. From these two facts it follows that the density of the atmosphere is inversely as its absolute temperature—in other words, hot air is specifically lighter than cold air. This aphorism gives a clue to the origin of those great movements of the atmosphere which we call "winds." Wherever the air becomes heated on the earth's surface it expands, and the barometer falls. Wherever the air is chilled it contracts, and the barometer rises. By these changes in atmospheric pressure are brought about the great wind circulations which have been mentioned in Chapter I.

Another important consequence of Charles's or Regnault's Law is rarefaction of the atmosphere at great altitudes. Speaking in general terms, the atmosphere exerts at the sea level a pressure of about 15 lbs. (strictly speaking, 14·73 lbs.) to the square inch. That is to say, a column of air one inch square, if built up from the earth's surface to the extreme limit of the atmosphere, or to a height of some 200 miles, would weigh about 15 lbs. (14·73 lbs.) This weight is equal to 2160 lbs., or nearly 1 ton on a square foot, or 1 kilogramme on a square centimetre, or 263,000,000 tons on a square mile. A pressure of 15 lbs. upon the square inch is technically spoken of as a pressure of *one atmosphere*. A column of mercury 30 inches in height and 1 square inch in section is found to weigh 14·73 lbs., and so is equivalent to the weight of a column of atmospheric air of the same section. The principle of the construction of the barometer is based upon this fact, as we shall see in a subsequent chapter. Now, if we ascend 2·7 miles, or to a little below the summit of Mont Blanc (15,781 feet), half the weight of the atmosphere will have been left below, and the barometer will read not 30 but only 15 inches. In accordance with Charles's or Regnault's Law, a given bulk of air will, at the height mentioned, expand to twice the volume it would have at sea-level. At a height of 5·4 miles its volume would be again doubled, and the barometer would read only 7·5 inches, and so on until at 60 miles above sea-level "the air is probably as rare as the best vacuum that can be produced by the air-pump" (R. J. Mann). The outward limit of the atmosphere must be determined by a counterpoise between gravity on the one hand and centrifugal force and the repulsive action of the aerial molecules on the other. Where that limit lies cannot be stated with certainty, but investigations upon the duration of twilight assign to the atmosphere a height of 45 miles at the lowest estimate, and of 190 or possibly 212 miles at the highest. The latter great elevation is inferred by M. Liáis, from observations upon the influence

of the rarer regions of the atmosphere upon twilight at Rio Janeiro.<sup>1</sup>

Experiments prove that atmospheric pressure is exerted equally in all directions—downwards, as already shown ; but also upwards and horizontally or laterally. Otto von Guericke's classical experiment with the *Magdeburg Hemispheres*, first performed in 1650 before the Imperial Diet at Ratisbon, is conclusive on this point. Hence it is that objects near the earth's surface are not crushed by the pressure of the atmosphere—a pressure so tremendous that an average-sized man sustains a weight of some 15 tons. In this pressure of air in all directions we have a further and effective cause of air movement or wind. A column of cold air being heavier than an equal volume of warm air, its lower strata are pushed towards the area where atmospheric pressure is less, or towards the area of warm and therefore lighter air. The wind, in other words, blows from the area of high barometer towards that of low barometer, not, indeed, in a straight line, but anticyclonically, as explained in Chapter I.

The atmosphere, when pure and dry, possesses two further remarkable properties—*transparency* and *diathermancy*. Transparency means that pure air is permeable to the vibrations of *light*. In consequence, we are able to scan the heavens in one direction and to study the effects of light as broken up into colour on the earth in the other direction. When aqueous vapour intervenes, we gaze with admiration on the glories of sunrise and of sunset, which are due to diffraction of light, absorption of the blue rays of the spectrum taking place because their wave-lengths are small, while the yellow and red vibrations of greater length are allowed to pass through the aqueous vapour and so are reflected to earth.

Diathermancy (Gk. *διάθερμος*, *thoroughly warm*) is the property of transmitting radiant heat, and this property dry air possesses in a remarkable degree ; it is so freely perme-

<sup>1</sup> *Comptes Rendus*, tome xlvi. p. 109.

able to radiant heat that both at great altitudes, as on the snow-covered Alps, and in high latitudes, as within the Arctic Circle, the sun's heat may be of extraordinary power, provided only that the atmosphere is extremely dry. Mr. R. H. Scott says:<sup>1</sup> "The observation is as old as the time of Scoresby, that on board a whaler you may see the pitch bubbling out of the seams of the ship where the sun shines on them, while ice is forming on the side of the ship which is in shade." It has been computed that the sun's rays lose, under ordinary circumstances, 20 per cent of their heat by absorption while passing vertically through the earth's atmosphere. The percentage of loss increases as the path of the heat rays becomes more and more horizontal, until soon after sunrise, or shortly before sunset, a condition of complete, or almost complete, *athermancy* is reached—that is, the power of stopping radiant heat (corresponding to opacity as regards light), is greatest, the heat rays being entirely intercepted by the dense, damp strata of the atmosphere, at sunrise and sunset.

The heat waves from the sun are long and short. The long waves are absorbed as they pass through the atmosphere towards the earth. The short waves reach the surface, whence they are reflected or radiated back again in lengthened waves, to meet their fate at last in absorption by the aqueous vapour of the atmosphere. In this way radiation into space is checked, and life is preserved upon the face of the globe.

In the British Islands diathermancy is most decided during the prevalence of clear skies and dry easterly winds in spring and early summer; it is least marked during the prevalence of damp fogs and mists in late autumn and the winter season of the year.

<sup>1</sup> *Elementary Meteorology*, p. 57. 1883.

## CHAPTER III

### THE COMPOSITION OF THE ATMOSPHERE

Components of the Atmosphere—A mechanical Mixture of Oxygen and Nitrogen—Nature's cleansing Operations—Volumetric Analyses of Air—Proofs that Air is a mechanical Mixture and not a chemical Combination—Sources of the Carbon Dioxide of the Atmosphere—Its Distribution—Action of Chlorophyll upon it—Ozone—Other gaseous Constituents of the Atmosphere—Graham's Law of the Diffusion of Gases—Mineral Constituents of the Atmosphere—Micro-organisms, or Microbes—Permanganate of Potassium Test for organic Matter in the Air—Aqueous Vapour.

CAREFUL volumetric analysis shows that atmospheric air consists almost entirely of a mechanical mixture of oxygen and nitrogen together, with a small and variable quantity of carbon dioxide or carbonic acid ( $\text{CO}_2$ ). There is also present in the air moisture or aqueous vapour, the amount of which varies, especially with the temperature. Peroxide of hydrogen and nitrous and nitric acids are occasional components; so is sulphurous acid in the vicinity of large towns. Besides the foregoing, very minute traces of ammonia, as well as sulphide of hydrogen or its ammonia compound, and a variable quantity of organic matter derived from the animal, vegetable, and mineral kingdoms, are commonly present in those strata of the atmosphere which are nearest the earth's surface at sea level.

The air is purest on the summits of lofty mountains, on open prairies or moorlands, in Arctic regions, and in mid-ocean.

It is temporarily purified by gales and thunderstorms, downpours of rain, copious dews, and heavy falls of snow or hail—all of them great cleansing operations of nature, which the Germans expressively call “Niederschläge” (precipitants). (Cornelius B. Fox).

The most elaborate volumetric analyses of air have been made by Dr. Angus Smith, Bunsen, and Regnault. In a series of fifteen analyses, Bunsen found the oxygen *by volume* to vary from 20·970 to 20·840 per cent. Regnault's examinations of air from different parts of the world gave very similar results—20·940 to 20·850 per cent. In country air he occasionally found the percentage volume of oxygen to rise to 21·000. On one occasion the air of Paris yielded 20·999 of oxygen by volume per cent. Angus Smith, in twenty-two examinations, found 20·938 per cent of oxygen in the most crowded parts of Perth, while the air of the heath and of the seashore gave 20·999. For all practical purposes the percentage volume of nitrogen in the air may be found by subtracting the foregoing figures from 100, for carbon dioxide is present only in quantities ranging from ·025 to ·045 per cent, or ·25 to ·45 per 1000 parts by volume.

In order easily to remember the composition of the atmosphere by volume and by weight we may say that in 100 parts there are of—

	Volumes.	Grains weight.
Oxygen . . . . .	20·96	23·10
Nitrogen . . . . .	79·00	76·84
Carbon dioxide . . . . .	0·04	0·06
	<hr/> 100·00	<hr/> 100·00

It is right also to mention that, in analyses by *weight*, the percentage weights of oxygen and nitrogen may be translated into percentage volumes by dividing the respective specific gravities of these gases into their respective percentage weights. The specific gravity of oxygen is 1·10561; that of nitrogen is 0·97135.

Atmospheric air is not a chemical combination of oxygen and nitrogen. It is simply a mechanical mixture, in which the molecules of oxygen are separate and distinct from those of nitrogen, through which they vibrate at inconceivable speed without let or hindrance of any importance. Only when the nitrogen molecules are so compressed by cold as to form a liquid or a solid is the free play of the oxygen molecules so far interfered with as to lead to the formation of the viscid jelly-mass which represents atmospheric air when frozen solid.

That air is a mechanical mixture and not a chemical combination is proved by the following considerations :—

1. There is no chemical formula for air, for the relative proportions of oxygen and of nitrogen present in it are not those of their combining weights, or of any simple multiple of those weights.

2. When air is artificially made by mixing oxygen and nitrogen together in proper proportions, no change of volume takes place, nor is heat or electricity disengaged as in the production of ordinary chemical combinations.

3. Air is slightly soluble in water, but oxygen dissolves more readily than nitrogen. If water, in which air has been dissolved, is boiled, the air which is expelled is found to contain nearly 35 per cent of oxygen, instead of only 21 per cent. The air is oxygenated to the amount of 14 per cent. This could not happen if air was a stable chemical compound.

4. The refraction of air is the mean of the refraction of oxygen and of that of nitrogen. If air was a chemical compound it would have a refraction of its own, not the mean refraction of its constituent gases.

Carbon dioxide is a normal constituent of the atmosphere. The table given above shows that it forms four out of every 10,000 volumes of air, and weighs six grains out of every 10,000 grains of air. If it exceeded this amount to any great extent, it would poison animal life ; if it fell short of this amount, the vegetable kingdom would starve.



The carbon dioxide of the atmosphere is derived from—

1. The soil and subterranean sources generally.
2. The respiration of animals.
3. Combustion.
4. Fermentation and decomposition.
5. The burning of limestone in lime-kilns.
6. Carbonated natural mineral waters.

Experiments prove that on land the quantity of carbon dioxide in the air is greater by night than by day, because so much of the gas is exhaled by plants at night. It increases after rain and towards midday. At sea, it is greater by day (5 volumes per 10,000) than by night (3 volumes per 10,000). M. Mêne<sup>1</sup> found that the highest percentage of the gas in the air was in October, and that its amount falls to a minimum in December, January, and August. Risler<sup>2</sup> arrived at somewhat analogous results from investigations at Nyon, Switzerland. Frankland,<sup>3</sup> Angus Smith, and M. G. Tissandier<sup>4</sup> all found larger quantities of the gas at considerable elevations than lower down at medium heights. Frankland's experiments were made at the summit of Mont Blanc; Tissandier's in a balloon. At moderate elevations, however, the quantity of carbon dioxide is not so great as on the ground or at sea level.

The composition of the atmosphere, as regards oxygen and carbon dioxide, is maintained by the action of chlorophyll—the green granular matter formed in the cells of the leaves of plants—which, under the influence of sunlight, has the extraordinary power of splitting carbon dioxide up into its two constituents—*carbon* which it retains, and *oxygen* which it exhales (Wynter Blyth).

*Ozone* (Gk. ὄζω, *I have a smell*) is a colourless, gaseous

<sup>1</sup> *Comptes Rendus*, lvii. p. 155.

<sup>2</sup> *Comptes Rendus*, xciv. pp. 1390, 1391.

<sup>3</sup> *Journal of the Chemical Society*, 1861.

<sup>4</sup> *Comptes Rendus*, April 12, 1875.

substance, with a peculiar smell like weak chlorine, which is developed as the immediate result of electrical disturbances. Houzeau has experimentally demonstrated its amount in country air to be one volume in 700,000 volumes of air. It is absent in cities, in crowded dwelling-rooms, and over marshes. Unfortunately, the tests for it react to other substances in the atmosphere, such as hydrogen dioxide (peroxide of hydrogen) and nitric acid. The whole subject, however, of ozone and of ozone-testing will more fittingly be considered in Chapter XXIII. on Atmospheric Electricity (see p. 296).

The other gases which are more or less constantly present in the atmosphere have already been named. *Nitric acid* is generally present in minute quantities. *Sulphurous acid* is derived from the combustion of coal in large towns. From experiments undertaken at Lille, A. Ladureau<sup>1</sup> found that it increased in amount during calm weather, while it equally decreased on stormy days.

Mr. Horace T. Brown estimates the normal amount of *ammonia* present in the air to be about six parts per 1,000,000. Heavy rain lessens the amount for a time.

The presence of *hydrogen sulphide* in the atmosphere of large towns is proved by the tarnishing of silver plate and coins. It may be present as ammonium sulphide.

Besides carbon dioxide, *marsh-gas* is always present in the air, although in minute quantities. Its chemical formula is  $\text{CH}_4$ . It is a product of decomposition of organic matter in stagnant pools. Hence its name. It is also called *methane*, and constitutes the *fire-damp* of coal mines.

These gases diffuse freely through the atmosphere in obedience to a fixed law, which is that the diffusibility of two gases varies in the inverse ratio of the square roots of their densities. This law of the diffusion of gases, commonly called "Graham's Law," is based upon a consideration of the size and velocity of repulsion of the molecules of each gas. If one molecule, say of oxygen, weighs sixteen times as

<sup>1</sup> *Ann. Chem. Phys.* 5, xxix. pp. 427-32.

much as another, say one of hydrogen, then the latter has to move four times as fast as the former in order to strike as effective a blow. Hydrogen, a light gas, diffuses four times as fast as oxygen, a heavy one. The rate of diffusion is in this instance inversely as the square roots of one and sixteen.

“The process of diffusion,” says Professor Miller in his *Chemical Physics*, “is one which is continually performing an important part in the atmosphere around us. Accumulations of gases which are unfit for the support of animal and vegetable life are by its means silently and speedily dispersed, and this process thereby contributes largely to maintain that uniformity in the composition of the aerial ocean which is so essential to the comfort and health of the animal creation. Respiration itself, but for the process of diffusion, would fail of its appointed end, in rapidly renewing in the lungs a fresh supply of air in place of that which has been rendered unfit for the support of life by the chemical changes which it has undergone.”

Among mineral constituents of the atmosphere *common salt* (sodium chloride) is the most frequently met with, especially in the lower strata of the air. Spectroscopic analysis of the Bunsen flame invariably gives the sodium line in consequence of the presence of salt. *Metallic dust* of various kinds abounds in the vicinity of manufactories and in the air of mines.

Vast numbers of *micro-organisms*, or *microbes*, infest the air. These belong both to the pathogenic and to the non-pathogenic groups. They are infrequent in the air of mid-ocean and on high mountains, but abound in the air of towns, swarming in that of ill-ventilated dwelling-rooms. Mr. J. B. Dancer,<sup>1</sup> F.R.A.S., examined the solid particles of the air of Manchester microscopically, and came to the conclusion “that 37½ millions of these bodies [particles of both organic and

<sup>1</sup> *Proceedings of the Literary and Philosophical Society of Manchester*, vol. iv. Series 3. 1867-68.

inorganic origin], exclusive of other substances, were collected from 2495 litres = 88 cubic feet of the 'air of Manchester,' a quantity which would be respired in about ten hours by a man of ordinary size when actively employed."

According to Mr. A. Wynter Blyth,<sup>1</sup> the best chemical method of estimating organic matter in the air is its approximate estimation by means of permanganate of potassium. A known bulk of air is drawn through a little distilled water, and the amount of oxygen consumed is determined by the Forchammer process. Ten cubic centimetres of a standard solution of permanganate of potassium,<sup>2</sup> and ten cubic centimetres of sulphuric acid, diluted to one-third, are added to a known bulk of water, say a litre. The whole is then heated for four hours to 80° F. (26·6° C.) At the end of that time the water is titrated—that is, has its strength determined—with a hyposulphite solution made by dissolving one part of crystallised sodic hyposulphite in a litre of water, using iodide of potassium and starch as an indicator. The value is obtained by running a control with distilled water.

One of the most important constituents of the atmosphere is *aqueous vapour*, or water in a gaseous or aëriiform state. A vapour, like a gas, is subject to the laws of expansion and of compression, which have been already discussed in these pages—but only *within certain limits*. "If," says Mr. R. H. Scott,<sup>3</sup> "these limits be overpast, *i.e.* if the pressure becomes too great or the temperature falls too low, a portion of the vapour will pass into the state of liquid. Under any circumstances of pressure and temperature, a given space can contain only a given quantity of vapour. This is as true of vapour mixed with air as of vapour by itself."

The overwhelming influence of aqueous vapour in practical meteorology arises in part from its sensitiveness to the action

<sup>1</sup> *A Manual of Public Health*, p. 96. 1890.

<sup>2</sup> Made by dissolving '395 grm. of potassic permanganate in a litre of water. Each c.c. contains '0001 grm. of available oxygen.

<sup>3</sup> *Elementary Meteorology*, p. 95. 1883.

of heat—even moderate changes of temperature causing it to expand or contract, to evaporate or condense, with great facility; but more especially from its liability to pass from the gaseous or vaporous, to the liquid or even solid form, at temperatures of everyday occurrence in nature. It is, however, to the marvellous heat-absorbing powers of aqueous vapour that the attention of the practical meteorologist must in particular be directed, when he seeks an explanation of the phenomena of what we call “Weather.”

## PART II.—PRACTICAL METEOROLOGY

### CHAPTER IV

#### BRITISH METEOROLOGICAL OBSERVATIONS

Merle's Journal of the Weather, 1337-1344—Admiral FitzRoy's Charts and Forecasts—Synoptic Weather Charts—Meteorology of the British Isles—Stations of the First Order—Anemographic Stations—Stations of the Second Order—Telegraphic Reporting Stations—"Isobars" and "Isotherms"—Extra Stations—Royal Meteorological Society—Scottish Meteorological Society—Daily Weather Report—Weekly Weather Report—Monthly Summary—Accumulated Temperature—Numerical Scales for Telegraphic Weather Reports—Code System—Meteorological Conditions which influence Disease and the Death-rate—Equipment of a Second Order Station.

THE earliest known Journal of the Weather was that kept at Oxford by the Rev. William Merle, Fellow of Merton College and afterwards Rector of Driby, Lincolnshire, during the seven years 1337-1344. His "*Consideraciones Temperiei pro 7 Annis*" were discovered in a MS.<sup>1</sup> in the Bodleian Library, Oxford, in 1891, and were immediately afterwards reproduced and translated under the supervision of Mr. G. J. Symons, F.R.S., to whom British meteorology owes so much. The observations are climatological and are written in Latin in Old English characters. They represent the primeval stage of weather study, in which popular weather prognostics came to

<sup>1</sup> Digby MS. 176, fol. 4.

be drawn from daily scanning of the heavens, untiring observation of the movements of animals, including the arrival and departure of migratory birds, of the leafing and flowering of trees and shrubs, of the ripening of harvests and fruits, and of the fall of the leaf in autumn. These phenological observations in bygone days conferred a marvellous power of forecasting weather, and so they do at the present day also, so far as local districts are concerned.

Since the discovery of the barometer in the seventeenth century, isolated observations on atmospheric pressure—crude, no doubt, and unreduced to any standard altitude or temperature—afforded an increased power of weather forecasting.

It was not, however, until 1861 that the application of telegraphy to the synchronous study of the weather at distant stations revolutionised meteorology and raised it to the dignity of a science. The service of Daily Weather Charts and Forecasts, which was inaugurated by the late Admiral FitzRoy in the year named, has been amplified and improved since then, but to him belongs the credit of organising a system of weather study which now extends over the whole civilised world. Every country in Europe; Canada, and the United States; India, Australia, and New Zealand—all have their Meteorological Offices or Weather Bureaux, at which synoptic weather charts and forecasts are prepared at least once a day.

The word “synoptic” (Gk. *συνοπτικός* from *σύνοψις*, a seeing all together, a general view) signifies that the weather chart has been prepared from observations taken at the same moment of time over a large tract of country, and that it illustrates the type of weather prevailing throughout the district embraced in the chart at the hour of observation.

The following account of the method in which the land meteorology of the British Islands is studied through the medium of the Meteorological Office, London, will apply *mutatis mutandis* to the Weather Bureaux of the British Colonies and of Foreign States.

The observatories in the United Kingdom in connection with the Central Office may be arranged in five classes:—

1. *Stations of the First Order, or Self-recording Observatories*, which are furnished with self-registering instruments by which all the principal meteorological phenomena are recorded *continuously*. These alone afford the materials necessary for the study of the periodic variations of the meteorological elements. There are seven such stations at present: three in England—Falmouth, Kew, and Stonyhurst; three in Scotland—Glasgow, Aberdeen, and Fort-William; and only one in Ireland—Valentia Island, in Kerry. The observatory at Armagh was relegated to Class II. some years ago.

2. *Anemographic Stations*, furnished with instruments registering the wind only. At Armagh, rainfall and sunshine are in addition recorded. The observations from these stations are important in connection with storms, and afford evidence available in courts of law relative to collisions at sea and damage done by wind either on land or at sea.

3. *Stations of the Second Order, or Climatological Observatories*, of which upwards of 100 are now at work. At the end of March 1892 the total number of these stations was 103, including 17 belonging to the Royal Meteorological Society and 19 belonging to the Scottish Meteorological Society. The stations are distributed as follows:—45 in England, 4 in Wales, 28 in Scotland, and 26 in Ireland. Reports from eleven of the Irish stations are regularly supplied to the Registrar-General for Ireland for his Weekly and Quarterly Returns. At all of these climatological stations regular eye observations are taken twice daily, at 9 A.M. and 9 P.M., of atmospheric pressure, temperature (dry bulb and wet bulb), wind, cloud, and weather, with the daily maxima and minima of temperature, the daily rainfall, together with general remarks on the weather. The observers at these stations are all volunteers. All the stations are regularly inspected by inspectors from the Meteorological Office.

4. *Telegraphic Reporting-Stations*—fifty-nine in number



—at which the observations are taken by eye at certain hours determined by the requirements of the telegraphic system. In some cases the eye observations are supplemented by self-recording aneroid barometers, etc.

The foreign reporting-stations, twenty-eight in number, extend along the entire western coast of the continent of Europe, from Bodö in lat.  $67^{\circ}$  N. to Lisbon in lat.  $38^{\circ}$  N., and include four stations on the shores of the Baltic, three in Germany, and two in the Mediterranean.

The remaining thirty-one telegraphic reporting-stations are scattered throughout Great Britain and Ireland and the adjacent islands. At these stations observations are taken at 8 A.M. and 6 P.M. Greenwich time, and are telegraphed to London according to a special cipher code. In addition, observations are taken at 2 P.M. daily at fifteen home and two foreign stations (Skudesnæs in Norway, and Rochefort on the west coast of France) and at once telegraphed in cipher to London.

As the reports come in, the information is entered on a chart, which is preserved in the Office, and from which the Daily Weather Report is prepared. This Report fills four large quarto pages, and is arranged as follows :—

Page 1 contains the whole of the fifty-nine reports from which the maps for the day (given on page 2) are prepared, and the 6 P.M. reports of the previous day, together with the maximum and minimum temperatures of the air, and the rainfall for the previous twenty-four hours.

Page 2 contains (1) a map of North-Western Europe showing, for 8 A.M. on the date of publication, the distribution of pressure, the prevalent winds, and the sea disturbance, with necessary explanations, together with a table showing the mean atmospheric pressure for the month at twenty-five stations during the twenty years 1871-1890 ; (2) a similar map showing the distribution of temperature at 8 A.M., the weather at each station, and the distribution of rainfall during the past twenty-four hours, together with a table of the mean tempera-

ture of the air and of evaporation at 8 A.M., the means of the daily maximum and minimum temperatures, and the mean rainfall for the month at the same twenty-five stations in the United Kingdom. The mean monthly rainfall values are those for the twenty-five years 1866-1890. The other means are for the twenty years 1871-1890. On these maps lines are drawn through the places where atmospheric pressure and temperature are respectively equal. The lines of equal pressure are called "isobars" (Gk. ἴσος, *equal*; βάρος, *weight*); those of equal temperature are called "isotherms" (Gk. ἴσος, *equal*; θερμῆ, *warmth*). Isobars are by far the most important element in forecasting, while isotherms play a very subordinate part. The direction of the wind is marked by arrows, which fly with the wind. They carry a number of "flèches" proportional to the force of the wind estimated by the Beaufort scale (see p. 35).

Page 3 contains (1) notes on the "general situation" at 8 A.M., and a statement as to the probable changes in the system of weather then prevalent; and (2) the forecasts drawn up for each district of the British islands—eleven in number—at 11 A.M., and an explanation of the meaning of the storm signals exhibited on our coasts. These forecasts refer to the weather likely to be experienced during the twenty-four hours ending at noon of the day succeeding that of publication.

Page 4 contains the reports for 2 P.M. of the previous day, an account of the distribution of pressure, temperature, wind and weather experienced over the whole of continental Europe on the previous day, and, on Mondays, a brief summary of the weather experienced during the previous week.

The standing portion of the reports, such as the maps and mean tables, is printed in blue, while the information for each day is in black.

5 *Extra Stations*, furnishing returns with less completeness and detail than those of the Second Order. These

returns are not published by the Office, but some of them are used in the checking of Storm Warnings. The rainfall values at these extra stations also are copied and supplied to Mr. George J. Symons, F.R.S., for publication in *British Rainfall*, an annual volume, of which he is the indefatigable compiler and editor.

A continuous record of the amount of bright sunshine is received from forty-four stations in the British Isles, of which some are First or Second Order Stations, whilst from others the sunshine record is alone received.

Such is the official machinery for the scientific study of the weather in the British Isles. It should be mentioned that the Meteorological Office, situated at 63 Victoria Street, Westminster, London, S.W., is under the management of the Meteorological Council. The Council, which was registered as a corporate body under the "Companies Act, 1867," on October 8, 1891, also administers an annual parliamentary grant for meteorological purposes. It was £15,300 in each of the financial years 1891 and 1892. The Secretary of the Council is Mr. Robert H. Scott, M.A. Univ. Dubl., F.R.S., and the Marine Superintendent is Navigating-Lieutenant C. W. Baillie, R.N., F.R.A.S.

Besides the Meteorological Office, the Royal Meteorological Society and the Scottish Meteorological Society have covered the United Kingdom with a network of climatological and phenological stations.<sup>1</sup> Each of these societies also publishes a journal containing many valuable papers on meteorological subjects. Mention should also be made in this connection of the wonderful system of rainfall observation which Mr. Symons, F.R.S., has organised through years of patient and untiring labour. In 1891 the number of perfect rainfall returns published in *British Rainfall* amounted to 2799—2091 in England, 168 in Wales, 359 in Scotland, and 181 in Ireland. England had about one observer for

<sup>1</sup> Phenological stations are those at which a registry is kept of natural periodic phenomena connected with the animal and vegetable kingdoms.

each 25 square miles, Scotland about one for each 80 square miles, and Ireland only about one for each 180 square miles.

In relation to the study of the meteorology of the British Isles, allusion should be made to two periodical publications of the Meteorological Office apart from the *Daily Weather Report*. These are (1) The *Weekly Weather Report*; (2) the *Monthly Summary*, issued as a supplement to the same.

The *Weekly Weather Report* has appeared since the beginning of February 1878. It is published regularly on Thursdays, and is illustrated by three maps for each day of the week. The maps show for 8 A.M. the temperature, weather, and sea disturbance; and for 8 A.M. and 6 P.M. the distribution of atmospheric pressure and the winds over and on the coasts of Europe. The information given on the first and second pages of each Report is based upon observations of temperature and rainfall made at seventy-six stations, and of sunshine records taken at forty-seven stations. The Reports contain also tables of "Accumulated Temperature." These are designed to give persons engaged in agriculture better means of estimating the manner in which vegetation is affected by temperature than those afforded by the more usual methods of treating the readings of the thermometer. The tables show for each week, and for the whole period from the beginning of the year, the weekly and progressive values, respectively, of the combined amount and duration of the excess or defect of the air temperature, above or below a suitably fixed standard or *base temperature*. The base value adopted is 42° F., as being nearly equivalent to 6° C., which has been considered by continental writers on these subjects to be the critical value, the temperature above which is mainly effectual in starting and maintaining the growth, and in completing the ripening of agricultural crops in a European climate. This base is also convenient as being precisely 10° F. above the freezing point, or melting point of ice.

Accumulated Temperature is expressed in Day Degrees—a day degree signifying 1° F. of excess or defect of temperature

above or below 42° F. continued for twenty-four hours, or any other number of degrees for an inversely proportional number of hours. It has been ascertained, by calculation from a considerable series of hourly observations at various places, that the accumulated temperature may be computed, with a very close approximation to the truth, from the observed daily maximum and minimum temperatures alone.

The *Monthly Summary* of the *Weekly Weather Report* gives for each calendar month the mean and principal values for the different elements—pressure, temperature, rainfall, and sunshine—and the differences between these and the averages for the corresponding months in a long series of past years. There are also four maps, showing the distribution of atmospheric pressure, wind, temperature, and rainfall, and the movements of the principal barometrical depressions observed during the month, as well as some brief notes as to the chief features exhibited.

To return to the *Daily Weather Report*, it may interest the reader to learn something about the composition of the weather telegrams which are sent at 8 A.M. by Greenwich time daily to the Meteorological Office, London. The telegraphic reports, which are addressed simply to “WEATHER, LONDON,” consist of two parts.

The first part is composed entirely of figures, arranged in groups of five each, in accordance with the Code approved by the International Meteorological Congress, held at Utrecht in September, 1874. The second part consists mainly of words, occasionally mingled with figures in groups, and is designed to throw additional light on the information given in the first part of the message.

The following numerical scales are used in drawing up the telegrams :—

*Wind Direction.*—The thirty-two different points of the compass are supposed to be numbered, beginning with 01 = N. by E. and 02 = N.N.E. (*true bearings*), to 08 corresponding to E., 16 to S., 24 to W., and 32 to N. According to

this scale, S.S.E. would be telegraphed "14," and W. by N. "25."

*Wind Force.*—This is estimated in accordance with the annexed scale, commonly known as the "Beaufort Scale," because it was originally drawn up by Admiral Sir F. Beaufort, in command of H.M.S. *Woolwich* in 1805. The wording has been altered so as to suit the present use of double topsails. Added to the table also is a column giving the *average* value in miles per hour travelled by the wind during the prevalence of the different forces.

TABLE I.—BEAUFORT SCALE OF WIND FORCE.

		Miles per hour.
0. Calm . . . . .		3
1. Light Air . . . . .	Just sufficient to give steerage way . . . . .	8
2. Light breeze . . . . .	That in which a well-conditioned man-of-war, with all sail set, and clean full, would go in smooth water from . . . . .	1 to 2 knots . . . . . 13
3. Gentle breeze . . . . .		3 to 4 knots . . . . . 18
4. Moderate breeze . . . . .		5 to 6 knots . . . . . 23
5. Fresh breeze . . . . .	That to which she could just carry in chase, full and by . . . . .	Royals, etc. . . . . 28
6. Strong breeze . . . . .		Topgallant sails . . . . . 34
7. Moderate gale . . . . .		Topsails, jib, etc. . . . . 40
8. Fresh gale . . . . .		Reefed upper topsails and courses . . . . . 48
9. Strong gale . . . . .		Lower topsails and courses . . . . . 56
10. Whole gale . . . . .	That with which she could scarcely bear lower main topsail and reefed foresail . . . . .	65
11. Storm . . . . .	That which would reduce her to storm staysails . . . . .	75
12. Hurricane . . . . .	That which no canvas could withstand . . . . .	90

As storms in the British Islands are rarely, if ever, so violent as those in tropical latitudes, great caution should be used in the insertion of extreme figures in the telegraphic reports, such as 12 for the wind and 9 for the sea.

TABLE II.—SCALE OF SEA DISTURBANCE AND WEATHER.

<i>Sea Disturbance.</i>		
0 = Dead calm.	4 = Moderate.	7 = High.
1 = Very smooth.	5 = Rather rough.	8 = Very high.
2 = Smooth.	6 = Rough.	9 = Tremendous.
3 = Slight.		

<i>Weather.</i>	
0 = Sky quite clear.	5 = Rain falling.
1 = Sky a quarter clouded.	6 = Snow falling.
2 = Sky half clouded.	7 = Haze.
3 = Sky threequarters clouded.	8 = Fog.
4 = Sky entirely overcast.	9 = Thunderstorm.

Any other phenomena must be reported in words after the groups of figures, such as "lightning last evening," "heavy dew," "aurora." In this scale the values 0 to 4 refer to the *amount* of cloud, not to its *density*.

*Time.*—00 or 24 stands for midnight ; 01 for 1 A.M., and so on every hour to 11 P.M., which is represented by 23.

Armed with the foregoing scales, the observer having taken the readings at 8 A.M. (Greenwich time) transmits a telegraphic message to "Weather, London," consisting of six groups of five figures each. Here is an example:—

97622    09549    96228    06253    50046    64485

The first group contains the reading of the barometer (omitting the first figure of the value), reduced to 32° F. and the mean sea level, for 6 P.M. on the previous day, and the direction of the wind (*true*, not magnetic) at the same hour. 97622 is thus resolved into: Barometer, 29·76 inches; wind, W.S.W.

The second group gives the force of the wind at 6 P.M. on the previous day, the weather and air temperature at the same hour. 09549 thus becomes: Wind force, 9, or a strong gale; weather, rainy; air temperature, 49°.

The third group supplies the reading of the barometer at 8 A.M., reduced to 32° F. at mean sea-level, and also the

direction of the wind. Thus 96228 becomes: Barometer, 29·62 inches; wind, N.W.

The fourth group gives the wind force, weather, and air temperature at 8 A.M., for 06253 = wind force, 6, or a strong breeze; 2, half-clouded sky; dry-bulb thermometer, 53°.

The fifth group contains the reading of the wet-bulb thermometer at 8 A.M., and the amount of precipitation or rainfall, including melted snow and hail, during the last twenty-four hours, in inches, tenths, and hundredths, omitting the decimal point. For example: 50046 = wet-bulb temperature, 50°; rainfall = ·046 inch.

The sixth group gives the maximum and minimum temperatures in the last twenty-four hours, together with the amount of sea disturbance at 8 A.M. At inland stations the last figure is of course always 0. Thus, 64485 means that the maximum temperature in the twenty-four hours ending 8 A.M. has been 64°, the minimum temperature has been 48°, and the sea is "rather rough" at 8 A.M. (*i.e.* sea disturbance, 5).

Certain selected stations send in additional reports in three groups only at 2 P.M. and 6 P.M. daily. These groups correspond closely with the third, fourth, and fifth groups in the 8 A.M. report. Special telegrams in threatening weather are sent in a similar way at other times as required.

By the adoption of this code system, a very full report can be condensed into what is equivalent to only six words—for, under the Post-Office Regulations, five figures, or a letter preceding or following a group of figures, are counted as only one word, and charged for accordingly. The foregoing information has been culled from the official instructions for meteorological telegraphy, prepared for the use of observers exclusively, in accordance with the International Code adopted at Utrecht in September 1874.

The meteorological conditions which possess the greatest interest and value for Medical Officers of Health, from their influence on the prevalence of disease and on the death-rate are, undoubtedly, *temperature, humidity, and rainfall.* But



as these depend to a large extent on the state of the barometer, the direction and force of the wind, and the condition of the sky as regards cloud, fog, and mist or haze, it is necessary to study the whole group of meteorological phenomena. In subsequent chapters, then, a detailed description of the various instruments required by the observer will be given, and the practical application of the information afforded by them will be explained.

The instruments required for a Second Order Station are a standard barometer, maximum and minimum thermometers, dry and wet bulb thermometers, and a rain gauge. All the four thermometers named should be suspended in a properly placed Stevenson thermometer screen (see p. 108). These instruments—barometer, four thermometers, and rain gauge—are indispensable, but besides them it is desirable to have also a black-bulb maximum thermometer *in vacuo*, a bright-bulb maximum thermometer *in vacuo*, and a minimum thermometer (graduated on the stem, without attached scale) for terrestrial radiation, one or more earth thermometers, an anemometer, and a sunshine recorder. All the thermometers should be graduated on the stem, and only such instruments should be used as have been verified at Kew Observatory, so that the “index-error” may be known.

## CHAPTER V

### HISTORY, ORGANISATION, AND WORK OF THE UNITED STATES WEATHER BUREAU

#### 1. *Historical Sketch*

THE development of interest in meteorology in the United States dates from the earliest times of its history. It was apparently Benjamin Franklin who first called attention to the progression of weather from west to east. He noted that a north-easterly storm appeared earlier at Philadelphia than at Boston.

It was Thomas Jefferson, afterwards President of the United States, who first undertook in that country simultaneous meteorological observations. From 1772 to 1777 he carried on such observations at Monticello with Mr. (afterwards Bishop) Madison, who was located at Williamsburg, both in Virginia, and about 120 miles apart.

With the invention of the telegraph by Morse, in 1837, came almost immediately the idea of collecting at one place simultaneous observations from different parts of the States; and on this followed, in about ten years, the idea of charting these instantaneous observations, and deducing from this chart some conclusions as to the future weather. This idea was proposed and vigorously canvassed by Commodore Maury in the early fifties. It was put into operation by Professor Henry about the same time, and continued until the breaking

out of the Civil War, when it was discontinued. Professor Henry used a wall map, with movable symbols. Each day, when the observations were received, they were entered on this map, and from the appearance of the map he drew certain conclusions about the weather, which were transmitted to Congress, and attracted much attention. On the occurrence of the late Civil War the matter was dropped until 1869, when Professor Cleveland Abbe, then Director of the Cincinnati Observatory, undertook the collection of data and the forecasting of the weather for the Cincinnati Board of Trade. The data was collected free of cost by the Western Union Telegraph Company, and the map employed by Professor Abbe was made up in the local office of that Company by the manager at Cincinnati.

In the meantime very great interest was being taken in the same direction by Professor I. A. Lapham, of Milwaukee, Wisconsin, and it was perhaps Professor Lapham who personally interested a prominent member of Congress from Wisconsin, Hon. H. E. Paine, who finally introduced into Congress the bill which, on becoming law, created the Weather Service of the United States. In the session of February 9 to April 20, 1870, a joint resolution was passed by Congress, which required the Secretary of War to take meteorological observations at the military stations in the interior of the continent, and at other points in the states and territories of the United States, and to give notice on the northern lakes and on the sea-coast, by magnetic telegraph and marine signals, of the approach and force of storms. At the same session an appropriation of \$15,000 was made to carry into effect the foregoing resolution. This work was placed by the Secretary of War in the hands of the Chief Signal-Officer, as it involved questions of signalling and had been recommended by him. At this time General Myer was Chief Signal-Officer, and it was very fortunate for the meteorological service of the States that it was first placed in such energetic hands.

On March 3, 1871, an appropriation was made for this service in the following terms:—

“For manufacture, purchase, or repair (of) meteorological and other necessary instruments; for telegraphing reports; for expenses of storm-signals announcing probable approach and force of storms; for instrument shelters; for hire, furniture, and expense of offices maintained for public use in cities or posts receiving reports; for maps and bulletins to be displayed in chambers of commerce and boards of trade rooms; for books and stationery, and for incidental expenses not otherwise provided for, \$102,451.”

On June 10, 1872, another Appropriation Bill was passed, the preceding being the first appropriation looking to the establishment of a meteorological service throughout the country. The latter bill repeated the former, and after the word storms added the following words, “throughout the United States, for the benefit of commerce and agriculture,” and at the end of the clause, in the nature of legislation, was inserted the following proviso: “Authorising Secretary of War to provide for such stations, reports, and signals as may be found necessary.”

Annual appropriations were made thereafter for the service, and in terms enlarging its scope, until it was transferred, in 1891, to the Department of Agriculture as the Weather Bureau.

The first weather bulletin of the new service was issued November 1, 1870, and the first storm warning a week later. The first weather map appeared on January 1, 1871. This was not the earliest weather map published, because before it there had been those issued under the direction of Professor Abbe, and even before that a series of weather maps had been started elsewhere. In 1861, Admiral FitzRoy inaugurated the British system of weather charts and forecasts. On September 16, 1863, Leverrier, at Paris, France, began the publication of a series of weather maps, which have continued without interruption from that day to this. The American series was the third of the twenty or more which are now in progress in various parts of the world.

General Myer continued in charge of the meteorological service, as Chief Signal-Officer, until his death on August 24, 1880. His administration of this service was characterised by very great energy, which was followed by great success. The forecasts made at that time had, to a larger degree than at any subsequent time until quite recently, the popular approval and confidence. General Myer was a very strong, decisive, and exact executive officer. It was to him that the popular nickname of "Old Probs." was attached, because the official forecasts were then published as "probabilities." Not one of his successors has arrived at so high a grade of general favour as to be endowed with a popular, semi-humorous, and semi-affectionate nickname.

After the decease of General Myer, General Wm. B. Hazen became Chief Signal-Officer, the date of his appointment being December, 1880. He died January 16, 1887. His administration of the meteorological service was of a distinctly different character from that of General Myer. It was characterised, not by such administrative energy, but by a notably greater interest in the scientific side of meteorological work. During the administration of General Hazen there was a very large growth and development of scientific meteorology. General Myer always held that scientific work should be left to private enterprise. It was General Hazen's idea that the meteorological service was to be in advance of private enterprise quite as much in the scientific work as in the practical work. It was his belief that the opportunities for scientific study afforded by the general weather service of the United States were far in advance of any opportunity which could be at the command of an individual.

General Hazen was succeeded by General (at that time Captain) A. W. Greely. He was senior assistant at the time of General Hazen's decease, and assumed charge until a Chief Signal-Officer was appointed. He was nominated by the President for Chief Signal-Officer and Brigadier-General on February 16, 1887, and was confirmed by the Senate in these

places March 3, 1887. General Greely had conducted the exploration party of the Signal Service to Lady Franklin Bay in the polar regions, had charge while they remained there, and was one of the few survivors who returned to the United States. General Greely remained in charge of the meteorological service until it was transferred by law from the War Department to the Department of Agriculture on July 1, 1891. He is still in charge of the Signal Service, now relieved of its meteorological duties. The agitation for the transfer from military to civilian hands had existed for a long time, and had been the source of much hard feeling, both in the Signal Service itself and among meteorologists outside of the service.

On October 1, 1890, a bill was finally passed which provided that "the civilian duties now performed by the signal corps of the army shall hereafter devolve upon a bureau, to be known as the Weather Bureau, which on and after July 1, 1891, shall be established in and attached to the Department of Agriculture." In accordance with law the service was so transferred, and Mr. Mark W. Harrington, then Professor of Astronomy and Director of the Observatory at the University of Michigan, and founder and editor of the *American Meteorological Journal*, was placed in charge.

By the terms of the transfer the Chief of the Weather Bureau, under the direction of the Secretary of Agriculture, has charge of the forecasting of weather, the issue of storm warnings, the display of weather and flood signals for the benefit of agriculture, commerce, and navigation, the gauging and reporting of rivers, the maintenance and working of sea-coast telegraph lines, and the collection and transmission of marine intelligence for the benefit of commerce and navigation, the reporting of temperature and rainfall conditions for the cotton interests, the display of frost and cold-wave signals, the distribution of meteorological information in the interests of agriculture and commerce, and the taking of such meteorological observations as may be neces-

sary to establish and record the climatic conditions of the United States, or as are essential for the proper execution of the foregoing duties.

The first Appropriation Bill set aside a considerable sum for the distribution of forecasts to farmers. For this reason, and because of the transfer of the Bureau to the Department of Agriculture, especial attention has been given since the transfer to the more extensive and complete distribution of the forecasts to country communities and especially to farmers.

The expenditures for the Weather Service of the United States, except in so far as is stated above for the first years, cannot be easily made out from the accounts, until 1882. This is because under the system practised in the War Department, the accounts are not kept separate for individual bureaux, but so far as pay and allowances are concerned are mingled with the accounts of other bureaux. Beginning with 1882 it is practicable to separate them and ascertain the amount actually expended for the meteorological service. These amounts are as follows :—

Fiscal year ending June 30.	Amount Expended.
1882 . . . . .	\$988,615·90
1883 . . . . .	993,520·00
1884 . . . . .	984,451·30
1885 . . . . .	966,076·44
1886 . . . . .	960,812·06
1887 . . . . .	902,042·67
1888 . . . . .	909,410·74
1889 . . . . .	853,396·27
1890 . . . . .	810,622·59
1891 . . . . .	877,659·80
1892 . . . . .	830,783·33 <sup>1</sup>
1893 . . . . .	892,805·20 <sup>1</sup>
1894 . . . . .	850,000·00 <sup>2</sup>
1895 . . . . .	854,223·00 <sup>3</sup>

<sup>1</sup> Accounts not yet permanently closed.

<sup>2</sup> Approximate. (Year not completed at time of writing.)

<sup>3</sup> Official estimate submitted to Congress.

Most of the employees were at first enlisted men in the army, generally of the rank of privates only, with officials of higher rank in the central office at Washington City. Arrangements were soon made by which they could have promotion through the non-commissioned grades, and eventually for admission to the commissioned grades, but the latter was rarely effected. The change in *personnel* has been slow and conservative, and there are now (1893) many men in the service who have completed their twentieth year in its duties. The enlisted men were protected from partisan aggression by the fact of enlistment. During General Greely's administration, by the Sundry Civil Act, approved October 2, 1888, it was provided that any person performing duty in any capacity as officer, clerk, or otherwise, who has heretofore been paid as an enlisted man, may be continued in such office, clerkship, or employment. This amounted to placing the Signal Service force in the city of Washington under the control of the Departmental Civil Service rules. Under Chief Harrington's administration, on February 1, 1893, by order of the President, the force outside of Washington was brought within the provisions of the Civil Service Act, and the Civil Service protection of the employees of the Bureau was completed, as far as was compatible with the present standing of the law.

Professor Abbe was asked by General Myer to join the service at the beginning of its meteorological work, and he has remained in the service continuously from that time to this. Major H. H. C. Dunwoody was assigned to the service early in its history and still remains with it. He is the only officer of the army who has remained continuously with the civilian Weather Bureau. Among the better known names of those who have been connected with the meteorological service are Wm. Ferrel (1882-86), deceased, September 18, 1891; Dr. T. C. Mendenhall (1885-87), now Superintendent of the U.S. Coast and Geodetic Survey; I. A. Lapham (1871-72), and Dr. Carl Barus (1892-93). Professor Loomis



was for many years in close connection with the service, if not actually employed in it. Among those remaining in the service may be mentioned Professor H. A. Hazen (not of kin to General W. B. Hazen), whose service began in 1881, Professor C. H. Marvin (from 1884), and Professor F. H. Bigelow (from October 1891).

Early in his administration General Myer attempted to give to his observers a fundamental knowledge of meteorology, and for this purpose established a training school at Arlington, across the Potomac from Washington. This was at first called Fort Whipple, later Fort Myer. General Myer's plan was enlarged by General Hazen, until the training school at Fort Myer included both observers and officers, and courses of training, ranging all the way from those of the drill-master in infantry, cavalry, and artillery practice, to courses on physics, electricity, and meteorology by competent professors. This school was closed in 1886 by order of the Secretary of War, and against the protest of General Hazen. It has not been resumed, and the better and more promising state of general education in meteorology makes its existence less necessary. The Bureau endeavours to encourage in a great many ways the increased pursuit of meteorology in schools of all grades, and is meeting with gratifying success. General Hazen made strong endeavours to attract well-educated young men into the service, and had a fair measure of success. Many of these men still remain in the service, while others have become successful teachers. Those who now enter the service must have a good academic education and some knowledge of meteorology to start with. They then have a definite course of practical instruction under the observer in charge. When they reach the grade of Local Forecast Official they are brought to Washington for a brief practical course in weather predictions. Appointment to a professorship in the Weather Bureau now involves a competitive test of exacting character, as may be judged from the following quotation from the latest announcement :—

“The examination will be open to all. Success in practical forecasting will count 75 per cent of the examination. An essay upon ‘Weather Forecasts, and how to improve them’ will count  $12\frac{1}{2}$  per cent; and an examination on meteorology (text-book, Waldo’s *Modern Meteorology*) will count  $12\frac{1}{2}$  per cent.

“Intending competitors must prepare and forward to the Chief of the Bureau an essay, not exceeding 3000 words, upon ‘Weather Forecasts, and how to improve them.’ Each essay to be signed by a *nom de plume*, with true name and address in sealed envelope accompanying. These papers must be in the hands of the Chief of the Bureau by December 1, 1893. The judges will be the Chief, the Assistant Chief, and one other. The best ten essays will be selected, and the authors notified to present themselves at this office for competitive test in forecasting, and further examination as to their knowledge of meteorology.”

Among the most important dates in the history of the meteorological service of the United States are the following:—

1871, November 13. First exchange of observations with Canada. This continues to the present and is very helpful in the forecast work of the Bureau. Arrangements are now (1894) in progress for a similar exchange with Mexico.

1872, January. As authorised by the Appropriation Bill for that fiscal year, the service arranged for reports of the stages of rivers, and in the following spring these were utilised in forecasts of floods.

1872, September 3. First balloon ascent of the Signal Service for meteorological purposes. The ascent was made by Samuel A. King, aeronaut, and George C. Schaeffer jr. as meteorological observer.

1873. In the autumn of this year began the report of observations from the West Indies.

1875, July 1. On this date began the publication of the bulletins and charts of international meteorological obser-

vations. The first was for the date of January 1, 1875. The series was discontinued at the end of 1887, but the monthly and annual summaries continued to 1889.

1876. Stations were established at St. Michael's and St. Paul's in Alaska.

1881-84. The international polar explorations were begun by the United States in 1881. The Lady Franklin Bay party returned in 1884.

1881, April 11. The movement for the assistance of state weather services was initiated by a letter of this date.

1887. In May the first weather crop bulletin was published.

1887. The marine meteorological service was surrendered to the Hydrographic Office of the Navy.

1888. A beginning was made in the installation of automatic barographs and thermographs at stations, thus enabling hourly readings to be made of the principal meteorological elements.

1889. The publication of the Bibliography of Meteorology was begun by the appearance of the first part in this year.

1891, July. The system of Local Forecast Officials was first put in operation.

1892, Spring. The special investigation of the Great Lakes was begun.

1892, Summer. The first systematic study of thunderstorms by the meteorological service.

1892, August. The first meeting of the Association of State Weather Services.

1893. Continuous practice work by all forecasters was introduced; the competitive idea for filling professorships with accomplished forecasters was adopted; the Flood Section was reorganised and local predictions placed in the hands of local forecast officials; the first current chart of the Great Lakes was issued; the first annual volume in the form fulfilling the international requirements was published.

## CHAPTER VI

### HISTORY, ORGANISATION, AND WORK OF THE UNITED STATES WEATHER BUREAU (*continued*)

#### 2. *Organisation*

THE various bureaux in Washington City are, with one or two exceptions, directly under a member of the Cabinet. The Weather Bureau is under the Secretary of Agriculture. As in the other bureaux, under their proper Secretaries, he can dictate the policy of the Bureau, and can appoint or dismiss any or all employees, with the exception of the Chief of the Bureau, who is appointed by the President and confirmed by the Senate; and even in this case the wishes of the Secretary would always receive favourable consideration. While the officers of the Bureau may be changed at the will of the Secretary, as a matter of fact such change is infrequent, except in the force of messengers and labourers. The chief officers of the Bureau are continued with little reference to changes of administration, and in the technical observing force such change is practically unknown.

The Chief Signal-Officer, while in charge of the meteorological service, was a brigadier-general in the army and received the compensation of that rank, which, with allowances, is about \$6000. The Chief of the Weather Bureau, since the transfer, receives a salary of \$4500, without allowances. The Chief Signal-Officer was accustomed to surround

himself, for his personal aides, with officers of lower rank, from major to lieutenant, and the *personnel* and number varied at his desire. The Chief of the Weather Bureau has no such force of employees to draw upon. He was permitted by the law of transfer to select four army officers skilled in the work of the service, to tide him over the change from military to civilian *régime*. As a matter of fact only three such details existed at any one time, and in 1893 the number was reduced to one. Besides that the Chief of the Weather Bureau is surrounded by his staff of civilian professors, four in number, and these positions are quite permanent.

Under the Chief of the Weather Bureau, and aiding him in the control of the entire force in Washington, and outside, are the Assistant Chief, the Chief Clerk, the Disbursing Officer, Property Clerk, and four Inspectors.

The Assistant Chief is the *alter ego* of the Chief, and takes his place and duties during the Chief's absence from the city. He is also Chief of the Forecast Division, having direct charge of the most important work performed by the Bureau. In 1893 the Assistant Chief was Major H. H. C. Dunwoody, the detail from the army already referred to.

The Chief Clerk has control of the clerical force in Washington, and also of all questions of *personnel*, under the Chief of the Bureau, outside of Washington. He has also direct charge of the correspondence and of the files. The salary of the Assistant Chief allowed by law is \$3000, that of the Chief Clerk \$2250.

The Disbursing Clerk of the Bureau has charge of all disbursements and receipts of money, and is responsible directly to the Disbursing Officer of the Department of Agriculture, being thus, more directly than any other officer than the Chief of the Bureau, responsible to the Secretary of Agriculture.

The Property Clerk has charge of all property of the Bureau, makes arrangements for purchases and sales when

necessary, receives property, tests its quality, recommends acceptance or rejection, and has it packed and distributed to the various parts of the United States where it is needed. Every item of property in the entire Bureau, from one corner of the United States to the other, is under the direct charge of this officer, and must be accounted for. The system of book-keeping is so complete that should a question arise as to any individual thermometer, for instance, from among the thousands that have been issued for use, by consulting his books it can be ascertained exactly where it is and in whose charge it is, and the receipt for the same can be found.

The Inspectors are charged with the duty of personally supervising the stations' outfit, their *personnel*, and their work. They visit stations at regular intervals to ascertain if the property is in perfect order, if the instruments are in good condition, and if the work is properly performed. They are also sent to stations when it is necessary to have any special inspection performed, for purposes of discipline, or for any other reason.

The appropriations for the Bureau are made annually by Congress, and are a part of the appropriations for the Department of Agriculture. An estimate is carefully made by the officers of the Bureau some months before the session of Congress in which the appropriation must be made, and about a year before the appropriation can become available. This estimate is submitted to the Secretary of Agriculture, and after receiving his approval passes to the Committee on Appropriations of the House of Representatives. On receiving their approval it is submitted to Congress.

Among the various divisions of the central office at Washington stands foremost the Forecast Division. It has charge of forecasts, of floods, of the telegraphic section, of storm signals, and of the practice which is continuously performed by the forecasters. The forecasts are made twice a day, immediately on receipt of the telegraphic reports of

observations from the regular telegraphic stations. As soon as the forecasts are made, the maps are printed in the Bureau office, and the forecasts given to the Associated and United Press Companies, by which they are distributed over the United States. Each forecast contains statements concerning the weather for divisions of the United States, each division being usually a State, or a large part of the State. The forecast officials on duty at Washington are kept in constant practice. They generally have the rank of professor. Besides this practice, which occupies a fractional part of the day, each professor is entrusted with other and important duties. One has charge of the instrument-room and of all duties relating to instruments. Another has charge of the *Monthly Weather Review*, which he edits, and also of a great variety of duties relating to theoretical and scientific meteorology. Another has charge of the collection of statistics concerning tornadoes and other destructive storms. And the fourth is entrusted with the special investigation of the relation of meteorology to magnetism. The telegraph section under this division has a force of operators who receive and send telegrams, and have charge of the various coast telegraph lines belonging to the Weather Bureau.

The State Weather Service Division is in charge of the weather-crop work, the thunder-storm work, the distribution of temperature and weather signals, and the snow charts of the Bureau. In general its work is essentially climatological. It is the centre of the State Weather Services scattered over the United States. It receives weekly during the crop season the weather-crop reports from the state centres, and digests them into the Weather-Crop Bulletin, which is immediately sent to press, and appears ready for distribution the day the reports are received. It prepares and sends to the state centres, for distribution from those points, the signals for temperature and weather which are intended in general for the agricultural communities; and in a manner similar to the weather-crop bulletins, during the winter

season it collects the data for snow charts, and has the charts printed and distributed the day the data are collected. It is also in charge of the special thunder-storm work, this work being done through the machinery of the State Weather Services.

The Records Division is entrusted with the care of the records, with the compilation of data of all sorts required for the work of the Bureau or by the general public, and with the publication of reports, more especially the annual reports made for general information. The accumulation of records in charge of this division has, after over twenty years of work, become extremely great, and includes not only the records of the meteorological service which finally ended in the Weather Bureau, but also of that meteorological service which was carried on previously by the Smithsonian Institution, and that also by the Surgeon-General, which to some extent preceded that of the Smithsonian. These records are kept in a fire-proof vault in such form as to be readily accessible. Other private records have been added to these, either by purchase or gift, until the collection forms by far the most complete record of climatological interest to be found in the United States—so complete, in fact, that its use is entirely indispensable to any one who wishes to make a competent study of any feature of the weather or climate of the States. In the compilation of data for the general public a great deal of time is spent by the Records Division. All sorts of questions relating to all sorts of features of the weather and climate come constantly to the Bureau. The replies must be made with very great care, so as to be thoroughly authentic. No less important is its duty in checking observations and in detection of errors. The system is so complete that the errors are charged up against the individual observers, and at regular times a statement is issued giving the names of the observers who have been the most free from errors in the preceding interval.

To the Instrument Section is entrusted the question of



purchase and shipment of instruments, their test when received, their condition at stations, their repairs when needed, and the examination of the automatic records as they are received from the various stations. It is also occupied with devising new forms of instruments and new methods of taking observations, and performs a large amount of work in physics, more or less directly connected with this purpose.

The Publications Division is in charge of the publishing and mailing of the material of the Weather Bureau. Those matters which are urgent are published in the Bureau office. In addition to that there are a few other publications made by the Bureau office which are not urgent, but are used to fill up the intervals of time on the part of the compositors and pressmen. The most of the other matter issued by the Bureau is published by the Government Printing Office at a fixed price, the same being deducted from the appropriation for the Bureau. In a few special cases the publications of the Bureau are made by joint-resolution of Congress, in which case there is no charge against the Appropriations of the Bureau. The publications made in the Bureau office are the maps of all sorts, the reports requiring immediate distribution, and special publications of the same sort. Of the other publications, not matters of so much urgency but actually published in the Bureau, are many of the innumerable "forms" used in the collection and distribution of data, the *Monthly Weather Review*, which is prepared and printed entirely within the chief office at Washington, and some of the series of printed bulletins in octavo form issued by the Bureau. Also lithographed maps and charts, though not urgent, are usually printed by the Bureau. This division has in its charge a draughting-room, in which maps are prepared for printing and other necessary drawings are made; and the composing-room, in which a considerable number of printers are employed. In this division labour is saved in all possible ways, the most notable one, perhaps, being that of

the use of a long series of logographs. In the publication of weather tables and forms the same combination of letters and figures frequently recurs, and in this case a single type has been cast to include these letters and figures. In this division is also included the press-room. A large part of the work of the Bureau is lithographed, because the lithograph makes the cheapest, easiest, and readiest means of publishing urgent data in chartographic form. As a result a force of lithographers is kept in connection with the press-room. Also connected with the division are the folding and stitching room and the mailing-room. The mailing lists are kept with care, in order to economise the publications of the Bureau.

Connected with the general office at Washington is also a library, containing a number of books and pamphlets as shown by the accompanying Table, so arranged as to show the annual growth. The library also contains many meteorological and some geographical charts.

These books are obtained in considerable part by exchange with other Meteorological Services and with various Governments, in part also by gift, but in large part by actual purchase. The result is a technical and special library of unusual size and value. So large and complete is it, that with the aid of correspondents from all over the world, the librarian has undertaken to publish a bibliography of meteorology.

In 1884 the Signal Office began the compilation from the printed literature comprising the books, pamphlets, memoirs, and papers in serial publications of all kinds, relating to meteorology and its applications. In 1887 the number of titles collected and classified was about 50,000. Since this time annual additions have been made, and the references have been brought down to January of 1892. The collection at the end of 1893 comprises about 65,000 titles. From 1889 to 1891 portions of the bibliography were lithographed and milligraphed.

BOOKS AND PAMPHLETS ADDED TO THE LIBRARY OF THE WEATHER  
BUREAU FROM 1873 to DECEMBER 1, 1893

Fiscal Year ending June 30.	No. of Volumes.	Gain.	No. of Pamphlets.	Gain.
1873	2,470		230	
1874	...	542	...	240
1875	3,012		470	
		298		119
1876	3,310		589	
		322		85
1877	3,632		674	
		189		66
1878	3,821		740	
		328		82
1879	4,149		822	
		276		67
1880	4,425		889	
		327		69
1881	4,752		958	
		1827		
1882	6,579			
		1174		
1883	7,753			
		963		
1884	8,716			
		1027		
1885	9,743			
		797		
1886	10,540			
		565		
1887	<sup>1</sup> 9,845			
		475		
1888	10,320			
		791		
1889	11,111		2500	
		421		150
1890	<sup>2</sup> 11,532		2650	
		950		350
1891	12,482		3000	
		760		545
1892	<sup>3</sup> 12,742		3345	
		1170		653
1893	13,912		3998	
		389		642
Dec. 1, 1893	14,301		4640	

<sup>1</sup> 1260 volumes transferred to the War Department Library.

<sup>2</sup> 375 volumes discarded.

<sup>3</sup> 500 volumes and 200 pamphlets relating to military signalling transferred to the Signal Service.

The following Table gives statistics relating to these portions :—

	When issued.	No. of titles.	No. in library of Weather Bureau.	Percentage in library of Weather Bureau.	Number of authors.
Part I. Temperature	1889	4,400	2100	47	1800
„ II. Moisture	1889	5,500	2435	44	2650
„ III. Winds	1891	2,000	1100	55	960
„ IV. Storms	1891	4,300	2380	54	1647
Total . . .	...	16,200	8015	50	...

In addition to these various sections of the Bureau there is a large mass of correspondence to be cared for. This comes under the direct cognizance of the Chief Clerk, who has a small force of clerks under him to perform this work. The letters received are assigned to the various divisions or individuals most competent to answer them. The replies are drawn up by these divisions or individuals, with the aid of stenographers, and sent to the Chief Clerk for supervision or signature before being mailed. Correspondence, manuscripts, and other papers of importance are passed over to a special official called the File Clerk, who has entire charge of the files of the Bureau, and whose duty it is to speedily find any paper of any date required by any officer, and to return it to its place when it comes back to him.

Especial attention is also paid to comments and criticisms of the Bureau from whatever source they come, and to this part of the time of one clerk is devoted. The observers at stations are instructed to send to the central office all comments on the Bureau, and especially criticisms of it. This serves the double purpose of keeping the Bureau in close touch with the popular wants, and of informing the central office of the way in which these wants are filled at the stations. These matters are kept filed in such a way as to be of ready for reference.

There is also connected with the office in Washington a considerable number of labourers and messengers, who perform the various duties of this sort which may arise. They are under a Captain of the Watch. An important duty, and one which takes a considerable number of persons, is the distribution of the weather maps, when printed, to the various public offices and other places in the city of Washington where they are of use.

In the scientific and clerical force at Washington 107 persons are employed. In the force relative to the buildings and grounds, including labourers, there are 44 persons, and in the publications force, 32 persons, making in Washington a total of 183 persons employed, with annual salaries ranging from that of the Chief of the Bureau to that of the lowest labourer, at \$300 per annum, and that of charwoman at \$240. The principal part of this force is in the clerical grade, receiving salaries which range from \$720 to \$1800.

What precedes relates only to the central office in Washington City. There is also a large number of employees scattered at numerous stations over the entire United States. These stations are: Regular telegraphic stations, stations in the West Indies (excluding stations in Canada, with which we carry on only an exchange, these stations being controlled by the Canadian Service), river and flood reporting stations, voluntary stations, mountain stations, telegraph line repair stations, storm signal stations, temperature and weather stations, and stations in the cotton, rice, and sugar regions; also stations for special reports of thunder-storms and others. The accompanying Table (I.) shows the number of reporting stations of the meteorological service of the United States for the different years since the establishment of this service. In the same Table is the number of State Weather Services, to which reference will be made hereafter.

TABLE I  
REPORTING STATIONS OF THE UNITED STATES  
METEOROLOGICAL SERVICE

YEAR.	TELEGRAPH.			River and Flood Reporting.	No. of State Weather Services.	No. of Voluntary Stations.	Mountain Stations.
	In United States.	Exchange with Canada	In West Indies.				
1871	55	1	0	0	0	0	1
1872	65	7	0	1	0	0	1
1873	71	11	4	39	0	0	3
1874	86	15	6	40	0	332	2
1875	88	15	6	40	1	327	2
1876	130 <sup>1</sup>	15	6	43	1	316	2
1877	123	12	0	43	1	294	2
1878	146	12	1	51	1	277	2
1879	160	12	1	49	1	251	2
1880	172	16	1	49	1	245	2
1881	155	17	1	49	2	225	2
1882	152	18	1	50	8	198	2
1883	139	17	1	58	8	253	2
1884	147	12	1	71	13	286	2
1885	160	25	1	96	16	311	2
1886	160	24	1	96	19	307	2
1887	145	23	1	96	19	289	2
1888	145	20	1	92	24	1069	1
1889	145	20	1	85	26	1679	0
1890	147	20	4	118	28	1924	0
1891	152	20	4	145	30	2028	0
1892	148	20	6	177	42	2180	2
1893	145	21	5	209	42	2367	2

<sup>1</sup> Includes 38 Military Telegraph Stations.

The regular stations of the meteorological service are those from which telegraphic reports are received now twice, formerly thrice, daily. They may consist of a larger or smaller number of officials and employees, varying from one to seven or eight. Where the number is larger it consists of a forecast official in charge, assistant observers under him, those occupied in making the maps, assistants, and messengers. The salaries at these stations range from that of the local forecast official,

\$1500, to that of the messenger, which may be as low as \$360 or \$300 per year. They have also a regular outfit of instruments, consisting of barometer, thermometer, anemometer, and psychrometer at all of the stations, and in addition to these, at more or less of the stations there is a series of self-registering instruments, barograph, thermograph, complete anemograph, pluviograph, sunshine recorder, and possibly others in special cases. They also usually have a small library, consisting of the publications of the Bureau and a few other practical works intended to aid in self-training, and also in making proper and suitable replies to questions addressed to them by the public. At these stations every possible use is made of the telephone and the telegraph, and other means of rapid communication. They are generally located in public buildings, when such buildings exist in the city in which they are placed. In fact, the General Statutes contemplate in the construction of new public buildings the leaving of space for the Weather Bureau, as well as for other Government services which require to be represented in the city in question. These stations publish, in many cases, weather maps by a special process called the milliograph process,—a rapid method for turning out fair specimens of map-making,—the drawing and printing, folding and mailing, being all done by the employees at the station in question. In fact, many of these larger stations outside of Washington are small central stations, something like that in the city of Washington, and intended for the distribution of meteorological information in their vicinity, as Washington station is intended for the distribution of this information over the United States in general.

A list of regular Weather Bureau stations, alphabetically arranged, will be found in Appendix I.

Next come the State Weather Services, the centre for these services being generally in the capital of the state. In column 6 of Table I. will be found the number of State Weather Services acting in connection with the general

meteorological service of the United States. They are usually in close touch with the local state bodies interested in the work of the Bureau. They are frequently called on to make representations before the State Legislatures. They are nearly always in close contact with State Boards of Agriculture, and generally some member of the Board is one of the officials of the State Weather Service. These stations are centres for the voluntary observers of the states in which they are placed. From them are distributed the materials and information required by the voluntary observers, and to them are sent by these voluntary observers the meteorological and crop reports which they make at regular intervals. The voluntary stations are furnished with the instruments necessary for measuring temperature and precipitation, and are expected also to report on winds and clouds. They take careful observations of the state of the crops, and from week to week this information is telegraphed by them to the central station for the state. It may then be printed by the State Weather Service by counties and distributed in the state; but in any case it is condensed in a telegram which is sent to the central office at Washington, which telegram is employed in the construction of the Weather-Crop Bulletin issued weekly during the crop season by that office. The State Weather Service centre is also the centre for the distribution of weather and temperature signals intended for the information of the country districts, and more especially for farmers. Column 7 of Table I. shows the number of voluntary stations in the United States for each year of the service. It will be observed that the number in 1893 was nearly 2400. It is the aim of the Bureau to distribute these stations with as great uniformity as possible over the entire United States, and although in some regions where there is a special interest in climate, as in the vicinity of Boston, Los Angeles, and San Francisco, the stations are more close together than elsewhere, yet it is the aim of the service to distribute them at distances of from twenty to fifty miles apart only.



The State Weather Services are due to the need of more detailed information concerning the meteorological elements of importance to crops and their effects on the current condition of the crops. Some of the States had independent services of their own, supported out of the State treasuries, as Iowa and Michigan. They had an independent corps of observers, and the endeavour of the national service to extend and complete its work brought it occasionally into conflict with the state services and caused duplication of work. This at an early date gave rise to the idea that the national and state services should join forces for harmonious and economical work. The movement was officially initiated by a circular letter by General Hazen proposing such a union, dated April 11, 1881. The movement at first met with some opposition, but this has been allayed, until now there are forty-two of such services. They cover the entire territory of the United States, except Alaska. The difference between the number of these services (42) and the total number of states and territories (49) is due to the combination of the six New England States into one service and the incorporation of Delaware into the Maryland Service. The active executive officer of these services, or his first assistant, is always an employee of the Bureau, and the best of these services are aided or supported by funds from the state treasuries. It is probable that such a service will soon be formed in Alaska, so that the entire area of the United States will be covered by this very efficient means of informing the public of the effect of the current weather on crops, and of collecting valuable climatological data.

The observers of the State Weather Services and the crop correspondents are volunteers and serve without pay. As part compensation for their disinterested services they are furnished with the publications of the Bureau. These observers represent the intelligent interest in the work of the Bureau in their respective localities. They are often professional men, well-informed farmers, men who have

retired from active business, or such Government employees as postmasters, and it is in a spirit of public enterprise that they perform, often for a long series of years, the work that the Bureau desires. There is no difficulty in finding such observers in the more thickly populated parts of the country, whether old or new, but in the thinly populated districts—as the arid regions—these stations are yet sparsely scattered. In Alaska the observers are generally missionaries. The materials obtained by these observers are used for state publications, as well as for those of the national service. The whole makes a federal union of weather services, reminding one of the Federal union of the States.

The River and Flood Section, under the Forecast Division, has especial charge of the river gauges, which are scattered at frequent intervals up and down the principal rivers, from which reports are received at regular intervals. The number of these stations will be found in column 5 of Table I. The duty of the River and Flood Section is the forecasting of the conditions of the rivers, more especially during the period of flood. This work has heretofore been entirely done in the central office at Washington and was in the hands of one officer, who was alone entitled to make forecasts concerning the state of the rivers. It has been found, however, that it is impracticable for a single officer to obtain the intimate familiarity of, and keep in mind the current knowledge of, all the details that are necessary for safe forecasting the entire length of important rivers. There are so many local conditions—the width of the river, opportunity for set-back—so many conditions that may happen accidentally, as when a levee breaks, or when at a certain height the river may pour over the banks into an empty space at one side—that it has been found necessary to divide up the work among a considerable number of men, who are stationed in the vicinity of the places where the forecasts are to be made. These men become familiar with the details mentioned above, and hence can perform the work more satisfactorily. This

policy has been introduced since the season of the floods of 1893, and has not yet been sufficiently tested. It is confidently expected, however, that its success will be much more considerable than has been experienced heretofore.

The cotton, rice, sugar, and other special services are intended for the protection of specific crops grown in limited areas. Special reporters are scattered through these regions, who report with special reference to the climatological needs of these individual crops. For the cotton interest this service has been found to be quite successful. There has not been so good an opportunity to test it for the rice and sugar interests.

Concerning the relations of the Bureau with the public more in detail, it may be said that the forecasts made at the city of Washington, and at the other stations throughout the United States where such forecasts are made, eighty-three in number, are placed at once in the possession of the news-gathering agencies in that vicinity and distributed throughout the entire region interested. The number of distributing centres annually is given in Table II., on the next page.

The forecasts made in the evening at Washington, or elsewhere, will therefore appear in the morning papers, and the forecasts made from the morning observations will appear in the afternoon and evening papers. Moreover, from Washington and from the various stations where maps are made, the maps are distributed with a free hand to all interests that find them useful. The edition actually employed will be found stated in Table III., on page 66.

The rule governing their distribution is, that they shall go only where they will be of general public interest, or to persons who are making a special study of meteorology. The result is, that for each map issued a considerable number of the public probably receive the information that they require. A certain number of newspapers have also reproduced a map on a small scale in their pages for a longer or shorter time. This is done by means of what is

TABLE II  
DISTRIBUTING STATIONS, UNITED STATES METEOROLOGICAL  
SERVICE

Year.	Storm Signals.	Weather and Temperature.	Frost.	Cotton Region.	Stations making forecasts (Weather and Temperature).	Station issuing Weather Maps.
1871	...	...	...	...	...	...
1872	19	...	...	...	...	...
1873	25	...	...	...	...	...
1874	42	...	...	...	...	...
1875	43	...	...	...	...	...
1876	48	...	...	...	...	...
1877	44	...	...	...	...	...
1878	90	...	...	...	...	...
1879	94	...	...	...	...	...
1880	102	...	...	...	...	...
1881	116	...	...	...	...	...
1882	120	...	...	144	...	...
1883	117	...	...	131	...	...
1884	110	...	...	150	...	...
1885	109	21	831	155	...	...
1886	116	216	801	147	...	...
1887	115	607	788	145	...	7
1888	118	1055	795	128	...	37
1889	110	783	840	114	16	30
1890	118	828	812	126	71	37
1891	122	1646	871	121	79	44
1892	124	1888	492 <sup>1</sup>	125	85	61
1893	156	1613	458	125	83	72

called a "chalk plate," a metal plate with a layer of chalk, on which can be drawn with a needle the outlines of the map. This serves long enough to take a stereotype from, and the stereotype can be inserted in the columns of the newspapers. This particular part of the service depends very much upon opportunities which cannot be influenced by the Bureau—largely due to local newspaper rivalry. It may perhaps be said with a fair approximation to truth that there are generally many hundreds of thousands, sometimes millions of copies of the daily weather maps made in the United

<sup>1</sup> Reduction due to discontinuance of frost warnings addressed to Operator.

TABLE III

Year.	Weather Maps issued from Washington.		Weather-Crop Bulletins.		Monthly Weather Review.	
	No. of Issues in Year.	Average Daily Edition.	No. of Issues in Year.	Average Edition.	No. of Issues in Year.	Average Monthly Issue.
	July 1, 1883, to June 30, 1884	92,303	280	...	...	80,700
July 1, 1884, to June 30, 1885	...	347	...	...	30,890	2574
July 1, 1885, to June 30, 1886	126,717	347	...	...	32,570	2714
July 1, 1886, to June 30, 1887	128,139	337	...	...	34,425	2869
July 1, 1887, to June 30, 1888	108,119	296	...	...	31,100	2592
July 1, 1888, to June 30, 1889	135,735	372	14,080	402	32,400	2700
July 1, 1889, to June 30, 1890	182,468	500	16,695	477	33,500	2792
July 1, 1890, to June 30, 1891	191,843	526	10,450	299	30,000	2500
July 1, 1891, to June 30, 1892	251,749	690	55,630	1,590	38,000	3167
Six months	105,730	577	514,672	25,733	28,500	1958
July 1, 1892, to June 30, 1893	117,560	557	76,233	2,178	44,154	3679

States, and distributed by means of the newspapers. In addition to this distribution of forecasts and maps, there is also the question of the correspondence, a large body of which is devoted to the information of the public. The Bureau also carries on a system of lectures wherever and whenever they are desired or required by interests of sufficient importance. Certain of the employees in Washington, and others scattered throughout the United States, are given permission, when asked, to appear before public bodies, schools or elsewhere, and in a familiar way explain the working of the Bureau and the uses of the weather map. This is found to be particularly useful in connection with the State Boards of Agriculture, and also in connection with the schools. In the larger cities copies of the maps are distributed to the schools, and this is also true in some smaller communities. In these places an official of the Bureau occasionally appears and, either to the teachers as a body, or in an individual schoolroom to the pupils, gives the necessary information. It has been found also desirable to ask the Boards of Trade in the various states to appoint meteorological committees to inspect the manner in which the employees of the Bureau perform their work in the places where these Boards of Trade are located. Many of these committees are interested and efficient, and annually make a report to the Chief of the Bureau as to the work of the station in their city. These reports often contain valuable suggestions for the improvement of the Bureau, or important statements as to the way in which the work is done.

Outside of Washington the number of employees who devote their entire time to the work of the Bureau, exclusive of the labourers and cleaners, is 306. Of these, 30 receive an annual salary of \$1500. These are the local forecast officials. Of the remainder, 14 receive a salary of \$1400; 24 receive \$1300; 35 receive \$1200; 60 receive \$1100; 62 receive \$1000; 48 receive \$840; 25 receive \$720; 6 receive \$500; and 2 receive \$480.

## CHAPTER VII

### HISTORY, ORGANISATION, AND WORK OF THE UNITED STATES WEATHER BUREAU (*continued*)

#### 3. *Forecasts*

^ THE main duty of the Weather Bureau is the forecast of the weather, and special attention is paid, therefore, to this part of the work. The other features of the work of the Weather Bureau are incidental to this.

v At the hour of 8 o'clock, 75th Meridian time, the observers of the Weather Bureau all over the United States, at each telegraphic station, proceed to take their observations. These observations are taken, so far as possible, in exactly the same way at each station, with similar instruments, and with exactly the same precautions against error and corresponding provisions for their correction. As soon as these observations are taken—a proceeding which usually occupies the observer but a few moments—they are at once reduced to the form of a telegram and expressed in the words of the telegraphic “code” employed by the Bureau. They are then promptly taken to the telegraph office and at once sent on to the Bureau. For a few moments after 8 o'clock, morning and evening, all over the United States, all other telegraphic business gives way to the business of the Weather Bureau. The telegrams are at once forwarded, in order to reach the central office in Washington at the earliest possible moment. They are for-

warded, however, in such a way that they can be dropped on their passage at other stations where they are needed. That is to say, they are collected in "circuits," and the telegram for each station in the circuit is dropped at each of the stations where it may be of use. The result is, that the central office at Washington is furnished with the observations from all over the United States, and the individual stations wishing them are furnished with the observations which they need. They come into the central office at Washington in circuits—the Southern circuit, the New England circuit, and other circuits come in one after the other. They are received in the Bureau office, about an hour after they are taken, by operators employed for the purpose, and are at once taken off on the typewriter, and sent by messenger to the forecast-room. On reaching the forecast-room they are passed to an official, called a translator, whose duty it is to read in ordinary language the telegram expressed in the code, so that the clerks who surround him, and the forecast official, can obtain the information as rapidly as possible. Of these translators there are several in the office, and at each of the outside stations, where a considerable number of the reports are used, one man at least must be expert in the code.

This takes us to the forecast-room, which is a very busy place for about two hours after 9 o'clock in the morning and 9 o'clock in the evening, 75th Meridian time. This room has a force of clerks to take down the data on individual maps. At the same time a small force of printers proceed to set up the tables used on the maps, doing this directly from the reading of the translator. One of these is occupied with setting up the symbols for wind direction and weather, as they will appear eventually on the finished map. As rapidly as the translator reads the telegrams the data are placed on maps, of which there are four, the principal map (which is the proper weather map used in the regular forecasts) and three auxiliary maps made by the clerks as the observations come in, and used by the forecast official to aid



him in making the official forecast. The map proper, or weather map, which is afterwards published, is made by the forecast official himself, or under his immediate supervision. As soon as these maps are finished, and that is almost immediately after the reading of the last telegram received, the forecaster proceeds at once to dictate his forecasts to a stenographer beside him. These are made for separate States, or for halves or quarters of larger States, and must be made in a certain fixed order, in which order they are always printed. As they are taken by the stenographer the compositors set them up, and almost as soon as they are finished by the forecast official they are in print and the proof copy is taken off. This is read by the forecaster before he leaves the room. After making the forecasts he also decides to what points special signals shall be sent indicating high winds or storms, and gives orders to this effect.

The principal map, being finished in this way as a manuscript, is taken at once to the lithographer, transferred to stone, placed on the press by pressmen who are waiting to receive it, and run off with all possible celerity. Messengers stand in waiting, so that the first few copies are taken in hand, carried to the trains, or to the points where they are to be left, by means of bicycles or otherwise, so that with all possible despatch the maps are distributed as soon as they are printed. In the meantime the agents of the great news-collecting agencies are at hand to receive the forecasts, which they distribute by telegraph to various parts of the United States. The time which elapses from the taking of the observations until the map is finally ready for the messengers varies from two and a half hours to three hours, depending upon circumstances. It is rare for it to reach three hours. The usual time is two hours and thirty-five minutes to two hours and forty-five minutes.

The forecasts were formerly made for the day or the night on which the observations were received. This being the case, notwithstanding the speed that was used in getting

them before the public, the period for which they were intended was partly passed before the forecasts could reach their readers. This has now been changed, so that the forecasts that are made from the morning observations, as well as those from the evening observations, are intended for the next day. This amounts to making forecasts for thirty-six hours ahead, instead of twenty-four, and even twelve, as was formerly the case. This has been found to be much more satisfactory to the public, and as a result forecasts can appear in the evening papers which are intended for the next day, so that those interested in the weather of that day can have abundant time to make their preparations.

The number of official forecasters in the central office at Washington is four (December, 1893), but this number is soon to be increased. Each forecaster makes the published forecasts for a month, when he is relieved by another. Care is taken to vary through the year the months for which each forecast official is responsible.

After the forecasts have been made comes the question of verification. This is done systematically, both for the official forecaster in Washington and for those who are on practice forecast. It is also done, from time to time, for the local forecast officials and other forecasters at stations. It is usually done by a series of rules of highly elaborate and technical character, which are printed in a code of "Special Instructions to Forecasters," and with which the forecaster is expected to be entirely familiar. Under these rules precise definitions are given to matters which can be forecasted. Limits are given to the rise and fall of temperature, definition is given to rain, to "cold wave," and other matters which are subject to forecasting. From these somewhat complicated rules a series of averages are drawn up, and these make the rating which the official receives. It has been found by considerable experience that high ratings and public satisfaction are not necessarily concurrent. The rules for forecasting are so technical as to confine the forecaster to a limited range of

precise expressions, and require in each case a definite forecast, though the forecaster may be unwilling to hazard it on account of uncertain conditions. In cases of this kind it is really better for the public use to give the degree of possibility, probability, or uncertainty under which the forecaster labours from the information which he has in hand. By so doing, however, he loses his high grading in the verification, so that he stands between the Scylla on the one side, of precise verification, and the Charybdis on the other, of complete comprehension by the reading public, and he must make his way between them the best he can. It is said to sometimes result in what is called "hedging" in forecasting, where expressions are made with special reference to their values in verification. There is no set of rules which can be drawn up that will absolutely prevent this. Thus one may be given a high verification, but fail in usefulness to the public. The custom has therefore grown up of not paying such close attention to the official rating of verification obtained by the forecaster as to the satisfaction shown by the public in the newspapers and elsewhere. Forecasters have been encouraged to state, without technical limitations of language, exactly what they expect to occur from the data in hand, and to give the public all the information which they have in language which, while condensed, may freely express the amount of confidence which they have in their predictions.

There is also made up and printed with the forecasts a summary of changes in the weather over the United States in the last twenty-four hours, and this is of considerable public interest, and is consulted perhaps as much as the forecasts themselves. By the use of the weather maps and constant consultation of the forecasts, many readers have become so skilful that by means of the summary they can make their own forecasts for their definite purposes, and with more satisfaction to themselves than that afforded by the official forecasts.

In the forecasts a series of different things are predicted. There is a general statement as to the probable changes of

the meteorological elements for each district for which forecasts are made. There is also a prediction for local storms, when the forecaster finds indications of them on the maps. When the statement is made that severe local storms may be expected in any particular district of the United States, it is intended to convey the possibility of the occurrence of tornadoes or cloud bursts. It is a warning to the public to be on the look-out and to prepare for them. It is thought that in this way the public can be warned of the possibility of the tornado without being terrified by the actual prediction for a quarter of the state, when the tornado will occur in any case in only a very small part of that area. Predictions are also made for high or dangerous winds, and special storm signals are ordered up to convey this information to the public. They are made also for cold waves, for frosts, and for stages of rivers where of interest, and for floods. From the general forecasts are taken specific ones for weather and temperature, which are distributed to inland and country districts. In some cases the local observer can order up cautionary signals at certain ports, also information signals. The latter are intended to notify masters of vessels that additional information can be obtained by calling at the Weather Bureau station, and that this information is of such a nature as to be of importance to them if they are about to leave port. Special bulletins are occasionally sent out when any dangerous storm is in progress, and specific information can be given in the interval between the two daily maps. For instance, when the recent hurricanes were passing northward from the South Atlantic Coast over the Eastern States, the people in advance of them were kept warned of the approach of the storms, and these warnings were sent out at any hour deemed necessary. Special efforts were made to distribute these warnings to all post-offices and other points of local importance throughout the path of the storm, and these efforts were in a measure successful.

^ Somewhat similar forecasts are made at local or district

stations. They are, however, not so elaborate as those made at the central office in Washington ; although generally more in detail, they are confined to more limited areas. In general it is intended that the evening forecasts shall be distributed from the central office from the afternoon observations, and forecasts from the local stations sent out from the morning observations.

✓ The forecasts are, of course, sometimes criticised, as are also the summaries. It is, however, admitted by the general public that all human institutions sometimes go astray, and serious errors occur so seldom as to be excused and overlooked. It is considered more harmful to the public interest to alarm a large area over a doubtful storm than to refrain from mentioning it. The forecast field of the United States is, on the whole, a more favourable one than that of any other country on the globe. It extends from ocean to ocean in the middle latitudes, where storms are more frequent. The storms that come in from Canada can also be noted before their arrival by means of the telegrams sent to the Bureau from the Canadian stations. Practically the Weather Bureau has an outlook over the entire field of the North American continent, north of Mexico and south of latitude 50°. Over this field the observations are taken at one simultaneous instant. The maps can be made for this large area with more accuracy than can be done in Europe, where a number of weather services occupy a relatively small territory, while observations are taken in different states at different hours. The only field for meteorological work which approximates that of the United States is that of Australia, but in this case the dry centre of the island or continent disturbs the progress of cyclones over it much more than they are disturbed in the United States by the Rocky Mountains and the dry plains.

“Practice forecasts” are carried on by official forecasters not on duty, every day in the year. They make forecasts exactly as if they were making them for the general public. They

are verified in exactly the same way. To these gentlemen are also entrusted a series of special problems depending directly upon forecasting. These they work out deliberately from the maps already on file, and report. Their reports are taken into account in future forecasts.

The telegraph section of the Forecast Division is in charge of a series of telegraph lines along the coasts where lines are not required by commercial interests. Among the lines owned by the Bureau at present, the more important are, the line connecting Nantucket with the mainland, the one connecting the station at Hatteras with the commercial lines, the one passing along the length of the Indian River in Florida (soon to be abandoned because a commercial line is building parallel to it, and not distant), and the line which connects Tatoosh Island, in the extreme north-west of the States, with the commercial lines. These lines are all pioneer lines, and also served other interests, such as the Life Saving Service, the Maritime Exchanges, Wrecking Companies needs, etc. The mileage of telegraph lines under the control of the meteorological service from year to year, is given in the accompanying Table on page 76.

These lines are only put up where they are needed for the purposes of the Bureau, and the requirements cannot be supplied by the commercial lines. They are usually along the coasts, erected by special bill passed by Congress, and are used until commercial lines are gradually extended and fill their requirements, when they are surrendered, usually by sale at auction, after advertising.

The subject of telegraphic tolls in the Weather Bureau is one of very serious importance, making one of the largest items of expenditure. They amount, on an average, to about \$12,000 per month, and a slight change in the wording of the contract with the commercial companies—a change which would hardly be noted by any one unfamiliar with the details of telegraphic work—may make a great difference in the monthly bill for the use of these lines,

TABLE I

Statement of the United States Military and Sea-coast Telegraph Lines built, abandoned, and worked by the Signal Service (1873-91), and the Weather Bureau (1891-93), during each year from 1873 to 1893 inclusive.

(NOTE.—No lines were built prior to 1873.)

Year.	Sea-coast.			Military.			Total Miles in Operation.	Year.
	Miles Built.	Miles Abandoned.	Miles In Operation.	Miles Built.	Miles Abandoned.	Miles In Operation.		
1873	60	...	60	...	...	...	60	1873
1874	231	...	291	750	...	750	1041	1874
1875	...	...	291	105	...	855	1146	1875
1876	233	...	524	1676	...	2531	3055	1876
1877	...	...	524	430	...	2961	3485	1877
1878	...	...	524	192	...	3153	3677	1878
1879	30	...	584	1843	...	4966	5580	1879
1880	31	...	615	479	145	5330	5945	1880
1881	...	...	615	499	769	5060	5675	1881
1882	...	...	615	798	744	5114	5729	1882
1883	108	...	723	12	2470	2656	3379	1883
1884	9	50	682	53	88	2621	3303	1884
1885	...	4	678	91	259	2453	3131	1885
1886	104	277	505	3	283	2173	2678	1886
1887	...	69	436	316	481	2008	2444	1887
1888	189	...	625	30	344	1694	2319	1888
1889	...	...	625	21	335	1380	2005	1889
1890	8	...	633	99	425	1054	1687	1890
1891	...	...	633	...	29	1025 <sup>1</sup>	1658	1891
1892	...	4	629	...	...	...	629	1892
1893	31	15	645	...	...	...	645	1893

Total lines built, 8431 miles, including 85 miles of sub-marine cable.

<sup>1</sup> Transferred to Signal Service, July 1, 1891.

as paid by the Bureau. The larger total of expenditures for the Bureau during the fiscal year ending June 30, 1893, larger than that of the preceding or following year, is chiefly due to the telegraph rates which were adopted for that year. A very slight change in the rates proved to be advantageous to the telegraph companies and expensive to the Bureau. These contracts are made by the year, and the succeeding year the contract was more favourable for the Bureau. The rates are by law fixed by the Secretary of Agriculture at the beginning of each fiscal year.

The items telegraphed from the stations are (in their proper order): name of station, the corrected readings of pressure and temperature, the direction of wind, state of weather and precipitation, current wind velocity and minimum or maximum temperature, according as it is in the morning or evening forecast that is telegraphed, report of observations, of frost, dew-point and time of observation, upper clouds, lower clouds, except forms of nimbus moving with the surface winds, maximum wind velocity and direction, and special monthly reports when required. This will all be included in eleven words, by the telegraphic code. The code which is employed for this purpose is quite elaborate and ingenious, and requires on the part of the observers much study to become familiar with it. For instance, to show the amount of the clouds and the rain and snow, in connection with the direction of the wind at the time, a series of words are selected, which change for each one-hundredth of the rain. When the weather is calm the words concerning it will begin with "I," *ink* representing no rain, *inquire* representing .01 inch of rain, *ingot* representing .48, *insolent* representing .88, and so on. If, under these circumstances, it is snow instead of rain, the words relating to it begin with "O," *oak* standing for no snow, *obituary* for .20 of an inch, *outgoing* for .48, *obtuse* for .90, and so on. When the wind is north the words for rain begin with "Di," and the words for snow with "Do." When the wind is east the words for rain begin with "Fe,"



for snow with "Fo," and so on. As an illustration of the use of the code we may take the following example: *Cheyenne, Burnett, Member, Immense, Camp, Continued, Nimber*. These are seven in number, the usual number of words in the telegrams to the Bureau. This translated, as it may be done at sight by the experienced translator, is as follows: "Cheyenne, Wyoming. The barometer stands at 30·10. The temperature is 64°. Direction of the wind is south. Weather is cloudy. Precipitation has been ·14 of an inch. The current wind velocity is six miles. Minimum temperature 54°. Dew-point 52°. Time 8 A.M. Amount of clouds ·2. Kind of upper clouds, cirro-cumulus. Direction of wind, south-west. Amount of lower clouds ·6. Kind of clouds, stratus. Direction of motion, south." Thus it will be seen that by the use of this code the Weather Bureau is in receipt of information requiring about seventy words, and in the tolls to be paid to the telegraph companies it is counted as only seven words. Not only is the code of use in economising the expenditures of the Bureau to a very great degree, but it is also of use in the additional care which is taken in the sending of the code despatch over that of an ordinary despatch. If the above seventy words or more had been written out in full it would have been much more probable that an error would have occurred in the transmission than when they were expressed in the code. The code employed by the Bureau is of very ingenious construction, and a long trial has proved it to be very complete and satisfactory. It is dissimilar from any other code in use, and has been invented by employees for the purposes for which it is used. This code is intended only for the use of the Weather Bureau, and is not understood by operators generally.

The telegraph section is also charged with the auditing of the telegraph accounts, an extensive and complicated piece of labour. They are entrusted with this by the telegraph companies themselves, who rarely, if ever, question the

results of their work. This gives to this section of the service a large amount of clerical work.

The river and flood work is also under the Forecast Division. In the case of this work the difficulties are very great. Each river has a regimen of its own—its own peculiarities, idiosyncrasies, and characteristics. These must be learned for each river, and they depend largely on the size and character of the basin which the river drains. There is also a difference in the effect of precipitation on the height of the river, with the season at which the precipitation occurs, and with the state and character of the surface of the river basin. Should heavy rains fall in August, after dry weather, they will have a very different effect on the river from that of a heavy rainfall in the spring, when the ground is frozen and the rain carries off with it also the melted snow. There is also a series of difficulties of peculiar character in trying to ascertain and forecast the result of the meeting of flood-crests of rivers. For instance, when the Ohio has a flood-crest at Cincinnati, its tributary, the Cumberland River, has its own flood-crest, and the Tennessee River has still another. These all come into the lower Ohio, between Cincinnati and the mouth of the river at Cairo. It is a matter of extreme difficulty to know what the result will be on the crest already existing in the Ohio. Will it be accelerated in its progress, or retarded? Will it be heightened, or lengthened? These are among the questions which it is necessary to decide under such circumstances, and the decision of which presents very considerable difficulties. Other disturbances of the flood-crest may occur, as, for instance, when it reaches a certain height the surface water may pour out into some pocket from which the river is separated at lower levels. This is the case with the great St. Francis marshes, which lie in south-eastern Missouri and north-eastern Arkansas. Fairly cut off from the main river when the water is low or moderate, they are easily accessible to the water when the Mississippi is high, and amount to an

enormous reservoir which receives the water when high and gives it out slowly, and at a later date.

To aid the observers in their work elaborate river gauges have been placed on the rivers, distributed as experience has found to be most necessary. This is the case with most of the important rivers at the present time, but the service has not reached as yet the streams of secondary importance. It is being gradually extended, and as time passes these gauges will be found also on the latter streams, and the service will be extended to all river basins of importance in the area covered by it.

Even with this complete apparatus floods occur for which the Bureau can hardly hope to make successful forecasts. As an illustration of these floods, the results of a cloud-burst may be mentioned. For instance, some years ago one occurred on the side of Pike's Peak and the neighbouring mountains. The water poured down in a stream of such volume that miles of railway were carried away, and occasionally the steel rails were bent and twisted by the force of the water, and this through a river bed usually dry. Another illustration of this class is to be found in the Johnstown disaster in Pennsylvania. A large reservoir was sustained near the head of a comparatively insignificant stream. This reservoir had a high retaining wall, and had existed for years. Rains in the mountains of rather unusual character, but not altogether exceptional, carried away the retaining wall, and the result was a fearful disaster to the town on the river below. To forecast such a flood as this it would be necessary to have a constant watch kept of the dam enclosing the reservoir. A watchman was employed, but the yielding of the dam was so sudden that it was foreseen by him but a short time before it actually occurred.

## CHAPTER VIII

### HISTORY, ORGANISATION, AND WORK OF THE UNITED STATES WEATHER BUREAU (*continued*)

#### 4. *Distribution of Forecasts*

THE problems of the distribution of forecasts, after they are made, are quite as important as those involved in making them, and are in some respects more novel. The means actually employed in distributing the forecasts in the meteorological service of the United States are, first, the use of the news-collecting agencies of the newspapers. This method is of long standing, and arrangements have been perfected by means of which the forecasts when made are passed at once into the hands of the representatives of these agencies and by them are distributed at their own cost to the parts of the United States where they are desired. Many of the great metropolitan dailies desire the entire series of forecasts, others those for their vicinity only, or for the States immediately around them. This is arranged by the agencies for collecting news, without trouble or expenditure on the part of the Weather Bureau.

The second way of communicating the forecasts to the public is by means of the storm and cautionary signals. These are under the direct control of the forecaster, and he decides after each forecast to which station the telegrams ordering the observer to display these signals shall be

sent. There are a number of minor stations for the purpose of display only, and the signal ordered to be displayed at the centre station is also to be displayed at these minor stations, unless otherwise ordered. The cautionary, storm, and information signals are as given in Chart A. These signals are intended for inland and country districts.

The State Weather Service Division has charge of making or discontinuing these display stations, sending signals and receiving reports. The series of flags used is given in Chart B. They are of a very simple and suggestive character, are easily learned by anybody in five minutes, and form, on the whole, the most satisfactory series of signals distributed to the general public.

One of the most important problems which has to be considered by the Weather Bureau, and the solution of which has not yet been entirely satisfactorily made, is, what is the best means of communicating, by means of signals, the forecasts of the weather. The flags are the means now employed. They have many advantages—they are inexpensive; they are easily handled; they are attractive in character. There are also very many objections to them. They wear out rapidly and need to be renewed at frequent intervals. They also change their colours, particularly in large manufacturing cities, and although the colours have been selected with reference to being distinguishable the longest time and distance possible, yet it happens in some of the smoky cities that the blue flags and the white flags cannot be distinguished from each other in a few weeks.

✓ The system of ball, cylinder and cone, which is used in the Old World, has not recommended itself in the States, because it is expensive, clumsy, and very difficult to manage. A better method has been proposed by a private inventor. It consists only of a ball and fishtail. The ball can be run up and down a halyard, and the fishtail can be changed in its angle to the horizon. By the combination of these two a long series of important facts can be communicated to the

## CHART A.

### U.S. DEPARTMENT OF AGRICULTURE, WEATHER BUREAU.

#### CAUTIONARY SIGNALS.

(Displayed only on the Great Lakes.)



N.W. winds. S.W. winds. N.E. winds. S.E. winds.

#### STORM SIGNALS.

(Displayed both on the Lakes and seaboard.)

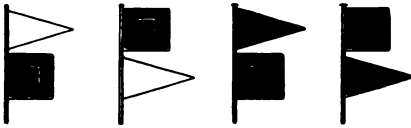

N.W. winds. S.W. winds. N.E. winds. S.E. winds.

#### INFORMATION SIGNAL.



westerly (from south-west to north). The pennant above the flag indicates that the wind is expected to blow from the northerly quadrant; below, from the southerly quadrant.

The Information Signal consists of a red pennant, and indicates that the local observer has received information from the central office of a storm covering a limited area, dangerous only for vessels about to sail to certain points. The signal is intended to be a notification to shipmasters that valuable information will be given them upon application to the local observer.

By night a red light will indicate easterly winds, and a white light above a red light will indicate westerly winds.

The system of weather, temperature, and rain signals displayed throughout the country is distinct from the cautionary and storm signals, the latter being principally for the information of maritime interests, and are displayed at the principal ports of the Great Lakes, and on the Atlantic, Pacific, and Gulf coasts.

#### EXPLANATION OF CAUTIONARY AND STORM SIGNALS.

A red flag with a white centre, displayed at stations on the Great Lakes, indicates that the winds expected will not be so severe but well-found, sea-worthy vessels can meet them without danger.

A red flag with a black centre at stations either on the Lake or seaboard indicates that the storm is expected to be severe.

The pennants displayed with the flags indicate the direction of the wind; red, easterly (from north-east to south); white,

## CHART B.

U.S. DEPARTMENT OF AGRICULTURE, WEATHER BUREAU.

### EXPLANATION OF FLAG SIGNALS.

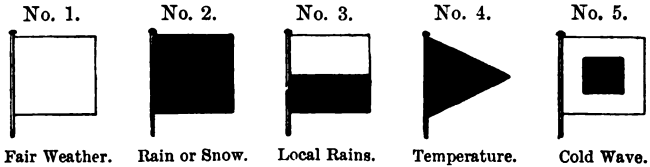

### INTERPRETATION OF DISPLAYS.

- No. 1, alone, indicates fair weather, stationary temperature.
- No. 2, alone, indicates rain or snow, stationary temperature.
- No. 3, alone, indicates local rain, stationary temperature.
- No. 1, with No. 4 above it, indicates fair weather, warmer.
- No. 1, with No. 4 below it, indicates fair weather, colder.
- No. 2, with No. 4 above it, indicates warmer weather, rain or snow.
- No. 2, with No. 4 below it, indicates colder weather, rain or snow.
- No. 3, with No. 4 above it, indicates warmer weather with local rains.
- No. 3, with No. 4 below it, indicates colder weather with local rains.
- No. 1, with No. 5 above it, indicates fair weather, cold wave.
- No. 2, with No. 5 above it, indicates wet weather, cold wave.

### EXPLANATION OF WHISTLE SIGNALS.

The warning signal, to attract attention, will be a long blast of from fifteen to twenty seconds duration. After this warning signal has been sounded, long blasts (of from four to six seconds' duration) refer to weather, and short blasts (of from one to three seconds duration) refer to temperature; those for weather to be sounded first.

<i>Blasts.</i>	<i>Indicate.</i>
One long . . . . .	Fair weather.
Two long . . . . .	Rain or Snow.
Three long . . . . .	Local rains.
One short . . . . .	Lower temperature.
Two short . . . . .	Higher temperature.
Three short . . . . .	Cold wave.

### INTERPRETATION OF COMBINATION BLASTS.

- One long, alone . . . . . Fair weather, stationary temperature.
- Two long, alone . . . . . Rain or snow stationary temperature.
- One long and short . . . . . Fair weather, lower temperature.
- Two long and two short . . . . . Rain or snow, higher temperature.
- One long and three short . . . . . Fair weather, cold wave.
- Three long and two short . . . . . Local rains, higher temperature.

By repeating each combination a few times, with an interval of ten seconds between, possibilities of error in reading the forecasts will be avoided, such as may arise from variable winds, or failure to hear the warning signal.

public. It is little liable to get out of order, is very easily managed, but is somewhat expensive in its installation.

The service has made use of a series of railway-train signals. These are signals which are hung on the sides of the baggage or postal car, and can be recognised at a considerable distance by any one who is in position to see the passing train. They would be very satisfactory to all within sight of the passing train, were the signals themselves cared for properly. Their care, however, must be left to the employees of the railway, and is an additional burden placed on their shoulders. The result is, that in some cases they are neglected, and one can occasionally see a railway train bearing fair-weather signals when travelling through a storm.

Another sort of signals which has been used extensively, and which has been found to be fairly satisfactory, is the whistle signal. This is employed only in the case of stationary engines. When moving locomotives, in addition to the series of signals required by law to be given in approaching or leaving stations, or at crossings, give also the weather signals, it would become entirely unbearable for those who lived along the road. Besides, the signals would have to be repeated at frequent intervals during the passage of the train, in order to be of any use. On the other hand, in the case of the stationary engines, the signals can be given once or twice during the day, at beginning of work or at noon, and they can be heard and understood by all who are in hearing of the whistle, and produce so little disturbance in the way of whistling as to be generally unobjectionable. But even in this case protests are occasionally received. In one case the whistle was located in the vicinity of a retreat intended for nervous invalids, and caused so much annoyance that it was finally dispensed with. The code consists of a series of long and short whistles, very simple in character and very easy to understand.

The firing of a cannon has also been made use of for the purpose of conveying information concerning the coming



weather. It has been employed chiefly to give information concerning frosts. In one notable case it has been given the credit of having saved an entire crop within the range of its hearing.

None of these methods can successfully reach all country communities and individual farms. How to do this is the problem yet to be solved. Among the suggested solutions is the extension of free delivery of mail, but this would require an enormous expenditure on the part of the general Government—an expense that has been estimated not only in millions, but in hundreds of millions of dollars. Another method proposed is that of the extension of the telephone to farmers' houses. This is entirely practicable, and will perhaps in time be accomplished. The telephone rates now charged under the patents, are somewhat higher than farmers would be willing to pay. It is possible that at the expiration of the telephone patents these rates will be reduced until they will come within reach of the members of the agricultural interests. Another method proposed is that of small captive balloons, which can be made of different shapes and placed in variable order, and allowed to rise to such a height as to be visible for many miles. Still another is that of coloured powder flashes. These give promise in some cases, but have been submitted to no satisfactory test. A much more promising method for future use is that of the search-light, rendered possible by the brilliancy of the electric light. As is well known, the shadows of the electric light are easily distinguishable on a cloudy sky, and may be made distinguishable on a clear sky when there is dust in the air. A simple code of signals could be invented which, when projected on low clouds, could be seen through a radius of forty or fifty miles. If they were projected on a clear sky in such a way as to be distinguishable, they could be seen through a radius of much greater distance. This method has been tested to some extent by private enterprise on the top of Mount Washington, and the reports received from it are fairly satisfactory.

The results of the forecasts are to be found in the very

great benefits which this foreknowledge of the weather affords to marine and inland commerce and agriculture, and to business of all sorts. The evidences that these benefits are real and numerous exist in the Bureau in very great numbers, and it would be a hopeless task to endeavour to summarise them. To illustrate the character of these advantages, for instance, to commerce, it may be said that in the case of the two very severe hurricanes in the autumn of 1893, which struck inland on the South Atlantic coast and passed northward, warnings were given in abundant time before the hurricanes struck the coast. In the case of the first, the warnings of the Bureau were not fully heeded, with the result of a great deal of damage to shipping—particularly in the South. In the case of the second hurricane, the warnings of the Bureau were heeded with great care in both the South and North, with the result that there was comparatively little damage to shipping, except where it lay in port in a more or less exposed position. As an illustration of the possible advantages to inland commerce, it may be mentioned that street railway managers are especially anxious for forecasts of snow, its probable character and depth, and it has been reported to the Bureau, in more than one case, that a successful forecast of a heavy snowstorm has resulted in the keeping up of the traffic on street-car lines that would otherwise be blocked, and that the saving effected by this and the protection of property could be measured only in thousands of dollars. As an illustration of the protection that is afforded to agriculturists, it may be mentioned that special warnings are sent out of frosts, and the public interested has learned to heed them. As, for instance, some time ago the entire cranberry crop of Wisconsin, which is condensed into one rather limited region, is said to have been saved by the timely warnings of frost sent out by the Bureau, permitting the owners to flood their lands, and thus protect the berries from the injury which the frosts would cause. Numerous illustrations can be found as to the usefulness of the Bureau to trades and professions,

where the general public would not suspect that such usefulness could exist. As one instance, it may be mentioned that a firm carrying on the business of artificially curing wood has written to the Bureau that they depend in their business on the forecasts made by the Bureau, and that they regulate their furnaces by them.

The records also are of great use in all sorts of business. It rarely occurs that a railway has a case for damaged fruit but the Bureau is called on to testify in the case. In a great variety of Admiralty cases the decision frequently depends more or less directly on the testimony given by the Bureau as to the direction of the wind and the character of the weather at the time and place the loss occurred. Even in some cases of damages between citizens, the central office, or one of its stations, is called upon for information, and upon the very day of this writing a call was made at the Bureau to ascertain what was the weather on the 26th of November, 1890, in the city of Washington, as it was wanted in a case where a person passing along the street had fallen into an excavation, and his executor was endeavouring to collect damages for the injury resulting.

As a further illustration of the use of the weather map, reference may be made to a statement by the assistant-engineer, U.S.A., at Fort Mitchell, Ala. He says: "The map reaches me about forty-eight hours after issue, but from its data, and the well-known conditions of weather as I could see them, I have laid my plans for work of jetty building—*i.e.* as to whether it would be best to drive piles or to fill in those already driven, so as to take best advantage of river stage and overhead weather—two and three days ahead, and I have never missed it once so far as work went, though on three occasions lately we have had showers when I expected fair weather." This illustrates the fact that persons specially interested in the weather can, by means of weather maps and other data, make forecasts of greater value to them than those made by the Bureau.

### 5. *Scientific Work*

The scientific work of the Bureau is difficult to sum up, as it extends in a great many directions, and has been occupied with a great variety of details. The Bureau has endeavoured particularly to collect observations of special importance for the information of meteorologists, and for future study. This was the case with the long series of international simultaneous observations started by the meteorological service and continued by them for many years. The exact dates and the nature of the publications can be found in the bibliographical list accompanying. This was an undertaking not limited by national boundaries, and the maps published covered a large part of the earth's surface. It includes a fund of interesting meteorological matter which very few have as yet taken the pains to explore. This was the case also with the mountain meteorological stations established early in the history of the Signal Service, and including Mount Washington, Pike's Peak, and mountains in the south-eastern states; at the present time limited to Pike's Peak, with some observations on Mount Washington. This was the case also with the international polar expeditions sent out by the meteorological service—one to Point Barrow and the other to Lady Franklin Bay, to which reference has already been made. A similar helping hand was lent to meteorologists in general in the labour performed by the officials of the Bureau in organising and conducting the Meteorological Congress at Chicago in 1893, and the Bureau is about to print the results of that Congress, comprising about six hundred printed pages, and making one of the most authentic and complete of meteorological publications.

The methods under which the scientific work of the Bureau has been carried on are various. In the early years of the Bureau a study-room under Professor Abbe was organised, and to this room came all the multitudinous questions, more or less directly scientific, which were sent to

the central office. Here they were carefully studied, and hence the results were issued, either in correspondence or in publications. The scientific works produced by members of the meteorological force have sometimes been printed by the Government. Illustrations of these are found in the cases of Professor Ferrel's work, of the works of Professor Abbe, and of many others. Sometimes the work of the Bureau has been printed by private enterprise, or otherwise than by the Government. The observations taken on Pike's Peak were printed by the Harvard College Observatory. The results of the electrical work, done under the direction of Dr. Mendenhall, were printed by the National Academy of Sciences. The Service has also encouraged the work of those outside its own ranks and given them such aid as it could, and as a result a series of works by eminent men has been published by the Bureau. For instance, those of Professor Loomis and Professor S. P. Langley.

Of the work done in general meteorology we find illustration in the publications of Professor Ferrel, and also in the "Preparatory Studies" made by Professor Abbe. Both of these were printed by the Signal Service as appendices to the annual reports.

In the matter of instruments the work has been more abundant and more detailed. Professor Abbe's "Treatise on Instruments" is an appendix to one of the annual volumes. Professor Marvin has devoted himself to many sides of the study of instruments. Professor Waldo, while connected with the service, occupied himself with the standardising of the instruments of the service.

The study of storms on the part of the meteorological service has continued from its first establishment. The publication of the Daily Weather Map is really a contribution to this subject, and in addition to these, special maps and bulletins have been issued on many individual storms. Latterly, in continuation of the work on the Great Lakes, a series of maps for every special storm affecting these

bodies of waters has been issued. In addition to these the service has been continuously interested in the investigation of thunder-storms, and their forecast. In the summer of 1892 an elaborate campaign was undertaken on this subject. All of the states from Main to Missouri, and north of Kentucky and Maryland, took part in this campaign. The results of these investigations were afterwards condensed in a report on the subject of the forecasts of such storms. A similar campaign was made in 1893, but a digest of the material has not yet been made. There have also been many special studies of individual tornadoes, and in several cases a series of charts has been issued, covering the period in which the tornadoes occurred. Several reports on this subject have been printed by the Bureau, and the studies of the Bureau officers have resulted in two or three books, and many publications in journals and other places.

The questions of solar physics, of electricity, and of magnetism, have occupied the service not only directly, but independent studies also have been encouraged by it, and the results have been published by the service. Dr. T. C. Mendenhall was authorised by General Hazen to organise a special service for the study of atmospheric electricity, and the results of these studies were collected and published for Dr. Mendenhall by the National Academy of Sciences. Professor Bigelow has made a study of the relations of magnetism to meteorology. He has printed several reports on this subject, and others are to follow. Clouds have also received the attention of the Bureau officials, and many photographs have been made, and a collection of them has been deposited in the library.

The work of the service in ballooning has been continued from early days in its history. [Sixteen ascents have been made, as is shown by the accompanying Table, and five of these by Professor Hazen himself—a considerable ratio of the whole. The results have been printed, generally in journals, sometimes in the annual reports of the Chief Signal-Officer.

TABLE I.—LIST OF

Date.	Place.		Dis- tance in miles.	Balloon.
	Starting.	Landing.		
Sept. 3, 1872;	Rochester, N. Y.	East Bloomfield	24	Aurora
April 3, 1877	Nashville, Tenn.	N. E. of Nashville	18	King Carnival
June 18, 1877	" "	Gallatin	26?	Buffalo
June 19, 1877	Gallatin	Near Lebanon	13?	"
Aug. 30, 1877	Philadelphia	Centreville, N.J.		"
Sept. 12, 1881 :	Minneapolis, Minn.	Cow pasture	5	Great North-west
Oct. 13, 14, 1881	Chicago	Flambeau R., Wis.	430	" "
Jan. 19, 1885	Philadelphia	Manhattan, N.J.	60	Eagle Eyrie
March 13, 1885	"	Union, Pa.	16	"
March 27, 1885	"	Newby, N.J.	70	"
April 16, 1885	"	Williamstown, N.J.	23	"
June 24, 1886	Providence, R. I.	Voluntown, Ct.		City of Boston
June 25, 1886	W. Greenwich, R.I.	Providence		" "
June 17, 1887	St. Lewis	Hoffman, Ills.	55	" The World "
Aug. 13, 1887	Philadelphia	Philadelphia	40	Great North-west
Oct. 27, 1892	Fort Myer, Va.	Suitland, Md.	9	Carlotta

There have been some studies of spectroscopy and its relations to practical meteorology. Professor Upton, under General Hazen, made a special study of the spectroscope, which was printed as a bulletin. Later, Dr. Jewell, under the direction of Professor Rowland of Johns Hopkins University, has made an elaborate study of some new aspects of this problem, which give promise of success in its practical application to forecasting. A paper on this subject is nearly ready for printing. The subject of the radiation from gases is another of the problems in which the Bureau has interested competent students outside of its ranks.

In climatology the work of the Bureau has been very extensive. A series of climatological monographs has been published on the Western States, on the arid regions, and on the States occupying the great plains. The *Monthly Weather Review*, which has appeared continuously for so many years, has a number of contributions on the subject

## BALLOON ASCENTS.

Size.	Men.	Height.	Temperature.		Time.		Observer.	Aeronaut.
			Start.	Top.	Start.	Land- ing.		
20,000	2	5,560	59?	40	17·4	18·21	G. C. Schaeffer, Jr.	S. A. King.
25,000	2	5,040	59	47	15·00	17·25	A. C. Ford.	" "
92,000	2	6,580	87	67	17·3	19·18	" "	" "
92,000	2	16,200?	?	?	7·58	12·2	" "	" "
92,000	7	8,600	86	59	14·59	17·30	F. M. M. Beall.	" "
90,000	7	2,600	74?		18·43	20·00?	Winslow Upton.	" "
90,000	2	8,640		43?	17·25?	14·15	G. Hass Hagan.	" "
					(13th)	(14th)		
25,000	2	4,800	23	13	16·12	19·5	W. H. Hammon.	" "
25,000	2	4,350	24	23	13·38	16·12	" "	" "
25,000	2	6,217	51	35	12·27	14·19	" "	" "
25,000	2	4,310	50	33	12·31	14·20	" "	" "
40,000	4	1,000					H. A. Hazen.	James Allen.
40,000	2	9,780	61	48	7·50	9·39	" "	" "
160,000	4	15,410	92	36	17·26	20·17	" "	Alfred Moore.
90,000	7	6,940	75	52	16·38	20·36	" "	S. A. King.
9,000	2	9,400	43	13	15·33	17·5	" "	John Ellis.

of climatology. Rainfall has also occupied the attention of the Bureau to a very great degree. The rainfall maps are published regularly in the *Monthly Weather Review*, and many special studies have been printed in atlas form, or otherwise. A special climatological section was organised and continued during the fiscal year of 1893, and was devoted to the subject of precipitation over the entire United States. The material is now in process of preparation for printing, and will be the most complete contribution ever made on this subject. Hourly observations, since they began, have been the subject of several discussions. One relates more especially to the corrections which must be made in temperature observations taken at any hour of the day to get the true mean temperature of the day. Another relates to the diurnal variations of the barometer, and the conclusions which can be drawn from them. The work of the meteorological service has been in some sense brought together



and condensed in General Greely's *American Weather*. The more interesting meteorological and climatological features of the United States discovered up to that time are mentioned therein. There have also been some climatological studies of individual regions. A party was stationed for some time in Death Valley, California, and the results of their work have been published in a climatological bulletin on that subject. Continuous meteorological work has been carried on over the Great Lakes for two years. The results so far have been the publication of a map of wrecks by meteorological causes on the Great Lakes, and of a preliminary current map of the same Lakes. The climatology of Chicago was compiled, and has been recently printed.

In the matter of forecasts and their verification, a great deal has been printed, both in the annual reports of the Chief Signal-Officer and in other publications. The subject of cold waves has received an especial amount of attention.

As to the meteorological side of agricultural science, the studies of the service have been numerous, but have been for the most part made under the Weather Bureau rather than under the Signal Service. Two bulletins on the relations of soil to climate, from competent students of the subject, have been printed, and a paper on the variations of ground water and its relation to meteorology makes another bulletin. A paper has been also printed on the climatology of the cotton plant, and one on the tobacco plant is in process of preparation. A large bulletin has been compiled on the relation of climate to crops, and is ready for publication. It embraces the more important studies that have been made on this subject up to the date of its publication.

It may be well to add that the official experiments in rain-making which attracted so much attention for a year or more, were not made by the Weather Bureau, nor in any way under its direction. The Bureau offered to send experts with the rain-making expeditions, but the expert charged with the duty of conducting them did not see fit to avail himself

of this offer. The movement in favour of these experiments originated in certain enthusiasts not connected with the Government service, and was brought directly to Congress without the intermediation of the executive departments. The appropriations were made, and the Secretary of Agriculture, without solicitation on his part, was charged with the duty of expending them for the purpose intended. He called to his aid Mr. Dyrenforth, a patent attorney, who conducted the experiments, and reported on the results. Mr. Dyrenforth reported a considerable measure of success, but unfortunately in no case did the report of unbiased experts agree with his. In the first summer's work he had with him an accomplished meteorologist, but this gentleman's report was adverse to him, and he was discarded. In the second summer it was only those experts who got knowledge of his intentions in time, and without his invitation, who were able to report—and this generally under unfavourable conditions—and again their reports were unfavourable. Not only did Mr. Dyrenforth not settle the matter experimentally, but he did not leave sufficient evidence in its favour to justify a conservative administration of public affairs in trying again the experiment of making rain by explosions.

## CHAPTER IX

### AIR TEMPERATURE AND ITS MEASUREMENT

Temperature the most important Meteorological Factor—Meaning of the word Thermometer—History of the Instrument—Fahrenheit's Scale—Why Mercury was selected as the Medium for measuring Temperature—Celsius' Scale—The Centigrade Thermometer—Réaumur's Scale—Relations of the three Scales to one another—Rules for reducing Readings of one Scale to those of another—Melting Point of Ice—Freezing Point of Water—Boiling Point of Water varies with Atmospheric Pressure and with Altitude—Definition of a Thermometer—Steps in the Construction of this Instrument.

No other meteorological factor exercises a more potent influence over the animal and vegetable kingdoms than does temperature. Hence we may fitly commence our study of the weather with an account of the instrument which is in daily use for the purpose of *measuring* the *warmth* of the air, namely, the thermometer (Gk. *θέρμη*, *heat*; *μέτρον*, *a measure*). The principle of the instrument is that it measures temperature by the expansion of bodies.

The thermometer is supposed to have been invented by Sanctorio, of Padua, in 1590; but the history of the instrument is involved in obscurity until 1714, when Fahrenheit, of Dantzic, constructed the thermometer which bears his name. He used mercury instead of spirit of wine, and introduced a scale graduated from the melting point of ice to the boiling point of water at sea-level, and under ordinary conditions of temperature and pressure. Fahrenheit arrived at his zero

point in a curious way. He is believed to have held that for all practical purposes the lowest temperature likely to call for registration was that reached in an Icelandic winter. It is, however, more likely that his zero was fixed by experiment with a freezing mixture of snow and chloride of sodium (common salt) or of snow and chloride of ammonium (sal ammoniac).

Counting then from zero, Fahrenheit made the melting point of ice  $32^{\circ}$  and the boiling point of water  $212^{\circ}$ , thus dividing the distance between these two crucial points into  $180^{\circ}$ , or half the number of degrees in a circle ( $360^{\circ}$ ). This scale is commonly used throughout the British Dominions and in the United States of America. Its advantages are that, under ordinary circumstances, the *minus* sign ( $-$ ) is not required, while the smallness of the degrees permits very accurate measurements of temperature.

Mercury was selected as the medium for indicating temperature, because (1) of its equal expansion at different temperatures—equal increments of bulk corresponding to equal increments of temperature; (2) of its low freezing point ( $-37.9^{\circ}$  F.), its high boiling point ( $675.1^{\circ}$  F.), its high conductivity of heat, and its low specific heat, or “the amount of heat required to raise 1 lb. of mercury one degree, in terms of that necessary to raise 1 lb. of water one degree” (R. H. Scott). For the recording of temperatures below its freezing point, mercury is replaced by spirit, which medium is also used because of its transparency in the construction of the minimum thermometer in common use. In this instrument a small and light float of glass or enamel, called the “index,” is immersed in the spirit. Hence it is necessary that the spirit should be transparent in order that the exact position of the index may be observed.

In 1742, Celsius, a professor in the University of Upsala, in Sweden, divided the scale of the mercurial thermometer between the melting point of ice and the boiling point of water into  $100^{\circ}$ . According to this scale, therefore, the

melting point of ice is zero, and the boiling point of water is  $100^{\circ}$  at an atmospherical pressure of 760 millimètres (29.922 inches) in the latitude of Paris. Hence the name *Centigrade*, by which this thermometer is usually known. It is extensively used on the continent of Europe, and, indeed, by scientific men of all nations.

A third thermometer scale is that introduced about 1731 by Réaumur, a French physicist, who was born at La Rochelle in 1683. According to this scale there are only  $80^{\circ}$  between zero, the melting point of ice, and the boiling point of water. The Réaumur scale is still used in Russia and parts of Germany, but the Celsius or Centigrade thermometer scale is rapidly superseding it in those countries.

The following figures, copied from Chambers's *Encyclopædia* (Art. "Thermometer"), will render the relations of these three scales easily understood:—

Fahrenheit	$0^{\circ}$	$32^{\circ}$	$77^{\circ}$	$122^{\circ}$	$212^{\circ}$
Réaumur . . .		$0^{\circ}$	$20^{\circ}$	$40^{\circ}$	$80^{\circ}$
Centigrade . . .		$0^{\circ}$	$25^{\circ}$	$50^{\circ}$	$100^{\circ}$

To reduce a reading taken by one scale to the corresponding reading taken by another becomes quite easy, if we remember the primary relations of the scales to one another, namely,  $80^{\circ}$  R. =  $100^{\circ}$  C. =  $180^{\circ}$  F.; or in the most simple form:  $4^{\circ}$  R. =  $5^{\circ}$  C. =  $9^{\circ}$  F. The only element of difficulty is the management of  $32^{\circ}$  F., which corresponds to the zero of the other scales. It is quite clear that when we are reducing Fahrenheit to Centigrade or Réaumur, we must take away, or subtract,  $32^{\circ}$  from the result; whereas in reducing either of the other scales to Fahrenheit, we must add  $32^{\circ}$  to the result.

The following proportional statements may be of use.

1. For Fahrenheit's thermometer:—

$$F. : R. :: 180 : 80, \text{ i.e. } 9 : 4. \quad \text{Therefore } F. = \frac{9R.}{4} + 32^{\circ}$$

$$F. : C. :: 180 : 100, \text{ i.e. } 9 : 5. \quad \text{Therefore } F. = \frac{9C.}{5} + 32^{\circ}$$

2. For Celsius' thermometer :—

$$C. : F. :: 100 : 180, \text{ i.e. } 5 : 9. \quad \text{Therefore } C. = \frac{(F. - 32) \times 5}{9}$$

$$C. : R. :: 100 : 80, \text{ i.e. } 5 : 4. \quad \text{Therefore } C. = \frac{5R.}{4}$$

3. For Réaumur's thermometer :—

$$R. : F. :: 80 : 180, \text{ i.e. } 4 : 9. \quad \text{Therefore } R. = \frac{(F. - 32) \times 4}{9}$$

$$R. : C. :: 80 : 100, \text{ i.e. } 4 : 5. \quad \text{Therefore } R. = \frac{4C.}{5}$$

In speaking of the fixed points on the thermometer scale it will be observed that the expressions used have been "the melting point of ice" and "the boiling point of water."

The melting point of ice is exactly 32° F., and 0° of both the Centigrade and Réaumur scales. The phrase is used in preference to the "freezing point of water," because water, if perfectly still, may be chilled several degrees below 32° F. without freezing. Under such circumstances, if it is suddenly agitated, it will congeal instantly. Again, water which holds a salt in solution has a freezing point considerably below 32° F. Only distilled water is admissible in these delicate experiments.

The boiling point of water is a still more variable quantity than the freezing point, and hence the term must be qualified by the addition of the words "at mean sea-level, the barometer standing at 29.905 inches in the latitude of London." The French standard of pressure already referred to is 760 mm. in the latitude of Paris. Ebullition takes place the moment the tension of the vapour of water equals the atmospheric pressure. It is evident that the lower the pressure, the more easily will vapour escape from heated water, giving rise to the phenomenon known as "ebullition" or boiling. The converse is equally true, and under a pressure of fifty atmospheres the boiling point of water is raised to 510° F. In fact, water can be heated to almost any degree

without boiling, provided it is subjected to a sufficient pressure.

As a matter of fact, the boiling point falls one degree of Fahrenheit's scale for every 0.589 inch of barometric fall at moderate heights. Accordingly, should the barometer fall to 27.549 inches at sea-level—and this actually occurred on January 24, 1884, and more recently on December 8, 1886—the boiling point would be 208° instead of 212°. A still more striking variation in the boiling point occurs at great elevations. For instance, at Quito, in Mexico, 9000 feet above the sea, water boils at 194°; on the summit of Mont Blanc (15,781 feet) at 183° F.; and on Gaurisankar, or Mount Everest, the highest peak of the Himalayas (29,002 feet), it would boil at 158° F., were it possible to make the experiment. Advantage has actually been taken of this dependence of the boiling point on elevation to roughly measure the heights of mountains. Mr. R. Strachan, F.R. Met. Soc., suggests a simple rule for ascertaining the relative elevation of two stations. It is to multiply by 9 the difference in barometrical readings between them, taken in hundredths of an inch. The result gives the difference in feet between the stations. This rule depends on the principle that the difference of height corresponding to a difference in barometrical readings of 0.1 inch is approximately 90 feet. For instance, for the change of level from 200 to 290 feet, the difference in barometrical readings (the sea-level reading being 30 inches) is .101 inch at 40° and .098 inch at 50° (R. H. Scott).

In the case of the Centigrade and Réaumur scales, all temperatures below the melting point of ice have a minus sign (-) prefixed. In the case of the Fahrenheit scale the zero point is 32° below the melting point of ice. The minus sign is, therefore, very seldom required for temperatures occurring in the British Isles. The value -40° represents the same temperature on the Fahrenheit and Centigrade scales.

A thermometer consists of a capillary glass tube of

uniform bore, hermetically sealed at one end, and blown at the other into a bulb filled with mercury or spirit. Any given temperature is measured by the amount of expansion undergone by the liquid in the bulb when exposed to that temperature. The liquid moves up the capillary tube from the bulb as temperature rises, and retreats towards the bulb as temperature falls. In all cases, the scale of degrees by which the readings are made should *be engraved on the glass tube itself, that is, on the stem.*

The steps in the construction of a thermometer are four in number: (1) calibrating the tube; (2) filling; (3) "curing"; (4) graduation.

(1) Uniformity of calibre is attained in glass-blowing by introducing a bead of mercury, say an inch in length, and noting by measurement if this thread of the liquid metal occupies the same extent of the tube at different points.

(2) The thermometer is filled, after blowing a bulb at the bottom, by filling a small funnel at the top with mercury and then expelling the air in part from the bulb by heat. As the bulb cools, a vacuum is formed, to fill up which some of the mercury slips back from the funnel into the bulb. The process is repeated until the bulb is quite filled with mercury.

(3) "Curing" is referred to afterwards. The process consists in laying the instrument aside for a year or so after filling, so that the glass may assume a permanent shape, or "season," and so obviate the error known as "displacement of zero."

(4) Graduation is the marking of the scale on the thermometer stem, the fixed points of temperature of melting ice ( $32^{\circ}$  F.), and of boiling water at a pressure of 29.905 inches ( $212^{\circ}$  F.) being duly ascertained by direct experiment in each case.



## CHAPTER X

### THERMOMETERS

Standard Thermometers—Ordinary Thermometers—"Displacement of Zero"—Registering Thermometers—Phillips's Maximum Thermometer—Negretti and Zambra's Maximum Thermometer—Rutherford's Minimum Thermometer—Objections to Spirit Thermometers—Six's combined Maximum and Minimum Thermometer—Casella's mercurial Minimum Thermometer—Exposure of Instruments—Stevenson's Thermometer Stand and Screen—The "Wall Screen"—Method of Reading the Instruments—The Sling Thermometer (*Thermomètre fronde*)—Self-recording Thermometers, or Thermographs—Electrical and Photographic Thermographs—Radiation Thermometers—Mean Temperature—Average Mean Temperature.

THE thermometers used in meteorological observatories are : standard thermometers, ordinary thermometers, registering thermometers, self-recording thermometers, and radiation thermometers.

1. A *standard thermometer* is made with every precaution to secure accuracy. It is not intended for daily use, but only for testing from time to time the correctness of the ordinary thermometers with which observations are made. The scale should not be cut on the stem for several years after the carefully selected tube and bulb have been filled. This delay is necessary in order to guard against the defect called the "displacement of zero," by which a thermometer is made to read too high. This defect arises from the gradual contraction of the bulb which results from the slowness with which fused glass returns to its original density. Of course, as the

bulb contracts, it holds less mercury, which is forced into the tube to a higher level than the temperature warrants. Except for use in extremely cold climates, a standard thermometer should be made with mercury, because of its uniform rate of expansion. Its scale should range from far below zero to the boiling point of water.

2. *Ordinary thermometers* should be constructed of mercury. They should be scaled from  $-40^{\circ}$  to  $110^{\circ}$  or  $120^{\circ}$ . In the British Isles a range from  $-15^{\circ}$  or  $-10^{\circ}$  to  $100^{\circ}$  is ample. In every case, an ordinary thermometer should carry with it a certificate of verification at Kew Observatory, or other recognised scientific institution. At least once a year each instrument should be tested for the "displacement of zero," by being plunged into a mass of melting snow or ice.

The Kew Observatory Thermometer (Fig. 1) is an excellent instrument, particularly adapted for taking reliable observations at sea, as it is proof against the corrosive action of salt water and of damp, and is protected by a copper case. This thermometer is 12 inches long, with the degrees etched on the stem and the figures indelibly burned on the porcelain scale, which ranges from  $0^{\circ}$  to  $120^{\circ}$  Fahr. It is made after the Meteorological Office and Admiralty pattern, and carries with it a certificate of verification at Kew Observatory.

3. *Registering thermometers* are so constructed as to enable us to read off from them the highest or lowest temperature to which they have been exposed in a given length of time—usually twenty-four hours. As it is too inconvenient to read these instruments at the close of a civil day—that is, at midnight—they are by arrangement read at the latest observing hour of the day, or 9 P.M. in the British

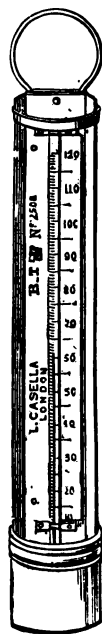

FIG. 1.—Kew Observatory Thermometer.

Isles. The thermometer which is used for registering the highest or maximal temperature of the day of twenty-four hours is called a "maximum thermometer." Similarly, that which registers the lowest or minimal temperature is called a "minimum thermometer." In both maximum and minimum thermometers the contrivance by means of which we are able to read the extremes of temperature is called the "index."

*Maximum thermometers* are of two kinds, called after their designers, Phillips's and Negretti and Zambra's.

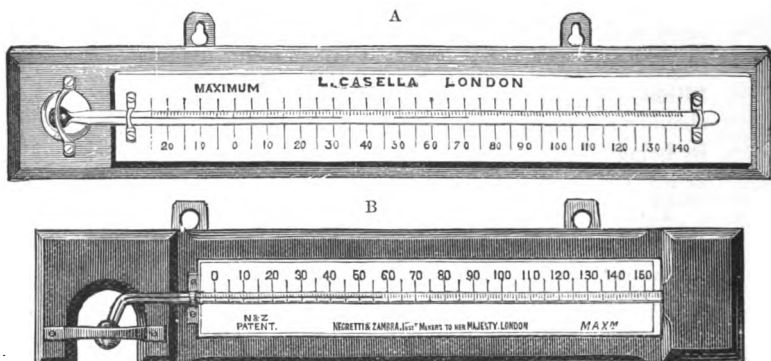

FIG. 2.—A, Phillips's, and B, Negretti and Zambra's Maximum Thermometers.

In the instrument invented by Professor Phillips, F.R.S., of Oxford (Fig. 2, A), the index is really a small fragment of the column of mercury separated from the main body by a tiny bubble of air. When the column expands, this fragment is pushed before it, but when the column contracts, it remains behind in the capillary tube, so marking the point of highest temperature. This delicate arrangement is apt to get out of order, the air bubble being displaced and so permitting the index to coalesce with the main thread or column of mercury, thus converting the instrument into an ordinary thermometer.

Negretti and Zambra devised a plan which is as ingenious as it is simple (Fig. 2, B). The mercurial thread in the thermometer tube forms itself the index in this way: the bore of the

tube is bent at a sharp angle and so much reduced in calibre close to the bulb that, while the expansion of the mercury in the bulb is quite capable of forcing the liquid past the constriction into the tube, on cooling, the portion of mercury which has so passed into the tube breaks off from the main body and remains in the tube to register the highest point to which it had reached. In fact, when contracting, cohesion fails, and the mercury in the bulb is unable to draw back the portion in the tube, a separation taking place where the tube is both bent and constricted.

The maximum thermometer should be suspended in the thermometer stand or Stevenson screen horizontally, or almost horizontally. The bulb end should be gently and slightly depressed before reading, so as to secure that the index is in apposition with the constriction in the tube at the near or bulb end. Great care should be taken to handle the instruments as little as possible while reading them; otherwise erroneous records may result.

These thermometers are both set in the same way. They are taken in the hand and swung briskly, bulb downwards; or else they may be lightly tapped, bulb downwards, on the wooden ledge of the stand. In this way the instrument becomes for the time being an ordinary thermometer, showing the existing temperature of the surrounding air.

*Minimum thermometers* are also of two kinds—Casella's, a mercurial thermometer; Rutherford's, a spirit thermometer. The former is a beautiful instrument, and especially adapted for use in tropical climates, where the intense heat by day causes spirit to volatilise quickly. The latter is the minimum thermometer, which is in almost universal use at our home and colonial stations (Fig. 3). In its construction a small metallic index is immersed in the spirit. Before using, this index is allowed to run down to the end of the column of liquid by sloping the thermometer with the bulb uppermost. In this way the thermometer is "set." It should then be placed in a nearly horizontal position in the screen, any slight inclination

being towards the bulb, so as to facilitate the backward movement of the index when the spirit contracts with a falling temperature. When this happens, the index is drawn back with the spirit by the force of capillary attraction. On a rise of temperature taking place, the spirit expands and flows past the index, which remains behind to mark the lowest or minimum temperature.

A spirit thermometer such as that just described should be carefully watched and periodically compared with a

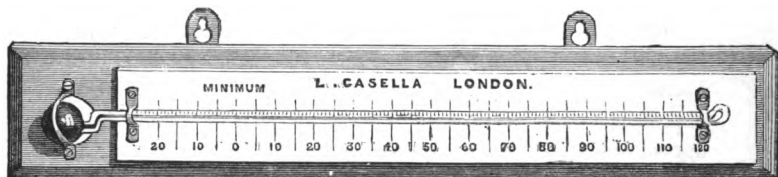

FIG. 3.—Rutherford's Minimum Thermometer, filled with pure alcohol for ordinary registration, engine-divided on the stem.

reliable mercurial thermometer, for some of the spirit is apt to volatilise and afterwards to condense in the distal or further end of the tube, causing the instrument to read too low by two, three, or even more degrees.

Such an accident is easily remedied by swinging the thermometer backwards and forwards, bulb downwards. It may, however, be necessary to cautiously heat the distal end of the tube in the flame, or near the flame, of a spirit lamp. This causes the condensed spirit again to volatilise. If the instrument is then cooled in the position bulb downwards, the freshly condensed spirit will gradually trickle downwards and join the main body of the liquid.

Spirit thermometers are by no means as sensitive as mercurial ones, mercury having a much lower specific heat and a much higher conductivity than alcohol. Hence, it is becoming usual to make the bulb of the spirit thermometer of such a shape—forked or cylindrical—that as large a surface of the spirit as possible shall be exposed to the action of the air.

Mention should be made of the registering thermometers which were devised in the eighteenth century, but which are now discarded as useless for scientific purposes. In 1757, Lord Charles Cavendish, a Vice-President of the Royal Society, read a paper before the Society on a maximum thermometer and a minimum thermometer which he had designed. This paper will be found in the 50th volume of the *Philosophical Transactions* (p. 300). His instruments suggested to Mr. James Six, a quarter of a century later (in 1782), the idea of an improved registering thermometer, which has ever since been known as "Six's Thermometer" (Fig. 4). It combines in one instrument a maximum and a minimum thermometer. It consists of a long tube bent parallel to itself in the centre like a siphon, and terminating at each extremity in a bulb, one of which bulbs is larger than the other. The bend of the tube is filled with a plug of mercury. The remainder of the tube and both bulbs are filled with spirit, but in the smaller bulb there is also a bubble of highly compressed air. A small needle index of steel, with a capillary filament attached to it, floats on each end of the plug of mercury.

As temperature rises, the spirit in the larger bulb expands, and pushes the mercurial plug with one of the indexes in front of it into the distal tube. When temperature falls, the spirit of course contracts, and the elasticity of the compressed air bubble in the distal bulb causes the mercury to pass back after the retreating spirit, the distal index remaining behind to mark the point of highest temperature. But as the mercury passes back into the proximal

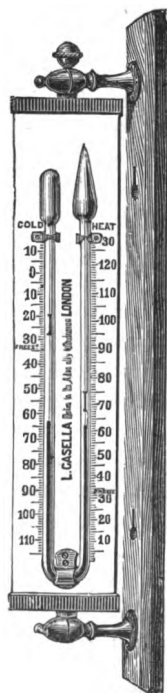

FIG. 4.  
Six's Thermometer.

tube, it pushes the other index before it towards the larger bulb until temperature ceases to fall. When this happens, the proximal index remains to mark the lowest temperature.

The indexes, being of steel, can be "set" for a new observation by means of a magnet—in this way by attraction they are drawn back to the surface of each end of the plug of mercury.

Since a mercurial minimum thermometer is much better suited for use in hot climates than a spirit thermometer, it may be well to describe Casella's ingenious instrument at some length. Mercury is the only fluid employed in its make. The bulb and column are of the same size as in the standard maximum thermometer, and cold is thus registered under precisely the same conditions as heat. No steel or other index is employed. In this thermometer advantage is taken of a curious property of mercury, which tends to adhere to glass *in vacuo*.

Various experiments were undertaken by Mr. Louis P. Casella, F.R. Met. Soc., for the purpose of discovering some means by which in a mercurial thermometer the mercury itself might be detained at the point of lowest temperature, and so serve as a self-registering minimum thermometer. It occurred to him that the adhesive property of mercury for glass *in vacuo*—together with the fact that, where two tubes are united to one bulb, this fluid will rise by expansion in the larger, and recede by contraction in the smaller, tube—might enable him to attain his object. The result was the invention of probably the first instrument known to register past indications without having or forming any separate index.

The general form and arrangement of this ingenious instrument are shown in the accompanying illustrations (Fig. 5), of which the upper drawing represents a full-sized section. A tube with large bore is made to come off from the upper side of the thermometer stem a short distance in front of the bulb. At the distal end of this large-bored tube a flat glass diaphragm is formed by the abrupt junction of a small pear-shaped

chamber (*ab*), the inlet to which at *b* is larger than the bore of the indicating tube, or stem of the thermometer.

The thermometer being set, as temperature falls, the mercury in the bulb contracts and withdraws the fluid in the stem only. When the minimum temperature is reached, the

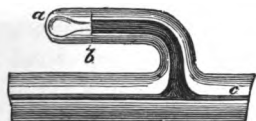

mercurial column in the stem marks it, not only at the moment, but afterwards also. For as soon as the mercury in the bulb begins to expand



FIG. 5.—Casella's Mercurial Minimum Thermometer.

with a rise of temperature, it finds an easier passage into the tube of larger bore, and through it into the pear-shaped chamber beyond. In the tube of smaller bore, that is, the stem of the thermometer, adhesion or capillary attraction holds the mercury and prevents its recession from the point indicating the lowest temperature that had been reached since the instrument was set.

To set the thermometer, it should be placed in a horizontal position, with the back plate suspended on a nail, and the lower part supported on a hook. The bulb end may now be gently raised or lowered, causing the mercury to flow slowly until the bent part is full and the chamber (*ab*) is quite empty. At this point the flow of mercury in the long stem of the thermometer is arrested, and indicates the exact temperature of the bulb, that is, of the air, at the time. When out of use, or after transit, it may happen that, on raising the bulb, the mercury will not at first flow out from the small chamber (*ab*). In such a case, however, a slight tap with the hand on the opposite end of the instrument, with the bulb uppermost, will readily cause it to do so.



The maximum and minimum thermometers, the ordinary or dry-bulb thermometer, and the wet-bulb thermometer, by which the temperature of evaporation is shown, as will be

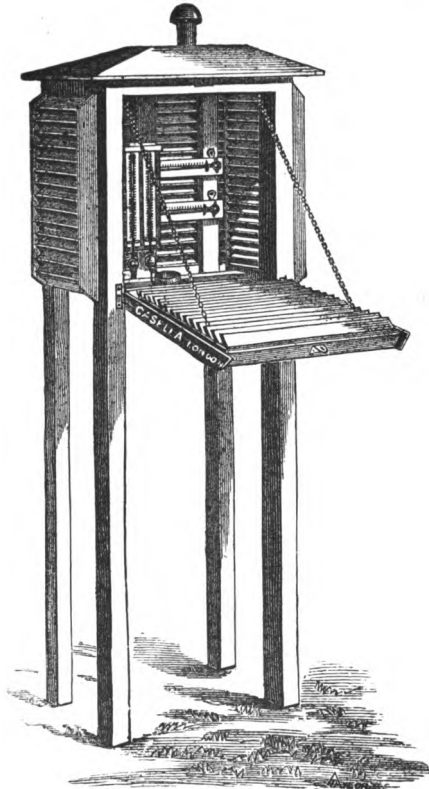

FIG. 6.—Stevenson's Thermometer Stand.

afterwards described,<sup>1</sup> should all be suspended in a suitable screen or thermometer stand.

Thermometers should be protected from the direct or reflected rays of the sun, but at the same time should be freely

<sup>1</sup> See p. 191.

exposed to the open air. These ends are best attained by placing them in a thermometer stand, such as the louvred box designed by Mr. Thomas Stevenson, C.E., of Edinburgh—hence called the Stevenson stand or screen (Fig. 6). The pattern of this screen, which has been approved by the Royal Meteorological Society, is described in the *Quarterly Journal* of the Society (vol. x. p. 92, 1884). The screen is a double louvred box, its interior being 18 inches long, 11 inches wide, and 15 inches high. It has a double roof, the upper one projecting 2 inches beyond the body of the screen on all sides, and sloping from front to back. The front is hinged as a door and opens downwards. The thermometers are suspended on uprights near the middle of the screen, which should be painted white within and without, the finishing coat consisting of white paint and copal varnish. The screen should be mounted on four stout posts over short grass and freely exposed. It should not stand in the shade or within 7 feet of any wall, particularly of one with a southern aspect. The door of the screen should open towards the north.

In towns, at many telegraphic stations, and on board ship, a "wall screen" must take the place of the freely exposed Stevenson stand just described. It consists of a covered case, with louvred wings, fixed on a wall facing north, at the height of 4 feet from the ground, by means of large holdfasts.

The Royal Meteorological Society recommends that the observations with the thermometers just described should be made as follows:—Having opened the screen, the dry and wet bulb thermometers are to be read first, so that they may not be affected by the nearness of the observer. The maximum thermometer is to be read next, by noting the point at which the end of the column of mercury is lying. The minimum thermometer is read last, by noting the position of the end of the index furthest from the bulb. The surface of the column of spirit shows the temperature at the time of observation. A second reading of all the thermometers should be

taken to guard against any mistake in the first entry. The maximum and minimum thermometers should then be set. When set, the end of the mercury in the maximum and the end of the index farthest from the bulb in the minimum should indicate the same temperature as the dry bulb. The door of the screen should finally be closed, after fresh water has been poured over the wet-bulb thermometer.

*Sling thermometer.* — Under the name of *thermomètre fronde* (sling thermometer) the French meteorologist M. Arago, in 1830, devised a method of measuring air temperature by means of a thermometer attached to a string and allowed to swing rapidly round for the space of half a minute or so. By this method the use of a screen is dispensed with, and *even in full sunshine* a close approximation to the true air temperature in the shade may be obtained. This method is, of course, applicable only for isolated observations.

4. *Self-recording thermometers, or thermographs,* are so arranged as to record their own readings, independently of the observer, either at frequent intervals in the case of the electrical thermograph, or continuously, as in the photographic thermograph.

In the electrical thermographs designed by Dr. Theorell, of Upsala, and Professor F. van Rysselberghe, of Ostend, the thermometer tube is open at the upper end, and a wire is introduced into it which, by a clock-work mechanism long before devised by Sir Charles Wheatstone, is caused to descend at regular intervals until it touches the surface of the mercury. At the moment of contact an electric current is generated, which causes a needle to prick a paper, on which the thermometer scale is marked, at the point corresponding to the height of the mercurial column at the time. The wire is then raised mechanically and contact is broken (R. H. Scott). In Sir Charles Wheatstone's thermograph the mercury became oxidised by the electric spark produced at the moment that the dip separated from the mercury (*étincelle de rupture*); but this inconvenience has been obviated.

A photographic thermograph is in use in the stations of the First Order managed by the Meteorological Council of the Royal Society. In this instrument a bubble of air is introduced into the column of mercury, and this moves up and down with the temperature, the bore of the tube being larger than in Phillips's maximum thermometer. A lamp is placed before the instrument, and a photograph of the space occupied by the air bubble is continuously taken on prepared paper stretched on a drum, which is caused to revolve on its own axis once in forty-eight hours.

At Greenwich Observatory a thermograph of a rather different construction is employed. It is made somewhat on the principle of the Kew Barograph. The light is allowed to pass through the thermometer tube above the level of the mercury on to the sensitised paper. We in this way get a continuous photographic tracing which corresponds along its lower edge with the temperature range, the level of the mercury abruptly cutting off the photographic tracing below.

5. *Radiation thermometers.*—The subject of radiation is so important that we shall consider it in the next chapter, and there explain the instruments by which it is measured.

Having taken observations with the thermometers already described, we are in a position to ascertain the Mean Temperature, or that temperature which has an intermediate value—(1) between the several successive hourly temperatures recorded by a thermograph, or read by an observer every hour throughout an entire solar day of twenty-four hours; or (2) between the extreme readings recorded in that time; or (3) between the dry-bulb readings taken twice or thrice daily, at 9 A.M. and 9 P.M., as at all British stations of the Second Order; or at 7 A.M., 1 P.M., and 9 P.M., as in Russia; or at 6 A.M., 2 P.M., and 10 P.M., as in Austria.

These are the three methods adopted for ascertaining what is known as mean temperature of a *day*. The mean temperature of a *month* is obtained by dividing the figure 31, or 30, or 29, or 28, as the case may be, into the sum of that number

of daily values. The mean temperature of a year is similarly obtained by dividing the figure 12 into the sum of that number of monthly values.

The term *average mean temperature* is properly applied to that temperature which represents the mean of a number of means. For example, in Dublin the mean temperature of May, 1893, was  $56\cdot7^{\circ}$ , but the average mean temperature for May in that city in a long series of years (1865-1892, that is, twenty-eight years) was  $52\cdot0^{\circ}$ . We say then that the mean temperature of May, 1893, was  $4\cdot7^{\circ}$  above the average.

When dealing with diurnal extremes of temperature, a sufficient approximation to the mean temperature is obtained by taking the arithmetical mean of the maximum and minimum thermometer readings, according to the formula—

$$\text{Min.} + \{\text{Max.} - \text{Min.}\} \times \cdot 5 = \text{M.T.}$$

A careful comparison, however, with the results yielded by thermograms, as the tracings taken by the thermograph are called, has suggested the following empirical formula, in which the coefficient *C*, a variable quantity from month to month, takes the place of the constant coefficient  $\cdot 5$ .

$$\text{Min.} + \{\text{Max.} - \text{Min.}\} \times C = \text{M.T.}$$

The annexed Table gives the coefficients for the different months.

Months.		Coefficient.
January	} . . . .	0·520
December		
February	} . . . .	0·500
November		
March	} . . . .	0·485
October		
April	} . . . .	0·476
September		
May	} . . . .	0·470
August		
June	} . . . .	0·465
July		

In accordance with this Table, the mean temperature of May, 1893, in Dublin, was

not—

$$\text{Min.} + \{\text{Max.} - \text{Min.}\} \times \cdot 5$$

but—

$$\text{Min.} + \{\text{Max.} - \text{Min.}\} \times \cdot 470$$

Interpolating the actual values we have

not—

$$50\cdot6^{\circ} + \{62\cdot7^{\circ} - 50\cdot6^{\circ}\} \times \cdot 5 = 56\cdot7^{\circ}$$

but—

$$50\cdot6^{\circ} + \{62\cdot7 - 50\cdot6^{\circ}\} \times \cdot 470 = 56\cdot3^{\circ}$$

## CHAPTER XI

### RADIATION

Heat: how transmitted—Conduction—Convection—Radiation—Solar Radiation—Terrestrial Radiation—Effect of Altitude on Temperature: how brought about—Radiation Thermometers—Black-bulb Thermometer *in vacuo*—Bright-bulb Thermometer *in vacuo*—Southall's Heli-pyrometer—Herschel's Actinometer—Pouillet's Pyrheliometer—Grass Minimum Thermometers—Earth Temperatures—Critical Temperature at depth of 4 feet—Duration of bright Sunshine—Sunshine Recorders.

HEAT is communicated, or transmitted from body to body or from place to place, in at least three different ways—by *conduction*, by *convection*, and by *radiation*.

Conduction is the transmission of heat through a conductor, or a substance or body capable of being a medium for its transmission—for example, an iron poker, as contrasted with a stick, which latter is a non-conductor. To quote the *American Cyclopædia*: “The communication of heat from one body to another when they are in contact, or through a homogeneous body from particle to particle, constitutes conduction.” As a rule, conductors of heat are also conductors of electricity.

In practical meteorology we have illustrations of conduction of heat in the propagation of changes of temperature from the surface of the earth to the successive strata of the subsoil; and in the alternate heating and chilling of the lowest strata of the air through contact with the ground.

The subsoil temperature is recorded by means of underground thermometers, such as are figured in the accompanying illustrations (Figs. 7 and 8).



FIG. 7.—Underground Thermometer.

Convection is the transference or transmission of heat by means of currents generated in liquids and gases by changes of temperature and other causes. When a spirit lamp is applied to the bottom of a vessel of water, the heated water at the bottom expands, becomes specifically lighter, and so rises to the surface, carrying with it or *conveying* the heat it has received. Thus, by convection, heat is diffused at last through the whole mass of the water in the vessel. A similar experiment on a stupendous scale in nature causes hot and cold winds in the atmosphere, as well as vast ocean currents like the Gulf Stream, which conveys heat or warmth to high latitudes along the north-western coast of Europe. Convection, like conduction, applies to heat and electricity alike.

Radiation is the transmission from a point or surface of rays of heat along divergent lines (Lat. *radius*, a semi-diameter of a circle; hence a beam or ray of light proceeding from a bright object along divergent right lines or *radii*), not from particle to



FIG. 8.  
Underground Thermometer.



particle of the same body (as in conduction), but from one body to another, through air, or vacuum, or space. Radiant heat is, in fact, identical with light, only the wave-lengths of the rays of which it consists are at moderate temperatures longer than those corresponding to red light, and so they do not present the phenomena of light. If, however, the temperature of a body is increased, it begins to glow with a dull red light, which passes through shades of yellow, violet, and blue, until an intensely heated body is said to be incandescent, which means that it gives off a light as white as that of the sun, and which contains in their proper proportions all the colours of sunlight.

Radiant heat, then, spreads along straight lines, diverging in all directions from the source of heat. "Its intensity," says Dr. Alex. Buchan,<sup>1</sup> "is proportioned to the temperature of the source, is inversely as the square of the distance from the source, and is greater according to the degree of inclination of the surface on which the rays fall."

Heat is radiated towards the earth from the fixed stars, the planets, the moon, but, above all, the sun. Indeed, for all practical meteorological purposes we may assume that the sun's rays are the only source whence heat reaches the earth's surface. We speak, therefore, of solar radiation alone in connection with the *receipt* of heat by the earth.

In a paper on the "Conservation of Solar Energy," read before the Royal Society on March 2, 1882, Dr. C. William Siemens, D.C.L., F.R.S., observed: "The amount of heat radiated from the sun has been approximately computed by the aid of the pyrheliometer of Pouillet, and by the actinometers of Herschel and others, at 18,000,000 of heat units from every square foot of its surface per hour, or, put popularly, as equal to the heat that would be produced by the perfect combustion every thirty-six hours of a mass of coal, of specific gravity = 1.5, as great as that of our earth.

<sup>1</sup> *Introductory Text-Book of Meteorology*, p. 48. William Blackwood and Sons: Edinburgh and London. 1871.

“If the sun were surrounded by a solid sphere of a radius equal to the mean distance of the sun from the earth (95,000,000 of miles), the whole of this prodigious amount of heat would be intercepted ; but considering that the earth’s apparent diameter, as seen from the sun, is only seventeen seconds, the earth can intercept only the 2250 millionth part.”

In accordance with physical laws no sooner does the earth receive heat from the sun than it begins to radiate it back again into space in all directions. Hence we speak of *terrestrial radiation*.

From what has been stated above in a quotation from Dr. Buchan, it is clear that solar radiation is much less in winter than in summer, owing to increased inclination ; but it is also less in July than in December (taking the earth as a whole), because in the latter month the sun and the earth are some three millions of miles nearer to each other than in the former. According to Mr. R. H. Scott, F.R.S., with the existing value of the eccentricity of the earth’s orbit, the amount of heat received in perihelion (the southern summer) is to that received in aphelion (the northern summer) as 1.034 is to 0.967.

Solar radiation is also interfered with by clouds, but is not materially affected by the air through which it passes ; nor is it diverted from a straight course by the wind (Buchan).

Terrestrial radiation tends to dissipate into space the heat which the earth has received from the sun, and as a consequence temperature falls in winter, when the slanting rays of the sun pour down less heat upon the earth’s surface. Again, not only the seasonal, but also the diurnal, range of temperature, depends on radiation. By day, solar radiation predominates and temperature rises ; by night, solar radiation ceases while terrestrial radiation continues, and so temperature falls. Just as solar radiation is interfered with by clouds, so an overcast sky interrupts terrestrial radiation.

Hence dew is not deposited on a cloudy night, because the thermometer does not fall below the temperature of saturation, or the dew point. But even an excess of moisture in the atmosphere interferes with terrestrial radiation, so that very low temperatures are never felt in damp weather, while severe frosts occur in spring nights, when the air is very dry and the sky is often clear.

A covering of snow at one and the same time prevents and facilitates radiation. The explanation of this paradox is that the snow acts like a cloud canopy and interferes with radiation from the surface of the ground, which is in this way kept warm. But, further, snow is a bad conductor of heat, and so the warmth is imprisoned beneath it through non-conduction. Hence the surface of the snow becomes intensely cold, for no heat reaches it from below, while it radiates freely into space what heat it does already possess.

Dr. Hann<sup>1</sup> calculated that in a vertical column of absolutely dry air the thermometer should fall 1° F. for every 182 feet of altitude, or 1° C. for every 100 metres. In nature, however, there is practically no such thing as absolutely dry air. The moisture in the atmosphere, then, is liable to be condensed as the temperature falls with increasing altitude. But in the process of condensation latent heat is set free in large quantities with the effect of lessening the rate of cooling in the vertical column of air. Sir John Herschel long ago calculated that the slower rate of cooling amounted to about 1° F. for every 300 feet of vertical height, and this value is generally accepted. It is, however, necessary to explain that sometimes in winter conditions of temperature are actually reversed, and an "upbank thaw," as it is called, may occur on mountains with the arrival on their slopes of a warm air current, while the cold dense air in the valleys and plains below may cause unbroken frosts at lower levels.

In estimating the influence of radiation upon climate, it is to be borne in mind that the specific heat of water is much

<sup>1</sup> *Allgemeine Erdkunde*. Third edition. Tempsky: Prague. 1881.

higher than that of land—in the proportion of about four to one. Hence solar radiation heats water much more slowly than it heats dry land, and again water cools in turn much more slowly than dry land does. In these facts we recognise one explanation of the modifying and mollifying effects of the ocean upon climate. Its presence controls temperature, forbidding it to rise quickly in summer or to fall quickly in winter. Of course, by convection also, currents of cool water flow towards warm regions, and currents of warm water towards cold regions.

We are now in a position to resume the description of various thermometers employed in meteorological observations, which was begun in the preceding chapter.

5. *Radiation thermometers.*—*Solar radiation* is measured by the black-bulb thermometer *in vacuo*, an instrument which was first suggested by Sir John Herschel. The Rev. Fenwick W. Stow, M.A., of Aysgarth Vicarage, Bedale, Yorkshire, de-

scribes this instrument as follows:—The insulated solar maximum thermometer, usually called the black bulb *in vacuo*, is a sensitive maximum thermometer, having the bulb and a given portion of the stem covered with lamp black, the whole being enclosed in a glass tube from which all air and moisture have been removed, so that the heat of the sun's rays is thus obtained, apart from the influence of vapour or passing currents of air. The stem near the bulb must be blackened to prevent reduction of temperature in the bulb through conduction, the bright stem chilled by radiation in this way

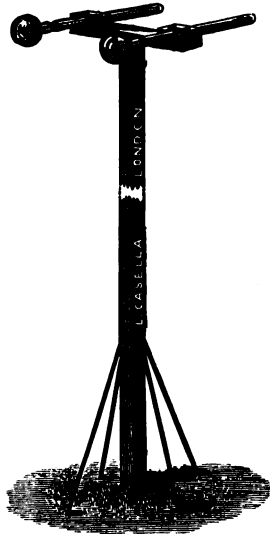

FIG. 9.—Solar Radiation Thermometer Stand.

affecting the bulb. This delicate instrument should be placed on a stand 4 feet above the ground, in an open space, with its bulb directed towards the south-east, and free from contact with any substance whatever.

The Royal Meteorological Society recommends the use, in addition to the black bulb, of a bright-bulb thermometer *in vacuo*. The readings of this latter instrument will, of course, be lower than those of the black bulb, because the bright bulb will radiate freely the heat which it receives from the sun's rays. Fig. 9 represents these thermometers *in situ*.

The *helio-pyrometer*, arranged by Mr. T. Southall, of Birmingham, gives extraordinary readings at times (216°, 217°, and even 231·5° in July, 1859), and these readings are confirmed by water being caused to boil violently in a small vessel attached to the apparatus. One of Casella's solar radiation maximum thermometers, made on Professor Phillips's principle, is fixed on a cushion at the bottom of a box, the sides of which are also cushioned, and a thick piece of plate glass is laid upon the top to prevent currents of air carrying off the heat as well as with the view of preventing the cooling effects of terrestrial radiation. The box is placed in such a position that the sun's rays may fall as nearly as possible perpendicularly on the glass. A change of position to secure this end may be required twice or three times a day. No doubt a portion of the sun's heat is lost by reflection from the surface of the plate-glass cover, but the amount of the loss can be calculated.

Other solar radiation instruments which deserve mention are: Sir John Herschel's actinometer (Gk. ἀκτίς, *a ray*; μέτρον, *a measure*), Padre Secchi's solar intensity apparatus, and Pouillet's pyrliometer (Gk. πῦρ, *fire or heat*; ἥλιος, *the sun*; μέτρον, *a measure*). By means of this last instrument the effect of the sun's heat upon a given area is ascertained by the number of degrees of heat imparted to a given quantity of mercury in five minutes.

The Richard system for recording solar heat (actinometer)

is partly based upon researches made by Professor Violle, and is represented in Fig. 10. Two thermometers, the bulb of

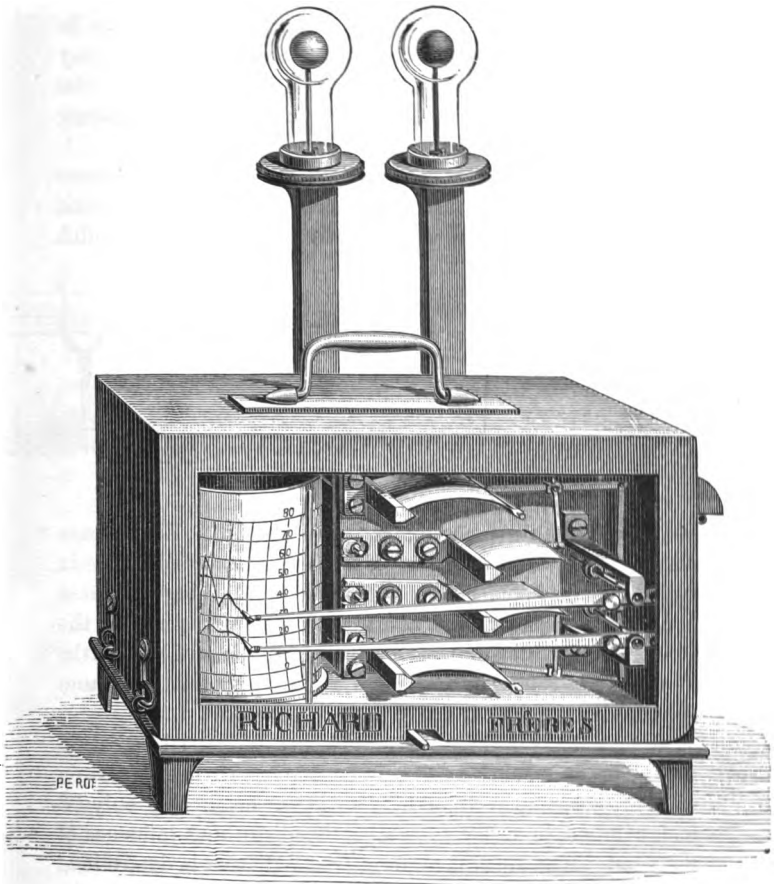

FIG. 10.—Richards' Actinometer.

one of which is bright, while that of the other is a dull black, are protected by glass spheres and record on a single sheet,

so that the difference of their readings, and also the times of their respective maxima, can be easily seen.

When using the black bulb *in vacuo*, observations should also be made with the ordinary maximum thermometer in the shade. The greatest amount of radiation during the day will then be approximately indicated by subtracting the maximal temperature in the shade from the maximal reading recorded by the solar radiation thermometer.

*Terrestrial Radiation.*—The thermometer used for registering this meteorological factor is a delicate self-registering spirit minimum thermometer, of Rutherford's construction, which

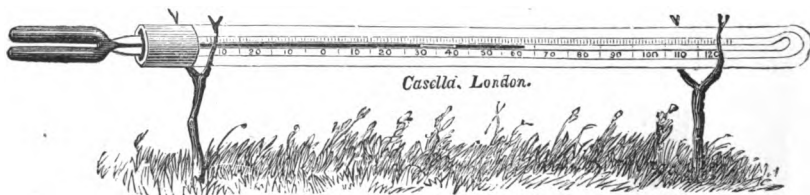

FIG. 11.—Casella's Bifurcated Grass Minimum.

is enclosed in a glass cylinder for protection. To increase the sensitiveness of the spirit "grass minimum," Mr. Casella designed a thermometer in which the bulb, being extended in a forked form, exposes a greatly increased surface to the air (Fig. 11). In this way the instrument is rendered little, if at all, less sensitive than Mr. Casella's mercurial minimum already described.

A thermometer intended to measure terrestrial radiation should be suspended over a piece of smooth lawn grass on wooden props shaped like Y's, at a height of only 3 inches or so, in order to escape the disturbing influence of the wind. The amount of terrestrial radiation is determined by subtracting from the minimal temperature recorded in the thermometer screen the minimum registered on the grass. Should the ground be covered with snow the radiation thermometer should be laid upon the surface of the snow.

Where a grass plot is not available the thermometer should be placed on a large black board laid upon the ground.

*Earth Temperatures.*—In connection with radiation it is desirable to ascertain the temperature of the soil at fixed depths. This may best be done by using Symons's earth thermometer (Fig. 12).<sup>1</sup> It is a sluggish thermometer mounted on a short weighted stick attached to a strong chain. It is lowered by means of this chain into a long, stout, iron pipe, pointed at the lower end and driven into the earth to any required depth—1 foot, 2 feet, 3 feet, or 4 feet below the surface. The top of the iron pipe or tube is closed by a tight-fitting iron cap. The tube should be driven into the soil below short grass and in a well-exposed situation.

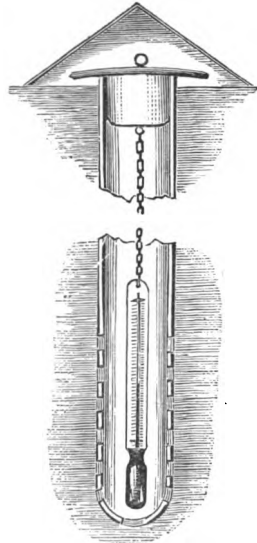

FIG. 12.—Symons's Earth Thermometer.

Mr. Casella also has designed a self-registering thermometer for immersion to any depth in the earth or wells, where it will record the maximum and minimum temperatures for a required interval of time.

From observations at the Calton Hill, Edinburgh, Principal Forbes concludes that the seasonal variations of temperature are reversed at a depth of 24 feet—the greatest warmth occurring at that depth about January 4, and the greatest cold about July 13. Below 40 feet there is no annual variation in the temperature of the soil.

The temperature of the soil, as shown by the earth ther-

<sup>1</sup> "Improved Form of Thermometer for observing Earth Temperature." By G. J. Symons, F.M.S. *Quarterly Journal of the Meteorological Society*, vol. iii. p. 421, 1877.



mometer, has a vital bearing on public health. Systematic observations at the City Meteorological Observatory, 299 Oldham Road, Manchester, have convinced Dr. John Tatham, lately the able Medical Officer of Health for that great city, but now Medical Superintendent of Statistics at Somerset House, that, in accordance with the views of Dr. Edward Ballard, F.R.S., when the earth temperature at the depth of 4 feet from the surface rises to 56° F. infantile diarrhoea may be expected to become epidemic in the city. This "critical temperature," as Dr. Ballard aptly calls it, was reached at a very early date (June 20-21) in 1893, and accordingly the deaths from diarrhoea, which had been 4·7 per week on the average in the six weeks ending June 10, compared with 2·0 per week during the same period in 1892, increased from 11 in the week ending June 17, to 18 in that ending June 24, 58 in that ending July 1, 72 in that ending July 8, 83 in that ending July 15.

In 1892, the 4 feet earth temperature did not reach 56° until August.

There can be no doubt that the prevalence of cholera or epidemic summer diarrhoea, the prevalence of enteric fever, and that of cholera are all equally determined by this critical subsoil temperature of 56°.

*Duration of Bright Sunshine.*—Within the past twelve years striking observations have been made on this point under the auspices of the Meteorological Office, London, and of the Royal Meteorological Society and the Scottish Meteorological Society. It is manifest that the amount of solar radiation will depend on the amount of bright sunshine. A remarkable instance of this occurred in the spring of 1893, when the registered amount of bright sunshine was much in excess of the average, and when solar radiation was so powerful as to cause a marvellous blossoming not only of the ordinary spring flowers and shrubs, but also of shrubs which rarely flower in ordinary years in the climate of the British Isles.

The instruments which are used for recording the dura-

tion of sunshine are (1) the Campbell-Stokes Burning Recorder ; (2) the Whipple-Casella Universal Sunshine Recorder ; (3) the Jordan Photographic Recorder. The principle of the first two of these instruments is the same. It consists in burning a tracing in a piece of mill-board placed in the focus of rays from a glass sphere, which acts as a lens when exposed to bright sunshine. The burning recorder was originally devised in 1854 by Mr. John F. Campbell, F.G.S., of Islay, and was improved by Professor Sir George G. Stokes, Bart., F.R.S., of Cambridge.

1. The Campbell-Stokes Sunshine Recorder consists of a sphere of glass 4 inches in diameter, supported on a pedestal in a metal zodiacal frame (Fig. 13). It should be fixed in

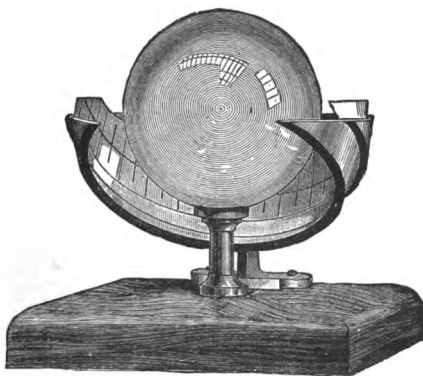

FIG. 13.—The Campbell-Stokes Sunshine Recorder.

an open position, so that the sun's rays may fall upon it at any time between sunrise and sunset. It must face due south, so that the sun's image shall fall upon the meridian line marked on the inside of the ring supporting the recording cards when the sun is itself upon the meridian. The axis of the ring in question must be inclined to the horizon at an angle equal to the latitude of the place, and the instru-

ment must be level as regards east and west.<sup>1</sup> There are three grooves in the ring which supports the card : one holds rectangular cards with hour figures printed upon them suit-

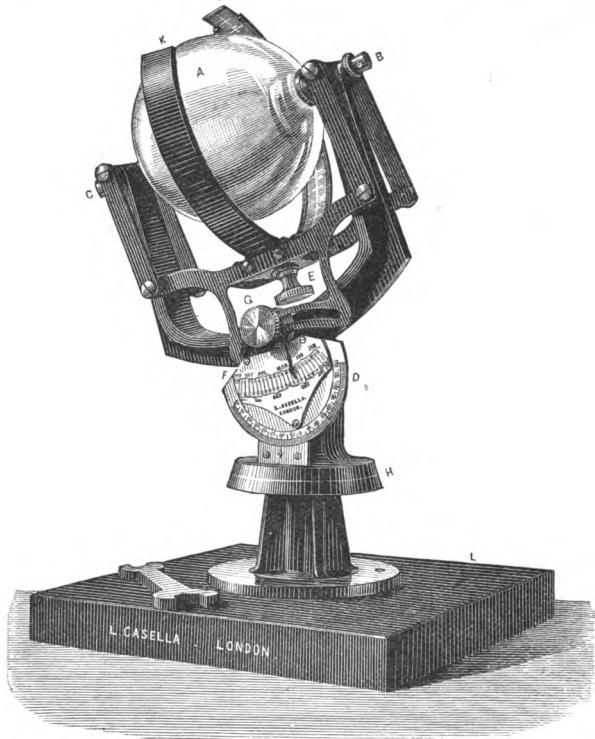

FIG. 14.—The Whipple-Casella Universal Sunshine Recorder

able for the equinoxes ; one, long curved cards similarly time-marked for summer ; and one, short curved cards for winter. A card being fixed in the proper groove according

<sup>1</sup> *Quarterly Journal of the Meteorological Society*, vol. vi. p. 83, 1880. "Description of the Card Supporter for Sunshine Recorders adopted at the Meteorological Office." By Professor George Gabriel Stokes, M.A., F.R.S.

to the season of the year, the sun when shining burns away or chars the surface at the points on which its image falls from moment to moment, and thus a tracing of bright sunshine is given. A card should be removed daily after sunset, and a new one inserted ready for next day. This apparatus costs £9 : 9s.

2. The Whipple-Casella modification of this instrument

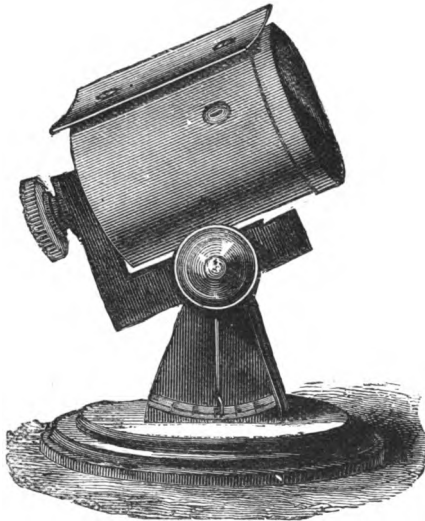

FIG. 15.—Jordan Photographic Sunshine Recorder.

has divided latitude and diurnal circles, so that it can be set for any locality and for any day in the year, thus earning its name of "Universal Sunshine Recorder." It is an expensive instrument, costing £17 ; but, owing to its powers of adjustment to time and place, it requires merely a strip of cardboard duly hour-marked instead of Sir George G. Stokes's equinoctial and summer and winter cards. (See Fig. 14.)

3. In 1838 an automatic Daylight or Sunlight Recorder was invented and constructed by Mr. T. B. Jordan, who

wrote and published an account of his invention in the *Sixth Annual Report of the Royal Cornwall Polytechnic Society* (p. 185). The instrument, however, which now goes by the name of the "Jordan Photographic Sunshine Recorder," was

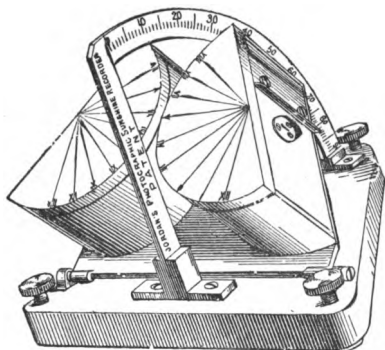

FIG. 16.—Improved Jordan Photographic Sunshine Recorder.

designed in 1885 by Mr. James B. Jordan of the Home Office.<sup>1</sup> Two forms of the Jordan Photographic Sunshine Recorder are in use. The first pattern, represented in Fig. 15, brought out in 1885, consists of a cylindrical box, on the inside of which a sheet of sensitive cyanotype paper is carefully placed day by day. The sunlight is admitted into the box by two small apertures, and acts on the paper chemically, leaving a tracing as the ray travels across it owing to the earth's rotation. The improved pattern (Fig. 16) has two semi-cylindrical boxes, one to hold the forenoon, the other the afternoon record. A slit, through which the beam of sunlight finds entrance, is placed in the centre of the rectangular side of each box, so that the length of the beam within the chamber is the radius of the cylindrical surface on which it is projected. The path of the sun-beam, therefore, follows a straight line on the sensitive paper at all seasons. The instrument must be carefully adjusted to the meridian and to the latitude of the place, and must be firmly fixed (Wm. Marriott, F.R. Met. Soc.)

<sup>1</sup> *Quart. Journ. of the Royal Met. Soc.*, 1886, vol. xii. p. 23.

## CHAPTER XII

### ATMOSPHERIC PRESSURE

The Barometer and its Uses—Galileo's Observation—Torricelli's Discovery—The "Torricellian Vacuum"—Principle involved in Nature's abhorrence of a Vacuum—Fluids used in constructing a Barometer: Mercury, Water, Glycerine—Jordan's Glycerine Barometer—Estimation of the Height of the Atmosphere—Pascal's Experiments—Estimation of Mountain Altitudes by means of the Barometer—Scaling and Lettering of the Barometer—The "Weather Glass," or Wheel Barometer, of Robert Hooke—History of the Barometer.

WE have already seen in Chapter II. that the atmosphere has weight, and can be weighed. The instrument by which this is effected is called the barometer (Gk. *βάρος*, *weight*; *μέτρον*, *a measure*). But it would be most misleading to suppose that the only use of the barometer is the mere weighing of the atmosphere. By a careful study of the properties of this marvellous instrument we are enabled to measure the heights of mountains, to ascertain the distribution of atmospheric pressure over the earth's surface by sea as well as by land, and at the different seasons of the year; to understand in consequence the prevalent winds at all times and in all places, to trace the ever-shifting distribution of atmospheric pressure over vast districts, and finally, to "forecast" the weather. This may be done either by a consideration of barometrical observations taken at a single station, or by means of telegraphic information as to a number of such observations taken synchronously (or at the same

moment of time) at many stations scattered over a large area like the west, north-west, and centre of Europe, or the United States of America and Canada.

Surely such far-reaching potentialities as those now indicated bespeak for so wonderful an instrument our liveliest interest and most attentive study.

An observation of Galileo Galilei, of Pisa, the father of

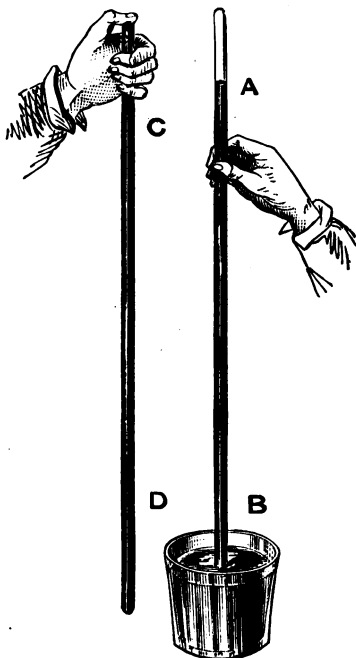

FIG. 17.—Torricelli's Experiment.

experimental science, that water would not rise in a pump more than "eighteen cubits" (*diciotto braccia*) above the level of a well, led to the discovery of the pressure of the atmosphere by Evangelista Torricelli, his pupil and successor in the Chair of Philosophy and Mathematics at Florence, who also devised the means of measuring that pressure. Torricelli's famous experiment was made in 1643. He was testing Galileo's dictum that "Nature abhors a vacuum" (up to 32 feet, in the case of water), and for convenience employed mercury. By doing so, he found that Nature's abhor-

rence of a vacuum varied for different fluids. Torricelli filled a tube, 3 feet long, with mercury, and then inverted it, and plunged its lower end into a basin filled half with mercury and half with water. So long as the lower end of the tube remained below the level of the mercury in the basin, the height of

the column of mercury in the tube proved to be about 30 inches, and a vacant space of 6 inches was left at the top of the tube—a space which afterwards came to be, and is still, known as the *Torricellian vacuum*. The moment, however, that the lower end of the tube was raised above the surface of the mercury in the basin into the overlying stratum of water, all the mercury in the tube rushed out, its place being taken by the water, which equally readily rushed in and *filled the tube completely*. Reasoning out the matter, the philosopher concluded that some one force existed which was able to support a column of mercury to a height of 30 inches in the tube, but a column of water to a much greater height. This force could be none other than the pressure of the atmosphere on the open surface of the fluids—mercury and water—in the basin. Thus was the barometer discovered.

Torricelli further proved that Nature's abhorrence of a vacuum was represented by a column of fluid inversely proportional to its specific gravity. Take the very fluids under consideration—water and mercury; the specific gravity of water being 1, that of mercury is 13·594, and we get this inverse proportion :—

1 : 13·594 :: 30 inches : x = the required height of a column of water supported by the atmosphere.

$$13·594 \times 30 \text{ inches} = 407·82 \text{ inches} = 33·99 \text{ feet.}$$

This principle has been taken advantage of in selecting fluids for the construction of a barometer. Thus mercury is one of the handiest, because, in addition to other recommendations, it requires a tube only 32 inches long in consequence of its high specific gravity. On the other hand, if we could use water in an immense tube 35 or 36 feet in length, the smallest variations in atmospheric pressure could easily be observed. Water, however, is not available because of its high freezing point. Hence we select glycerine, the specific gravity of which is 1·26, and which, while undiluted, does



not freeze at any known terrestrial temperature (a 50 per cent solution freezes at  $-31^{\circ}$  C., or  $-23\cdot8^{\circ}$  F.) In practice we find that a column of glycerine 27 or 28 feet high will yield most valuable barometrical indications. The proportional statement is:—

1·26 : 1 :: 33·99 feet : x = the required height of the column of glycerine in feet or inches—

1·26)33·99(26·976 feet, or 323·7 inches.

$$\begin{array}{r} 252 \\ \hline 879 \\ 756 \\ \hline 1230 \\ 1134 \\ \hline 960 \\ 882 \\ \hline 780 \\ 756 \\ \hline 24 \end{array}$$

The proportional statement between glycerine and mercury works out as follows:—

1·26 : 13·594 :: 30 inches : x = the required height of the column of glycerine in inches or feet—

1·26)13·594 × 30, *i.e.* 407·82(323·6 inches = 323·7 inches *quam proxime*  
= 26·975 feet.

$$\begin{array}{r} 378 \\ \hline 298 \\ 252 \\ \hline 462 \\ 378 \\ \hline 840 \\ 756 \\ \hline 84 \end{array}$$

Jordan's glycerine barometer, used at the *Times* Office, London, consists of a gas tube, five-eighths of an inch in diameter and 28 feet in height. As glycerine has a singular affinity for water, the glycerine in the cistern of this gigantic barometer is covered with a layer of paraffin oil.

The advantage of the glycerine barometer then is that it magnifies tenfold, as it were, the readings of the mercurial

barometer—323·7 inches on the scale of the glycerine barometer corresponding to 30 inches on that of the mercurial barometer.

Another interesting application of the principle that the

THE TIMES OFFICE, 2 A.M.  
 READINGS OF THE JORDAN BAROMETER (CORRECTED)  
 DURING THE PAST TWENTY-FOUR HOURS.  
 FEBRUARY 26—27.

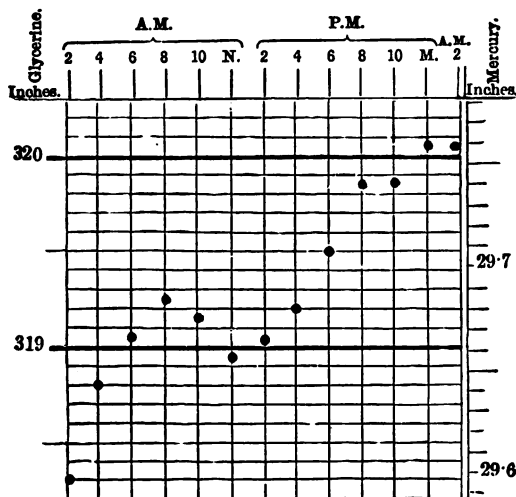

FIG. 18.

heights of columns of liquids or gases are inversely proportional to their specific gravities is the attempt to determine the height of the atmosphere. As air is about 10,000 times lighter than mercury, the height of the atmosphere should on this principle be 10,000 times 30 inches, or 300,000 inches, that is 4·7 miles. In Chapter II., however, it has been shown that the density of the aërial column lessens according to its height, and so, as a matter of fact, the height of the atmosphere is vastly greater than 4·7 miles—an alti-

tude which falls short of the highest peak of the Himalayas by 4000 feet.

Torricelli's surmises received their full confirmation at the hands of the French philosopher, Blaise Pascal, of Clermont, in Auvergne. In 1647 he was in Paris, when the thought struck him that if the Torricellian theory of atmospheric pressure was correct, the height of the column of mercury supported by the air should be less on the top than at the foot of a mountain. He accordingly wrote to his brother-in-law, Perrier, who lived at Clermont, to request him to ascend the neighbouring Puy de Dôme, with the Torricellian tube in his hands. It was not until September 19, 1648, that Perrier was able to carry out the long-projected experiment. In the presence of a distinguished company of savants in Clermont he on that day repeatedly performed the Torricellian experiment. The party then ascended the mountain, which at a distance of 8 miles rises some 3510 feet above Clermont, and to Perrier's surprise, and ultimately to Pascal's delight, the mercury was found to stand 3·33 inches lower on the summit than at Clermont. On the way down, at Font de l'Arbre, the column was proved to have an intermediate height. Perrier's observations on this memorable day gave 3458 feet for the height of the Puy de Dôme above Clermont, and the actual height is now stated to be 3511 feet. The account of this experiment was given by Blaise Pascal himself in a pamphlet published in Paris in 1648, and entitled "Récit de la grande Expérience de l'Equilibre des Liqueurs."<sup>1</sup>

During the years 1649-1650 readings of the "Torricellian column," as it was called, were taken daily, and at the same time, by Pascal at Paris, Perrier at Clermont, and Chanut and Descartes at Stockholm, "in order to see if anything could be discovered by confronting them with one another." Mr.

<sup>1</sup> *Neudrucke von Schriften und Karten über Meteorologie und Erdmagnetismus.* Herausgegeben von Professor Dr. G. Hellmann. 4to. Berlin: A. Ascher and Co. 1893.

Richard Strachan, F.R. Met. Soc., who gives much of the foregoing information in a lecture delivered under the auspices of the Meteorological Society in 1878,<sup>1</sup> observes: "Pascal was thus the pioneer of the synchronous observations upon which modern storm-warnings depend."

In 1665 the Hon. Robert Boyle observed the Torricellian column in relation to weather, and gave it a scale and lettering. In the same year Robert Hooke invented the "weather glass" or wheel barometer.

In the *Philosophical Transactions* for 1666, p. 153, we read that "Modern Philosophers, to avoid Circumlocutions, call that Instrument, wherein a Cylinder of Quicksilver, of between 28 and 31 inches in Altitude, is kept suspended after the manner of the Torricellian Experiment, a Barometer or Baroscope<sup>2</sup> . . . to detect all the minute variations in the Pressure and weight of the air."

A very full historical account of the barometer was communicated to the Royal Meteorological Society on March 17, 1886, by the President, Mr. William Ellis, F.R.A.S., of the Royal Observatory, Greenwich. His Presidential Address will be found in the twelfth volume of the *Quarterly Journal of the Royal Meteorological Society* (No. 59, July 1886, p. 131).

<sup>1</sup> *Modern Meteorology*, p. 70 et seq. London: Edward Stanford. 1879.

<sup>2</sup> Gk. βάρος, weight; σκοπέω, I inspect.

## CHAPTER XIII

### THE BAROMETER

The Mercurial Barometer—Extreme Limits of Atmospheric Pressure at Sea-Level—"Torricellian Vacuum"—Attached Thermometer—Mounting of the Mercurial Barometer—Two Difficulties in the Construction of this Instrument—How they are Surmounted—"Error of Capacity"—Capacity Correction—The Fortin Barometer—The Kew Barometer (Adie)—The Siphon Barometer (Gay-Lussac)—The "Gun Barometer" (FitzRoy)—The Wheel Barometer, or "Weather Glass" (Hooke)—Self-registering Barometers, or "Barographs"—King's Mechanical Barograph—Ronalds's Photographic Barograph—Redier's Mercurial Registering Barometer—Wheatstone's Electrical Barograph—Transmission of Barometric Indications by Electricity (J. Joly)—Substitutes for Mercurial Barometers: the Aneroid Barometer—Its Altitude Scale—Bourdon's Metallic Barometer—Measurement of Heights—The "Engineering Aneroid"—Sympiesometer—Hypsometer.

THE most usual form of barometer is a glass tube, about 34 inches in length, closed at one end and carefully filled with pure mercury, of the specific gravity of 13·594. If necessary, the mercury in the tube should be boiled to expel all air. The tube is then placed vertically with its open end dipping into a cup of mercury called the "cistern." When so placed the mercury falls in the tube at sea-level to 30 inches, or some point not very much above or below that level, according to the pressure of the atmosphere at the time.

In Dublin the extreme limits of pressure recorded since 1860 have been—highest, 30·935 inches, on January 10,

1882; lowest, 27·758 inches, on December 8, 1886. But these values by no means represent the extreme range of the barometer. On Thursday, January 5, 1893, the reading at Moscow was 31·27 inches. On Saturday, January 26, 1884, the barometer fell to 27·332 inches at Ochtertyre, near Crieff, in Perthshire, and on Saturday, February 5, 1870, the reading of 27·33 inches was recorded on board the Cunard steamer *Tarifa* in the North Atlantic, in lat. 51° N. and long. 24° W. But even these extremes, all reduced to 32° and mean sea-level, have been exceeded. In a communication to *Nature*, dated January 6, 1887 (vol. xxxv. p. 344), Mr. Blanford states that "the cyclone which on the morning of September 22, 1885, swept over False Point, on the coast of Orissa, gave the lower readings 27·135 inches at the beginning of the central calm, and 27·154 inches half an hour later (both readings reduced to 32° and sea-level)." These readings were made by a verified standard barometer, and are thoroughly authentic. For comparison with English standards a further subtractive correction of ·011 inch has to be applied, which would make the lowest reading 27·124 inches.

In an interesting paper<sup>1</sup> on "The Storm and Low Barometer of December 8 and 9, 1886," Mr. Charles Harding, F.R. Met. Soc., quotes from Professor Loomis's *Contributions to Meteorology*, chap. ii., a reading of 31·72 inches, reduced to sea-level, observed at Semipalatinsk, in Western Siberia (lat. 50° 24' N., long. 80° 13' E.) on December 16, 1877, the reading at Barnaul being 31·63 inches at the same time. This gives a difference from Mr. Blanford's reading, 27·12 inches, of +4·6 inches, which is probably the maximal range of the barometer ever observed at the earth's surface (reduced to sea-level).

These extreme readings, although rarely observed, should be provided for in the scaling of a barometer, which should range from 32 inches to 26 inches, or less to allow for altitude.

<sup>1</sup> *Quart. Journ. of the Royal Met. Soc.*, vol. xiii. p. 201, 1887.

The space above the mercury in the barometer tube is still called the "Torricellian vacuum," and, provided the tube has been properly filled, this space should contain nothing except a little of the vapour of mercury.

As mercury expands with heat, it is essential that a thermometer should be attached to every barometer, in order to show the temperature of the mercurial column. Once this value is ascertained, a suitable correction must be applied to the reading of the barometer so as to reduce it to the fixed or standard temperature of 32° F.

The mercurial barometer is best mounted in a brass case, because the coefficient of expansion of brass by heat is well known—a matter of great importance, as the tables for correcting readings for temperature are based upon the coefficients of expansion of mercury, glass, and brass. Barometers mounted in wood are of inferior value for scientific purposes.

The attentive reader will at this point suggest to his own mind two difficulties in the construction of the barometer. One is, how to cover the cistern so as to prevent the escape of the mercury, and so render the instrument portable without interfering with atmospheric pressure on the surface of the mercury contained in the cistern. This is effected by constructing the bottom of the cistern of leather, as in the Fortin barometer; or by covering a small cavity in the roof of the cistern with leather, as in the Kew barometer.

Again, it is evident that the *level* of the mercury in the cistern will change according as the barometer rises or falls. If it rises, there will be more mercury in the tube and less in the cistern, and the level of the mercury in the latter will fall. On the other hand, if the barometer falls, there will be less mercury in the tube and more in the cistern, in which the level of the mercury will in consequence rise. In a word, "the zero of the scale does not always correspond with the level of the mercury in the cistern" (Fred. J. Brockway). As in all cases the height of the barometer is calculated

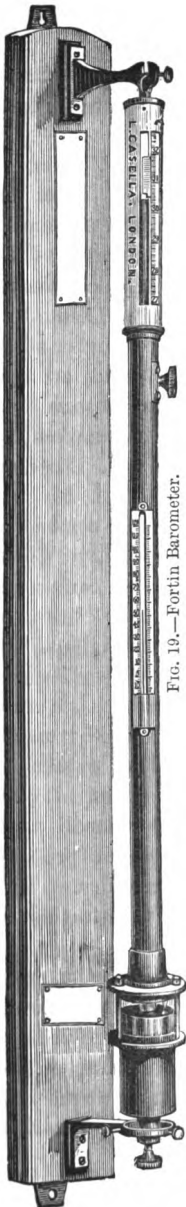

FIG. 19.—Fortin Barometer.

from the level of the mercury in the cistern, we must apply a correction for the error arising from the change of level in the cistern—the “error of capacity,” as it is called. Formerly, tables for applying a “capacity correction” were employed, but they are not now required, owing to the adoption of barometers of the Fortin, Kew, or Siphon patterns.

- (1) The Fortin barometer has a pliable or flexible base to its cistern.
- (2) The Kew barometer has a contracted scale.
- (3) The Siphon barometer dispenses with the use of a cistern altogether.

1. In the Standard Barometer, commonly called Fortin’s barometer, the starting-point, or zero, of the scale is formed by an ivory pin, which must be brought into exact contact with the surface of the mercury in the cistern whenever an observation is made. This is effected by fixing a screw below and in contact with the flexible leather bottom of the cistern. The adjustment is made by means of a thumb-screw, which raises or depresses the flexible leathern base of the cistern until the tip of the ivory pin—technically called the *fiducial point*—and its image reflected in the mercury in the cistern appear exactly to touch each other, when viewed through a glazed aperture in the wall of the cistern.

In Fig. 20, an ingenious arrangement devised by Mr. Wallis, for facilitating the



adjustment of the barometer scale, is represented. It can be clamped to any of the barometers constructed on the Fortin principle.

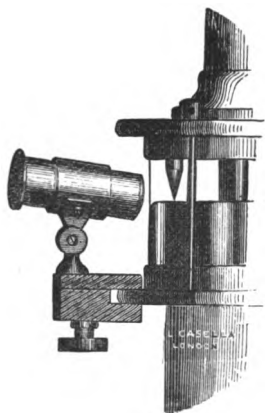

FIG. 20.—Wallis's arrangement for adjusting the Ivory Point.

2. In 1853, Mr. P. Adie, of Edinburgh, invented a barometer for use at sea, which is commonly known as the Kew barometer (Fig. 21). It is so called because it was recommended by the Kew Committee of the British Association for adoption by the Government as best suited for marine observations then about to be commenced by the Admiralty and the Board of Trade. Its distinctive features are a brass frame, a contracted tube, having a pipette, a closed cistern, and a scale of contracted inches. In this, the "Marine

Barometer," the tube is of small calibre throughout the greater part of its length in order to lessen the oscillations of the mercury caused by the ship's motion, which are technically known as "pumping." This renders the instrument rather sluggish, but not materially so. The cistern is entirely composed of iron (because brass being an alloy is liable to be acted on by mercury), and only a small aperture in its roof is left through which atmospheric pressure is able to exert itself on the contained mercury. This aperture is, as has been said above, covered with leather to prevent the escape of the mercury.

In this instrument the "error of capacity" is compensated by contracting the divisions on the scale from above downwards, in proportion to the relative sizes of the tube and the cistern. In ordinary Kew barometers the diameter of the tube is about 0.25 inch, and that of the cistern about 1.25 inch. Accordingly, starting from 32 inches correctly marked

off from a definite point below, the "inches" of the scale are shortened in the proportion of 0.04 inch for every true inch.

Every tube is fitted with an "air-trap," which is a small funnel or pipette inserted somewhere between the range of the column and the neck of the cistern. The pipette was first proposed by Gay-Lussac in order to stop the ascent into the Torricellian vacuum of any air or moisture which may work its way from the cistern into the tube between the glass and the mercury (Fig. 22).

The so-called "Gun Barometer" was designed by Admiral Robert FitzRoy, in 1861, for the naval service. It is a modification of the marine barometer, and is intended to withstand the concussion of heavy ordnance. The glass tube is surrounded wherever possible with vulcanised india-rubber tubing as packing. This checks the vibration from firing, but does not hold the tube too rigidly.



FIG. 21.  
Kew Barometer.



FIG. 22.  
Gay-Lussac  
Air-Trap.

3. To Gay-Lussac we owe the Siphon barometer, which consists of a bent glass tube of uniform calibre, but with one branch or leg much longer than the other. The longer limb is closed at the end and carefully filled with pure mercury, the shorter limb is quite open, and serves as a cistern. As the mercury falls in the long limb, leaving the Torricellian vacuum above it, it must rise to an equivalent height in the short limb. The motion in each limb is exactly one-half of what takes place in a Fortin barometer. The atmospheric pressure, or "height of the barometer," is the difference between the two levels, so that two readings must on every occasion be taken

—one, of the level of the mercury in one limb; the other, of the level in the other limb. This instrument is the only mercurial barometer suitable for mountain climbing, owing to its lightness and portability (Fig. 23).



FIG. 23.  
Siphon  
Barometer.

The ordinary wheel barometer, or "weather glass," was invented in 1665-6 by Robert Hooke, Secretary of the Royal Society. It is a siphon barometer. Resting on the mercury in the shorter limb is a float connected by a silken cord with a light counterpoise at the other side of a fixed pulley, round which the cord is coiled two or three times. A needle indicator attached to the axis of this pulley rotates with the rise and fall of the mercury round a graduated circular dial, on which are also the words: "set fair," "fair," "change," "rain," "much rain," and "stormy." These words are intended to indicate what weather may be expected when the needle points to each part of the dial.

Although a popular instrument, the wheel barometer is of no scientific value. Its principle, however, has been applied in the construction of one form of self-registering barometer, or *barograph* (Gk. βάρος, *weight*; γράφω, *I write*). A pencil is attached to the cord connected with the float, and this pencil is so arranged that it draws a continuous tracing on ruled paper which is moved by clockwork.

In a modified barograph of this kind, ruled metallic paper spread on a revolving vertical drum of about 4 inches diameter is pierced at given intervals (usually every hour) by a needle shot out by clockwork, and ingeniously connected by means of a pulley with the mercurial surface in the short limb of a siphon barometer. The drum or cylinder in this baro-

graph is made to revolve once a week by means of clock-work.

One of the costliest barographs in existence was designed in 1853 by the late Mr. Alfred King, C.E., of Liverpool (Fig. 24). About 130 lbs. of mercury are employed in the construction of this instrument, and the effects of friction, which are the great drawback in wheel barometers, are entirely overcome by the most sensitive mechanical arrangements. In this ingenious barograph the tube is partly supported by the mercury in the fixed cistern, which, as it rises and falls, raises and depresses the tube. A delicate mechanical contrivance records this change of level continuously on a revolving drum. The barometric column is made to show nearly 6 inches for each inch of the ordinary barometer. This instrument has for many years been in use at the Bidston Observatory, near Liverpool. It is fully described in the late Mr. Hartnup's "Report to the Mersey Docks Board for 1865."

Mr. R. H. Scott, F.R.S., speaking of barographs,<sup>1</sup> observes: "The principle of registration generally adopted in this country for the better class of barographs is photographic, not mechanical."

The late Sir Francis Ronalds in 1847 designed a photographic barograph, which in a modified form is employed in the First Order Stations of the Meteorological Office, London. The principle of the instrument is described at length in the "Report of the Meteorological Committee of the Royal Society for 1867" (pp. 40-42). "The barometer is of the ordinary pattern and the light is admitted through the Torricellian vacuum, so that the actual height of the mercury itself is photographed without the intervention of any mechanical contrivance" (R. H. Scott).

Those who are interested in this subject of barographs will find at p. 412 of the second volume of the *Quarterly Journal of the Meteorological Society*, a description of a new barograph invented by M. Louis Redier, which was communicated to

<sup>1</sup> *Elementary Meteorology*, p. 77.

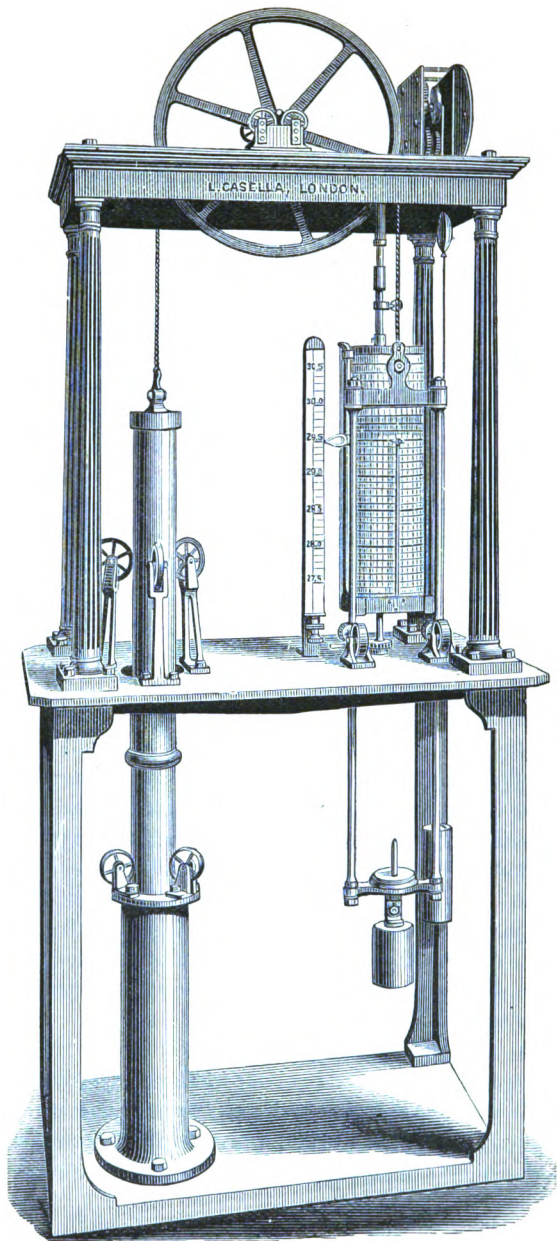

FIG. 24.—Alfred King's Barograph.

the Society on March 17, 1875, by Mr. G. J. Symons, F.R.S. The apparatus is so arranged that all the work is done by a powerful clock movement, and the barometer, of the siphon type, has only to direct the action of the clockwork.

In 1886, M. Redier, in a pamphlet, described a later form of his mechanical barograph under the title "Nouveau baromètre enregistreur à mercure." In it the barometer is at rest. A differential clock train keeps a light horizontal arm in continuous slight vertical oscillation close to the point of a stalk rising from the mercury in the lower branch of a siphon tube. As the arm follows the stalk in all its variations of position, the barometric variations, through a pencil, become continuously recorded.

In addition to *mechanical contrivances* and *photography*, *electricity* has been employed in the construction of the barograph. Sir Charles Wheatstone, in the *British Association Report* for 1842, suggested the adaptation of electricity for the purpose. He proposed that a platinum wire, controlled by a clock, should make contact at given intervals with the mercury in the tube of a barometer or other instrument, for example the dry and wet-bulb thermometers, so creating an electric current which should determine both the record and the value of the element (W. Ellis). This principle has been since applied in the barographs included in the combined meteorographs of Salleron (1860), Theorell (1869), and Van Rysselberghe (1873), the records being all intermittent.

*Transmission of Barometric Indications by Electricity.*— In 1882, Mr. J. Joly, of Dublin, described in *Nature* (vol. xxv. p. 559) a plan for ascertaining the reading of a distant mercurial barometer, connected with the recording station telegraphically. He carries two wires through the head of the barometer tube. One of these of a given diameter is continued downward into the mercury to a point below which the mercury never falls. The continuation of the other is a fine carbon thread, also of a given diameter, carried to the same point and there joined to the wire. The outer ends of

the wires pass to the recording station, an electric current sent from which traverses both wire and carbon in its passage. The carbon being a substance of high resistance, a very small change in its effective length due to the rise or fall of the mercury in the barometer tube, exposing less or more of the fine carbon thread, will tell on the potential of the returning current. This variation of potential would, in Mr. Joly's opinion, be sufficiently marked to enable an observer at the recording station to measure the barometric variations at a station four miles distant, involving eight miles of wire.

Before explaining the method of reading the barometer, it may be well to describe some substitutes for mercurial barometers which have been devised.

The *Aneroid Barometer* is the chief of these. It was invented by M. Vidi, of Paris, in 1843, and patented in the following year. The French patent is dated April 19, 1844. As the name implies it contains no fluid (Gk. *α, priv.* ; *νηρός, wet or damp*, hence *liquid or fluid* ; and *εἶδος, form or shape*). For this reason the aneroid is also known as the "holosteric barometer," the word "holosteric" meaning "entirely solid" (Gk. *ὅλος, whole* ; *στερεός, solid*). In this ingenious instrument the pressure of the atmosphere is measured by its effect in altering the shape of a small, hermetically sealed, exhausted metallic box, called the "vacuum chamber." This vacuum chamber is composed of two discs of corrugated German silver soldered together. Its sides are made in concentric rings, so as to increase their elasticity, and one of them is fastened to the back of the brass case which contains the whole mechanism. A strong spring also fixed to the case is so arranged as to act in opposition to the motion of the vacuum chamber, preventing its sides collapsing when the effect of reduced atmospheric pressure is added to that of extreme exhaustion of the chamber. A lever, composed of iron and brass so as to compensate for changes in temperature, connects the spring, by means of a bent lever at its further end, with a watch-chain which is wound about

an "arbor" (axle or spindle). An index-hand or pointer, fixed to the arbor in front, is by its revolution caused to rotate backwards and forwards over an experimentally graduated dial, and so is made to mark the variations in atmospheric pressure from time to time. A very slight alteration of the size of the vacuum chamber produces a large deviation of the index-hand,  $\frac{1}{220}$ th of an inch, causing it to move through 3 inches as marked on the dial.



FIG. 25.—Aneroid Barometer.



FIG. 26.—Aneroid, extra small, in silver case.

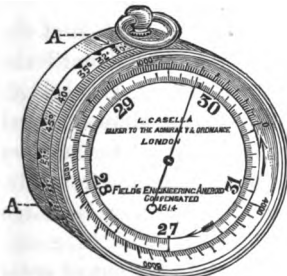

FIG. 27.—Field's Engineering Aneroid Barometer.



FIG. 28.—Extra-sensitive Aneroid Barometer.

When pressure increases, the falling in of the corrugated sides of the vacuum chamber will pull upon the lever, which in turn, acting through the second or bent lever, will pull upon the chain, drawing it off the arbor and so causing the pointer to move across the dial towards the right, marking high pressures.



When pressure decreases, the expansion of the vacuum chamber will allow the compensating spring to push away the lever, which will relax the chain, allowing it to be wound round the arbor by a spiral hair-spring, which will move the arbor and pointer towards the left, marking low pressure.

In 1851, Rusk added an altitude scale to the aneroid barometer.

A Metallic Barometer, designed by M. Bourdon in 1851, is a modification of the principle of the aneroid.

This instrument is described in Besant's *Elementary Hydrostatics* (Chapter V. "Notes"), and in the Report of the Jury on Philosophical Instruments in the Great Exhibition of 1851, as well as in a lecture by Mr. James Glaisher, F.R.S., on these instruments. It consists of a thin elastic metal tube of elliptic section, in shape a portion of a circle, closed at its ends and exhausted of air. Alterations in the pressure of the atmosphere are indicated by the ends of the tube approaching towards each other when pressure increases, and receding from each other when pressure diminishes. These motions are communicated by gearing work to an index hand traversing a dial plate. No definite explanation of the principle of action of this instrument was offered until the Rev. E. Hill, M.A., Fellow of St. John's College, Cambridge, communicated a paper on the subject to the Meteorological Society on February 21, 1872. The above particulars are taken partly from Mr. Ellis's address, but chiefly from Mr. Hill's communication. His explanation, however, is of too recondite a nature to be reproduced here.

Aneroids, while very sensitive, are apt to get out of order owing to defects in construction, rusting, or loss of elasticity in the springs. They are therefore not used at Second Order Stations or for concerted observations, for which accurate mercurial barometers are indispensable.

If an aneroid is employed its readings should be frequently compared with those of a reliable mercurial barometer reduced to 32° F. It is a popular instrument because of its

convenient size and portability. Besides, it requires no correction for its own temperature.

*Measurement of Altitudes.*—An aneroid in good order will show with precision the difference in height between the various stories in a lofty house, the varying gradients in travelling on a railway, and mountain or balloon elevations—it may be up to 24,000 feet. One of the chief uses of the aneroid, indeed, is the measurement of altitudes. Owing to the elasticity of the atmosphere, the reduction of pressure does not proceed evenly with altitude, and accordingly special altitude scales have been computed, which are engraved on the dial of the instrument. A correction for the temperature of the air (not for that of the instrument) must always be made, and so in the “Engineering Aneroid,” invented by Mr. Rogers Field, B.A., Assoc. Inst. C.E., F.R. Met. Soc., and manufactured exclusively by Mr. L. Casella, this correction is taken into account by making the scale adjustable for temperature (Fig. 27).

While on this subject, it will be well briefly to describe two other instruments which are used for ascertaining the altitude—one a barometer, the other a thermometer—the *sympiesometer* and the *hypsometer* respectively.

The *sympiesometer*, or “compression measure” (Gk. συμπίεσις, *compression*, from συμπίεζω, to press or squeeze together; μέτρον, a measure), was invented by Mr. P. Adie, of Edinburgh (Fig. 29). It is a sensitive but unreliable kind of barometer

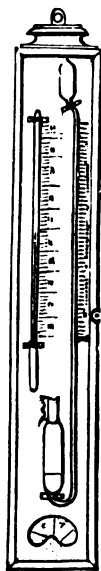

FIG. 29.—Adie's Sympiesometer.

consisting of a glass tube 18 inches in length and three-quarters of an inch in diameter, which terminates in a closed bulb above, and, after a sharp bend, in an open cistern below. The pressure of the air, acting through the latter on the surface of a fluid, such as oil or glycerine, in the lower part of the cistern and of the

tube, forces it upwards so as to compress an elastic gas, such as hydrogen or air, in the upper part of the tube and

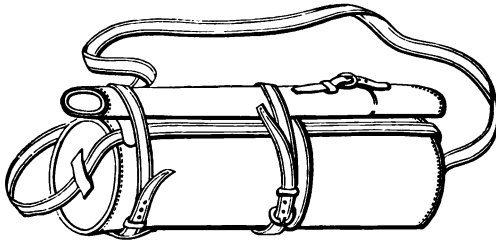

FIG. 30.—Portable Leather Case for holding Casella's Hypsometer.

in the bulb. The amount of compression is read off on an adjustable scale, the index of which must be set to the division on the scale corresponding to the temperature indicated by an attached thermometer.

The principle of the *hypsometer* (Gk. ὑψος, *height*; μέτρον, *a measure*) is based on the fact, already referred to in Chapter IX. p. 97, that the boiling point of water falls according as atmospheric pressure is reduced. The instrument consists of a vessel for water, with a spirit lamp for heating it, and an enclosed thermometer for showing the temperature of ebullition. In Casella's hypsometer (Fig. 31), a strong, small-bulbed thermometer, divided and figured on the stem, is sheltered from cold when in use by a double telescopic chamber, into which it is introduced to any required depth through a loose piece of india-rubber at the top. When the water boils, the vapour fills the inner chamber and envelops the thermometer, bulb and stem alike, finally descending in the outer chamber and escaping by a pipe outlet. Mr. Casella has constructed a smaller instrument on the same principle, which is much used by Alpine travellers.



FIG. 31.—Casella's Hypsometer.

## CHAPTER XIV

### BAROMETRICAL READINGS

Attached Thermometer—Mounting of Barometer—Method of taking a Barometrical Observation—"Capillary Action"—Capillarity—The Vernier—Graduation of British Barometers—Corrections to be applied to Barometrical Readings: Index Error, Capacity, Capillarity, Temperature, Altitude—Verification of a Barometer—The Cathetometer—Kew Certificate—Schumacher's Formula for Reduction of Barometer Readings to 32°—Ordnance Datum for Great Britain—Ordnance Datum for Ireland—Table of Corrections for Altitude controlled by existing Air Temperature and Pressure—Laplace's Formula for finding the difference in Height between two Places—Determination of Mountain Heights by the Barometer.

SINCE mercury expands by heat and contracts by cold, it is necessary that every barometer should carry a thermometer closely attached to its metal case, or preferably to its glass tube and cistern. By means of this "attached thermometer" the observer is placed in a position to apply a proper correction to the reading of the barometer with the view of reducing that reading to the fixed standard of temperature, or 32° F.

Before any observation is made, the barometer should be mounted in a room with an equable temperature, not near a fireplace or a stove. Its scale should be on a level with the observer's eye—5 feet, or 5 feet 6 inches above the floor. It must hang vertically: "*Care should be taken that no readings from a barometer which is not hanging truly vertically should*

ever be recorded.”<sup>1</sup> “To facilitate readings, a piece of white paper or of opal glass should be fixed immediately behind the part of the tube at which the readings are taken, and if the barometer be of the Fortin pattern another piece should be placed behind the cistern.”<sup>2</sup> This arrangement may be seen well represented in Fig. 19 above (p. 139).

The method of taking a barometrical observation is as follows :—

1. The attached thermometer should first be read, no matter what kind of barometer is employed. The temperature of the external air (dry-bulb reading) should also be taken.

2. Next, in the case of a Fortin or standard barometer, the mercury in the cistern should be adjusted by turning the screw at the bottom, so that the tip of the ivory pin, or the *fiducial point*, should barely touch the surface of the mercury. This manipulation is not required, nor is it possible, in the case of the Kew barometer, in which (as has been explained) the scale of shortened inches compensates for the error due to capacity.

3. The barometer tube should, after this, be gently tapped to overcome any tendency to adhesion between the mercury and the glass, and to allow capillary action to assert itself.

It is necessary to mention that, in obedience to what is called “capillary action,” a liquid like water, capable of wetting a clean glass tube open at both ends, will rise in such a tube above the level of its surface in the vessel containing it, and higher and higher according to the fineness of the bore of the tube. Hence the term “capillary,” from the Latin “capilla,” a *fine hair*. Further, the liquid will stand above the general level in the tube where it approaches the sides, so that its upper surface in the tube will be curved

<sup>1</sup> *Instructions in the Use of Meteorological Instruments*, compiled by Robert H. Scott, M.A., F.R.S. Reprinted 1885.

<sup>2</sup> *Hints to Meteorological Observers*. By William Marriott, F.R. Met. Soc.

and *concave*, owing to *capillary attraction*. On the other hand, a liquid like mercury, incapable of wetting such a tube, will stand in the tube below the level of its surface in the vessel, and where it approaches the sides of the tube, its level will be below its general level in the tube, so that its upper surface will be curved and *convex*, owing to *capillary repulsion*. This causes the mercury in a barometer always to stand a little lower than the height due to atmospheric pressure, and necessitates a correction for *capillarity*. Such a correction is less in a barometer in which the mercury has been boiled in the tube than in an unboiled tube, for by the boiling a film of air, which in unboiled tubes adheres to the glass, is expelled. The error is also reduced by widening the bore of the tube; for example, the depression in a boiled tube of a quarter of an inch in diameter is  $\cdot 02$  inch, whereas in a similar tube of half an inch diameter it is only  $\cdot 003$  inch.

4. It follows from the foregoing that, in reading a barometer, the height should be taken from the very apex of the convexity, or of the *meniscus*, as it is called (Gk. *μηίσκος*, a *crescent*, from *μήνη*, the moon). This is done by means of the vernier, the two lower edges of which should be brought, by turning the mill-head pinion which moves the rack up or down, to form a tangent with the convex surface of the mercury. As Mr. Marriott well remarks: "The front and back edges of the vernier, the *top* of the mercury, and the eye of the observer must be in the same straight line."

But what is the *vernier*? It is a short scale named after its inventor, Pierre Vernier, made to slide by means of a rack and pinion along the divisions of a graduated scale, such as that of a barometer, and its divisions are so contrived as to be slightly shorter than those of the barometer scale, which is generally divided into inches, tenths, and half-tenths, or five-hundredths ( $\cdot 05$ ) of an inch. The vernier is made equal in length to twenty-four half-tenth divisions of the barometer scale, and is then itself divided into twenty-five equal parts. From this it follows that each space on the vernier scale falls

short of a space on the barometer scale by the twenty-fifth part of .05 inch, or

$$\frac{1}{25} \times \frac{1}{5} = \frac{1}{125} = \frac{1}{1000} = .002 \text{ inch.}$$

Each division of the vernier, therefore, represents a difference

of .002 inch, or one five-hundredth of an inch in pressure, while by interpolating a reading between any two divisions of the vernier, we are enabled to read the pressure to .001 inch, or the one-thousandth of an inch.

In using the vernier, the division on the barometer scale at or below which the lower edge of the vernier stands after setting it should first be read off. In the accompanying figure two cases are illustrated. In one (that to the left), the lowest line on the vernier scale exactly coincides with the division 29.50 on the barometer scale. The reading is therefore 29.500 inches precisely. In the other (that to the right), the reading on the barometer scale gives us 29.65,

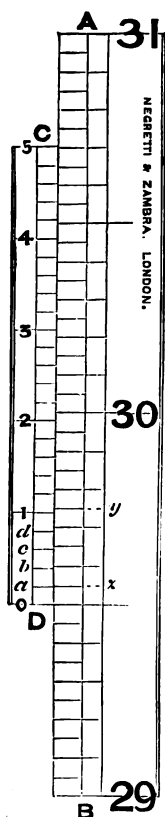

Case 1.

FIG. 32.

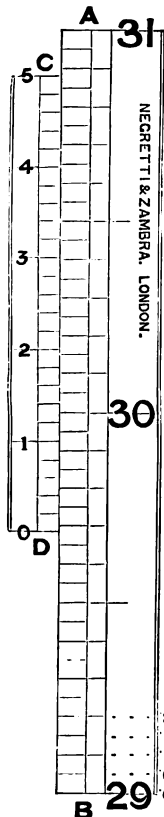

Case 2.

FIG. 33.

Method of reading the Vernier.

but the height of the column of mercury is in reality that

amount in inches *plus* the vernier indication. On looking up the vernier scale in this case, we find that the second and third divisions above the figure 3 coincide with a division on the barometer scale. It is therefore necessary to add the decimal  $\cdot 035$  to the first reading, thus :—

$$29\cdot65 + \cdot035 = 29\cdot685 \text{ inches.}$$

In cases where it is hard to say which division of the barometer scale is that *below* the lower edge of the vernier, the reading of the latter will itself point out which division on the barometer scale should be taken. For example, in the left-hand drawing the correct reading is manifestly 29·500 inches, not  $29\cdot50 + \cdot050 = 29\cdot550$  inches. In fact the value of the vernier reading in the example is zero:  $29\cdot50 + 000 = 29\cdot500$  inches.

It may be well to repeat, what has been already conveyed in different words, that English barometers are usually graduated in the following way :—

1. Every long line cut on the barometer scale represents one-tenth of an inch ( $\cdot 100$  inch).
2. Every short line cut on the barometer scale represents five-hundredths of an inch ( $\cdot 050$  inch).
3. Every long line cut on the vernier scale represents one-hundredth of an inch ( $\cdot 010$  inch).
4. Every short line cut on the vernier scale represents two-thousandths of an inch ( $\cdot 002$  inch).

#### CORRECTIONS TO BE APPLIED TO READINGS OF THE BAROMETER

Before barometrical readings taken synchronously at different places by various observers can be compared with each other and used for scientific purposes a number of corrections must be applied to the recorded readings. Many of these corrections have been already mentioned, but all of them must now be referred to and classified according as



they relate to a given instrument, or are applicable to the readings of any instrument taken under the same conditions.

The corrections of the former class are *three* in number—

- I. Index error.
- II. Capacity.
- III. Capillarity.

Those of the latter class are *two* in number—

- IV. Temperature.
- V. Altitude, or height above sea-level.

I. *Index Error*.—This is detected by careful comparison with a recognised standard barometer. It includes all errors in graduation of the scale. The detection of the index error is simple in the case of the Fortin barometer, but complicated in that of the Kew barometer. The latter instrument must be tested at every half inch of the scale from 27 to 31 inches, because its inches are less than true inches. To pass through this ordeal it is necessary to use artificial means of increasing or reducing pressure, and so the instrument and the standard have to be placed in an air-tight chamber connected with an air pump. The instruments can thus be made to read higher or lower as the air in the chamber is compressed or exhausted. Glass windows through which the instruments can be seen are placed in the upper part of the iron air-tight chamber, but of course the verniers cannot be used, as the observer is outside the chamber. To overcome this difficulty an apparatus called a cathetometer (Gk. *κάθετος*, *let down*; hence ἡ *κάθετος* [sc. *γραμμὴ*], *a perpendicular line*, *a perpendicular height*; *μέτρον*, *a measure*, has been devised. This is a vertical scale, on which a vernier and a telescope are made to slide by means of a rack and pinion. The divisions on the scale correspond exactly with those on the tube of the standard barometer. The cathetometer (Figs. 34, 35, and 36) is placed at a distance of 5 or 6 feet from the air-tight chamber. The telescope carries two horizontal wires, one fixed, and the other capable of being moved by a micrometer screw. The

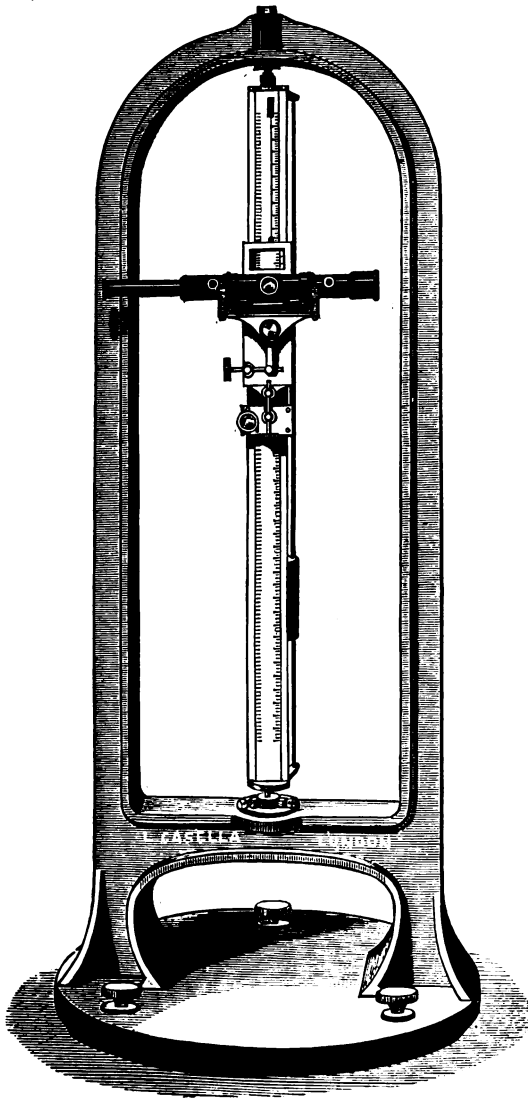

FIG. 34.—Cathetometer constructed for the Indian Government.

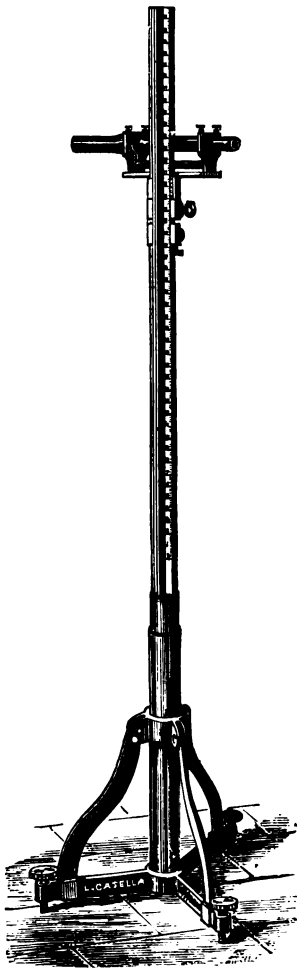

FIG. 35.—Cathetometer, as used at Kew Observatory.



FIG. 36.—Cathetometer, 6½ feet in height.

difference between the height of the column of mercury and the nearest division on the scale of the standard can be measured either with the vertical scale and vernier, or with the micrometer wire. The errors detected in this way include not only the index error, but also the correction required for capillarity.

II. *Capacity*.—The meaning of this term has been already explained. It will be remembered that the siphon barometer requires no correction for capacity. In the Fortin barometer it is provided for by adjusting the scale to the level of the mercury in the cistern, and in the Kew barometer, by shortening the “inches” cut on the scale. In barometers with closed cisterns and a scale of true inches engraved on the case, there is a certain height of the mercurial column which is correctly measured by the scale. This is called the *neutral point*, and it should be marked on the scale by the maker, who should also state the ratio of the interior area of the tube to that of the cistern thus:  $\text{Capacity} = \frac{1}{50}$ . From these data the correction for capacity is found by taking a fiftieth part of the difference between the height read off and that of the neutral point, adding the resulting value to the reading when the column is higher than the neutral point, subtracting it from the reading when it is lower than that point.

III. *Capillarity*.—It has been shown above that the effect of capillary action is always to depress the mercury in a barometer. The amount of depression is nearly inversely proportional to the diameter of the tube, and is always greater in unboiled than in boiled tubes.

The correction for capillarity is always additive (+), and according to the Report of the Committee of the Royal Society on Physics and Meteorology, 1840, it varies from +0.004 inch in the case of an unboiled, and +0.002 inch in that of a boiled tube of the diameter of 0.60 inch, to +0.142 inch in the case of an unboiled, and +0.070 inch in that of a boiled tube of the diameter of 0.10 inch.

The certificate of verification of a barometer issued from Kew Observatory includes the three corrections we have been

considering as applicable to the individual instrument. Here is a copy of the certificate which accompanied the barometer in use at my own station of the Second Order :—

Corrections to the Scale Readings of Barometer, 877,

by Adie, London.

in. At 27·5	in. At 28·0	in. At 28·5	in. At 29·0	in. At 29·5	in. At 30·0	in. At 30·5	in. At 31·0
in. +0·030	in. +0·026	in. +0·022	in. +0·019	in. +0·015	in. +0·011	in. +0·008	in. +0·004

When the sign of the correction is +, the quantity is to be *added* to the observed reading; and when -, to be *subtracted* from it. The corrections given above include those for Index Error, Capacity, and Capillarity.

Pro. B. STEWART,

KEW OBSERVATORY, Jan. 7, 1867.

T. W. BAKER.

IV. *Temperature*.—Both the mercurial column and the brass scale of a barometer expand by heat, and so the height of the column varies with temperature. It therefore becomes necessary to reduce all observations to what they would have been at a given temperature, which is taken as a standard. This standard temperature is 32° F.

An elaborate table for reducing the readings of barometers mounted in brass frames to 32° F. has been computed from the following formula given by Schumacher :—

$$\text{Correction} = -h \frac{m(t - 32^\circ) - s(t - 62^\circ)}{1 + m(t - 32^\circ)}, \text{ in which}$$

$h$  = reading of the barometer,

$t$  = temperature of attached thermometer,

$m$  = expansion of mercury for 1° F., taken as ·0001001 of its length at 32°,

$s$  = expansion of the substance of which the scale is made; for brass  $s$ , is taken as ·00001041 of its length ( $h$ ) at the standard temperature for the scale, viz. 62° F.

In this Table the sign of the correction changes from + to - at the temperature of  $29^{\circ}$ , as the formula gives negative results for  $3^{\circ}$  below  $32^{\circ}$ .

V. *Altitude*.—Every barometrical observation should be reduced to mean sea-level as a standard, because as the barometer measures the pressure of the atmosphere, the height of its column will vary with that pressure, becoming less as we ascend and leave some of the atmosphere, and, therefore, some of its pressure below us; and, on the other hand, becoming greater as we descend and leave more of the atmosphere and more of its pressure above us. For Great Britain the mean sea-level at Liverpool has been selected by the Ordnance Survey as their datum, and the altitude of a barometer at any station in England, Scotland, or Wales may be easily determined by reference to the nearest Ordnance Bench Mark. The Ordnance Datum plane for Ireland differs from that for England and Wales by  $-7.4$  feet—that for Ireland being low water spring-tides, while that for England is mean tide-level. In order that observations in the two countries should be exactly comparable, the Meteorological Office, in 1890, issued new tables for use in Ireland in reducing barometrical readings to the Liverpool Ordnance Datum.

Any table of corrections for altitude or reduction to mean sea-level must take cognisance of two disturbing elements, the temperature of the air and the actual air pressure at sea-level at the time of observation. The air temperature must be taken from the dry-bulb thermometer, not from the thermometer attached to the barometer. Table II. in Appendix I. to *Instructions in the Use of Meteorological Instruments*, compiled by direction of the Meteorological Council by Mr. Robert H. Scott, M.A., F.R.S., contains data for reducing to sea-level barometrical observations made at every 10 feet from 10 to 1500 feet above the datum, and at temperatures varying by  $10^{\circ}$  from  $-20^{\circ}$  F. to  $100^{\circ}$  F., that is a range of  $120^{\circ}$ . The Table is given for two pressures at the lower or

sea-level station, namely, 30 and 27 inches. For intermediate pressures the correction may be obtained by interpolating proportional parts.

For heights exceeding those given in the Table, the value, at the sea-level, of a barometer reading at a station, the height of which is known, may be calculated from the following formula :—

$$\text{Log } \frac{h}{h'} = f \div \left\{ 60159 \left( 1 + \frac{t+t'-64}{900} \right) \left( 1 + \cdot 00268 \cos 2l \right) \left( 1 \times \frac{f+52251}{20886861} \right) \right\}$$

From a table of common logarithms, the natural number corresponding to  $\log \frac{h}{h'}$  is found ; or,  $\frac{h}{h'} = n$ ,

And  $h = n h'$ .

In this formula—

$h$  and  $h'$  = barometer reduced to 32° F. at the lower and upper stations respectively,

$t$  and  $t'$  = the temperature of the air at the respective stations,

$f$  = elevation of upper station in feet,

$l$  = latitude of the place.

The above formula is merely an inversion of the well-known formula given by Laplace in his *Mécanique Céleste*, for finding the difference of elevation between any two places by means of the barometer, which, adapted to Fahrenheit's thermometer and English feet and inches, is—

$$f = 60159 \log \frac{h}{h'} \left( 1 + \frac{t+t'-64}{900} \right) \left( 1 + \cdot 00268 \cos 2l \right) \left( 1 + \frac{f+52251}{20886861} + \frac{x}{10443430} \right)$$

In this formula  $f$  is the difference of elevation between the two stations, and  $x$  is the height of the lower station above the sea-level.

In the last factor an approximate value must be used for  $f$ .

Not only, then, can we reduce the barometer reading at one level to that at another, the relative heights of the two stations being known, but we can conversely determine the difference in height between two stations if we know the barometrical readings and the temperature at each at the same moment of time. In other words, we can determine the height of a mountain by barometrical readings taken simultaneously on the summit, and at sea-level.



## CHAPTER XV

### BAROMETRICAL FLUCTUATIONS

Periodic and Non-periodic Variations in Atmospheric Pressure—Regular and Irregular Variations—Regular : Diurnal and Annual—Irregular : Cyclonic and Anticyclonic—Distribution of Diurnal Variations—Explanation—Dove's Theory—Mr. Strachan's Objections—Diurnal Range of Pressure—Bibliography—Annual Variations of Pressure—Periodical Anticyclonic and Cyclonic Systems—Explanation of their Formation—Trade Winds—Irregular Variations in Pressure—Isobars : Primary and Secondary Shapes—Cyclonic and Anticyclonic—Secondary or Subsidiary Depression—V-shaped Depression—Straight Isobars—"Wedge" of High Pressure—"Col" of High Pressure—Cyclonic and Anticyclonic Systems contrasted—"Radiation Weather"—"Intensity"—Path of Cyclonic Systems—Weather Changes accompanying their Passage—"Veering," "Hauling," "Backing" of the Wind—Anticyclonic Weather : (1) in Winter ; (2) in Summer.

ATMOSPHERIC pressure as measured by the barometer is subject to two classes of variations—*periodic* and *non-periodic*. The first are *regular* ; the second, *irregular*.

The regular, or periodic, variations are (1) *diurnal*, (2) *annual*.

The irregular or non-periodic variations are (1) *cyclonic*, (2) *anticyclonic*.

1. Diurnal variations are best marked within the tropics, or in the torrid zone. They are less marked in temperate climates, absolutely because their physical cause is there less potent, relatively because the irregular variations in atmo-

spheric pressure so frequent in higher latitudes tend to mask them. They gradually sink to zero towards the Arctic and Antarctic Circles and the Poles. So regular is the daily rise and fall of the barometer in the tropics that Humboldt said that the time of day might be inferred from it within seventeen minutes.

As the earth rotates on its axis day by day, the hemisphere facing the sun becomes overheated, the air over it expands, becomes specifically lighter, rises and tends to flow away from the day hemisphere to the night hemisphere. The barometer consequently falls in the hottest part of the day, reaching a minimum about 3 P.M. But a second, though less decided minimum occurs about 3 A.M. This cannot be caused in the same way as the day minimum, for, as a matter of fact, the air is coldest about 3 or 4 A.M. We must therefore seek elsewhere for an explanation. It is to be found, according to Dove (and his theory received the sanction of Sabine), in the state of tension of aqueous vapour in the early morning. As we shall see when we come to discuss the subject of the moisture of the atmosphere, barometrical pressure is made up of two elements—the pressure of dry air, and the pressure of aqueous vapour suspended in the atmosphere. This latter is technically called the elastic force, or tension of aqueous vapour. Now long before 3 A.M. dew has fallen heavily—in other words, the aqueous vapour has been condensed by the nightly fall of temperature, and has left the atmosphere in the condition of dried or desiccated air. In this way the tension of aqueous vapour is largely withdrawn, and the barometer falls.

As there are two minima of pressure, so there are two maxima. Of these the first occurs about 10 A.M., the second about 10 P.M. Condensation of the air after a cold night partly accounts for the forenoon wave-crest of pressure. But another potent cause is rapid evaporation and consequently increasing tension of aqueous vapour. The evening maximum is no doubt due to a brisk decrease of temperature,

causing condensation of the atmosphere coupled with the saturated state of the air after the evaporation of the daytime. The vapour tension, or elastic force, in a word attains *its* maximum.

The foregoing theory affords a rational explanation of these interesting diurnal fluctuations of pressure, and it receives support from the fact that at stations far distant from the sea, or with a high mean temperature—that is, at places where the diurnal ranges of temperature are least interfered with by large evaporating surfaces like the ocean or by moist winds—the maximum at 10 P.M., and the minimum at 3 A.M., which are largely due to the condition of the aqueous vapour, are only slightly marked.

Dove's theory, however, does not receive universal acceptance, because (in the words of Mr. R. Strachan, F.R. Met. Soc.<sup>1</sup>) "the diurnal range of vapour tension does not always and everywhere conform to the simple oscillation." According to Mr. Strachan, in the Island of Ascension we still have a double period for the diurnal range of the barometer, but the vapour tension and the dry air pressure of which it is composed both exhibit a double period also. Such cases completely demolish the theory. Mr. Strachan adds: "A hypothesis then remains yet to be framed which shall account for the diurnal range of the barometer in all seasons and places."

Be that as it may, the fact remains that every day of twenty-four hours sees two vast waves of high pressure and two equally vast troughs of low pressure sweep round the globe at a speed equal to the revolution of the earth on its axis. It is as if two solar tides, stupendous in extent, with their alternate ebb and flow, were generated in the atmosphere by the action of the sun, or, as Inspector-General Robert Lawson suggests, by alternate accelerations and retardations of the motion of the atmosphere revolving with the earth on its axis, caused by the relation which the atmo-

<sup>1</sup> "The Barometer and its Uses," *Modern Meteorology*, p. 89. 1879.

sphere bears to the orbital motion of the earth as distinguished from its axial motion.

The *diurnal range* of pressure, as the difference between the extreme daily oscillations is called, exceeds one-tenth of an inch within the tropics—at Calcutta it is as great as 0·127 inch in January (dry north-east monsoon), but only 0·093 inch in July (moist south-west monsoon)—the average for the whole year being 0·116 inch. At Plymouth and in Dublin it is about 0·020 inch, or only one-sixth of the tropical value. In St. Petersburg it is 0·012 inch, and within the Arctic Circle it merges gradually into the *annual range*, owing to the length of the circumpolar day and night.

From observations in Dublin, extending over as many as thirty years, I am prepared to say that the diurnal range of pressure is quite perceptible in anticyclonic weather, especially in spring-time, when the air is dry and the diurnal range of temperature is large. It is doubtless even better marked at an inland station like Parsonstown or Armagh under like circumstances. Observations, carefully analysed by Mr. Francis Campbell Bayard, have shown that it increases steadily from north-west towards south-east over Western and Central Europe.

The following references to the recent bibliography of diurnal range of pressure may prove of interest. The papers will be found in the *Quarterly Journal of the Royal Meteorological Society*.

1. On the Diurnal Variations of the Barometer. By John Knox Laughton, M.A., F.R.A.S. (vol. ii. p. 155—read April 15, 1874).
2. The Diurnal Inequalities of the Barometer and Thermometer, as illustrated by the observations made at the summit and base of Mount Washington, N.H., during the month of May, 1872. By W. W. Rundell, F.M.S. (vol. ii. p. 217—read June 17, 1874).
3. On the Diurnal Variation of the Barometer at Zi-Ka-

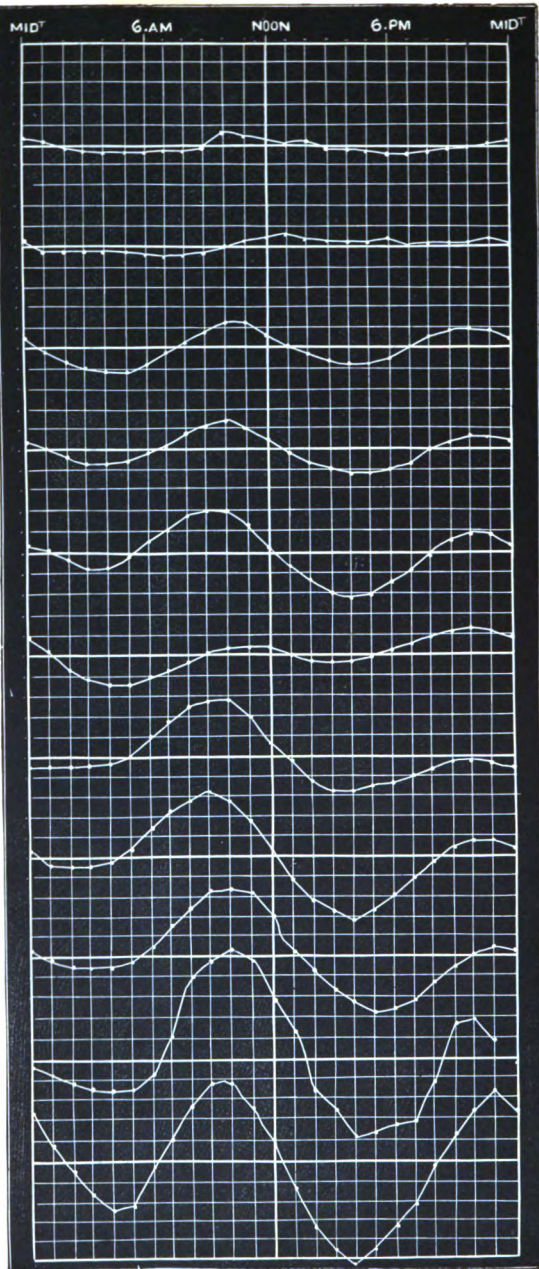

Sitka, 57° 0'.

St. Petersburg, 59° 56'.

Greenwich, 51° 28'.

Halle, 51° 28'.

Geneva, 46° 13'.

Grt. St. Bernard, 45° 50'.

Toronto, 43° 38'.

Philadelphia, 39° 50'.

San Francisco, 37° 48'.

Calcutta, 22° 35'.

Cunnana, 10° 27'.

FIG. 37.—DIURNAL OSCILLATION OF THE BAROMETER IN VARIOUS LATITUDES.  
 Note.—The distance between each two horizontal lines represents 0.01 inch. Thus at Sitka the reading at 10 A.M. is 0.008 inch above the mean.

- Wei (a suburb of Shanghai,  $31^{\circ} 15'$  north latitude), and Mean Atmospheric Pressure and Temperature at Shanghai. By Rev. Augustus M. Columbel, S.J. (vol. ii. p. 232—read June 17, 1874).
4. Suggestions on certain Variations, annual and diurnal, in the Relation of the Barometric Gradient to the Force of the Wind. By the Rev. W. Clement Ley, M.A., F.M.S. (vol. iii. p. 232—read June 21, 1876).
  5. On the Diurnal Variation of the Barometer at the Royal Observatory, Greenwich. By William Ellis, F.R.A.S., of the Royal Observatory (vol. iii. p. 467—read June 20, 1877).
  6. On a Method of sometimes determining the amount of the Diurnal Variation of the Barometer on any particular day. By the Hon. Ralph Abercromby, F.M.S. (vol. iv. p. 198—read June 19, 1878).
  7. The Daily Inequality of the Barometer. By W. W. Rundell, F.M.S. (vol. v. p. 1—read May 15, 1879).
  8. Diurnal Variations of the Barometric Pressure in the British Isles. By Frederick Chambers, Meteorological Reporter, Bombay (vol. v. p. 133—read February 19, 1879). See a paper by the same author in the *Philosophical Transactions of the Royal Society* for 1873—"Convection Current Theory."
  9. The Diurnal Range of Atmospheric Pressure. By Richard Strachan, F.M.S. (vol. vi. p. 42—read December 17, 1879).
  10. Results of Hourly Readings derived from a Redier Barograph at Geldeston, Norfolk, for the four years ending February 1886. By E. T. Dowson, F.R. Met. Soc. (vol. xiii. p. 21—read November 17, 1886).
  11. On the Cause of the Diurnal Oscillation of the Barometer. By Robert Lawson, LL.D., Inspector-General of Hospitals (vol. xiv. p. 1—read November 16, 1887).
  12. The Diurnal Range of the Barometer in Great Britain

and Ireland, derived from the hourly records of the nine principal Observatories in the Kingdom during the years 1876-80. By Francis Campbell Bayard, LL.M., F.R. Met. Soc. (vol. xv. p. 146—read April 17, 1889).

2. *Annual Variations* in atmospheric pressure are on a far vaster scale than the daily ranges we have been considering. As typical examples, we may adduce the high-pressure areas observed in January over the central districts of North America (30·20 to 30·30 inches) and over Central Asia (30·30 to 30·40 inches and upwards. These anticyclonic systems on a gigantic scale give place in July to equally well-marked low pressure, or cyclonic, systems—the mean pressure falling over the central parts of North America to 29·80 inches and less, or half an inch on the average below the mean pressure of January; and over Central Asia to 29·60 inches and less, or eight-tenths of an inch below the January mean.

Again compare the low-pressure areas of January situated over the Pacific south of Alaska (29·60 inches), and over the Atlantic south of Greenland and Iceland (29·40 inches), with the comparatively high mean pressures for July in these oceanic regions—29·90 to 30·00 inches over the Pacific, 29·80 to 29·90 inches over the Atlantic.

Let us seek for an explanation of these phenomena.

Over the centre of that vast continent of the Eastern Hemisphere or Old World, which is formed by Europe and Asia, the air in summer becomes much warmer than that over the Atlantic Ocean to the west, and over the Pacific Ocean to the east. In consequence, the air is rarefied, and the barometer falls over Russia, Siberia, and other inland countries—the isobars, or lines of equal barometrical pressure, curving round the area of lowest pressure—while it remains comparatively high over the North Atlantic and North Pacific Oceans. In accordance with Buys Ballot's Law, a circulation of air will commence round the barometrical depression thus

formed : an immense *cyclone* develops, the winds blowing against the hands of a watch, from south-west in India and China (the south-west monsoon) ; from south, south-east, and east in Japan and North-eastern Siberia ; from north-east and north in North-western Siberia and Northern Russia ; from north-west and west over the west and south of Europe and South-western Asia.

In winter, on the other hand, the air over the central districts of Europe and Asia, rendered dry by the intense heat of summer and its accompanying excess of evaporation, becomes rapidly chilled to an extreme degree. The autumnal snows cover the ground, cutting off terrestrial radiation and causing a still more decided fall of temperature. By this the air is condensed and the barometer rises at a time when a vacuum is forming over the Atlantic and Pacific Oceans owing to the updraught and lateral dispersion of the light warm air which had been resting upon the surface of those oceans, and which may at the time possess a temperature  $60^{\circ}$  or even  $80^{\circ}$  higher than that of the air over the interior of the great continent. Owing to the advancing season also, and the consequent general decrease of temperature, the air over these oceans becomes saturated with moisture, frequent rains result, and a further reduction of atmospheric pressure results, caused by the latent heat set free in the formation of rain. In this way, conditions are brought about which are the reverse of those observed in summer : an immense anti-cyclone is formed, the winds circulating round and *out from* the centre of high pressure in a direction with the hands of a watch, blowing from north-west and north in Japan and China ; from north-east in India (the north-east monsoon) ; from east and south-east in Russia and Southern Europe ; from south-west in the British Isles ; and from west in Northern Russia and Siberia. In Central Russia and Siberia a region of calms will exist near the position of the highest atmospheric pressure. In the winter season the predominant winds over Scandinavia are south-easterly, but this apparent



anomaly is in fact a beautiful fulfilment of the very laws it seems to contradict. We have seen that in winter a barometrical depression exists over the North Atlantic Ocean, particularly over that portion of it which is called the Norwegian Sea. It is this which draws the wind from south-east over Sweden and Norway, in strict agreement with Buys Ballot's Law.

A precisely similar state of things, though on a somewhat reduced scale, holds good in the Western Hemisphere, or New World. In summer, a barometrical depression, or cyclonic system, develops over Upper Canada and the Central States of the Great Republic, round which minimum the prevailing winds sweep in a gentle curve against watch-hands. In winter, on the contrary, an area of high atmospheric pressure, or anticyclonic system, develops in the same region, and round its central zone of calms the prevailing winds blow with watch-hands. Hence the prevalent north-west and north winds, which bring to Labrador, Lower Canada, and the Eastern States the rigorous winters of the American Atlantic Seaboard; although, of course, the setting of a polar current of iceberg-laden water southwards along that seaboard intensifies the rigours of the climate, just as the warm waters of the Gulf Stream in laving the western shores of Europe temper the climate even further north than the Arctic Circle.

In equatorial regions, where air temperature and moisture are constants throughout the year, the annual variation in atmospheric pressure is trifling in amount. In the southern hemisphere, however, seasonal changes in pressure again become marked, although they are not so pronounced as in the northern hemisphere where dry land or continent so largely takes the place of ocean.

*Trade Winds.*—Leaving out of count the great disturbances of pressure from winter to summer and from summer to winter, caused by the rise and fall of temperature over the continents of the Old and New Worlds, we find that a belt

of comparatively high pressure, from 30·00 to 30·20 inches, encircles the earth at the tropics both north and south of the equator, while over the equator and the immediate vicinity to 10° or 15° north and south, the barometer stands from one-tenth to two-tenths of an inch lower. These areas of high and relatively low pressure oscillate backwards and forwards with the season: in January the northern zone of high pressure approaches the equator, while the corresponding southern zone recedes from it. Conversely, in July, the northern zone retreats northwards, while the southern advances towards the equator. In obedience to Buys Ballot's Law, permanent winds blow from these respective areas of high pressure towards the equatorial trough of low pressure, constituting the North-east Trades of the Tropic of Cancer and the South-east Trades of the Tropic of Capricorn.

Dr. Alexander Buchan, in a masterly analysis of barometrical observations taken at some four hundred stations scattered all over the globe, has ascertained that atmospheric pressure is lowest throughout the year over the Antarctic Ocean, about 29 inches. "In the hemisphere where winter reigns, the greatest pressure lies over the land; the larger the continent, the greater the pressure. In the hemisphere where summer reigns the low pressures are over the land, the high over the oceans." Mr. R. Strachan, whose words we have just quoted, gives the following Table of the most remarkable areas of high and low pressures:—

Period.	Position.	Pressure.
		Inches.
December, January, February .	{ Iceland	29·4
	{ 50° N. 170° W.	29·6
	{ 50° N. 100° E.	30·4
	{ 0° to 40° S.	30·0
June, July, August . . . .	{ 40° N. 90° E.	29·5
	{ 30° N. 40° W.	30·2

So far, periodical variations in atmospheric pressure

have been our theme. We have now to consider those irregular variations which daily, monthly, and yearly occasion changes in wind and weather over more or less extensive areas of the earth's surface. They are measured or determined by drawing lines of equal barometrical pressure, or isobars, on a map of the area under discussion, which is then called a synoptic weather chart. These isobars are drawn for each tenth of an inch. They tend to assume two primary

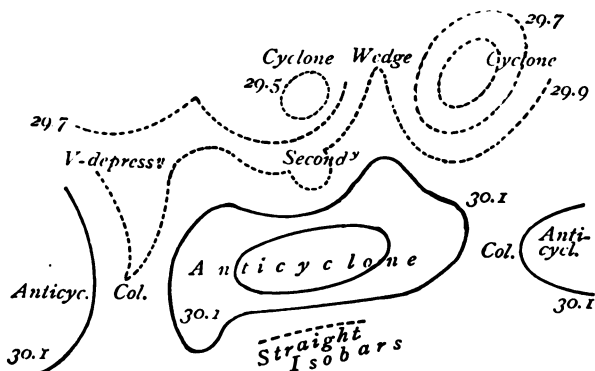

FIG. 38.—Cyclonic and Anticyclonic Isobars.

and five secondary shapes (Fig. 38). If they enclose an area of low pressure, forming a circle or an oval, they are described as *cyclonic* in shape, from the Gk. κύκλος, a circle. If, on the contrary, the isobars encircle an area of high pressure, they are described as *anticyclonic*—the Greek preposition *ἀντί* meaning originally *over against*, *opposite*, hence *in opposition to*.

Thus we have two primary types of isobars—*cyclonic* and *anticyclonic*.

The secondary shapes are five in number. They are for the most part modifications of the primary types, or connected with either one or other of them. Thus, in a cyclonic system, one or more of the isobars sometimes curves outwards

from the centre, forming a loop which embraces a secondary area of low pressure in the periphery of the primary cyclone. Such a system is called in consequence a *secondary* or *subsidiary depression*.

Again, isobars embracing an area of relatively low pressure, instead of curving into a cyclone run or bend into the shape of the letter V. Such a system is called a *V-shaped depression*.

Occasionally, in the third place, the isobars run parallel to each other, or nearly so, it may be for hundreds of miles, assuming the form neither of cyclonic nor of anticyclonic isobars. They are then called *straight isobars*.

In the fourth place, when cyclonic systems are following each other in rapid succession, and when an anticyclone is in the neighbourhood, a tongue of high pressure inserts itself like a wedge between two areas of low pressure. Such a system resembles an inverted V, but is the converse of a V-shaped depression, because its isobars enclose an area, not of low, but of high pressure. It is called a "*wedge*."

Lastly, two anticyclones may be connected with each other by means of a furrow or neck of relatively low or less high pressure, and this system is called a *col*, because it is analogous to the col which forms a pass between two adjacent mountain-peaks (Ralph Abercromby).

Speaking in general terms, we may contrast cyclonic with anticyclonic systems as follows:—

1. Cyclonic areas as a rule travel, it may be, at the rate of 20 miles an hour or upwards—in equatorial regions from east to west, in extra-tropical latitudes usually from west to east.

Anticyclonic systems, on the contrary, are often stationary for days or weeks, or their motion is slow and irregular. They frequently move away from the track of cyclonic systems almost at right angles.

2. In cyclonic systems the isobars generally approach each other much more closely than do those of anticyclones—in

other words, the gradients are steeper and therefore the winds are stronger in cyclones than in anticyclones.

3. Unsettled, windy, rainy, or showery weather is commonly associated with cyclonic systems. In anticyclones, on the contrary, conditions are as a rule fine, quiet, and dry. In winter, however, dense fogs sometimes accompany the calms of an anticyclone, and in parts of its periphery the sky may be densely clouded. If rain should fall, it is usually drizzling—not heavy. In summer, hot sunshine by day and cool nights accompany an anticyclone, and sea fogs are prevalent when the calm-centre overlies the sea. In any case, much haze obscures the horizon.

4. Thunderstorms are very apt to develop in connection with V-shaped and secondary depressions. In the former, violent shifts of wind and sudden changes of temperature usually occur, these phenomena being accompanied by heavy squalls and showers of rain and hail, or, in winter, snow.

5. The weather accompanying anticyclones is well described by the Hon. Ralph Abercromby as “radiation weather”—hot suns by day and cool nights in summer; intense frost in winter, so long as the sky is tolerably clear.

6. The term “*intensity*” applied to an anticyclone means that the barometer has reached an unusual height in its centre; further, that the system is of vast extent and also of long duration. The same term applied to a cyclonic system means that the isobars are close together, and that the system is deep and moving quickly. “There is no difference,” says the Hon. Ralph Abercromby,<sup>1</sup> “between the cyclones which cause storms and those which cause ordinary weather except *intensity*.”

The great majority of the atmospheric depressions which pass over the British Islands come in from the Atlantic and travel, most usually in a north-easterly, less frequently in an easterly or south-easterly direction. Their advent, passage, and departure are attended by definite changes in the weather.

<sup>1</sup> *Weather*, p. 29. London: Kegan Paul, Trench and Co. 1887.

First, in front of the disturbance, the sky becomes streaked with cirrus cloud, which spreads out into a thin veil of cirriform cloud or cirro-stratus, in which solar or lunar halos develop, and through which is seen a "watery sun" or a "watery moon" as the case may be. The wind freshens from south-east, the cloud canopy thickens, and a stratum of lower clouds of the scud-cumulus type develops, coming up from south-east or south under the cirriform sheet, which is probably travelling from west or south-west. Drizzling rain next sets in, and finally heavier driving rain and squalls from the southward. As the lowest pressure is reached, the wind may fall calm if the centre of the system is near at hand. Then more or less suddenly and completely the wind shifts to west or north-west, with dense clouds, heavy rain or showers of rain and hail, and a brisk fall of temperature. The clouds now break, and massive cumuli drive past across a deep blue sky, sharp showers probably falling at intervals in the rear of the disturbance.

In the case we have been supposing, the depression or cyclonic system is travelling north-eastwards. It is to be noted that the wind is said to "veer" or "haul" when it changes *with the sun*; for example, when it changes from east to south-east, south, or south-west, or from south to west or north-west, or from north-west to north-east, and so on. Should it change *against the sun*, it is said to "back," and when it changes completely in direction, as from east to west, or south to north, it is said to "shift."

On rare occasions depressions move slowly westwards or north-westwards from the Continent of Europe towards the British Islands. The western or north-western quadrant of the depression is then its *front*, and the weather varies accordingly, being "muggy," cloudy, and damp or wet.

In anticyclones, barometrical gradients are comparatively slight, and the force of the wind is correspondingly moderate as a rule. During winter intense cold prevails in the centre and in the south-east and south-west quadrants of the anti-

cyclone ; in its north-west and north-east quadrants—at least in Western Europe—conditions are milder. A typical instance of such a distribution of temperature occurred in the memorable frost of 1890-91. An anticyclone hung for weeks over Central Europe and the southern half of the British Islands. Intense cold prevailed in these districts, while the west of Ireland, the greater part of Scotland, and Scandinavia, came under the influence of warm south-west and west winds skirting the north-west and north-east quadrants of the anticyclone. The result was that in the extreme north of Scotland, as well as in the west of Ireland, the mean temperature for fifty-nine days (November 25, 1890, to January 22, 1891) was  $10^{\circ}$  higher than in the south-east of England. The mean temperature for the period was  $10^{\circ}$  or more below the average over the southern Midlands and south of England. In the north of England the deficiency, however, did not amount to  $5^{\circ}$ , and in the extreme north of Scotland it was less than  $1^{\circ}$ . At Sumburgh Head, in the Shetlands, frost occurred on only nine of the fifty-nine days, whereas at Biarritz it occurred on thirty-one days, and at Rome on nine days. At Brussels it froze daily throughout the period. On January 19, 1891, the harbour at Toulon was reported to be frozen over for the first time on record, while the ice floating on the Thames between London Bridge and the Tower was so packed that all movements of vessels had entirely ceased. On January 20, the river Tagus at Lisbon was frozen over and the Ebro was covered with 19 inches of ice, the first since 1829. In Regent's Park skating lasted forty-three days consecutively (December 13, 1890, to January 24, 1891), according to Col. Wheatley, R.E., of the Office of Works.

Anticyclonic weather in summer is characterised by dry, quiet, bright weather, hot suns by day being followed by cool nights, except in the north-west quadrant of the system, where the nights are warm and often cloudy.

## CHAPTER XVI

### THE ATMOSPHERE OF AQUEOUS VAPOUR

Aqueous Vapour, or Water in a Gaseous or Aëriform State—Its Elastic Force or Tension—Influence of Aqueous Vapour on the Barometer, on the Weather—Evaporation—Fogs—Capacity of the Atmosphere for Aqueous Vapour—Atmometry or Atmidometry—Hygrometry—Hyetometry—Determination of the Amount of Evaporation—Evaporimeters, Atmometers, or Atmidometers—Saturation—Heat made latent in Evaporation—Uses of Coolness produced by Evaporation—Amount of Evaporation—Babington's Atmidometer—Von Lamont's Atmometer—De la Rue's Evaporimeter—Richard's Self-recording Evaporation Gauge—Mr. Symons's Evaporimeter—Observations on Evaporation in Ireland by Mr. James Price, M. Eng., Univ. Dubl., C.E.

At the close of Chapter III., on the Composition of the Atmosphere, it was pointed out that one of its most important constituents was aqueous vapour, or water in a gaseous or aëriform state. Moisture is universally present in the atmosphere, but in very variable proportions as regards both time and place. To its elastic force or tension, the height of the barometer is to some extent due, and we might with propriety speak of two atmospheres instead of one atmosphere—the atmosphere of aqueous vapour as well as the atmosphere of dry air. No other factor singly exercises so profound, so far-reaching an influence on weather as the aqueous vapour of the atmosphere. Its liability to alter its form from the gaseous to the liquid or solid state and back again, the caloric phenomena which accompany these changes, and the extreme variability in amount of vapour present in the air,—these



all cause frequent fluctuations in temperature and pressure, in cloud and sunshine, in terrestrial and solar radiation, in wind and weather.

Watery vapour is constantly distilling into the atmosphere from the surface of oceans, lakes, and rivers, and from the moist soil. In general the tiny molecules, which make up the vapour, are invisible as they rise into the atmosphere to diffuse freely through the air and to float about in the interstices between the atoms of oxygen and nitrogen which compose the atmosphere. If, however, the aërial strata are much colder than the water surface upon which they rest, the evaporating water may appear instantly as steam or fog. This is one cause of winter fogs in the vicinity of large rivers like the Thames. On a frosty day such a river may be seen to literally *steam* into the atmosphere—the aqueous vapour being condensed as soon as it has separated from the water by evaporation. The fact is, that only a certain quantity of aqueous vapour can diffuse through the air in an invisible form, and that the quantity which can so diffuse varies with the temperature of the air. The warmer the air, the greater the quantity of vapour which it can sustain in an invisible state. The colder the air, the smaller the quantity of vapour it can so sustain. Setting out from 32° F., at which the air can sustain  $\frac{1}{80}$ th of its weight of transparent vapour, we find that for every increase of temperature of 27° the vapour-sustaining capacity of air is doubled. Thus, at 59°, air can sustain the  $\frac{1}{80}$ th part of its own weight of vapour, and at 86° the  $\frac{1}{40}$ th part. Each cubic foot of saturated air at 32° F. contains only 2·37 grains of aqueous vapour; at 60° it contains 5·87 grains; and at 80°, 10·81 grains. It follows from this that, if the atmosphere is suddenly chilled from 80° to 60°, nearly 5 grains of vapour will be condensed out of every cubic foot of air, forming mist or cloud and falling as rain. This is really the explanation of the most potent causes of rain.

It is evident that aqueous vapour, while constantly

present in the atmosphere, is equally constantly passing into it by evaporation and passing out of it by condensation. The subject, therefore, naturally falls under three headings, which are well given by Mr. R. H. Scott, F.R.S., in his *Elementary Meteorology* as follows :—

“1. *Atmometry*, or the determination of the amount of water passing into the air by evaporation.

“2. *Hygrometry*, or the determination of the amount of water present in the air in the vaporous form.

“3. *Hyetometry*, or the determination of the amount of water condensed out of the atmosphere in the form of [dew], [hoar-frost], rain, hail, or snow.”

#### ATMIDOMETRY

Evaporation is the process by which water is changed from the liquid or solid (ice or snow) state into vapour, and is carried off into the atmosphere as such. *Atmometry*, or, more correctly, *atmidometry* (Gk. ἀτμός or ἀτμός, *steam* or *vapour*; μέτρον, *a measure*), is the determination of the amount of evaporation by means of instruments which are indifferently called *evaporimeters*, *atmometers*, or *atmidometers*. Evaporation takes place most quickly into dry air at a high or increasing temperature. It is also facilitated by high wind, and to some extent by low barometrical pressure. In Western Europe the process is most active in spring, when the capacity for moisture of the atmosphere is increasing owing to the prevalence of desiccated easterly winds, whose temperature is fast rising. On the other hand, in late autumn (November) evaporation is usually almost at a standstill, because the temperature of the air is falling fast, and its capacity for moisture is diminishing, so that it is charged with vapour or *saturated*. When this last condition is present, evaporation ceases and the slightest additional fall of temperature would cause condensation into fog, cloud, or rain.

In evaporating, every grain of water absorbs heat sufficient

to raise 960 grains of water through 1° of Fahrenheit's scale. This heat is extracted from neighbouring objects, and is made *latent*, that is, it *lies hid* or *concealed* in the vapour, ready to be used again in the converse process of condensation. Latent heat can no longer excite a sensation of warmth, or be measured by the thermometer. It is, however, existent, and is employed in keeping the vaporous molecules "floating loosely and widely apart" (R. J. Mann).

The coolness produced by evaporation has been utilised in hot climates in many ways. Porous earthenware jars are employed to cool drinking-water, and in India railway carriages are cooled by placing damp matting across the windows, while ice is formed by exposing water in shallow pans, laid on straw, to the combined effects of evaporation and radiation at night.

From data which were collected some years ago by the Rev. Samuel Haughton, M.D., F.R.S., Senior Fellow of Trinity College, Dublin,<sup>1</sup> it would seem that in nearly all parts of the globe, situated reasonably near the coast, the rainfall is about equal to the evaporation from a *free water surface*, and that there can be no great transference of vapour from the torrid to the temperate zones (R. H. Scott).

Even at the present day no entirely satisfactory atmido-meter or evaporimeter exists.<sup>2</sup>

On November 24, 1859, Dr. Babington, F.R.S., exhibited to the Royal Society the evaporimeter, which now bears the name of "Babington's atmido-meter." It consists of an oblong

<sup>1</sup> *Six Lectures on Physical Geography*, p. 165. London: Longmans and Co. 1880.

<sup>2</sup> The reader who is interested in the subject will find articles on evaporation, in which exhaustive descriptions of the principal instruments in use for measuring evaporation are given, in—(1.) *Symons's British Rainfall*, p. 151. 1869. (2.) *Symons's Monthly Meteorological Magazine*, pp. 70-74. 1870. (3.) *Ibid.* pp. 156-159. 1876. (4.) *Ibid.* p. 2. 1887. (5.) *Symons's British Rainfall*, pp. 18-43. 1889. (6.) *Ibid.* pp. 17-29. 1890. (7.) *Quarterly Journal of the Royal Meteorological Society*, vol. xvii. pp. 186, 187. No. 79. July 1891.

hollow bulb of glass or copper, beneath which, and communicating with it by a contracted neck, is a second globular bulb, duly weighted with mercury or shot. The upper bulb is surmounted by a small glass or metal stem, having a scale graduated to grains and half-grains, on the top of which is fixed a shallow metal pan. The bulbs are immersed in a vessel of water having a circular hole in the cover, through which the stem rises. Distilled water is poured into the pan above until the zero of the stem sinks to a level with the cover of the vessel. As the water in the pan evaporates, the stem ascends, and the amount of the evaporation is indicated in grains.

In Professor von Lamont's atmometer the evaporation pan is a shallow cylinder with a slightly curved bottom, from the middle of which a narrow pipe leads to a vertical cylindrical reservoir of water containing a closely fitting piston. The position of this piston in the cylinder is adjustable by means of a screw which moves the piston vertically, and it can be read by a vertical scale attached to the piston, a pointer being carried by the cylinder. The method of observing is as follows:—The piston is screwed up so as to allow the water in the evaporation pan to run into the reservoir, leaving the connecting tube quite full, so that the water just makes the curved surface of the bottom of the pan continuous. The scale is then read and the water is driven by the piston up to within a little of the top of the pan, and the evaporation is allowed to take place. The piston is then raised, so that the water sinks again from the pan to the same point as before, and the scale is read again. The difference of readings in scale divisions gives the depths of water evaporated.

A manifest fault in these instruments is the exposure of the water in the evaporation-dish to gusts of wind at all seasons and to frost in winter.

In de la Rue's evaporimeter, the water evaporates from a surface of moistened parchment paper, stretched over a

shallow drum kept full of water, which is supplied from a cylindrical reservoir giving about 6 inches head. Into this vessel dips a narrow metal tube forming the only opening into a graduated cylinder of glass about 6 inches high and  $1\frac{1}{2}$  inch in diameter. The glass cylinder is in the first instance filled with water, and the tube leading from it, which dips into the reservoir, is perforated laterally. The water in the reservoir is therefore maintained at a constant level by a flow of water from the glass cylinder whenever the lateral opening becomes exposed to the air. The amount of water evaporated is given by the graduations on the glass cylinder, which are so drawn as to express the evaporation in hundredths of an inch.

A self-recording evaporation gauge was exhibited by MM. Richard, frères, of Paris, at the Twelfth Annual Exhibition of Instruments held by the Royal Meteorological Society in March, 1891. It consists of a pair of scales, one of which bears a basin of water or a plant. Weights are placed in the opposite scale to establish a state of equilibrium. A style is attached to the scale beam, and the pen records its motions on a revolving drum. The sensitiveness of the scale is regulated by a sliding weight, which being raised or lowered, raises or lowers the centre of gravity of the scale beam.

In *British Rainfall*, Mr. G. J. Symons, F.R.S., each year publishes a return of the evaporation from a water surface at his residence, Camden Square, London, N.W. He keeps a daily record of the depth of water evaporated from the surface of a tank 6 feet  $\times$  6 feet  $\times$  2 feet, buried 20 inches in the ground, and in which water to a depth of about 22 inches is usually kept. The average annual evaporation from this water surface in the years 1885-91 was 14.5 inches. Evaporation in London is greatest in June and July, least in December and January.

For many years Mr. James Price, M. Eng., Univ. Dublin, C.E., of Knockeevin, Greystones, County Wicklow, kept

evaporation gauges in connection with rain gauges in Dublin, and at Cavan, Sligo, Galway, and Athlone. Several reliable series of observations of great interest were obtained. For instance, during two consecutive years the evaporation in Dublin and at Galway was 26 inches, whereas in the County Cavan only 13 inches of water passed off into vapour. This showed that the habitual dampness of the air was exactly twice as great in Cavan as in Galway or Dublin. In Cavan there is a retentive sticky clay subsoil with endless lakes and a less wind-movement than on the coast at Galway, which also has a dry gravelly subsoil with but little stagnant water. The dampness is independent of the rainfall, which is heavier at Galway than in Cavan ; nor does it depend so much on the contiguity of the sea as on the nature of the subsoil and the amount of stagnant fresh water in the district. Mr. Price points out that there is something particularly bracing and invigorating in the air of those parts of Galway and Clare where a gravelly subsoil occurs. Indeed, he is so strongly of opinion that habitual dryness of the air as indicated by evaporation gauges has more to do with health than the matter of rainfall, that he suggests that each locality should have its evaporation gauges as well as its rain gauges. To make the results of observations on evaporation comparable, Mr. Price recommends that the water level in the evaporation gauge should be kept at a given standard, and he states that he has devised a plan whereby this can be accomplished automatically.

## CHAPTER XVII

### THE ATMOSPHERE OF AQUEOUS VAPOUR (*continued*)

Direct and Indirect Hygrometers—Organic and Inorganic Hygrometers—Dew Point—Direct Hygrometers: Daniell's, Regnault's, Dines's—Indirect Hygrometers: Saussure's Hair Hygrometer—Chemical Hygrometer—Mason's Dry and Wet Bulb Hygrometer—The Psychrometer—Apjohn's Formula for calculating the maximal Vapour Tension for the Dew Point—Glaisher's Hygrometrical Tables—Greenwich Factors—Examples of their Use—Relative Humidity—Management of the Wet-Bulb Thermometer—Distribution of Aqueous Vapour in the Atmosphere—"Absolute Humidity"—History of Hygrometers.

### HYGROMETRY

HYGROMETRY is on a more satisfactory basis than atmimetry. Hygrometers (Gk. *ὕγρως*, moist; *μέτρον*, a measure) are of two kinds—direct and indirect, and the latter class is further subdivided into organic and inorganic—organic hygrometers being those which depend for their indications on the effects produced on such organic substances as wool, twine, hair, and seaweed, by the varying humidity of the atmosphere.

All direct hygrometers experimentally illustrate the theory or principle of the *dew point*—that critical temperature at which dew begins to be deposited. We have seen that the capacity of the atmosphere for taking up and holding aqueous vapour in suspension varies with the temperature; in other words, with the elastic force or tension of aqueous

vapour. If temperature falls, and with it the tension of vapour, a point is at last reached at which the air is saturated with moisture. Should the chilling process be continued, a deposition of dew takes place—the temperature has fallen below the dew point. Now, in a direct hygrometer the cooling process is continued until a film of condensed moisture, or “dew,” develops on a surface of polished metal or of glass. At this moment an attached thermometer is read off, giving the temperature of the dew point.

Three *direct hygrometers* call for description—Daniell’s, Regnault’s, and Dines’s.

Professor Daniell, F.R.S., in 1820 described the instrument which bears his name (Fig. 39). It consists of a glass tube, bent twice at a right angle, and terminating at each end in a glass ball or bulb. One of these bulbs is blackened, the other is covered with a jacket of fine linen or muslin. The black bulb is partly filled with pure ether, and encloses the bulb of a delicate thermometer, which just touches the surface of the ether. When it is desired to find the dew point, a little ether is allowed to drop on the muslin or linen jacket of the other bulb. It volatilises quickly, and in so doing makes a large quantity of heat latent. In consequence of this, the air in the covered bulb condenses, and owing to reduced pressure the ether in the black bulb begins to evaporate. This process, in its turn, chills the black bulb so that a ring of dew begins to form upon its exterior. At this instant the contained thermometer is read off, and the dew-point temperature is ascertained.

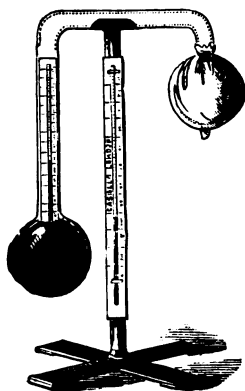

FIG. 39.  
Daniell's Hygrometer.

Regnault's direct hygrometer is a modification of Daniell's. In it there are two thermometers: one shows the temperature



of the air; the other dips through a stopper into a small vessel or thimble of polished silver, and is exposed during an experiment to the influence of a current of air bubbling through ether contained in the silver vessel. The observer

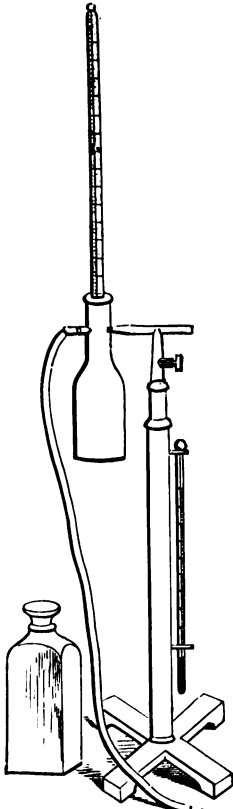

FIG. 40.—Regnault's Hygrometer.

creates the current of air by opening the tap of an aspirator, or jar containing rather less than a gallon of water. As the water flows out of this jar, it draws or aspirates air through a flexible tube connected by air-tight fittings with the silver thimble. To supply the place of the air thus drawn off, a fresh supply bubbles through the ether, drawn from the outer air through a small silver tube which is carried almost to the bottom of the silver thimble. As the air bubbles through the ether it causes it to volatilise, and in this way the temperature is so much reduced that dew is at last deposited on the outside of the polished silver vessel. The temperature indicated at this instant by the contained thermometer is that of the dew point. In a modified form of the instrument, the observers blow gently into the silver thimble, and the waste air is carried off from the silver bottle through a hollow bent tube, conducted into a hollow telescopic stand, which supports the whole apparatus.

The hygrometer (Figs. 41 and 42), designed by the late Mr. George Dines, F.M.S., is of simple construction, "consisting," says Mr. R. H. Scott,<sup>1</sup>

<sup>1</sup> *Elementary Meteorology*, p. 104.

“of a vase, A, fitted with a pipe at the bottom, which

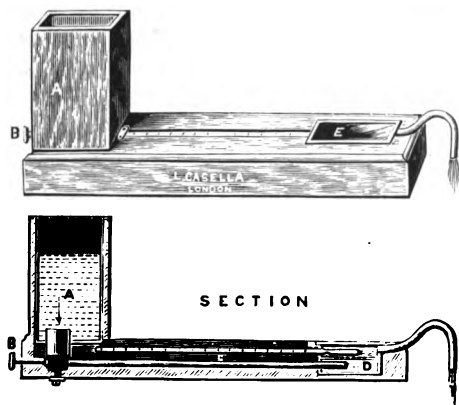

FIG. 41.—Dines's Hygrometer.

is conducted close under a plate of black glass, where it also envelops the bulb of a thermometer, C; a cock, B, is fitted at the base of the vase. Very cold water, or ice and water, is put into the vase, and the cock is opened; the glass speedily becomes dulled, and the thermometer is read. The cock is then closed again, the water in the tube soon rises in temperature, and the cloud disappears, the moment of its disappearance being that when the dew point is again reached. The operation may be repeated as long as the water in the vase remains at a temperature below the dew point.”

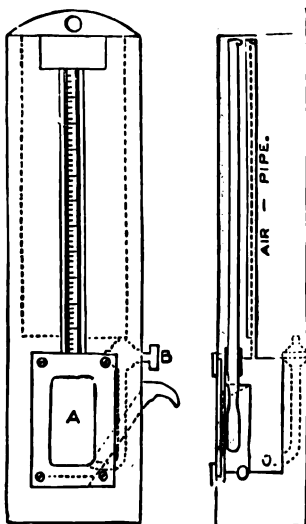

FIG. 42.—Vertical View of Dines's Hygrometer.

*Indirect Hygrometers.*—Many fibrous organic bodies tend to alter their molecular arrangement, or their appearance, when exposed to damp. In the hair hygrometer of Saussure advantage is taken of this tendency. A hair elongates when damp and contracts when dry. In Saussure's hygrometer a healthy human hair, freed from grease by careful boiling in an alkaline fluid, fixed at one end, is turned round a pulley, and supports a light weight. Connected with the pulley is an index hand or needle, which moves over a graduated scale, thus roughly showing the percentage humidity of the air, or the hygrometric state or degree of saturation of the air. Strictly speaking, Saussure's hygrometer is merely a hygroscope (Gk. ὑγρός, *moist*; σκοπέω, *I look at*), or an instrument which *shows* whether the air is moist or dry, without measuring the amount of moisture.

Among inorganic indirect hygrometers, mention should be made, in the first place, of two chemical hygrometers: one, a scientific toy; the other, an exact method of chemical analysis. The former is the toy ballet-dancer, a French invention, in which a change of colour of the dress from pink to red occurs when the weather becomes damp. The dress is stained with a solution of the nitrate or chloride of cobalt, which salts are hygroscopic in the way described. In the chemical hygrometer a known volume of air is made to pass by aspiration through weighed tubes packed with chloride of calcium, which has a singular affinity for moisture, and so desiccates the aspirated air. After the experiment the tubes are again carefully weighed, and the increased weight represents the amount of watery vapour present in the given volume of air.

In 1792 Hutton observed that a thermometer read lower if its bulb was wet. But it is to Sir John Leslie of Edinburgh, and to Mason of London, that we really owe the *psychrometer* (Gk. ψυχρός, *cold or chill*; μέτρον, *a measure*), or the dry and wet bulb hygrometer. This apparatus, which is now (often under the name of "Mason's Hygrometer")

everywhere employed in hygrometrical observations, consists of two carefully graduated thermometers, placed side by side at a distance of some four inches. One of these ther-

момeters marks the air temperature, and is called the "Dry Bulb." Round the bulb of the other a muslin cap is lightly tied, and this is kept moist with water drawn from a small reservoir by means of capillary attraction through a few strands of loosely twisted lamp-wick. As the moisture evaporates from this muslin cap, heat is made latent, and the temperature of the wet-bulb thermometer is depressed *in proportion to the amount and rapidity of evaporation*. From the respective readings of the dry and wet bulb thermometers many valuable deductions may be made: for example, the dew point, the tension or elastic force of vapour (or the amount of barometric pressure due to the vapour in the air), the relative humidity, the weight of vapour in a cubic foot of air, the amount of vapour required to saturate the air, the weight of a cubic foot of air in grains at the prevailing atmospheric pressure.

Many years ago, August in Germany, and Professor James Apjohn, M.D., of Trinity College, Dublin, independently investigated a method of determining, by calculation, the maximal vapour tension for the dew point from the temperatures of the dry and wet bulb thermometers. August's researches will be found in *Poggendorff's Annalen* for 1825 and 1828. In 1834 and 1835 Dr. Apjohn laid his investiga-

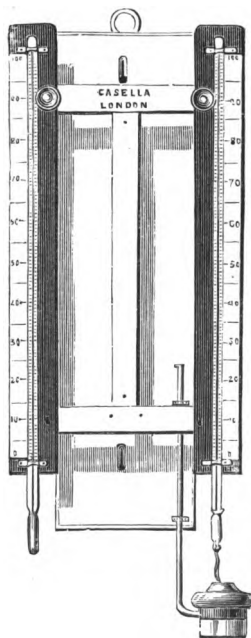

FIG. 43.—Mason's Hygrometer.

tions before the Royal Irish Academy. They are published in the *Philosophical Magazine* for 1835, and in the *Trans. R.I.A.* for 1837 (vol. xvii. p. 277).

The physical principle assumed by both investigators is precisely the same. Dr. Apjohn states it as follows:—

“When in the moist-bulb hygrometer the stationary temperature is attained, the caloric which vaporises the water is necessarily exactly equal to that which the air imparts in descending from the temperature of the atmosphere to that of the moistened bulb; and the air which has undergone this reduction becomes saturated with moisture.”

Let  $f$  = tension of aqueous vapour at the dew-point temperature which we desire to know.

$f'$  = tension of vapour at the temperature of evaporation, as shown by the wet-bulb thermometer.

The values of  $f$  and  $f'$  for every degree of temperature from 0° F. to 95° F. are known from experiments carefully performed by M. Regnault.

Further, let  $a$  = the specific heat of air.

$e$  = the latent heat of aqueous vapour.

$(t - t')$  or  $d$  = the difference between the reading of the dry-bulb thermometer and that of the wet bulb.

$p$  = the pressure of the air in inches; then Dr. Apjohn's formula is—

$$f = f' - \frac{48a(t - t')}{e} \times \frac{p - f'}{30}$$

or, with the coefficient—

$$f = f' - 0.1147(t - t') \times \frac{p - f'}{30}$$

This formula, for wet-bulb temperatures above 32°, works out thus:  $f = f' - \frac{(t - t')}{87} \times \frac{h}{30}$ ,  $h$  being the height of the barometer, substituted for  $(p - f')$

The fraction  $\frac{p-f'}{30}$  usually does not differ much from unity at stations near the sea-level (R. H. Scott).

Consequently, the formula is abbreviated into—

$$f=f' - \frac{t-t'}{87}, \text{ or } f=f' - \frac{d}{87}$$

For temperatures of the wet bulb below  $32^{\circ}$ , the value is—

$$f-f' - \frac{t-t'}{96}, \text{ or } f=f' - \frac{d}{96}$$

Mr. James Glaisher, F.R.S., by instituting a series of comparisons between synchronous observations of the dry and wet bulb thermometers and of Daniell's hygrometer, made at Greenwich from 1841 to 1854, and also at high temperatures in India, and at low and medium temperatures at Toronto, constructed special tables, based on a series of numbers called the Greenwich Factors, by means of which the dew point and other hygrometrical results may be ascertained by inspection. Glaisher's hygrometrical tables, as they are called, have passed through many editions, and are now almost universally employed by practical meteorologists for the purpose of deducing the dew point, vapour tension, and relative humidity (saturation = 100), from observations of the dry and wet bulb thermometers. A copy of these useful Hygrometrical Tables is supplied to each observer by the Meteorological Council of the Royal Society, and a further simplification of them by Mr. William Marriott, F.R. Met. Soc., will be found in *Hints to Meteorological Observers*, prepared by him under the direction of the Council of the Royal Meteorological Society.

Although these "short cuts" exist, it may be interesting to explain the use of Glaisher's factors by which the dew point is found.

From the dry-bulb reading subtract the wet-bulb reading, multiply the difference by the factor corresponding to the

dry-bulb reading, and subtract the product from the dry-bulb reading. The result is the dew point.

For example—

Dry bulb = 53°  
Wet bulb = 49°.

Then,

$53^\circ - 49^\circ = 4^\circ \times 2.00$  (the factor corresponding to  $53^\circ$ ) = 8,  
 $53^\circ - 8^\circ = 45^\circ$  = the dew-point temperature sought for.

A Table of Glaisher's Factors will be found in the Appendix.

To ascertain the dew point is of practical importance from a health standpoint as well as in agriculture and horticulture. As Dr. Buchan observes: <sup>1</sup> "It indicates the point near which the descent of the temperature of the air during the night will be arrested." "Thus, then," he adds, "the dew point determines the minimum temperature of the night." The moment the dew point is reached, dew is deposited and latent heat is given out, causing temperature to rise. After a time, the air is by radiation again cooled down to the dew point, when the same process is repeated through the night—the air temperature gently oscillating round the dew point, so long as the sky is clear and the air tolerably calm.

Having once found the dew point, we can determine the percentage of saturation or the *relative humidity*, provided we have before us a table of the tension or elastic force of aqueous vapour at ordinary temperatures.

Assuming the dry-bulb temperature as above to be  $53^\circ$ , and that of the dew point to be  $45^\circ$ , we enter Table II. (Appendix) and extract the tension at  $53^\circ$ , namely, .403 inch, as well as that at  $45^\circ$ , namely, .299 inch. If the air were saturated with moisture the tension would be .403 inch, but it is only .299 inch. From these facts the percentage of saturation, that is, the *relative humidity*, is easily calculated by simple proportion—100 being taken to represent saturation and 0 absolutely dry air—  
 $.403 : .299 :: 100 : x = 74.2$  per cent.

---

<sup>1</sup> *Introductory Text-Book of Meteorology*, p. 96. William Blackwood and Sons. 1871.

If from the tension of aqueous vapour at the dry-bulb temperature, we subtract that at the dew point, we obtain the force of evaporation. Thus, in the example we have chosen,  $\cdot403 - \cdot299 = \cdot104$  inch.

In order to avoid erroneous deductions from observations made with the dry and wet bulb thermometers, it is necessary to keep the wet bulb in working order by frequent douching of the muslin covering and the capillary threads connecting it with the cistern or reservoir. Soft river water, or rain water, or distilled water should be used for this purpose. If spring water or hard lime-waters are used, their calcareous salts are deposited in the meshes of the muslin and the strands of lamp-wick or floss-silk leading to the cistern, capillary attraction is interrupted, the muslin dries, and evaporation ceases.

In frost, it is a matter of great difficulty to keep the wet bulb acting. In the first place, so long as the water surrounding it is actually freezing, its temperature will remain steadily at  $32^{\circ}$  although the dry bulb may be some degrees lower. This is brought about by the disengagement of latent heat during the process of freezing. Again, when the wet bulb and its connections are thoroughly frozen, capillary action between the cistern and the bulb will cease, the ice about the bulb will soon evaporate, and the wet bulb will no longer indicate the temperature of evaporation. In such a contingency, the muslin covering of the bulb must be damped with a small wet camel's hair brush about half an hour before the time of observation. In Russia the use of the hair hygrometer has been enjoined in winter.

Aqueous vapour is most abundant in the atmosphere near extensive water surfaces. It is very deficient in the centres of continents, and rapidly diminishes in amount as we ascend through the atmosphere. Mr. R. H. Scott says that it has been calculated that one-half the quantity of vapour in the air is contained in the lowest 6000 feet of the atmosphere, and that the amount contained in the air above 20,000 feet



is only one-tenth part of that at the surface of the ground. Hence the burning power of the sun in the arid atmosphere of lofty mountain peaks and slopes. Tyndall<sup>1</sup> well observes that a sheet of vapour acts as a screen to the earth, being in a great measure impervious to heat. When the air is laden with moisture, visible or invisible, the intensity of the sun's rays is controlled by day and terrestrial radiation is checked by night. It is at the same time perhaps necessary to explain that moderate heat with a damp atmosphere is singularly oppressive, but this arises from another cause than actual elevation of temperature, and that is interference with evaporation. The air being wellnigh saturated, evaporation is checked and its cooling and beneficial influence is in consequence unfelt.

The tension or elastic force of aqueous vapour represents the pressure of all the vapour in the air above the place of observation. It is expressed in terms of inches of the barometrical column, and represents the *absolute humidity* of the atmosphere. It is greatest near the equator, least near the poles; greater over the ocean than over dry land, in summer than in winter, by day than by night, at sea level than in the upper strata of the atmosphere.

"A Contribution to the History of Hygrometers" was the title of a Presidential Address delivered before the British Meteorological Society on March 16, 1881, by Mr. G. J. Symons, F.R.S. It will repay perusal, and is to be found in the *Quarterly Journal of the Meteorological Society* for July 1881 (vol. vii. p. 161).

<sup>1</sup> *Heat, a Mode of Motion*, p. 385. London: Longmans, Green and Co. 1880.

## CHAPTER XVIII

### THE ATMOSPHERE OF AQUEOUS VAPOUR (*continued*)

Hyetometry includes seven Modes of Condensation of the Watery Vapour of the Atmosphere—Dew—Two Forms of Dew: “Serein” and “Rosée”—Hoar Frost—Silver Thaw (*Glatteis, Verglas*)—Interference with Formation of Dew—Measurement of Dew—Mist and Fog—“Scotch Mist”—Formation of Fogs, Clouds, and Rain—Mr. John Aitken’s Researches—The Influence of Atmospheric Dust—Mr. Aitken’s Koniscope—The Number of Dust Particles in the Air—How Fog or Mist forms—Dry Town Fogs—Haze.

#### HYETOMETRY

TAKEN in a practical rather than a strictly etymological sense the word *hyetometry* (Gk. *ὕετός*, *rain*; *μέτρον*, *a measure*) may be extended in meaning so as to embrace all the different ways in which aqueous vapour is condensed out of the atmosphere and again restored to the earth from which it was originally taken up by evaporation.

Condensation of the watery vapour of the atmosphere takes place under *seven* different forms—(1) dew, (2) fog, (3) mist, (4) cloud, (5) rain, (6) hail, (7) snow. We shall consider each of these in more or less detail.

*Dew.*—The origin of dew attracted the attention of physicists towards the close of the eighteenth century, and the names of Pictet of Geneva, Le Roy of Montpellier, Six of Canterbury, and Patrick Wilson of Glasgow, are especially connected with the subject. But it is to Dr. Charles William

Wells, a London physician, that we are indebted for a clear explanation of the nature of dew. He published in 1814 his celebrated *Essay on Dew*, and his theory of dew has ever since been generally accepted.

Dew is moisture deposited from the atmosphere under a clear sky in the colder hours, and therefore particularly at night. As the sun sinks in the western sky and finally sets, of course solar radiation becomes less and finally ceases. But simultaneously, provided the sky is clear and the atmosphere is tolerably dry and calm, terrestrial radiation increases, causing a rapid fall of temperature, so that at last the dew point is reached. The moment temperature falls below this point, dew is deposited, first and chiefly on those substances which are the best and therefore the most powerful radiators of heat. Such are hair, wool, straw, grass, and herbage in general. There are really two kinds of dew, and in French they are distinguished by separate words—*serein* and *rosée*. *Serein* is the falling evening dew, which results from the general chilling of the stratum of air nearest the earth's surface after sundown. *Rosée* is the dew seen in the morning gathered in drops on the surface of leaves and other cool surfaces, and at the extremities of blades of grass; it is the morning dew, and its deposition depends on the more rapid radiation from the substances on which it gathers. This causes the moisture of the air which comes into contact with the leaves or grass to be condensed and to form drops of dew upon their surface.

In winter, should the dew point be below 32°, hoar frost instead of dew is deposited, even forest trees assuming a thick coating of rime. This is to be distinguished from a phenomenon which occurs at the beginning of a sudden thaw after a severe frost and which is called "silver thaw," or "glazed frost" (German, *Glätteis*; French, *verglas*). When a warm, damp air comes into contact with frozen surfaces, its moisture is condensed and deposited in a solid form like hoar frost or light snow. Should rain fall on such

surfaces, it is at once converted into a sheet of ice, which renders city pavements and country roads equally impassable for the time being. Silver thaw sometimes inflicts great injury on trees and plants. Mr. R. H. Scott quotes a remarkable example of the phenomenon which occurred in France in January 1879, and was described by M. Godefroy in the 89th volume of the *Comptes Rendus* of the French Academy (p. 999). During a severe frost it rained heavily, but the rain instantly was congealed on contact with still frozen surfaces, so that branches of trees snapped off, and even the trees themselves were felled by the weight of superincumbent ice. A twig of a lime tree, 4 inches long, weighed 930 grains, but when freed from ice only 7·5 grains. A laurel leaf carried a coating of ice which weighed 1120 grains. These figures sufficiently explain the destructive action of a glazed frost.

The formation of dew is interfered with by (1) a high wind, (2) a very damp atmosphere even with a cloudless sky, because aqueous vapour checks terrestrial radiation, (3) a cloudy sky, which radiates back the heat cast off by terrestrial radiation, (4) the proximity of buildings or of lofty trees.

The most systematic attempt to measure the amount of dew which has been yet made, was by the late Mr. George Dines, F.M.S.<sup>1</sup> His observations numbered 198, and were carried out in 1877 and 1878 near his residence at Walton-on-Thames, on open grass land, at a height of 52 feet above Ordnance Datum. On only three occasions was an amount of dew exceeding 0·010 inch in depth deposited upon his measuring glasses. Taking the average of all his observations and multiplying the result by 365, the annual *depth* of dew would appear to be 1·397 inch. If the observations on the grass only are taken, the amount is 1·022 inch. Mr. Dines considered that it might fairly be assumed that

<sup>1</sup> *Quarterly Journal of the Meteorological Society*, vol. v. p. 157, 1879.

the average annual deposit of dew upon the surface of the earth falls short of 1·5 inch.

*Mist and Fog.*—Possibly the simplest way to describe these phenomena is to say that they are really cloud formations in contact with, or suspended just above, the surface of the ground or ocean. Mist is, in the strict sense of the term, visible watery particles suspended in the atmosphere at or near the surface of the earth. In an applied sense it is coarser watery particles assuming the form of tiny rain-drops, and so floating in the air or falling to the ground. Such is the proverbial *Scotch Mist*.

Fog differs from cloud only in being near or in contact with the ground, and from mist only in regard to the fineness of the watery particles of which it is made up. It is to be remembered, however, that, in winter especially, dry smoke-fog often forms over large cities, notably over London and Manchester. Nothing is more remarkable than the property of fog to conduct sounds of all kinds to unwonted distances. Fog and mist are, strictly speaking, not aqueous vapour at all, but water itself in minutest particles or droplets. In the formation of fog and mist, aqueous vapour is condensed and latent heat is set free. These two facts establish the nature of fog and mist—they are water, not watery vapour. When objects exposed to their influence are moistened, or when an appreciable amount of water is collected in the rain gauge during fog and mist, we speak of a “wet fog.”

In a Presidential Address to the Royal Meteorological Society on January 16, 1889, Dr. William Marcet, F.R.S., classifies fogs into sea fogs, lake fogs, river fogs, waterfall or spray clouds, and town fogs. This interesting address is published in the *Quarterly Journal* of the Society for April 1889 (vol. xv. p. 59).

It is to the scientific researches of Mr. John Aitken, F.R.S., of Falkirk, N.B., that we are especially indebted for our knowledge of the formation of fogs, clouds, and rain. It was in the autumn of 1875, when studying the action of

“free surfaces” in water when changing from one state to another, that Mr. Aitken first observed the conditions necessary for cloudy condensation.<sup>1</sup> By a “free surface” is meant a surface at which water is *free to change its condition*. For instance, the surface of a piece of ice in water is a “free surface” at which the ice may change to water, or the water change to ice. Again, a surface of water bounded by its own vapour is a “free surface,” at which the water may vaporise, or vapour condense. What are called the “freezing point” and the “boiling point” of water are the temperatures, 0° C. and 100° C. respectively, at which these changes take place at such “free surfaces.” When there is no “free surface” in the water, we have at present no knowledge whatever as to the temperature at which these changes will take place. It is well known that water may be cooled in the absence of “free surfaces” far below the “freezing point” without becoming solid. Several years ago, Mr. Aitken showed reason for believing that ice, in the absence of “free surfaces,” could be heated to a temperature above the “freezing point” without melting.<sup>2</sup> Professor Carnelly has more recently shown this to be possible, and has succeeded in raising the temperature of ice to 180° C.<sup>3</sup> Further, Mr. Aitken has shown in the paper above referred to, that if water be deprived of all “free surfaces” it may be heated in metal vessels while under atmospheric pressure to a temperature far above the “boiling point,” when it passes into vapour with explosive violence.

From the foregoing considerations it is evident that a necessary condition for water changing its state is the presence of a “free surface,” or “free surfaces,” at which the change can take place.

Let us now look, with Mr. Aitken, at the process, as it

<sup>1</sup> “On Dust, Fogs, and Clouds.” By John Aitken, F.R.S.E. *Trans. Royal Soc. Edin.*, vol. xxx. part i. 1883, p. 337.

<sup>2</sup> *Trans. Roy. Scottish Soc. of Arts*, 1874-75.

<sup>3</sup> *Nature*, vol. xxii. 1880, p. 435.

goes on in nature, of water changing from its gaseous or vaporous to its liquid state—in other words, to the cloudy condensation of our atmosphere.

“As the heat of the sun increases,” writes Mr. Aitken,<sup>1</sup> “and the temperature of the earth rises, more and more water becomes evaporated from its surface, and passes from its liquid form to its invisible gaseous condition; and so long as the temperature continues to increase, more and more vapour is added to the air. This increased amount of vapour in hot air compared to cold air is generally explained by saying that hot air dissolves more water than cold air. This, however, is not the case. Air has no solvent action whatever on water vapour. Water vapour rises into air to the same amount that it would do into a vacuum at the same temperature, only it rises into air more slowly than into a vacuum, and the amount of vapour which can remain in the air is independent of the amount of air present, that is, independent of the pressure of the air, and depends only on the temperature.

“After air has become what is called ‘saturated’ with vapour, that is, when the vapour tension is that due to the temperature, a momentary condition of stability is attained. Suppose the temperature to fall, a change must now take place. All the water cannot remain as invisible vapour; some of it must condense out into its visible form. It is this condensed water held in mechanical suspension in the air to which we give the names of fog, cloud, mist, and rain—phenomena having some resemblance to each other, yet possessing marked differences. The particles composing a fog, for instance, are so fine they scarcely fall through the air, a cloud is a little coarser in the grain, while a mist is coarser still in texture, and rain is any of these while falling, whether it be a wetting mist or a drenching rain. And the question now comes, Why this difference? Why should the water vapour condense out of the air in one case in particles so

<sup>1</sup> “On Dust, Fogs, and Clouds.” *Loc. cit.* p. 337.

minute they seem to have no weight, and remain suspended in the air, while in another case they are large-grained and fall rapidly?"

The key to the answer to this question is given by a very simple and beautiful experiment, which I had recently the good fortune to see Mr. Aitken repeat during the Congress of the British Institute of Public Health in Edinburgh (July 1893). Two large glass receivers, A and B, are connected with a small boiler by means of pipes. The receiver A is filled with ordinary air—the air of the room. The receiver B is also filled with the air of the room, but before entering the receiver the air is passed through a filter of cotton-wool, and *all dust removed from it*. The receivers being so prepared, steam is allowed to pass from the boiler into both receivers. As it enters A it is seen to rise in the globe, forming a beautiful white foggy cloud of condensed vapour—a cloud so dense that the observer cannot see through it. On the other hand, when the steam is allowed to enter B, *not the slightest appearance of cloudiness is observed* in this receiver, although it is as full of water as the receiver A, which remains for some time densely packed with fog. The air is "supersaturated" in both receivers, but only in A does the water condense out and form a cloudiness; in B it remains in its invisible but supersaturated vaporous form. The only possible explanation is that the great difference between the appearance of the two receivers is *due to the dust in the air*. Dusty air—that is, ordinary air—gives a dense white cloud of condensed vapour. Dustless air gives no fogging whatever.

The truth is, that molecules of vapour do not combine with each other and form a particle of fog or mist; but a "free surface" must be present for them to condense upon. The vapour condenses on the dust suspended in the air, because the dust particles form "free surfaces" at which the condensation can take place at a higher temperature than where they are not present. Where there is abundance of dust there is abundance of "free surfaces," and the visible condensed



vapour forms a dense cloud; but where no dust particles are present there are no "free surfaces," and the vapour is not condensed into its visible form but remains in a supersaturated vaporous state until the circulation of the air in the receiver brings it into contact with the "free surfaces" of the sides of the receiver, where it condenses into droplets of water. If the fog in receiver A is allowed to settle, and more steam is blown in, without allowing any dusty air to enter, a fresh fog is formed, and so on many times in succession. It will, however, be noticed that after each condensation the fog becomes less and less dense, but at the same time more coarse-grained and heavier, until at last no visible fog forms, but the condensed vapour will be seen falling as fine rain. Exactly the same thing may be observed if the experiment is varied by cooling "saturated" air by expansion in a large globular glass-flask connected with an air pump.

These experiments show clearly—

1. That when water vapour condenses in the atmosphere, it always does so on some solid nucleus.

2. That the dust particles in the air form the nuclei on which it condenses.

3. That if there were no dust in the air, there would be no fogs, no clouds, no mists, and probably no rain.

That the air, when no dust is present, is really supersaturated in these experiments, is evident from the fact that when the dust particles become few, the fog particles are not only few, but are much heavier than when they are numerous; and also from the fact that they increase in size as they fall through the air. Each falling particle becomes a "free surface," at which the supersaturated vapour can condense and increase the size of the drop.

Mr. Aitken draws a graphic picture of what would occur in nature if there were no dust in the atmosphere. "When the air got into the condition in which rain falls—that is, burdened with supersaturated vapour—it would convert everything on the surface of the earth into a condenser, on

which it would deposit itself. Every blade of grass and every branch of tree would drip with moisture deposited by the passing air ; our dresses would become wet and dripping, and umbrellas useless ; but our miseries would not end here. The insides of our houses would become wet ; the walls and every object in the room would run with moisture. We have in this fine dust a most beautiful illustration of how the little things in this world work great effects in virtue of their numbers. The importance of the office, and the magnitude of the effects wrought by these less than microscopic dust particles, strike one with as great wonder as the great depths and vast areas of rock which, the palæontologist tells us, is composed of the remains of microscopic animals."

Atmospheric dust, capable of fog and cloud production, is probably composed of fine salt-dust from the spray of the ocean, meteoric dust, volcanic dust, condensed gases, and combustion dust. Mr. Aitken admits the accuracy of Professor Tyndall's observation that extreme heat causes dust motes to become invisible in the sunbeam, but he disputes the accuracy of the conclusion that the heat has destroyed the motes. According to him, the heat would seem to destroy the light-reflecting power of the dust by breaking up the larger motes into smaller ones and by carbonising, or in some way changing their colour, and so making them less light-reflecting. But that the motes are not destroyed is evident, because the fog-producing power of the air so superheated is actually increased—a fact proved by experiment, and explained on the assumption that the number of the particles is increased by being broken up by the heat.

Mr. Aitken bursts into poetry in prose when explaining one source of the immense quantities of fine sodic-chloride dust ever floating in the air, and its usefulness in the economy of nature. He says : "The ocean, which under a tropical sun quietly yields up its waters to be carried away by the passing air, almost looks as if he repented the gift, when tossed and angry under tempestuous winds, as he sends forth

his spray, which dried and disguised as fine dust becomes his messenger to cause the waters to cease from their vaporous wanderings, descend in fertilising showers, and again return to their liquid home."

For testing the amount of dust particles in the air—what Milton calls "The gay motes that people the sunbeams"—Mr. Aitken has designed several ingenious instruments, such as his dust-counter, his pocket dust-counter, and his koni-scope. It would be foreign to the subject-matter of these pages to describe these instruments, but it may be useful to explain what is meant by a koniscope (Gk. *κόνις*, *dust*; *σκοπέω*, *I inspect*). In the course of his experiments, Mr. Aitken observed that certain colour phenomena took place in cloudy condensation produced by expansion, and it occurred to him that as the colours so produced varied according to the number of dust particles present in the air experimented on, an instrument might be constructed by means of which, in a rough and ready way no doubt, the amount of dust in the air might be tested by observing the tints produced in it. The instrument consists of an air pump and a metal tube with glass ends, called the "test tube." The capacity of the pump should be from half to threequarters that of the test-tube. Near one end of the test tube is a passage by which it communicates with the air pump, and near the other end is attached a stop-cock for admitting the air to be tested. Pointing the test tube towards some suitable source of light (preferably daylight), so as to illuminate it from end to end, the stop-cock is closed, and one full stroke of the pump is made, when the resultant colour in the test-tube is at once noted. This colour would indicate the number of particles. For instance, if there are few particles, one stroke will make the light in the test-tube first blue, then green, then yellow; and then a second stroke, blue and green, finishing with yellow. But if there are a great many particles present, one stroke will not give the whole of the first series of colours, but may stop at the blue.

The number of dust particles in the atmosphere is immense. To take a single instance: Mr. Aitken states that he has found that a cigarette smoker sends 4,000,000,000 particles, more or less, into the air with every puff he makes! He has numbered the dust particles in the atmosphere at many places in Great Britain and on the Continent, and has come to the following conclusions as to the relation between the amount of dust and meteorological phenomena:<sup>1</sup>—

1st. The earth's atmosphere is greatly polluted with dust produced by human agency.

2nd. This dust is carried to considerable elevations by the hot air rising over cities, by the hot and moist air rising from sun-heated areas of the earth's surface, and by winds driving the dusty air up the slopes of hills.

3rd. The transparency of the air depends on the number of dust particles in it, and also on its humidity. The less the dust the more transparent is the air, and the drier the air the more transparent it is. There is no evidence that humidity alone—that is, water in its gaseous condition and apart from dust—has any effect on the transparency.

4th. The dust particles in the atmosphere have vapour condensed on them though the air itself may not be saturated.

5th. The amount of vapour condensed on the dust in unsaturated air depends on the "relative humidity," and also on the "absolute humidity" of the air. The higher the humidity and the higher the vapour tension, the greater is the amount of moisture held by the dust particles when the air is not saturated.

6th. Haze is generally produced by dust, and if the air be dry, the vapour has but little effect, and the density of the haze depends chiefly on the number of particles present.

7th. None of the tests made of the Mediterranean sea air show it to be very free from dust.

8th. The amount of dust in the atmosphere of pure

<sup>1</sup> *Proc. Royal Soc. Edin.*, vol. xvii. p. 246, 1890.

country districts varies with the velocity and the direction of the wind—fall of wind being accompanied by an increase in dust. Winds blowing from populous districts generally bring dusty air.

9th. The observations are still too few to afford satisfactory evidence of the relation between the amount of dust in the atmosphere and climate.

Fog or mist forms in different ways :—

1. On a clear, calm night, terrestrial radiation so chills the air near the ground that over a level surface like a plain the aqueous vapour of the atmosphere is, through a height of a few inches or feet, condensed into visible water particles, or mist, which is hence called *radiation fog*. It is best seen on autumn nights over low-lying, flat fields, very locally distributed and very evanescent, should a breeze spring up.

2. In winter, and even in summer or autumn, provided the night is clear, and calm, and cool enough, white fogs form rapidly over rivers and lakes, the temperature of which is several degrees above that of the contiguous air. Under these circumstances, the water surface may be seen to *steam* into the atmosphere. While travelling from Ardrossan to Glasgow between 4 and 4.50 A.M. on July 27, 1893, I had an opportunity of observing very perfect examples of radiation fog, and of the fog formed over running water. The morning was calm and clear, and at Ardrossan, on the sea coast, the thermometer had fallen to 49° in the screen after a rather warm summer's day.

The damp of the river fog  
That rises after the sun goes down.

Or, as Shakespeare has it in *King Lear*—

You fen-suck'd fogs, drawn by the powerful sun.

Cities built on the banks of large rivers are liable to suffer from fogs of this kind, the visitation being intensified by the presence of undue quantities of carbon in the atmosphere,

so that the fog is no longer white and pure as in the open country, but assumes the colour of pea-soup, or becomes so dense and murky as to rival the darkness of an overcast sky at midnight—so extraordinary is the light-absorbing power of a city, smoke-begrimed fog.

Mr. Aitken asks the pertinent question, Why should the smoke, which usually rises and is carried away by the winds, fall to the ground when we have fogs? He thinks that the conditions which account for the fog also account for the smoke falling. He says:<sup>1</sup> "When we have fogs the atmosphere is nearly saturated with vapour, and the smoke particles, being good radiators, are soon cooled, and form nuclei on which the vapour condenses. The smoke particles thus become loaded with moisture, which prevents them rising, and by sinking into our streets add their murky thickness to the foggy air. This seems to explain the well-known sign of falling smoke being an indication of coming rain. That the colour or blackness of what is called a pea-soup fog is due to smoke is, I think, evident from the fact that a town fog enters our houses and carries its murky thickness into our rooms, and will not be induced to make itself invisible however warmly we treat it. It will on no account dissolve into thin air, however warm our rooms, for the simple reason that heat only dissolves the moisture and leaves the smoke, which constitutes a room fog, to settle slowly, and soil and destroy the furniture. If the fog was pure, that is to say, was a true fog and nothing but a fog, such as one sees in the country, it would dissolve when heated, as every well-conditioned country fog does—at least I never remember meeting a fog in a country house."

Somewhat in the character of an optimist, Mr. Aitken puts in a good word for a smoke fog as a deodoriser (carbon), and a disinfectant and antiseptic (sulphurous acid). To say the least, it is a nauseous remedy, if a remedy it can be regarded.

<sup>1</sup> "Dust, Fogs, and Clouds." *Trans. of the Royal Soc. of Edinburgh*. vol. xxx. part i. p. 353.

Town fogs, just like the smoke fogs which penetrate our dwelling-houses, are frequently *dry*. Professor E. Frankland, D.C.L., F.R.S., in some experiments on the influence of coal-smoke on foggy air found that water, when its surface is covered with a film of coal-tar, evaporates much less readily on that account. He suggests that this physical fact affords an explanation of the formation of dry town fogs.<sup>1</sup>

3. In winter, when an anticyclone, with its accompanying cold and frost, disperses and gives place to cyclonic conditions and a warm, moist, equatorial air-current, a fog forms. This is due to the sudden chill of the warm moist air by its impact against the cold surfaces of the ground, trees, and buildings in the locality.

4. In spring, when in quiet, bright, anticyclonic weather the temperature of the air rises quickly over large islands like Great Britain and Ireland, the adjoining seas, still cold from the preceding winter, condense the vapour of the air into dense fogs. These fogs often envelop our east coasts, where they depress the day temperature perhaps 20°, or even 25°, below that of inland stations. Thus on April 5, 1893, the thermometer rose to 70° at Cambridge, but did not exceed 46° at Yarmouth, where fog prevailed all day. The same phenomenon on a more extensive scale is observed off the banks of Newfoundland, where a polar current of cold water meets the warm air of the mainland of North America, and dense fogs are the result.

5. Large icebergs are nearly constantly surrounded by fog, which they have generated by chilling the surrounding warm moist atmosphere.

6. Promontories, jutting into the sea, and mountains are very apt to generate fog and mist, when they are said to be "cloud-capped." So the poet Longfellow sings in *Evangeline*—

. . . Aloft on the mountains  
Sea fogs pitched their tents, and mists from the mighty Atlantic.

---

<sup>1</sup> "On Dry Fogs." *Proceedings of the Royal Society*, 1878.

Warm, moist air is forced upwards along their sides to an elevation where saturation is at last reached owing to the lower temperature, and in this way the mist or cloud is produced. Mountain peaks sometimes seem to "smoke" or "steam," owing to the continuous formation of a column of mist or cloud, which spreads out laterally or horizontally to the leeward of the peak. At times also a cloud or mist seems to be motionless at the top of a mountain or suspended just above it. In reality, the mass of vapour forming the cloud or mist is moving with the wind, but the watery particles of which it is composed do not condense until they reach a certain point where the cold mountain-top reduces temperature below the dew-point, while at the other extremity they evaporate and become invisible. The frontispiece, which is a photograph of the Matterhorn, taken at Riffel, at an elevation of 8430 feet above sea-level, by Mr. Greenwood Pim, M.A., shows this smoke or steam cloud very well.

In this connection mention may be made of *haze*, which is often observed in anticyclonic, fine, dry weather, particularly during the prevalence of easterly wind in spring. Haze more or less impedes vision, shutting out from view distant mountain landscapes on shore and at sea, causing the horizon to disappear, and the sea and sky to merge into one gray plane. The atmosphere is dry but dense during the prevalence of haze. It is, no doubt, partly caused by the presence of dust and smoke in excess in the air, and probably also by partial condensation of the aqueous vapour by the cold polar air-current which it so often accompanies. At the same time, it must be acknowledged that haze and intense heat are often observed together. A peculiar obscuration of the atmosphere which sometimes appears in summer is called "Dust haze" (in German "Höhenrauch"). It is more common on the Continent than in the British Islands. Its origin is not quite understood, but at times it has been traced to extensive fires on the moors or in the forests of Northern Europe. To its formation dust certainly contributes.



On rare occasions a stratum of haze forms at a great height above the earth, while the lower strata of the atmosphere remain perhaps unusually clear. This happened on Sunday, May 22, 1870, over a great part of Ireland. So clear was the lower air that Snowdon was indistinctly seen from the Hill of Howth on the north of Dublin Bay, while a vapour fog or haze, suspended in mid air, absorbed the blue rays of the solar spectrum, causing the sun to assume a pinkish or carmine tint, and a strange lurid light to spread over the landscape. I described the phenomenon in *Symons's Monthly Meteorological Magazine* for June 1870 (vol. v. p. 65).

The accompanying photograph, taken by Mr. F. J. Rebman, shows the sunshine breaking through a dense morning vapour fog or mist at Eltham.



EARLY MORNING MIST. Copyright Photograph taken by Mr. F. J. REEMAN at Ellham.

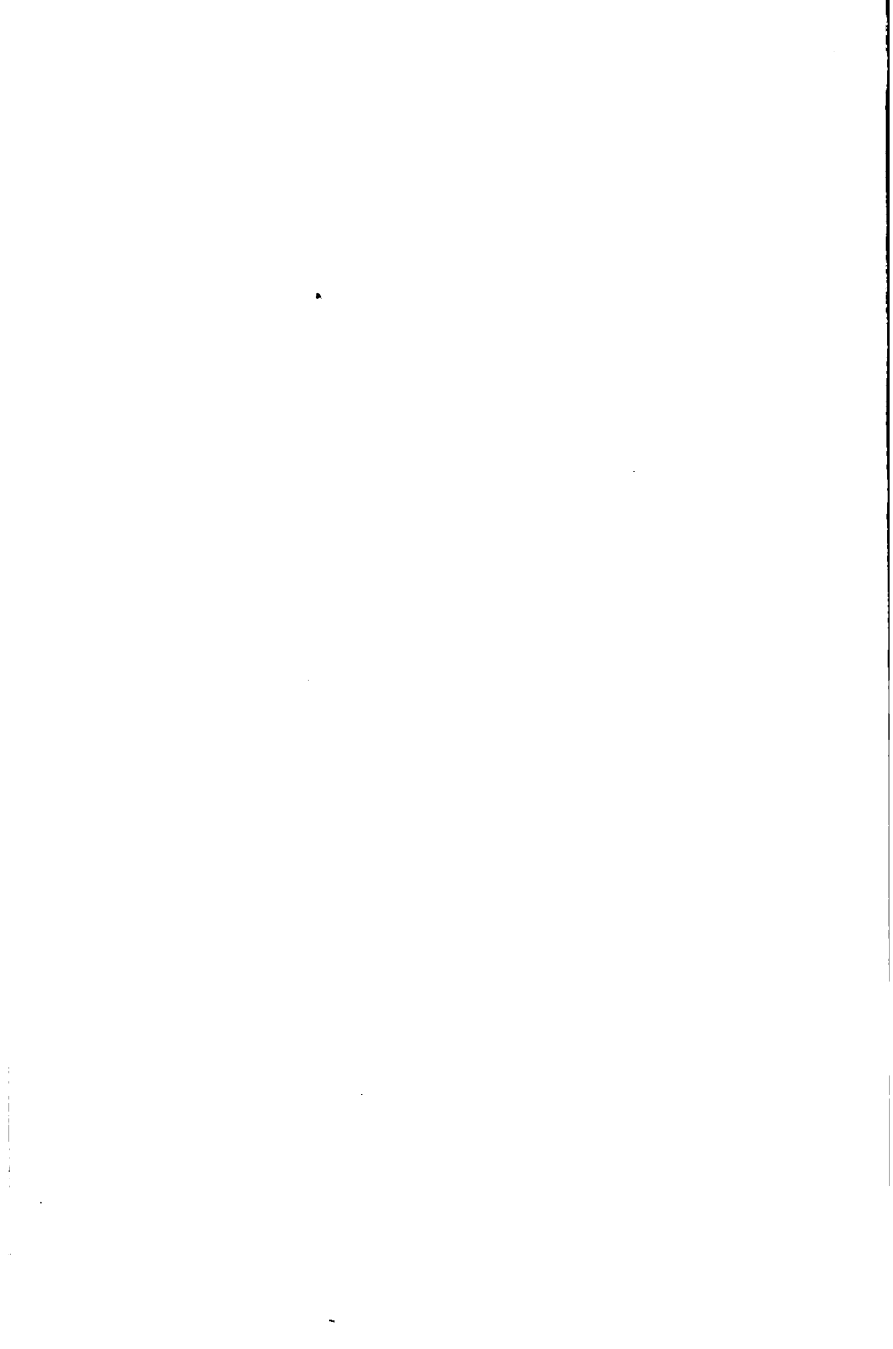

## CHAPTER XIX

### THE ATMOSPHERE OF AQUEOUS VAPOUR (*continued*)

Definition of a "Cloud"—Height of Clouds—The "Cloud Line"—Luke Howard's Classification of Cloud Forms—Upper Clouds: Cirrus, Cirro-cumulus, Cirro-stratus—Pallium (Poëy)—The Mackerel Sky—Lower Clouds: Stratus, Cumulus, Cumulo-stratus, Nimbus—Roll-cumulus—"Pocky" or "Festooned" Cloud—Cloud-slopes in Cumulus—Various meanings of the word "Nimbus"—Scud—Cloud observations—Scale for the amount of Cloud—Characters of Thunder-clouds—Their rapid changes in Formation, Shape, and Density.

#### CLOUDS

WE pass from fogs to clouds by an easy and rational transition. A cloud is a collection of particles of aqueous vapour condensed into watery particles and floating in the atmosphere at some height above the ground. This height varies from a few hundred feet to several miles, feathery cirri having been observed far above him by Gay-Lussac, in September, 1804, when in a balloon at a height of 23,000 feet, or considerably more than four miles. Tyndall has aptly applied the term "water dust" to the minute particles of water, condensed from aqueous vapour, which go to make up a cloud.

The "cloud line," or that level below which cloud formations seldom or never take place, varies in different parts of the world. In South America, Mr. R. H. Scott says it is about 9000 feet; in the Tyrol it sinks to about 5000 feet; and in the

British Islands, out of a great number of observed cloud levels, one-third were below 2500 feet.

Lamarck, in 1801, first classified clouds, but it is to the distinguished climatologist, Mr. Luke Howard, F.R.S., that we are indebted for a classification of cloud forms which is still in use. In his *Essay on the Modifications of Clouds*, first published in 1803, and re-issued as a third edition by Mr. John Churchill, of London, in 1865, Howard recognised three primary types and four compound types. The primary types are—(1) cirrus, or “mare’s tails”; (2) stratus, or “ground fog”; (3) cumulus, or “wool-pack.” The secondary or compound types are—(1) cirro-stratus, or “sheet cloud”; (2) cirro-cumulus, or “mackerel sky”; (3) cumulo-stratus, or “shower cloud”; (4) nimbus, or “rain cloud.” These cloud-forms arrange themselves into two groups, when their height is considered, namely—*upper* and *lower* clouds.

I. *Upper Clouds*.—There is good reason to believe that the clouds belonging to this class—cirrus, cirro-cumulus, and cirro-stratus—are usually composed, not of watery particles, but of ice-crystals. The vast height at which these clouds float would suggest this, but they are also the halo-producing clouds, and the phenomena of halos can be explained only by the refraction of light through ice-crystals.

1. Cirrus (cir.) (Lat. *cirrus*, a hair) is the loftiest of all clouds. It consists of delicate wavy sprays, like a wisp of hair, thread fibres, or feathers, often arranged in parallel lines across the sky, these lines apparently converging towards the horizon and diverging near the zenith owing to perspective. Observations of the cirrus cloud are of the first importance in weather forecasting. There is no doubt that its formation is connected with the overflow, in the upper regions of the atmosphere, of air which has been carried aloft in the front of a cyclonic system which is developing. It generally appears in that quarter of the sky from which the coming disturbance is advancing, but its motion is often quite different from that of the wind or of the lower clouds. Thus

the cirrus may be travelling from west, while the lower clouds are coming from south-west or south, and the wind from south or south-east. Most usually detached sprays precede the main body of the cirri, as scouts precede a body of troops in the field or on the march. In consequence of the intimate relation which cirrus bears to atmospheric depressions, or cyclonic systems, its appearance in the sky often betokens wind as well as broken, rainy weather. In winter, its arrival is one of the earliest signs of a thaw.

2. Cirro-stratus (cir.-s.) is commonly formed from cirrus by increased condensation, which extends to a lower level in the sky. When bad weather is approaching, a uniform sheet of cirro-stratus overspreads the sky. This "sheet-cloud" has been called *Pallium* (Lat. *a cloak*) by Poëy. In it solar and lunar halos are apt to form, and we speak of a watery sun or moon when it has begun to interfere with the solar or lunar rays. As it sinks to a lower level, it becomes denser, entirely intercepting sunshine or moonlight, and soon rain begins to fall from it, while *scud* drifts rapidly before the wind far beneath it. The word *scud* is applied to fragments of cloud of the stratiform or cumulus type in rapid motion. As regards prognosis of rain, we may say that rain is sure to fall when cir.-s. supervenes on cir.—in other words, when the cloud level is descending through the air. On the other hand, when cir.-s. forms while cumuli are in the sky, in fact by the ascent of the lower clouds, the weather will probably take up, for this cloud will then interfere with evaporation and sunshine, and so check the formation of cumuli—clouds which are very likely to condense into showers.

3. Cirro-cumulus (cir.-c.) consists of small, well-defined, round, oval, or globular dense, or soft and fleecy masses of cloud at a lower level than cirrus. These white woolly masses resemble a flock of sheep lying down. They have also been compared to the markings on a mackerel, hence the expression "a mackerel sky." Cir.-c. is essentially a fine weather

cloud, and is suspended at a great height in the atmosphere, though not so high as cirrus.

II. *Lower Clouds*.—These are stratus, cumulus, cumulostratus, and nimbus, and they are usually composed of watery particles, that is, condensed vapour, except in winter or when they freeze into ice-crystals as they rise into the atmosphere, as those of the cumulus type nearly always do.

1. Under the name of “Stratus” (str.), Howard described the cloudy formation which spreads over low-lying ground at nightfall and vanishes as temperature rises in the morning. He also called it “ground fog,” and defined it as “a widely extended continuous horizontal sheet increasing from below upwards.” Mr. Scott<sup>1</sup> says that “stratus is generally a fine weather cloud, appearing during the evenings and mornings of the brightest days. At times it overspreads the whole sky in the form of a low, gloomy, foggy canopy, the atmosphere being more or less foggy under it. All low detached clouds which look like a piece of lifted fog, and are not in any way consolidated into a definite form, are *stratus*.”

2. “Cumulus” (cum.) is essentially an evaporation cloud, appearing in its prime when evaporation is taking place rapidly, and when strong upborne or ascensional currents are carrying the aqueous vapour rapidly above the line of saturation or of the dew-point. The cloud in consequence appears with a sharply-defined horizontal base, while its upper portions form magnificent globular masses, snow-white in bright sunshine, but elsewhere—

Rolled in masses dark and swelling  
As proud to be the thunder's dwelling.

MOORE, *Lalla Rookh*.

Cumulus is seen as either a land cloud or a sea cloud under absolutely contrasted conditions. As a land cloud, it may best be studied in summer or autumn. A rain-bearing

<sup>1</sup> *Elementary Meteorology*, p. 127. 1883.

depression, we will suppose, has passed away, and the sky has cleared completely at or after nightfall. Terrestrial radiation has full play during the ensuing night, and towards morning the air is damp and very cold for the time of year. The morning breaks without a cloud, but when the sun's power begins to increase, a few soft scud-cumuli begin to fleck the deep blue sky. These clouds rapidly develop in size and density, and rise to a higher and higher plane, as the line of saturation ascends with the rising temperature near the earth's surface. At last the cumuli become piled up into threatening masses, with snow-white sharply-defined crests. Their summits now begin to spread out in front into a fan-like cirriform crest, and simultaneously a heavy shower of rain or hail may be observed falling from the base of the cloud mass. Probably a peal of thunder will be heard re-echoing now and again through these *nimbi*, as they are called. Such a cloud formation as that just described is almost confined to the land. Over the sea the sky will either remain clear or the cumuli will be seen to *waste* quickly. The reason for this is clear. Over the land there is a strong ascending air-current owing to the increasing heat; over the sea, on the contrary, the air is descending from above to supply the place of the air which has passed in over the land as a sea-breeze. These summer cumuli are especially apt to gather round chill mountain-tops. In tropical climates their formation at certain seasons leads to a daily afternoon thunderstorm and torrents of rain.

Cumulus is not infrequently a sea cloud in high latitudes in winter and during the prevalence of a polar air-current, when there is no cirriform cloud about. Under such conditions sea cumuli form *by night*. A cold land breeze blows off the coast to supply the place of the warmer air over the sea which has risen to such a height as to lead to condensation of its aqueous vapour into vast masses of frozen cumulus. On the east coast of Ireland I have often witnessed the development of such night cumuli in winter during the prevalence



of a northerly or north-easterly wind. A curious result of their formation is the precipitation at sea and along the coast of heavy showers of cold rain and hail, or sleet and snow, while a few miles inland a clear sky and keen frost may prevail.

Sometimes cumulus assumes a modified shape. Instead of towering aloft into great snowy masses, it almost covers the sky, spreading out into long cylindrical rolls, between which gleams of sunlight are seen here and there. This modification has been called by the authorities of the Meteorological Office, London, *Roll-cumulus*.

Again, but more rarely, the cumulus cloud appears inverted, topsy-turvey or upside down, its globular or mammilated surface being underneath, while its horizontal layer is uppermost. To this rare appearance (which, however, I have often seen) the name "pocky-cloud" is given in the Orkneys, where it is recognised as a sure sign of storm. A more euphonious name for it is "the festooned cloud." It is caused by a warmer and damper stratum of air above, and a colder and drier stratum below. A very faithful illustration of this cloud will be found in *Symons's Meteorological Magazine* for June 1874 (vol. ix. p. 65). It was seen at Elterwater, near Ambleside, by Mr. Edward Tucker, junior.

A very interesting feature about cumuli is the peculiar slopes which they commonly assume. As a rule their upper portions travel more quickly than their bases, of which the motion is retarded by proximity to the earth. Accordingly the rounded summit of the cloud is seen in advance of the base—the cloud appears to be rolling over upon itself, and this really does occur. But the globular head or crown of the cloud is not directly in front—it is usually inclined to the right-hand side of the line of advance at an angle of some 45° or so, while the base of the cloud similarly trails behind to the left hand of the line of advance. In fact the whole cloud seems to slope away from the centre of lowest atmospheric pressure, the situation of which is roughly indicated

by that of the "neutral point," or the point of the compass whence the cloud-slope springs. In anticyclonic systems just the reverse sometimes occurs, the base of the cumulus outstrips its apex and the cloud-slope is towards the left hand of the line of advance in front, and towards the right hand behind. In this case the under current travels more rapidly than the upper current, and the *set* of the air is outward from the area of high pressure, the centre of which lies to the right of the observer, who in every case is supposed to stand with his back to the wind.

3. "Cumulo-stratus" (cum.-s.) was described by Howard as "the 'cirro-stratus' blended with the 'cumulus,' and either appearing intermixed with the heaps of the latter, or *superadding a widespread structure to its base.*" R. H. Scott explains that this is the *cumulus*, as it were, changing into a *nimbus* or rain cloud. He adds that it is dark and flat at its base, and is traversed by horizontal lines of dark cloud.

4. "Nimbus" (nim.). This is the "rain cloud," according to Howard, who defines it as "a cloud or system of clouds from which rain is falling. It is a horizontal sheet above which the 'cirrus' spreads while the 'cumulus' enters it laterally and from beneath." As so defined, it is really the "shower cloud," or a mass of cumulus which is being rapidly condensed into rain, hail, or snow. It is a composite cloud, towering from the realms of cumulus into those of cirriform cloud above, and streaked with stratiform cloud beneath, so that Howard called this form of nimbus by the composite name of "cumulo-cirro-stratus."

But with equal propriety the term nimbus is applied to a diffuse sheet of cirro-stratus from which rain has begun to fall in front of the centre of an area of low pressure (cyclonic system), or indeed to any cloud or system of clouds from which rain is actually falling.

Besides the foregoing classical cloud types, mention should be made of *scud*, a term which is used to indicate loosely

formed, vapoury, detached clouds driving rapidly before the wind, as the poet Longfellow has it—

Borne on the scud of the sea.

In recording observations on clouds, the contractions *Cir.*, *Cir.-c.*, *Cir.-s.*, *Str.*, *Cum.*, *Cum.-s.*, *Nim.*, and *Scud*, should alone be used. The scale for the amount of cloud varies from 0 "blue sky," or "cloudless," to 10 "entirely overcast." The *direction from which* all clouds are coming should be recorded. Very often cloud direction is far from corresponding with wind direction, and this is especially true of upper clouds. The *apparent rate* at which clouds move should also be noticed, as well as the radiant points, in the case of cirrus in particular.

When thunder threatens, cloud undergoes rapid changes of formation, shape, and density, and nearly always a peculiarly dense cirrus or cirro-stratus is superimposed on massive, lurid cumuli. Whenever it is possible, photographs of thunderclouds and of rare cloud formations in general should be taken.

In a report<sup>1</sup> recently issued by the Vatican Observatory (*Pubblicazioni della Specola Vaticana*, Fasciculus III.), Signor Mannucci, of Rome, gives a brief account of systems of cloud-classification. He practically accepts the classification proposed by Abercromby and Hildebrandsson at the International Conference held in Munich in 1891, and set forth in the Cloud-Atlas of Hildebrandsson, Köppen, and Neumayer. This classification recognises ten different species arranged in five principal groups. The first group (A) comprises the highest clouds in our atmosphere; the second group (B) includes clouds at a medium height; and the third group (C) low clouds. In the fourth group (D) we have clouds in ascending currents; and, finally, the fifth (E) contains the masses of vapour changing in form. In the first four groups the letter (*a*) is used to distinguish the forms of cloud usually

<sup>1</sup> See *Nature*, February 8, 1894, pp. 341, *et. seq.*

accompanied by fine weather, and (b) for those characteristic of bad weather. The following is the grouping as given by Signor Mannucci :—

GROUP A.

Clouds from medium altitudes up to an average of 9000 metres.

1. Cirrus (a).
2. Cirro-stratus (b).
3. Cirro-cumulus.

GROUP B.

Clouds having altitudes from 3000 to 6000 metres.

4. Alto-cumulus (a).
5. Alto-stratus (b).

GROUP C.

Clouds the bases of which have altitudes from 1000 to 2000 metres.

6. Strato-cumulus (a).
7. Nimbus (b).

GROUP D.

Clouds on ascending columns of air, with bases about 1400 metres high, and summits from 3000 to 5000 metres.

8. Cumulus (a).
9. Cumulo-nimbus (b).

GROUP E.

Fogbanks up to about 1500 metres.

10. Stratus.

## CHAPTER XX

### THE ATMOSPHERE OF AQUEOUS VAPOUR (*continued*)

Relative amount of Precipitation as Dew and as Rainfall—Excessive Precipitation in the Khasi Hills, Assam—Rainfall Observations in the Seventeenth Century—Weighing the Rainfall—Hooke's Rain Gauge (1695)—Exhibition of Rain Gauges by the Royal Meteorological Society in 1891—Chief Gauges in use : Meteorological Office Gauge, Symons's Snowdon Gauge, the Mountain Gauge, Symons's Storm Gauge, Crosley's Registering Gauge, Yeates's Registering Gauge, Richards' Self-recording Rain Gauge—Measurement of Rain—Time and Method of Observing—Variation of Rainfall with Elevation, how explained—Physical Cause of Rain—Snow—Sleet—Hail—Measurement of Snow—Theory of the Formation of Hail—Examples of Hail Storms—Soft Hail—Relative Size and Weight of Hailstones—Distribution of Rain : (1) Geographical, (2) Seasonal, (3) Diurnal—Weight and Bulk of Rain.

#### HYETOMETRY : PRECIPITATION

IN the last Chapter it was shown that precipitation in the form of dew or hoar frost fell short of an average of 1.5 inches per annum all over the earth's surface (G. Dines). It is manifest that this figure represents a very small proportion of the total precipitation, which takes place in the form of rain, hail, or snow. There are, however, no precise statistics of the average rainfall all over the earth's surface. Nevertheless, we shall probably be near the mark when we say that the precipitation in the form of dew or hoar frost is only about *one-twentieth* of that in the form of rain, hail, and

snow. There are districts which are practically rainless; there are other districts where the rainfall is measured in hundreds of inches. On the Khasi Hills, Assam, some two hundred miles to the north-eastward of Calcutta, the average downpour is said to be more than 500 inches, or about 42 feet. Five-sixths of this astonishing rainfall occurs during the south-west monsoon, when the vapour-laden south and south-west winds are forced up by the hills to an altitude far above the saturation line. At Cherra Poonjee, situated on the southern verge of the Khasi Hills, just outside the Tropic of Cancer (lat.  $25^{\circ} 17' N.$ ), the rainfall in June 1851 amounted to 148.53 inches, or more than falls in the British Islands in four years. In 1861, the rainfall is stated to have reached 905.12 inches, of which 336.14 inches are returned for the month of July alone. It is true that these last figures are accepted with reserve by Professor John Eliot,<sup>1</sup> of Presidency College, Calcutta, and rejected as untrustworthy by Mr. Henry F. Blanford, F.R.S., F.R.Met.Soc., in a paper on the "Variations of the Rainfall at Cherra Poonjee in the Khasi Hills, Assam," which he read before the Royal Meteorological Society on April 15, 1891.<sup>2</sup> In discussing this paper, however, Mr. Tripp, F.R.Met.Soc., showed that from a comparison of variations in the rainfall at other stations there was nothing improbable in a maximum of over 990 inches with a mean of 500 at Cherra Poonjee.

*Rainfall Observations.*—In a letter to Galileo, dated June 10, 1639, B. Castelli, of Perugia, records the earliest authentic measurement of rainfall; but it was an isolated observation suggested by an exceptionally heavy downpour of rain, and led to no practical advance.<sup>3</sup> In a "Contribution to the

<sup>1</sup> "The Rainfall of Cherrapunji." *Quarterly Journal of the British Met. Soc.* vol. viii. 1882, p. 41.

<sup>2</sup> *Quarterly Journal of the Royal Meteorological Society*, vol. xvii. No. 79, July 1891, p. 146.

<sup>3</sup> Dr. G. Hellmann. "Die Anfänge der meteorologischen Beobachtungen und Instrumente." *Himmel und Erde*. II. Jahrgang, 3 und 4 Hefte.

History of Rain Gauges," read before the Royal Meteorological Society on March 18, 1891,<sup>1</sup> Mr. G. J. Symons, F.R.S., tells us that, most curiously, the first rain gauge designed was not an ordinary one, but a recording gauge. On January 22, 166 $\frac{1}{2}$ , Dr. (afterwards Sir Christopher) Wren showed before the Royal Society his experiment of filling a vessel with water, which emptied itself when filled to a certain height. Ten years later a tipping-bucket rain gauge, on Sir Christopher Wren's plan, was ordered for construction by the Royal Society.

The earliest published returns of rainfall were made in Paris, in 1668, by M. Pierre Perrault, who wrote an anonymous work, *De l'Origine des Fontaines*, and in England by Mr. R. Townley, of Townley, near Burnley, Lancashire, whose observations were begun on January 1, 1677. Three years earlier, in 1674, an unknown observer at Dijon was recording the rainfall, and he afterwards supplied Mariotte, of Paris,

with records from that city. The gauge used at Dijon is thus described by Mariotte: "Un vaisseau quarré qui avoit environ deux pieds de diamètre, au fond duquel il y avoit un tuyau qui portoit l'eau de la pluie qui y tomboit dans un vaisseau cylindrique."

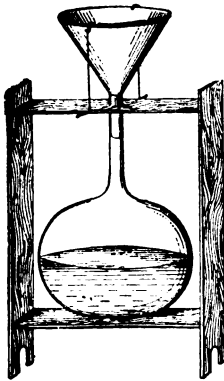

FIG. 44.—Hooke's Rain Gauge.

In 1695, Mr. Robert Hooke *weighed* the rainfall at Gresham College, London. The rain gauge (Fig. 44) used by him consisted of a large bottle called a "bolt head," capable of holding more than two gallons, and with a neck 20 inches long. Into it was conducted the pipe of a funnel (apparently of

glass like the bottle) 11·4 inches in diameter. The funnel was steadied by two stays or pack threads strained by two pins. The glasses—that is the funnel and the bottle—were

<sup>1</sup> *Quarterly Journ. of the Royal Met. Soc.*, vol. xvii. No. 79.

supported in a wooden frame. The collected water was weighed every Monday morning by troy weight. Thus, from August 12, 1695, to the same date in 1696, 131 lbs. 7 ozs. 113 grains of rain fell, that is 29·11 inches.

The Twelfth Annual Exhibition of Instruments held by the Royal Meteorological Society, March 3 to 19, 1891, was devoted to rain gauges, evaporation gauges, and like instruments. An official description of the various instruments exhibited will be found in the number of the *Quarterly Journal of the Royal Meteorological Society* for July 1891 (vol. xvi. No. 79, p. 180). A few of the many instruments only will need description. The largest gauge ever made has been in use at Rothamsted, Harpenden, Herts, since the beginning of 1853. Its receiving area equals the one-thousandth of an acre. A coloured drawing of this monster gauge by Lady Lawes, of Rothamsted, was exhibited; so also was a specimen of Colonel Ward's 2-inch gauge, one of the smallest in use. One was more than two thousand times as large as the other, and yet their indications did not differ by anything like 5 per cent. The smallest gauge ever used is only 1 inch in diameter, and its readings have been proved by experiments—undertaken by Colonel Ward and continued by the Rev. C. H. Griffith and the Rev. Fenwick W. Stow—to differ from those of a gauge five hundred times its size by less than 2 per cent.

Theoretically, square gauges are simpler than circular gauges, but in practice the latter are mostly used because they are not so apt to get out of shape as the former, and the least denting of the rim of a rain gauge would interfere with its measurement.

1. *Meteorological Office Gauge*.—This gauge, 8 inches in diameter, is in very general use (Fig. 45). It is made of copper, and has a circular collecting funnel surmounted by a vertical rim, about 6 inches in depth, in order to catch snow. On top of this rim or cylinder is a stout brass ring, ground to a knife-edge above, so that its circular shape is preserved, and the



in-splashing of raindrops is entirely prevented. The rain, caught in the funnel, flows through a pipe into a large copper can capable of holding  $4\frac{1}{2}$  inches of rain. From this it is poured into a graduated measure-glass, and its quantity is read off in thousandths, hundredths, and tenths of an inch. A fall of an inch of rain means that a square tray 12 inches long and 12

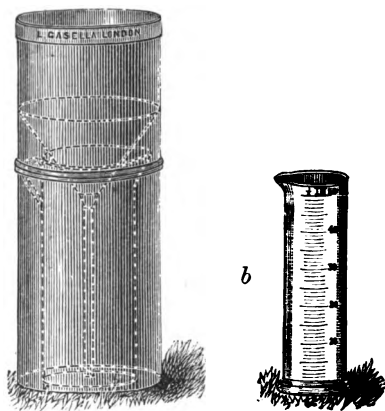

FIG. 45.—Meteorological Office Rain Gauge.

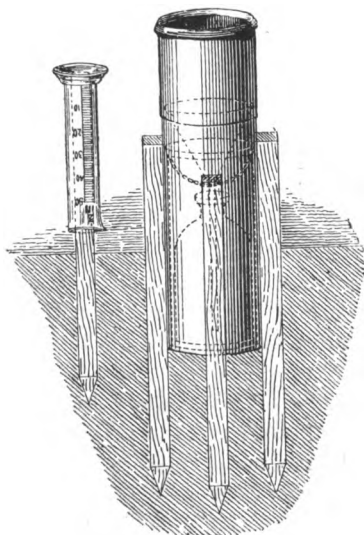

FIG. 46.—Snowdon Rain Gauge.

inches wide would be filled up to a height of 1 inch by such a rainfall.

2. *Symons's Snowdon Gauge* (Fig. 46) resembles the foregoing, but has a diameter of only 5 inches. In it a cylinder rises 4 inches vertically from the edge of the cone of the funnel—constituting what is called a "Snowdon rim." A gauge of this kind in copper is nearly indestructible and independent of frost. The galvanised Snowdon gauge is much cheaper, and will last for fifteen or twenty years.

3. The *Mountain Gauge* (Fig. 47) is intended for rough mountain work, and for waterworks purposes in wet districts. It is a "float gauge," and is constructed according to a pattern

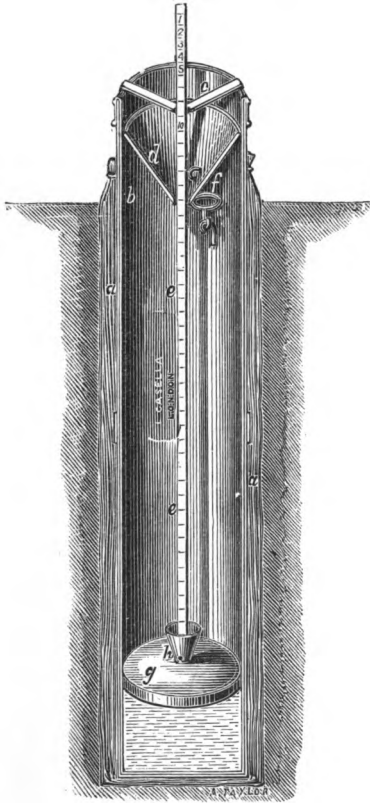

FIG. 47.—Mountain Rain Gauge.

adopted by Mr. G. J. Symons, and described in *British Rainfall*, 1867 (p. 16). It is capable of holding 48 inches of rain, and may be read off to tenths of an inch by means of a rod attached to the cup of the float and a cross-piece.

To avoid error from its intercepting the rain, the rod is detached from the float, and it is dropped into the cup only when an observation is to be made.

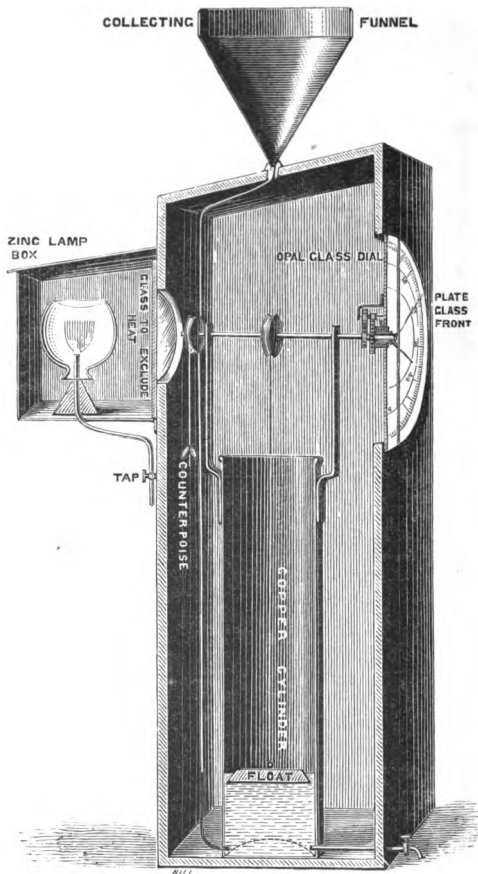

FIG. 48.—Symons's Storm Rain Gauge (Second Pattern).

4. *Symons's Storm Rain Gauge* is not intended for general use, or for yielding continuous records, but for enabling

observers to record in detail the rate at which heavy rains fall during thunderstorms. With one of these instruments, in London, on June 23, 1878, rain was ascertained to be falling for thirty seconds at the rate of 12 inches an hour, or 288 inches a day. The first pattern of this gauge was apt to be broken by frost, and therefore could be put out only in summer time. In a second stronger and more elaborate instrument (Fig. 48) the rain passes into a copper cylinder in which is a float, which rises as the rain falls. The float has a string passing round a pulley, and kept taut by a counterpoise. Therefore, when the float rises, the pulley turns. To the extremity of the axle of the pulley a hand or index is attached, which completes a revolution on a graduated dial when an inch of rain has fallen. Inside the case there is a simple wheel-work whereby another short hand, like the hour-hand of a clock, completes a revolution for 5 inches of rain. With this gauge it is therefore quite easy to read from a window the fall of rain to hundredths of an inch, and by doing this, say, every thirty seconds, the minutest detail of the fall of rain can be ascertained. This instrument is constructed by Negretti and Zambra.

There are several self-registering and recording rain gauges. For example—

5. *Crosley's registering rain gauge*, of which the area is 100 inches (Fig. 49). Beneath the tube leading from the funnel there is a vibrating divided bucket. When one compartment of this bucket has received a cubic inch of water, that is, when 0.01 inch of rain has fallen, the bucket tips, the index advances

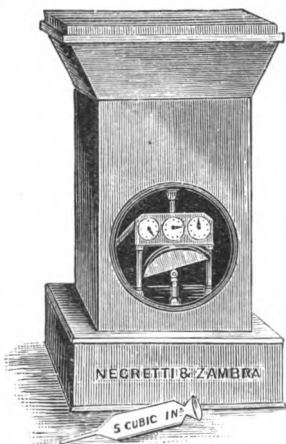

FIG. 49.—Crosley's Self-registering Rain Gauge.

on the first dial, and the second bucket begins to fill, and so on indefinitely. Crosley was a gas-meter maker, and brought out his gauge first in the year 1829.

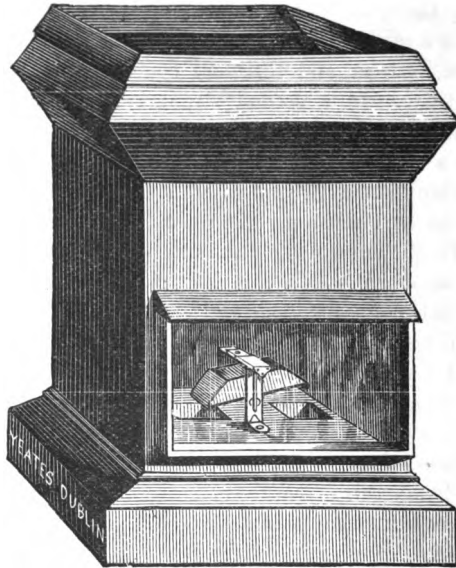

FIG. 50.—Yeates's Electrical Self-registering Rain Gauge.

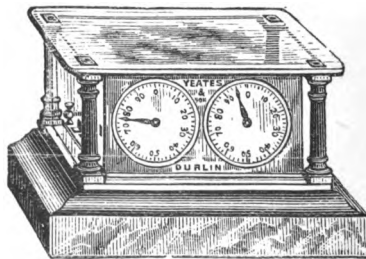

FIG. 51.—Registering part of Yeates's Rain Gauge.

6. Messrs. Yeates and Son of Dublin have designed a very ingenious *electrical self-registering rain gauge* (Figs. 50 and 51). The funnel is 100 square inches in area, and the measuring

bucket (the working parts of which are made of platinum alloy with agate bearings) is adjusted to turn with one cubic inch of water. At each turn of the bucket electrical contact is made, and the index hand moves one division. The advantage of this instrument is that the funnel may be placed in any exposed position out of doors, while the registering part can be fixed indoors. As this apparatus is entirely self-acting, each cubic inch of water, as it is weighed and recorded, is emptied out, so that no error can arise from evaporation.

7. M.M. Richard Frères, of Paris, have invented a float pattern and a balance-pattern *self-recording rain gauge*. In the float pattern (Fig. 52) a funnel collects the rain, which is carried by a pipe into a reservoir in which there is a float. A style, carrying a writing pen, follows the motion of the float, rising 4 inches for a rainfall of 0.4 inch. When the pen

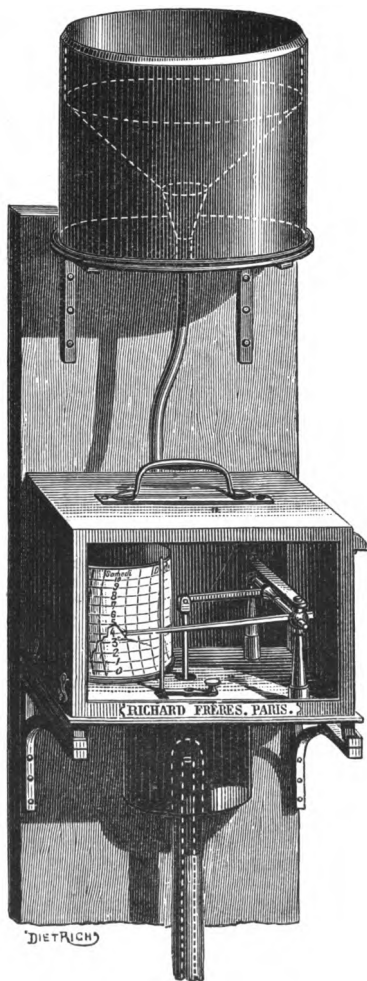

FIG. 52 — Richards' Self-recording Rain Gauge (Float Pattern).

reaches the top of a revolving drum, the reservoir empties itself automatically by means of a siphon, the float falls to the bottom, and the pen returns to zero. The siphon is started by an electro-magnet which, on the circuit of a battery being

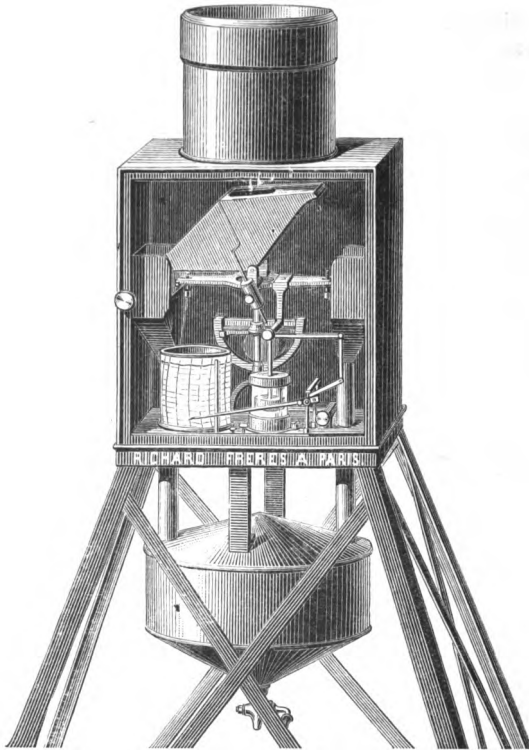

FIG. 53.—Richard's Self-recording Rain Gauge (Balance Pattern).

completed, pulls the float down and causes a sudden rise of the water-level, thereby filling the siphon. In the balance or bucket pattern (Fig. 53) the rain is led into a tipping-bucket divided into two compartments and placed on a balance. One of these compartments being under the funnel, the rain falls into it

and causes the balance to descend. A writing pen records this motion on a revolving drum. When the pen has reached the top of the drum (0·4 inch of rain), the tipping-bucket reservoir oscillates, and the water filling the first compartment is emptied into a controlling reservoir. This motion causes the second or empty compartment of the bucket to place itself under the funnel. The filling and emptying of each compartment is alternately and automatically produced, and to each of these double operations a rise and a fall of the writing pen corresponds. It may be well to mention that Mr. L. Casella, of Holborn Bars, London, E.C., is agent for MM. Richard Frères of Paris, and through him any of the automatic recording instruments of the Richard system can be obtained.

No matter what rain gauge is employed, the instrument should be firmly set in a well-exposed position, at least as far in feet from any building, tree, or high wall, as the height of that obstacle. "The angle subtended in each azimuth by the nearest obstacle, such as a building or tree, should not exceed 30°, and the true bearing of the obstacle from the gauge should be carefully measured and noted in the register" (R. H. Scott). The gauge should be placed on the ground rather than on a roof, unless in the case of a small town garden in which it is impossible to obtain a sufficient exposure. The height of the rim of the funnel should be 1 foot above the ground. This should be given in all returns of rainfall as well as the height of the gauge above mean sea-level. It is essential that the top of the cylinder above the funnel should be absolutely horizontal.

*Measurement of Rain.*—The rainfall should be measured at 9 A.M. daily, and the amount should be entered to the *previous day*, for of the twenty-four hours which elapsed since the last measurement, fifteen belonged to the previous day, and only nine to the day on which the measurement is made. The gauge must be examined daily, whether rain has fallen or not; if there is no water in the gauge a line or dash should be inserted in the register. The water is poured from the can in the interior of the gauge into the graduated



measure glass, which is scaled to represent hundredths, five-hundredths, and tenths of an inch up to half an inch of rainfall (0.50 inch). If the fall exceeds half an inch, the water first measured should be carefully preserved until the whole rainfall has been registered and the amount written down. The measure glass must be placed on a perfectly level surface before reading, and allowance should be made for capillary attraction, by which the water is drawn a little way up the sides of the glass above the general level in the measure.

Even the minutest quantity (0.001 inch) should be recorded, but a day is not to be counted a "rainy day" unless the measurement amounts to 0.005 inch (five-thousandths of an inch). Very heavy falls of rain should, if possible, be measured immediately after they occur, and noticed in the "Remarks" column of the *Meteorological Register*. The amount should, of course, be included in the next regular entry.

More rain is collected on the ground than on the top of a building or of a stand at a height above the ground. In *British Rainfall*, 1880, will be found papers on this subject by the late Mr. George Dines, F.R. Met. Soc., and Mr. G. J. Symons, F.R.S. The latter writer believes that the deficiency in the amount of rain collected in gauges on high buildings is wholly due to the position of the gauge, to the configuration of that portion of the building which is close to the gauge, and to the strength and direction of the wind during times of rain. In the many experiments which Mr. Symons quotes there was no evidence of any difference between the fall of rain, at various heights from 60 feet to 260 feet above the ground. Observations made at the Wolverhampton Waterworks in the years 1849-52 showed that the rainfall on the top of the water-tower, 180 feet high, was on the average only 76 per cent of that recorded by a low gauge at the foot of the tower on a post about 7 feet high. Season, however, had a marked influence, for while the ratio for the summer five months, May to September, averaged 81 per cent., that for the winter and windy five months averaged only 68 per cent.

Symons's explanation is now generally accepted, and it has finally disposed of the old theory that the growth of the raindrop by the condensation of particles of aqueous vapour floating in its path through the air was adequate to explain the difference of rainfall with elevation. Sir John Herschel, it is true, had already demolished this theory, by showing that the latent heat of steam being about 1000° F., drops of rain, if they acquire an increase in weight amounting to 1 per cent by condensed vapour, must, in so doing, have their temperature raised 10° F. If they acquire an increase of 5 per cent, they must have their temperature raised about 50° F. In the paper from which we have culled these remarks, Mr. Symons observes: <sup>1</sup> "Experimental evidence proves that Mr. Jevons was quite right in his theoretical view—that the fall of rain is practically identical at all elevations, and that the observed differences are due to imperfect collection by the gauges."

In reference to the remarkable statements of Sir John Herschel just quoted, the effect of rainfall in warming the air may be imagined from a calculation by the Rev. Dr. Haughton, F.R.S., Senior Fellow of Trinity College, Dublin,<sup>2</sup> that "*one gallon of rainfall gives out latent heat sufficient to melt 75 lbs. of ice, or to melt 45 lbs. of cast iron.* From this datum it is easy to see that every inch of rainfall is capable of melting a layer of ice upwards of eight inches in thickness (exactly 8.1698 inches) spread over the ground." From such considerations Dr. Haughton concludes that on the west coast of Ireland the heat derived from the rainfall is equivalent to one-half of that derived from the sun (R. H. Scott).

The *physical cause* of rain is the sudden chilling of comparatively warm air, more or less laden with moisture, either by its ascent into the upper and colder regions of the atmosphere, or by its impact against cold mountain slopes, or (in winter) the colder surface of the ground, as on the western

<sup>1</sup> *British Rainfall*, 1881, p. 45.

<sup>2</sup> *Physical Geography*, p. 126.

coasts of Europe in winter. The former cause is more potent in summer, the latter in winter. It was formerly supposed that rain was largely caused by the mixture of masses of air of different temperatures. But, even supposing that any such admixture did take place (which is problematical) Dr. Hann has shown, from a comparison between the units of heat set free by condensation and the weight of aqueous vapour per cubic foot of air at any two given temperatures—one high, the other low—that the mixture of volumes of air cannot be very effective in causing precipitation; in fact, the setting free of latent heat in the process of condensation largely prevents that fall of temperature which is assumed to take place and to cause a rainfall.

Before making a few remarks as to the Distribution of Rain, it may be well to say something about the other forms in which precipitation takes place—snow, sleet, and hail.

1. *Snow* consists of watery particles, frozen or congealed into crystalline forms of infinite variety and exquisite beauty. It is white or transparent, and entangles in its loose texture relatively large quantities of atmospheric air (about ten times its own bulk). To this last peculiarity snow owes its property of being a very bad conductor of heat, so that it protects the earth from the effects of terrestrial radiation in winter, the soil underneath it being at times 40° warmer than the superincumbent air. The white colour of snow is due to the blending of prismatic colours flashed from the countless surfaces of minute snow crystals, as well as to the air entangled by these crystals; it is analogous to the whiteness of pounded glass or of foam. *Red snow* and *green snow* have been observed in the Arctic Regions and elsewhere. The coloration is due to the presence of minute micro-organisms,  $\frac{1}{1000}$ th inch in diameter, called *Protococcus nivalis*.

In a beautiful word-picture Professor Tyndall describes a fall of snow which he witnessed on the summit of Monte Rosa, as “a shower of frozen flowers; all of them were six-leaved; some of the leaves threw out lateral rib-like ferns;

some were rounded, others arrowy and serrated ; some were close, others reticulated, but there was no deviation from the six-leaved type. Nature seemed determined to make us some compensation for the loss of all prospect, and thus showered down upon us those lovely blossoms of the frost, and had a spirit of the mountain inquired my choice—the view or the frozen flowers—I should have hesitated before giving up that exquisite vegetation. It was wonderful to think of as well as beautiful to behold. Let us imagine the eye gifted with a microscopic power sufficient to enable it to see the molecules which composed those starry crystals ; to observe the solid nucleus formed and floating in the air ; to see it drawing towards it its allied atoms, and those arranging themselves as if they moved to music, and ending by rendering that music concrete. Surely such an exhibition of power, such an apparent demonstration of a resident intelligence in what we are accustomed to call ‘brute matter,’ would appear perfectly miraculous, and yet the reality would, if we could see it, transcend the fancy. If the Houses of Parliament were built up by the forces resident in their own bricks and lithologic blocks, and without the aid of hodman or mason, there would be nothing intrinsically more wonderful in the process than in the molecular architecture which delighted us upon the summit of Monte Rosa.”

Snowflakes vary in size to a remarkable extent. The largest are fully an inch in diameter, and are observed at a comparatively high temperature ( $32^{\circ}$ , or slightly above freezing-point), and when the air is very damp. The flakes are seldom less than  $\frac{1}{10}$ th inch in diameter, but in an extremely cold, dry atmosphere they may not exceed  $\frac{7}{100}$ ths of an inch ; they then form “snow dust,” the penetrating power of which nothing can resist when it is driven before a strong wind, as in the “blizzard” of North America.

A very elaborate series of 151 different forms of snow crystals, drawn by Mr. James Glaisher, F.R.S., will be found in the Fifth Report of the Council of the British Meteor-

logical Society (now the Royal Meteorological Society), published in 1855. The crystals are either hexagonal plates or six-pointed stars, with angles which are always multiples of  $15^\circ$  or  $30^\circ$ , so bearing a close relation to those of a regular hexagon (R. H. Scott).

Beautiful engravings of snow crystals will be found in the *Philosophical Transactions* for 1742 (vol. xlii.), by Dr. Leonard Stocke of Middleburg, in Zealand; and in the same publication for 1755 (vol. xlix.), by Dr. John Nettie, also of Middleburg. The latter series includes ninety-one different forms of crystals, which were observed in the intensely cold winter of 1740-41.

When snow falls, its measurement demands constant attention on the part of the observer. Should the wind be high and temperature very low, drifting of "snow dust" will be apt to vitiate the measurement. Snow will be blown out of the gauge on the one hand or drifted into it on the other. The depth of snow in a sheltered place, free from drifting, should be carefully measured by a two-foot rule. On a very rough estimate, one foot of dry snow may be taken to represent an inch of rain. The rain gauge should be visited frequently during a snowstorm, and the snow carefully removed and thawed in a covered vessel protected from evaporation. It is also recommended to melt the snow in the funnel and cylinder of the rain gauge suddenly by adding a known quantity of hot water, the amount of which should be deducted from the final measurement. In practice this plan does not work well, for the shrinkage of the water in volume caused by its rapid reduction of temperature introduces a considerable element of error into the calculation. In some gauges hot water is poured into an outer casing, and the snow is thawed in the funnel and cylinder without admixture with the water at all. This is an excellent plan, but requires a more costly instrument, such as the snow-melting rain gauge invented by Mr. James Sidebottom, F.R. Met. Soc. In this instrument the case is double, and warm

water is poured into an angular tube, thus melting the snow. When the snow (with which the warm water is never in contact) in the funnel is melted the water is run off by a tap, and if needed a fresh supply is added. By this arrangement any mistake from adding a wrong quantity of water is rendered impossible.

Should the snow have been lifted out of the funnel by the wind, a good plan is to take the outside cylinder of the gauge, which has the same diameter as the funnel, and to insert it in the snow where it lies level and of a uniform depth. The solid cylinder or section of snow, thus cut out, should then be melted and the resulting water measured.

2. *Sleet* is half thawed snow, or mingled snow and rain. It is of rare occurrence in rigorous climates, but is frequently observed in a British winter, and in the vicinity of large lakes or the open sea. Sleet is generally formed by falling through a stratum of air much warmer than that in which condensation has taken place and whence it has come. It is, therefore, just the opposite of "frozen rain" or "silver thaw" — a phenomenon which occasionally happens in winter, particularly in connection with "glazed frost" (Germ. *Glatteis*). In this case, rain drops, sometimes of large size, fall from clouds in a warm upper current into a stratum of air near the ground, the temperature of which may still be many degrees below freezing-point. The result is that the rain-drops freeze before or when they reach the ground. They fall as particles, or pellets, or spicula of clear, transparent ice, and presently the surface of the ground becomes coated with ice, rendering locomotion on roads and foot-ways well-nigh impossible.

On January 22, 1867, a "silver thaw" occurred in the south-east of England, which is thus described by Mr. G. J. Symons in the *Meteorological Magazine* for February, 1867: "At 7.10 P.M., the ground being then frozen and the temperature of the air below freezing-point, some rather sleety hail began to fall on the pavement; it crackled under foot, and flattened out into diminutive lozenges; about 8 P.M. it

turned to rain, although the temperature of the air was still several degrees below freezing-point, and the ground was about 24°. The necessary result was the coating of everything with a layer of ice. At 9 P.M. the temperature at 4 ft. above the ground was 26·2°, and it was still raining, and the rain still freezing on pavement, walls, gravel walks, umbrellas, in fact on everything. We never recollect being (meteorologically) more mortified than we were at the failure of all our efforts to reach the thermometers 20 feet above the ground; but climbing an iced pole was a feat beyond us, and we know not what was the temperature at that small elevation. . . . Of course the streets were in a frightful state. . . . There was for some hours (till 3 A.M. in London) no safe mode of traversing the roads or pavements but the very novel one of skating.”

In 1672 accounts reached the Royal Society of a remarkable “silver thaw” which visited Somersetshire and Oxfordshire early in December of that year, and caused great destruction of trees in plantations and orchards. One observer weighed the sprig of an ash tree of just three quarters of a pound. The ice on it weighed sixteen pounds at least.<sup>1</sup>

3. *Hail* (Germ. *Hagel*, French, *Grêle*), while as white as snow, is much denser than it, and often consists of a central nucleus of ice or condensed snow, with alternate deposits of hoar frost and of ice surrounding it, the latter sometimes taking the form of pyramidal crystals. According to Dr. Marcet, the formation of hail requires (1) a large accession of moisture; (2) a temperature below freezing-point; (3) the presence of electrified clouds. Typical hailstorms are nearly always associated with thunder and lightning, and Mr. R. H. Scott says that Volta supposed that the hail pellets are kept in a state of constant oscillation between two oppositely electrified clouds, until by continued condensation the stones grow so heavy that at last gravity prevails, and they break

<sup>1</sup> *Philosophical Trans.* (abridged), vol. i. pp. 455 and 478. London: C. and R. Baldwin. 1809.

through the lower stratum of the clouds and fall to the earth. Hail, strictly speaking, is a day phenomenon, and occurs when the air is warm near the ground, while the upper air is intensely cold. Under these circumstances, dense and electrical cumuli form, and from these clouds the hail descends. Such hailstones vary in size from a small pea to an orange or a goose egg. Before they fall, all observers agree that a loud and continuous roar is heard, caused by the stones being dashed hither and thither in the air, either by electrical agency, as Volta thought, or—as seems more likely—by a cyclonic whirl of air in the vicinity of the storm cloud. This is really Dove's theory. He held that hailstorms are always whirlwinds, but with their axes almost horizontal instead of vertical. I thoroughly endorse this view. It is supported by the behaviour of the barometer in what are called "thunderstorm depressions," by the cyclonic shifting of the wind in any ordinary summer shower, and by the phenomena attending spring tornadoes in North America and elsewhere. One of my earliest recollections is my having been an eye-witness of a tornado of this kind which devastated a part of Dublin on the afternoon of Thursday, April 18, 1850. The Rev. Dr. Lloyd, then President of the Royal Irish Academy and afterwards Provost of Trinity College, Dublin, communicated a most interesting and graphic account of the tornado to the Academy four days after it occurred, of which the following is an abstract:—

"The first indications of the approach of the storm were observed soon after three o'clock. Massive *cumuli* were seen forming in the south-western portion of the sky. These became denser as they approached, until they formed a mass of an ash-grey colour, projected on a sky of a paler tint, while the rugged outliers from the mass, of the peculiar form (between *cirrus* and *cumulus*) which indicates a high degree of electrical tension, showed plainly that a storm was approaching. About half-past three o'clock it burst forth. The flashes of lightning (generally forked) succeeded one



another with rapidity, and at length the roar of the thunder seemed continuous. Some persons who observed the phenomenon from a distance, were able to distinguish the two strata of oppositely electrical clouds, and to see the electrical discharges passing between them.

“Hitherto the wind was light, and there was that peculiar closeness in the air which is the result of high temperature and excessive humidity. Shortly before four o'clock the rain commenced; this was followed almost immediately by discharges of hail, and at 4 P.M. the terrific tornado, which was the grand and peculiar feature of this storm, reached us.

“This gale, which appears to have been a true whirlwind, first sprung up from the south-east, driving the hail before it impetuously. It then suddenly, and apparently in an instant, shifted to the point of the compass diametrically opposite, and blew with increased violence from the north-west. The noise about this time of the shifting of the wind was terrific, and arose (as is conjectured respecting similar tropical phenomena) from the confused conflict of hail in the air. The size of the hailstones as well as the vehemence of the gale appeared to be greater during the second phase of the storm than in the first. These masses, many of which were as large as a pigeon's egg, were formed of a nucleus of snow or sleet, surrounded by transparent ice, and this again was succeeded by an opaque white layer, followed by a second coating of ice; in some of them I counted five alternations.

“In less than ten minutes the tornado had passed. The wind returned to a gentle breeze from the south-west, and the weather became beautiful.”

Dr. Lloyd adds: “In the tornado, the vortex is of much smaller dimensions (than that of a ‘cyclone’ or ‘great revolving storm’), and is produced by rapidly ascending currents of air, caused by the heating of a limited portion of the earth's surface under the action of the sun's rays. In the temperate zones, accordingly, it is never produced in winter. These ascending currents are loaded with vapour, which (owing to

the rapid evaporation) is in a highly electrical state, and when they reach the colder regions of the atmosphere the vapour is condensed, and electrical clouds are rapidly formed."

In the park and garden of Trinity College nineteen trees were uprooted by the tornado, eleven being trees of large size. Ten fell from the south-east, or under the influence of the first half of the gale, and nine from the north-west. The bearings of the fallen trees were accurately taken, and showed that the main direction of the south-east gale was S. 56° E., and that of the north-west gale N. 53° W. The centre of the vortex, therefore, passed over the College Park.

The barometer fell from 29·964 inches at 1 P.M. to 29·930 inches at 4 P.M., rising again to 29·944 inches at 7 P.M.

From an official return made by the Metropolitan Police, it appears that damage to the amount of £26,332 : 0 : 11 was done in the city by the tornado, including the breaking of 388,635 panes of glass.

On the morning of August 31, 1891, Venice was devastated by a hailstorm, of which an eye-witness writes:—"I never before realised how property can be destroyed, and personal injury inflicted, and even death incurred, by simple exposure for a minute or two to the blows of hailstones. Now I do. The storm came on with a suddenness that took us all by surprise. A few dark clouds coming over the city from the north and west, and a few flashes of lightning and rattling peals of thunder, and in a moment a tempest of hail was upon us. The awful noise made me think that the hurricane of wind that was raging was sweeping the roofs clear of their tiles and levelling chimneys to the ground. In part that was the case, but the noise was the noise of hailstones, solid pieces of ice as big as eggs, and some as big as oranges, that did not fall, but were being driven with terrific force on to the roofs of the houses, on to the pavement, and into the water. . . . As they fell into the canal that goes by my door its usually quiet surface seemed to boil furiously. The storm was over in a few minutes, and I went out

Venice seemed to have suffered a bombardment. . . . The officials in the office of the *Adriatica* newspaper secured some of the hailstones as they fell, and had them weighed. Several weighed 250 grammes, that is, more than half a pound. In some places the streets seemed to be covered with a bed of white stones."

In cold weather in spring hail sometimes assumes another form, and falls from cumuli in pyramidal soft masses, like miniature snowballs. This is "*soft hail*" (Germ. *Graupel*; French, *Grésil*). The front of the pyramid as it falls is convex; the remainder of the soft hailstone is either conical, when the whole resembles a tiny peg-top upside down, or pyramidal with a hexagonal or square base, as if it originally formed part of a large sphere of hail. Mr. H. A. Cosgrave, M.A., describes the former shape as having characterised hailstones which fell on July 3, 1877, at Kilsallaghan, Co. Dublin;<sup>1</sup> while W. T. Black figures the latter shape in an account of a heavy fall of hail at Leamington, on March 31, 1876.<sup>2</sup> Hail of moderate size accompanies snow showers in winter whether by day or by night, coming with northerly (north-west to north-east) winds. Tiny granules of hail also fall from the gray roll-cumulus of winter anticyclones, but never in large quantity.

An attempt has been made by Mr. G. J. Symons, in his *Meteorological Magazine*,<sup>3</sup> to determine the weight of hailstones in relation to their size. He gives a table which is based on the assumptions:—

- (1) That the hailstones are truly spherical.
- (2) That they consist wholly of clear ice.

A cubic inch of water weighs 253 grains, but the specific gravity of ice is 0.93, therefore a cubic inch of ice cannot weigh more than 235 grains, or a trifle over half an avoirdupois ounce. Each 0.01 inch of rain in the measuring jar

<sup>1</sup> *Symons's Monthly Meteorological Magazine*, vol. xii. p. 86.

<sup>2</sup> *Loc. cit.*, vol. xi. pp. 55, 56.

<sup>3</sup> Vol. xiv. p. 115; 1879.

of an eight-inch gauge contains 127 grains. Each 0·01 inch in that of a five-inch gauge weighs 50 grains. If, therefore, ten selected hailstones when gradually melted in the measuring glass of the five-inch gauge yield 0·13 inch, we have—

$$\frac{13 \times 50}{10} \text{ grains} = 65 \text{ grains of water} = \text{the weight of each of the ten hailstones.}$$

The most modern work on "Hail" is from the pen of the Hon. Rollo Russell, F.R. Met. Soc., and was published in 1893 (London: Edward Stanford). The author concludes, as the result of a wide experience, that the clouds in which large hail has its origin are commonly at a great height, between 15,000 and 40,000 feet, or higher. These clouds are the result chiefly of expansion and refrigeration of warm humid air, of the sudden mixture of masses of air greatly differing in temperature and vapour tension, and of free radiation. The nucleus of a hailstone consists of a snowflake, pellet, or spicule, which falls from the uppermost cloud. The snowflake, pellet, or spicule, is electrified as a result of condensation, and as it falls attaches particles of ice and globules of water below the freezing-point to itself, the particles arranging themselves commonly in a stellate form, or concentrically round the nucleus. The variety of form of the primitive kernel is great, and consequently hailstones of many different shapes may be met with. The ordinary top-shaped hailstone is produced by the lower side growing more quickly than the upper, as it comes into contact with more particles; and since the impact is most forcible on the lower side, the ice of the spheroidal base is the hardest. Mr. Russell's book is illustrated by two photographs of hailstones (actual size) taken after a terrific thunderstorm at Richmond, Yorkshire, on July 8, 1893, by Mr. H. J. Metcalfe, photographer, High Row, Richmond, Yorks. Some of the hailstones figured have a diameter of two inches.

*Distribution of Rain.*—This topic may be considered under the headings—geographical and seasonal.

I. *Geographical.*—1. *British Islands.*—Thanks in great measure to the energy and organising power of Mr. G. J. Symons, F.R.S., the United Kingdom is now covered with a network of rain-gauge stations, upwards of 2000 in number, and the observations are digested and published in *British Rainfall* each year under the personal supervision and editorship of Mr. Symons. His coloured rainfall map gives the leading facts in a striking and intelligible form. The average annual rainfall *as a rule* decreases from west to east, both in Ireland and in Great Britain. It exceeds 75 inches in the west of Scotland, the English Lake District, in the mountains of North Wales, and on the top of Dartmoor in Devonshire. Seathwaite in Borrowdale, at the south end of Derwentwater, has an annual fall of 140 inches on the average; near Sty Head above it the mean fall is 175 inches, or some 15 feet, rising in wet years above 200 inches, or 17 feet. In Ireland the rainfall is heaviest in the neighbourhood of Killarney (about 60 inches), smallest in and about Dublin (about 28 inches), and in the Co. Down. On the east coast of England it falls well below 25 inches.

The reason for this distribution is that westerly winds are those which prevail most in the British Islands. They reach the mountainous western coasts off the Atlantic, and laden with moisture in consequence are forced upwards above the saturation line. When these prevalent winds reach the eastern sea-board they have already lost a great deal of their moisture through condensation, and they are *descending*,—a state of things which raises their temperature and increases their capacity for vapour. They are like the dry, warm, south wind of the northern slopes of the Alps, which is called the *Föhn* in Switzerland.

2. In *Foreign Parts*, the *wettest* regions are the equatorial zone of calms over the Atlantic and Pacific Oceans, and “localities where damp winds meet mountain ranges and are forced upwards” (R. H. Scott). Examples of the latter are the Khasi Hills in Assam, the Western Ghats in India, the

western coast of Norway, Sitka in North-West America, Valdivia in Southern Chili, and Hokitika in New Zealand. The *driest* regions are the Sahara, Egypt, Arabia, and Persia, the southern *steppes* of Russia, the north-west of India (Kurrachee), the Great Salt Lake region in North America, the Kalahari Desert in South Africa, the interior of Australia, and Peru and Chili between the Andes and the sea in South America. The desert of Gobi, in Central Asia, is rendered almost rainless by intercepting chains of lofty mountains.

II. *Seasonal*.—On the western shores of Europe the winter rainfall exceeds that of summer in persistence and amount. This is due to the prevalence of westerly winds, and to the coldness of the highlands near the Atlantic sea-board. On the Continent of Europe the summer rainfall exceeds that of winter, at all events in amount. This is doubtless in consequence of the torrential rains which accompany summer thunderstorms. In fact, as Mr. R. H. Scott puts it, *the rains of low latitudes are essentially summer rains*, as they occur principally when the sun is highest. Another good name for them would be “evaporation rains,” because they fall from cumuli which have been formed by evaporation and the ascent of the vapour above the saturation or condensation line. The great Indian rains accompany the south-west monsoon—that is, they are caused by the condensation of the vapour-laden winds blowing from the Indian Ocean.

In Dublin, the monthly rainfall is least in May and June, greatest in October and August.

III. The *diurnal* fall of rain is determined by the seasons. As a rule, in winter more rain falls by night than by day; in summer, more rain falls by day than by night. At ordinary British stations falls of more than 2 inches in the twenty-four hours are not common. In Dublin, since 1864, such a fall has occurred only on three occasions,—August 13, 1874 (2·482 inches); October 27, 1880 (2·736 inches); and May 28, 1892 (2·056 inches). But these downpours pale into insignificance before the record rainfalls of the world, of

which, perhaps, the most notable is that which wrought such terrible ruin in Brisbane at the beginning of February, 1893. In the Blackall Ranges, near the city of Brisbane, 77·305 inches of rain fell in the four days ending February 3, 35·714 inches being the measurement on February 2. But this fall, tremendous as it is, does not stand out as a world's record, for on June 14, 1876, 40·80 inches of rain fell within twenty-four hours at Cherra Poonjee, Khasi Hills, Assam, being at the rate of 1·7 inches per hour.<sup>1</sup>

*Weight and Bulk of Rain.*—When we speak of an inch of rain, we mean that sufficient has fallen to fill to overflowing a vessel which is *one inch in length, one inch in breadth, and one inch in depth*—that is, a volume of *one cubic inch*. Now, an acre contains 6,272,640 square inches, each of which would receive an inch depth of rain, if the rainfall was one inch. One inch of rain over an acre is therefore 6,272,640 cubic inches. But, according to recent determinations,<sup>2</sup> one imperial gallon contains 277·123 cubic inches. So that—

$$\frac{6,272,640}{277\cdot123} = 22,635 \text{ gallons; or } 101 \text{ tons } 0 \text{ cwt. } 3 \text{ qrs. } 26 \text{ lb.}$$

In round numbers, therefore, a rainfall of one inch means a downpour of 101 tons of water on every acre. As there are 640 acres in a square mile, a rainfall of one inch means a precipitation of 64,640 tons of water on every square mile.

<sup>1</sup> Prof. John Eliot, "The Rainfall of Cherrapunji," *Quart. Journ. of the Met. Soc.*, vol. viii. pp. 47, 51. 1882.

<sup>2</sup> *Table-Book*, p. 35. By Rev. Isaac Warren, M.A. Longmans, Green, and Co. 1888.

## CHAPTER XXI

### ANEMOMETRY AND ANEMOMETERS

Wind : what it is and how produced—Force or Velocity of Wind depends on Barometric Gradients—Estimation of Wind Force—Beaufort Scale—Wind Direction—Bearings should be true—Variation of the Compass—Position of the Pole Star—Equation of Time—A Windrose : how determined—Anemometers : Pendulum, Bridled, Pressure Plate, Pressure on a Fluid, Velocity, Evaporation or Temperature, Suction, Direction, Inclination, Musical, Dines's Helicoid, MM. Richards' Anémo-Cinémographe—Lambert's Formula for determining Mean Direction of the Wind—Mr. Dines's Comparative Experiments with Anemometers—Casella's self-recording Anemometer.

WIND is air naturally in motion with any degree of velocity ; it is a current of air. Wind is produced by differences of atmospheric pressure, and these differences are in (turn referable to—indeed, largely dependent on—variations in temperature. It has been already shown that the *force* of the wind is governed by the steepness of barometric *gradients*—in other words, by the closeness to each other of the isobars, or lines of equal atmospheric pressure. All mechanical obstacles, however, interfere with the velocity or force of the wind,—for these two terms come to mean the same thing owing to the substantial nature of the air,—and, accordingly, we find that in general the force of the wind is greater at sea than on dry land, at a distance above the earth than on the surface of the ground, on the sea-coast than at an inland station, on the slope or summit of a mountain than on a plain, on a bare plain than in a wooded or hilly district.

In the *Narrative of a Voyage to the Southern Atlantic*



*Ocean in the Years 1828-30, performed in H.M. Chanticleer, Captain the late Henry Foster, F.R.S.,*<sup>1</sup> Mr. W. H. B. Webster, surgeon, R.N., stated the general principles of the relation of wind to atmospheric pressure, and foreshadowed Buys Ballot's Law. His remarks were based on personal observation of the singular difference between the mean height of the barometer at the Cape of Good Hope and at Valparaiso on the coast of Chili (about 30 inches), and that at Cape Horn, Staten Island, and New South Shetland (29·3 to 29·4 inches). He says:<sup>2</sup> "If we suppose that at any time the barometer is high at one place and low at the other, we shall have at Cape Horn the barometer at 28·3 inches, while at Valparaiso or the Cape it will be at 30·6 inches, being an occasional (nay, frequent) difference of more than two inches. Now, if we consider these changes to take place principally in the lower strata of the atmosphere, which in fact must be the case, and that they range within the limits of five or six miles' altitude, how great must be the difference of the weights and pressures of the reciprocal columns. It is not surprising, then, that there should be continual gales endeavouring to restore the equilibrium. From the foregoing statements it may be safely inferred that 'the mean height of the barometer at the level of the sea being the same in every part of the globe' is by no means correct; but, on the contrary, that every place has its own peculiar height of the barometer; and to this permanent variation, a circumstance not heretofore recognised, may be attributed the perpetual interchange and motions of the atmosphere."

In this connection, it may be incidentally mentioned that it is the steep gradient over the immense Southern Ocean which gives rise to the strong and gusty anti-trades or westerly winds which blow in the "Roaring Forties" of that ocean, and which prevail as far south as lat. 50°.

The oldest method of observing wind is by sensation or

<sup>1</sup> From the *Private Journals of W. H. B. Webster*, 2 vols. London, 1834.

<sup>2</sup> *Op. cit.* vol. i. p. 316.

by estimation. It is a rough but ready method, and in the hands of a skilled observer yields fairly satisfactory results.

The earliest attempts at estimating wind *force* were doubtless made by sailors, from whom we have learned the expressions, a "gale," a "whole gale," a "squall," a "strong breeze," a "capful of wind," a "light breeze," a "dead calm." It has been already stated that such expressions were reduced to a scale by Admiral Sir F. Beaufort in 1805, whose Table of Wind Force (revised) is printed at page 35 of this book. The nautical part of this table is of little use to a landsman, and, accordingly, the equivalent velocities and pressures have been calculated at the Meteorological Office, London, and included in the Table. The mean velocity in English miles per hour being known, the equivalent velocities according to the metric scale—*i.e.* in metres per second—are obtained by multiplying the figures in the third column—that is, the number of English miles—by the factor 0·447. The pressure in pounds on the square foot is calculated on the formula,  $P = 0\cdot005 V^2$ , given by Colonel Sir H. James, R.E., F.R.S., in his *Instructions for taking Meteorological Observations*, 1861, p. 32. The Table will then read as follows for land observations:—

TABLE OF BEAUFORT'S SCALE OF WIND FORCE WITH  
EQUIVALENT VELOCITIES AND PRESSURES

Force.	Beaufort Scale in Words.	Mean Velocity, English Miles per hour.	Mean Velocity, Metres per Second.	Mean Pressures in lbs. on the Square Foot.
0.	Calm . . .	3	1·3	·75 oz.
1.	Light air . . .	8	3·6	5·0 "
2.	Light breeze . . .	13	5·8	13·5 "
3.	Gentle breeze . . .	18	8·0	1·6 lb.
4.	Moderate breeze . . .	23	10·3	2·65 "
5.	Fresh breeze . . .	28	12·5	4·0 "
6.	Strong breeze . . .	34	15·2	5·75 "
7.	Moderate gale . . .	40	17·9	8·0 "
8.	Fresh gale . . .	48	21·5	11·5 "
9.	Strong gale . . .	56	25·0	15·7 "
10.	Whole gale . . .	65	29·1	21·2 "
11.	Storm . . .	75	33·5	28·2 "
12.	Hurricane . . .	90	40·2	40·5 "

The justification of this table will be found in a paper contained in the *Quarterly Journal of the Meteorological Society*, vol. ii. p. 109, "An Attempt to establish a Relation between the Velocity of the Wind and its Force," by Robert H. Scott, F.R.S. The scale of velocities included in the table must, however, be regarded as merely provisional, and as applicable chiefly to coast stations. At inland stations, the velocity corresponding to a given force is much smaller, because the *general motion* of the air is retarded by inequalities in the surface of the ground, while wind force is naturally estimated from that of the *gusts*.

*Wind Direction.*—By this term is meant the point of the compass *from* which the wind is blowing. It may be ascertained by observing for a few moments the movements of a properly set and freely movable vane or weathercock. Chaucer has it—

"As a *wedercok* that turneth his face with every wind."

When a weathercock is not available, the drift of the smoke from exposed chimneys should be carefully noted. *Under all circumstances*, the bearings should be true and not magnetic (by compass). In the British Islands the *variation* of the compass at the present time ranges from 16° in the extreme east of England to 23° in the extreme north-west of Ireland—the magnetic north lying so many degrees to west of the true north, or the true north so many degrees to east of the magnetic north. Roughly speaking, a true north and south line lies along the line north-north-east to south-south-west by compass. Accordingly, we get the following Table for the conversion of directions observed by mariner's compass in the United Kingdom to approximate true bearings:—

Compass Bearings.	True Bearings.
North	North-north-west
North-north-east	North
North-east	North-north-east
East-north-east	North-east

Compass Bearings.	True Bearings.
East	East-north-east
East-south-east	East
South-east	East-south-east
South-south-east	South-east
South	South-south-east
South-south-west	South
South-west	South-south-west
West-south-west	South-west
West	West-south-west
West-north-west	West
North-west	West-north-west
North-north-west	North-west

In the absence of a mariner's compass, we can ascertain the north point by means of the pole star, or the south point by means of the sun. The pole star, Polaris, is practically due north in January and July at 6 A.M. and 6 P.M., in February and August at 4 A.M. and 4 P.M., in March and September at 2 A.M. and 2 P.M., in April and October at noon and midnight, in May and November at 10 A.M. and 10 P.M., in December and June at 8 A.M. and 8 P.M. In order to ascertain the position of due south, we must know the longitude of a given place and also the *equation of time*, or the difference between mean and apparent time, that is, the difference between the time of day indicated by the sun's position on the meridian and that indicated by a perfect clock going uniformly all the year round. As a matter of fact the sun is not always on the meridian at 12 o'clock noon. It was so in 1893 on April 15, June 14, August 31, and December 24; but on November 2 and 3 it reached the meridian 16 minutes 21 seconds before noon, and on February 9, 10, 11, and 12, it was 14 minutes 26 seconds late, not arriving at the meridian until 0 hour 14 minutes 26 seconds P.M. Greenwich time is converted into local time by *subtracting* four minutes for every degree of west longitude, by *adding* four minutes for every degree of east longitude. Thus, noon at Greenwich becomes 11 hours 35 minutes A.M. in Dublin, the longitude of the Irish capital being  $6^{\circ} 15'$  west ( $6^{\circ} \times 4' = 24' + 1' = 25m.$ )

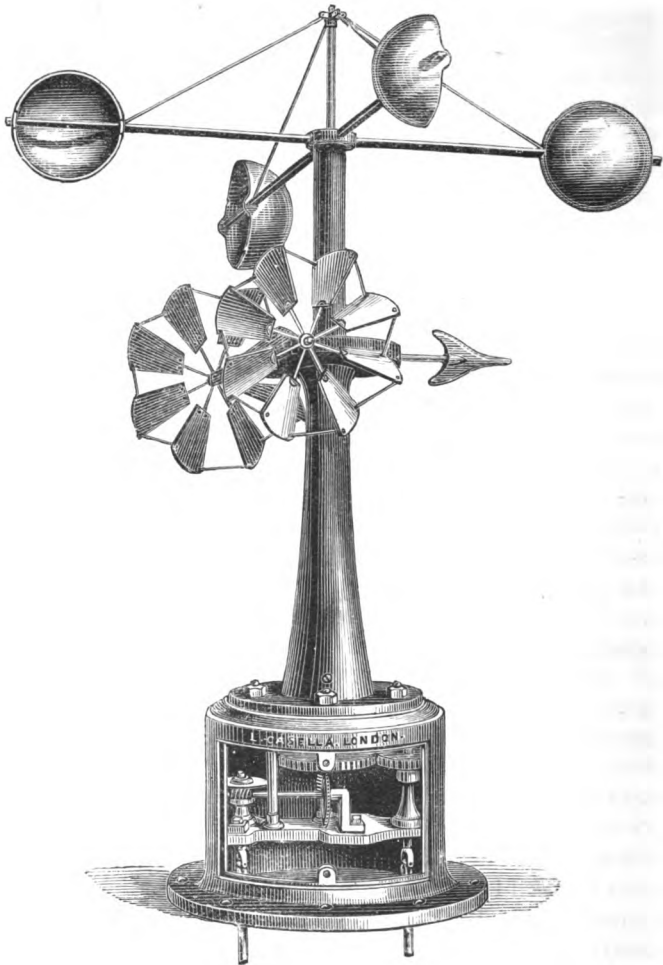

FIG. 54.—Casella's Self-recording Anemometer or Anemograph (see p. 275).

In *Bradshaw's British Railway Guide* a map gives longitude from Greenwich in time direct, without calculation.

A "windrose" may be constructed "by calculating the percentage proportion of the number of wind observations from each point of the compass, and printing the results either in a tabular form or representing them by a diagram. Windroses may be made to show the force, as well as the direction, of the wind from different points" (R. H. Scott).

*Anemometers.*—The history of mechanical anemometry

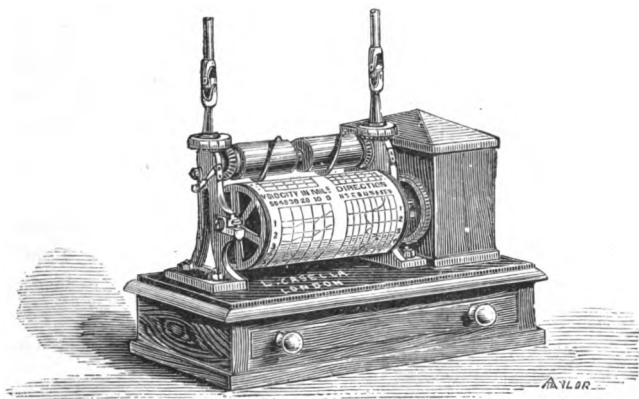

FIG. 55.—Recording Cylinder of Casella's Anemograph.

(Gk. *ἀνεμος*, *wind*; *μέτρον*, *a measure*) may be held to date from the year 1667, when the Royal Society published a revised edition of "Master Rooke's" *Directions for Seamen*. The editors were Dr. Hooke and Sir Robert Moray, who say, *inter alia*, "The strength of the wind is measured by an instrument such as is represented." The representation shows a plate suspended by a bar from a pivot, and thus able to swing upwards when pressed by the wind along a graduated quadrant, the quadrant itself, with the plate, turning freely as a vane on a vertical shaft.

On March 15, 1882, Mr. J. K. Laughton, M.A., F.R.G.S.,

read his presidential address to the British Meteorological Society, entitling it a "Historical Sketch of Anemometry and Anemometers."<sup>1</sup> To this address I am indebted for the foregoing information as well as for the following classification of anemometers:—

A. *Pendulum*.—Such as Hooke's (1667), Pickering's anemoscope (1744), Dalberg's (1780), Schmidt's (of Giessen) (1828), Wild's (1861), Howlett's (1868). The Vienna Congress (1873) recommended the introduction of Professor Wild's gauge, which is in use in Russia and Switzerland. It consists of a rectangular plate hung on hinges on a horizontal axis. The angle which this makes with the vertical indicates the force of the wind. This instrument measures the force of light winds accurately, but fails in the case of strong winds, because the plate will be kept almost horizontal by even a moderate breeze.

B. *Bridled*.—Wolf (1708), Leupold (1724), Leutmann (1725), Beaufoy (1821), Francis Galton's "torsion anemometer" (1879), in which a set of Robinson's cups are bridled by a spring on a vertical shaft; Ronalds (1844), Stokes (1881). In Sir F. Ronalds's instrument the force of the wind is determined by means of a simple balance.

C. *Pressure Plate*.—Bouguer's (*Traité du Navire*, 1746), in which a piece of cardboard, 6 inches square, was fixed perpendicularly on to a light rod, which pressed into a tube against a spring; Abbé Nollet (*L'Art des Expériences*, 1770); Osler's (1836), in which the plate was separated from the wedge-shaped vane, and acted on a wire passing down the hollow spindle of the vane. In this way Mr. Osler obtained two distinct registers—one of direction, the other of pressure. Mr. Osler has more recently adapted a windmill vane to give direction instead of the original wedge-shaped vane.

Jelinek (1850), in order to avoid the vacuum behind the pressure plate, cased it in by a cylinder, closed behind, against

<sup>1</sup> *Quarterly Journal of the Met. Soc.*, vol. viii. No. 43, p. 161. 1882.

which it bore by three spiral springs. Cator (1864) made the back of the plate the base of a cone, and received the

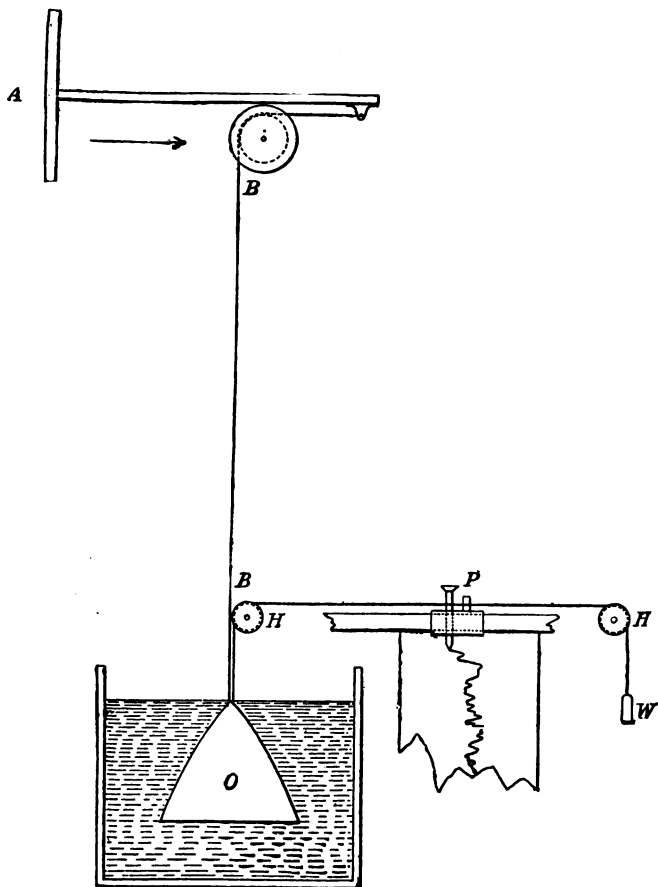

FIG. 56.—Pressure Plate Anemometer.

pressure on a system of levers instead of a spring. Professor Wilke, of Stockholm (1785), described another form of



pressure anemometer which he called an Anemobarometer. Pujoulx (1830 ?) adopted the same plan in causing the pressure to act on a bladder containing air, which by means of a double siphon-shaped tube forced a column of coloured liquid to rise.

The principle of the pressure plate anemometers is shown in the drawing on the preceding page (Fig. 56) used to

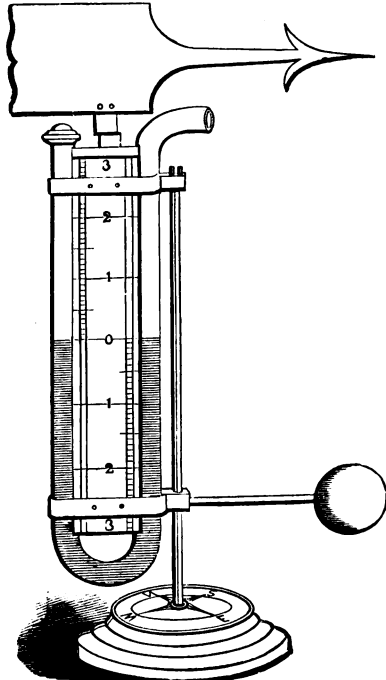

FIG. 57.—Lind's Anemometer.

illustrate Mr. Dines's anemometer comparisons at Oxshott (*Quarterly Journal of the Royal Meteorological Society*, vol. xviii.½ No. 83, July 1892, pp. 165 *et seq.*).

D. *Pressure on a Fluid.*—Lind's (1775) anemometer

consisted of a Pitot's or U-tube, swinging freely on a vertical spindle, so as to form a direction vane (Fig. 57). The tube nearer the spindle was bent back at right angles, so as to present its mouth to the wind, which, acting on water in the bend of the tube, forced it up the other leg of the U, the difference of level giving a measure of the wind force. Wollaston (1829) modified this principle in the construction of his "differential barometer." Adie (1836) caused the air to blow down a bell-mouthed tube, led into the inside of a cylinder, air-tight above, but open below, which floats

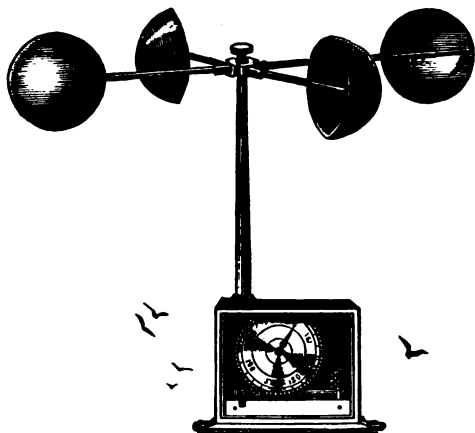

FIG. 58.—Robinson's Anemometer.

in a vessel containing water. This small "gasometer" rises as the pressure of the air inside is increased.

#### E. *Velocity.*

1. Wheel with axis, horizontal or vertical, perpendicular to the direction of the wind. Lomonosow (1751).
2. Windmill sails, or fan, with axis in the direction of the wind. Woltman (1790); Whewell (1837); Rev. W. Foster (1844).
3. Hemispherical cups (Fig. 58). The Rev. W. Romney

Robinson, D.D., in 1846, applied a fact, "which," he said, "he had learned from the late Richard Lovell Edgeworth, that if hemispherical cups be carried by horizontal arms attached to a vertical axis, with their diametral planes vertical, they constitute an effective windmill, which he (Dr. Robinson) had found revolves with one-third of the wind's velocity." "To the bottom of the axis is attached wheel-work actuating a revolving disc, which rotates through a degree for every mile traversed by the wind." The principle of this anemometer is based entirely on the difference of the wind pressure on the concave and convex sides of the cups. Dr. Robinson adopted 3 as a general and constant co-efficient to express this ratio. The co-efficient 2.5 was proposed by Professor Sir George Stokes, Bart., in a paper in the *Proceedings of the Royal Society* (vol. xxxii. p. 170), but Mr. Laughton considers that this is only an approximation, and ought in strictness to be changed for each individual instrument and every different wind. Dr. Robinson's anemometer is described in the *Transactions of the Royal Irish Academy* for 1850. The readings on the dials of this anemometer are as follows:—One complete revolution of the *first* stamped index-wheel equals  $\frac{1}{10}$ th of a mile; the *second*, 1 mile; the *third*, 10 miles; the *fourth*, 100 miles; the *fifth*, 1000 miles. Necessarily, in noting such reading, it must be done backwards, according to the indications on the instrument. The cups travel at a rate equal to one-third that of the wind; but allowance having been made for this in graduating the circles, a true reading is at once obtained. Negretti and Zambra's Improved Robinson's Anemometer (Fig. 59), as described by Col. Sir H. James, R.E., F.R.S., has two graduated circles. The outer circle is graduated

into five miles, each divided into tenths, and the inner circle from 5 to 505 miles. The velocity of the wind at any particular moment is found by observing this index before and after a certain interval of time—as one or five minutes—and then multiply the rate by sixty or twelve to find the velocity in miles per hour.

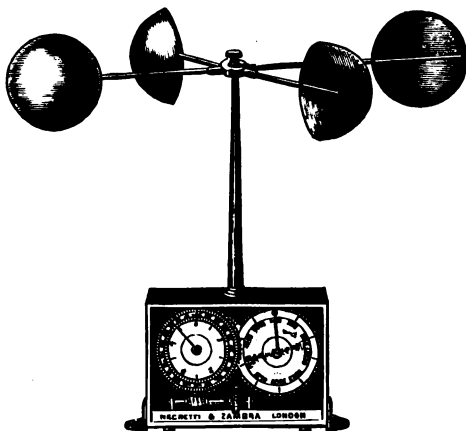

FIG. 59.—Negretti and Zambra's Improved Robinson's Anemometer.

4. Current meter. In a portable magnetic anemometer and current meter for maritime use, designed by Mr. R. M. Lowne in 1874,<sup>1</sup> the measurement of a current of air or water is effected by the revolution of a wheel carrying a number of plates of very thin aluminium, so arranged that their flat surfaces lie at an angle of  $45^\circ$  to the plane of the wheel's motion. When a wheel so formed is placed in a current, it revolves in a given time a number of turns that exactly express the velocity of the current which passes the wheel. The number of

<sup>1</sup> *Quarterly Journal Met. Soc.*, vol. ii. p. 285. 1874.

the revolutions of the wheel is indicated by pointers turning on a dial, and traversing circles on which the lineal feet of the current are expressed by graduations and figures.

At the suggestion of the late Dr. Edmund Parkes, F.R.S., of the Royal Victoria Hospital, Netley, Mr. Casella, of London, constructed an air meter for measuring the velocity of currents of air passing through mines, hospitals, and other public buildings (Fig. 60).

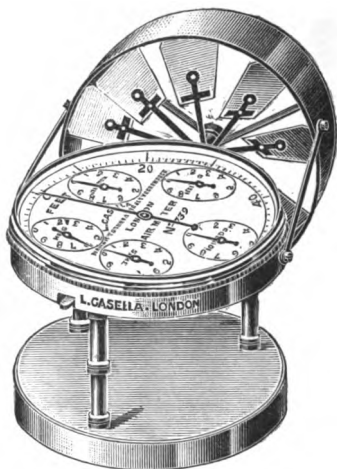

FIG. 60.—Air-meter.

F. *Evaporation or Temperature.*—These anemometers are based on the principle enunciated by Leslie in his *Experimental Inquiry* (1804), that “The refrigerant power of a stream of air is exactly proportional to its velocity. Hence we may determine the rate of cooling that corresponds to any given velocity.” Leslie’s anemometer is a thermometer with a bulb larger than usual. Sir David Brewster (1829) adopted the principle, that “when water is exposed to wind the quantity evaporated in a given time is propor-

tional to the velocity of the wind, the capacity of the air for moisture remaining the same. His anemometer consisted of a light frame, on which was stretched a surface of sponge or coarse flannel to be wetted. This frame was fixed perpendicularly on a light horizontal rod, pivoted on an upright spindle, round which it turned so as to face the wind. On the other arm of the rod was a sliding weight, the rod being graduated as a steelyard. The observed loss of weight gave a measure of evaporation, and so of the wind's velocity. Phillips (1848-49) re-invented the methods of calculating the velocity of the wind from its power of cooling or evaporating.

G. *Suction*.—Anemometers coming under this heading are based on a principle, first illustrated by Bernoulli about 1738, that the friction of masses of fluid in motion induces a power of suction as a result of the production of a partial vacuum. Professor Overduyn, of Delft (1854), and M. Bourdon (1882) applied this principle to the measurement of wind. G. A. Hagemann (1876) designed two anemometers, one for stationary observations, the other for observations on board ship or when travelling. The latter combines the pressure with the suction principle; the former adopts the suction principle only.

In his anemometer for stationary use, Hagemann<sup>1</sup> uses only the rarefaction produced by the wind on an open perpendicular tube. This tube is usually a piece of ordinary gas-pipe,  $\frac{1}{4}$  to  $\frac{1}{2}$  inch in diameter, and is fastened either to a mast or on a prominent place, such as a high chimney or a church tower. The pipe has at the top a gilt brass mouth-piece, with an opening of not less than 3 mm. It is carried down to the anemometer, properly so called, which consists of a vessel about half filled with pure water. From the bottom of this vessel a pipe enters and opens above the water surface into the cavity of a small gasometer, made of very light tinned sheet brass, and having an upper surface of

<sup>1</sup> *Quarterly Journal of the Met. Soc.*, vol. v. 1879, p. 208.

exactly 100 square centimetres. The gasometer dips into the water, and is hung by a strong silk, which, after first having passed over a pulley connected by a wheel with an index-hand, has its other end fastened to a spring properly tempered. The open perpendicular tube is connected by means of a caoutchouc tube with the pipe which enters the anemometer. When the connections are thus made, it is evident that any change in rarefaction will turn the index-hand. A rarefaction of 1 mm. water pressure will act as if a layer of 1 mm. of water were laid on the whole surface of the gasometer; this on 100 square centimetres is a weight of 10 grammes. Hence, by loading the gasometer with 10, 20, 30, 40, up to 100 grammes, the position of the index will correspond to 1, 2, up to 10 mm. suction, and the scale is divided accordingly. A scale for velocity of wind, in metres per second, is calculated by the formula  $V = 3.9 \times \sqrt{h}$  ( $h$  being the water pressure in millimetres), and is also marked. The velocity of the wind is, so to speak, weighed. Neither temperature, pressure, moisture, rain, snow, nor hail has any influence upon this anemometer, the action of which is regarded by the inventor as perfectly satisfactory. The Hagemann anemometers are manufactured by Nyrop of Copenhagen.

H. *Direction*.—Lomonosow (1751) attached to the vane-spindle of his anemometer a vertical wheel, with a tube containing mercury running round the greater part of its circumference—perhaps 300°. As this wheel, bridled by a spring, turned on its axis, a small quantity of the mercury was poured out into a tray beneath, divided into thirty-two radiating compartments; the compartment in which the mercury was afterwards found indicated the direction of the wind, the quantity of mercury its force. Beaudoux (1777) registered the direction only by fine sand falling into a similarly divided tray. Goddard (1844) used water in the same way. Craveri (1866?) adopted a similar method of registry, corn grains being the weight employed.

I. *Inclination*.—Various instruments have been designed with the object of showing whether any given current of wind has an upward or downward tendency. Benzenberg (1801) caused the windward end of the direction vane to carry a vertical fork open to the wind; across this was fixed the axis of a horizontal vane, which showed the inclination of the wind. Cacciatore (1840), Director of the Observatory at Palermo, caused the velocity of the wind to be given by a horizontal fan of four curved sails, which, being segments—apparently quadrants—of a cylinder, necessarily revolved in one direction. A similar fan on a horizontal axis was fixed in a rectangular frame fastened to an upright spindle, so as always to swing away from the wind and rotate in a plane at right angles to the wind's direction. It could be acted on only by the vertical component of the wind. More modern instruments for observing the inclination are those invented by Professor Hennessy (1856) and Father Dechevrens (1881) of the Observatory of Zi-Ka-Wei, near Shanghai (*Sur l'Inclinaison des Vents*).

In 1886, Mr. Louis Marino Casella, F.R. Met. Soc., described to the Royal Meteorological Society an altazimuth anemometer which he had designed and patented. The object of the instrument is to record continuously the vertical angle, as well as the horizontal direction and force of the wind. A full description of his instrument will be found in the *Quarterly Journal of the Royal Meteorological Society*, vol. xii. No. 60, October 1886, p. 246. The existence of air-currents moving in a direction more or less inclined to the plane of the horizon, or "*inclined currents*" as Mr. Casella calls them in his paper, being conceded, the necessity for the study of their inclination and velocity is at once apparent. Mr. Casella's anemometer, which includes in its construction the principle of the engineering instrument known as the altazimuth, records continuously on one sheet of paper the pressure, direction, and inclination of the wind, with all its changes, the pressure plate being always maintained truly at



a right angle to the wind. The apparatus for indicating the direction of the wind consists of a vane (Fig. 61A) constructed of a pair of diverging blades fixed to a cap, mounted so as to rotate about a vertical axis, the motion of this vane being transmitted by a vertical tubular shaft passing downwards

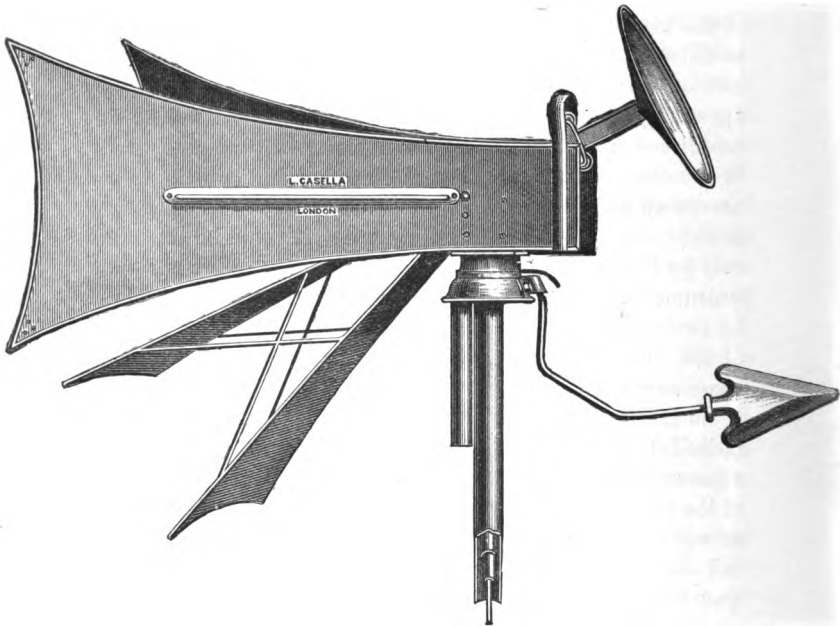

FIG. 61A.—Vane of Casella's Altazimuth Anemometer.

through the usual fixed column to the registering mechanism. This tubular shaft, called the "direction tube," is made to operate the styles which record its movements through the medium of pinions and wheels, conveying motion to two discs, which are made to carry pencils in a vertical position and equi-distant; three styles are used, so that one is always ready to enter on the scale at one side when another leaves it at the other side (Fig. 61B).

The apparatus for indicating the inclination of the wind, that is, its divergence from a horizontal plane, consists of a similar vane (composed of a pair of diverging blades), mounted on a horizontal axis within the direction vane, so balanced as

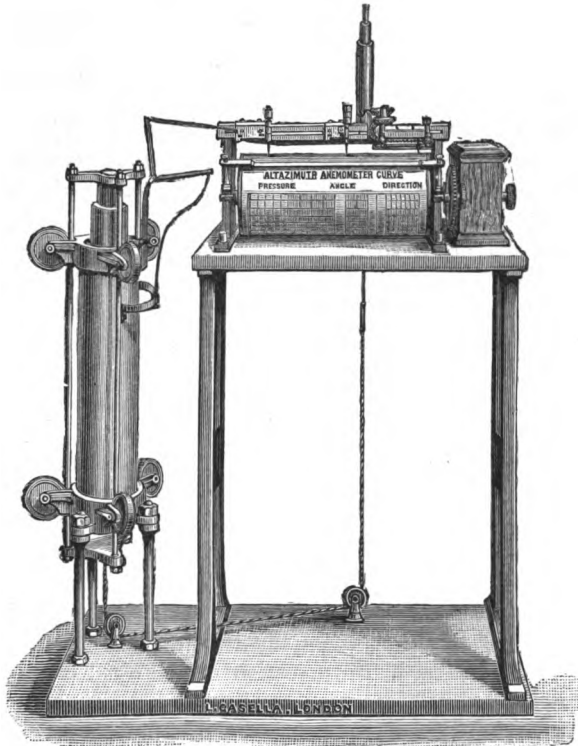

FIG. 61B.—Casella's Altazimuth Anemometer.

to assume normally, when no wind is blowing, a position in which its longitudinal axis is horizontal. To ensure this, the vane is brought to a condition of stable equilibrium as closely approximating to that of instability as it is possible to bring it.

The oscillating motion of this inclination vane is transmitted to its registering mechanism by a tubular connecting rod, jointed to the vane by a pair of links, which move up and down inside the direction tube; the inclination tube is so connected with the carriage of a style. Thus its longitudinal motion only affects the latter, which thus records upon the scale the oscillations of the vane due to the varying inclination of the wind.

The pressure plate is a disc having an area of  $1\frac{1}{2}$  square feet fixed to a guide rod, fitted to slide between pairs of guide rollers in the frame of the inclination vane, and moving with it. This plate should have had a cone at the back, which was omitted in its construction. In order to prevent the varying positions of the pressure plate affecting the balance of the vane, its motion is constantly and exactly compensated by a movable weight running on rollers, so arranged that the weight moves to a proportionate extent in the opposite direction to the pressure plate, so as to maintain the balance of the vane in all positions of the pressure plate. The motion of the pressure plate is transmitted to the apparatus for measuring the force by means of a chain attached to the guide rod of the plate, and passing down over a pulley through the tubular shaft of the inclination vane. To prevent the weight of this chain affecting the accuracy of the records, it is exactly balanced by a counterpoise hanging in a casing carried by the cap. In this way the pressure plate is kept perpendicular to the direction of the air current, not only in azimuth but also in altitude.

The apparatus for measuring the pressure consists of a cistern containing mercury and a displacement plunger immersed therein, connected to a frame of guide rods joined together above and below the mercury cistern, which works up and down against guide wheels mounted around the cistern, the chain being attached to the bottom of the frame. The plunger has a varying ratio of displacement for successive depths of immersion, so that the scale may be open for the

smaller and compressed for the greater (and less frequent) pressures. In order to check the motion of the plunger and avoid inaccuracy in the indications, due to the momentum of the parts, the lower end of the plunger is provided with a disc fitting more or less closely to the sides of the mercury cistern, so as to prevent the too rapid passage of the mercury from one side of the disc to the other.

The frame is connected to the carriage of the marker for registering the motions of the plunger by means of a bell-crank lever. The carriage carrying the recording pencil is mounted to travel upon rollers running upon the oppositely bevelled edges of a horizontal bar and rollers running on the front and back surfaces, by which it is truly guided with the least possible friction. The markers are all metallic, sliding in sockets and pressing by their own weight or by springs on the paper. The scales for the different records are marked upon a single sheet of paper wrapped round a cylinder, rotated at a uniform speed by a clock movement in the usual manner.

As a mere anemoscope, Mr. Laughton considers that none of these elaborate contrivances excels the simple little feather vane in daily use on board our men-of-war. It is a tapering tail, 8 inches long by  $1\frac{1}{2}$  wide where broadest, made of the softest down or feathers, and tied to the top of a staff by a short thread. Let the wind blow how it will this must stream with it.

J. *Musical Anemometers* have been suggested and designed by Hooke (1667), Athanasius Kircher, Leupold (1724), and Delamanon (1782). These instruments were so constructed as to emit musical sounds when the wind blew upon them. They were scientific toys at the best.

K. *The Helicoid Anemometer*.—In the *Quarterly Journal of the Royal Meteorological Society* (vol. xiii. p. 218, 1887), Mr. W. H. Dines, B.A., F.R. Met. Soc., has a paper on a "New Form of Velocity Anemometer," which he read before

the Society on April 20, 1887. In this instrument an attempt was made to measure the velocity of the wind by the rotation of a small pair of windmill sails, the pitch of the sails being altered automatically, so that their rate may always bear the same ratio to that of the wind. These sails present what is called a "helicoid" surface (Gk. *ἑλιξ*, a *spiral*; and *εἶδος*, *resemblance*), or one which may be rotated about its axis in a

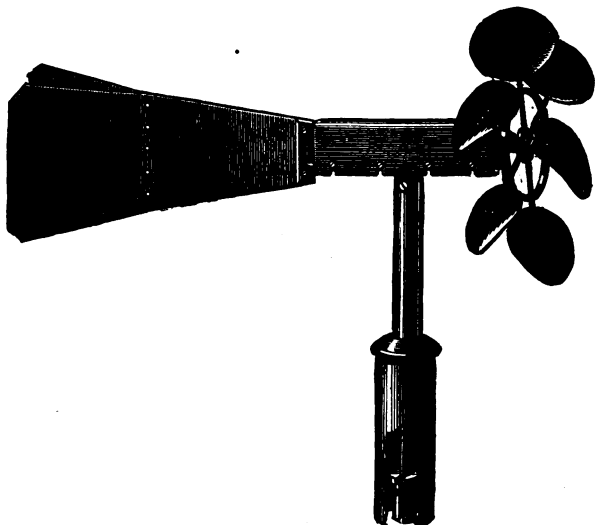

FIG. 62.—Vane of Richards' Anémo-Cinémographe.

current of air (the axis of course pointing in the direction of the current) without causing any deflection or whirl in the air passing over it.

L. *The Anémo-Cinémographe*.—On May 19, 1892, the late Mr. G. M. Whipple, B.Sc., Superintendent of the Kew Observatory, laid before the Royal Meteorological Society the results of a comparison of Richards' *Anémo-Cinémographe* with the standard Beckley Anemograph at

the Kew Observatory.<sup>1</sup> This ingenious instrument (Figs. 62, 63, 64, and 65) is a modification of the old Whewell fan, or windmill vane, the change being in the shape of each

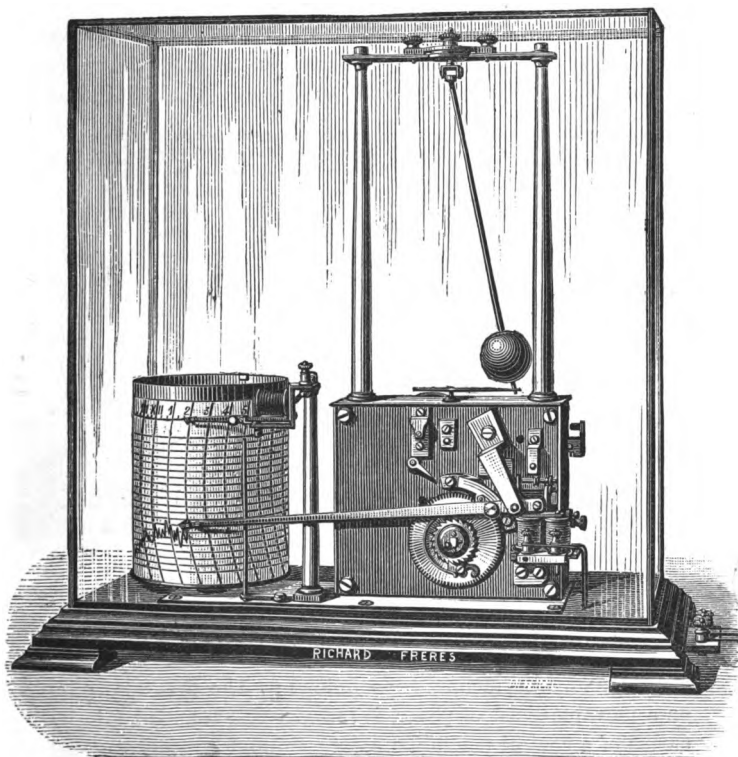

FIG. 68.—Richards' Anémo-Cinémographe.

blade of the vane, which is made oval and fitted at an angle of  $45^\circ$  to the axis. The vanes are said by MM. Richards to have been carefully calibrated. The fan is formed by six little wings or vanes of sheet aluminium, 4 inches in diameter,

<sup>1</sup> *Quart. Journ. of the Royal Met. Soc.*, vol. xviii. p. 257. 1892.

inclined at  $45^\circ$ , riveted on very light steel arms, the diameter of which is so calculated that the vane should make exactly one turn for the passage of a metre of wind (Fig. 62). Its running is always verified by means of a whirling frame fitted up in an experimental room where the air is absolutely calm, and, if necessary, a table of corrections is supplied. The recording part of the apparatus is called the *Anémo-Cinémographe*

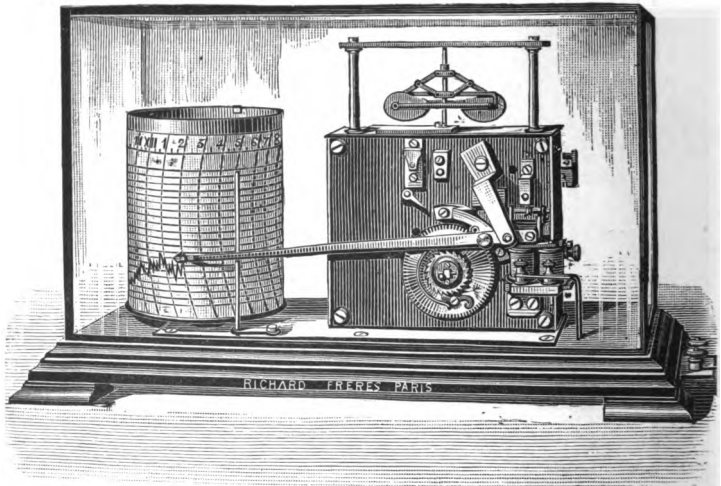

FIG. 64.—Richards' Anémo-Cinémographe (Second Form).

*graphe*, and, in principle, is as follows:—The pen, recording on a movable sheet of paper, is lowered at a constant rate by means of a conical pendulum acting through a train of wheel work, whilst a second train, driven by the fan, is always tending to force it up from the lower edge of the paper; its position, therefore, is governed by the relative difference in the velocity of the two trains of wheel work, being at zero of the scale when the air is calm, but at other times it records the rate of the fan in metres per second (Fig. 63). Fig. 64 represents another pattern of the same instrument, which,

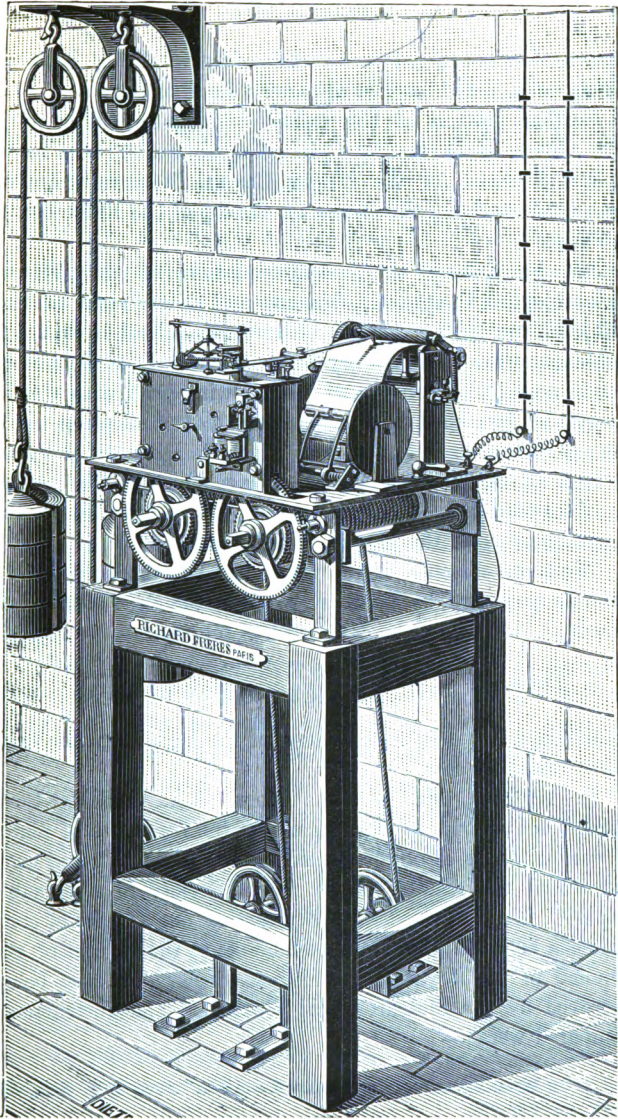

FIG. 65.—Anémo-Cinémographe in position.



however, does not record the direction of the wind, MM. Richard having constructed another apparatus for that purpose.

Another pattern of the anémo-cinémographe (Fig. 65), with endless paper running  $1\frac{1}{4}$  inches a minute, has been made by MM. Richard for the Bureau Central Météorologique of France for studying the storms on the top of the Eiffel Tower in Paris.

Notwithstanding the recommendation of the Vienna Meteorological Congress, Robinson's and Osler's anemometers still hold the field in British observatories at all events. A Robinson anemometer should be well exposed, its machinery should be kept well oiled, and the following particulars should always be furnished with a register of its indications:—1. Length of arm (axis to centre of cup); 2. Diameter of cups; 3. How the registration is effected (mechanically, electrically, or otherwise); 4. Name of maker; 5. Height above the general surface of the ground (Wm. Marriott).

The *mean direction* of the wind may be calculated by the formula proposed by Lambert towards the close of the last century. It is given by Mr. Scott as follows:—

$$\tan \phi = \frac{E. - W. + (N.E. + S.E. - S.W. - N.W.) \cos 45^\circ}{N. - S. + (N.E. + N.W. - S.E. - S.W.) \cos 45^\circ}$$

In this equation  $\phi$  is the deviation of the mean direction from north round by east.

In 1889-90, Mr. W. H. Dines, B.A., F.R. Met. Soc., carried out a series of experiments on the resistance of plates of various forms at oblique incidences to the wind, and communicated the results to the Royal Society in a valuable paper.<sup>1</sup> Mr. Dines subsequently carried out a series of comparisons between specified anemometers at the request of the Council of the Royal Meteorological Society, the cost being defrayed by the Meteorological Council. The instruments compared were:—

<sup>1</sup> "On Wind Pressure on an Inclined Surface," *Proc. Roy. Soc.*, vol. xlviii. pp. 233-257.

- |                          |   |  |
|--------------------------|---|--|
| Velocity<br>Instruments. | { | 1. Kew Pattern Robinson Anemometer.  |
|                          |   | 2. Self-adjusting Helicoid Anemometer (Dines). This instrument is described as stated above in the <i>Quarterly Journal of the Royal Meteorological Society</i> , vol. xiii. p. 218, 1887. |
|                          |   | 3. Small Air Meter.  |
| Pressure<br>Instruments. | { | 4. Foot Circular Pressure Rate.  |
|                          |   | 5. A special modification of the Tube Anemometer.  |

The conclusions arrived at are given in a note appended to the Report of the Meteorological Council to the Royal Society for the year ending March 31, 1892 (pp. 23, 24). They are to the effect that, with proper precautions, the tube anemometer—a combination of Lind's and Hagemann's instruments—will form a most useful and convenient instrument, that the relation between pressure and velocity for a foot circular plate, and at ordinary barometrical pressure, is  $P = \cdot 003 V^2$ ; and that the factor of the Kew Pattern Robinson Anemometer is practically constant for all velocities except very low ones, that its value must lie between 2·20 and 2·00, and that there is a very great probability that it is within  $2\frac{1}{2}$  per cent of 2·10.

Mr. Dines read his paper on "Anemometer Comparisons" before the Royal Meteorological Society, on April 20, 1892. It is fully illustrated, and was published in the *Quarterly Journal of the Society* (vol. xviii. No. 83, July 1892, p. 165).

At pages 254 and 255, illustrations are given of an enlarged anemometer or anemograph, constructed by Mr. L. Casella for harbours and public observatories. In this arrangement (Fig. 54) windmill fans are added to the wind vane, causing the mean direction of the wind to be accurately indicated by means of a revolving cylinder (Fig. 55) to which paper is attached. The direction as well as velocity is continuously shown for every minute of time by means of a clock, which forms part of the instrument. The exposed part of this anemometer may be placed at any height, whilst the registering part is kept in a room or other covered place for observation.

## CHAPTER XXII

### ATMOSPHERIC ELECTRICITY

Identity of Atmospheric Electricity and that obtained from an Electric Machine—The Electroscope—The Nature of Electricity—Atmospheric Electrical Phenomena—Electrical Density, Force, and Potential—Use of the Electroscope—The Collector—The Electrometer—Coulomb's Torsion Balance—The Electrophorus—The Replenisher—The Diurnal and Annual March of Atmospheric Electricity—Its Distribution—Thunderstorms: Professor Mohn's Classification—Cyclonic and Heat Thunderstorms—Geographical Distribution of Thunderstorms.

THE identity of atmospheric electricity with that obtained from an electrical machine, foreshadowed by Dr. Wall in 1708, was finally proved by Benjamin Franklin in June 1752. His classical experiment of obtaining electricity from the clouds by flying a kite need not be referred to in detail. In a letter to Mr. Peter Collinson, F.R.S., dated Philadelphia, October 1752, Franklin describes his electric kite.<sup>1</sup> Suffice it to say that the experiment is a dangerous one. In June 1753 M. de Romas in France repeated it, using a fine wire 550 feet long instead of a string, with the result that he obtained flashes 9 or 10 feet in length, which were accompanied by a loud report. On one occasion De Romas was struck down, but not killed, by such a charge. In August of the same year, Professor Richmann, of Petersburg, lost his life during a thunderstorm. He approached the end of the conducting wire, when a ball of fire apparently leaped to his head, killing him on the spot.

<sup>1</sup> *Philosophical Transactions*, vol. xcv. p. 565. 1752.

Lemonnier proved, by means of insulated metal rods, that the atmosphere is charged with electricity even in fine weather. Volta and De Saussure, subsequently, each constructed an instrument called an *electroscope*, for collecting atmospheric electricity and demonstrating its effects. In De Saussure's electroscope the electricity conducted from a rod to two little pith balls suspended by fine wires in a glass case caused them to diverge from one another. Alessandro Volta of Pavia substituted two blades of straw an inch long for the pith balls. The most delicate of all electroscopes is that which is called the "gold-leaf electroscope."

Before, however, I attempt to describe the chief electrical phenomena in nature, it will be desirable to draw attention to certain rudimentary facts relating to the nature of electricity. These are admirably summarised in the following sentences taken from an address on "Atmospheric Electricity," delivered before the Royal Meteorological Society on March 21, 1888, by the late Dr. W. Marcet, F.R.S., then President of the Society.<sup>1</sup>

"Like *heat*," says Dr. Marcet, "electricity is the manifestation of a peculiar condition of a body, and bodies are said to be *electrified* when after having been rubbed, or placed in communication with an electrified object, they exercise an attraction or repulsion, more or less great, upon other light bodies. On inquiring into this phenomenon, it is found that the *electricity* developed by friction from different substances, such as *glass* on one hand, and *sealing-wax* on the other, is not identical, and that there are consequently two electricities varying from each other in some of their characters. It may be said in a general way:—

"1. That there is an attraction between an electrified body and another not electrified.

"2. That there is an attraction between two bodies electrified, the one by a rubbed glass rod, the other by a rubbed stick of sealing-wax, or of some resinous substance.

<sup>1</sup> *Quart. Journ. of the Royal Met. Soc.*, vol. xiv. p. 197. 1888.

“3. That there is a repulsion between two bodies, both of which are electrified either by glass or by sealing-wax.

“To put these laws of nature more clearly, electricities of different kinds attract each other, and electricities of the same kind repel each other.

“In order to distinguish between the two kinds of electricity, the one is called *vitreous* electricity, from its being generated from glass, and is known as *positive*, while the other is called *resinous* electricity, and is known as *negative*.”

Atmospheric electricity may, from time to time, reveal its presence by very unequivocal phenomena, of which the chief are—(1) Thunder and lightning, (2) hailstones, (3) aurora—the aurora borealis being peculiar to the northern hemisphere, the aurora australis to the southern.

But apart from these manifestations, observations should be made upon the electricity existing in the air under ordinary circumstances, so as to determine, firstly, whether it is positive or negative; secondly, what is its intensity or tension.

In a Report on Atmospheric Electricity, drawn up at the request of the Permanent Committee of the First International Meteorological Congress at Vienna, and published by the Meteorological Council in 1878, Professor J. D. Everett, M.A., Queen's College, Belfast, observes that in discussions relating to the electrical condition of the air at a specified point, three things must be carefully distinguished: electrical density, electrical force, and electrical potential.

(a) The electrical *density* at a point in the air is the quantity of electricity, per unit volume, with which the air at the point is charged.

(b) The electrical *force* at a point is the force with which a unit of positive electricity would be acted on, if brought to the point without altering, by its inductive action, the previously existing distribution.

(c) The electrical *potential* at a point is the work which

would be done by electrical force upon a unit of positive electricity passing from the point to the earth, the movement of this unit being supposed not to disturb the pre-existing distribution.

In Mr. R. H. Scott's *Instructions in the Use of Meteorological Instruments*<sup>1</sup> concise information as to the apparatus used in researches on atmospheric electricity will be found. From that source chiefly the following is culled :—

1. The *electroscope* is intended to show the *nature* or *kind* of electricity present in the air. By far the most sensitive instrument for this purpose is the gold-leaf electroscope, in which electricity collected from the neighbouring atmosphere is made to act through a metal rod, called a conductor, upon two delicate gold leaves suspended at the end of the rod and applied closely to each other. The leaves, when brought under the influence of the same kind

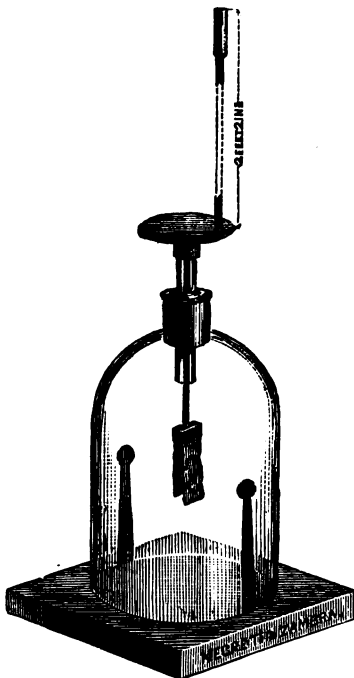

FIG. 66.—Gold-leaf Electroscope.

of electricity, will diverge or repel each other. As very little electricity can be observed near the ground, the conductor should be placed in contact with the air at some height above the earth's surface, by means of a—

2. *Collector*.—This may be a metallic arrow tied to one

<sup>1</sup> Reprinted, p. 60 *et seq.*, 1885. London : E. Stanford.

end of a conducting string and then shot upwards into the air. The electroscope will be found electrified as the arrow mounts. A gilded fishing-rod may be substituted as a conductor, its lower end being *insulated*, that is, surrounded by a non-conductor such as caoutchouc.

Volta's collector is a flame burning at a height, either in a lantern hung to a mast and connected with the electroscope by a wire, or in the form of a slow burning match attached to the top of a long metal rod. The electricity of the air, in the neighbourhood of the flame, by its inductive action on the conductor, causes electricity of the opposite kind to accumulate at the upper extremity, whence it is constantly carried off by the connection currents in the flame, leaving the conductor charged with electricity of the same kind and potential as the air.

It is necessary again to explain that the term *potential*, as applied to electricity, means the energy of an electrical charge measured by its power to do work ; it is electro-motive force. "When one body is charged with electricity to a higher potential than another, electricity tends to pass off, so as to equalise the potential on the two bodies" (R. H. Scott).

Mr. Scott says that "when we speak of the motion of the electricity from one body to another, we say that this is effected owing to difference of potential." He adds : "Difference of electric potentials may very well be termed 'difference of electric heights.'"

The water-dropping collector, invented by Sir William Thomson, now Lord Kelvin, Professor of Natural Philosophy in the University of Glasgow, is on the same principle as Volta's method. A copper can is placed on an insulating support, either of ebonite with its surface thinly coated with paraffin, or of glass surrounded with pumice-stone impregnated with sulphuric acid. From the can a small pipe projects far into the air and terminates in a fine jet. The can being filled with water, and the tap which opens into the jet being turned on, a small stream of water is allowed to flow out *guttatim*,

in drops. In half a minute the can is found to be electrified to the same extent and in the same way as the air at the point of the tube.

This collector cannot be employed in frost, for the water freezes in the jet. At such times the use of a slow burning match, made of blotting paper, steeped in a solution of nitrate of lead, dried and rolled, is recommended by Lord Kelvin.

Since electrical density is greater on projecting surfaces and less on hollow surfaces than on planes, the collector should not be near trees, or houses, or within a closed space.

3. *Electrometer*.—This is an instrument which is intended to measure the *amount* of electricity, or the electric intensity, tension, or potential. The earliest electrometer was Coulomb's Torsion Balance, by means of which one of the principal laws of electricity was discovered—that two electrified bodies, whose size is very small in comparison with their distance apart, attract or repel each other with a force proportional to the inverse square of the distance which separates them. Lord Kelvin has designed two kinds of electrometer—(1) the Quadrant Electrometer for observatory use; (2) the Portable Electrometer.

In the Quadrant, or modified Divided-Ring, Electrometer, a needle of thin sheet aluminium, cut so as to resemble in form a figure "8" with the hollows filled in, and carrying above it a small light mirror weighing only a fraction of a grain, is suspended from its centre by two fine silk threads, the distance between which can be varied at will. The needle swings horizontally inside a shallow cylindrical brass box, which is cut into four equal segments or quadrants, each insulated separately by glass supports, but connected alternately by thin wires. Each pair of quadrants is also connected to a stiff wire passing through the case of the instruments, to form the two electrodes, or terminals, for the attachment of the collecting and earth wires.

The base of the electrometer contains a Leyden jar, partially



filled with strong sulphuric acid, and a platinum wire, hung from the lower surface of the needle, is made to dip into the acid.

A lamp and a divided scale are placed about a yard in front of the instrument, and the light shining through an aperture in the frame of the scale is reflected by the mirror on the scale, where the position of the image of a wire stretched across the hole can be accurately observed.

In order to make use of this electrometer the needle must be charged with electricity from a small electrophorus or electricity-bearer, brought into contact with a wire (charging electrode) dipping into the sulphuric acid at the bottom of the Leyden jar. One of the electrodes connected with the segments is then joined by a wire to the water-dropping collector; the other is placed in communication with the earth through a wire attached to a gas-pipe, or similar conductor. The needle will then be deflected towards either one side or the other, according as the electricity of the atmosphere is of the nature to repel or attract it, and the extent of repulsion, as measured on the scale, is proportional to the amount of difference of potential between the atmospheric and terrestrial electricities.

To secure that the needle shall remain fully charged, an auxiliary apparatus for the generation of electricity, termed a *replenisher*, is fixed inside the case, by turning which the charge can be restored to its original potential. This is indicated by a small gauge consisting of a light lever, made of thin aluminium, and fixed to the top of the instrument. One end of this gauge carries an index which moves in front of a small scale. The other end is flattened into a plate of about a square centimetre in area, which is repelled by another plate, similarly electrified, fixed to the top of the instrument, and in metallic connection with the sulphuric acid of the Leyden jar, so as to be charged to the same potential as the indicating needle. The position of the index being therefore once determined, it is easy, by giving a few

turns to the replenisher, at least once daily, to bring the potential of the charge of the instrument up to its original value.

The scale value of each electrometer must be experimentally determined by means of a galvanic battery of constant intensity such as Daniell's. Knowing the electro-motive force of the cell employed in the battery, the indications of

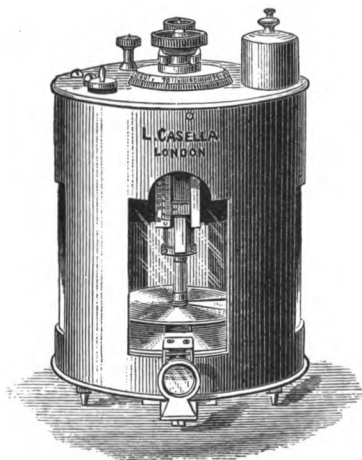

FIG. 67.—Thomson's Portable Electrometer.

the electrometer scale may be converted into terms of the absolute unit of electro-motive force or "volts."

If the electrometer is used as a self-recording instrument, a drum carrying photographic paper, and maintained in rotation at a uniform rate by a chain of clock-work, is substituted for the divided scale, and the aperture is reduced so as to form a mere dot of light on the cylinder.

Thomson's quadrant electrometer was used, in conjunction with a water-dropping collector, for photographically recording atmospheric electricity at the Kew Observatory from 1874 to 1885. It has been in use at the Royal Observatory, Greenwich, since 1877. The instrument was

described, with illustrations, in the *British Association Report* for 1867, p. 489.

In Lord Kelvin's Portable Electrometer (Fig. 67) the electricity is collected by means of a burning fuse at the extremity of a vertical wire. An illustrated description of it is given in the *British Association Report* for 1867, p. 501.

Another electrometer which is highly recommended is Peltier's. It was used for more than thirty years by the late M. Quetelet at Brussels, and for upwards of twenty years at Utrecht. This electrometer is described in the *Annuaire Météorologique de France*, 1850, p. 181, and in the *British Association Report*, 1849 (Transactions of Sections, p. 11).

Quetelet, according to Mr. R. H. Scott, drew the following conclusions from five years' observations with the electrometer at Brussels:—

1. The diurnal march of electricity, at a constant height above the ground, exhibits two maxima and two minima.

2. The maxima and minima of electrical tension precede by about an hour those of barometric pressure (see Chap. XV. p. 165 above). The maxima occur when temperature is either rising or falling most rapidly—8 A.M. and 9 P.M. in summer, 10 A.M. and 6 P.M. in winter. The day minimum corresponds with the period of maximal temperature and minimal humidity. The epoch of the night minimum has not been satisfactorily determined, but was referred by De Saussure and Schübler to shortly before daybreak.

3. The annual march of electricity presents one maximum in summer (June) and one minimum in winter (January).

In nature the atmosphere, whether clear or cloudy, always shows an electric reaction—it is in a state of electric tension, which increases remarkably with altitude, as has been observed by De Saussure, Erman, Quetelet, Lord Kelvin, and the Hon. Ralph Abercromby (by the last named on the Peak of Teneriffe in July and August 1878). Under a clear sky atmospheric electricity is nearly always *positive*. According to Peltier, land is always *negative* in its electrical character,

while Becquerel observed that sea-water is always *positive*. M. De la Rive holds that the positive electricity of the air is derived mainly from the sea. In these facts we gain a clue to the origin of thunderstorms and other atmospheric phenomena of an electric character.

Professor Henry Mohn, Director of the Norske Meteorologiske Institut, Christiania, has classified thunderstorms into two groups—*Heat Thunderstorms* and *Cyclonic Thunderstorms*. The former type belongs to summer and to hot climates; the latter to winter and to insular climates.

*Cyclonic Thunderstorms* are so called because they accompany deep atmospheric depressions such as traverse the North Atlantic Ocean and the north-western sea-board of Europe, especially in winter. Scarcely a gale of wind of any extreme intensity occurs without attendant electrical phenomena. Occasional flashes of sheet-lightning light up the sky over wide areas during the passage of a winter storm, and here and there sharp hail and sleet squalls, with a few vivid flashes and loud peals of thunder, are experienced. While these cyclonic thunderstorms are not so violent they are quite as dangerous as summer thunderstorms, if not more so, because in them the clouds drift at a lower level, so that the lightning is more likely to strike the ground.

*Heat Thunderstorms* are especially associated with sudden and extreme alterations in atmospheric temperature. Perhaps a cool night has been followed by a blazing sun and a light south or south-east wind. Vast quantities of aqueous vapour rise in the atmosphere as the result of rapid evaporation. Massive cumuli form, the upper edges of which become more and more dense, and appear snowy white as the sun shines upon them. These clouds are probably surcharged with positive electricity. Then a light surface current of air arises and blows *towards* the approaching cumuli, while an angry-looking lurid cloud stratum, negatively electrified, forms in the lower strata of the air, and is seen constantly to change its shape and density. Presently, the top of the piled-up

cumuli spreads out into a dense cirriform sheet, and at once thunder is heard, and rain or hail begins to fall in great quantities. With flash after flash, peal upon peal, the storm momentarily gathers strength and increases in violence. The hail and rain fall intermittently in drenching showers, and the whole sky becomes overcast, while the wind either falls light, dies down to a calm, or shifts perhaps to the opposite point of the compass in a fierce squall. The rain then lightens, the thunder and lightning become less frequent and more distant, and gradually the sky clears and the air feels cool and fresh—temperature perhaps being 10°, 15°, or even 20° lower than before the storm.

From a careful analysis of the thunderstorms of 1888 and 1889 over the south and east of England, undertaken at the instance of the Council of the Royal Meteorological Society, Mr. William Marriott, F.R. Met. Soc., arrives at the conclusion that thunderstorm formations are small atmospheric whirls—in all respects like ordinary cyclones. The whirl, which is most probably confined to a stratum of air at only a short distance from the earth's surface, not more than 4000 to 6000 feet, may vary from one mile to ten miles or more in diameter. Thunderstorms usually occur when the isobars show large areas of ill-defined low pressure containing several shallow minima, called "thunderstorm depressions," or when there is a "lane" or "trough" of low pressure between adjoining areas of relatively high pressure. Mist and fog often precede thunderstorms, which may accompany high barometer readings as well as low. On May 21, 1888, there was a thunderstorm with the barometer at 30·40 ins. On March 26, 1888, there was one with pressure below 29·00 ins. When isobars are drawn for hundredths, instead of tenths, of an inch, a number of small but distinct areas of low pressure, or cyclones, with regular wind circulation, may generally be recognised in thundery weather. These "thunderstorm depressions" often circulate round a large but shallow area of low barometer, forming secondary or

subsidiary depressions to it as a primary. At other times they travel perhaps for hundreds of miles along a direct line, the rate of progression being sometimes as much as 50 miles an hour. On May 18-19, 1888, a storm passed across England from Christchurch, Hants (8.15 P.M.), to Edinburgh (4 A.M.) and Cupar-Fife (4.5 A.M.) Similarly, on June 2, 1889, a storm travelled northwards from Wiltshire (3 A.M.) to Edinburgh (10.44 A.M.), and probably to Kirkwall, in the Orkneys (3.37 P.M.), a distance of 550 miles, at a uniform rate of 50 miles an hour.

Thunderstorms often break out over the same line of country on consecutive days, and nothing is more curious than to watch thunder-clouds springing into existence in the sky time after time above a particular place or district, as if there was a direct electrical attraction between the earth just there and the superincumbent atmosphere for the time being, and this no doubt is in reality the case. Heat thunderstorms show a diurnal and an annual periodicity. In tropical climates their periodicity is best marked. According to Arago, Jamaica is peculiarly liable to thunderstorms. From November to April the day breaks cloudless, but between 11 A.M. and 1 P.M. the mountains of Port Royal become covered with towering thunder-clouds. At the last-named hour rain falls in torrents, lightning flashes in all directions, and the crash of thunder is incessant and deafening. But the storm is quickly spent, and a brilliant evening follows. It is an old observation of Caldcleugh<sup>1</sup> that at Rio Janeiro it was customary to state in invitations whether the guests were to assemble before or after the thunderstorm, which was practically a daily episode.

Europe presents examples of both types of thunderstorms. On the Continent and in England heat thunderstorms are prevalent in the summer months, the result being that the rainfall of July and August is particularly heavy, if not

<sup>1</sup> Quoted by Daniell in his *Meteorological Essays and Observations* (First Edition, p. 335. 1823).

incessant. In Ireland, Scotland, and Norway heat thunderstorms are less frequent, while cyclonic thunderstorms are apt to occur, especially in the south-east quadrant of deep winter depressions. In Iceland thunderstorms are almost unknown in summer, whereas they frequently occur in winter. Dr. Alexander Buchan, in papers contributed to the Scottish Meteorological Society on the "Meteorology of Iceland"<sup>1</sup> and on the "Rainfall of Scotland,"<sup>2</sup> says, that during the twenty-five years, 1846-1870, thirty-one thunderstorms occurred at Stykkisholm, Iceland, in January, seventeen in February, eight in March, six in April, two in May, none in June, two in July, none in August, five in September, five in October, fourteen in November, and twenty-five in December. In the second of the two papers mentioned, Dr. Buchan shows that the thunderstorms of the north-west of Scotland belong to the cyclonic type, while those of the south-east are heat thunderstorms for the most part.

England is celebrated for its thunderstorms in summer. They are far more severe and far more frequent than those felt in Ireland. This is due to the fact that the southerly winds in front of the depressions, which the thunderstorms accompany, have crossed the sea in the case of Ireland, but land—that is France—in the case of England. The contrast of temperature between the south wind in front and the north wind behind the centre or trough of low pressure is, therefore, much greater for England than it is for Ireland. Again, the heated air rising over France is negatively electrified, while the warm sea-air in Ireland is positively electrified. There is, then, attraction between the negative electricity of the ascending current and the positive electricity of the atmosphere over England, whereas over Ireland both the atmosphere and the ascending current of warm moist air are positively electrified. Hence there is no attraction, and

<sup>1</sup> *Journal of the Scottish Meteorological Society*, New Series, vol. ii. p. 289. 1869.

<sup>2</sup> *Loc. cit.*, vol. iii. p. 251. 1873.

no electrical energy is evoked. At the same time it is true that negative electricity forecasts rain, of which there is no lack in Ireland. On the other hand, as Mr. Scott points out, a sudden development of positive electricity in wet weather is a certain sign of the sky clearing.



## CHAPTER XXIII

### ATMOSPHERIC ELECTRICITY (*continued*)

Lightning—Thunder—Varieties of Lightning: zigzag, or forked; diffused, or sheet; globular, or ball lightning—Fulgurites—Rapidity of Lightning—St. Elmo's Fire—Hail—The Aurora: how caused; its height; its colour—Ozone—Lightning-conductors.

*Lightning*, according to Professor Balfour Stewart, owes its brilliancy to the generation of heat along the path of the electric discharge so intense as to render the various constituents of the air momentarily incandescent. This generation of heat is due to the resistance of non-conductors in the air to the discharge which takes place when clouds charged with different electricities approach each other.

*Thunder* is the noise, or atmospheric vibrations, produced in the first place by the tremendous expansion due to the heat of the lightning flash, and then by an in-rush of air to fill up the vacuum so caused. Its prolonged reverberations are merely an acoustic phenomenon—an echo on a stupendous scale. When thunder is heard close at hand, it sounds first like a volley of musketry, because a separate report accompanies each zigzag movement on the part of the flash which is pursuing its uneven, if rapid, paths through masses of air of different conducting powers—moist air being a better conductor than dry air. As sound travels infinitely less quickly than light, a flash which is a mile away will be seen about five seconds before the thunder is heard.

Lightning may be described as of three kinds—(1) *zigzag* or *forked* lightning ; (2) *diffused*, *summer*, or *sheet* lightning ; (3) *globular* or *ball* lightning.

Forked lightning does not occur in nature as drawn by artists. We know this, thanks to Mr. James Nasmyth's observations communicated to the British Association in 1856. His statements have been amply confirmed by sixty photographic reproductions of lightning flashes, received by the Thunderstorm Committee of the Royal Meteorological Society in 1888, in reply to a circular sent out in June 1887. The first report of that Committee, drawn up by the Hon. Ralph Abercromby, F.R.Met.Soc., goes to show that lightning assumes certain typical forms—1. Stream lightning ; 2. Luminous lightning ; 3. Ramified lightning ; 4. Meandering lightning ; 5. Beaded or chapletted lightning ; 6. Ribbon lightning.

Flashes of forked lightning take place horizontally or vertically between oppositely electrified clouds ; or vertically between the negative earth and a positive cloud. The latter is very dangerous. But even when a living object is not in the direct path of the discharge, and so killed by the effect of the electricity on the nervous centres or muscular system, death may ensue by induction from what is called the "return shock." Suppose two clouds of opposite electricities are hovering over the earth at no great elevation. They will *induce* opposite electricities to their own in objects on the ground beneath them. A discharge now takes place between the clouds, establishing electrical equilibrium so far as they are concerned. When this takes place the induced electricity in objects on the ground disappears, causing such a nervous shock to living beings as to deprive them of life. When a telephone gong sounds during a thunderstorm, it indicates that a return-shock is taking place.

Summer or sheet lightning is the diffused flash of light which illuminates the horizon or the distant clouds when a thunderstorm is raging at a great distance from the observer,

perhaps 100 or even 150 miles away—far beyond the limits (15, or at the most 20, miles) at which thunder is audible.

Globular or ball lightning—“fire-balls”—is more persistent than forked lightning, remaining visible for several seconds, or even as long as *three minutes*, as happened at Milan in 1841 (Arago). It shows itself as a luminous sphere or ball of fire, in diameter varying from a few inches to two or three feet, which moves slowly and at last bursts with a loud report like a bomb-shell. Mr. Scott, in his *Elementary Meteorology*, adduces several instances of this rare form of lightning.

The destructive effects of lightning are twofold, mechanical and combustible. If a flash of lightning strikes a sandy soil, it fuses or vitrifies the silicious particles into a *fulminary tube* or *fulgurite* (Lat. *fulgur*, *flashing lightning*). The German term is very expressive—*Blitzröhren*, *lightning tubes*. As a matter of fact, there is no such thing as a *thunderbolt*. In a paper on “The Non-existence of Thunderbolts,” contributed by Mr. G. J. Symons, F.R.S., to the Royal Meteorological Society on March 21, 1888,<sup>1</sup> the author effectually disposes of this myth.

The lightning flash moves with inconceivable velocity. Sir Charles Wheatstone, by means of a rapidly revolving mirror, showed that the duration of a spark, 0·1 inch in length, in air at ordinary atmospheric pressure was about  $\frac{1}{24000}$  of a second. He also ascertained that its velocity along the insulated wire with which he experimented, was nearly 290,000 miles in a second—that is, half as great again as the velocity of light, 186,000 miles in a second.

Mr. R. H. Scott acknowledges, in his *Elementary Meteorology*,<sup>2</sup> his indebtedness to Mr. De la Rue for the following calculation of the potential necessary to produce a flash of lightning a mile in length. By his and Dr. Müller’s experiments (*Philosophical Transactions*, vol. clxix. p. 118) with

<sup>1</sup> *Quarterly Journ. of the Royal Met. Soc.*, vol. xiv. p. 208. 1888.

<sup>2</sup> Page 180.

his magnificent battery, the striking distance, between points, when 11,000 cells were used, the potential of each being 1.06 "volts," was 0.62 inch. This striking distance varies with the square of the number of cells employed. Then, as 1 mile = 63,360 inches, we have  $\sqrt{\frac{63,360}{0.62}} \times 11,000 = 3,516,480$  cells, as the amount requisite to produce such a flash.

*St. Elmo's Fire* is the *Castor and Pollux* of the ancients. It is an induction phenomenon, and occurs when an electrified cloud approaches a prominent or pointed obstacle like the mast of a vessel, a flagstaff, a tree-top, or a lightning-conductor. The electricity of the cloud and of the earth combine, not in a flash of lightning, but more slowly and continuously, so that a flame seems to rise from the projecting point. Cæsar noticed it after a hailstorm, and described it in the words: "Eâdem nocte legionis quintæ cacumina suâ sponte arsêrunt." The phenomenon, according to Mr. Scott, is of the nature of the "brush" discharge of the electrical machine. It has received many names, such as "St. Elmo's Fire" and "Comozants"—a corruption of "corposants"—from the Latin *corpus sanctum* (Italian, *corpo santo*). Displays of St. Elmo's Fire, accompanied by hissing or loud crackling sounds, are not uncommon at great elevations: on the top of Ben Nevis, in the Alps, and at the high-level observatory on the summit of Pike's Peak in Colorado, United States of America. Pike's Peak, 14,151 feet above the sea, was until lately the highest observatory in the world.

*Hail* is intimately related to atmospheric electricity, as was stated in Chapter XX. (p. 240). Professor Colladon, of Geneva, considers that the heavy rainfall preceding a hailstorm causes a strong downward current of air; which induces by suction a partial vacuum in the upper clouds. At once a fall of temperature takes place accompanied by a sudden reduction of vapour tension, which causes a condensation of moisture into frozen particles. These are alternately attracted and repelled by intensely electrified masses of cloud, thus increasing

rapidly in size until they become so heavy that they fall to the ground as hailstones. M. Colladon supposes that the cloud masses become strongly electrified through the agency of lateral up-draughts of air caused by the central down-draught from the shower of rain preceding the hailstorm. It will be observed that this theory closely agrees with the views of Volta as to the formation of hail referred to in Chapter XX. (p. 240).

*Aurora.*—This electrical phenomenon is rarely seen in low altitudes or at the equator. It is a luminous appearance in the northern sky (*Aurora borealis*), or in the southern sky (*Aurora australis*), and assumes most frequently the aspect of an arch of light above a "dark segment" of sky at right angles to the magnetic meridian, from which arch bright rays or luminous pillars called *streamers* shoot up with a wavy, quivering motion towards the magnetic zenith. According to Professor Loomis, in America the aurora borealis appears most frequently between latitude 50° and latitude 62° north. In Europe and Asia the auroral region is situated farther north than in America—the region of maximal frequency lying between the parallels of 66° and 75°. In fact, the aurora is seen oftenest within an oval zone surrounding the north pole, the central line of which zone crosses the meridian of Washington in latitude 56° north, and that of Petersburg in latitude 71° north. Auroral displays are therefore more common in America than in Europe. The shape of this auroral zone bears some resemblance to the line of equal magnetic dip as well as to a "magnetic parallel"—that is, a "line everywhere perpendicular to a magnetic meridian." Professor Loomis thinks it probable that an auroral display round the north magnetic pole of the earth is uniformly attended by a simultaneous display round the south magnetic pole. That a connection exists between the aurora and terrestrial magnetism is proved by the extreme agitation of the magnetic needle during an auroral display. In a note, further, on the relation between sun-spots and weather,<sup>1</sup> Mr. R. H. Scott

<sup>1</sup> *Elementary Meteorology*, Appendix V. p. 392. 1883.

points out that modern observations show that the appearance of an unusually large spot on the sun's surface is almost invariably accompanied by a "magnetic storm" felt simultaneously in all parts of the globe. When such magnetic storms occur, brilliant displays of the aurora usually take place—the aurora thus also exhibiting a periodicity allied to that of sun-spots, which show epochs of greatest frequency every ten or eleven years. The last epoch of this kind fell in 1891-92.

In his presidential address on "Atmospheric Electricity," delivered at the meeting of the Royal Meteorological Society, March 21, 1888,<sup>1</sup> Dr. W. Marcet, F.R.S., says that the aurora borealis is now generally considered to be due to positive electricity from the sea between the tropics being carried into the upper atmospheric regions, and thence wafted to the poles by the higher aerial currents. In the vicinity of the poles it descends towards the earth and meets the terrestrial negative electricity in a rarefied atmosphere. Luminous discharges then take place, their brightness being increased by the presence of masses of ice-particles in the atmosphere. These phenomena occur in the neighbourhood of what are called the North and South Magnetic Poles, and from this circumstance assume the form of bands so peculiar to these auroræ.

Researches carried out by Messrs. De la Rue and Müller<sup>2</sup> go to prove that the aurora may appear at any height between a few thousand feet and 80 to 100 miles. Experiments made with M. De la Rue's battery of 11,000 cells established the interesting fact, that the colour of the discharge with the same potential varied with, and was apparently determined by, the tenuity of the gas or air. The authors give the following table of the pressures at which they actually obtained discharges, represented by the corresponding calculated heights, and also of the tints at each height:—

<sup>1</sup> *Quarterly Journ. of the Royal Met. Soc.*, vol. xiv. p. 207. 1888.

<sup>2</sup> *Proceedings of the Royal Society*, vol. xxx. p. 332.

Height in Miles.	Tint.	Height in Miles.	Tint.
81·47	Pale and faint	27·42	Carmine
37·67	Maximal brilliancy	17·86	„
33·96	Pale salmon	12·42	„
32·87	Salmon coloured	11·58	Full red
30·86	„ „		

The roseate and salmon-coloured tints are always near the positive source of the electric or magnetic current. The discharge at the negative terminal, in air, is always of a violet hue, and, accordingly, this tint in the aurora indicates the proximity of the negative source.

*Ozone.*—In 1785, the Dutch physicist, Van Marum, while passing a succession of electric sparks from a powerful electric machine through a tube containing oxygen, was attracted by a peculiar odour which developed in the oxygen, and which he attributed to the “electric matter,” calling it accordingly the “smell of electricity.” In 1840, M. Schönbein, of Basle, named the substance which gave rise to this odour *ozone*, from the Greek  $\delta\zeta\omega$ , *I have a smell*. His views as to the exact nature of ozone passed through several phases. At first he thought it was an element analogous to the halogen group—chlorine, bromine, iodine, and fluorine. Then he considered the possibility of its being a constituent of nitrogen, or a higher oxide of hydrogen, because he found that it could also be produced by the action of phosphorus on moist air (1845). Lastly, in 1852, he came to the conclusion, with other observers, De la Rive and Marignac, that ozone is really oxygen in an *allotropic* state, just as diamond is an allotropic form of carbon, coke or charcoal being the usual forms of this latter element.

This view was fully confirmed by the experimental researches of Dr. Andrews in 1856. He proved that ozone was really an allotropic form of oxygen, and that it was

identical in its nature by whatever process it was prepared. Andrews also demonstrated that ozone can be turned back into oxygen by exposing it to high temperatures (300° C.).<sup>1</sup>

In 1858, Schönbein started a new and plausible hypothesis. He announced that ordinary oxygen was a neutral combination of two oppositely electrical and therefore very active bodies. One of these was ozone, or *negative oxygen*, which was formed during the electrification of oxygen or air, the electrolysis of water, the slow oxidation of phosphorus, and the decomposition of most metallic peroxides. He called those substances which evolved this kind of oxygen *ozonides*. The other, the *positive oxygen*, or *antozone*, he failed to isolate, but he assumed its existence in a certain class of peroxides, which he called *antozonides*, examples being the peroxides of hydrogen and barium in particular, also the so-called ozonised turpentine, cod-liver oil, and ether. This ingenious theory was demolished in 1863 by Sir B. C. Brodie.

In 1860, Andrews and Tait presented a very important communication on the subject of ozone to the Royal Society. These observers, in the first place, confirmed a previously known fact that only a small proportion of oxygen (*one-twelfth*, at most) can be converted into ozone by the electric discharge. But they also found that a constant and considerable diminution of volume accompanied the change—one hundred volumes of oxygen, subjected to the silent discharge, contracting to ninety-two volumes. Hence ozone must be denser than oxygen. Nor was this all, for when mercury, or some other oxidisable substance, was introduced into the ozonised oxygen, and the ozone entirely absorbed, the residual oxygen had precisely the same volume as it had before the removal of the ozone, so that the density of ozone appeared to be absolutely infinite.

Dr. Odling suggested that the formation of ozone might really consist in the condensation of another atom of oxygen into each diatomic or dyad molecule of ordinary oxygen.

<sup>1</sup> *Philosophical Transactions of the Royal Society*, 1856.



The chemical formula for free oxygen being  $O_2$ , that for ozone would, therefore, be  $O_3$ ; and the density of ozone would be one-half greater than that of oxygen. When 100 volumes of oxygen were reduced by ozonisation to ninety-two, it might be supposed that eight volumes of oxygen combined with sixteen volumes of oxygen to produce sixteen volumes of ozone. The reaction might be represented in this way—

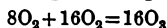

The absorption of the ozone by the mercury, or iodine, etc., might really be only the removal of the third atom of oxygen, which would, of course, leave the volume unaltered—

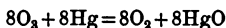

The same view would account for the mutual reduction which ozone and hydrogen dioxide exercise upon one another, and in fact for all known reactions of ozone—

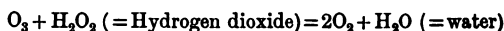

This beautiful hypothesis received a remarkable experimental verification at the hands of M. Soret,<sup>1</sup> who succeeded in finding a body, oil of turpentine, which, instead of removing *only one atom* of oxygen from each molecule of ozone, as most substances do, *absorbs the entire molecule, the whole three atoms of oxygen*. To take our previous illustration, if the ninety-two volumes of ozonised oxygen were treated with oil of turpentine, a dense white cloud would appear, the ozone would vanish, but instead of the volume remaining the same it would contract to seventy-six volumes, the  $16O_3$  having been removed bodily instead of being merely reduced to  $16O_2$ .<sup>2</sup>

A great number of experiments have given the atomic weight of ozone as twenty-four, and consequently its molecular weight as forty-eight. This is just the weight of three atoms of oxygen, namely,  $16 \times 3 = 48$ , of which, accordingly, it is now universally believed to be composed.

<sup>1</sup> *Comptes Rendus*, November 27, 1865.

<sup>2</sup> *Medical Times and Gazette*, October 5, 1867, pp. 383, 384.

Mr. Francis E. Twemlow, F.M.S., in a paper on ozone, read before the British Meteorological Society on March 17, 1875, indicates the chief points of difference between ozone and ordinary oxygen :—

1. It liberates iodine from iodide of potassium.
2. It oxidises rapidly the precious metals.
3. It destroys vegetable colours.
4. It possesses a remarkable smell, like weak chlorine, whilst oxygen is odourless.

Ozone bleaches most vegetable colours, and is a strong oxidiser, and so it may be called “nascent” or “active oxygen.” The latter fact probably affords the real clue to the supposed connection between an absence of ozone in the atmosphere and outbreaks of cholera, dysentery, and other like diseases. Their relation attracted the attention of M. Quetelet in Belgium, and of M. Andrand, of Paris, in the cholera outbreak of 1849. According to Glaisher, Moffat, Hunt, and others, the occurrence of cholera and choleraic diarrhoea is coincident with an absence or diminution of ozone, and their departure with a return of ozone (C. B. Fox, M.D.<sup>1</sup>). On the other hand, Dr. Moffat remarks that “the prevalence of influenza, and the spread of catarrhal affections, are invariably connected with an excess of ozone in the atmosphere.” The fact is that ozone irritates the mucous membranes, and so has been credited with producing epidemic catarrh.

Although colourless in its gaseous form, ozone appears as a blue fluid when liquefied by cold and pressure. It decomposes a solution of iodide of potassium and sets free iodine, which gives a blue coloration when brought into contact with a solution of starch. Ozone test-papers are strips of blotting paper or filter paper steeped in a solution of potassic iodide and starch. When moistened and exposed to an ozone-laden atmosphere such test-papers turn blue.

Testing for ozone is even still in an unsatisfactory state.

<sup>1</sup> *Ozone and Antozone*. London: J. and A. Churchill. 1873.

Any other oxidising agent in the air, such as hydrogen dioxide or nitric acid, will reduce the potassic iodide, so that the test given above is open to serious fallacy. Dr. Cornelius B. Fox, who has paid particular attention to this question in his work on *Ozone and Antozone*,<sup>1</sup> says that, if we wish to ascertain the amount of ozone present in the air to the exclusion of the other air purifiers, we employ a paper which is *alone* acted upon by ozone, such as the iodised litmus paper. With this test, we do not take any notice of the amount of iodine set free, but we observe the amount of potash formed by the union of the ozone with the potassium. Potash, being an alkali, has the property of turning red litmus blue. The greater or less conversion of the red litmus into blue shows a greater or less quantity of ozone in the air.

*Lightning-conductors.*—B. Franklin devised the lightning-rod, or lightning-conductor, which is now universally adopted. The principle of the lightning-conductor (Fr. *paratonnerre*; German, *Blitzableiter*) is that electricity selects the better of two conducting passages, and that when it has got a sufficient conducting passage it is disarmed of all destructive energy. A lightning-conductor is a metallic rod, usually of galvanised iron or of copper, which terminates above in one or more sharp points, and below in *moist* earth or in a sufficient expanse of water. This metallic rod, when placed on a building or on the mast of a vessel, protects it by affording a ready passage to the electricity of the earth into the atmosphere, so establishing electric equilibrium gradually and silently. As Mr. R. H. Scott well observes,<sup>2</sup> “The action depends on what is called the ‘power of points.’ The electricity on a sphere is uniformly distributed over the surface; on an oval figure it tends to accumulate at the ends. On a cylinder this tendency is more strongly developed, and, when the cylinder becomes a fine wire, the tension is so great at

<sup>1</sup> Page 168. London: J. and A. Churchill. 1873.

<sup>2</sup> *Elementary Meteorology*, p. 183.

the end that the electricity soon forces its way into the surrounding air and escapes."

A lightning-conductor consists of three parts : the pointed rod, overtopping the building ; the conductor, or part connecting the top with the ground ; and the part in the ground. In a very able paper, entitled "Remarks on some Practical Points connected with the Construction of Lightning-conductors,"<sup>1</sup> the late Dr. Robert J. Mann, F.R.A.S., President of the British Meteorological Society, laid down the indispensable conditions for an efficient lightning-conductor as follows :—1. The lightning-conductor must be made of good conducting material metallically continuous from summit to base, and of a dimension that is sufficient for the ready and free conveyance of the largest discharge that can possibly have to pass through it. 2. It must have ample earth-contacts, and these contacts must be examined frequently, to prove that they are not getting gradually impaired through the operation of chemical and electrical erosion. 3. It must terminate above in well-formed and well-arranged points, which are fixed and distributed with some definite regard to the size, form, and plan of the building. 4. There must be no part of the building, whether it be of metal or of less readily conducting material, which comes near to the limiting surface of a conical space, having the highest point of the conductor for its apex, and having a base twice as wide as the lightning-conductor is high, without having a point projecting out some little distance beyond, and made part of the general conducting line of the lightning-rod by a communication with it beneath. 5. There must be no mass of conducting metal, and, above all things, no gas-pipe connected with the main, within striking distance of the lightning-rod, lest at any time either the points or the earth-contacts shall have been so far deranged or impaired as to leave it possible for discharges of high tension, instead of continuous streams

<sup>1</sup> *Quarterly Journal of the Meteorological Society*, vol. ii. p. 417. 1875.

of low tension, to pass through the rod, and to be diverted from it into such undesigned routes of escape.

The Meteorological Society about twelve years ago organised a conference of delegates from various scientific and professional societies to examine into the whole question of lightning-conductors, and the conference drew up a code of rules<sup>1</sup> very much on the lines indicated by Dr. Mann in his paper published in 1875. The chief matters to be attended to are these:—(1) The point of the upper terminal should not be sharp, not sharper than a cone of which the height is equal to the radius of its base. All points should be platinised, gilded, or nickel-plated so as to resist oxidation. (2) Rods should be taken down the side of the building most exposed to rain, and held firmly but not too tightly by hold-fasts, so as to allow of contraction and expansion by changes of temperature. (3) The rod should consist of copper, weighing not less than 6 oz. per foot-run, and the conductivity of which is not less than 90 per cent of that of pure copper, either in the form of tape or rope of stout wires, no individual wire being less than No. 12 B.W.G. Iron may be used, but should not weigh less than  $2\frac{1}{4}$  lbs. per foot-run. (4) Although electricity of high tension will jump across bad joints, they diminish the efficacy of the conductor; therefore, every joint, besides being well cleaned, screwed, scarfed, or riveted, should be thoroughly soldered. (5) Iron rods should be painted, whether galvanised or not. (6) The rod should not be bent abruptly round sharp corners. (7) As far as practicable, it is desirable that the conductor should be connected to extensive masses of metal, such as hot-water pipes, both inside and outside the building; but it should be kept away from all soft metal pipes, and from internal gas-pipes of every kind. (8) It is essential that the lower extremity of the conductor should be buried in permanently damp soil, hence proximity to rain-water pipes and to drains is desirable.

<sup>1</sup> *Report of the Lightning-rod Conference*, 16 pp. London: Spon. 1882.

It is a very good plan to make the conductor bifurcate close below the surface of the ground, and adopt two of the following methods for securing the escape of the lightning into the earth :—A strip of copper tape may be led from the bottom of the rod to the nearest gas or water *main*, not merely to a lead pipe, and be soldered to it ; or a tape may be soldered to a sheet of copper 3 feet  $\times$  3 feet and  $\frac{1}{16}$  inch thick, buried in permanently wet earth, and surrounded by cinders or coke ; or many yards of the tape may be laid in a trench filled with coke, taking care that the surfaces of copper are, as in the previous cases, not less than 18 square feet. Where iron is used for the rod, a 'galvanised iron plate of similar dimensions should be employed.

A lightning-conductor should be kept away from a gas-pipe, because if there was any defect in the connections, an electric discharge of high potential might cause a spark and so ignite the gas.

## PART III.—CLIMATE AND WEATHER

### CHAPTER XXIV

#### CLIMATE

Meaning of the term "Climate"—Definition of Climate—Accumulated Temperature—Effect of Temperature on the Animal and Vegetable Kingdoms—Principal Factors of Climate: Latitude, Altitude, Relative Distribution of Land and Water—Presence of Ocean Currents.

In his work on *Elementary Meteorology*, Mr. R. H. Scott, F.R.S., observes<sup>1</sup> that the old division of the world by Parmenides<sup>2</sup> into five zones—a central torrid zone, northern and southern temperate and frigid zones—has been found to be quite inadequate as a representation of the climatology of the globe.

In its original and stricter etymological sense the word *climate* (Gk. κλίμα, a *slope* or *inclination*) was applied to one of a series of regions or zones of the earth running parallel to the equator, from which the earth's surface was supposed to slope to the poles, hence the Latin rendering of κλίμα, *inclinatio cæli*.

According to this view, put forward by Claudius Ptolemy, the author of the *Ptolemaic System of the Universe* (A.D. 120-149), climate was determined solely by latitude, and one

<sup>1</sup> At p. 338.

<sup>2</sup> Of Elis. Flourished *circ.* B.C. 430.

climate differed from another only as regards the relative length of the midsummer day and the relative altitude of the noon-tide sun. As a matter of fact, latitude is only one, and that, as we shall see presently, by no means the most important, factor in the determination of climate.

We may define climate as the condition of a country, district, or place, in relation to certain meteorological elements—notably, air temperature, atmospheric pressure and wind, atmospheric moisture and electricity—viewed more particularly in their effects upon animal or vegetable life. It is these effects which determine the distribution of a fauna or of a flora in a given region of the globe. Mr. Scott points out<sup>1</sup> that the distribution of the plants of most importance to mankind, such as the cereals, depends chiefly on the summer temperature, while the distribution of animals is more dependent on the winter temperature. For example, the district of Manitoba in Canada yields magnificent crops of wheat, although its winter temperature often falls far below zero of the Fahrenheit scale. Maize again succeeds well in extreme climates, the summer season alone being sufficient for its whole life. On the other hand, plants, which, so to speak, are *alive throughout the year*, like the fuchsia, the laurel, or even the hawthorn, would perish in the bitter winter of the “Canadian North-West,” although they flourish in climates like that of the British Islands, where the fate of a wheat crop trembles yearly in the balance and where maize entirely fails to grow.

In connection with this topic, attention has already been drawn to the estimation of accumulated temperature, or warmth available for agricultural purposes, expressed in “day-degrees” (see Chapter IV. p. 33). It may be well to repeat that a “day-degree” signifies 1° continued for twenty-four hours, or any other number of degrees, for an inversely proportional number of hours, the term “accumulated temperature” indicating the combined amount and duration of an

<sup>1</sup> *Elementary Meteorology*, p. 338. 1883.



excess or defect of temperature above or below 42° F. for the period named.

Animals can bear a greater range of temperature than plants, and so their territorial distribution is more extensive than that of individual members of the vegetable kingdom. As Mr. Scott puts it: "The distribution of animals is more dependent on the winter temperature."

Climate depends chiefly on (1) distance from the equator, or latitude; (2) physical configuration of the surface; (3) elevation; (4) nearness, or otherwise, of oceans; (5) prevailing winds. In his Lumleian Lectures on "Aëro-therapeutics in Lung Disease," delivered before the Royal College of Physicians of London in 1893, Dr. C. Theodore Williams, M.A., F.R.C.P., gives the principal factors of climate as follows:—

1. *Latitude*—Naturally the greatest influence as describing the position of the sun towards the earth in a certain region, and thus determining the length and intensity of sunshine.
2. *Altitude*—By which the effects of latitude may be to some extent neutralised, for even in the Tropics, at a height of 16,000 feet, snow and ice may exist, the temperature falling in ascending mountains 1° F. for every 300 feet.
3. *Relative Distribution of Land and Water*, and especially the presence of vast tracts of either desert or ocean; the former accentuating extremes of temperature, and the latter tempering them.
4. *Presence of Ocean Currents*, flowing from higher or lower latitudes (as the case may be) and thereby qualifying the climate.
5. *Proximity of Mountain Ranges*, and their influence on the shelter from wind and on the rainfall.
6. *Soil*.—Its permeability or impermeability to moisture.
7. *Vegetation*.
8. *Rainfall*.—Its amount and annual distribution.
9. *Prevailing Winds*.

It will be necessary to consider these factors in more detail.

I. *Latitude*.—A writer in *Chambers's Encyclopædia* (Art. "Climate"), says: "The effect of the sun's rays is greatest where they fall perpendicularly on the surface of the earth, and diminishes as their obliquity increases; the surface which receives any given amount of the sun's rays increasing with their increased obliquity, as  $a'b'$  is greater than  $ab$  in the annexed figure, whilst at the same time the oblique rays being subjected to the influence of a greater number of particles of the atmosphere, as  $c'a'$  is longer than  $ca$ , a greater amount of their heat is absorbed before they reach the surface of the

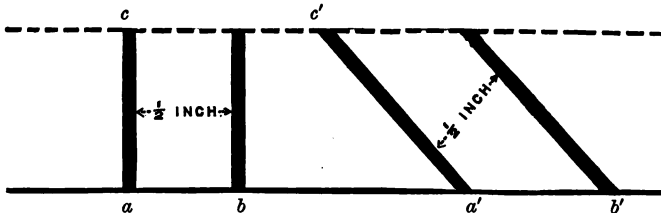

FIG. 68.—Diagram illustrating the effect of the perpendicular and the oblique falling of the Sun's rays.

earth at all. The greater or smaller extent of surface receiving a certain amount of heat, also makes important differences to arise from *exposure* by slope towards the equator or towards the nearer pole."

II. *Altitude*.—It has been already shown (see Chapter XI. p. 118) that temperature decreases with increasing elevation above sea-level, and that this is largely due to diminishing density of the atmosphere, as well as to reduced humidity. Even on the equator perpetual snow and ice are found above a certain height, and Quito, the capital of Ecuador, at an altitude of 9451 feet, enjoys an eternal spring, the mean temperature of the whole year and of every season being steady at 60° F.

The fall of temperature with altitude is not, however, uniform at all places having the same latitude. A striking example of this is met with in the climates of the Himalayan

mountains. On the southern slopes of this vast and gigantic chain the snow-line, or limit of perpetual snow, is depressed by the precipitation of large quantities of snow and rain from the moisture-laden south-west winds coming from the Indian Ocean. These winds, first chilled and deprived of their moisture, but afterwards warmed by the latent heat set free in the condensation of their vapour into rain or snow, cross the summits of the Himalayan peaks and descend towards the plains of Central Asia. Being abnormally dry, these winds have an immense capacity for both heat and moisture, and so, as they descend, they become rapidly still warmer and at the same time lick up both water and snow. The result is that the snow-line on the northern slopes of the Himalayas is at least 4000 feet higher than it is on the southern side. Strictly analogous phenomena attend the passage of a south wind across the Alps, where it is called the *Föhn*; of a south-east wind across the mountainous interior of Greenland, bringing with it comparative warmth to North Greenland and Smith Sound; and of a "nor'-wester" across the mountains of New Zealand. This last wind, taking its origin in the South Pacific, deposits its moisture on the western slopes of the New Zealand Alps, and appears in the Province of Canterbury on the east coast as a *very dry, and often a hot*, wind unaccompanied with rain. It is said that, when the *Föhn* is blowing in the Alps, the snow melts with marvellous rapidity, so that it is popularly called the "snow-devourer" (*Schneefresser*).<sup>1</sup>

III. *Relative Distribution of Land and Water*.—In our study of climate we may lay down as aphorisms—

*First*. That hot air is lighter than cold air.

*Secondly*. That the rapidity with which the processes of heating and cooling of air goes on is in direct proportion to the amount of aqueous vapour contained in that air—dry air

<sup>1</sup> For a full account of the Swiss *Föhn* wind, see a paper by Dr. Wild, now the Director of the Imperial Observatory at St. Petersburg, *Ueber Föhn und Eiszeit* (Bern, 1868).

becoming heated or cooled more rapidly and more completely than moist air, other conditions being alike.

*Thirdly.* That, consequently, the air over large areas of land, being drier, becomes more rapidly heated in summer and more rapidly cooled in winter than air which is in contact with extensive water-surfaces; and,

*Fourthly.* That the radiation-heating power of dry land is greater than that of water, as also the radiation-cooling power of dry land is greater than that of water.

This group of facts is of paramount importance in climatology. The effect of them upon the climate of the great continent of Europe and Asia has already been described in Chapter XV. (see p. 171, above).

We can, indeed, form but little idea of the enormous changes of temperature which take place in Central and Northern Asia between the seasons of summer and winter. But that these changes are sufficient to produce the great variation in barometrical pressure on which depends the varying wind-system of the continents of Europe and Asia in those seasons may be easily shown by a comparison of the range of temperature between July and January in an insular<sup>1</sup> climate like our own, and at Yakutsk in Siberia, which is situated close to the centre of lowest and highest barometrical pressures in those months respectively. At Dublin the mean temperature of July is about 60° F., of January about 40° F.—a range of only 20°. The corresponding mean temperatures at Yakutsk are 66° F. and -45° F. respectively—a range of 111°. For weeks in summer the thermometer ranges between 80° and 90° at this place, while in winter it may descend 90° below the freezing-point of water. Well does Humboldt observe :<sup>2</sup>—

<sup>1</sup> The term *Insular* and *Continental*, as applied to climate, usually signify merely that it is characterised by a small or by an extreme range of temperature respectively, without any reference to the geographical position of a place as regards the seaboard.

<sup>2</sup> *Kosmos*, vol. i. p. 352.

“The inhabitants of the countries where such *continental climates* prevail seemed doomed, like the unfortunates in Dante's *Purgatory*—

A soffrir tormenti caldi e geli.”

Or, as Milton has so admirably expressed it—

From beds of raging fire to starve in ice.

The capability of man to endure variations and extremes of temperature,” says Dr. Theodore Williams, “has been proved to be very great, for General Greely states that at Fort Conger, U.S.A., in February 1882, he experienced the low temperature of  $-66\cdot2^{\circ}$  F., and at another time, in the Maricopa Desert, Arizona, he saw noted the air temperature of  $114^{\circ}$  F., while the metal of his aneroid beside him as he rode assumed a temperature of  $144^{\circ}$  F.”

The lowest temperature recorded is  $-90^{\circ}$  F. at Werchodzansk, in Siberia, lat.  $67\cdot5^{\circ}$  N. This cold station lies in the valley of the river Jana, 330 feet above sea-level. At Poplar River, Montana, North America, the thermometer fell to  $-63\cdot1^{\circ}$  in January 1885.

The principal laws of distribution of annual range of temperature, given by Professor Supan in a paper which appeared in the first volume of Kettler's *Zeitschrift für Wissenschaftliche Geographie*, are thus summarised by Mr. R. H. Scott :—

1. The annual range of temperature increases from the equator towards the poles, and from the coast towards the interior of a continent. It is greatest— $100^{\circ}$  F. and upwards—in Siberia near Yakutsk. It is least—under  $20^{\circ}$  F.—over almost the whole of the sea surface of the globe, in South America and South Africa.

2. The regions of extreme range in the northern hemisphere coincide approximately with the districts of lowest temperature in winter. On the whole the range curves in their course resemble the isotherms of January.

3. The range is greater in the northern than in the southern hemisphere.

4. In the middle and higher latitudes of both hemispheres, with the exception of Greenland and Patagonia, the western coasts have a less range than the eastern.

5. In the interior of the continents the range, in mountainous districts, diminishes with the height above the sea.

Probably nowhere is the influence of the ocean in restricting the annual range of temperature more marked than off the extreme south-west coast of England. In the Scilly Isles the mean temperature of the sea surface ranges between  $49^{\circ}$  in February and  $61^{\circ}$  in August, that is through  $12^{\circ}$ . The mean temperature of the air is  $46.3^{\circ}$  in January and  $61.5^{\circ}$  in July—a mean annual range of only  $15.2^{\circ}$ . At Yarmouth, also *on* the sea, but not *in* the ocean, the temperature of the sea surface ranges from  $37^{\circ}$  in January to  $61^{\circ}$  in July—the mean temperature of the air being  $37.9^{\circ}$  and  $62.5^{\circ}$  in the months named—a mean annual range of  $24.6^{\circ}$ .

Perhaps no single element has a greater influence upon climate than the presence of water. Its specific heat<sup>1</sup> is only *one-fourth* that of dry land, and consequently it absorbs heat more slowly, stores up a larger amount of it, and parts with it less rapidly. Again, owing to condensation by cold, surface water, when exposed to low temperatures, sinks, and its place is taken by the deeper strata of warmer liquid. Equilibrium of temperature is thus maintained in the neighbourhood of extensive areas of water. In warm weather evaporation from water surfaces tends to cool the superincumbent air, to increase the humidity, and to fill the atmosphere with clouds. Hence the equable, cloudy, and moist climates of seaboards. Extensive lakes produce similar effects on a smaller scale. Thus, in the Canadian winter, what may be a storm of rain on the shores of Lake Superior is often a fall of snow a few miles inland. When districts of

<sup>1</sup> The *specific heat* of a substance is the number of units of heat required to raise the temperature of one pound of it by one degree.

country are partly covered with water, the climate is rendered damp and cool, for the evaporation from wet earth is much greater than that from an uniform water-surface. Under such circumstances there is reason to believe that a climate would even be improved by changing marshes or morasses into sheets of open water. Like good results often follow the carrying out of effective drainage works, and there can be no doubt that, if the water-shed of the Shannon, for example, were properly drained, the climate of the whole of Ireland would be made drier and warmer. This is a subject of vital importance to all who have agricultural interests in view, as well as to those who have regard to the public health.

In estimating the effect of water surfaces upon climate it should not be forgotten that, while fresh water attains its maximal density at  $39\cdot2^{\circ}$  F., and freezes at  $32\cdot0^{\circ}$ , sea water continues to contract until it is chilled down to  $26\cdot2^{\circ}$  F., and does not freeze above  $28\cdot4^{\circ}$ . The result is that sea water in the open will not begin to freeze on its surface until all its depths have been cooled nearly to freezing-point, whereas fresh water needs to be chilled throughout only to  $39\cdot2^{\circ}$  before ice commences to form on its surface.

Turning to the question of the influence of dry land on climate, we find that the *configuration of the surface* of the ground exercises an effect second only to that of the *amount* of land. Thus, as a rule, when the surface slopes away from the sun, the rigour of the climate is intensified. We have especially striking examples of this in North Germany, Siberia, and those parts of North America which slope towards Hudson's Bay. The converse is also true, and is exemplified in the excessive summer-heat of Northern Italy, India, and Southern China. Most winter resorts are situated on grounds having a southern, or solar, aspect. But leaving out of consideration the *direct* influence of the presence or absence of the sun's rays, the cooling of the air by terrestrial radiation is found to affect localities in very different degrees. Where the surface is uniformly level, as in the case of plains or

table-lands, radiation proceeds uniformly, and the whole district is equally chilled. If the air is calm, and the sky clear, radiation goes on rapidly, and the temperature falls. Should the sky be clouded and the air in motion, radiation is uniformly checked. The alternations in either case are similar over the whole area of level ground. In hilly or mountainous districts radiation acts as before, but the air which is cooled becomes specifically heavier, and immediately commences to flow down the mountain sides. As it is replaced by warmer air, the temperature remains comparatively high and uniform. On high ground, also, the atmosphere is seldom calm, so that radiation is usually more or less checked, and warmth is maintained. Valleys, however, experience extreme variations of temperature for two reasons—first, because the cooled air flows down into them from the surrounding high grounds; and, secondly, because, being so much shut in, they are fully exposed in the absence of wind to the influence of radiation.

Great diurnal range of temperature is a marked feature in inland districts, particularly when the earth's surface is desert or scantily dotted with vegetation. Thus at Mooltan (where the thermometer ranges yearly from 29° to 126° F. in the shade), Rawal Pindi, and other stations in the Punjab, the daily range in April and November may amount to 40°. The same state of things is observed in Egypt, on the steppes of Southern Russia, and on the prairies of North America.

IV. *Ocean Currents* of either warm or cold water modify climate in a remarkable degree. They are named according to the direction *towards which they flow*. The ameliorating effects of the presence of a vast water-surface are intensified in the case of oceans, such as the Pacific and Atlantic, in winter time, by the setting towards the Arctic and Antarctic regions of immense surface-currents of warm water. The best known of these currents is the Gulf Stream, which flows north-eastward along the western coasts of Europe, and to



which we are so largely indebted for our wonderfully mild British winters.

“Its climatic effect,” says Mr. J. Knox Laughton, M.A.,<sup>1</sup> “when stated in measures of heat, is stupendous—it is the very poetry and romance of arithmetic.” He proceeds to show that the heat brought by the Gulf Stream into the North Atlantic has been fairly estimated as not less than one-fifth of the whole heat possessed by the surface-water of that division of the ocean. Assuming, with Sir John Herschel, that the temperature of space is 239° below zero, and taking the existing temperature of the North Atlantic as 56° above zero, we find that the heat which it actually has corresponds to a temperature of 295° (namely, 239° + 56°), the fifth part of which is 59°. If, then, the fifth part of its heat—that is, the heat derived from the Gulf Stream—were taken away from it, the surface water of the North Atlantic would have an average temperature of -3° F., or 35° below the freezing-point of fresh water.<sup>2</sup> It is roughly estimated that about five billions of cubic feet of water are hourly poured through the Straits of Florida into the North Atlantic. This water has at the time an average temperature of not less than 65°, but after performing a circuit in the North Atlantic, it returns to the Tropics as an undercurrent with an average temperature not above 40°. It has imparted to the air over the North Atlantic the heat corresponding to a difference in temperature amounting to 25°. Now, the British standard measure of heat—the *thermal unit*—is the quantity of heat required to raise the temperature of 1 lb. of water by 1°, while a cubic foot of water weighs about 64 lbs. With these data, we find that the heat thrown out by the Gulf Stream every hour into the air of the North Atlantic is  $25 \times 64 \times 5,000,000,000,000$  thermal units.

But every thermal unit, according to the “Law of Equiva-

<sup>1</sup> In a lecture on “Air Temperature: its Distribution and Range” (*Modern Meteorology*, 1879. Edward Stanford. 1879).

<sup>2</sup> Croll's *Climate and Time*, p. 35, *et seq.*

lence," experimentally established by Dr. Joule, of Manchester, is capable of lifting a weight of 772 lbs. through a height of 1 foot. Consequently the heat hourly dispersed from the water of the Gulf Stream, if stored up and applied as power, would be capable of lifting each hour,  $772 \times 25 \times 64 \times 5,000,000,000,000$  lbs., through a height of 1 foot—that is, of doing the work of steam-engines having an aggregate horse-power of 3,119,000,000,000—a power equal to that of nearly 400,000,000 ships such as our largest ironclads.<sup>1</sup>

Ocean currents of *cold* water also exist. Of these the most notable, probably, is that which flows out of Baffin's Bay down the eastern shores of North America, and which is known as the American Arctic Current. Its cooling influence is felt as far south as Cape Cod in latitude 42°.

An Arctic current of far less magnitude flows into the North Pacific through Behring's Straits. It chills the air over Kamchatka and Japan in the summer season, throwing the isotherms over the North Pacific into remarkable loops in July, when the current is strongest owing to the melting of the polar ice. In the southern hemisphere, the oceanic polar currents form a still more striking feature in the physical geography. According to Sir F. Evans,<sup>2</sup> all the surface water between the Antarctic Circle and the parallel of 45° S. seems to drift northwards and eastwards, causing the isotherms on the western coasts of America, Africa, and Australia to dip down towards the equator (R. H. Scott). The best known of these currents is the Peruvian, or Humboldt's current, which washes the west coast of South America. Mr. Scott also points out that the influence of the Antarctic Atlantic current on the west coast of Africa is such that the temperature of the sea near Cape Town is sometimes 20° lower than in the corresponding latitude on the eastern side of the continent.

<sup>1</sup> Croll's *Climate and Time*, p. 25.

<sup>2</sup> *Brit. Assoc. Report*, 1876, p. 175.

## CHAPTER XXV

### CLIMATE (*continued*)

Proximity of Mountain Ranges, Soil, Vegetation, Rainfall, Prevailing Winds—Cold Winds: East Wind of Spring in the British Isles, Mistral, Tramontana, Nortes of Gulf of Mexico, Pampēras, Tormentos, Etesian Winds—Hot Winds: Scirocco, Solano, Leveche, Harmattan, Khamseen, Simoom, Hot Wind of Australia, Föhn, Leste.

V. *Proximity of Mountain Ranges.*—Dr. Alex. Buchan, in his *Introductory Text-Book of Meteorology*,<sup>1</sup> says that, apart from diverting the winds from their course, the chief effect which mountain ranges have upon the temperature (and so upon climate) is to drain the winds which cross them of their moisture. Colder winters and hotter summers in places to the leeward, as compared with places to the windward, are thus caused; for the protecting screen of aqueous vapour is partially removed by condensation, and so the country to the leeward of a mountain-chain becomes more fully exposed to both solar and terrestrial radiation. For the same reason the rainfall is lessened in such sheltered localities, although it is of course proportionately increased on the windward side of the mountains. Dr. Theodore Williams cites the extraordinarily dry climate of Colorado, which lies under the lee of the Rocky Mountains, as an instance of the influence of a mountain-range on climate. Nearer home we have similar examples on a much smaller scale in several parts of the British Isles: heavy and continuous rainfalls in the

<sup>1</sup> William Blackwood and Sons: Edinburgh and London. 1871. P. 73.

mountainous districts of Kerry, Cumberland, and the west of Scotland, contrasting with comparatively dry climates in Dublin, the Lowlands of Scotland, and the coasts of the Moray Firth, Nairnshire, and the Carse of Sutherland. These last-named districts, according to Mr. Scott, owe their good fortune mainly to the fact of their lying on the leeward of an extensive mountain district. As regards Dublin, a range of mountains lies a few miles south of the city, with summits varying in height from 1000 to more than 2500 feet. This mountain-chain intercepts the vapour-laden winds at all points between south-south-east and south-west. In consequence, the rainfall is diminished and the sky is comparatively cleared during the continuance of the southerly and south-westerly winds which so frequently prevail. Dublin and its neighbourhood are the only part of Ireland where the annual rainfall falls short of 30 inches—it is about 28 inches—and this depends on the geographical situation of the city on the east coast and to the leeward of high lands, grouped into mountains to the south-east, south, and south-west, whereby the rain-bearing winds are drained of their superabundant moisture before they reach the valley of the Liffey and the plains lying north of that river.

VI. *Soil*.—With regard to the absorbing power of heat possessed by soils, Schübler has arranged them in the following order,<sup>1</sup> 100 being assumed as the standard :—

Sand with some lime, 100 ; pure sand, 95·6 ; light clay, 76·9 ; gypsum, 73·2 ; heavy clay, 71·11 ; clayey earth, 68·4 ; pure clay, 66·7 ; fine chalk, 61·8 ; humus,<sup>2</sup> 49. This list shows the high absorbing power of the sands, and the comparative coldness of the clays and humus. The absorbing

<sup>1</sup> Parkes's *Manual of Hygiene*, p. 312. 4th edition.

<sup>2</sup> Humus is the organic matter of the soil, which is made up of the products of the decomposition of vegetable substances. These products may be arranged in three classes : (1) those soluble in water—crenic, apocrenic, and ulmic acids ; (2) those soluble in alkaline solutions, but not in pure water—humic and geic acids ; (3) those insoluble—humin and ulmin.

power of water possessed by soils varies in a similar manner—sands retain but little water, clays about 10 to 20 times as much as sands, and humus double as much again. Clays and humus are comparatively unsuitable as sites for building, owing to their characters of coldness and dampness. In some diseases they are very injurious, as, for example, in phthisis, rheumatism, and catarrh. If damp soils be exposed to a high temperature, they may give rise to malaria, owing to decomposition of the organic matter mixed with them. Marshy soils, alluvial soils, old estuaries, and deltas, contain much organic matter, and should be regarded with suspicion. Peaty soils also are largely composed of organic matter, but they are not malarious, owing probably to the preservative properties of peat. Granite, metamorphic and trap rocks, clay-slate, chalk, sandstone, gravels, and the pure sands, are healthy, and suited for building sites. The limestone and magnesian limestone rocks and mixed sands are only moderately healthy.<sup>1</sup>

Three diseases, leaving ague out of the question, appear to be intimately connected with the presence of water in the soil. In 1862, Dr. Bowditch, of Boston, U.S., drew attention to the relations between the prevalence of phthisis and the amount of sub-soil water. His researches were amply confirmed by Dr. (now Sir George) Buchanan,<sup>2</sup> who discovered that the death-rate from phthisis in various towns in England was greatly reduced in consequence of efficient drainage and removal of the sub-soil water. Some years ago Pettenkofer of Munich advanced the doctrine of the ultimate dependence of enteric fever and of cholera on the varying level of the sub-soil or "under-ground" water,<sup>3</sup> the most dangerous period, according to him, being that of the sinking of the water after a previous rise.

<sup>1</sup> Cf. Parkes, *Loc. cit.* p. 314, *seq.*

<sup>2</sup> *Ninth and Tenth Reports of the Medical Officer of Health to the Privy Council.*

<sup>3</sup> *Zeitschrift für Biologie*, 1868.

The high absorbent power of loose sandy soils is doubtless due to the presence of large quantities of imprisoned air, which converts the sand into a bad conductor of heat. Hence such soils heat readily in summer and cool readily in winter *near the surface*; but these extremes of temperature do not penetrate to any depth. Dr. Williams states<sup>1</sup> that the sandy soil in an Arabian or Egyptian desert may be heated to 120°, 140°, or even 200° F., and when the particles of this hot sand are carried through the air by the terrible simoom, the shade temperature may rise to 125°. On the other hand, Dr. Buchan says, in his *Introductory Text-Book of Meteorology*,<sup>2</sup> that in Scotland, for a period of nine years, the temperature at three inches below the surface fell to 26·5° in loose sandy soils, but at a depth of 12 inches the freezing-point was only once observed. In clay soils, at 3 inches the lowest temperature recorded was 28°, whilst at 12 inches the temperature often fell to freezing, and even at 22 inches 32° was once more recorded.

VII. *Vegetation*.—A district covered with a luxuriant growth of plants and forest trees has a comparatively uniform and temperate climate. By day the heat is lessened, because the vegetation intercepts a large proportion of the sun's rays, which would otherwise heat the earth's surface; also, because the evaporation from leaves and grasses renders heat latent, and so keeps the atmosphere cool. By night radiation from the surface of the ground is checked, and so the fall of temperature is diminished. Forests control evaporation and increase the humidity of the air; they are also said to increase the rainfall, but this seems not to be satisfactorily established. As moist air prevents excessive heat in summer and excessive cold in winter, forests are thus seen to be of use in mitigating extremes of climate. In winter they afford shelter from storms, and in tropical climates the spread of malaria is prevented by the interposition of trees.

The third number of *Petermann's Mittheilungen* for 1885

<sup>1</sup> *Lumleian Lectures*, 1893.

<sup>2</sup> P. 46. 1871.

contained an article of exceptional interest by Herr A. Wojeikof on the influence of forests on climate. The first step towards a scientific investigation of this subject was taken when the Bavarian forest meteorological stations were established, and when Prussia, Alsace-Lorraine, France, Switzerland, and Italy followed the example. As a general rule it may be laid down that during the warmer season—1, the temperatures of the earth and air are lower in the forests than in contiguous woodless places; 2, their variations are less; 3, the relative humidity is greater. The influence of forests in diminishing evaporation from water and the soil is so great that it cannot be accounted for solely by the lower temperature of the warm months, the greater humidity, or even by the shade—the protection from the wind afforded by the trees is regarded by Herr Wojeikof as more important than all these factors together in reducing the amount of evaporation. With respect to the influence of forests on rainfall and snowfall, there is as yet only a single series of observations supplying comparative statistics, and extending over a sufficiently long period, namely, six years. These were taken in the neighbourhood of Nancy by the pupils of the School of Forestry of that city, under the direction of M. Mathieu, sub-director of the school. These observations, reported in *Polybiblion*, 1882, prove that—

1. Forests increase the quantity of meteoric waters which fall on the ground, and thus favour the growth of springs and of underground waters.

2. In a forest region the ground receives under cover of the trees as much water as, or more than, the uncovered ground of regions with little or no wood.

3. The cover of the trees of a forest diminishes to a large degree the evaporation of the water received by the ground, and thus contributes to the maintenance of the moisture of the latter, and to the regular flow of springs.

4. The temperature in a forest is much less variable than in the open, although, on the whole, it may be a little lower;

but the *minima* are there constantly higher, and the *maxima* constantly lower, than in regions not covered with wood.

M. Fautrat, when sub-inspector of forests at Senlis, made observations on forestial meteorology during four years. These, although conducted on a different method, fully corroborate those of M. Mathieu in several respects. He adds the following interesting remarks:—Rain falls most abundantly over forests with trees in full leaf; the humidity of the air is much higher over masses of *Pinus sylvestris* than over masses of leaved species; and the leafage and branches of leaved trees intercept one-third, and those of resinous trees one-half, of the rain water, which afterwards returns to the atmosphere by evaporation.

Herr Wojeikof endeavoured to ascertain the influence of forests on the climatic conditions of their neighbourhood in the western parts of the Old World, between the 38th and 52nd degrees N. latitude, the places selected being in all cases in the open. Thus, for the 52nd degree, eight stations were taken between Valentia Island, in Ireland, on the west, and the Kirghiz steppe on the east; for the 50th, Guernsey on the west, Semipalatinsk on the east, and ten other intervening stations; and so on for each two degrees of latitude to 38° N. The general result of the observations at fifty stations in six different degrees of latitude is that in Western Europe and Asia large forests have a great effect upon the temperature of places near them: the normal increase of temperature as we travel eastward from the Atlantic Ocean to the interior of the continent is not merely interrupted by the influence of forests, but places far removed from the coast through that influence enjoy a cooler summer than those actually on the sea. A striking example of this is Bosnia, where the summer is 4·5° to 8·1° F. cooler than in Herzegovina. Bosnia, separated by lofty mountain ranges from the sea, has extensive forests; Herzegovina, on the contrary, is almost disafforested. Even on the Island of Lissa, where under the full influence of the Adriatic Sea the summer should be cooler,



the temperature is more than  $1.8^{\circ}$  higher than it is in Bosnia. In Portugal, which is poor in forests, the temperature rises very rapidly towards the interior during the almost rainless summer. The heat is still greater in stony Attica, notwithstanding the proximity of the sea. On the eastern shore of the Caspian, owing to the desert of sand and stone, the summer temperature is extremely high, whereas at Lenkoran, on the western shore of that vast inland sea, a cool though dry summer is enjoyed. In the great Lenkoran forest vegetation is more luxuriant than in any part of Europe, for a tangled mass of climbing plants encircles the trees so that it is always humid in the forest. Yet here the rain curve is a sub-tropical one—very little rain falling in the summer, but large quantities in autumn and winter. The water is stored up in the forest, so maintaining evaporation during the summer droughts.

“To sum up: forests exercise an influence on climate which does not cease on their borders, but extends over a larger or smaller adjacent region according to the size, kind, and position of forest. Hence, man by afforestation and disafforestation can modify the climate around him; but it is an extreme position to hold that by afforestation the waste places of the earth can be made fertile. There are places incapable of being afforested, which would not give the necessary nourishment to trees” (*Nature*, vol. xxxii., 1885, p. 115).

VIII. *Rainfall*.—The influence of precipitation on climate has already been discussed at some length in Chapter XX. (p. 246). In estimating it, regard should be had to the monthly, seasonal, and yearly rainfall, both in individual periods and on an average of many such periods. Equally important is it to know the number of “rainy days” (or days upon which  $\cdot 005$  inch of rain or upwards is measured in the gauge) which may be expected to occur in each month, season, or year. Nor should the probability of heavy or torrential rainfalls—1 inch or upwards—be left out of account. It is evident that a moderate rainfall spread over many days throughout the year may constitute a *wet* climate, while a still heavier rainfall

restricted to a given season may characterise what is essentially a *dry* climate. Another element worthy of consideration is the frequency of thunderstorms, so often attended by torrential rains, and of hailstorms. Lastly, the seasonal limits of snowfall should be investigated and the average and extreme duration of an unbroken snow-covering.

This last topic has been ably handled by Dr. Alexander Wojeikof in a paper on the "Influence of Accumulations of Snow on Climate," which was read before the Royal Meteorological Society, June 17, 1885.<sup>1</sup> It has already been shown in these pages that snow is a bad conductor of heat, and accordingly protects the underlying soil from excessive cold. But much depends on the structure of the snow. If it consists of loosely piled small feathery flakes, which entangle air in large quantity, it is a thoroughly bad conductor, and so affords most protection. If, however, by alternate thawing and freezing, it solidifies into ice—assuming the form called in Germany *Firn*, and in France *névé*—it is a far better conductor of heat, and the underlying soil will quickly freeze.

Again, the air over a snow-covered surface will become extremely cold—first, because the snow cuts off from it the warmth of the ground, and secondly, because dry feathery snow is a good radiator of heat. Then, as there is but little dust in the air over a snow-covered country upon which the solar rays can act, these rays will be unable by themselves to thaw a deep snow covering. How then is it that the winter snow *does* melt in the northern parts of Europe, Asia, and North America? Dr. Wojeikof has no doubt that the thaw is first caused by winds from warmer quarters, or from open oceans. These warm winds cause the upper layer of snow to melt. After it has been frozen again it is changed to *névé*, that is, to a condition in which it is somewhat diathermanous to solar heat and radiates heat much less freely. Once this happens, the melting of snow goes on much more easily. To a small extent the melting of the snow may be helped by dust brought

<sup>1</sup> *Quart. Journ. of the Royal Met. Soc.*, vol. xi. 1885, page 299.

by the winds from continental areas already free from snow. No doubt a great quantity of heat is expended on the melting of the snow, and so the warm winds are chilled and lose their power of thawing the snow. But near the border of the snow-covered country, when the snow has mostly melted there, the surface of the ground can be heated by the sun and thus become a source of heat for the country lying still further to the northward. The melting of the snow is progressive from say February to June in the northern hemisphere. It begins close to seas which do not freeze, and continental areas which are not permanently covered with snow even in mid-winter. Thence it proceeds intermittently by leaps and bounds until all the lowlands of our hemisphere are freed from their snow-covering.

In high southern latitudes no such happy event takes place. Sir James Ross proved that the mean temperature of the shores of the Antarctic Continent, or the islands bound together by glacier ice and so appearing like a continent, is much below the freezing-point even at midsummer. There is no notable melting of snow, and what is melted is very soon replaced by fresh snow. The geographical position explains this. The shores of the Antarctic Continent are washed by an ocean, the surface water of which has a temperature below freezing-point to about  $62^{\circ}$  S. even in summer, while they lie at a distance of  $20^{\circ}$  or more from any land area of lower latitude which could supply warmth for the thawing of their eternal snows. We see, then, that the sun's rays are of themselves unable to raise the temperature above freezing-point, notwithstanding the nearness of the sun to the earth in the summer of the southern hemisphere.

In our northern hemisphere the melting of the snow keeps the temperature for a long time near freezing-point. This is the reason why April is so much colder than October in Central European Russia, in Canada, and in the more northern of the United States. Hence also the keenness of the easterly winds of spring in Western Europe, even in the British Islands.

It is clear that at the period when the mean temperature begins to rise above the freezing-point, very much depends on the store of cold existing in the vicinity in the form of snow and ice. The larger it is, the slower and more irregular will be the rise of temperature. At the beginning of winter, also, a heavy fall of snow over a large continental area intensifies and gives a permanency to succeeding cold.

IX. *Prevalent Winds*.—The division of winds into (1) Permanent, (2) Periodic, and (3) Variable, must now be considered. Dr. Theodore Williams well observes that, beyond the use of winds for propelling vessels and machinery, they serve a distinctly hygienic object in dispersing noxious exhalations whether animal or vegetable, in permitting free evaporation and thus preventing accumulation of moisture, and maintaining the circulation of the air which is necessary for the purification of the atmosphere. Their influence upon climate is indisputable. They raise or lower temperature, increase or diminish humidity, cause or prevent rainfall, interrupt sunshine by bringing up clouds, or clear the sky when descending from the higher strata of the atmosphere.

Apart from the permanent aerial currents, which are called the "Trade winds," and which blow within the Tropics as a north-east wind north of the equator and as a south-east wind south of the equator; and from the periodic aerial currents, of which the most striking examples are the Indian monsoons—the south-west monsoon (of summer) and the north-east monsoon (of winter), there are certain local winds, which prevail occasionally and produce very decided effects upon both animal and vegetable life. This class may be subdivided into *occasional cold winds*, prevalent in winter and spring, and *occasional warm winds*, prevalent in summer and autumn. On this subject Mr. W. Marriott, Secretary of the Royal Meteorological Society, made a valuable communication at one of the Conferences on "Meteorology in Relation to Health," held at the International Health Exhibition in London in July 1884.

The cold winds are :—

1. The *East Wind* of the British spring, which is dry, cold, and keenly penetrating. Sir Arthur Mitchell, in a "Note on the Weather of 1867 and on some effects of East Wind,"<sup>1</sup> shows how much a cold dry wind must chill the surface of the body by conduction, and also by evaporation. He adds : "The quantity of heat which our bodies lose in this way is far from insignificant, and the loss cannot be sustained without involving extensive and important physiological actions, and without influencing the state of health. In feeble and delicate constitutions the resources of nature prove insufficient to meet the demand made on them, and a condition of disease then ensues."

2. The *Mistral* is a violent north-west wind, dry, cold, and parching, which sweeps the shores of the Gulf of Lyons, drying up and withering vegetation, and predisposing to pleurisy and pneumonia in the inhabitants of Provence. Writing of it, Mr. Scott quotes the old couplet :—

Le Parlement, le Mistral, et la Durance  
Sont les trois fléaux de la Provence.

3. The *Tramontana* is a searching northerly blast, which is felt along the eastern shores of the Adriatic. A similar furious northerly wind is known in Trieste and Dalmatia as the *Bora*.

4. The *Nortes* (*Northers*) of the Gulf of Mexico have a pernicious influence upon health and vegetation. Mr. R. Russell, in his *North America : its Agriculture and Climate*, states that in Southern Texas, in January 1855, with a Norther, temperature fell from 81° to 18° in forty-one hours.

5. The *Pampëro* is a dry, cold, south-west wind, which prevails on the coast of Brazil, blowing with great force across the pampas, or plains, of the river Plate. In the Argentine Republic similar winds are called *Tormentos*.

6. The *Etesian Winds* of south-eastern Europe blow across

<sup>1</sup> *Journal of the Scottish Meteorological Society*, vol ii. p 80.

the Mediterranean towards North Africa, apparently to supply the place of the heated air which rises from the Sahara and other African deserts.

The chief hot winds are :—

1. The *Scirocco*—a hot south-east wind blowing from the immense deserts of Northern Africa. It is a dry wind on the African coast, but blows in Italy and Sicily as a hot, moist wind, from the oppressiveness of which there is no escape. Mr. Marriott states the case well when he says: “though not fatal to human life, it is deadly to human temper.” In Sicily, during its continuance, the thermometer sometimes rises to 110° in the shade.

2. The *Solano* is the scirocco of Spain. It is a very hot, dry, and dusty south-east wind, most deleterious to health and to temper, hence the Spanish proverb: “Ask no favour during the Solano.” So also is the *Leveche* or hot south-west wind of the Iberian Peninsula.

3. The *Harmattan* of the west coast of Africa is a hot easterly wind, laden with dust and sand from the Sahara. It prevails in December, January, and February.

4. The *Khamseen*, or *Khamsin*, is the hot wind from the desert in Egypt. It is so called, not because it lasts for fifty days, but because it is liable to occur during the fifty days following Easter. It blows from S. or S.S.E., the more easterly variety being the most disagreeable. It usually blows for three days, but may last for seven days at a time. The number of Khamseen days in any one year would seem to vary from four to twenty. During its prevalence the air becomes extremely dry, and is filled with fine sand in a highly electrified condition (F. M. Sandwith<sup>1</sup>).

5. The dreaded and deadly *Simoom* of the deserts of Arabia, Kutchee, and Upper Scinde, is really a circular storm, or tornado—in fact, a whirlwind which lasts only ten minutes or thereabouts.

<sup>1</sup> *Egypt as a Health Resort*, p. 32. London: Kegan Paul, Trench and Co. 1889.

6. The *Hot Wind* of Australia, locally known as a "Brickfielder," blows from the north. It is most severe in the months of November, December, and January. In Sydney it may send the thermometer up to  $100^{\circ}$ , once it rose to  $106.9^{\circ}$ , but in Central Australia the heat is even more intense, Captain Sturt having reported a shade temperature of  $131^{\circ}$  on January 21, 1845. Dr. Hann, in his *Handbuch der Klimatologie*, p. 639, quotes an observation of Dr. Neumann, formerly Director of the Melbourne Flagstaff Observatory, respecting the hot wind of January 21-22, 1860, that "the apples were literally roasted on the trees, where the north wind had set in." This north wind is displaced by a sudden south wind which is called a "burster," and its effect is to reduce temperature with marvellous rapidity.

7. The *Föhn*, or warm, dry wind of the valleys in the north-east of Switzerland, has already been described.

8. The *Leste* is a very dry and parching wind, sometimes very hot, which blows over Madeira from E.N.E. or E.S.E., taking its origin in the Sahara. Its dryness is remarkable, for it traverses 300 miles of sea before it reaches the island.

There is no doubt that, among the elements which make up climate, temperature holds the foremost place. Accordingly, the accompanying Chart (C) will both interest and instruct the reader. It was prepared by Mr. Wm. Marriott, F. R. Met. Soc., some years ago by direction of the Council of the Royal Meteorological Society. The mean annual temperature in the shade in degrees Fahrenheit of certain places in various parts of the world is shown on the thermometer scale to the left-hand side, while the highest and lowest shade temperatures, observed at the specified places in all parts of the world, are drawn on the right-hand scale. When the highest temperatures are indicated the names of the places are printed in SMALL CAPITALS; when the lowest temperatures, in *italics*.

# CHART C.

Thermometer showing the Mean Annual Temperature of certain places in various parts of the World.

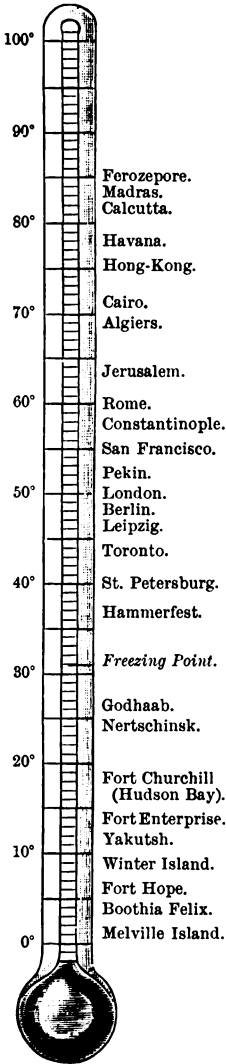

Thermometer showing the Highest and Lowest Temperatures observed at certain places in various parts of the World.

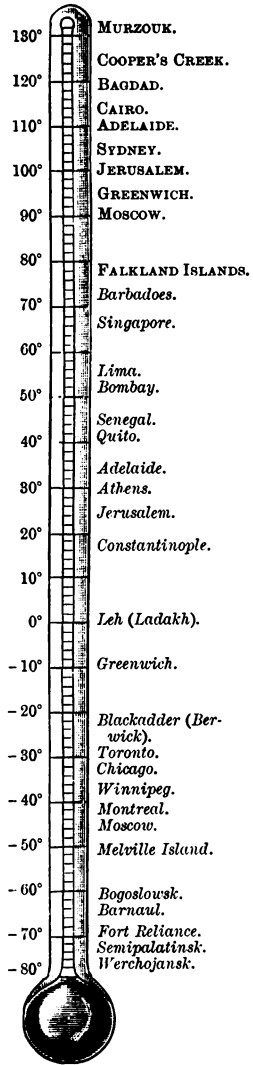





## CHAPTER XXVI

### THE CLIMATE OF THE BRITISH ISLANDS

Division of Climates into (1) Insular, or Moderate ; (2) Continental, or Excessive—Distribution of Atmospheric Pressure according to Season—Climate of the British Isles : (1) in Summer ; (2) in Winter—Isothermals in July and January—Features in the Climatology of Great Britain and Ireland—Sea Temperatures : in Winter and in Summer—Air Temperatures : arrangement of the Isotherms in January, April, July, and October—Atmospheric Pressure : its Monthly Distribution—Equinoctial Gales.

WITHIN the limits of a small book it would be impossible to do full justice to the great theme of climatology. It must suffice to repeat that, because water by its presence not less than by its motion so profoundly modifies climatic conditions, climates are, by universal consent, divided into *insular* or *moderate*, and *continental* or *excessive*. Of the former, the climate of the British Islands affords a typical example ; of the latter, the climate of Siberia may be taken as a type. But an *insular* climate is by no means confined to *islands* (Lat. *insulæ*). The western shores of all continents enjoy moderate climates which are fully entitled to be described as “insular.” On the other hand, the interior of continents and their eastern shores are exposed to extremes of heat and cold, which equally justify the appellation “continental,” applied to their climate.

The great changes which take place in the distribution of atmospheric pressure over the immense continent of Europe and Asia and the adjoining oceans—the North Atlantic and

the North Pacific—have been already described and explained (Chapter XV., p. 170). It was there shown that, in summer, a vast *cyclonic* system develops over Europe and Asia, the wind blowing against the hands of a watch in accordance with Buys Ballot's Law, round an area of low barometer formed over the heated inland regions, from S.W. in India and China (the south-west monsoon); from S., S.E., and E. in Japan, and North-eastern Siberia; from N.E. and N. in North-western Siberia; from N.W. and W. over most of Southern Europe and South-western Asia.

In winter, on the contrary, over the ice-bound, snow-covered, boundless Eurasian plain an immense anticyclone is formed, the winds circulating round and *out from* the centre of high pressure in a direction with the hands of a watch, blowing from N.W. and N. in Japan and China; from N.E. in India (the north-east monsoon); from E. and S.E. in Russia and Southern Europe; from S.W. in the British Isles; and from W. in Northern Russia and Siberia.

These considerations facilitate an explanation of the climate of the British Isles (1) in summer and (2) in winter.

It will easily be seen how the summer continental depression influences the climate of the British Isles. Air is drawn from W. and N.W. over these countries, and as this air blows over the surface of a wide ocean, and from high latitudes, it is cool and moist. Do not these two words describe our summer? These ocean winds prevail chiefly on the W. and N.W. shores of Ireland and Scotland, which have thus the rainiest and the coolest summer, while this season is warmer and drier as we go eastward and southward, to the south-eastern counties of England. This is well illustrated in Dr. Buchan's Chart<sup>1</sup> of the Isothermals<sup>2</sup> of the British Isles in July.

It is not necessary to consider at length the influence of

<sup>1</sup> "The Mean Temperature of the British Islands." By Alexander Buchan. *Journal of the Scottish Meteorological Society*, vol. vi. New Series. No. 64, p. 22. 1882. <sup>2</sup> Gk. *ἴσος* = equal, and *θερμῆ* = warmth.

the winter-system of barometrical pressure on our climate. During the earlier winter months a great stream of warm, very moist air, as a rule, flows north-eastward and northward over these islands round the Atlantic depression, the centre of which lies near Iceland. But this stream does not flow evenly. Along its eastern edge it is in continual conflict with the cold anticyclonic air, which is travelling westward from Russia and Siberia, and immense volumes of the latter are frequently rushing in to supply the place of those volumes of the warm air which, owing to their low density, have presumably risen from the earth's surface towards the higher strata of the atmosphere. This conflict between two such opposite currents of air causes our storms, and those violent and rapid alternations of temperature which are so prejudicial to health in the winter months.

The reason for the occurrence of these alternations of temperature will be explained when we remember that most of these gales, or *bourrasques* as they have been termed, are cyclonic in character, and that they generally cross the British Isles from S.W. to N.E., less frequently from W. to E., and still less frequently from N.W. to S.E. The southerly winds which blow over the country in front of the centre of the storms are warm and moist, while the northerly winds, which prevail over those districts already reached and passed by the centre, are cold, and after a time dry. No better examples of this can be given than the remarkable gales of December 8 and 9, 1872, and of February 2, 1873. In front of the former, temperature rose generally to about 50° over the south of Ireland, most part of England, and all of France; while it fell almost to the freezing-point over those districts a few hours later when the centre had passed. The second gale referred to was accompanied by a range of 18° (Fahrenheit) over the whole of France. Mr. Scott says<sup>1</sup> that a great contrast of tempera-

<sup>1</sup> *Weather Charts and Storm Warnings*, p. 134. London: Henry S. King. 1876.

ture between adjacent stations or, so to speak, a great "thermometric gradient," being an indication of serious atmospheric disturbance, is the precursor or concomitant of a serious storm. He quotes, as an example, the gale of November 14, 1875, which followed hard upon a difference of  $36^{\circ}$  in temperature at 8 A.M. of the previous between Scilly ( $57^{\circ}$ ) and Wick ( $21^{\circ}$ ).

The effect of the warm Atlantic air-current on the Isothermals of the British Isles is well represented in Dr. Buchan's Chart for January.<sup>1</sup>

Anticyclonic wind-systems sometimes prevail over Western Europe, but much less frequently than cyclonic systems. They cause dry, often cold weather, and are much more persistent than cyclones.

Anticyclones are better marked, as a rule, in winter than in summer, and historical "hard frosts" in the British Isles are almost invariably connected with one of these systems. The great frost of 1890-91, which lasted in the south-east of England, almost without interruption, from November 25, 1890, to January 22, 1891, was connected with the presence of a large area of high barometric pressure which maintained a nearly permanent position over Central Europe. The incoming disturbances from the Atlantic could not effect a passage into Europe, but were fended off by the European anticyclone, their centres being kept well out in the Atlantic. Ireland and Scotland came from time to time under the warming influence of these Atlantic depressions or cyclones, and so the frost was neither severe nor continuous in those countries; but England was not affected by them, and so the cold held in its intensity particularly in the eastern, south-eastern, and midland parts of the country. Mr. Charles Harding, F.R. Met. Soc., in a paper<sup>2</sup> on this historical frost,

<sup>1</sup> "The Mean Temperature of the British Islands." By Alexander Buchan. *Journal of the Scottish Meteorological Society*, vol. vi. New Series. No. 64, p. 22. 1882.

<sup>2</sup> Read before the Royal Meteorological Society on February 18, 1891.

states that the very dry character of the weather over England during the frost was also attributable to the fact that the European anticyclone embraced the southern portion of the kingdom, and although on two or three occasions there were some rather heavy falls of snow, the aggregate fall of snow and rain was but trifling in comparison with the average.

In the chapter on "Weather" in his *Elementary Meteorology* (p. 360), Mr. R. H. Scott well observes:—

"The weather we experience in Western Europe is distinctly related to these areas of depression and anticyclones, to the rate at which they respectively travel over the earth's surface, and to the distance which intervenes between their respective centres. As in a system of either kind we may meet with winds from any point of the compass, which will have different qualities as to temperature, humidity, etc., according as they belong to one or the other, we see the great importance of the consideration, first pointed out by W. Köppen,<sup>1</sup> and subsequently by Captain Toynbee,<sup>2</sup> that *the climatic character of a wind depends on its origin, i.e. on its belonging to a depression or to an anticyclone.*" He adds: "Anticyclones are generally more or less stationary, but depressions move over the earth's surface, usually from west to east in these latitudes, their paths as they advance, though chiefly ruled by the distribution of pressure, being liable to modification by the irregularities of the surface over which they pass; and their effects, as to the amount of cloud and rain to which they give rise, being influenced by the same causes. A south-west wind, for instance, may blow over a flat country with a clear sky, but as soon as the air reaches a hill-side and is forced to ascend, the moisture it contains is condensed, clouds are formed, and rain is frequently the result."

One of the most recent contributions to the climatology of

<sup>1</sup> *Repertorium für Meteorologie*, vol. iv. 1875.

<sup>2</sup> *The Meteorology of the North Atlantic during August 1873*, p. 97. London. 1878.

England and Ireland is a paper by Mr. Francis Campbell Bayard, F.R. Met. Soc., which was read before the Royal Meteorological Society on June 15, 1892.<sup>1</sup> The author carefully analysed the observations taken during the ten years, 1881-90, at nineteen Second Order Stations (sixteen in England and three in Ireland), and at thirty-three Climatological Stations (thirty-two in England and one in the Channel Islands), and he arrives at the following general conclusions :—

(1) With respect to *mean temperature*, the sea-coast stations are warm in winter and cool in summer, whilst the inland stations are cold in winter and hot in summer.

(2) The *mean maximum temperature* occurs at all stations in July or August, while the *mean minimum temperature* takes place mostly in December or January, except at Llandudno and the south-western sea-coast stations, where it is later, taking place in February or March.

(3) *Relative humidity* is lowest at the sea-coast stations and highest at the inland ones.

(4) The south-western district seems most *cloudy* in winter, spring, and autumn, and the southern district the least cloudy in the summer months ; and the sea-coast stations are, as a rule, less cloudy than the inland ones.

(5) *Rainfall* is smallest in April, and, as a rule, greatest in November, and it increases as we travel from east to west.

Mr. Bayard's paper, it is true, does not include Scotland in its scope, and three stations in Ireland—Londonderry, Dublin, and Killarney—are far too few to serve as a basis for climatological conclusions. Nevertheless the foregoing sentences epitomise the facts relating to the climate of the British Islands at large. This is shown by referring to a series of elaborate communications on the subject, which Dr. Alexander Buchan has from time to time since 1862 laid before the Scottish Meteorological Society.

<sup>1</sup> See the *Quarterly Journal* of the Society, New Series, vol. xviii. No. 84, p. 213.

## I.—SEA TEMPERATURES

In an article on the "Temperature of the British Islands,"<sup>1</sup> Dr. Buchan says that a very cursory examination of the British isothermals is enough to show the powerful influence of the sea in modifying their course in the different months of the year. Hence the temperature of the sea which washes our shores is a question of the first importance in investigating the climate of these islands. Observations on sea temperature have been made at different points round the Scottish coasts since 1855, when the Scottish Meteorological Society was founded, and more recently in Farö and Iceland. During the three years, July 1879 to June 1882, observations, from which maps of the sea temperature all round the British Isles have been constructed in the Meteorological Office, London, were taken at certain coastguard stations, lighthouses, and lightships to the number of forty-nine. The results have been embodied in a Meteorological Atlas of the British Isles, published by the authority of the Meteorological Council in 1883.

The mean temperatures of the sea surface vary as follows :—

<i>January</i>	Highest, 49°—Cleggan, Co. Galway ; Scilly, Truro, Penzance.
	Lowest, 37°—Yarmouth, Berwick.
<i>February</i>	Highest, 49°—Scilly, Seven-Stones L. V., <sup>2</sup> Cornwall.
	Lowest, 37°—Burntisland, Fifeshire.
<i>March</i>	Highest, 51°—Cleggan, Co. Galway.
	Lowest, 40°—Dunrobin, Holkham, Leman and Ower, L. V.
<i>April</i>	Highest, 51°—Cleggan, Valentia Island, Scilly.
	Lowest, 42°—Berwick, Leman and Ower L. V., Norfolk.
<i>May</i>	Highest, 56°—Valentia Island.
	Lowest, 45°—Berwick.
<i>June</i>	Highest, 58°—West Coast of Ireland, Bristol Channel, Padstow, Cornwall ; Yarmouth.
	Lowest, 49°—North Unst, Shetland ; Berwick.

<sup>1</sup> *Journal of the Scottish Met. Soc.*, New Series, vol. iii. p. 102.

<sup>2</sup> L. V. = Light-vessel.



<i>July</i> . . .	Highest, 62°—Bristol Channel. Lowest, 52°—North Unst, Wick, Berwick.
<i>August</i> . .	Highest, 64°—The Owers L. V., off the Sussex coast. Lowest, 52°—North Unst, East Yell, Shetland.
<i>September</i> .	Highest, 62°—Cleggan, County Galway ; Dover. Lowest, 52°—Shetland.
<i>October</i> . .	Highest, 59°—Mouth of the Thames. Lowest, 47°—Fraserburgh.
<i>November</i> .	Highest, 54°—Truro. Lowest, 44°—Fraserburgh, Berwick.
<i>December</i> .	Highest, 52°—St. Agnes' Head, Cornwall. Lowest, 39°—Berwick.

WINTER.—According to Dr. Buchan, the high temperature of the northern islands in winter is one of the best illustrations which could be adduced of the powerful influence of the ocean on climate. The conserving influence of the sea on the temperature is also seen, though in a less degree, in the openings of the Irish Sea and the English Channel. The isothermals indicative of the mildest British climate in winter are seen enveloping Ireland in January. The west and north coasts of Wales share in the genial influence of this offshoot from the warm waters of the Atlantic. The mildest winter climate of Great Britain, however, is found in the peninsula of Devon and Cornwall, which is not only further south, but is also more completely enveloped by the ocean than any other part of the British Islands. A rapid lowering of temperature takes place from the Land's End eastwards to Kent, because the English Channel is comparatively shallow, is near the colder continent, and is connected with the colder North Sea.

SUMMER.—Owing to the great preponderance of sea over land in the vicinity of the Hebrides, the Orkneys, and the Shetlands, the temperature of these islands is remarkably reduced in summer. A tendency to *northing* in the summer winds is also mentioned by Dr. Buchan as another cause for the marked diminution of summer heat in the northern parts of Great Britain. The Irish Sea and the English Channel

moderate the heat of summer along their coasts. Conversely, warmth is relatively greatest in those parts of the British Islands which are most removed from the direct and indirect influence of the sea. Hence there is a curving northwards of the isothermals of June, July, and August through the central parts of Great Britain, from the Thames Valley northwards to the Moray Firth. The patch of highest mean temperature corresponds closely with the Thames Valley, and is most marked in the immediate vicinity of London. In a paper on the climate of Dublin, written in 1886, I showed how beneficial was the influence of the Irish Sea upon that city, not only in winter and spring, when it softened and warmed by some 5° the keen, dry, searching easterly winds of those seasons, but also in summer. In calm, clear weather in summer time, no sooner has the sun mounted high in the heavens than a cool, refreshing sea breeze—a typical “inbat,”<sup>1</sup> as the modern Greeks call it—sets in towards the land, so that extreme or oppressive heat is rarely experienced. Indeed, an oppressive atmosphere happens only when a damp, warm, south-west wind is blowing, with a more or less clouded sky. On July 16, 1876, the thermometer no doubt did rise in the Irish capital to 87·2°, but this was altogether a phenomenal occurrence. Temperatures above 80° in the screen in Dublin nearly always coincide with winds off the land, from some point between south and west, and a clear or only slightly clouded sky. On August 15, 1893, the maximum in Dublin was 79·8° (practically 80°), with a calm atmosphere or light variable sea breezes, but with the clouds coming from south-west.

Speaking on his paper on the “Mean Temperature of the British Islands,” at a meeting of the Scottish Meteorological Society on July 20, 1881, Dr. Buchan laid special stress on the influence of the Atlantic and other surrounding seas upon the temperature. He pointed out the great influence of the Irish Sea in affecting the course of the isothermals, and also

<sup>1</sup> Evidently a derivative from *ἐμβάτω*.

that of the Atlantic, particularly off the north-west of Scotland. In winter the temperature of St. Kilda is as high as that of Penzance, and the temperature at Cape Wrath as high as that of the Isle of Wight. Taking the British Islands as a whole, the mean annual temperature in the west,  $52\cdot0^{\circ}$ , was represented about the same latitude in the east by a mean annual temperature of  $51\cdot0^{\circ}$ —in other words, the west was one degree warmer than the east.

## II.—AIR TEMPERATURES

Observations upon this element fully justify Dr. Buchan's dogmatic statement that "the climate of the British Islands is eminently insular; that is, it is not subject to great extremes of heat and cold, but is remarkably equable throughout the year—being much milder in winter and cooler in summer than in continental regions in the same latitudes."

We now possess two series of Temperature Charts, which may be accepted as conclusive evidence of the distribution, annually and monthly, of air temperature throughout the British Isles. The first series was drawn up by Dr. Buchan for the Scottish Meteorological Society originally in 1871. It was based upon observations extending over thirteen years, beginning with January 1857, and terminating with December 1869. These observations on the daily maxima and minima were taken at seventy-six stations in Scotland, sixty-seven in England, twelve in Ireland, and fifteen in adjoining countries on the Continent. The mean temperatures used by Dr. Buchan are the arithmetical means of the daily maximal and minimal thermometer readings. The means so obtained were increased by an addition at the rate of  $1^{\circ}$  for every 300 feet of elevation above the sea, and were set down, so corrected, in their proper position on thirteen charts, from which the isothermals for each of the twelve months and for the year were drawn. Dr. Buchan's paper will be found in volume iii. (New Series) of the *Journal of the Scottish Meteorological Society*, 1873, p. 102.

Of this paper a still more elaborate communication on the "Mean Temperature of the British Islands," based on twenty-four years' observations ending with 1880, and laid before the Scottish Meteorological Society by Dr. Buchan in 1882,<sup>1</sup> may be regarded as a revision. The observations embrace a period nearly double the length of that of the earlier paper, and were taken at 24 places in Ireland, 132 in Scotland, and 138 in England. Thus, the series of Plates illustrating this second paper and giving the isothermal lines for each month, may be accepted as faithfully representing the temperature of the British Islands in exceedingly close agreement with the true mean annual temperature of this portion of the globe—"a datum," says Dr. Buchan, "of no small importance in many inquiries which deal with the physics of the atmosphere and underground temperature."

The second series of Temperature Charts was drawn up by the authority of the Meteorological Council and published, in 1883, in the *Meteorological Atlas of the British Isles*. It is based upon observations of the maximum and minimum thermometers made daily during the twenty years, 1861-1880 inclusive, at seventy-five stations—thirty-one in Scotland and the adjacent islands, thirty-five in England (including the Channel Islands), and nine in Ireland. The mean temperatures given in the Atlas, which consists of twelve monthly maps and one yearly map, are the arithmetical means of the daily maxima and minima. They have been reduced to their sea-level value by the addition of a correction at the rate of one degree Fahrenheit for each 300 feet of vertical elevation. The isotherms in these maps are drawn for each degree, the value for each being inserted in large figures at one of the extremities of each line.

An analysis of these maps shows that the isotherm of 46°, representing the mean temperature of the whole year, skirts the north coasts of the Hebrides and Scotland. The mean

<sup>1</sup> *Journal of the Scottish Meteorological Society*. New Series. Vol. vi. p. 22. 1882.

temperature then increases as we travel southwards, with many interesting local irregularities, until the isotherm of  $52^{\circ}$  is found off the extreme south-west of Ireland, whence it passes east-south-eastward by the Land's End in Cornwall to Jersey. The mean annual temperature in the Scilly Islands is  $53.1^{\circ}$ . Scotland lies between the isotherms of  $46^{\circ}$  ( $45.8^{\circ}$ ) and  $48^{\circ}$  ( $48.3^{\circ}$ ); England between those of  $47^{\circ}$  and  $52^{\circ}$ ; Ireland between those of  $48^{\circ}$  ( $48.4^{\circ}$ ) and  $51^{\circ}$  ( $51.3^{\circ}$ ).

Taking the first month of each quarter of the year, we obtain the following results:—

*January.*—The area of greatest cold is represented in Scotland by the isotherm of  $36^{\circ}$ , which embraces Aberdeenshire. Temperature increases from that low value to  $40^{\circ}$  all along the extreme western coast of Argyllshire and the Hebrides to the Shetlands. In England the area of greatest cold is represented by the isotherm of  $37^{\circ}$ , which covers parts of Norfolk, Lincolnshire, Huntingdonshire, and Cambridge-shire near the Wash. The isotherm of  $42^{\circ}$  passes southwards down the west coast of Wales across the borders of Devon and Cornwall; that of  $45^{\circ}$  just touches the Land's End, while that of  $46^{\circ}$  ( $46.3^{\circ}$ ) passes through the Scilly Islands. In Ireland the isotherm of  $40^{\circ}$  embraces an oval-shaped area on what may be called the "lee side" of the island, extending from the western, or inland, half of Antrim southwards to the Counties Kilkenny and Carlow. The isotherm of  $41^{\circ}$  passes through Dublin south-westwards to Fermoy, and then in a curve towards north-west and north to the extreme north of the island near Lough Swilly. On the other hand, the isotherm of  $45^{\circ}$  sweeps southwards down the extreme western coast from Achill Island to Valentia.

*April.*—This is a transitional month—the characteristic winter isotherms are now giving place to those equally characteristic of summer. In Scotland the isotherms run from north-west to south-east, with local interruptions— $44^{\circ}$  crosses Caithness;  $47^{\circ}$  Wigtonshire and Dumfries. In England the isotherms run in the same direction— $46^{\circ}$  skirting the north

east coast, and  $50^{\circ}$  showing itself near London north of the Thames, and also over Devonshire and Cornwall. In Ireland temperature is very uniform, ranging from  $47^{\circ}$  in the extreme north to  $49^{\circ}$  in Kerry and Cork.

*July.*—The summer distribution of temperature is now seen to full advantage—inland districts being warmest, and coast districts coolest. In Scotland, the isotherm of  $55^{\circ}$  sweeps in a convex curve round the north-west and north coasts from the Hebrides to the Orkneys. The almost circular isotherm of  $59^{\circ}$  covers the centre of Scotland, including Perthshire, Lanarkshire, and the Lothians. The English coasts vary from  $59^{\circ}$  in Northumberland to  $62^{\circ}$  along the shores of the English Channel and Suffolk. Inland,  $63^{\circ}$  covers the Midlands and  $64^{\circ}$  is found surrounding and especially to the north of London. In Ireland,  $58^{\circ}$  skirts the north, and  $59^{\circ}$  the west coast, while  $61^{\circ}$  embraces a large area extending from the southern shores of Lough Neagh to Cork. Tipperary and North Cork, with Kilkenny and Carlow, enjoy a mean temperature of  $62^{\circ}$ . The great central plain extending from Galway to Dublin is somewhat cooler— $60.4^{\circ}$  to  $60.8^{\circ}$ ; this is doubtless due to the immense quantity of water with which the Bog of Allen and other less extensive peat bogs are charged, as well as to the number of lakes in the centre and west of the country.

*October.*—In this month, the winter distribution of temperature begins to appear in the drawing of the isothermal lines. Scotland varies from below  $47^{\circ}$  in the north, north-east, and south-east, to  $49^{\circ}$  in the south-west; England from  $48.4^{\circ}$  in Durham to  $53.6^{\circ}$  at Penzance, and  $55.1$  in the Scilly Islands; Ireland from  $49^{\circ}$  in a large oval in the north and centre to  $52^{\circ}$  in the south-east, and  $53^{\circ}$  off the promontories of Kerry and south-west Cork.

With respect to the reduction of mean temperature to sea-level in these charts, I may remind the reader that, while it is expedient from a scientific point of view that such a reduction should be made, it is quite unnecessary, nay, even mis-

leading, from either an agricultural or a medical standpoint. We want to know what are the *actual* climatic conditions under which both plants and animals live. Further, in a suggestive address on "The Relations of the Official Weather Services to Sanitary Science," delivered before the American Public Health Association at their recent Conference at Mexico, Mr. Mark W. Harrington, the very able Superintendent of the Weather Bureau of the United States Government, very wisely and properly pointed out that the meteorological data required by sanitarians and physicians may not be furnished in a form suitable for their purpose. For instance, among the temperature data—for health resorts especially—physicians particularly want to know the *extreme range* as well as the *mean*. Two places may have the same mean temperature, say 45° F., but they may be as far apart as the Poles in their availability for invalids. One place may have an occasional range of 40° F. within a few hours, the other may not have an absolute annual range of that amount.

"For hygienic purposes," says the writer of the Address, "the details of temperature are of interest, as on a sunny day the temperature may differ greatly in short distances, depending on the exposure and the character of the surroundings. The meteorologist has defined the air temperature as that of the free air at about the height of a man, the thermometer being protected from all radiation. With such a definition the temperature data which could be prepared from observations now taken, and which might be of use to sanitarians, would appear to be as follows:—

"The *mean temperatures* of the hours, months, seasons, and year.

"The *mean maxima and minima* for the months, seasons, and year.

"The *absolute maxima and minima* for the same.

"The *mean and absolute amplitudes* for the same.

"*Interdiurnal variability* (*i.e.* the mean change in mean daily temperatures).

“ *List of sharp changes of temperature of short duration.*

“ *Frequency of freezing days (mean temperature less than 32° F.); of frost days (minimum temperature below 32° F.); of hot days (maximum temperature 86° F.), and of very hot days (maximum temperature 95° F.)*

“ *Mean and absolute dates of the last and first frosts.*

“ *Mean and absolute duration of freezing, of hot, and of very hot weather.*

“ *Means of temperature of evaporation (i.e. of the wet-bulb thermometer).*

“ This is an element which has not been discussed, so far as known to the writer, though Lieutenant Glassford suggested it to him some time ago. Its significance lies in the fact that it would approximately represent the temperature of the person in hot weather. It would help to distinguish between the distressing moist heat of some stations and the more endurable dry heat of others. It should probably be given in means, and associated with the corresponding air temperature (or temperature by the dry-bulb thermometer). It could be given thus :—

Air Temperature.	Mean.	Temperature of Evaporation.
70° to 80°	75°	...
80° to 90°	85°	...
90° to 100°	95°	...
100° or more	...	...

“ A similar table for low temperatures might be of use, as it is thought that dry, cold weather is less hard to endure than wet, cold weather.”

### III.—ATMOSPHERIC PRESSURE

The “ *Meteorological Atlas of the British Isles* ” includes also thirteen maps, showing the distribution of mean barometrical pressure over the United Kingdom for each month and for the whole year, during the twenty years, 1861 to 1880. For purposes of comparison the readings have in all cases been reduced to their mean sea-level value ; but I agree



with the Superintendent of the Weather Bureau of the United States Government in thinking that, from a hygienic or medical point of view, it is the pressure to which an individual is actually exposed and not that felt at sea-level, perhaps 1000 feet below him, which is required in investigations as to the influence of climate on health.

This view was evidently shared by the compilers of the Atlas, for each map bears the following "Note":—

"The approximate mean pressure for the month (or year) may be found by subtracting from the pressure indicated by the nearest isobars a correction obtained as follows:—from 1·21 inch, subtract for each 10° above zero, Fahr., 0·025 inch; the residue will be the correction for an elevation of 1000 feet, and the correction for the actual elevation will be proportional to this."

The barometrical maps, moreover, are full of interest, particularly as the monthly distribution of pressure gives a clue to the direction and force of the predominant winds.

In this series of maps, isobars have been drawn for the even hundredths of an inch of pressure so as to correspond as nearly as practicable with the actual observations recorded. The readings are reduced to sea-level and also to 32° F.

In the chart for the whole year, and indeed in that for every one of the twelve months, the isobars have a cyclonic or concave trend in the north, but an anticyclonic or convex trend over the south of the United Kingdom. This at once explains the more settled weather of the south contrasted with the less settled weather of the north. Next, we observe that throughout the year pressure is on the average lower in the north than in the south. The differences in pressure are not uniform, however, throughout the year. Thus, in January, the isobar of 29·66 inches runs across the extreme north of Scotland from south-west to north-east, that of 29·98 inches crosses Kent in a north-easterly direction. Here we have a difference of pressure amounting to ·32 of an inch and gradients for *south-westerly* winds over the whole kingdom. This dif-

ference steadily diminishes from January through February (when it is  $\cdot 22$  inch— $29\cdot 74$  and  $29\cdot 98$  inches), March ( $\cdot 14$  inch— $29\cdot 76$  and  $29\cdot 90$  inches), April ( $\cdot 10$  inch— $29\cdot 86$  and  $29\cdot 96$  inches), to May, when it is only  $\cdot 08$  inch— $29\cdot 91$  inches and  $29\cdot 99$  inches. It will at once occur to the reader that this equalisation of pressure means the dying out of the strong south-west winds of winter and the interspersing of a large proportion of easterly winds with the predominant westerly winds of our latitudes. Once May has passed a gradual reverting to the winter type of distribution may be noticed, thus :—

<i>June</i>	N. $29\cdot 88$ inches ;	S. $30\cdot 01$ inches—	difference,	$\cdot 13$ inch.
<i>July</i>	N. $29\cdot 84$ ,,	S. $30\cdot 00$ ,,	,,	$\cdot 16$ inch.
<i>August</i>	N. $29\cdot 82$ ,,	S. $29\cdot 98$ ,,	,,	$\cdot 16$ inch.
<i>September</i>	N. $29\cdot 76$ ,,	S. $29\cdot 96$ ,,	,,	$\cdot 20$ inch.
<i>October</i>	N. $29\cdot 72$ ,,	S. $29\cdot 92$ ,,	,,	$\cdot 20$ inch.
<i>November</i>	N. $29\cdot 74$ ,,	S. $29\cdot 94$ ,,	,,	$\cdot 20$ inch.
<i>December</i>	N. $29\cdot 70$ ,,	S. $29\cdot 98$ ,,	,,	$\cdot 28$ inch.

I have compared these values with those given in Dr. Buchan's charts of the isobars, showing in inches the mean atmospheric pressure of the British Isles, monthly and yearly, on an average of twenty-four years, ending with 1880, and I find a remarkable agreement between the two sets of observations. In November, however, the mean pressure for the north of Scotland is given by Dr. Buchan as  $29\cdot 78$  inches.

A necessary consequence of the changes in the monthly distribution of atmospheric pressure above indicated is, that January is the stormiest month in the British Isles. A careful analysis of the reports of storms received at the Meteorological Office, London, for the fourteen years, 1870-1883, has led Mr. R. H. Scott to the conclusion that there is no strongly-marked storm-maximum at either equinox—in September storm prevalence is increasing from a marked minimum in June and July; in March it is decreasing from a sharply-defined maximum in January. Equinoctial gales, as such, are non-existent.<sup>1</sup>

<sup>1</sup> *Quarterly Journ. of the Roy. Met. Soc.*, vol. x., 1884, p. 236.

## CHAPTER XXVII

### THE CLIMATE OF THE BRITISH ISLANDS (*continued*)

Distribution of Rainfall in the British Islands—Regions of heaviest Rainfall—How determined: Prevalent Winds, Exposure to these Winds, Mountains—Regions of least Rainfall—Geological Formation—Its Local Influence on Temperature—Permanent Elevation of Surface—Pebble Beds, Sands, and Sandstones—Clays and Shales—Limestones—Crystalline Rocks, whether Slates or Schists—Climatological Tables for Dublin.

#### IV.—RAINFALL

It is well said by Dr. A. Buchan, in his third paper on the Climate of the British Islands,<sup>1</sup> that, as regards these islands, the greatest differences in local climates arise from differences in the rainfall. Thus, on comparing the climate of Skye with that of the southern coasts of the Moray Firth, their mean temperatures in no month differ so much as 2·0°, and for several months of the year they are nearly identical. But the annual rainfall of Skye rises to, and in many places exceeds, 100 inches, whereas at Culloden it only amounts to 26·17 inches, and at Burghead to 25·23 inches. This difference in the rainfall, with the clear skies and strong sunshine which accompany it, renders the south shore of the Moray Firth one of the finest grain-producing districts of Scotland. It is this aspect of the rainfall which gives it so prominent a place in the climatology of a country.

<sup>1</sup> *Journal of the Scottish Meteorological Society.* New Series. Vol. vii. page 131. 1886.

Dr. Buchan's article on "The Annual Rainfall of the British Islands" is based on observations of the rainfall made at 547 stations in Scotland, 1080 in England and Wales, and 213 in Ireland; in all, 1840. The period selected for discussion was the twenty-four years extending from 1860 to 1883, inclusive. Dr. Buchan handsomely acknowledges his obligations to Mr. Symons's *British Rainfall*, a publication which rendered such an inquiry possible. The observed, but in some instances calculated, twenty-four years' averages were transferred to a map of the British Islands, which was then coloured with six different tints—these shadings showing the districts where the mean annual rainfall did not exceed 25 inches (*pale pink*), was from 25 to 30 inches (*red*), from 30 to 40 inches (*dark red*), from 40 to 60 inches (*pale blue*), from 60 to 80 inches (*blue*), and, lastly, above 80 inches (*dark blue*).

In the "Meteorological Atlas of the British Isles" (1883), the rainfall for the whole year is shown on a map by lines drawn, for each 5 or 10 inches of rain, from place to place having the same annual rainfall. This rainfall map was constructed by plotting on a large scale all the mean annual rainfall values for the fifteen years, 1866 to 1880, inclusive, which are given in "Rainfall Tables of the British Isles," compiled from the records of 366 stations by Mr. G. J. Symons, F.R.S., and published by the authority of the Meteorological Council in 1883. The rainfall indicated by the lines upon a map, drawn on a reduced scale for the Atlas, is the mean quantity actually observed at these selected stations. It is not claimed that this map is perfect, for a much larger amount of rain is known to fall in some places, notably on mountain slopes, of which no such record exists as to admit of its being shown on so small a map. In Ireland and the west of Scotland this defect is aggravated by the fact that for large areas no record whatever is obtainable for the period embraced in the inquiry.

It should be mentioned that the Rainfall Tables, prepared by Mr. Symons at the request of the Meteorological Council,

are illustrated by three coloured maps of England, Scotland, and Ireland, respectively, which exhibit, not only the geographical position of the 366 stations furnishing the rainfall records, but also the area in square miles of the river catchment basins in which these stations are severally situated.

The key to the distribution of rainfall in the British Islands is "the direction of the rain-bearing winds in their relation to the physical configuration of the surface" (Buchan).

The regions of heaviest rainfall, 60 to 80 inches or upwards, are: Skye and the Western Highlands, the Lake District in Cumberland and Westmoreland, the mountainous district in North Wales, the mountainous district in the south-east of Wales, Dartmoor in Devonshire, the Highlands of West Galway, and the neighbourhood of Killarney and the Macgillicuddy Reeks in Kerry. This distribution of heavy rainfall is determined by—1, prevalent south-west winds, blowing vapour-laden from the Atlantic Ocean; 2, the exposure to these winds of mountains, or high tablelands like Dartmoor, with valleys opening to the westward or south-westward. On the mountain slopes the warm, moist air is condensed into mist, cloud, and rain.

Over the south of Scotland the rainfall is not excessive, because the rain-bearing south-westerly winds have been partially dried in their passage across Ireland before they reach the district in question.

The absolutely largest annual rainfalls are—in *Scotland*, at Glencroe, Argyllshire, at an elevation of 520 feet (128·50 inches); in *England*, at the Styne, Cumberland, 1077 feet (185·96 inches—so far as yet observed, the heaviest rainfall anywhere in the British Islands), at Seathwaite, Cumberland, 422 feet (143·21 inches in the twenty-four years, 1860-83; 139·29 inches in the fifteen years, 1866-80); in *Wales*, at Beddgelert, Carnarvonshire, 264 feet (116·90 inches), Rhiwbrifdir, Merionethshire, 1100 feet (102·56 inches), Ty-Draw-Treherbert, Glamorgan, 735 feet (96·18 inches); in *Ireland*, at Kylemore, County Galway, 105 feet (89·40 inches),

at Foffany, County Down, 920 feet (72·26 inches), and at Derreen, Kenmare, County Kerry, 74 feet (69·40 inches).

A rainfall of 40 inches a year, or upwards, occurs over about a fourth part of the surface of England and Wales, about half of that of Ireland, and considerably more than half of that of Scotland (Buchan). Nowhere along the whole east coast of Great Britain, or for some distance inland, does the average yearly rainfall reach 40 inches. On the east coast of Ireland, however, the rainfall rises to, or exceeds, 40 inches in the mountainous districts of Wicklow, Down (the Mourne Mountains), and Antrim. On the other hand, the annual rainfall is well below 30 inches in Dublin and its vicinity, for reasons which have been already explained.

Wherever mountains or "downs" run east and west, a heavy rainfall is propagated eastwards along their southern face, while the precipitation is diminished to the northward of the barrier which they oppose to the rain-bearing south-west winds. Thus the mountains of Sutherland, the Grampians, the Cheviots, the Pennine range, and the Downs of the south of England, all cause an extension eastward of a heavier rainfall along their southern slopes, but a diminution in the rainfall to the northward and north-eastward. Precisely the same thing on a smaller scale is found in connection with the Pentland Hills, near Edinburgh, the Mourne Mountains in the County Down, and the Dublin and Wicklow mountains. Leith (28·00 inches), Edinburgh (28·31 inches), Donaghadee (31·08 inches), and Dublin (28·36 inches), all owe their comparatively small precipitation to their geographical position north-east of the mountain ranges mentioned. The rainfall at Belfast (Queen's College) is, on the average, 34·73 inches. This is no doubt due to the proximity of Divis and other mountains north-west of the city, heavy rains falling with south-east winds, which impinge upon those hills.

"The influence of the breakdown of the watershed of Scotland between the Firths of Forth and Clyde," writes Dr. Buchan, "is strikingly manifested in the overspreading

of western parts of Perthshire, Stirlingshire, and Dumbar-tonshire, with a truly western rainfall as regards amount, and the direction of the winds with which it falls; and in the extension eastwards, through Kinross-shire, of a rainfall of fully 40 inches, which occurs nowhere else over comparatively level plains so far to the east of the watershed separating the western and eastern districts."

Turning to the regions of least rainfall, we find a large area in England extending from the Humber to the estuary of the Thames (exclusive of the higher grounds of Lincoln and Norfolk), over which the annual precipitation falls short of 25 inches. In Cambridgeshire it is generally about 23 inches, except at Wisbech Observatory, where it rises to  $26\frac{1}{2}$  inches. The smallest rainfall of all is at Shoeburyness, in Essex, where the average for the eighteen years, 1866-83, was only 21.42 inches. In 1874, only 14.20 inches fell at this station. On the higher grounds of Lincoln and Norfolk the rainfall exceeds 25 inches, because the precipitation with easterly winds is increased. Similarly the rainfall of the Yorkshire Wolds is made to exceed that of neighbouring districts. A small patch in the valley of the Thames, from Kew to Marlow, in Bucks, has an annual fall of less than 25 inches—Kew Observatory, twenty-four years, 1860-83 = 25.26 inches; fifteen years, 1866-80 = 24.67 inches. Between the valley of the Thames and the Humber, the rainfall nowhere reaches 30 inches, except near the Chiltern Hills (Buchan).

In Scotland, the annual rainfall falls short of 30 inches in the north-eastern part of Caithness, round the Moray Firth from Tain to the mouth of the Spey, along the east coast from Peterhead in Aberdeenshire to Burntisland in Fifeshire, the low ground of Midlothian and East Lothian, and lower Tweeddale from Kelso to Berwick. The absolutely smallest rainfalls are observed on the very shores of the Moray Firth from Tarbet-Ness to Burghead (25 to 28 inches), the extreme north-east of East Lothian (25 to 29 inches), and the lower Tweed from Coldstream to Jedburgh ( $26\frac{1}{2}$  inches).

The only part of Ireland where the rainfall falls short of 30 inches is Dublin and its vicinity (about 28 inches). The reason for this diminished rainfall has been given above.

#### V.—GEOLOGICAL FORMATION

In a lecture on "The Physical Influences which affect the British Climate," delivered early in the year 1893, in the Public Health Department of King's College, London,<sup>1</sup> Mr. H. G. Seeley, F.R.S., Professor of Geography in the College, aptly observes: "The areas of heavier rainfall are the regions of higher land, and a rainfall map in England closely approximates in its broad features to a geological map." Allusion has already been made to the marked influence on rainfall exercised by the high lands and mountain chains in various parts of the United Kingdom. The configuration of the coast line and the distribution of high and low ground govern the rainfall to a remarkable extent, and in this way control climate generally. As Mr. Seeley remarks: "Next to the situation of our islands upon the earth's surface, the most important element in climate is the geological structure, and contour of the surface of the country."

In his lecture, Professor Seeley shows that there are two ways in which the geological structure affects climate: first, it has a local influence on temperature; secondly, it is a main element in modifying the relative durability of the rock material which determines the elevation of the surface. It would be foreign to the purpose of this book to enter into details as to the geology of the British Islands. Suffice it to say, with Professor Seeley, that the chief geological formations which have a bearing upon climate may be classed as (1) pebble beds, sands, and sandstones; (2) clays and shales; (3) limestones. There are, in addition, certain altered conditions of these simple forms, in which a more or less crystalline texture is developed, which may be the micro-crystalline texture of slate or the micro-crystalline texture of schist.

<sup>1</sup> See *The Journal of State Medicine*, vol. i. No. 4, p. 165. April 1893.



1. The pebble beds, sands, and sandstones are commonly warmer and drier than other rocks. Their *dryness* is due to the existence of porous interspaces between the quartz grains of which these rock forms are so largely composed. This wholesome property may be interfered with by the presence of a cement which will bind the grains of quartz together, or of a bed of clay, which will render the sand impervious. The dryness, or otherwise, of sand strata will also largely depend on the angle at which they are inclined; horizontal strata are naturally less dry than inclined strata. The *warmth* of a sandy soil is probably due to its dryness as well as to the low specific heat of the quartz.

2. The particles of which *clays* are composed are extremely small and consist chiefly of silicate of alumina. Some clay soils contain as much as 40 per cent of alumina, but the usual proportion is much smaller. In Scotland, clay soils are found chiefly on the coal-measures, the boulder clay, and as alluvium in the valleys. The last named is the richest form of clay and is known as *carse* clay. In the north of England, the aluminous shales of the coal-measures yield soils in their properties very like those in Scotland. England also abounds in clay soils derived from other geological formations such as London clay, plastic, weald, gault, and blue lias clay. An astonishing quantity of water may be held in a clay soil, which has an almost boundless affinity for moisture. In a warm, dry summer, wide and deep chasms open in clay owing to the evaporation of the water it contains. Clay land is looked upon as cold—a condition attributed by Professor Seeley, theoretically, to the small size of its constituent particles and the way in which they are divided from each other by films of water. Through evaporation from a clay soil, the superincumbent atmosphere is rendered moist and cool. Precisely the same effect is produced in Ireland by the water-soaked morasses or *bogs*, which, according to Sir Robert Kane, M.D., cover 2,830,000 acres, or about one-seventh part of the entire surface of the island. The Bog of Allen stretches

in a vast plain across the centre of the island, having a summit elevation of 280 feet. Its apparent influence on the mean temperature has been alluded to above.

Owing to the retentive and non-porous nature of clay soils, there is no deep filtration and underground storage of water. The superficial strata become water-logged, and the imprisoned waters are very liable to contamination with surface impurities or with the products of chemical decomposition in the clay itself.

3. The third great group of water-formed rocks is the *limestones* (Seeley). The carboniferous limestone covers an immense area in the Pennine chain and North of England, and forms the base of nearly all our coalfields. It also underlies the peat-moss bogs of Central Ireland. The oolitic limestones, more or less continuous, and chalk, stretch from the Yorkshire coast to the South of England, forming parallel ridges of hills. Being soluble under flowing waters charged with carbonic acid gas, the surface is always deeply scored with valleys (Seeley). The ancient and oolitic limestones are not as absorbent as the newer chalk, which is very pervious to water. As water percolates through these limestones, it becomes highly charged with lime salts. According to Professor Seeley, limestones always give up a good deal of vapour under sunshine, and have a warm steamy atmosphere above them in summer, which is in marked contrast to the bracing air of sandstones with silicious or calcareous cements. When there is even a thin bed of clay on the summit of a limestone ridge, such as forms the insoluble residue left by atmospheric denudation, the climatic conditions are changed.

4. The crystalline rocks, whether slates or schists, usually occur in elevated country in the west of England, in Scotland, and in parts of Ireland. They are remarkable, chiefly, for their impervious and almost insoluble character. "The high and irregular ground which they form, like their western position, causes them to have a great effect in radiating heat, and therefore in producing winds which descend from the mountainous regions, and in condensing rain."

Professor Seeley, in the paper from which I have so largely quoted, observes with justice that "the influence of the soil upon climate is complicated by the effects of the climate in transporting and forming the superficial soil."

The foregoing sketch of the Climate of the British Islands may fitly conclude with two Climatological Tables for the City of Dublin, lat. 53° 20' N., long. 6° 75' W., altitude 50 feet.

The materials for these Tables were obtained in the preparation of an Abstract of Observations taken by me in the City of Dublin during the twenty-three years, 1865-1887, inclusive. This abstract was compiled at the request of M. L. Cruls, the Director of the Imperial Observatory at Rio de Janeiro, Brazil, who undertook to prepare a *Dictionnaire Climatologique Universel*, the publication of which was to be under the care and at the expense of the Observatory of Brazil.

TABLE I.—TEMPERATURE, HUMIDITY, CLOUD, RAIN, AND WIND

	TEMPERATURE			RELATIVE HUMIDITY Mean Percentage	CLOUD— Percentage of	RAIN		WIND			FROSTS— 32° or less in Screen
	Mean	Mean Max.	Mean Min.			Amount in Inches	Number of Rainy Days	General Directions	Number of Gales	THUNDER—No. of Times heard	
January	41°·3	45°·3	37°·3	85·4	64	2·241	17·7	S. W. & W.	120	3	148
February	43°·0	47°·2	38°·8	84·9	66	2·183	17·3	W. & S. W.	94	4	71
March	43°·3	48°·2	38°·3	81·9	60	2·030	16·4	W. & N. W.	96	3	128
April	47°·8	53°·6	42°·0	79·6	56	2·034	14·8	E. & W.	50	8	14
May	51°·9	58°·2	45°·5	75·9	55	2·072	15·5	E.	51	17	2
June	57°·8	64°·3	51°·3	76·8	60	1·839	14·0	W. & N. W.	23	33	0
July	60°·8	67°·2	54°·4	78·0	62	2·350	17·1	W.	29	53	0
August	59°·8	65°·9	53°·7	81·9	58	2·766	15·3	W.	44	20	0
September	55°·8	61°·4	50°·2	84·3	56	2·288	15·0	W. & S. W.	71	10	0
October	49°·8	54°·6	44°·9	85·5	59	3·111	17·4	N. W. & S. W.	87	12	12
November	44°·5	48°·7	40°·3	85·9	62	2·340	16·9	W. & N. W.	85	7	62
December	41°·1	45°·1	37°·1	85·7	61	2·419	17·0	W. & S. W.	119	1	174
Annual Means	°	°	°	%	%	Inches		W. & S. W. & N. W.	869	171	611

The extreme temperatures recorded in the thermometer screen were :—

Highest, 87·2°, on July 16, 1876.

Lowest, 13·3°, on December 14, 1882.

The average relative humidity and the average percentage of cloud are based on eighteen years' observations at 9 A.M. and 9 P.M. from 1870 to 1887, both inclusive.

TABLE II.—ATMOSPHERIC PRESSURE

Year	Mean Height of Barometer	Max. Height of Barometer	Min. Height of Barometer	Annual Range of Pressure
	Inches	Inches	Inches	Inches
1865	29·956	30·860	28·310	2·550
1866	29·869	30·700	28·570	2·130
1867	29·952	30·670	28·600	2·070
1868	29·949	30·670	28·770	1·900
1869	29·950	30·610	28·660	1·950
1870	29·940	30·615	28·587	2·028
1871	29·886	30·538	28·460	2·078
1872	29·737	30·402	28·397	2·005
1873	29·930	30·728	28·345	2·383
1874	29·944	30·866	28·556	2·310
1875	29·964	30·673	28·715	1·958
1876	29·863	30·662	28·448	2·214
1877	29·852	30·700	28·303	2·397
1878	29·921	30·712	28·720	1·992
1879	29·923	30·717	28·820	1·897
1880	29·964	30·676	28·373	2·303
1881	29·910	30·737	28·377	2·360
1882	29·881	30·935	28·718	2·217
1883	29·923	30·802	28·573	2·229
1884	29·942	30·729	28·150	2·579
1885	29·902	30·657	28·413	2·244
1886	29·884	30·776	27·758	3·018
1887	30·015	30·681	28·538	2·143
Means	29·916	30·701	28·485	2·216

The average annual atmospheric pressure in the twenty-three years was 29·916 inches.

The average annual oscillation of atmospheric pressure (barometric range) was 2·216 inches.

The maximal reading of the barometer in the twenty-three years was 30·935 inches, on January 18, 1882.

The minimal reading of the barometer in the twenty-three years was 27·758 inches, on December 8, 1886.

The extreme barometrical range was 3·177 inches.

The climate of the British Isles is essentially windy or even stormy. Hence the following will prove of interest to the student of that climate.

In a paper read before the Royal Meteorological Society, on June 20, 1894, Mr. R. H. Curtis stated that the greatest force of an individual gust which he had met with was registered in December, 1891, and amounted to a rate of 111 miles per hour, which with the old factor would be equivalent to a rate of about 160 miles per hour. Gusts at a rate of from 90 to 100 miles per hour have many times been recorded, but the usual limit for gusts may be taken to equal about 80 miles per hour, which on the old scale would be equivalent to about 120 miles per hour. Gales and strong winds differ much in character. There are gales which are essentially squally. In these the gusts constitute the main feature. In an average gale the ordinary gusts occur at intervals of about ten to twenty seconds; the extreme gusts at intervals of about a minute. Another class of gales show a tolerably steady wind-velocity. In the third class are gales which appear to be made up of two series of rapidly succeeding squalls; the one series at a comparatively low rate of velocity, the other at a much higher one, the wind-force shifting rapidly, and very frequently from one series to the other. Mr. Curtis had not infrequently found very distinctly marked in the anemometer tracings a prolonged pulsation in the wind-force, which recurs again and again with more or less regularity, sometimes every twenty minutes or half an hour, sometimes at longer intervals of about an hour or so.

## PART IV.—THE INFLUENCE OF SEASON AND OF WEATHER ON DISEASE

### CHAPTER XXVIII

#### ACUTE INFECTIVE DISEASES

Introductory Remarks—Dr. William Heberden's Observations on Weather and Disease in 1797—Meteorological Factors which influence the Prevalence and Fatality of Disease: Mean Temperature, Rainfall, Humidity—Acute Infective Diseases: Influenza, Cholera, Diarrhoeal Diseases—Dr. Edward Ballard's Researches—Influence of the Temperature of the Soil—The critical Subsoil Temperature of 56° F. at a depth of Four Feet—Dr. E. Meinert's Observations on Cholera Infantum—Dr. Ballard's working Hypothesis.

OBSERVATIONS as to the influence of weather upon health are as old as meteorology itself—nay older, if we admit that Aristotle was the founder of the Science. More than four hundred years before Christ, Hippocrates of Cos, the "Father of Medicine," had penned his immortal "Aphorisms," and had written "*Περὶ ἀέρων, ὑδάτων, τόπων*" ("On Air, Waters, and Places") and "*Περὶ διαίτης*" ("On Regimen"). In these works we meet with passages as applicable to-day as they were twenty-three centuries ago.

The suggestions thrown out by the Greek physician were allowed to remain almost a dead letter. His doctrines as to the close relations of climatology to medicine became dimmed by the rust of time, and were neglected or forgotten.

In the "Introduction" to his splendid *Geographical and Historical Pathology*, August Hirsch observes that only in a few of the best Greek and Roman medical authors, such as Celsus, Asclepiades, and Aretaeus, do we find here and there indications that they gave some attention to the various effects of "climate" and "diet" upon the human organism in health and disease. Such questions were unfamiliar to the physicians of the Middle Ages; and it was only in the sixteenth century that naturalists and physicians again began to investigate the changing aspects of organic life, including the life of man, in various quarters of the globe.

That in these countries but little attention was given to the subject is evident from the antiquity and popularity of the proverb: "A green Christmas makes a fat churchyard." Even Sydenham stated<sup>1</sup> that a prevailing epidemic ceased on the approach of winter—a statement which is no doubt true in the case of Asiatic cholera, but is of by no means universal or even common application. On the whole, however, Sydenham's observations on the dependence of disease on season are accurate and well worth perusal.

The first modern paper on Weather and Disease was a communication made to the Royal Society in 1797 by Dr. William Heberden, jun., F.R.S., on the "Influence of Cold on the Health of the Inhabitants of London."<sup>2</sup> The author showed that a difference of above 20° between the mean temperatures in London in January 1795, and that in the same month of 1796—the former being an excessively cold month, and the latter an equally mild one—caused the deaths in January 1795 to exceed those in January 1796 by 1352.

In my remarks on the Influence of Season and Weather on Disease, I shall confine myself almost exclusively to three meteorological factors—*mean temperature*, *rainfall*, and *humidity*; of these, the first is the most important, as it is

<sup>1</sup> Swan's *Sydenham*, p. 9. 1769.

<sup>2</sup> *Philosophical Transactions*, vol. lxxxvi. No. 11.

in truth the resultant of many other factors. In the following chapters we shall consider the influence of season and weather upon some of the principal Acute Infective Diseases.

## ACUTE INFECTIVE DISEASES

### 1. *Influenza*

On February 28, 1890, I read a paper on the "Influenza Epidemic of 1889-90, as observed in Dublin," before the Royal Academy of Medicine in Ireland. The two earliest cases of the disease which came under my notice dated from Thursday and Friday, December 5 and 6, 1889, respectively. The outbreak was at its height in the first half of January 1890, a month which proved one of the sickliest ever experienced within living memory. The whole "Epidemic Constitution"—to use Sydenham's classical phrase—was changed for the worse; the power of resisting disease was lessened; and extreme languor and prostration passed over the population like a pandemic. Towards the close of January the epidemic waned, but in the middle of February there was a recrudescence of it. The duration of the outbreak was practically eleven weeks. In Dublin while the mean temperature of the first two weeks of the epidemic period was about equal to the average, a remarkable excess of temperature afterwards set in, lasting for at least five weeks, and culminating in the second and third weeks of the new year, the mean temperatures of which were no less than  $7\cdot5^{\circ}$  and  $7\cdot9^{\circ}$  respectively above the average. Now, if any one fact has been established in relation to the winter death-rate in Dublin, it is that the deaths from all causes, and particularly from diseases of the respiratory organs, such as bronchitis and pneumonia, vary in number inversely with the temperature. If the thermometer is high in winter the death-rate is moderate or low; if the thermometer is low, the death-rate is high.



For example, the mean temperature of the first six weeks of 1881 was only  $35.6^{\circ}$ , or  $5.4^{\circ}$  below the average. The mean weekly number of deaths from all causes in that period were  $40.1$  above the average in a population of 350,000; and the mean weekly number of deaths from diseases of the respiratory organs were  $29.1$  above the average. On the other hand, in 1884, the mean temperature of the first six weeks was  $45.1^{\circ}$ , or  $4.1^{\circ}$  above the average. The mean weekly number of deaths were  $37.2$  below the average, while the mean weekly number of deaths from respiratory diseases were  $19.2$  below the average.

And now we come to the opening six weeks of 1890, when the mean temperature shows an excess comparable with that of 1884—it was  $44.2^{\circ}$ , or  $3.2^{\circ}$  above the average, and only  $0.9^{\circ}$  below the value for 1884. Under these circumstances, a low rate of mortality from all causes, and especially from respiratory diseases, was to have been looked for. But how different were the facts! The mean weekly number of deaths were  $60.8$  above the average— $285.0$  against  $224.2$ . The mean deaths from respiratory diseases were  $40.0$  above the average— $98.7$  against  $58.7$ . The mean weekly deaths from bronchitis were  $65.0$ , compared with the average,  $42.4$ ; while the mean weekly deaths from pneumonia were  $23.3$  compared with an average of  $8.6$ .

It is of interest to observe that, whereas the deaths referred to bronchitis were only 53 per cent in excess of the average, those referred to pneumonia were no less than 171 per cent in excess.

The prime cause of this heightened death-rate at the beginning of 1890 was manifestly the epidemic of influenza, which proved more pernicious to the population of Dublin than the extreme cold of January 1881.

But the incidence of the outbreak in a winter month was only accidental. Recent experiences confirm Hirsch's statement that influenza has prevailed in all seasons of the year, in all climates, independently of telluric conditions, and under

the most various states of the weather—high and low temperature, steady and changeable weather, much or little atmospheric humidity. There is not the slightest ground for assuming a causal relation between the production of influenza and certain states of the barometer. Hirsch gives a table embracing 125 epidemics or pandemics, which ran their course independently of one another; and of these outbreaks, 50 are shown to have begun in winter (December to February), 35 in spring (March to May), 16 in summer (June to August), 24 in autumn (September to November). Certainly winter comes out very decidedly as the season of the year most favourable to the setting up of the disease, but we must remember that an epidemic once developed runs its course equally through all seasons of the year, of which fact the pandemics of 1580, 1781-82, 1831, 1832-33, 1836-37, are striking illustrations.

We may conclude then that the prevalence of this strange disease is absolutely independent of season and weather—a fact which distinguishes influenza from epidemic bronchial catarrh.<sup>1</sup> “Et tempore frigidiori et calidiori, et flante tam Austro quam Borea, et pluvioso et sereno cœlo, peragravit hasce omnes Europæ regiones, et omnia loca indiscriminatim.”<sup>2</sup> As Morgagni says: “Tempestate frigidâ et siccâ, cœlo die noctuque sereno.”

## 2. Cholera

That cholera tends to prevail in the warmer months of the year is sufficiently borne out by the history of the disease. In the accompanying Table are given the deaths from the disease by months in some of the great epidemics of late

<sup>1</sup> Hirsch. *Handbook of Geographical and Historical Pathology*, vol. i. p. 26. New Syd. Soc. 1883.

<sup>2</sup> Petrus Salius Diversus, cited by Dunning (*Med. and Phys. Journal*, vol. x. p. 43), and quoted by Dr. Thomas Hancock in an excellent article on Influenza in the second volume of the *Cyclopædia of Practical Medicine*, published in 1833.

years, and the figures speak for themselves. In one case, that of Limerick, 1849, we meet with an early spring epidemic, and in January of the same year a large mortality from cholera prevailed in England. But these exceptions only prove the rule. If from the totals we omit the Paris outburst of April 1832, in which city the epidemic kindled into flame for the second time in July of that year, we have an increasing series of deaths from February to September, and a decreasing series from the last-named month to December.

“Real epidemics of cholera,” writes Professor Faye,<sup>1</sup> “in the more rigorous season of winter have very seldom occurred, while sporadic cases have very frequently shown themselves even in winter. At Breslau a winter epidemic prevailed in 1848-49, continuing from October till March, with the same fatality as had characterised summer epidemics at the same place; and at St. Petersburg, as in several of the districts of Russia, cholera has prevailed in winter, although to a far less degree than in summer, so that the Russian physicians have often declared that the disease is prevalent in the winter quarter. At Bergen, in Norway, the epidemic of 1848-49 was also a winter epidemic. It is therefore not altogether without reason that cholera has been stated to observe no season; but if we take into consideration both the relative infrequency of its appearance in winter, and its impaired virulence under intense degrees of cold, this assertion as to the compatibility of the disease with a winter temperature experiences a very important limitation. Perhaps the explanation of the matter is not very remote. At Bergen, for example, the winter is often rainy and the air in proportion mild, so that the freezing of the earth’s surface to any depth does not occur; and the winter of 1848-49 was really of this kind. It is well known also that cholera at St. Petersburg in winter time is almost exclusively confined to the unhealthy

<sup>1</sup> “Om Cholera-Epidemien i Norge i Aaret, 1853.” (“On the Cholera Epidemic in Norway, in the year 1853.”)

TABLE I.—Showing the Deaths from Cholera, by Months, in several Epidemics, since 1832, in various Cities and Countries of Europe.

MONTHS.	England, 1832.	England, 1849.	Paris, 1832.	Paris, 1849.	Dublin, 1849.	Limerick, 1849.	Dublin, 1866.	Sweden, 1834.	Sweden, 1850.	Sweden, 1866.	Christiania, 1833.	Christiania, 1850.	Christiania, 1853.	Christiania, 1866.	Paris, 1892.	Hamburg, 1892.	TOTALS.
January	614	658	?	?	2	0	0	?	?	0	0	0	0	0	0	0	1,274
February	708	371	?	?	6	6	0	?	?	0	0	0	0	0	0	0	1,091
March	1519	302	90	573	8	591	1	?	?	0	0	0	0	0	0	0	3,084
April	1401	107	12,733	1929	32	143	0	?	?	0	0	0	0	0	0	0	16,345
May	748	327	812	4509	197	4	1	?	?	0	0	0	0	0	0	0	6,368
June	1363	2,046	868	8669	477	1	0	?	?	4	0	0	0	0	19	0	13,647
July	4816	7,570	2,573	865	314	0	2	30	0	483	0	0	6	0	78	0	16,737
August	8875	15,872	969	1382	276	0	74	5904	209	943	0	0	164	8	211	3030	37,917
September	5479	20,379	357	1142	298	1	270	6124	213	1209	0	0	1356	20	535	4500	41,903
October	4080	4,654	62	115	49	0	508	490	880	508	262	50	60	0	102	100	11,920
November	802	844	?	?	5	0	273	58	342	30	538	37	11	0	6	2	2,948
December	140	163	?	?	0	0	66	31	87	1	17	0	0	0	16	16	537

houses situated on the low and swampy banks of the Neva, belonging to an indigent labouring population ; and, indeed, it is not strange that low-lying and over-crowded cellars, beneath which the soil has scarcely stiffened, with a favourable and confined oven-temperature, should foster the contagion and occasion a constant, though tardy, propagation of the disease. Whether conditions of this kind held at Breslau I am unable to say ; but, in any case, it is certain that violent epidemics during severe winter-frost very rarely, if, indeed, ever, occur."

Professor Faye goes on to say that, while the epidemic (of 1853) was at its worst at Christiania, the atmosphere was steadily warm and the air, in addition, clear and very still. This continued for about three weeks, during which the daily numbers of cases, which were then at the highest, scarcely varied. At this point of time—the middle of September—the air was set in motion by a strong and stormy north-west wind, and, remarkably enough, the number of cases fell, *next day*, to about one-half. Similarly, at Bergen, during the epidemic of 1848-49, a strong and cold north-easterly gale, supervening on a lengthened period of milder temperature, caused a considerable fall in the number of cholera cases.

In the epidemic of 1866 the acme of mortality from cholera was reached in Dublin about the middle of October, the weather of the preceding week having been continuously *calm, cloudy, foggy, damp, with a very high barometer, and a great deficiency of ozone* (the latter showing a mean value of only 10 per cent at the Ordnance Survey Office, Phoenix Park).

The decrease in the mortality was consequent on a freshening breeze and a change of wind from N.E. to S.W., a diminution of barometrical pressure, a moderate and continued rainfall, a rise in ozone to 70 per cent, and a gradually falling temperature. The coincidence of a high barometer with a great development of cholera has often been remarked, but striking exceptions are also on record.

Keeping in view the fact that heavy rain and a strong breeze are most valuable detergents and disinfectants, it seems probable that the *calm weather* consequent on slight barometrical gradients, so common in anticyclonic, or high-pressure systems, has more influence than the mere height of the barometer itself. In December, the epidemic died out rapidly, and no death occurred later than the 29th of that month, on which day—it is most interesting to note—the intense frost of January 1867, was ushered in by a fall of temperature amounting to 15° in a few hours.

The meteorological conditions just alluded to, and the influence of season, are to be classed among the *predisposing* causes of cholera. Its *exciting* cause is, of course, the introduction into the human system, and particularly the intestinal canal, of the specific virus or contagium of the disease, the *comma-bacillus* of Koch. I thoroughly agree with Mr. Ernest Hart when he says with uncompromising dogmatism: "We may lay aside all pedantry and mystery-talk of 'epidemic constitution,' 'pandemic waves,' 'telluric influences,' 'cholera blasts,' 'cholera clouds,' 'blue mists,' and the like terms of art with which an amiable class of meteorologists have delighted to cloak ignorance. Asiatic cholera is a *filth disease, which is carried by dirty people to dirty places.*" "Cholera," he adds, "does not travel by air waves or blasts. We can drink cholera and eat cholera, but we cannot 'catch' cholera in the sense in which we catch measles, scarlatina, or whooping-cough. Cholera is carried by men in their clothing and their secretions along the lines of human intercourse. Earlier epidemics of Asiatic cholera took three years to reach us, by caravan and fitful travel, from its Asian home. It comes now not as a pedestrian or a horseman, but by locomotive and fast steamboat." I believe that cholera is taken precisely as enteric fever is taken, that is, it is most usually swallowed in water, less commonly in milk, or it is eaten in solid food, or exceptionally it is inhaled and swallowed with the saliva when a liquid medium containing its virus has

evaporated, leaving that virus to be air-borne for a short distance. Further, I am satisfied that cholera, like *cholera nostras* or cholérine, and enteric fever also, becomes much more virulent when the subsoil temperature reaches the critical point of 56° F. at four feet below the surface. As this occurs most readily when the level of the subsoil water (German, *Grundwasser*) is low, the significance of Pettenkofer's theory is at once evident. That veteran sanitarian says in one of his later papers :<sup>1</sup> "The fluctuations in the level of the subsoil water have a meaning for ætiology, only because they are traced back to those primary influences by which air and water are made to share, in varying proportion, the possession of the pores of an impregnated soil. Beyond that they have no significance."

### 3. Diarrhœal Diseases

These propositions may be laid down :—

1. In summer and autumn the tendency to sickness and death is chiefly connected with the digestive organs—diarrhœa, dysentery, and simple cholera or cholérine (*cholera nostras*), being the affections which are especially prevalent and fatal during these seasons.
2. In summer and autumn a rise of mean temperature above the average increases the number of cases of, and the mortality from, the diseases named.
3. On the other hand, a cool rainy summer and autumn controls their prevalence and fatality.
4. Diarrhœal diseases become epidemic when the subsoil temperature at a depth of 4 feet below the surface permanently reaches 56° F. ; this may therefore be called the "critical temperature."

<sup>1</sup> *Zeitschrift für Biologie*, Heft. vi p. 527. 1870. Quoted by Hirsch, *loc. cit.* vol. i. p. 466.

In Table III. facts are given, which support the first of these propositions. Reference to the last two columns of the Table will convince the reader that yearly towards the end of July or the beginning of August, on an average, diarrhœal diseases, and particularly cholera, assume epidemic proportions in singular obedience to a law of periodicity and with all the suddenness of an explosion. Of every 100 deaths from diarrhœal diseases taking place annually, only 3 occur in the four weeks ending June 17, only 3·9 in the four weeks ending July 15. Then the percentage runs up to 9·7 in the next four weeks (ending August 12), and to no less than 23·0 in the period ending September 9. In the *eight* weeks ending October 7, 45·5 of every 100 deaths from diarrhœal diseases take place. Similarly in the case of simple cholera, of 100 deaths occurring in the whole year, only 0·6 takes place in the four weeks ending May 20 ; whereas in the period ending September 9, 26·9 take place, and in that ending October 7, no less than 28·8—55·7 per cent of the annual mortality in *eight* weeks.

From the curves of mortality given by Dr. A. Buchan and Sir Arthur Mitchell in their paper on “The Influence of Weather on Mortality from Different Diseases and at Different Ages” (*Journal of the Scottish Meteorological Society*, vol. iv. p. 187), it would appear that the diarrhœal and choleraic death-rates rise in London to a yearly maximum about three weeks earlier than in Dublin. This is doubtless due to the earlier rise of the subsoil temperature at 4 feet to 56° in London than in Dublin.

In support of the second and third propositions we have only to refer to the Reports of the Registrar-General for Ireland for the years 1868 and 1887 (warm, dry years), and for the cold, wet year 1879. The facts may best be thrown into a short tabular statement as follows :—



TABLE II.

Quarter	1868			1877			1879		
	Mean Temp.	Diarrhoeal Deaths	Cholertine	Mean Temp.	Diarrhoeal Deaths	Cholertine	Mean Temp.	Diarrhoeal Deaths	Cholertine
I.	44°·7	39	0	41°·9	31	2	39°·3	39	0
II.	55°·5	22	1	53°·1	27	0	49°·7	38	0
III.	60°·7	289	11	59°·3	331	11	56°·4	54	1
IV.	45°·3	77	0	43°·3	71	1	43°·8	54	1
	51°·6	427	12	49°·4	460	14	47°·3	185	2

In his Weekly Return of Births and Deaths in Dublin for August 22, 1868, the Registrar-General for Ireland wrote : "The number of deaths from diarrhoea registered during the week amounted to forty-nine, showing an increase of twenty-three on the number registered during the week preceding, and being thirty-five more than the average deaths from this disease in the corresponding week of the four previous years." In his return for the corresponding week in 1879, the Registrar-General observed : "Owing chiefly to the low mortality from diarrhoea, the number of deaths from zymotic diseases is considerably under the average for the thirty-fourth week of the last ten years." As a matter of fact, only *one* death from diarrhoea was registered in the whole Dublin Registration District in this week, and the largest number of deaths from the disease registered in any week during 1879 was eight in the week ending Saturday, September 13. A more striking contrast can hardly be imagined than that between the epidemic prevalence of diarrhoea in the warm season of 1868 and its absence in the cool summer of 1879.

The year 1868 may be cited as an example of an unusually *warm year*. There was an almost complete absence of frost, and during ten out of the twelve months the mean temperature was above the average : the excess varying from 0·5° in

January to  $3.8^{\circ}$  in March—the warmest March within the twenty years now under discussion. October and November were cold—the deficit of temperature amounting to  $2.0^{\circ}$  and  $1.1^{\circ}$  respectively. Notwithstanding this, the mean temperature of the whole year was  $51.6^{\circ}$ , compared with an average of  $49.8^{\circ}$  (excess =  $1.8^{\circ}$ ). A remarkable drought prevailed from the last week in April to the 10th of August, when a tropical rainfall occurred. During this period of nearly three and a half months, only 2.797 inches of rain fell in the city. On six occasions during the summer of this year the thermometer rose to  $80^{\circ}$  in the shade in Dublin—the highest readings of all being  $86^{\circ}$  on July 15 and  $85^{\circ}$  on July 21. On August 1 the maximum was  $82^{\circ}$ , and even as late as September 6 the high reading of  $77^{\circ}$  was noted.

In marked contrast to 1868, and as an instance of a *cold year*, 1879 stands out in bold relief. The annual mean temperature was only  $47.3^{\circ}$ —that is,  $2.5^{\circ}$  below the average ( $49.8^{\circ}$ ). *Every* month was colder than usual—the deficit of mean temperature ranging from  $6.1^{\circ}$  in January,  $3.6^{\circ}$  in April,  $3.5^{\circ}$  in July, and  $3.4^{\circ}$  in December, to  $0.3^{\circ}$  in October and  $0.5^{\circ}$  in November. Curiously enough, these last-named months were relatively the coldest in the warm year, 1868. There was a singular absence of summer heat in July and August; in each of these months the shade temperature exceeded  $70^{\circ}$  on one day only in Dublin, and on nine days in July it did not reach  $60^{\circ}$ . The low temperature was accompanied with—to some extent depended upon—a continuous rather than a heavy rainfall. During the six months ending September 30, rain fell on 125 out of 183 days—that is to say, on two out of every three days. The amount of cloud during this cold, damp, sunless year, was 7.5 per cent over the average. The cold weather, which persisted almost throughout 1879, set in first on October 21, 1878. This period of low temperature had probably not been paralleled for intensity and duration within the present century.

In their classical paper already quoted, Dr. Buchan and

TABLE III.—Showing the Average and Total Deaths from Diarrhoeal Diseases and Simple Cholera in the Dublin Registration District in each of Thirteen Four-weekly Periods in the Twenty Years, 1872-91; and the Percentage of the same in each of the said Periods.

Four-Week Periods.	Corresponding Periods in Calendar.	Average Number of Deaths, 1872-81.		Average Number of Deaths, 1882-91.		Total Number of Deaths in 20 years.		Percentage of the Average Annual Deaths.	
		Diarrhoeal Diseases.	Simple Cholera.	Diarrhoeal Diseases.	Simple Cholera.	Diarrhoeal Diseases.	Simple Cholera.	Diarrhoeal Diseases.	Simple Cholera.
I.	1 to Jan. 28.	12·9	...	9·0	0·2	219	2	4·2	1·3
II.	Jan. 29, Feb. 25.	10·9	...	7·6	0·1	185	1	3·6	·7
III.	Feb. 26, Mar. 25.	10·1	0·1	8·5	...	186	...	3·6	·7
IV.	Mar. 26, Ap. 22.	12·7	0·2	6·5	0·2	192	4	3·7	2·6
V.	Ap. 23, May 20.	9·8	0·1	7·4	...	172	1	3·3	·6
VI.	May 21, June 17.	9·3	0·4	6·5	0·2	158	6	3·0	3·8
VII.	June 18, July 15.	10·1	0·6	10·3	0·1	204	7	3·9	4·5
VIII.	July 16, Aug. 12.	22·8	1·3	27·5	0·7	503	20	9·7	12·8
IX.	Aug. 13, Sept. 9.	53·6	2·5	65·4	1·7	1190	42	23·0	26·9
X.	Sept. 10, Oct. 7.	53·8	1·1	63·2	3·4	1170	45	22·5	28·8
XI.	Oct. 8, Nov. 4.	23·0	0·2	31·0	0·7	540	9	10·4	5·8
XII.	Nov. 5, Dec. 2.	13·2	0·4	13·1	1·1	263	15	5·1	9·6
XIII.	Dec. 3, Dec. 30.	9·4	0·2	10·5	0·1	199	3	3·8	1·9
Fifty-Two Weeks.	January 1 to December 30.	2516	71	2665	85	5181	156	99·8	100·0
Fifty-Third Week.	...	1873=2 1879=3	...	1884=3 1890=0	...	8	...	·2	...
General Totals . . .	General Totals . . .	2521	71	2668	85	5189	156	100·0	100·0

Sir Arthur Mitchell speak of "the close and direct relations which the progress of mortality from these (diarrhœal) diseases bears to temperature. This relation is seen in the startling suddenness with which they shoot up during the hottest weeks of the year, and the suddenness, equally startling, with which they fall on the advent of colder weather." The authors point out that the death-rate curves for diarrhœa and cholera rise and fall about a month earlier than do those for dysentery and epidemic cholera. The annual phases of the former diseases are, in other words, about a month earlier than those of the latter. For all four diseases, the curves are reproduced in all their essential features from year to year. In very hot summers the numbers of deaths are enormously increased, and in cold summers, such as 1860, the deaths from bowel complaints are correspondingly few.

The fourth proposition was first advanced by Dr. Edward Ballard, in his elaborate Report to the Local Government Board for England upon the causation of the annual mortality from "Diarrhœa," which is observed principally in the summer season of the year.<sup>1</sup> That a *high atmospheric temperature* conduces to a high diarrhœal mortality, and a low atmospheric temperature to a low diarrhœal mortality, Dr. Ballard admits: it is, he says, "an established fact which no one can dispute." But his inquiry showed that the influence thus exerted is *not a direct influence*, except in so far as it affects also infant mortality from all causes. *Rainfall* again exerts an influence on diarrhœa, but apparently not equally in all periods of the diarrhœal season. The diarrhœal mortality is greater in dry, less in wet seasons. But here again the influence exerted is not direct (*e.g.* by a washing of the atmosphere, so to speak), but indirect, namely, by its effect mainly in preventing the rise and (probably to a less extent) in hastening the fall of the temperature of the earth.

<sup>1</sup> *Supplement in Continuation of the Report of the Medical Officer for 1887. Seventeenth Annual Report of the Local Government Board, 1887-88. London: Eyre and Spottiswoode, 1889. Quarto, p. 1 et. seq.*

*Wind* and *comparative calm* affect the diarrhoeal mortality. Other things being equal, calm in the diarrhoeal season promotes it, and high winds tend to lessen it.

But *soil* and the *temperature of the soil* are far more important predisposing causes of diarrhoeal diseases. Their prevalence and fatality is low in dwelling-houses built on a foundation of *solid rock*. Deep and wide and frequent fissuring of the rock in a town, or superficial alternations of rock with looser material, modify this immunity. On the other hand, a *loose soil*, more or less freely permeable by water and by air, is a soil on which diarrhoeal mortality is apt to be high. Of all natural soils, sand and surface mould to a considerable depth are "the most diarrhoeal." Gravel varies in its relation to diarrhoeal mortality according to its texture: fine, sand-like gravel predisposes to diarrhoeal prevalence; coarse, rock-like gravel is more wholesome. Clay soils do not in themselves favour diarrhoea. A soil which is a mixture of clay, sand and stones (commonly called a "marl"), is apparently favourable or unfavourable to diarrhoeal mortality in proportion as it is loose and permeable on the one hand, or plastic on the other. The presence of much *organic matter* in the soil renders it distinctly more conducive to high diarrhoeal mortality than it otherwise would be. Hence dwellings built upon made ground, the refuse of towns, or the site of market-gardens, are unwholesome. And, of course, a sewage-soaked subsoil is most unwholesome and dangerous. *Excessive wetness* and *complete dryness* of the subsoil appear to be alike unfavourable to diarrhoea. *Habitual dampness*, which is not sufficient to preclude the free admission of air to the interstices of the subsoil, favours diarrhoeal prevalence.

Dr. Ballard, however, considers that the *Temperature of the Soil* is a far more effective element in the causation than any of the meteorological factors just mentioned. He constructed for London and many other towns in the kingdom a large number of charts, showing week by week for many

years the earth-temperature at a depth of 1 foot from the surface and at a depth of 4 feet also, each chart showing in addition the diarrhoeal mortality of the corresponding weeks. The general result shown by these charts is as follows:—

*a.* The summer rise of diarrhoeal mortality does not commence until the mean temperature recorded by the 4-foot earth thermometer has attained somewhere about 56° Fahr., no matter what may have been the temperature previously attained by the atmosphere or recorded by the 1-foot earth thermometer.

*β.* The maximal diarrhoeal mortality of the year is usually observed in the week in which the temperature recorded by the 4-foot earth thermometer attains its mean weekly maximum.

*γ.* The decline of the diarrhoeal mortality coincides with the decline of the temperature recorded by the 4-foot earth thermometer, which temperature *declines* very much more slowly than the atmospheric temperature, or than that recorded by the 1-foot earth thermometer. The epidemic mortality may in consequence continue (although declining) long after the last-mentioned temperatures have fallen greatly, and may extend some way into the fourth quarter of the year.

*δ.* The atmospheric temperature and that of the more superficial layers of the soil exert little, if any, influence on the prevalence of diarrhoea until the temperature recorded by the 4-foot earth thermometer has risen to 56° F. Then their influence is apparent, but it is a subsidiary one, notwithstanding the statement made by Dr. August Hirsch that the summer diarrhoea of children makes its appearance as an epidemic only in those districts whose average temperature for the day in the warm season is rather more than 15° C. (59° F.)<sup>1</sup>

It is interesting to notice that in an excellent article on "Cholera Infantum," which appeared in the *Medical Annual* for 1893, Dr. E. Meinert, of Dresden, entirely adopts Dr.

<sup>1</sup> *Handbook of Geographical and Historical Pathology*, vol. iii. p. 379. New Syd. Soc. 1886.

Ballard's views as to the meteorological ætiology of this disease, while he also expresses his entire concurrence with Dr. Ballard's statement that *density of buildings*, whether dwelling-houses or other, upon area—quite apart from *density of population* upon area—promotes diarrhœal mortality to a remarkable degree, particularly because crowding together of buildings of whatever sort restricts and offers an impediment to the free circulation of air. Dr. Edward W. Hope, the Assistant Medical Officer of Health for Liverpool, has investigated the influence of the *mode of feeding* of young infants upon the prevalence and fatality of diarrhœa, and arrives at the following conclusions: <sup>1</sup>—

1. Infants fed solely from the breast are remarkably exempt from fatal diarrhœa.
2. Infants fed in whatever way with artificial food to the exclusion of breast milk are those who suffer most heavily from fatal diarrhœa.
3. Children fed partially at the breast, and partially with other kinds of food, suffer to a considerable extent from fatal diarrhœa, but very much less than those who are brought up altogether by hand.
4. As regards the use of "the bottle," it is decidedly more dangerous than artificial feeding without the bottle.

In relation to this part of the subject, Dr. Ballard's observations go to show that the circumstances of *food-keeping*, of its exposure to telluric emanations (*e.g.* in underground cellars), or to emanations from accumulations of domestic filth, etc. (*e.g.* when kept in pantries, etc., to which such emanations have more or less free access), tends to render it liable to produce diarrhœa, especially where the storing place of food is dark, and not exposed to currents of air.

Dr. Ballard believes that a working hypothesis, or provisional explanation, that would best accord with the whole

<sup>1</sup> Cf. Dr. Ballard's Report, p. 6.

evidence in his possession bearing on the production of epidemic diarrhoea, may be stated as follows :—

1. The essential cause of diarrhoea resides ordinarily in the superficial layers of the earth, where it is intimately associated with the life processes of some micro-organism not yet detected, captured, or isolated.

2. The vital manifestations of such organism are dependent, among other things, perhaps principally, upon conditions of season and on the presence of dead organic matter which is its pabulum.

3. On occasion, such micro-organism is capable of getting abroad from its primary habitat, the earth, and having become air-borne obtains opportunity for fastening on non-living organic material, and of using such organic material both as nidus and as pabulum in undergoing various phases of its life-history.

4. In food, inside of as well as outside of the human body, such micro-organism finds, especially at certain seasons, nidus and pabulum convenient for its development, multiplication, or evolution.

5. From food, as also from the contained organic matter of particular soils, such micro-organism can manufacture, by the chemical changes wrought therein through certain of its life processes, a substance which is a *virulent chemical poison*.

6. This chemical substance is, in the human body, the material cause of epidemic diarrhoea.

To the foregoing, we have only to add Dr. Meinert's words: "The poison, or a combination of poisons, appears to work upon the medulla oblongata, for there lies the centre for intestinal secretion, vomitings, convulsions, respiratory and vaso-motor phenomena."



## CHAPTER XXIX

### ACUTE INFECTIVE DISEASES (*continued*)

Influence on the Prevalence of Enteric Fever of (1) Season ; (2) Temperature and Moisture ; (3) Soil and Underground Water—Outbreaks at Terling and in Trinity College, Dublin—Seasonal Mortality from Enteric Fever in Dublin for Twenty Years, 1872-91—Typhus Fever a Disease of Winter and Spring—Influence of Season, Overcrowding, Defective Ventilation, Temperature and Atmospheric Moisture—Seasonal Mortality from Typhus in Dublin for Twenty Years, 1872-91—Seasonal Prevalence of (1) Smallpox ; (2) Measles ; (3) Scarlatina.

#### 4. *Enteric Fever*

It is fitting that this disease should be taken next in order after cholera and the diarrhoeal diseases, to which it presents so many points of analogy.

*Season.*—Enteric fever is most prevalent in *autumn* and *early winter*, hence the names by which it is often described in America—“*Autumnal*,” or “*Fall Fever*” (Austin Flint). The exciting cause of the disease seems to be called into action only, as Murchison says, “by the *protracted* heat of summer and autumn, while it required the *protracted* cold of winter and spring to impair its activity or to destroy it.” An examination of the Returns of the Registrar-General for Ireland shows that enteric fever exhibits, as the summer rolls by, a decided tendency to increase in Dublin at an earlier period than typhus. This is, no doubt, partly due to the fact that the secondary phenomena of enteric fever are

generally developed in connection with the digestive system, acute and infective diseases of which system increase towards autumn.

The accompanying diagram (1) is reproduced from the

Annual Summary of the Registrar - General for England for 1890:—

*Temperature and Moisture.*—*Hot, dry, calm* summers increase the prevalence of enteric fever, which is less frequent in *cold, wet, stormy* seasons. *Warm, damp* weather, however, predisposes to the disease. Floods occurring in badly drained localities may impregnate sources of drinking-water with the germs of enteric fever, and so lead to its outbreak.

*Soil and Under-ground Water.*<sup>1</sup>—Professor von Pettenkofer

DIAGRAM 1.—ENTERIC FEVER (22 YEARS 1869-90).

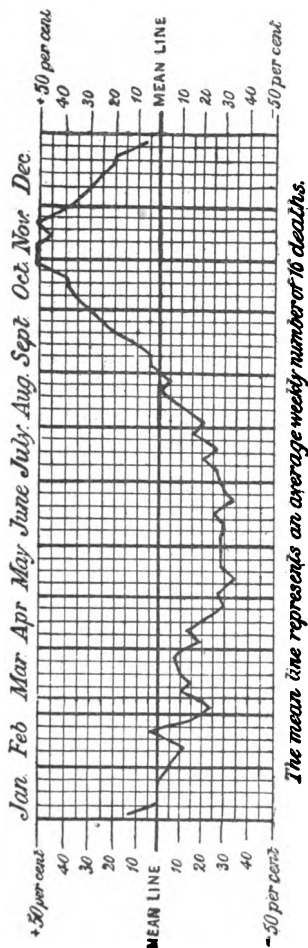

FIG. 69.

<sup>1</sup> An excellent *résumé* of various papers on this subject in the *Zeitschrift für Biologie* will be found in the *Ugeskrift for Læger*, Copenhagen, January 30, 1869. A translation by my father, Dr. W. D. Moore, appeared in the *Dubl. Journ. of Med. Science*, vol. xlvii. p. 497, May 1869.

and Professor Buhl, of Munich, have shown that when the subsoil water in that city (as measured by the depth of water in the surface wells) is falling the number of cases of enteric fever increases; when the water level is rising the number of cases diminishes. Liebermeister and Buchanan suppose that these observations simply illustrate the mode in which the disease is communicated by means of drinking-water. When the subsoil water is low any noxious matters in it accumulate and acquire a greater virulence.

In the case of an outbreak of enteric fever at Terling, Essex, in December 1867, Dr. Thorne Thorne, then an Inspector, and now Medical Officer, of the Local Government Board of England, found that the disease had broken out with great severity precisely when the wells were high.<sup>1</sup>

Two or three years after the introduction of the Vartry Water Supply into Dublin, in 1868, a serious local outbreak of enteric fever took place in Trinity College, Dublin. It was confined to the resident water-drinkers in the College. An inquiry was instituted into the cause of the outbreak, the Rev. Dr. Haughton, F.R.S., Fellow of Trinity College, Dr. Apjohn, F.R.S., then Professor of Chemistry in the University of Dublin, and Mr. Dowling, then Professor of Engineering in the University, being appointed to act as Commissioners by the Rev. H. Lloyd, D.D., at the time Provost of Trinity College. It was found that, owing to high tides in the river Liffey, and the accumulation of water in the subsoil, in consequence partly of the disuse of the pumps after the introduction of the Vartry water, and partly of the leakage of the Vartry water itself from defective house-drains, the foul subsoil water had overflowed into and contaminated the well within the College precincts from which the drinking-water in use in the College was drawn. Ever since that time the level of the subsoil water in Trinity College has been kept low by steam pumping, at a cost of about £300 per annum, with the result that within the past twenty-three years no

<sup>1</sup> *Tenth Report of the Medical Officer of the Privy Council*, p. 51. 1868.

indigenous outbreak of enteric fever has occurred amongst the residents in the College.

TABLE IV.—Showing the Total number of Deaths from Enteric Fever in the Dublin Registration District in each of Thirteen Four-weekly Periods in the Twenty Years, 1872-91; the Average yearly number of Deaths from this Fever in the Decennial Periods, 1872-81, and 1882-91, respectively; and the Percentage of the Total Mortality from the same Fever in each of the said Periods.

Four-week Periods.	Corresponding Periods in Calendar.	Average Number of Deaths, 1872-81.	Average Number of Deaths, 1882-91.	Total Number of Deaths in 20 years.	Percentage of the Average Annual Deaths.
I.	Jan. 1 to Jan. 28 . . .	16·1	12·1	282	8·6
II.	Jan. 29 ,, Feb. 25 . . .	16·0	10·8	268	8·2
III.	Feb. 26 ,, Mar. 25 . . .	14·6	13·2	278	8·5
IV.	Mar. 26 ,, Ap. 22 . . .	12·3	9·8	221	6·8
V.	Ap. 23 ,, May 20 . . .	14·3	9·6	239	7·3
VI.	May 21 ,, June 17 . . .	8·7	8·1	168	5·1
VII.	June 18 ,, July 15 . . .	10·6	8·6	192	5·9
VIII.	July 16 ,, Aug. 12 . . .	9·2	7·9	171	5·3
IX.	Aug. 13 ,, Sept. 9 . . .	10·7	10·1	208	6·3
X.	Sept. 10 ,, Oct. 7 . . .	14·3	10·9	252	7·7
XI.	Oct. 8 ,, Nov. 4 . . .	12·7	19·7	324	9·9
XII.	Nov. 5 ,, Dec. 2 . . .	15·9	17·1	330	10·1
XIII. <sup>1</sup>	Dec. 3 ,, Dec. 30 . . .	13·8	20·2	340	10·3
	Totals . . .	1692	1581	3273	100·0

<sup>1</sup> The thirteenth period included five weeks in 1873 (no deaths), 1879 (2 deaths), 1884 (7 deaths), and 1890 (7 deaths). These 16 deaths raise the periodic averages from 13·6 to 13·8 in 1872-81, and from 18·8 to 20·2 in 1882-91, and the yearly averages from 169·0 to 169·2 in 1872-81, and from 156·7 to 158·1 in 1882-91.

The preceding Table supplies information as to the seasonal mortality from enteric fever in Dublin in the twenty years ending 1891. The facts are drawn from the Reports of the Registrar-General for Ireland. In this Table the year is divided into *thirteen* periods of *four* weeks each. In each of

the years 1873, 1879, 1884, and 1890, *fifty-three* weeks are included in order to bring the Registrar-General's statistics into agreement with the calendar. In these four additional weeks, sixteen deaths from enteric fever were registered, thus raising by so many the number of deaths recorded in the thirteenth four-week period in the Table.

The Table shows that, allowance being made for a three weeks' illness before death and registration occur, enteric fever increases in prevalence and fatality towards the end of July, that is, with a rise of the subsoil temperature at 4 feet to and above the critical point of 56° F. Its epidemic character becomes pronounced in September and continues until the close of February, after which the disease becomes less frequent and deadly, reaching its spring minimum at the beginning of May. From this time to the end of June is also the period of its annual minimum, while its annual maximum takes place about the middle of November. These results agree remarkably with the curve for typhoid fever for all ages and both sexes given by Buchan and Mitchell.<sup>1</sup> This is a well-marked curve (they say) resembling the curve for scarlatina in showing the maximal death-rate in October and November, but differing from it in the duration and phases of the minimal period. Scarlatina falls below its average in the beginning of January, typhoid fever not till the last week of February; scarlet fever has its absolute minimum period from the middle of March to the middle of May, typhoid fever from the middle of May to the end of June; scarlet fever begins steadily to rise in the second week of May, typhoid not till the beginning of July, when the heat of summer has fairly set in.

##### 5. *Typhus Fever*

Typhus is essentially a disease of winter and spring—that is, of the colder seasons of the year. Among the predisposing

<sup>1</sup> "The Influence of Weather on Mortality," *Journ. of the Scot. Met. Soc.*, vol. iv. p. 197.

causes of this fever, *season* and *atmospheric temperature* are commonly included.

*Season.*—During twenty-three years, January and March were the months in which the number of admissions of typhus patients to the London Fever Hospital reached a maximum—the minimum falling in September, August, and July. This distribution was from time to time disturbed by an epidemic, outbreaks of typhus commencing and advancing irrespective of season. An examination of the Registrar-General's (Ireland) Returns of deaths from typhus in Dublin, undertaken many years ago, led me to the conclusion that the death-rate from typhus attains its *maximum in January* and its *minimum in September*. The reason for this is not far to seek. Typhus is often intimately related to overcrowding, and affections of the respiratory organs are among its most frequent complications. Hence we should expect to meet with it, especially in the colder seasons of the year. Murchison points out that typhus does not always become more prevalent with the commencement of cold weather, nor does it decline immediately on the advent of summer. He correctly infers from this that the increase of typhus in winter and spring is not so much due to the direct effect of cold as to the *continued overcrowding* and *defective ventilation* of the dwellings of the poor in cold weather.

The accompanying Table gives the facts relating to the deaths from typhus in Dublin during the twenty years, 1872-91, inclusive.

Apart from our present inquiry, one gratifying circumstance stands prominently out from the figures in the foregoing Table, and that is, the fact that typhus fever is practically dying out in Dublin. The number of deaths from the disease fell nearly 50 per cent—to 507 from 996—in the second decennium discussed in the Table.

An analysis of the Table proves that the mortality from typhus reaches a minimum in the ninth and tenth periods—August 13 to October 7 ; while the minimal death-rate from

enteric fever has already occurred in the eighth period—July 16 to August 12; this fever exhibiting, as the summer rolls by, a decided tendency to increase at an earlier period than typhus. The highest percentage death-rates from typhus are met with in the seasons of winter, spring, and early summer—10·4 per cent of the fatal cases being registered in the second period (January 29 to February 25), and 10·0 per cent in the fifth period (April 23 to May 20).

TABLE V.—Showing the Total number of Deaths from Typhus Fever in the Dublin Registration District in each of Thirteen Four-Weekly Periods in the Twenty Years, 1872-91; the Average yearly number of Deaths from this Fever in the Decennial Periods, 1872-81 and 1882-91 respectively; and the Percentage of the Total Mortality from the same Fever in each of the said Periods.

Four-week Periods.	Corresponding Periods in Calendar.	Average Number of Deaths, 1872-81.	Average Number of Deaths, 1882-91.	Total Number of Deaths 20 years.	Percentage of the Average Annual Deaths.
I.	Jan. 1 to Jan. 28 . . .	9·0	4·3	133	8·8
II.	Jan. 29 ,, Feb. 25 . . .	9·8	5·9	157	10·4
III.	Feb. 26 ,, Mar. 25 . . .	8·1	5·4	135	9·0
IV.	Mar. 26 ,, Ap. 22 . . .	7·4	5·8	132	8·8
V.	Ap. 23 ,, May 20 . . .	10·2	4·8	150	10·0
VI.	May 21 ,, June 17 . . .	9·6	3·1	127	8·4
VII.	June 18 ,, July 15 . . .	7·1	4·1	112	7·5
VIII.	July 16 ,, Aug. 12 . . .	7·5	2·4	99	6·6
IX.	Aug. 13 ,, Sept. 9 . . .	4·6	3·4	80	5·3
X.	Sept. 10 ,, Oct. 7 . . .	5·1	2·0	71	4·7
XI.	Oct. 8 ,, Nov. 4 . . .	6·0	3·4	94	6·3
XII.	Nov. 5 ,, Dec. 2 . . .	6·9	2·9	98	6·5
XIII. <sup>1</sup>	Dec. 3 ,, Dec. 30 . . .	8·3	3·2	115	7·7
	Totals . . .	996	507	1503	100·0

<sup>1</sup> The thirteenth period included five weeks in 1873 (4 deaths), 1879 (3 deaths), 1884 (no deaths), and 1890 (no deaths). These 7 deaths raise the periodic average from 7·6 to 8·3, and the yearly average from 98·9 to 99·6, in 1872-81.

According to Buchan and Mitchell,<sup>1</sup> the curve for typhus is above the average from January to the beginning of May, and with the exception of the hot season of July and beginning of August, it is below the average from the middle of May to the end of September. It seems probable that the curve has two maxima, the larger in the early months of the year, and the smaller in the height of summer. Buchan's and Mitchell's typhus curve is based on only six years' returns of mortality—1869-74.

*Temperature and Moisture in the Atmosphere* do not seem to have any marked predisposing influence on typhus, notwithstanding the opinion advanced by Dr. T. W. Grimshaw, now Registrar-General for Ireland, in 1866,<sup>2</sup> that a warm moist state of the atmosphere seemed to favour an increase of typhus, whereas dryness with cold had a contrary influence. Murchison was unable to trace any such connection, but points out that exposure to cold and wet, if long continued, depresses the nervous system and so favours the onset of typhus.

## 6. *Smallpox*

Turning now to the principal eruptive fevers, we find that, although the incidence of smallpox is apparently *independent of climate*, yet the *season of the year* has a marked influence upon the prevalence of the disease. Nearly all writers are agreed that, while outbreaks of smallpox may occur at all seasons, they mostly begin towards the end of autumn and in the early spring, or in the cold season. In a word, smallpox is essentially a *disease of winter and spring*. In the British Islands, and Western Europe generally, for example, the monthly number of cases is high from November onwards; but from May a rapid decline in the prevalence of

<sup>1</sup> *Loc. cit.* p. 197.

<sup>2</sup> "On Atmospheric Conditions influencing the Prevalence of Typhus," *Dubl. Quar. Journ. of Med. Science*, May 1866.



the disease takes place, the least number of cases being observed in September.

The accompanying diagram (2) is copied from the Annual Summary of Births and Deaths of the Registrar-General for England for 1890. It shows the weekly departure from the average weekly number of deaths from smallpox (17) in London in the fifty years, 1841-90 inclusive:—

DIAGRAM 2.—SMALLPOX (50 YEARS 1841-90).

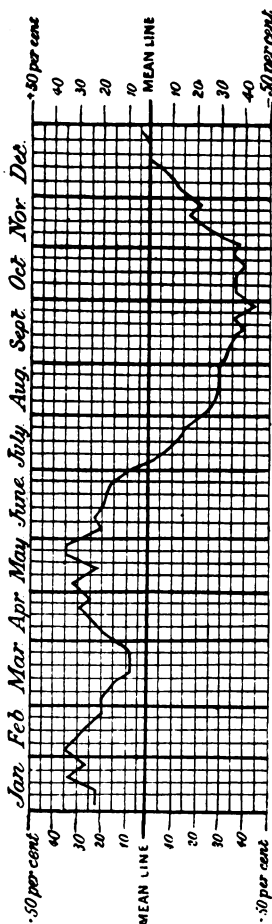

The mean line represents an average weekly number of 17 deaths.

FIG. 70.

horizontal line representing the mean; and when the

In this diagram the thick horizontal line represents the mean weekly mortality from smallpox in London, on the supposition that the mortality is spread equally over the fifty-two weeks of the year—the fifty-third week, when it occurs, being ignored. The curved line represents the amount per cent by which the average mortality in each week differs from this mean. When the percentage for any week is above the mean, the amount of the percentage excess is marked above the

percentage is below the mean it is marked below the line.

It must be remembered that the data on which the curve is formed are the deaths registered in each week, not the deaths which occurred in the week, and that the registration is usually a few days after the death; and, secondly, that the curve relates to deaths—that is, the final termination of the attack of illness, and not its commencement. So that, in estimating the effect of season in generating smallpox, allowance must be made for the average duration of this disease when fatal—that is, eleven or twelve days. It is, moreover, possible that the curve of mortality may, for another reason, not accurately represent the curve of prevalence. For it may be that an attack of smallpox is more likely to terminate fatally if it occurs at one season—for example, midwinter—than if it occurs at another, such as midsummer.

The diagram shows that at the beginning of February, and in the second half of May, the weekly number of deaths was 35 per cent in excess of the average weekly number of 17 deaths represented by the mean line, whereas at the end of September there was a deficit of 43 per cent in the weekly number of deaths as compared with the same average weekly number over the whole year.

In Dublin, during the autumn of 1871, the prevalence of, and mortality from, smallpox increased with a fall of mean temperature below 50°, and the greatest severity of the epidemic was experienced in the first half of the following April, shortly after a period of intense cold for the time of year. With the rise of mean temperature to between 55° and 60° in the middle of June, the epidemic declined rapidly. Abundant rainfalls seemed to be followed by remissions in the severity of the epidemic, and the converse was also true.<sup>1</sup>

Buchan and Mitchell say that the curve for smallpox is

<sup>1</sup> *Manual of Public Health for Ireland 1875*, p. 298. Dublin: Fannin and Co. See also Buchan's and Mitchell's Paper in the *Journal of the Scottish Meteorological Society*, 1874.

one of the simplest of the curves, showing that the mortality from the disease is above the average from Christmas till the end of June, the maximum falling in the last week of May, and the minimum in the last week of September.

From statistics as to the prevalence of the disease in Sweden, by months, in the years 1862-69 inclusive,<sup>1</sup> it appears that the greatest prevalence of smallpox is observed in May, the cases in that month being 13·7 per cent of the total cases occurring in the year; while the least prevalence is observed in September, when only 3·9 per cent of all the cases in the year occur. From November the monthly number of cases is high, but from May a rapid decline in the prevalence of the disease takes place.

When due allowance has been made for difference of climate, these results agree very closely with the observations which have been recorded in this country on the relation of smallpox to season. Dr. Edward Ballard,<sup>2</sup> writing of the epidemic of 1871, observed:—

“There is some reason for believing that the variations of the epidemic (of smallpox), from week to week, are influenced to a certain extent by atmospheric conditions and more especially by variation in temperature.”

He then quoted a series of remarkable coincidences between the fluctuations of mean temperature and those of the smallpox mortality in London during the winter of 1870-71. In the number of the *Medical Times and Gazette* for May 13, 1871, he wrote:—

“The epidemic has now lasted a good six months. It may be regarded as assuming a distinctly epidemic form in November, shortly after the mean temperature of the air had fallen decidedly below 50°. In the progress of the seasons

<sup>1</sup> These statistics were compiled from exhaustive annual reports by the late Dr. Wistrand, as to the morbidity of Sweden, and are the direct fruit of an admirable system of disease-registration, which has been in operation for many years in Sweden, and also in the other Scandinavian countries.

<sup>2</sup> *Medical Times and Gazette*, March 11, 1871.

we have now arrived at a time when this mean temperature is again reached. The mean temperature of the last three weeks, as recorded at Greenwich, has been 50°, 50·7°, and 49·7°. It is customary about the second week in May for some check in the consecutive weekly rises of temperature to take place, but after this, in the ordinary or average progress of events, the steady rise towards the summer temperature may be expected to set in, and with it there is at least a hope that the epidemic will begin to fade.”

A week later, the same writer said :—

“The sudden fall of deaths in London from smallpox which occurred last week, namely, from 288 to 232, occurring about three weeks after the mean temperature of 50° was reached, appears to be confirmatory of the favourable hopes we expressed last week, that the epidemic had, for this season, arrived at its climax.”

And so it had, for although the decline was occasionally interrupted, the virulence of the epidemic was broken in May, in accurate fulfilment of the anticipations which had been grounded on a consideration of the influence of temperature on its progress.

### 7. Measles

*Seasonal Prevalence.*—Although, like smallpox, apparently *independent of climate*—for it is met with alike amidst Arctic snows, in temperate latitudes, and under the tropical sun—measles prevails especially in the *spring* and *autumnal quarters* of the year. An analysis of the weekly returns of deaths from measles in the Dublin Registration District, published by the Registrar-General for Ireland, long since led me to the conclusion that a mean temperature above 58·6° was not favourable to the spread of this disease, and that a mean temperature below 42·0° was equally inimical to its prevalence.<sup>1</sup> These results are in strict accord with those arrived at by Dr.

<sup>1</sup> *Manual of Public Health for Ireland.* 1875. Pp. 300, 301.

Edward Ballard, who says<sup>1</sup> that the only condition concerned in the arrest of the spread of measles in summer is the rise of

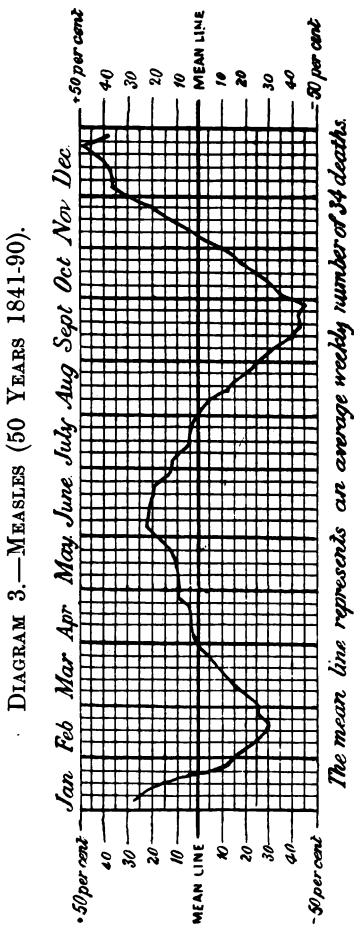

the temperature of the air above a mean of 60° F., while towards winter a fall below 42° F. also distinctly tends to check the disease.

The accompanying diagram (3), copied from the Annual Summary of Births, Deaths, and Causes of Death in London and other great towns for 1890, by the Registrar - General for England, is based upon the weekly returns of deaths from measles in London for the fifty years, 1841-90 inclusive. In it, the mean line represents an average weekly number of 34 deaths under discussion, and the weekly curve shows a double maximum and a double minimum, the larger maximum falling in November, December, and January, with an extreme excess of 50

<sup>1</sup> Eleventh Report of the Medical Officer of the Privy Council. 1868. No. 3. Pp. 54-62.

per cent in the fourth week of December, and the smaller in May and June, with an extreme excess of 25 per cent in the first week of June. The larger minimum falls in August, September, and October, extreme deficit being 45 per cent below average in the last week of September, and the smaller minimum in February and March—extreme deficit, 30 per cent below average in the third week of February.

According to Buchan and Mitchell, who examined the London death-rates for the thirty years beginning with 1845 and ending with 1874, the measles curve is remarkable in showing a double maximum and minimum during the year, the larger maximum occurring in November, December, and January, and the smaller in May and June; the larger minimum in August, September, and October, and the smaller in February and March. The most rapid fluctuation takes place in the fall observed from Christmas to the middle of February, the weekly deaths falling from 50 per cent in excess of the average to 30 per cent below it—that is, from 51 to 24, the average weekly number of deaths throughout the year being 34. This curve is one of the steadiest from year to year, both the December and the June maxima being well marked in nearly every one of the thirty years analysed by Buchan and Mitchell, and the yearly minima also being well marked.

In Table VI. is contained an analysis of the deaths from measles registered in the Dublin Registration District during the twenty years ending 1891, with the corresponding figures for scarlet fever. The two annual maxima and minima for measles are shown in the last column, but it will be observed that, as compared with London, the Dublin spring minimum is feebly marked, while the incidence of the autumnal minimum is later. Similarly, the summer maximum falls later in Dublin than it does in London.

It is instructive to compare the figures for measles with those for scarlet fever. It will be seen that these diseases are correlative, measles being very much in evidence when

TABLE VI.—Showing the Total number of Deaths from Scarlet Fever and from Measles in the Dublin Registration District in each of Thirteen Four-week Periods in the Twenty Years, 1872-91; the Average yearly number of Deaths from these diseases in the Decennial Periods, 1872-81 and 1882-91 respectively; and the Percentage of the Total Mortality from the same Fevers in each of the said Periods.

Four-week Periods.	Corresponding Periods in Calendar.	Average No. of Deaths 1872-81.		Average No. of Deaths 1882-91.		Total No. of Deaths 20 years.		Percentage of the Average Annual Deaths.	
		Scarlet Fever.	Measles.	Scarlet Fever.	Measles.	Scarlet Fever.	Measles.	Scarlet Fever.	Measles.
I.	Jan. 1 to Jan. 28	25·2	17·1	14·2	20·6	39·4	37·7	8·8	10·3
II.	Jan. 29 ,, Feb. 25	21·3	13·8	9·7	19·8	31·0	33·6	6·9	9·2
III.	Feb. 26 ,, Mar. 25	23·3	9·8	7·7	22·3	31·0	32·1	6·9	8·7
IV.	Mar. 26 ,, Ap. 22	20·9	12·7	5·9	19·5	26·8	32·2	6·0	8·8
V.	Ap. 23 ,, May 20	20·0	13·4	8·6	17·3	28·6	31·7	6·4	8·6
VI.	May 21 ,, June 17	20·7	14·7	7·2	13·6	27·9	28·3	6·3	7·7
VII.	June 18 ,, July 15	20·3	16·9	6·7	16·7	27·0	33·6	6·0	9·2
VIII.	July 16 ,, Aug. 12	19·5	14·6	6·7	13·9	26·2	28·5	5·9	7·8
IX.	Aug. 13 ,, Sept. 9	21·0	10·9	8·7	10·1	29·7	21·0	6·7	5·7
X.	Sept. 10 ,, Oct. 7	25·2	10·0	11·8	5·6	37·0	15·6	8·3	4·2
XI.	Oct. 8 ,, Nov. 4	29·7	13·9	18·0	4·1	47·7	18·0	10·7	4·9
XII.	Nov. 5 ,, Dec. 2	31·6	16·1	19·6	6·1	51·2	22·2	11·5	6·0
XIII.	Dec. 3 ,, Dec. 30	25·2 <sup>1</sup>	26·9 <sup>2</sup>	17·6 <sup>1</sup>	5·7 <sup>2</sup>	42·8	32·6	9·6	8·9
	Totals	3089	1908	1424	1753	4463	3671	100·0	100·0

<sup>1</sup> Including 9 deaths registered in the fifty-third week of 1873, and 4 deaths in that of 1879, 11 in that of 1884, and 2 in that of 1890.

<sup>2</sup> Including 3 deaths registered in the fifty-third week of 1879, 3 in that of 1884, and 6 in that of 1890.

scarlet fever is infrequent, and the latter disease attaining its autumnal maximum when the prevalence of measles is only beginning to increase.

### 8. *Scarlatina or Scarlet Fever*

*Climatic Influences* do not play a prominent part in determining the geographical distribution of this disease, for although the tropical and sub-tropical regions of Asia and Africa have so far almost entirely escaped scarlet fever, yet it has often prevailed epidemically in the tropical countries of South America; and, on the other hand, in certain cold or temperate climates scarlet fever is among the rarest of diseases.

There is, however, evidence that *season* does influence its prevalence. "*Scarlatina*," observes the Registrar-General of England,<sup>1</sup> "discovers a uniform, well-marked tendency to increase in the last six months, and attain its maximum in the December quarter, the earlier half of the following year witnessing a decrease." In Dublin, also, the disease is almost invariably most prevalent and fatal in the fourth quarter of the year.

From an analysis of the weekly death-rate from scarlatina in Dublin it would seem that this fever shows a tendency to increase when the mean temperature rises much above 50°, while a fall of mean temperature below this point in autumn checks the further rise of the mortality.<sup>2</sup> In this city, scarlet fever is most fatal in the forty-sixth week of the year (middle of November) and least fatal in the twenty-fourth week (middle of June). Dr. Edward Ballard draws inferences which confirm these results.<sup>3</sup> The "Annual Summary of Births, Deaths, and Causes of Deaths," of the Registrar-General of

<sup>1</sup> *Twenty-eighth Annual Report of Births, Deaths, and Marriages*, p. 38.

<sup>2</sup> *Manual of Public Health for Ireland*. 1875. Pp. 303, 304.

<sup>3</sup> *Eleventh Report of the Medical Officer of the Privy Council*. 1868. No. 3. Pp. 54-62.



England, for 1890, is illustrated by the annexed diagram (4.),

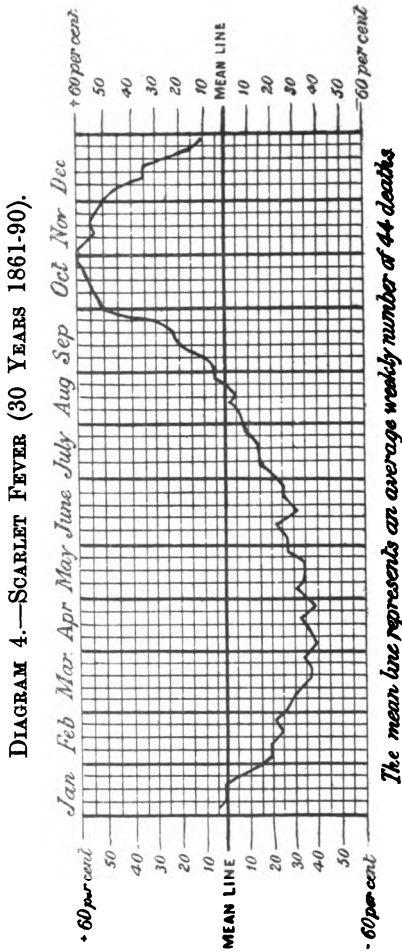

showing the weekly mortality curve for scarlet fever in London on an average of thirty years (1861-90). The curve consists

of a single wave, which rises to its crest (60 per cent above the mean line, which represents an average weekly number of 44 deaths) in October and November, while the trough extends from February to August. It is a suggestive fact that the corresponding curves for diphtheria and enteric fever are also single wave curves, closely resembling each other and that of scarlatina in rising to a crest in October and November, and showing a trough from February to August.

From their analysis of the deaths from scarlet fever registered in London in the thirty years, 1845-1874, Buchan and Mitchell conclude that this disease has its maximum from the beginning of September to the end of the year, and its minimum from February to July. The period of the highest death-rate is from the beginning of October to the end of November, being nearly 60 per cent above the average, and the lowest in March, April, and May, when it is about 33 per cent below its average. In each of the thirty years the deaths increased at the time of mean maximum, and in all except four of the years the increase was considerable. During ten of the years a high death-rate was continued on into the year immediately following, but in every year the deaths became fewer, and diminished steadily, if not rapidly.

## CHAPTER XXX

### THE SEASONAL PREVALENCE OF PNEUMONIC FEVER<sup>1</sup>

IN April 1875, Dr. T. W. Grimshaw, now Registrar-General for Ireland, and I, read before the Medical Society of the King and Queen's College of Physicians a paper on what we ventured to call "Pythogenic Pneumonia." This paper, which was published in the number of the *Dublin Journal of Medical Science* for May 1875,<sup>2</sup> was based upon observations of pneumonia in Steevens' and Cork Street Hospitals, Dublin, during the summer of 1874—when an epidemic of the disease prevailed in the Irish capital—as well as upon an analysis of the statistics of death from bronchitis and pneumonia registered in Dublin during nine years ending with 1873. In the same communication, the meteorological and epidemic conditions of 1874 were discussed, and our researches seemed to warrant us in drawing the following conclusions:—

1. That the bibliography of pneumonia indicates the existence of a form of the disease which arises under miasmatic influences, and is contagious.

2. That this view is supported by the relation which exists between this form of pneumonia and certain zymotic affections—notably, enteric fever and cholera—and by the resemblance between it and epizootic pleuro-pneumonia.

<sup>1</sup> Reprinted, by permission, from the *Transactions of the Ninth Session of the International Medical Congress*. Vol. v. p. 45. Washington, D.C., U.S.A. 1887.

<sup>2</sup> Vol. lix. No. 41. Third Series. Page 399.

3. That its ætiology justifies us in regarding the disease as a zymotic affection and in naming it "*pythogenic pneumonia*."

4. That pythogenic pneumonia presents peculiar clinical features which enable us to distinguish it from ordinary pneumonia.

5. That much of the pneumonia which prevailed in Dublin during 1874 was of this pythogenic character.

6. That whereas ordinary pneumonia is specially prevalent during a continuance of cold, dry weather, with high winds and extreme variations in temperature, pythogenic pneumonia reaches its maximum during tolerably *warm* weather, accompanied with a dry air, deficient rainfall, hot sun and rapid evaporation.

The years which have elapsed since the publication of this paper on "*Pythogenic Pneumonia*" have been fruitful in the literature of the subject to an unprecedented degree. Among the many monographs on pneumonia which have of late appeared, perhaps the most valuable are that by the late Dr. August Hirsch, Professor of Medicine in the University of Berlin, on the Geographical and Historical Pathology of the Disease,<sup>1</sup> and that by the late Dr. C. Friedländer, of Berlin, on the "*Micrococci of Pneumonia*."<sup>2</sup>

Hirsch, after pointing out that pneumonia, even in its narrowest acceptation of fibrinous or so-called croupous pneumonia, is an anatomical term that includes several inflammatory processes differing from one another in their ætiology, goes on to observe that the prevalence of the malady depends very decidedly upon certain influences of season and weather. He gives an elaborate Table of percentages of pneumonic prevalence in the several months at a large number of places in Europe and America. According to this Table,

<sup>1</sup> *Handbook of Geographical and Historical Pathology*. Vol. iii. Translated from the Second German Edition, by Charles Creighton, M.D. London: The New Sydenham Society. 1886.

<sup>2</sup> *Fortschritte der Medicin*. Band 1, Heft 22, Nov. 22, 1883. Translated for the New Sydenham Society. By Edgar Thurston. 1886.

the largest number of cases falls in the months from February to May; the smallest number in the period from July to September. Taking the average for all the places mentioned in the Table, it appears that 34·7 per cent of the patients were attacked in spring (March to May inclusive); 29·0 in winter (December to February); 18·3 in autumn (September to November); and 18·0 in summer (June to August). The combined percentage for winter and spring is 63·7; that for summer and autumn is 36·3. If the number of cases in summer be taken as 1, then autumn has 1·02, winter 1·6, and spring 1·9. Nearly all the recorded epidemics of pneumonia have occurred in winter and spring. From the foregoing considerations, Hirsch confidently concludes that the origin of the malady is dependent on weather influences proper to winter and spring, and more particularly on *sudden changes of temperature and considerable fluctuations in the proportion of moisture in the air*. He holds that any exceptionally large number of cases of "inflammation of the lungs" at the other seasons, more especially in summer, has coincided with the prevalence of the same meteorological conditions phenomenally at that season.

"But that conclusion," he goes on to say, "is still further borne out by the fact that in those northern regions (Russia, Sweden, Denmark, Germany, England, the North of France, and the Northern States of the American Union) where the most sudden and severe changes of temperature fall in spring, the largest number of cases is met with in spring also; while in the warmer and sub-tropical countries (Italy, islands of the Mediterranean, Spain and Portugal, Greece, Algiers, Southern States of the Union, Chili and Peru), which are subject to those meteorological influences, for the most part, in winter, it is winter that represents the proper season of pneumonia. And that applies not merely to sporadic cases, but, in part at least, to epidemic outbreaks of the malady as well. One other fact deserves to be noticed here, namely, that those tracts of country, especially in the tropics, which are highly

favoured in their climate or in the steadiness of the temperature from day to day (Egypt, many parts of India, including Bengal and the plain of Burmah, California, etc.), are subject to pneumonia to a comparatively slight extent."

In the paper on "Pythogenic Pneumonia," by Dr. Grimshaw and myself, will be found a Table, compiled from the returns of the Registrar-General for Ireland, which shows the number of deaths from bronchitis and pneumonia registered in the Dublin Registration District in each quarter of the nine years, 1865-1873 inclusive. According to that Table, of every 100 deaths from bronchitis, 44 on the average occurred in the first quarter of the year, 22 in the second, only 10 in the third, and 24 in the fourth quarter. Thus, the mortality from bronchitis was twice as great in the first as it was in the second quarter, and more than four times greater in the first than in the third quarter.

Very different were the facts as to pneumonia: of every 100 deaths from this disease, 32 on the average occurred in the first quarter, 27 in the second, 16 in the third, and 25 in the fourth quarter. The mortality from pneumonia was only *one-fifth* greater in the first than in the second quarter, and only twice as great in the first as in the third quarter. The extreme winter fatality of bronchitis and its low summer fatality were equally wanting in the case of pneumonia.

A careful analysis of the weekly returns of the Registrars-General of England and Ireland for ten years ending with 1885, and of the same returns for the year 1886, brings out a similar remarkable contrast between bronchitis and pneumonia, as to the time of year when these diseases are respectively most prevalent and fatal in London and Dublin.

Table I. contains the figures relating to pneumonia; Table II. those relating to bronchitis. Each Table sets forth the weekly average number of deaths in London and in Dublin from pneumonia and bronchitis respectively, in the ten years, 1876-85, as well as the actual weekly number of deaths from these diseases in the year 1886.



TABLE II.—Showing the Deaths from Bronchitis, by Weeks and Quarters, in Dublin and London, in the Ten Years 1876-85 inclusive, and in the year 1886.

Week.	DUBLIN REGISTRATION DISTRICT.					LONDON REGISTRATION DISTRICT.										
	First Quarter		Second Quarter		Third Quarter		Fourth Quarter		First Quarter		Second Quarter		Third Quarter		Fourth Quarter	
	1876-85	1886	1876-85	1886	1876-85	1886	1876-85	1886	1876-85	1886	1876-85	1886	1876-85	1886	1876-85	1886
1	43·4	26	33·0	30	13·0	11	18·9	7	314·7	338	309·0	218	106·8	93	135·9	124
2	42·3	21	31·6	20	15·9	8	19·8	11	311·8	351	277·5	213	102·8	88	166·1	122
3	44·5	32	36·0	27	12·6	13	18·9	12	350·2	308	239·8	179	97·2	71	195·9	160
4	49·7	29	29·0	30	13·2	10	22·6	13	368·2	330	222·7	175	92·8	84	221·6	189
5	48·3	38	26·4	22	12·4	4	24·3	11	435·6	304	193·0	179	95·7	82	237·5	176
6	54·3	40	26·9	16	11·7	16	26·5	22	405·2	394	189·8	166	90·5	76	266·1	186
7	50·2	52	21·5	13	13·0	7	29·7	24	340·7	452	172·1	137	91·6	74	272·1	216
8	43·4	47	24·2	17	11·2	10	34·1	16	290·9	439	157·3	108	83·7	89	289·5	273
9	38·6	28	23·2	24	13·0	13	32·8	23	289·9	526	146·0	91	86·6	63	297·4	278
10	37·3	55	22·8	11	12·5	9	39·4	33	295·2	566	143·2	96	82·5	59	294·4	327
11	35·0	41	20·2	11	14·5	17	42·1	33	304·4	646	124·4	90	95·5	85	345·3	260
12	41·4	38	19·0	15	14·1	14	43·3	30	318·9	474	114·2	82	109·7	71	342·2	276
13	38·5	28	19·4	8	15·6	6	43·0	35	332·8	330	108·1	98	118·4	102	347·1	370
Totals	566·9	475	338·2	244	172·7	138	395·4	270	4358·5	5458	2397·1	1832	1253·8	1037	3413·2	2957
Per cent	38·5	42·1	23·0	21·7	11·7	12·2	26·8	24·0	38·2	48·4	21·0	16·2	11·0	9·2	29·8	26·2
	Total deaths from Bronchitis : Dublin, 1876-85 (average), 1473·2; 1886, 1127.					Total deaths from Bronchitis : London, 1876-85 (average), 11422·6; 1886, 11284.										



In Tables III. and IV. these numerical results are thrown into curves.

It will be observed that the statistics for London and for Dublin agree to a remarkable extent. In both cities bron-

Table III. *Showing the average weekly number of Deaths from Bronchitis, and from Pneumonia in the Decade 1876-1885 in the Dublin Registration District.*

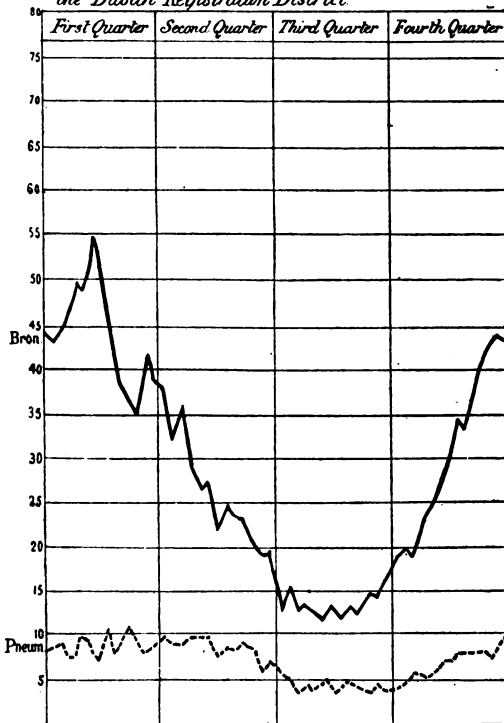

chitis falls to a very low ebb in the third, or summer, quarter of the year (July to September inclusive), when only 12 per cent of the deaths annually caused by this disease take place in Dublin, and only 11 per cent in London. In the last, or fourth, quarter (October to December inclusive), the per-

centage of deaths from bronchitis rises to 27 in Dublin and to 30 in London. The maximal mortality occurs in the first quarter (January to March inclusive), when it is 38 per cent

Table IV. *Showing the average weekly number of Deaths from Bronchitis, and from Pneumonia in the Decade 1876-1885-in London*

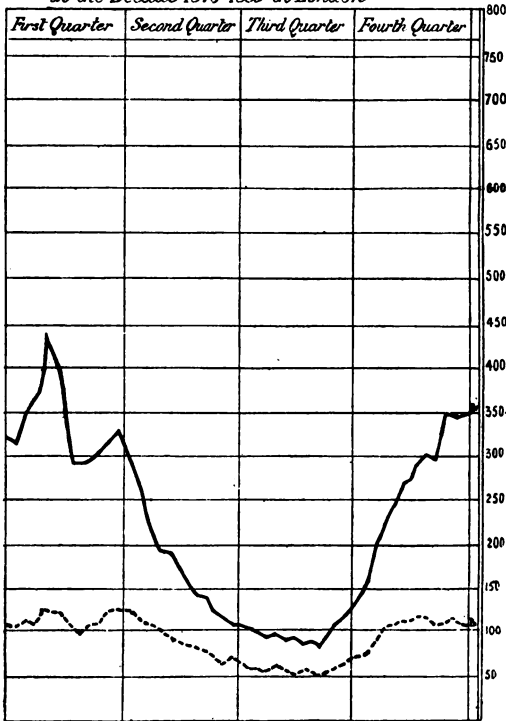

in both London and Dublin. In the second, or spring, quarter (April to June inclusive), the deaths from bronchitis declined to 23 per cent in Dublin and to 21 per cent in London.

The mortality from "pneumonic fever" is very differently

distributed throughout the year. In the summer quarter more than 14 per cent of the deaths yearly referable to this disease are recorded in Dublin, and more than 15 per cent in London. In the first quarter, the figures are : Dublin, 31 per cent ; London, 31 per cent ; in the second quarter they are : Dublin, 30 per cent ; London, 26 per cent ; in the fourth quarter they are : Dublin, 24 per cent ; London, 28 per cent.

From these numerical results it therefore appears that the fatality and (indirectly) the prevalence of pneumonic fever from season to season do not correspond with the seasonal prevalence and fatality of bronchitis. The latter disease—be it of primary or secondary origin—increases and kills in direct relation to the setting in of cold weather, with excessive relative humidity and increased and frequent precipitation in the form of rain, snow or sleet, and hail. It subsides in prevalence and fatality with the advance of spring and the advent of summer.

Pneumonic fever, on the other hand, increases less quickly in winter, and remains more prevalent and fatal in spring and summer, than bronchitis ; its maximal incidence coincides with the season of dry, harsh winds and hot sunshine in spring, when also the relative humidity is low, precipitation is scanty, while the diurnal range of temperature is extreme.

A closer study of Tables III. and IV. yields some interesting results. In the first place, we observe that the London curves of deaths both from bronchitis and pneumonia vary less from week to week than the corresponding curves for Dublin, which are much less regular and, as it were, more serrated. The reason for this evidently is, that in the case of London we have to deal with a population which is now some twelve times greater than that of Dublin, hence the law of periodicity fulfils itself with greater exactness in the vast population of London than in the comparatively small population of Dublin. The death curves of the larger city are, as it were, seen through a magnifying glass of ten diameters, in the corresponding death curves of Dublin, the variations

from week to week being magnified or multiplied tenfold. In the second place, it will be noticed that bronchitis is uniformly throughout the year less fatal in proportion to the population in London than it is in Dublin, while the converse is true of pneumonia. According to the Census of 1881, the middle year of the decade with which we are at present concerned, the population of the London Registration District was 3,893,272; that of the Dublin Registration District was 348,293. The average quarterly number of deaths from bronchitis in the ten years, 1876-85, were these:—

First quarter, Dublin, 566·9; London, 4358·5.

Second quarter, Dublin, 338·2; London, 2397·1.

Third quarter, Dublin, 172·7; London, 1253·8.

Fourth quarter, Dublin, 395·4; London, 3413·2.

On the other hand, the average quarterly number of deaths from pneumonia in the same ten years were:—

First quarter, Dublin, 112·2; London, 1467·2.

Second quarter, Dublin, 108·8; London, 1222·5.

Third quarter, Dublin, 51·4; London, 734·8.

Fourth quarter, Dublin, 85·9; London, 1350·2.

The third point of interest in Tables III. and IV. is the dip in the death curve from bronchitis, both in London and in Dublin, from the seventh to the tenth week of the year. This would seem to depend on several causes—first, the removal by death at the beginning of the year of those individuals who were most susceptible to bronchitis; secondly, the acclimatisation of the surviving population to the continued cold of winter; and thirdly, the prevalence of south-west winds and open weather toward the close of January and early in February. With the setting in of the searching east winds of early spring the death curve again rises at the beginning of March, when also there is a marked rise in the death-toll exacted by pneumonia, more especially in London.

Another curious point is, that the changes in the contour of the death curves apparently occur a week earlier in London than they do in Dublin. Delay in registration in the latter

city seems to be the explanation of this otherwise puzzling circumstance.

It will be observed that in the foregoing analysis only statistics of deaths are considered, and these, unfortunately, are of minor value compared with statistics of the prevalence of bronchitis and of pneumonia respectively, were such available. Let us hope that the day is not far distant when registration of disease will be compulsory, as registration of the cause of death is at present. Until this much-needed reform is carried into effect, statistical inquiries into the prevalence of disease in localities and in seasons will want much of that precision which alone can give them scientific value.

How are we to explain the continued frequency of pneumonic fever in summer and autumn? In my opinion the solution of this paradox is to be sought in the consideration of the *pythogenic* origin of the disease in many instances, and particularly in the warm season of the year. In a word, I would regard exposure to cold, extremes of temperature, harsh, drying winds, and other personal or climatological conditions as merely so many *predisposing* causes of the disease, while I would reserve for the introduction into the system of a specific virus or contagium the *rôle* of an *exciting* cause—perhaps the sole exciting cause—of pneumonic fever. As to the exact nature of that virus or contagium, we are as yet practically ignorant, but the researches and discoveries of Klebs, Eberth, Koch, Fränkel, and Friedländer in connection with the bacteria of pneumonia—chief among them, the *Pneumococcus* (*Pneumoniokokken*) of Friedländer and the *Diplococcus pneumonice* of Fränkel—are full of promise. We stand on the threshold of a new Science of Medicine, and before long a flood of light will doubtless be shed upon the intimate nature and pathology of pneumonia as well as of other blood diseases.

In the "Medical Report of Cork Street Fever Hospital and House of Recovery, Dublin," for the year 1884, I ventured

to assert that the claims of pneumonia to be considered a specific fever rested principally upon—

1. Its not infrequent epidemic prevalence, which the bibliography of the disease places beyond dispute.

2. Its proved infectiousness in some instances, as, for example, those observed at Dalton in the spring months of 1883, by Dr. E. Slade King, and Mr. Sloane Michell, M.R.C.S. England.<sup>1</sup>

3. Its occasional pythogenic origin, and the remarkable correlation which appears to exist between it and enteric fever.

4. Its mode of onset, or “invasion,” which exactly resembles that of the recognised specific fevers.

5. The appearance of constitutional symptoms before the development of local signs, or even local symptoms in many instances; in other words, the existence of a “true period of invasion.”

6. The critical termination of the febrile movement in all uncomplicated cases.

7. The presence of local epi-phenomena in connection with the skin, such, for example, as eruptions of herpes, the appearance of taches bleuâtres, and the occurrence of desquamation.

8. The development of sequelæ in some cases, such as an attack of nephritis, followed by renal dropsy, ataxia like that observed after typhus or diphtheria, and so on.

9. The discovery of a bacterium in pneumonic exudation, to which analogy, at all events, points as pathognomonic.

In my hospital and private practice I have acquired the habit of expressing the relation of the local lesion in pneumonia, or pneumonic fever, to the essential disorder, in terms of the intestinal lesion in enteric fever to that disease. Just as physicians and pathologists have long since come to avoid the dangerous error—I would even say heresy—of Broussais and his school, who held that the pyrexia or feverishness in

<sup>1</sup> Cf. *The Practitioner*. April, 1884.

enteric fever was symptomatic of and secondary to a local inflammation of the glands of the small intestine, so we shall come in time to avoid the similar and not less dangerous but more widely disseminated error, of regarding the pyrexia in pneumonia as symptomatic of and secondary to a local inflammation of the lungs. The day is seemingly not far distant when we shall speak of "pneumonic fever" in precisely the same way as we use the term "enteric fever" at present—that is, to signify a zymotic or specific blood disease, manifesting itself after the lapse of a certain time, by physical phenomena—objective and subjective—connected, in this instance, with the lungs.

## APPENDIX I

LIST OF THE REGULAR STATIONS OF THE UNITED STATES  
WEATHER BUREAU. (Those Stations which are marked  
with an asterisk have instruments making continuous  
records.)

- |                       |                        |
|-----------------------|------------------------|
| *Abilene, Texas.      | Columbia, S. C.        |
| *Albany, N. Y.        | Columbus, Ohio.        |
| *Alpena, Mich.        | Concordia, Kans.       |
| Amarillo, Texas.      | Corpus Christi, Texas. |
| Astoria, Oregon.      | Currituck Inlet, N. C. |
| *Atlanta, Ga.         | *Davenport, Iowa.      |
| Atlantic City, N. J.  | *Denver, Colorado.     |
| *Augusta, Ga.         | *Des Moines, Iowa.     |
| Baker City, Oregon.   | *Detroit, Mich.        |
| *Baltimore, Md.       | *Dodge City, Kans.     |
| *Bismarck, N. Dak.    | Dubuque, Iowa.         |
| Block Island, R. I.   | *Duluth, Minn.         |
| *Boston, Mass.        | East Clallam, Wash.    |
| *Buffalo, N. Y.       | *Eastport, Maine.      |
| Cairo, Illinois.      | *El Paso, Texas.       |
| Canby, Fort, Wash.    | Erie, Pennsylvania.    |
| Cape Henry, Va.       | Escanaba, Mich.        |
| Carson City, Nev.     | Eureka, California.    |
| Charleston, S. C.     | Fort Smith, Ark.       |
| Charlotte, N. C.      | Fresno, Cal.           |
| Chattanooga, Tenn.    | *Galveston, Texas.     |
| Cheyenne, Wyoming.    | *Grand Haven, Mich.    |
| *Chicago, Ill.        | Green Bay, Wis.        |
| *Cincinnati, Ohio.    | Hannibal, Mo.          |
| *Cleveland, Ohio.     | Harrisburg, Pa.        |
| *Colorado Spgs., Col. | Hatteras, N. C.        |
| *Columbia, Mo.        | *Havre, Mont.          |



- \*Helena, Mont.
- \*Huron, S. Dak.  
Idaho Falls, Idaho.
- \*Indianapolis, Ind.  
Ithaca, N. Y.
- \*Jacksonville, Fla.  
Jupiter, Fla.
- \*Kansas City, Mo.  
Kearney, Nebraska.
- \*Keeler, Cal.  
Keokuk, Iowa.
- \*Key West, Fla.  
Kitty Hawk, N.C.
- \*Knoxville, Tenn.  
La Crosse, Wis.  
Lander, Wyoming.  
Little Rock, Ark.  
Los Angeles, Cal.
- \*Louisville, Ky.
- \*Lynchburg, Va.
- \*Marquette, Mich.
- \*Memphis, Tenn.  
Meridian, Miss.  
Miles City, Mont.
- \*Milwaukee, Wis.  
Minneapolis, Minn.  
Mobile, Alabama.  
Montgomery, Alabama.
- \*Moorhead, Minn.
- \*Nantucket, Mass.  
Narragansett Pier, R.I.
- \*Nashville, Tenn.  
Neah Bay, Wash.  
New Brunswick, N.J.
- \*New Haven, Conn.  
New London, Conn.
- \*New Orleans, La.
- \*New York City, N. Y.
- \*Norfolk, Virginia.  
Northfield, Vermont.  
North Platte, Nebr.  
Oklahoma, O. T.
- \*Olympia, Wash.
- \*Omaha, Nebraska.  
Oswego, New York.  
Palestine, Texas.  
Parkersburg, W. Va.  
Pensacola, Fla.
- \*Philadelphia, Pa.  
Pierre, S. Dak.
- \*Pike's Peak, Colo.
- \*Pittsburg, Pa.  
Point Reyes Light, Cal.  
Port Angeles, Wash.  
Port Crescent, Wash.  
Port Huron, Mich.
- \*Portland, Maine.
- \*Portland, Oregon.  
Pueblo, Colorado.  
Pysht, Wash.  
Raleigh, N.C.  
Rapid City, S. Dak.
- \*Red Bluff, Cal.
- \*Rochester, N. Y.
- \*Roseburg, Oregon.  
Sacramento, Cal.
- \*Saint Louis, Mo.
- \*Saint Paul, Minn.  
Saint Vincent, Minn.
- \*Salt Lake City, Utah.  
San Antonio, Texas.
- \*San Diego, Cal.  
Sandusky, Ohio.
- \*San Francisco, Cal.
- \*Santa Fe, New Mexico.
- \*Sault Ste. Marie, Mich.
- \*Savannah, Ga.  
Seattle, Washington.  
Shreveport, La.  
Sioux City, Iowa.  
Southport, N.C.
- \*Spokane, Wash.  
Springfield, Ill.  
Springfield, Mo.
- \*Tampa, Florida.  
Tatoosh Island, Wash.

Titusville, Fla.	*Washington, D.C.
*Toledo, Ohio.	Wichita, Kansas.
Topeka, Kansas.	Williston, N. Dak.
Tucson, Arizona.	*Wilmington, N.C.
Valentine, Neb.	Winnemucca, Nevada.
*Vicksburg, Miss.	Woods Holl, Mass.
Vineyard Haven, Mass.	Yankton, S. Dak.
Walla Walla, Wash.	*Yuma, Arizona.

## APPENDIX II

### THE MORE IMPORTANT PUBLICATIONS OF THE UNITED STATES METEOROLOGICAL SERVICE

#### THE SIGNAL SERVICE, FROM 1861 TO JUNE 30, 1891

- 1870-1891. Annual Report of the Chief Signal-Officer, U.S. Army, 1870-1891. 8vo. Wash. 1870-1892 (Meteorological Report).
- 1871, 1872. Correspondence and Reports in Reference to the Observations and Report of Storms by Telegraph and Signal for the Benefit of Commerce. 8vo. Wash. 1871. 43 pp. ; 1872. 203 pp.
- 1871, 1872, 1874, 1875, 1879, 1881. Instructions to Observer Sergeants, Signal Service, U.S.A., on duty at Stations. 8vo. Wash. 1871. 25 pp. ; 1872. 59 pp. ; 1874. 116 pp. ; 1875. 139 pp. ; 4to. Wash. 1879. 162 pp. ; 8vo. Wash. 1881. 241 pp. ; 1887. 142 pp. Title in this edition changed to "General Instructions to Observers of the Signal Service."
- 1871-1891. War Department Weather Maps. Jan. 1, 1871, to June 30, 1891. Issued as : Tri-daily Weather Maps, Signal Service, U.S. Army, Jan. 1, 1871, to Dec. 31, 1880. Continued as : Daily Weather Maps, Jan. 1, 1881, to Dec. 31, 1886. Continued as : Tri-daily Weather Maps, Jan. 1, 1887, to June 30, 1888. Continued as : Bi-daily Weather Maps, July 1, 1888, to Sept. 30, 1888. Title changed to : "Semi-daily Weather Maps," Oct. 1, 1888. 16 in. x 22 in. Wash. 1871-1891.
- (1872.) Report of Meteorological Observations made at Mt. Washington, N.H., during May 1872. 8vo. (Wash. 1872). 60 pp.

- (1872-1881.) Weekly Weather Chronicle. Nov. 16, 1872, to April 4, 1881. Sm. 4to. Wash. 1872-1881.
- 1872-1884. Daily Bulletin of Weather Reports, taken at 7.35 A.M., 4.35 P.M., and 11.35 P.M., Washington mean time, with the synopses, probabilities, and facts; March 1872 to June 1877. (Printed monthly.) 8vo. Wash. 1872-1877. (Oct. to Dec. 1875 not published.) Same: Sept. 1872 to Jan. 1875; Jan. to Dec. 1877, with tri-daily maps. Jan. 1878 to Dec. 1880, without maps. 4to. Wash. 1873-1882. Maps for 1878 printed later as: Tri-daily Meteorological Record. Obl. 4to. Wash. 1884. (Feb. 1887 title changed to: "Daily Bulletin, etc., with synopses, indications and facts"; Sept. 1877, title changed to: "Daily Bulletin of Simultaneous Weather Reports, etc., with synopses, indications, and facts.")
- 1872-1891. Monthly Weather Review, June 1872 to June 1891. 4to. Wash. 1872-1891. (The Reviews for Oct. 1872 to Dec. 1883, also published in the Annual Reports.)
- 1875-1889. Bulletin of International Meteorological Observations taken simultaneously at 7.35 A.M., Jan 1, 1875, to Dec. 31, 1880. Same: taken at 7 A.M., Jan 1, 1881, to June 30, 1884. (Printed daily.) 4to. Wash. 1875-1885. From Jan. 1881 to June 1884, monthly summaries added. 1882, title changed to: "Bulletin of International Meteorology," July 1884, title changed to: "Summary and Review of International Meteorological Observations," and issued monthly to Dec. 1887. 4to. Wash. 1885-1889.

## UNITED STATES SIGNAL SERVICE PROFESSIONAL PAPERS

1881. No. 1. Abbe (Cleveland). Report on the Solar Eclipse of July 1878. 4to. Wash. 1881. 186 pp. 34 pl.
1881. No. 2. Greely (A. W.). Isothermal Lines of the United States, 1871-1880. 4to. Wash. 1881. 1 p. 12 pl.
1881. No. 3. Greely (A. W.). Chronological List of Auroras observed from 1870 to 1879. 4to. Wash. 1881. 76 pp.
1881. No. 4. Finley (J. P.). Report of the Tornadoes of May 29 and 30, 1879, in Kansas, Nebraska, Missouri, and Iowa. 4to. Wash. 1881. 116 pp. 29 ch.

1881. No. 5. Information Relative to the Construction and Maintenance of Time-balls. 4to. Wash. 1881. 31 pp. 3 pl.
1882. No. 6. Hazen (Henry A.). The Reduction of Air-pressure to Sea Level at Elevated Stations west of the Mississippi River. 4to. Wash. 1882. 42 pp. 20 maps.
1884. No. 7. Finley (J. P.). Report on the Character of Six Hundred Tornadoes. 4to. Wash. 1884. 29 pp. 3 ch.
1882. No. 8. Ferrel (William). Recent Mathematical Papers concerning the Motions of the Atmosphere. Part I. The Motions of Fluids and Solids on the Earth's Surface. Reprinted with notes by Frank Waldo. 4to. Wash. 1882. 51 pp.
1883. No. 9. Dunwoody (H. H. C.). Charts and Tables showing Geographical Distribution of Rainfall in the United States. 4to. Wash. 1883. 29 pp. 3 ch.
1882. No. 10. Tables of Rainfall and Temperature compared with Crop Production. 4to. Wash. 1882. 15 pp.
1883. No. 11. Sherman (O.T.). Meteorological and Physical Observations on the East Coast of British America. 4to. Wash. 1883. 202 pp. 1 ch.
1882. No. 12. Ferrel (William). Popular Essays on the Movements of the Atmosphere. 4to. Wash. 1882. 59 pp.
1884. No. 13. Ferrel (William). Temperature of the Atmosphere and Earth's Surface. 4to. Wash. 1884. 69 pp.
1884. No. 14. Finley (J. P.). Charts of Relative Storm Frequency for a Portion of the Northern Hemisphere. 4to. Wash. 1884. 9 pp. 13 ch.
1884. No. 15. Langley (S. P.). Researches on Solar Heat and its absorption by the Earth's Atmosphere. A Report of the Mt. Whitney expedition. 4to. Wash. 1884. 239 pp. 22 pl.
1885. No. 16. Finley (J. P.). Tornado Studies for 1884. 4to. Wash. 1885. 15 pp. 72 ch. 72 tables.
1886. No. 17. Ferrel (William). Recent Advances in Meteorology. Published as Part II., Appendix No. 71, of the Annual Report of the Chief Signal-Officer for 1885. 4to. Wash. 1886. 440 pp.
1885. No. 18. Hazen (H. A.). Thermometer Exposure. 4to. Wash. 1885. 32 pp.

## UNITED STATES SIGNAL SERVICE NOTES

1882. No. 1. Bailey (W. O.). Report on the Michigan Forest Fires of 1881. 8vo. Wash. 1882. 16 pp. 6 ch.
1882. No. 2. Birkhimer (W. E.). Memoir on the Use of Homing Pigeons for Military Purposes. 8vo. Wash. 1882. 27 pp.
1882. No. 3. Allen (James). To Foretell Frost. 8vo. Wash. 1882. 11 pp.
1883. No. 4. Upton (Winslow). The Use of the Spectroscope in Meteorological Observations. 8vo. Wash. 1883. 7 pp. 3 ch.
1883. No. 5. Work of the Signal Service in the Arctic Regions. 8vo. Wash. 1883. 40 pp. 1 ch.
1883. No. 6. Hazen (H. A.). Report on Wind Velocities at the Lake Crib and at Chicago. 8vo. Wash. 1883. 20 pp.
1883. No. 7. Hazen (H. A.). Variation of Rainfall west of the Mississippi River. 8vo. Wash. 1883. 8 pp.
1883. No. 8. Waldo (Frank). The Study of Meteorology in the Higher Schools of Germany, Switzerland, and Austria. 8vo. Wash. 1883. 9 pp.
1883. No. 9. Dunwoody (H. H. C.). Weather Proverbs. 8vo. Wash. 1883. 148 pp. 1 map.
1883. No. 10. Garlington (E. A.). Report on Lady Franklin Bay Expedition of 1883. 8vo. Wash. 1883. 52 pp. 1 map.
1883. No. 11. Ward (F. K.). The Elements of the Heliograph. 8vo. Wash. 1883. 12 pp.
1884. No. 12. Finley (J. P.). The Special Characteristics of Tornadoes, with Practical Directions for the Protection of Life and Property. 8vo. Wash. 1884. 19 pp.
1885. No. 13. Curtis (G. E.). The Relation between Northerners and Magnetic Disturbances at Havana, Cuba. 8vo. Wash. 1885. 16 pp.
1884. No. 14. Lamar (W. H.), jr. and Ellis (F. W.). Physical Observations during the Lady Franklin Bay Expedition of 1883. 8vo. Wash. 1884. 62 pp. 14 pl. 1 map.
1884. No. 15. Hazen (H. A.). Danger Lines and River Floods of 1882. 8vo. Wash. 1884. 30 pp.
1884. No. 16. Curtis (G. E.). The Effect of Wind Currents on Rainfall. 8vo. Wash. 1884. 11 pp. 2 pl.

1884. No. 17. Morrill (Park). A First Report upon Observations of Atmospheric Electricity at Baltimore, Md. 8vo. Wash. 1884. 8 pp. 6 ch.
1885. No. 18. M'Adie (Alexander). The Aurora in its Relations to Meteorology. 8vo. Wash. 1885. 21 pp. 14 ch.
1885. No. 19. Glenn (S. W.). Report on the Tornado of Aug. 28, 1884, near Huron, Dakota. 8vo. Wash. 1885. 10 pp. 11 ch.
1885. No. 20. Hazen (H. A.). Thunderstorms of May 1884. 8vo. Wash. 1885. 8 pp. 2 ch.
1885. No. 21. How to use Weather Maps. Not published.
1885. No. 22. Russell (Thomas). Corrections of Thermometers. 8vo. Wash. 1885. 11 pp.
1885. No. 23. Woodruff (T. M.). Cold Waves and their Progress. A Preliminary Study. 8vo. Wash. 1885. 21 pp.
1884. History of the Signal Service, with catalogue of publications, instruments, and stations. 8vo. Wash. 1884. 39 pp.
1886. Recent Advances in Meteorology. By William Ferrel. Annual Report of the Chief Signal-Officer for 1885. Part II. 8vo. Wash. 1886. 440 pp.
1887. Weather-Crop Bulletin, May 1, 1887, to June 30, 1891. (Issued weekly from March to September; monthly from October to February.) 4to. and fol. sheets. Wash. 1887-1891. (Folio sheets, cyclostyle.) May 1891, form changed to sheets 18 in. x 22 in., with rainfall and temperature maps.
1888. Treatise on Meteorological Apparatus and Method. By Cleveland Abbe. Annual Report of the Chief Signal-Officer for 1887. Part II. 8vo. Wash. 1888. 392 pp. 36 pl.
1888. General Subject Indexes to the Monthly Weather Reviews and Annual Reports of the Chief Signal-Officer of the Army to 1887. (Issued annually after this date.) 8vo. Wash. 1888. 52 pp.
1888. Charts showing the Rainfall in the United States for each Month from January 1870 to December 1873, based largely on reports from voluntary observers. 4to. Wash. 1888. 48 ch.
1888. Instructions for Weather Predictions and Verifications. Signal Service Instructions, No. 33, 1888. 12mo. Wash. 1888. 31 pp.

- Amer. Met. J. Ann Arbor, vi. 1889, 19-32.
1889. Tables for obtaining the Temperature of the Dew-Point, Relative Humidity, and Vapour Pressure. Prepared for use in the U.S. Signal Service. 8vo. Wash. 1889. 24 pp.
1889. Charts showing the Normal Monthly Rainfall in the United States (extracted from the Monthly Weather Review), with Notes and Tables. Prepared under the direction of Gen. A. W. Greely, C.S.O., by Capt. H. H. C. Dunwoody. 4to. Wash. 1889. 12 pp. 13 ch.
1889. Bibliography of Meteorology. A classed catalogue of the printed literature of meteorology from the origin of printing to the close of 1881; with a supplement to the close of 1887 and an author index. Edited by Oliver L. Fassig, Bibliographer and Librarian. Part I. Temperature; Part II. Moisture; Part III. Winds; Part IV. Storms. 4to. Wash. 1889-1891. (Lithograph and milligraph.)
1889. Meteorological Observations made on the Summit of Pike's Peak, Colo., Jan. 1874 to June 1888. Under the direction of the Chief Signal-Officer. Ann. Astr. Obsy., Harvard College, Camb., vol. xxii. 1889. 4to. Camb. 1889. 475 pp.
- 1889, 1891. Daily International Charts. Oct. 1, 1886, to Dec. 31, 1887. July 1, 1884, to Dec. 31, 1884. Fol. Wash. 1889, 1891.
1890. Stages of the Ohio River and of its Principal Tributaries, 1858 to 1889 inclusive. Part I. Prepared under the direction of Brig.-Gen. A. W. Greely, C.S.O., by T. Russell, Asst. Prof. 4to. Wash. 1890. xviii. 377 pp. (Milliographed.)
1890. Preparatory Studies for Deductive Methods in Storm and Weather Predictions. By Cleveland Abbe. Annual Report of the Chief Signal-Officer for 1889. Part II. 8vo. Wash. 1890. 165 pp. 3 maps.
1891. Mean Temperatures and their Corrections in the United States. Prepared under the direction of Gen. A. W. Greely, Chief Signal-Officer, by Alexander M'Adie, M.A. 4to. Wash. 1891. x. 45 pp.



1891. Charts showing the Average Monthly Cloudiness in the United States. Prepared under the direction of Gen. A. W. Greely, Chief Signal-Officer. Fol. Wash. 1891. 12 ch.
1891. Charts showing the "Probability of Rainy Days," prepared from Observations for Eighteen Years. Prepared under the direction of Gen. A. W. Greely, Chief Signal-Officer. Fol. Wash. 1891. 12 ch.

ARCTIC SERIES OF PUBLICATIONS ISSUED IN CONNECTION  
WITH THE SIGNAL SERVICE, UNITED STATES ARMY

1885. No. 1. Report of the International Polar Expedition to Point Barrow, Alaska, 1881-1883. By Lieut. P. H. Ray. 4to. Wash. 1885. 695 pp. pl.
1886. No. 2. Contributions to the Natural History of Alaska. Results of Investigations made chiefly in the Yukon District and the Aleutian Islands, from May 1874 to August 1881. By L. M. Turner. 4to. Wash. 1886. 226 pp. 26 pl.
1887. No. 3. Report upon Natural History Collections made in Alaska between the Years 1877 and 1881 by Edward W. Nelson. Edited by Henry W. Henshaw. 4to. Wash. 1887. 337 pp. 21 pl.
1888. No. 4. Report of the Proceedings of the United States Expedition to Lady Franklin Bay, Grinnell Land. (International Polar Expedition, 1881-1883.) By Lieut. A. W. Greely. Vol. i. narrative; vol. ii. observations. 2 vols. 4to. Wash. 1888.

REPORTS OF THE CHIEF SIGNAL-OFFICER, PUBLISHED  
BY SPECIAL AUTHORITY OF CONGRESS

1888. The Rainfall of the Pacific Slope and the Western States and Territories. Report by the Chief Signal-Officer. (50th Congr. 1st sess., Sen. ex. doc. 92.) 4to. Wash. 1888. 101 pp. 15 ch.
1889. The Climate of Oregon and Washington Territory. Report by the Chief Signal-Officer. (50th Congr. 1st sess., Sen. ex. doc. 282.) 4to. Wash. 1889. 37 pp. 7 ch.
1890. Climate of Nebraska, particularly in reference to the

- Temperature and Rainfall and their Influence upon the Agricultural Interests of the State. Report by the Chief Signal-Officer. (51st Congr. 1st sess., Sen. ex. doc. 115.) 4to. Wash. 1890. 60 pp. 12 ch.
1891. Report on the Climatology of the Arid Regions of the United States, with reference to Irrigation. By Lieut. W. A. Glassford, under direction of Gen. A. W. Greely, C.S.O. (51st Congr. 2nd sess., H.R. ex. doc. 287.) 4to. Wash. 1891. 368 pp. 46 maps and plates.
1892. Report of the Chief Signal-Officer of the Army on the Climatic Conditions of the State of Texas. (Sen. ex. doc. No. 5, 52nd Congr. 1st sess.) 4to. Wash. 1892. 120 pp. 13 ch.

PUBLICATIONS OF THE UNITED STATES WEATHER BUREAU, FROM  
JULY 1, 1891, TO DECEMBER 1, 1893

- 1891-1893. Semi-Daily Weather Maps. July 1, 1891, to Dec. 1, 1893. 23 × 18 in. Wash. 1891-1893.
- 1891-1893. Monthly Weather Review, including Annual Summary. July 1891 to Sept. 1893. 4to. Wash. 1891-1893.
- 1891-1893. Weather-Crop Bulletin. (Weekly during the season of growing crops; monthly during the remainder of the year.) 18 × 24 in. Wash. 1891-1893.
1892. No. 1. Notes on the Climate and Meteorology of Death Valley, California. By Mark W. Harrington, Chief of the Weather Bureau. June 1892. (Octavo) 50 pp.
1892. No. 2. Notes on a New Method for the Discussion of Magnetic Observations. By Frank H. Bigelow, Professor of Meteorology. July 1892. (Octavo) 41 pp.
1892. No. 3. A Report on the Relations of Soil to Climate. By E. W. Hilgard, Professor of Agriculture and Agricultural Chemistry, University of California. July 1892. (Octavo) 59 pp.
1892. No. 4. Some Physical Properties of Soils in their Relation to Moisture and Crop Distribution. By Milton Whitney, Professor of Geology and Soil Physics,

- Maryland Agricultural College ; Physicist, Maryland Agricultural Experiment Station ; Fellow by Courtesy, Johns Hopkins University. Aug. 1892. (Octavo) 90 pp.
1892. No. 5. Observations and Experiments on the Fluctuations in the Level and Rate of Movement of Ground-Water on the Wisconsin Agricultural Experiment Station Farm, and at Whitewater, Wisconsin. By Franklin H. King, Professor of Agricultural Physics, University of Wisconsin ; Physicist, Wisconsin Agricultural Experiment Station. Dec. 1892. (Octavo) 75 pp.
1892. No. 6. The Diurnal Variation of Barometric Pressure. By Frank N. Cole, Ph.D., Assistant Professor of Mathematics, University of Michigan. Dec. 1892. (Octavo) 32 pp.
1893. No. 7. Report of the First Annual Meeting of the American Association of State Weather Services. (Co-operating with the Weather Bureau, U.S. Department of Agriculture.) Feb. 1893. (Octavo) 49 pp.
1893. No. 8. Report on the Climatology of the Cotton Plant. By P. H. Mell, Ph.D., Professor of Geology and Botany in Alabama Polytechnic Institute ; Director Alabama Weather Service. April 1893. (Octavo) 58 pp.
1893. No. 9. Report on the Forecasting of Thunderstorms during the Summer of 1892. By N. S. Conger, Inspector, Weather Bureau. May 1893. (Octavo) 54 pp.
1893. No. 10. The Climate of Chicago. By Henry A. Hazen, Professor of Meteorology.
- 1891, 1893. Special Report of the Chief of the Weather Bureau to the Secretary of Agriculture, 1891. (Report for the months July to Sept. 1893.) 8vo. Wash. 1891. 26 pp.
- 1891-1893. Report of the Chief of the Weather Bureau for 1891 ; same for 1892. Extracts from the Report of the Secretary of Agriculture for 1891 and 1892. 8vo. Wash. 1892, 1893. 93 pp. and 76 pp.
1892. Instructions for Voluntary Observers. Prepared under direction of the Chief of the Weather Bureau, by Thomas Russell. 8vo. Wash. 1892. 100 pp.

1892. Instructions for Special River Observers. Prepared under direction of the Chief of the Weather Bureau, by Thomas Russell. 8vo. Wash. 1892. 50 pp.
1893. Summary of International Meteorological Observations (1878-1887). Bulletin A. By Major H. H. C. Dunwoody. 19 × 23·5 in. Wash. 1893. x. pp. 59 ch.
1893. Lake Storm Bulletin. Published in the interest of the Lake Marine. Nos. 1 to 4, 1893. 20 × 19 in. Wash. 1893.
1892. Current Chart of the Great Lakes, 1892. 24 × 34 in. Wash. 1893.

REPORT OF THE CHIEF OF THE WEATHER BUREAU, PRINTED  
BY SPECIAL AUTHORITY OF CONGRESS

1893. Certain Climatic Features of the two Dakotas. By Lieut. John P. Finley, U.S. Weather Bureau. Sen. ex. doc. No. 157. 52nd Congr. 1st. sess. 4to. Wash. 1893. 180 pp. 95 pl.

## APPENDIX III

### HYGROMETRICAL TABLES (Glaisher).

#### I. TABLE OF FACTORS.

Reading of the Dry-Bulb Thermometer.	Factor.	Reading of the Dry-Bulb Thermometer.	Factor.	Reading of the Dry-Bulb Thermometer.	Factor.
20°	8·14	44°	2·18	68°	1·79
21	7·88	45	2·16	69	1·78
22	7·60	46	2·14	70	1·77
23	7·28	47	2·12	71	1·76
24	6·92	48	2·10	72	1·75
25	6·53	49	2·08	73	1·74
26	6·08	50	2·06	74	1·73
27	5·61	51	2·04	75	1·72
28	5·12	52	2·02	76	1·71
29	4·63	53	2·00	77	1·70
30	4·15	54	1·98	78	1·69
31	3·70	55	1·96	79	1·69
32	3·32	56	1·94	80	1·68
33	3·01	57	1·92	81	1·68
34	2·77	58	1·90	82	1·67
35	2·60	59	1·89	83	1·67
36	2·50	60	1·88	84	1·66
37	2·42	61	1·87	85	1·65
38	2·36	62	1·86	86	1·65
39	2·32	63	1·85	87	1·64
40	2·29	64	1·83	88	1·64
41	2·26	65	1·82	89	1·63
42	2·23	66	1·81	90	1·63
43	2·20	67	1·80	91	1·62

HYGROMETRICAL TABLES—*Continued.*

TABLE II.—Tension, or Elastic Force of Aqueous Vapour in inches of Mercury for every Degree of Temperature from 0° to 95°.

Temp.	Tension.	Temp.	Tension.	Temp.	Tension.	Temp.	Tension.
0°	·044	24°	·129	48°	·335	72°	·785
1	·046	25	·135	49	·348	73	·812
2	·048	26	·141	50	·361	74	·840
3	·050	27	·147	51	·374	75	·868
4	·052	28	·153	52	·388	76	·897
5	·054	29	·160	53	·403	77	·927
6	·057	30	·167	54	·418	78	·958
7	·060	31	·174	55	·433	79	·990
8	·062	32	·181	56	·449	80	1·023
9	·065	33	·188	57	·465	81	1·057
10	·068	34	·196	58	·482	82	1·092
11	·071	35	·204	59	·500	83	1·128
12	·074	36	·212	60	·518	84	1·165
13	·078	37	·220	61	·537	85	1·203
14	·082	38	·229	62	·556	86	1·242
15	·086	39	·238	63	·576	87	1·282
16	·090	40	·247	64	·596	88	1·323
17	·094	41	·257	65	·617	89	1·366
18	·098	42	·267	66	·639	90	1·410
19	·103	43	·277	67	·661	91	1·455
20	·108	44	·288	68	·684	92	1·501
21	·113	45	·299	69	·708	93	1·548
22	·118	46	·311	70	·733	94	1·596
23	·123	47	·323	71	·759	95	1·646



## INDEX OF SUBJECTS AND PLACES

- ABSOLUTE** humidity, 196, 207  
**Accumulated** temperature, 33, 34, 305  
**Actinometer**, 116 ; Herschel's, 120 ; Richards', 120, 121  
**Acute infective diseases**, 359, 376  
**Air temperatures of the British Islands**, 338  
**Air-trap in a barometer**, 141  
**Air**, weight of, 12 ; liquefaction of, 13 ; freezing of, 14 ; elasticity of, 15 ; rarefaction of, 16 ; volumetric analyses of, 20 ; temperature and its measurement, 94 ; capacity for containing aqueous vapour, 180 ; supersaturated, 203, 204, 205  
**Aitken's dust-counters and koniscope**, 206  
**Alcohol**, specific heat of, 104  
**Allotropic oxygen**, 296  
**Altazimuth anemometer**, Casella's, 265  
**Altitude**, barometric correction for, 156, 161  
     effect of, on rainfall, 234, 235 ; on temperature, 118, 306, 307 ; on electric tension, 284 ; on climate, 306, 307  
**Altitudes**, measurement of, 149  
**Alto-cumulus cloud**, 221  
**Alto-stratus cloud**, 221  
**American Arctic current**, 315  
*American Weather*, General Greely's, 92  
**Ammonia in air**, 19, 23  
**Ammonium sulphide in air**, 19, 23  
**Amount of cloud**, 36  
**Anemobarometer**, Wilke's, 258  
**Anémo - cinémographe**, Richards', 270-273  
**Anemograph**, Casella's, 254 ; Beckley, 271  
**Anemographic stations**, 29  
**Anemometers**, 249 ; history of, 255 ; pendulum, 256 ; bridled, 256 ; pressure plate, 256 ; torsion, 256 ; Osler's, 256, 274 ; Dines's, 257, 269 ; pressure on a fluid, 258, 259 ; Lind's, 258, 259, 275 ; velocity, 259 ; hemispherical cup, 259 ; Robinson's, 256, 259, 260, 274, 275 ; current meter, 261 ; evaporation or temperature, 262 ; suction, 263 ; Hagemann's, 263, 275 ; direction, 264 ; Lomonosow's, 264 ; inclination, 265 ; Casella's self-recording, 254, 275 ; Casella's altazimuth, 265 ; musical, 269 ; helicoid, 269 ; Richards', 270 ; Kew pattern, 274, 275  
**Anemometry**, 249 ; history of, 255  
**Anemoscope**, Pickering's, 256 ; Laughton's feather-vane, 269  
**Aneroid barometer**, 146, 147 ; drawbacks to its use, 148 ; engineering, 149  
**Annual barometric variations**, 164, 170  
     march of electrical tension, 284  
     rainfall of the British Islands, 347  
**Antarctic Continent**, why constantly snow-covered, 324



- Anticyclones, 8, 171, 172, 177, 330, 332, 333
- Anticyclonic, 3, 174, 330, 332, 333; circulation of air, 6, 17, 171, 172; barometric variations, 164, 174  
system contrasted with cyclonic, 175  
weather, in winter, 177; in summer, 178
- Antozone, 297, 300
- Antozonides, 297
- Aphelion, 117
- Apjohn's formula, 191, 191
- Appendix, 407
- April mean temperature, 340
- Aqueous vapour, atmosphere of, 179, 186, 197, 213, 222  
vapour in the air, 19, 25, 308; tension of, 165, 166, 179, 186, 191, 196; where most abundant, 195
- Arctic circle, diurnal range of pressure in, 164, 167
- Asia, climate of, 171, 309, 310, 321, 329, 330
- Athermancy, 18
- Atlas, meteorological, of the British Isles, 335, 339, 343, 344, 347
- Atmidometers, 182, 183
- Atmidometry, 181
- Atmometry, 181
- Atmosphere, definition of, 10; its physical properties, 10; its height, 16, 133; its transparency and diathermancy, 17; its composition, 19; of aqueous vapour, 179, 186, 197, 213, 222; dampness of, 196; in a constant state of electric tension, 284
- Atmospheric air, weight of, 12; liquefaction of, 13; freezing of, 14; elasticity of, 15; rarefaction of, 16; where purest, 19; its composition, 19; a mechanical mixture, 21  
dust, 203-205; composition of, 205  
electricity, 276, 290; nature of, 277; its phenomena, 278  
pressure, 129; how measured, 129; extremes of, 136, 137; variations in, 164; influence of aqueous vapour on, 179; in British Islands, 343; in Dublin, 355, 356
- Atomic theory of Dalton, 15
- Attached thermometer, 151
- Attraction, capillary, 153; electrical, 277
- Aurora, 278, 294; borealis, 278, 294; australis, 278, 294; distribution of, 294; periodicity of, 295; explanation of, 295; height of, 295, 296; tints of, 296
- Australian "brickfielders," 328; "burstlers," 328
- Autumnal distribution of disease, 366-368  
fever, 376
- Average mean temperature, 112
- Axis of rotation, earth's, 4, 10
- BABINGTON'S atmidometer, 182
- Backing of wind, 177
- Balance pattern rain-gauges, 231, 232
- Ball lightning, 291, 292
- Balloon ascents for meteorological purposes, 47, 89-91
- Barograph, 142; meaning of the term, 142, King's, 143, 144; Ronalds's photographic, 143; Redier's mechanical, 143, 145; electric, 145
- Barometer, 28, 129; history of the, 135; meaning of the word, 129; uses of the instrument, 129; its discovery, 131; its construction, 136; mercurial, 131, 136, 138, 139; glycerine, 132; wheel, 135, 142, 143; extreme readings of, 136, 137; mounting, 138; Wollaston's differential, 259  
aneroid, 146, 147; holosteric, 146; metallic, 148  
corrections to be applied to readings of, 155, 156, 159, 161  
how to be mounted, 151, 152  
readings, 151  
scale, 155

- Barometer, variations in height of, 164
- Barometrical fluctuations, 164  
gradients, 7, 8, 249
- Baroscope, 135
- Base temperature, 33
- Beaded lightning, 291
- Bearings, how determined by compass, 252; by the pole star, 253; by the sun, 253
- Beaufort scale of wind force, 31, 35, 251
- Beckley anemograph, 271
- Behring's Straits current, 315
- Bench-mark, Ordnance Survey, 161
- Bergen, cholera at, 362-364
- Black-bulb thermometer *in vacuo*, 119
- Blitzableiter, 300
- "Blitzröhren," 292
- Blizzard, 237
- "Blue mists," 365
- Bogs, influence of, on climate, 352, 353
- Boiling-point of water, 95, 97-99, 150, 201
- Boomerang, principle of the, 12
- Bora of Trieste and Dalmatia, 326
- Bourrasques, 331
- Boyle's and Mariotte's law, 13
- "Brickfielders," Australian, 328
- Bridled anemometers, 256
- Bright sunshine, duration of, 124
- Bright-bulb thermometer *in vacuo*, 120
- Brisbane, torrential rainfall in, 248
- British Association for the Advancement of Science, 140
- Islands, rainfall in, 246, 346; climate of, 305, 329; sea-temperatures round, 311, 335; air-temperatures of, 338; atmospheric pressure in, 343
- meteorological observations, 27
- Meteorological Office, 7, 28, 32, 34, 124
- British Rainfall*, 32, 182, 183, 227, 234, 235, 246, 347
- Bronchitis, seasonal prevalence of, 397, 399, 400-403
- Brush discharge and St. Elmo's fire, 293
- Bulb, forked or cylindrical thermometer, 104, 122
- Bunsen flame, 24
- Bureau, United States Weather, 39, 41, 43, 49; its cost, 44; its departments, 51-55; its library, 55-57; its regular stations, 407; its publications, 410
- Bureaux, weather, 28
- Burning sunshine recorder, 125
- "Bursts," Australian, 328
- Buys Ballot's law, 3, 6, 8, 170, 172, 173, 250, 330
- CALIBRATING thermometer tubes, 99
- Calm, meaning of the term, 4
- Campbell-Stokes Sunshine Recorder, 125
- Canada, climate of, 305, 311
- Cancer, Tropic of, 11
- Capacity correction in barometers, 139, 140, 156, 159
- Capillarity, correction for, 153, 156, 159
- Capillary action in barometer, 152, 153
- attraction, 152, 153; repulsion, 153
- Capricorn, Tropic of, 11
- Carbon dioxide in air, 19-21; whence derived, 22
- Casella's mercurial minimum thermometer, 103, 106, 107
- self-recording anemometer, 254, 275; air-meter, 262; altazimuth anemometer, 265-269
- self-registering earth thermometer, 123
- solar radiation maximum thermometer, 120
- Castor and Pollux, 293
- Cathetometer, 156-158
- Cautionary signals, 81, 82
- Celsius' thermometer scale, 95-97
- Centigrade thermometer, 14, 96, 97
- Centrifugal force, 16
- Chalk, 353
- Chapletted lightning, 291
- Charles's law, 15, 16
- Charts, weather, 28, 30, 31, 39, 41, 66, 69, 70, 86, 88
- Cherra Poonjee, rainfall at, 223, 248

- Chief of the United States Weather Bureau, 43, 45, 47, 49, 50  
Signal Officer, United States, 40, 42, 49, 89, 92, 410, 416, 417
- Chlorophyll, chemical action of, 22
- Cholera, 358; and subsoil temperature, 124; and ozone, 299; and subsoil water, 318  
"Cholera blasts," 365  
"Cholera clouds," 365  
infantum, 373, 374  
*nostras*, 366  
seasonal prevalence of, 361-366
- Cholerine and subsoil temperature, 124, 366
- Christiania, Cholera in, 364
- Cirro-cumulus cloud, 214, 215, 221
- Cirro-stratus cloud, 214, 215, 219, 221
- Cirrus cloud, 214, 221; an aid in forecasting, 214
- Cistern, barometer, 136, 138
- City fog, 208-210
- Classification of clouds, 214, 220, 221  
gales, 356  
thunderstorms, 285  
winds, 325
- Clays, influence of, on climate, 317, 351, 352
- Climate, 304, 316; meaning of the word, 304; influence of radiation upon, 118; influence of forests upon, 319, 320; on what it depends, 306  
and weather, 304  
definitions of, 304, 305; insular and continental, 309, 329; moderate and excessive, 329  
of the British Islands, 329, 346; influence of soils on, 351
- Climatological observatories, 29, 32, 334  
Tables for Dublin, 354, 355
- Climatology, 3, 90, 92, 304, 309, 329, 333, 334
- Cloud, 197, 213  
amount of, 36; scale for, 220
- Cloud-atlas, 220
- Cloud-line, 213
- Cloud-slopes in cumulus, 218
- Clouds, classification of, 214, 220, 221
- Clouds, 213; photographs of, 89; height of, 213, 214  
formation of, by mountains, 210, 211  
upper, 214; lower, 214, 216
- Cloudy condensation in air, 203
- Code, International, 37; United States Weather, 71, 77, 78
- Coefficient of expansion of a gas, 14 for obtaining mean temperatures, 112
- Col of high pressure, 175
- "Cold wave," 71, 92  
winds, 325-327
- Collector, electrical, 279-281
- Colorado, climate of, 316
- Colour phenomena from dust, 206
- Combustion dust, 205
- Comma bacillus of cholera, 365
- Comozants, 293
- Compass bearings compared with true bearings, 252, 253
- Composition of the atmosphere, 19
- Compression measure, 149  
of gases, law of, 13
- Condensation, 197; its various forms, 197
- Conduction of heat, 114
- Conductors, lightning, 300
- Configuration of surface, influence of, on climate, 312
- Congress, International Meteorological, 7, 34, 220, 256, 274, 278
- Conservation of solar energy, 116
- Consumption and subsoil drainage, 318
- Continental climate, 309, 329
- Convection of heat, 114, 115
- Corposants, 293
- Corrections in barometer readings, 153, 155, 156
- Cost of United States weather service, 44
- Cotton plant, climatology of the, 92
- Coulomb's torsion balance, 281
- Council, Meteorological, 32, 111, 274, 278, 335, 339, 347
- "Critical" temperature of the soil, 124, 366, 367

- Crosley's registering rain-gauge, 229  
 Crystalline rocks, 351, 353  
 Crystals, snow, 237, 238; ice, 214, 216, 239  
 Cumulo-cirro-stratus cloud, 219  
 Cumulo-nimbus, 221  
 Cumulo-stratus cloud, 214, 219  
 Cumulus cloud, 214, 216, 219, 221; formation of, 217; festooned, 218; cloud slopes in, 218  
 Curing thermometer tubes, 99  
 Current meter anemometer, 261  
 Currents, inclined air, 265  
 Cyclones, 8, 171, 172, 175-177, 242, 286  
 Cyclonic, 3, 174; system, 5, 330, 333; clouds in, 219; contrasted with anticyclonic, 175; circulation of air, 6, 171, 172, barometric variations, 164, 174  
 thunderstorms, 285  
 DAILY weather charts, 28, 30, 31, 88  
 weather reports, 30, 31, 33, 34  
 Daniell's hygrometer, 187; galvanic battery, 283  
 Dates in the history of the United States weather service, 47  
 Datum, Ordnance Survey, 161  
 Day degrees, 33, 305; meaning of term, 33, 34  
 Daylight Recorder, Jordan's, 127  
 Death Valley, California, 92  
 Density, electrical, 278  
 of buildings a cause of diarrhoea, 374  
 Depression, atmospheric, 170, 172  
 secondary or subsidiary, 175, 286, 287  
 thunderstorm, 241, 286  
 V-shaped, 175  
 Dew, 118, 186, 187, 194, 197, 198, 222; theory of, 198; its measurement, 198, 222; its formation interfered with, 199  
 point, 186-188, 191, 194; mode of determining, 194  
 Diarrhoea and subsoil temperature, 124, 366, 367  
 Diarrhoeal diseases, 366; nature and action of the poison of, 375  
 Diathermancy, 17, 18, 323; meaning of term, 17  
 Differential barometer, Wollaston's, 259  
 Diffused lightning, 291  
 Diffusion of gases, 23, 24  
 Dines's heliocid anemometer, 269, 270; hygrometer, 187-189  
 Diploma in State Medicine, 3  
 Direct hygrometers, 187  
 Direction of wind, 34, 35, 252; how determined, 7, 252; Lambert's formula for, 274; true, not magnetic, 36, 252  
 anemometers, 264  
 Disease, influence of season and weather on, 357  
 registration, necessity for, 404  
 Diseases, acute infective, 359, 376  
 Displacement of zero, 100  
 Distributing stations, United States Meteorological Service, 65  
 Distribution of forecasts in United States, 81  
 of rain, 236, 245-247  
 Diurnal barometric variations, 164  
 march of electricity, 284  
 rainfall, 247  
 Drainage, subsoil, and consumption, 318  
 Dry-bulb thermometer, 161, 190, 191  
 Dublin, extremes of atmospheric pressure in, 136, 137; diurnal range of atmospheric pressure in, 167; hail-storm in, 241-243; rainfall in, 247; mean temperatures in, 309; climate of, 317, 337; climatological tables for, 354, 355; influenza epidemic in, 359; cholera in, 364; diarrhoeal diseases in, 366, 367; enteric fever in, 376; typhus in, 381, 382; smallpox in, 385; measles in, 387, 389, 390; scarlatina in, 390, 392; pneumonic fever in, 394, 397; bronchitis in, 400-403  
 Dust as a condenser of aqueous vapour in air, 203  
 Dust-counter, Aitken's, 206  
 Dust haze, 211

- Dust particles in air, 203-205 ;  
 composition of, 205 ; colour-  
 phenomena from, 206 ; number  
 in atmosphere, 207  
 water, 313 ; snow, 237, 238  
 Dysentery and ozone, 299
- EARTH temperatures, 123  
 thermometer, Symons's, 123 ;  
 Casella's, 123
- Earth's axis of rotation, 4, 10, 11,  
 165
- Easterly winds of spring, 326 ; why  
 so cold, 324
- Ebullition, 97
- Eccentricity of the earth's orbit, 117
- Ecliptic, 11
- Elastic force of aqueous vapour,  
 165, 166, 179, 186, 191, 196
- Elasticity of air, 15
- Electric kite, 276
- Electrical barographs, 145, 146  
 collector, 279 ; Volta's, 280 ;  
 Thomson's water - dropping,  
 280  
 density, 268  
 force, 278, 279, 281  
 induction, 280  
 intensity, 278, 281 ; diurnal and  
 annual march of, 284  
 potential, 278, 280, 281, 292  
 replenisher, 282  
 self-registering rain-gauge, 230  
 tension, 278, 281 ; diurnal and  
 annual march of, 284 ; effect  
 of altitude on, 284  
 thermographs, 110
- Electricity, atmospheric, 279, 290 ;  
 nature of, 277 ; phenomena  
 attending, 278  
 compared with heat, 277  
 convection of, 115  
 diurnal march of, 284  
 negative, 278, 284, 289  
 positive, 278, 284, 285, 289  
 resinous, 277, 278  
 transmission of barometric indi-  
 cations by, 145  
 vitreous, 277, 278
- Electrified bodies, 277
- Electrodes, 282
- Electrometer, 281 ; Thomson's  
 Quadrant, 281 ; Thomson's  
 Portable, 281, 284 ; photo-  
 graphic, 283 ; Peltier's, 284  
 Electro-motive force, 280 ; expressed  
 in "volts," 283  
 Electrophorus, 282  
 Electroscopes, 277 ; described, 279  
 Elevation, effect of, on boiling point,  
 98, 150 ; on temperature, 118  
 Engineering aneroid, 149  
 England, thunderstorms in, 288 ;  
 distribution of rainfall in, 246,  
 348-350 ; soils in, 352 ; scarlet  
 fever in, 391, 392  
 Enteric fever and subsoil tempera-  
 ture, 124 ; and subsoil water,  
 318  
 fever and its seasonal prevalence,  
 376  
 feverishness in, 405  
 "Epidemic constitution," 359, 365  
 influenza, 359-361  
 summer diarrhœa and subsoil  
 temperature, 124  
 Equation of time, 253  
 Equator, 11 ; distance from the, as  
 influencing climate, 306  
 snow and ice under the, 307  
 Equinoctial gales, 345  
 points, 11  
 Equinoxes, 11  
 "Error of capacity," 139, 140  
 on temperature, 118  
 Etesian winds of south-eastern  
 Europe, 326  
*Étincelle de rupture*, 110  
 Europe, thunderstorms in, 287,  
 288 ; climate of, 171, 309,  
 321, 329, 330  
 Evaporation, 181 ; coolness pro-  
 duced by, 182 ; force of, 195  
 anemometer, 262, 263  
 in London, 184 ; in Ireland, 184,  
 185  
 rains, 247  
 Evaporimeters, 182 ; de la Rue's, 183  
 Excessive climates, 329  
 Expansion of air, 14 ; coefficient of, 14  
 Exposure of rain-gauge, 233  
 Extra stations, 31  
 Extremes of atmospheric pressure,  
 136, 137

- FACTORS, Glaiser's, 193, 420 ;  
Greenwich, 193
- Fahrenheit's thermometer, 14, 94-96, 98, 305
- "Fall Fever," 376
- Fauna, influence of climate on, 305, 306
- Festooned cloud, 218
- Fever, enteric, and subsoil temperature, 124 ; and sunsoil water, 318  
in Dublin, 394  
pneumonic, seasonal prevalence of, 394
- Fiducial point in Standard Barometer, 139, 152
- Filling thermometer tubes, 99
- Fire-balls, electrical, 292
- Fire-damp in air, 23
- Fire, St. Elmo's, 293
- Firn, 323
- Flag-signals in United States, 82
- Float pattern rain-gauges, 227, 231
- Floods in American rivers, 79, 80
- Flora, influence of climate on, 305, 306
- Fog, 197, 200 ; varieties of, 200 ; formation of, 200, 201, 208  
wet, 200 ; dry smoke, 200
- Föhn wind of north-east Switzerland, 246, 308, 328 ; the "snow-devourer," 308
- Food-keeping, defective, and diarrhoea, 374
- Force of wind, how determined, 7, 31, 249, 251 ; Beaufort Scale, 31, 35, 251  
evaporation, 195 ; electricity, 278, 279 ; electro-motive, 288, 283
- Forchammer process, 25
- Forecast Division of United States Weather Bureau, 51, 63, 68, 75, 79, 81
- Forecasting, cirrus observations an aid to, 214
- Forecasts, 9, 28, 31, 40, 42, 51, 52, 64, 68-74, 81, 84-86, 129  
distribution of, in United States, 81
- Forests, influence of, on climate, 319-321
- Forked lightning, 291
- Forked thermometer bulb, 104, 122
- Formula for reduction of barometer readings, 161, 162
- Fortin barometer, 138-141, 152, 156, 159
- Free water surfaces, 201
- Freezing mixtures, 95  
point of water, 95, 201
- Friction, development of electricity by, 277
- Frost of 1890-91, 178  
glazed, 198, 199  
hard, in British Islands, 332
- Frozen air, 14 ; nitrogen, 14  
rain, 198, 199, 239, 240
- Fulgurite, 292
- Fulminary tube, 292
- GALES, classification of, 356  
equinoctial, 345
- Galvanic battery, Daniell's, 283
- Gas, definition of a, 13 ; liquefaction of, 13 ; compression of, 13 ; diffusion of, 23
- Gases, laws relating to, 13, 23  
condensed, in atmosphere, 205
- Gauge, evaporation, de la Rue's self-recording, 184  
rain, history of the, 223-225  
float, 227, 231 ; storm, 228 ; Negretti and Zambra's, 229 ; self-recording, 229-231 ; Crosley's registering, 229 ; Yeates's electric self-registering, 230 ; Richards' self-recording, 231 ; Meteorological Office, 225 ; Snowdon, 226 ; mountain, 227  
position of, 233
- Geographical distribution of rain, 246, 346
- Geological formation as influencing British climate, 351
- Glaiser's hygrometrical tables, 193, 420  
factors, 193, 420
- Glass, weather, 135, 142
- Glatteis, 198, 239
- Glazed frost, 198, 199, 239, 240
- Globular lightning, 291, 292
- Glycerine, specific gravity of, 131  
barometer, 132

- Gold-leaf electroscope, 277; described, 279
- Gradients, barometrical, 7, 8, 249  
thermometric, 332
- Graduation of thermometer tubes, 99  
barometer scale, 155, 156
- Graupel, 244
- Gravity, specific, 131, 133
- Great Britain, rainfall in, 246;  
thunderstorms in, 288; temperature in, 338-341
- Green snow, 236; its cause, 236
- Greenwich Observatory, 111, 283  
factors, 193
- Grêle, 240
- Grésil, 244
- Ground fog, 214, 216  
frost,
- Grundwasser, 366
- Gulf Stream, 115, 172, 313; its climatic effect, 314, 315
- "Gun Barometer," 141
- Gyratory movement of air, 4, 6
- HAGEL, 240
- Hagemann's anemometer, 263, 275
- Hail, 197, 236, 240; its formation, 240, 241, 245; soft, 244; weight of, 244; shape of, 245; its relation to electricity, 278, 293, 294
- Hailstorms, 240-245, 293, 294, 323
- Hair hygrometer, 190; used in winter in Russia, 195
- Halos, solar and lunar, 215
- Hard frosts in British Islands, 332
- Harmattan of the west coast of Africa, 327
- Hauling of wind, 177
- Haze, 207, 211; dust, 211
- Health and weather, 2  
influence of temperature of the soil on, 124  
Medical Officers of, 37
- Heat and electricity compared, 277  
conduction of, 114  
convection of, 114, 115  
definition of specific, 311  
how transmitted, 114  
latent, 182.  
radiant, 17, 18, 116
- Heat, radiation of, 114, 115  
specific, of mercury, 104; alcohol, 104; water, 118, 311  
unit, 314
- Heat-waves, 17, 18; thunderstorms, 285
- Height of the atmosphere, 16, 133  
of barometer, 141  
of clouds, 213, 214  
of columns of liquids or gases inversely proportional to their specific gravity, 133
- Helicoid anemometer, 269  
surface, meaning of the term, 270
- Helio-pyrometer, 120
- Hemispheres, Magdeburg, 17
- Hemispherical cup anemometer, 259
- High-pressure areas, 171
- Himalayas, climate of the, 307, 308
- Hoar frost, 198, 222
- Höhenrauch, 211
- Holosteric barometer, 146
- Hot wind of Australia, 328  
winds, 327, 328
- Hourly observations, 91
- Humboldt's current, 315
- Humidity, 37  
absolute, 196, 207  
and disease, 358  
relative, 191, 194, 207
- Humus, definition of, 317; influence on climate, 317
- Hydrogen sulphide in air, 19, 23
- Hyetometry, 181, 197, 222; meaning of term, 197
- Hygrometers, 186; direct, 186, 187; indirect, 186, 190; organic, 186; inorganic, 186; Daniell's, 187, 193; Regnault's, 187; Dines's, 188; Saussure's, 190; chemical, 190; dry and wet bulb, 190, 191; Mason's, 190, 191; history of, 196
- Hygrometrical tables, 193, 420
- Hygrometry, 181, 186
- Hygroscope, 190
- Hypsometer, 149, 150
- ICE, melting-point of, 95, 97, 99, 201
- Icebergs as fog-producers, 210
- Ice-crystals, 214, 216, 239

- Iceland, winter thunderstorms in, 288
- "Inbat," 337
- Inclination anemometers, 265
- Inclined currents, 265
- Index error, 38, 156, 159
- Indian monsoons, 325
- Indirect hygrometers, 190
- Induction, 280, 291, 293; phenomena caused by, 291, 293
- Infective diseases, acute, 359, 376
- Influence of season and weather on disease, 357
- Influenza, 359-361
- Instrument Section of the United States Weather Bureau, 53
- Instruments required for Second Order Station, 38
- Insular climate, 309, 329
- Insulated, meaning of, 280
- Insulation, 280
- Intensity of cyclones, 176  
electricity, 278
- International Meteorological Congress, 7, 34, 220, 256, 274, 278  
Code, 37
- Inverted cumulus cloud, 218
- Ireland, rainfall in, 246, 348, 349, 351; thunderstorms in, 288; climate of, 312; mean temperatures of, 338-341; soils in, 352
- Irregular barometric variations, 164, 174
- Isobars, 6, 174, 249; meaning of term, 31; straight, 175; in thunderstorms, 286
- Isothermals, 330, 332; British, 335
- Isotherms, 31, 330, 332; meaning of term, 31
- JAMAICA, thunderstorms in, 287
- January mean temperature, 340
- Johns Hopkins University, 90
- Jordan photographic sunshine recorder, 128  
glycerine barometer, 132
- Journal of the Weather, Merle's, 27
- July mean temperature, 341
- KEW Observatory, 29, 38, 101, 159, 160, 270, 271, 283
- Kew Observatory anemograph, 271, 274, 275  
barograph, 111  
barometer, 138-140, 152, 156, 159  
thermometer, 101
- Khasi Hills, rainfall in the, 223, 246
- Khamseen, or Khamsin, of Egypt, 327
- Kilda, St., winter temperature in, 338
- King's barograph, 143, 144
- Kite, Franklin's electric, 276
- Koniscope, or dust-detector, Aitken's, 206
- LAMBERT'S formula for mean direction of wind, 274
- Lamont's atmometer, 183
- Land meteorology of the British Islands, 28
- Land and sea breezes, 217  
and water, influence of, on climate, 306, 308-313
- Latent heat, 182; its use, 182
- Latitude, influence of, on climate, 305-307
- Law of Buys Ballot, 3, 6, 8, 170, 172, 173, 250  
Boyle and Mariotte, 13, 15  
Charles, 14, 15  
Graham, 23  
Regnault, 14, 15
- Laws of electricity, 277, 278
- Lenkoran forest, 322
- Leste of Madeira, 328
- Leveche of the Iberian Peninsula, 327
- Leyden jar, 281, 282
- Library of the United States Weather Bureau, 55-57
- Light, vibrations of, 17
- Lightning, 290, 291; what it is, 290; its varieties, 291  
zigzag or forked, 291; diffused, 291; summer, 291; sheet, 291; globular, 292; ball, 292; tubes, 292  
rapidity of, 292  
conductors, 300, 301; their principle, 300; description of,



- 300, 301; conditions for an efficient, 301-3
- Lightning-rod, 300; conference, 302
- Limestone soils, influence on climate, 351, 353  
carboniferous, 353; oolitic, 353; ancient, 353
- Lind's anemometer, 258, 275
- Liquefaction of gases by cold, 13
- London clay, 352
- London, diarrhoeal diseases in, 367; smallpox in, 384, 386; measles in, 388, 389; scarlatina in, 392, 393; pneumonic fever in, 397; bronchitis in, 399-403  
evaporation in, 184; remarkable rainfall in, 229  
Fever Hospital, 381  
Meteorological Office, 7, 28, 32, 34, 124, 143, 218, 225, 251, 335
- Lower clouds, 214, 216
- Low-pressure areas, 4, 170
- Luminous lightning, 291
- Lunar halos, 215
- Lungs, inflammation of the, 394, 396
- MACKEREL** sky, 214, 215
- Magdeburg Hemispheres, 17
- Magnetic bearings compared with true bearings, 252, 253  
parallel, 294; storms, 294, 295
- Magnetism, terrestrial, and aurora, 294
- Malaria, 318
- Maps, rainfall, 91  
weather, 28, 30, 31, 39, 41, 66, 69, 70, 86
- Mares' tails, 214
- Marine barometer, 140
- Marl, 372
- Marsh-gas in air, 23
- Marshy soils, influence of, on health, 318
- Mason's hygrometer, 190, 191
- Matterhorn, 211
- Maximum thermometers, 102, 103
- Mean direction of wind, Lambert's formula for, 274
- Mean temperature, 111; of British Islands, 338  
and disease, 358  
coefficients, 112  
how obtained, 111, 112  
reduction to sea-level, 338, 339, 341
- Meandering lightning, 291
- Measles, seasonal prevalence of, 387; in London, 388
- Measurement of altitudes, 149, 163  
rainfall, 233, 234  
snow, 238
- Medical Officers of Health, 37
- Medicine and meteorology, 2  
State, diploma in, 3
- Melting-point of ice, 95, 97, 99
- Meniscus, meaning of the term, 153
- Mercurial minimum thermometer, 103, 106, 107  
barometer, 131
- Mercury, specific heat of, 104; specific gravity of, 131; as a medium for indicating temperature, 95, 101, 104; atmospheric pressure, 131
- Metallic dust in air, 24; barometer, 148
- Meteoric dust, 205
- Meteorographs, 146
- Meteorological Atlas of the British Isles, 335, 339, 343, 344, 347  
Congress, International, 7, 34, 220, 256, 274, 278  
Council, 32, 111, 274, 278, 335, 339, 347  
information bearing on public health, 342  
observations, British, 27, 29  
Office, London, 7, 28, 32, 34, 124, 143, 218, 225, 251, 335  
Society, Royal, 32, 109, 120, 124, 167, 193, 224, 225, 238, 265, 269, 270, 274, 275, 277, 286, 291, 292, 295, 299, 301, 302, 323, 325, 328, 334  
Society, Scottish, 32, 124, 288, 334, 335, 337, 339
- Meteorology, meaning of the term, 1, 2; relations existing between medicine and, 2; a science, 9; practical, 27
- Methane in air, 23

- Microbes in air, 24, 375  
 Micrococci of pneumonia, 395, 404  
 Micro-organisms in air, 24, 375  
 Mineral constituents of the atmosphere, 24  
 Minimum thermometers, 102, 103, 106, 107  
 Mist, 197, 200; formation of, 208  
   Scotch, 200  
 Mistral of the Gulf of Lyons, 326  
 Mists, cholera blue, 365  
 Moderate climates, 329  
 Molecular analysis of air, 13  
 Monsoons, Indian, 325  
 Monte Rosa, fall of snow on, 236, 237  
 Monthly summary of weather, 33, 34  
   Weather Review, United States, 52, 54, 66, 90, 91  
 Moon, watery, 177  
 Mountain, determination of height of, 163  
   cloud-capped, 210  
   rain-gauge, 227  
   ranges, effect of, on climate, 306, 316  
 Munich, International Meteorological Conference, 220  
 Musical anemometers, 269
- NASCENT oxygen, 299  
 Nature's abhorrence of a vacuum, 130, 131  
 Negative electricity, 278, 284, 289  
   oxygen, 297  
 Negretti and Zambra's maximum thermometer, 102  
   improved Robinson's anemometer, 260  
   storm rain-gauge, 229  
 Neutral point in barometer scale, 159  
   point in cloud-slopes, 218  
 Névé, 323  
 Niederslage, 20  
 Nimbus, 214, 217, 219, 221; different applications of the term, 219  
 Nitric acid in air, 19, 23  
 Nitrogen in air, 19-21  
 Non-periodic barometric fluctuations, 164, 174
- Nortes (Northers) of the Gulf of Mexico, 326  
 North-east trade winds, 173
- OBSERVATIONS, meteorological, 27; synchronous, 129, 135, 155, 193  
   barometer, 152  
   phenological, 28, 32  
   rainfall, 223, 224  
 Observatories, self-recording, 29; climatological, 29  
 Observatory, Kew, 29, 38, 101, 159, 160, 270, 271, 283  
   Greenwich, 111, 283  
 Occasional cold winds, 325  
   warm winds, 325  
 Ocean currents affecting climate, 306, 313-315  
   currents, warm, 313; cold, 315  
   influence of, on climate, 306, 311  
 October mean temperature, 341  
 Office, Meteorological, London, 7, 28, 32, 34, 124, 143, 218, 225, 251, 335  
 Officers of Health, Medical, 37  
 "Old Probs.," 42  
 Opacity, 18  
 Ordinary thermometers, 100, 101  
 Ordnance Survey Datum, 161  
   Survey Office, Phoenix Park, 364  
 Organic matter in the air, tests for, 25  
 Osler's anemometer, 256, 274  
 Oxshott, anemometer comparisons at, 258  
 Oxygen, liquid, 14; in air, 19-21; allotropic, 296; negative, 297; positive, 297; nascent, 299; active, 299  
 Ozone, 22, 23, 296; theories as to its nature, 296, 297, 298; properties of, 299; influence on disease, 299; tests for, 299, 300  
 Ozonides, 297
- PALLIUM, 215  
 Pampêro of Brazil, 326  
 Pandemic waves, 365  
 Parachute, principle of the, 21

- Paratonnerre, 300  
 Paris, cholera in, 362, 363  
 Peaty soils, influence of, on health, 318 ; on climate, 352, 353  
 Pebble beds and climate, 351, 352  
 Peltier's electrometer, 284  
 Pendulum anemometers, 256  
 Perihelion, 117  
 Periodic barometric fluctuations, 164  
   thunderstorms, 217, 287 ; winds, 325, 326  
 Permanent winds, 325  
 Peruvian current, 315  
 Phenological observations, 28, 32  
 Phillips's maximum thermometer, 102, 111  
 Phoenix Park Ordnance Survey Office, 364  
 Photographic thermograph, 111  
   barograph, 143  
   electrometer, 283  
   sunshine recorder, 128  
 Photographs of thunder-clouds, 220  
 Phthisis and subsoil drainage, 318  
 Physical cause of rain, 235  
 Physicians and meteorological information, 342  
 Pitot's tube, 259  
 Pneumococcus of Friedländer, 404  
 Pneumonia, 394 ; its claims to rank as a specific fever, 404, 405  
 Pneumonic fever, seasonal prevalence of, 394  
   in Dublin, 394, 395  
 Pocky-cloud, 218  
 Poison of diarrhoeal diseases, 375  
 Pole-star, position of the, 253  
 Portable electrometer, Thomson's, 281, 284  
 Positive electricity, 278, 284, 285, 289  
   oxygen, 297  
 Potential, electrical, 278, 280, 281, 292 ; difference of, 280  
 Practical meteorology, 27  
 Practice forecasts, 74  
 Precipitation, 91, 222, 322  
 Pressure, atmospheric, 129  
   plate anemometer, 256  
   on a fluid anemometer, 258  
 Prevailing winds in relation to climate, 306, 325  
 Prevalent winds, classification of, 325  
   "Probabilities," 42  
 Protococcus nivalis, 236  
 Proximity of mountain ranges, 316  
 Psychrometer, 190  
 Public Health, Diploma in, 3  
   influence of temperature of the soil on, 124  
   meteorological information bearing on, 342  
 Publications Division of the United States Weather Bureau, 54  
 "Pumping" in a barometer, 140  
 Pyrheliometer of Pouillet, 116, 120  
 Pythogenic pneumonia, 394, 395  
 QUADRANT electrometer, Thomson's, 281-283  
   "Quicksilver, Cylinder of," 135  
 Quito, climate of, 307  
 RADIANT heat, 17, 18, 116  
 Radiation fog, 208  
   of heat, 114-116 ; terrestrial, 117, 122 ; solar, 116, 117, 119, 120  
   thermometers, 100, 111, 119  
   "Radiation weather," 176  
 Rain, 197 ; its physical cause, 235 ; its distribution, 236, 245-247  
   cloud, 214  
   frozen, 198, 199, 239, 240  
   weight and bulk of, 248  
 Rainfall, 37, 91, 223 ; and disease, 358 ; weighing the, 224 ; measurement of, 233, 234  
   and diarrhoea, 371  
   how affected by altitude, 234, 235  
   in relation to climate, 246, 306, 322  
   observations, 223, 224, 347  
   of the British Islands, 246, 346  
   tables prepared by Mr. G. J. Symons, 347  
 Rain-gauges, history of, 223-225 ; varieties of, 225-232  
   exposure of, 233  
 Rain-making, 92, 93

- Rainy day, definition of a, 234,  
 322  
 Ramified lightning, 291  
 Rarefaction of air at great altitudes,  
 16  
 Réaumur thermometer scale, 96-98  
 Recorders, sunshine, 125-128  
 Records Division of the United States  
 Weather Bureau, 53  
 Red snow, 236 ; its cause, 236  
 Registering rain-gauges, 229, 230,  
 231  
     thermometers, 100, 101  
 Registration of disease, 404  
 Regnault's law, 14-16  
     direct hygrometer, 187, 188  
 Regular barometric variations, 164  
 Relative humidity, 191, 194, 207 ;  
     mode of determining, 194  
 Replenisher, electrical, 282  
 Report on atmospheric electricity,  
 278  
 Reporting Stations, British Tele-  
 graphic, 29, 30 ; United States,  
 58, 59  
 Reports, daily weather, 30, 31,  
 33, 34 ; weekly weather, 33,  
 34  
 Repulsion, capillary, 153 ; electrical,  
 278  
 Return shock in thunderstorms,  
 291  
 Review, United States Monthly  
 Weather, 52, 54, 66, 90, 91  
 Ribbon lightning, 291  
 Richards' anémo-cinémographe, 270  
 Rime, 198  
 Rio Janeiro, periodic thunderstorms  
 at, 287  
 River and Flood Section of the United  
 States Weather Bureau, 63, 79,  
 80  
     and flood work in United  
 States Weather Bureau, 79, 80  
     fog, 208  
 Roaring Forties, 250  
 Robinson's cup anemometer, 256,  
 259, 274, 275  
 Roll-cumulus, 218  
 Rosée, 198  
 Rotation of earth on its axis, 4, 10  
 Royal Meteorological Society, 32,  
 109, 120, 124, 167, 193, 224,  
 225, 238, 265, 269, 270, 274,  
 275, 277, 286, 291, 292, 295,  
 299, 301, 302, 323, 325, 328,  
 334  
 Royal Observatory, Greenwich, 111,  
 283  
 Rutherford's spirit minimum ther-  
 mometer, 103  
  
 SALARIES of United States weather  
 employees, 67  
 Salt dust, 205  
 Sands, their influence on climate, 351,  
 352  
 Sandstones, 351, 352  
 Sanitary Science, Diploma in, 3  
 Saturation, 181 ; percentage degree  
 of, 190, 191, 194  
 Saussure's hair hygrometer, 190  
 Scale, Beaufort, of Wind Force, 31,  
 35, 37, 251  
     barometer, 155  
     for amount of cloud, 220  
     of Sea Disturbance, 36, 37  
     thermometer, 94-98, 100, 101  
     vernier, 153-155  
     weather, 36  
 Scarlatina, seasonal prevalence of,  
 380, 389, 391  
 Schists, 351, 353  
 "Schneeffresser," 308  
 Scientific work of the United States  
 weather Bureau, 87  
 Scirocco of North Africa and Sicily,  
 327  
 Scotch mist, 200  
 Scotland, subsoil temperature in,  
 319 ; temperature of, 339-  
 341 ; distribution of rainfall  
 in, 246, 348-350 ; soils in,  
 352  
 Scottish Meteorological Society, 32,  
 124, 288, 334, 335, 337-339  
 Screen, thermometer wall, 109  
 Scud-cloud, 215, 219  
 Sea breezes and land breezes, 217  
     Disturbance, Scale of, 36, 37  
 Sea-fogs, 200, 210  
     level, reduction of barometer read-  
     ings to, 161 ; of temperature  
     to, 341

- Sea temperatures round British islands, 311, 335
- Sea water, electrical state of, 284  
freezing-point of, 312  
maximal density of, 312
- Search-light signals in meteorology, 84
- Season, influence of, on disease, 357
- Seasonal distribution of rainfall, 247; thunderstorms, 287, 288  
disease, 357
- Secondary barometric depression, 175, 286
- Self-recording Observatories, 29  
barometers, 143  
electrometer, 283  
evaporation gauge, Richards', 184  
rain gauges, 229-231  
thermometers, 100, 110
- Serein, 198
- Shales, 351, 352
- Sheet-cloud, 214, 215  
lightning, 291, 292
- Shock, return, in thunderstorms, 291
- Shower-cloud, 214, 219
- Siberia, excessive climate of, 171, 309, 310, 321, 329
- Signal-Officer, United States Chief, 40, 42, 49, 89, 92, 410, 416, 417
- Signals, storm and cautionary, 81-83  
ball, cylinder, and cone, 82  
ball and fish-tail, 82  
cannon-firing, 83  
flags, 82  
railway train, 83  
search-light, 84  
telephone, 84  
whistle, 83
- Silver thaw, 198, 199, 239, 240
- Simoom of Arabia, Kutchee, and Upper Scinde, 327
- Siphon barometer, 139, 141, 159
- Six's thermometer, 105
- Sky, mackerel, 214
- Slates, 351, 353
- Sleet, 236, 239; definition of, 239
- Sling Thermometer, 110
- Slopes, cloud, in cumulus, 218
- Smallpox, seasonal prevalence of, 383; in Dublin, 385; in Sweden, 386; in London, 384, 386, 387
- Smoke-fog, dry, 200, 210; wet, 208, 209; as a deodoriser, disinfectant, and antiseptic, 209
- Snow, 197, 236; its properties, 236; its measurement, 238; fall of, on Monte Rosa, 236, 237  
red, 236; green, 236; dust, 237, 238
- Snow-covering, 118, 236, 323  
effects of, on climate, 323
- Snow-crystals, 237
- "Snow-devourer," the, 308
- Snowdon rain-gauge, 226
- Snowfall, limit of, 323
- Snowflakes, 237
- Snow forecasts, 85
- Snow-line, mountain, 308
- Society, Royal Meteorological, 32, 109, 120, 124, 167, 193, 224, 225, 238, 265, 269, 270, 274, 275, 277, 286, 291, 292, 295, 299, 301, 302, 323, 325, 328, 334
- Scottish, 32, 124, 258, 334, 335, 337-339
- Sodium chloride in air, 24
- Soft hail, 244
- Soil, temperature of the, 123, 319; its relation to health, 124, 366; its relation to climate, 306, 317-319, 351-354  
a cause of diarrhœal diseases, 372, 373
- Solano of Spain, 327
- Solar halos, 215  
intensity apparatus, Padre Secchi's, 120  
radiation, 116, 117, 119; how measured, 119; thermometer, 120
- Solstice, meaning of term, 11
- South-east Trade Winds, 173
- Specific gravity of mercury, 131; water, 131  
gravity, heights of columns of liquids or gases inversely proportional to their, 133

- Specific heat defined, 311  
 heat of mercury, 104 ; alcohol, 104 ; water, 118
- Spectroscopy in meteorology, 90
- Spirit minimum thermometer, 103
- Stand, thermometer, 38, 103, 108, 109
- Standard thermometers, 38, 100  
 barometer, 139  
 temperature in barometric observations, 160
- State Medicine, Diploma in, 3
- State Weather Service Division of United States Weather Bureau, 52, 60-63, 82
- Stations, Distributing, United States Meteorological Service, 65
- Stations of the First Order, 29, 143  
 Anemographic, 29  
 Extra Reporting, 31  
 of United States Weather Bureau, 407  
 Phenological, 32.  
 Second Order, 29, 148, 160, 334 ; instruments required for, 38  
 Telegraphic Reporting, 29, 30, 58, 59
- St. Elmo's Fire, 293
- Stevenson, thermometer stand, 38, 103, 109
- Storm-warnings, 32, 81, 82  
 rain-gauge, 228
- Storms, classification of, 356  
 magnetic, 294, 295
- Straight isobars, 175
- Strato-cumulus cloud, 221
- Stratus clouds, 214, 216, 221
- Stream lightning, 291
- Subsidiary barometric depression, 175, 287
- Subsoil water, influence of, on health, 318, 366, 377, 378  
 temperature, influence of, on health, 124, 366, 372, 373
- Suction anemometers, 263
- Sulphurous acid in air, 19, 23
- Summer diarrhoea and subsoil temperature, 124, 366  
 climate of British Islands, 330  
 distribution of atmospheric pressure, 8, 170 ; of thunderstorms, 287 ; of disease, 366
- Summer haze, 211 ; lightning, 291, 292  
 sea temperatures, 336
- Sun, watery, 177 ; southing of the, 253
- Sunshine, duration of bright, 124 ; measurement of, 125  
 recorders, 125-128
- Sun-spots and weather, 294  
 and magnetic storms, 295
- Supersaturated air, 203-205
- Surface, configuration of, effect on climate caused by, 312 ;
- Sweden, smallpox in, 386
- Sympiesometer, 149
- Synchronous observations, 129, 135  
 155, 193
- Synoptic Weather Charts, 28
- TELEGRAPH section of the Forecast Division of the United States Weather Bureau, 75 ; lines in United States, 76
- Telegraphic Reporting Stations, 29, 30, 58, 59  
 transmission of barometric indications, 146  
 Weather Code, United States, 71, 77, 78
- Telegraphy, application of, to weather study, 28
- Telephone in meteorology, 84
- "Telluric influences" in spread of disease, 365
- Temperature, accumulated, 33, 34, 305  
 air and its measurement, 37, 94  
 and diarrhoea, 371 ; and enteric fever, 377  
 anemometer, 262  
 base, 33  
 correction for, in reading the barometer, 156, 160  
 earth, 123, 319, 366  
 effect of elevation on, 118, 306, 307 ; effect of forests on, 321  
 lowest recorded, 310  
 mean, 111 ; average mean, 112 ; and disease, 358  
 of sea round British Islands, 311, 335

- Tension of aqueous vapour, 165, 179, 186, 191, 196  
   electricity, 278, 281  
 Terling, enteric fever at, 378  
 Terrestrial radiation, 117; how measured, 122  
 Tests for ozone, 299, 300  
 Thaw, silver, 198, 199, 239, 240  
   cirrus cloud a sign of, 215  
 Theory of the winds, 4, 5  
 Thermal unit, 314  
 Thermographs, 110  
 Thermometer, 94; meaning of word, 94; construction of a, 99  
   attached, 151  
   black-bulb, *in vacuo*, 119  
   bright-bulb, *in vacuo*, 120  
   dry-bulb, 161, 190, 191  
   earth, 123  
   maximum, 102  
   minimum, 102, 103, 106, 107  
   ordinary, 100, 101  
   radiation, 100  
   registering, 100, 101  
   scales, 94-98  
   self-recording, 101, 110  
   solar radiation maximum, 120  
   stand, 38, 103, 108, 109  
   standard, 100  
   wet-bulb, 190, 191; management of, 195  
*Thermomètre fronde*, 110  
 Thermometric gradient, 332  
 Thomson's water-dropping collector, 280; electrometers, 281  
 Thunder, 217, 220, 240, 290; what it is, 290; its relation to hail, 240; electricity, 278  
 Thunderbolts, non-existent, 292  
 Thunderclouds, characteristics of, 220  
 Thunderstorm depression, 241, 286  
   Committee of the Royal Meteorological Society, 286, 291  
 Thunderstorms, periodic, 217, 287; heat, 285; cyclonic, 285; Mohn's classification of, 285; analysis of, 286; occurrence of, 323  
 Tobacco plant, climatology of the, 92  
 Tormentos of the Argentine Republic, 326  
 Tornadoes, 241-243, 327  
 Torricellian column, 134, 135  
   experiment, 130, 131, 134, 135  
   vacuum, 130, 131, 138, 141, 145  
 Torsion anemometer, 256; balance, Coulomb's, 281  
 Town fog, 208-210  
 Trade Winds, 172, 173, 325  
 Tramontana of the Adriatic, 326  
 Transmission of barometric indications by electricity, 146  
 Transparency of the atmosphere, 17  
 Trinity College, Dublin, enteric fever in, 378  
 Tropics, meaning of term, 11; diurnal variation of barometer in the, 164  
 Tube anemometer, 275  
 Twilight, 16  
 Typhus fever, seasonal prevalence of, 380, 381  
  
 UNDERGROUND water and health, 318, 366, 377, 378  
 United States Weather Bureau, 39, 41, 43, 44, 49, 51-58  
   *Monthly Weather Review*, 52  
   its scientific work, 87; its stations, 407  
   service created, 40; its cost, 44; its publications, 410  
 Universal Sunshine Recorder, 127  
 "Upbank thaw," 118  
 Upper clouds, 214  
 Utrecht International Meteorological Congress, 34, 37  
  
 VACUUM, Torricellian, 130, 131, 138, 141, 145  
 Vane, 252  
 Vapour, aqueous, in the air, 19, 25, 179, 180, 308; tension of, 165, 166, 179, 186, 191, 196; atmosphere of, 179, 186, 197, 213, 222; amount of, required for saturation, 191; where most abundant, 195  
 Variable winds, 325  
 Vartry Water Supply, Dublin, 378  
 Veer, meaning of, 177  
 Vegetation in relation to climate, 305 306, 319, 320

- Velocity of wind, 7, 251  
 anemometers, 259
- Venice, hail-storm in, 243
- Verglas, 198
- Verification Certificate, Kew Observatory, 101
- Vernier in the barometer, 153-156 ;  
 method of reading it, 154
- V-shaped depression, 175 ; thunderstorms in, 176
- Vibrations of light, 17
- Vienna International Meteorological Congress, 7, 256, 274, 278
- Volcanic dust, 205
- Volta's collector, 280
- Volts, 283, 293 ; meaning of, 283
- Volumetric analyses of air, 20
- WALDO'S *Modern Meteorology*, 47**
- Wales, distribution of rainfall in, 348
- Wall screen, thermometer, 109
- Water, boiling-point of, 95, 97-99, 201  
 dust, 213  
 free surfaces of, 201  
 freezing-point of, 95, 97, 99, 201  
 influence of, on climate, 306, 311  
 specific heat of, 118 ; specific gravity of, 131  
 subsoil, influence of, on health, 318, 366, 377, 378  
 underground, 318, 366, 377, 378
- Watery moon, 177  
 sun, 177  
 vapour in the air, 19, 25, 179, 180, 308 ; tension of, 165, 166, 179, 186, 191, 196 ; where most abundant, 195
- Wave-lengths of light, 17 ; of heat, 17, 18
- Weather, 26 ; Merle's Journal of the, 27 ; telegraphy and, 28 ; bureaux, 28 ; reports, daily and weekly, 33, 34 ; scale of, 36 ; bureau of United States, 39, 41, 43, 47 51-58 ; service, United States, 40 ; its cost, 44 ; its stations, 407 ; its publications, 410 ; influence on disease, 357  
 and health, 2
- Weather, anticyclonic, in winter, 177 ; in summer, 178  
 bureau stations, 60  
 radiation, 176
- Weather-cock, 252
- Weather - crop bulletin, United States, 52, 61, 66  
 "Weather-glass," 135, 142, 143
- Weather maps, 28, 30, 31, 39, 41, 66, 69, 70, 86, 88
- Weather Review, Monthly*, United States, 52, 54, 66, 90, 91
- Wedge of high pressure, 175
- Weekly Weather Report*, 33, 34
- Weight of air, 12, 191 ; of hailstones, 244 ; of rain, 248  
 of vapour in a cubic foot of air, 191
- Wells's *Essay on Dew*, 198
- Werchojansk, low temperature at, 310
- Wet-bulb thermometer, 190, 191 ; management of, 195
- Wet fog, 200
- Wheel-barometer, 135, 142, 143
- Whipple-Casella "Universal" Sunshine Recorder, 127
- Whirlwind, 327
- Wind, definition of, 4, 249 ; direction of, how determined, 7, 252 ; velocity or force of, 7 ; how generated, 15 ; direction of, 34, 35, 274 ; force, Beaufort scale of, 31, 35, 251 ; true direction of, 36 ; veering of, 177 ; hauling of, 177 ; backing of, 177
- Windrose, 255 ; how constructed, 255
- Winds, Trade, 172, 173, 325 ; prevailing, and climate, 306, 325 ; permanent, 325 ; periodic, 325 ; variable, 325 ; uses of, 325 ; influence on climate, 325 ; occasional cold, 325, 326 ; occasional warm, 325, 327, 328
- Winter distribution of atmospheric pressure, 8, 171 ; of thunderstorms, 287, 288 ; of disease, 358-360  
 climate of British Islands, 330



Winter fog, 210	Yeates's electric self-registering
sea temperatures, 336	rain-gauge, 203
Wool-pack cloud, 214	
YAKUTSK, extreme temperatures at,	ZERO, displacement of, 100
309, 310	Zigzag lightning, 291
	Zones, climatic, 304

## INDEX OF PROPER NAMES

- ABBE**, Professor Cleveland, 40, 41, 45, 87, 88, 411, 414, 415  
**Abercromby**, Hon. Ralph, 7, 169, 175, 176, 220, 284, 291  
**Adie**, P., 140, 149, 259  
**Aitken**, John, 200-207, 209  
**Allen**, James, 91, 413  
**Andrand**, 299  
**Andrews**, Dr., 296, 297  
**Apjohn**, Professor James, 191, 192, 378  
**Arago**, François, 110, 287, 292  
**Aræus**, 358  
**Aristotle**, 1, 357  
**Asclepiades**, 358  
**August**, 191  
  
**BABINGTON**, 182  
**Baillie**, Navigating-Lieutenant C. W., 32  
**Baily**, W. O., 413  
**Baker**, T. W., 160  
**Ball**, Sir Robert S., 14  
**Ballard**, Edward, 3, 124, 371, 372, 374, 386-388, 391  
**Barus**, Dr. Carl, 45  
**Bayard**, Francis Campbell, 167, 170, 334  
**Beall**, F. M. M., 91  
**Beaudoux**, 264  
**Beaufort**, Admiral Sir F., 31, 35, 251  
**Beaufoy**, 256  
**Beckley**, 271  
**Becquerel**, 285  
**Benzenberg**, 265  
**Bernoulli**, 263  
**Besant**, 148  
  
**Bigelow**, Professor Frank H., 46, 89, 417  
**Birkhimer**, W. E., 413  
**Bouguer**, 256  
**Bourdon**, 148, 263  
**Bowditch**, Dr., 318  
**Boyle**, Hon. Robert, 13, 15, 135  
**Black**, W. T., 244  
**Blanford**, Henry F., 137, 223  
**Blyth**, A. Wynter, 22, 25  
**Brewster**, Sir David, 262  
**Brockway**, Dr. Fred. J., 13, 138  
**Brodie**, Sir B. C., 297  
**Broussais**, 405  
**Brown**, Horace T., 23  
**Buchan**, Dr. Alexander, 116, 117, 173, 194, 288, 316, 319, 330, 332, 334-339, 345-350, 367, 369, 380, 383, 385, 389, 393  
**Buchanan**, Sir George, 318, 378  
**Buhl**, Professor, 3, 378  
**Bunsen**, 20, 24  
**Buys Ballot**, 3, 6, 8, 170, 172, 173, 250, 330  
  
**CACCIATORE**, 265  
**Cæsar**, 293  
**Caldcleugh**, 287  
**Campbell**, John F., 125  
**Carnelly**, Professor, 201  
**Casella**, Louis Marino, 265  
**Casella**, Louis P., 103, 106, 120, 122, 123, 127, 149, 150, 233, 254, 262  
**Castelli**, B., 223  
**Cator**, 257  
**Cavendish**, Lord Charles, 104  
**Celsius**, 95-97

- Celsius, 2, 358  
 Chambers, Frederick, 169  
 Chanut, 134  
 Charles, 15, 16  
 Chaucer, 252  
 Churchill, John, 214  
 Cicero, 1  
 Cole, Dr. Frank N., 418  
 Colladon, Professor, 293, 294  
 Collinson, Peter, 276  
 Columbel, Rev. Augustus M., 169  
 Conger, Inspector N. S., 418  
 Cosgrave, Henry A., 244  
 Coulomb, 281  
 Craveri, 264  
 Creighton, Dr. Charles, 395  
 Croll, 314, 315  
 Crosley, 229  
 Cruls, M. L., 354  
 Curtis, G. E., 413  
 Curtis, R. H., 356
- DALBERG, 256  
 Dalton, John, 15  
 Dancer, J. B., 24  
 Daniell, Professor, 188, 283  
 Dante, 310  
 Dechevrens, 265  
 Delamanon, 269  
 Descartes, 134  
 Dewar, Professor, 13, 14  
 Dines, George, 187, 188, 199, 222,  
 234, 257, 258, 269, 274, 275  
 Diversus, Petrus Salius, 361  
 Dove, 165, 166, 241  
 Dowling, Professor, 378  
 Dowson, E. T., 169  
 Dunning, 361  
 Dunwoody, Major H. H. C., 45,  
 50, 412, 413, 415, 419  
 Dyrenforth, Mr., 93
- EBERTH, 404  
 Edgeworth, Richard Lovell, 260  
 Eliot, Professor John, 223, 248  
 Ellis, John, 91  
 Ellis, William, 135, 145, 148, 169  
 Ellis, W. F., 413  
 Erman, Professor Adolf, 6, 284  
 Evans, Sir F., 315  
 Everett, Professor J. D., 278
- FAHRENHEIT, 14, 94-96, 98, 305  
 Fassig, Oliver L., 415  
 Fautrat, M., 321  
 Faye, Professor, 362, 364  
 Ferrel, Professor William, 45, 88,  
 412, 414  
 Field, Rogers, 149  
 Finley, Lieutenant John P., 411,  
 412, 419  
 FitzRoy, Admiral Robert, 28, 41, 141  
 Flint, Austin, 376  
 Forbes, Principal, 123  
 Ford, A. C., 91  
 Fortin, 138-141, 152, 156, 159  
 Foster, Henry, 250  
 Foster, Rev. W., 259  
 Fox, Dr. Cornelius B., 20, 299,  
 300  
 Frankland, Professor E., 22, 210  
 Franklin, Benjamin, 39, 276, 300  
 Friedländer, Dr. C., 395, 404
- GALILEO, Galilei, 130, 223  
 Galton, Francis, 256  
 Garlington, E. A., 413  
 Gay-Lussac, Louis Joseph, 15, 141,  
 213  
 Glaisher, James, 148, 193, 237, 299,  
 420  
 Glassford, Lieutenant W. A., 343,  
 417  
 Glenn, S. W., 414  
 Goddard, 264  
 Godefroy, 199  
 Graham, 23  
 Greely, General A. W., 42, 43, 45,  
 92, 310, 411, 415-417  
 Greely, Lieutenant A. W., 416  
 Griffith, Rev. C. H., 225  
 Grimshaw, T. W., Registrar-General  
 for Ireland, 29, 367, 368, 376,  
 380, 381, 383, 394, 397  
 Guericke, Otto von, 17
- HAGAN, George Hass, 91  
 Hagemann, G. A., 263, 264, 275  
 Hammon, William H., 91  
 Hancock, Dr. Thomas, 361  
 Hann, Dr. J., 118, 328  
 Harding, Charles, 137, 332  
 Harrington, Mark W., 43, 45, 342,  
 417

- Hart, Dr. Ernest, 365  
Hartnup, 143  
Haughton, Rev. Samuel, 182, 235, 378  
Hazen, General William B., 42, 46  
Hazen, Professor Henry A., 46, 89, 90, 91, 412-414, 418  
Heberden, Dr. William, 358  
Hellmann, Professor Dr. G., 134, 223  
Hennessy, Professor, 265  
Henry, Professor, 39, 40  
Henshaw, Henry W., 416  
Herschel, Sir John, 116, 118-120, 235, 314  
Hesiod, 11  
Hildebrandsson, 220  
Hilgard, Professor E. W., 417  
Hill, Rev. E., 148  
Hippocrates, 2, 357  
Hirsch, August, 358, 360, 361, 366, 373, 395, 396  
Homer, 11  
Hooke, Robert, 135, 142, 224, 255, 256, 269  
Hope, Dr. Edward W., 374  
Houzeau, 23  
Howard, Luke, 214, 216, 219  
Howlett, 256  
Humboldt, 165, 309, 315  
Hunt, 299  
Hutton, 190
- JAMES**, Colonel Sir H., 251, 260  
Jefferson, President Thomas, 39  
Jelinek, 256  
Jevons, 235  
Jewell, Dr., 90  
Joly, J., 145, 146  
Jordan, James B., 128, 132  
Jordan, T. B., 127  
Joule, Dr., 315
- KANE**, Sir Robert, 352  
Kelvin, Lord, 13, 280, 281, 283, 284  
Kettler, 310  
King, Alfred, 143, 144  
King, Dr. E. Slade, 405  
King, Franklin H., 418  
King, Samuel A., 47, 91  
Kircher, Athanasius, 269  
Klebs, 404
- Koch, 365, 404  
Köppen, Dr. W., 220, 333
- LADUREAU, A., 23  
Lamar, W. H., jr., 413  
Lamarck, 214  
Lambert, 274  
Lamont, Professor von, 183  
Langley, Professor S.P., 88, 412  
Lapham, Professor J. A., 40, 45  
Laplace, 162  
Laughton, John Knox, 167, 255, 260, 269, 314  
Lawes, Lady, 225  
Lawson, Inspector-General Robert, 166, 169  
Lemonnier, 277  
Le Roy, 197  
Leslie, Sir John, 190, 262  
Leupold, 256, 269  
Leutmann, 256  
Leverrier, 41  
Ley, Rev. W. Clement, 4, 169  
Liais, M., 16  
Liebermeister, 378  
Lind, 258, 275  
Lloyd, Rev. Humphrey, 3, 241, 242, 378  
Lomonosow, 259, 264  
Longfellow, H. W., 210, 220  
Loomis, Professor, 45, 88, 137, 294  
Lowne, R. M., 261
- M'ADIE, Alexander, 414, 415  
Madison, Bishop, 39  
Mann, Dr. Robert J., 12, 16, 182, 301, 302  
Marcet, Dr. William, 200, 240, 277, 295  
Marignac, 286  
Mariotte, Edmé, 13, 15, 224  
Marriott, William, 128, 153, 193, 274, 286, 325, 327  
Marum, Van, 296  
Marvin, Professor C. H., 46, 88  
Mason, 190  
Mathieu, 320, 321  
Maury, Commodore, 39  
Meinert, Dr. E., 373, 375  
Mell, Professor P. H., 418  
Mendenhall, Dr. T. C., 45, 88, 89  
Méne, 22

- Mennucci, 220, 221  
 Merle, Rev. William, 27  
 Metcalfe, H. J., 245  
 Michell, Mr. Sloane, 405  
 Miller, Professor, 24  
 Milton, John, 206, 310  
 Mitchell, Sir Arthur, 3, 326, 367,  
 371, 380, 383, 385, 389, 393  
 Moffat, Dr., 299  
 Mohn, Professor Henry, 285  
 Moore, Alfred, 91  
 Moore, Dr. William D., 377  
 Moore, Thomas, 216  
 Moray, Sir Robert, 255  
 Morgagni, 361  
 Morrill, Park, 414  
 Morse, 39  
 Müller, Dr., 292, 295  
 Murchison, Dr. Charles, 381, 383  
 Myer, General, 40, 42, 45, 46
- NASMYTH, James, 291  
 Negretti, 102, 229, 260  
 Nelson, Edward W., 416  
 Nettie, Dr. John, 238  
 Neumann, 328  
 Neumayer, 220  
 Nollet, Abbé, 256
- ODLING, 297  
 Osler, 256, 274  
 Overduyn, Professor, 263
- PAINE, Hon. H. E., 40  
 Parkes, Professor Edmund A., 3,  
 262, 317, 318  
 Parmenides, 304  
 Pascal, Blaise, 134, 135  
 Peltier, 284  
 Perrault, Pierre, 224  
 Perrier, 134  
 Petermann, 319  
 Pettenkofer, Professor von, 3, 318,  
 366, 377  
 Phillips, Professor, 102, 120, 263  
 Pickering, 256  
 Pictet, 197  
 Pim, Greenwood, 211  
 Pitot, 259  
 Plato, 1  
 Poëy, 215  
 Pouillet, 116, 120
- Price, James, 184, 185  
 Ptolemy, Claudius, 304  
 Pujoulx, 258
- QUETELET, 3, 284, 299
- RAY, Lieutenant P. H., 416  
 Réaumur, 96-98  
 Rebman, F. J., 212  
 Redier, Louis, 143, 145  
 Regnault, 14, 15, 20, 187, 192  
 Richard, frères, 120, 184, 231-233,  
 270-274  
 Richmann, Professor, 276  
 Risler, 22  
 Rive, Auguste de la, 285, 296  
 Robinson, Rev. T. Romney, 256,  
 259, 260, 274, 275  
 Romas, M. de, 276  
 Ronalds, Sir Francis, 143, 256  
 Rooke, "Master," 255  
 Ross, Sir James, 324  
 Rouse, 12  
 Rowland, Professor, 90  
 Rue, De la, 183, 292, 295  
 Rundell, W. W., 167, 169  
 Rusk, 148  
 Russell, Hon. Rollo, 245  
 Russell, R., 326  
 Russell, Thomas, 414, 415, 418, 419  
 Rutherford, 103, 122  
 Rysselberghe, Prof. F. van, 110, 146
- SABINE, 165  
 Salleron, 145  
 Sanctorio, 94  
 Sandwith, F. M., 327  
 Saussure, De, 190, 277, 284  
 Schaeffer, George C., jr., 47, 91  
 Schmidt, 256  
 Schönbein, 296, 297  
 Schübler, 284, 317  
 Schumacher, 160  
 Scoresby, 18  
 Scott, R. H., 6, 18, 25, 32, 95, 98,  
 110, 116, 143, 161, 181, 182,  
 188, 193, 195, 199, 213, 216,  
 219, 233, 235, 238, 240, 246,  
 247, 252, 255, 274, 279, 280,  
 284, 289, 292-294, 300, 304-  
 306, 310, 315, 317, 326, 331,  
 333, 345

- Secchi, Padre, 120  
 Seeley, Professor H. G., 351-354  
 Shakespeare, 208  
 Sherman, O. T., 412  
 Sidebottom, James, 238  
 Siemens, Dr. C. William, 116  
 Six, James, 105, 197  
 Smith, Angus, 20, 22  
 Socrates, 1  
 Soret, 298  
 Southall, T., 120  
 Stark, 3  
 Stevenson, Thomas, 7, 38, 103, 109  
 Stewart, Professor Balfour, 160, 290  
 Stooke, Dr. Leonard, 238  
 Stokes, Professor Sir George G., 125, 126, 256, 260  
 Stow, Rev. Fenwick W., 119, 225  
 Strachan, Richard, 98, 135, 166, 169, 173  
 Supan, 310  
 Sydenham, Dr. Thomas, 358, 359  
 Symons, George J., 27, 32, 123, 145, 184, 184, 196, 212, 218, 224, 226-228, 234, 235, 239, 244, 292, 347  
  
 TAIT, 297  
 Tatham, Dr. John, 124  
 Theorell, 110, 145  
 Thomson, Sir William (see "Lord Kelvin"), 13, 280, 281, 283, 284  
 Thorne, Dr. R. Thorne, 378  
 Thurston, Edgar, 395  
 Tissandier, M. G., 22  
 Torricelli, Evangelista, 130, 131, 134  
 Townley, R., 224  
 Toynbee, Captain, 333  
 Tripp, 223  
 Tucker, Edward, jr., 218  
 Turner, L. M., 416  
 Twemlow, Francis E., 299  
  
 Tyndall, Professor John, 196, 205, 213, 236  
  
 UPTON, Professor Winslow, 90, 91, 413  
  
 VAN MARUM, 296  
 Vernier, Pierre, 153  
 Vidi, 146  
 Violle, Professor, 121  
 Volta, Alessandro, 240, 241, 277, 280, 294  
  
 WALDO, Professor Frank, 47, 88, 412, 413  
 Wall, Dr., 276  
 Wallis, 139  
 Ward, Colonel, 225  
 Ward, F. K., 413  
 Warren, Rev. Isaac, 248  
 Webster, W. H. B., 250  
 Wells, Charles William, 197  
 Wheatley, Colonel, 178  
 Wheatstone, Sir Charles, 110, 145, 292  
 Whewell, 259, 271  
 Whipple, G. M., 127, 270  
 Whitney, Professor Milton, 417  
 Wild, Professor, 256  
 Wilke, Professor, 257  
 Williams, Dr. C. Theodore, 306, 310, 316, 319, 325  
 Wilson, Patrick, 197  
 Wojeikof, 320, 321, 323  
 Wolf, 256  
 Wollaston, 259  
 Woltman, 259  
 Woodruff, T. M., 414  
 Wren, Sir Christopher, 224  
  
 YEATES, George, 230  
  
 ZAMBRA, 102, 229, 260

THE END



89074774761



b89074774761a