



TORONTO
LAUNDRY
MACHINERY



FOURTH EDITION

JANUARY—NINETEEN TWELVE

CATALOGUE
of
HIGH-GRADE MODERN
Laundry Machinery

JOHN O'NEILL, Jr., *President and Treasurer*
JOHN C. O'BRIEN, *Secretary and Sales Manager*
L. H. SLAGHT, - *Managing Director*
GEO. E. SUTTON, *Mechanical Superintendent*

DIRECTORS :

JOHN O'NEILL, Jr. JOHN C. O'BRIEN
L. H. SLAGHT A. L. MALONE

Manufactured by
TORONTO LAUNDRY MACHINE CO.,
LIMITED
TORONTO, CANADA

Head Office, Salesrooms and Factory :
DUNDAS BRIDGES, TORONTO, CANADA

Eastern Office and Salesrooms :
46 CRAIG ST. WEST, MONTREAL, QUE.

AGENCIES AT :
ST. JOHN, N. B.; WINNIPEG, MAN.; CALGARY, ALTA.; EDMONTON, ALTA.; VANCOUVER, B. C.

THE MARK OF QUALITY
THE TORONTO LINE

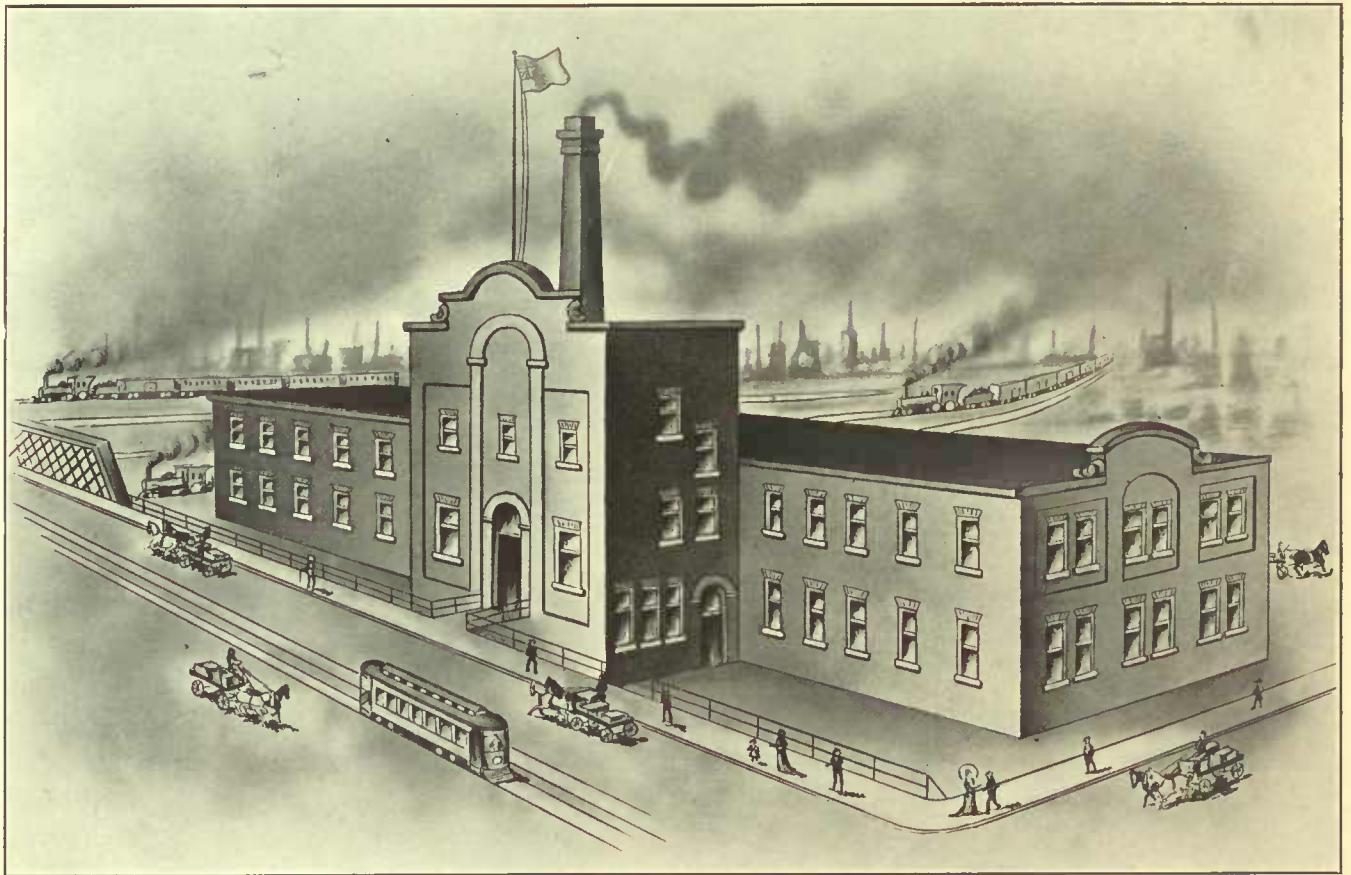

MANUFACTORY, SALESROOMS AND GENERAL OFFICE
DUNDAS BRIDGES
TORONTO, - - CANADA



THE TORONTO LINE

Introduction



WE take pleasure in presenting to the trade this, the fourth edition of our Catalogue, which places before the Canadian Launderer the well known TORONTO LINE of Modern Laundry Machinery.

The products of this Company as outlined and described herein have been designed and perfected in their mechanical features along the lines of the best practice, and are the results of long experience, as the entire efforts of this Company have been concentrated in the manufacture and sale of Modern Laundry Machinery and Equipment of the highest grade for the last eleven years. We have made a special study of the requirements of the Laundry trade, it being part of our policy to anticipate as far as possible the advanced ideas and practices of the Laundry Industry. With this object in view we are constantly improving our present machines and bringing out many new ones, some of which are presented here for the first time.

Our policy has always been to price our machines as low as is consistent with the best of material obtainable and the highest grade of construction possible. Believing that the maxim "cheap machinery is not that which costs the least money, but is that which embodies the best of material and workmanship, and is built for life and service," we produce a line of machines which, while they may not market for the least money, are still the most economical because in the long run they are worth the slight difference, not low priced machinery, but cheap for quality that is BEST VALUE.

Our Engineering Department is prepared to furnish plans, specifications and arrangement of the machines in any sized plant. By reason of the excellence of our machines, of the fairness of our prices, and our intention and ability to serve you with promptness and courtesy, we are sure that we shall merit a continuance of your valued patronage.

THE TORONTO LAUNDRY MACHINE CO.,
LIMITED



Special Notices

Applying to the Ordering and Shipping of Goods Described in this Catalogue

IN ordering from this Catalogue, avoid errors by giving name and size of article desired, and refer to page number. It is not necessary to mutilate the book by tearing out pages, we can send circulars on request.

As we are constantly remodelling and improving our machines, we reserve the right to ship any of the machines illustrated herein, which may be ordered, but including such changes and improvements as shall have been made during the interval between the publishing of this catalogue and the placing of the order, and this right is acknowledged and agreed to by the customer in placing his order and is accepted by us upon these conditions unless otherwise specified.

If special routing is desired, same should be specified, and our shipping department will be governed accordingly, otherwise we will ship for the best interests of the customer. On goods 100 lbs. or less, shipments will be made by express, where rate would equal freight, cartage, etc.

Before returning any goods, we request correspondence. Unless otherwise agreed, parties returning goods are responsible for the proper delivery and must prepay charges.

All claims must be made within ten days after receipt of goods.

We are not responsible for delays or damages from strikes, accidents and other causes beyond our control.

Unless otherwise agreed, goods are delivered F. O. B. Toronto, Ont.

All goods are shipped at BUYER'S RISK, and carriers act as BUYER'S AGENT in handling them.

They are carefully examined before leaving our works and found to be in good condition, and so receipted for by Transportation Company.

If they are delivered to you in bad order, **REFUSE TO REMOVE THEM** and make your claim for damages against Transportation Company.

Remember that if you accept goods in bad order you forfeit all claims against carriers for damages, and it is very important that you examine goods before receipting for them.

We are not responsible for damages to goods in transit, as our responsibility ceases on delivery of goods to carriers.

Upon request, we will assist in making any claim.



Toronto Wooden Washers

DESCRIPTION

ON the following pages we show the various sizes and styles of Washers we are manufacturing. The life and service of washers is a vital question, and nothing but the best stock and workmanship should enter into the construction of these machines. We are therefore making but one grade of Washer.

OUTSIDE CYLINDER

The outside cylinder, or shell, is made of 2-inch dressed selected Cypress, and is fitted with heavy galvanized bands and sliding doors with bronze handles. We use a combination water inlet and outlet Tee with our special quick-opening valve with bottom discharge. Unless otherwise specified all our Washers are shipped with discharge at header end and water glass on opposite end, the steam and water connections in the combination Tee being left for connections from the same end as that upon which the water gauge is placed.

INSIDE CYLINDER

The inside cylinder is made of selected Georgia pine, except the ribs, which are of hard maple. The cylinders are trimmed with galvanized iron bands and bronze locks, catches, hinges and bolts. All double geared machines 36 inches in diameter are fitted with bronze rings for bolts, one on each end. The 40-inch diameter machines have two bronze rings for bolts on each end. The bronze ring is very important to the life of wooden cylinder heads. Around each bolt hole a lug is cast to the ring, and the bolt which holds the trunion does not come in contact with the wood at all, as the lug is nearly the thickness of the head. By use of this arrangement the trunion is held perfectly rigid, and there is no wear on the cylinder ends due to torsional strain. All washers are measured by the outside measurements of the inside cylinder. The nails used in fastening the staves and ribs to the cylinder heads are all heavily regalvanized and the bands are fastened with bronze screws.

REVERSING MOVEMENT

Each Washer is fitted with our well-known Movement or Header. This movement automatically reverses the cylinder every third revolution. The Header is designed as simply as possible and contains in all about a dozen pieces, including belt loops and shifter. All gears used on our machines are machined from the solid casting by automatic machinery, and are covered with protecting shields as shown.



THE TORONTO LINE

Toronto Standard Washer

24 Inches Diameter.

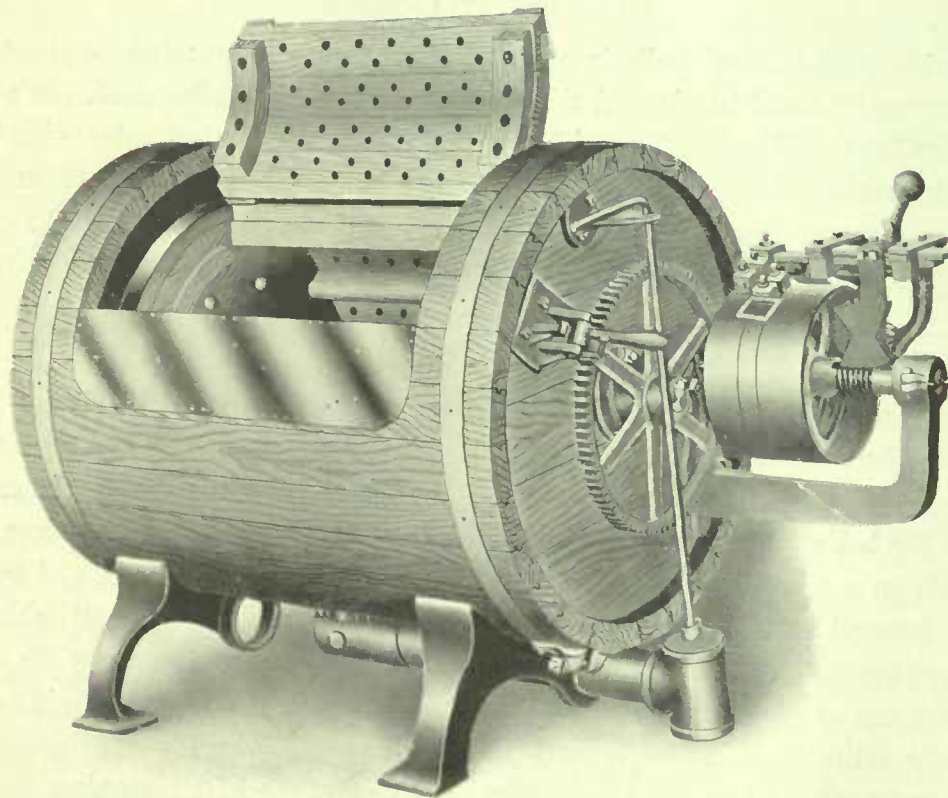

SINGLE GEARED

See Page 9



Toronto Standard Washers

Single and Double Geared

SPECIFICATIONS									
Shirts	No	Cylinder	Diameter of Pulleys inches	Floor Space inches	Face of Pulleys inches	Speed	Weight lbs.	Belts	
								Inside	Outside
25	1	24 × 24 inches, hand	..	30 × 50	450
25	2	24 × 24 " power	12	30 × 50	6	100	500	1¼	1½
35	3	24 × 30 " "	12	30 × 56	6	100	600	1¼	1½
55	3½	32 × 30 " "	16	41 × 66	10	160	1000	1¾	2¼
75	4	36 × 30 " "	16	45 × 66	10	160	1100	1¾	2¼
100	5	36 × 40 " "	16	45 × 76	10	160	1200	1¾	2¼
125	6	36 × 50 " "	16	45 × 86	10	160	1400	1¾	2¼
150	7	36 × 60 D. G.	16	54 × 110	10	160	1800	1¾	2¼
175	8	36 × 70 " "	16	54 × 120	10	160	2000	1¾	2¼

All drains on these Washers 3 inches diameter, excepting Nos. 1, 2 and 3 which have 2 inches.

Water inlet on all the above machines same size as discharge. Steam connections ½ inch.

Unless otherwise specified, washers are always shipped with outlet at right hand or Header end and the Steam, Hot and Cold Water Inlets at the opposite end.

Toronto Standard Washer

36 Inches Diameter.

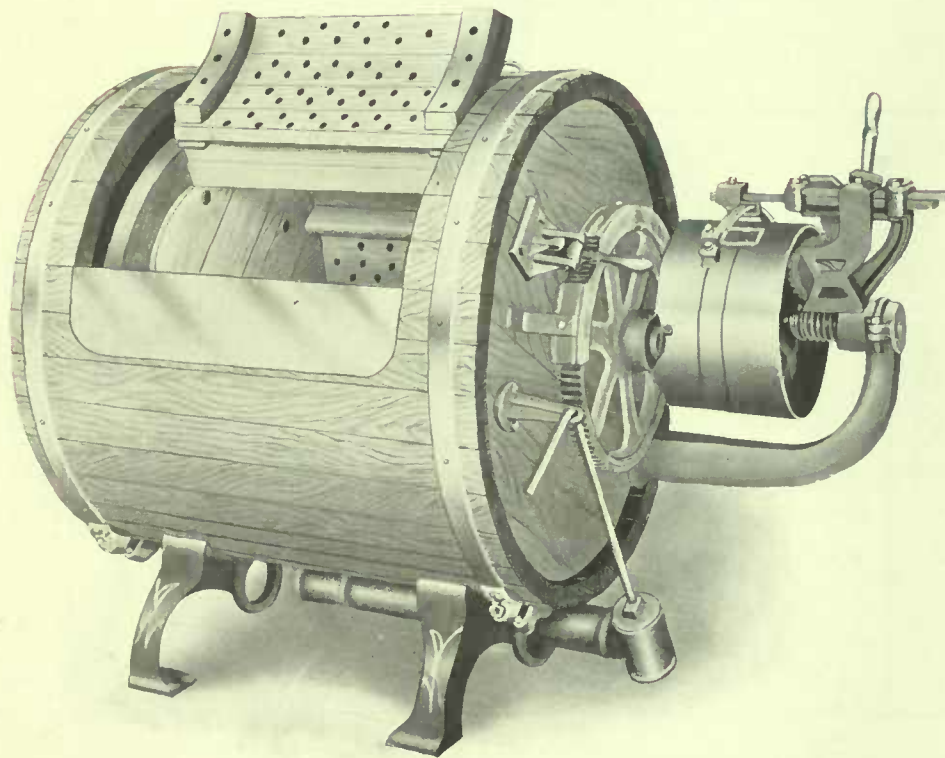

SINGLE GEARED

See Page 9



Toronto Standard Washer

36 Inches Diameter.

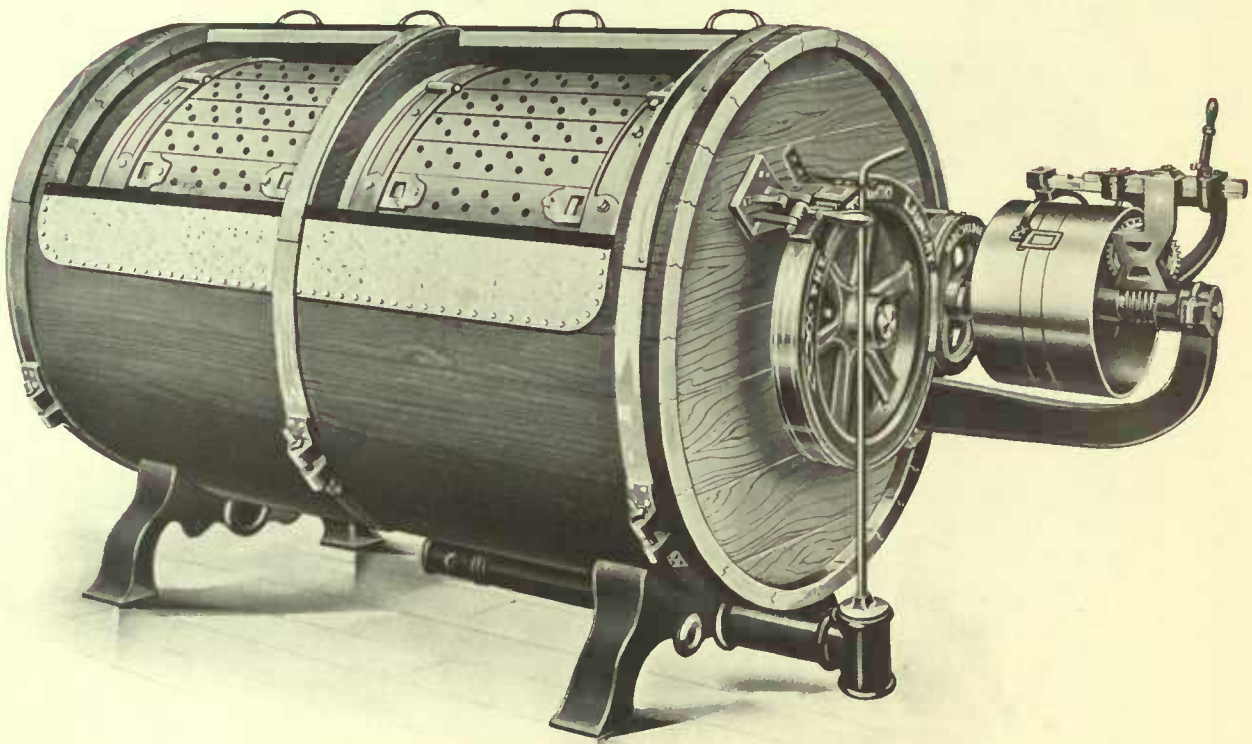

DOUBLE GEARED

See Page 9



THE TORONTO LINE

Toronto Imperial Iron Frame Washer

Made in two Diameters, 36 inch and 40 inch.

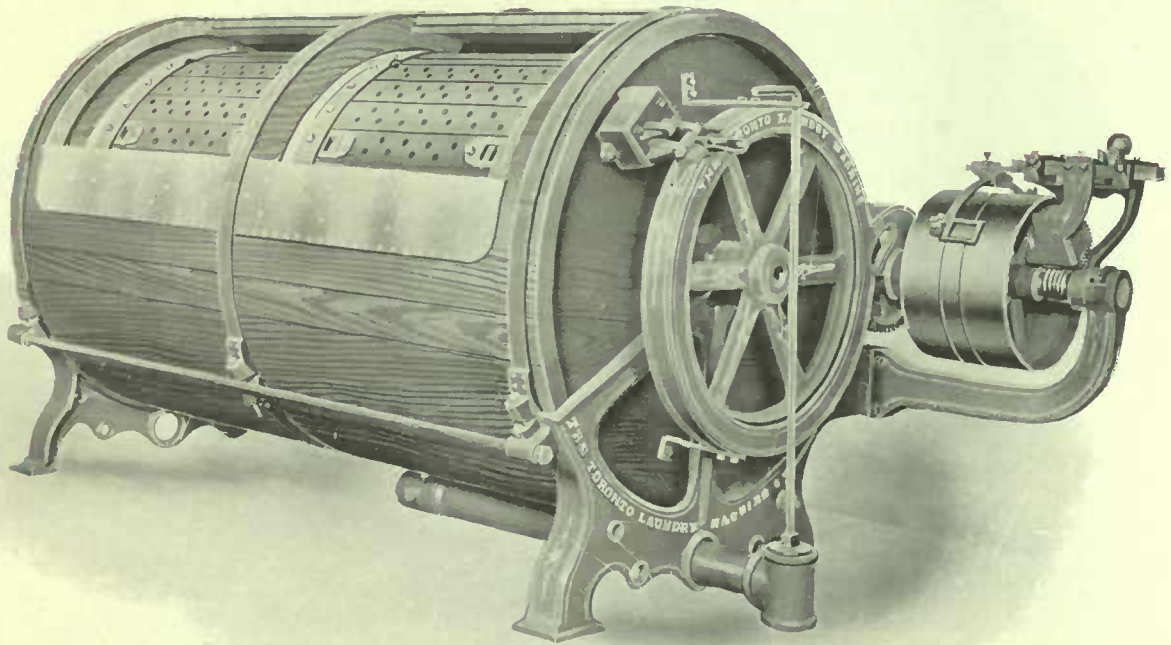

SINGLE AND DOUBLE GEARED



Toronto Imperial Iron Frame Washers

SINGLE AND DOUBLE GEARED

Made in Two Diameters—36 inch and 40 inch.

AMONG the many superior points of this style of machine we call attention to the following: The Header bolts directly to the rigid iron frame which stands entirely independent of either the outside or inside cylinder. The frames are drawn together by tie-rods holding the outside shell securely without the aid of any additional fastenings. Laundrymen will at once recognize the ease with which the cylinder or shell may be removed for any purpose, and the still more important improvement of overcoming the bolting of the bearings and header to the end of the tub, which in time becomes water soaked and soft, thereby loosening the header or the throwing out of alignment of the gears by reason of the swelling of the wood.

The 40 inch diameter Imperial Washer was designed especially for washing large quantities of flat work, and the specifications of our Elevated Movement, on page 19, are the same for this machine, with the exception that the movement is placed upon the end.

SPECIFICATIONS									
Shirts	No.	Cylinder in inches	Diameter of Pulleys inches	Floor Space inches	Face of Pulleys inches	Speed	Weight lbs.	Belts	
								Inside	Outside
100	35	36 × 40 D. G.	16	54 × 90	10	180	1700	1¾	2¼
125	36	36 × 50 D. G.	16	54 × 100	10	180	2100	1¾	2¼
150	37	36 × 60 D. G.	16	54 × 110	10	180	2300	1¾	2¼
175	38	36 × 70 D. G.	16	54 × 120	10	180	2600	1¾	2¼
140	39	40 × 40 S. G.	18	48 × 80	14	225	1500	2½	3
140	40	40 × 40 D. G.	18	60 × 99	14	225	1700	2½	3
175	41	40 × 50 S. G.	18	48 × 90	14	225	1700	2½	3
175	42	40 × 50 D. G.	18	60 × 109	14	225	1900	2½	3
210	43	40 × 60 D. G.	18	60 × 119	14	225	2300	2½	3
245	44	40 × 70 D. G.	18	60 × 129	14	225	2600	2½	3
280	45	40 × 80 D. G.	18	60 × 139	14	225	2900	2½	3
315	46	40 × 90 D. G.	18	60 × 149	14	225	3100	2½	3
350	47	40 × 100 D. G.	18	60 × 159	14	225	3500	2½	3

All drains on these Washers 3 inches diameter. Water inlet, 3 inches. Steam inlet, ½ inch.

Outlet at Header end. Steam and Water Inlets at left hand end.



THE TORONTO LINE

Toronto Elevated Movement Washers

36 inches Diameter.

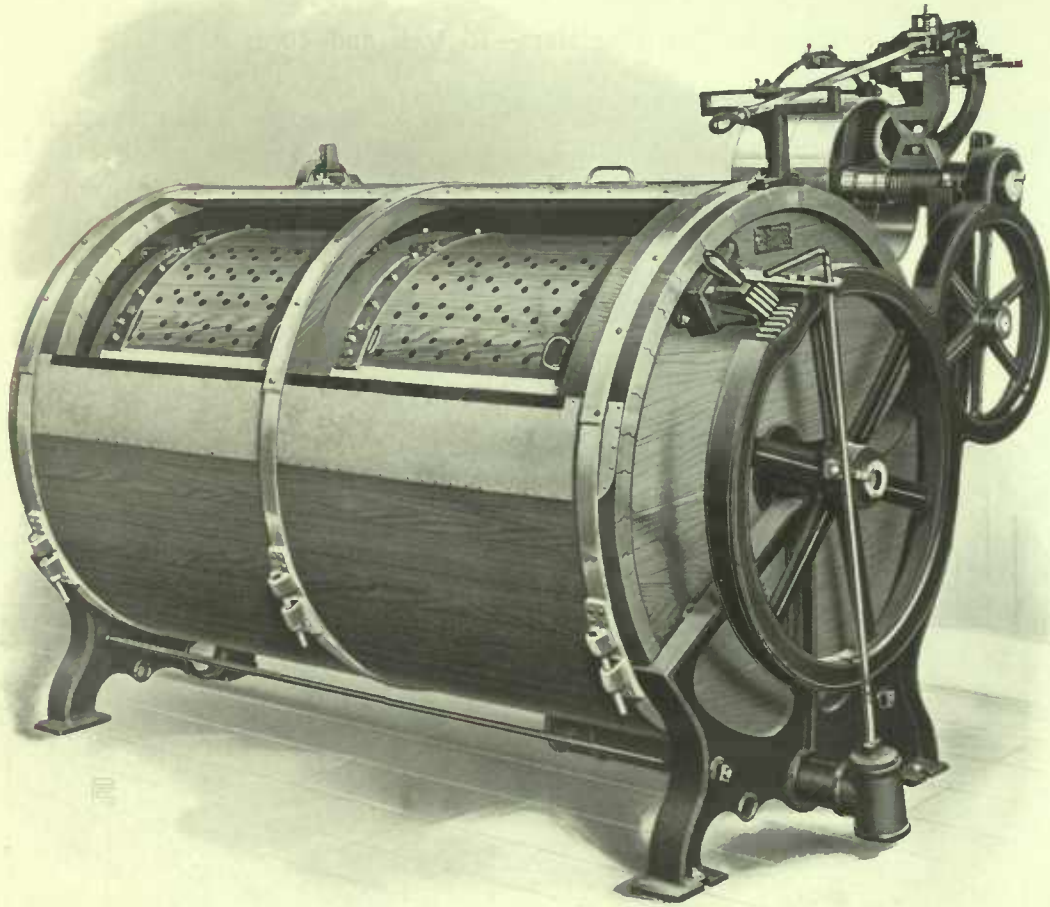

Wood Cylinder

Wood Outside Case

SPECIFICATIONS

Shirts	No.	Cylinder in inches	Diam. of Pulleys inches	Floor Space inches	Face of Pulleys inches	Speed	Weight lbs.	Belts		Compartmentments
								Inside	Outside	
125	55	36 x 50 D. G.	16	54 x 80	10	180	2100	1 3/4	2 1/4	1
150	56	36 x 60 D. G.	16	54 x 90	10	180	2300	1 3/4	2 1/4	2
175	57	36 x 70 D. G.	16	54 x 100	10	180	2500	1 3/4	2 1/4	2
200	58	36 x 80 D. G.	16	54 x 110	10	180	2700	1 3/4	2 1/4	2
225	59	36 x 90 D. G.	16	54 x 120	10	180	2900	1 3/4	2 1/4	3
250	60	36 x 100 D. G.	16	54 x 130	10	180	3100	1 3/4	2 1/4	3

Water inlet 3 inches diameter. Discharge 3 inches diameter. Steam connections 1/2 inch.
Outlet on Header End. Steam and Water Inlets at Left Hand End.



Toronto Elevated Movement Washers

36 Inches Diameter.

THE 36 x 60 inch Machine as shown in the cut on the opposite page is one of the most popular machines of our Elevated Type. THE MAIN FEATURES being the economy of floor space, and the ease of operation together with the powerful drive that each style of Elevated machine has been provided with.

FLOOR SPACE. By comparing the floor space that the same capacity machine of the End Movement Type occupies, it will be seen that Four Elevated Movement Washers occupy less space than Three where the movement is upon the end. When this Type machine was first introduced it was supposed that a high ceiling was required, but this machine will operate satisfactorily, where the ceiling is over seven feet high.

OPERATION. The starting Lever is conveniently placed near the front of the machine, within easy reach. Drawing the lever TOWARDS you Starts the machine and shoving it BACK Stops it. To bring the cylinder doors around to the opening move the lever to the RIGHT or LEFT in its slide until the door comes to the proper place and then drop it in the center slot. This movement of the lever to the right or left throws one of the belts upon the center pulley $\frac{3}{4}$ inch and this brings the cylinder around very slowly.

POWERFUL DRIVE. The Toronto Elevated Movement Washers have the most powerful driving mechanism of any Elevated Washers made. The 36 inch machine having a ratio of power applied of 1 to 30, that is the power delivered by the belt at the driving pulley is increased 30 times at the cylinder. This is a vital point in any washer and well deserves your careful consideration. The large gears on the cylinder are 30 inches in diameter with faces $1\frac{5}{8}$ inches. Large Main bearings 3 x 7 inches. The Intermediate gears do not run upon studs but are firmly fastened to the shaft at both ends. Brass channel along door opening and heavy Galvanized Iron Apron down the front of the washer.



THE TORONTO LINE

Toronto Elevated Movement Washer

36 Inches Diameter.

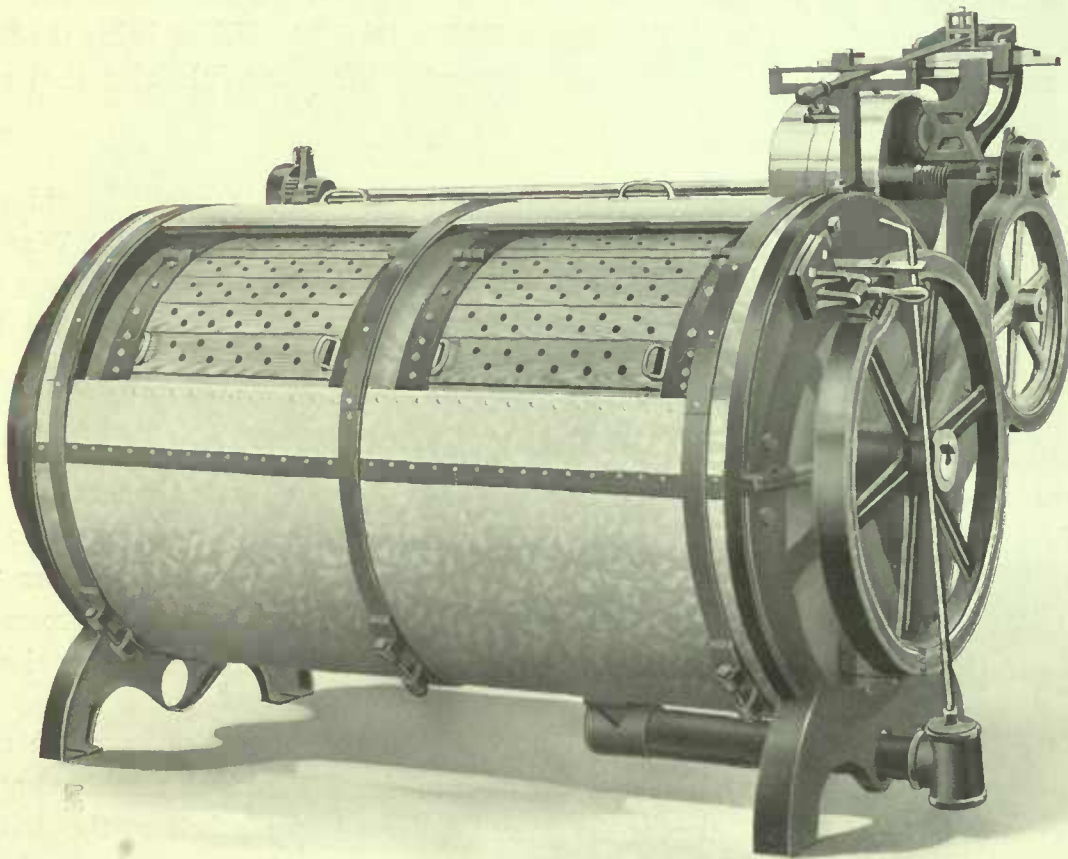

Galvanized Iron Outer Case.

Wooden Cylinder.



Toronto Dry-Room Tumbler

Construction

CYLINDERS. This machine is regularly constructed with the cylinder made of No 13 Half Hard Sheet Brass with the perforations as close together as possible and doubly embossed. The ends are of cast iron and the trunnions are 3 inch diameter. The Cylinders are braced very rigidly by the use of several steel channel stays. The locks, hinges, etc., are solid brass. **WIRE WOVEN** Cylinders are also supplied if ordered and these are made up in the same substantial manner as the sheet brass ones, with half inch brass or galvanized iron wire mesh and perforated sheet brass door. In ordering the wire mesh cylinder, give number of the machine required with the prefix **BRASS OR GALVANIZED WIRE MESH CYLINDER.**

OUTER CASE. The frames are substantially built of cast iron and the shell is made of $\frac{1}{8}$ inch Galvanized Steel Sheets, making it in as far as possible air tight.

AUTOMATIC ATTACHMENT. We have just perfected and attached to our Dry-Room Tumblers both in the 36 inch and 42 inch diameters an automatic device whereby a few turns of a crank conveniently placed near the front of the left hand end of the machine, shifts the belt from the tight to the loose pulley on the fan shaft, applies the brake to overcome the momentum of the fan and raises the outside door into a vertical position. By this single operation the fan is stopped before the door is opened and conversely, the door closes first, the brake is removed and the fan is started. By stopping the fan before the door is opened instead of there being an outrush of heated air into the operator's face, there is a decided inward draft of cool air. The door is automatically **LOCKED** both when **OPEN** and **SHUT** and there is no danger of the door falling down upon the operator, neither can the heat escape by reason of the intense blast from the fan blowing the door open.

COILS. The coils are mounted upon trucks, resting upon tracks and may easily be removed for cleaning purposes. These coils are protected by a baffle plate inserted between them and the cylinder, which prevents any lint from falling into the coils, and which also causes the air to pass entirely through the heated coils before being forced into the cylinder. The coils are made up in two sections, and either or both sections may be used at one time, giving as much or as little heat as may be required for the particular articles being dried.

VENTILATING FAN. The Fan on the 36 inch machine is 16 inches in diameter, with 16 steel blades, while the fan of the 42 inch machine is 18 inches in diameter, with 18 steel blades. The fans upon the different machines have blades of such length as will deliver the proper amount of air to each of the different sizes, heated to the proper heat, which is about 250 degrees Fahrenheit. The quantity of heated air ranging in the 36 inch machines from 2500 to 5000, and in the 42 inch machines from 3500 to 6000 cubic feet per minute.



Toronto Elevated Movement Washers

36 inches Diameter.

Galvanized Outer Case.

Wooden Cylinder.

THE Toronto Metal Case Washers are the result of a careful record having been kept of the repairs necessary during the life time of the wooden washers. The result of these records proving conclusively that the major portion of these repairs was due to the outer case gradually giving way and throwing the whole machine out of alignment. We found that it was comparatively easy to renew a cylinder upon any of our machines but the attaching of a new outer case was an expensive undertaking at the best for the reason that the whole machine required to be dismantled for this purpose.

With the galvanized iron outer case, the only important part that requires renewing is the cylinder and a new cylinder may be placed in the machine by merely removing the upper half of the case. The general construction of this machine is the same as the 36 inch Elevated Movement Washer with the wooden cylinder, with the exception that the outer case is all metal. The galvanized sheets are number ten guage and are galvanized after having been cut and rolled to shape. The ends are cast iron with the legs and shaft bearings all complete in the one casting. The intermediate gear shaft and the main cylinder bearings are each fitted with phosphor bronze removable bearings made to standard guage. This type of machine has been in use now for the past three years and owing to the slight difference in the cost over and above the all wood machine, it has become a very popular machine.

SPECIFICATIONS										
Shirts	No.	Cylinder in inches	Diameter of Pulleys inches	Floor Space inches	Face of Pulleys inches	Speed	Weight lbs.	Belts		Compartments
								Inside	Outside	
125	101	36 × 50 D. G.	16	54 × 80	10	180	2200	1¾	2¼	1
150	102	36 × 60 D. G.	16	54 × 90	10	180	2400	1¾	2¼	2
175	103	36 × 70 D. G.	16	54 × 100	10	180	2600	1¾	2¼	2
200	104	36 × 80 D. G.	16	54 × 110	10	180	2800	1¾	2¼	2
225	105	36 × 90 D. G.	16	54 × 120	10	180	3000	1¾	2¼	3
250	106	36 × 100 D. G.	16	54 × 130	10	180	3200	1¾	2¼	3

Water inlet, 3 inches diameter. Discharge, 3 inches diameter. Steam connections, ½ inch.

Outlet on Header end. Steam and Water Inlets at left hand end.



THE TORONTO LINE

Toronto Elevated Movement Washer

40 Inches Diameter

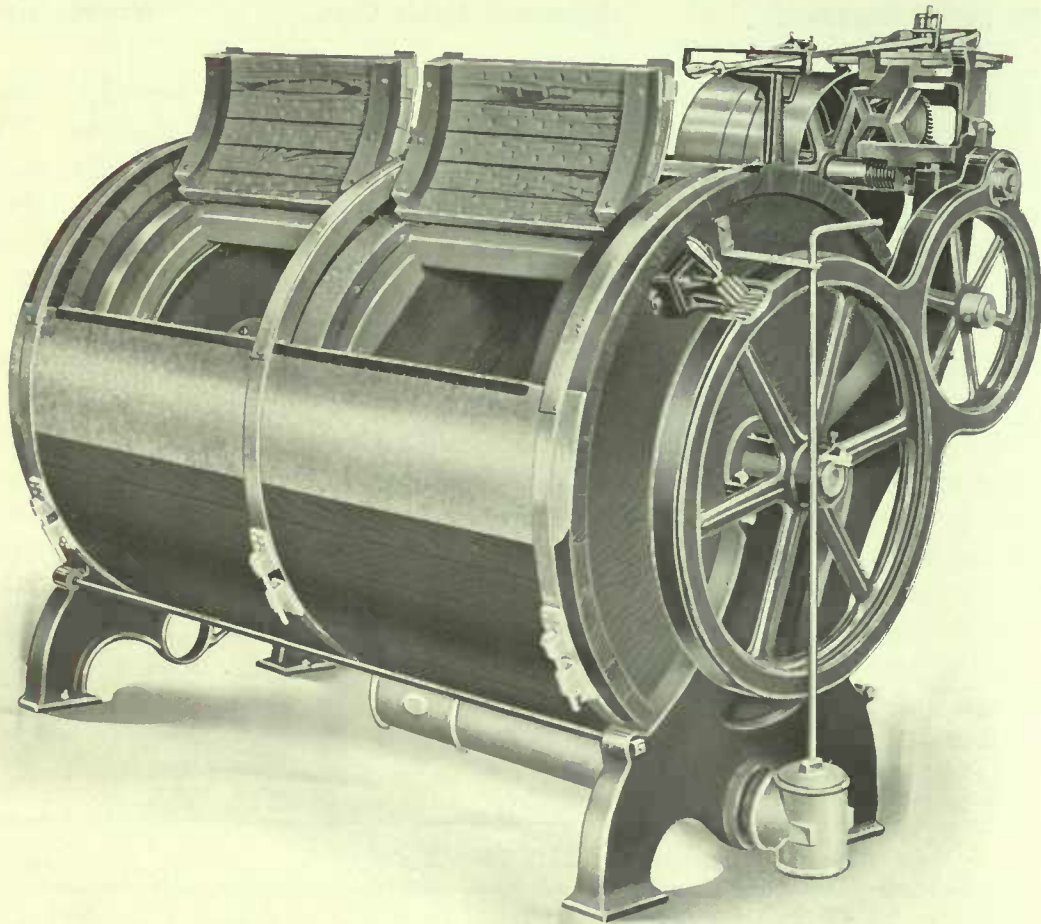

Wood Cylinder.

Wood Outside Case.

SPECIFICATIONS									
Shirts	No.	Cylinder in inches	Diameter of Pulleys inches	Floor Space inches	Face of Pulleys inches	Speed	Weight lbs.	Belts	
								Inside	Outside
175	48	40 x 50	20	60 x 80	14	225	2300	2 1/2	3
210	50	40 x 60	20	60 x 90	14	225	2700	2 1/2	3
245	51	40 x 70	20	60 x 100	14	225	3000	2 1/2	3
280	52	40 x 80	20	60 x 110	14	225	3200	2 1/2	3
315	53	40 x 90	20	60 x 120	14	225	3400	2 1/2	3
350	54	40 x 100	20	60 x 130	14	225	3900	2 1/2	3



Toronto Elevated Movement Washers

40 Inches Diameter.

THE "FAMOUS FORTY" Elevated Movement Washer is now almost too well known to require description as there are hundreds of these machines in daily use in every part of the country from Halifax to Vancouver, but the following details are given herewith in order to further emphasize the original and superior qualities of this splendid machine :

This was the first Elevated Movement Washer made in Canada, and the laundry that purchased our first machine several years ago is still using it and every machine which they have purchased since has been of the same type.

The inner cylinder has spider or trunnions nearly the full diameter of cylinder. The bolts fastening spider are carried on the inside of cylinder by large brass rings as large as can be used. The inner row of bolts are also carried by a brass ring. The hinges, locks, bolts and catches are all brass. These machines (60 inch, 70 inch and 80 inch) are all made with one partition and two compartments, with two doors on inside and outside cylinders. The 90 inch and 100 inch machines are made with three compartments, three doors inside and outside, which are much more convenient than the long doors.

By doing this we are enabled to have a $3\frac{1}{2}$ inch band passed entirely around between the doors of inside cylinder, giving it great stability, and we are also enabled to have a band entirely around outside cylinder between the doors, preventing outer cylinder from swelling and bulging out in the centre. The large gears on cylinder are 33 inches in diameter, with a 2 inch face.

The main Bearings as well as the bearings of the intermediate shaft are fitted with renewal phosphor bronze bearings made to standard gauge and template, and these may be renewed at any time.

Large main bearings 3 inches diameter by 7 inches long. The intermediate gears do not run on studs as in other makes, but on a shaft that extends along the back of machine. Both shafts are of steel $1\frac{1}{8}$ inches diameter. Machines 90 inches and 100 inches long have additional centre legs and bearings for shafts. Pulleys are 20 inches diameter, driven by $2\frac{1}{2}$ and 3 inch belts, making an extraordinary powerful machine. The 40 inch machine has the most powerful drive of any washer made. The ratio of power at the pulleys and at the cylinder being 1 to 45. The lever used to operate the machine is convenient to the operator when standing in front of machine and requires no reaching for. By pulling lever forward machine starts; by shoving back it stops. To bring door around opposite opening all that is required is to shove the lever to one side or the other, whichever way you may wish to run the cylinder. As a space saver there is none to equal it. The space required for this machine is only 30 inches more than the inside cylinder, with the result that four of these machines will occupy the same space that only three of the ordinary kind will take of the same capacity.

Among the many improvements to this machine since issuing our last catalogue, we call attention to the following : The water inlet has been increased to 3 inches diameter ; the discharge is now 5 inches diameter, with our special quick opening valve with full 5 inch bottom discharge. By these changes these large machines may be filled or emptied in less than a minute.

Instead of using a sheet brass apron on the front of these machines we are now using a heavy galvanized iron and a heavy brass channel across the door opening, extending down a short distance on the out and in side of the wood. By this means the goods, in being taken from the washer, only come in contact with the brass channel, while the galvanized iron apron will withstand the hard usage it receives by reason of the trucks being bumped against it, to a great deal better extent than the sheet brass.



Toronto Elevated Movement Washer

40 inches Diameter.

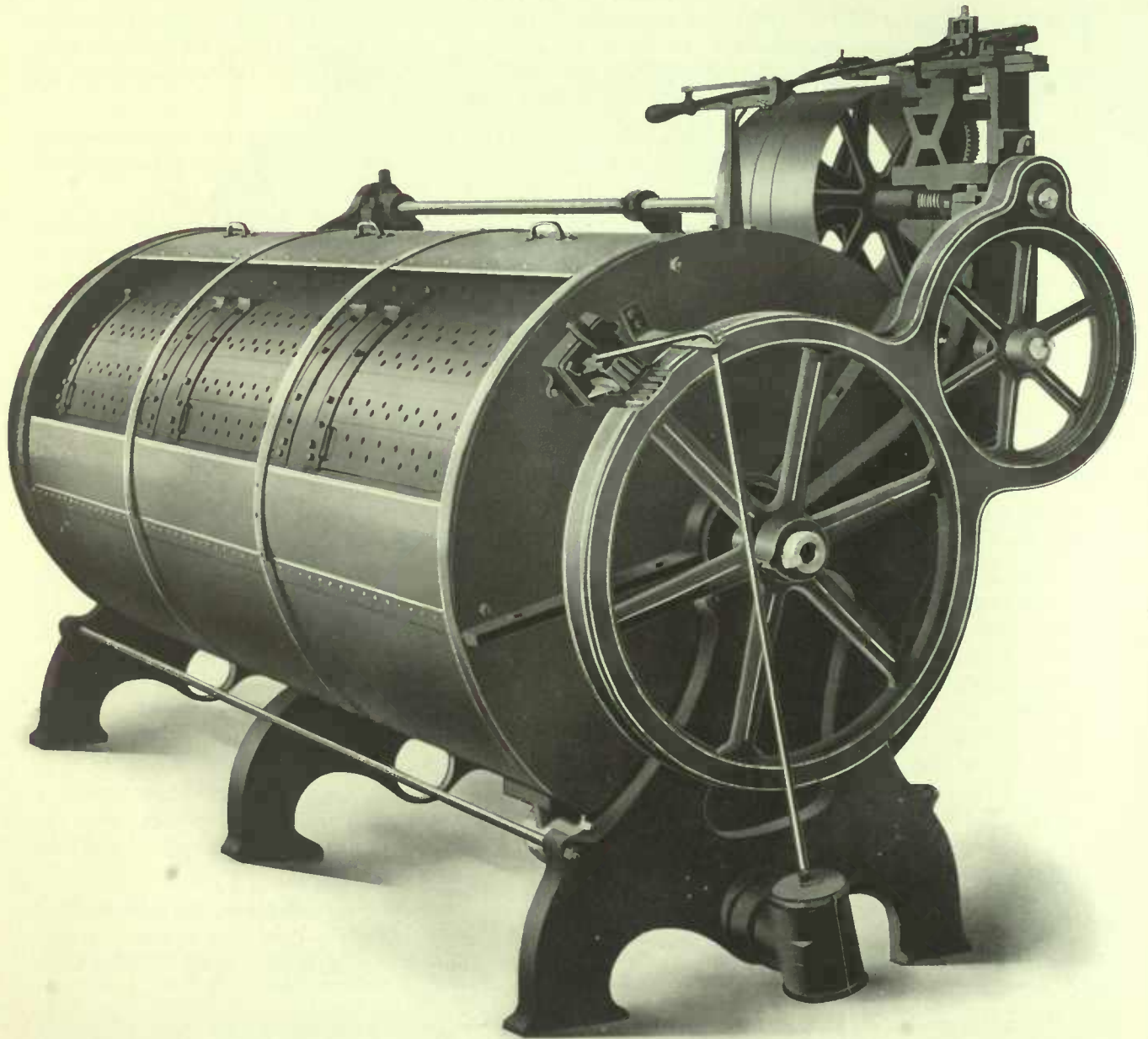

Galvanized Iron Outer Case.

Wooden Cylinder.



Toronto Elevated Movement Washers

40 inches Diameter. Galvanized Outer Case. Wooden Cylinder.

THE description and remarks covering THE FAMOUS FORTY ELEVATED MOVEMENT WASHER as given on page 19 cover this machine. The only difference being that the above mentioned machine has the outer case construction entirely of metal, and the remarks covering the 36 inch Elevated Movement Washer with metal outer case apply as well to the 40 inch diameter.

SPECIFICATIONS								
Shirts	No.	Cylinder in inches	Diameter of Pulleys inches	Floor Space inches	Speed	Weight lbs.	Belts	
							Inside	Outside
175	94	40 × 50	20	60 × 80	225	2500	2½	3
210	95	40 × 60	20	60 × 90	225	2900	2½	3
245	96	40 × 70	20	60 × 100	225	3200	2½	3
280	97	40 × 80	20	60 × 110	225	3400	2½	3
315	98	40 × 90	20	60 × 120	225	3600	2½	3
350	99	40 × 100	20	60 × 130	225	4100	2½	3
350	100	40 × 100	20	60 × 130	225	4200	2½	3



Toronto Wet Wash Elevated Movement Washer

40 Inches Diameter.

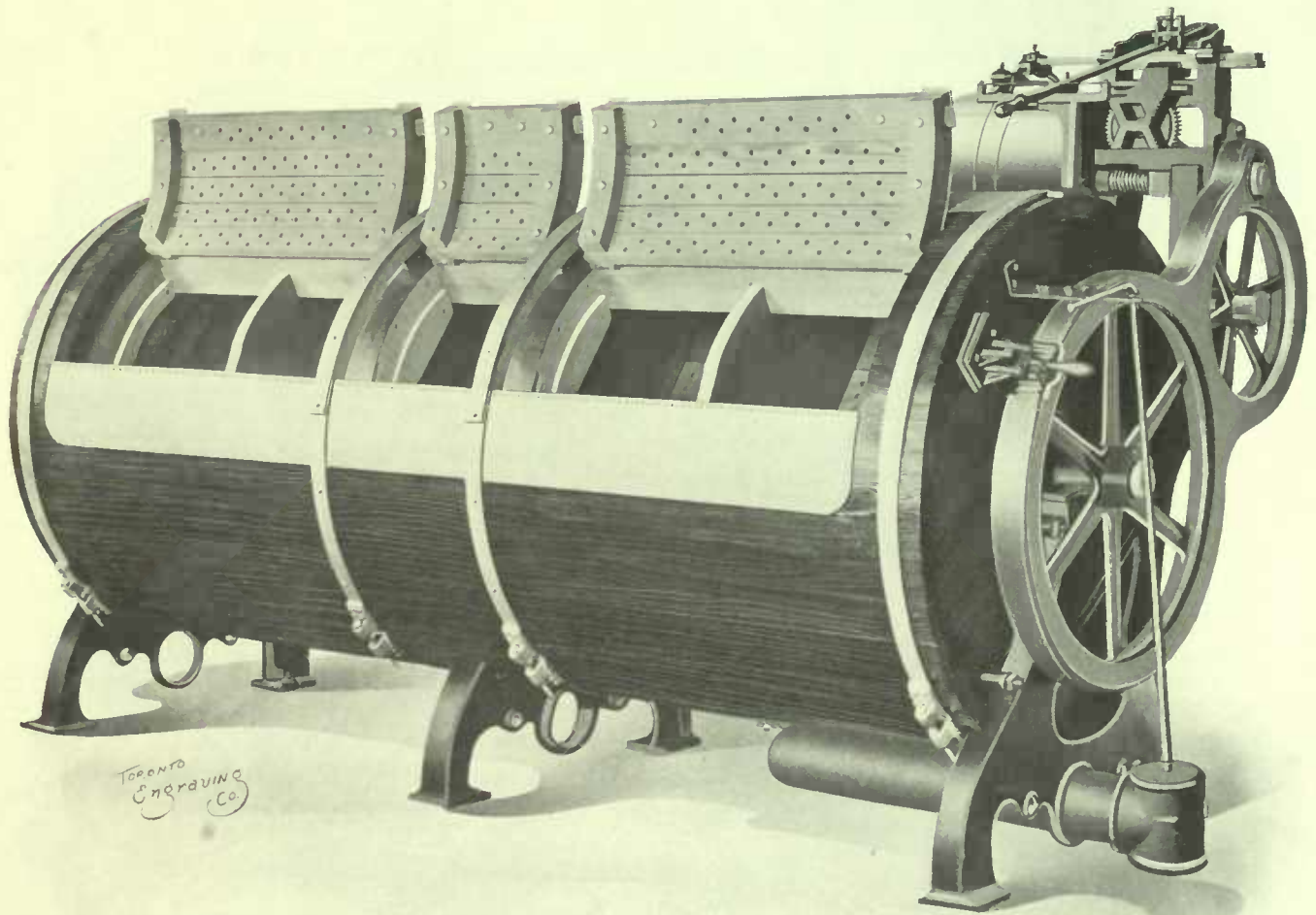

10 Compartments



Toronto Wet Wash Washers

Elevated Movement. 40 Inches Diameter

THE WET WASH WASHER shown on the opposite page was designed especially for this class of business and our object was to produce a machine that would handle ten washes at the same time. This object was accomplished by making a cylinder that was divided longitudinally into two halves and each of these halves was again divided into five compartments by vertical partitions, giving in all ten compartments. There are three doors opening into each five pockets and the two sets of doors being exactly opposite each other make the cylinder perfectly balanced. The object in dividing the cylinder through the center was to obtain the ten compartments in the 40 x 100 inch Elevated Movement Washer Cylinder, and it was only after this machine had been in actual use that the advantages of this type of construction became evident. The actual time of washing was reduced one-third and even then the work was better done than in the ordinary machine, and the reason for this reduction was that the center division lifted the goods in one side of the cylinder clear out of the water once every revolution, and when the machine came to be unloaded, all the goods in the upper half are resting upon this center division and there is no exertion required in the unloading of the machine.

While the machine shown is 40 x 100 inches and is divided into ten compartments, we are prepared to supply any type of machine made up with any required number of compartments, to suit the individual requirements.

SPECIFICATIONS									
Compartmentments	Cylinder	Pulleys inches	Belts inches	Width of Face inches	Speed	Floor Space inches	Weight lbs.	Diameter Water Inlet inches	Diameter Discharge inches
10	6 Doors Inside 3 Doors Each Side 3 Doors Outside Shell	20	2½ & 3	14	225 R. P. M.	60 x 130	3900	3	5

Discharge Valve on the Right Hand End.
Water and Steam Inlets on Left Hand End.



THE TORONTO LINE

Toronto Elevated Movement Washers

Galvanized Iron Outer Case

Wooden Cylinder

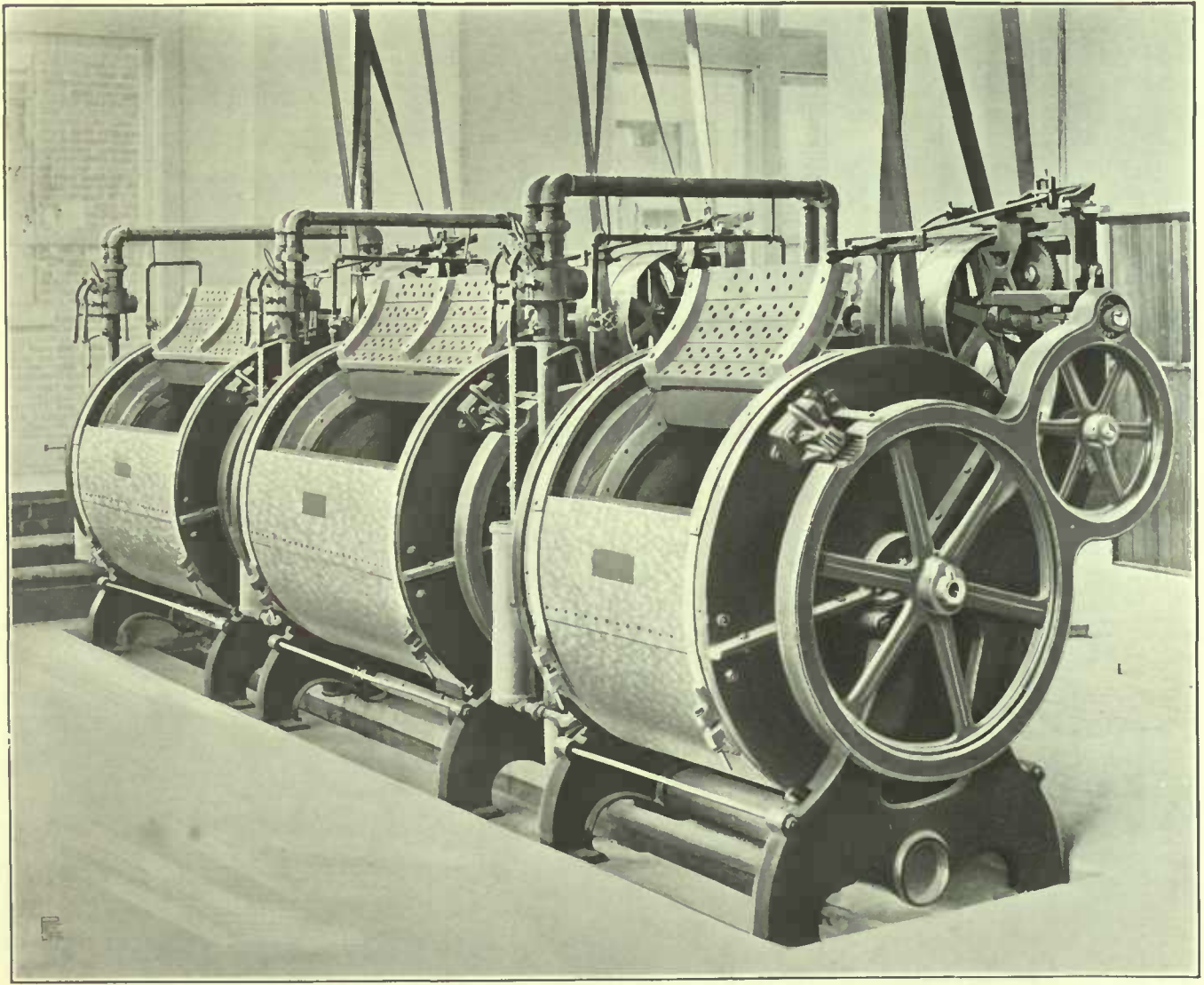

An ideal installation of three FAMOUS FORTY Elevated Movement Washers in the New Method Laundry, Toronto, equipped with the Yates Automatic Washer Inlet Valves.



The Yates Automatic Washer Inlet Valve

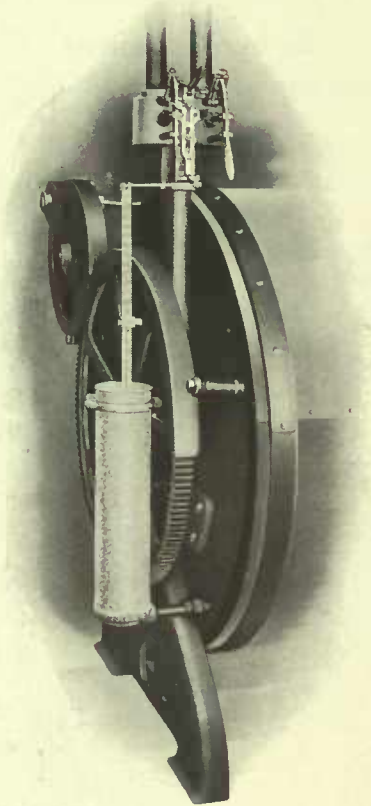

HERE is a washer valve that practically eliminates valve trouble in the wash-room. It can be relied upon to work always.

It is made on honor and we believe good for fifteen or twenty years of constant service.

It is a saver of water, materials, and time, and will pay for itself, in the ordinary laundry, within two years and still be worth its cost.

The body of the valve is a solid brass casting, which eliminates all iron rust troubles.

It is slow closing under all pressures, which means no water-hammer and long life to the valve and your piping.

Made in two sizes—1½ inch, weight 25 lbs. 2 inch, weight 35 lbs.



Toronto Solid Head Metal Case Washer

24 Inches Diameter.

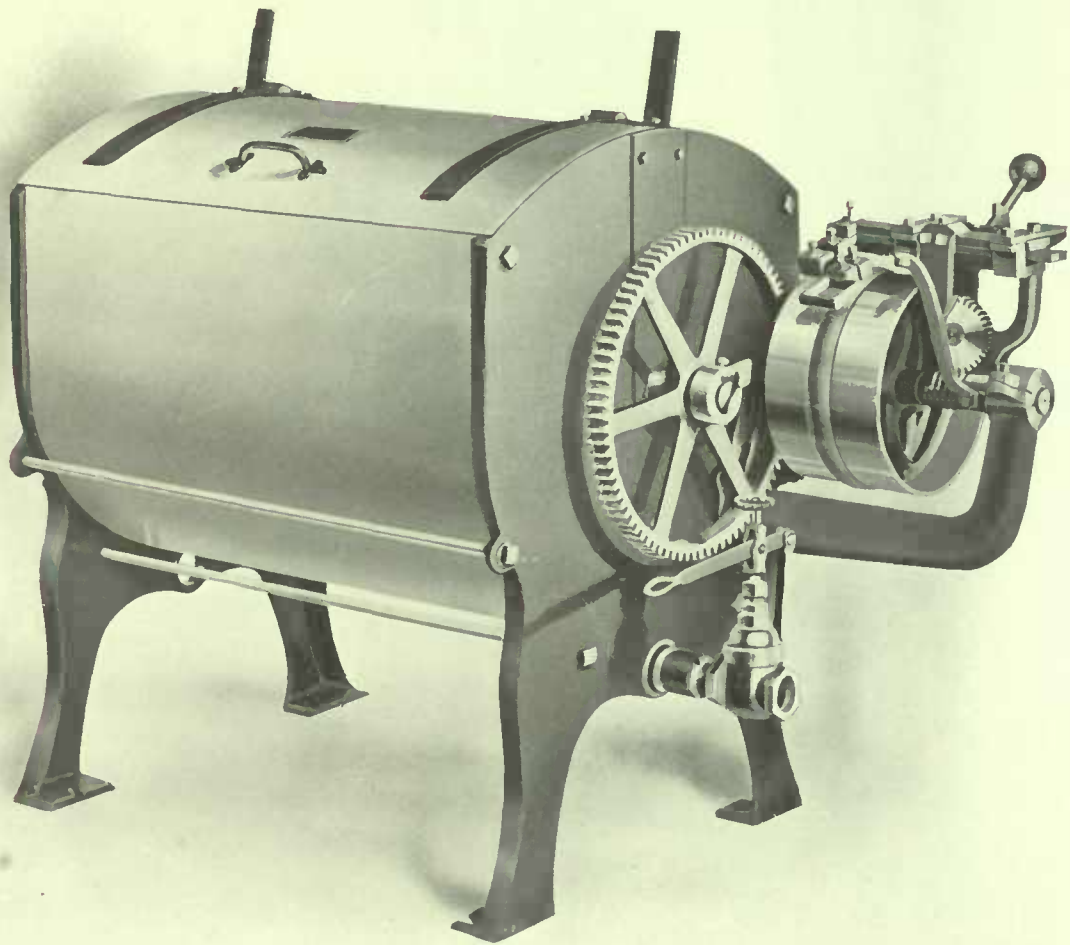

Brass or Wooden Cylinder



Toronto Solid Head Metal Case Washers

Brass or Wooden Cylinders.

24 inches and 30 inches Diameter.

THE TORONTO SOLID HEAD METAL CASE WASHERS were designed to fill the demand for a durable and sanitary washer, and which at the same time would be an inexpensive machine. This machine was originally designed for the dry cleaning trade but the demand for this machine from small institutions throughout the country for use as a laundry washer has warranted us in including this machine in our regular line of washing machines. These machines are made in two diameters, 24 inches and 30 inches, and in length from 24 inches to 50 inches, with cylinders of either wood or brass. The Outer Case of the machine is made of galvanized iron, "U" shaped, with solid cast iron heads. The door opening is at the top and prevents all splashing. The door itself is made in two parts hinged at the center, steel spring rests are attached to each end forming a rest to hold the cover in an upright position. The cylinder door when open rests against the door on the outside ease. One of the essential features of this machine is that by removing a few cap screws from the back of the cover and the slides on the head, the cylinder may be taken out without disturbing the rest of the machine. The wooden cylinder is fitted with solid brass locks, hinges, catches, bolts, etc., and the outer door is also fitted with brass handle, catches, etc. The brass cylinders are made of No. 13 half hard sheet brass with embossed perforations, the trunions on the brass cylinder are of cast iron galvanized, and the cylinder is drawn together by tie rods passing through the several ribs of the cylinder. The water space between the cylinder and the outer shell of these machines is less than one inch.

Water Inlet $1\frac{1}{2}$ inches.

Water Outlet $1\frac{1}{2}$ inches.

Steam Inlet $\frac{3}{8}$ inch.



Toronto Solid Head Metal Case Washer

30 Inches Diameter.

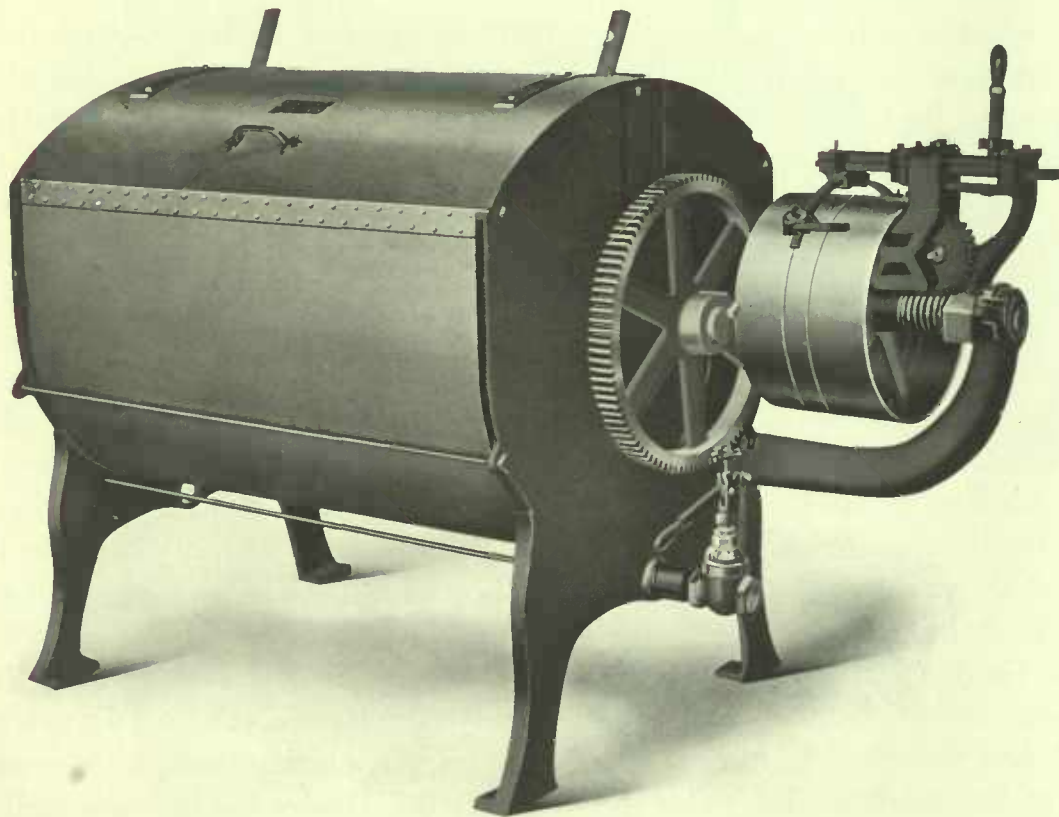

Brass or Wooden Cylinder



Toronto Solid Head Metal Case Washers

24 Inches and 30 Inches Diameter.

24 Inch Toronto Solid Head Washers

Galvanized Iron Outside Shell.

Brass or Wood Cylinders.

SPECIFICATIONS					
No.	Size, inches	Floor Space inches	Pulleys	Cylinder	Weight lbs.
131	24 × 24	34 × 46	Hand	Wood	350
132	24 × 24	34 × 46	12	Wood	375
133	24 × 24	34 × 46	Hand	Brass	350
134	24 × 24	34 × 46	12	Brass	375
135	24 × 30	34 × 52	Hand	Wood	425
136	24 × 30	34 × 52	12	Wood	450
137	24 × 30	34 × 52	Hand	Brass	425
138	24 × 30	34 × 52	12	Brass	450
Pulleys, 125 R. P. M.			Belts, 1¼ and 1½		

30 inch Toronto Solid Head Washers

Galvanized Iron Outside Shell.

Brass or Wood Cylinders.

SPECIFICATIONS					
No.	Size, inches	Floor Space inches	Pulleys, inches	Cylinder	Weight lbs.
139	30 × 30	38 × 54	16	Wood	550
140	30 × 30	38 × 54	16	Brass	550
141	30 × 40	38 × 64	16	Wood	650
142	30 × 40	38 × 64	16	Brass	650
143	30 × 50	38 × 74	16	Wood	750
144	30 × 50	38 × 74	16	Brass	750
Pulleys, 125 R. P. M.			Belts, 1¾ and 2¼		



Toronto Metallic Washers

MOST Laundrymen have learned by experience that the better the appliance the better the work, and and with that truism established it is a recognized fact that the washroom, the foundation for good work, must have the best washing machines that can be constructed. The Brass Washer has been constructed to meet every requirement. A fault of the ordinary Washer is that excessive loads weaken its parts. The Brass Washer is impregnable and the solidity precludes the possibility of wear, thus giving superior durability.

From the sanitary standpoint this Washer is an ideal invention. Cleanliness is a paramount requisite in the washroom. The wood washer is an absorber and accumulator of the unclean dregs of the washing process; it holds the scum that rises to the surface and creates a condition detrimental to producing good clean work. The Brass Washer prevents all such difficulties, is easily cleaned, stays clean longer and cannot retain dirt or impurity. We furnish these Machines in either galvanized case and iron ends with brass cylinder, or wooden case with brass cylinder, or brass case and brass cylinder. Our Sterilizer or Disinfecting Washers are finished in the same first-class manner.

GENERAL DESCRIPTION OF THE CONSTRUCTION OF TORONTO METALLIC WASHERS

The OUTER CASE is constructed of two sheets of No. 10 gauge galvanized steel. These sheets are fabricated and rolled before being galvanized which insures them against the possibility of rusting by reason of the edges and openings being raw and which are not protected by the galvanizing. These sheets on all end movement machines are the full half circumference of the outer case, while on the Elevated Movement Machines the lower sheet extends from the front opening for two-thirds of the circumference. On all types of Toronto Metallic Washers these sheets are inserted into a slot cast in the iron heads. The two heads are drawn up tightly against the sheets by means of bronze tie bolts, $\frac{5}{8}$ inch diameter.

These sheets are NOT RIVETTED as they used to be in the older type of machine and a special water tight slip joint is provided where the upper and lower sheets meet both at the front and rear of the machine. These joints are self locking and are not rivetted or bolted. To remove the upper half of the outer shell requires the unloosening of only a few bolts in the flanges where the upper and lower parts of the cast iron heads are joined together.

A reference to the several half tone engravings will illustrate this system, and they also show combination head with the legs cast all in one piece. The bands upon the outer case are of galvanized iron and the sliding doors on all Metallic Washers are made of No. 16 hard sheet brass with bronze handles. These brass doors are the result of years of experience, and have proved a solution of the difficulty usually experienced with galvanized doors, which on account of their constant use commence to rust inside the slides as soon as the galvanizing wears off, with the result that the doors after a short time become very stiff in sliding backwards and forwards.



Toronto Metallic Washers

CYLINDER. The cylinders of all Toronto Metallic Washers are constructed of No. 13 half hard sheet brass with the perforations doubly embossed. Each cylinder has seven formed sheet brass ribs through which are passed $\frac{5}{8}$ inch truss bolts for securing the galvanized cast iron trunnions. The brass sheets on each end of the inner cylinder are 1-16 inch in thickness of hard sheet brass the full diameter of the cylinder. The galvanized cast iron trunnions have inwardly projecting flanges on the inside of which the brass sheets forming the cylinder are securely riveted. On all machines over 50 inches in length two doors are provided on both the inner cylinder and the outer case. The doors on the inner cylinder having hinges, catches, locks, etc., all of solid brass.

GEARS. The gears are all machine cut from solid castings and are protected with gear cases as shown in the several illustrations. These machines are all fitted with the Toronto lever handle, bottom discharge washer valves with full three inch opening. The water inlet is three inches and the steam inlet one-half inch. The Standard Machines are fitted with the discharge on the right hand end and the water and steam inlets and gauge glass upon the left hand end, but these may be reversed if we are so instructed when the machine is ordered.

REVERSING MOVEMENT. The header is of our well-known type and is clearly shown in the several cuts. This is one of the most simple headers in use to-day and consists of about a dozen pieces, including the belt loops.

JOURNALS. The main or cylinder journals are three inches diameter by eight inches long of phosphor bronze made to standard guage and templet and may be renewed without removing the cylinder from its case.

Sterilizer Washers

The above specifications also cover our Sterilizer Washers, which are designed for disinfecting as well as washing the goods. These washers are provided with heavy doors and clamps for securely fastening the same, and are provided with an opening for a four-inch diameter ventilating pipe, which should be connected with the chimney or carried outside of the laundry room to carry off the odors from the goods while cleaning them. The construction of this machine is such that the goods may be washed at a high temperature, thereby thoroughly disinfecting them.

Toronto Metallic Washers

32 inches Diameter. Brass Cylinder. Galvanized Iron Case.

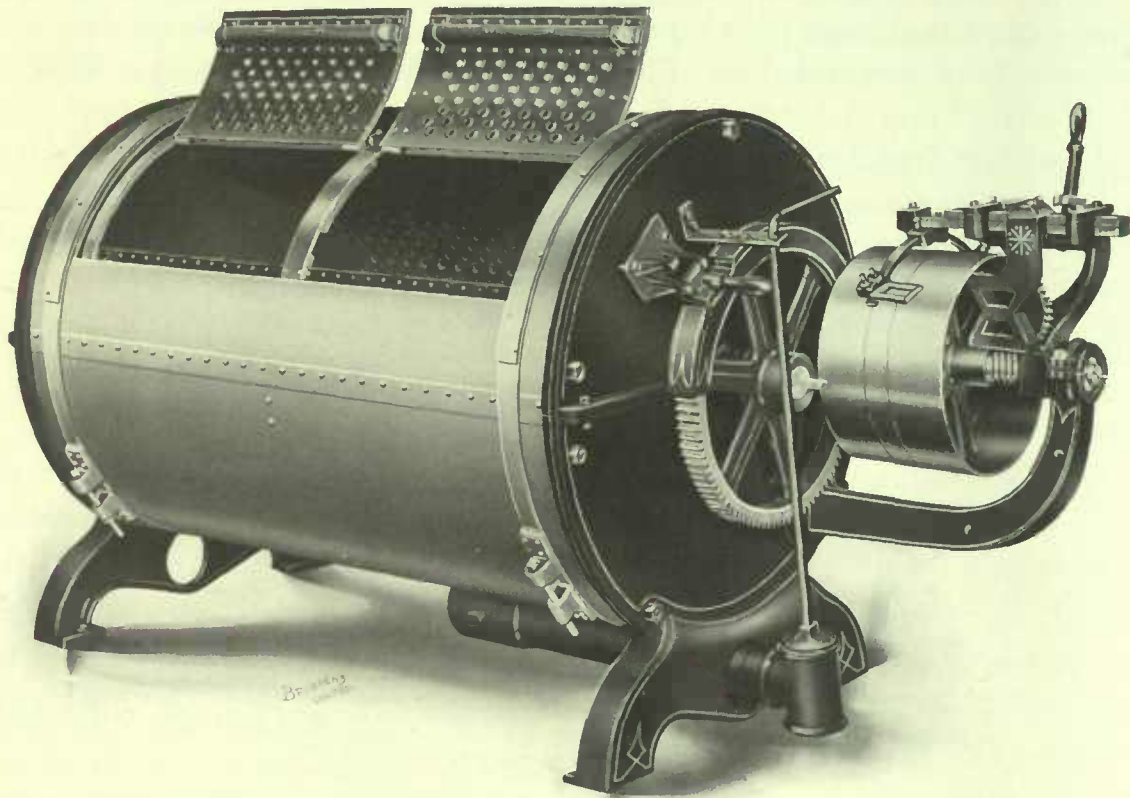

SINGLE AND DOUBLE GEARED

SPECIFICATIONS											
Cylinder and Case	Shirts	No.	Cylinder in inches	Pulleys inches	Floor Space inches	Face inches	Speed	Weight lbs.	Belts		
									Inside	Outside	
Brass Cylinder with Galvanized Case	100	15	32 × 46 S. G.	16	40 × 94	10	160	1600	1 3/4	2 1/4	
	125	16	32 × 54 S. G.	16	40 × 102	10	160	1800	1 3/4	2 1/4	
	125	17	32 × 54 D. G.	16	48 × 106	10	160	2100	1 3/4	2 1/4	
	150	18	32 × 62 D. G.	16	48 × 114	10	160	2400	1 3/4	2 1/4	
Brass Cylinder with Wooden Case	100	19	32 × 46 S. G.	16	40 × 94	10	160	1500	1 3/4	2 1/4	
	125	20	32 × 54 S. G.	16	40 × 102	10	160	1700	1 3/4	2 1/4	
	125	21	32 × 54 D. G.	16	48 × 106	10	160	2100	1 3/4	2 1/4	
	150	22	32 × 62 D. G.	16	48 × 114	10	160	2400	1 3/4	2 1/4	

For General Description of Metallic Washers, see pages 30 and 31.



Toronto Metallic Washers

32 inches Diameter. Brass Cylinder. Galvanized Iron Case.

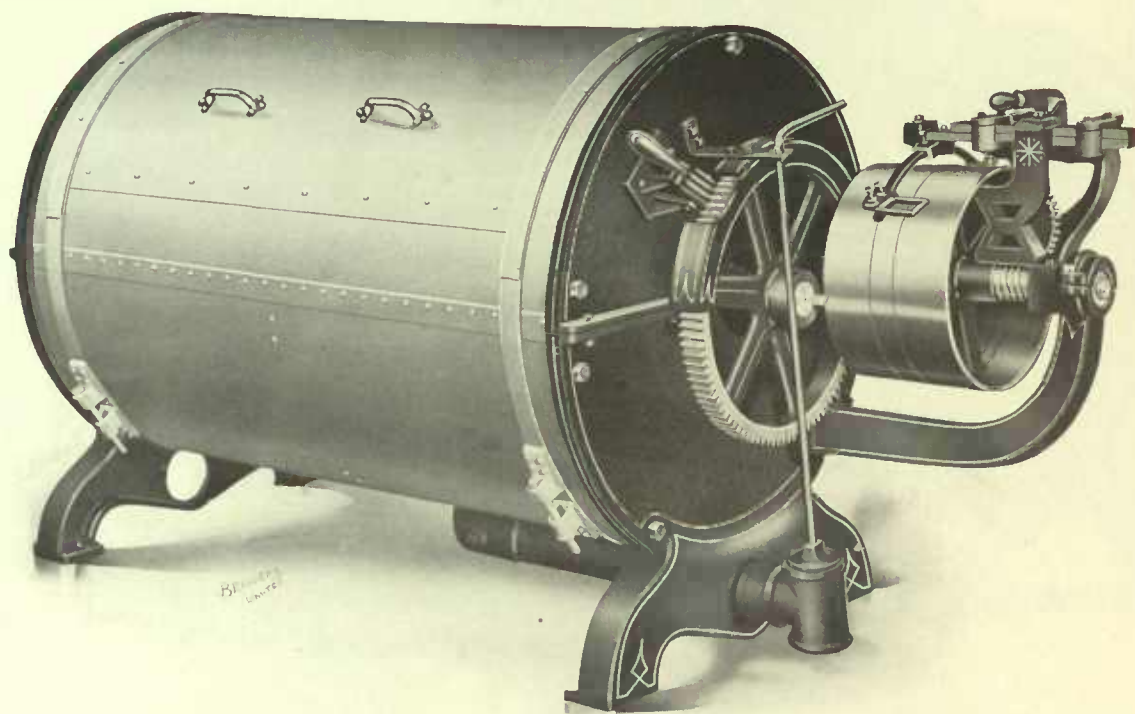

SINGLE AND DOUBLE GEARED

SPECIFICATIONS											
32 Inches Diameter											
Cylinder and Case	Shirts	No.	Cylinder in inches	Pulleys inches	Floor Space inches	Face inches	Speed	Weight lbs.	Belts		
									Inside	Outside	
Brass Cylinder with Brass Case	100	23	32 × 46 S. G.	16	40 × 94	10	160	1600	1 $\frac{3}{4}$	2 $\frac{1}{4}$	
	125	24	32 × 54 S. G.	16	40 × 102	10	160	1800	1 $\frac{3}{4}$	2 $\frac{1}{4}$	
	125	25	32 × 54 D. G.	16	48 × 106	10	160	2100	1 $\frac{3}{4}$	2 $\frac{1}{4}$	
	150	26	33 × 62 D. G.	16	48 × 114	10	160	2400	1 $\frac{3}{4}$	2 $\frac{1}{4}$	
32 Inches Diameter, Sterilizer Washer											
Brass Cylinder with Galvanized Case	100	27	32 × 46 S. G.	16	40 × 94	10	160	1600	1 $\frac{3}{4}$	2 $\frac{1}{4}$	
	125	28	32 × 54 S. G.	16	40 × 102	10	160	1800	1 $\frac{3}{4}$	2 $\frac{1}{4}$	
	125	29	32 × 54 D. G.	16	48 × 106	10	160	2100	1 $\frac{3}{4}$	2 $\frac{1}{4}$	
	150	30	32 × 62 D. G.	16	48 × 114	10	160	2400	1 $\frac{3}{4}$	2 $\frac{1}{4}$	

For general description of Metallic Washers, see pages 30 and 31.



THE TORONTO LINE

Toronto Metallic Washers

36 Inches Diameter.

Galvanized Outer Case.

Brass Cylinder.

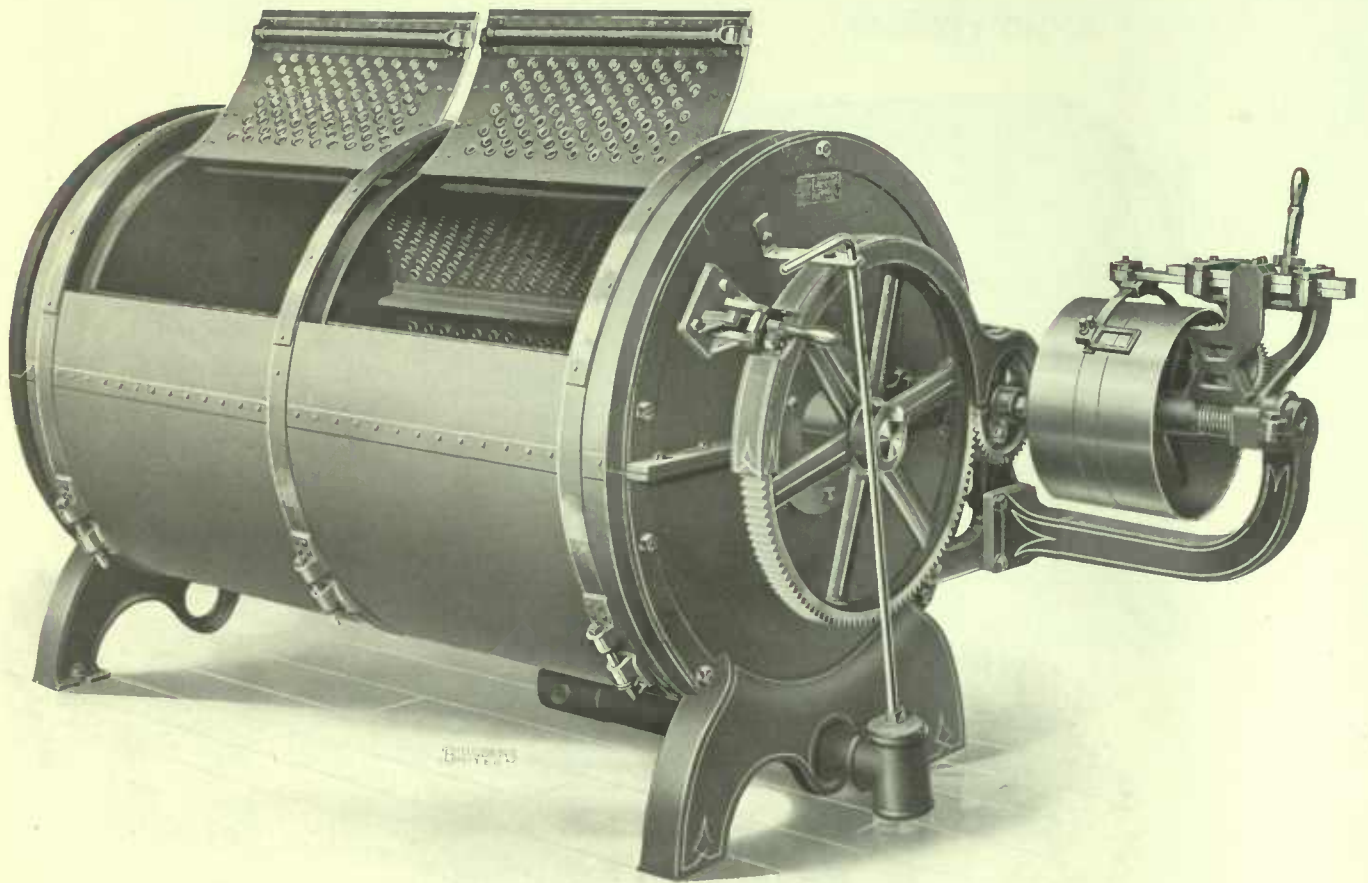

DOUBLE GEARED

SPECIFICATIONS

36 inches Diameter

Cylinder and Case	Shirts	No.	Cylinder in inches	Weight lbs.	Floor Space in inches	Pulleys inches	Face inches	Speed	Belts	
									Inside	Outside
Brass Cylinder with Galvanized Case	150	61	36 x 46 S. G.	1800	44 x 94	16	10	200	1 3/4	2 1/4
	175	62	36 x 54 S. G.	2000	44 x 102	16	10	200	1 3/4	2 1/4
	175	63	36 x 54 D. G.	2400	52 x 106	16	10	200	1 3/4	2 1/4
	200	64	36 x 62 D. G.	2700	52 x 114	16	10	200	1 3/4	2 1/4
Brass Cylinder with Wooden Case	150	65	36 x 46 S. G.	1700	46 x 94	16	10	200	1 3/4	2 1/4
	175	66	36 x 54 S. G.	1900	46 x 102	16	10	200	1 3/4	2 1/4
	175	67	36 x 54 D. G.	2300	54 x 106	16	10	200	1 3/4	2 1/4
	200	68	36 x 62 D. G.	2600	54 x 114	16	10	200	1 3/4	2 1/4

For general description of Metallic Washers, see pages 30 and 31.

Toronto Metallic Washers

36 Inches Diameter.

Galvanized Outer Case Brass Cylinder.

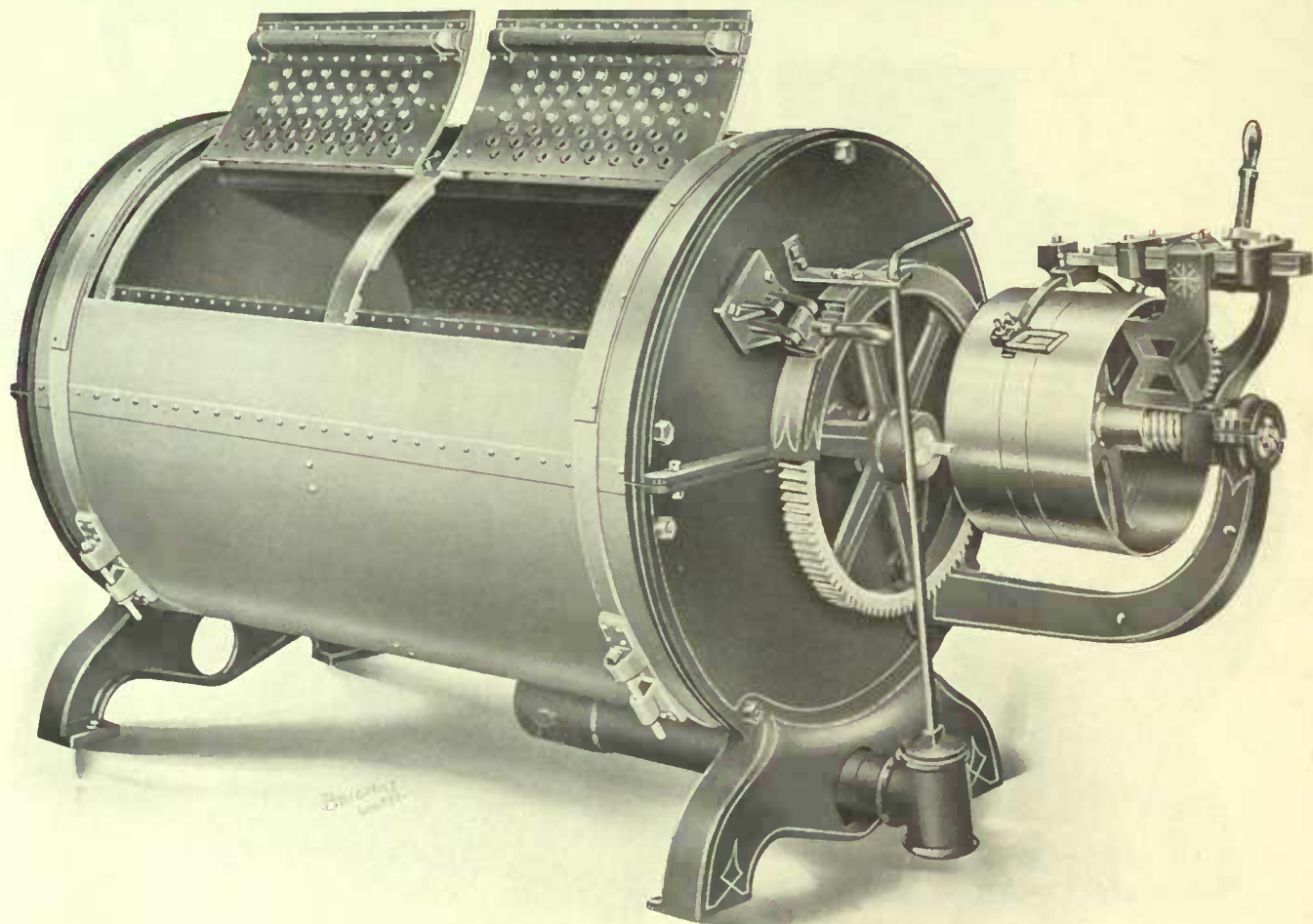

SINGLE GEARED

SPECIFICATIONS											
36 inches Diameter											
Cylinder and Case	Shirts	No.	Cylinder in inches	Weight lbs.	Floor Space inches	Pulleys inches	Face inches	Speed	Belts		
									Inside	Outside	
Brass Cylinder with Brass Case	150	69	36 × 46 S. G.	1800	44 × 94	16	10	200	1 3/4	2 1/4	
	175	70	36 × 54 S. G.	2000	44 × 102	16	10	200	1 3/4	2 1/4	
	175	71	36 × 54 D. G.	2400	52 × 106	16	10	200	1 3/4	2 1/4	
	200	72	36 × 62 D. G.	2700	52 × 114	16	10	200	1 3/4	2 1/4	
36 inches Diameter, Sterilizer Washer											
Brass Cylinder with Galvanized Case	150	73	36 × 46 S. G.	2000	44 × 98	16	10	200	1 3/4	2 1/4	
	175	74	36 × 54 S. G.	2200	44 × 104	16	10	200	1 3/4	2 1/4	
	175	75	36 × 54 D. G.	2600	52 × 108	16	10	200	1 3/4	2 1/4	
	200	76	36 × 62 D. G.	2900	52 × 116	16	10	200	1 3/4	2 1/4	

For general description of Metallic Washers, see pages 30 and 31.



THE TORONTO LINE

Toronto Elevated Movement Metallic Washers

36 Inches Diameter. Galvanized Outer Case.
Brass Cylinders.

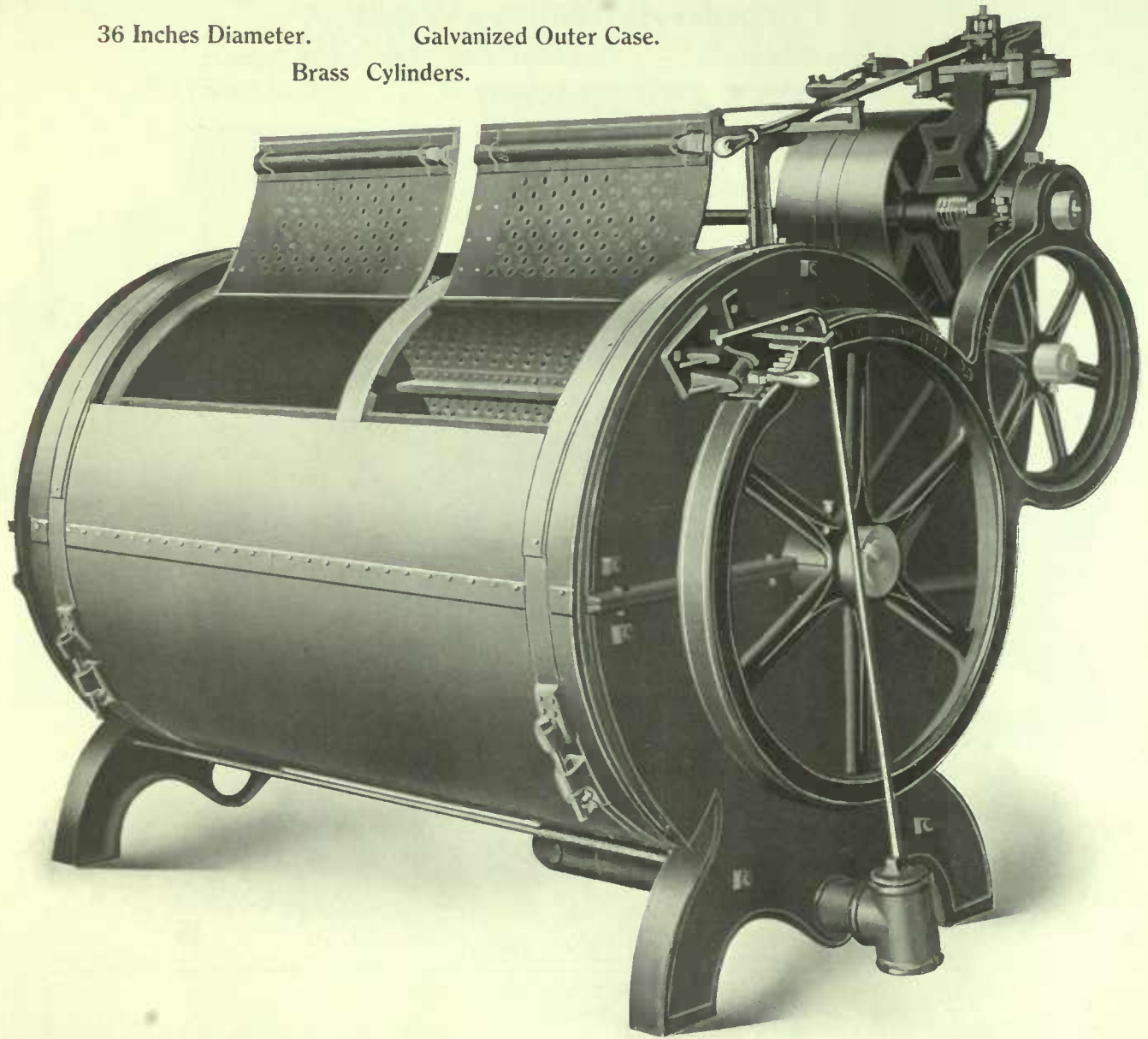

DOUBLE GEARED ONLY

SPECIFICATIONS

Cylinder and Case	Shirts	No.	Cylinder in inches	Weight lbs.	Floor Space inches	Pulleys		Speed	Belts	
						Diam.	Face		Inside	Outside
Brass Cylinder	150	107	36 x 46	2300	54 x 76	16	10	200	1 3/4	2 1/4
Galvanized Outer Case	170	108	36 x 54	2600	54 x 84	16	10	200	1 3/4	2 1/4
	200	109	36 x 62	2900	54 x 92	16	10	200	1 3/4	2 1/4

For General Description of Metallic Washers, see pages 30 and 31.



THE TORONTO LINE

Details of Cement Washroom Trench

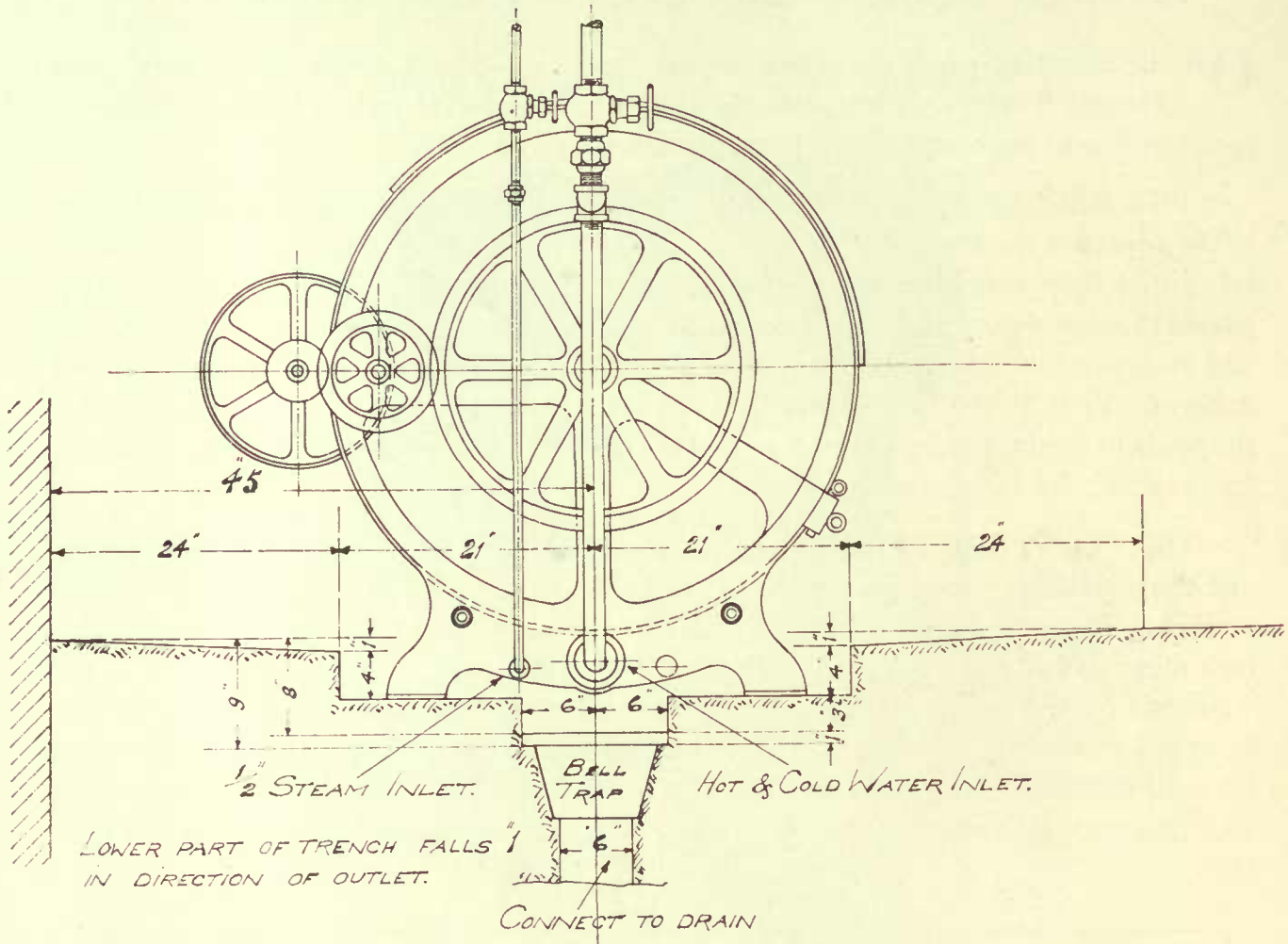

THE above illustration shows our Standard Washroom Trench, which we have used in a great many installations. The center of the trench should be 45 inches from the wall to allow easy access to the rear of the machines for oiling, etc. The full depth of the trench at the drain should be nine inches below the finished level of the floor. The floor starting at a point 24 inches from the main trench should drop 1 inch in 24 inches, both back and front, then 4 inches to where the feet of the washers rest, and then the final drop of 3 inches at the ends of the bottom trench, which should have a further drop of 1 inch from the ends towards the drain. The fall of 1 inch at the front and back of the washers takes care of any overflow or splashing and carries it back to the trench. Where it is not possible to get the full 9 inches drop, the two main trenches may be made shallower, but if this is done then the width of the lower trench should be made greater to give the same area. We shall be pleased to mail a blue print of this trench upon request.



Toronto Fancy Goods and Flannel Washers

ON the following pages are shown several types of The Toronto Fancy Goods and Flannel Washers. These are only a few of the different styles of this machine, the specifications of the complete line being given on page 42.

THE RESULTS OBTAINED in the washing of Flannels, by hand or otherwise, up to the advent of the Flannel Washer, were at the best very indifferent, the great difficulty being that they were always subjected to a certain amount of pounding, and were often passed through waters of different temperatures during the several stages of washing, and even passable results were only obtained by entrusting this work to experienced workers. THE TORONTO FLANNEL WASHER is so designed that it is impossible for the goods to receive the least pounding and the water may be maintained at any degree of temperature, for the entire washing.

TEMPERATURE REGULATION. To obtain the water at a stated temperature and to maintain the same during the entire wash we have placed upon the machine the overhead tank, fitted with a heavy Special Thermometer, two 1-inch overflow pipes, 1½-inch cold and hot water inlets, ¾-inch steam pipe, and the outlet from the tank to the washer is fitted complete with 2½-inch pipe with controlling valve as shown at the left hand end of machines. The water should be maintained at 90 degrees Fahrenheit during the entire process. The overhead tank may be filled as often as necessary to complete the wash, and care should be taken that the water is brought up to the same temperature each time.

SPECIFICATIONS								
Shirts	No.	Cylinder inches	Diameter of Pulleys inches	Floor Space inches	Speed	Weight lbs.	Belts	
							Inside	Outside
125	110	36 × 50 D. G.	16	54 x 100	180	2100	1¾	2¼
125	78	36 × 50 D. G.	16	54 x 100	180	2700	1¾	2¼
125	79	36 × 50 D. G.	16	54 x 100	180	2600	1¾	2¼
125	112	36 × 50 D. G.	16	54 x 100	180	2300	1¾	2¼
125	111	36 × 50 D. G.	16	54 x 100	180	2900	1¾	2¼
125	113	36 × 50 D. G.	16	54 x 80	180	2100	1¾	2¼
125	114	36 × 50 D. G.	16	54 x 80	180	2300	1¾	2¼
125	115	36 × 50 D. G.	16	54 x 80	180	2200	1¾	2¼



THE TORONTO LINE

Toronto Fancy Goods and Flannel Washer

36 Inches Diameter.

50 Inches Long.

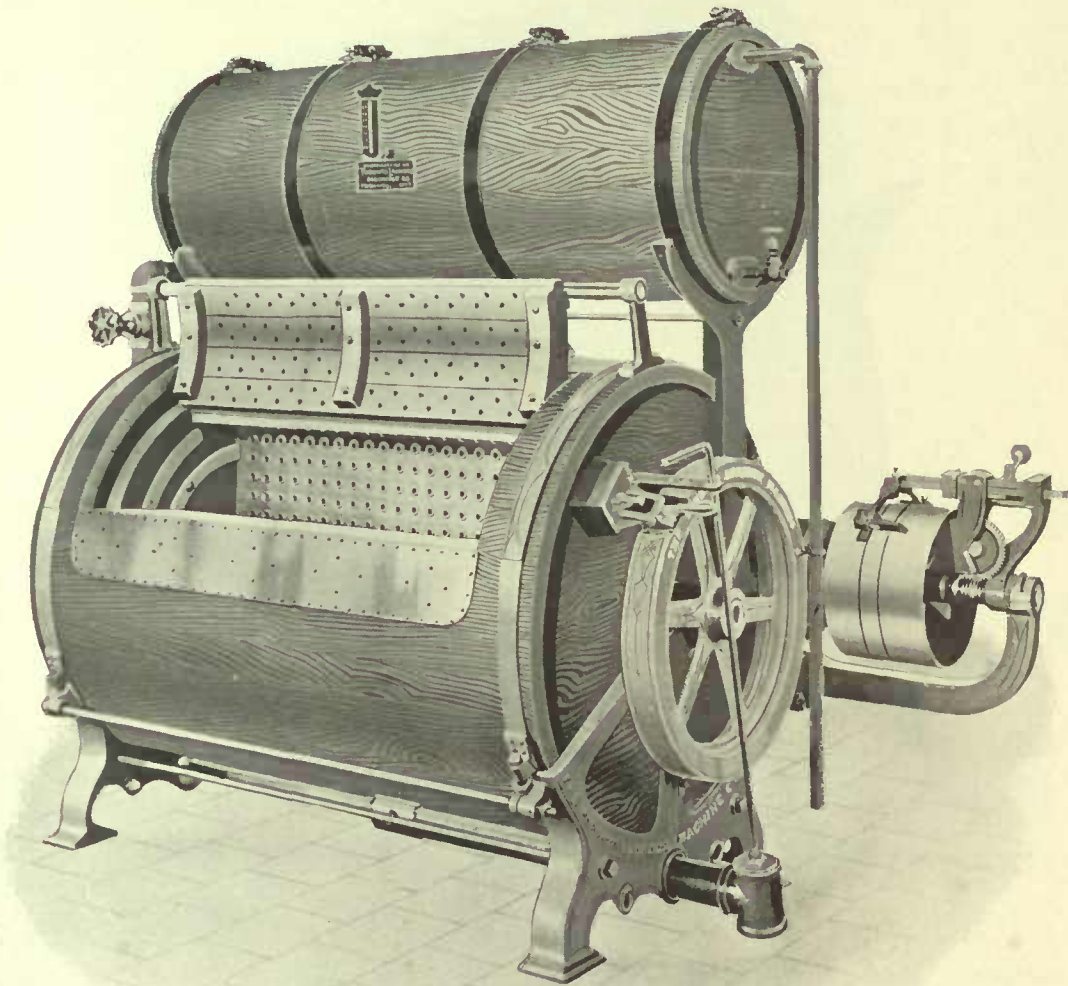

Wooden Outer Case and Cylinder with Overhead Tank
End Movement No. 78



Cylinder For Toronto Fancy Goods and Flannel Washer

With Brass Partitions

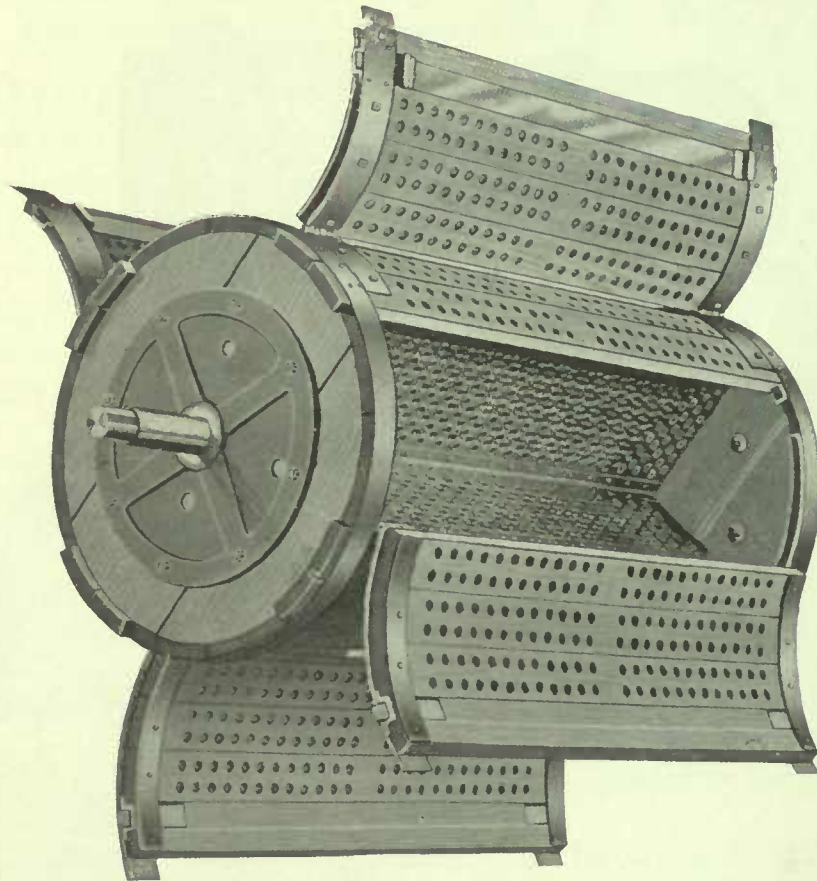

THE CYLINDER, whether of all Brass, or Wood with Brass Partitions, is divided lengthwise into quarters, by two sheets of Hard Brass, No. 8 guage, placed at right angles to each other and extending across the diameter of the cylinder. The Brass Division Plates are punched and embossed upon both sides and a perfectly smooth surface is presented to the goods in each compartment. **FOUR DOORS** are provided (one for each compartment), the full length of the machine, and the goods are really held stationary, in each pocket, the motion of the cylinder merely sousing them backwards and forwards through the water, the numerous holes allowing the water to pass freely through the goods.



THE TORONTO LINE

Toronto Fancy Goods and Flannel Washer

36 Inches Diameter.

50 Inches Long.

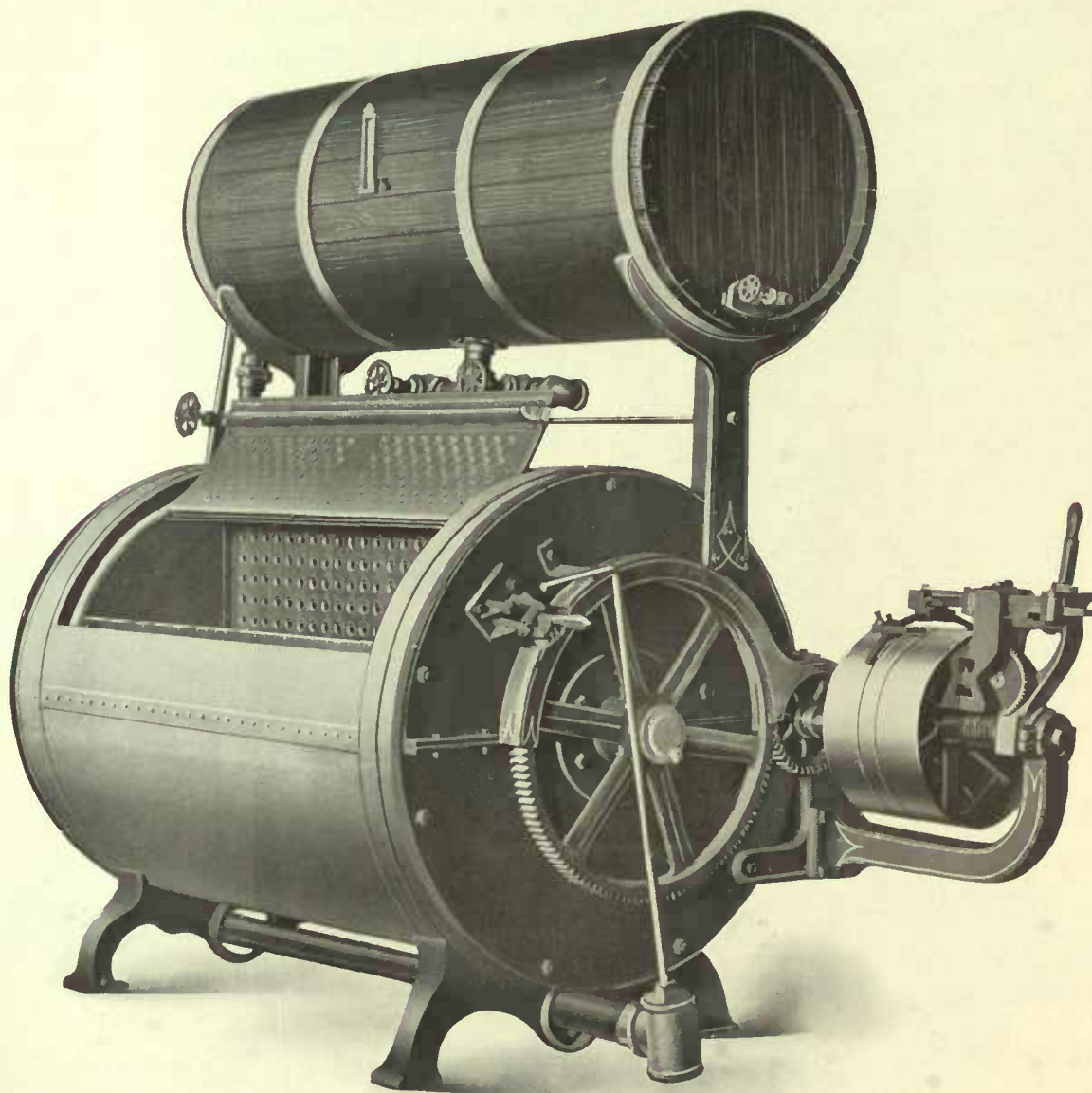

Brass Cylinder.

Galvanized Outer Case.

Overhead Wooden Tank.

End Movement No. 111.



Toronto Fancy Goods and Flannel Washer

FANCY GOODS. This machine has revolutionized the washing of Fancy Goods, as delicate articles such as Ladies' Blouses, Lace Curtains, Handkerchiefs and Fine Fabrics in fact any articles which require very careful handling, may be washed in this machine without a possible chance of injury. The use of nets in which these articles are often placed is entirely done away with, and strings attached to ladies' blouses and aprons need no special attention, as they come from the machine as freely as when first placed therein. The saving in nets alone will pay for the machine in a very short time.

To meet the many requirements we have made this machine in several combinations, as described in the following list, one of which machines being suitable for almost any special requirement:—

No. 110—Wooden Machine without Overhead Tank. End movement.

No. 78—Wooden Machine with Overhead Tank. End movement.

No. 79—Wooden Machine with Overhead Tank, All Brass Cylinder and end movement.

No. 112—Galvanized Iron Outer Case, All Brass Cylinder, without Overhead Tank. End movement.

No. 111—Galvanized Iron Outer Case, All Brass Cylinder, with Overhead Tank. End movement.

No. 113—Wooden Machine, without Overhead Tank. Elevated movement.

No. 114—Galvanized Iron Outer Case, All Brass Cylinder, without Overhead Tank. Elevated movement.

No. 115—Galvanized Iron Outer Case, Wooden Cylinder, without Overhead Tank. Elevated movement.

In Laundries where it is possible to obtain the water at the proper temperature without the use of the Overhead Tank, any of the above machines without the tanks would be suitable. In the case of the Elevated Movement Machines it is not possible to attach the Overhead Tank, and if any of these machines are to be used solely for fancy goods they would not require to be fitted with the tank.



Toronto Fancy Goods and Flannel Washer

36 Inches Diameter.

50 Inches Long.

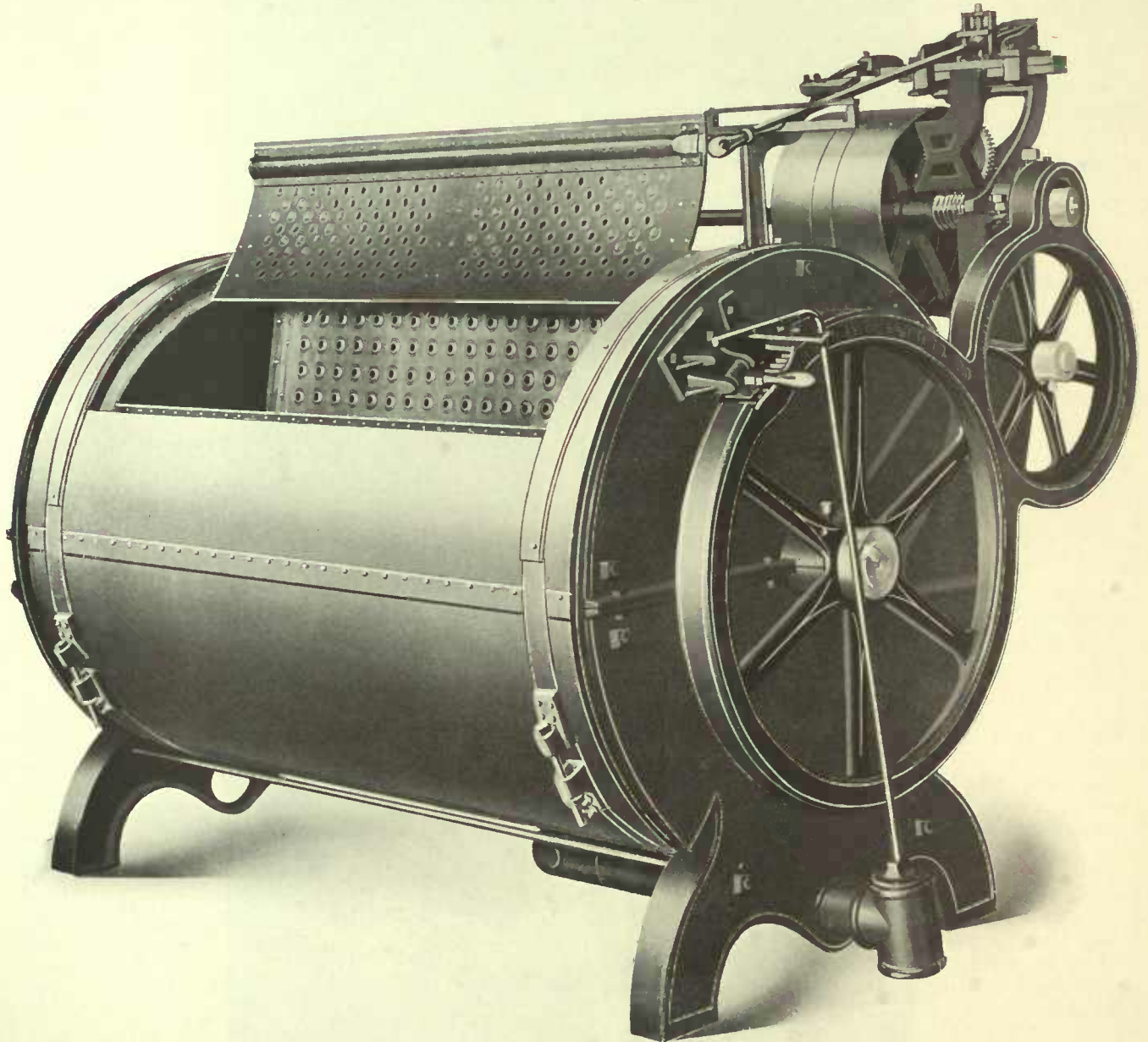

Brass Cylinder.

Galvanized Iron Case.

Elevated Movement.

No. 114.

The Electrolyzer

A Machine for Making Bleach

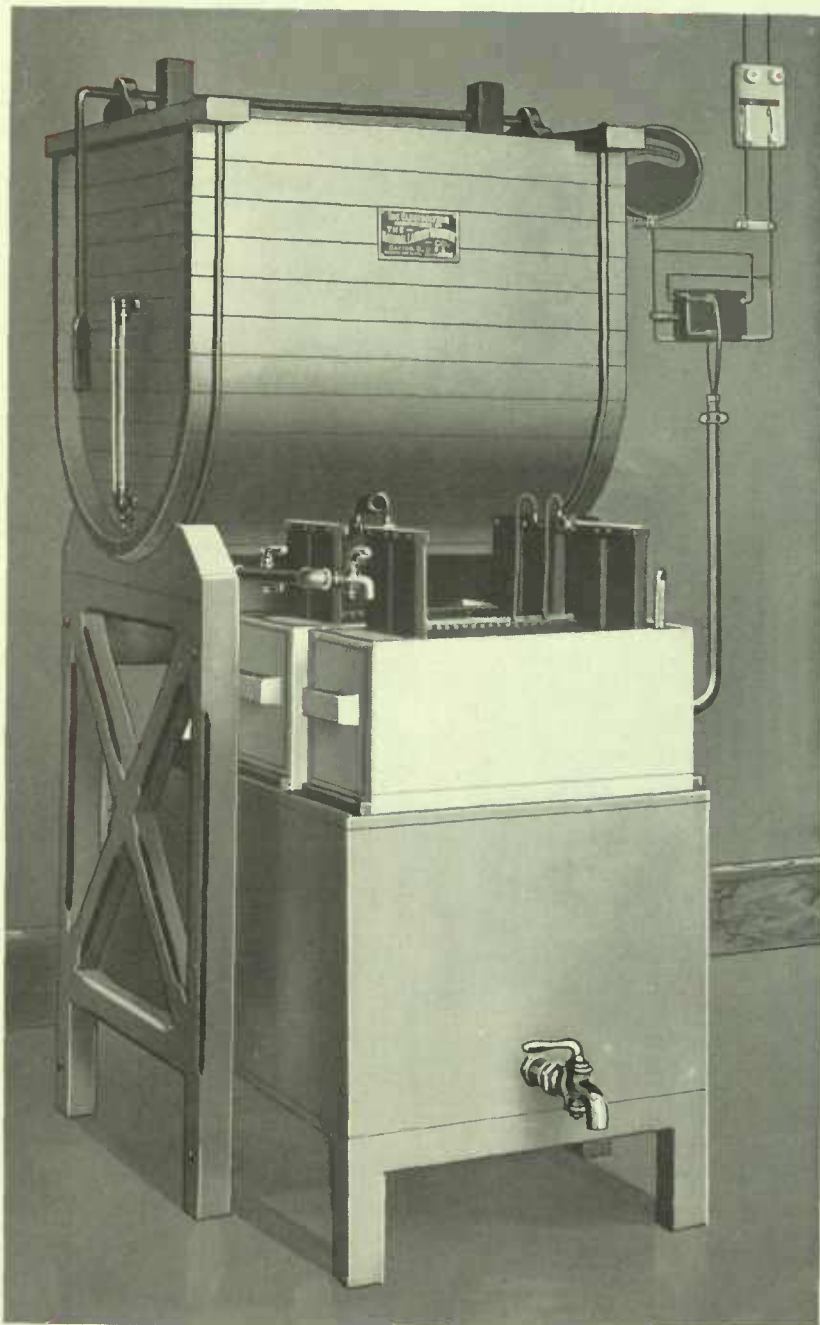

The above is a photographic reproduction of the Electrolyzer, a machine which produces the least injurious bleaching liquor, and at the lowest cost, from ordinary salt water by means of an electrical current. It is being used most successfully in about one hundred of the best laundries in the United States, and by thousands in Europe.



Why Buy an Electrolyzer?

1. Harmlessness to clothes.
2. Reduction in the use of oxalic acid.
3. Low cost of production of bleach.
4. Uniformity of strength of the bleach.
5. Cleanliness in operation.
6. Small space required.
7. Sewers kept clean, never clogging with organic matter.
8. Surplus bleaching liquor can be sold for disinfectant purposes at a profit.
9. Advantages derived by advertising to your customers the elimination of dangerous elements used, such as chloride of lime.
10. Initial cost low, and cost of maintenance will not exceed what you often pay out for broken jars and carboys.
11. Users of our machine are instructed how to determine the presence of acid or alkali in goods after going through the laundry process.
12. Neutrality of the bleaching liquor produced.

Saving of Linen

Paramount Among the Reasons for Installing an Electrolyzer is that of Saving Customers' Linen

In comparing electrolytic solution of Sodium Hypochlorite (the bleaching liquor produced by the Electrolyzer) and Calcium Hypochlorite (the bleaching liquor produced by Chloride of Lime), the most striking feature is that the bleaching action of one gram of chlorine in the former is equal in intensity to 1.52 to 2 grams of chlorine in the latter; that lower temperatures may be used, and that the action is much more rapid for cold solutions. The chlorine atom in the electrolytically prepared Sodium Hypochlorite is less stable in the presence of organic matter, and acting with a greater rapidity involves less loss to the fibres than with more stable substances. The Electrolytic bleach is therefore more powerful in its action than solutions of bleaching powder of the same chlorine strength, and has a more efficient action with a less injurious effect on the fibre.

The Sodium Salts are more soluble than the Calcium Salts, and hence less rinsing is required to extract the Sodium Hypochlorite than in the case of the corresponding calcium compound.

We enable every one of our customers to readily determine the presence of acid or alkali in their finished product. This alone should be ample justification for buying one of our machines.

We can bleach at a lower temperature with Electrolytic bleach than with Chloride of Lime, because the common bleaching agent is liberated more easily; consequently steam is saved as well as the customers' linen. The lower the temperature of the water in which the bleaching is done, the better for the goods bleached.

We are now prepared to quote prices on generators, and can assure lowest possible prices thereon. If interested in placing in your laundry electrical equipment, write us for information.

Hospitals, hotels and all public institutions have a double use for electrolyzers. Our machine can be used not only to produce bleaching liquor for use in the laundry, but the most effective disinfectant known to chemistry is found in the chlorine as produced by the Electrolyzer. When Sodium Hypochlorite is used to flush out drain pipes in large buildings, no clogging is encountered.

In Europe municipalities own and operate plants to produce chlorine electrolytically, same being used to sprinkle streets to guard against disease.

Our machine has been recommended for use to a municipality by a prominent chemist to produce disinfectant for its fifteen schoolhouses.

DETERMINE THE PRESENCE OF ACIDS OR ALKALI

Every launderer knows that the heat of the dry-house on improperly rinsed goods is more destructive than anything else; if the launderer could always be present at every rinsing process to see that there were no traces of acid or alkali, everything would go along swimmingly; but, unfortunately, busy laundrymen cannot do that. Oxalic acid, undoubtedly, is one of the most dangerous elements, if improperly handled, that a laundryman has to deal with. The less used, the less danger, and certainly less can be used in a neutral bleach like ours than in a bleach where you have an excess of alkali, as in a chloride of lime bleach.

This machine marks one of the greatest advances yet made in the laundry business, and in order to instal it you do not have to displace any other machine for which you have paid a big price.



THE TORONTO LINE

Toronto Improved Extractor

Countershaft Attached or Detached.

Solid Curb.

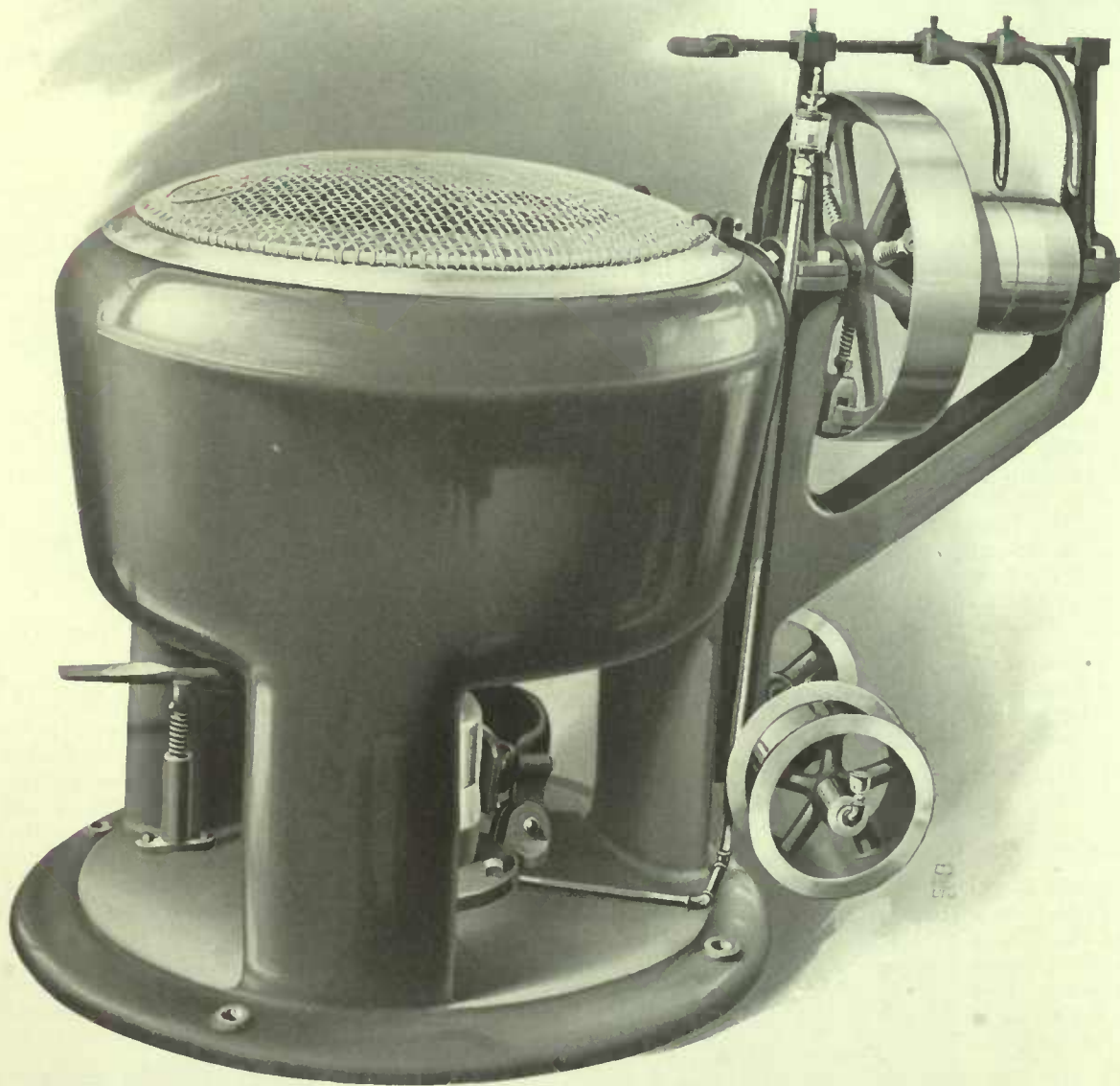

20 and 26 Inch with Countershaft Attached



Toronto Improved Extractor

Countershaft, Attached or Detached.

Solid Curb.

TORONTO Extractors present cardinal points of excellence that cannot be too strongly emphasized. In each type they possess the strength to withstand the demands of both speed and load. They are well proportioned, mechanically, perfect and symmetrically designed, and by reason of their easy running qualities, and freedom from vibration have demonstrated their ability to save both power and labor.

The Toronto Improved Extractor with detachable sub base as shown on the opposite page, stands for all that is good since the invention of the centrifugal extractor for the extraction of water from clothes. Embodying as it does the convenience of operation (being the lowest under driven extractor on the market), and other original features mentioned below.

The outer shell legs and base are all cast in one piece, but with the sub-base that holds the rubbers and spindle bearing, detachable.

The cast steel spindle is hollow and the oil from the sight feed oiler enters the oil well in the sub base and flows up through this hollow spindle and out through small radiating holes to lubricate the bronze bearing.

As an aid to cleanliness we are supplying this machine fitted with a polished, spun copper top. No. 4—Rubber Springs are used on these machines. See page 59.

SPECIFICATIONS								
	No.	Basket inches	Speed of Counters	Diameter of Pulleys inches	Face of Pulleys inches	Belts inches	Floor Space inches	Weight lbs.
Countershaft attached	170	20	500	8	8	3½	30 x 54	800
Countershaft detached	171	20	500	8	8	3½	30 x 30	800
Countershaft attached	181	26	450	8	8	3½	36 x 60	1300
Countershaft detached	182	26	450	8	8	3½	36 x 36	1300

DIRECT CONNECTED MOTOR DRIVEN

No. 176—20 inch Basket. Motor 1 H. P.

No. 177—26 inch Basket. Motor 2 H. P.



THE TORONTO LINE

Toronto Improved Extractor

Angle Countershaft Attached.

Solid Curb.

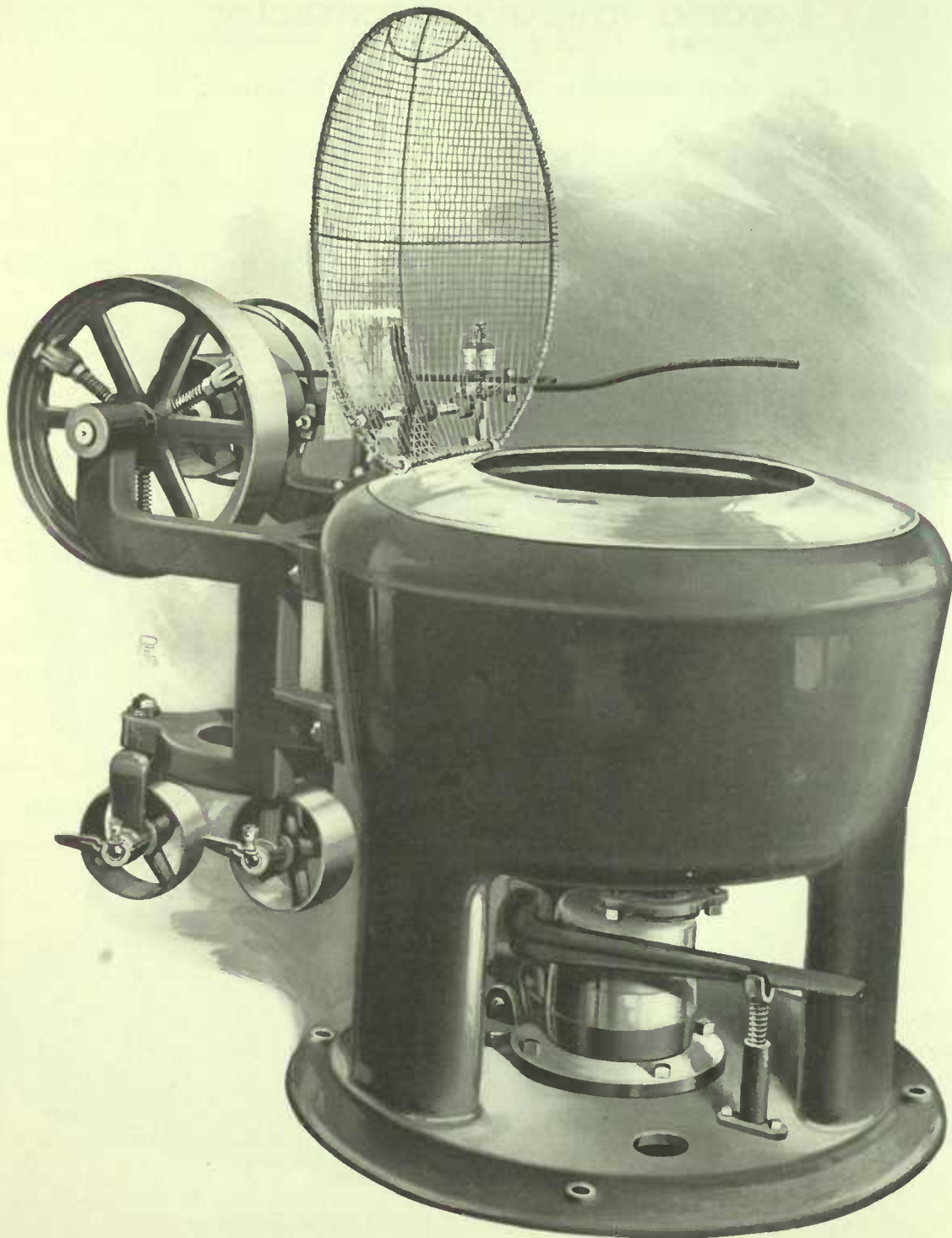

26 Inch With Angle Countershaft Attached. No. 172



Toronto Improved Extractor

Angle Countershaft Attached. Solid Curb.

THE main advantage of the Angle Countershaft over the regular kind is that it may be placed directly under the line shaft and the space that it occupies in the trench or between two washers is only 36 inches wide against 60 inches that the regular Countershaft Attached Machine occupies. The Friction Pulley shown in the different illustrations is now part of the regular equipment of every extractor which leaves our factory.

Safety Covers

The safety covers shown upon several of the extractors herein illustrated are not included in the regular equipment of these machines, and will not be shipped attached to the machines unless specially ordered.

These covers will fit almost any machine, and we are prepared to furnish the covers separately. They are automatic in their action, as the cover has to be down to start the machine, and the lever operating the belt must be shoved over to the loose pulley before the cover will remain in an upright position. The covers are made either of galvanized iron or entirely of brass. No. 4—Rubber Springs are used in this machine. See page 59.

SPECIFICATIONS							
No.	Basket inches	Speed of Counter	Pulleys inches		Belts in inches	Floor Space inches	Weight lbs.
			Diam.	Face			
172	26	450	8	8	3½	36 x 60	1300

Toronto Solid Curb Extractor

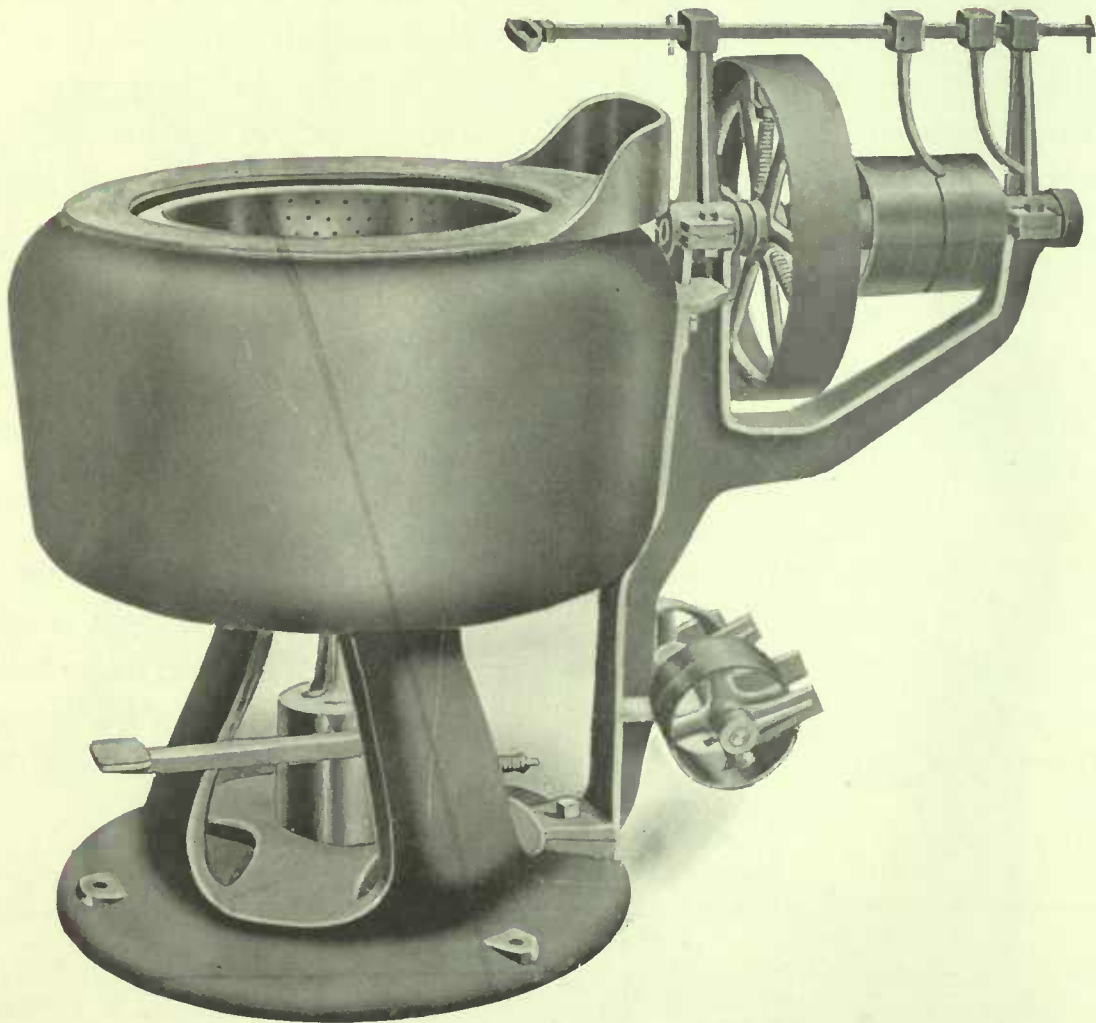

26 Inch Countershaft Attached. No. 173

Toronto Solid Curb Extractor

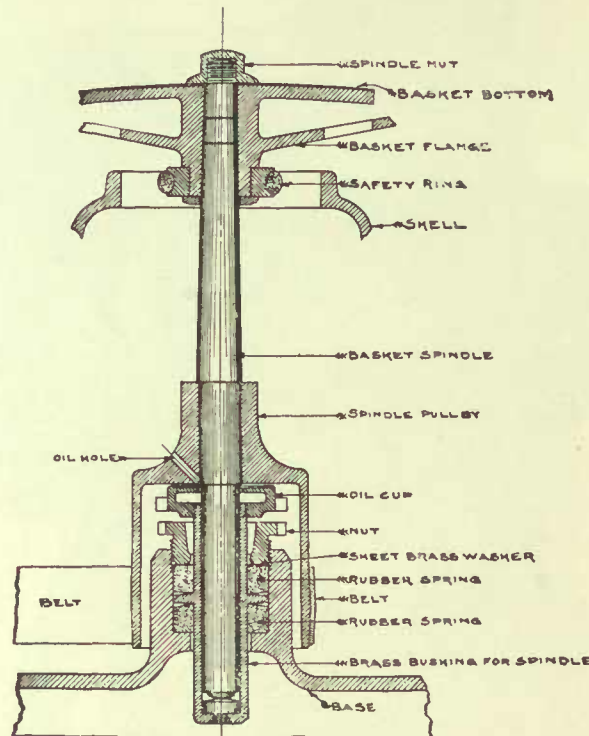

Sectional View through Spindle

A GREAT many laundrymen prefer a solid Curb Extractor, and to supply this demand we have added the machine as shown on the opposite page. In this machine the shell, legs and bearing base are cast all in one solid piece, with the same careful attention given to all the working parts that is exercised in the construction of our improved machines, as shown on pages 46, 47, 48 and 49.

This machine is made with three styles of countershafts, attached, detached, or angle, and we can supply either the Improved or Solid Curb, with motor direct attached.

SPECIFICATIONS								
	No.	Basket inches	Speed of Countershaft	Diameter of Pulleys inches	Face of Pulleys inches	Belt inches	Floor Space inches	Weight lbs.
Countershaft attached	123	26	400	7½	6	3	36 x 60	1300
Countershaft detached	216	26	400	7½	6	3	36 x 36	1300
Countershaft angle	174	26	400	7½	6	3	36 x 60	1300
Motor driven	175	26	3	36 x 60	1400

No. 2.—Rubber Springs are used in these machines. See page 59.

Toronto Solid Curb Extractor

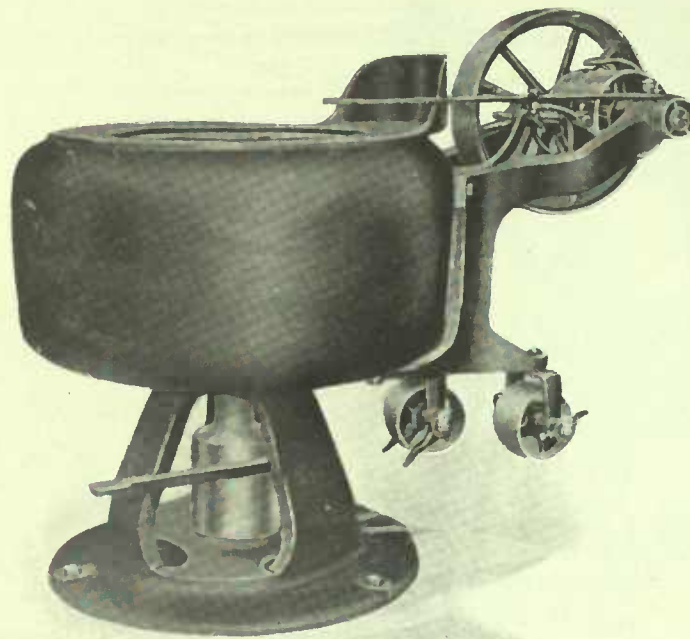

26 INCHES WITH ANGLE COUNTERSHAFT

No. 174

THIS allows of the machine being placed between two washers, and belted direct from line shaft without wasting any space and also allows of loading and unloading from the front of the machine. The specifications of 26-inch Counter Attached Machine cover this Extractor. See page 51. Floor space, 3 feet x 5 feet.

THE INSIDE

The steel spindle supporting the basket runs in a solid bronze bushing on a tool steel bearing. This bushing is held in place in the bearing base by two rubber springs and securely fastened there by means of a lock nut. These springs allow necessary oscillation of the basket and at the same time relieve the shell of all vibration. Directly underneath the basket the spindle is surrounded by our patent rubber safety ring which does away with any possibility of the basket striking when carelessly loaded. Result—safe, satisfactory service. No. 2—Rubber Springs are used in this machine. See page 59.



Toronto Motor Driven Extractor



Toronto Solid Curb Extractor

Vertical Motor Attached. No. 175

WE are prepared to furnish any of the different type of TORONTO EXTRACTORS with direct connected motors as shown above. The Motor for the 26-inch Extractor being two H. P., and for the 20-inch Extractor the Motor is 1 H. P. Each machine being equipped with a two pole knife switch and a one minute starting box.

When ordering kindly give the voltage and state whether you are using direct or alternating current. If direct give exact voltage, as 110 or 220 volts if alternating, advise us as to whether single, two or three phase and the number of cycles, together with the voltage. No. 2—Rubber Springs are used in this machine. See page 59.



THE TORONTO LINE

Sectional View Solid Curb Extractor

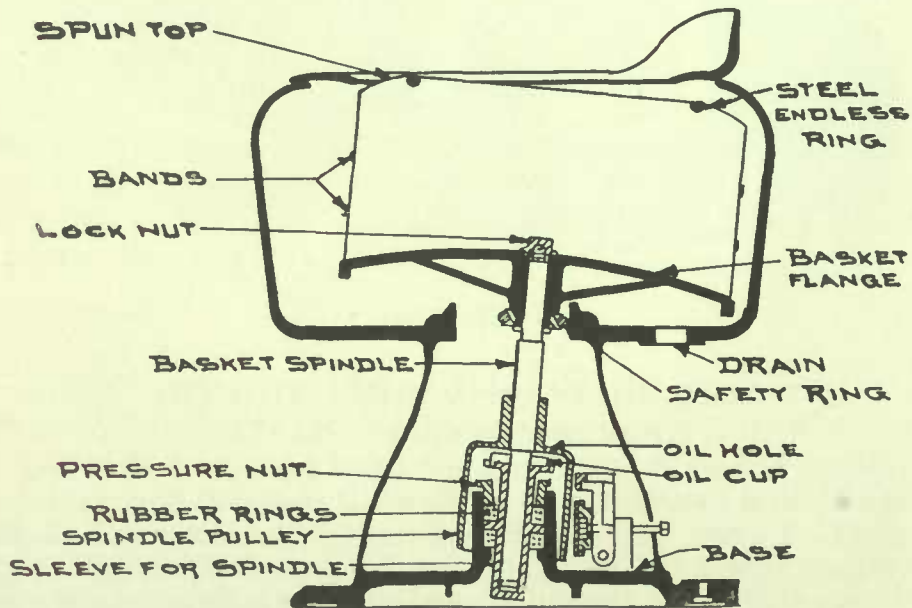
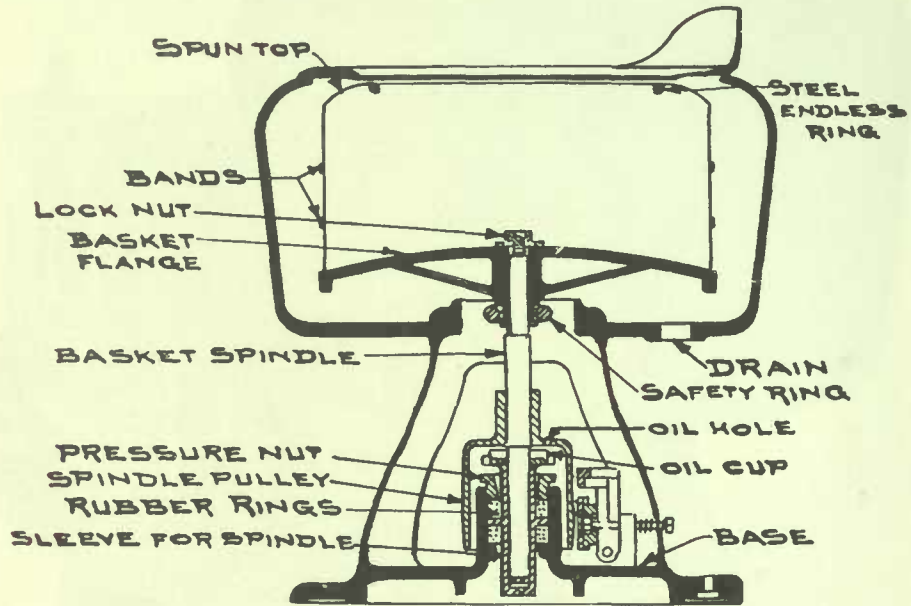

Hand Extractor



No. 178

THE shell is made of double galvanized steel reinforced at the top and bottom with heavy cast iron rings securely bolted together. The basket is made of either perforated galvanized steel, or perforated tinned copper. It is held at the top by a heavy cast, galvanized curb, and at the bottom by a substantial spider revolving on a hardened center, in a suitable socket. The bearings of the two shafts are of the adjustable bicycle ball bearing principle, insuring easy running with the least effort, and we believe this machine to be the easiest running hand extractor in the world. We sell many of these extractors to dyers and cleaners, and for naphtha cleaning they are absolutely necessary.

While this machine is not intended to be run by power, we can supply tight and loose pulleys for belt drive if required.

Shipping Weight, 250 lbs.



THE TORONTO LINE

Toronto Starch Extractor

No. 179

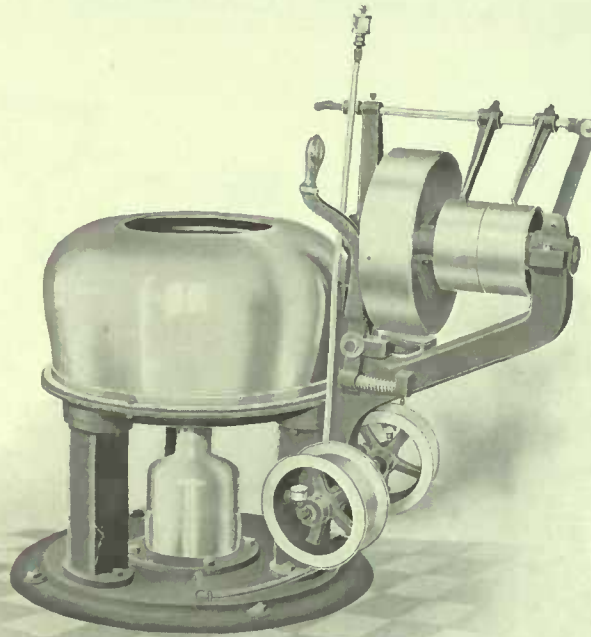

THIS machine is the result of the demand for an Extractor to run at a high rate of speed and for more than the usual length of time, to extract the starch from ladies' clothes when they are to be ironed direct from the Extractor. The machine may also be effectively used for collars and cuffs, and also for the removal of surplus starch from dipped work. The distinguishing characteristic of this machine is that the outer shell is removable, and it is only a minute's work to remove the cover and the machine may be readily cleaned. No. 4—Rubber Springs are used in this machine. See page 59.

SPECIFICATIONS						
	No.	Floor Space inches	Weight lbs.	Size of Pulley on Counter inches	Speed R. P. M.	Belt inches
20 inch Attached Countershaft	179	27 x 43	1000	8 x 3	450	3
20 inch Detached Countershaft	180	27 x 36	950	8 x 3	450	3

DIRECT CONNECTED MOTOR DRIVEN

No. 183—20 inch Basket.

Motor, 1 H. P.



Extractor Instructions

General Instructions on How to Load and Operate Successfully Centrifugal Extractors

HOW TO LOAD AN EXTRACTOR

In loading extractors with flat work, the heavy pieces, such as spreads and bath towels, should, whenever possible, be placed at the bottom of the basket and wound around uniformly. Place the goods in the basket in bunches and pack fairly tight. See that the ends of one bunch are entirely in the basket; that is do not have loose ends hanging out to become entangled with the next bunch. Move the basket around and press the linen against the sides.

By loading in this way you will not have the pieces "crossed" and will avoid having the linen tear or split, as the extractor gains speed. By crossed pieces is meant where the ends of a sheet or cloth is fastened by the weight of the load in opposite sides of the basket and as the goods are forced back by the centrifugal force, the piece is stretched as tight as a drum head, and often splits with a loud report.

Load the extractor flush with the top of the shell and no fuller. Be careful to have no loose ends hanging out.

CAUTION:—Never hold your hand on the extractor while the basket is in motion.

The steel spindle supporting the basket, runs in a solid bronze bushing on a tool steel bearing. This bushing is held in place in the bearing base by two rubber springs and securely fastened there by means of a lock nut.

These springs allow necessary oscillation of the basket, and at the same time relieve the shell of all vibration. Directly underneath the basket the spindle is surrounded by our patent rubber safety ring which does away with any possibility of the basket striking when improperly loaded.

Practically the only wearable part of our extractor is the rubber controlling spring.

Should these springs become soft after some use, there will be too much oscillation and the basket will not run smoothly.

The basket should (at all times) be kept just steady enough to prevent the safety ring from striking, for it does continually strike during operation it is apt to bend the spindle and throw the basket out of balance.

You can easily ascertain if the springs are too loose by moving the top of the basket from side to side.

TO TIGHTEN THE SPRINGS

Screw down the nut directly over these springs—so as to keep them at the same tension as when you first started. To do this

1. Unscrew and remove water guard from top of shell.
2. Lift out basket, spindle, and spindle pulley, by simply raising up basket.

This brings the lock nut (below) and the oil cup (above) into view and reach.

The nut may then be tightened to suit with the wrench we furnish with each extractor.

The oil cup should be left about one-half inch above and away from the lock nut.

TO CHANGE SPRINGS

Should the springs entirely loose their elasticity, they should be replaced with a new set.

In this case the oil cup and the lock nut are unscrewed and the brass spindle bushing lifted out, when it will be easy to slide off the old springs and place on the new.

Do not forget to replace the sheet brass washer between the upper spring and the lock nut.

OILING

Oil the spindle bearing through the oil hole in the top of the spindle pulley or through lubricator.

ORDERING REPAIR PARTS

In ordering repair parts refer to diagram on page 51, and order parts by name.

If it is the little tool steel bearing upon which the spindle rests ask for a "Spindle Step." All other parts are marked and should be perfectly clear.

DON'T FORGET TO STATE SIZE OF EXTRACTOR AND WHETHER TORONTO IMPROVED OR TORONTO SOLID CURB TYPE

If you will follow these instructions it will facilitate the work of our shipping department, and you will receive **JUST WHAT YOU WANT** without delay.



THE TORONTO LINE

Details For Installing Toronto Extractors

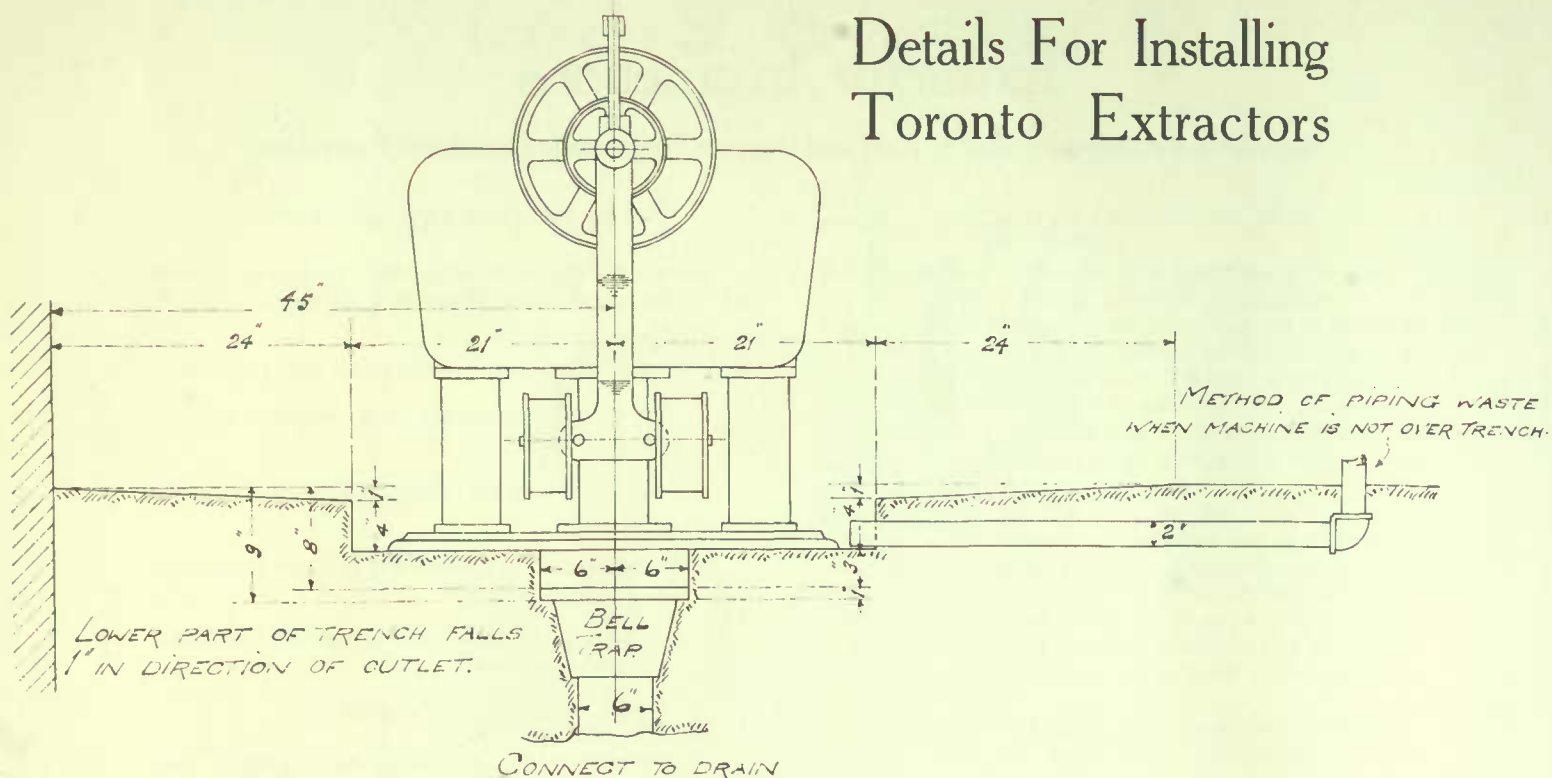

Details of Trench, Showing Extractor Located

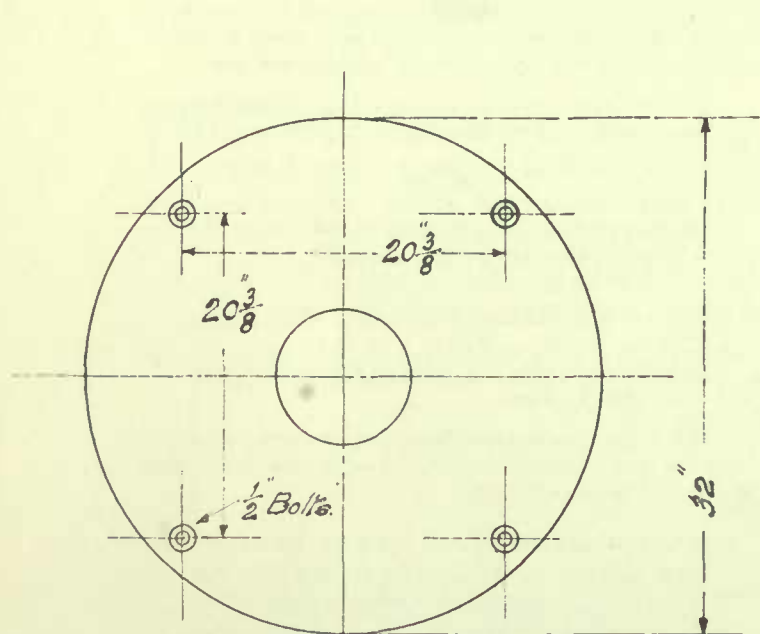

PLAN OF BOLT HOLES FOR 20" TORONTO IMPROVED EXTRACTOR.

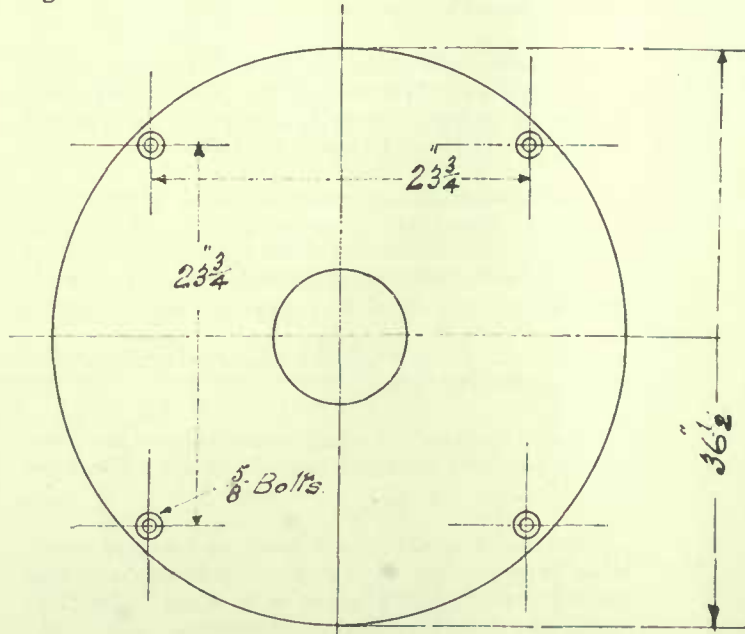

PLAN OF BOLT HOLES FOR 26" TORONTO IMPROVED EXTRACTOR.

Foundation Bolts Should Extend 3 Inches Above the Finished Level of Floor



THE TORONTO LINE

Details For Installing Toronto Extractors

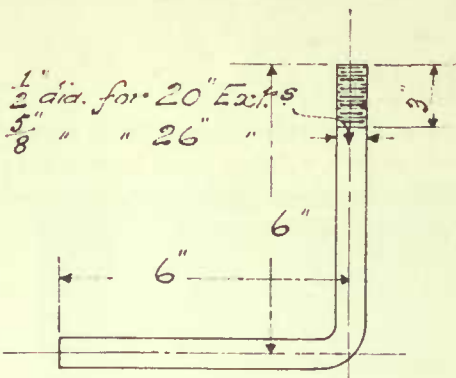

FOUNDATION BOLTS.
TOP OF BOLT TO EXTEND 3" ABOVE
FINISHED FLOOR LEVEL.

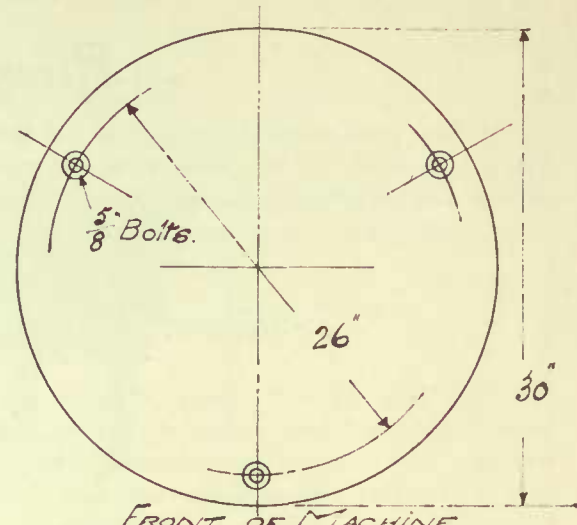

FRONT OF MACHINE.
PLAN OF BOLT HOLES FOR
26" TORONTO SOLID CURB EXTRACTOR.

Rubbers for 20" and 26" Toronto Extractors

THE TORONTO LAUNDRY MACHINE CO. TORONTO.

479

① Rubbers for old style 20" & 26" Toronto Extractors with side arm.

② Rubber Bumper Ring for all sizes of Toronto Extractors.

② Rubbers for 26" Toronto Solid Curb Extractors

③ Rubbers for 20" & 26" Toronto Improved Extractors.

④ Rubbers for 20" & 26" Toronto Improved Extractors.

Top rubber is 1 1/2" thick.
Bottom " " 1 1/4"

Notes 3 & 4 rubbers are alike excepting the diam, & old rubbers should be carefully measured in order to be sure of getting the proper size

RUBBER SPRINGS FOR TORONTO EXTRACTORS



THE TORONTO LINE

Power Wringers

If there is no power driven rubber roll Wringer attached to your stationary tubs you are losing money. The time your wash man spends wringing small articles in an extractor when a wringer could handle them quicker and better, costs money. One of these Wringers on your stationary tubs will wring in just a few seconds one or two articles which would take several minutes in the regular extractor.

“Conquerer”

The “Conquerer” Power Wringer has a heavy galvanized iron frame with steel spiral springs. The rolls can be reversed so as to place pulleys at either end complete with belt shifter. Pulleys, 12 inches diameter, 2½ inch face.

- No. 33 Rolls 17" x 3¼"
- No. 34 Rolls 20" x 3¼"
- No. 35 Rolls 24" x 3¼"
- No. 36 Rolls 30" x 3¼"
- No. 37 Rolls 36" x 3¼"

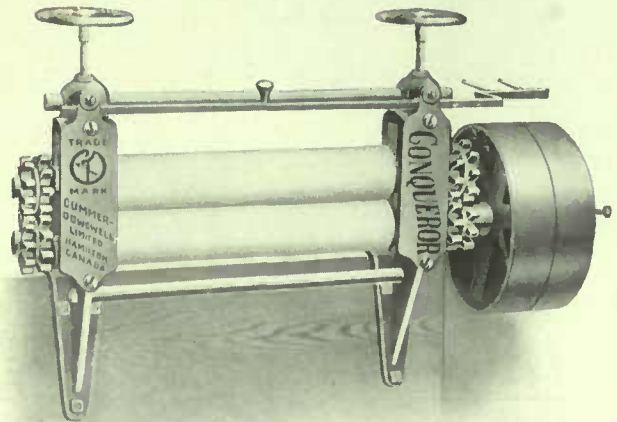

“Mogul”

Galvanized Iron Bearings
For Stationary Use only.

Especially suitable for factories, hotels, and laundries. Improved guide board. Heavy steel spring.

Special grade rolls with name branded on them. Rolls (regular size) 14 x 3¼ inches, made especially for power with tight and loose pulleys.

This Wringer is carried in stock, but we are prepared to supply the same style with rolls of any length required.

If handle is supplied in lieu of pulleys a reduction of \$3.00 is made. Each Wringer packed in strong case.

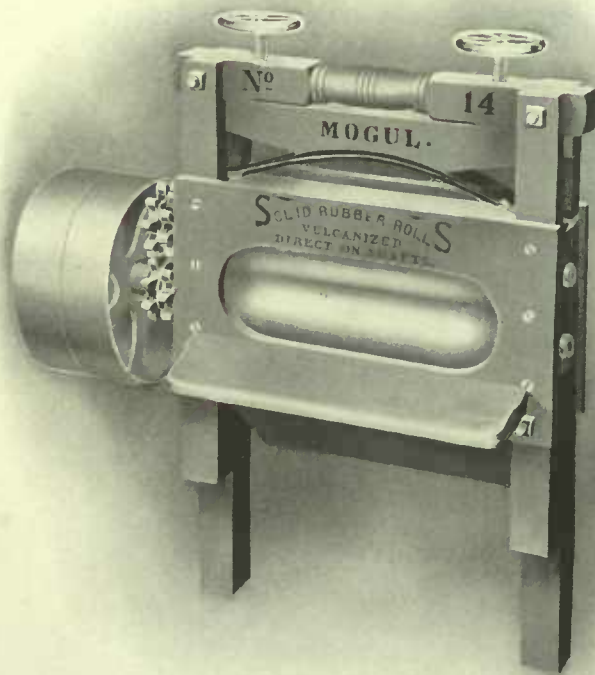

Stationary Wash Tubs

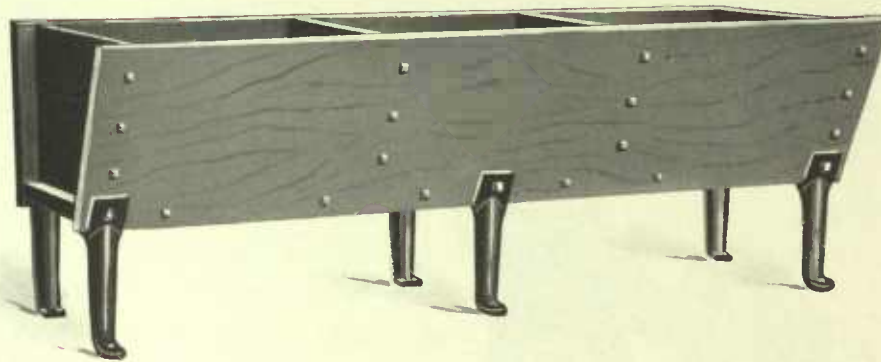

Cypress Wood Tubs

Compartments	Weight, lbs.
1	150
2	220
3	300
4	375

THESE are made of the best quality 2-inch Cypress, grooved, leaded, and put together with lag screws. Made in one, two, three and four compartments, each compartment 24 inches wide at the top, tapering to 18 inches at the bottom, 17 inches deep and 24 inches long. Special sizes to order.

Our Tubs are all fitted with brass plugs and chains, and pipe discharge ready for outside connections. Heavy pattern iron legs hold the Tubs, as shown in cut.

Alberene Stone Tubs

Compartments	Length	Width	Depth
1	24"	24"	16"
2	48"	24"	16"
3	72"	24"	16"
3	84"	24"	16"

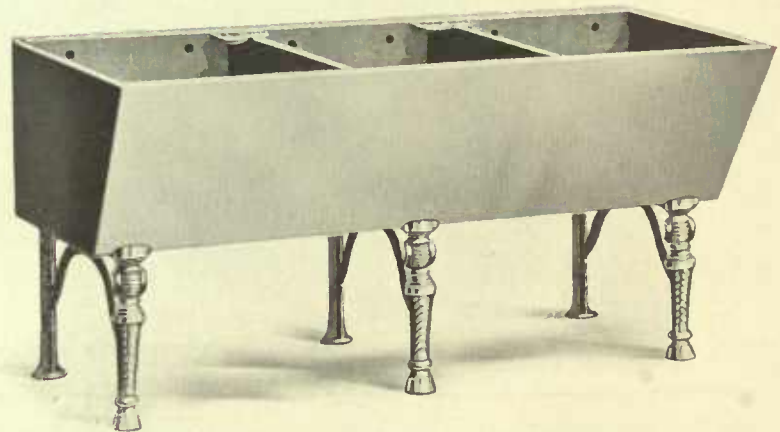

ALBERENE STONE has for years been considered superior to any QUARRIED PRODUCT suitable for purposes requiring a sanitary, non-porous and durable stone. It is gray in color, close grained, uniform in density and hardness, and wears as smooth as polished marble. Absolutely non-absorbent, it is as sweet and clean after years of use as when first installed.

On account of its sanitary excellence it is peculiarly adapted for laundry purposes.



THE TORONTO LINE

Tolhurst Self-Balancing Extractors

26, 32 and 40 inch Belt Driven, Self Balancing Hydro Extractors

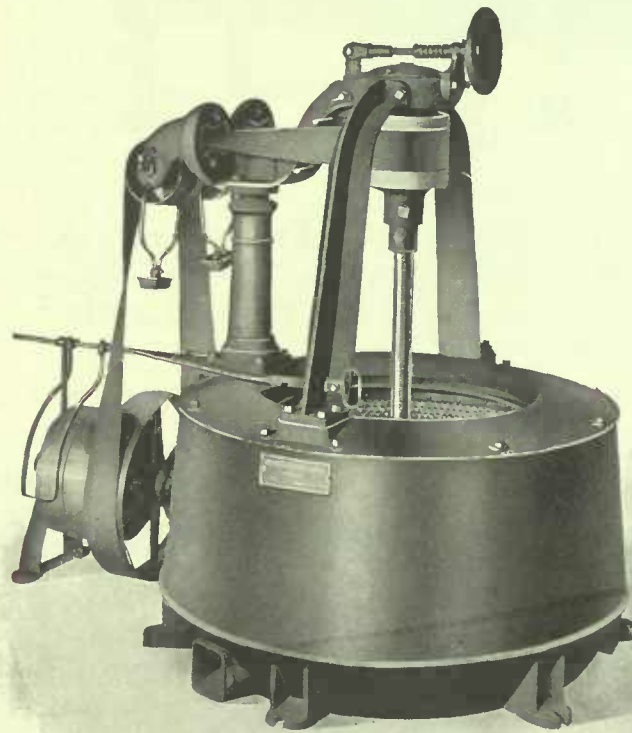

SPECIFICATIONS

No.	Size	Floor Space	Size of Belts	Pulley on Countershaft	Drive Pulleys on Countershaft	Spindle Pulleys	Weight
184	26"	3' 5" x 4' 10"	4 " and 3 "	20" x 4 "	10" x 6"	7"	1100
185	32"	3' 11" x 5' 6"	4½" and 3½"	20" x 4½"	10" x 9"	7"	1700
186	40"	4' 8" x 6' 5"	5 " and 4 "	20" x 5 "	10" x 10"	7"	2700



Tolhurst Self Balancing Extractors

GENERAL DESCRIPTION

TOLHURST Self-Balancing Hydro-Extractors have been favorably known for many years. They are especially notable for reliability, durability and smoothness of operation.

The sizes and styles shown on preceding pages are those which our long experience finds most suitable for general requirements.

FOR BLEACHING OR DYEING of delicate colors the basket has a bronze top ring, perforated copper side sheet, steel hoops, and cast iron bottom, covered on the inside with sheet copper, the inside of basket being tinned. The case is of cast iron.

This style of basket is also used for LAUNDRY WORK and the Extractor is then equipped with belt shield.

THE TOLHURST SELF-BALANCING FEATURE is unique, ingenious and remarkably effective. The force of gravity alone accomplishes the result, eliminating springs, rubber cushions and all such devices. The Extractors carry heavy loads at high speeds with great steadiness.

THE UPRIGHT SHAFT is of steel, made hollow to convey oil to lower bearings, thus securing perfect lubrication.

At all points the question of lubrication has had careful attention and the upper bearing is so protected that oil or dirt from it cannot reach the basket.

THE BALL BEARING in step is an important improvement, reducing friction and permitting basket to quickly attain full speed. Ball Bearing is not furnished unless specially ordered.

COUNTER-SHAFT for starting and stopping the Extractor is attached to machine as shown in cuts.

The illustration on page 64 shows the 26, 32 and 40-inch Motor-Driven Self-Balancing Hydro-Extractors.

After exhaustive tests, this method of applying motor to an Extractor has been adopted as most satisfactory.

The belts provides a flexible connection, thus giving motor an opportunity to acquire some momentum and avoiding undue strains at starting.

With this type of Motor Drive there is no chance for vibration to reach the motor. This is of great value to Motor Drives.

One of the advantages of the Motor-Driven Extractor is the rapidity with which the basket attains full speed.

When so ordered, the motor is fitted with vertically adjustable base.

When ordering, please state fully the characteristics of current.

Tolhurst Self-Balancing Extractors

26, 32 and 40 inch Motor-Driven, Self-Balancing Hydro-Extractors

Sizes Indicates Inside Diameter of Revolving Basket

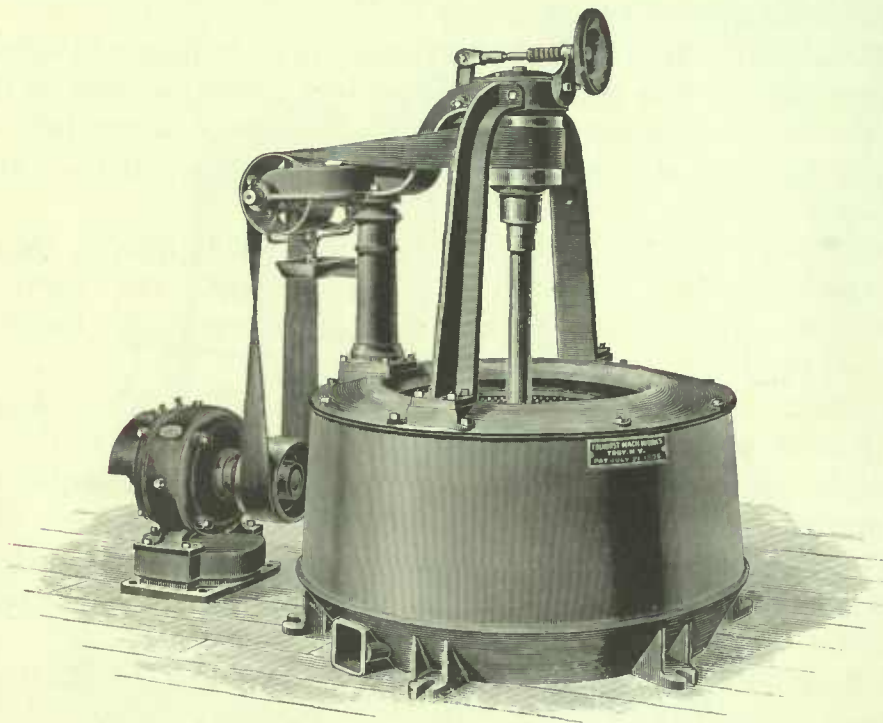

SPECIFICATIONS						
No.	Size, inches	R. P. M.		H. P. of Motor	Speed of Motor	Size of Pulley on Motor, inches
		Basket	Counter			
187	26	1000	350	2	1000	7 x 4
188	32	900	368	3	900	7 x 4½
189	40	850	386	5	850	7 x 5

Never speed an Extractor beyond its rated speed. It is dangerous.

Do not touch the basket or attempt to handle contents while it is in motion.



THE TORONTO LINE

Sectional View of Belt Driven Self Balancing Hydro-Extractor

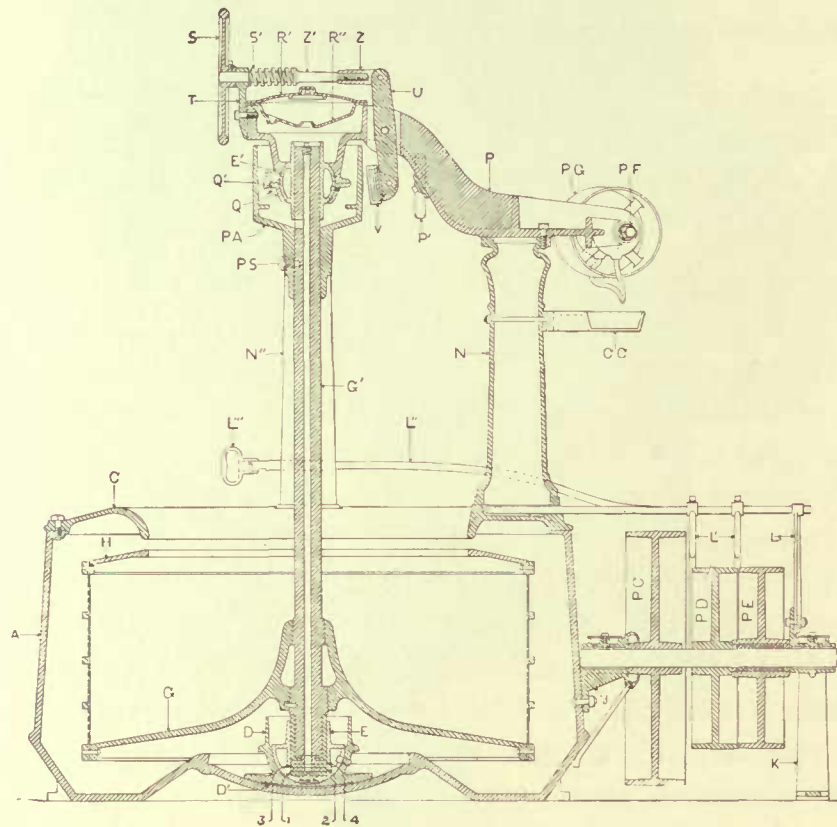

Parts Lettered for Convenience in Ordering Repairs

- | | | | | | |
|------------|--------------------|------|---------------------------------|-----|---------------------------|
| 1, 2, 3, 4 | Washers | L | Shipper Bar Support | PG | Idler Pulley |
| A | Case | L' | Shipper Fork | PS | Basket Pulley Screw |
| C | Top Ring | L'' | Shipper Bar | Q | Clamp Ring for Upper Ball |
| CC | Drip Pan | L''' | Shipper Bar Handle | R' | Top of Oil Reservoir |
| D | Step Cup | N | Back Column | R'' | Bottom of Oil Reservoir |
| E | Bottom Ball | N'' | Side Brace | S | Brake Wheel |
| E' | Bronze Top Ball | P | Top Frame | S' | Brake Spring |
| G | Basket Bottom | P' | Belt Guide | T | Brake Bracket |
| G' | Spindle | PA | Basket Pulley | U | Brake Lever |
| H | Top Ring of Basket | PC | Driving Pulley | V | Brake Shoe Casting |
| J | Case Bearing | PD | Driven Tight Pulley | Z | Brake Screw Nut |
| K | Outboard Bearing | PE | Loose Pulley | Z' | Brake Screw |
| | | PF | Nut on Idler Stud with Oil Hole | | |



Toronto Dry-Room Tumbler

THE Toronto Dryroom Tumbler is a combination of the Drying Room, and the Shaker or Tumbler, which, with the additional use of a Ventilating Fan provides a much better, quicker and more economical means of drying.

The goods to be dried are placed in the Dryroom Tumbler direct from the Extractor and the drying is accomplished by forcing a continuous current of heated air through and through the goods as they are being tumbled about in the cylinder, which is reversed by the Reversing Header at every third revolution.

Each machine is fitted with a bank of steam heated pipe coils, placed immediately below the cylinder, but separated therefrom by a galvanized sheet iron partition. The Circulating Air Fan draws its supply of cold air in through the fine mesh wire screen (shown in front of the coils) and after passing through the coils this highly heated air passes through the fan and is forced down through the goods in the cylinder. The heated air is freely admitted through the numerous openings in the cylinder and strikes the goods at the top just as they are about to fall, after having been carried nearly to the top by the momentum of the cylinder. The air being heated to about 250 degrees Fahrenheit becomes laden with moisture, and as moist air is heavier than dry heated air, the tendency is to descend, and it is assisted in this by the goods above continually dropping and forcing out the moisture laden air and the lint through the discharge pipes placed at each end of the outer case, and this air and lint may be carried through galvanized pipes and discharged at any convenient point.

SPECIFICATIONS							
36 inches and 42 inches Diameter							
No.	Cylinder inches	Coils Inches	Height Inches	Ft. of Pipe	Square feet Heating Surface	Vent Pipe inches	Size of Steam Connections inches
145	36 x 36	1	72	432	150	10	1
146	36 x 42	1	72	504	172	10	1
147	36 x 48	1	72	576	191	10	1
148	36 x 54	1	72	648	220	10	1
149	36 x 60	1	72	720	250	10	1
150	42 x 42	1 1/4	80	560	240	10	1 1/4
151	42 x 48	1 1/4	80	640	278	10	1 1/4
152	42 x 54	1 1/4	80	720	310	10	1 1/4
153	42 x 60	1 1/4	80	800	350	10	1 1/4



THE TORONTO LINE

Toronto Dry-Room Tumbler

36 inch and 42 inch Diameters. Brass Cylinders.

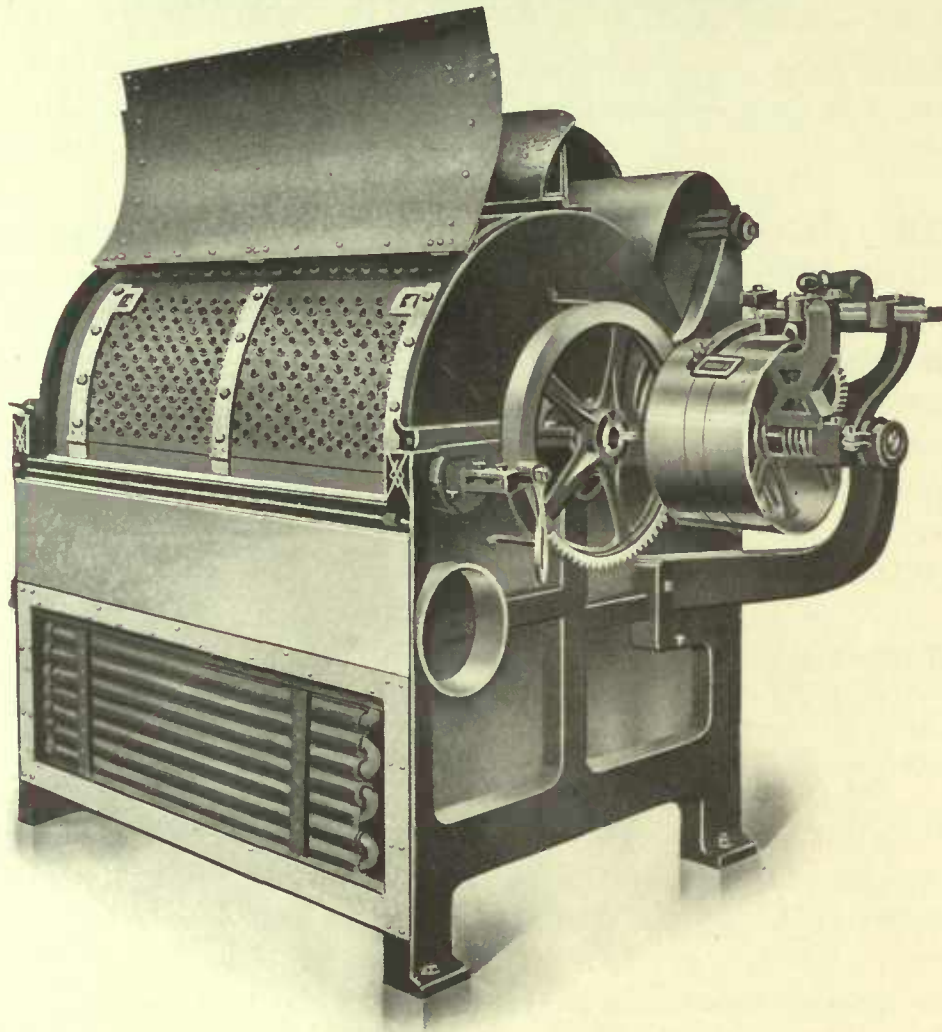

SPECIFICATIONS

36 inch and 42 inch Diameter

No.	Cylinder inches	Header Pulleys			Belts	Fan Pulleys			Belt inches	Floor Space inches	Weight lbs.
		Diam. inches	Face inches	Revs.		Diam. inches	Face inches	Revs.			
145	36 x 36	16	10	190	1 3/4 and 2 1/4	4	8	1000	3	54 x 80	3000
146	36 x 42	16	10	190	1 3/4 and 2 1/4	4	8	1000	3	54 x 86	3200
147	36 x 48	16	10	190	1 3/4 and 2 1/4	4	8	1000	3	54 x 92	3400
148	36 x 54	16	10	190	1 3/4 and 2 1/4	4	8	1000	3	54 x 98	3600
149	36 x 60	16	10	190	1 3/4 and 2 1/4	4	8	1000	3	54 x 104	3800
150	42 x 42	20	14	190	2 1/2 and 3	4	8	1000	3	64 x 86	4200
151	42 x 48	20	14	190	2 1/2 and 3	4	8	1000	3	64 x 92	4500
152	42 x 54	20	14	190	2 1/2 and 3	4	8	1000	3	64 x 98	4800
153	42 x 60	20	14	190	2 1/2 and 3	4	8	1000	3	64 x 104	5100



Toronto Dry-Room Tumbler

Construction

CYLINDERS. This machine is regularly constructed with the cylinder made of No. 13 Half Hard Sheet Brass with the perforations as close together as possible and doubly embossed. The ends are of cast iron and the trunnions are 3-inch diameter. The Cylinders are braced very rigidly by the use of several steel channel stays. The locks, hinges, etc., are solid brass. **WIRE WOVEN** Cylinders are also supplied if ordered and these are made up in the same substantial manner as the sheet brass ones, with $\frac{1}{2}$ -inch brass or galvanized iron wire mesh and perforated sheet brass door. In ordering the wire mesh cylinder, give number of the machine required with the prefix **BRASS OR GALVANIZED WIRE MESH CYLINDER.**

OUTER CASE. The frames are substantially built of cast iron and the shell is made of 1-16 inch Galvanized Steel Sheets, making it in as far as possible air tight.

COILS. The coils are mounted upon trucks, resting upon tracks and may be easily removed for cleaning purposes. These coils are protected by a baffle plate inserted between them and the cylinder, which prevents any lint from falling into the coils, and which also causes the air to pass entirely through the heated coils before being forced into the cylinder. The coils are made up in two sections, and either or both sections may be used at one time, giving as much or as little heat as may be required for the particular articles being dried.

VENTILATING FAN. The Fan on the 36-inch machine is 16 inches in diameter, with 16 steel blades, while the fan of the 42-inch machine is 18 inches in diameter, with 18 steel blades. The fans upon the different machines have blades of such length as will deliver the proper amount of air to each of the different sizes, heated to the proper heat, which is about 250 degrees Fahrenheit. The quantity of heated air ranging in the 36-inch machines from 2500 to 5000, and in the 42-inch machines from 3500 to 6000 cubic feet per minute.



THE TORONTO LINE

Toronto Dry-Room Tumbler

RANGE OF USEFULNESS. The range of work that may be dried in this machine is almost unlimited. Among the many articles which the Dryroom Tumbler will dry better and quicker may be mentioned the following:—

Bathing Suits,	Butcher's Coats,
Bath Towels,	Barber's Towels,
Rough Dry,	Rugs,
Dyed Goods,	Heavy Curtains,
Underwear,	Overalls,
Barber's Coats,	Butcher's Aprons,
Massage Towels,	Bags,
Roller Towels,	Carpets,
Dry Cleaned Goods,	Wet Cleaned Goods,
Socks and Stockings,	Bed Spreads,
Semi-Drying of Flat Work.	

FLAT WORK. By partially evaporating the moisture out of Flat Work, especially in the heavier pieces, a small Flat Work Ironer will handle the work of a much larger machine. Its capacity is greatly increased, as the goods are partly dried, the wrinkles have been removed, and the edges are not turned over, which permits of the goods being fed into the ironer faster and at the same time they are dried and ironed much quicker.

TIME SAVING. The time generally required to dry a load in the Dryroom Tumbler is from 10 to 15 minutes for light work and from 15 to 30 minutes for the heavier articles. A great saving in time is effected, for the reason that the goods do not have to be either hung up or taken down, quick drying is assured, there is very little handling and much less chance of their being soiled.

SPACE SAVING. This feature alone will strongly recommend this machine, as it will dry in the same time the goods that would require an ordinary dryroom occupying a space four times as great, and the only labor attached is in the loading and unloading of the cylinder.

QUALITY OF WORK. It is impossible to obtain by any other method the beautiful finish imparted to the goods, as they are finished soft and fluffy, are odorless and require very little finishing. It is the only method of drying Bath Towels that is thoroughly satisfactory, they are ready for parcelling when taken from the machine, are as soft as a glove and require NO IRONING.

DYED AND CLEANED GOODS. This machine is being largely used by Dyers and Cleaners, taking the place of the Dust Wheel and the Drying Room for dyed and scoured goods, and also for thoroughly drying all garments before being Dry Cleaned. The action of the machine breaks up crystalized substances upon the garments, and they require much less spotting.



THE TORONTO LINE

Toronto Shaker or Tumbler

Cylinder 44 inches x 48 inches

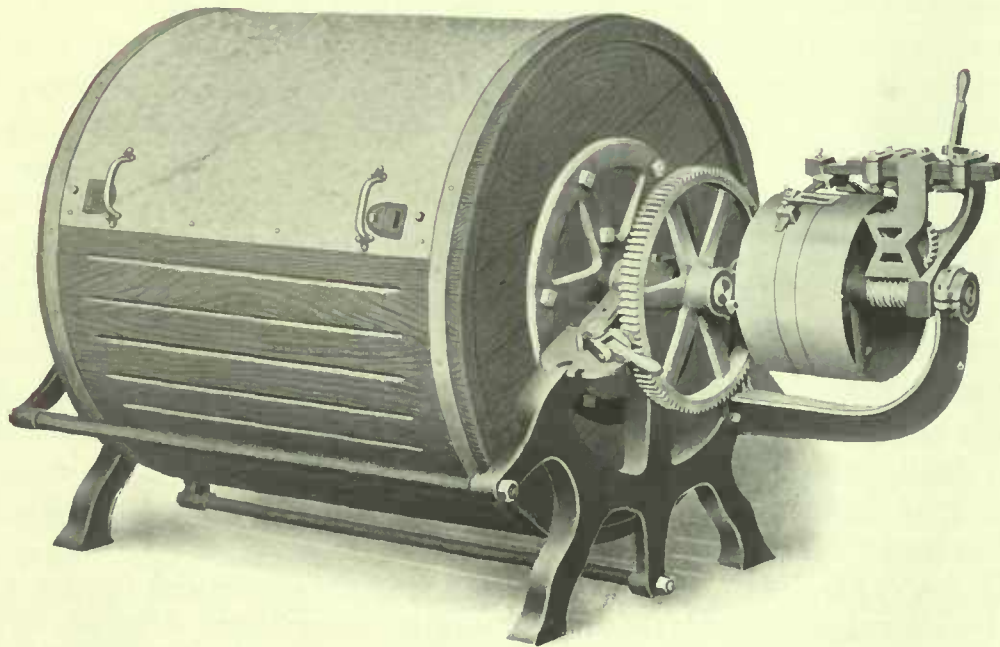

Belt Driven No. 190

Motor Driven No. 191



Toronto Shaker or Tumbler

Cylinder 44 inches x 48 inches.

THIS machine is one of the greatest labor-saving ones in our line, and especially in those laundries that do a large amount of flat work. It not only loosens the goods that are taken from the Extractor, but it shakes the lint out of them as well. The cylinder is strongly built of the same material as is used in our washer cylinder and is mounted on a substantial iron frame.

When fitted with direct connected motor the motor is erected on a substantial frame elevated above the header and attached to the right hand frame. The pulley upon the motor is the full width of the header pulleys and the motion is transmitted by means of two short belts.

SPECIFICATIONS					
Diameter of Pulleys	Revolutions	Belts	Pulley on Line Shaft, Straight Face	Floor Space	Weight
16 inches	160	1 $\frac{3}{4}$ and 2 $\frac{1}{4}$ inches	10 inches	50 x 84 inches	1450 lbs.

Toronto Standard Flat Work Ironer

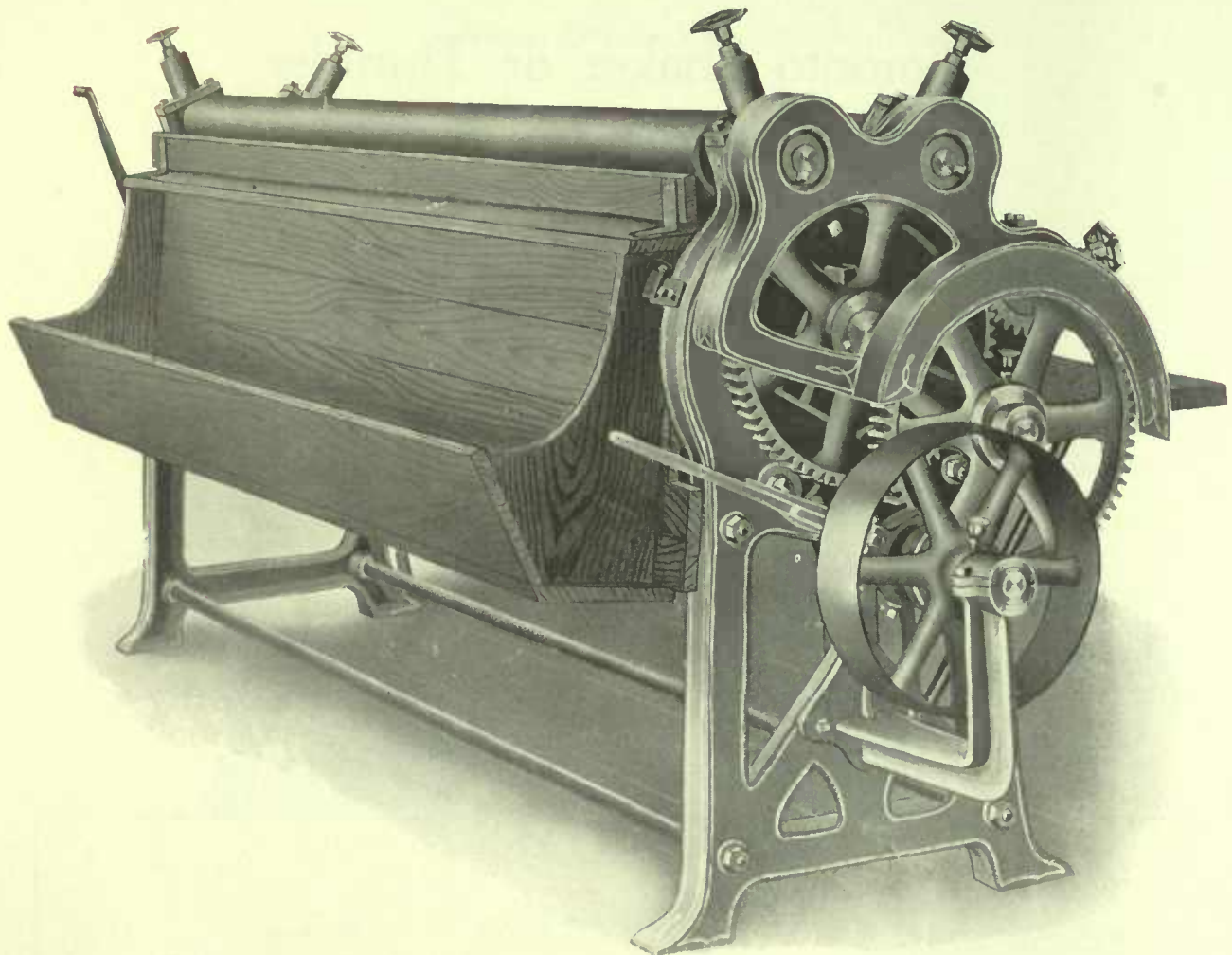

Made in Four Sizes.

SPECIFICATIONS							
Number		Cylinder inches	Floor Space	Diameter of Pulleys inches	Belt inches	Speed of Pulleys per min.	Weight lbs.
Belt	Motor						
196	192	16 x 48	86 x 50	16	4	60	2700
197	193	16 x 64	100 x 50	16	4	60	3000
198	194	16 x 75	110 x 50	16	4	60	3200
199	195	16 x 90	135 x 50	16	4	60	3450



Toronto Standard Flat Work Ironer

THE cut on the opposite page shows our "TORONTO" STEAM-HEATED ROTARY FLAT WORK IRONER, which is recognized as a favorite with public Laundries, Hotels and Institutions. It has a steam cylinder 16 inches in diameter running in combination with three auxiliary padded rolls, covered with heavy wool covering, which absorbs the moisture and protects the hems of the goods. The machine presents a radiating surface of from 2500 to 5000 square inches (according to length of cylinder), sufficient to dry and iron the goods taken directly from the extractor.

The gears are covered with shields and safety guard on feeding side, so arranged as to reduce all possible danger to a minimum.

An especially desirable feature of this machine is that the steam inlet and drain are, by an improved device, both at one end of machine. We guarantee by this improved device to be freer of condensation than any other Mangle on the market to-day.

The advantages of this feature render it by far the most desirable Mangle ever offered to public Laundries, Hotels, and Institutions.

The construction of this Mangle throughout is of the best material, including cut gears, steel shaft, and is finished in nickel and brass.

This machine has been so improved that the auxiliary rolls are all driven from one large gear on end of cylinder, doing away with the train of gears on end of Mangle opposite driving end, thereby removing all unequal strain. These machines are all properly adjusted and tested before leaving our factory.

The machine operates with a single belt, and is started or stopped by means of a lever operated clutch. In addition to these safety devices above mentioned, the pressure is applied to the roll by means of a lever, and this pressure is relieved and the rolls drop free of each other by merely moving this lever a few inches.

The motor driven machines are fitted with 1-H P. direct connected motor and Cutler Hammer variable speed controller. In ordering the Motor Driven Machine be sure and state fully the kind of current that the motor is to operate upon.

COVERING FOR ROLLS			
Size	Burlap	Wool Blanket	No. 12 Cotton Duck
16 in. x 48 in.	3 pieces, 50 in. x 60 in.	3 pieces, 50 in. x 108 in.	3 pieces, 50 in. x 108 in.
16 in. x 64 in.	3 pieces, 66 in. x 60 in.	3 pieces, 66 in. x 108 in.	3 pieces, 66 in. x 108 in.
16 in. x 75 in.	3 pieces, 78 in. x 60 in.	3 pieces, 78 in. x 108 in.	3 pieces, 78 in. x 108 in.
16 in. x 90 in.	3 pieces, 93 in. x 60 in.	3 pieces, 93 in. x 108 in.	3 pieces, 93 in. x 108 in.



THE TORONTO LINE

Single Roll Flat Work Ironer

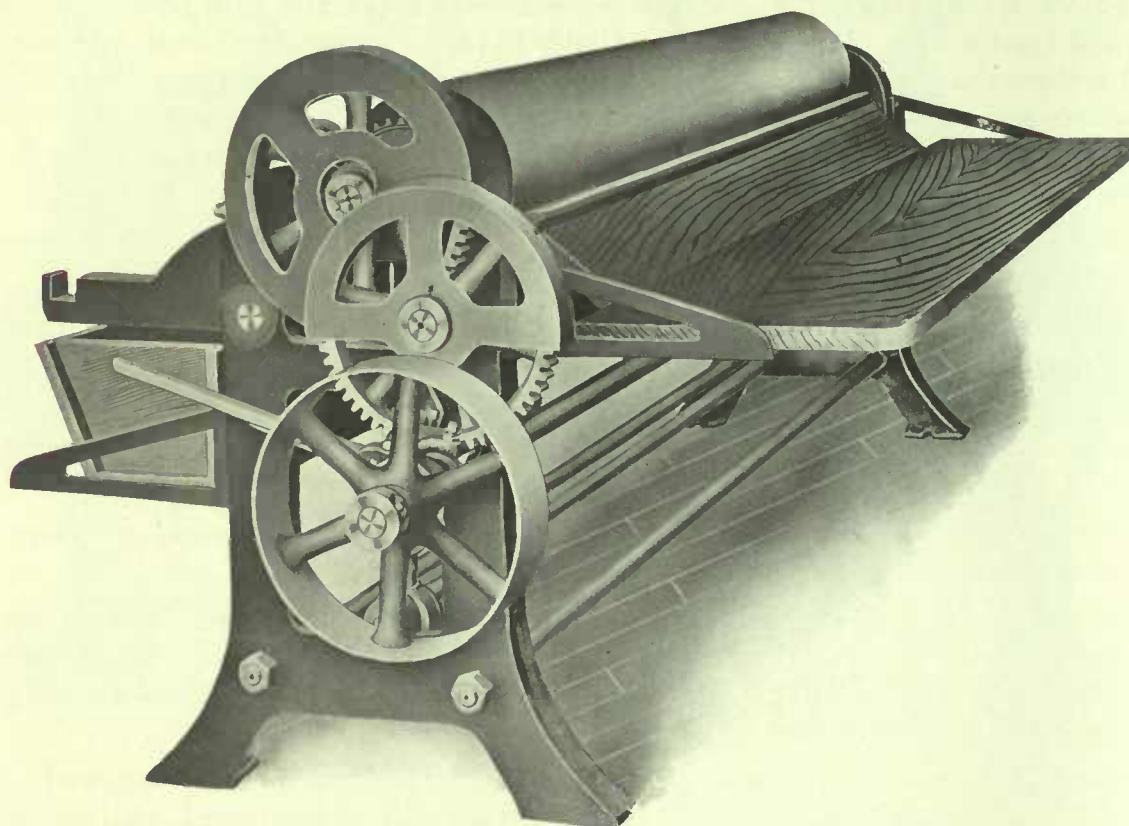

Made in Four Lengths, 48, 64, 75 and 90 inches.

COVERING FOR ROLLS			
Size	Burlap	Wool Blanket	No. 12 Cotton Duck
12 in. x 48 in.	1 piece, 50 in. x 120 in.	1 piece, 50 in. x 144 in.	1 piece, 56 in. x 108 in.
12 in. x 64 in.	1 piece, 66 in. x 120 in.	1 piece, 66 in. x 144 in.	1 piece, 70 in. x 108 in.
12 in. x 75 in.	1 piece, 78 in. x 120 in.	1 piece, 78 in. x 144 in.	1 piece, 81 in. x 108 in.
12 in. x 90 in.	1 piece, 93 in. x 120 in.	1 piece, 93 in. x 144 in.	1 piece, 96 in. x 108 in.

Feed Roll, 1-piece Wool Blanket, 36 in. x Actual Length of Machine.



Single Roll Flat Work Ironer

THIS machine is composed of a single roll and corresponding steam chest in which it travels. The roll is 12 inches in diameter, about 38 inches in circumference. Of this circumference about 12 inches is under pressure and goods passing through this machine are in contact with nearly 20 inches of heated surface. Owing to the amount of heated surface, the greater part of which is under pressure of the roll, the capacity of this machine is greater than would be imagined at first thought. With average steam pressure it will iron all pieces, other than very heavy ones, in two passes through the machine. Its range of usefulness is from handkerchiefs and fine, delicate pieces to table and bed linen. It is a valuable and necessary machine to every well-equipped laundry. The Motor Driven Machines are fitted with a $\frac{1}{2}$ -H.P. Direct Connected Electric Motor and Cutler Hammer Variable Speed Controller. In ordering the Motor Driven Machines be sure and state fully the kind of current that the motor is to operate upon.

SPECIFICATIONS								
Number		Size inches	Weight lbs.	Floor Space inches	Diameter of Pulley inches	Face inches	Belt inches	Speed
Belt Driven	Motor Driven							
200	204	48	1500	48 x 90	16	3	3	50
201	205	64	1800	48 x 106	16	3	3	50
202	206	75	2100	48 x 117	16	3	3	50
203	207	90	2400	48 x 132	16	3	3	50



THE TORONTO LINE

Two Roll Flat Work Ironer

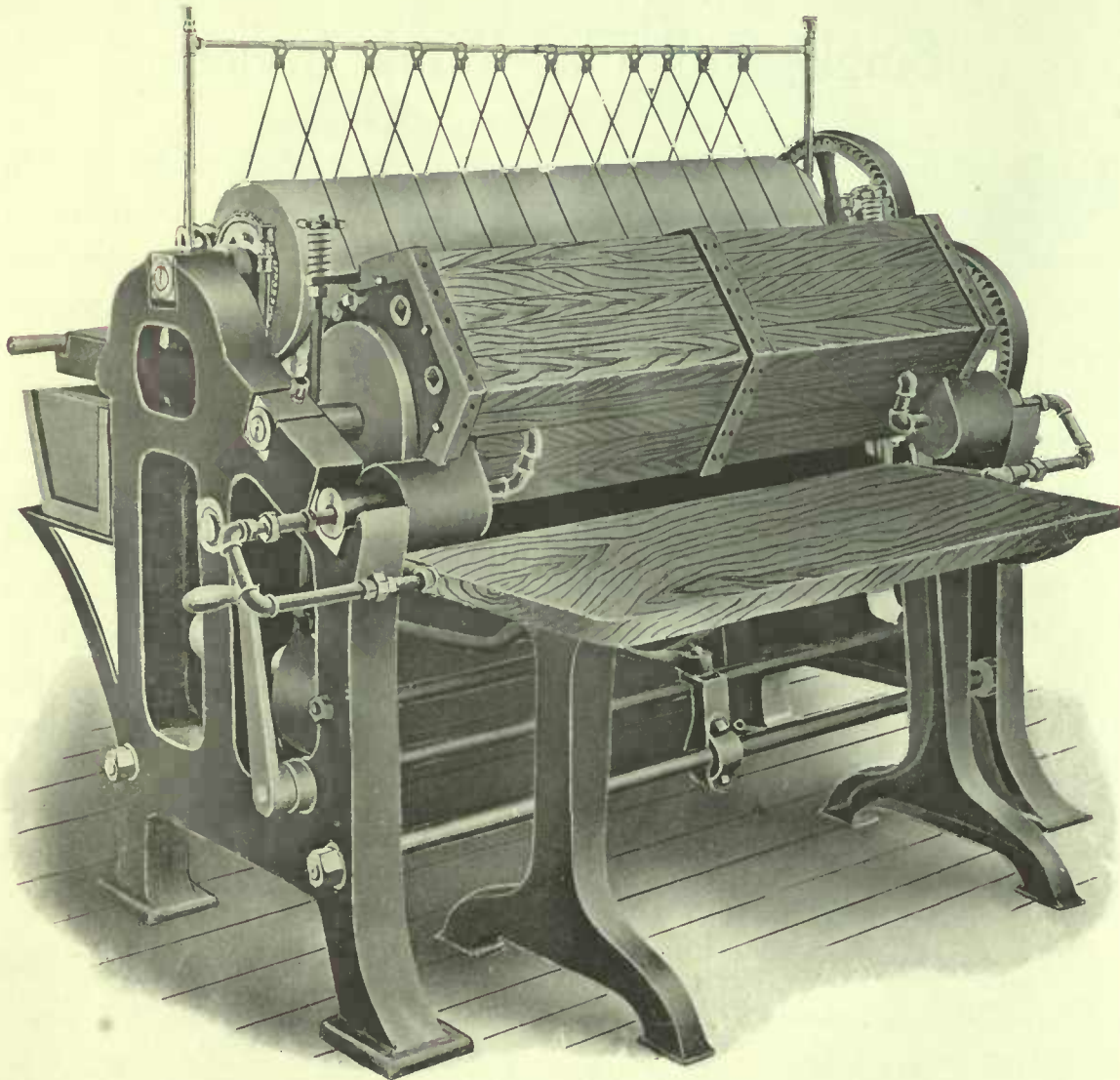

Delivery Side of 48 inch Machine.

COVERING FOR ROLLS

Size	Burlap	Wool Blanket	No. 12 Cotton Duck
12 in. x 48 in.	2 pieces, 50 in. x 120 in.	2 pieces, 50 in. x 144 in.	2 pieces, 56 in. x 108 in.
12 in. x 64 in.	2 pieces, 66 in. x 120 in.	2 pieces, 66 in. x 144 in.	2 pieces, 70 in. x 108 in.
12 in. x 75 in.	2 pieces, 78 in. x 120 in.	2 pieces, 78 in. x 144 in.	2 pieces, 81 in. x 108 in.
12 in. x 90 in.	2 pieces, 93 in. x 120 in.	2 pieces, 93 in. x 144 in.	2 pieces, 90 in. x 108 in.

Feed Roll, 1-piece Wool Blanket, 36 in. x Actual Length of Machine.



Two Roll Flat Work Ironer

THIS machine was designed to meet the conditions of moderate capacity at a reasonable price, and differs from the Single Roll Flat Work Ironer in the fact that it has two rolls, instead of one, ironing the goods the same on both sides and is capable of a wider range of usefulness. It is to be distinguished also on account of being constructed upon the Sectional Principle. An additional section or sections may be added at any time to any of the several lengths, the same as the Multiple Mangle. This feature alone makes this machine a very popular one.

As in all the Toronto Line of Flat Work Ironers the rolls may be raised entirely free from the steam chests when not in use.

At a slower speed than in the larger machines, the general run of goods are finished in one pass through.

Furnished with two-speed countershaft attached to the machine and, also, our well-known safety and feed roll combined.

The Motor Driven Machines are fitted with 1-H.P. Direct Connected Electric Motor and with Cutler Hammer Variable Speed Controller. In ordering the Motor Driven Machines be sure and state the kind of current the motor is to operate upon.

SPECIFICATIONS								
Number		Size inches	Weight lbs.	Floor Space inches	Diameter of Pulleys inches	Speed	Face inches	Belt inches
Belt Driven	Motor Driven							
208	212	48	3000	55 x 90	16 and 20	40 and 60	3	3
209	213	64	3800	55 x 106	16 and 20	40 and 60	3	3
210	214	75	4500	55 x 117	16 and 20	40 and 60	3	3
211	215	90	5600	55 x 132	16 and 20	40 and 60	3	3



THE TORONTO LINE

Toronto Duplex Sectional Flat Work Ironer

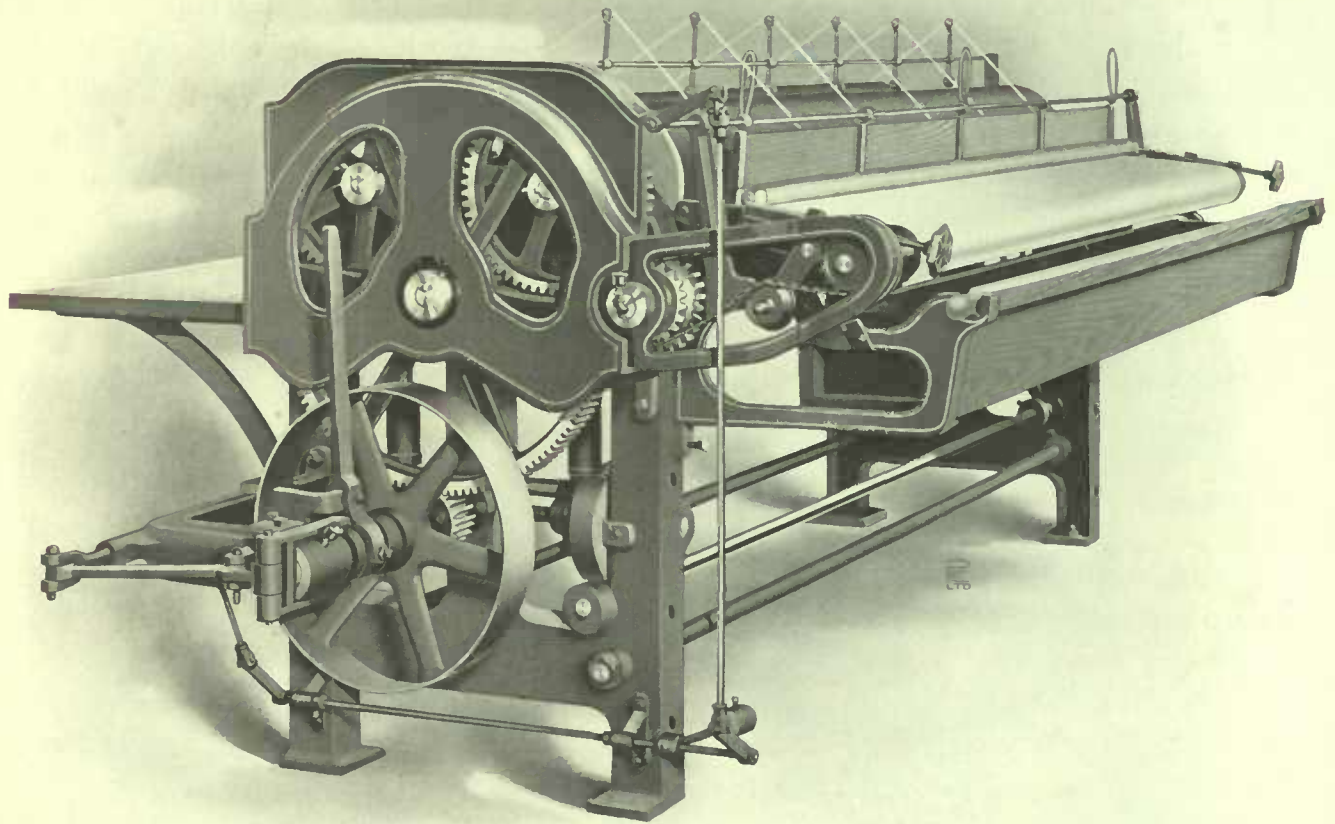

Feeding Side.

Ribbon Apron Feed. Automatic Safety Stop.

COVERING FOR ROLLS			
Rolls	Burlap	Wool Blanket	No. 12 Cotton Duck
48 inch	2 pieces 54 in. x 120 in.	2 pieces 50 in. x 144 in.	2 pieces 50 in. x 108 in.
64 inch	2 pieces 70 in. x 120 in.	2 pieces 66 in. x 144 in.	2 pieces 66 in. x 108 in.
75 inch	2 pieces 81 in. x 120 in.	2 pieces 77 in. x 144 in.	2 pieces 77 in. x 108 in.
90 inch	2 pieces 96 in. x 120 in.	2 pieces 92 in. x 144 in.	2 pieces 92 in. x 108 in.
100 inch	2 pieces 106 in. x 120 in.	2 pieces 102 in. x 144 in.	2 pieces 102 in. x 108 in.
120 inch	2 pieces 126 in. x 120 in.	2 pieces 122 in. x 144 in.	2 pieces 122 in. x 108 in.



Toronto Duplex Sectional Flat Work Ironer

THE Toronto Duplex Sectional Flat Work Ironer consists of a First Section containing Two Padded Rolls $12\frac{1}{2}$ inches in diameter, together with their corresponding steam chests, and is made in a wide range of lengths, in fact this machine may be had in a length and with a number of rolls that will suit almost any requirement. The First Section contains all the driving mechanism, the Ribbon Apron Feed and the Automatic Safety Stopping Device and an additional Section or Sections, each containing Two Rolls may be added at any future time. To attach the additional section it is necessary to remove only FOUR BOLTS from the two brackets that support the Delivery Table and attach the brackets to the new section. The Additional Sections are added to the Delivery Side of the machine and there is no other change required excepting as above stated.

RIBBON APRON FEED AND AUTOMATIC SAFETY STOPPING DEVICE

Each Duplex machine is fitted with a Ribbon Apron Feed and an Automatic Safety Stopping Device. The Ribbon Apron Feed consists of a number of Canvas Belts 2 inches wide, which form a carrying apron the full length of the machine. The goods are laid out upon this moving apron and are fed into the machine automatically. This ribbon apron feed is a great help to the operators, as it feeds the goods into the machine in just the condition that they are laid down upon the carrying Feed Apron and if they are laid down with the edges perfectly straight they are bound to come out in the same manner. By the use of the Ribbon Apron Feed there is no occasion for the operators hands to be placed anywhere near the point where the goods enter between the roll and the chest. The Automatic Safety Stopping Device is one of the most commendable features of this machine inasmuch as it assures the absolute safety of the operators. There is a small Brass Safety Roll which runs upon the Ribbon Aprons and which is driven merely by the friction caused by its weight, everything that enters the machine has to pass under this roll.

(Description Continued on Page 81)



Toronto Duplex Sectional Flat Work Ironer

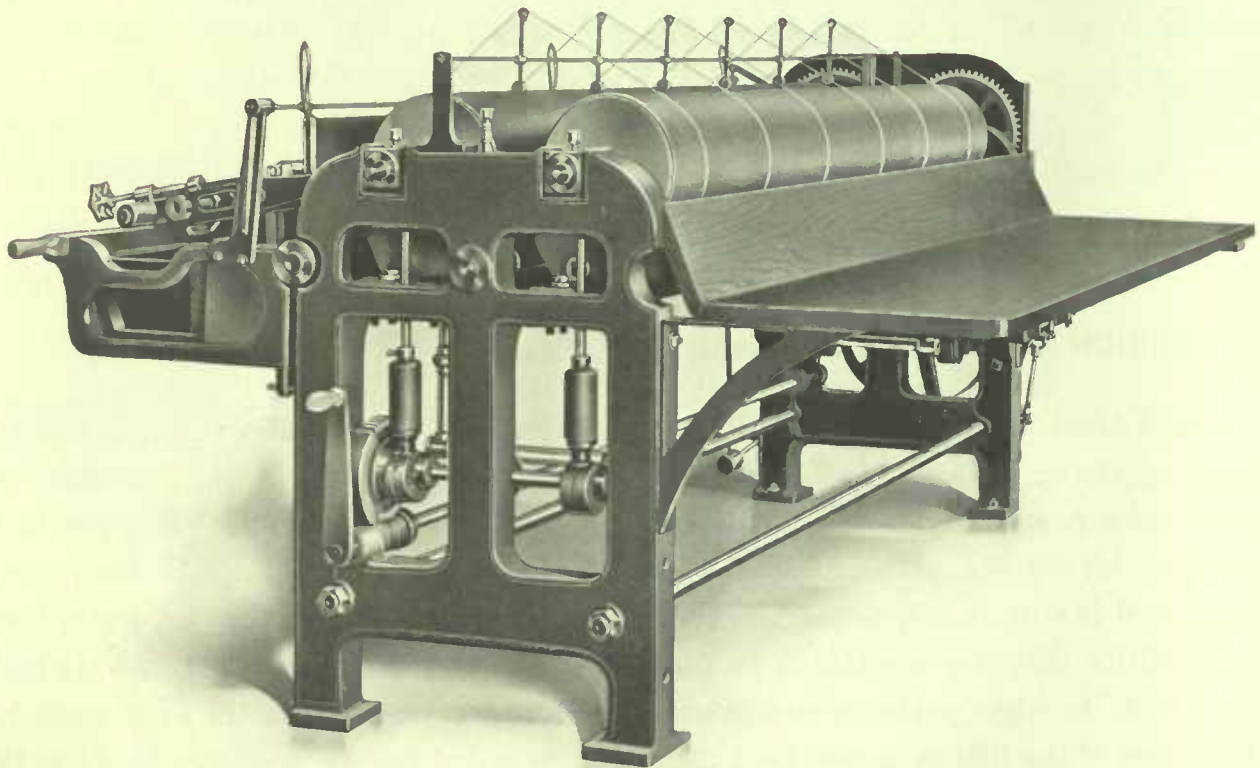

Delivery Side.

Rolls $12\frac{1}{2}$ inches Diameter. 48, 64, 75, 90 and 120 inches Long.

Ribbon Apron Feed. Automatic Apron Stop.



Toronto Duplex Sectional Flat Work Ironers

(Continued from page 79)

IMMEDIATELY behind this Brass Safety Roll and with its lower edge placed $\frac{1}{2}$ an inch above the Ribbon Aprons an Auxiliary Automatic Stop Operating Plate has been suspended and which extends for the full length of the rolls. This Plate is placed between the Brass Safety Roll and the point where the goods enter the machine. As this plate is placed so close to the Ribbon Aprons, only the goods to be ironed can pass underneath and if anything comes in contact with this Plate it swings towards the large roll, releases the mechanism that drives the Ironer and stopping the whole machine instantly. The machine may be stopped also by the operator drawing forward either of the three small levers which are shown attached to the Stopping Plate, one at each end and one in the center. This machine is also made with a $1\frac{1}{2}$ -H.P. Electric Motor directly attached and when so driven the Automatic Safety Stop operates in the same manner as above described with the exception that a movement of the Stopping Plate of $\frac{1}{2}$ inch cuts off the Electric Current from the motor. A special Cutler Hammer Speed Regulator is also attached, giving a wide range of speeds.

In ordering the Motor Driven Machines be sure and state the kind of current that the motor is to operate upon.

SPECIFICATIONS							
Length of Rolls inches	Number Belt Driven	Number Motor Driven	Weight First Section	Weight Additional Section	Floor Space First Section inches	Floor Space Additional Section inches	Square Inch Heated Surface Each Section
48	217	218	3000	2450	84 x 72	84 x 32	1728
64	219	220	3800	2975	100 x 72	100 x 32	230
75	221	222	4500	3350	111 x 72	111 x 32	2700
90	223	224	5500	3900	126 x 72	126 x 32	3240
100	225	226	6200	4200	136 x 72	136 x 32	3600
120	227	228	7000	4800	156 x 72	156 x 32	4320
Driving Pulley, 20 x 4 inches. Speed, 40 R. P. M. Belt, 4 inches. Steam Feed, 1 inch. Drip, $\frac{1}{2}$ inch.							

Supplied with the machine is a complete set of Covering, Feeding Box, Delivery Table, Six Shaking Out Bars, Two Iron Racks for Bars, Automatic Safety Stop, Ribbon Apron Feed, Pressure Relief Valve and Steam Gauge. EACH STEAM CHEST is tested to 200 lbs. hydraulic pressure at the factory, and this test is CERTIFIED to by our testing department, and every chest is stamped on its upper surface near the end to this effect.

Toronto Multiple or Sectional Flat Work Ironer

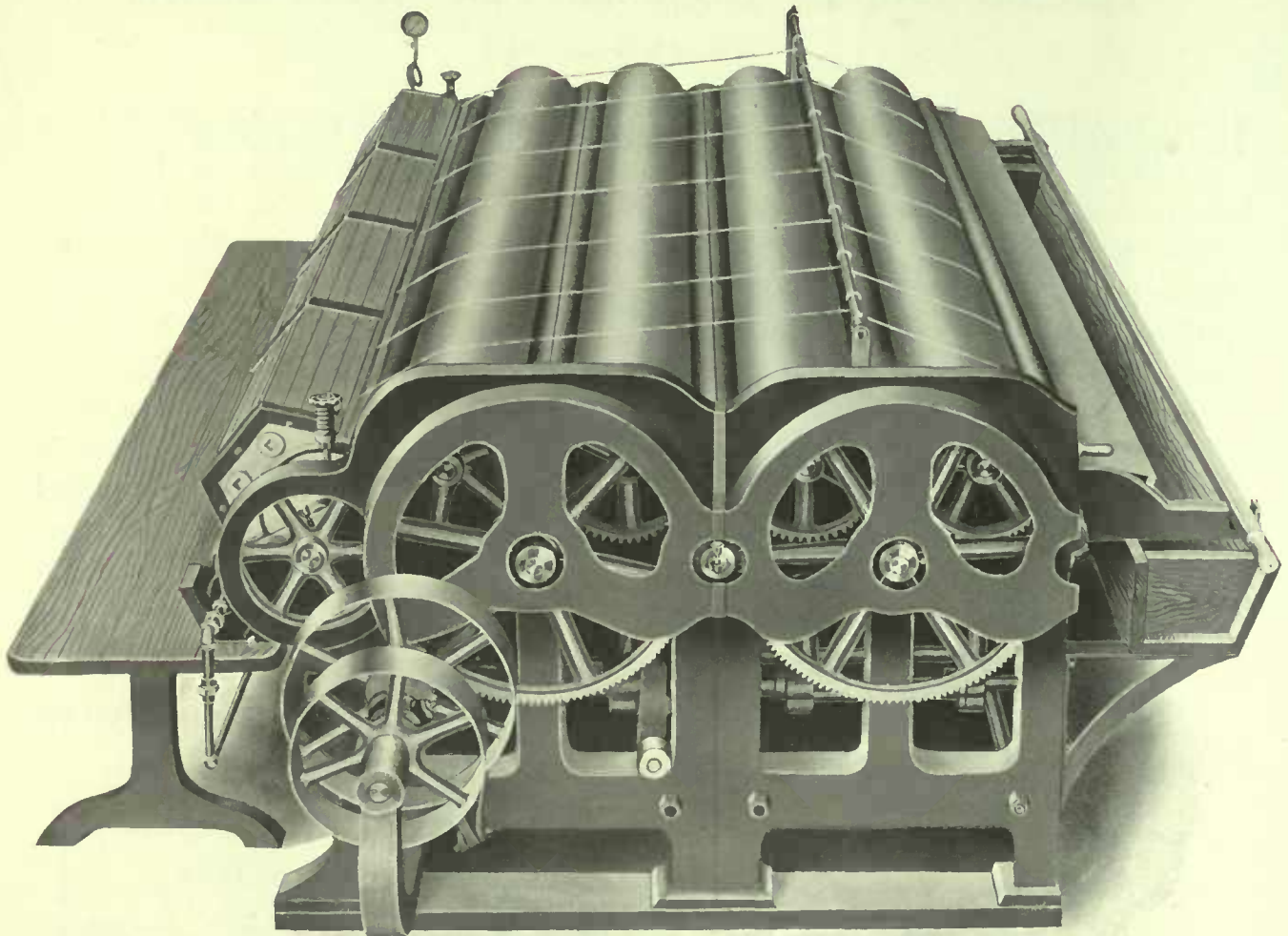

Five Roll, 120 inch Multiple Flat Work Ironer

THE above illustration shows the **FIRST UNIT OF THREE ROLLS** and to which have been added a **SECOND SECTION** converting the machine from a **THREE ROLL** into a **FIVE ROLL** machine. All sizes of the Multiple Machine iron the goods on **BOTH Sides**. The Five Roll machine will iron most goods of ordinary thickness in one pass through when wrung for twenty minutes in the extractor, with the steam pressure at not less than Eighty Pounds, and when the condensation is properly cared for and this at a speed of Thirty-Five Feet per minute.



Toronto Multiple or Sectional Flat Work Ironer

THIS Flat Work Ironer consists of the first section or unit of three rolls and three steam chests which constitutes a complete machine. This may be added to, one section or more at a time of two rolls each, as the business demands. The union is very simple to make as the castings are all drilled to template for the connecting bolts. The driving mechanism is attached to the first unit and whether the additions make it a five, seven or nine roll machine, the drive remains upon the first section.

This feature has made this machine a wonderfully popular one, as when the capacity of the original section has outgrown, an additional unit may be added without having to dispose of the old machine, and avoiding the trouble and inconvenience of having to remove the old and install a new one.

It has been our aim to produce a machine with as few parts as possible, consistent with high efficiency, and in this machine we have an ironer suitable for any size laundry, large, medium or small, that is the least complicated and most complete machine on the market at a reasonable price.

The Safety Feeding device used on this machine makes it absolutely impossible for the operator to be caught in the machine. As it is true of all safety devices, that they are safeguards only so long as they are used properly and kept in perfect condition, we would draw the attention of laundrymen to this fact.

The rolls on all units of the Multiple Flat Work Ironer are $12\frac{1}{2}$ inches in diameter, and finish both sides of the goods in passing through.

This machine may also be had with Ribbon Apron Feed and Automatic Stopping Device the same as shown and described for the Duplex and Compound Flat Work Ironers.

The Motor Driven Machines are fitted with a $2\frac{1}{2}$ -H.P. Direct Connected Electric Motor and with Cutler Hammer Variable Speed Controller. In ordering the Motor Driven Machine be sure and state fully the kind of current the motor is to operate upon.

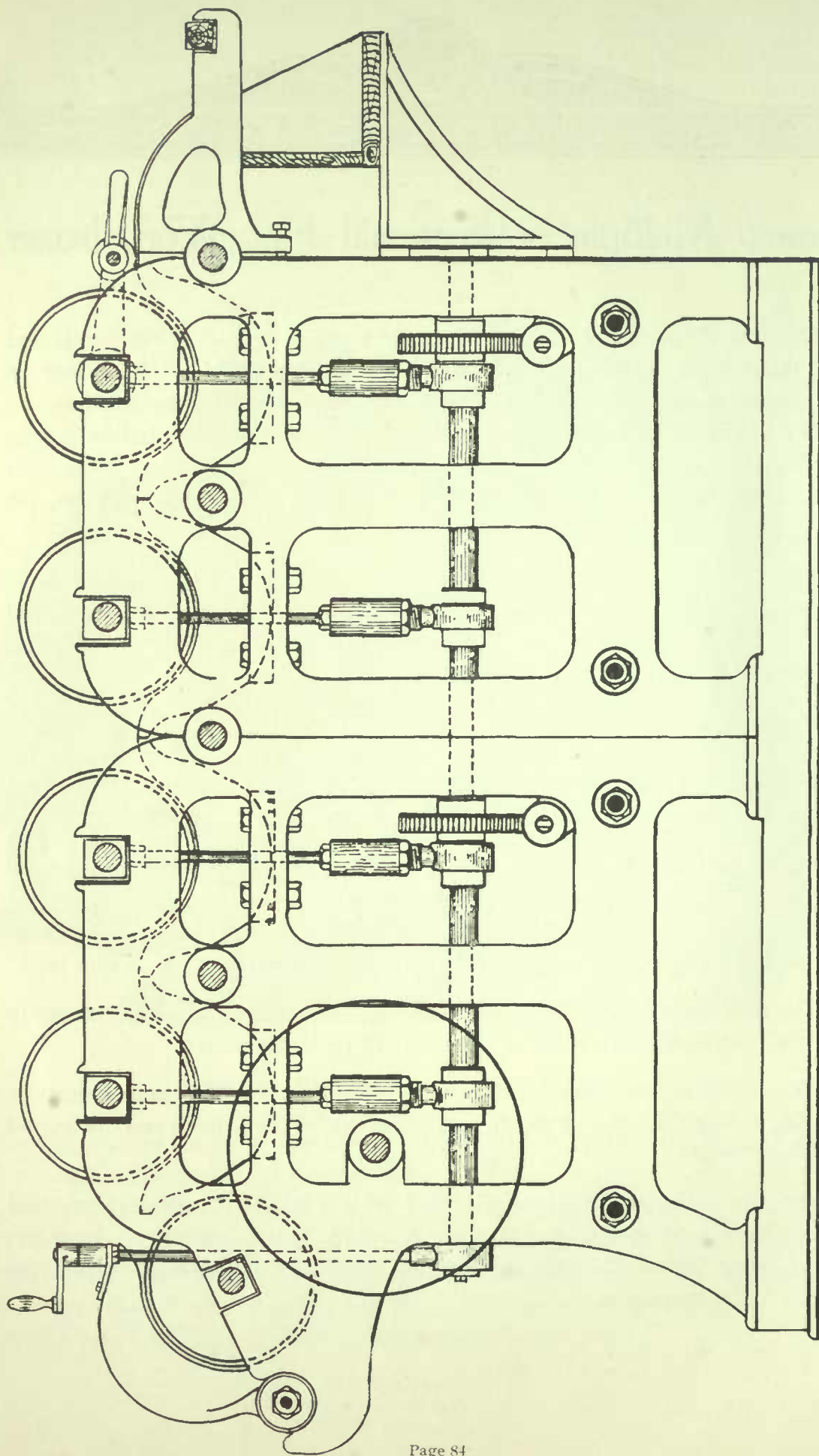

Sectional View, Five Roll Multiple Flat Work Ironer



Toronto Multiple or Sectional Flat Work Ironers

EACH Steam Chest is tested to 200 lbs. hydraulic pressure at the factory by our Testing Department, and the result of this test is certified to upon the upper surface of each chest near the end by stamping a certification of the test together with the names of the parties making test.

SPECIFICATIONS								
Length of Rolls inches	Number Belt Driven	Number Motor Driven	Weight First Section	Weight Additional Section	Floor Space First Section inches	Floor Space Additional Section, inches	Square Inch Heated Surface First Section	Square Inch Heated Surface Additional Section
48	229	230	3900	2450	98 x 90	98 x 32	2592	1728
64	231	232	4700	2975	114 x 90	114 x 32	3456	2304
75	233	234	5250	5250	125 x 90	125 x 32	4050	2700
90	235	236	6000	3900	140 x 90	140 x 32	4860	3240
100	237	238	6500	4200	150 x 90	150 x 32	5400	3600
110	239	240	7000	4500	160 x 90	160 x 32	5940	3960
120	241	242	7500	4800	170 x 90	170 x 32	6480	4320

Driving Pulleys are 16 and 20 inches diameter, 4 inch Face. Speed, 40 and 60 R. P. M. Belts, 4 inches.
Steam Feed, 1 inch. Drip, 1 inch.

What is Supplied with Each Machine

We supply with each Toronto Multiple Flat Work Ironer, one complete set of Covering, Feeding Box, Sheet Brass Feeding Board, Delivery Table, Six Shaking Out Bars, Two Iron Racks for Bars, Pressure Relief Valve and Steam Gauge.

COVERING FOR ROLLS			
The following list of Covering is for each roll, and in ordering new Covering be sure and give the number of rolls Covering is required for.			
Rolls	Burlap	Wool Blanket	No. 12 Cotton Duck
48 in.	1 piece, 54 in. x 120 in.	1 piece, 50 in. x 144 in.	1 piece, 50 in. x 108 in.
64 in.	1 piece, 70 in. x 120 in.	1 piece, 66 in. x 144 in.	1 piece, 66 in. x 108 in.
75 in.	1 piece, 81 in. x 120 in.	1 piece, 77 in. x 144 in.	1 piece, 77 in. x 108 in.
90 in.	1 piece, 96 in. x 120 in.	1 piece, 92 in. x 144 in.	1 piece, 92 in. x 108 in.
100 in.	1 piece, 106 in. x 120 in.	1 piece, 102 in. x 144 in.	1 piece, 102 in. x 108 in.
110 in.	1 piece, 116 in. x 120 in.	1 piece, 112 in. x 144 in.	1 piece, 112 in. x 108 in.
120 in.	1 piece, 126 in. x 120 in.	1 piece, 122 in. x 144 in.	1 piece, 122 in. x 108 in.



THE TORONTO LINE

Toronto Compound Flat Work Ironer

Seven Rolls. 120 inch

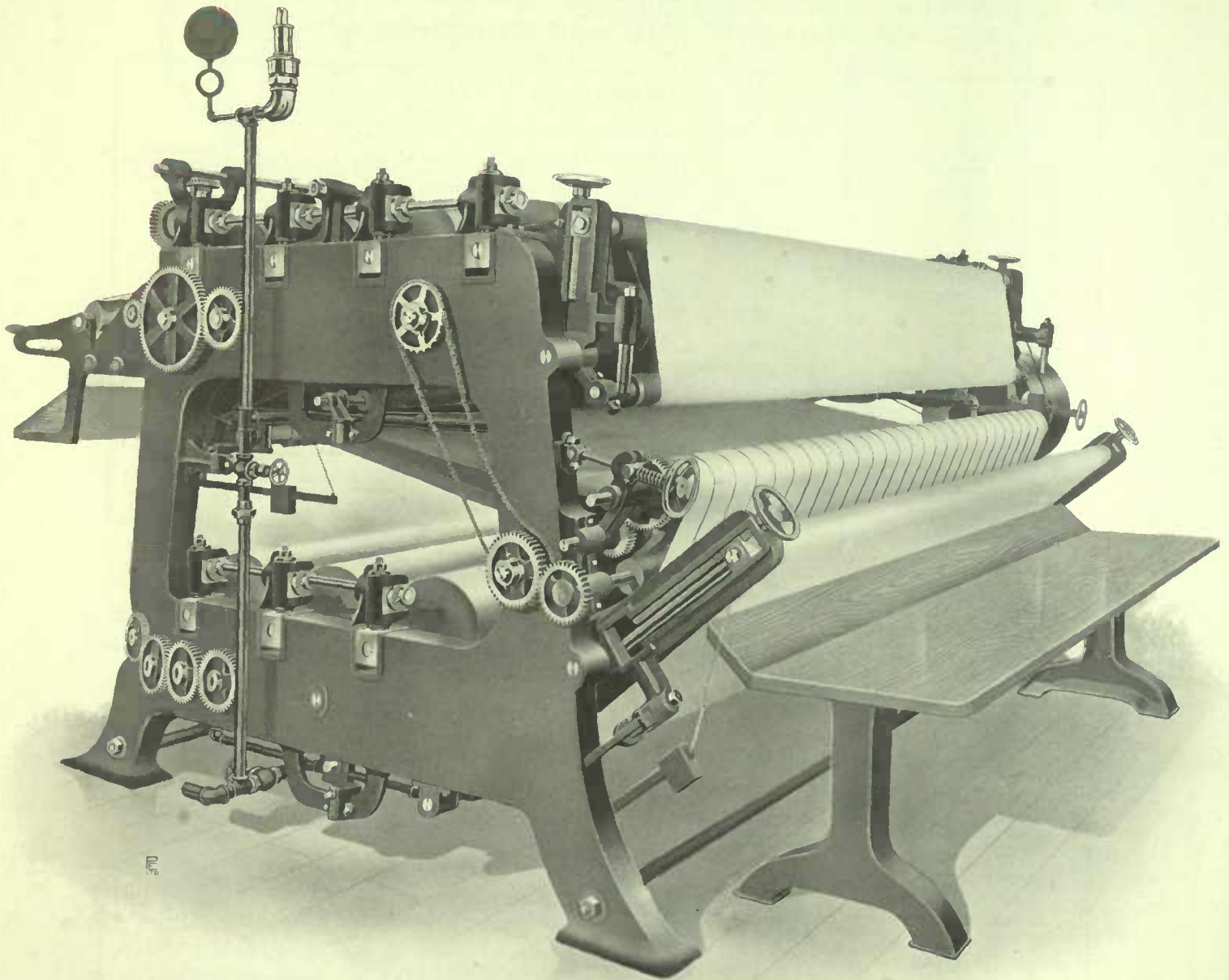

DELIVERY SIDE



THE TORONTO LINE

Toronto Compound Flat Work Ironer

THE Toronto Compound Flat Work Ironer herein illustrated and described represents the highest development of the Steam Chest Flat Work Ironer. The most popular and widely used type of machine in use at the present time.

By referring to the cuts of the Machine it will be seen that it consists of seven padded rolls, $12\frac{1}{2}$ inches in diameter, 120 inches long, together with their corresponding steam chests. Instead of the rolls and chests being placed in one continuous series, they are divided into two—one series containing four rolls and chests, being elevated above the other series, which contains three rolls and chests.

The passage of the goods to be ironed through the machine is accomplished by means of the padded rolls, two ribbon feed aprons and three short carrying aprons. Briefly described, the operation is as follows:—

The goods are fed into the upper series of rolls and chests by means of the main Ribbon Apron Feed. This is an apron composed of narrow canvas belts acting as a whole, which allows of faster and more accurate feeding.

The goods then pass between the rolls and steam chests until they reach the end of the fourth chest; here they are taken by the upper conveying apron, and while being held firmly up against the bottoms of the upper series of chests are carried back to the feeding side of the machine. By referring to the sectional cut of the main Feed Apron it will be seen that the goods are then taken by the intermediate conveying apron, and while lying on top of the same entire-

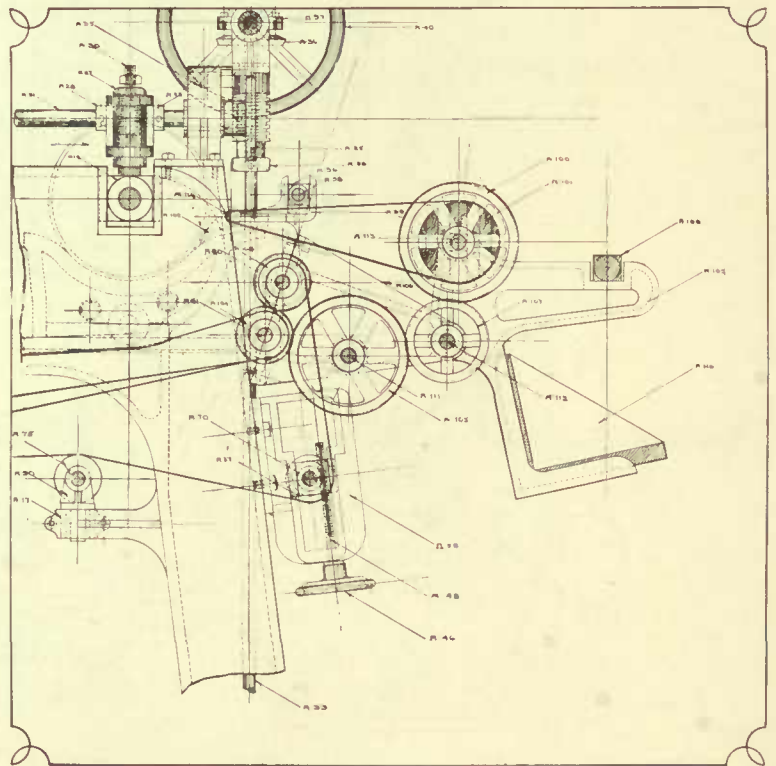

Main Ribbon Apron Feed



THE TORONTO LINE

Toronto Compound Flat Work Ironer

7 Rolls. 120 inch.

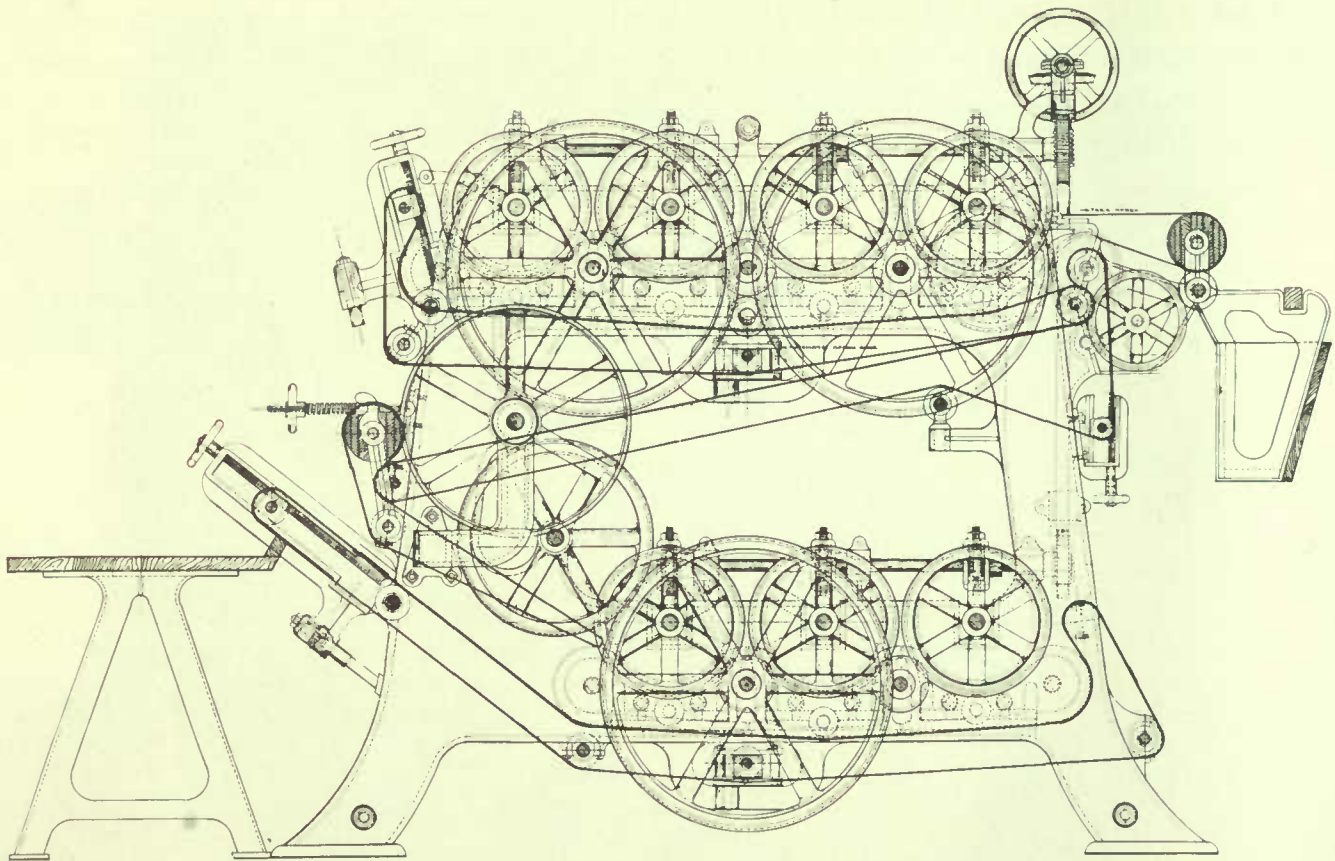

END ELEVATION SHOWING ARRANGEMENT OF ROLLS, CHESTS AND APRONS

ly free and out of contact with either steam chests or other aprons, they reach the lower ribbon apron feed, which automatically enters them into the lower series, when after passing between the three rolls and chests they are then taken by the lower conveying apron along the under surface of the lower chests and are delivered to the folding table. The ironing done by the lower series of rolls and chests is done on the opposite side of the goods to that which was ironed in passing through the upper series.

In designing this machine our aim was to produce a machine that would as far as possible embody all the most commendable features that have been produced in the evolution of the modern Flat Work Ironer, but our especial attention was given to a very vital point, and one which has been almost entirely ignored in flat work ironer construction—that of PROPER MEANS OF EVAPORATION.

Perfect evaporation during the passage of the goods through the Ironer means increased capacity (without increasing the steam consumption) and the lessening of the cost of up-keep of the covering. We believe, and we make the statement without fear of successful contradiction, that ample space for the free evaporation of the moisture, during the passage of the goods, is of greater value than the same area of heated surface where the evaporation is smothered or confined.

The Toronto Compound Flat Work Ironer has the greatest number of square inches of heated and drying surface of any Flat Work Ironer in the world, having a total of 44,064 square inches. Of this amount 12,240 square inches represent the evaporating surface in addition to the evaporating space between each roll.

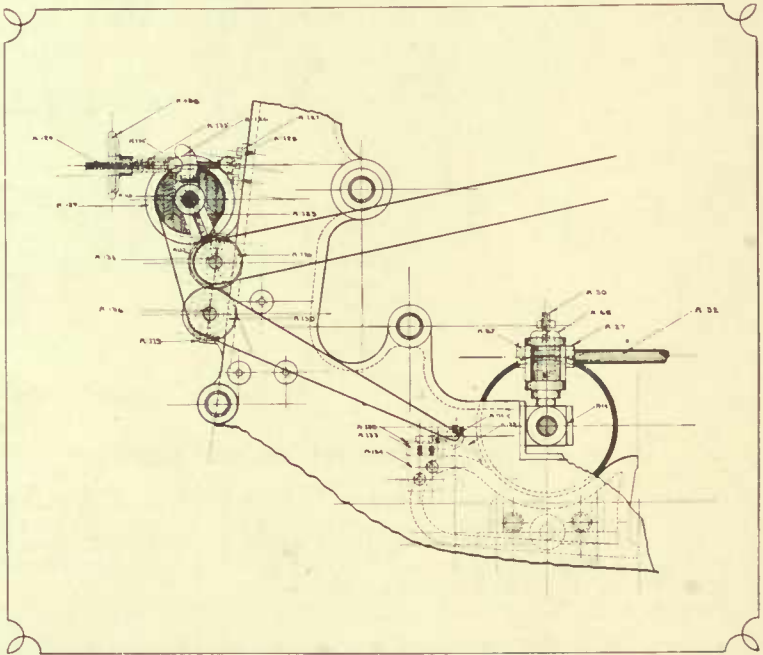

Lower Ribbon Apron Feed

On the Compound Ironer this evaporation takes place midway during the passage of the goods through the machine. The goods, after leaving the bottom of the front



THE TORONTO LINE

chest on the upper series, are carried on top of the intermediate conveying apron, through the highly heated space between the upper and lower series of rolls and chests until they enter the lower rolls. The moisture, in the form of vapor, escaping into the atmosphere from the goods during the passage, there being an area of more than 85 square feet of the goods open to the free evaporation of the moisture.

This large evaporating surface has proven our contention regarding the value of *Perfect Evaporation* beyond a shadow of doubt during the exhaustive tests to which this machine has been subjected during the last year in handling large quantities of flat work of all descriptions.

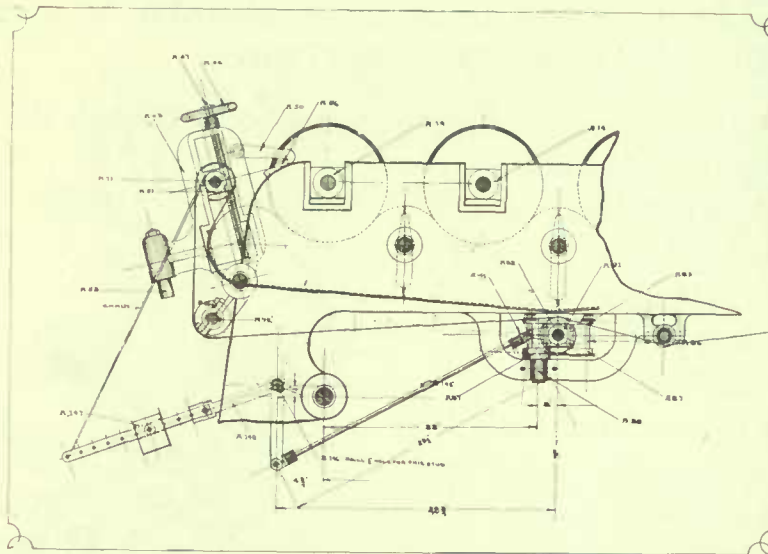

Automatic Apron Guide—Upper Apron

The compound feature of the machine also commends it, as all goods are ironed equally upon both sides. While this is a decided advantage, as both sides of the goods are perfectly finished, it is especially desirable on such articles as Pillow Cases, Roller Towels, Hand Towels, etc.

The absolute safety of operators was also given our particular attention, and in addition to the brass safety roll placed on the upper feed apron, an auxiliary automatic stop operating plate has been suspended between the safety roll and the point where the goods enter. Should anything come in contact with this plate it swings toward the large roll, thereby releasing the driving mechanism and instantly stopping the machine. In addition to the above all the gears are protected by shields to prevent the operator's clothing becoming caught.

The pressure control is placed convenient to the operators, so that they may increase or release the pressure to suit the goods being ironed. A dial shows at a glance the amount of pressure upon the rolls. All the rolls are raised or lowered from the feeding platform. Once the machine is erected the pressure springs for the rolls are so enclosed that it is impossible for anyone to tamper with them. The pressure controlling mechanism is so constructed that as much or as little pressure may be placed upon the rolls as may be desired, but it is the same on each of the seven rolls and the same on each end of each roll. This positively prevents the covering from crowding to one end. The covering on each roll consists of: One piece burlap, 126 x 120 inches; one piece wool blanket, 120 x 144 inches; one piece of No. 12 cotton duck, 126 x 108 inches.

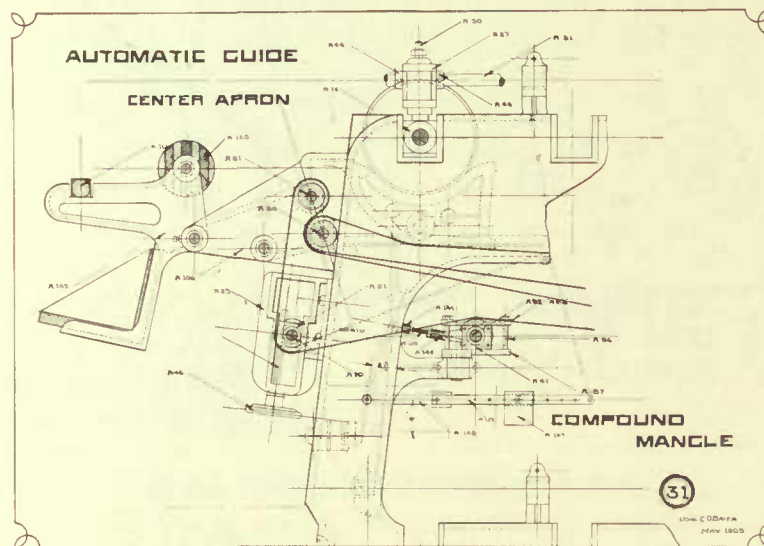

Automatic Apron Guide—Centre or Intermediate Apron

The covering of the Compound Ironer is simplicity itself. We have demonstrated that the old covering can be removed, new covering placed upon the rolls and the machine in operation again, all inside one hour from the time of starting. The teeth of the roll gears during this operation are arranged to come entirely out of mesh. This is a special feature, as it allows the covering to be stripped, unwound or replaced on any one roll without disturbing the others.

This means a considerable saving in time in the removing of the old covering or the straightening of a cover that may have been wrinkled or twisted in covering. There is no backing up of this machine for any purpose.

The three conveying aprons used on the Compound Ironer—upper, intermediate and lower aprons—are 15 ft., 15 ft. 6 in., and 19 ft. respectively in length, which includes 4 in. lap, their combined length being shorter than the two long aprons used on most other makes. These aprons are made of No. 4 cotton duck, 122 inches wide, and may be placed on the machine without having to remove a roll. The upper and lower aprons may be instantly dropped entirely away from the heated chests when the machine is not in use. The intermediate apron does not come in direct contact with the heated steam chests.

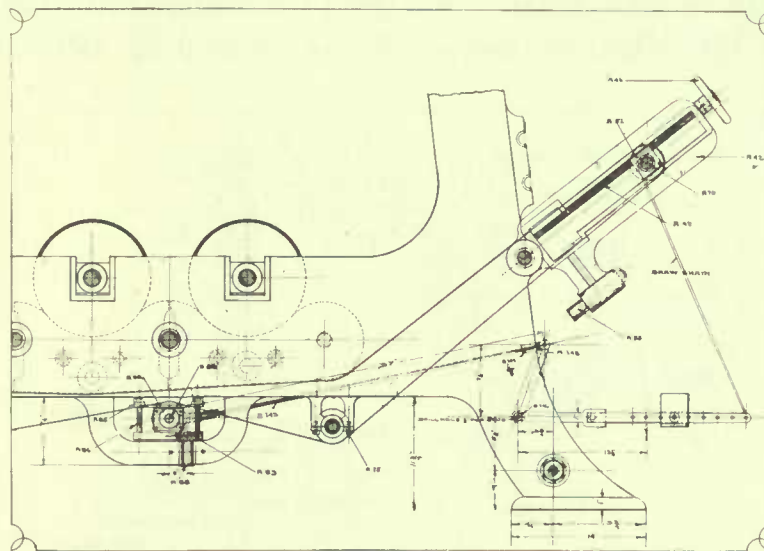

Automatic Apron Guide—Lower Apron

Spring buffers are attached to all the apron drop brackets, to protect them from damage in the event of their being accidentally dropped while lowering the aprons.

The intermediate conveying apron does not come in contact with the heated steam chests at any point and should last indefinitely.

Automatic guides, illustrated by the several cuts herein, control all aprons and keep them running straight and true. No further attention need be given the aprons once the automatic guides are set.

The gears throughout the machine are machine cut from solid castings, and all fast running pinions are of rawhide to make the machine, as far as possible, noiseless.



A variable speed countershaft is supplied with the machine, giving a surface speed on the rolls of from a minimum of seven feet to a maximum of seventy feet per minute, and any intermediate surface speed may be obtained instantly.

For ease in ordering duplicate parts each piece entering into the construction of this Ironer is either plainly marked or stamped with its serial number, which will avoid unnecessary delay, as all the information or description required is the number of the part required.

The Compound Ironer occupies a space 12 feet by 13 feet, or 155 square feet, being less than that occupied by the 48 x 120 inch cylinder machines, while being nearly three times the capacity and from 25 to 50 per cent. less floor space than any steam chest machine that will even nearly compare with the capacity of the Compound Ironer.

The enormous capacity of the Compound Flat Work Ironer, the high grade character of the work produced, simplicity of construction and operation, low cost of maintenance, economy of floor space, ease of ordering renewal parts, together with its low cost as compared to its capacity combine in making it the Ideal Machine.

Every necessity is supplied with the machine. One complete set of covering, aprons, steam trap, pressure reducer, steam gauge, feeding box, platform, delivery table, two horses, six bars, and variable speed countershaft. Speed of countershaft 300 R. P. M. Weight of machine complete 25,000 lbs.

The Motor Driven Machine is furnished with a Three Horse Power, Direct Connected, Direct Current Electric Motor and Cutler Hammer Special Speed Regulator or Controller, to give the desired speed.

The safety stopping device is also operated electrically, cutting off the electric current to the motor and instantly stopping the machine.

In ordering the Motor Driven Machine be sure and state fully the kind of current that the motor is to operate upon.



THE TORONTO LINE

Climax Straightening Machine

Patented October 10th, 1911



Machine Ready for Use.

THIS little machine is presented herewith for the first time after a thorough test in one of the largest laundries in Toronto. The machine was designed for the straightening of a wide range of articles in a Steam Laundry, but more especially for the small pieces of flat work such as handkerchiefs, napkins, towels, pillow cases, etc. The operation of the machine is as follows: One edge of the article is drawn out straight and laid upon the padded surface of the machine directly below the pressure bar. The next piece is laid upon the first one and so on until there are three or four dozen pieces in the pile. The pressure bar is then brought down upon the pile by means of the foot lever and by tilting this foot lever towards the machine the clamp is held in this position until released. The upper edges being firmly held by the pressure clamp, the lower part of the whole pile is thrown back over the top of the pressure bar and then the lower end of each article is drawn towards the operator by holding the two lower corners one in each hand and pulling sufficiently to remove all wrinkles and straighten the edges. The article is then laid upon the padded surface and the process is repeated for each article, with the result that every article so handled is perfectly squared. These are now passed to the mangle, where they are fed through without requiring any attention on the feeders part in the way of keeping these goods smooth and straight, and this is especially true in the case of handkerchiefs, which are one of the hardest articles to finish on a flat work ironer and have every edge perfectly straight and the corners square.



Climax Straightening Machine

Patented October 10th, 1911

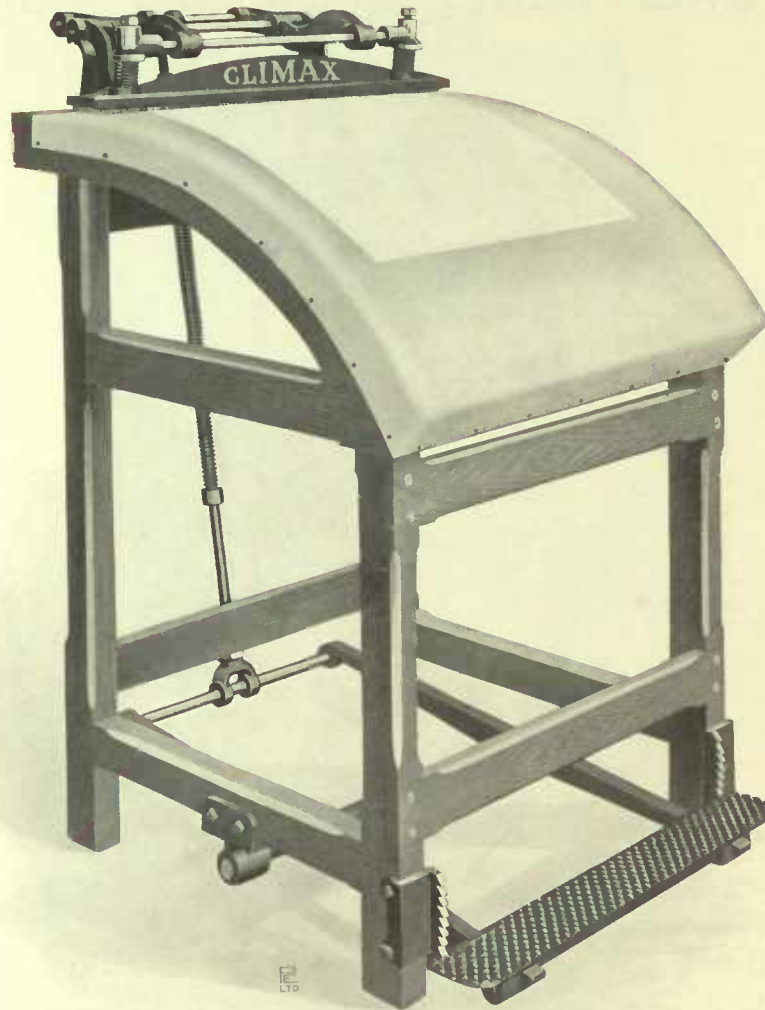

Machine Holding Upper Edge of Goods

WE have demonstrated that the small pieces of flat work can be straightened upon this machine as quickly as they can be shaken out by hand, and while in this particular there is no saving of time over the old way, every article is perfectly square, and the time required in feeding into the mangle is more than cut in two.

Underwear, pajamas, flannel shirts, etc., can be straightened in the same manner as the flat work, and then ironed on small flat work ironer, instead of being hand ironed. Socks and stockings should be clamped by the feet and the legs drawn out straight, and they require no further ironing. Heavy underwear should be straightened out before drying, and they require no further finishing.

The results obtained by the use of the Climax Straightening Machine, especially on handkerchiefs and small pieces of flat work, will appeal most to the launderer who is particular as to having all small articles finished perfectly square and straight, and this result is positively assured by the use of this machine.

Floor Space, 36 x 36 inches.

Weight, 200 lbs.

Leader Power Barrel Collar and Cuff Starcher



THIS machine is used extensively in small Laundries and Institutions where the volume of work to be done does not warrant the use of the more expensive machines. The machine is complete as shown, including pulleys, special trunnions, bearings, handle and with wooden stand. Made in the following sizes.

Number	Gallons	Price
0	5	\$15.50
1	9	15.50
2	15	16.00
3	20	17.00
4	25	19.00
5	35	23.00



THE TORONTO LINE

Toronto Dip Wheel Collar and Cuff Starcher

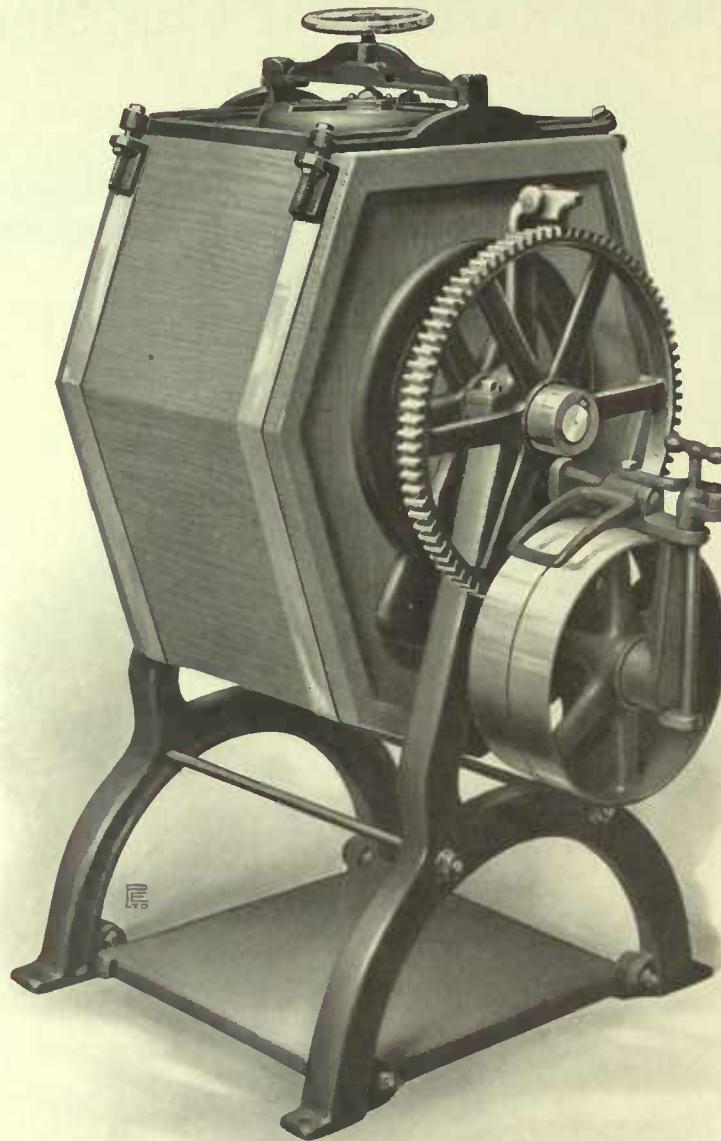

Belt Driven, No. 243.

Motor Driven, No. 257.

THIS machine, as well as the character of the work it accomplishes, is too well known to demand mention in this connection. It has established itself firmly in the trade and may be relied upon as trustworthy in service and substantial and lasting in character.

This machine may also be had with direct connected electric motor, ½ H. P.

In ordering machine with motor attached, state whether the current is Direct or Alternating. If Direct, state voltage, 110 or 220. If Alternating give voltage and state whether single, one or two phase and cycles.

SPECIFICATIONS

Size inches	Pulleys Inches Diameter	Face inches	Belt inches	Speed, R. P. M.	Weight, lbs.	Floor Space inches	Packed for Export
17 x 17 x 31	12	5	2½	100	400	36 x 48	36 cubic feet



THE TORONTO LINE

The Bishop Collar and Cuff Starcher

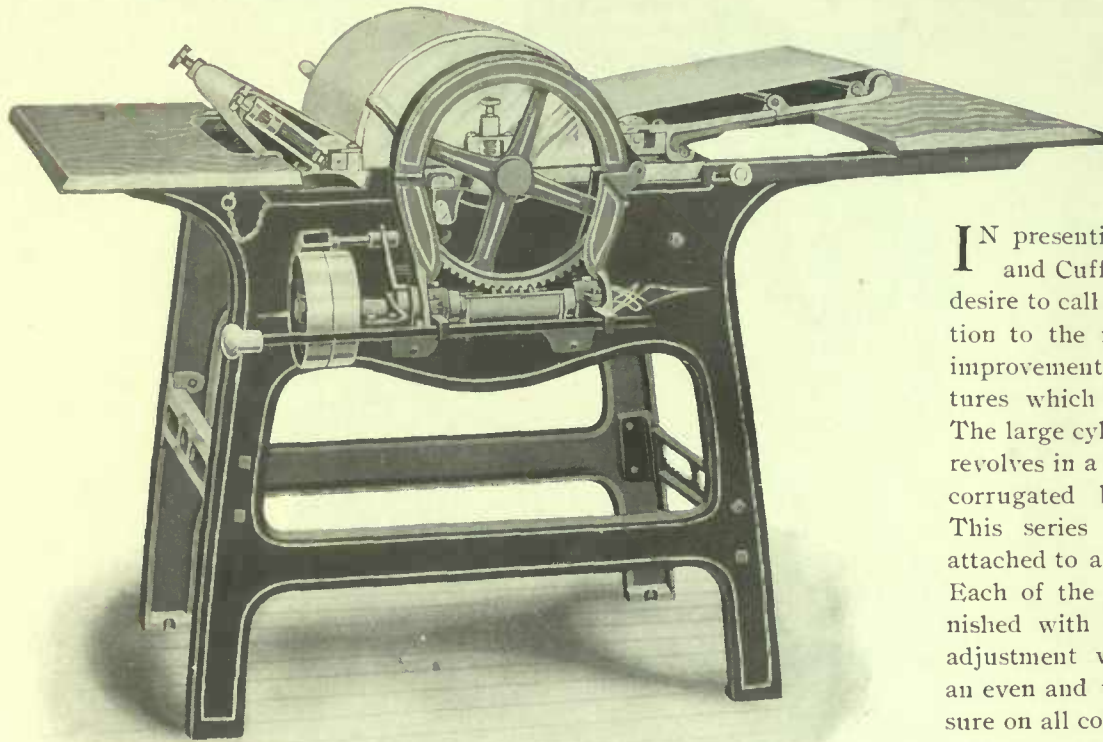

IN presenting this Collar and Cuff Starcher, we desire to call especial attention to the many distinct improvements and new features which it embodies. The large cylinder or drum revolves in a series of small corrugated brass rollers. This series of rollers is attached to a brass cradle. Each of the rollers is furnished with an automatic adjustment which insures an even and uniform pressure on all collars and cuffs passing through the machine.

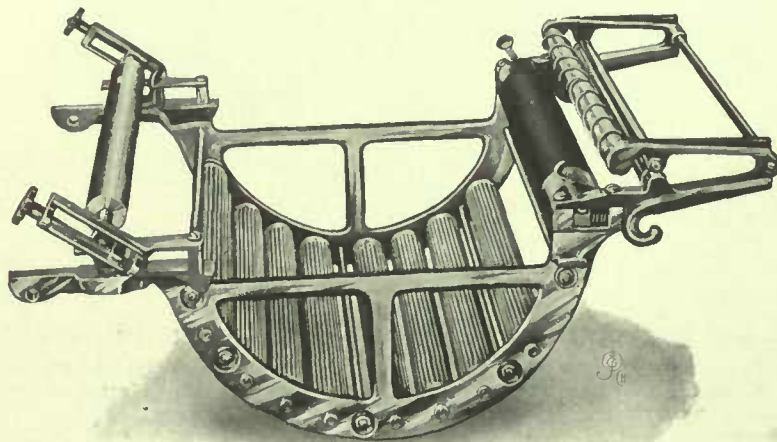

New Cradle for Bishop Collar and Cuff Starcher, with Interchangeable Bearings.
Can be furnished for any Bishop machines now in use.



THE TORONTO LINE

The Bishop Collar and Cuff Starcher

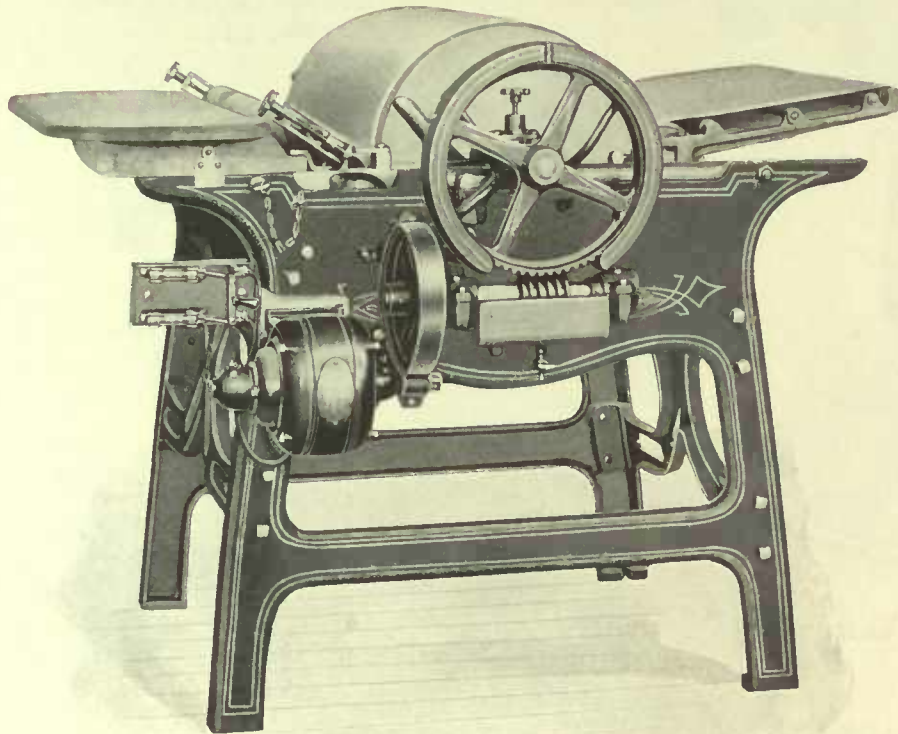

24 inch Collar Starcher, with Motor Attached. Motor, 1/8 H. P.

Electric Equipment Furnished Separately is Desired.

THE Linen Apron which serves as a carrier is very durable. It encircles the series of rollers underneath the drum, and by means of an apron adjuster it can be tightened or loosened at will.

The Wiping Roller effects a decided economy, as the pieces come out of the machine so smooth and straight that little labor of this nature is necessary.

All parts coming in contact with the starch are made of brass or copper.

The simplicity and durability of this machine, the clear working method, the easy access for cleaning, and the large capacity, make this Collar and Cuff Starcher far superior to any other machine of its kind on the market.

To open machine, throw back the gear guard, fold over apron carrier, remove feed board, unlock machine, throw back drum, lift up cradle.

To remove apron, take out side pins attached to chains and lift entire cradle out of tank.

To clean machine, draw off starch, fill with water, turn on steam, let machine run for a few minutes, then draw off water.

Remove covering at night, putting a clean piece of mangle cloth on the next morning. To cover cylinder, use one turn of mangle cloth and three turns of cheese cloth.

Keep machine full of starch while in use, and keep starch hot. Use from 14 to 16 ounces to the gallon.

Regulate the pressure by adjusting the thumb screws on each side of the cylinder. Adjust the wiping roll by means of the two small thumb screws, one on each side.

Clean machine thoroughly (with Sapolio) before using first time.

SPECIFICATIONS

Size	Number Belt Driven	Number Motor Driven	Floor Space	Weight lbs.	Case Dimensions Cubic Feet	Capacity Per Hour	Speed	Pulleys Inches	Belt Inches Width
14	258	261	2 ft. 10 in. x 4 ft. 10 in.	350	30	1000	150	6 x 3	1 1/4
18	259	262	3 ft. 2 in. x 4 ft. 10 in.	372	37	1500	150	6 x 3	1 1/4
24	263	260	3 ft. 8 in. x 4 ft. 10 in.	400	50	2000	150	6 x 3	1 1/4



THE TORONTO LINE

Toronto Improved Shirt Starcher

No. 244

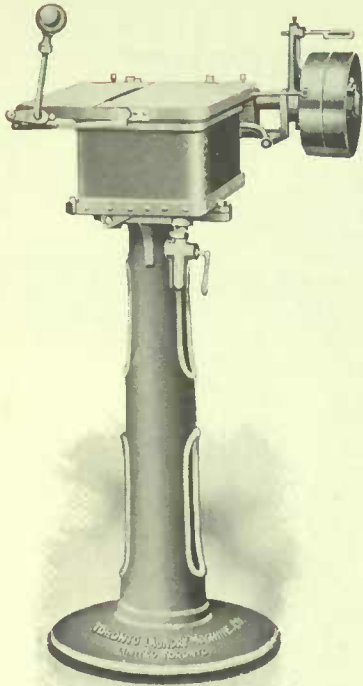

Side View

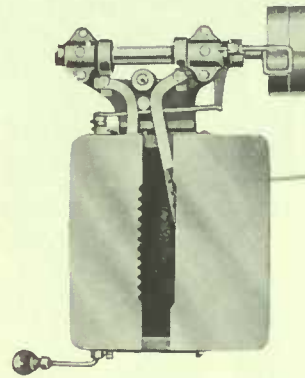

Top View

THE RUBBING mechanism on this Starcher is the simplest and best ever used. It consists of two cams pushing against the rubbing arm. It is noiseless, not liable to wear, and if it does wear, simple means are provided for adjustment.

We equip the machine with rubbing corrugated brass paddles; rolls of wood or brass rolls can be substituted if so ordered.

The operation of starching is simplicity itself. Fill the box with hot starch, fold the shirt bosom lengthwise, placing the wristbands against the folded bosom, submerge the parts to be starched in the opening, then close and lock the lid by throwing the handle, which starts the machine automatically leaving the operator free to get the next shirt ready and wipe off one previously starched; the shirt will be starched in 15 or 20 seconds. When done, unlock and swing lid to side; this action stops the machine. When the shirt is raised and the surplus starch is squeezed out it is ready to be wiped off. Then hang up to dry; always keep the starch hot (this starcher has a steam chest in bottom of box) it will work through the goods better and quicker than when cold.

The pulleys are 8 x 3½ inches; speed, 250 revolutions; belt, 1½ inches; floor space, 28 x 24 inches; weight, 150 pounds; case dimensions, 22 cubic feet.



THE TORONTO LINE

Toronto Improved Curved Board Shirt Starcher

No. 245.

With Indestructible Brass Roll.

The Machine that Starches to a Line

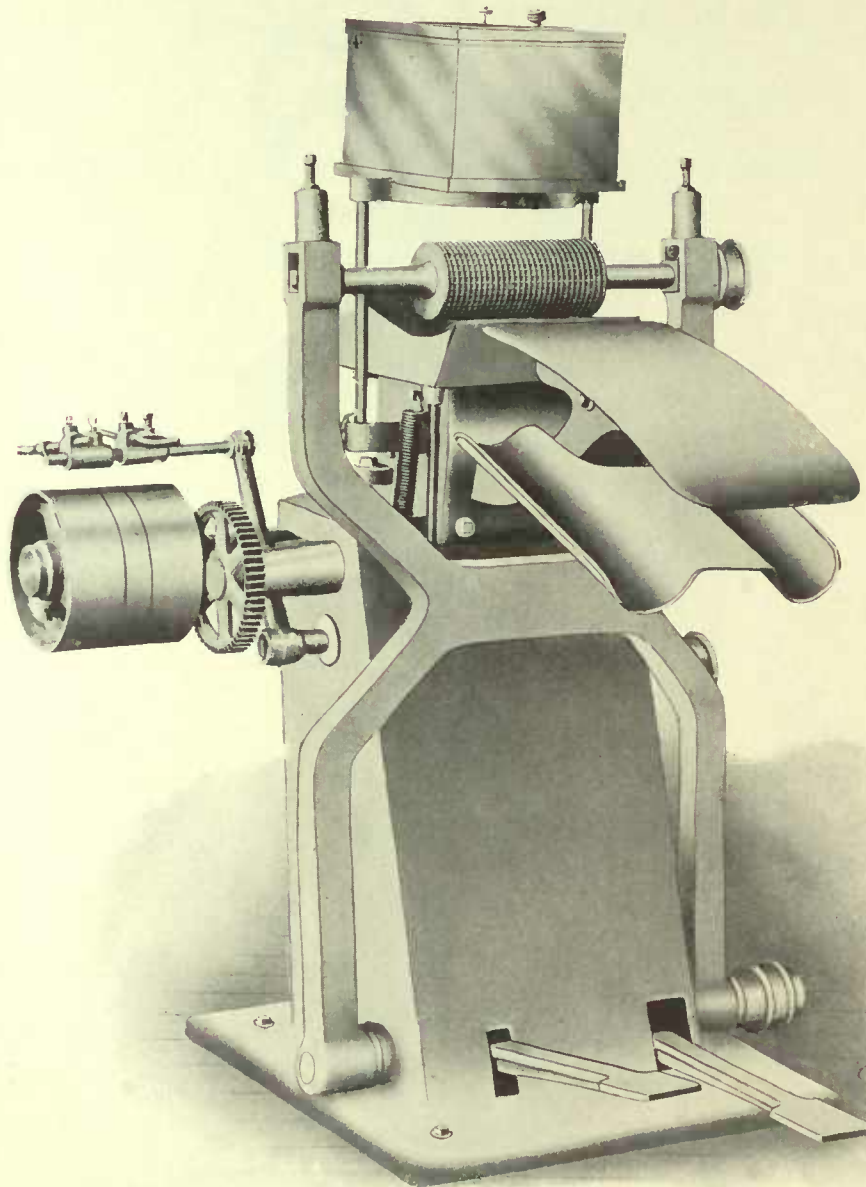

IN placing this machine before the public we are satisfied that it will be appreciated by the laundryman as filling a long felt want. In this machine you have combined a machine that is substantial, that does the work, that is noiseless, easy to operate, and that saves fully 25 per cent. of your starch bills, as this machine puts the starch only where it is needed. We have a number of improvements in our machine. One steam pipe heats steam chest, under reservoir, starch pan, and under board. Both starch pan and reservoir are removable, permitting of the proper washing of same—a distinct feature of our machine. The roll revolving in the opposite direction from the way it travels over the board offers just enough resistance to force the starch through the goods. The machine is very simple. No complicated parts to get out of order.

SPECIFICATIONS

Pulley	Speed	Belt	Floor Space	Weight	Packed for Export
8 x 7 inches	160 revolutions	1 1/4 inches	40 x 40 inches	1200 lbs.	40 cubic feet



Toronto Wrist Band and Negligee Shirt Starcher No. 246



With Indestructible Brass Rolls.

For starching collars, cuffs, neck bands, wrist bands of negligee shirts, and ladies' waists.

PRACTICAL, SIMPLE, EFFECTIVE

Any fourteen-year-old girl can operate it—no wiping off necessary after using. Starch is put in just where it is needed, and there is no spreading or slopping to other parts of garment. The carrying roll runs continuously in the starch, a new and valuable feature, saving much time. It has a capacity of 75 dozen shirts or waists per day, which, with an operator at \$4.50 per week, means you can produce your work at ONE CENT PER DOZEN. Just compare this with your present methods.

SPECIFICATIONS

Speed Revolutions	Belt inches	Size of Pulley inches	Weight lbs.	Floor Space feet	Packed for Export cubic feet
40	13 $\frac{1}{4}$	12	200	2 x 3	26

Starch Room Specialties

Toronto Steam Heated Wiping Board, All Metal.

This Board was designed especially for wiping shirts. The Board is steam-heated, as is also the starch cup.

Weight, 120 lbs., Floor Space, 15 x 36 inches, Packed for Export, 12 cubic feet.

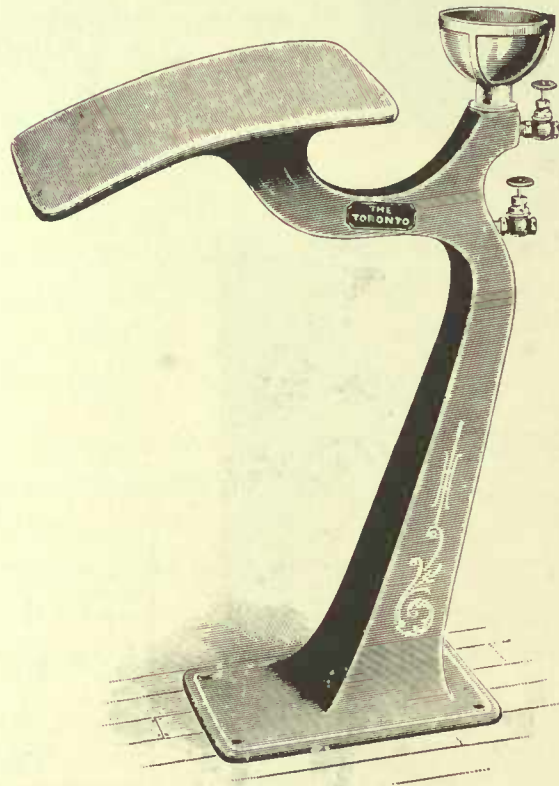

No. 256



Copper Dipper
One Quart and Three Quarts



Copper Pail
Three Gallon

Toronto Heat-Retaining Starch Cooker



SPECIFICATIONS				
Size Gallons	Number Galvanized Outside	Number All Copper	Floor Space inches	Weight lbs.
20	264	268	30 x 30	200
25	265	269	32 x 32	250
50	266	270	32 x 32	300
75	267	271	36 x 36	350



THE TORONTO LINE

Toronto Heat Retaining Starch Cooker

AFTER a thorough test has proved to be the only invention on the market for converting the raw starch into a solution for giving weight, body and perfect stiffness to linen. The inner tank is made of copper, slightly slanted to draining valve at the bottom. This copper tank is marked inside with a graduating scale for measuring water. Around the copper tank is another tank made of heavy galvanized metal. Between the two tanks is a four-inch space which is filled with a non-radiating material and prevents the loss of heat and keeps the starch at a temperature within a few degrees of the boiling point for fourteen hours without any addition of steam. This four-inch wall is twice the thickness found in most other cookers.

The condenser on side of cooker absolutely abstracts all condensation, delivering only perfectly dry steam to the bottom of the inner tank in such a manner as to spray, thus thoroughly agitating and breaking the starch globules, making a perfect starch solution. A guage glass has also been added to the condenser showing at a glance the amount of condensation.

The hinged cover is made double, the same as the cooker, to prevent radiation. While the starch is cooking, the dry steam enters from the bottom and goes through the solution to the top, leaving only the heat which it contained. The steam condenses on the inclined sides of the cover and instead of running back into the starch, all this water is caught in a trough placed at the base of the incline and carried through a small drip pipe to the outside.

This machine is also made with the body of the machine constructed entirely of sheet copper.

Copper Steam Jacket Starch Kettle

Made of heavy copper, polished on outside and tinned inside. Tested to 100 lbs. pressure. Made in 5, 10, 15, 20, 25 and 30 gallons capacity.

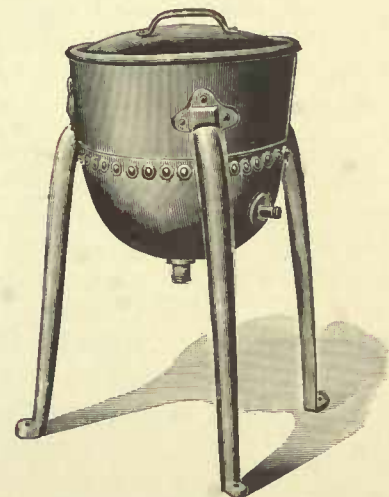

Style B

Sparrow Metallic Dry-Rooms

All Metal.

Stove Heated.

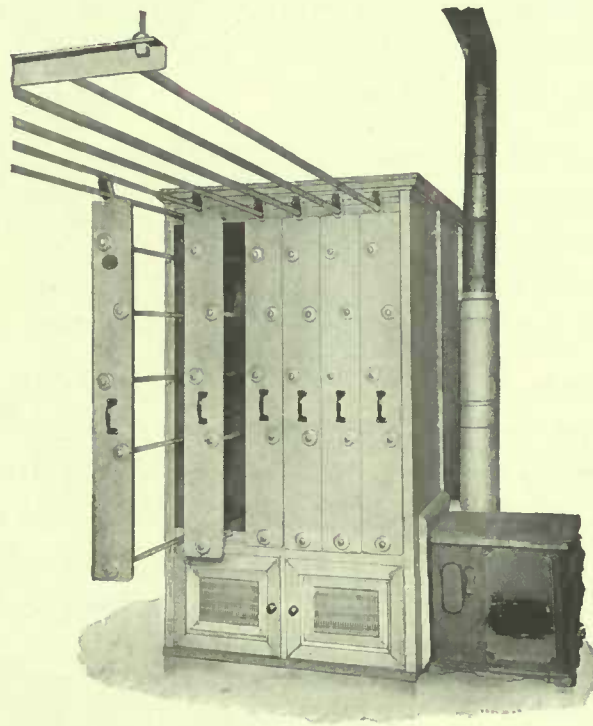

One Fire Does It All :

Boils the Clothes.

Dries the Clothes.

Heats the Irons.

Heats the Pressure-Boiler.



Sparrow Metallic Dry-Rooms

SOME DESIRABLE FEATURES.

MADE of galvanized metal throughout ; cannot rust, corrode or stain, and is fire-proof.

The Laundry Stove furnishes a means for all requirements—*heats water, boils clothes, heats flat-irons and dries the clothes* all by *one fire*, and costing no more to operate than any ordinary stove.

Heat from the stove can be directed either to the Drier or the flue by heat-controlling device, thus shutting off radiation in the Drier when desired.

The Drier furnishes a system of ventilation that is simply perfect, and which airs and ventilates the clothes as perfectly as sunshine. No discoloration whatever. *Fresh air is constantly admitted and moisture and superfluous hot air continually carried away.*

Stove furnished with hot-water backs when ordered.

Wire racks prevent the clothes from falling in the heating drums.

The " Perfect " Clothes Drier and Laundry Stove is constructed to produce results identical with the conditions of the *most perfect out-door air, viz: quick-drying, thorough ventilation and the removal of all moisture and impurities.*

The amount of space occupied is very small in comparison with the large amount of work to be accomplished, each rack being equal to 35 feet of line.

By a most perfect ventilating system but one flue is required for both stove and Drier use. The heat from the smoke-pipe and flue is used to force a continuous ventilation.

The " Perfect " Driers are made to fit any room and almost any space. They are built in size according to requirements. Each Drier is made for the room in which it is to be placed, built in length, height and general form to most conveniently suit the respective room. In planning the machine for the given room, we endeavor to build the same as near 7 feet 6 inches in length (exclusive of the space to draw out racks) as possible, but can make them much shorter. The racks can be drawn out by a doorway or window without any interference, as the traveler bars are generally a few inches from the ceiling, and the hanging racks, when in use, are only pulled out for a few moments at a time for the removal of any garment.

Our extended experience is planning machines for laundry rooms of all sizes and shapes, if furnished with a rough sketch of the laundry room, with measurements, showing doors, windows, tubs, flue, height of ceiling and size of house or institution, will enable us and we will be pleased to return a working drawing, showing a machine of proper size planned to suit the room, for the prospective purchaser's approval, for which we make no charge. We earnestly solicit the same, and extend thanks for the privilege to submit our proposition for the erection of our " PERFECT " LAUNDRY DRIER.

Made also for Steam or Gas, and in all Widths for Any Purpose Required.

Toronto Sectional Dry-Rooms

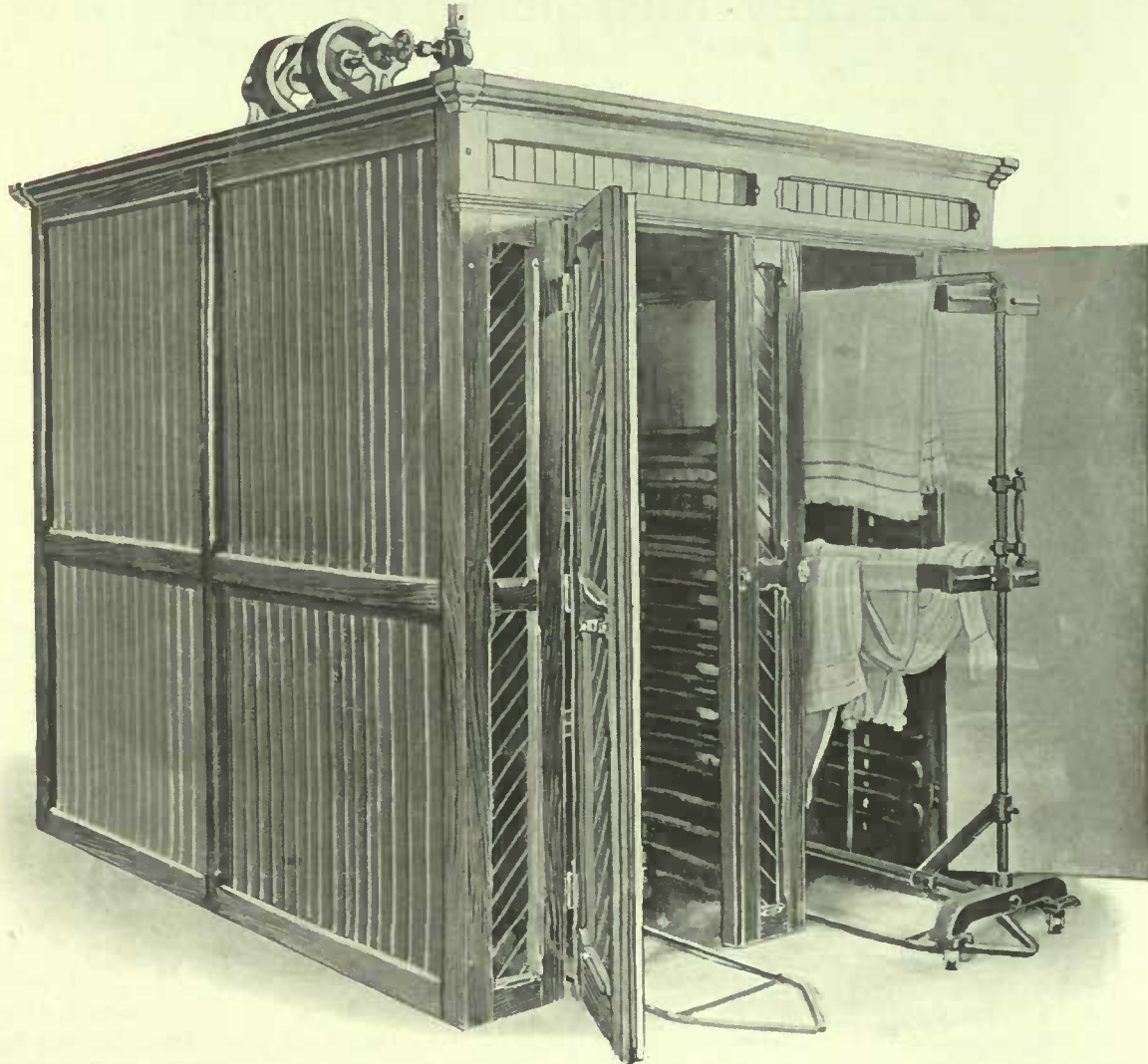

DIMENSIONS AND CAPACITIES
Wood or Metallic

Number		No. of Sections	No. of Trucks Dry-Room Holds	No. of Trucks Sent with Dry-Room	Capacity per Day in Shirts Dozen	Capacity per Day in Collars and Cuffs Dozen	Front	Depth	Height Over All	Shipping Weight Wood lbs.	Shipping Weight Metallic lbs.
All Wood	All Metal										
272	247	1	2	3	75	750	6 ft. 9 in.	8 ft. 4 in.	7 ft. 3 in.	3,000	2,300
273	248	1½	3	4	110	1,100	10 ft. 0 in.	8 ft. 4 in.	7 ft. 3 in.	4,500	3,400
274	249	2	4	6	150	1,500	13 ft. 6 in.	8 ft. 4 in.	7 ft. 3 in.	6,000	4,600
275	250	3	6	8	225	2,250	20 ft. 3 in.	8 ft. 4 in.	7 ft. 3 in.	9,000	6,900
276	251	4	8	12	300	3,000	27 ft. 0 in.	8 ft. 4 in.	7 ft. 3 in.	12,000	9,200
277	252	5	10	14	375	3,750	33 ft. 9 in.	8 ft. 4 in.	7 ft. 3 in.	15,000	11,500
278	253	6	12	16	450	4,500	40 ft. 6 in.	8 ft. 4 in.	7 ft. 3 in.	18,000	13,800
279	254	7	14	20	525	5,250	47 ft. 3 in.	8 ft. 4 in.	7 ft. 3 in.	21,000	16,100
280	255	8	16	22	600	6,000	54 ft. 0 in.	8 ft. 4 in.	7 ft. 3 in.	24,000	18,400

For furnishings sent with each Dry-Room, see page 111.



Toronto Sectional Dry-Rooms

THE importance of drying in laundry work cannot be over-valued by the owner who would be successful. Whether he realizes it or not, he will soon come to know that this process has a distinct bearing on all subsequent work.

Goods properly dried are half ironed, and our Sectional Dry-room dries them properly. As a natural result, enterprising laundrymen throughout the country are fast adopting this system of drying. As all classes of work may be dried to advantage on this Dry-room, it does not interfere with our Automatic Conveyor Dry-room, which may be classed as a specialty. Each compartment is arranged for two trucks, and has three coils, one on each side of room and one in center. The interior is lined with abestos, covered with tin.

A fan in center of top of Dry-room provides for the circulation of air, and is driven by a countershaft on the roof of Dry-room.

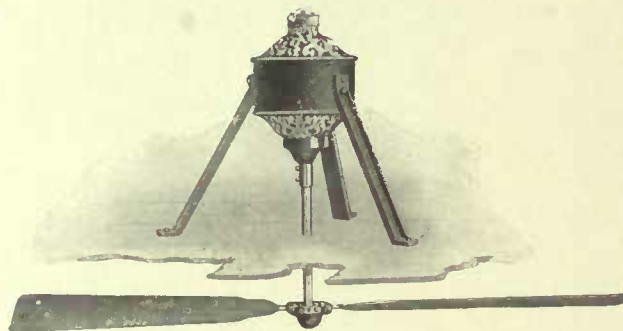

Direct Connected Vertical Motor Fan.

We are prepared to supply a direct connected vertical motor fan as illustrated above for direct current only either 115 or 230 volts. This fan may be attached to an ordinary lamp socket if desired. This makes an ideal arrangement and adds only slightly to the cost of the dry-room.

The Dry-room is knocked down and shipped in convenient sized sections so that they can be readily handled, and each part is plainly marked, thus facilitating erection.

The cabinet is made of first quality selected kiln dried oak. The lining makes it absolutely fire proof and heat retaining. It is handsome, durable and perfect in every detail.

Pulley on Countershaft, 10 x 3 inches. 150 revolutions. Belt 2½ inches.

Toronto Sectional Dry-Rooms

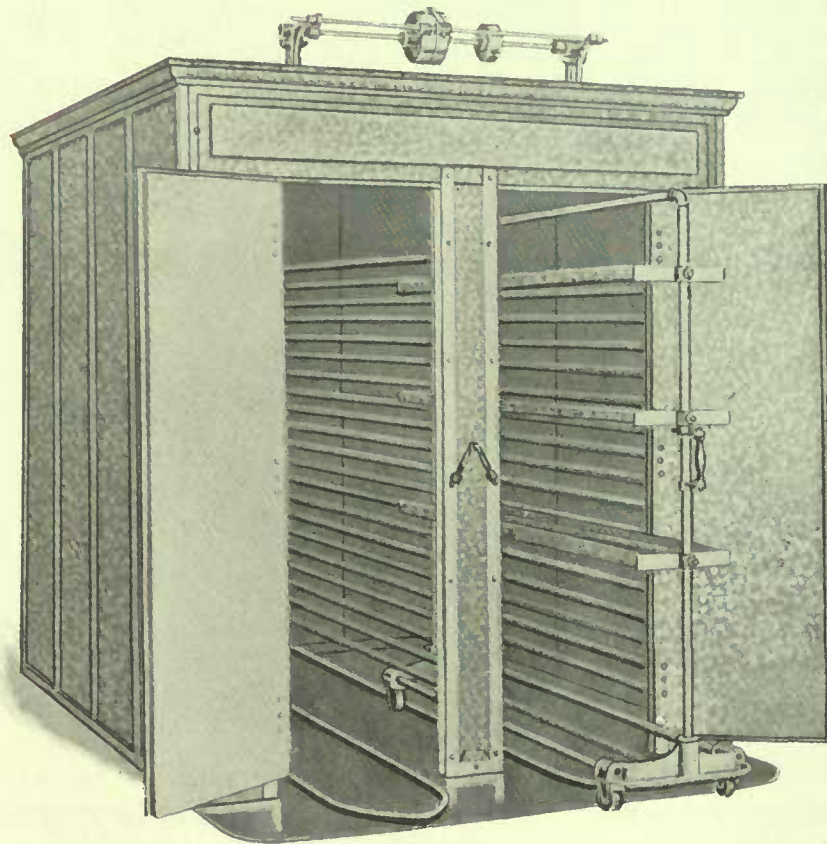

All Metal Sectional Dry-Room.



Toronto Sectional Dry-Rooms

All Metal.

THE All Metal Dry-Room shown on the opposite page is made of two thicknesses of heavy, galvanized iron, with a non-radiating, dead air space of one inch between the layers. The Metallic Dry-Room has only that advantage of durability, such as metal possesses over wood, and a slight difference in weight in favor of the metal room.

WHAT WE FURNISH.

With either the Metallic or Wooden Dry-Room we furnish: Three coils of $1\frac{1}{4}$ inch pipe, 19 pipes high, tested to 150 lbs. hydraulic pressure; fan and countershaft for the top of dry-room, the fan being driven by a quarter twist belt from countershaft; countershaft is complete with two pulleys, 10 inches diameter, 3 inches face, one to drive the fan, and the other being the drive pulley on counter and should make 150 revolutions per minute; three all metal trucks with four 3-inch Anti-Friction castors and handles at each end; 28 wooden bars; 100 shirt hangers, and one gross brass cup hooks for collars. At a slight additional cost we can supply metal instead of wooden bars.

All the purchaser is required to furnish is: steam connections to and from the coils, power to countershaft and belting.

The specifications on pages 108 and 109 cover the Metal Dry-Rooms as well as the Wooden room.

A direct connected vertical motor fan as illustrated and described on page 109 may be attached to the all metal dry-room as well as the wood sectional dry-room.

Toronto Automatic Conveyor Dry-Rooms

Perfection in Clothes Drying.

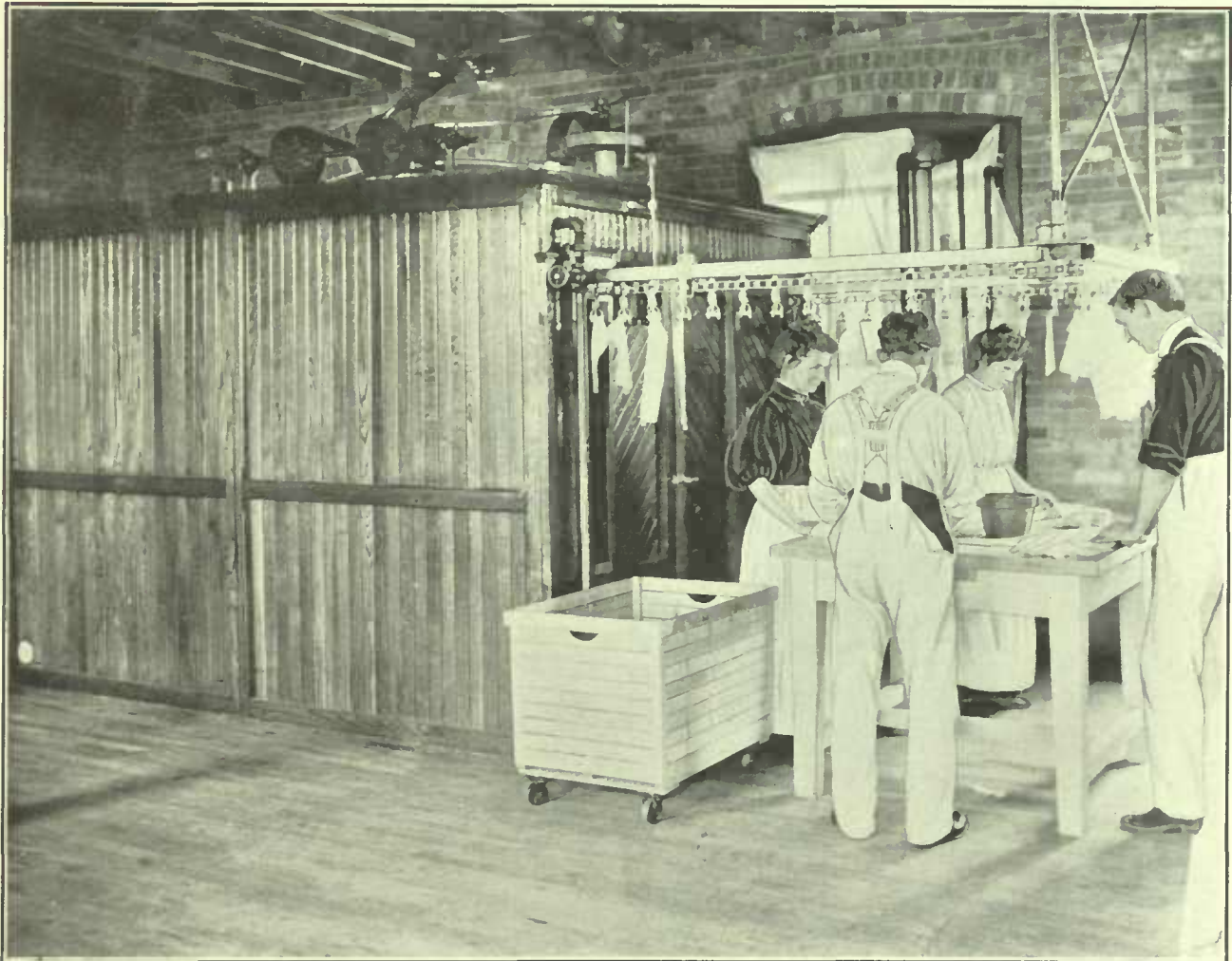



Toronto Automatic Conveyor Dry-Rooms

FOR the benefit of laundrymen not familiar with the merits and operation of this machine, we will briefly describe the same. The steam coils are placed upon the sides and back of the dry-room. The steam entering at the top of one side, and after passing through the continuous coils, leaves at bottom of coils upon the opposite side. We use no headers in the dry-room, the coils being connected at the back by brass seated unions, thus making it possible to place coils in position in a very few minutes, and also allows for the removal of any one of the pipes. A circulating fan is placed in the center of the top of dry-room to circulate the air and distribute the heated air evenly. The conveyor upon which the goods are hung is operated by a header placed upon the top of dry-room. The goods are hung upon the conveyor and pass into the dry-room, one piece at a time, passing back and forth through the room until they emerge upon the opposite side from which they entered, having been subjected to the same temperature during the entire trip, and being only so many minutes inside the dry-room, just sufficient time being allowed by the driving mechanism to thoroughly dry the goods. Each article, immediately upon leaving dry-room, is automatically lifted from the hook and dropped into basket placed to receive it. The shirt and collar starching machines should be so arranged in front of room, that the operators may hang the goods directly upon the chain.

The electric signal notifies you of the different lots, specials, etc., and never forgets. To use the words of one of our customers, "It does everything but talk."

These dry-rooms, by reason of their speed, cleanliness, reliability and labor saving qualities, have appealed most strongly to the trade as representing the highest development in modern methods of drying clothes. The Conveyor Dry-Room is used to the best advantage in drying collars and cuffs, the purpose for which it was originally designed. We can, however, supply these rooms with much heavier German Silver hooks for carrying heavy goods, rough, dry and fancy clothes, or with Special No. 3 Rough Dry and Fancy Goods chain.

The capacity, per trip of 30 minutes, of the dry-room, as given in the table of capacities, is based upon a steam pressure at the dry-room of 80 lbs. properly trapped, and is governed only by the conditions under which the rooms are operated, their location, steam pressure, etc. To our knowledge more than 100 per cent. increase over the rated capacity has been obtained under proper conditions. Practically any capacity may be secured in one dry-room by combining any two of the different sizes in tandem as shown on page 118. By this method a greater capacity is obtained than the total combined capacities of the two rooms for the reason that the room into which the goods first pass evaporates the major portion of the moisture and after leaving the first room and entering the second they are subject to an intense dry heat.



THE TORONTO LINE

Toronto Automatic Conveyor Dry-Rooms

Four Loop Independent Frame Work.

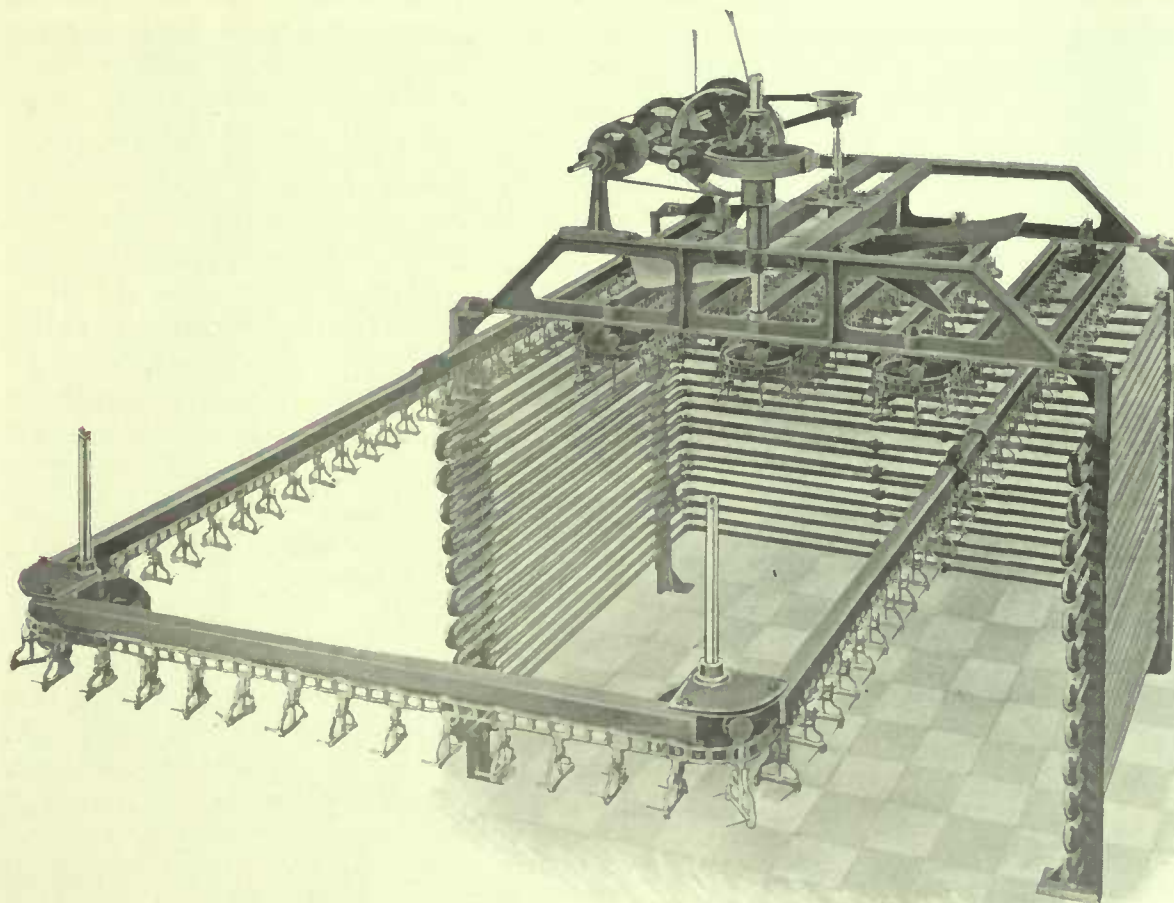



Toronto Automatic Conveyor Dry-Rooms

DETAILS OF CONSTRUCTION

INDEPENDENT FRAME consists of four steel channels securely bolted to two cast iron bridges which are also bolted to two tie beams, making a very rigid support for the conveyor tracks and chain as well as the driving mechanism for fan and operating header. The header and fan pulley are so arranged that they will take the belts from any direction. This is accomplished by merely swinging the header around in its bearing and tightening the same at the proper angle for belts. The starting and stopping device is clearly shown in cut, consisting of a lever conveniently placed for the operator. There is no connection whatever between the woodwork and iron frame of this machine, the wood being only used to keep out the dust and retain the heat.

CHAIN. The chain is composed of No. 45 Link Chain Belting with Phosphor Bronze Hangers, all heavily tinned. Each hanger is fitted with renewable German Silver Hook. The chain is made up in three styles, No. 1 chain has light German Silver Hooks for collars and cuffs. No. 2 chain has heavy German Silver Hooks and is for Shirts and Fancy Goods. No. 3 chain is designed especially for Fancy Goods and no hooks are required.

TRACK. The track upon our new type of Automatic Conveyor Dry-room is entirely self contained. Being supported entirely from the Dry-room itself. The steel track is formed to the required shape and is made especially for Automatic Dry-rooms.

CABINET is made of selected, matched red oak, lined with sheet asbestos and covered inside with heavy block tin, with all joints locked.

SIMPLICITY, these rooms are simple—although automatic, and combine in the highest degree, skilled labor, time and space saving qualities, together with greatest efficiency.

WORKMANSHIP upon these rooms is careful and conscientious, all complicated parts are eliminated, with the result that we have produced a dry-room of the highest order, that will dry perfectly and quickly and is both handsome and durable.

GUARANTEE. This machine is sold under a guarantee for twelve months from date of purchase, to be free from inherit defects in workmanship or material, and the Company will repair or replace any such defects which may develop under normal and proper use within the above time, provided that this machine shall not have been taxed beyond its normal capacity, and shall have been operated in accordance with the Company's instructions.

SETTING UP AND OPERATING

We send full instructions for the setting up and operating of the dry-room.

These rooms are all set up and thoroughly tested before leaving the factory, are all numbered and crated, and can be re-erected by any ordinary mechanic.

When equipped for individual motor drive we supply a 1-H.P. Motor for this purpose.

The Fan may be also directly driven by a Vertical Motor of $\frac{1}{8}$ -H.P.

Toronto Automatic Conveyor Dry-Rooms

4 Loop Automatic Dry-Room

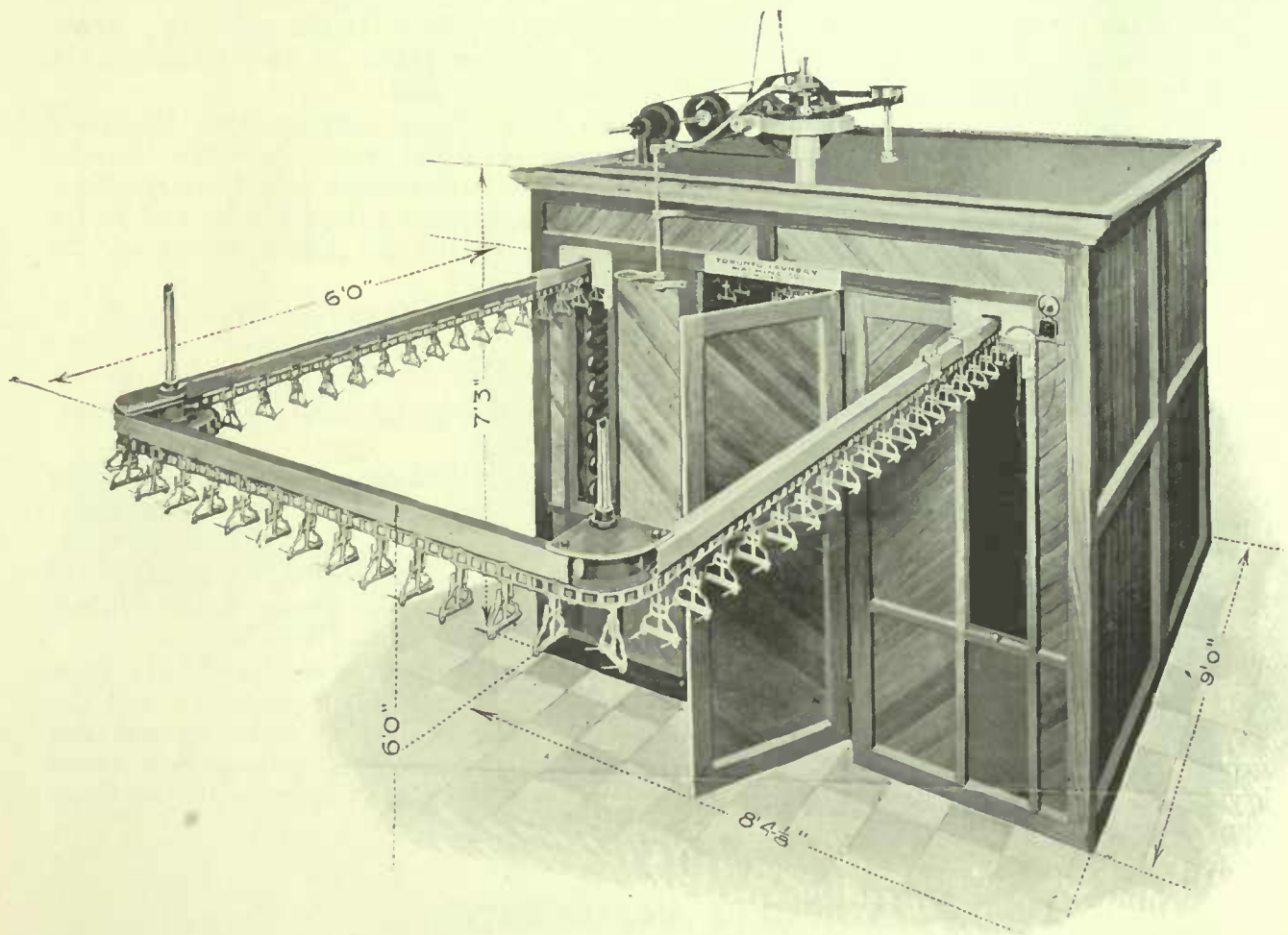



Toronto Automatic Conveyor Dry-Rooms

GENERAL DETAILS								
No.	Loops	R. P. M. of Header Pulley	Size of Drive Pulley for Header inches	Header Belt inches	Fan Belt inches	Diameter of Fan Pulley inches	Weight	Number of Fans
154	2	35	4 x 3	3	2	6	3200	1
155	2	40	4½ x 3	3	2	6	3300	1
156	2	50	5 x 3	3	2	6	3500	2
157	2	70	7 x 3	3	2	6	3900	2
158	3	46	5 x 3	3	2	6	3500	1
159	3	53	5 x 3	3	2	6	3700	1
160	3	68	7 x 3	3	2	6	4100	2
161	3	98	10 x 3	3	2	6	4900	2
162	4	66	7 x 3	3	2	6	4300	1
163	4	76	7½ x 3	3	2	6	4600	1
164	4	96	10 x 3	3	2	6	5200	2
165	4	136	14 x 3	3	2	6	6400	2
166	5	89	10 x 3	3	2	6	5300	1
167	5	105	12 x 3	3	2	6	5600	1
168	5	135	14 x 3	3	2	6	6200	2
169	5	180	18 x 3	3	2	6	7400	2

The sizes of the driving pulleys for the header as given above are figured upon the full trip being made in thirty minutes and all rooms are shipped fitted with the above mentioned pulleys unless otherwise ordered.

Countershaft is intended to be run at 150 R. P. M.

Driven Pulley on Countershaft is 16 x 3 inches.

Diameter of Countershaft is $1\frac{3}{8}$ inches.

Pulley on Countershaft to drive Fan is 10 x 3 inches.

Pulley on Header is 16 x 3 inches.

Steam Feed Connections on all Dry-Rooms, $1\frac{1}{4}$ inches.



Toronto Automatic Conveyor Dry-Rooms

Combination of Two Three Loop Dry-Rooms in Tandem

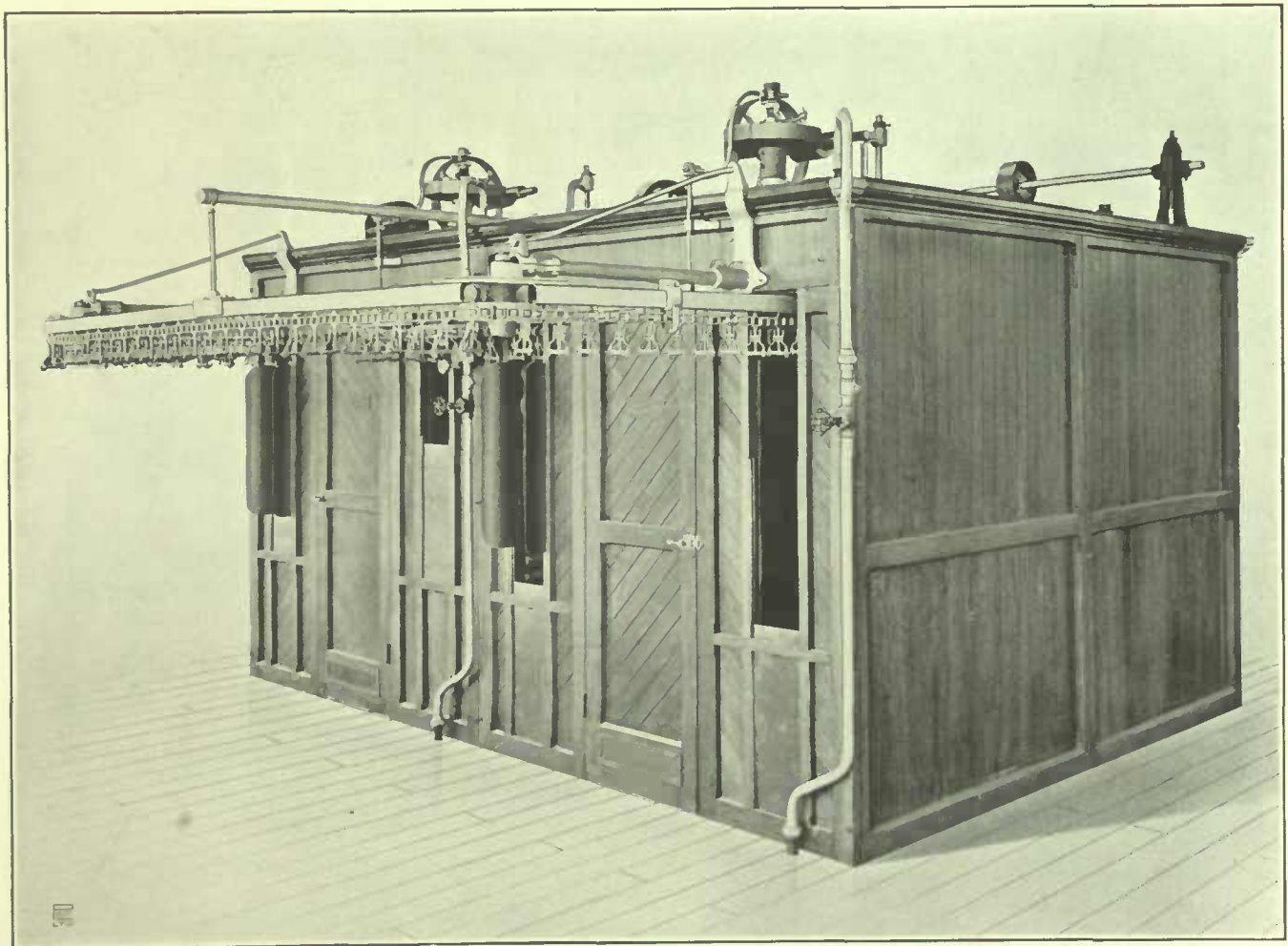

New Type Self Contained Track



Toronto Automatic Conveyor Dry-Rooms

DIMENSIONS, CAPACITIES, ETC.											
No.	Loops	Depth feet	Feet of Chain	Links	Hanger	Links Inside	Hangers Inside	Shirts Inside	Collars Inside	Feet 1½ Pipe	Heating Surface sq. feet
154	2	9	47	230	115	152	76	76	152	440	190
155	2	10	51	250	125	170	85	85	170	484	210
156	2	12	59	290	145	206	103	103	206	572	250
157	2	16	75	370	185	278	139	139	278	648	280
158	3	9	62	307	154	228	114	114	228	473	200
159	3	10	68	337	169	255	127	127	255	517	221
160	3	12	80	397	198	309	154	154	309	605	260
161	3	16	104	517	244	417	208	208	417	781	340
162	4	9	78	385	192	304	152	152	304	500	220
163	4	10	86	425	213	340	170	170	340	544	231
164	4	12	102	505	252	412	206	206	412	632	280
165	4	16	134	665	332	556	278	278	556	808	350
166	5	9	95	468	234	380	190	190	380	550	240
167	5	10	105	518	259	425	212	212	425	594	260
168	5	12	125	618	309	515	258	258	515	682	300
169	5	16	165	818	409	695	347	347	695	858	371

The figures under the headings SHIRTS INSIDE and COLLARS INSIDE, also represent the capacity in Shirts and Collars of each of the different sized Dry-Rooms over trip of thirty minutes.

The TRACK extends beyond the front of each Dry-Room 6 feet.

Dimensions of Cabinets.

- 2 Loop Front, 4 feet 9½ inches. Height, 7 feet 3 inches. Depth, 9, 10, 12 and 16 feet.
- 3 Loop Front, 6 feet 6¾ inches. Height, 7 feet 3 inches. Depth, 9, 10, 12 and 16 feet.
- 4 Loop Front, 8 feet 4¼ inches. Height, 7 feet 3 inches. Depth, 9, 10, 12 and 16 feet.
- 5 Loop Front, 10 feet 1¾ inches. Height, 7 feet 3 inches. Depth, 9, 10, 12 and 16 feet.

Toronto Lace Curtain Dry-Rooms

With Metal Adjustable Curtain Frames.

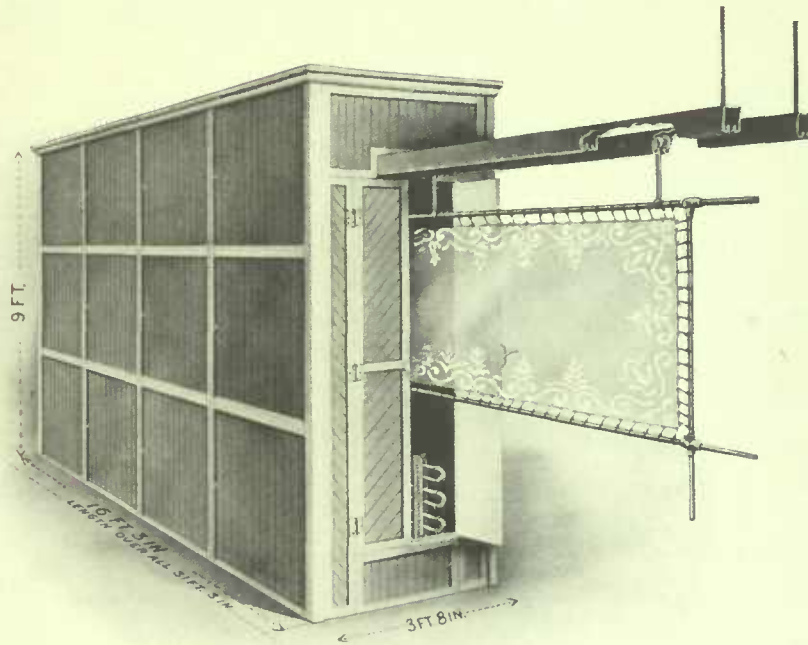

No. 303

THE outer cabinet of the Curtain Dry-Room is constructed of selected Oak, lined with asbestos and covered with heavy block tin, with all joints securely locked.

There are two coils of $1\frac{1}{4}$ inch pipes, six pipes high, extending the length of the Dry-Room. These coils are placed on each side near the floor. No fan is required in this room. Otherwise the construction is very similar to the sectional Dry-Room shown on pages 108 and 109. Two metal adjustable curtain frames are fitted with trolleys and the curtain frames are drawn in and out of the Dry-Room by means of the trolleys operating in the Coburn trolley track which is attached to the Dry-Room as shown in illustration.

SPECIFICATIONS				
Length	Height	Width	Weight	Steam Connections
16 ft. 3 in.	9 ft.	3 ft. 8 in.	2500 lbs.	$1\frac{1}{4}$ in.

Toronto Lace Curtain Dry-Rooms

With Horizontal Padded Surfaces.

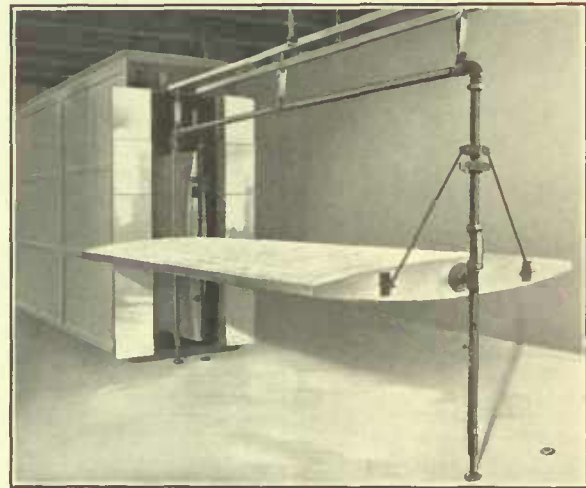
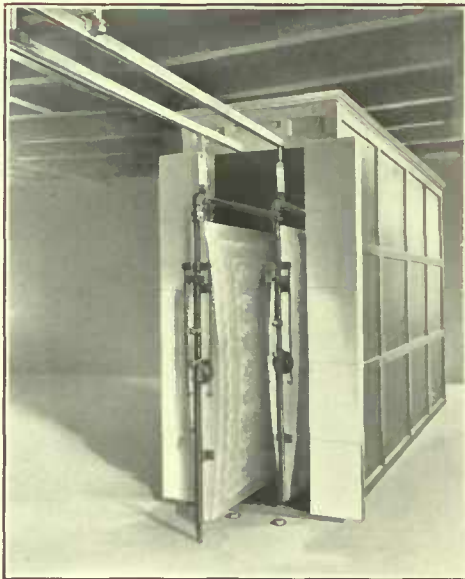

No. 304

THE accompanying illustrations of our new lace curtain dry-room very clearly show the many original features which it embodies. The outer cabinet, the coil and the trolley track are the same as described on page 120, but this dry-room has two padded surfaces each 6 feet wide, 12 feet long. There are two surfaces on each rack, making in all four surfaces upon which the curtains may be pinned. This dry-room is a combination of the cabinet dry-room and the box type of curtain dryer, but it has a special advantage over the latter in that the operators when pinning the curtains on the padded surfaces are away from the heat entirely. The padded surface when in a horizontal position is held perfectly rigid, and by releasing a catch it may be swung to a vertical position, where it automatically locks and is held until released. The pinning of the curtains upon the surface, which is marked into small square, is accomplished very rapidly, and as there are four of these surfaces for this purpose the capacity of this dry-room is very great.

SPECIFICATIONS				
Length	Height	Width	Weight	Steam Connections
16 ft. 3 in.	9 ft.	3 ft. 8 in.	3000 lbs.	1¼ in.

Toronto Dampening Cabinet

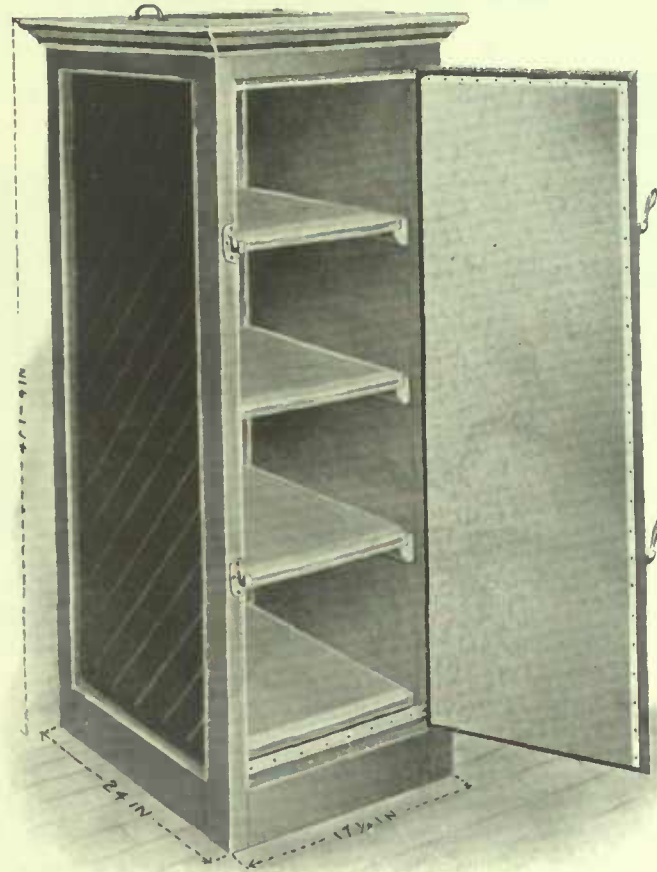

THE Dampening Cabinet preserves the clothes in an ideal state of dampness after they come from the machines. The case is constructed of selected oak, lined throughout with sheet zinc and in the bottom is a reservoir for holding water, so that the goods may be preserved in a thoroughly moist condition and kept always ready to iron. It should be placed beside the Ironer, so that the operator can open the lid and remove the goods from the top shelf as required. The shelves are removable, so that the dampened goods may be stacked on them and placed in the Cabinet. Weight, 100 lbs.

Empire Collar and Cuff Dampener

No. 282

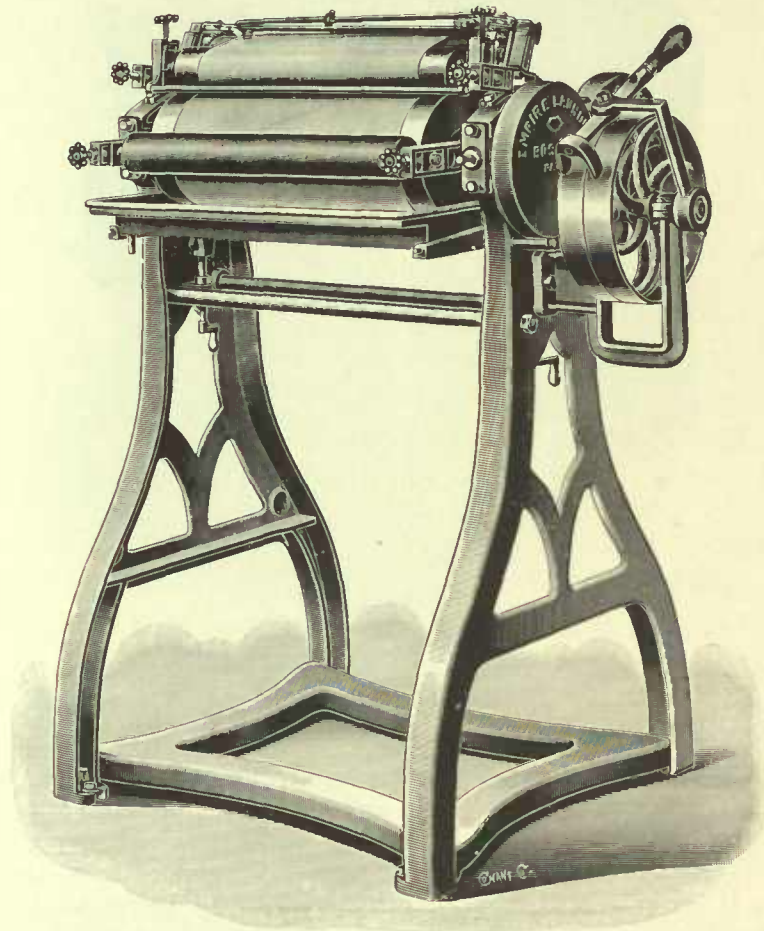

THE Empire Collar and Cuff Dampener is very simple in construction, as is shown by the cut; only one short apron is used, twenty-eight inches in length, and this is automatically guided to the center of rolls. There are only six rolls in machine, and consequently the wear on machine is minimum, and the cost of aprons almost nothing. These rolls are metallic and rubber covered, which keeps them from warping and corroding. The tanks can be removed for cleansing purposes. It is well made and occupies very little floor space. The capacity is unlimited, and there is no time lost between this machine and the Collar and Cuff Ironer.

Rolls, 19 inches; pulleys, 10 inches; belt, 1½ inches; revolutions, 80; floor space, 3 x 2 feet; weight, 175 lbs.; cubic measure, 15 cubic feet.



The Huebsch Spray Dampener



No. 283. A Dampening Tip—It's All In The Dip.

THE cut shows our Spray Dampener with pressure regulating device attached. This pressure regulating device is our latest improvement, and can be attached to any make of Spray Dampener. It produces a positive and uniform pressure. Is easily regulated to meet the requirements for the class of work to be dampened, and is so simple that any girl can handle it with very little experience. Where water conditions are not positively uniform it is a very valuable addition to any Spray Dampener as it is not affected by either water or steam pressure fluctuating. It also produces a hot spray which penetrates and seasons the clothes quicker than if dampened with a cold spray.

The union connecting with the Spray pipes is provided with a very fine strainer, which prevents the Spray Lugs becoming clogged up with any foreign matter that may be in the water. In fact it is a device that will overcome any objection that can be made to the old style of Spray Dampener.

The Spray Dampener is supplied without the Regulating Attachment as shown above and this attachment is only used where the water pressure is irregular or below 40 lbs. If this attachment is required be sure and mention this in ordering.

Without Regulating Attachment No. 284. With Regulating Attachment No. 283.



A Few Suggestions for Connecting and Operating the Spray Dampener

FOR the Spray Dampener without the regulating device it is only necessary to make water connections at the inlet and make a connection for the drain.

If Spray Dampener is equipped with pressure regulating device connect the water and steam. The valves are labelled showing the one to be connected with water and the one to be connected with steam. After making these connections connect the drain.

After the water tank is supplied with water, open the angle valve about one half turn, after which turn on the steam. After the injector picks up the water, the pressure can be regulated by increasing or decreasing supply at the angle valve. The guage showing at all times exactly under what pressure the machine is running.

To get the most uniform results, the garment should be dipped in a position to expose the largest amount of surface to the spray. For heavy garments such as skirts, etc., it might be necessary to dip two or three times.

The dampness of garments can be regulated by the amount of pressure or by the quickness of dipping same. If shirts are to be ironed by gas machines one dip at 30 lbs. pressure produces very good results. If they are to be ironed by press machines one dip at 45 lbs. produces good results. However, this can be very easily regulated by increasing or decreasing the pressure, or dipping slower or faster, whichever the case may be.

The Toronto Conveyor Shirt Dampener

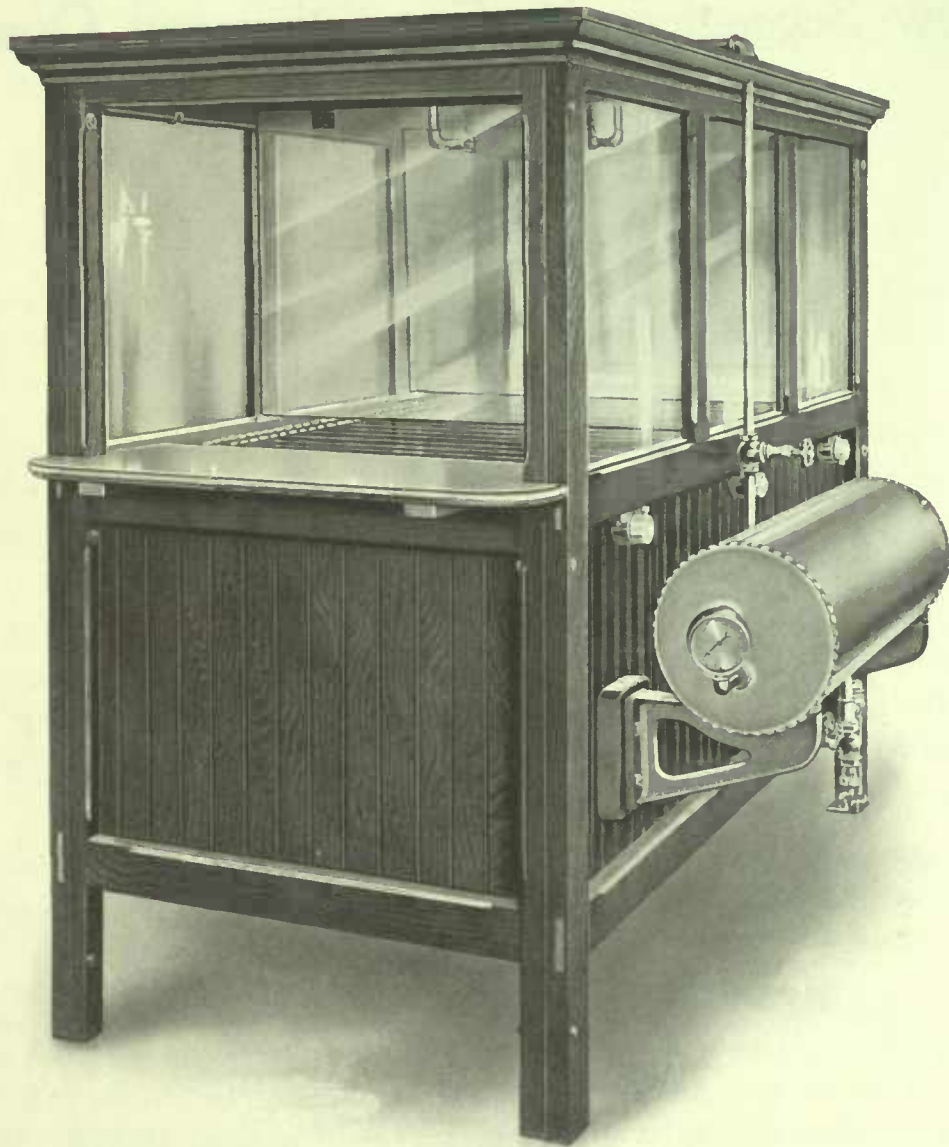

Delivery Side.

THE TORONTO CONVEYOR SHIRT DAMPENER, as shown above, positively assures an evenness of dampening which is unobtainable by any other method. The shirts are laid flat with the bosom upwards on the wire apron which carries them through the machine between a series of spray nozzles which are located above and below the apron, and the amount of moisture may be regulated to meet the individual requirement. The uniform speed at which the carrier travels gives a uniform dampness to each article, and there is no dependence upon the skill of the operator in securing this result. The shirts are fed into the machine by one operator, and the folding table is placed convenient to the delivery side so that the operator on this side may fold the goods directly from the machine.

The Toronto Conveyor Shirt Dampener



Feeding Side

THE CARRIER consists of phosphor bronze link chain with $\frac{1}{8}$ inch hard brass wire rods connecting the two chains together and forming a carrying apron which allows the spray to reach the garment from below.

THE PRESSURE TANK consists of a twenty gallon galvanized iron tank with pressure gauge. The water enters the tank from below and the supply for the spray nozzles is also taken from the tank at the bottom. A check valve is placed on the supply pipe before it enters the tank. The air in the tank is gradually compressed by the water entering and this compressed air maintains the pressure upon the spray nozzles for a considerable time, should the pressure on the supply pipe vary on account of water being used for washers etc., and which reduces for the time the pressure of the water service.

SPECIFICATIONS

Height	Length	Width	Pulleys		Speed	Belt	Weight
			Diameter	Face			
5 ft. 2 in.	6 ft. 6 in.	3 ft. 3 in.	12 in.	4 in.	12 R. P. M.	1 $\frac{3}{4}$ in.	700 lbs.

Belt Driven No. 285

Motor Driven No. 286



THE TORONTO LINE

Truck Dampening Press

No. 287.

A FEATURE

THE FOLLOW UP BOTTOM, which is a distinctive feature in THE TRUCK PRESS, assures an equality of constant pressure when the truck is removed from the press. The practical laundryman will recognize this as an important item, for the reason that goods can be dampened and run through the press previous to closing down for the night, and be found in perfect condition for ironing the following morning. One press is usually sufficient for any laundry and additional trucks can be supplied, each truck being equal in capacity to the box upon the steam or hydraulic presses. In a great many laundries a separate truck is used for the different kinds of work and the loaded truck is placed convenient to the ironers and the work taken directly from the truck as required. By this means the truck acts in the same manner as the dampening cabinet so often used, and the last article removed from the truck is still perfectly damp.

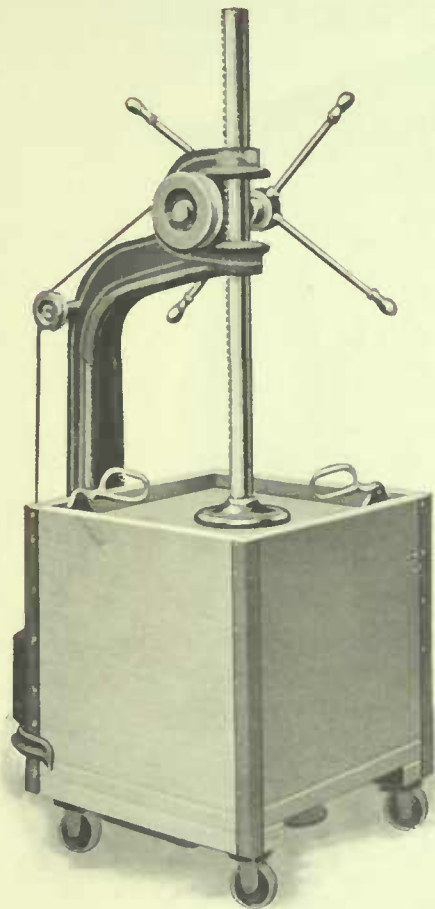

Showing Truck in Position for Applying Pressure

The Truck

Insuring Continuous Pressure.

Floor Space, 24 x 32 inches.

Weight (Press and two Trucks), 700 lbs.

Two Trucks are furnished with each Press.

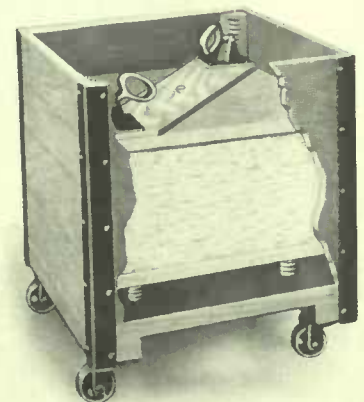

Showing Springs Under Follow Up Bottom



THE TORONTO LINE

Truck Dampening Press

A marvel of efficiency.

Unlimited Capacity.

Saves Time.

Produces uniform results with no expense for maintenance.

Leaky valves and all bothersome features of the steam press eliminated.

When the dampening truck is properly loaded the cover is placed in position and the truck run upon the platform, which operation immediately removes all pressure from the castors.

Turning the handle at right of the machine applies the pressure without any labored effort on the part of the operator.

Applying the pressure automatically locks the cover in place where it is held firmly (until released) by means of ratchet locks.

The truck does not remain in the press, but is instantly removed, thus making room for another load. Hence, the greater number of trucks in use, the more rapidly the work can be handled.



Dampening Press.

Although not shown in the above illustration, the platform of each machine is fitted with small roller which, materially helps the placing of the truck in position.



THE TORONTO LINE

Toronto Hydraulic Dampening Press

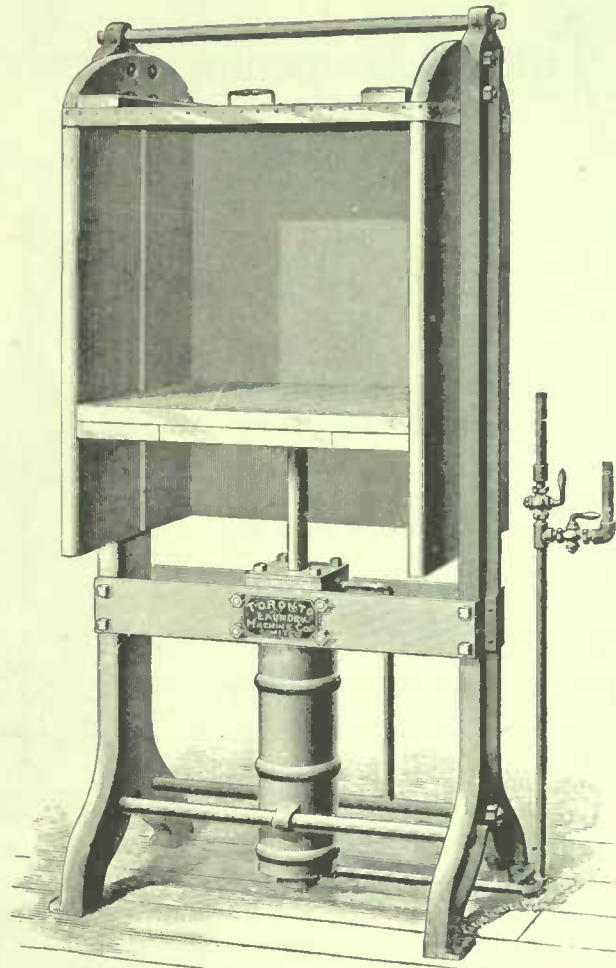

No. 288

THE cardinal points of a press are strength, ease of operation, durability and economy. The full pressure is applied by merely turning the valve, and is always exerted, thus overcoming the trouble occasioned by the dampener operator forgetting to give the press an extra turn after the goods have been in five or ten minutes.

It follows up the goods as they become packed, and requires no further attention until they are to be removed.

We make this machine with 5-inch cylinder for use at any pressure of water.

The box is 22 inches wide, by 20 inches deep, by 24 inches high.

Shipping weight, 375 lbs.; packed for export, 26 cubic feet.

Clothes Sprinklers and Spray Nozzles



Goose Neck



Fig. 197

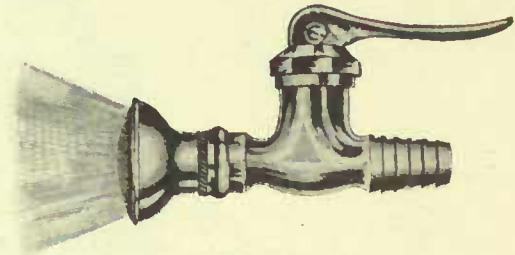

Straight

Auto-Pop Spray Nozzle.

AUTOMATICALLY controls the spray. The lever opens and closes the valve at the same time working a cleaning needle through the nozzle aperture, making it self-cleaning.

The above attachments are especially suitable for the dampening of fancy goods.

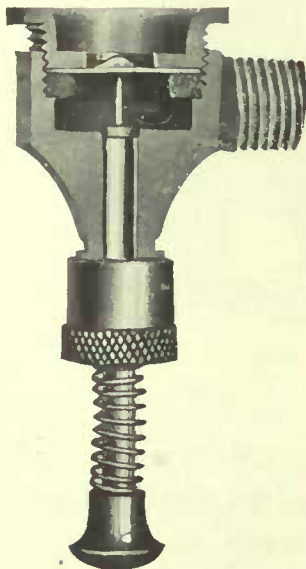

Fig. 255
Sectional View DuSpray Nozzle



Fig. 259

DuSpray Nozzles.

The DuSpray Nozzle throws a very fine bell-shaped spray, furnished with brass disc through the aperture of which a Degorgen Stem is passed for cleaning. By pressing the plunger down in cut the needle passes through the aperture and cleans the same. This type of spray nozzle is used upon The Toronto Conveyor Shirt Dampener and has also been used with success upon the Spray Dampener on account of the easy cleaning feature.



THE TORONTO LINE

Sharp's "F" Collar and Cuff Ironer

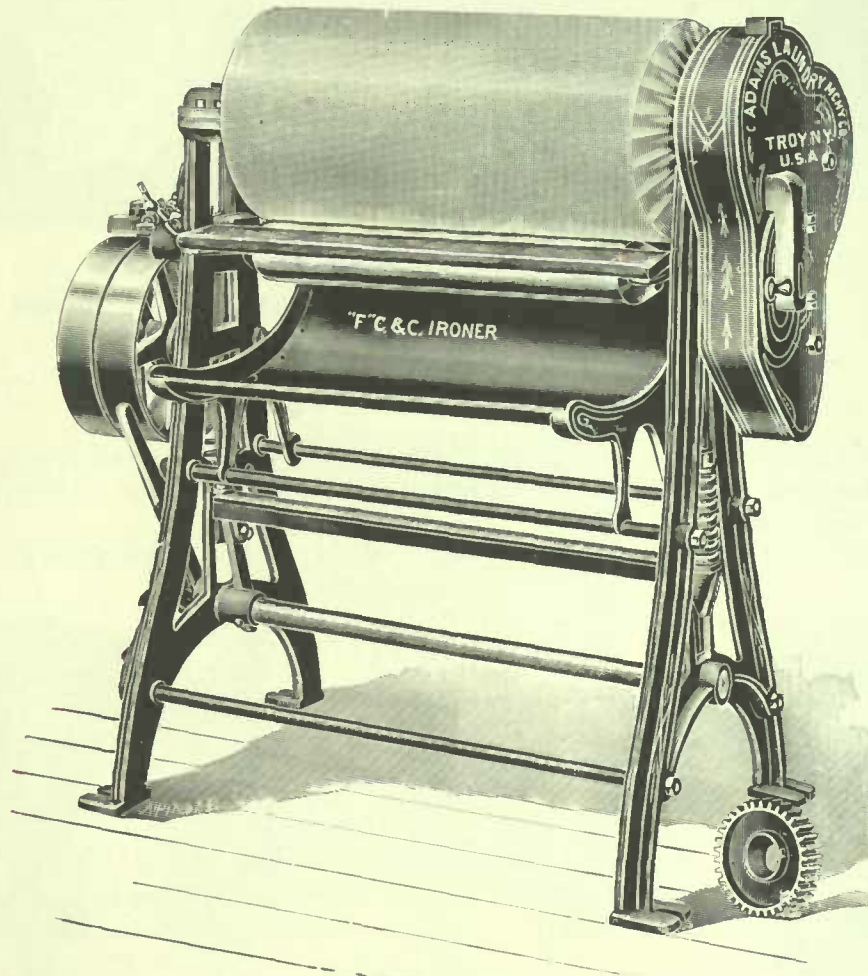

FOR use in small laundries, hotels, etc., requiring but one operator, and having an ironing surface of 24 inches. Two styles are made—one for domestic and medium gloss, and the other for medium and high gloss. Finish desired should be specified. Can also be used for ironing towels, pillow slips, handkerchiefs, etc.

These Ironers are gas heated; specify if burner is for natural, city or gasoline gas.

SPECIFICATIONS					
Number	Speed	Diam. of Pulley	Face of Pulley	Weight	Floor Space
289	55	14 in.	3 in.	550 lbs.	24 x 48 in.

Sharp's "C" Collar and Cuff Ironer

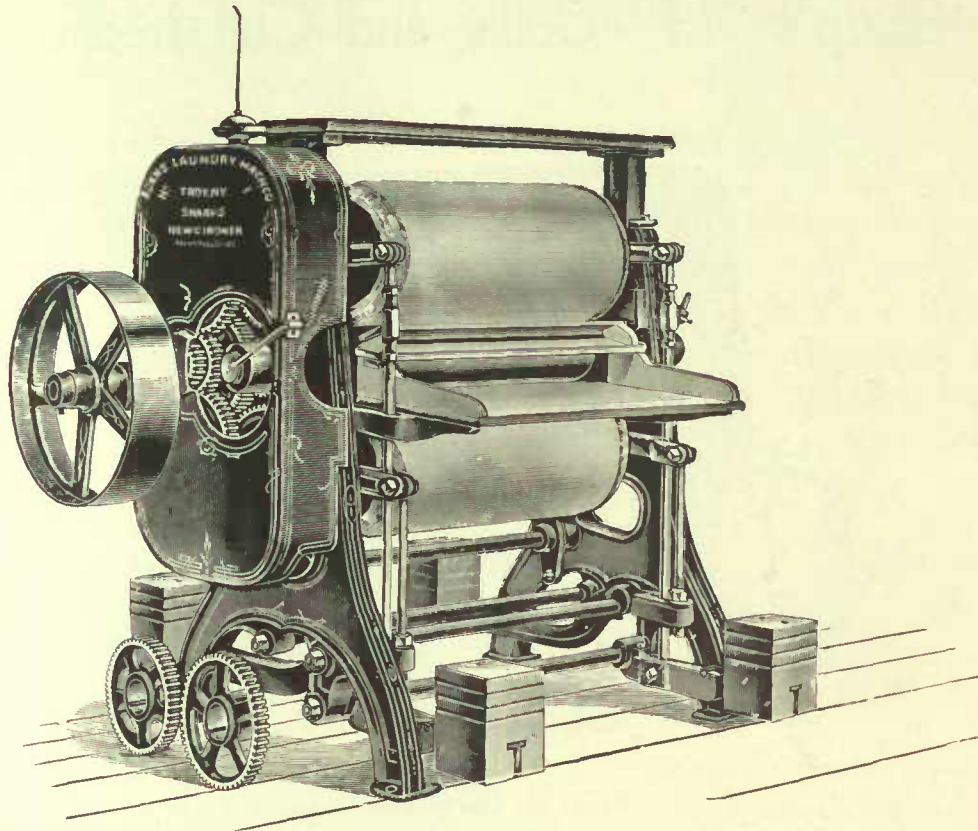

THIS machine has an ironing surface of 24 inches, and gives a domestic, light gloss or heavy gloss finish. The general design of the "H" machine is retained in this machine, except that there is no shifting device, there being but one pulley geared directly in the centre of the machine.

We sometimes furnish a scoop with this machine, which is extra, for return work, using only one operator.

The results given by this machine are the most satisfactory of any of its type.

Gas or steam heated, if for gas state whether city, natural or gasoline gas is used.

Steam Heated. Belt Driven. No. 292.

Motor Driven. No. 294.

Gas Heated. Belt Driven. No. 291.

Motor Driven. No. 293.

SPECIFICATIONS

Weight	Height	Floor Space	Length of Ironing Surface	Capacity	Diameter of Pulley	Speed of Pulley (Gloss)	Speed of Pulley (Domestic)	Speed (Steam)	Width of Belt
2000 lbs.	4 ft. 6 in.	3 ft. 3 in. x 5 ft. 8 in.	24 in.	600 doz. per day	20 in.	100 rev.	36 rev.	60 rev.	4 in.

Sharp's "H" Collar and Cuff Ironer

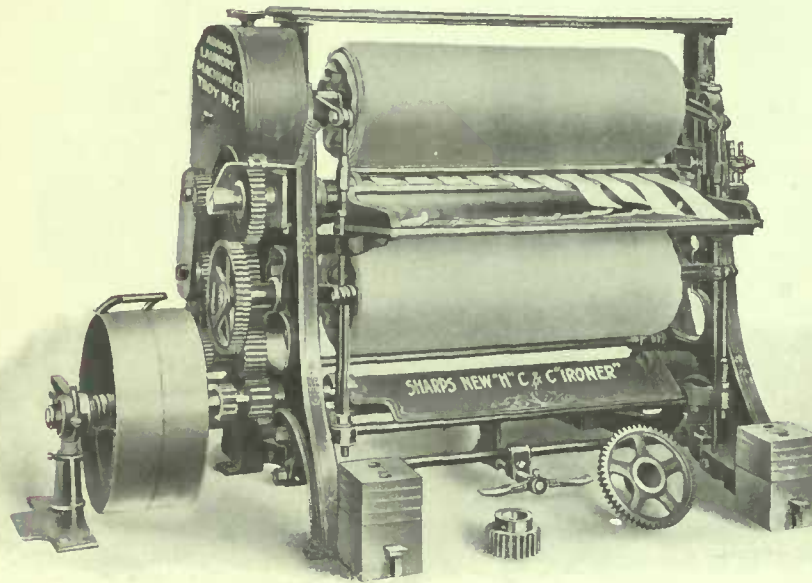

Steam or Gas-Heated.

SPECIFICATIONS		
	36 inch.	30 inch.
Floor Space.....	6 ft. 6 in. x 4 ft. 6 in.	6 ft. 0 in. x 4 ft. 6 in.
Weight.....	3,000 lbs.	2,700 lbs.
Height.....	53 inches	53 inches
Gas Heated. Belt Driven.....	No. 295	No. 296
Steam Heated. Belt Driven.....	No. 297	No. 298
Gas Heated. Motor Driven.....	No. 299	No. 300
Steam Heated. Motor Driven.....	No. 301	No. 302



Sharp's "H" Collar and Cuff Ironer

THIS is a high grade machine giving four different finishes, from a very high gloss to a perfect domestic, and has a capacity of 800 dozen a day with two operators. The hot roll has three speeds, being changed by three extra gears that go with the machine. The covered drums have two speeds, one for gloss and one for domestic finish, obtained by changing the sleeve pinion gears on the pulley shaft. The gears are all "cut" and the gearing direct, makes it impossible to break them. There are two oil holes to each bearing, being oiled through the studs from the outside of the plate, and the inside of the frame. It may be oiled while in operation.

Two sizes are made; one having a hot roll working surface of 30 inches, and the other of 36 inches. The shifting device is worked by the operator's foot on either side of the machine, and there are no stay rods to interfere. The surpassing features of this machine over others of its type are:

It Produces a Higher Gloss.
 A Perfect Domestic Finish.
 A Medium Gloss.
 A Superior Oiling Device.

Great Strength of Gearing.
 Its Unequalled Belt Shifter.
 Its Large Capacity.
 High Pulley Speed.

A scoop is sometimes furnished when one operator is desired, and the machine should then run on the high speed. Gas or steam heated; if for gas state whether city, natural or gasoline gas is used.

SPECIFICATIONS						
Sizes	Diameter of Pulley	Speed	Belt	Diameter of Hot Roll	Diameter of Padded Roll	Circumference of Padded Roll
36 in.	20 in.	90 Gas.	4 in.	5¼ in.	13⅜ in.	42 in.
30 in	20 in.	60 Steam	4 in.	5¼ in.	13⅜ in.	42 in.



THE TORONTO LINE

Rex 24 inch Collar and Cuff Ironer

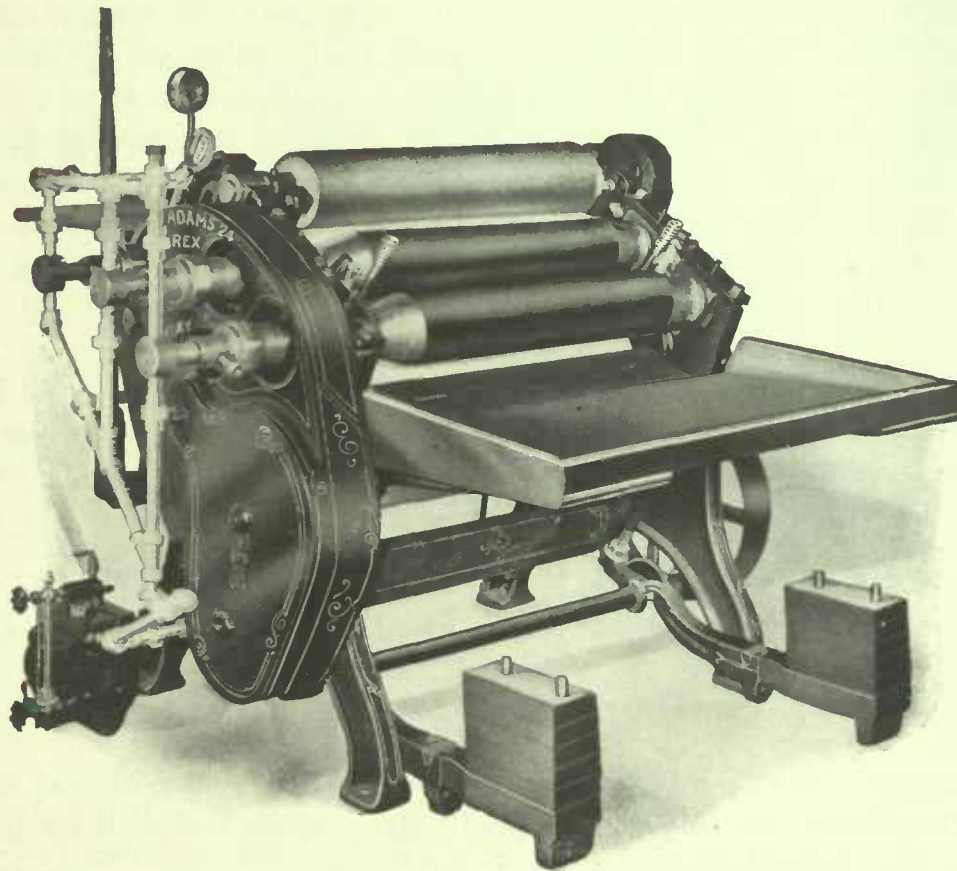

Showing Steam Heated Ironer No. 305.

Pressure by Weights.

Three Small Heated Rolls.

Small Expense of Dressing.

Two Padded Rolls.

Gas or Steam Heated.



Adams "Rex" 24 Inch Collar and Cuff Ironer

THE "Monarch" Ironers have demonstrated that the proper principle for Collar Ironers is that on which the heated rolls are the small ones, and the pressure given by weights.

This type of Ironer prevents buckled or wrinkled collars with properly prepared goods.

This Ironer is ONE PASS, and can be furnished either STEAM or GAS HEATED. There are three (3) "hot rolls" which are $5\frac{1}{4}$ inches in diameter, and but two (2) "padded rolls;" one small one and a large one requiring very little care and dressing.

The "hot rolls" revolve in stationary boxes. Pressure is put on by weights and lever.

No aprons, collars guided by metal knives. Gears are cut and protected by shields. Driving pulley is of latest clutch pattern.

Machine can have gears thrown out of mesh for easy dressing.

The "hot rolls" have self-oiling boxes. Gears oiled through studs. Machine has two (2) tables. The feed table has safety guard and the feed is arranged for greatest possible ease, and hence capacity for work, to the operator.

This Ironer is the model type for those changing from a MANY PASS to a ONE PASS Ironer. It is especially adapted for the medium size laundry which isn't quite big enough to require our "Junior" or "Monarch Steam."

Where steam heated, a trap is furnished with the machine. If gas heated, burners can be furnished for any kind of gas.

Arranged for one finish; Perfect Domestic. Speed of pulley, 40 R.P.M., giving 40 inches delivery per minute. The Steam Machines are equipped with special heating attachments for finishing wrong side of collar.

One size only, 24 inch ironing surface.

Diameter of pulley, 18 inches.

Width of belt, 3 in.

Height of machine, 4 ft.

Weight, 2000 lbs.

Floor Space: 5 ft. 4 in. width x 4 ft. from table to table end.

Steam Heated. Belt Driven. No. 305.

Motor Driven. No. 307.

Gas Heated. Belt Driven. No. 306.

Motor Driven. No. 308.



Sharp's Junior Monarch Gas Collar and Cuff Ironer

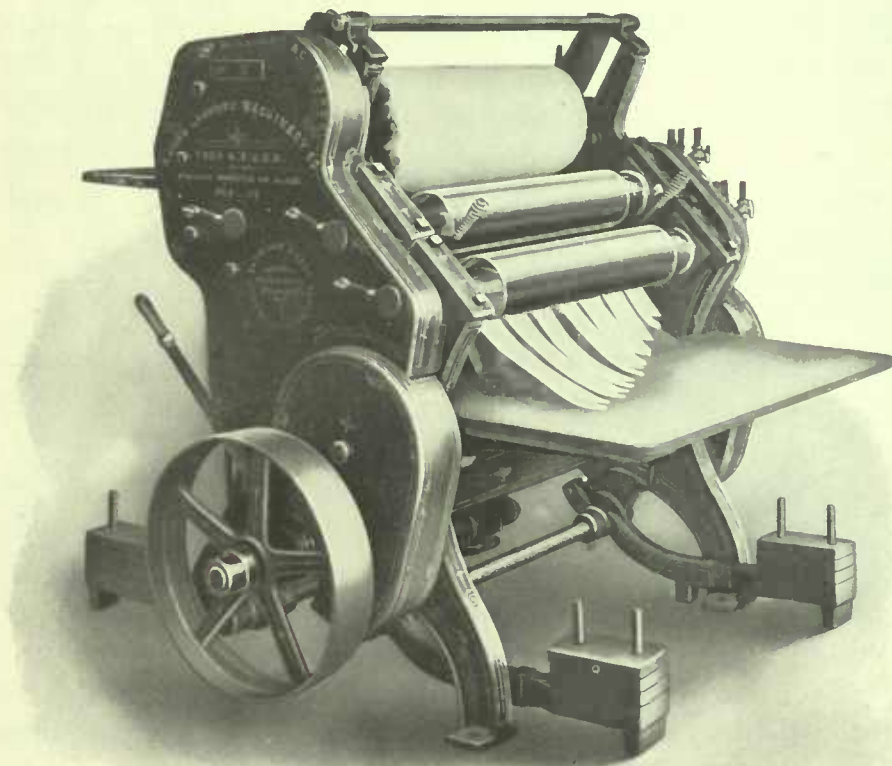



Sharp's Junior Monarch Gas Collar and Cuff Ironer

THIS machine was designed to meet the demand for a medium size machine which would be of the same high standard as our "Monarch" Collar and Cuff Ironer. It embodies all the high-grade qualities of the large "Monarch," having three hot rolls and two padded rolls, and the shifting gear arrangement, all gears being cut and protected by covers. It produces either a domestic or medium gloss finish, the change in finish being made without stopping the machine. Having but one pulley—a clutch pulley—it can be belted from any angle, either up or down. The covered rolls can be thrown out of gear while covering the machine, if it is desired to roll the goods back, as is sometimes necessary should a wrinkle get in the goods so that they have to be unwound, for re-rolling.

Only one passage of the collars and cuffs is required, and one operator can do the work.

The highest commendation for the many machines installed since the "Junior Monarch" was placed on the market stamp this machine as the highest type medium size, one pass Collar and Cuff Ironer made.

Made in two sizes with 24-inch and 36-inch length of ironing surface on the hot rolls.

The machines are provided with a special air and gas mixer.

In ordering, state whether burners are desired for natural, city or gasoline gas.

SPECIFICATIONS		
	24 Inch	36 Inch
Diameter of Hot Rolls	5¼ in.	5¼ in.
Diameter of Padded Rolls (covered)	10½ in. and 15¾ in.	10½ and 15¾ in.
Circumference of Padded Roll (covered)	33 in. and 49½ in.	33 in. and 49½ in.
Speed of Pulley	60 to 90 rev.	60 to 90 rev.
Diameter of Pulley	20 in.	20 in.
Width of Belt	4 in.	4 in.
Height of Machine	4 ft. 8 in.	4 ft. 8 in.
Weight	2,600 lbs.	3,000 lbs.
Floor Space	5 ft. 4 in. × 5 ft. 4 in.	5 ft. 4 in. × 6 ft. 4 in.
Belt Driven	No. 309	No. 475
Motor Driven	No. 310	No. 476

Sharp's Monarch Steam Collar and Cuff Ironer

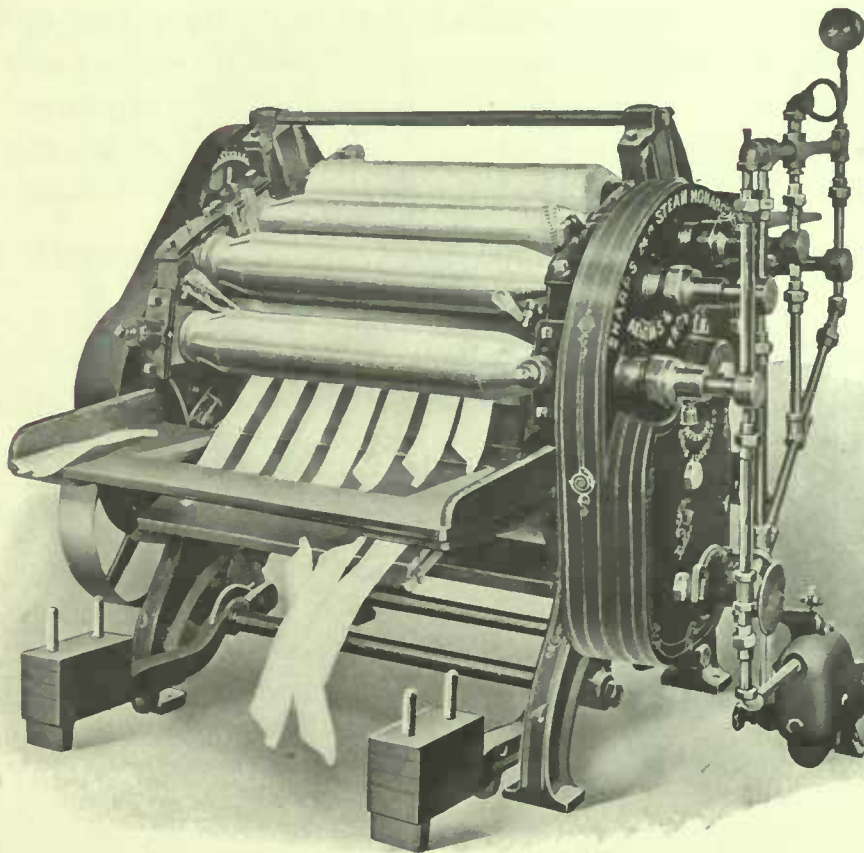



Sharp's Monarch Steam Collar and Cuff Ironer

IN the past all steam heated Collar and Cuff Ironers have been built on the mangle type, having many small "padded rolls" and the "hot rolls" being of large diameter. These machines require constant care in the dressing of the rolls to prevent buckling and wrinkling of the collars, and to avoid this, we are pleased to present to your notice herewith a Steam Heated Collar and Cuff Ironer built on exactly the same principles as gas heated machines.

This Ironer is of the One-Pass type, having one more "hot roll" than our Monarch gas machines. The "hot rolls" are $5\frac{1}{4}$ inches in diameter and there are but two "padded rolls"; one small one $5\frac{5}{8}$ inches diameter by $17\frac{3}{4}$ inches circumference, and a large one $15\frac{3}{4}$ inches diameter by $49\frac{1}{2}$ inches circumference, when covered.

The "hot rolls" of the Ironer revolve in stationary boxes. The "padded rolls" are controlled by a lever and weights to get the pressure desired (which is the proper principle). In other steam ironers the pressure is given through springs and screws.

There are no aprons on the machine to require adjustment. The collars are guided the same as in gas machines, by metal knives. There can be no buckling because the collar must run on the large padded roll, and not under many padded rolls of varying sizes.

All gears are cut (not cast) and protected by covers. There is a shifting device for the gears which allows a change of finish being made without stopping the machine, producing either a perfect domestic or medium gloss finish, as desired.

There being but one pulley, a clutch pulley, the machine may be belted from any angle either up or down, and the "padded rolls" may be thrown out of gear while the machine is being covered, if a wrinkle gets in the goods making it necessary to unwind for re-rolling.

The "hot rolls" have self-oiling boxes. The gears are oiled through the studs. All oiling may be done while the machine is in operation.

Each machine is provided with two tables. The receiving table on the back being of the drop pattern, which may be let down to deliver the finished work into a basket, therefore requiring but one operator to run the machine. The feeding table is provided with a safety guard, and the position of the table insures the greatest possible amount of ease, and hence capacity for work to the operator.

With a travel of sixty inches a minute on the rolls a maximum capacity is given the machine dependent only on the rapidity of the operator, providing sixty to ninety pounds of good, clean, live, dry steam is brought direct from the boiler to the ironer. Proper trapping of the machine is provided for by an Improved Steam Trap which accompanies each machine.

The machine is built in three sizes with the following lengths of ironing surface respectively: 24 inch, 36 inch, 50 inch. Either Belt Driven or with Motor Direct Connected.

SPECIFICATIONS			
	24 inch	36 inch	50 inch
Diameter of Hot Rolls	$5\frac{1}{4}$ in.	$5\frac{1}{4}$ in.	$5\frac{1}{4}$ in.
Diameter of Padded Rolls (covered)	$5\frac{5}{8}$ in. and $15\frac{3}{4}$ in.	$5\frac{5}{8}$ in. and $15\frac{3}{4}$ in.	$5\frac{5}{8}$ in. and $15\frac{3}{4}$ in.
Circumference of Padded Roll (covered)	$17\frac{3}{4}$ in. and $49\frac{1}{2}$ in.	$17\frac{3}{4}$ in. and $49\frac{1}{2}$ in.	$17\frac{3}{4}$ in. and $49\frac{1}{2}$ in.
Speed of Pulley	60	60	60
Diameter of Pulley	20 in.	20 in.	20 in.
Width of Belt	4 in.	4 in.	4 in.
Height of Machine	4 ft. $2\frac{1}{2}$ in.	4 ft. $2\frac{1}{2}$ in.	4 ft. $2\frac{1}{2}$ in.
Weight	2,500 lbs.	2,850 lbs.	3,250 lbs.
Floor Space	6 ft. 2 in. x 5 ft. 8 in.	6 ft. 2 in. x 6 ft. 8 in.	6 ft. 6 in. x 8 ft. 2 in.
Number, Belt Driven	311	312	313
Number, Motor Driven	314	315	316

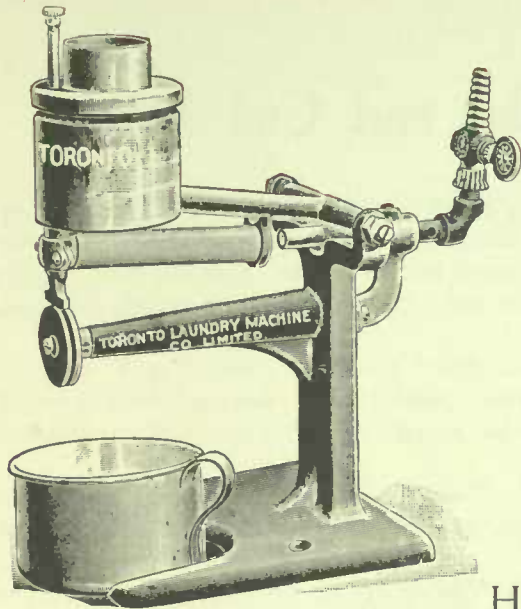

Improved Seam Dampeners

No. 319

OUR Seam Dampener has replaced seam dampeners of almost every make wherever they have been tried. Our machine is not a toy, but a good large machine, substantially built. The water is kept hot by burner under reservoir, and the flow of water is regulated by thumb screw in top of valve. The felt roll washer between the wheels absorbs and holds enough water to moisten the finished side collar, thereby dampening both sides with one operation.

Hand Seam Dampener

No. 320

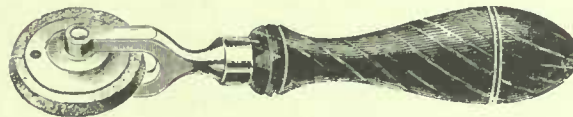

An Effective and Inexpensive Seam Dampener

Collar Finishing Table

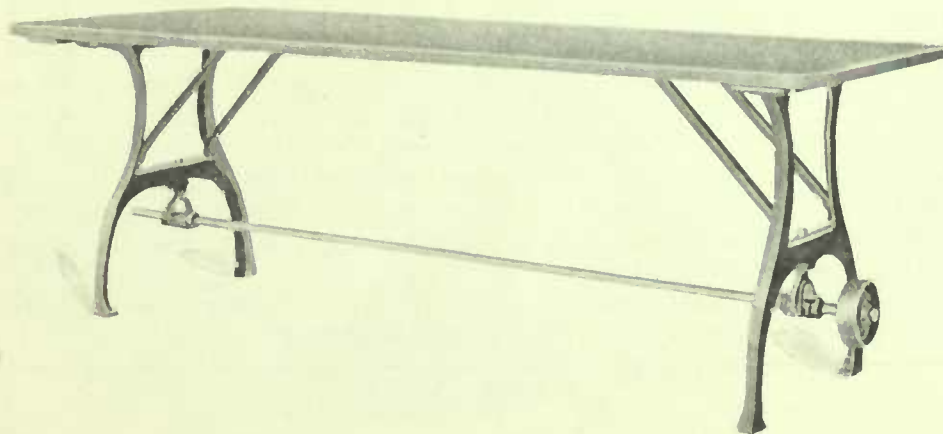

The above table equipped with shaft is for use with Collar Finishing Machines. It is also sold without the shaft for use as a bundling table. Where the shaft is used a motor can also be furnished. Or the legs and iron parts will be sold separate if desired. Ten and twelve foot tables are fitted with three legs.

SPECIFICATIONS			
No.	Size	Weight	Motor Driven
321	3 ft. x 8 ft.	215 lbs.	324
322	3 ft. x 10 ft.	275 lbs.	325
323	3 ft. x 12 ft.	285 lbs.	326

Bishop's Automatic Seam Dampeners

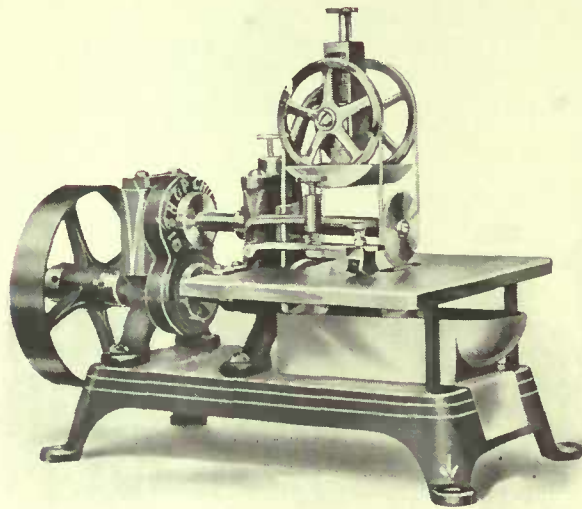

Cord Seam Dampeners. No. 317.

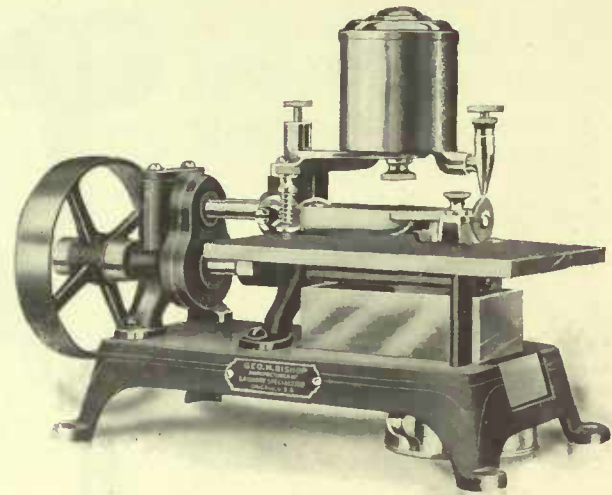

Cordless Seam Dampeners. No. 318.

WE ARE prepared to supply these Dampeners either without or with the cord and the general description, as follows, applies to the cordless machine, in all other respects excepting that it has no cords.

In this machine collars are fed seam side up—allowing the collar to be dampened on the wrong side, by coming in contact with a dampening cord, and on the under or right side, by a metal roller running directly in the water pan underneath. This method insures absolute uniformity in dampening.

Where a string is used, greater uniformity is the result, as the string absorbs this moisture, consequently there is always a supply of water when and where needed. Not so much moisture is required on the right as on the wrong side of collars, consequently we use the metal roller which supplies the desired amount.

The moisture is easily regulated by tightening or loosening the dampening cord to meet individual requirements.

The guide on this machine is easily adjustable and is absolutely positive, so that the dampening roller follows the seam exactly

A trial will convince you of its merits.

SPECIFICATIONS				
Weight, lbs.	Speed	Belt, inches	Pulley, inches	Packed for Export
35	120	1	6	4 cubic feet



THE TORONTO LINE

The New Shaw Shaper

No. 21, Shaw Machine.

No. 211, Shaw Machine.

No. 212, Shaw Machine.

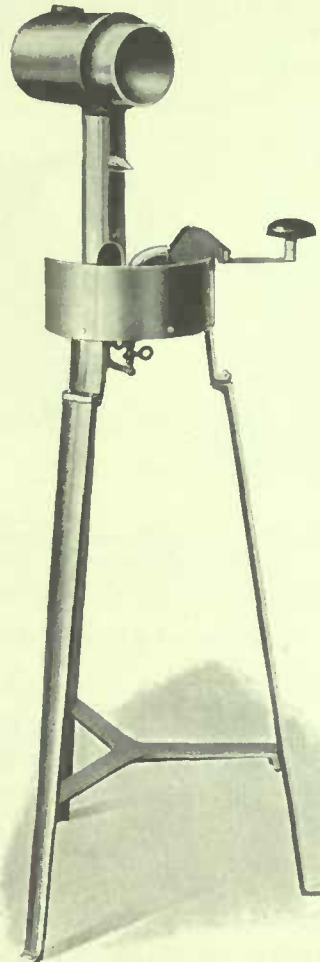

THE several "Shaw" Machines shown on this and following pages are all of our re-designed model and were the result of about two years of experimental work. They have been in the hands of laundrymen in all parts of the country for over six years now, and have used all sorts of fuel and pressures with unvarying success. In the gas heated machines one of the chief improvements over the old "Shaw" is in the iron which is heated directly by a gas flame which burns inside of it. The operator, may, therefore, keep the iron constantly hot at just the right temperature, and avoid the annoyance, delay and work of poor quality caused by the iron getting cold. On this account alone the operator can turn out at least 30 per cent. more work with this iron than with the old one.

The burner can be regulated both as to amount of gas and amount of air admitted. This allows you, by making the slight necessary adjustment, to burn any kind of gas at any pressure without getting either smoke or soot.

Machine with legs to stand on floor and with shaping tube. There is an opening at the back of this machine which allows shirts attached to collars to pass through and hang down while the collar is being ironed.

The No. 21 machine is equipped with burners for natural and manufactured gas or gas from a gasoline plant. If wanted for last named fuel, please be sure to specify name of manufacturer of the system, and whether it is a one pipe or two pipe system.

The No. 211 machine is equipped with electrically heated iron and Tube. In ordering one of these please be sure to specify voltage to be used. We can furnish any voltage up to 220, but recommend 110.

The No. 212 machine is equipped with independent gasoline tank, generator and burner.

The heating equipment on the No. 212 machine gives a colorless blue flame of uniform heat and from which there is neither smoke nor soot. Owing to the character of, and room necessary for piping this gasoline heating equipment can be attached to this style of machine only. The efficiency is such that the cost of fuel is only about two cents per day.

New Shaw Shapers

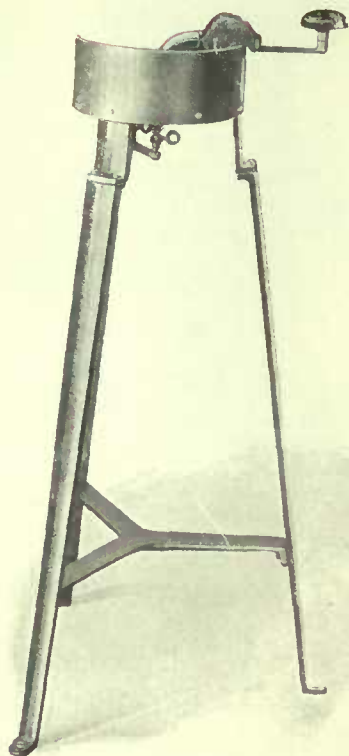

No. 23 SHAW MACHINE.

No. 231 SHAW MACHINE.

Machine to stand on table with shaping tube and without legs.

The No. 23 machine is equipped with burners for natural and manufactured gas or gas from a gasoline plant. If wanted for last named fuel, please be sure to specify name of manufacturer of the system and whether it is a one-pipe or two-pipe system.

The No. 231 machine is equipped with electrically heated iron and tube. In ordering one of these, please be sure to specify voltage to be used. We can furnish any voltage up to 220, but recommend 110.

No. 22 SHAW MACHINE.

No. 221 SHAW MACHINE.

Machine to stand on floor, with legs, but without shaping tube.

The No. 22 is equipped with burners for natural and manufactured gas or gas from a gasoline plant. If wanted for last named fuel, please be sure to specify name of manufacturer of the system and whether it is a one-pipe or two-pipe system.

The No. 221 machine is equipped with electrically heated iron. In ordering one of these, please be sure to specify voltage to be used. We can furnish any voltage up to 220 but recommend 110.

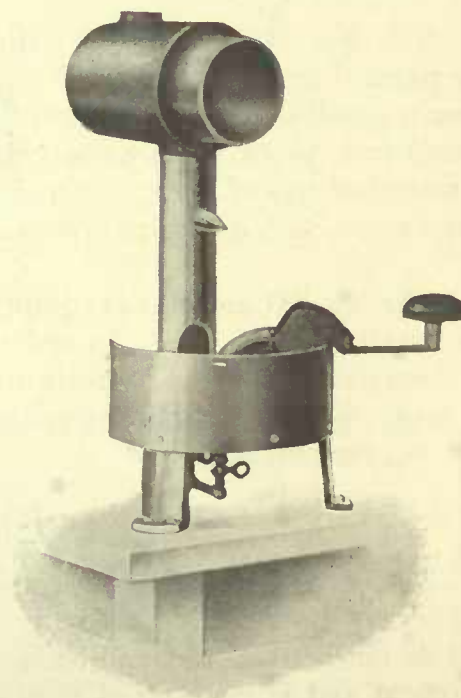



THE TORONTO LINE

The New Shaw Shapers

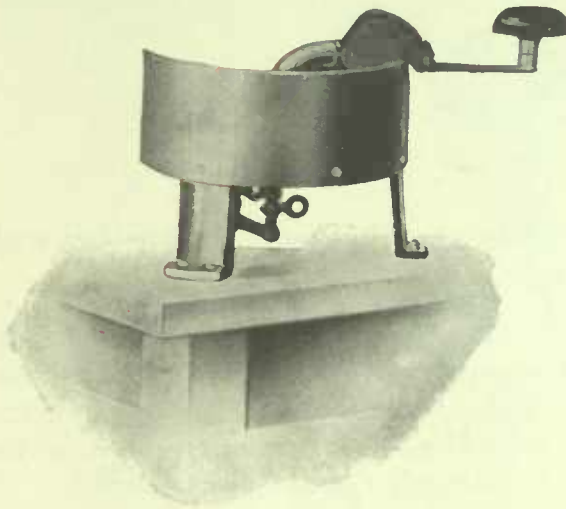

No. 24 SHAW MACHINE
No. 241 SHAW MACHINE

Machine to stand on table, without shaping tube and without legs.

The No. 24 is equipped with burner for natural and manufactured gas or gas from a gasoline plant. If wanted for last named fuel, please be sure to specify name of manufacturer of the system and whether it is a one-pipe or two-pipe system.

The No. 241 machine is equipped with electrically heated iron. In ordering one of these please be sure to specify voltage to be used. We can furnish any voltage up to 220, but recommend 110.

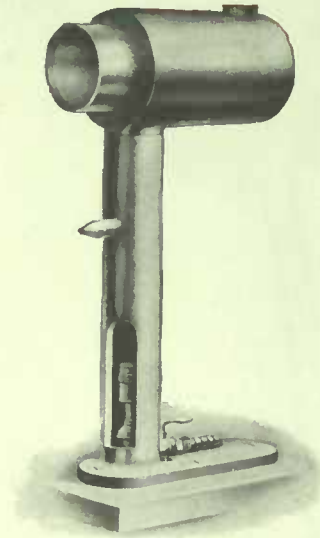

No. 25 SHAPING TUBE
No. 251 SHAPING TUBE

Shaping Tube on independent stand.

The No. 25 Tube is heated with gas and equipped with burner for natural or manufactured gas or gas from gasoline plant, which will regulate heat to any desired temperature. If wanted for last named fuel, please be sure to specify name of manufacturer of the system and whether it is a one-pipe or two-pipe system.

The No. 251 is equipped with electrically heated tube. In ordering one of these, please be sure to specify voltage to be used. We can furnish any voltage up to 220, but recommend 110.

Electric Machines

There are hundreds of Electric Machines in use in laundries now and they are giving perfect satisfaction. We are, therefore, offering them to the laundrymen generally and do not hesitate to stand back of them in every way. Every machine is tested before shipment and is guaranteed to give satisfaction.



THE TORONTO LINE

Bishop Steam Tube Shapers

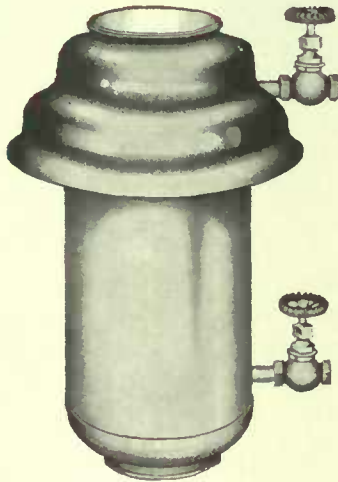

Vertical. No. 381

These Hot Tube shapers are both fitted with removable Porcelain Lined Tubes. A great many Laundries are now using two Hot Tube Shapers upon the Collar Finishing Table, one Horizontal Tube for shaping the collars after being seam dampened, and a Vertical Hot Tube Shaper for a final shaping after being edge ironed.

This system produces a collar through which the tie slips easily.

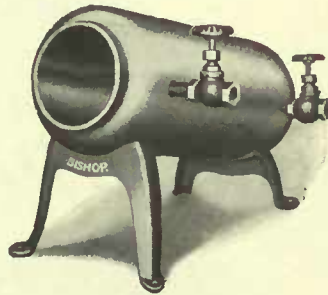

Horizontal. No. 382

DIMENSIONS			
Tube	Table Space Vertical	Table Space Horizontal	Weight
4 1/4 in. inside diameter 18 in. long	18 in. x 18 in.	12 in. x 20 in.	70 lbs.



THE TORONTO LINE

Bishop Steam Tipper

No. 383



Steam Tipper. Steam Dampeners for Wing Points and Lay-Down Collars. With Shaping Horn.

DIMENSIONS

Weight, 17 lbs.

Table Space, 8 x 17 inches.

Hand Edge Ironer

Gas Heated, No. 26.

Electrically Heated, No. 261.

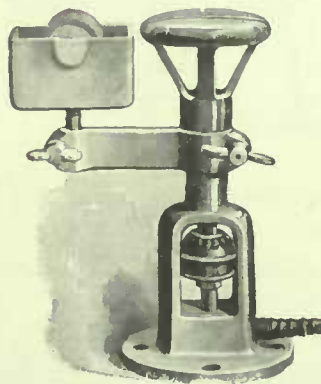

EDGE Ironer for standing collars and cuffs. Equipped with burner for natural gas, manufactured gas or gas from a gasoline plant. If wanted for last named fuel, please be sure to specify name of manufacturer of the system and whether it is a one-pipe or two-pipe system. The Water Box containing the covered wooden roll is adjustable in every way.

It can be arranged so that one stroke will carry the collar over both roll and iron, or it can be arranged in any other position.



THE TORONTO LINE

Toronto Power Rough Edge Ironer

No. 327

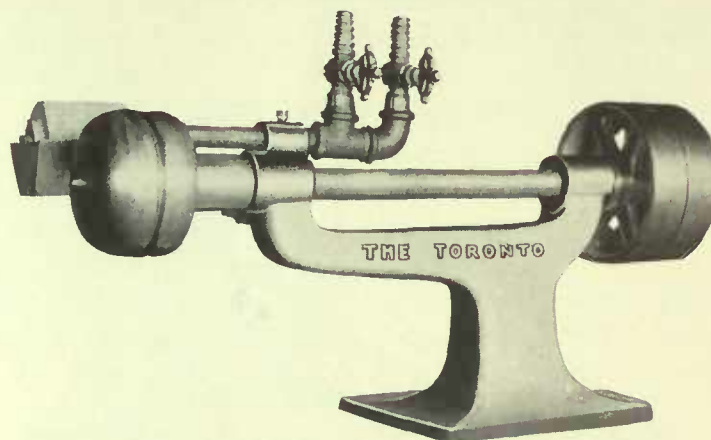

On this little machine the edge of collar is dampened and ironed with one operation, a distinct feature of the machine, leaving an edge as smooth as velvet. No laundry should be without this edger.

DIMENSIONS		
Pulleys, inches diameter	Belt, inches	Speed, revolutions
6	1 1/4	500

Bishop Power Edger

Belt Driven, No. 384.

Motor Driven, No. 285.

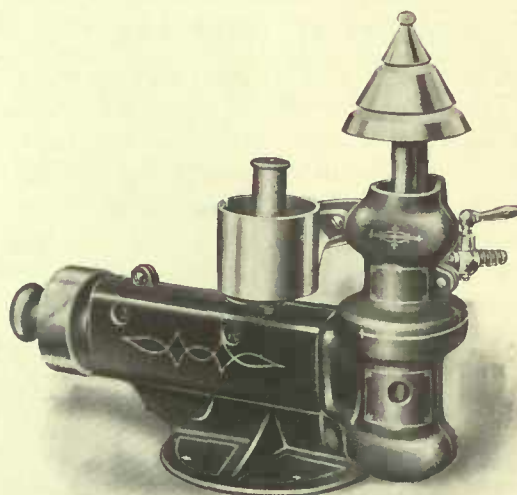

DIMENSIONS				
Table Space, inches	Weight, lbs.	Pulley, inches	Speed	Belt, inches
7 x 14	19	3	300	3/4



The Toronto Automatic Edge Ironer and Shaper

For Stand-Up Collars and Cuffs.

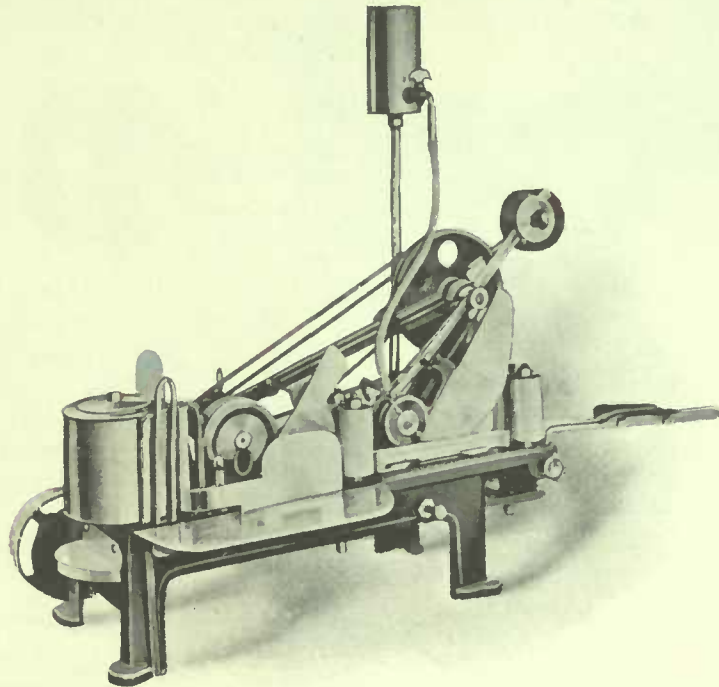

No. 328

WHAT IT WILL DO

CAPACITY. This machine will take any size or shape of cuffs or collars (except turn-down collars) and will dampen and iron *perfectly* one edge of twenty to twenty-five thousand pieces per day of ten hours, when fed to full capacity. It will deliver the collars nicely shaped at the same operation. It will deliver the cuffs either shaped or straight as may be desired. Once through does the work and *does it right*.

CHARACTER OF WORK. The machine is perfectly automatic in action, consequently *good work does not depend on a skilled or careful operator*. Simply see that the iron is hot, that the damper is damp, feed the collars in, and *the machine will do the rest and do it right*.

Absolutely removes rough edges without injury to the collars or Cuffs.

HOW IT IS DONE

The collars or cuffs are fed into the machine as shown at right hand of illustration. They are caught by the upright revolving rubber rolls and pulled forward along the guide track, raising the revolving dampener which dampens evenly the edges as they pass, are caught by the second pair of rolls and as they move along in the guide track they raise and pass under the grooved ironing wheel heated by gas and revolving at a high speed, where all rough edges are removed and a smooth edge comfortable to the neck of the wearer is given. Continuing along the guide track they are next caught by the shaper roll shown at left of illustration. In running collars (or cuffs that are desired to be shaped) the "shield" which simply sets in two holes in bed of machine in front of and close to the rubber shaper roll, is *lifted out*, when the pieces are delivered from the front of the machine nicely shaped. *Replace the "shield" and loosen thumb screw* that holds the small steel shaper roll against the large rubber roll, and the pieces are delivered from the *end* of the machine *straight*.



The Toronto Automatic Edge Ironer and Shaper

REMOVING all rough edges from collars and cuffs and shaping collars at same operation. Cuffs shaped or straight as desired. Perfectly automatic. Once through does the work and does it right.

GENERAL DESCRIPTION

The Automatic Edge Ironer and Shaper consists essentially of the following parts:

A Revolving Dampener fed from a water tank attached to the frame of the machine. (Steam can be used for dampening if preferred.)

A Revolving Iron heated by gas.

A Rubber Shaper Roll and a small Steel Shaper Roll, operating together.

A "Shield" fitted to set into two holes in the bed of the machine so that it stands upright in front of and close to the large rubber roll to be used only when linen is to go through without being shaped. When linen is to be shaped the "Shield" is simply lifted out.

A Guide Track for the collars and cuffs to travel in.

A "Guide Shoe" fitted to set into two holes in the bed of the machine and extend back from the end of the machine where the linen enters, to support the linen and insure that it starts into the machine in a horizontal or level position. The linen must pass through the machine in the same position in which it starts, therefore the rear end of the pieces being fed in must not be dropped below the level of the bed of the machine. This is particularly useful in feeding curved or "Fat-man" collars, which are handled perfectly if started into the machine in a level position.

Revolving Rubber Rolls to pull the collars or cuffs through the machine.

The Dampener and the Iron are hung on pivoted arms balanced by weights, so that they readily adjust themselves to any height or shape of collar or cuff.

All the pieces on the front part of the machine are so arranged that they can be lifted off without unscrewing any bolts or screws, thus leaving all parts of the machine touched by the collars or cuffs thoroughly open for cleaning.

Guides, shields, and all metal parts of the machine touched by the collars or cuffs are nickel plated, as is also the water tank and its support. The rolls are white rubber.

The machine is driven by machine-cut bevel gear wheels, giving a positive motion with no chance for lost motion through slipping belts. These are all located under the bed of the machine, out of the way, and completely protected from contact.

The construction is first-class, and with proper care the machine will do its work indefinitely without expense for repairs or renewals.

SETTING UP THE MACHINE

The only things necessary to set up this machine ready to run are: A table to set it on, a belt and pulley on the line shaft to run it by, and a connection to the gas pipe to heat the iron. Arrow on drive wheel shows direction in which it revolves, and it should have a speed of about 150 or 160 per minute.

Shipping weight, 60 pounds without box; table space, 18 x 36 inches; packed for export, 5 cubic feet.

All machines shipped by freight unless special instructions are given to ship by express.



THE TORONTO LINE

Turn-Down Collar Shaper

No. 330

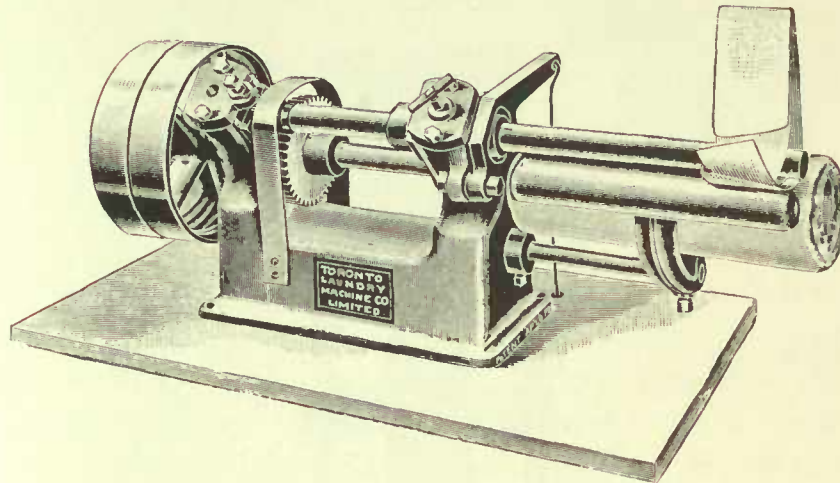

THE turn-down collar is one of the greatest annoyances the laundry-man of to-day has to contend with, and this little machine was specially designed to help them out of their trouble. It will shape perfectly without breaking turn-down collars, and without pressing the points. Straight collars are shaped to perfection on this machine. The pressure is operated by a foot treadle, and a trial will convince you of its merits.

SPECIFICATIONS

Pulley, inches	Speed, revolutions	Belt, inches	Table Space, inches	Weight, lbs.	Packed for Export
11	40	1	12 x 24	50	4 cubic feet

Wing Point Dampener and Turner

No. 331

Of all the "big little things" that have been devised for the improvement in the quality of the work in the collar department—this little machine heads the list.

The success with which this machine has met was well warranted, so thoroughly does it perform the work for which it was designed. The surface of the point is very lightly dampened by a thin vapor of steam. The seam or turning line is dampened more heavily by a jet of steam. The upper clamp under which the point is inserted and over which it is folded, forms a guide for turning the point to an exact line.

The points are, therefore, sponged, seam dampened and folded back ready for the Tipper, all in one operation.

The machine is provided with a steam separator inlet and drip valves, and the whole is heavily nickel plated.

The Dampener and Turner in connection with our Wing Point Tipper forms the most efficient equipment we have yet seen for handling wing point collars.

With this equipment it is simply impossible to break a point.

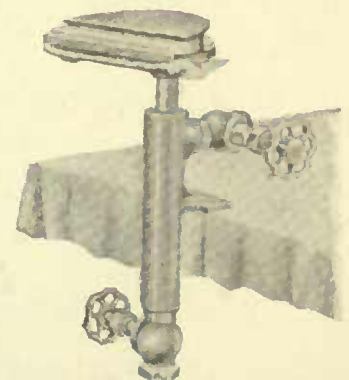

Add this outfit to your Finishing Department.

Add to the Quality of your Collars.

Remove another Source of Trouble.

Wing Point Tipper

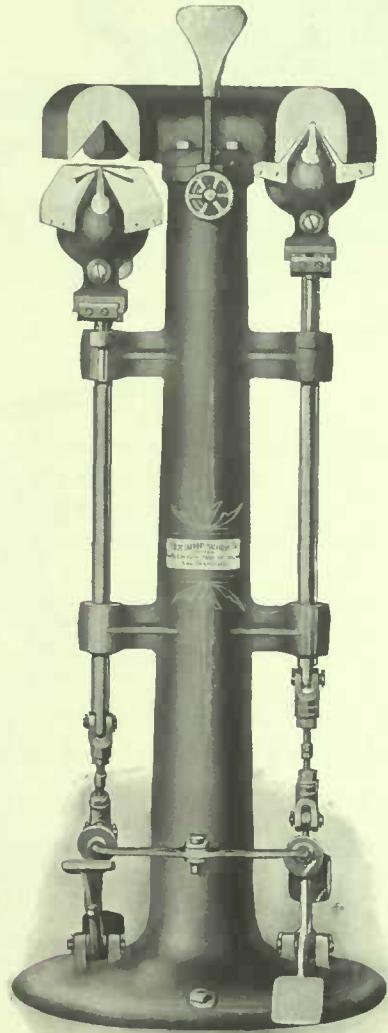

No. 332

Floor Space, 18 inches x 18 inches.

Weight, 245 lbs.



Wing Point Tipper



OUR Wing Point Tipper offers without doubt the best method ever devised for ironing wing point collars. Formerly these points were ironed by hand or stamped in one of the old style tipping machines to press the seam down flat. As the collar had been previously ironed, this ironed the point twice, resulting in a very brittle point and the collar soon became cracked and broken at the seams. Our New Tipper turns and finishes both wings at the one operation saving about five distinct operations used in tipping by the old methods.

The points after having been seam dampened are placed in the machine and by pressing the foot treadle, the right side of the points are pressed in contact with the steam heated head. This irons the seams of both points down flat and moulds them into their proper position.

No matter how frayed or broken the folded edges may be they are forced up into the angle of the heated head and come out as smooth as when new.

As the whole work is done while the tips are still moist and hot there is no possibility of their breaking.

It is a preserver of wing point collars and it saves time and money—as in one operation it irons the points.

The points are, therefore, sponged, seam dampened and folded back ready for the Tipper all in one operation.

The machine is provided with a steam separator inlet and drip valves.

The Dampener and Turner in connection with our Wing Point Tipper forms the most efficient equipment we have yet seen for handling wing point collars. See page 153.



THE TORONTO LINE

Toronto Racer Bosom Ironer

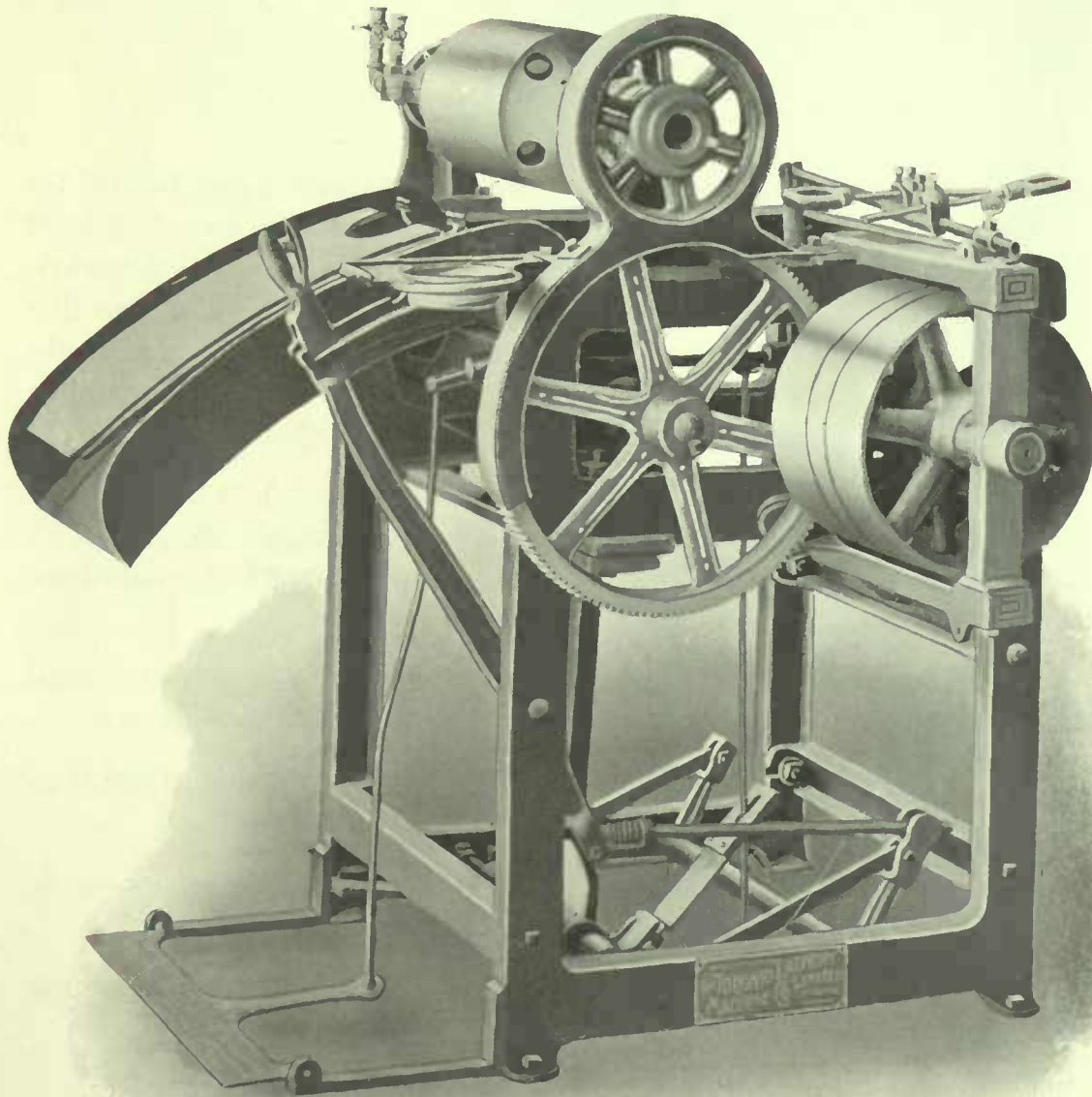

Gas or Electrically Heated.

Semi-Domestic Finish.



Toronto Racer Bosom Ironer

THE Heated Roll is 8 inches in diameter, giving over 25 inches of ironing surface for each revolution of the roll. This gives a very large capacity and the finest grade of finish, as is evidenced by the fact that it has found its way into the majority of the best laundries throughout the country. A child can operate this machine, and to enable a new operator to become proficient in a very short time and to avoid confusion in reversing we have our machines equipped with an automatic shifting device which reverses the machine automatically at the end of each forward stroke.

The ironing surface of our machine is curved and has a circular motion which offers many points of advantage, some of which are as follows:

When the board is in position ready for the shirt it is at such an angle that the head end or the neck is very near the operator, thereby greatly facilitating the operation of setting the shirt properly on the ironing board. The construction of our board is such that the bosoms do not draw in from the sides as on the ordinary straight surface machines. The nature of the two curves is such that they afford a large drying surface, therefore great speed. It is supplied with a set of centre and yoke clamps working independently of each other. They are of an improved pattern, effective, and do not get out of order. It has a lever or optional pressure device that drops the board at any point at any time during the ironing operation. This enables the operator to iron either or both ways. This is one of the greatest features ever presented to the trade for the purpose of ironing open front shirts, and we claim it is almost impossible to iron an open front shirt perfectly on a machine without this device.

The foot treadle, being the full width of the machine, enables the operator to use either foot. Merely pressing the treadle runs the board in and the removal of the foot causes the board to return to its original position.

SPECIFICATIONS					
Roll	Pulleys	Speed	Belts	Weight	Floor Space
8 in. diameter	12 in. diameter, 8 in. face	125 rev. per minute	1½ in.	1000 lbs.	60 in. x 60 in.

Gas Heated. Belt Driven. No. 333.
Electrically Heated. Belt Driven. No. 335.

Motor Driven. No. 334.
Motor Driven. No. 336.

Sinclair Newark Bosom Ironer

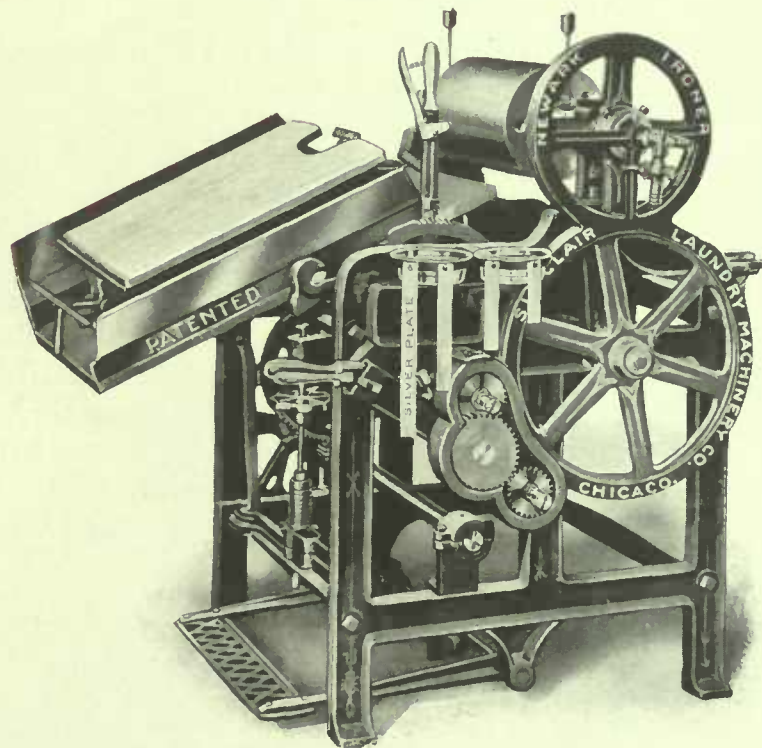

Bosom Ironer. No. 478.

Combined Ironer. No. 477.



Sinclair Newark Ironer

THE Newark Ironer has always been one of the most perfect shirt ironers on the market, and with the latest improvements, as herewith outlined, it stands far ahead of any other ironer ever before manufactured. The Newark Ironer gives two distinct finishes, one domestic, the other medium gloss, the change being made by dropping the lower right hand lever, which throws a compound gear in mesh with the larger gear, and increasing the speed of the hot roll over forty per cent. This change can be made when machine is in operation if desired.

1. The ironing surface tilts to an angle of 45 degrees, which enables the operator to remove a finished shirt and place another one on the surface with great alacrity.

2. The tilting device gives you the benefit of ironing a shirt on a flat surface, yet possessing the merits of a curved board ironer.

3. The neck and shoulder clamps are operated from the head of the board, as on other ironers.

4. All shirts, no matter what kind, are drawn over the board and clamped on neck and shoulder. No shirts are reversed, resulting in the perfect ironing and shaping of all styles and shapes of bosoms.

5. The shape of the surface is such that it is absolutely impossible to iron a bosom improperly, as the lines of the bosom of the shirt will be drawn perfect in every case.

6. The ironers, Nos. 3 and 4, are finished with two surface plates, which are interchangeable. One surface plate, 9 x 21 inches for stiff bosom shirts, the other, 12 x 21 inches, for negligee or pleated bosoms. The 12-inch surface is cushioned, and the negligee or pleated shirt with or without buttons, can be ironed perfectly at the rate of 45 to 50 per hour. In case the shirt has buttons we guarantee the same may be ironed perfectly without injury to the rolls or buttons. Stiff bosom shirts can also be ironed perfectly on the 12-inch surface.

7. The operator can change the surface plates in less than one-half minute.

8. The hot roll is 8½ inches in diameter and 12 inches long, thus finishing all bosoms and giving the body ironer a marginal line as a guide.

9. Where desired we will furnish this Ironer as a combined, and in this case the hot roll is of the same diameter and 18 inches long, and an extra C. and C. surface 18 x 22 inches is furnished with the Ironer.

10. Foot treadle extends full width of Ironer, thus enabling operator to use either foot.

11. All main bearings are provided with oil cups.

The pulleys on this machine are 12 inches in diameter and 2-inch face, and should make 200 revolutions per minute. Use a 1-inch belt. Floor space 3½ feet x 4 feet; weight, 900 pounds.



THE TORONTO LINE

Toronto Combined Shirt, Collar and Cuff Ironer

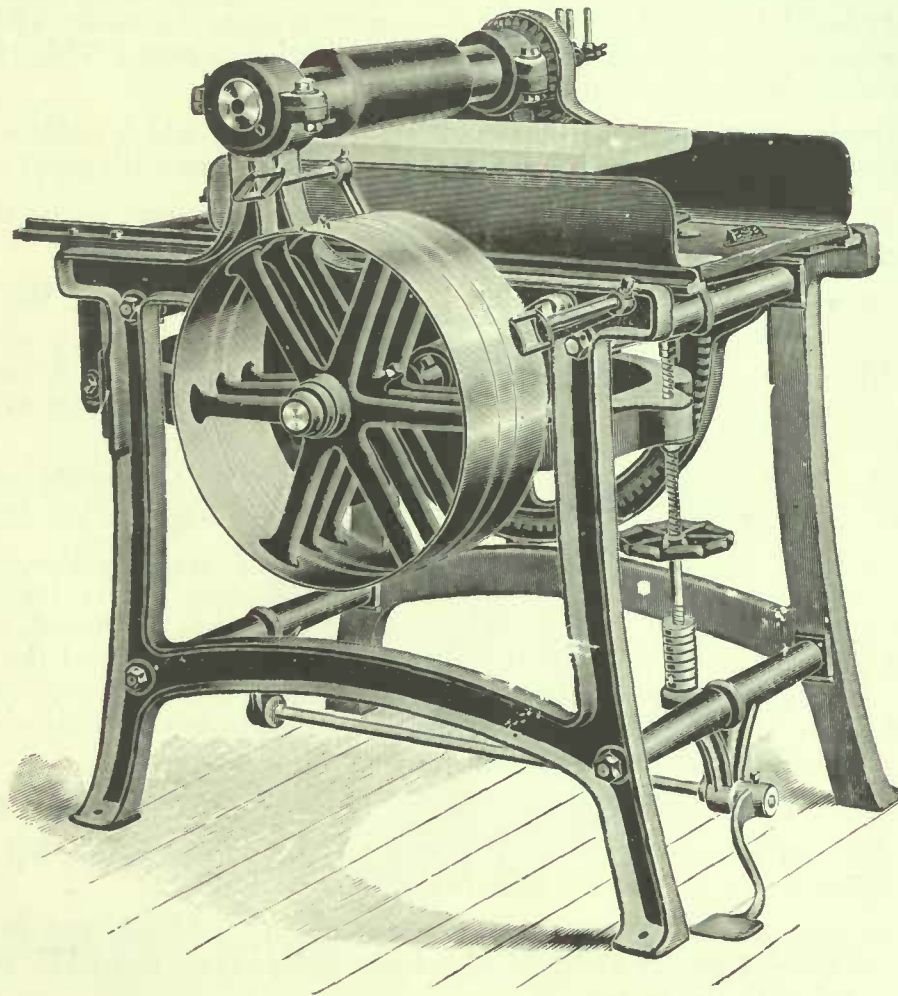

No. 337

Gas or Electrically Heated.



Toronto Combined Shirt, Collar and Cuff Ironer

THIS machine is almost too well known to require any description. It is one of the most useful machines used in a laundry on account of the general class of work it does. In our machine we have combined all the features that go to make up a first-class shirt, collar and cuff ironer.

A most important change has been made in this machine recently and we are now supplying only **ONE IRONING BOARD** but with **THREE IRONING SURFACES**. These ironing surfaces consist of one for Collars and Cuffs, one for Stiff Bosom Shirts and one for Negligeé Shirts. The ironing surfaces may be attached or removed from the ironing board by merely loosening a thumb screw. The Negligeé Surface has a sheet of Sponge Rubber inserted down the centre to prevent the buttons from Breaking, and in addition we supply a number of strips of sheet Aluminum which go in between the two halves of the bosom, serving to protect the buttons and also to iron the under side of the Bosom, the same as on the Bosom Press.

This machine may now be had either gas or electrically heated, and either belt driven or with direct connected motor.

All gears are machine cut from the solid. All parts that come in contact with shirt are made of polished brass.

This machine may be had for hand power, with gasoline burner.

As its work is general it is the most used machine in the laundry. Collars and cuffs can be ironed upon it with the same ease of operation as is the case when ironing shirts. The capacity of the machine is limited only by the speed of the operator, and with a fair operator 400 to 500 shirts or 2,500 collars and cuffs can be ironed in 10 hours.

SPECIFICATIONS					
Diameter of Pulleys	Belts	Speed of Pulleys	Length of Driving Roll	Weight	Floor Space
16 in.	1¼ in.	160	13 in.	900 lbs.	36 x 60 in.

Gas Heated, Belt Driven No. 337.
Electrically Heated, Belt Driven No. 339.

Motor Driven No. 338.
Motor Driven No. 340.

Toronto Domestic Neck-band Ironer

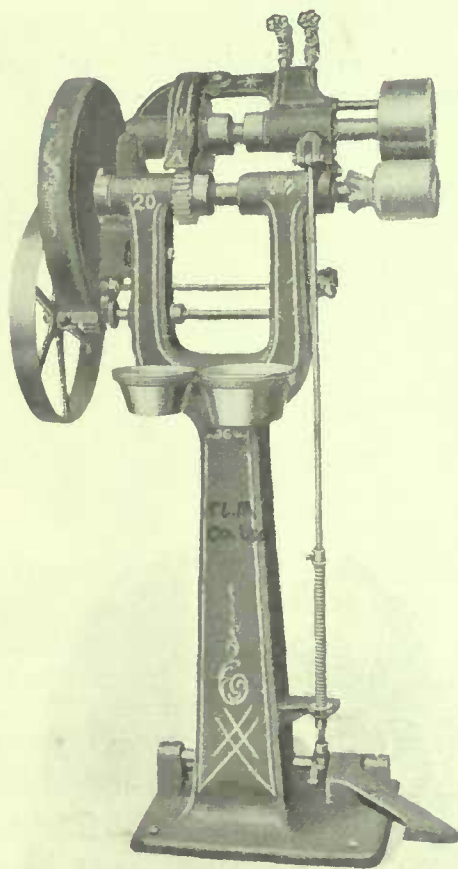

27"

No. 341



Toronto Domestic Neck-band Ironer

THIS machine was designed to meet the demand of the laundrymen of this country for a machine that irons the neck-bands properly without stretching or imparting a polish to it. The heated roll is six inches in diameter and the padded one three and a half inches in diameter. They are offset so the work can always be seen by the operator. The main advantages of this machine are a neck-band that is not stretched, a domestic neck-band, a stiff neck-band.

The rolls are furnished 4 inches wide so that this machine may be also used for ironing the attached cuffs or wristbands.

We also make this machine with a shoe instead of the hot roll. The machine is made up for a roll machine complete, then the roll and small gears are removed and the shoe substituted, so that they may be replaced at any time. Unless otherwise specified we will ship roll machine.

SPECIFICATIONS					
Pulley	Speed	Belt	Weight	Floor Space	Packed for Export
12 in. diameter	50 revolutions	1 ½ in.	275 lbs.	27 in. x 22 in.	20 cubic ft.

Gas Heated. Belt Driven. No. 341.

Motor Driven. No. 342.

Electrically Heated. Belt Driven. No. 343.

Motor Driven. No. 344.

Toronto Reverse Body Ironer

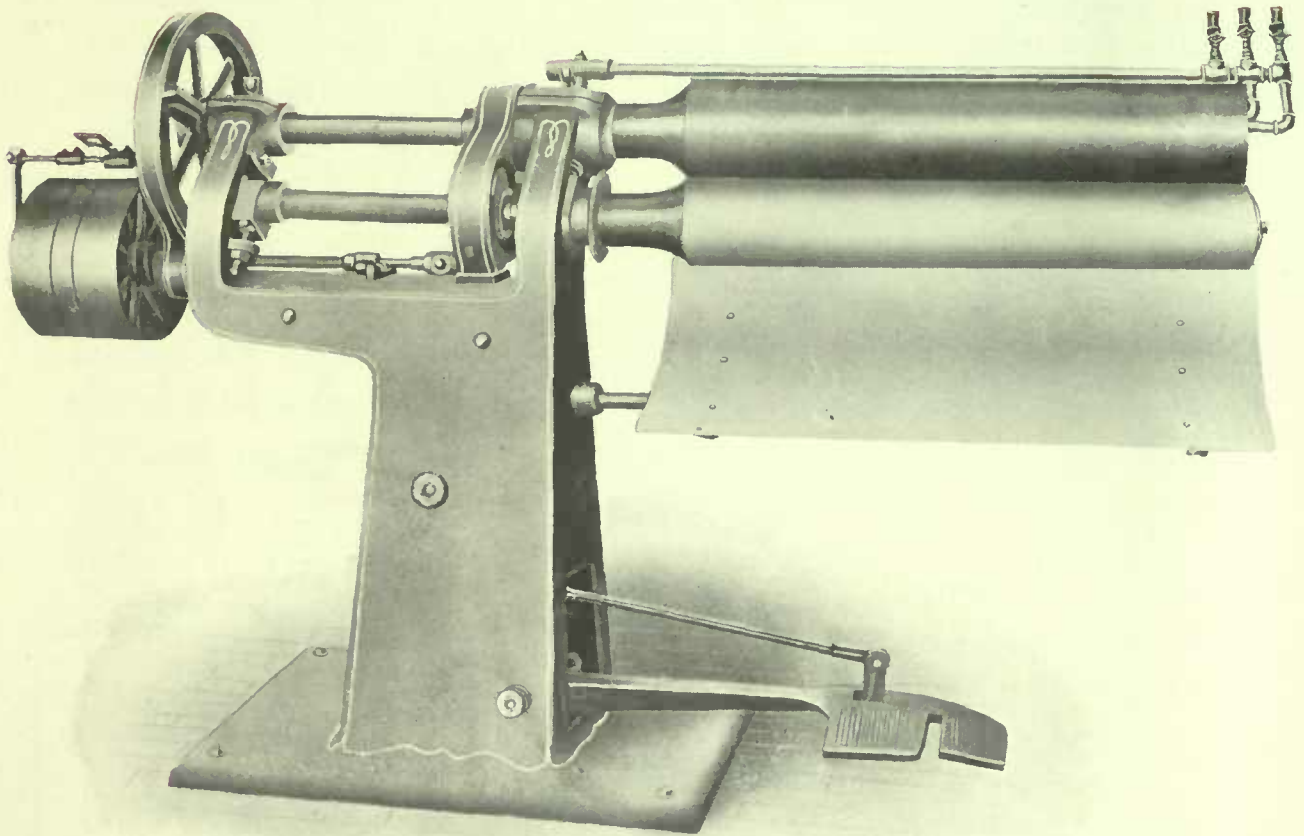

36 Inch.

Belt Reverse.



Toronto Belt Reverse Body Ironer

NO machine in its class possesses more sterling features or is deserving of greater favor, combining effectiveness, strength, durability and economy, in fact it is an ideal machine. The bearings are long and being perfectly parallel equalize the strain. The cut gears, with fibre pinion, make it perfectly noiseless. The reverse movement is very simple and at the same time effective, and as both rolls reverse at the same time it is very easy on the work. The treadles for raising the hot roll and reversing machine are fastened one on the other close to the floor, doing away with the platform that has to be used with most machines. This machine can be operated by one or both feet. One of the objectionable features of the ordinary body ironer is that the large roll bearing next the roll was a continual source of trouble by reason of the babbitt wearing away quickly and the dust and dirt dropping down on the goods. To overcome this in our body ironer the top cap is bored from the solid and is perfectly adjustable to wear. WE USE NO LINERS on our bearings. In their place we have four set screws, one in each corner of cap. The cap is placed on roll and these set screws are screwed through the cap until they come in contact with the frame, then the cap screws are drawn down upon them. To take up the wear all that is necessary is to loosen cap screws, unscrew set screws slightly and then tighten up cap screws. The lower half of the hot roll bearing is fitted with an interchangeable Phosphor Bronze Bearing. One of the most important improvements in this machine since last issuing our catalogue is the COUNTERBALANCED TREADLE. There is a counterbalancing weight attached to the extended end of the treadle inside the frame of the Body Ironer and this weight just balances the weight of the lower roll and the treadles. Instead of the operator having to overcome this dead weight thousands of times each day, all the weight of the rolls is counteracted and the pressure exerted by the operator upon the treadle is all used for IRONING. The operation of one of our new Body Ironers is therefore greatly less fatuiging and we would especially call attention to this feature. These machines, as well as all the Toronto Ironing Machines, may be had heated either by Gas or Electricity, and either driven by Belt or Direct Connected Motor. Where no gas or electricity is available these machines may be fitted, at a slight additional cost, with a Gasoline Burner. The three connections shown upon the Burner on the opposite page, should have the two outside ones connected to the blower, and the centre is for gas. The outer connection is for circulating air inside the roll and is only an auxiliary to be used where the air pressure is not very great.

SPECIFICATIONS										
Rolls inches	No. Gas Heated		No. Electrically Driven		Pulleys			Belts	Weight	Floor Space inches
	Belt Driven	Motor Driven	Belt Driven	Motor Driven	Diameter inches	Face inches	R. P. M.			
20	345	350	355	360	12	8	125	1½	925	36 × 80
24	346	351	356	361	12	8	125	1½	975	36 × 84
30	347	352	357	362	12	8	125	1½	1025	36 × 90
34	348	353	358	363	12	8	125	1½	1075	36 × 94
36	349	354	359	364	12	8	125	1½	1100	36 × 96

Toronto Reverse Sleeve Ironer

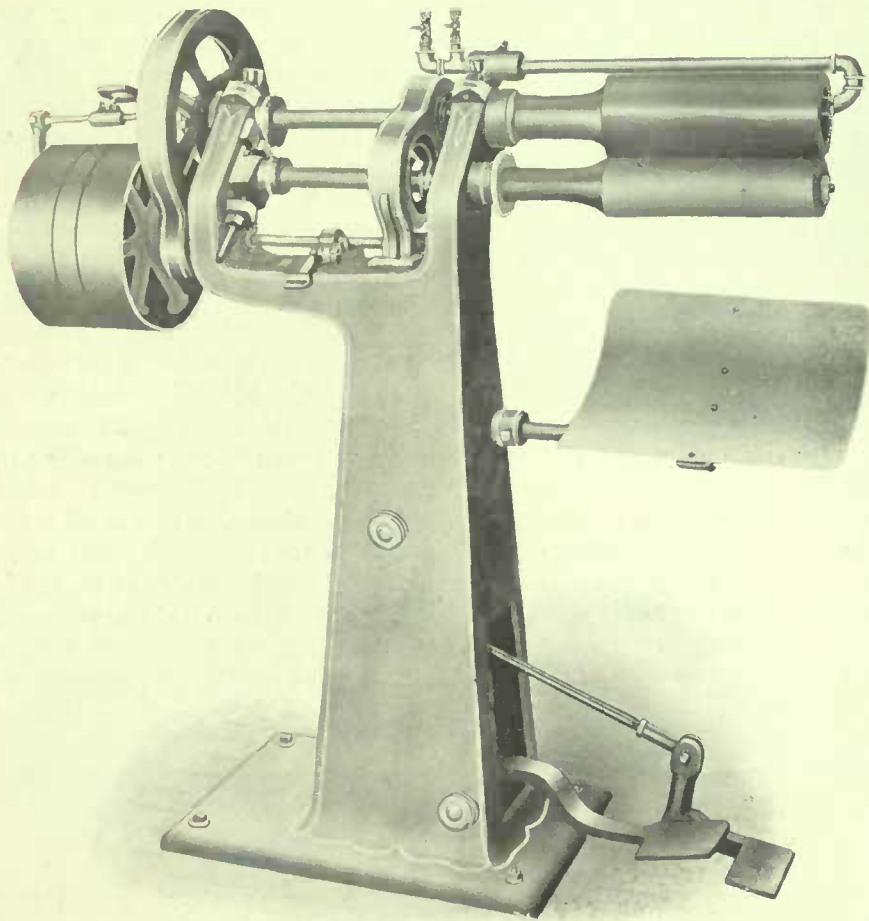

12 inch.

Belt Reverse.



Toronto Reverse Sleeve Ironer

FOR the purpose of a name, we speak of this machine as a Sleeve Ironer, but its sphere of usefulness, is by no means, limited to the mere ironing of shirt sleeves. It will be found particularly valuable in the ironing of flounces, shirt waists and, in fact, most of the small pieces of ladies' wear which are now gravitating to the public laundries in such large quantities.

It is speedy and at the same time it irons properly. The gears are so arranged that both heated and padded rolls are driven at the same speed and it therefore imparts a perfect domestic finish. If the machine is kept properly padded it will not batter down and burnish the seams, and the finish will excel that of the hand iron, while the amount of work which an operator can produce will be many times greater than can possibly be produced by hand. The 6-inch roll is best suited to the ironing of wristbands and yokes, and when the work is confined to shirt waists, flounces, etc., the 9-inch roll is to be preferred. While in the ironing of shirt sleeves and bodies of shirt waists, the 12-inch roll is recommended.

Ample space is left between the inner end of the ironing roll and the frame of the machine to accommodate the unironed portion of the garment. A brass shield protects the garment from being soiled either by contact with the frame or by oil from the bearings.

Excepting that this machine is smaller it is in every respect the same as the body ironers illustrated and described on pages 164 and 165, and the description of the construction and special features of the Body Ironer apply as well to this machine, which is also fitted with a COUNTER BALANCE TREADLE.

SPECIFICATIONS										
Rolls Inches	Gas Heated		Electrically Heated		Pulleys			Belts	Weight lbs	Floor Space Inches
	Belt Driven	Motor Driven	Belt Driven	Motor Driven	Diameter Inches	Face Inches	R. P. M.			
6	365	369	373	377	12	8	125	1 ½	500	20 × 42
9	366	370	374	378	12	8	125	1 ½	525	20 × 45
12	367	371	375	379	12	8	125	1 ½	550	20 × 48
18	368	372	376	380	12	8	125	1 ½	600	20 × 54



Toronto Press Machines

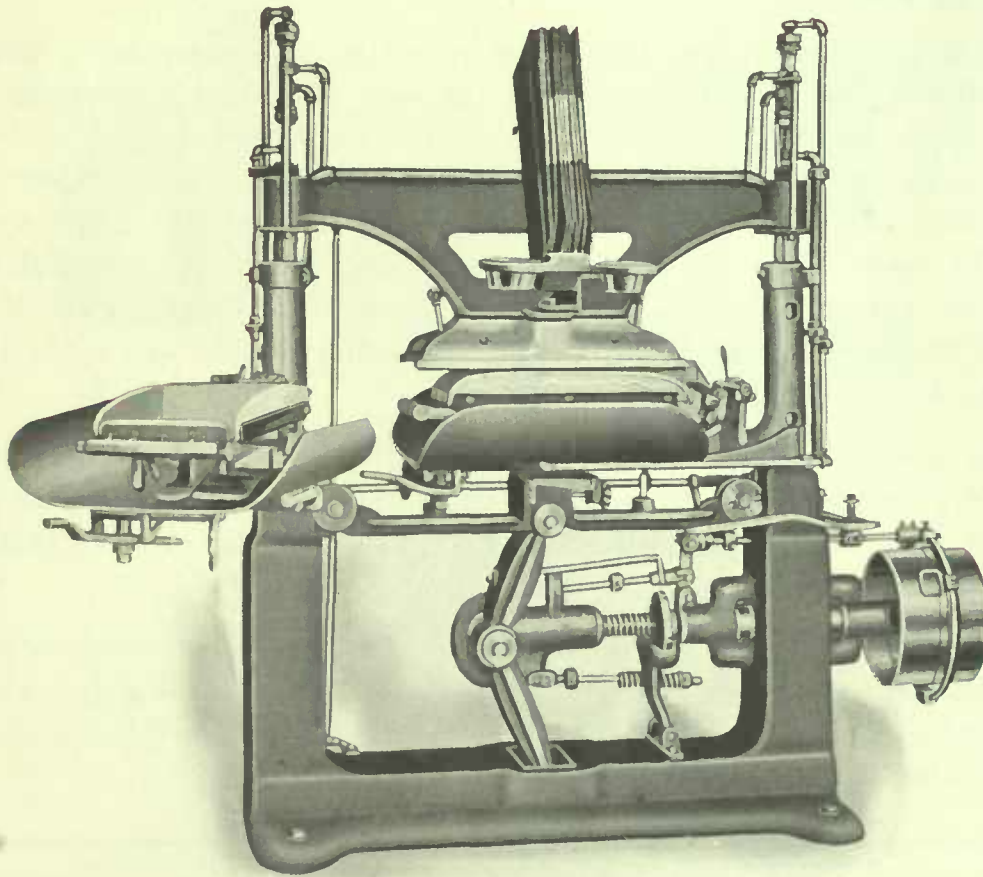

Toronto Bosom Press.

Both Surfaces Steam Heated.

Belt Driven.

With Wide Boards.

No. 392.



Toronto Press Machines

IRONING BY PRESSURE

ON the following pages we illustrate and describe a full line of Toronto Press Machines. The pressure system of ironing is the nearest approach to a production of that **LIKE NEW APPEARANCE** which up to the present time has only been possible to obtain by hand ironing. These machines produce a finish that is without gloss and at the same time is perfectly smooth and the appearance of the original finish of the goods when new is retained by this system of pressure ironing without any wear, stretching, friction or motion, just by pressure of the goods against a polished surface heated by steam. Shirts are ironed perfectly flat and unlike other older methods of ironing, these will remain flat when worn and do not have the fault of bulging as is usually found in shirts ironed by the rotary process. Wear and tear upon the goods ironed is entirely eliminated and the pressure system has this advantage even over the hand ironing system, for the reason that even an expert hand ironer has to resort to a certain amount of stretching and pulling in order to get a nice appearing finish to the garment.

The following Press Machines have both ironing and padded surfaces steam heated, and the process of ironing is the same in all the machines, the goods being laid upon the padded surface and pressed against the steam heated ironing surface. The only difference between the machines is that in the case of the bosom press, the pressure is applied either by belt or motor, but in the case of the smaller machine this is applied by foot treadles, and the fact that most of these machines require no power to operate allows them to be placed wherever convenient and without regard to locations convenient to shafting, the bosom press alone requiring power, and if this machine is motor driven it may be placed in any convenient location. The addition of any of these machines, whether only one or the whole line, will prove a valuable one in the laundry, as by their use a marked improvement in the quantity and quality of the work produced is sure to follow, and inexperienced help may be taught to operate these machines and produce perfect work and become proficient in a much less time than on the rotary machines.

Toronto Press Machines

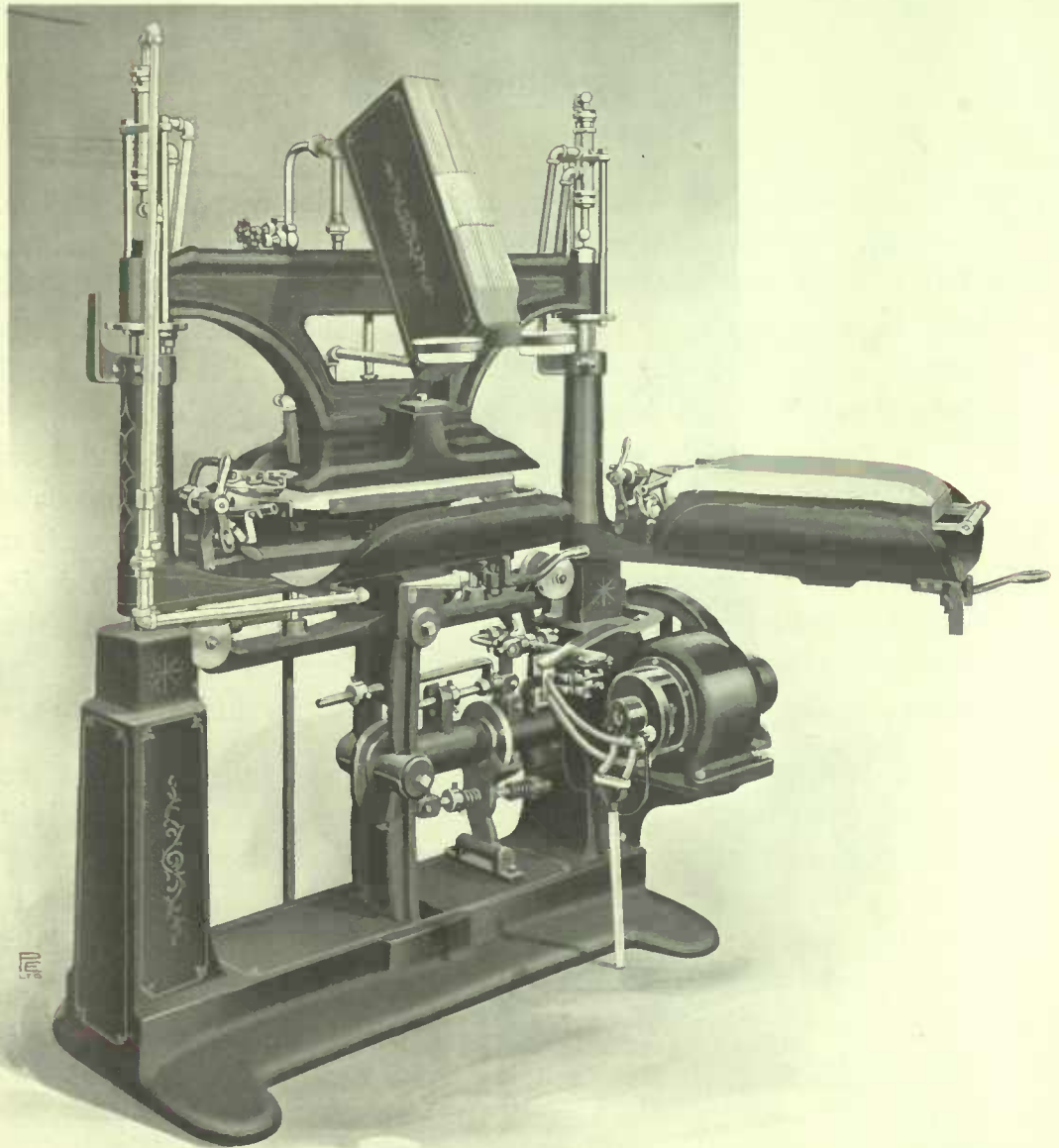

Toronto Bosom Press

Both Surfaces Steam Heated.

Motor Driven

With Wide Boards.

No. 391.



Toronto Press Machines

THE TORONTO BOSOM PRESS.

THE Toronto Bosom Press illustrated herewith embodies a great number of original features and represents a machine which is the product of expert workmen and carefully selected material and is complete in every detail. One of the most commendable features of the Toronto Bosom Press is its simplicity of design and completeness of its mechanical features. Every part is in the open, exposed to view and there are no parts which are inaccessible. The ironing and padded surfaces are wide and cover a greater surface of the shirt front than was possible with the older, narrower type of press. The steam heated padded surface requires to be changed only once in several days. The bosom plates are contained in a steam heated chamber. All sizes and styles of shirt fronts can be perfectly ironed upon these machines. The buttons are protected by the yielding padded surface, which is padded with 20 thicknesses of double faced Canton flannel. It is impossible to apply the pressure unless the padded surface is in its proper position, directly under the steam chest. The Toronto Bosom Press, with $\frac{1}{2}$ H. P. Direct Connected Motor, as shown on the opposite page, is also equipped with this safety feature and is the only motor driven press containing the same. The machines as illustrated are equipped for starting and stopping by means of a lever, but they may also be fitted with a foot treadle for this purpose if so desired.

SPECIFICATIONS						
Number	PULLEYS			Belts, inches	Floor Space inches	Weight, lbs.
	Diameter, inches	Face, inches	R. P. M.			
Belt Driven, 392	12	8	175	1 $\frac{1}{4}$	48 x 84	2100
Motor Driven, 391	12	8	175	1 $\frac{1}{4}$	48 x 84	2100



THE TORONTO LINE

Toronto Press Machines

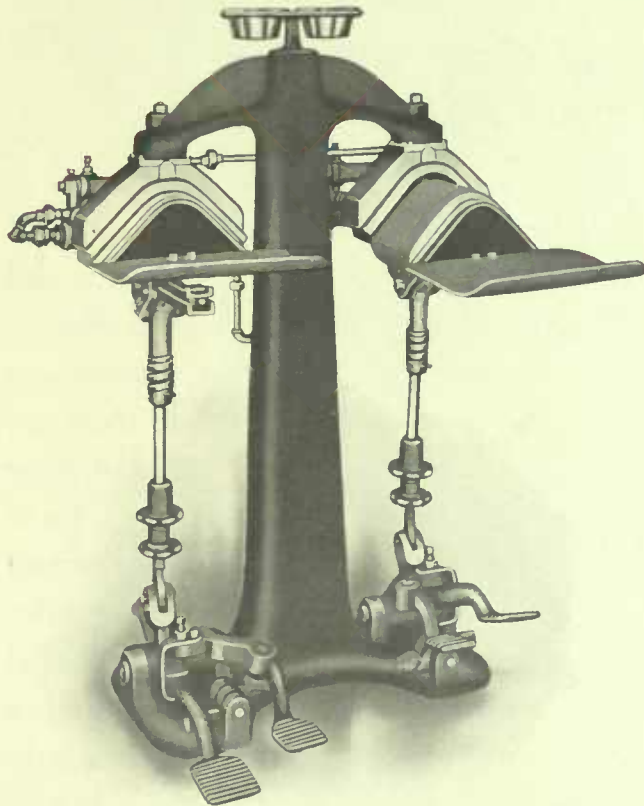

Double Saddle Cuff Press. No. 393.

Yoke and Neckband Press.

THE Toronto Combined Neckband and Yoke Press is a practical combination of the neckband press and yoke press. The neckbands ironed by this press are moulded into a shape which adds greatly to the appearance and comfort of the finished neckband. It is impossible by this means to stretch the neckband. The Yoke Press consists of the round flat steam heated ironing and padded surface which irons the yoke out flat and adds considerably to the appearance of the finished work.

SPECIFICATIONS		
Steam Connections	Weight	Floor Space
$\frac{3}{8}$ in.	600 lbs.	36 x 38 in.

Cuff Press.

THE Toronto Double Saddle Cuff Press is furnished with the ironing and padded surfaces both steam heated. The machine will mould wristbands and attached cuffs into a very graceful curve, eliminating the possibility of cracking the cuffs in the centre which so often happens in bending the flat ironed cuff into shape. Power is applied by means of the foot treadles, the action is positive and altogether it is a very simple machine and a very necessary one in the equipment of the modern laundry.

SPECIFICATIONS		
Steam Connections	Weight	Floor Space
$\frac{3}{8}$ in.	600 lbs.	30 x 36 in.

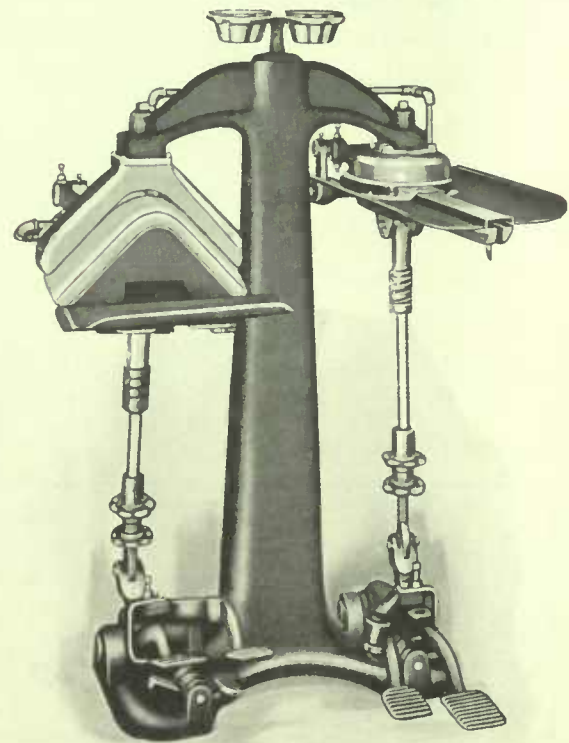

Combined Yoke and Neckband Press. No. 394.

Toronto Press Machines

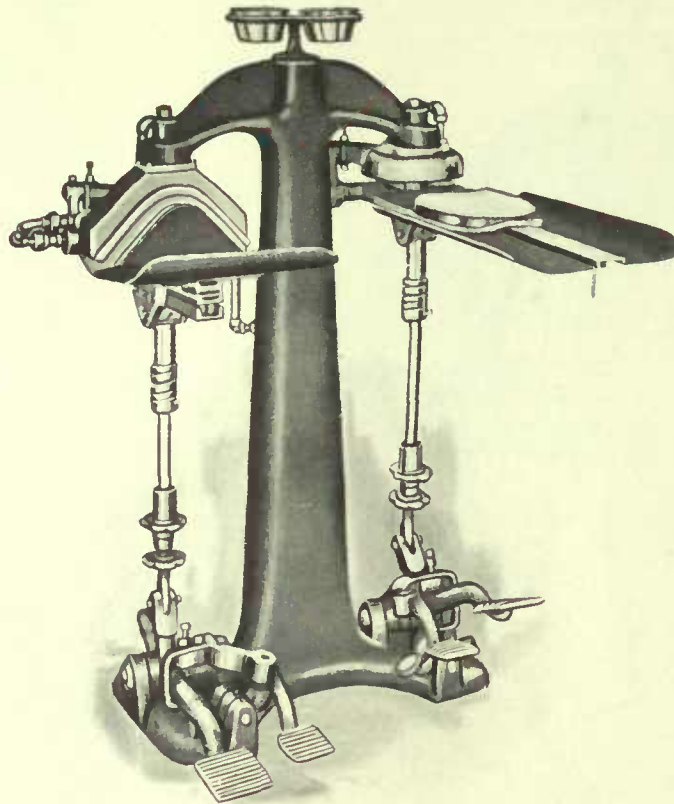

Combined Cuff and Yoke Press. No. 395.

Collar Press.

THE Toronto Collar Press was designed for the purpose of fixing GO BACK Collars, which have become blistered or are otherwise imperfect. By sponging the imperfect spots and placing the collar in the Collar Press the collar is finished perfectly. Every laundry should be equipped with one of these economical and time saving machines. This Press should be placed close to the inspection table, so that the collars that are imperfect may be only momentarily delayed in their passage through the laundry.

SPECIFICATIONS		
Steam Connections	Weight	Floor Space
$\frac{3}{8}$ in.	400 lbs.	36 x 36 in.

Cuff and Yoke Press.

THE Toronto Combined Cuff and Yoke Press is another practical combination of the Press Machines, being a combination of the Yoke and Cuff Presses. The power is applied in the same manner as the other small presses, and the heads and pads are also steam heated, and this combination is especially recommended for the laundry where this Press would be the only Press included for their equipment, as it will handle cuffs and wristbauds and also the yokes.

SPECIFICATIONS		
Steam Connections	Weight	Floor Space
$\frac{3}{8}$ in.	600 lbs.	36 x 40 in.

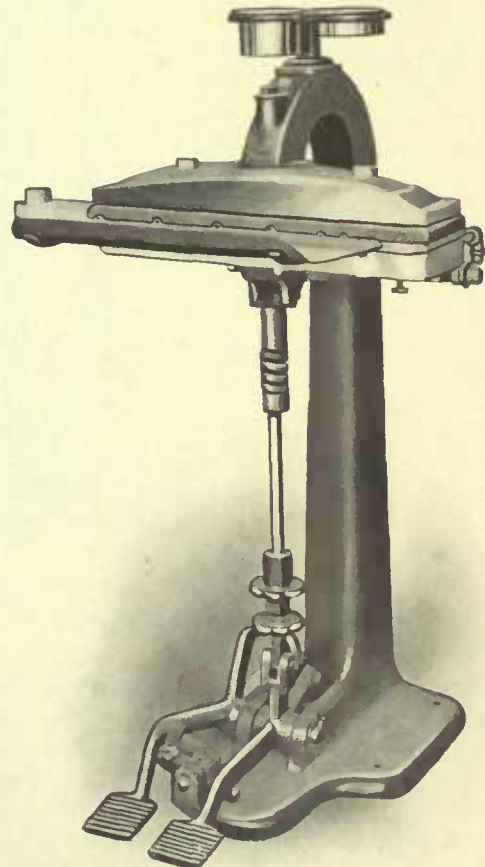

Collar Press. No. 396.



THE TORONTO LINE

Toronto Press Machines

No. 397

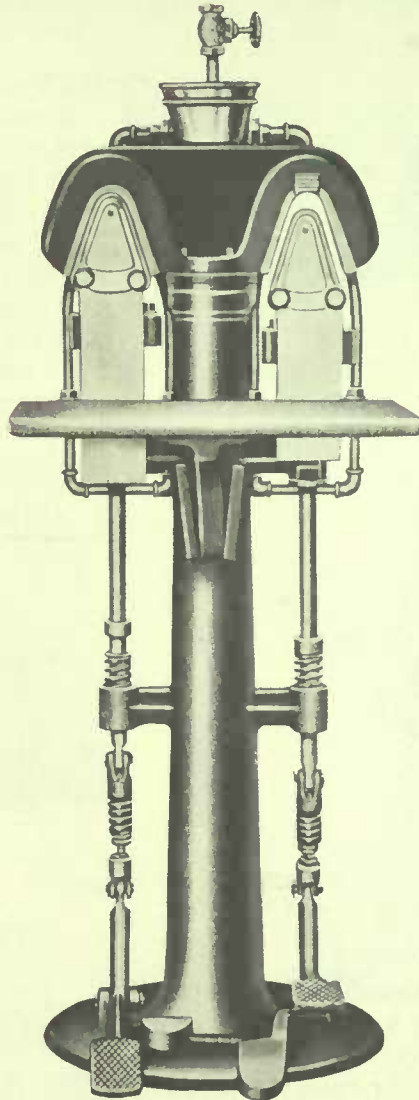

Ladies' Shirt Waist Cuff Press

THE Toronto Ladies' Shirt Waist Cuff Press, was designed to iron the attached cuffs on Ladies' Shirt Waists as it was impossible to iron the same on the regular cuff press owing to the fact that the gussets were not long enough to permit the cuff being straightened out sufficiently flat on that machine. By using the above machine, this work is accomplished in a perfect manner by means of the "V" shaped ironing heads which permits the ironing of an attached cuff where the gusset is only a couple of inches long.

SPECIFICATIONS		
Steam Connections	Floor Space	Weight
$\frac{3}{8}$ in.	24 x 24 in.	400 lbs.



Toronto Press Machines

No. 397

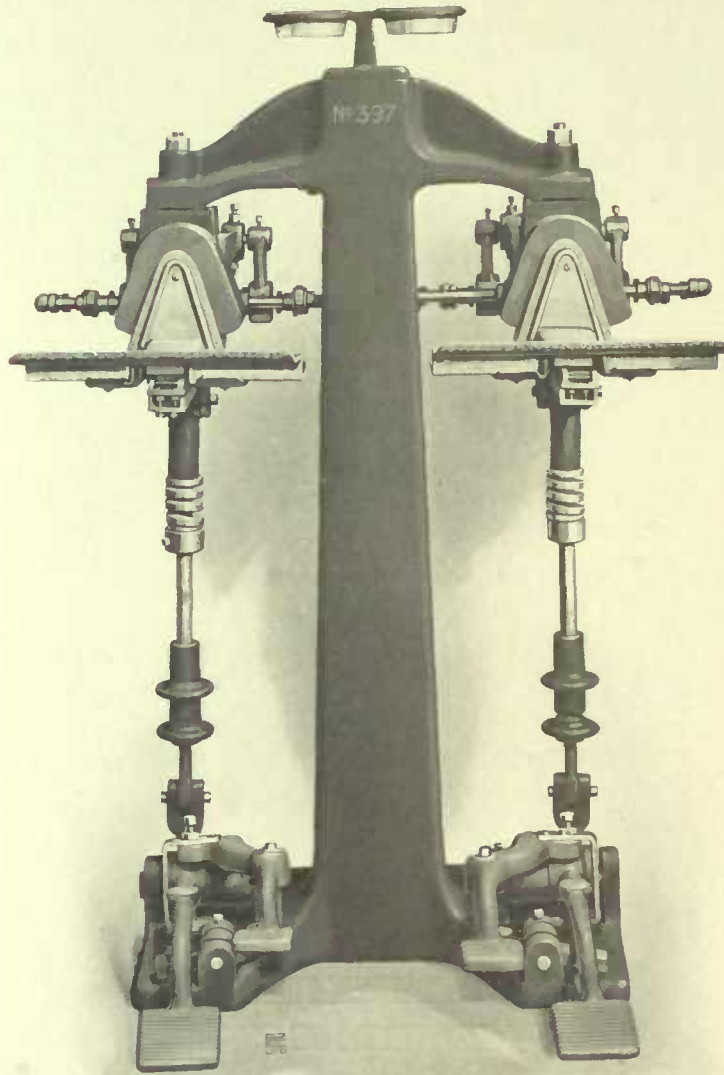

Ladies' Shirt Waist Cuff Press

THE Toronto Ladies' Shirt Waist Cuff Press, was designed to iron the attached cuffs on Ladies' Shirt Waists as it was impossible to iron the same on the regular cuff press owing to the fact that the gussets were not long enough to permit the cuff being straightened out sufficiently flat on that machine. By using the above machine, this work is accomplished in a perfect manner by means of the "V" shaped ironing heads which permits the ironing of an attached cuff where the gusset is only a couple of inches long.

SPECIFICATIONS		
Steam Connections	Floor Space	Weight
$\frac{3}{8}$ in.	24 x 24 in.	400 lbs.

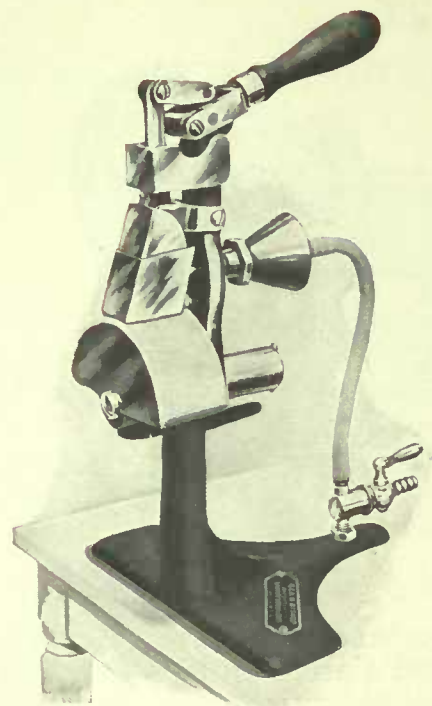

Bishop Neck-band Fixer

No. 388

An indispensable little machine for fixing up broken down neck-bands either before or after they have been folded, and should be on the finishing table of every laundry, large or small.

SPECIFICATIONS		
Height	Table Space	Weight
13½ in.	8 x 9 in.	14 lbs.

Shirt Folding Board

For Negligee Shirts.
Can Be Used on Any Table.

DIMENSIONS		
Table Space	Size of Plate	Weight
13 x 28½ in.	8½ x 22 in.	12 lbs.

Special sizes to order.



Hand Fluting Tong

Nickel Plated



No. 389

Sizes ⅛, ⅙, and ¼ Inch Diameter.

No. 390

Toronto Power Fluter

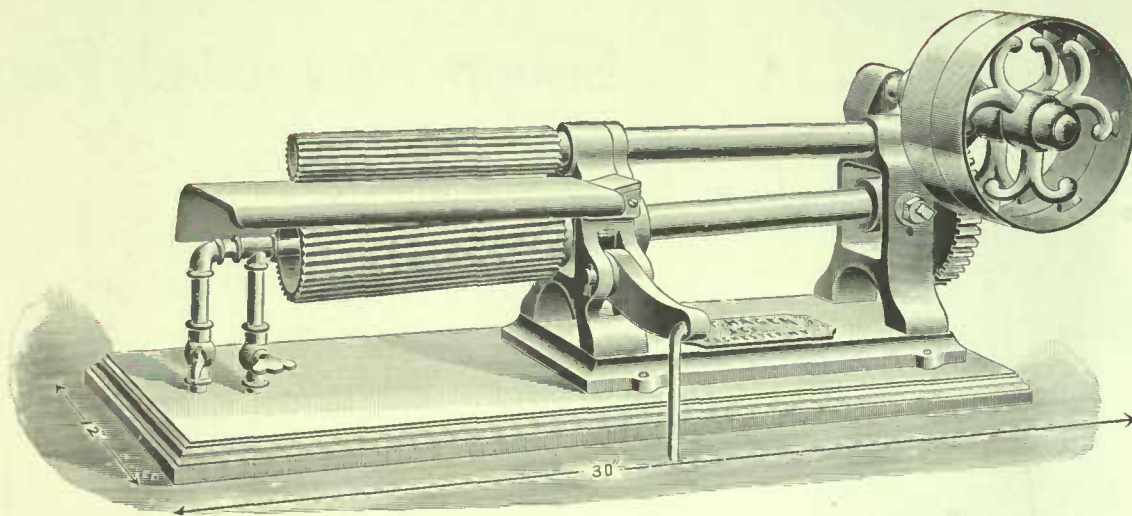

No. 386

THIS machine is another specialty which, while not recommended for every laundry, yet every laundryman should look into its merits and consider carefully whether he can use it to advantage or not. It is very convenient, inexpensive, and where any quantity of ladies' clothes are handled will pay for itself in a few months. It is heated by gas, and the goods are protected by a brass table or feed board. The operator has the use of both hands to handle her work, making it more rapid than the hand fluter and avoiding the use of slugs.

SPECIFICATIONS				
Pulleys	Rolls	Belt	Speed	Packed for Export
6 in. diameter	7 in. long	1½ in.	100 rev.	3 cubic feet

Bishop's Steam Heated Power Fluter

Made to overcome the objectionable features of a gas machine.

Some of the advantages :

CLEANLINESS, UNIFORM HEAT, NO SCORCHING.

SPECIFICATIONS			
Length of Roll	Weight	Speed	Size of Pulley
8 in.	160 lbs.	200 rev.	6 in. × 1½ in.

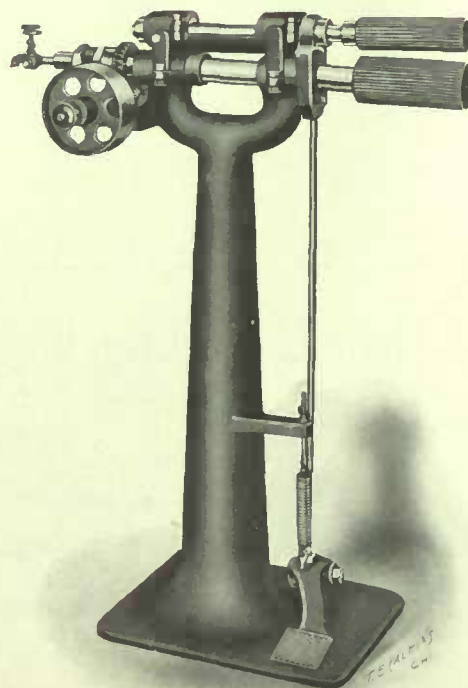

No. 387

Toronto Gas Iron Heaters

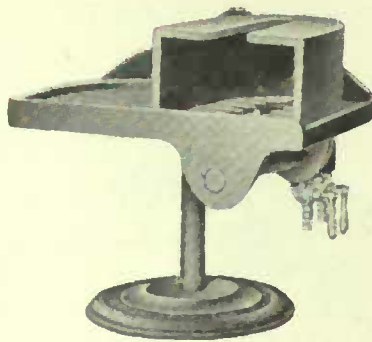

Single Heater. No. 398.

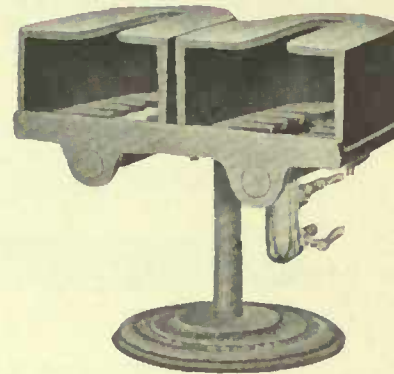

Double Heater. No. 399.

THESE are very effective and economical gas heated stoves for the laundry, heating sad or polishing irons. The hot blast is secured by forcing a current of air into the gas burner by means of a pressure blower. The principle is the same as in an ironing machine, giving a strong, intense heat with a small consumption of gas, with perfect combustion, consequently no smoke. They can be used just as readily with natural gas and also with Atmospheric Burners. Heater can be fastened to the wall or used on table.

Shirt Ironing Table

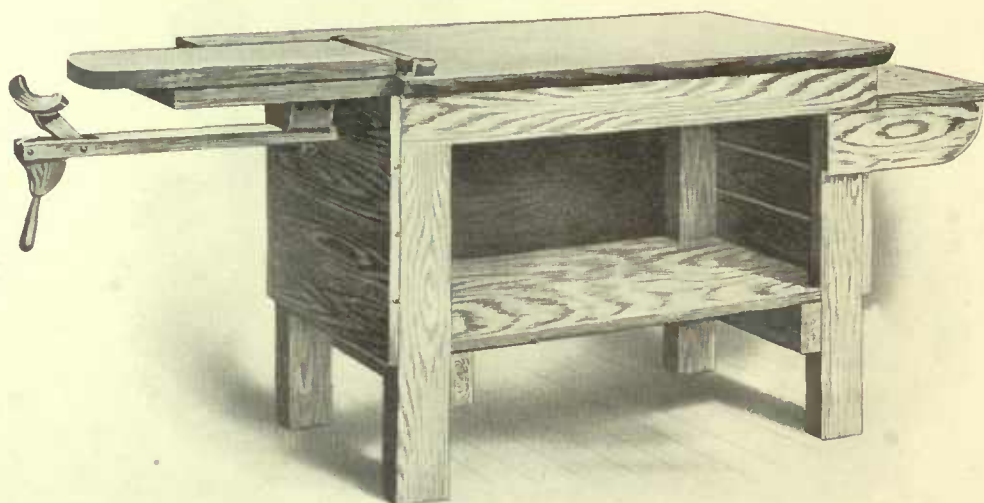

No. 411

Floor Space, 32 x 87 inches.

Weight, 250 lbs.

Toronto Gas Heated Ironing Tables

No. 402



With Sleeve Board in Position.

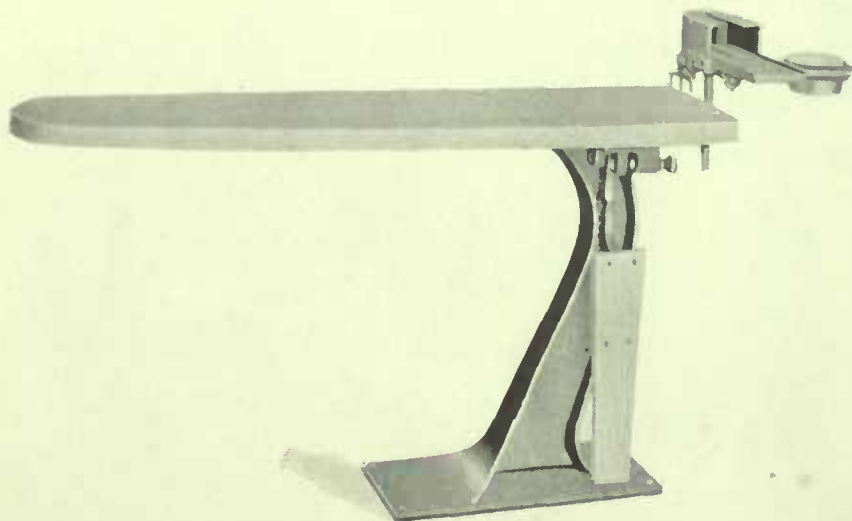

With Sleeve Board Dropped



Toronto Gas Heated Ironing Table

THIS Self-contained Ironing Table commends itself to all progressive laundrymen by reason of its all-round usefulness and convenience. As everything that is necessary for ironing is within reach of the operator, the stove, iron rest, water and sponge cup being conveniently placed. The sleeve board on this table drops down out of the way, and when up in its position is perfectly rigid. In ordering kindly state whether atmospheric or pressure burners are required. Unless otherwise stated in order, tables will be sent equipped with pressure burners.

Skirt Protector

No. 403

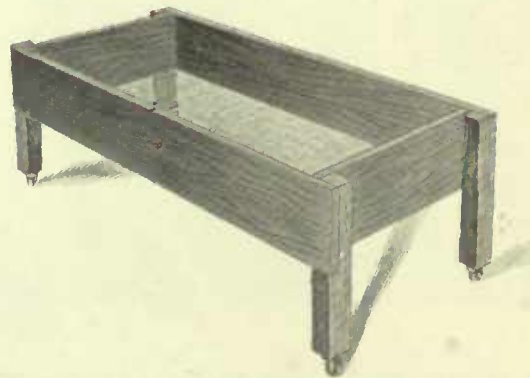

For use with Ironing Tables to prevent long articles from touching the floor.

Size 18 x 36 inches.

Weight 25 lbs.

The Huebsch Adjustable Hosiery Forms and Applying Machine



Adjustable Hosiery Forms and Applying Machine No. 412.



The Huebsch Adjustable Hosiery Forms and Applying Machine

IN drawing your attention to this equipment we are sure the practical features of it will impress you immediately, marking as they do the most real advance that has been made in improving the output and reducing the operating expenses. It eliminates entirely the ironing of hosiery, besides giving them a "LIKE NEW" appearance. The socks and stockings are very easily and quickly put on to the forms by placing the form into the machine, as shown on page 180. The machine being equipped with two discs on each end, carries the sock or stocking over the heel of the form, after which the form is withdrawn and the heel adjusted according to the size of the sock or stocking. They are now ready for the Dry-room, and the fact that all parts of the sock or stocking are equally exposed makes the drying operation a very short one, and at the same time can be obtained in no other way.

THE MONEY IS HERE

It is a known fact that this class of work is the most profitable that comes into the laundry, and nothing will develop it so quickly as doing it in the best possible way. Our Hosiery Form and Machine enables you to do this, thus giving your patrons greater satisfaction and at the same time reducing your operating expenses.

READY FOR THE DRY-ROOM

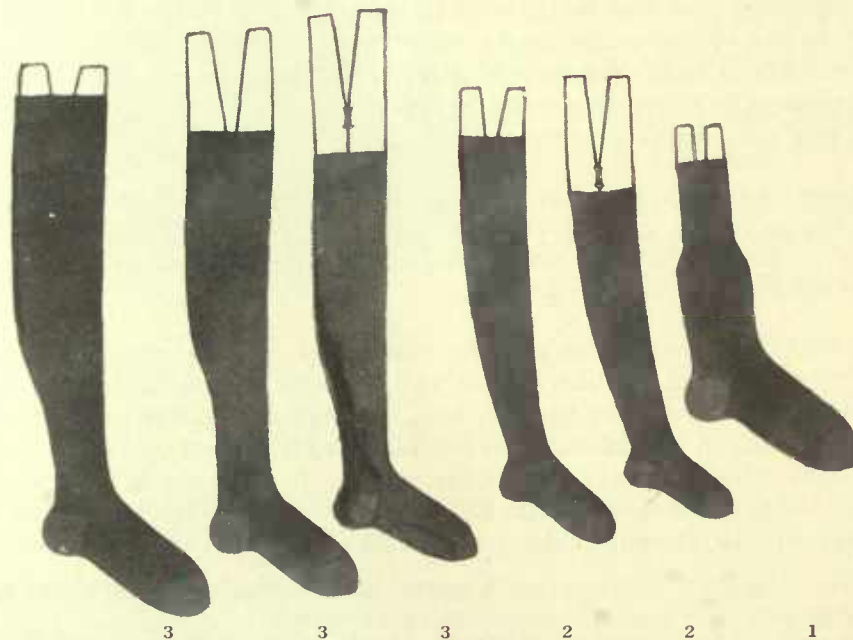

The above cut shows a sock and stockings of different sizes ready for the Dry-room. The forms are made in three sizes. No. 1 will take any size stock; No. 2, stockings up to 8-year-old size, and No. 3, from 8 year to full size stockings. By this arrangement it will be seen that only three sizes are required to handle effectively all the various sizes of socks and stockings that a laundry receives. 100 forms are supplied with the machine.

Floor Space, 36 x 36 inches.

Weight, 100 lbs.



Hoffman Pressing Machines

THE ART OF CLOTHES PRESSING

THE Hoffman is a combination of steam heat and pressure. The steam is generated in a boiler attached to the machine, it requiring twenty to thirty pounds of steam to sponge the goods. The steam is superheated to a high degree of temperature before being injected in the garment, which is placed on a press block similar to the ordinary one in use by tailors. The iron is then brought to bear upon the garment, and at the same time the necessary amount of steam is released and forces its way through the garment, sponging and pressing it at the same time. The foot lever supplies the pressure needed.

The pressing of clothes is performed by applying steam to the cloth, rendering it soft and flexible and easy to stretch and mould into the desired shape. The method of accomplishing this from time immemorial has been by placing a wet cloth, known as a sponge or press cloth, over the goods to be pressed, then applying to this an iron hot enough to turn the water in the sponge into steam and drive it down into the goods beneath. This iron is usually heated on a stove until hot enough, or probably a little hotter than is needed. This iron by being heated on the stove and cooled during the operation of pressing, is but for a short time in the proper degree of heat for the work in hand, and to overcome this there has been developed a means of heating the iron by gas or electricity while in use. This has now become very common in pressing. Even with such an Iron, since the cold water in the press cloth has to be converted into steam, it is necessary that the iron be hotter than would be required to do the pressing alone, and consequently if left in one spot too long will burn or scorch the garment.

Many efforts have been made to improve in detail these self heating irons, by means of applying pressure by levers, but up to the time of the invention of "THE HOFFMAN" pressing by direct application of steam, no advance had been made in the art, nor had any material advantage been gained over the methods of our forgotten ancestors.

"THE " HOFFMAN " Steam Clothes Pressing Machine is one of those radical steps forward that proves the superiority of the times in which we live, and is a factor of the Twentieth Century. Not only does this accomplish all that was done by the hand iron, but the direct application of steam to the garment is both sanitary and renovating, and accomplishes the desired ends without that excessive pressure that has heretofore been thought necessary and has often destroyed the life of the goods. It also does away entirely with the necessity of handling the sponge cloth, and by its greater inherent worth allows of much surface being covered at one operation, thereby doubling and trebling the output of each presser.

While " THE HOFFMAN " has been on the market but a short time, hundreds of them are now in daily use, and meeting with such favorable comments as it deserves.

It is, therefore, with pleasure that we present " THE HOFFMAN," pointing out in detail its many merits as a money saver, time saver, worry saver, capable of better work than any hand iron can possibly accomplish.

Hoffman Pressing Machines



Rear view shown with boiler attached.

HOFFMAN AA

PATENTED

Steam Heated Head and Buck.

SIZE OF HEAD AND BUCK		
Length	Width Large End	Width Small End
32 in.	10½ in.	7 in.

Weight approximately 600 lbs.

Floor space, four feet square.

The popular press for ladies' and gents's suits, skirts and overcoats.

This machine is also made for direct steam connection where from 50 to 60 lbs. steam pressure is available at machine.

HOFFMAN STYLE AA

This machine has a steam heated head and buck, giving heat on both sides of the garment at all times.

It is operated either from direct steam or from a boiler attached to machine.

It requires no gas connections on head, and can be operated by direct steam, without any gas whatever.

This Press handles goods in all different fabrics no matter what their nature or weight may be (silks excepted).

You cannot scorch the garment or change the color with "HOFFMAN" Presses.



The Hoffman Pressing Machines

THE HOFFMAN "C"

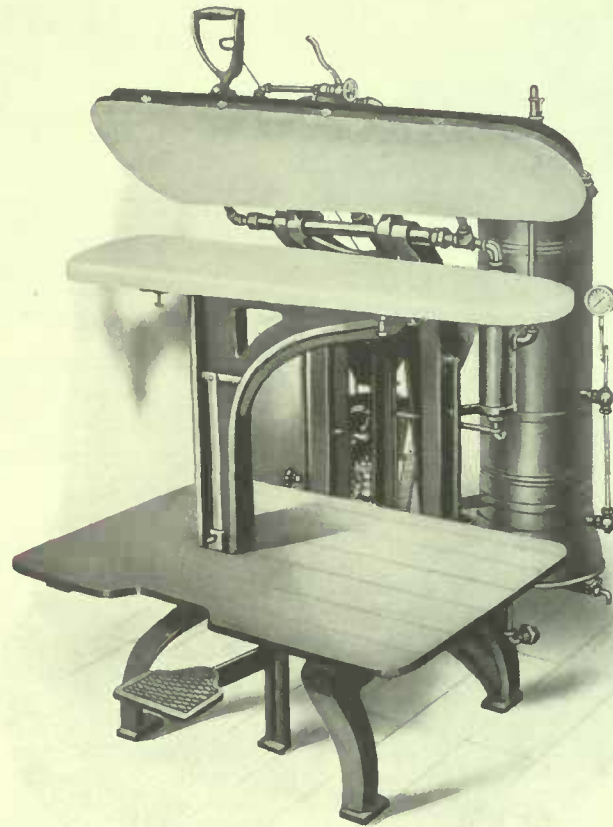

Front View. Shown With Boiler Attached.

"The HOFF-MAN" "C" having a long buck and adjustable table, is especially adapted to pressing skirts, overcoats, and articles of length.

May also be had for direct steam connection where from 50 to 60 lbs. steam pressure is available at machine.

Capacity, 40 to 50 skirts per day.

It is also used for steaming and pressing woolens in the laundry, and gives much better results than the steam table.

Regularly furnished with burners fitted for city gas—burners will be furnished for natural gas, air pressure gas, or gasoline gas when requested.

Floor space required—four feet square.

All machines are shipped fully set up and requiring only gas connections to operate.

Weight of machine, 900 pounds.

Weight crated for shipment, 1,100 pounds.

Copper Steam Table

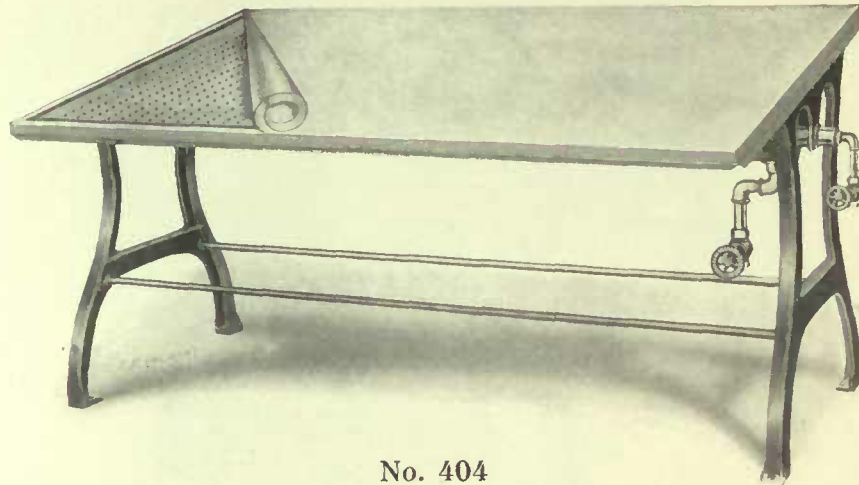

No. 404

THE top and entire lining is of heavy copper, the under side being reinforced with galvanized steel. The back (or side farthest from the operator) is on a higher level than the front, allowing the escaping steam to rise towards the back, thus preventing its coming in contact with the face of the operator. Note the shifting rod in front, allowing the operator to turn the steam on or off without changing position. This arrangement places the steam under ABSOLUTE and INSTANTANEOUS control of the operator.

DIMENSIONS		
Size	Height	Weight
5½ ft. x 30 in.	33 in.	200 lbs.
Special sizes to order.		



Pants and Skirt
Steamer

THE lower shell and stand is made of iron, the shell being galvanized. The top is constructed of heavy perforated copper, making it the most durable and highly satisfactory steamer on the market.

Can be furnished with two compartments, if desired.

DIMENSIONS			
Special Skirt Steamer.		No. 405.	
Length	Width at Heel	Width at Toe	Weight
5 ft.	19 in.	9½ in.	250 lbs.
Pants and Skirt Steamer.		No. 406.	
5 ft.	14 in.	4 in.	210 lbs.

New Improved Copper Steam Drying Cylinder



THIS is a new improved Copper Steam Drying Cylinder for Silk Merino, Cashmere, Repp, Ribbon, Laces and Lace Curtains, etc. It is the only perfect cylinder on the market, and embodies all the good points of a Drying Cylinder. It is provided with iron braces on inside and vacuum valve, which makes it impossible for the cylinder to collapse. Made of strong heavy copper, heavily tinned and perfectly smooth. Rolled, complete with iron stands, selected hard wood for hand rings. Pressure valve, steam valve and automatic drain of the following dimensions:

DIMENSIONS		
No.	Inches	Weight
414	48 x 120	1100 lbs.
415	48 x 96	1000 lbs.
416	36 x 120	900 lbs.
417	36 x 72	700 lbs.
418	30 x 84	650 lbs.
419	24 x 72	550 lbs.
420	20 x 60	450 lbs.

Perforated Copper Steam Board

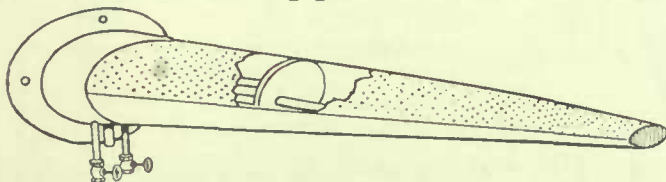

Built of extra strong and well hammered copper, smoothly perforated, brazed and soldered. We build a complete line in all sizes, or can make any style after your own design or idea.

Made with partition, so either end can be used when whole table is not required.

DIMENSIONS				
No.	Length	Width	Height	Weight
421	60 in.	22 in.	5 in.	100 lbs.
422	48 in.	20 in.	4 in.	80 lbs.
423	36 in.	18 in.	3 in.	70 lbs.

Copper Heating Coils for Dye House

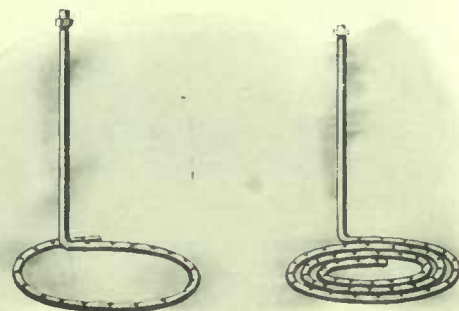

Made to any size ordered.
 One Coil No. 424. Three Coils No. 425.



Ideal Steam-Jacketed Feather Dyer

No. 426

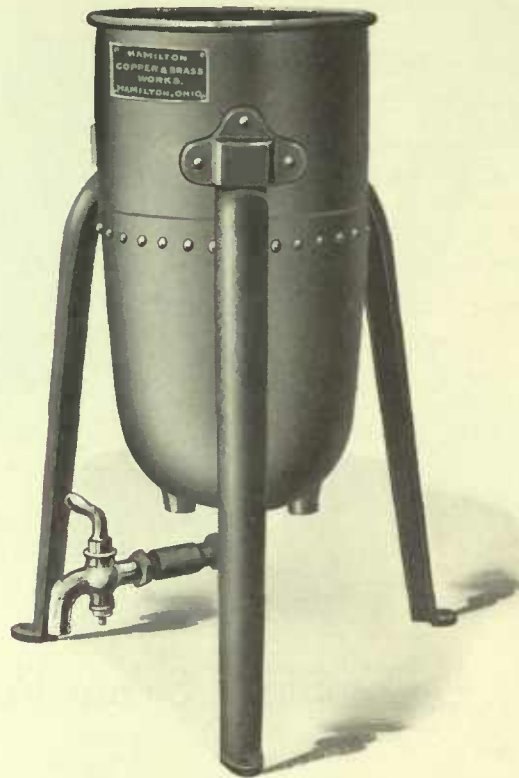

Ideal Copper Steam-Jacketed Feather Dyer.

Size 21 in. deep × 11 in. Diameter.

THIS new and practical outfit furnishes the ideal means of satisfactorily dyeing feathers. Measuring on the inside twenty-one inches deep and eleven inches in diameter, it makes a very convenient size and will not only accommodate the largest plume but the smallest size as well.

The jacket, as illustration shows, occupies almost two-thirds the height of the kettle, giving it a very large steam space, thus making an exceedingly quick heater.

Owing to its shape and size, it affords a speedy, reliable and inexpensive method for dyeing feathers, as it does not necessitate dyeing in kettles of large capacities.

When different colors for small work are required at one time, the Ideal Steam-Jacketed Feather Dyers are found indispensable.

This Kettle is made of the best hammered copper throughout, and is warranted to resist one hundred pounds steam pressure. It has a three-quarter inch steam inlet and outlet and a three-quarter inch draw-off, the latter opening being fitted with a brass faucet, as illustrated. Shipping weight, 90 pounds.

Copper Dye Kettle

THIS Kettle is made of heavy copper with re-inforced bottom, making one of the best Dye Kettles made. The steam enters at the bottom through a spray nozzle. It is fitted with a steam separator at one side, allowing only live dry steam to enter.

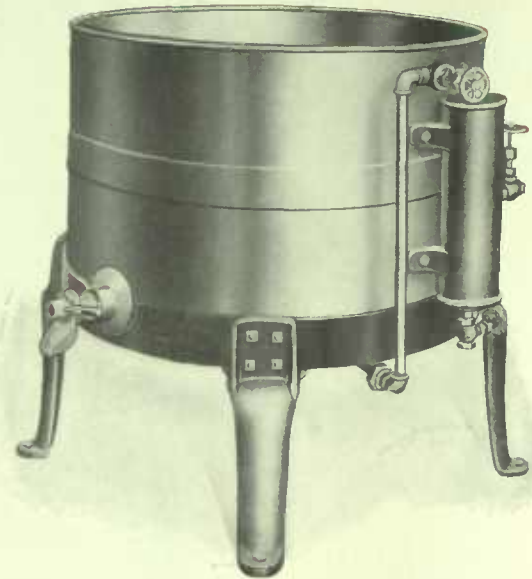

WEIGHTS		
No.	Gallons	Pounds
426	20	100
427	40	110
428	60	115
429	80	120

Special sizes to order.

Steam Heated Glove Cone



No. 430

Combined Steam Puff Ironer



No. 431

The several shaped heads are arranged in convenient form, adapting it to the use of more than one operator.

DIMENSIONS	
Floor Space	Weight
26 x 26 in.	94 lbs.

Glass Top Spotting Board



No. 407

SPECIFICATIONS						
Height	Length	Width at Front of Board	Width at Back of Board	Top	Glass	Weight
36 in.	57 in.	11 in.	20 in.	1 $\frac{5}{8}$ in. wood	$\frac{5}{16}$ in. plate	198 lbs. net



No. 408

Galvanized Iron Soap Tank

SPECIFICATIONS		
Capacity	Diameter	Height
60 gallons	24 in.	30 in.
Complete with perforated Galvanized Steam Pipe.		

Actual Sizes and Shapes of Toronto Puff Irons

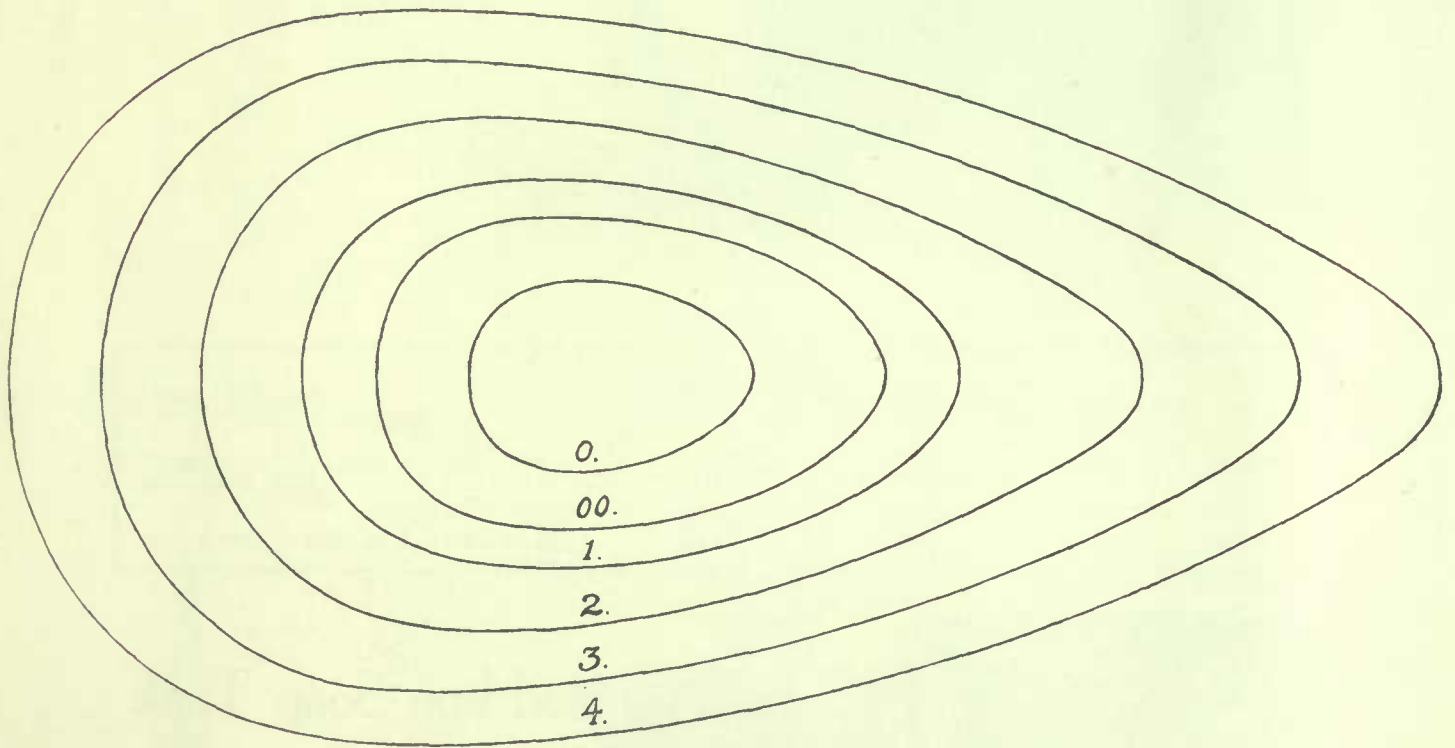

The Puff Irons are steam heated, and are supplied with inlet and outlet valves. The upper pipe and the head are polished and nickel-plated.

Improved Steam Heated Puff Irons

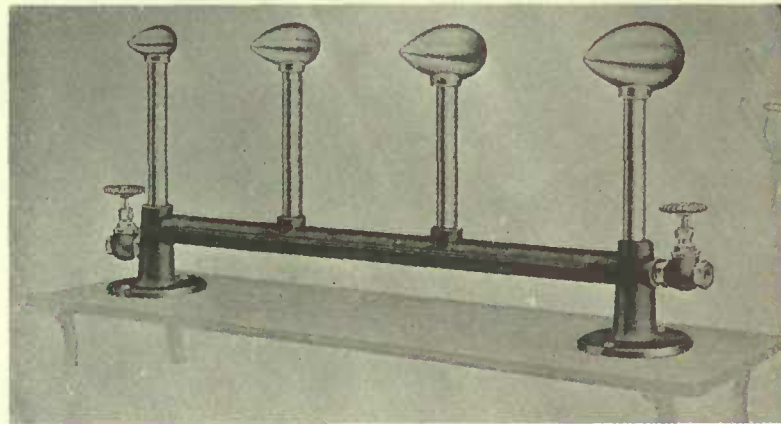

Nickel Plated.

Connected Puffers.

Sizes : 3 x 2 in.

5 x 2½ in.

6½ x ¾ in.

8 x ¾ in.

Single Puff Irons

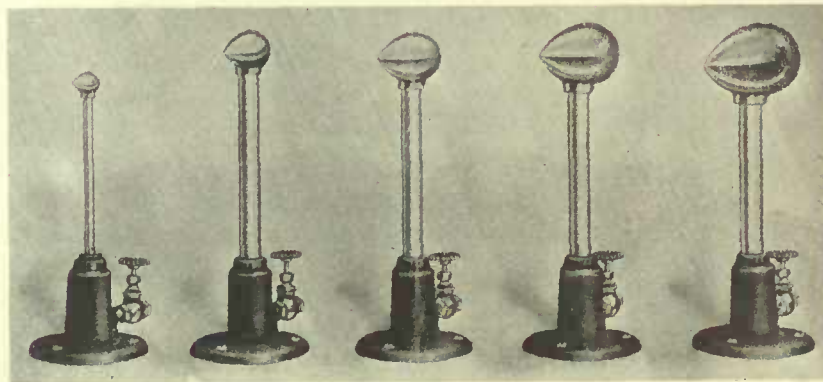

Nickel Plated

Numbers : 0

1

2

3

4

Sizes : 1½ x 1 in.

3 x 2 in.

5 x 2½ in.

6½ x ¾ in.

8 x ¾ in.



THE TORONTO LINE

Monarch Square or Oval Shaped Benzine Still

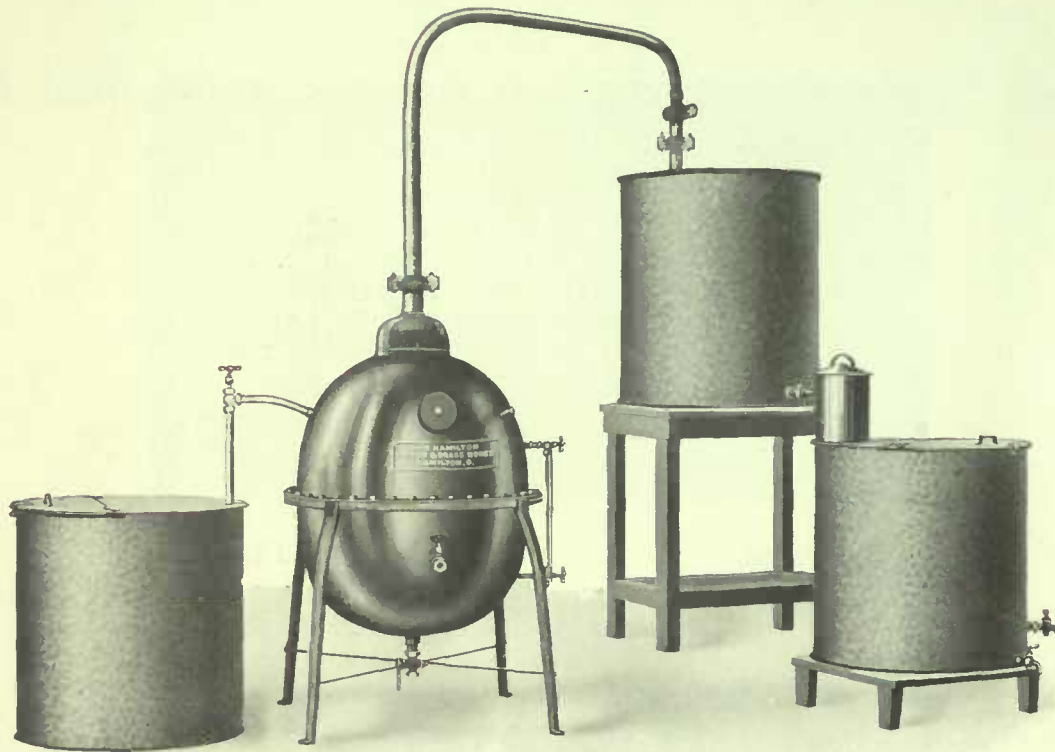

SPECIFICATIONS

No.	Capacity Gals.	Floor Space Feet	Gasoline Inlet Inches	Steam Connections inches	Weight lbs.	Water Connections	
						Inlet, inches	Outlet, inches
432	15	5½ × 3	¾	¾	315	½	1
433	20	5½ × 3½	¾	¾	400	½	1
434	25	6 × 4	¾	¾	450	½	1
435	50	7 × 4½	1	¾	600	¾	1¼
436	75	8 × 5	1	1	700	¾	1¼
437	100	8½ × 6	1	1	950	¾	1¼
438	150	9½ × 6	1¼	1¼	1150	1	1¼
439	200	10 × 8	1¼	1¼	1350	1	1¼

Unless otherwise specified, Square Shaped Still will be shipped. In ordering be sure and specify whether Square or Oval Still is required.



Monarch Square or Oval Shaped Benzine Still

AUTOMATIC VACUUM VALVE. We provide all our Stills with an automatic vacuum valve, which makes it absolutely impossible for the Still to collapse, thus insuring perfect safety.

DESCRIPTION. The Monarch Square or Oval-Shaped Still, as illustration shows, consists of a Charge Tank, Still, Worm Condenser, Condenser Tank, Separator, and Receiving Tank.

CONSTRUCTION. The Still, which is made of heavy Lake Superior Copper throughout, is well hammered, supported on substantial iron legs and bolted together in two sections with wrought iron flanges. The copper of each section or shell is turned over the full width of iron flanges and holes punched to receive bolts. The holes in flanges are drilled—not punched. The Still is provided with heavy brass hand-hole cap and set of brass gauges with glass tube, protected with brass rods. All the fittings shown on illustration are of brass and furnished attached to Still, which make it ready for steam connection. The outfit is shipped in this manner. This feature saves expense and considerable time when erecting the apparatus, and should be considered when selecting a Still. We not only provide the large size Stills with a copper Vapor Dome, but the very smallest size as well.

The Vapor or Connecting Pipe is of copper, tapering and connected to an all-copper tapering worm condenser. The Worm Condenser is set in three pairs of tinned wrought iron supporting bars, bolted together. Worm Condenser connects with brass union to a highly polished copper Separating Can.

This Separating Can is tinned inside, and as its name implies, separates the water from the benzine automatically.

Charge and Receiving Tanks are made of galvanized iron, and the Worm Tank of same material, but heavier.

Worm Tank is provided with a water inlet connection on side near bottom and overflow on side near top.

PROCESS OF OPERATION. The complete Still is set up in our works, tested and thoroughly operated.

MINIMUM COST OF OPERATION. The Still operated according to instructions which we give, will recover an absolute Pure and Clean Distillate, at a minimum cost of steam, as the steam coil on inside of Still is of ample size to insure perfect condensation.

FULL CAPACITY. All size Stills will hold the full amount for which each size is rated. We guarantee them full capacity, and while they do not require a hundred pounds of steam pressure to operate same, we guarantee them to stand a steam pressure of a hundred pounds.

INSTRUCTIONS. Instructions are furnished with each outfit, and the Still is so simple in its construction, arrangement and operation, that, together with the simple instructions, any one can operate the Still.

REMARKS. Prices on the Monarch Oval-Shaped Stills include crating for shipment, but do not include the frame work shown for supports of Receiving and Worm Tanks, unless otherwise ordered, when we will furnish same at lowest possible prices.

With the Square Still we supply a steel frame for the Worm Tank.

The specifications on the opposite page apply to both types of Still.



THE TORONTO LINE

Electric Irons



WE are prepared to supply the trade with Electric Smoothing Irons, manufactured by the two leading makers of Electric heated devices. It is necessary in ordering these Irons to state the exact voltage for which they are required.

COST OF OPERATION

The rates for current vary widely, depending on the cost of generation, competition, and more or less on the progressiveness of the management. Because of this difference it is impossible to state the exact cost of operating our devices. We can only say that practically all of the devices listed cost less to operate, all things considered, than those heated by other methods. In many instances the cost of operating is not to be considered as it is far less than that of other fuels. In some instances even though the direct cost is greater, the saving to be affected in labor, work and convenience, far outweigh the extra cost.

WATT CONSUMPTION

We have specified the maximum Watt Consumption of all articles because current is usually sold at so many cents per unit or kilowatt hour, a kilowatt being 1,000 watts.

If a device consuming 500 watts is used one hour, the consumption is one-half of a kilowatt hour, and if used two hours the consumption would be one kilowatt hour. For example, a small water heater No. 5205, consumption of which is 300 watts is used five minutes to boil a pint of water and the rate of current is 10 cents per unit or kilowatt. As the device consumes only $\frac{1}{6}$ of a unit and is used only $\frac{1}{12}$ of an hour the consumption would be 25 watt hours and the cost of the operation $\frac{1}{4}$ of a cent, (\$.0025).

This is a fair example and demonstrates the efficiency and economy of a device of this kind.

In estimating the cost of operating flat irons and devices where the current is necessarily turned off a good part of the time, particularly when the Irons are used on light work it is necessary to allow for this and estimate that although the consumption of an iron may be 500 watts and the iron may be used continuously for four or five hours, the current has not been turned on all the time. In fact experience has shown that taking out the time when the current is turned off because the heat is too great for light work the actual time that the current is turned on is only from one-third to one-half of the total length of time that the iron is used. Therefore in estimating the current consumption bear this in mind.

With reference to the cost of operating flat irons we beg to advise that practically all of the leading laundries in the country have adopted them and it stands to reason that they would not do so unless the cost of operating compared very favorably with that of gas or other fuel.



THE TORONTO LINE

Electric Irons

Simplex Type.

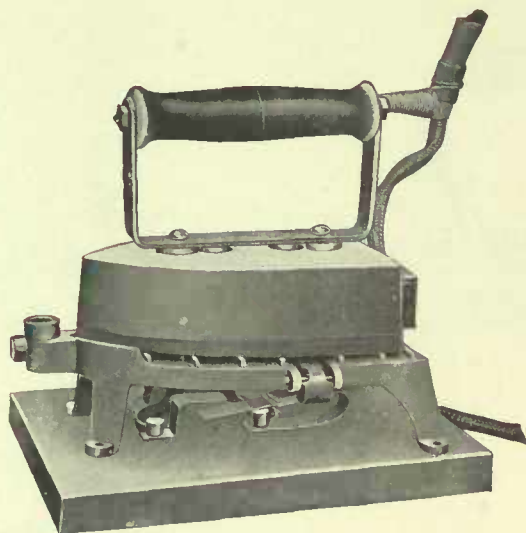

No. 1565

STANDARD size for laundry use, pointed or round nose, with Automatic Regulating Stand. This stand automatically cuts off a portion of the current when the iron is placed upon the stand, not only saving electricity, but prolonging the life of the iron by preventing its becoming over-heated.

Face, 6¼ in. x 4 in.	Current consumption, 300	Watts		Weight, 7½ lbs.
		Min.	Max.	
		300	450.	

American Type.

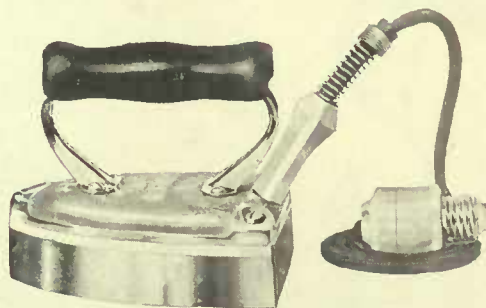

No. 7-L

THE No. 7-L Iron is the best seller of this line for the reason that it is large enough to answer all requirements for general laundry and domestic work, gives a sufficient volume of heat, keeps up its temperature and is still light enough for all ordinary purposes.

Face, 5¾ in. x 3¾ in.	Watts, 500.	Weight, 7 lbs.
-----------------------	-------------	----------------



THE TORONTO LINE

Irons

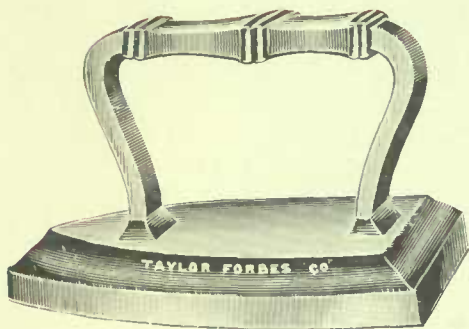

Common Sad Irons

Sizes :

3, 4, 5, 6, 7, 8, 9, 10, 12 and 22 lbs.

7 cents per lb., nett.

Tailors' Goose Irons

Sizes :

12, 14, 16, 18, 20, 22 and 24 lbs.

7 cents per lb., nett.

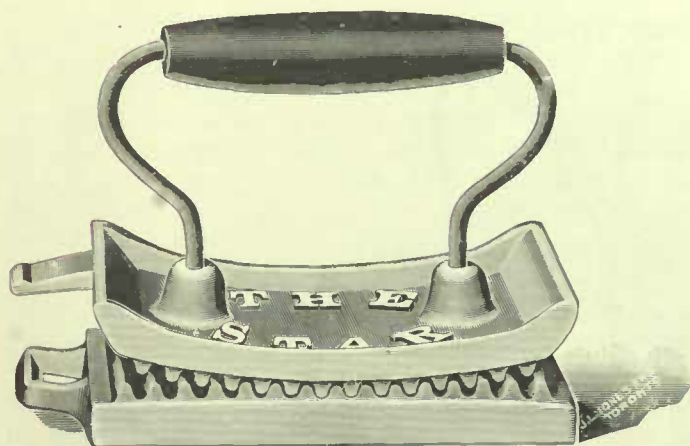
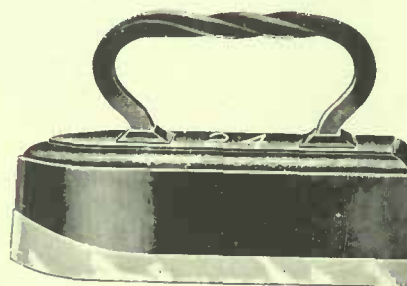

Star Fluting Iron

Weight, Iron and Stand 10 lbs.

Price 75 cents, nett.



THE TORONTO LINE

Toronto Curtain Frames

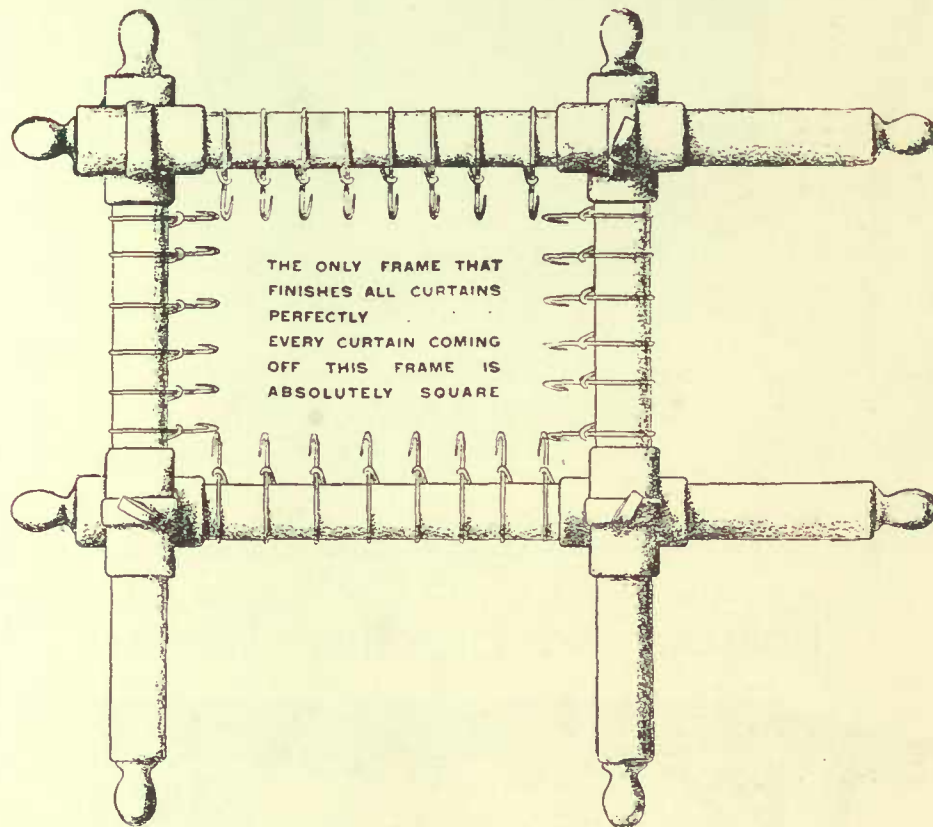

No. 409.

THIS Frame is indispensable to a laundryman doing a large quantity of lace curtains. It is made of $\frac{3}{4}$ galvanized pipe, with adjustable brass corner pieces, which allows frame to be adjusted to any size of curtain up to 7 feet by 14 feet. The 150 German silver hooks supplied with frame are ample to take care of each scallop on the largest curtain, thereby assuring a perfect finish.



THE TORONTO LINE

Washroom Truck Tubs

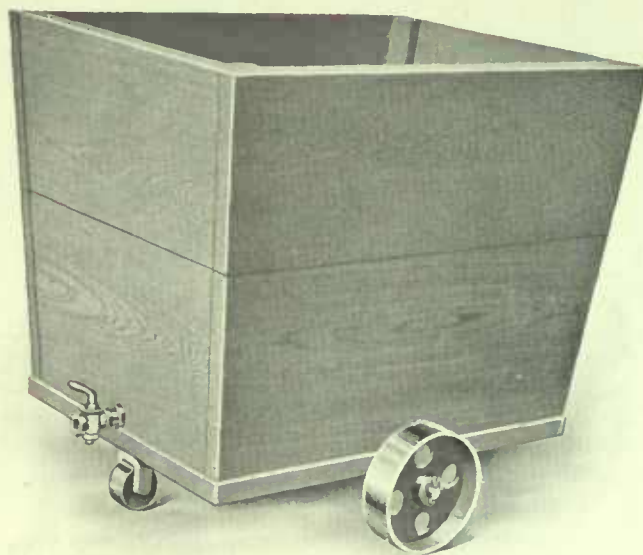

Truck Tubs. No. 445.

Made of $1\frac{3}{4}$ inch Cypress and fitted with roller casters, outlet valve and false bottom.
Size, 36 x 26 x 28 inches. Weight 190 pounds.

- No. 481 Same as above, but with four swivel wheel castors. Weight 190 lbs.
No. 482 Same as 481, but with cast iron bottom and all corners protected by 2" x 2" x $\frac{1}{8}$ " angle irons. Weight 225 lbs.

Folding and Bundling Tables

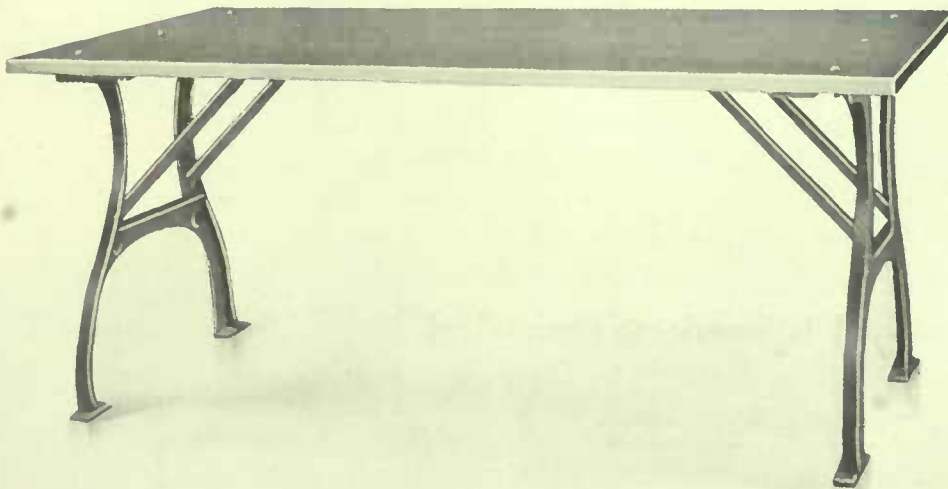

Made in three sizes : No. 446, 3 x 8 feet. No. 447, 3 x 10 feet. No. 448, 3 x 12 feet.
3 x 10, 3 x 12 have three legs.



THE TORONTO LINE

The Little Giant Paper Press

The Only Practical Way of Converting Your Waste Paper Into Money.

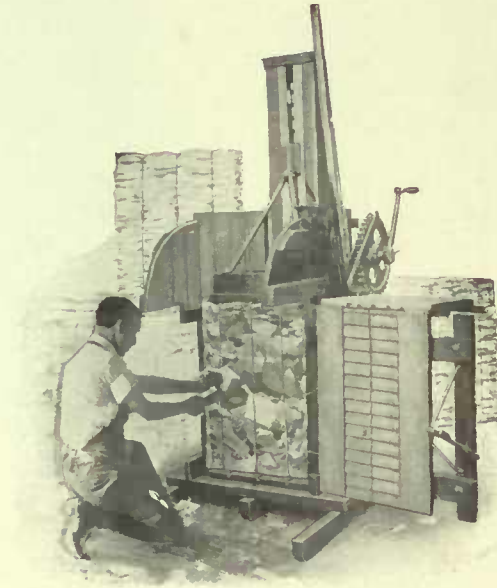

Made in Two Sizes :

No. 1, 16 x 20 Inch Case (100 to 150 lbs. to Bale).

Price \$65 F. O. B. Toronto.

No. 2, 16 x 26 Inch Case (150 to 200 lbs. to Bale).

Price \$75 F. O. B. Toronto.

THE Little Giant is the best type of receptacle for the scrap in the process of accumulation. As the waste basket is emptied into the baling case, it is closed up. When the case is filled with loose scrap the power is applied and the charge pressed to its ultimate density.

The scrap being always in the closed case and under full pressure, there is no opportunity for a fire to originate from this fruitful source of destruction.

The Bale is finished by several fillings of the box, making a package built up of layers that will retain its shape with all sorts of handling in shipment.

Four or five minutes time a day will mean from 10 to 35 cents worth of scrap in shape for market every day. It actually takes less time to handle paper in this way than to carry it out in an alley and burn it or have it carted off.

The floor space given up to the Little Giant Press is 3 x 4 feet. To operate it conveniently 5 x 5 feet will be ample. Its height is 7 feet 1 inch. This will warrant its use in any out of the way point or in the cellar and is less than one-half the room necessary in using other types of presses.

The leverage applied is progressive ; at the highest point of application being 72 to 1. An ordinary boy will produce from 110 to 150 pound bale of paper 16 x 20 x 30 inches in dimensions. This insures you getting the maximum weight in a car.

The installation of a Little Giant has been found by hundreds of Laundries a money making investment and worth its price in convenience, added cleanliness and the elimination of fire risks.

Wire Woven Baskets, Hampers and Trucks

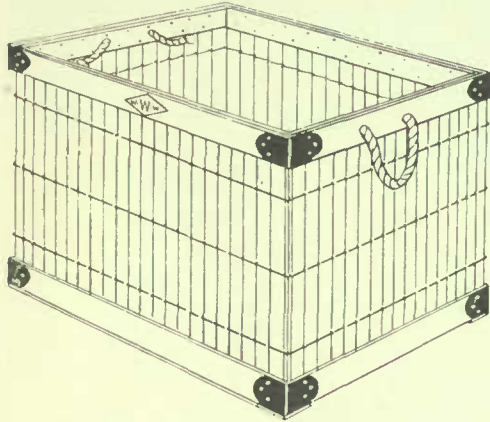

No. B 4 Without Cover.

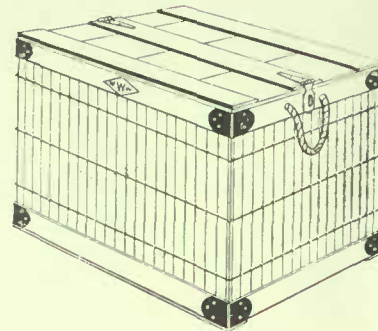

No. C 4 With Cover.

Wire Woven Baskets

SPECIFICATIONS											
No.	Capacity Imperial Measure	Dimensions Inside			Price	No.	Capacity Imperial Measure	Dimensions Inside			Price
		Length	Width	Depth				Length	Width	Depth	
C 1	1 Bushel	17 in.	13 in.	12 in.	\$1.10	C 5	5½ Bushels	29 in.	20½ in.	21 in.	\$2.80
C 2	2 Bushels	22½ in.	17 in.	12 in.	1.50	C 6	6¼ Bushels	32 in.	22 in.	21 in.	3.10
C 3	3 Bushels	26 in.	17 in.	15¼ in.	2.00	C 8	8½ Bushels	34½ in.	25 in.	21 in.	3.70
C 4	4½ Bushels	26 in.	19 in.	21 in.	2 50						

If covers are not required deduct 10 per cent. from above prices.

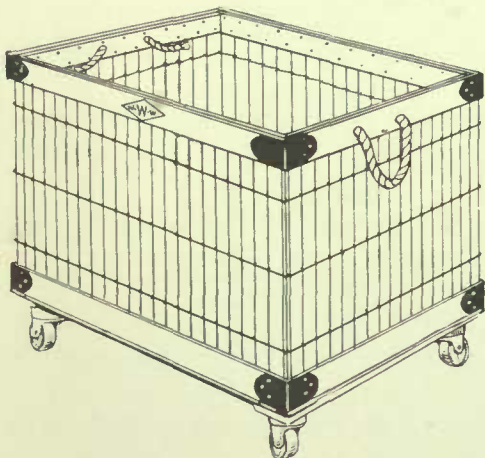

No. T 5 Washroom Truck.

Wire Woven, Swivel Wheel Washroom Trucks

SPECIFICATIONS				
No.	Length	Width	Depth	Price
T 5	29 in.	20½ in.	21 in.	\$3.50
T 6	32 in.	22 in.	21 in.	3.90
T 8	34½ in.	25 in.	21 in.	4.60



THE TORONTO LINE

Power and Hand Wringers

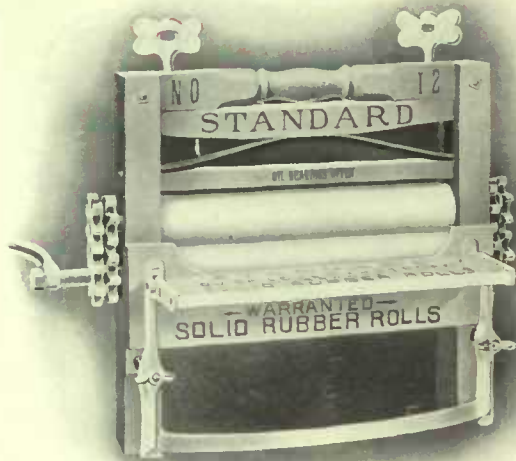

No. 440

Ajax

Metal Bearings

Heavy Two-Leaf Steel Spring. Reversible Drip Board which sheds the water on either side. Rolls warranted two years in family use. Made in one size: Rolls 14 x 2 1/4 inches. Specially adapted for Hotels, Large Families and Laundries. Furnished with tight and loose pulleys for power when desired, at \$3.00 extra, each. Packed one only in a case.

Weight, 43 lbs.

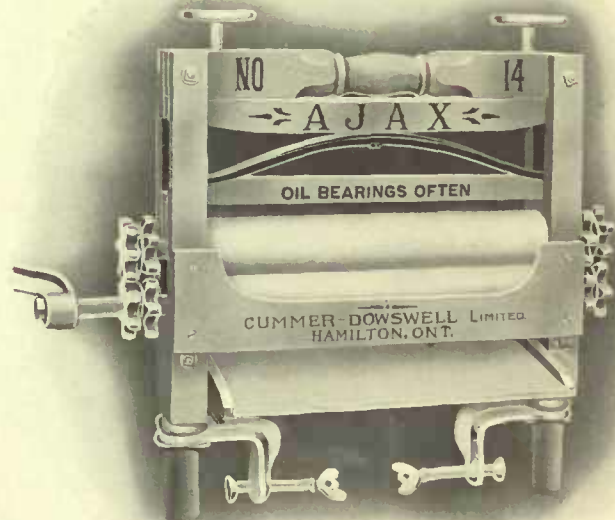

Hand Power No. 442
Belt Driven No. 480

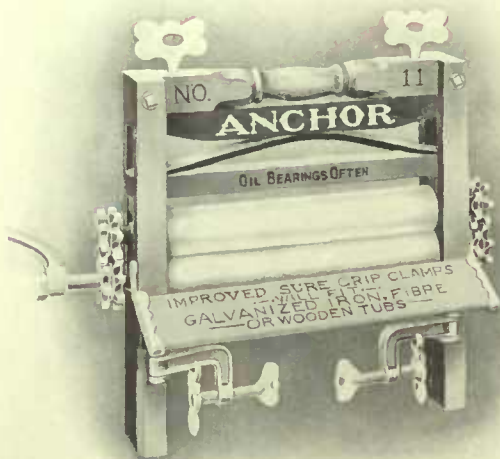

No. 441

Standard

Steel Ball Bearings same as used in high grade bicycles. Steel springs giving even and elastic pressure. Improved guide board and patented quick lever tub clamping attachment. Wheel pressure screws.

Extra grade rolls with name branded on them. Roll warranted two years. Size of rolls 12 x 2 inches.

Particularly adapted for use in Large Families, Hotels and Small Laundries. Warranty tag attached to each Wringer. Packed one in case.

Weight, 28 lbs.

Anchor Ball Bearings

Steel Spring giving even and elastic pressure. Wheel top screws. Improved guide board. Sure grip tub clamps suitable for indurated fibre or galvanized iron tubs.

Extra grade rolls with name branded on them. Warranted two years. Size of rolls 11 x 1 1/4 inches.

Adapted for family use, hotels and small laundries. Packed three in case.

Weight, 20 lbs.



The Garnet Gasoline Burner

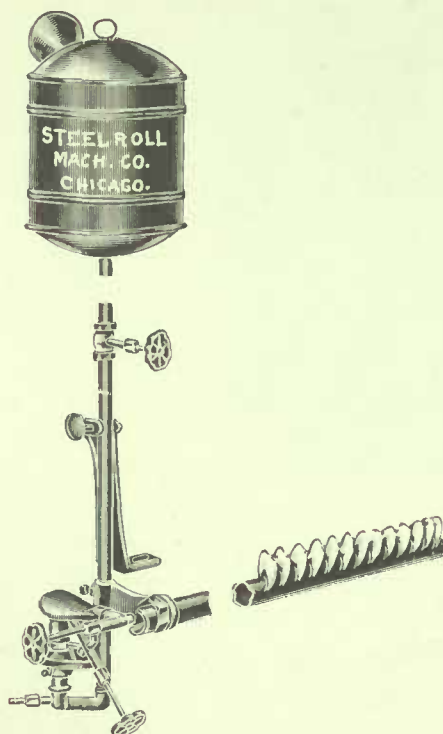

No. 443

THIS Gasoline Burner is the most powerful one on the market. The generator is capable of such perfect regulation that it will heat satisfactorily anything from a little 3-inch Edge Ironer to a large 49-inch Mangle. We have used this Burner for years on all our Mangles, Sad Iron Heaters, Combined Ironers, Edge Ironers, etc., and have sold thousands of them for other purposes. It is so arranged that the tank can be filled without disturbing the adjustment or without a step-ladder, by simply removing the thumb nut shown at the top of the tank pipe brace and then resting the tank on the back of a chair with the funnel upward convenient for filling. When properly used according to directions there is no danger of fire or explosion, and is by far the most economical method of heating individual machines known.

Repairs for Gasoline Burners

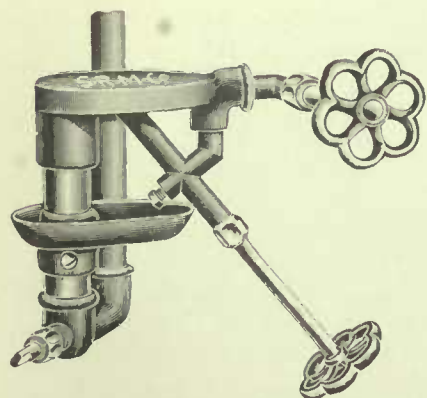

Generator.

- No. 1 Generator Caps.
- No. 2 Generator Tubes.
- No. 3 Generator Main Jets.
- No. 4 Generator Sub-Jets.
- No. 5 Generator Drip Cups.
- No. 6 Generator Return Bends.
- Swivels for Burners.
- Air Shield for Burners.
- Tank Pipe Braces for Burners.
- Oil Tank or Reservoirs for Burners.
- Tank Pipe in 2 foot lengths, with couplings.

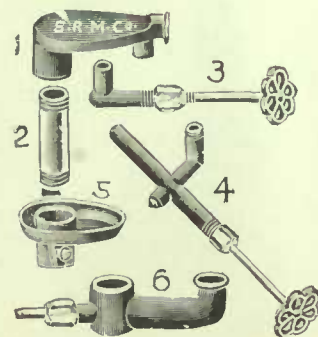

Generator Parts.



THE TORONTO LINE

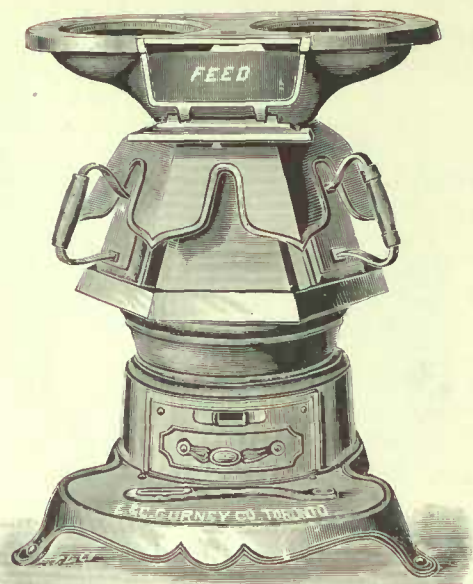

Iron Heating Stoves

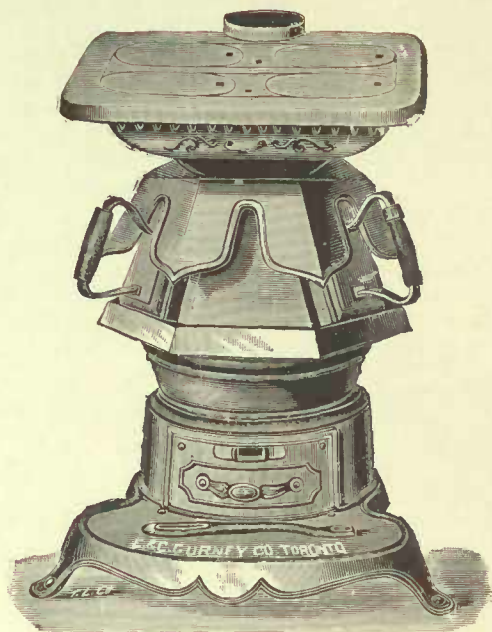

Laundry Stove. No. 10-2.

Capacity—Body, 10 Sad Irons; Top, 12 Sad Irons. Fitted with Dump Grate.

No.	List Price.	Shipping Weight.	Packed for Export.
10-2.	\$17.40	174 lbs.	12 cubic feet.

Extended Top has two 9 inch Covers and Centre, which can be removed to accommodate an ordinary 9 inch Wash Boiler.

Laundry Range. No. 10-4.

Capacity—15 Sad Irons. Four 7 inch Covers. Fitted with Dump Grate.

No.	List Price.	Shipping Weight.	Packed for Export.
10-4	\$19.00	176 lbs.	12 cubic feet

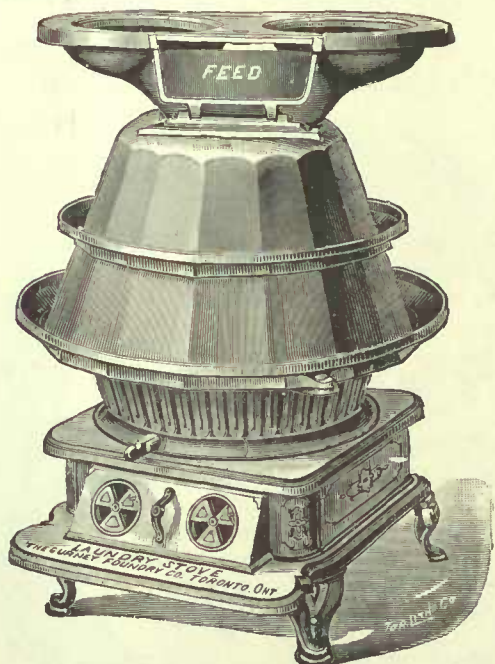

Laundry Range. No. 42.

Capacity—Body, 30 Sad Irons or 15 Tailors' Irons; Top, 12 Sad Irons or 6 Tailors' Irons. With Oval Top. Fitted with Dump Grate.

No.	List Price.	Shipping Weight.	Packed for Export
42	\$60.00	395 lbs.	20 cubic feet.

42 including Water Coil for Heating Boiler... \$2.50 400 lbs. 20 cubic feet.

Arranged to take a 9 inch Wash Boiler on top.

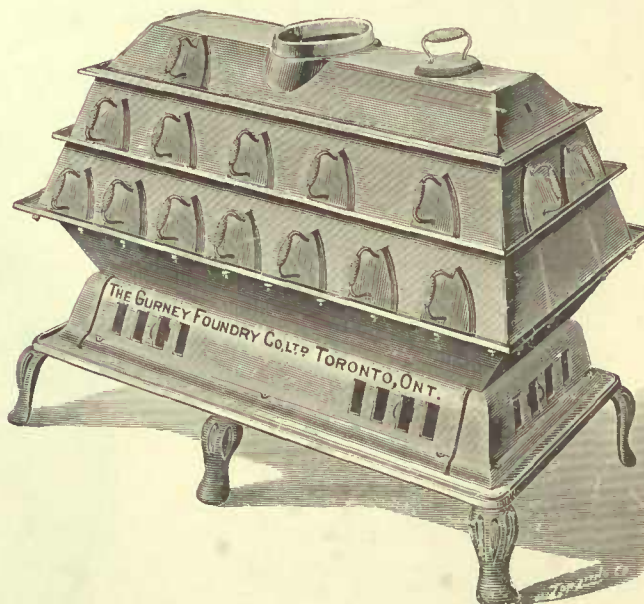

Laundry Heater. No. 100.

Capacity—100 Sad Irons or 40 Tailors' Irons.

Dimensions—4 feet 1 inch long by 3 feet 2 inches high.

Fire box is divided into two compartments, each compartment has side and end draft. These compartments or fire boxes can be used singly or together.

No.	List Price.	Shipping Weight.	Packed for Export.
100	\$110.00	780 lbs.	30 cubic feet.

Especially constructed for large Hotels, Public Institutions Laundries, etc.

Toronto Gas Generator

No. 410

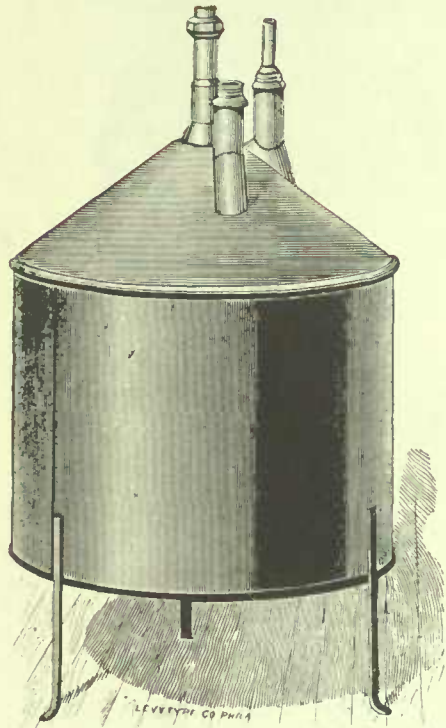

FOR generating gas from gasoline for heating Ironing Machines, where manufactured gas is not obtainable. The cost of production is between seventy-five cents and one dollar per thousand cubic feet, according to the price at which gasoline may be purchased.

The centre pipe is for connection to the positive pressure blower and should be fitted with an air cock to control the pressure. The opening fitted with screw cap is for filling the generator and the other opening on side fitted with union connection is for piping gas to the different machines. This generator has a capacity sufficient for four ironing machines.

Floor Space 24 x 24 inches. Weight 65 lbs.

Toronto Friction

Pulley

No. 444

Made in 18-inch diameter for driving 20 or 26-inch Extractors. With this pulley on your Extractors you can throw on the belt without slackening of speed or squeaking. Its use assures a great saving in time, belts, machinery and power.

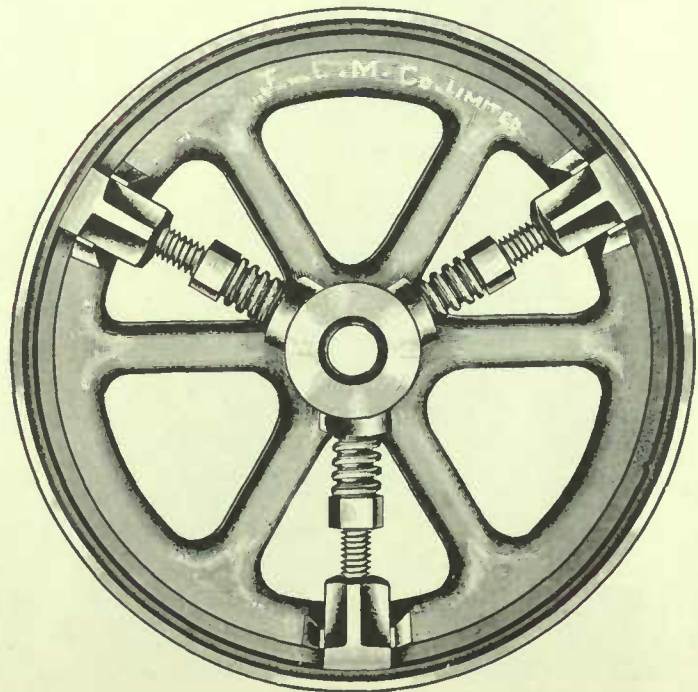



THE TORONTO LINE

Exhaust and Ventilating Fans

Disc Fans

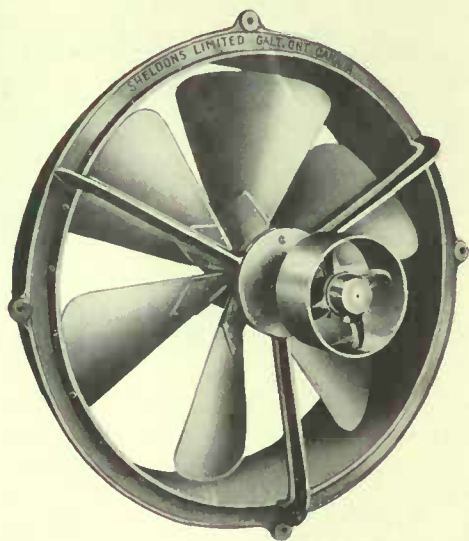

Fig. 5

In ordering state which way the fan is required to run.
All fans made right hand unless otherwise specified.

IN Laundries, Hotels, Restaurants, Schools, in fact all places where large bodies congregate, or unwholesome gases are generated, the necessity for a constant and rapid admission of fresh air is essential from a hygienic standpoint, hence the wide and growing use of the Ventilating Fan,

The cut shows Fan that can be placed inside a window frame, discharging outside the building. This arrangement is especially adapted to Laundries and other places where it is desired to exhaust vapors, foul air, etc., from the room and to insure a regular circulation and supply of fresh air in the rooms and can be fitted to almost any window.

SPECIFICATIONS—BELT OR MOTOR DRIVEN

Size of Fan	Diameter of Wheel in inches	Diameter of Pulley	Face of Pulley	Range of Speed	Approximate cubic ft. of air per minute free inlet and outlet	Approximate H. P. required to Drive Fan	Shipping Weight
18	18	4	2 1/2	500 to 1100	1585 to 3540	.048 to .336	78
24	24	6	3 1/4	370 to 820	2830 to 6280	.085 to .597	110
30	30	8	4 1/4	285 to 655	4400 to 9800	.135 to .93	180
36	36	10	4 3/4	250 to 550	6350 to 14000	.19 to 1.34	255
42	42	12	5 1/4	210 to 470	8650 to 19200	.26 to 1.85	375
48	48	13	5 3/4	185 to 410	11300 to 25000	.338 to 2.39	480
54	54	14	6 1/4	165 to 365	14200 to 31800	.428 to 3.05	575
60	60	16	6 3/4	145 to 325	17700 to 39300	.580 to 3.75	725
72	72	18	7 1/4	120 to 270	25400 to 56500	.76 to 5.4	850
84	84	20	7 3/4	105 to 230	34600 to 77000	1.1 to 7.35	1125

1lg Self-Cooled Motor Fans

Seven Distinctive Features

The FRAMES are liberally proportioned, protecting the fan wheel, and making a pleasing and durable installation possible.

The MOTOR RING is securely bolted to the arms. The motor is machined circular to template, which makes it practical to install motor and frame separately without disturbing alignment.

The SUPPORTING ARMS are hand forged from machine steel and are light strong and unbreakable.

The MOTOR HOOD or enclosure protects working parts of motor against dust, grease, steam or other foreign matter which would eventually damage the motor.

The WHEEL is constructed with steel blades and arms stamped to template. The hub is bored and reamed, making the wheel perfectly true and to run without vibration, ensuring the longest possible life to the bearings.

The OILING SYSTEM ensures both bearings being uniformly oiled from one point, making this the only fan of this type safely oiled while in operation.

The VENT PIPE supplies the motor with clean air, reduces the working temperature and increases the efficiency.

The SPEED CONTROLLER furnished with every direct current fan gives approximately 50% speed reduction by intermediate steps. This ensures still greater economy where full speed is not always necessary.

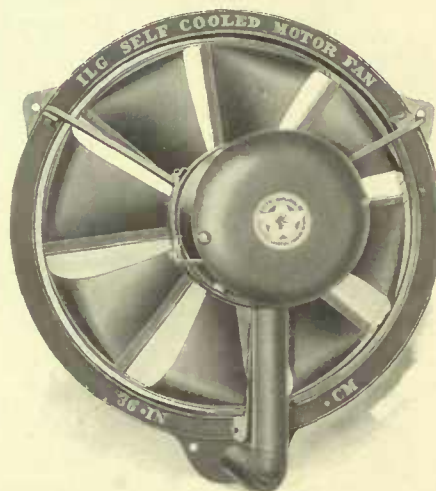

Fig. 45

The 1lg Self-Cooled Motor Fan.
Can. Patent No. 102,694.

The increasing demand for Electric Fans is due to a growing recognition of the numerous and varied applications in which they are useful. They are adapted for the ventilation of all types of buildings, the removal of smoke, noxious fumes and gases, steam and dust, for the cooling of overheated rooms. They are also more economical and effective than the aspirating coils frequently employed to assist the draft in ventilating shafts or flues in large public buildings.



THE TORONTO LINE

Jenkins Bros. Brass Globe and Angle Valves



Globe.



Angle.

NETT PRICE LIST.												
Size, inches.....	¼	¾	½	¾	1	1¼	1½	2	2½	3	3½	4
Price, each.....	\$0.66	\$0.75	\$1.00	\$1.35	\$1.80	\$2.80	\$3.90	\$5.90	\$11.25	\$16.00	\$30.00	\$40.00

Lunkenheimer "Handy" Gate Valves

(Patented and Name Registered in U. S. Patent Office.)

For Working Pressures not to exceed 75 pounds—Screw Ends only.

BRASS, IRON BODY BRASS MOUNTED ON ALL IRON.

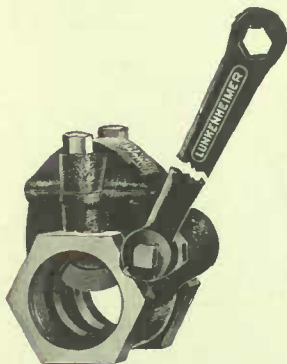

Fig. 430. Brass.

NETT PRICE LIST											
Sizes, inches.....	½	¾	1	1¼	1½	2	2½	3	3½	4	
Brass Body, Fig. 430.....each	\$1.90	\$2.20	\$3.00	\$4.50	\$6.00	\$9.00	\$16.00	\$23.00	\$48.00	\$72.00	

Screws ends only, not made with flange ends.

Lunkenheimer Double Seated "Clip" Gate Valves

(PATENTED)

QUICK OPENING PATTERN.

For Working Pressures up to 50 pounds—Screw or Flange Ends.

IRON BODY BRASS MOUNTED OR ALL IRON.

NETT PRICE LIST.								
Size, inches.....	½	¾	1	1¼	1½	2	2½	3
Iron Body, Brass Mounted, Screw Ends, Fig. 639...each	\$1.50	\$1.90	\$2.50	\$3.50	\$5.00	\$7.50	\$12.00	\$15.00

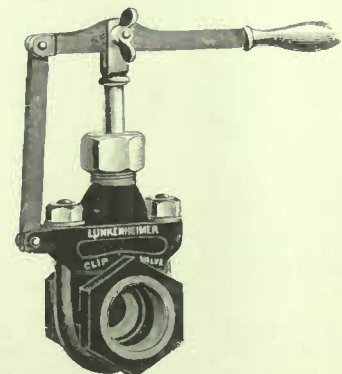

Fig. 639. Screw Ends.



The Jenkins Diamond Steam Trap



Inlet

Outlet

It is perfectly automatic, opens when there is water, closes when there is steam.

Always connect so that the steam and water will enter at end marked "inlet" and discharge at end marked "outlet."

For water containing sulphur, use iron. For general use, brass. Tapped $\frac{3}{4}$ inch pipe thread.

A simple inexpensive trap has long been needed and we have one here we can guarantee. Specially adapted for Steam Dry-Rooms, Collar Machines, Mangles or any place where 500 to 1,000 feet of inch pipe is to be taken care of. The expansible plug is of a special compound manufactured expressly for use in this trap. Stamped with our guarantee.

Roots' Acme Positive Pressure Blower

The cut represents the Acme Blower as made for power. It is used for a great variety of purposes and has proven superior to any other kind of blower for laundry purposes. The blower produces a steady blast of air under pressure and this may be piped to the different machines through ordinary gas piping, doing away with the unsightly tin tubing. A very large percentage of saving is also effected on account of the blast being positive and the proper amount of air and gas are used making a perfect mixture.

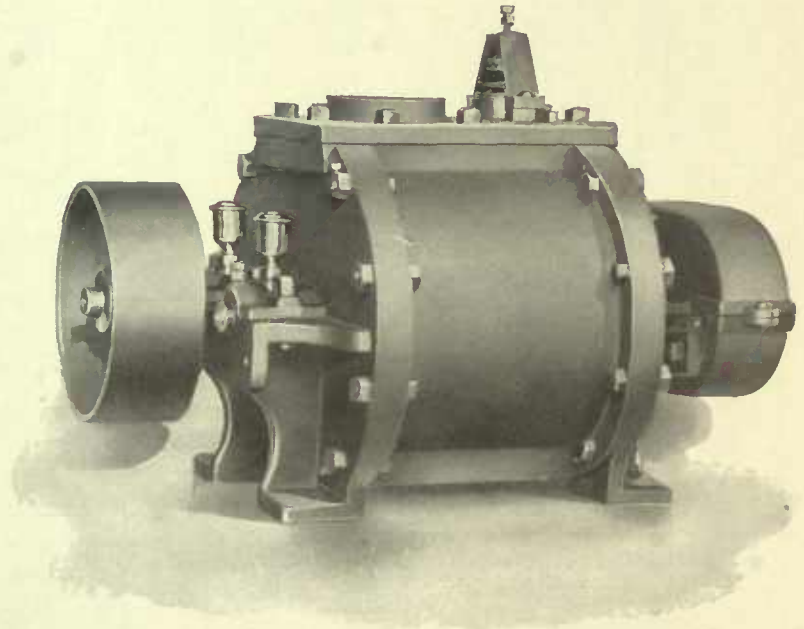

SPECIFICATIONS

No.	Capacity per Revolution	Diameter of Outlet	Size of Pulley inches	Medium Speed	Dimensions of Blower inches	Weights	
						Net	Gross
3	172 cu. in.	1 1/4 in.	5 1/2 x 1 3/4	450	10 x 10 1/2 x 16	55 lbs.	75 lbs.
3 1/2	325 cu. in.	2 in.	8 x 2	400	11 x 13 x 23	85 lbs.	110 lbs.
4	648 cu. in.	3 in.	10 x 3	350	12 x 16 x 26	188 lbs.	215 lbs.



THE TORONTO LINE

Anderson Steam Traps

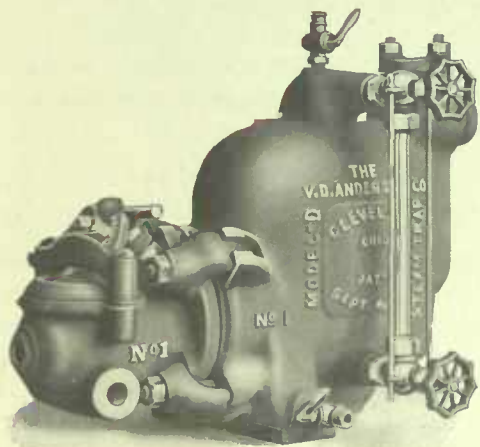

Model "D" Steam Trap.

AN Ideal Steam Trap, perfect in every detail, accurately built of materials best suited for the purpose.

Every part absolutely interchangeable.

Complete with Water Gauge, By-Pass, Air Valve, Blow Off Valve and Sediment Strainer.

These and many other original and exclusive features will be found only on the Anderson Model "D" Steam Trap.

The Strainer and Sediment Chamber prevents sediment or scale getting into the valve.

A Glass Water Gauge fitted to the trap makes it possible to ascertain at a glance whether the trap is working properly.

These traps will lift water against any back pressure less than the pressure at the trap.

Made for high or low pressure or exhaust steam.

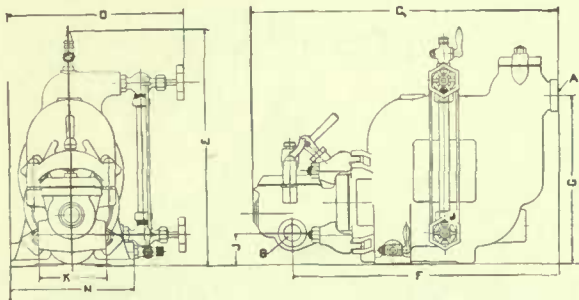

DIMENSIONS IN INCHES
of the Anderson Model "D" Steam Trap

SIZE NUMBERS

No. 1, No. 2, No. 3, No. 4, No. 5, No. 6, No. 7

A	1/2"	3/4"	1"	1 1/4"	1 1/2"	2"	2 1/2"
B	1/2"	3/4"	1"	1 1/4"	1 1/2"	2"	2 1/2"
C	19 1/4"	20 3/8"	24 1/4"	25 3/4"	30 3/8"	32 1/2"	39"
D	11 1/4"	11 1/4"	12 5/8"	13 1/4"	14 5/8"	15 1/2"	17 1/4"
E	15 1/2"	16 1/8"	18"	18 3/4"	22"	23 3/4"	27 5/8"
F	16 7/8"	18 1/4"	21"	22 3/8"	26 3/8"	28 1/2"	33 1/4"
G	10 3/4"	11 3/8"	13 1/2"	14 1/8"	17"	18 5/8"	22"
J	2"	2 1/8"	1 1/2"	2"	2 1/8"	2 1/8"	3 1/8"
K	4 1/4"	4 1/4"	4 7/8"	4 7/8"	6 1/2"	6 5/8"	8 1/8"
N	7 3/4"	7 3/4"	9 1/8"	9 1/2"	11 1/8"	12"	14"

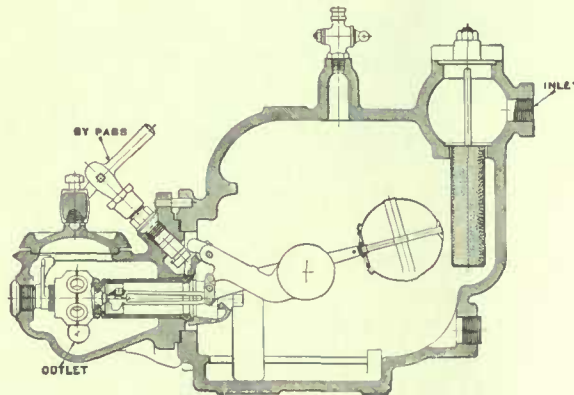

LIST PRICES, SIZES AND CAPACITIES
of the Anderson Model "D" Steam Trap

Code Word for Telegram	Hat	Hen	How	Hide	Harp	Hint	Ham
Size Number of Trap	1	2	3	4	5	6	7
Size of Pipe Connection, in inches	1/2	3/4	1	1 1/4	1 1/2	2	2 1/2
Maximum discharge of condensation per hour in pounds	1,500	2,400	4,000	5,600	8,000	12,000	24,000
Greatest number of square feet of surface that should be applied	1,000	1,600	2,600	4,700	7,000	10,000	20,000
Greatest number of lineal feet of 1 in. pipe surface that should be applied	3,000	5,000	8,000	14,000	20,000	30,000	60,000
Net weight of complete trap in pounds	81	92	150	166	208	321	525
Shipping Weight in pounds (boxed)	110	114	195	211	335	394	640
Price \$	26.50	28.50	36.00	43.00	60.00	82.00	132.00

Our Model "D" Trap is suitable for any pressure from 225 pounds down. Our standard Valve opening is adapted for pressures from 150 pounds down to 30 pounds. Our low pressure Valve Opening is adapted for pressures from 30 pounds down. For pressures below 10 pounds or above 150 pounds, we are prepared to furnish special valve openings.

NOTE—When ordering be sure to state maximum steam pressure at the trap.



THE TORONTO LINE

Cypress Water Tanks

CAPACITIES AND SIZES—2 inch stock.							
Diameter		Depth		No. of Hoops	Gallons	Shipping Weight lbs.	Price Complete, with Lugs
Feet	Inches	Feet	Inches				
3	0	3	0	3	158	220	\$18.60
3	0	3	5	4	180	256	20.50
4	6	3	5	4	406	402	29.00
6	0	3	5	4	720	586	39.00
6	0	5	5	5	1145	776	48.50
7	0	5	5	5	1559	921	51.50
7	6	6	5	5	2120	1140	63.00
8	0	6	5	6	2406	1248	68.00
8	6	7	5	6	3148	1462	78.50
9	0	4	5	4	2098	1104	73.50
9	0	6	5	5	3053	1394	74.00
9	0	8	5	7	4004	1711	91.00
9	6	8	5	7	4462	1859	99.00
9	6	9	5	7	4992	2002	106.00
11	0	10	6	8	7405	2632	147.00
12	6	11	5	9	10481	3279	172.00



Price List Wood Split Pulleys

Standard Price List.		WIDTH OF FACE.											In effect January 1st, 1909.	
Diam. Inches	3	4	5	6	8	10	12	14	16	18	20	22	24	
4	\$2.80	\$2.90	\$3.10	\$3.30	\$3.70	\$4.10	\$4.50	
5	2.85	2.95	3.20	3.40	3.85	4.30	4.75	
6	2.90	3.00	3.25	3.50	4.00	4.50	5.00	
7	2.95	3.05	3.35	3.60	4.15	4.70	5.25	\$5.80	
8	3.00	3.10	3.40	3.70	4.30	4.90	5.50	6.10	
9	3.10	3.25	3.60	3.90	4.55	5.20	5.85	6.50	
10	3.25	3.40	3.75	4.10	4.80	5.50	6.20	6.90	\$7.60	
11	3.50	3.70	4.10	4.50	5.30	6.10	6.90	7.70	8.50	
12	3.75	4.00	4.45	4.90	5.80	6.70	7.60	8.50	9.40	\$10.30	
13	4.30	4.80	5.30	6.30	7.30	8.30	9.30	10.30	11.30	
14	4.60	5.15	5.70	6.80	7.90	9.00	10.10	11.20	12.30	\$13.40	
15	4.90	5.50	6.10	7.30	8.50	9.70	10.90	12.10	13.30	14.50	
16	5.20	5.85	6.50	7.80	9.10	10.40	11.70	13.00	14.30	15.60	\$16.90	
17	5.50	6.20	6.90	8.30	9.70	11.10	12.50	13.90	15.30	16.70	18.10	
18	5.80	6.55	7.30	8.80	10.30	11.80	13.30	14.80	16.30	17.80	19.30	\$20.80	
19	6.10	6.90	7.70	9.30	10.90	12.50	14.10	15.70	17.30	18.90	20.50	22.10	
20	6.40	7.25	8.10	9.80	11.50	13.20	14.90	16.60	18.30	20.00	21.70	23.40	
22	7.00	7.95	8.90	10.80	12.70	14.60	16.50	18.40	20.30	22.20	24.10	26.00	
24	7.70	8.80	9.90	12.10	14.30	16.50	18.70	20.90	23.10	25.30	27.50	29.70	
26	8.40	9.65	10.90	13.40	15.90	18.40	20.90	23.40	25.90	28.40	30.90	33.40	
28	9.10	10.50	11.90	14.70	17.50	20.30	23.10	25.90	28.70	31.50	34.30	37.10	
30	9.80	11.35	12.90	16.00	19.10	22.20	25.30	28.40	31.50	34.60	37.70	40.80	
32	10.50	12.20	13.90	17.30	20.70	24.10	27.50	30.90	34.30	37.70	41.10	44.50	
34	11.30	13.15	15.00	18.70	22.40	26.10	29.80	33.50	37.20	40.90	44.60	48.30	
36	12.10	14.10	16.10	20.10	24.10	28.10	32.10	36.10	40.10	44.10	48.10	
38	17.20	21.50	25.80	30.10	34.40	38.70	43.00	47.30	51.60	55.90	
40	18.30	22.90	27.50	32.10	36.70	41.30	45.90	50.50	55.10	59.70	
42	19.60	24.60	29.60	34.60	39.60	44.60	49.60	54.60	59.60	64.60	
44	20.90	26.30	31.70	37.10	42.50	47.90	53.30	58.70	64.10	69.50	
46	22.30	28.10	33.90	39.70	45.50	51.30	57.10	62.90	68.70	74.50	
48	23.80	30.00	36.20	42.40	48.60	54.80	61.00	67.20	73.40	79.60	
50	25.40	32.00	38.60	45.20	51.80	58.40	65.00	71.60	78.20	84.80	
52	27.10	34.10	41.10	48.10	55.10	62.10	69.10	76.10	83.10	90.10	
54	28.90	36.30	43.70	51.10	58.50	65.90	73.30	80.70	88.10	95.50	
56	30.80	38.60	46.40	54.20	62.00	69.80	77.60	85.40	93.20	101.00	
58	32.80	41.00	49.20	57.40	65.60	73.80	82.00	90.20	98.40	106.60	
60	34.90	43.50	52.10	60.70	69.30	77.90	86.50	95.10	103.70	112.30	
62	37.10	46.10	55.10	64.10	73.10	82.10	91.10	100.10	109.10	118.10	
64	39.40	48.80	58.20	67.60	77.00	86.40	95.80	105.20	114.60	124.00	
66	41.90	51.80	61.70	71.60	81.50	91.40	101.30	111.20	121.10	131.00	
68	44.50	54.90	65.30	75.70	86.10	96.50	106.90	117.30	127.70	138.10	
70	47.20	58.10	69.00	79.90	90.80	101.70	112.60	123.50	134.40	145.30	
72	50.00	61.40	72.80	84.20	95.60	107.00	118.40	129.80	141.20	152.60	
78	71.90	84.80	97.70	110.60	123.50	136.40	149.30	162.20	175.10	
84	83.30	97.70	112.10	126.50	140.90	155.30	169.70	184.10	198.50	
90	95.60	111.50	127.40	143.30	159.20	175.10	191.00	206.90	222.80	
96	109.00	126.50	144.00	161.50	179.00	196.50	214.00	231.50	249.00	
102	123.70	143.00	162.30	181.60	200.90	220.20	239.50	258.80	278.10	
108	139.30	160.40	181.50	202.60	223.70	244.80	265.90	287.00	308.10	
114	155.80	178.70	201.60	224.50	247.40	270.30	293.20	316.10	339.00	
120	173.20	197.90	222.60	247.30	272.00	296.70	321.40	346.10	370.80	



THE TORONTO LINE

Cold Rolled Steel Shafting

SPECIFICATIONS														
Diam. inches	Weight per foot	Price per lb.	Diam. inches	Weight per foot	Price per lb.	Diam. inches	Weight per foot	Price per lb.	Diam. inches	Weight per foot	Price per lb.	Diam. inches	Weight per foot	Price per lb.
$\frac{3}{16}$.095		$1\frac{1}{8}$	3.00		$1\frac{1}{8}$	10.00		$2\frac{1}{8}$	21.15		$3\frac{1}{8}$	36.40	
$\frac{1}{4}$.168		$1\frac{1}{8}$	3.38		2	10.70		$2\frac{7}{8}$	22.10		$3\frac{3}{4}$	37.57	
$\frac{5}{16}$.259		$1\frac{1}{8}$	3.77		$2\frac{1}{16}$	11.35		$2\frac{1}{8}$	23.06		$3\frac{11}{16}$	38.66	
$\frac{3}{8}$.370		$1\frac{1}{4}$	4.17		$2\frac{1}{8}$	12.07		3	24.05		$3\frac{7}{8}$	39.85	
$\frac{7}{16}$.510		$1\frac{1}{8}$	4.60	7	$2\frac{3}{16}$	12.80		$3\frac{1}{8}$	25.07		$3\frac{1}{2}$	41.04	6 1/2
$\frac{1}{2}$.666		$1\frac{3}{8}$	5.05		$2\frac{1}{4}$	13.52		$3\frac{1}{2}$	26.10		4	42.75	
$\frac{9}{16}$.843		$1\frac{1}{8}$	5.52		$2\frac{5}{16}$	14.35		$3\frac{1}{4}$	27.16		$4\frac{1}{4}$	48.26	
$\frac{5}{8}$	1.05	7	$1\frac{1}{2}$	6.09		$2\frac{3}{8}$	15.07	6	$3\frac{3}{4}$	28.22		$4\frac{7}{16}$	52.62	
$\frac{11}{16}$	1.25		$1\frac{1}{8}$	6.52		$2\frac{7}{16}$	15.90		$3\frac{1}{2}$	29.32		$4\frac{1}{2}$	54.11	
$\frac{3}{4}$	1.50		$1\frac{5}{8}$	7.06		$2\frac{1}{2}$	16.70		$3\frac{3}{8}$	30.43	6 1/2	$4\frac{3}{4}$	60.88	
$\frac{13}{16}$	1.75		$1\frac{1}{2}$	7.61		$2\frac{9}{16}$	17.55		$3\frac{7}{8}$	31.58		$4\frac{11}{16}$	65.50	7
$\frac{7}{8}$	2.03		$1\frac{3}{4}$	8.18	6	$2\frac{5}{8}$	18.40		$3\frac{1}{2}$	32.73		5	67.50	
$\frac{15}{16}$	2.34		$1\frac{11}{16}$	8.78		$2\frac{11}{16}$	19.30		$3\frac{11}{16}$	33.96				
1	2.68		$1\frac{7}{8}$	9.39		$2\frac{3}{4}$	20.20		$3\frac{5}{8}$	35.20				

Above prices are for shafts from 2 ft. to 24 ft. long, inclusive.

Cast Iron Safety Collars

Diameter.....	$1\frac{1}{8}$	$1\frac{1}{4}$	$1\frac{1}{2}$	$1\frac{3}{4}$	$2\frac{1}{8}$	$2\frac{1}{4}$	$2\frac{1}{2}$	$3\frac{1}{8}$	$3\frac{1}{4}$
Price30	.35	.40	.50	.60	.80	1.20	1.40	1.75

Genuine Oak Tanned Leather Belting

PRICE LIST— Adopted February 14, 1907											
Width inches	Price per ft.	Width inches	Price per ft.	Width inches	Price per ft.	Width inches	Price per ft.	Width inches	Price per ft.	Width inches	Price per ft.
$\frac{1}{2}$	\$0.12	$3\frac{3}{4}$	\$0.90	15	\$3.60	32	\$7.68	$\frac{3}{16}$	\$0.07	$\frac{7}{8}$	\$0.60
$\frac{5}{8}$15	496	16	3.84	34	8.16	$\frac{1}{4}$10	172
$\frac{3}{4}$18	$4\frac{1}{2}$	1.08	17	4.08	36	8.64	$\frac{5}{16}$14		
$\frac{7}{8}$21	5	1.20	18	4.32	40	9.60	$\frac{3}{8}$18		
124	$5\frac{1}{2}$	1.32	19	4.56	44	10.56			Cut Lacing	
$1\frac{1}{4}$30	6	1.44	20	4.80	48	11.52			Per bundle of	
$1\frac{1}{2}$36	$6\frac{1}{2}$	1.56	21	5.04	52	12.48			100 ft.	
$1\frac{3}{4}$42	7	1.68	22	5.28	56	13.44	$\frac{1}{8}$06	$\frac{1}{4}$	1.25
248	8	1.92	23	5.52	60	14.40	$\frac{3}{16}$10	$\frac{1}{8}$	1.50
$2\frac{1}{4}$54	9	2.16	24	5.76	64	15.36	$\frac{1}{4}$14	$\frac{3}{8}$	1.75
$2\frac{1}{2}$60	10	2.40	25	6.00	68	16.32	$\frac{5}{16}$18	$\frac{1}{2}$	2.25
$2\frac{3}{4}$66	11	2.64	26	6.24	72	17.28	$\frac{3}{8}$22	$\frac{5}{8}$	3.00
372	12	2.88	27	6.48			$\frac{1}{2}$30	$\frac{3}{4}$	3.75
$3\frac{1}{4}$78	13	3.12	28	6.72	Solid Round		$\frac{5}{8}$36		
$3\frac{1}{2}$84	14	3.36	30	7.20	$\frac{1}{8}$05	$\frac{3}{4}$46		

Double Belts, Double Price



Shaw Patent Compression Flange Couplings

Single Compression.

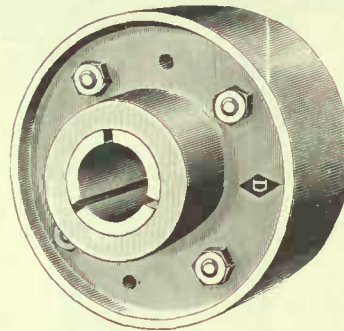

Style of Couplings for sizes 2¼ inches and smaller.

DESCRIPTION.

The sleeve is tapered from the middle to each end ; has six slots running nearly its entire length, three from one end and three from the other end, in alternation, and holds the ends of the shafts by compression. The outer shell has a bore tapering from the middle outward, the taper corresponding with the taper on the sleeve, the diameter of the bore being slightly less than the diameter of the sleeve.

The outer shell is divided in two, the halves being drawn together with four bolts and nuts, one-half having two threaded holes in it, with threads the same as on the bolts.

When the halves of the shell are drawn together by tightening the nuts on the bolts the pressure of the tapering bore on the tapering sleeve, which is compressible on account of its slots, causes the sleeve to grip the shaft. When in place, the flanges extend beyond the nuts and the heads of the bolts. In taking down the coupling, the nuts are removed from the bolts, and the halves of the shell can then be easily thrust apart by screwing the bolts into the threaded holes.

PRICE LIST.											
For Shaft	7/8	1	1 1/8	1 1/4	1 3/8	1 1/2	1 5/8	1 3/4	1 7/8	2	Inch
For Shaft	1 1/8	1 1/4	1 1/2	1 3/4	1 7/8	Inch
For Shaft	1 3/8	1 1/2	1 5/8	1 7/8	Inch
For Shaft	1 1/4	2	2 1/4	Inch
Outside diameter of Shell.....	4 7/8	4 7/8	4 7/8	5 1/4	5 7/8	6	7 1/2	7 3/8	8 1/8	9 1/8	Inch
Length of Sleeve.....	3 3/8	3 3/8	4	4 1/2	5 1/4	5 7/8	7 1/2	8 1/8	8 7/8	9 1/8	Inch
Total length of Coupling.....	3 3/8	3 3/8	4	4 1/2	5 1/4	5 7/8	7 1/2	8 1/8	8 7/8	9 1/8	Inch
Weight	6	6	8	9	13	15	32	35	43	54	Lbs.
Price	\$3 00	\$4.25	\$4.75	\$5.00	\$5.50	\$6.25	\$8.00	\$9 00	\$10 75	\$13.00	Each

Reducing Couplings, advance 10% on above prices. The larger shaft which the coupling fits determines the size.



THE TORONTO LINE

Adjustable Ball and Socket Hangers

With Capillary Bearings.

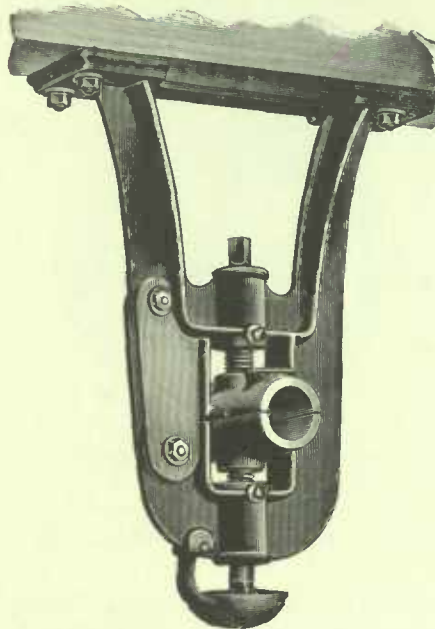

Single and Double Brace.

THESE Hangers are very neat in design, having the Greek Cross pattern of cross section, thus doing away with the old style of frame which was necessarily so heavy as to give the appearance of clumsiness. The plungers are large and have machine cut threads, the frames being tapped in a special machine so that the plungers are vertical to the base and in line with the shaft centre.

All Bearings are four diameters of shaft in length and are carefully babbited, reamed, and ends faced for collars.

After the plungers are permanently adjusted, a jam set screw holds the alignment perfectly firm. A lateral adjustment ranging from 1 inch to 2 inches is secured through oblong slots in the base of the frame. We carry a full stock of Hangers up to 36 inch drop, and are in position to manufacture to order any special drops or patterns other than those listed.

PRICE LIST.

Size of Shaft	Brace	DROP IN INCHES									
		8	10	12	14	16	18	20	24	30	36
1 $\frac{3}{8}$ and 1 $\frac{1}{4}$	Single	\$5.00	\$5.15	\$5.35	\$5.60	\$5.70	\$6.10	\$6.55			
	Double	5.40	5.55	5.75	6.00	6.10	6.50	6.95			
1 $\frac{7}{8}$ and 1 $\frac{1}{2}$	Single	5.35	5.50	5.70	5.95	6.05	6.45	6.90			
	Double	5.65	5.90	6.10	6.35	6.45	6.85	7.30			
1 $\frac{1}{2}$ and 1 $\frac{3}{4}$	Single	5.60	5.75	5.95	6.20	6.30	6.70	7.15			
	Double	6.00	6.15	6.35	6.60	6.70	7.10	7.55			
1 $\frac{5}{8}$ and 2	Single	8.25	8.75	8.90	9.20	9.65	9.70	10.20	\$11.05		
	Double	8.75	9.25	9.40	9.70	10.15	10.20	10.70	11.55		
2 $\frac{3}{8}$ and 2 $\frac{1}{4}$	Single	10.15	10.50	10.65	11.15	11.75	12.20	13.10	14.80	\$17.15	
	Double	10.70	11.05	11.20	11.70	12.30	12.75	13.65	15.35	17.70	
2 $\frac{7}{8}$ and 2 $\frac{1}{2}$	Single	10.75	11.10	11.25	11.75	12.35	12.80	13.70	15.40	17.75	
	Double	11.30	11.65	11.80	12.30	12.90	13.35	14.25	15.95	18.30	
2 $\frac{1}{2}$ and 2 $\frac{3}{4}$	Single	12.65	13.25	13.75	13.85	15.15	16.25	17.30	19.55	21.60	\$22.35
	Double	13.45	14.05	14.55	14.65	15.95	17.05	18.10	20.35	22.40	23.15
2 $\frac{5}{8}$ and 3	Single	15.40	15.90	16.50	16.60	17.90	19.00	20.05	23.30	24.35	25.10
	Double	16.20	16.70	17.30	17.40	18.70	19.80	20.85	23.10	25.15	25.90

When ordering Hangers give exact bore and drop wanted. Wall boxes, post boxes, floor stands, pillow blocks, split pulleys, and everything connected with the transmission of power, furnished at short notice and lowest prices.



THE TORONTO LINE

Fittings, Valves, Etc.

	SIZE, INCHES															
	1/8	1/4	3/8	1/2	5/8	1	1 1/4	1 1/2	2	2 1/2	3	3 1/2	4	4 1/2	5	6
Elbows, cast iron, R. H.....each	\$.05	\$.05	\$.06	\$.08	\$.10	\$.16	\$.20	\$.28	\$.50	\$.75	\$1.05	\$1.20	\$1.75	\$2.00	\$2.75	
Elbows, galvanized..... "	.10	.10	.12	.16	.21	.32	.40	.56	1.00	1.50	2.10	2.40	3.50	4.00	5.50	
Elbows, cast iron, R. & L. reducing	.06	.06	.07	.09	.12	.18	.23	.32	.60	.85	1.20	1.40	2.00	2.30	3.15	
45 Elbows, cast iron..... "	.06	.06	.07	.10	.12	.19	.24	.34	.60	.90	1.25	1.45	2.20	2.50	3.45	
Tees, cast iron..... "	.08	.08	.09	.12	.15	.23	.29	.41	.73	1.10	1.50	1.75	2.55	3.00	4.00	
Tees, cast iron, reducing..... "		.09	.10	.14	.17	.27	.33	.47	.83	1.25	1.75	2.00	2.95	3.50	4.60	
Tees, galvanized..... "	.16	.16	.18	.24	.30	.46	.58	.82	1.46	2.20	3.00	3.50	5.10	6.00	8.00	
Crosses, cast iron..... "		.15	.16	.22	.27	.42	.53	.75	1.30	2.00	2.70	3.15	4.60	5.50	7.25	
Crosses, cast iron, reducing..... "			.18	.25	.30	.46	.60	.88	1.45	2.20	3.00	3.50	5.10	6.00	8.00	
Return Bends, cast iron, close pat..			.18	.20	.22	.28	.40	.57	1.20	1.70		5.00				
Return Bends, cast iron, open pat..			.25	.26	.30	.40	.55	.80	1.35	2.20		5.75				
Plugs, cast iron..... "	.02	.02	.02	.03	.04	.05	.07	.10	.18	.25	.38	.42	.65	.88	1.20	
Y Bends, cast iron..... "			.20	.28	.34	.54	.66	.94	1.66	2.50	3.50	4.00	5.90	7.00	9.20	
Bushings..... "		.04	.04	.05	.06	.07	.09	.14	.21	.30	.40	.50	.75	.93	1.25	
Unions, malleable iron..... "	.18	.20	.22	.27	.33	.46	.58	.75	1.55	2.10	3.65	4.35				
Flange Unions..... "			.40	.46	.52	.64	.78	1.00	1.25	1.50	1.80	2.10	2.70	3.15	3.95	
Nipples, short..... "	.04	.04	.04	.05	.06	.08	.11	.13	.18	.29	.48	.75	.85	1.25	1.53	1.85
Nipples, long..... "	.06	.06	.06	.07	.09	.13	.17	.20	.27	.59	.72	1.05	1.20	1.70	2.45	2.90
Check Valves, Jenkins' Brass..... "	1.10	1.20	1.30	1.90	2.60	3.60	5.00	7.50	13.50	20.50						
Safety Valves, Jenkins' Brass..... "			4.12	4.95	5.50	8.25	10.15	15.50								
Steam Cocks, brass..... "	.85	.85	1.00	1.25	1.70	2.35	3.70	4.85	7.30	14.50	22.50	38.50	50.00			
Service Cocks, brass, extra heavy..	.75	.75	.85	.95	1.15	1.50	2.25	3.10	5.00	11.00	16.00					
Bibb Cocks, lever, common, rough. doz.	11.00	13.00	16.00	23.00	35.00	56.00	78.00	160.00								
Bibb Cocks, lever, finished..... "	12.00	14.00	17.00	26.00	39.00											
Brass Elbows, rough..... each	.12	.17	.21	.28	.30	.50	.85	1.10	1.50	3.50	5.50	7.00	10.00			
Brass Tees, rough..... "	.15	.20	.30	.40	.50	.75	1.00	1.30	1.75	4.00	5.50	9.00	13.00			
Pipe Hangers, Blake's..... "			.55	.55	.58	.60	.62	.65	.70	.75	.77	.85	.90	.95	1.05	
Pipe Hooks..... per 1000	3.25	3.50	4.10	5.10	6.90	8.80	12.00	16.00								

Standard Wrought Iron Pipe

FOR STEAM, GAS AND WATER						BLACK AND GALVANIZED					
Nominal size inside Diameter inches	Price per foot	Nominal Weight per foot pounds	Nominal size inside Diameter inches	Price per foot	Nominal Weight per foot pounds	Nominal size inside Diameter inches	Price per foot	Nominal Weight per foot pounds	Nominal size inside Diameter inches	Price per foot	Nominal Weight per foot pounds
1/4	\$.05 1/2	0.24	1 1/4	\$.22 1/2	2.24	4	\$1.08	10.66	9	\$3.40	33.70
1/2	.06 1/2	0.42	1 1/2	.27	2.68	4 1/2	1.30	12.49	10	4.25	40.00
3/4	.05 1/2	0.56	2	.36	3.61	5	1.45	14.50	11	4.75	45.00
1	.08 1/2	0.84	2 1/2	.57 1/2	5.74	6	1.88	18.76	12	5.20	49.00
1 1/4	.11 1/2	1.12	3	.75 1/2	7.54	7	2.35	23.27			
1 1/2	.16 1/2	1.67	3 1/2	.95	9.00	8	2.82	28.18			

For Galvanized Pipe add 6 cents per lb.



THE TORONTO LINE

The Gem Automatic Cut-Off Engine

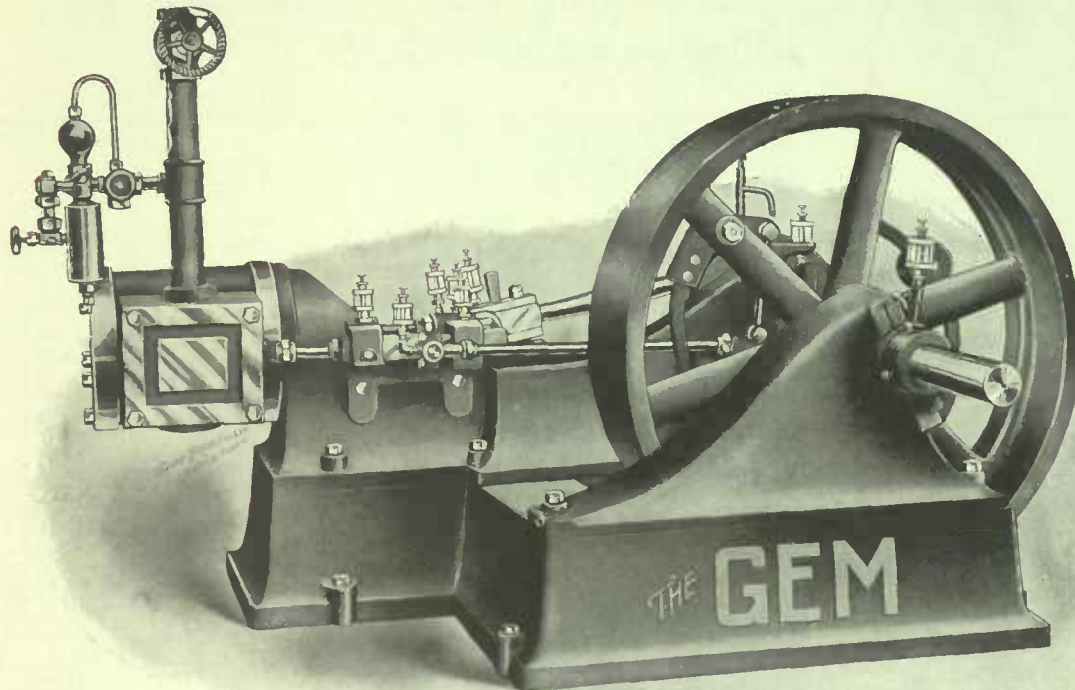

A TTRACTIVE in design and perfect in all working parts. This Engine has earned a high reputation by years of service under all conditions.

THE AUTOMATIC CUT-OFF GOVERNOR is of new and improved design within the fly wheel, all parts being accessible with a common wrench. There are two ways of regulating the speed viz :

By increasing or diminishing the tension of the spring.

By moving the weights upon the arms.

With these devices the best regulation can be obtained and the governing of the motion is at all times reliable.

To increase engine speed the weights must be moved toward the hub ; to decrease speed the weights must be moved outward from the hub and the tension spring should be drawn to correspond with the weights.

The valve must be well lubricated with high grade oil and the gland at end of steam chest evenly and well packed, otherwise the wearing parts will become dry, causing an uneven motion of engine.

DIMENSIONS OF THE GEM AUTOMATIC ENGINES

Based on 80 pounds Initial Pressure

No.	Horse Power	Cylinder		Diameter Shaft	Wheel		Pulley		Pipes		Revolutions	Weight
		Diameter	Stroke		Diameter	Face	Diameter	Face	Steam	Exhaust		
G. 1	6 to 8	4½	7	2	20	5½	14	6½	1	1¼	260 to 380	850
G. 2	8 to 10	5¼	7	2	24	6¾	16	7½	1¼	1½	230 to 320	1,100
G. 3	10 to 12	6	7½	2¼	30	6¾	18	8½	1½	2	230 to 300	1,300
G. 3½	12 to 15	6½	7½	2¼	30	6¾	18	10½	1½	2	230 to 300	1,400
G. 4	15 to 18	7½	8	2½	35	7	20	10½	2	2½	220 to 270	1,925
G. 5	20 to 25	8	10	3¼	40	10½	20	12½	2	2½	220 to 260	3,800
G. 5½	25 to 30	8½	10	3½	40	10½	20	12½	2	2½	220 to 260	4,200
G. 6	30 to 35	9¼	10	3½	40	10½	24	12½	2½	3	220 to 260	4,400
G. 7	35 to 40	10	10	3½	40	10½	24	14½	2½	3	220 to 260	4,700

TRIMMINGS—A complete set of Nickel Plated Glass Oilers, Sight Feed Lubricator, Throttle Valve and two Cylinder Cocks.

Automatic Vertical Centre Crank Engines

Perfect Construction. Smooth Running.
Fully Guaranteed.

Governed automatically by an improved device contained within the fly wheel, which governor is thoroughly automatic in its action and can be easily adjusted.

These engines are symmetrical in design, made from new patterns, durable and economical in the use of steam. All material and workmanship guaranteed the best, and the finish first-class.

Care must be used to keep valve and cylinder perfectly lubricated with high grade oil. If allowed to run dry it interferes with the smooth action of the governor.

TRIMMINGS—For Automatic Engines, a complete set of Nickel Plated Glass Oilers, Sight Feed Lubricator, Throttle Valve and Cylinder Cocks.

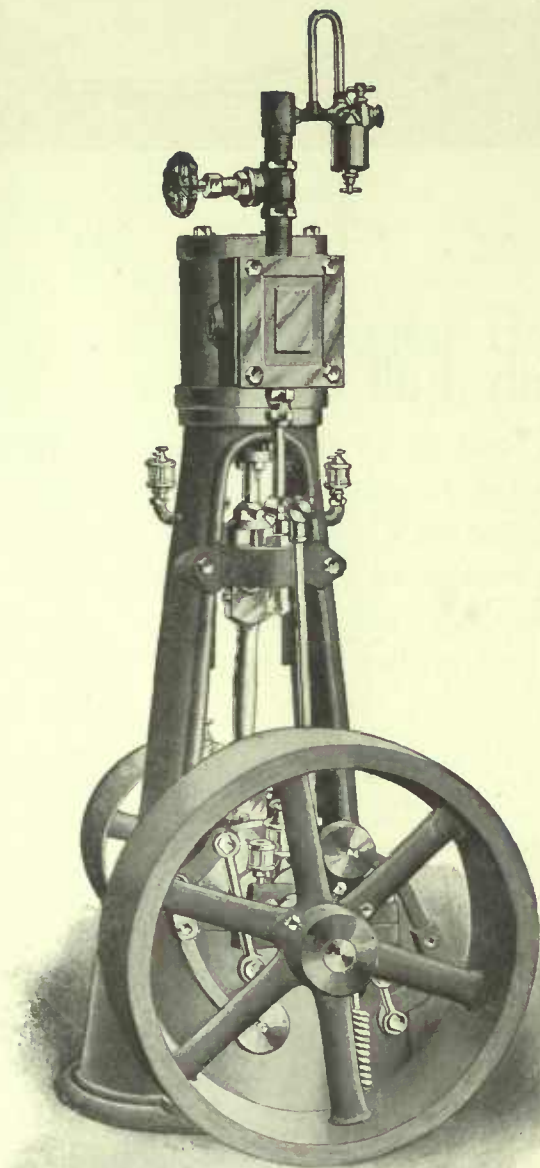

Dimensions of Automatic Vertical Centre Crank Engines. Based on 80 pounds Initial Pressure. Cut-off at $\frac{1}{4}$ Stroke.														
No.	Horse Power	Cylinder		Shaft Diam.	Balance Wheel		Pulley		Pipes		Revol. per Minute	Weight	Height floor to Centre of Shaft	Height floor to Top of Cylinder
		Diam.	Stroke		Diam.	Face	Diam.	Face	Steam	Exhst.				
A. V. 2	3	3	4 $\frac{1}{2}$	1 $\frac{1}{2}$	18	6	10	4 $\frac{1}{2}$	$\frac{1}{2}$	$\frac{3}{4}$	375	325	10	40
A. V. 3	4	3 $\frac{1}{2}$	4 $\frac{1}{2}$	1 $\frac{1}{2}$	18	6	10	4 $\frac{1}{2}$	$\frac{1}{2}$	$\frac{3}{4}$	375	350	10	40
A. V. 4	5	4	5	1 $\frac{1}{2}$	18	6	12	4 $\frac{1}{2}$	$\frac{3}{4}$	1	300	525	10 $\frac{1}{4}$	46
A. V. 5	6	4 $\frac{1}{2}$	5	1 $\frac{1}{2}$	18	6	12	4 $\frac{1}{2}$	$\frac{3}{4}$	1	300	575	10 $\frac{3}{8}$	46
A. V. 6	7	5	6 $\frac{1}{2}$	2	20	6	14	6 $\frac{1}{2}$	1	1 $\frac{1}{4}$	300	770	12 $\frac{1}{4}$	58 $\frac{1}{2}$
A. V. 7	8	5 $\frac{1}{2}$	6 $\frac{1}{2}$	2	20	6	14	6 $\frac{1}{2}$	1	1 $\frac{1}{4}$	275	850	12 $\frac{1}{4}$	58 $\frac{1}{4}$
A. V. 8	10	6	8	2 $\frac{1}{2}$	24	6	16	6 $\frac{1}{2}$	1 $\frac{1}{4}$	1 $\frac{1}{2}$	250	1300	14 $\frac{1}{2}$	62
A. V. 8 $\frac{1}{2}$	12	6 $\frac{1}{2}$	8	2 $\frac{1}{2}$	24	6	16	6 $\frac{1}{2}$	1 $\frac{1}{4}$	1 $\frac{1}{2}$	250	1350	14 $\frac{1}{2}$	62
A. V. 9	15	7	8	3	30	6 $\frac{3}{4}$	18	8 $\frac{1}{2}$	1 $\frac{1}{2}$	2	250	1400	16 $\frac{3}{8}$	64 $\frac{1}{2}$
A. V. 9 $\frac{1}{2}$	18	7 $\frac{1}{2}$	8	2 $\frac{1}{2}$	30	6 $\frac{3}{4}$	18	8 $\frac{1}{2}$	1 $\frac{1}{2}$	2	250	1450	16 $\frac{3}{8}$	64 $\frac{1}{2}$
A. V. 10	20	10	10	3 $\frac{1}{2}$	35	6 $\frac{3}{4}$	18	8 $\frac{1}{2}$	1 $\frac{1}{2}$	2	260	1750	17 $\frac{1}{2}$	69 $\frac{1}{2}$
A. V. 11	25	8	10	3 $\frac{1}{2}$	35	6 $\frac{3}{4}$	20	10 $\frac{1}{2}$	2	2 $\frac{1}{2}$	260	1800	17 $\frac{1}{2}$	69 $\frac{1}{2}$
A. V. 12	30	8 $\frac{1}{2}$	10	3 $\frac{1}{2}$	35	6 $\frac{3}{4}$	20	10 $\frac{1}{2}$	2	2 $\frac{1}{2}$	260	2000	17 $\frac{1}{2}$	69 $\frac{1}{2}$
A. V. 12 $\frac{1}{2}$	35	9 $\frac{1}{2}$	10	3 $\frac{1}{2}$	40	10 $\frac{1}{2}$	24	10 $\frac{1}{2}$	2 $\frac{1}{2}$	3	260	2100	18 $\frac{1}{8}$	69 $\frac{1}{4}$
A. V. 13	40	9 $\frac{1}{2}$	12	3 $\frac{3}{4}$	40	10 $\frac{1}{2}$	24	10 $\frac{1}{2}$	3	3	250	2800	18 $\frac{1}{8}$	83
A. V. 14	45	10	12	3 $\frac{3}{4}$	40	10 $\frac{1}{2}$	24	12	2 $\frac{1}{2}$	3 $\frac{1}{2}$	250	2800	18 $\frac{1}{8}$	83
A. V. 15	50	11	12	3 $\frac{3}{4}$	40	10 $\frac{1}{2}$	26	12	2 $\frac{1}{2}$	3 $\frac{1}{2}$	250	3100	18 $\frac{1}{8}$	83
A. V. 16	60	12	12	3 $\frac{3}{4}$	40	10 $\frac{1}{2}$	26	12	2 $\frac{1}{2}$	3 $\frac{1}{2}$	250	3600	18 $\frac{1}{8}$	83
A. V. 17	70	12	14	4 $\frac{1}{2}$	48	13	28	14	3	4	250	3900	21	91
A. V. 18	75	12 $\frac{1}{2}$	14	4 $\frac{1}{2}$	48	13	28	14	3	4	250	4200	21	91
A. V. 19	80	13	14	4 $\frac{1}{2}$	48	13	30	14	3	4	250	4500	21	91
A. V. 20	85	13 $\frac{1}{2}$	14	4 $\frac{1}{2}$	48	13	30	14	3	4	225	4800	21	91
A. V. 21	90	14	14	4 $\frac{1}{2}$	48	13	30	16	3 $\frac{1}{2}$	4 $\frac{1}{2}$	225	5300	21	91

Horizontal Boiler with Full Front

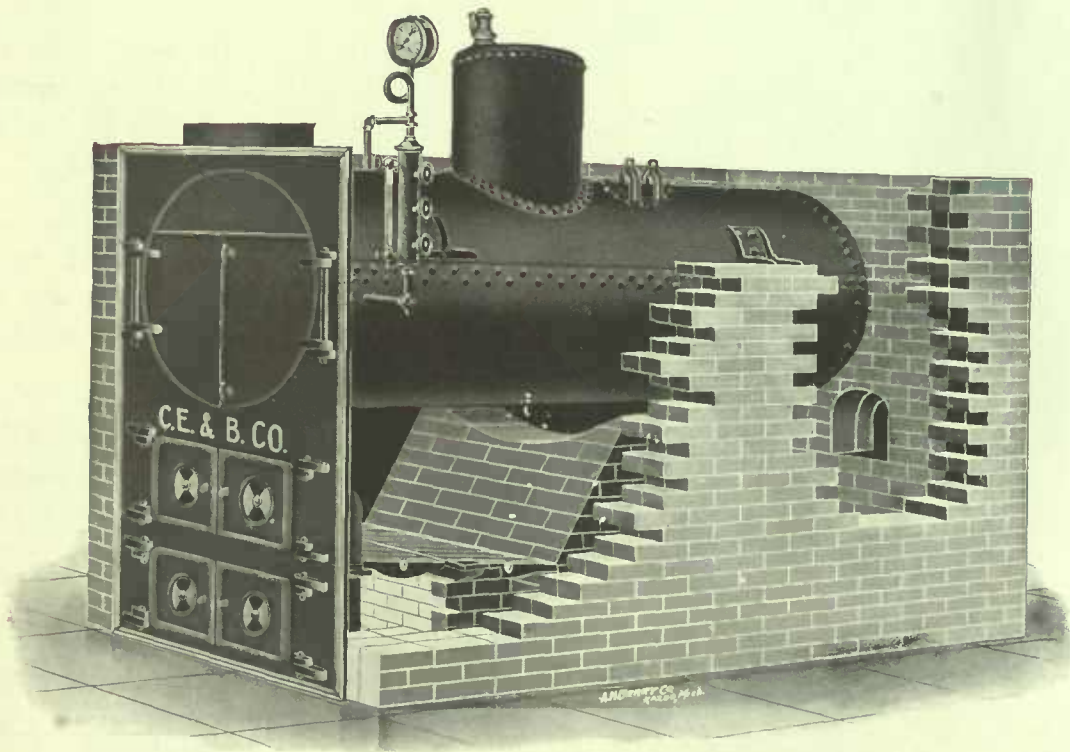



Horizontal Boiler with Full Front

FULL Flush Front with smoke doors opening to right and left. This style front is used on boilers 42 and 44 inches in diameter. Boilers less than 36 inches in diameter are furnished with single doors. Our Standard Boilers are all made from flange steel, 60,000 lbs. tensile strain, ductility 56 per cent. as indicated by reduction in area at point of fracture. Elongation 25 per cent. in length of eight inches. Our Boilers are all tested to 150 lbs. hydrostatic pressure and made perfectly tight in every rivett tube and seam before leaving our factory.

Fixtures comprise Full Flush Front complete with all castings, including grates, stack and guy rods, combination water column with steam and water gauges and three gauge cocks, safety valve, check and stop valves and blow-off valve. We also furnish an injector complete with pipes and valves fitted. We only furnish buckstays, cross rods, wall plates and rollers when called for in specifications and an extra charge is made for same.

Boilers 25 horse power and larger are made with flush ends, and smaller sizes with smoke box extension.

SPECIFICATIONS OF HORIZONTAL STATIONARY TUBULAR BOILERS														
Horse Power	Size of Boiler	Heating Surface sq. ft.	No. of 8 inch Tubes	Thickness of Shell inches	Thickness of Head inches	Size of Dome inches	Grate Surface inches	Length of Stack ft.	Diameter of Stack inches	Size of Safety Valve	Size of Feed Pipe inches	Size of Blow-Off Pipe inches	Weight complete lbs. about	Weight of Bare Boiler lbs.
8	30 × 5	120	20	$\frac{1}{4}$	$\frac{5}{16}$	16 × 16	30 × 30	24	14	1	1	1	2,800	1,200
10	30 × 7	150	20	$\frac{1}{4}$	$\frac{5}{16}$	16 × 18	34 × 30	24	14	$1\frac{1}{4}$	1	1	3,250	1,500
12	30 × 8	180	20	$\frac{1}{4}$	$\frac{5}{16}$	16 × 18	34 × 30	24	14	$1\frac{1}{4}$	1	1	3,600	1,750
15	36 × 8	226	26	$\frac{1}{4}$	$\frac{3}{8}$	22 × 20	36 × 36	24	16	$1\frac{1}{4}$	$1\frac{1}{4}$	$1\frac{1}{4}$	4,000	2,100
20	36 × 10	300	28	$\frac{1}{4}$	$\frac{3}{8}$	22 × 20	42 × 36	24	16	$1\frac{1}{2}$	$1\frac{1}{4}$	$1\frac{1}{4}$	4,750	2,600
25	36 × 12	375	30	$\frac{5}{16}$	$\frac{3}{8}$	22 × 22	42 × 42	35	20	2	$1\frac{1}{4}$	$1\frac{1}{4}$	6,050	3,200
30	42 × 10	446	40	$\frac{5}{16}$	$\frac{3}{8}$	24 × 24	42 × 44	35	22	$2\frac{1}{2}$	$1\frac{1}{2}$	$1\frac{1}{2}$	7,000	3,650
35	44 × 10	530	44	$\frac{5}{16}$	$\frac{3}{8}$	24 × 24	48 × 44	40	22	$2\frac{1}{2}$	$1\frac{1}{2}$	$1\frac{1}{2}$	7,250	4,150
40	44 × 12	600	44	$\frac{5}{16}$	$\frac{3}{8}$	24 × 24	48 × 48	40	24	3	$1\frac{1}{2}$	$1\frac{1}{2}$	9,200	4,800
45	48 × 12	675	48	$\frac{5}{16}$	$\frac{3}{8}$	28 × 28	54 × 48	40	24	3	$1\frac{1}{2}$	$1\frac{1}{2}$	10,150	5,500
50	48 × 14	760	50	$\frac{5}{16}$	$\frac{7}{16}$	30 × 30	54 × 48	40	26	3	$1\frac{1}{2}$	$1\frac{1}{2}$	10,900	6,500
60	54 × 14	900	48-3 $\frac{1}{2}$	$\frac{5}{16}$	$\frac{7}{16}$	36 × 32	54 × 60	40	28	4	$1\frac{1}{2}$	$1\frac{1}{2}$	12,000	7,500
70	54 - 16	1050	48-3 $\frac{1}{2}$	$\frac{5}{16}$	$\frac{7}{16}$	36 × 32	54 × 60	50	28	4	$1\frac{1}{2}$	$1\frac{1}{2}$	13,600	8,600
80	60 - 16	1200	46-4	$\frac{5}{16}$	$\frac{7}{16}$	36 × 32	54 × 60	60	28	5	2	2	15,100	10,660

Plain Vertical Boiler

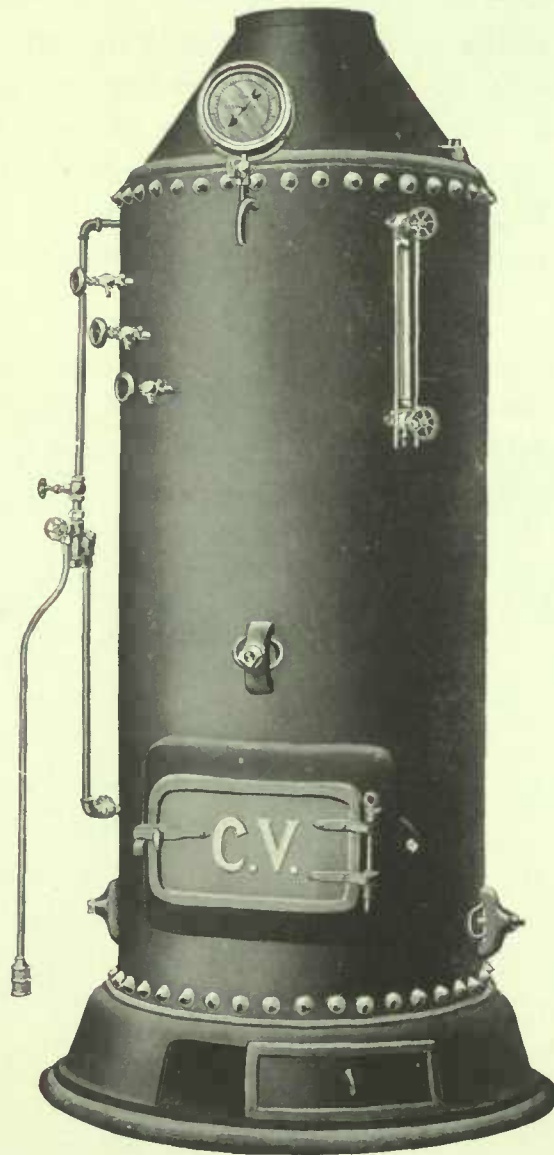

Plain Vertical Boiler



Plain Vertical Boiler

Our Leader.

Honest Construction.

THESE boilers are made of homogeneous steel, 60,000 pounds tensile strength to the square inch, with the best lap welded flues.

CAST FIXTURES—Base, Hood, Fir Door, Ash Pit Door and Grates.

TRIMMINGS—Injector fitted, Steam Gauge, Water Gauge, Gauge Cocks, Safety Valve, Blow-off, Check and Stop Valves.

All boilers above 26 inches in diameter have vertical seams, double riveted. They are made of flange Steel, 60,000 pounds tensile strength, and are tested to 150 pounds hydrostatic pressure.

SPECIFICATIONS OF PLAIN VERTICAL BOILERS															
Horse Power.....	1½	2	3	4	5	6	8	10	12	14	16	20	25	30	35
Diameter of boiler, inches.....	20	20	20	24	24	26	30	30	36	36	36	42	42	42	48
Height above base, inches.....	36	43	50	50	60	60	60	72	72	84	96	96	108	120	96
Diameter of furnace, inches.....	16	16	16	20	20	22	26	26	31	31	31	37	37	37	42
Height of furnace, inches.....	18	18	18	18	22	22	24	26	26	32	32	32	32	34	32
Size of safety valve, inches.....	¾	¾	¾	¾	¾	¾	1	1	1¼	1¼	1½	1½	2	2	2½
Size of blow-off, inches.....	¾	¾	¾	¾	¾	¾	¾	¾	1	1	1	1	1¼	1¼	1¼
Thickness of steel in shell, ins.....	⅝	¾	¾	¾	¾	¾	¾	¾	¾	¾	¾	¾	¾	¾	¾
Thickness of steel in heads, ins.....	¼	⅝	⅝	⅝	⅝	⅝	⅝	¾	¾	¾	¾	⅞	⅞	⅞	⅞
Thickness of steel in fire-box, ins.....	¼	¼	¼	¼	¼	¼	¼	¼	⅝	⅝	⅝	⅝	⅝	⅝	⅝
Length of tubes, inches.....	18	25	32	£2	38	38	36	48	48	56	64	64	76	86	64
Number of 2-inch tubes.....	19	19	19	31	31	37	43	43	55	55	55	79	85	91	138
Weight of boiler, without trimmings or fixtures.....	325	430	530	640	750	840	1010	1180	1520	1800	2280	3000	3400	3800	4000
Weight of boiler, complete.....	475	560	620	890	1060	1300	1550	1650	2350	2540	3000	4000	4400	4705	5700
Outside diameter of stack opening inches.....	8	8	8	8	8	10	10	10	16	16	16	20	20	20	24
Height, floor to top of hood, ins.....	50	54	60	66	76	76	76	94	98	108	120	120	132	144	120

Improved Duplex Steam Pumps

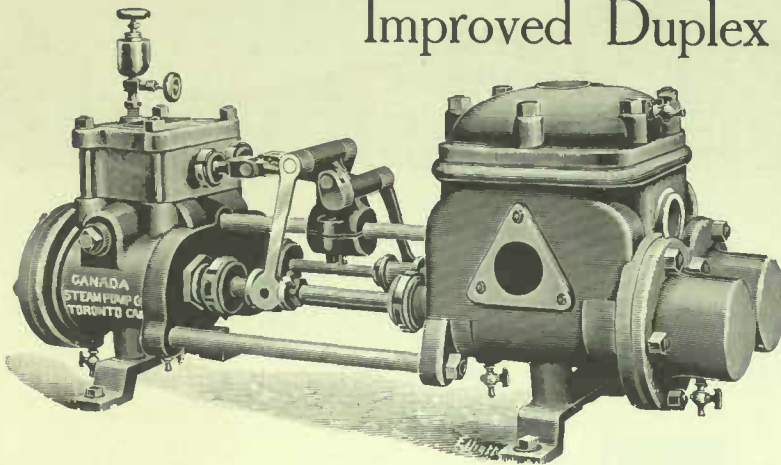

Regular Inside Plunger Pattern for
Feeding Boilers, Hydraulic Elevators,
Fire Protection, Etc.

This Cut is from 5¼ x 3½ x 5.

SIZES AND CAPACITIES

Steam Cylinder	Water Cylinder	Stroke	Gal. per Stroke each Plunger	Strokes per minute each Plunger	Gallons per minute both Plungers ordinary speed	Steam Pipe	Exhaust Pipe	Suction Pipe	Discharge Pipe
3	2	3	.04	100 to 250	8 to 20	¾	½	1¼	1
4½	2¾	4	.10	100 to 200	20 to 40	½	¾	2	1½
5¼	3½	5	.24	100 to 200	48 to 96	¾	1¼	2½	2
6	4	7	.39	100 to 150	78 to 117	1	1½	3	2½
7½	4½	10	.69	75 to 125	100 to 170	1½	2	5	4
7½	5	10	.81	75 to 125	122 to 203	1½	2	5	4
8	5	12	1.02	60 to 110	122 to 224	1½	2	5	4
8	6	12	1.47	60 to 110	175 to 325	1½	2	5	4
10	6	12	1.47	60 to 110	175 to 325	2	2½	5	4
10	6½	12	1.72	60 to 110	200 to 378	2	2½	5	4

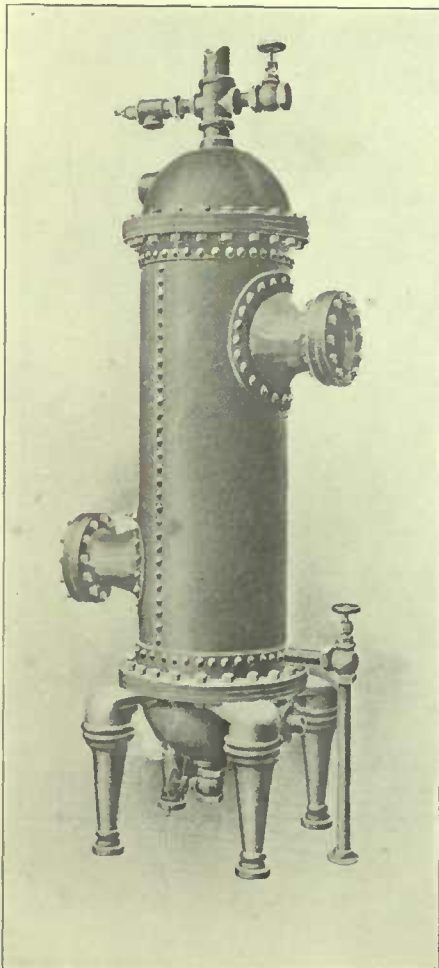

These Pumps are fitted with two double acting Plungers or packed Pistons, Rubber or Brass Valves, suitable for pumping hot or cold water. When fitted with Brass Plungers and Rods a slight extra charge is made. Standard sizes always in stock, also parts for repairs.

WRITE FOR PRICES AND DISCOUNTS.

Feed Water Heater

Easily connected to Exhaust Pipe of Engine. Guaranteed to heat water to 210 degrees. Made in sizes from 30 to 200 Horse Power. High efficiency, no back pressure, easily cleaned, durable, removable brass tubes.



Electric Motor Driven Machines in the Laundry

IN answering the question "What are the benefits to be derived through the use of individual motor drive in laundries?" let us see what factors contribute to the profitable operation of a laundry.

We may compare the actual operation of a laundry to that of a factory which manufactures a standard line of goods and also makes a specialty of job work.

To operate economically, the raw material must be taken in and worked up into the finished product with a minimum amount of handling and loss of time while going from one operation to another. The amount of wasted and spoiled material must be kept down or it will eat up the profits.

The expense for fuel, oil, repairs, maintenance, etc., must be kept at a minimum.

Provision must be made for taking care of "hurry-up" jobs and overtime work without wasting power or labor.

Let us see how the use of individual motor drive will assist in bringing about the above condition in the case of the operation of a laundry. In the first place the machinery must be so arranged that succeeding operations can be carried on without partly finished work having to be carried all over the establishment before being finished and ready for shipment; that is, where one piece of work has to go through several machines before being finished, these machines should be so grouped that the work may go through from one machine to the next in regular order and with a minimum amount of handling.

The use of individual motor drive makes this grouping possible where it would be difficult with belt drive as the machines must be placed where they can be driven from the line shaft, while with motor drive it is only necessary to find floor space for the machines without regard to the position in which they stand.

In the laundry, waste and spoiled material will take in goods which are torn and destroyed by being caught in belting and soiled by having come in contact with a greasy belt or by the grease from the shafts being dropped on them, and by the dirt which is constantly being carried up from the floor and distributed around the room by rapidly moving belts. Where motor drive is used, the greasy shafting and belting is done away with and all the dirt settles to the floor where it may be gathered up. The absence of the belting allows better lighting and consequently better and more rapid work from the operators of the machines.

As to saving in fuel, etc., we have found from tests in laundries running from line shafting in what would be called a good condition, that the actual power required to drive the machinery is only from 40 to 60% of the total power used, the balance of the power being wasted in driving line shafts and belts. It must be remembered that this loss goes on all the time, whether the machines are running or not. The remark is often made that since high pressure steam must be had in a laundry, and steam must be generated, the amount used for line shafts and belts cuts no figure. This is not correct, as every pound of steam, no matter how used, has to be generated at the expense of a certain amount of fuel and water, and for this reason saving in power means a saving in steam, and consequently in fuel and water, or in other words, operating expense.

Where hurry-up and over-time work is to be taken care of, and only a small part of the entire plant is run, the proportion of the power wasted to the power needed to do the work becomes something startling where belt drive is used. In the case of the laundry, equipped with individual motor drive, the proportion of the power wasted to the power actually used remains practically constant, whether the entire plant is operating or only a few machines, as when a machine is stopped all loss from transmitting power to that machine stops at the same time.

When a new laundry is equipped with motor drive, the cost of motors will be largely offset by the saving in investment in shafting and belting, and in case of laundries already equipped with belt drive, the saving in the operating expense obtained by installing individual drive will pay good interest on the investment required.

We are equipping Bosom Presses, Body Ironers, Sleeve Ironers, Band Ironers, Collar and Cuff Ironers, Starchers, Dampeners, Extractors, Mangles, Dry Rooms, Fans, Blowers, and in fact everything in the way of laundry machinery, with electric motors.

If you are interested write us and give us a list of the machinery you have to drive and we will make you an estimate on the motor equipment complete with the necessary accessories.

In considering our motor drive it should be borne in mind that these equipments have been developed to meet the severe requirements of laundry machine drive. This has necessitated the design of special apparatus in the way of operating mechanism and slow speed motors which has resulted in a motor drive which is as simple and durable as anything can be made.



THE TORONTO LINE

Electrical Equipment

Form L Direct Current Machines

Motors $\frac{1}{4}$ to $7\frac{1}{2}$ H. P. Generators .6 to 3.5 K. W. Nine Frame Sizes.

THE FORM L MOTORS are designed and built to meet any condition requiring small power for either belt or gear drive or for direct connection. They are furnished for outputs varying from one-twentieth to seven and one-half horse power for operation on 115, 230 or 500 volt direct current circuits. Of neat appearance and compact design, they are specially suited for application to all kinds of laundry machinery. Thousands of applications have been made with the Form L Motor, which has become a standard machine.

Accessories:

Belted outfits consist of Motor with Base (sizes G. L. and larger) no voltage release starter (sizes, B. L. and larger) and pulleys for all sizes.

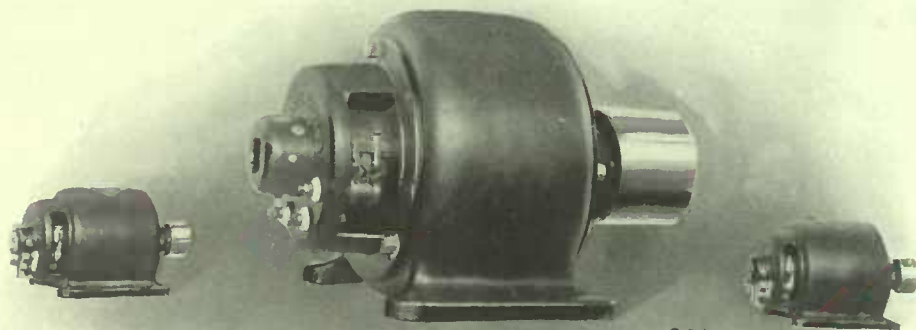

291

Form L Motors

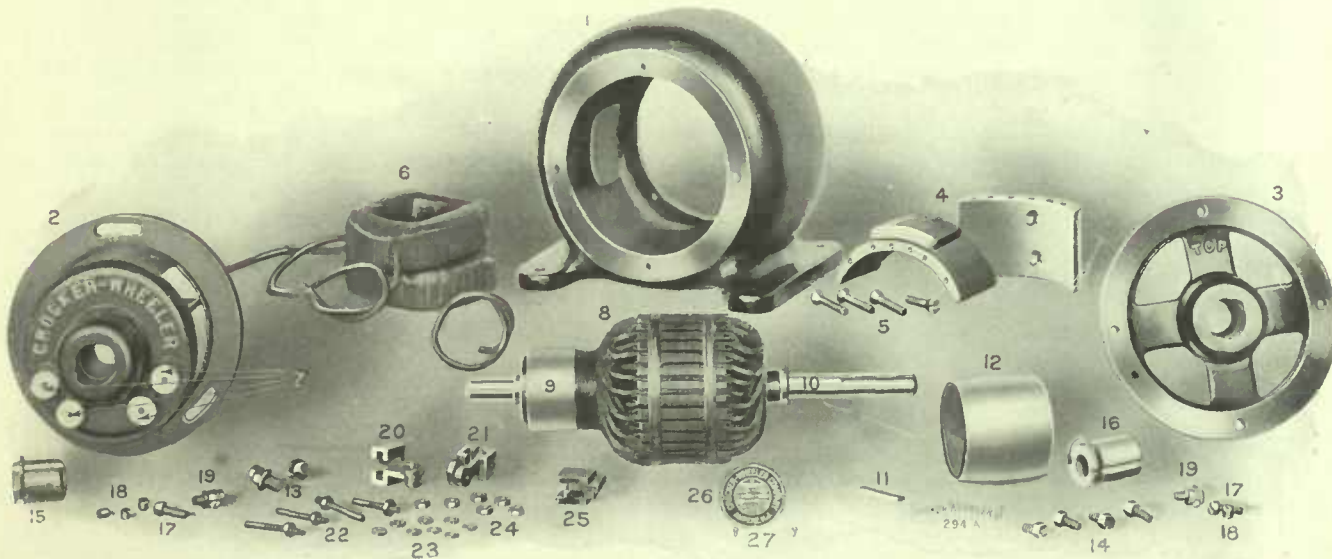

Size F. L. Motor Displayed

- | | | | |
|---------------------------------|--|-------------------------------------|---|
| 1. Magnet Frame. | 10. Shaft. | 16. Rear Journal Box with Oil Ring. | 23. Brass Washers for Brush and Terminal Studs. |
| 2. Front Shield. | 11. Pulley Key. | 17. Journal Box Cap Screw. | 24. Brush and Terminal Stud Nuts. |
| 3. Rear Shield. | 12. Pulley. | 18. Oil Well Plugs, | 25. Brushes. |
| 4. Pole Shoes. | 13. Front Shield Cap Screws, with Washers. | 19. } Brush Holders. | 26. Name Plate. |
| 5. Pole Shoe Screws. | 14. Rear Shield Cap Screws. | 20. } Brush Holders. | 27. Name Plate Pins. |
| 6. Field Coils. | 15. Front Journal Box with Oil Ring. | 21. } Brush Holders. | |
| 7. Porcelain Bushings. | | 22. Brush and Terminal Studs. | |
| 8. Armature (includes 9 and 10) | | | |
| 9. Commutator. | | | |



THE TORONTO LINE

Electrical Equipment

Ratings Form L Motors and Generators.

MOTOR.					
Size	Open Type				Weight
	Output	Speeds			
		H. P.	115 V	230 V	
A L	1-20	850	30
	1-8	1900	1900	
I	1-10	800	50
	1-1	1800	1800	
C L	1-5	725	725	85
	1-2	1600	1600	1740	
D L	3-10	545	545	125
	2-5	740	740	
	3-4	1200	1200	1300	
	1	1600	1600	1740	
E L	1-2	550	550	160
	3-4	850	850	
	1	1200	1200	1300	
	11-2	1800	1800	1950	
F L	3-4	570	570	215
	1	775	775	
	11-2	1200	1200	1300	
	2	1600	1600	1740	
G L	1	550	550	300
	11-2	830	830	
	2	1150	1150	1250	
	3	1725	1725	1875	
H L	11-2	500	500	365
	21-2	850	810	
	3	1040	1040	1140	
	5	1750	1750	1870	
I L	21-2	460	460	530
	33-4	690	690	
	5	960	960	1030	
	6	1190	
	71-2	1425	1550	

GENERATORS—115 Volt Ratings.				
Size	Output			Speed
	Watts	No. of 16 c. p. 55 Watt Carbon Lamps	No. of 20 c. p. 25 Watt Tungsten Lamps	
D L	600	11	24	1650
	800	15	32	2150
E L	800	15	32	1500
	1250	23	50	2200
F L	1250	23	50	1450
	1750	32	70	1950
G L	1750	32	70	1350
	2500	45	100	2000
H L	2500	45	100	1350
I L	3500	64	140	1200
	4000	73	160	1500

Form L generators are furnished in the above frame sizes for 125 V. at an increase in speed and capacity of approximately 7%. The IL size is also wound for 250 volts with the same speed and output as when designed for 125 volts.

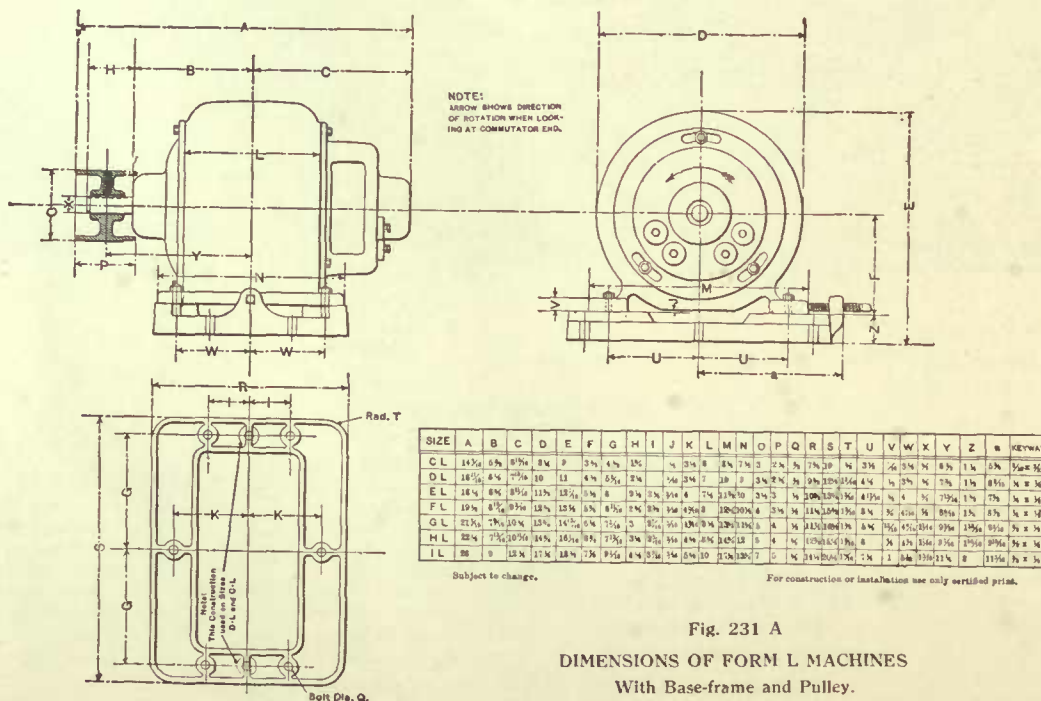

Fig. 231 A
DIMENSIONS OF FORM L MACHINES
With Base-frame and Pulley.



THE TORONTO LINE

Electrical Equipment

Form I Machines, Belt Type, Direct Current

Motors $3\frac{1}{4}$ to 50 H.P., Generators 3 to 45 K. W.

The Form I Motor can be used for belt, gear or direct drive, and is applicable to laundry machinery requiring constant or variable speed drive. Variable speed is obtained by means of armature or field control regulators or by a multiple voltage system of speed control. Form IF motors are designed specially for field weakening speed control through wide ranges.

Being compact and self contained, the Form I machine, either motor or generator, can be quickly and cheaply installed, and its careful electrical and mechanical design reduces maintenance cost to a minimum.

These machines give high average efficiency under working conditions. The construction combines simplicity and accessibility. The material and workmanship are of the highest grade.

Accessories. Belted outfits consist of motor with rail base, pulley and starter; or generator with rail base, pulley and field regulator. When the drive is by chain or gearing, the only accessory usually supplied is a starter or field regulator. Where speed control of the motor is desired, we are prepared to furnish the type of controller best suited for the particular case.

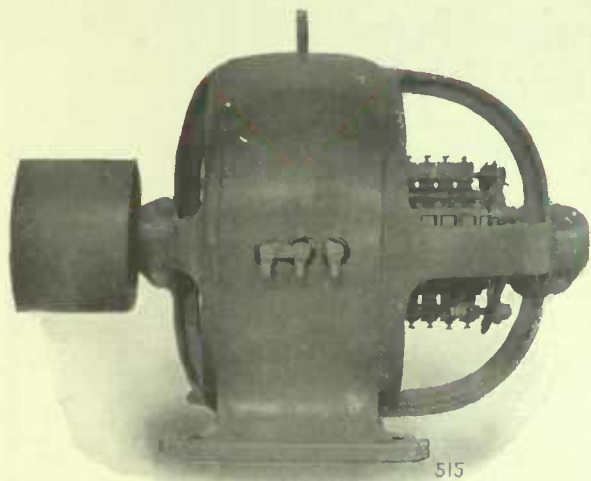

Form I Machine

control of the motor is desired, we are prepared to furnish the type of controller best suited for the particular case.

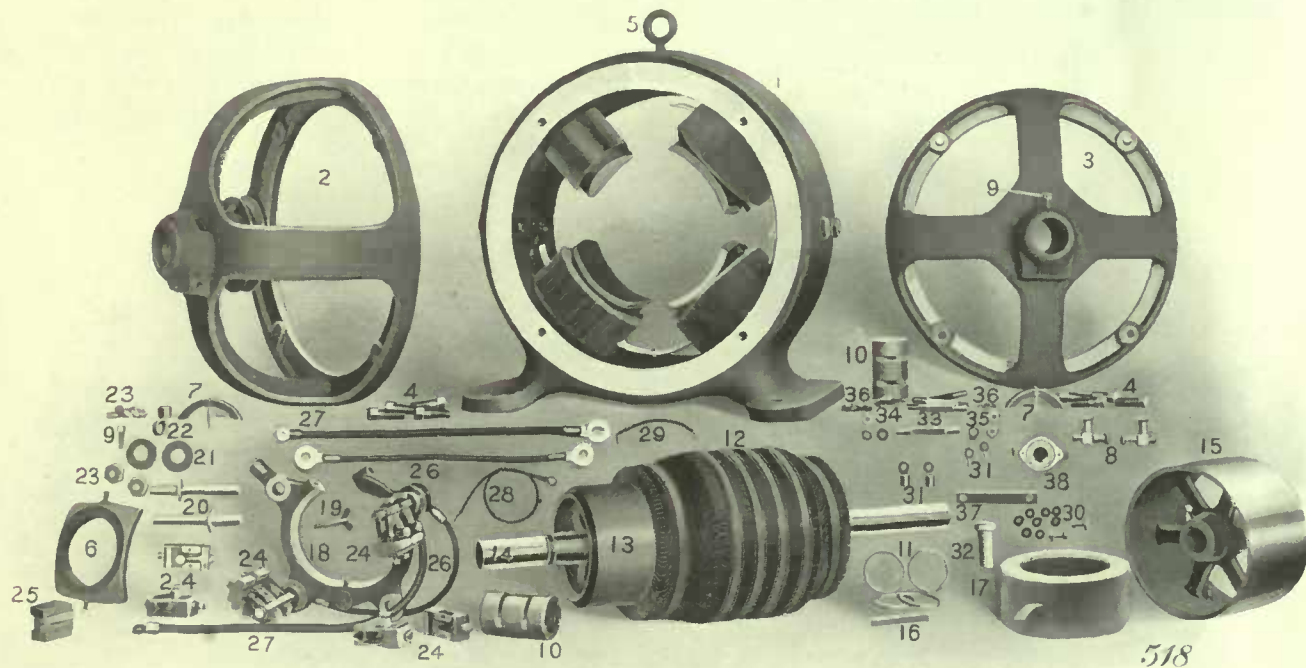

Form I Machine Displayed

- | | | | |
|-----------------------------|--------------------------------|------------------------------------|---|
| 1. Magnet Frame | 11. Oil Rings | *21. Brush Studs | 31. Flats with bolts for connecting Series Fields |
| 2. Front Shield | 12. Armature, includes 13 & 14 | 22. Insulating Washers | *32. Cable Tips |
| 3. Rear Shield | 13. Commutator | 23. Brush Stud Insulating Bushings | 33. Porcelain Bushings |
| 4. Shield Cap Screws | 14. Shaft | *24. Brush Stud Nuts | 34. Terminal Studs |
| 5. Eye Bolt | 15. Pulley | *25. Brush Holders | 35. Washers, plain brass |
| *6. Pole Shoe with Screws | 16. Pulley Key | 26. Brushes | 36. Main and Series Labels |
| 7. Oil Hole Cover and Chain | 17. Field Coils | *27. Connection Cable and Tips | 37. Terminal Stud Nuts |
| 8. Oil Gauges | *18. Rocker, includes 19 & 20 | *28. Terminal Cable and Tips | 38. Ties |
| 9. Journal Screws | *19. Rocker Handle | *29. Shunt Cable and Tips | 39. Name Plate and Screws |
| 10. Journal Boxes | *20. Wing Screw | 30. Shunt Field Connector | |

(*) These parts on $7\frac{1}{2}$ I are of slightly different design.



THE TORONTO LINE

Electrical Equipment

Ratings of Form I Motors and Generators.

MOTORS					GENERATORS				
Size	Output H. P.	Full Load Speed			Weights	Size	KW	115 V	230 V
		115 V	230 V	500 V					
7½-I	3½	430	450	650	7½-I	6	1025	1025
	5	600			6½
	7½	875	875	950		
	10	1260
10-I	5	400	400	1120	10-I	8¼	920	920
	6½	530	530			9	1220	1220
	10	825	825	880			10½
	13	1100	1100	1175			11½
15-I	7½	385	385	1650	15-I	12	875	875
	10	580	580			13
	15	800	800	840			16	1300	1300
	20	1200	1200	1250			17½
20-I	10	370	370	2100	20-I	16½	830	830
	13	490	490			18
	20	775	775	820			21¼	1075	1075
	26	1025	1025	1100			23
25-I	12½	365	365	2650	25-I	20¾	810	810
	17-½*	485	485			22½
	25	750	750	780			27½	1060	1060
	35	1000	1000	1050			30
35-I	17½*	340	340	3600	35-I	27½	760	760
	25*	465	465			30
	35	700	700	730			41½	1020	1020
	50	950	950	1000			45

Fig. 537

Dimensions of Form I Machines, with Rail Base and Pulley.

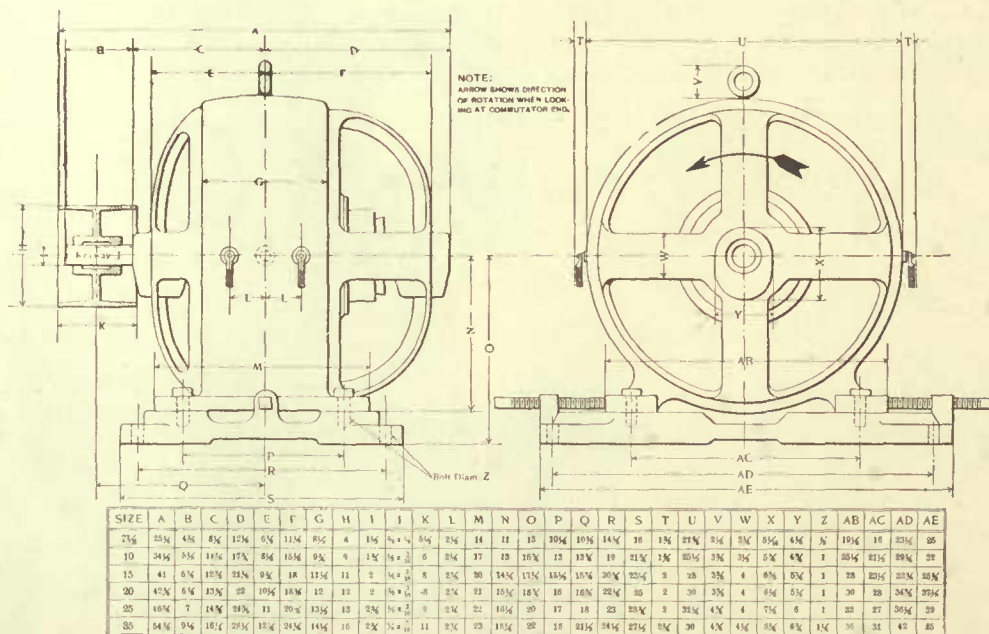



THE TORONTO LINE

Electrical Equipment

Form Q, Polyphase Induction Motors. Constant Speed. 60 Cycles, 1/2 to 250 H. P.

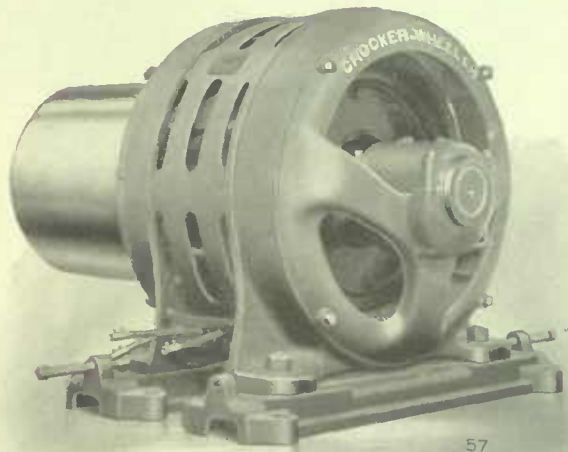

SQUIRREL CAGE INDUCTION MOTOR.

Induction motors can be applied to practically every form of industrial machinery. Every type of machine, however, does not call for the same type of induction motor. The concern that engineers the motor application must therefore have not only a complete knowledge of motor design, but also a thorough understanding of the requirements of the machinery to which the motor is to be applied.

These induction motors differ in vital features of construction from any other motor on the market. Every point of difference has been chosen because it stood for improved operation and greater durability.

ACCESSORIES: Belted outfits consists of motor with sliding base (or slotted feet for the smaller sizes), pulleys for all sizes, and starters for motors of over 5 horse power capacity.

Form Q Machine.

Displayed View of 40 H. P. Squirrel Cage Induction Motor.

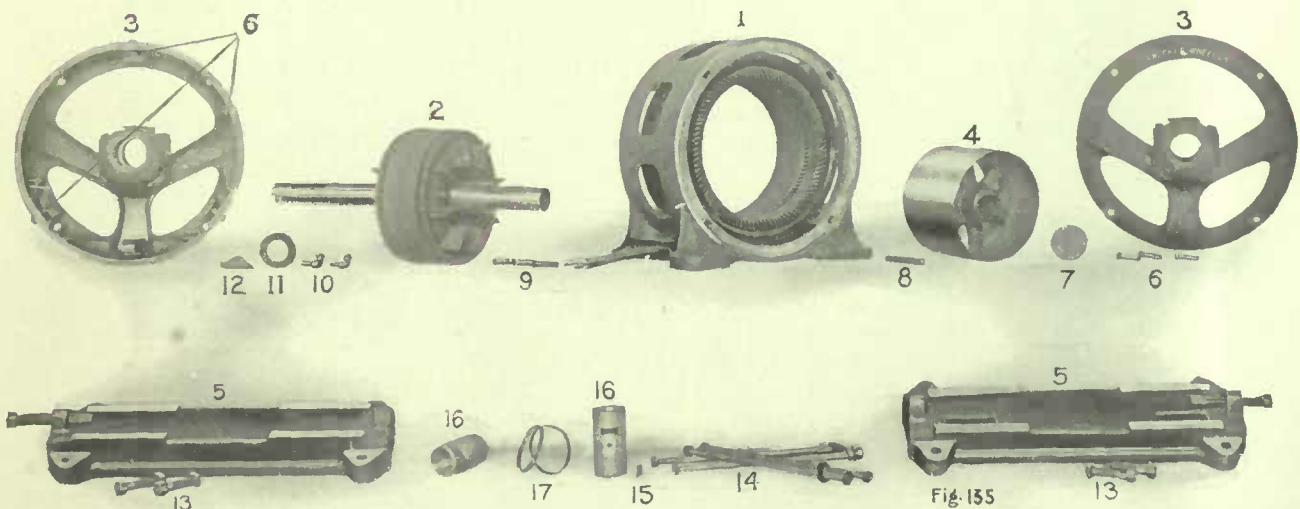

- 1. Stator.
- 2. Squirrel Cage Rotor.
- 3. Shields.
- 4. Pulley.
- 5. Rails.
- 6. Adjusting Screws.

- 7. Dust Cap.
- 8. Pulley Key.
- 9. Terminal Sleeves.
- 10. Oil Gauges.
- 11. Washer.
- 12. Oil Hole Cover.

- 13. Bolts.
- 14. Stator Studs.
- 15. Journal Box Set Screw.
- 16. Journal Boxes.
- 17. Oil Rings.



THE TORONTO LINE

Electrical Equipment

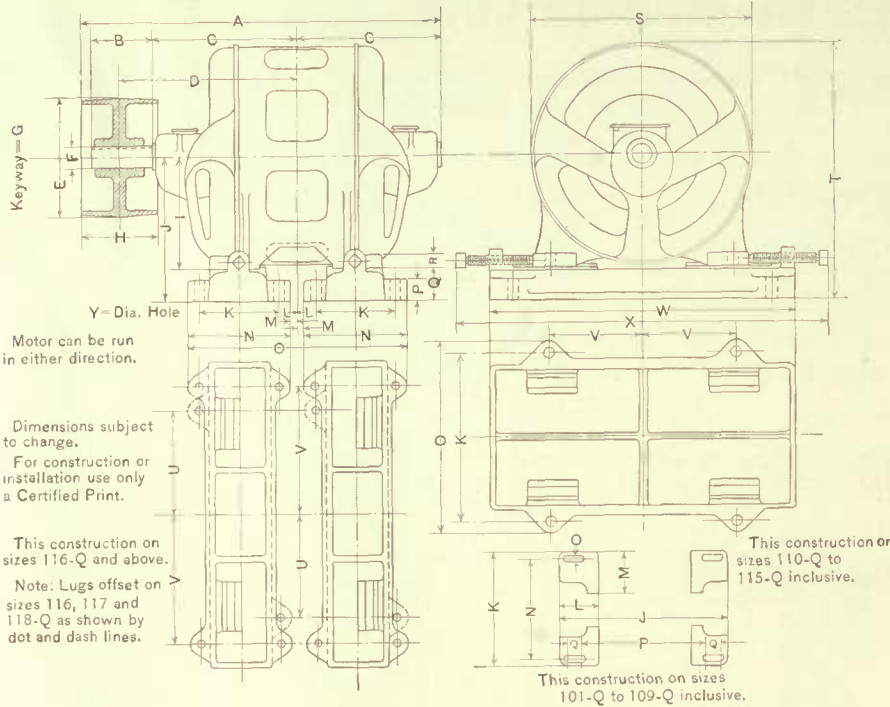

RATINGS FORM "Q" INDUCTION MOTORS

2 or 3 Phase, 220, 440, 550 Volts, 60 Cycles.

Frame Size	H. P. AT R. P. M.				Weight
	1720	1140	850	680	
106	1	90
107	2	120
109	3	2	165
111	5	3	2	275
113	7 1/2	5	3	...	365
114	10	7 1/2	5	625
115	15	10	7 1/2	915
116	20	15	10	...	1060
117	25	20	15	10	1300
118	20	15	1400
119	20	2150

Dimensions Form "Q" Machines, 60 Cycles.

RATINGS FORM "Q" INDUCTION MOTORS 25 Cycles

Frame Size	H. P. AT R. P. M.		Weight
	1420	710	
109	1	2	165
111	2	3	275
113	3	5	365
114	5	7 1/2	625
115	7 1/2	10	915
116	10	15	1060
117	15	...	1300
118	20	...	1400

SIZE	Slotted Feet																				X	Y				
	A	B	C	D	E	F	G	H	I	J	K	L	M	N	O	P	Q	R	S	T			U	V	W	
101-Q	14 1/10	2 1/4	6 3/8	7 1/8	3 1/4	4 1/8	1 x 1/8	2 1/4	4 1/4	8 3/8	6 3/8	2	1 7/8	5 1/4	7/16	5 3/4	5/8	1 1/2	7 13/16							
102-Q	14 5/16	2 1/4	6 3/8	7 1/8	3 1/4	4 1/8	1 x 1/8	2 1/4	4 1/4	9 1/4	6 3/8	2 1/4	2 1/4	5 1/4	9/16	6 3/4	5/8	1 1/2	8 3/8							
103-Q	14 9/16	2 1/4	6 3/8	7 1/8	3 1/4	4 1/8	1 x 1/8	2 1/4	4 1/4	9 1/4	6 3/8	2 1/4	2 1/4	5 1/4	9/16	6 3/4	5/8	1 1/2	8 3/8							
104-Q	14 7/8	2 1/4	6 1/8	7 1/8	3 1/2	4 1/8	1 x 1/8	2 1/4	5	9 3/8	7 3/8	2 1/8	2 1/8	5 3/4	9/16	6 7/8	5/8	1 1/2	9 1/4							
105-Q	14 11/16	2 1/4	6	7 3/16	3 1/2	4 1/8	1 x 1/8	2 1/4	5 1/2	10 1/2	6 3/4	2 1/4	2 1/4	5 1/2	11/16	7 1/4	5/8	1 1/2	10 1/4							
106-Q	15 1/8	2 1/4	6 3/8	7 1/8	3 1/2	4 1/8	1 x 1/8	2 1/4	5 5/8	11	6 7/8	2 1/4	2 1/4	5 1/2	11/16	7 3/4	5/8	1 1/2	11 1/4							
107-Q	16 1/16	3	6 3/8	8 1/8	4	4 1/8	1 x 1/8	3	5 7/8	11 7/8	7 1/4	2 1/4	2 1/4	5 1/2	11/16	7 3/4	5/8	1 1/2	11 1/4							
108-Q																										
109-Q	18 3/4	2	7 1/2	9 3/8	4 1/2	4 1/2	1 x 3/8	3	7	13	8 3/4	3	3 3/8	7 3/8	11/16	9	1 1/4	3	13 1/4							
110-Q																										
111-Q	20 3/8	3	8 1/8	10 1/8	4 3/4	4 1/2	1 x 3/8	3 1/2	7	9 1/4	12				13 3/4	1 1/4	2 1/4	3	13 1/2	15 7/8		5 1/2	18	24 1/4	3 1/4	
112-Q																										
113-Q	23 3/4	3 3/4	9 3/8	11 1/4	6	4 1/2	1 x 3/8	4 1/2	7 3/8	10 3/8	13 1/2				15	1 1/2	2 1/2	3	14 3/4	17 1/2		6	19 3/8	25 3/4	3 1/4	
114-Q	25 3/8	4 1/4	10 1/8	12 3/8	8	4 1/2	1 x 3/8	5	9 3/8	11 7/8	13 3/4				15 1/2	1 1/2	2 1/2	3	18 1/4	21		7 3/4	23	29 1/4	3 1/4	
115-Q	30 3/8	5 1/4	12 1/8	15 1/8	10	5 1/2	1 x 3/8	6	10 3/8	13 3/8	16 3/8				18 3/8	2	3	1 1/2	21 1/4	24 1/4		8 3/8	30	36 3/4	1 1/2	
116-Q	31 3/8	5 3/4	12 1/8	15 1/8	10	5 1/2	1 x 3/8	6	10 3/8	13 3/8	16 3/8				10 1/2	19 7/8	2	3	1 1/8	21	24 1/4	10	12 1/2	30	36 3/4	1 1/8
117-Q	34 1/8	6 1/2	13 1/8	17 1/8	12	6 1/2	1 x 3/8	8	11 3/8	15 3/8	18 1/8				10 3/4	20	2 3/8	3 1/2	1 1/4	22 3/4	26 1/2	10 3/4	13 3/8	31 1/8	38 1/2	1 1/8
118-Q	35 1/8	6 1/2	13 1/8	17 1/8	12	6 1/2	1 x 3/8	8	11 3/8	15 3/8	18 1/8				10 3/4	20 3/4	2 3/8	3 1/2	1 1/4	22 3/4	26 1/2	10 3/4	13 3/8	31 1/8	38 1/2	1 1/8
119-Q	41 1/8	8	16 1/2	20 1/2	13	8 1/2	1 x 3/8	9	14	18	10 3/8	1 1/2	3 3/8	13 3/8	27 1/8	2 1/2	4	1 1/2	27 3/8	31 1/8		16 1/8	38 1/2	47 1/2	1 1/8	
120-Q	42 1/8	8	16 1/2	20 1/2	13	8 1/2	1 x 3/8	9	14	18	10 3/8	2	3 1/2	13 3/8	27 3/8	2 1/2	4	1 1/2	27 3/8	31 1/8		16 1/8	38 1/2	47 1/2	1 1/8	
121-Q	45 1/8	9 1/4	17 1/2	22 1/2	15	9 1/2	1 x 3/8	11	15 1/2	19 1/2	11	1 3/8	3 3/8	14	28 1/2	2 3/4	4 1/4	1 3/8	30 3/8	34 1/8		17 1/2	41	50 1/4	1 1/4	
122-Q	46 1/8	9 1/4	17 1/2	22 1/2	15	9 1/2	1 x 3/8	11	15 1/2	19 1/2	11	1 3/8	3 3/8	14	28 1/2	2 3/4	4 1/4	1 3/8	30 3/8	34 1/8		17 1/2	41	50 1/4	1 1/4	
123-Q	54 3/8	10 1/2	20 3/8	27 3/8	15	9 1/2	1 x 3/8	13	15 1/2	19 1/2	11	3 3/4	2 1/4	14	32 1/2	2 3/4	4 1/4	1 3/8	30 3/8	34 1/8		17 1/2	41	50 1/4	1 1/4	
124-Q	55 1/8	11	21 1/8	28 1/8	20	4	1 x 3/8	13	18 3/8	22 3/8	11	3 3/8	2 1/2	14	32 1/2	2 3/4	4 1/4	1 3/8	36	40 3/8		20 3/8	46 3/4	50	1 1/4	
125-Q	59 3/8	13	23 1/8	29 3/8	21	4	1 x 3/8	15	18 3/8	22 3/8	11	4 3/8	3 3/8	14	34 1/2	2 3/4	4 1/4	1 3/8	36	40 3/8		20 3/8	46 3/4	50	1 1/4	
126-Q	73 1/8	17	26 1/8	36 3/8	23	5 1/2	1 x 3/8	20	23	29	13	1 7/8	3 3/8	16	32 3/4	3 1/4	6	2 1/4	45	51 1/2		24 1/4	56 1/2	65	1 1/4	
127-Q	81 1/8	21	27 1/8	40 3/8	30	5 1/2	1 x 3/8	26	23	29	13	3 3/8	1 1/2	16	35 1/4	3 1/2	6	2 1/4	45	51 1/2		24 1/4	56 1/2	65	1 1/4	

Dimensions Form "Q" Machines, 25 Cycles.



Direct Connected Engine Sets

Crocker-Wheeler Generators with Engines.

For Steam, Gas or Gasoline.

DIRECT Connected Generating Sets are the very latest refinement in the art of electric lighting and power for small as well as large installations; greater efficiency, more economical use of space, greater cleanliness, lower maintenance, cost, and extremely quiet running, are the principal advantages of a Direct Connected Set as compared with a Belted Steam Engine of any make, can be supplied, but those of Robb Engineering Company or American Blower Company have been selected as standard and are thoroughly high class and reliable.

Gasoline and Gas Engines manufactured by the Fay and Bowen Company are the only engines of this character that can be supplied for Direct Connection unless special arrangements are agreed upon before sale.

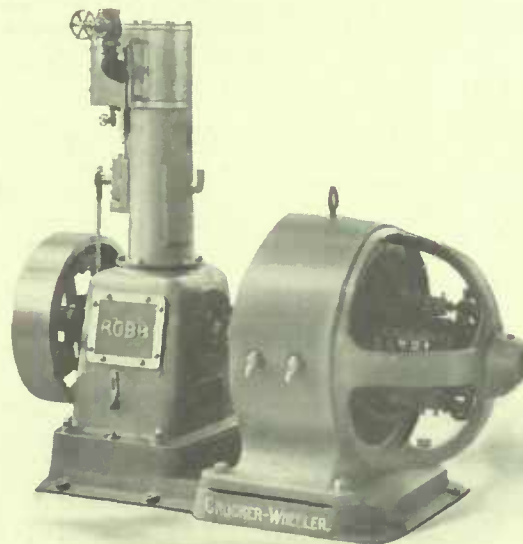

The above cut shows the general arrangement of these standard sets up to approximately 25 K. W. steam engine driven and up to 19 K. W. gasoline or gas engine driven.

All larger sizes of steam engine driven sets can be supplied in which Horizontal Engines and Engine Type Generators are used.

Complete Switchboard Equipments for the control of these sets, thus making a complete power plant can be supplied.

For further information consult factory.



THE TORONTO LINE

Electrical Equipment

Useful Information for Motor Users.

Ohm's Law. Direct Current Machinery.

$$\begin{aligned} \text{Amperes} &= \frac{\text{Volts}}{\text{Ohms}} \\ \text{Volts} &= \text{Amperes} \times \text{Ohms} \\ \text{Ohms} &= \frac{\text{Volts}}{\text{Amperes}} \\ \text{Volts} \times \text{Amperes} &= \text{Watts} \\ \text{H. P.} &= \frac{\text{Watts}}{746} \\ \text{Or Watts} &= \text{H. P.} \times 746 \end{aligned}$$

Examples.

I. To find the Amperes (Volts and Resistance being known).

For instance an ordinary incandescent lamp at 110 Volts and 220 Ohms resistance.

$$\text{Amperes} = \frac{\text{Volts}}{\text{Ohms}} \text{ or } \frac{110}{220} = \frac{1}{2} \text{ Ampere}$$

II. To find Volts (Amperes and Ohms being known).

$$\text{Volts} = \text{Amperes} \times \text{Ohms} \text{ or } \frac{1}{2} \times 220 = 110 \text{ Volts.}$$

III. To find resistance in Ohms, (Volts and Amperes being known).

$$\text{Ohms} = \frac{\text{Volts}}{\text{Amperes}} \text{ or } \frac{110}{\frac{1}{2}} = 220$$

IV. To find H. P. of a motor or generator used as a motor (Volts and Amperes being known).

$$\text{H. P.} = \frac{(\text{Volts} \times \text{Amperes}) \times \% \text{ efficiency}}{746}$$

V. To find H. P. required to drive a generator (Volts and Amperes being known).

$$\text{H. P.} = \frac{\text{Volts} \times \text{Amperes}}{746 \times \% \text{ efficiency}}$$

N. B.—Efficiency will vary according to size of machine and amount of load.

Method of finding exact Ampere capacity of generator and *approximate* Ampere capacity of motors (Kilowatts or H. P. and Volts being known).

If a 125 Volt Machine, multiply Kilowatts or H. P. by 8.

If a 250 Volt Machine, multiply Kilowatts or H. P. by 4

If a 500 Volt Machine, multiply Kilowatts or H. P. by 2.

Example.

Take a 20 Kilowatt 125 Volt Generator.

$$20 \times 8 = 160 \text{ Amperes.}$$

Or 20 Kilowatts, 500 Volts.

$$20 \times 2 = 40 \text{ Amperes.}$$

N. B.—Complete printed directions for the installation and care of motors or generators accompany each machine when shipped.

Lighting.

An ordinary 16 Candle Power Carbon 110 Volt Incandescent Lamp takes $\frac{1}{2}$ Amperes and 55 Watts of Electrical Energy, and a 20 Candle Power Tungsten Lamp takes .227 Amperes and 25 Watts.

The following examples are given to illustrate the method of determining the size Generator required to generate sufficient current for 100 lamps.

$$\text{Carbon Lamps: } \frac{100 \text{ 16 c. p.} \times 55 \text{ Watts}}{1000 \text{ (Watts-1 Kilowatt)}} = 5\frac{1}{2} \text{ Kilowatt.}$$

$$\text{Tungsten Lamps: } \frac{100 \text{ 20 c. p.} \times 25 \text{ Watts}}{1000 \text{ (Watts-1 Kilowatt)}} = 2\frac{1}{2} \text{ Kilowatt.}$$

CARRYING CAPACITY AND DIMENSIONS OF WIRES.

For Open and Concealed Work, as adopted by the Fire Underwriters.

B. & S. Gauge	Circular Mils.	AMPERES		Ohms per 1000 ft. at 20° C.
		Rubber Covered Wire	Weather-proof Wire	
18	1624	3	5	6.37
16	2584	6	8	4.01
14	4107	12	16	2.52
12	6530	17	23	1.59
10	10380	24	32	.997
8	16510	33	46	.627
6	26250	46	65	.394
5	33100	54	77	.313
4	41740	65	92	.248
3	52630	76	110	.197
2	66370	90	131	.156
1	83690	107	156	.124
0	105500	127	185	.0981
00	133100	150	220	.0778
000	167800	177	262	.0517
0000	211600	210	312	.0489

NOTE.—The lower limit is specified for rubber covered wires to prevent gradual deterioration of the high insulation by the heat of the wires but not from fear of igniting the insulation. The carrying capacity of 16 and 18 wire is given, but no smaller than 14 should be used except as allowed under rules 24 v and 45 b of the National Board of Fire Underwriters.



Useful Information for Laundrymen

LAUNDRYMEN will frequently find the information contained in the following rules and tables of great use to them :

Rules to Calculate the Speed of Pulleys

EXAMPLE FIRST. To find the size of driving pulley : multiply the diameter of the driven by the number of revolutions it should make, and divide the product by the revolutions of the driver. The quotient will be the size of the driver.

EXAMPLE SECOND. The diameter and revolutions of the driver being given, to find the diameter of the driven that shall make a given number of revolutions : multiply the diameter of the driver by the number of revolutions and divide the product by the number of revolutions of the driven. The quotient will be the size of the driven.

EXAMPLE THIRD. To find number of revolutions of the driven pulley : multiply the diameter of the driver by its number of revolutions and divide by diameter of driven. The quotient will be the number of revolutions of the driven.

EXAMPLE FOURTH. To find the speed of a countershaft : multiply the speed of the line shaft by the diameter of the drivers and divide the product obtained by multiplying the diameters of the driven pulleys. The quotient will be the speed of the countershaft.

EXAMPLE FIFTH. In calculating for gears, multiply or divide by the number of teeth.

Belts and Belting

LENGTH. When the length cannot be measured directly by a tape-line, the following approximate rule may be used : add the diameter of the two pulleys together, divide the sum by two and multiply the quotient by $3\frac{1}{4}$, and add the product to twice the distance between the centres of the shafts.

ARRANGEMENT. If possible to avoid it, connected shafts should never be placed one directly over the other, as in such case the belt must be kept very tight to do the work. For this purpose belts should be carefully selected of well-stretched leather. It is desirable that the angle of the belt with the floor should not exceed 45 degrees. It is also desirable to locate the shafting and machinery so that the belts should run off from each shaft in opposite directions, as that arrangement would relieve the bearings from the friction that would result when the belts all pull one way on the shaft.

TIGHT BELTS. Clamps with powerful screws are often used to put on belts with extreme tightness, and with most injurious strain upon the leather. They should be very judiciously used for horizontal belts which should be allowed sufficient slackness to move with a loose, undulating vibration on the returning side, as a test that they have no more strain imposed than is necessary simply to transmit the power.

CARE. Do not allow oil to drip upon the belts. It destroys the life of the leather. Leather belting cannot safely stand above 110 degrees of heat.

Rule for Obtaining Capacity of Tanks

The United States Standard Gallon contains 231 cubic inches and weighs $8\frac{1}{2}$ pounds. A cubic foot of water contains 7.48 gallons and weighs $62\frac{1}{2}$ pounds.

It is easy to calculate the contents of a tank in gallons in the following manner : multiply the length, breadth and depth of the tank together ; this will give the capacity of the tank in cubic feet ; each cubic foot of water is equal to $7\frac{1}{2}$ gallons, consequently the cubical capacity of the tank in feet requires to be multiplied by $7\frac{1}{2}$ to get the contents in gallons.

EXAMPLE. Suppose the tank measures 10 x 8 x 4 feet deep, the cubical capacity is therefore 320 cubic feet ; this multiplied by $7\frac{1}{2}$, gives 2,400 gallons as the contents of the tank. To find contents of cylindrical tanks : multiply the square of the diameter (if the tank is tapering take half of the sum of the two diameters) by the depth, both in inches, and multiply the product by .0034 ; the product is in gallons. To get barrels, divide product by $31\frac{1}{2}$.

Sensible Heat of Steam

5 lbs., 228 degrees	30 lbs., 274.4 degrees	60 lbs., 307.5 degrees	90 lbs., 331.3 degrees
10 lbs., 244.1 degrees	40 lbs., 287.1 degrees	70 lbs., 316.1 degrees	100 lbs., 338. degrees
20 lbs., 259.3 degrees	50 lbs., 298 degrees	80 lbs., 324.1 degrees	

Table of Approximate Numbers for Various Purposes

Diameter of Circle	× 3.1416 = the circumference.	Side of a square	× 1.128 = the diameter of an equal circle.
Circumference Circle	× .3183 = the diameter.	Square of a diameter	× .7854 = the area of a circle.
Diameter Circle	× .8862 = the side of an equal square.		

INDEX

A	Pages
Adjustable Hosiery Forms and Applying Machine.....	180-181
Automatic Edge Ironers and Shapers.....	150-152
Automatic Washer Inlet Valve, Yates.....	25
B	
Barrel Collar and Cuff Starcher.....	96
Baskets Wire Woven.....	200
Belting Leather.....	210
Bishop Collar and Cuff Starcher.....	98-99
Blowers Roots' Positive Pressure.....	207
Boilers,	
Horizontal with Full Flush Front.....	216-217
Plain Vertical.....	218-219
Body Ironer, Belt Reverse.....	164-165
Bosom Ironers,	
Rack.....	156-157
Newark.....	158-159
Combined.....	160-161
Bosom Presses.....	168-171
Bundling Table.....	198
Burners, Gamet Gasoline.....	202
C	
Cabinet, Dampening.....	122
Cement Washroom Trench.....	37
Climax Straightening Machine.....	94-95
Clothes Sprinklers and Spray Nozzles.....	131
Collar and Cuff Starchers,	
Barrel.....	96
Dip Wheel.....	97
Bishop.....	98-99
Collar and Cuff Dampener, Empire.....	123
Collar and Cuff Ironers.....	132-141
Collar Finishing Table.....	142
Collar Shapers. (See Shapers.)	
Collar Press.....	173
Collars, Cast Iron Safety.....	210
Combined Shirt, Collar and Cuff Ironer.....	160-161
Common Sad Irons.....	196
Combined Steam Puff Ironer.....	188
Combined Yoke and Neckband Press.....	172
Combined Cuff and Yoke Press.....	173
Connected Steam Puff Ironers.....	191
Copper Dippers.....	103
Copper Dye Kettle.....	188
Copper Heating Coils for Dye House.....	186
Copper Pails.....	103
Copper Steam Jacket Starch Kettle.....	105
Copper Steam Drying Cylinder.....	186
Copper Steam Board, Perforated, Wall Type.....	186
Copper Steam Table.....	185
Curtain Frames.....	197
Couplings, Shaw Compression.....	211
Covering for Flat Work Ironers.....	72-93
Cuff Press, Double.....	172
D	
Dampening Cabinet.....	122
Dampeners,	
Empire Collar and Cuff.....	123
Conveyor Shirt.....	126-127
Huebsch Spray.....	124-125
Improved Seam.....	142
Hand Seam.....	142
Bishop Automatic Seam.....	143
Wing Point Collar.....	153
Dampening Press	
Hydraulic.....	130
Truck.....	128-129
Dip Wheel Collar and Cuff Starcher.....	97
Direct Connected Engine Sets.....	228
Dryroom Tumbler.....	66-69
Dryrooms,	
Automatic Conveyor.....	112-119
Lace Curtain.....	120-121
Sectional Wood and Metallic.....	108-111
Sparrow Metallic.....	106-107
Dye House Copper Heating Coils.....	186
Dye Kettle, Copper.....	188
Dyer, Ideal Steam Jacketed Feather.....	187

E	Pages
Edge Ironers,	
Automatic.....	150-152
Hand.....	148
Power, Rough.....	149
Power, Bishop.....	149
Electrolyzers.....	44-45
Electrical Equipment.....	221-227
Electric Irons.....	194-195
Empire Collar and Cuff Dampener.....	123
Engines,	
Automatic Vertical.....	215
Gem Automatic Horizontal.....	214
Engine Sets, Direct Connected.....	228
Exhaust and Ventilating Fans.....	205
Extractors,	
Improved Solid Curb.....	46-49
Improved Solid Curb, Motor Driven.....	47
Details for Installing.....	58-59
Hand.....	55
Instructions.....	57
Rubber Springs for.....	59
Starch.....	56
Solid Curb.....	50-54
Tolhurst, Self-Balancing.....	62-65
Solid Curb, Motor Driven.....	53
F	
Fans, Exhaust and Ventilating.....	205
Feather Dyer, Ideal Steam Jacket.....	187
Feed Water Heaters.....	220
Fittings, Valves, etc.....	213
Fixer, Bishop Neckband.....	175
Flat Work Ironers,	
Compound 7 rolls, 120 inch.....	86-93
Duplex Sectional.....	78-81
Multiple or Sectional.....	82-85
Single Roll.....	74-75
Standard.....	72-73
Two Roll.....	76-77
Fluting Iron, Star.....	196
Fluting Tongs, Hand.....	175
Fluter, Gas Heated, Power.....	176
Bishop's, Steam Heated, Power.....	176
Folding Board for Negligee Shirts.....	175
Frames, Curtain.....	197
Friction Pulley.....	204
G	
Gas Iron Heaters.....	177
Gas Generator.....	204
Gasoline Burners.....	202
Galvanized Iron Soap Tank.....	189
Generators, Electric.....	221-227
Glass Top Spotting Board.....	189
Glove Cone, Steam Heated.....	188
H	
Hand Edge Ironer.....	148
Hand Fluting Tongs.....	175
Hand and Power Wringers.....	60 and 201
Hangers, Adjustable Ball and Socket.....	212
Hampers, Wire Woven.....	200
Heating Coils, Copper for Dyehouse.....	186
Heaters, Feed Water.....	220
Hoffman Pressing Machines.....	182-184
Huebsch Adjustable Hosiery Forms, and Applying Machines.....	180-181
Huebsch Spray Dampener.....	124-125
Hydraulic Dampening Press.....	130
I	
Ideal Steam Jacketed Feather Dyer.....	187
Improved Seam Dampeners.....	142
Irons, Common, Sad.....	196
Electric.....	194-195
Star Fluting.....	196
Tailors' Goose.....	196
Ironers, Collar and Cuff.....	132-141
Iron Heaters, Gas.....	177
Iron Heating Stoves.....	203
Irouing Tables,	
Gas Heated with Sleeve Board.....	178-179
Shirt.....	177

INDEX—Continued

L	Pages
Ladies' Shirt Waist Cuff Press	174
Leader Power Barrel Collar and Cuff Starcher.....	96
Little Giant Paper Press.....	199
M	
Mangles, (See Flat Work Ironers).....	
Monarch Square or Oval Benzine Stills	192-193
Motors, Electric.....	221-227
N	
Neckband Fixer (Bishop's).....	175
Neckband Ironer.....	162-163
P	
Pants and Skirt Steamer.....	185
Paper Press, Little Giant.....	199
Pipe Standard Wrought Iron.....	213
Power Wringers.....	60
Power and Hand Wringers.....	201
Power Fluter,	
Gas Heated.....	176
Steam Heated	176
Press Machines,	
Bosom.....	168-171
Collar	173
Combined Yoke and Neckband.....	172
Combined Cuff and Yoke.....	173
Double Saddle Cuff.....	172
Ladies' Shirt Waist Cuff.....	174
Pressing Machines,	
Hoffman.....	182-184
Puff Irons,	
Combined	188
Connected.....	191
Single.....	191
Pulleys, Wood Split.....	209
Pumps, Improved Duplex Steam.....	220
S	
Sad Irons.....	196
Seam Dampeners, Hand.....	142
Improved	142
Bishop's Automatic	143
Shaker or Tumbler.....	70-71
Shafting, Cold Rolled Steel.....	210
Shirt Dampener,	
Conveyor.....	126-127
Huebsch.....	124-125
Shirt Ironing Tables.....	177
Shirt Folding Board.....	175
Shapers,	
Automatic Stand-up Collar Edger and	150-151
Automatic Turn-down Collar Edger and.....	152
Shaw Collar.....	144-146
Steam Tube, Collar.....	147
Turn Down, Collar.....	153
Shirt Ironers,	
Racer Bosom	156-157
Body Ironer.....	164-165
Combined.....	160-161
Domestic Neckband.....	162-163
Newark Bosom.....	158-159
Sleeve	166-167
Single Puff Irons.....	191
Sizes and Shapes of Toronto Puff Irons.....	190
Skirt and Pants Steamer.....	185
Skirt Protector.....	179
Sleeve Ironer, Belt Reverse.....	166-167
Soap Tank, Galvanized Iron	189
Spray Dampener, Conveyor	126-127
Huebsch	124-125
Spray Nozzles	131
Sprinklers	131
Spotting Board, Glass Top	189
Starchers,	
Barrel Collar and Cuff	96
Bishop Collar and Cuff	98-99
Dip Wheel Collar and Cuff.....	97
Improved Curved Board Shirt.....	101
Improved Shirt	100
Wristband and Negligee	102
Starch Cookers, Copper Steam Jacket Kettle.....	105
Heat Retaining.....	104-105
Starch Room Specialities,	
Wiping Board	103

S	Pages
Copper Dippers.....	103
Copper Pail	103
Steam Board, Perforated Copper	186
Steam Drying Cylinder, Copper.....	186
Steam Heated Glove Cone	188
Steam Heated Puff Irons, Connected.....	191
Steam Heated Power Fluter, Bishop's	176
Steam Table, Copper	185
Steam Puff Ironer, Combined.....	188
Steam Traps,	
Anderson's Model "D".....	208
Jenkin's Diamond.....	207
Steam Tipper, Bishop's	148
Star Fluting Iron	196
Stills,	
Monarch, Square or Oval Shaped.....	192-193
Stoves, Iron Heating	203
Straightening Machine, Climax.....	94-95
T	
Tables,	
Bundling.....	198
Copper Steam	185
Gas Heated with Sleeve Board.....	178-179
Shirt Ironing	177
Collar Finishing.....	142
Tailor's Goose Irons	196
Tanks, Cypress Water.....	209
Tipper, Bishop Steam	148
Traps, Jenkin's Diamond.....	207
Anderson's Model "D"	208
Trench, Details of Cement Washroom	37
Tolhurst Extractors	62-65
Truck Dampening Press	128-129
Truck Tubs, Washroom	198
Trucks, Wire Woven, Washroom	200
Tube Shapers, Steam Collar.....	147
Turn Down Collar Shapers.....	153
Tumbler or Shaker	70-71
Tumbler Dryroom	66-69
U	
Useful Information for Motor Users	229
Useful Information for Laundrymen.....	230
V	
Valves,	
Brass Globe and Angle	206
Double Seated Clip Gate	206
Handy Gate	206
Yates Automatic Washer Inlet.....	25
Valves and Fittings	213
Ventilating and Exhaust Fans	205
W	
Washers,	
Elevated Movement Washers, 36" Diameter.....	14-17
Elevated Movement Washers, 40" Diameter.....	18-24
Fancy Goods and Flannel.....	38-43
Imperial Iron Frame	12-13
Solid Head Metal Case, 24" Diameter	26-29
Solid Head Metal Case, 24" and 30" Diameter.....	26-29
Standard.....	7-11
Metallic, General Description	30-31
Metallic, 32" Diameter	32-33
Metallic, 36" Diameter	34-35
Metallic, Elevated Movement, 36" Diameter	36
Metallic Sterilizers	31-35
Wet Wash Elevated Movement, 40" Diameter.....	22-23
Wash Tubs, Stationary	61
Washroom Trench, Details of.....	37
Washroom Truck Tubs	198
Water Tanks, Cypress	209
Wing Point Dampener and Turner	153
Wing Point Tipper	154-155
Wiping Board, Steam Heated	103
Wire Woven Baskets, Hampers and Trucks.....	200
Wringers, Power and Hand	60 and 201
Wristband and Negligee Shirt Starcher	102
Y	
Yates Automatic Washer Inlet Valve.....	25
Yoke and Neckband Press Combined.....	172

The Toronto Laundry
Machine Co., Limited