

7b
84-b
9470



LONDON:

PRINTED BY ROBSON, LEVEY, AND FRANKLYN
Great New Street and Fetter Lane.



THE HUNTER AND TIGRESS. JERICHAU, DENMARK.

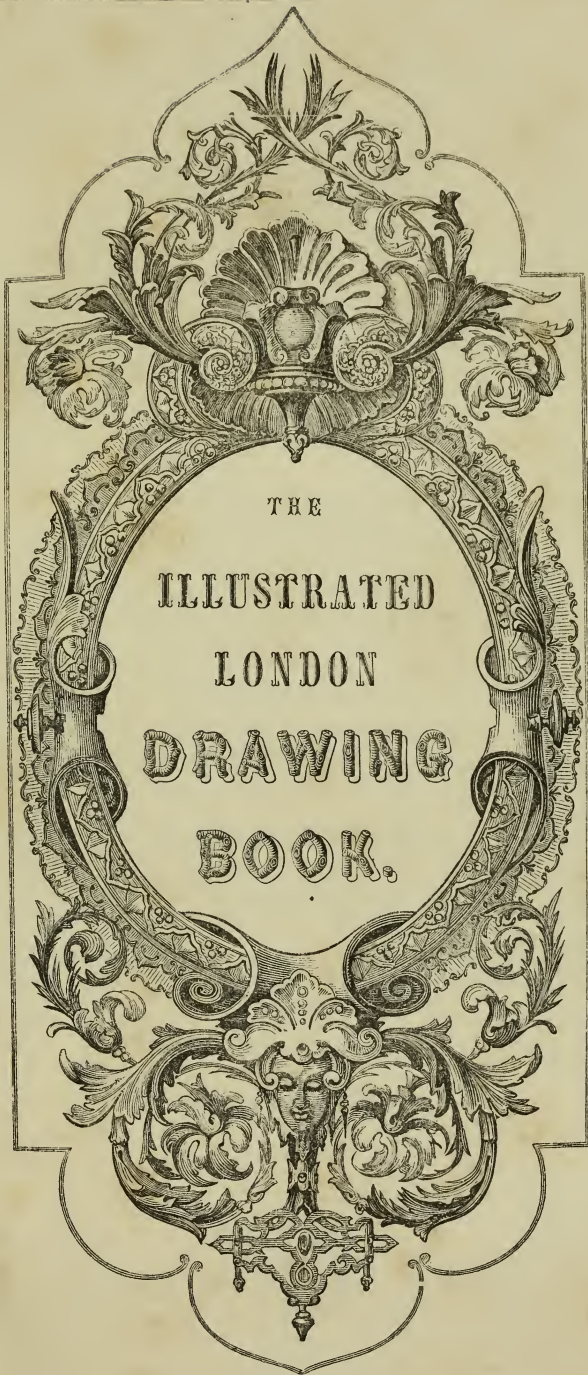

THE
ILLUSTRATED
LONDON
DRAWING
BOOK.

LONDON, 227 STRAND.

THE ILLUSTRATED
LONDON
DRAWING - BOOK.

CONTAINING

- I. PENCIL-SKETCHING.
- II. FIGURE AND OBJECT DRAWING.
- III. PERSPECTIVE AND ISOMETRICAL DRAWING.
- IV. ENGRAVING ON METAL AND WOOD.

WITH ABOUT

Three Hundred Illustrative Drawings and Diagrams.

EDITED AND ARRANGED BY

ROBERT SCOTT BURN, M.S.A.

AUTHOR OF "PRACTICAL VENTILATION," "HINTS ON SANATORY CONSTRUCTION,"
"THE ILLUSTRATED LONDON PRACTICAL GEOMETRY," ETC. ETC.

Second Edition.

LONDON:
INGRAM, COOKE, AND CO.

1853.



Digitized by the Internet Archive
in 2014

THE
ILLUSTRATED LONDON DRAWING-BOOK,

INTRODUCTION.

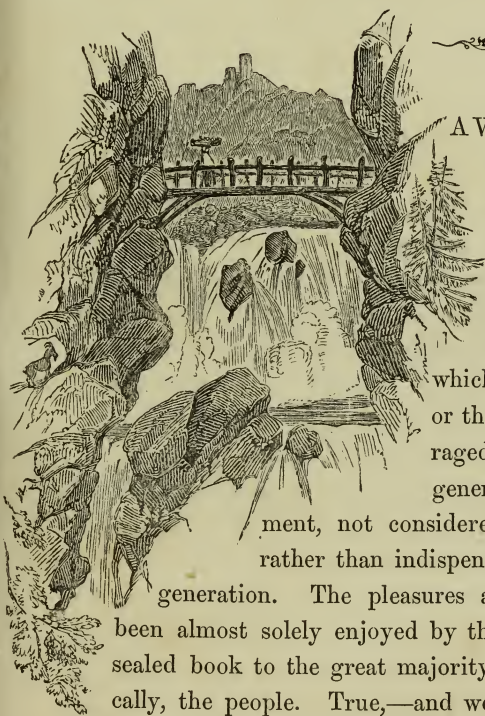

HAVING long witnessed the neglect of Art in our Educational systems, the author trusts that the present work will be found to supply a means of extending its useful and beneficial influence. Imparted to many as affording a means of gratification by which time may be pleasantly occupied, or the taste and talent of the artist encouraged and displayed, Drawing has been generally looked upon as an accomplishment, not considered as an essential—as ornamental rather than indispensable in the education of the rising generation. The pleasures and advantages of its pursuit have been almost solely enjoyed by the rich; while they have been as a sealed book to the great majority of those now designated emphatically, the people. True,—and we feel glad to admit it,—much has been done of late to place within the reach of many of the middle and working classes the means of acquiring a knowledge of the art. Our Schools of Design and Mechanics' Institutes have done much in this respect; but the extent of their operations has been exceedingly limited, and by no means meets what we deem the exigencies of the case. So far from looking upon a knowledge of the art of Drawing as necessary merely to the Artist or Designer, we hold that it should form an essential part

of general education—that its proper place is in the daily school, that its principles and practice should be inculcated in the daily lessons; in short, that equally with reading or writing, so should Drawing be deemed one of the branches of every-day tuition. And that such a position is correct, we deem a matter of easy proof. We are now fully alive to the importance of cultivating what are designated “habits of taste,” and the appreciation of the beautiful in art; and this chiefly—if for nothing else—from the practical value derivable therefrom in the improvement of our Arts and Manufactures. As a people, we are far behind Continental nations in practically applying to the details of every-day business those perceptions derived from a consideration and examination of the beautiful and artistic, whether as exemplified in the productions of art, or as witnessed in the ever-varied and graceful forms of surrounding nature. First among the helps to bring about another order of things in this respect is that of Drawing. By a thorough understanding of its details, an accuracy of perception and a facility for marking and retaining forms and arrangements are readily available. It is, then, of importance to place within the reach of all a means by which the Art in its varied branches may be easily communicated. The design of the present work is to contribute to this desideratum. We shall make our remarks as plain as possible, and as concise as the nature of the subject will admit of; and shall give unsparingly well-digested illustrations, believing that in this subject, at least, much is to be imparted to the pupil through the medium of the eye. It is to be hoped that this union of the pen with the pencil will be of great utility in quickly imparting a knowledge of the subjects under discussion. Before proceeding to our more immediate purpose, we shall offer a few remarks elucidatory of the plan or bearing of the system by which we mean to be guided in presenting the requisite information to the student.

A knowledge of Drawing is generally imparted by a course of irregular and desultory lessons, aided by a laborious practice, dependent more upon empirical rules than fixed and certain principles. We are aware that there are many honourable exceptions to this rule; but few, we think, will be disposed to deny that it *is* the rule. On the supposition that the pupil at the outset is utterly ignorant of the art, we commence our instructions by elucidating **FIRST PRINCIPLES**. As all drawings are reducible to certain lines and figures, we hold it necessary to enable the student to draw these elementary parts with the utmost facility; leading him by a series of examples from the drawing of a simple line, up to the most complicated sketch or object which may be offered to him; and then, by an advance to the more

intricate rules, making plain the laws of vision (the foundation of perspective), so as to delineate correctly the various views in which they may be presented to his notice: the aim of the introductory lessons being to enable the student thoroughly to understand the reason why every operation is performed as directed, not merely to give him a facility for copying any determined object without reference to principles. The student may by dint of practice acquire a facility for this merely mechanical style of imitation or copying; but unless he is well grounded in fundamental principles, his operations will be vague and uncertain. It may be considered true, that the better we are acquainted with the first principles of an art, its basis or foundation, so much more intimately conversant shall we be with all the intricacies of its diversified practice, and the less easily damped by its real or apparent difficulties. Students too frequently expend much time almost entirely in vain from want of attention to this truth, trite and commonplace as it may be deemed. In acquiring the practice of this art, they are too eager to pass from the simple rules, the importance of which they think lightly of. A sure and well-laid foundation will not only give increased security to the building, but will enable the workmen to proceed with confidence to the proper carrying out of the design in its entirety; on the contrary, an ill-laid foundation only engenders distrust, and may cause total failure. We are the more inclined to offer these remarks, being aware that students, at the commencement of a course of tuition, are apt, in their eagerness to be able to "copy" a drawing with facility, to overlook the importance of the practice which alone enables them satisfactorily to do so. It is the wisest course of procedure to master the details of an art, before proceeding to an acquaintance with its complicated examples.

We would, then, advise the student to pay particular attention to the instructions in their ENTIRETY which we place before him; if he be truly anxious to acquire a speedy yet accurate knowledge of the Art, he will assuredly find his account in doing so. Instead of vaguely wandering from example to example, as would be the case by following the converse of our plan, copying, yet copying he knows not how or why, he will be taught to draw all his combinations from simple rules and examples, we hope as simply stated; and thus he will proceed, slowly it may be, but all the more surely, from easy to complicated figures, drawing the one as readily as he does the other, and this because he will see in all their details, difficult to the uninitiated, but to him, a combination of simple lines as "familiar as household words."

The following is the arrangement we have adopted in this work:—The

First Section will be taken up with elucidating the practice of Pencil-Sketching as applied principally to decorative purposes, and as forming the groundwork of more extended practice in the higher branches of art. The *Second Section* will be devoted to the practice of Figure and Object Drawing. The *Third Section* will treat of Perspective, its principles and practice, applicable alike to the delineation of geometrical forms and of natural objects: *Isometrical Drawing* will be treated of under this section. The *Fourth Section* is designed to meet the wants of a large body of students, who are desirous of becoming acquainted with the readiest means of multiplying their sketches. Short and easy directions will be given, by which the student may be able to engrave or etch on copper or wood.

R. S. B.

1853.



THE
ILLUSTRATED LONDON DRAWING-BOOK.

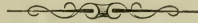

SECTION I.

OUTLINE SKETCHING.



BEFORE the apparent forms of objects can be delineated, it is absolutely necessary that the *hand* shall be able to follow the dictation of the *eye*; that is, the pupil must by certain practice be capable of forming the lines which constitute the outlines and other parts of the objects to be drawn: just as, before being able to write or copy written language, the hand must be taught to follow with ease and accuracy the forms which constitute the letters; so in drawing, the hand must be tutored to draw at once and unswervingly the form presented to the eye. Thus the handling of the pencil, the practice to enable the hand to draw without hesitation or uncertainty, and the

accurate rapidity essential in an expert draughtsman, may be considered as part of the alphabet of the art of free pencil-sketching. Nothing looks worse in a sketch than the evidences of an uncertainty in putting in the lines; just as if the hand was not to be trusted, or at least depended upon, in the formation of the parts dictated by the eye. The eye may take an accurate perception of the object to be drawn, yet its formation may be characterised by an indecision and shakiness (to use a common but apt enough expression), which to the initiated is painfully apparent.

In beginning, then, to acquire a ready facility in free sketching, in which the hand and eye are the sole guides, the pupil should consider it well-spent time to acquire by long practice an ease and freedom in handling the pencil, chalk, or crayon with which he makes his essay.

The first lessons may be performed with a piece of pointed chalk on a large black-board: some of our celebrated artists have not in their early days disdained the use of more primitive implements, as a piece of burnt stick and a whitewashed wall or barn-door. The larger the surface on which the lessons are drawn the better, consistent, of course, with convenience. If a black-board cannot be obtained, a large slate should be used. Until the pupil has acquired a facility for copying simple forms, he should not use paper and pencil; as in the event of drawing in a line wrong, it is much better at once to begin a new attempt, than try to improve the first by rubbing out the faulty parts and piecing the lines up. As the pupil must

necessarily expect to make many blunders at first starting, it will save paper if he will use a board or slate, from which the erroneous lines can be at once removed, a damp sponge being used for this purpose. By this plan any number of lines may be drawn.

Having provided himself with the necessary materials, the pupil may begin by drawing simple lines. These must be drawn without the assistance of a scale or ruler, by the hand alone.

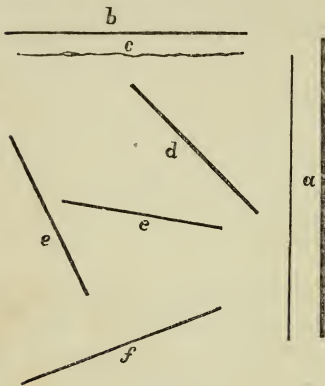

fig. 1.

The line *a*, fig. 1, will be parallel to the side of the board or slate, and perpendicular to the ends. The pupil should endeavour to make the line as regular as possible, and to run in one direction—that is, neither inclined to the right nor left. He should next draw horizontal lines, as *b*, beginning at the left and going towards the right hand. In drawing lines as *a*, the pupil should begin at the top and go towards the bottom; in a more advanced stage he should try to draw them from either end. The oblique lines *d e* and *f* should next be drawn. In all these exercises the line should be drawn boldly, in a

length at a time, not piece by piece: the hand should not rest on the board or slate while drawing, but should be free, so that the line may be drawn in at one sweep, as it were, of the arm or wrist. Irregular or “waved” lines should next be drawn, as at *c*: this style of line is useful in drawing broken lines, as in old ruins, trees, gates, stones, &c. &c. The pupil must not content himself with drawing a *few* examples of the lines we have given. He must practise for a long time, until he can at once with ease draw lines in any direction correctly; he ought to progress from simple to difficult, not hastily overlook the importance of mastering simple elementary lessons. With a view to assist him in arranging these, and to afford not only examples for practice, but also to prove by a gradation of attempts the connexion—too apt to be overlooked by many—between simple

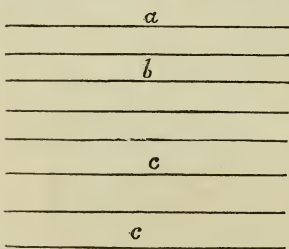

fig. 2.

lines and complex figures, simple parallel lines, as *a b c*, fig. 2, should be drawn.

But not only must the pupil endeavour to keep each line straight from beginning to end, free from waviness and indecision, and also parallel to one another, but another object must be kept in view; that is, the distance between the lines: hitherto he has drawn lines with no reference to this, but merely to their position and direction. No mechanical aids must be allowed to measure the distances, this must be

ascertained by the eye alone; and a readiness in this will be attained only by practice. The eye is like the memory; it must be kept in constant training before it will do its work. By inspecting the diagram, it will be perceived that the lines marked *c c* are further apart than those above. All gradations of distances should be carefully delineated; and if, after the lines are drawn, the eye should detect, or fancy it detects, any error in this respect,

let the lines be at once erased, and a new trial made ; and let this be done again and again, until the lines appear to be correctly drawn, both as regards boldness and correctness and distance apart. After drawing the horizontal lines, the student may then proceed to perpendicular lines. It may here be noted, to save future explanation, that when we use the term perpendicular, we mean it to be that applied to a line or lines which run parallel to the side of the board or slate ; and horizontal, those parallel to the ends : strictly speaking, both lines thus drawn are perpendicular to others which may be drawn parallel to their opposite sides. We, however, suppose the surface on which the pupil is drawing to be in the same position as this book while held open for reading ; the sides to represent the sides, and the ends the ends of the drawing-board or slate. Lines are horizontal when parallel with the lines of type, and perpendicular when parallel with the sides of the page ; it is in this sense, then, that we shall use the terms horizontal and perpendicular. Perpendicular lines, as in fig. 3, may next be drawn, close to one another at the sides, at *a* and *c*, and further separate at *b* ; they may also be drawn horizontally in the same way ;—this practice will be useful in more advanced stages. As the pupil will observe, the lines thus drawn give the appearance of roundness ; it is, in fact, the way by which engravers obtain this effect : the pupil will find it useful in fine pencil-drawing.

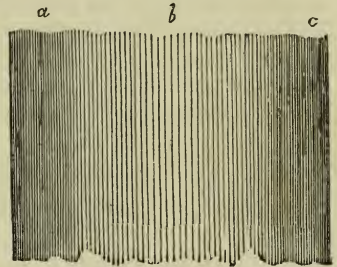

fig. 3.

The drawing of diagonal or oblique lines may next be practised, as in fig. 4. In all these examples, the board or slate should never be moved or reversed ; the end forming the topmost one should always remain so. We are aware that some persons have greater facilities for drawing lines in one direction than in another ; thus the majority of beginners would draw lines sloping from right to left with much more ease

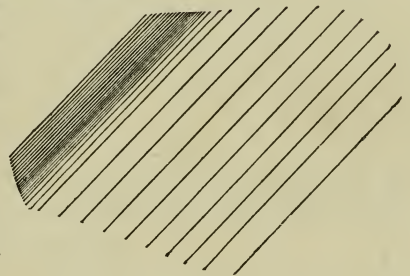

fig. 4.

than in the reverse position, as in the preceding sketch. We have seen cases where, in lessons like the foregoing, the lines sloping from right to left were drawn first, the board reversed, and lines to represent those sloping the reverse way drawn in the same direction exactly ; the board was then turned to its original position, when the sets of lines appeared sloping different ways, while, in reality, they were done both in the same manner. This practice is not honest either to the teacher or pupil, and should at once be discarded.

The examples now given have had reference only to one peculiar position of the lines to be drawn ; that is, they have all been horizontal, or all perpendicular or oblique : placed in the same relative position to one another. We now give an example where the lines go in different directions with respect to one another. Thus in drawing the lines *b a*, *a f*, *d c*,

and $c e$, fig. 5, care must be taken to have the lines perpendicular to one another; that is, supposing the lines ab, cd to be drawn first, the horizontal lines af, ce must be drawn so that the points or ends f, e shall neither be above nor below the ends or points a, c —that is, f and e must be exactly opposite a and c . In another work in this series* we have given ample directions for erecting lines perpendicular to one another geometrically; in the present case no mechanical aid is allowable, the eye is to be the only guide. Attention should also be paid to keeping the exact distance between the lines ab, af , and cd and ce .

The pupil must not imagine that all these modifications of lines are worthless; a little patience and reflection will suffice to shew him that they are, in truth, part of the groundwork, without which he can never hope to rear the superstructure of perfect drawing. We now proceed to a little more interesting labour, where simple figures are to be drawn; these, however, being neither more nor less than the lines already given variously disposed. Draw the lines ac, bc , fig. 6, meeting in the point c ; these form a certain angle: care should be taken

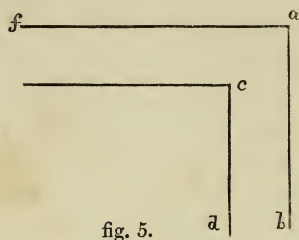

fig. 5.



fig. 6.

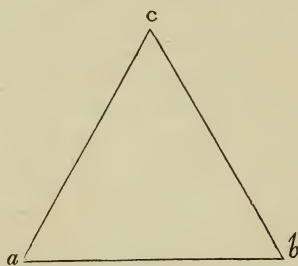

fig. 7.

to draw the lines as in the copy. Next draw the horizontal line ab , fig. 7, and a figure is formed which the pupil will at once recognise. Draw the

horizontal line ab , fig. 8; perpendicular to it, from the ends ab , draw the lines ac, bd , taking care that they are of the same length as ab ; draw the line cd , a square is at once formed. As it is an essential feature in this form that all the sides are equal, if the pupil, after drawing it, perceives any inequality therein, he should rub it out and proceed to another attempt. Some little practice must be given to the delineation of squares, angles, &c. If a parallelogram or oblong—vulgarly called an oblong square—is wished to be drawn, it may be

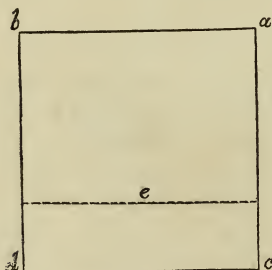

fig. 8.

done by making two opposite lines shorter than the others: the line e denotes the fourth outline of an oblong, of which the side is ab . If two oblongs be drawn, care being taken to have the inner lines the same distance within the outer ones all round, by adding a narrow

* Treatise on "Practical Geometry, and its application to Architectural Drawing."

line outside these, as in fig. 9, the representation of a picture-frame is obtained; the diagonal lines at the corners, as at *a* and *b*, being put in to represent the joinings at the corners of the frame, the "mitre" joints, as

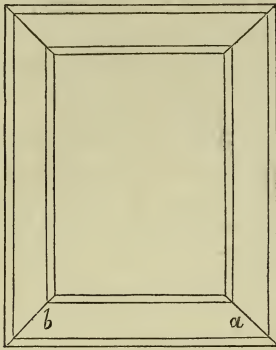

fig. 9.

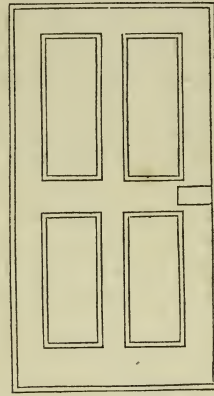

fig. 10.

they are termed. By first drawing the simple outlines, as in fig. 10, the foundation of a door is obtained, which is finished by filling in the extra lines as in the figure.

We now proceed to the drawing of curved lines, as in fig. 11. And as these are the basis of innumerable forms, the pupil must not rest satisfied with a few attempts at forming them; he must try and try again, until he is able, with a single sweep, to draw them correctly. They

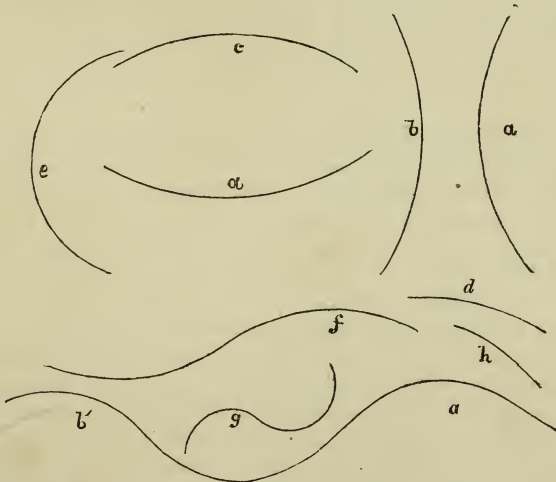

fig. 11.

must be done in one stroke, no piecing being allowed. Let the curved line *a* be first produced; beginning at the top, bring the arm or wrist down, so that at one operation the form may be traced; do this repeatedly, until the correct outline is attained at every trial. The pupil may next

proceed to the curved line *b*, which is merely the line *a* in another position ; then, after repeated trials, the lines *c*, *d*, *e*, *g*, and *h* may be drawn. These curves should be attempted to be drawn in all manner of positions, beginning at the top, then at the bottom, and making the curve upwards, and so on, until the utmost facility is attained in drawing them, however placed. The curved line generally known as the "line of beauty," *f a b'*, must next be mastered ; it is of the utmost importance to be able to do this easily and correctly. In all these and the future elementary lessons, the pupil must remember that when failing to draw a form correctly, he should at once rub it out or destroy it, and commence a new attempt.

Having, then, acquired a ready facility in drawing the simple elementary curved lines, the pupil may next proceed to the combination of these, as exemplified in simple figures, as circles and ellipses or ovals. First attempt to draw the circle *a' b*, fig. 12 : beginning at *a'*, sweep round by the right down to *b*, then from *b* towards the left and up to *a'*, where the circle was first

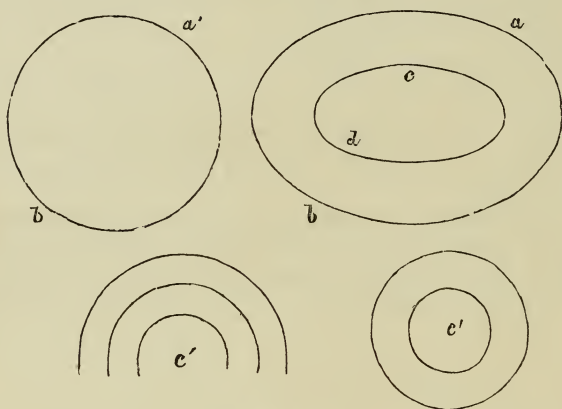

fig. 12.

begun. The pupil may also try to draw it by going the reverse way to the above. We are quite aware that it will be found rather a difficult matter to draw a circle correctly at the first, or rather even after repeated attempts ; but the pupil must not be discouraged, by dint of practice he will be able to draw circles of any size very correctly. We have seen circles drawn by hand so that the strictest test applied could scarcely point out an error in their outline, so correctly were they put in. Circles within circles may be drawn, as at *c'* ; care should be taken to have the lines at the same distance from each other all round. The ellipse *a b* must next be attempted ; this is a form eminently useful in delineating a multiplicity of forms met with in practice. Ovals within ovals may also be drawn, as at *c d*.

At this stage the pupil ought to be able to draw combinations of straight and curved lines, as met with in many forms which may be presented to him in after practice. The examples we intend now to place before him are all in pure outline, having no reference to picturesque arrangement, but designed to aid the pupil in drawing outlines with facility, and to prove to him, by a progression of ideas, that the most complicated forms are but made up of lines of extreme simplicity ; that although in the aggregate they may look complicated, in reality, when

carefully analysed, they are amazingly simple. Again, although the pupil may object to them as being easy and formal—in fact, not picturesque or decorative enough to please his hasty fancy,—he ought to recollect that, before being able to delineate objects shewn to his eye perspectively, he must have a thorough knowledge of the method of drawing the outlines of which the objects are composed, and a facility in making the hand follow aptly and readily the dictation of the eye. These can be alone attained by a steady application to elementary lessons.

Fig. 13 is the moulding, or form known in architecture as the “echinus”

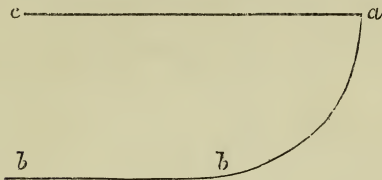

fig. 13.

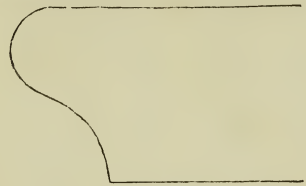

fig. 14.

or quarter-round. First draw the line *ac*, then *bb* at the proper distance; next mark with the eye the point *b* on the line *bb*, to which the curve from *a* joins; then put in the curve *ab* with one sweep. The curved portion of the moulding in fig. 14, known as the “ogee,” must be put in at one stroke of the pencil or chalk, previously drawing the top and bottom lines.

Fig. 15 is the “scotia;” it is formed geometrically by two portions of a circle, but the pupil should draw the curve at once with the hand. It is rather a difficult one to draw correctly, but practice will soon overcome the difficulty.

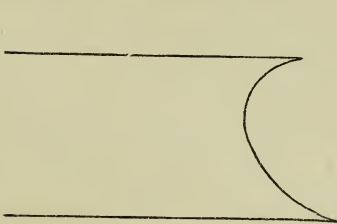

fig. 15.

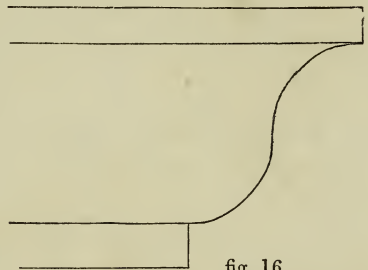

fig. 16.

Figure 16 is termed the “cyma recta;” it affords an exemplification of the line of beauty given in fig. 11.

Should the pupil ever extend the practice of the art beyond the simple lessons we have given him, he will find, in delineating the outlines of numerous subjects presented him, the vast utility of the “practice” such as we have placed before him in these foregoing examples. In sketching ancient or modern architectural edifices, he will find the forms we have presented of frequent recurrence.* We shall now proceed to give examples of the combinations of the forms or outlines we have just noticed.

* For the various kinds of mouldings, see the volume on “Practical Geometry, &c.” in this series.

Fig. 17 is half of the base of an architectural order frequently met with, called the Doric. Fig. 18 affords an exemplification of the outline of part

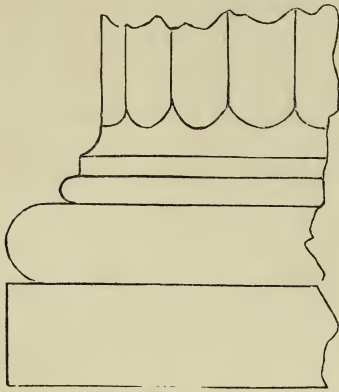

fig. 17.

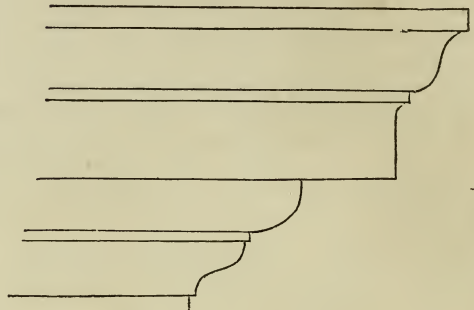

fig. 18.

of a "cornice" belonging to the Tuscan order. Let us slightly analyse the supposed proceedings of the pupil in delineating this. Suppose fig. 19 to be the rough sketch as first attempted. On examining the copy as given

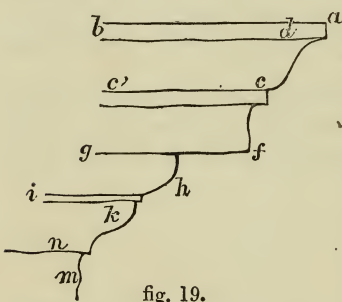

fig. 19.

in fig. 18, the pupil will at once perceive that the proportions are very incorrect: thus the distance between the two upper lines as at *d* is too little, the fillet being too narrow; again the point *c*, which regulates the extent of the curve from *a*, is too far from *a*, while the line *c'* is too near the line *d*; the space between *c'* and the line below it is too wide, and the line *f* is not perpendicular, but slopes outwards towards *f*; the distance between the line *fg* and the one immediately above it is also too narrow

by at least one-third. Again, the point *h*, where the portion of the circle begins, is too near the point *f*; the line *i* is also too near that of *fg*; the outline of the curve is not correct, it being too much bulged out near the point *k*; the line *n* is not straight, and that marked *m* is too far from the extreme end of the line. The pupil has here indicated a method of analysing his proceedings, comparing them with the correct copy, which he would do well in his earlier practice to use pretty frequently, until he is perfectly at home in correct delineation of outlines. It may be objected that this analysis is hypercriticism utterly uncalled for, from the simplicity of the practice; but let it be noted that if the pupil is not able, or unwilling to take the necessary trouble to enable him to draw simple outlines correctly, how can he be prevented, when he proceeds to more complicated examples, from drawing difficult outlines incorrectly? We hold that if a thing is worth doing at all, it is worth doing well; and how can a pupil do a thing correctly, unless from correct models or rules? and how can he ascertain whether he is following them, unless by careful comparison and examination? How often are the works of painters and artists found fault with, from the incorrectness of outline and the inconsistency of measurement observable,

which might be obviated by a more careful attention to the minute details, but are too frequently spurned at by aspiring artists ; but of which, after all, the most complicated picture is but a combination ? Thus the outline in fig. 19 presents all the lines and curves found in fig. 18, but the whole forms a delineation by no means correct ; and if a pupil is allowed to run from simple lessons without being able to master them, then the foundation of the art is sapped, and the superstructure certainly endangered. Correct outlining must be attained before the higher examples of art can be mastered.

Fig. 20 is an outline-sketch of the ornament called a quartre-foil, frequently met with in architectural and artistic decoration. It will be a somewhat difficult example to execute at first, but it affords good and useful practice. Fig. 21

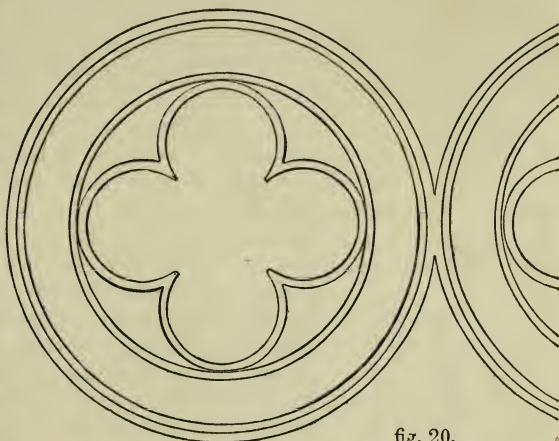

fig. 20.

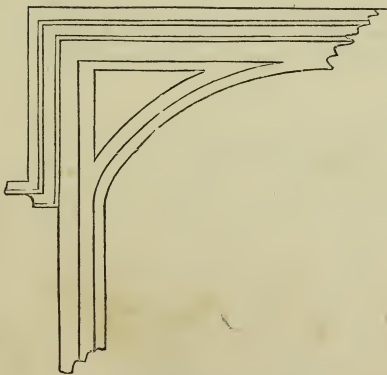

fig. 21.

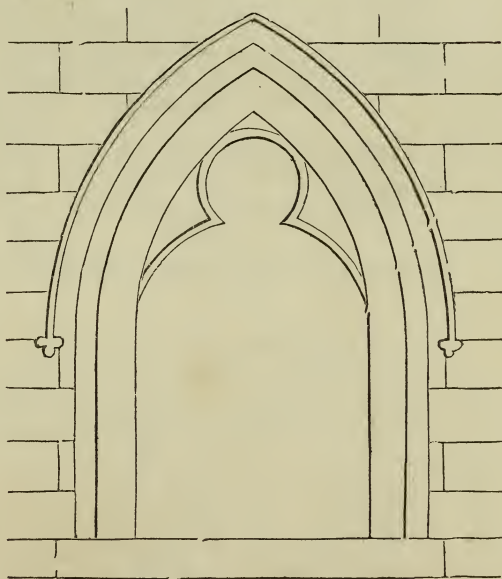

fig. 22.

is part of the arch and mullion of a window. Fig. 22 is an outline-sketch of a gothic recess in a wall.

The reader will perceive that in all these foregoing designs, although

consisting of pure outline, there exists a large amount of practice, which, if he has carefully mastered, will be of eminent service to him in the higher branches of the art.

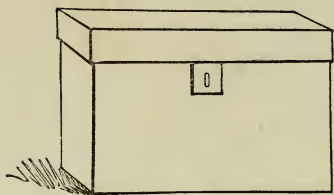

fig. 23.

give the perspective appearance to the representation. In this section we do not give the rules of perspective delineation, preferring to let the pupil become acquainted therewith after he has acquired the necessary

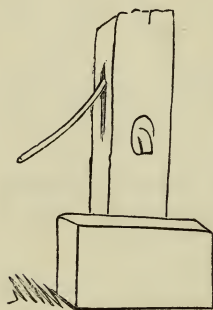

fig. 24.

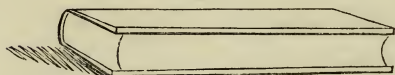

fig. 25.

facility for copying objects as they appear presented to his eye; this to us appearing the most natural course, as perspective cannot be taught unless the objects which illustrate the rules, and which are to be found in all perspective delineations, can themselves be sketched with ease. As soon as a pupil can copy an object correctly, so far as his own ideas go, he will at once perceive the utility of an art which by stated rules will enable him to test the accuracy of his proceedings. Fig. 24 is a free outline-sketch of a pump; by drawing the lower square first, thereafter the end and top, and next the upright oblong, finally putting in the handle and spout, the delineation will speedily be effected. The pupil at this stage should attempt to delineate the forms presented by placing boxes, square blocks, bricks, &c. in various positions. Fig. 25 is the representation of a book lying on its side; it is formed of both

straight and curved lines. He should draw the horizontal lines first,

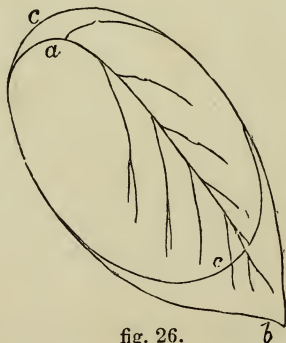

fig. 26.



fig. 27.

then the oblique, taking care to make the two lines forming the top

nearly parallel, and the others slightly to approach each other, to give the idea of distance; the under lines may be strengthened as in the figure, which will compensate for the absence of light and shade. Fig. 26 affords a good exemplification of the use of the oval or ellipse in forming leaves, &c. In the first place, a correct ellipse is to be drawn, thereafter the top *a* and the end *b* of the leaf, rubbing out the parts *cc* not required, and lastly putting in the fibres, as in the figure. The leaf is finished by putting in the serrated or saw-like edges, as in fig. 27. The



fig. 28.



fig. 29.

next fig. (28) is formed in the same way, the only difference being, that the leaf is comprised *within* the ellipse; the parts *aa* being rubbed out, and the edges filled in as in fig. 29. Fig. 30 exemplifies the use of the circle in delineating natural objects. A pear is drawn by first making the circle



fig. 30.



fig. 31.

as in fig. 30, thereafter finishing it as in fig. 31. The use of the circle is further demonstrated by figs. 32 and 33, which shew the method adopted in drawing an acorn. The method here indicated, of using ellipses and circles as the foundation of the outlines, is applicable to the formation of a

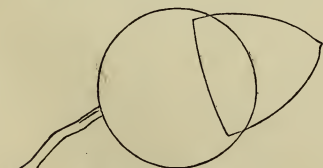

fig. 32.

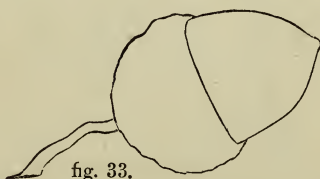

fig. 33.

vast variety of objects; thus vases and other forms can be rapidly delineated, as shewn in figs. 34 and 35.

Fig. 36 shews the position of the two ellipses *a* and *b*, which form the



fig. 34.



fig. 35.

bases of the ornamental sketch shewn in fig. 37. In like manner, the half-ellipse, formed on the horizontal line, in fig. 38, is the foundation of the

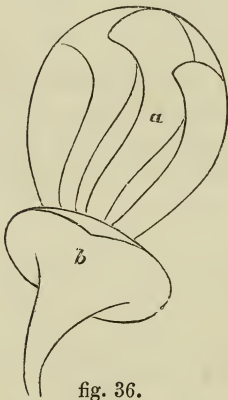

fig. 36.



fig. 37.

sketch shewn in fig. 39. So also is the foundation of a flower-petal shewn

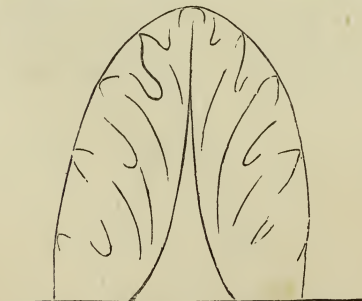

fig. 38.

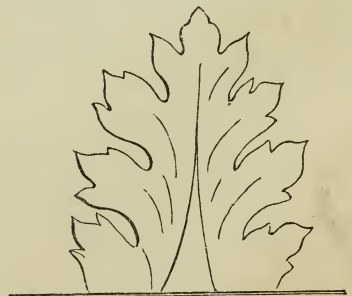

fig. 39.

in fig. 40 made clear by the analytical sketch in fig. 41, where the prelimi-

nary forms are shewn drawn. Again, the ornamental scroll in fig. 42 is

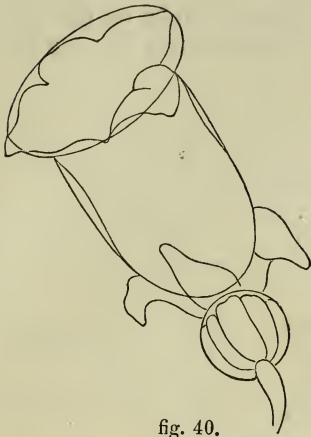

fig. 40.



fig. 41.

drawn by sketching a half-ellipse on the horizontal line. The convolvulus

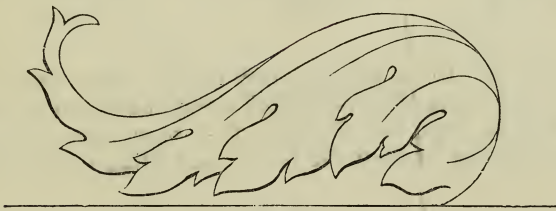

fig. 42.

flower and stem in fig. 43 are also drawn by previously sketching an ellipse

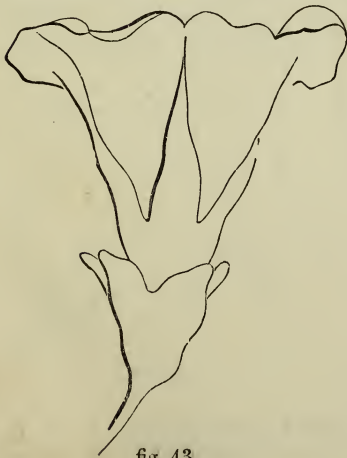

fig. 43.

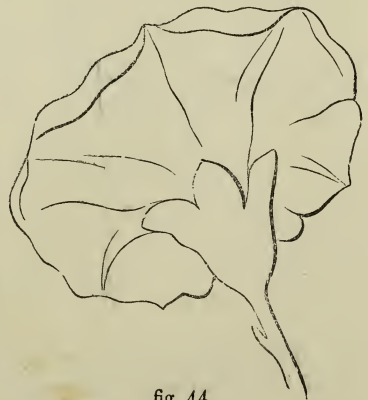

fig. 44.

to form the flower. In sketching the flower in fig. 44, the pupil must first

draw an outline which will take in the whole figure, making it as near the shape of the sketch as the eye dictates. After the correct outline is formed, the details must be drawn. The flower, stem, and leaves of the sketch in fig. 45 must be drawn in, the form being estimated chiefly by the eye; the stem ought to be put in first, thereafter the distances between the leaves, and then filling-in the details.

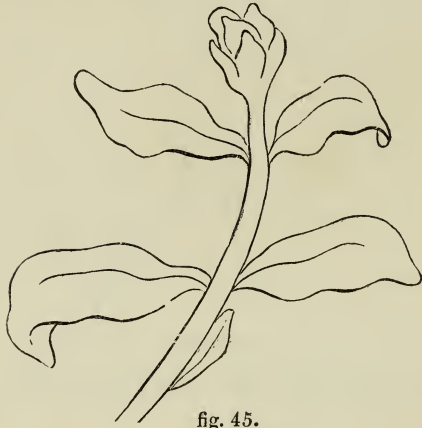

fig. 45.



fig. 46.

The ivy-leaf in fig. 46 is to be drawn in the same way as the last. The ivy stem and leaves shewn in fig. 47 should be drawn by first sketching out the length, form, and direction of the stem, then ascertaining and marking the distances between the leaves, and filling in the details as be-



fig. 47.



fig. 48.



fig. 49.

fore. The leaf in fig. 48, and the leaves in fig. 49, should next be copied. Fig. 50 is the leaf of the common "dock;" it is to be copied by first drawing an ellipse, thereafter filling-in the details. Fig. 51 is the stem and leaves of the "burdock;" the sketch may be put in at once by the assistance of

the eye; it may be better, however, to draw a circle for the part *a*, and an ellipse

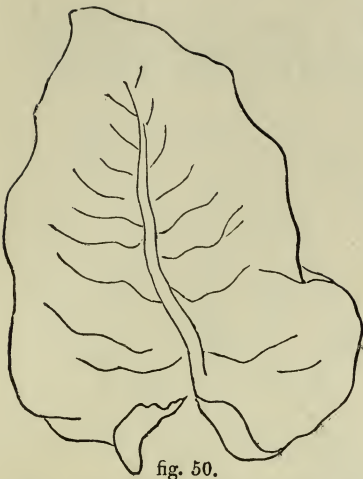

fig. 50.

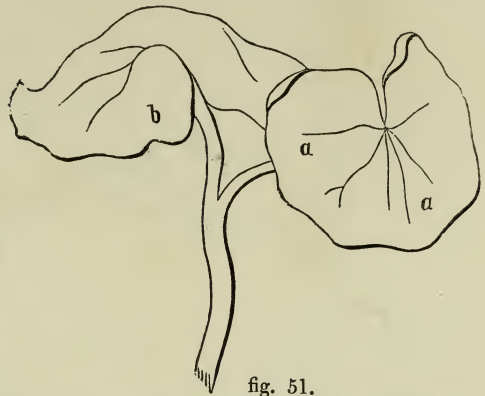

fig. 51.

for that of *b*. The scroll in fig. 52 may be sketched by drawing an

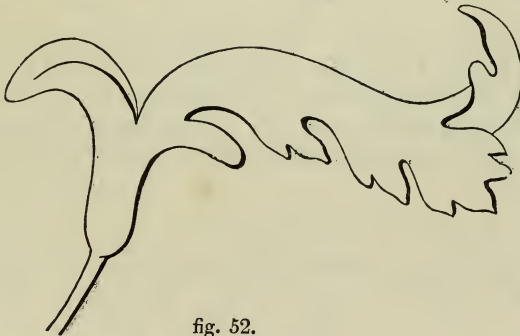

fig. 52.

outline which would touch all the parts of the design, thereafter filling up the

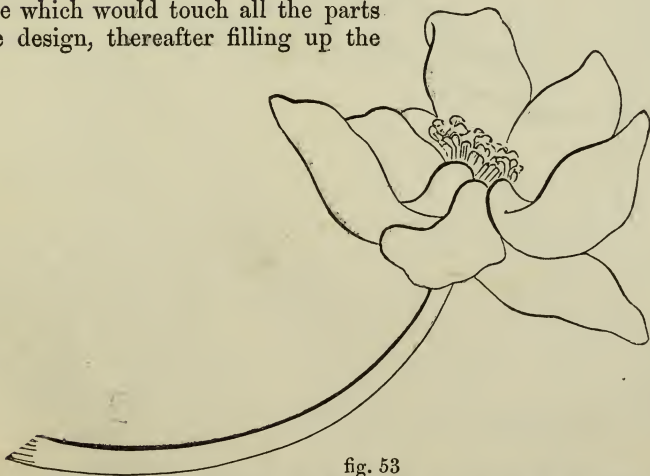

fig. 53

details. In drawing the sketch shewn in fig. 53, the pupil will have

to trust greatly to the eye: the stem should be drawn first, its length and direction being carefully noted; the distance of the extremities of the leaves from the stem should next be marked off, then their general out-

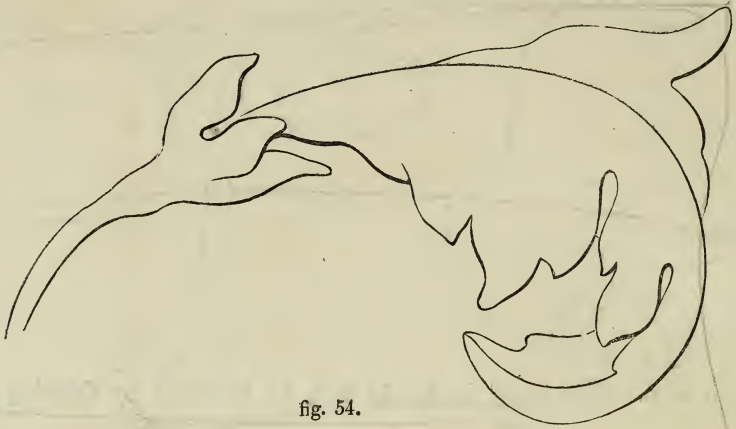

fig. 54.

line, and thereafter the details. The proportions the parts bear to one another must be attended to. The outline of the stem and the curve of the scroll of fig. 54 must first be drawn, the distances and proportions of the various parts being carefully observed. In sketching the scroll in fig. 55, the eye alone will be the guide, the directions and distances of the various

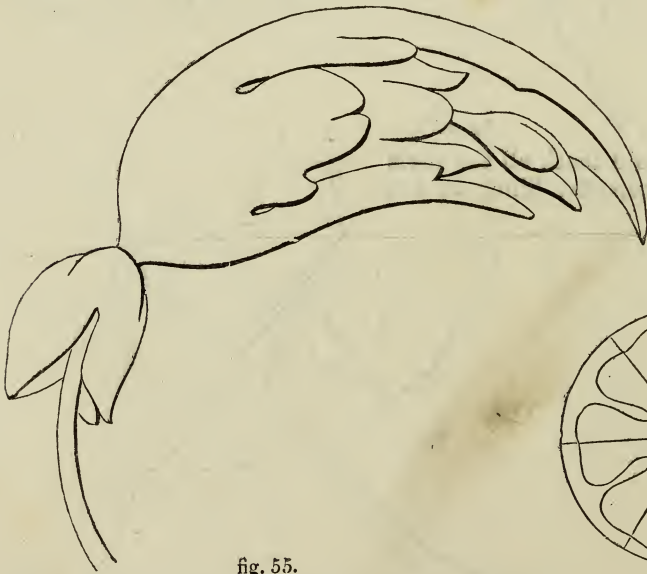

fig. 55.

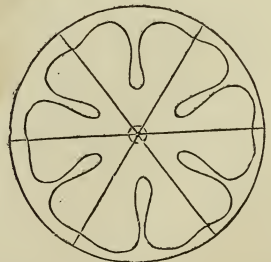

fig. 56.

parts being marked off before filling-in the details. The method of drawing the rosette, forming part of the scroll shewn in fig. 57, is displayed in

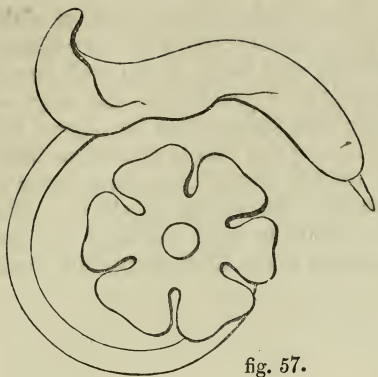

fig. 57.



fig. 58.



fig. 59.



fig. 60.

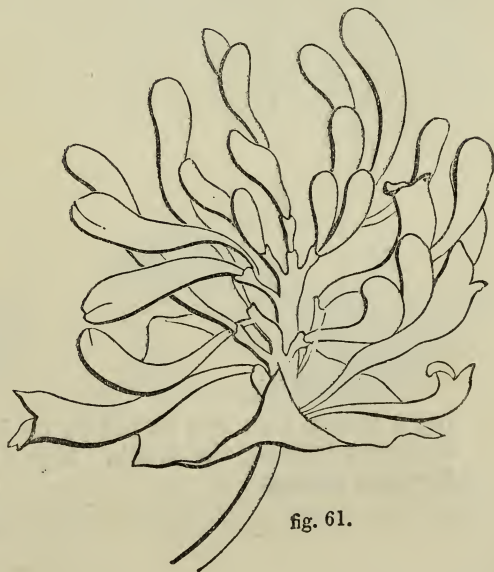

fig. 61.

fig. 56, the circle being drawn first. In sketching fig. 58, the direction of the curve must first be ascertained, its due proportions noted, thereafter filling-in the details. The stem, leaves, flowers, and buds of the wall-flower in fig. 59 will afford an interesting example for practice at this stage of progress; the stem, its length and direction, should first be drawn, the position of the leaves, &c. marked thereon, and the details thereafter filled-in. The sketch in fig. 60, which represents the stem, leaves, and flower of the yellow crowfoot, will be drawn in the same way as above. The flower of the honeysuckle in fig. 61 affords a good example for free pencil-sketching: the stem should be drawn first; then an outline made



fig. 62.



fig. 63.

which will touch all the exterior parts of the sketch, as in fig. 44 and fig. 52; the distances of the leaves should next be drawn on this, and the details put in. The pupil should endeavour to copy this example correctly: it may appear very difficult, but by a careful attention to the rules we have given, and a little determination to "try again," if perchance he should once or twice fail, the difficulty will soon vanish. The sketch in fig. 62, represent-



fig. 64.



fig. 65.

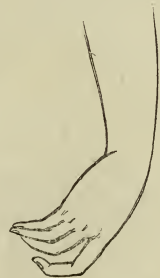

ing a human foot, may be put in, by first drawing the general outline, thereafter finishing the details. Figs. 63, 64, and 65, will be drawn in the same manner.

SECTION II.

FIGURE AND OBJECT DRAWING.

IN executing the lessons in this section, we would recommend the pupil to use cartridge-paper: this material has a rough surface, which takes the pencil easily, and will bear rubbing out well; it is, moreover, cheap, which—to a pupil who is apt to make many attempts before he succeeds in making a perfect copy—is a matter of some importance. A few black-lead pencils will be also requisite; some rather hard, to make the outlines, and others soft, for shading: for the latter purpose those marked B will be found the most useful.

In executing the copies here given, and indeed in all other drawings

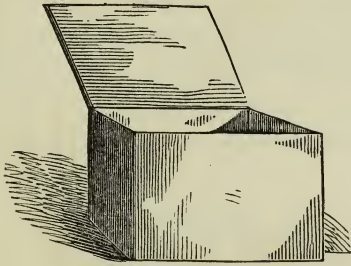

fig 1.

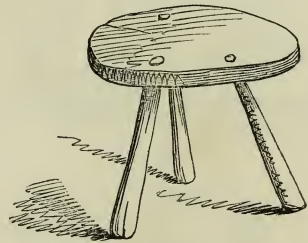

fig. 2.

which are to be shaded, the outlines must first be put in before any attempt to shade is made. The pupil should endeavour to produce the proper degree of shade at one operation, without having occasion to go over or darken it afterwards. This retouching spoils the effect of clearness and spirit which shading at one operation is calculated to give, and which all drawings should have. The drawings in figs. 1 and 2 will be very easily put in. The outline of fig. 3 should be drawn in the manner explained in Section I., the shading put in by bold strokes from top to bottom, because if

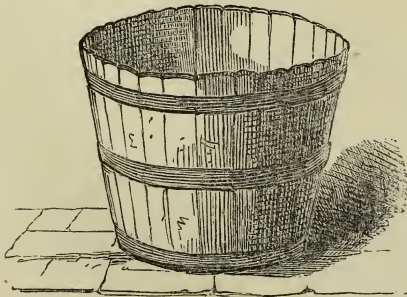

fig. 3.

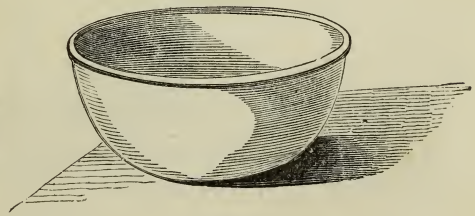

fig. 4.

done at two operations, a shadow would result, by which the effect would be spoiled; a few cross-strokes may be next put in, which will give a

little roundness to the sketch. In fig. 4 the nearest part of the oval is to be drawn considerably stronger, so as to bring it forward. Figs. 5 and 6

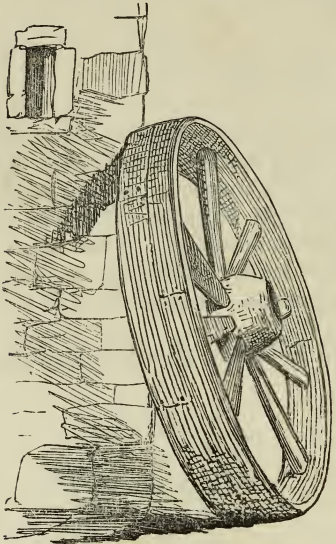

fig. 6.

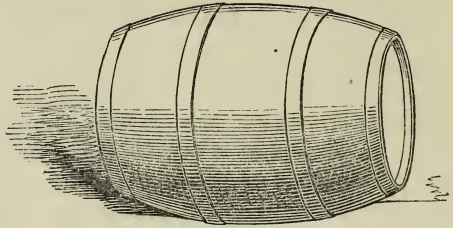

fig. 5.

are examples in which the ellipse is distinguishable. In copying fig. 7, a nice broken outline should first be obtained; the shading being simple needs no explanation. The outline of fig. 8 is to be drawn as formerly; the indented parts of the leaf to be put in slightly, and afterwards the

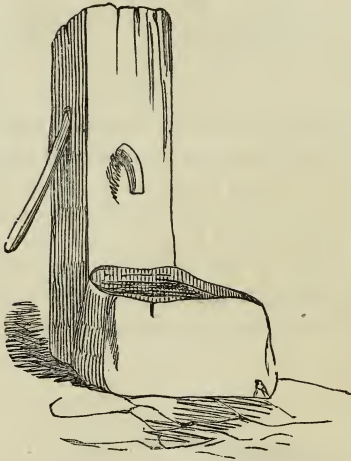

fig. 7.



fig. 8.

stronger shadow, which throws forward the curled edge of the leaf. In copying the annexed sketch of a grindstone, to get the outline correctly the framework should be drawn first, carefully observing the relative proportions of the parts, in order to give an idea of perspective.* Having

* In Section III. the subject of Perspective will be fully treated of. Before Perspective can be mastered, it is absolutely necessary that the pupil should be able to sketch by the assistance of the eye: hence our reason for making the Section on Perspective follow this and the preceding one.

done this, an ellipse may be drawn to represent the stone, part of this to be rubbed out afterwards : in shading the drawing, the nearer parts should be made darker than those distant ; this causes the latter to recede, having the appearance of distance. In figure 10 we give the representation of an old gate ; it is so simple that it needs no explanation. Fig. 11, which is the representation of a familiar object, is treated under a very simple effect of light and shade, the shaded parts bringing forward the light ones : this effect is called *relief*. It is of the utmost importance that the pupil should have a clear knowledge of the mode of producing this effect. We would recommend him to try the experiment of placing simple objects so as to relieve each other, and to sketch them

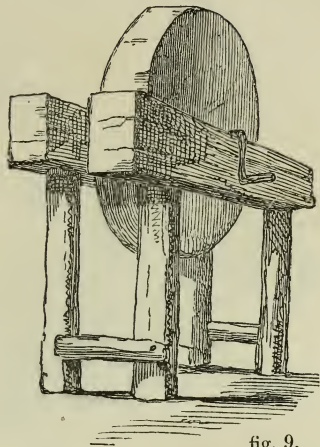

fig. 9.

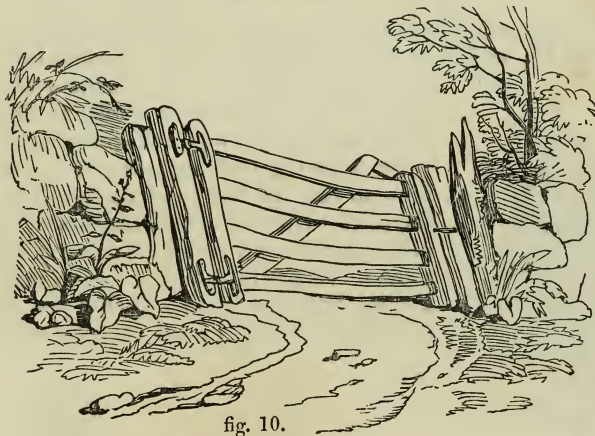

fig. 10.

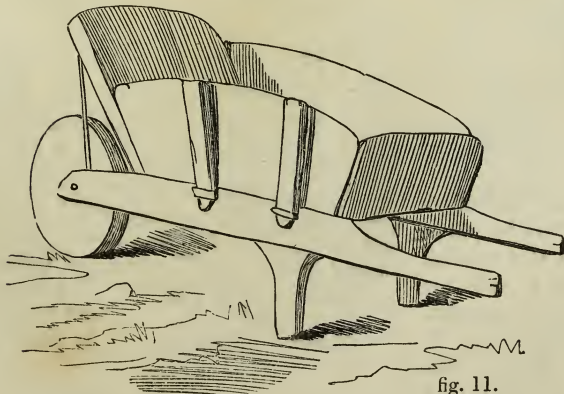

fig. 11.

in this manner ; this will enable him very speedily to understand the method

of attaining the effect. In fig. 12 the same effect is displayed, only reversed ;



fig. 12.

a mixture of light and shade throwing back the other end, which is in half tint. In fig. 13, which is the representation of a fuchsia-leaf, the outline must be put-in in the manner explained in Section I. ; the shading is similar to that in fig. 8. After copying this, we would recommend the pupil to get a similar leaf, and place it in various positions, so that the light and shade will be variously disposed. This will afford excellent practice, and will accustom the pupil to draw or sketch from nature. In fig. 14, which is the representation of a rural stile, the pupil will find the principle of relief shewn in figs. 11 and 12 again displayed ; the

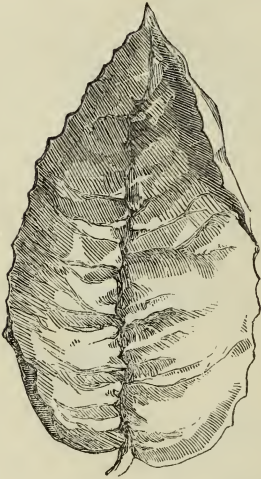

fig. 13.

shading behind the stumps throwing the light parts forward, and the shaded sides of these causing the back part to recede. In fig. 15 the sketch of a flower is given ; the manner of copying this will be evident from an

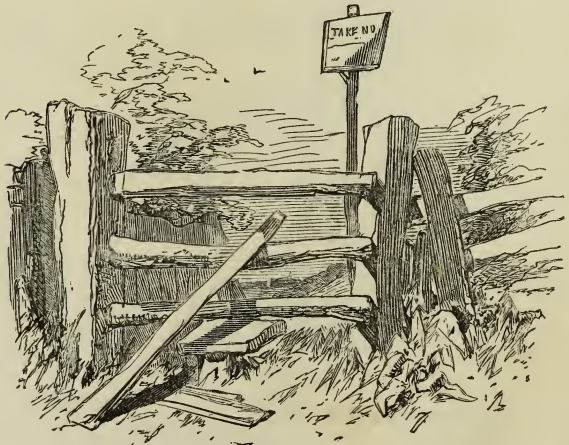

fig. 14.

inspection of the figure. In fig. 16 the effect of relief must be treated in the manner explained in fig 8. A group of dock-leaves is given in fig.



fig. 15.



fig. 16.

17 : these form an excellent study, and examples may be met with in any part of the country. After he has copied the example we have given, we would recommend the pupil to seek out a natural group and sketch it,



fig. 17.

carefully observing the relief which one leaf gives to the other ; if this relief were not noticeable, the leaves would appear as if they were adhering in a mass together. In fig. 18 a slight sketch of a tunnel, with overhanging foliage, is given ; it affords an example of how easily an effect may be

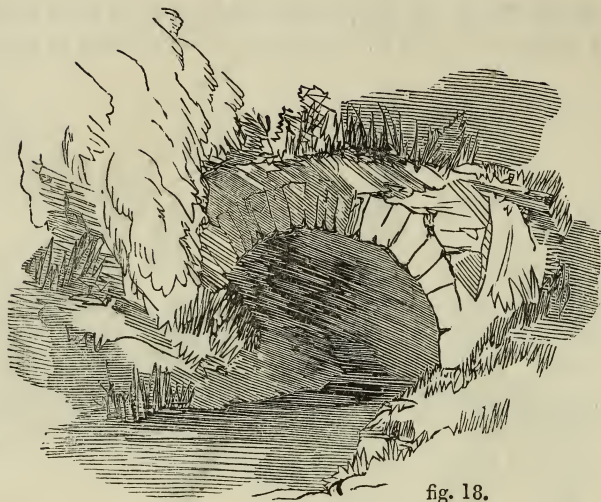

fig. 18.

obtained without much labour. In fig. 19 an old boat with a fisherman's basket is given ; this is treated under an effect of shade, with a slight shadowing behind the light end of the boat.



fig 19.



fig. 20.

In fig. 20 we have given another group of dock-leaves, and in fig. 21

a slight sketch, neither of which requires description. In figure 22, representing the foliage of the elm, the pupil must put the shading in with as few strokes as possible, so as to obtain the leafy appearance of the copy. The manner of putting in the foliage, &c. of an ash-tree is exemplified in fig. 23 ; the strokes must be given in a quick, free manner,

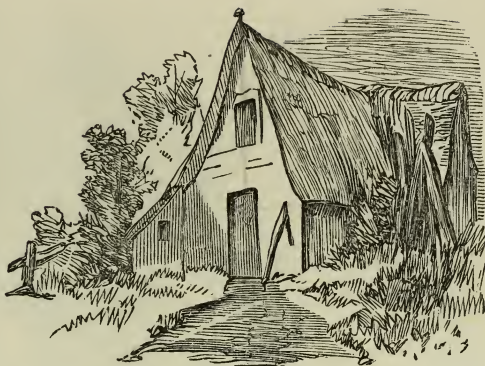

fig. 21.



fig. 22.



fig. 23.

and the branches in graceful curves. Fig. 24 illustrates the manner of delineating oak-foliage, which is done in a style very different from the former. The branches of an oak are twisted in endless variety ; the foliage is



fig. 24.



fig. 25.

drawn in a more angular style than that of the ash : it must, however, be

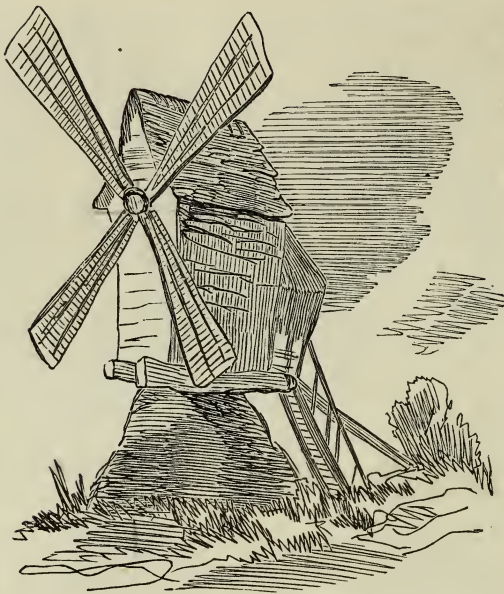

fig. 26.

kept free and loose, without formality. In fig. 25 the manner of delineating the foliage of a willow is shewn ; it is somewhat similar to that of the ash. In drawing the windmill in fig. 26 the outline is to be drawn in a broken

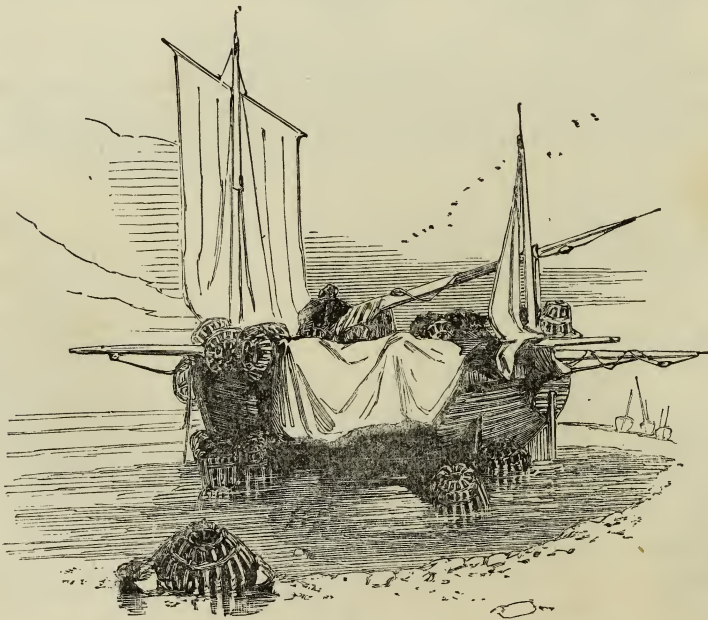

fig. 28.

manner, so as to agree with the subject ; a little decided shading on the lower part will give an effect, and the grass to be executed in a rough manner. The sketch in fig. 27 to be carefully outlined, and the shading done with care ; the dark parts to be put in last. The sketch of a ship in fig. 28 is given with a view of shewing the reflection of objects in water. Water in a perfectly quiescent state reflects the objects placed



fig. 30.



fig. 27.



fig. 29.

in it almost as distinctly as the objects themselves, only a little darker ; the darker the water is, the less distinct will the lights be. The sketch in fig. 29 must first be carefully outlined ; the shading to be begun at the top, proceeding down-

ward, to keep the marks from being smeared. In drawing the curled leaves, the pupil must be careful to give them the necessary relief. An inspection



fig. 31.

of the sketch will shew how this is done ; where the leaf is light, the curled part is thrown into shadow, which brings it forward. In sketching the stem and flower of the wallflower, given in fig. 30, the pupil must proceed as in the last. In drawing the sketch in fig. 31, the pupil must put in the stumps and stones first, then the direction of the branches in the tree ; the outline of trunk must be done next, in a free manner, carefully avoiding any formality, as the *outlines* of a tree give a *character* to the whole. The shading should, if possible, be done at once, avoiding the necessity of having to go over it again, as this takes away the clearness. It will be seen how the stumps are relieved by the

mass of shadow behind them. In the sketch of the old farm-house given in fig. 32, the light falls on the gable-end and the grass in front ; the foreground is kept in shadow, so as to bring it forward. This part must be



fig. 32.

kept either light or dark, according to the character of the objects which it is to relieve, but in all cases it must be the most forcible part of the

drawing. In the sketch of an old oak given in fig. 33, the weeds and small patch of foliage are kept in shadow, so as to support the tree; if these were kept light, the whole effect would be lost. The sketch in fig. 34 is treated under a broad effect of light, the upper part relieved by the foliage in the background, the old fence on either side being kept dark. The pupil will do well to look out for an object in the fields similar to this,



fig. 33.

and sketch it from various points of view. The moss-rose in fig. 35 must be drawn in the same manner as the other flowers. Fig. 36 is a scroll from the antique. In the first place, the outline must be carefully put in; the shading of the ground next done as flat and as even as possible; next, the details of the leaves; and lastly, the shadows and the broken part round the whole. In sketching the copy in fig. 37, the circular part of the bridge should be drawn in first, then the upper part and the outline of the whole; thereafter the foliage at the top, taking care not to make it too dark, as it should appear to recede from the eye. It may be taken as a general rule, that in distances shadows become lighter on account of the atmosphere, more so than lights, the dark parts being



fig. 34.



fig. 35.



fig. 36.

the first to lose their distinctness. The copy here given is treated with a broad effect of light. The few strongly-marked weeds give an effect to the whole; the reflections in the water are indistinct, in consequence of its



fig. 37.

being a running stream. The ass sketched in fig. 38 must first be carefully outlined, then pencilled in a vigorous manner, so as to give the rough effect.

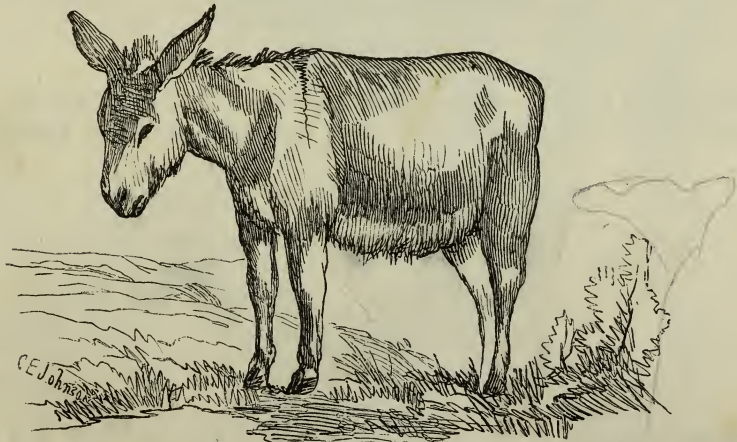

fig. 38.

In a former sketch we have given a specimen of the mode of delineating the foliage of an oak-tree. We now give another in which the tree is the principal object (fig. 39). The further branches are made darker, which brings out the nearer ones. The pupil will see from this sketch how the effect of water is given with very little trouble. The drawing in fig. 40 will



fig 39.

require very careful outlining before any of the shading is put in. The pupil should begin to shade the head first, then the neck, which fore-

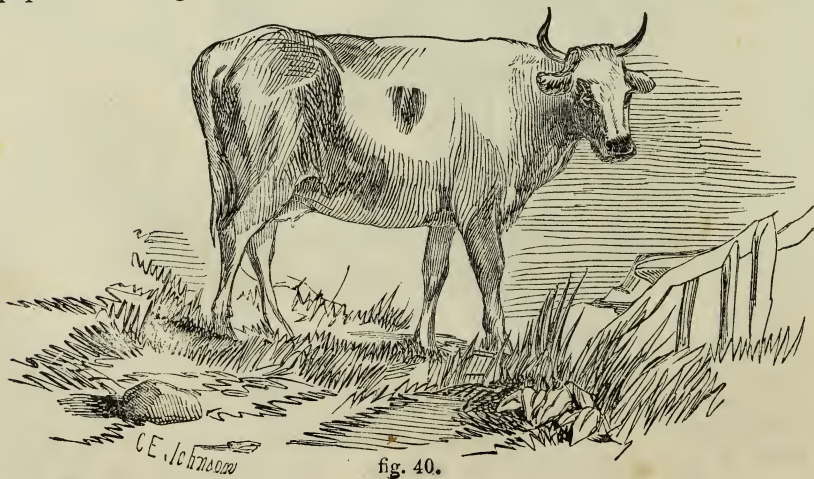

fig. 40.

shortens it. The weeds and grass should be put in in a bold manner, with some very dark shadows to give effect to the whole. The drawing in fig. 41 must first be carefully outlined; then the details of the trees put in, as the branches and the character of the foliage; the house should next be

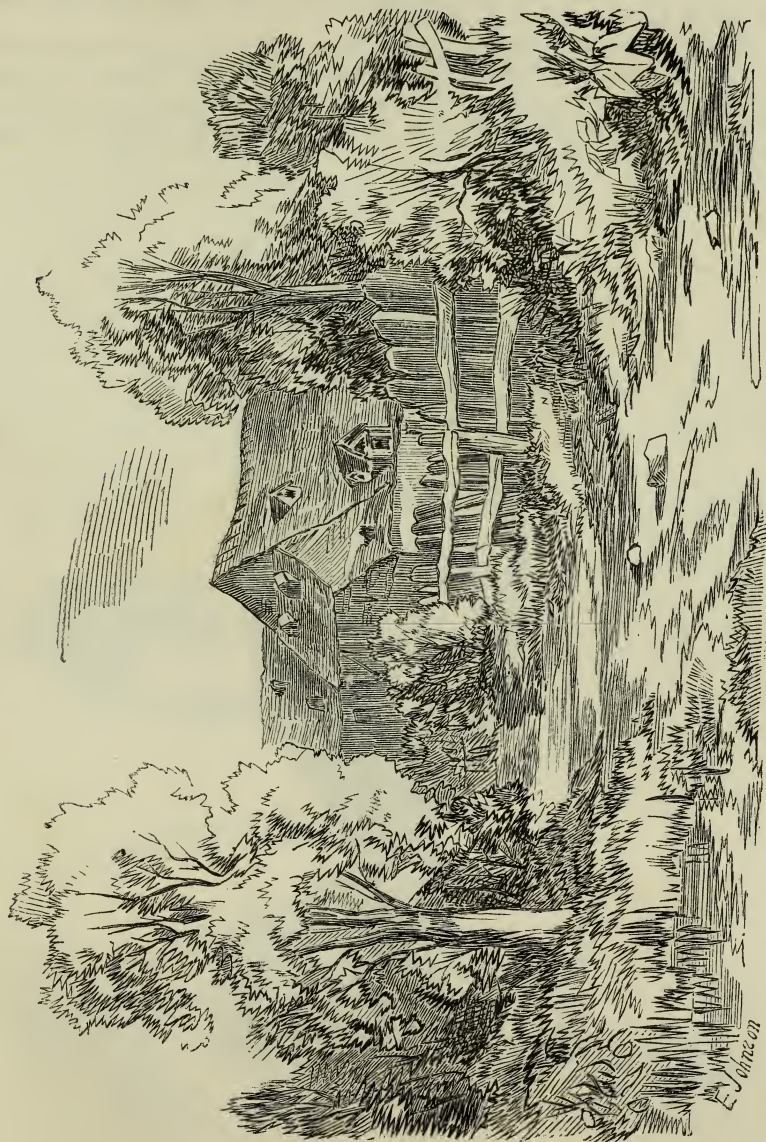

fig. 41.

finished, and the more distant parts; thereafter finishing the trees and the dark foliage which relieves them; and lastly, the foreground and water. In copying the vase from the antique given in fig. 42, the pupil will find the

rules given in Section I. of infinite use. A line must first be drawn down the centre, an ellipse thereafter formed, and for the lower parts, to mark the distances on each side correctly from the centre line. It would be advisable to try it, in the first place, without filling in the details; attempting it several times, at each trial adding a little more from the copy, until competent to draw the whole correctly.

Having gone thus far in drawing from objects, we now conclude the section. Having laid before him the rudiments or basis of the art, we leave it to the perseverance of the pupil to make further progress, as pencil-drawing will form a good foundation for the higher branches of art, as oil and water-colour painting.



fig. 42.

PART II.

PROPORTIONS OF THE HUMAN FIGURE.

WE have deemed it best to keep this class of drawing, treating of the proportions which different parts of the human frame bear to each other, according to the acknowledged standard of beauty, as derived from measurements from the antique, separate from the others. The student will find the lessons here given of great assistance in enabling him to draw from casts. We should advise him to habituate himself to this practice, as it will lay a foundation for attaining with ease a correctness of proportion, which constitutes the chief beauty in drawings of the human figure. He must not, however, suppose that beauty is always attained by attention to these rules, but chiefly correctness. There are many styles of beauty, the qualities of some consisting in a slight deviation in some point or other from the established proportions. This, however, is not carried so far as to become incorrectness.

We first begin with the various parts of the human "head divine"—the seat of the soul, as some term it. The mouth, of which a sketch is given

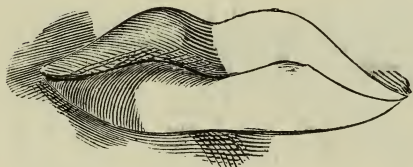

fig. a.

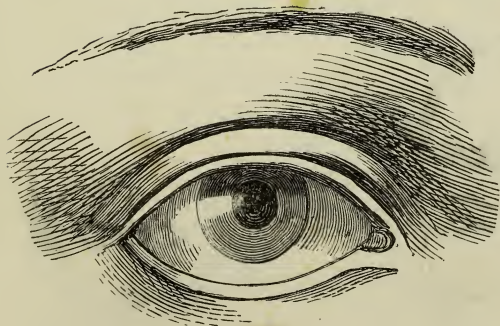

fig. c.



fig. b.

in fig. a, is equal in width to the length of one eye and a half, and the height to one-half. The mouth in profile is exactly the same height, but

only half the width; the upper lip projects less than the lower one. The nose in width is equal to one eye, and the height to two eyes, measuring parallel to the eyebrows (fig. *b*). The eye is composed of the ball, the sight, the lachrymal point (which is the point nearest the nose), the upper and lower

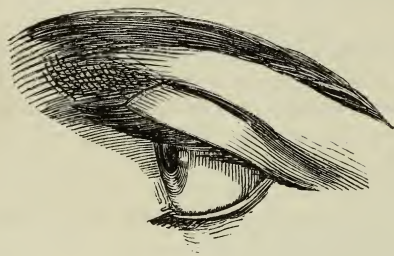
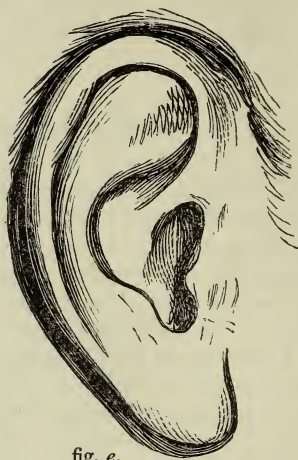
fig. *d*.fig. *e*.

eyelids, and the eyebrow (fig. *c*). The ball when seen in front is an exact

circle, with the sight in the centre; the height is equal to half the length, and the eyebrow is situated above the eyelid about one-third the length of the eye. The eye in profile is half the length and exactly the same height as when seen in front; the eyeball forms an ellipse, and the sight is always in the centre (fig. *d*).

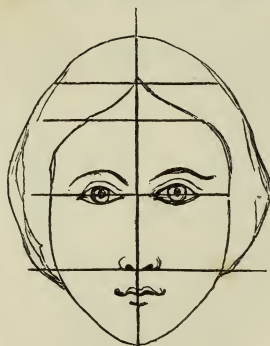
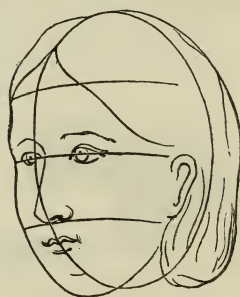
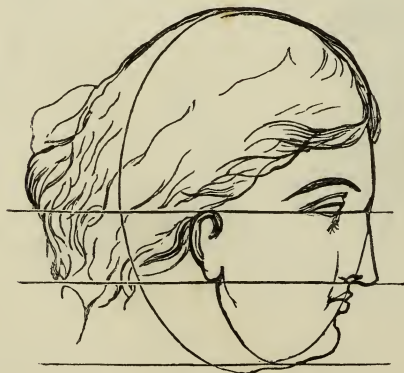
fig. *f*.fig. *g*.fig. *h*.fig. *i*.

The ear in width is equal to one eye, and its length to two eyes (fig. *e*). In

the annexed figure (fig. *f*) a front view of a face is given. In order to obtain a correct proportion, a perpendicular line must first be drawn, and then divided into two parts by a horizontal line drawn across the centre of it, which will give the point for the height of the eyes. After drawing the outline of the face, the perpendicular line must be divided, as in the sketch: the lower point will give the place for the lower part of the nose; the mouth is situated about half an eye lower than this; the ear is exactly the same length as the nose, consequently these are on a level. The same proportions are observable in the figures *g*, *h*, *i*, and *j*. The hand is the same length as the face, and its width is equal to one-half (fig. *k*). The side view of a hand is the same length as when seen in front (fig. *l*). The foot in profile is nine eyes in length and three in height (fig. *m*). Figures *n* to *q* inclusive are examples of hands, arms, &c. &c. The generally received proportion



fig. *j*.

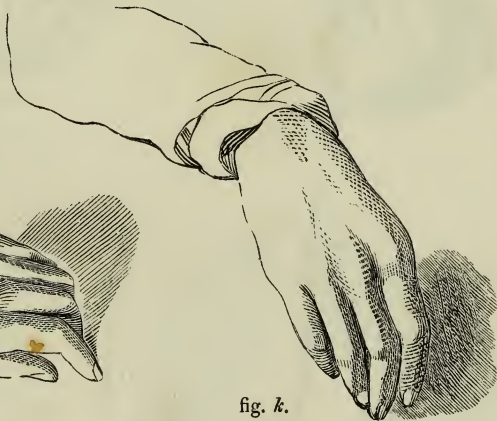

fig. *k*.

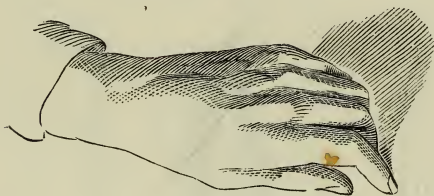

fig. *l*.



fig. *m*.

of a man is ten faces in height ; by extending the arms horizontally their full length, the same proportion is obtained. The length of two noses gives the width of the neck when seen in front. Two heads give the width of the shoulders when seen in front. The length of the fore-arm

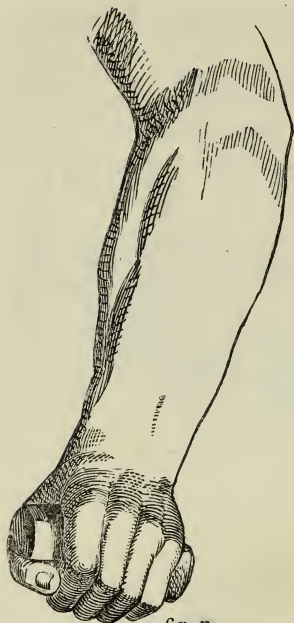

fig. n.



fig. o.

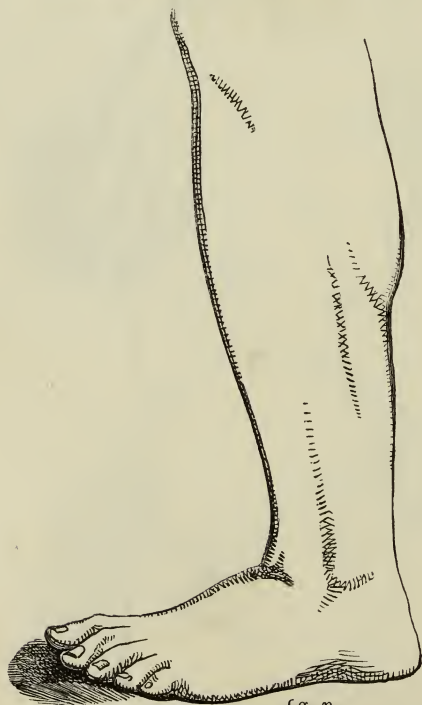

fig. n.

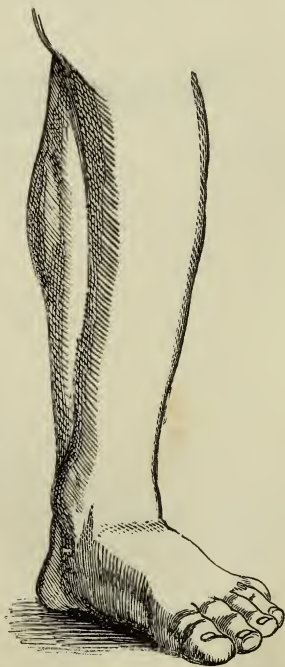
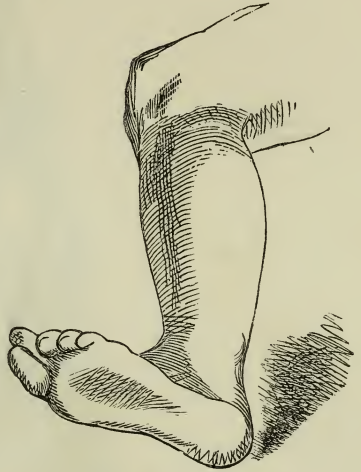

fig. q.

to the extremity of the fingers is equal to seven noses and a half. The width of the wrist as seen in front is equal to a nose and one-third. When

seen in front, the width of the knee is equal to two noses ; but in profile it is a degree less. The length of the leg from the knee to the heel is equal to three faces. When viewed in front, the width of the leg near the ankle is equal to a nose and a half, but it is less when viewed in profile. The annexed (fig. *r*) is a sketch of a leg foreshortened, and the following (fig. *s*) that of a bust. In figures *t* and *v* are given examples of figure-drawing, which the pupil would do well to copy.

At this stage of his progress the pupil should procure a plaster cast of the human form, or part of it. The materials he will require are, a drawing-board on which to fix his paper, a few sticks of black chalk, a leather stump, a small quantity of charcoal, and a port-crayon ; it would also be well if he obtained a quantity of the crayon paper, which is slightly tinted, and takes the chalk well.

fig. *r*.

The light should be allowed to fall on the sketch from the left hand. In order to catch the proper effect of the parts sketched, the pupil should sit so as to throw back the head as far as possible from the drawing. A correct outline of the bust or figure should first be drawn with the charcoal, which may be erased by slightly brushing it with a silk or other light handkerchief : this is better than rubbing the lines out, as the friction destroys the surface of the paper. After a correct outline of the subject is obtained, the pupil should trace it with the black chalk as faintly as possible, then by means of the handkerchief remove the charcoal, which will leave a beautiful clear outline ; after this he may begin the shading.

fig. *s*.

He must first scrape a little of the chalk on a paper as fine as possible, and rub the leather stump among

it ; taking this, he must rub in the shadows : these will by this means be soft and beautiful, and will prepare a good ground for the finish.



fig. 6.

Having rubbed in the shading as like that of the model as possible, carefully observing the different strength of the shadows, he must point or

sharpen his chalk, and begin to put in the details. He should patch over all the shading with the fine point of his chalk ; this, when done



fig. v.

in a proper manner, gives a very beautiful effect. In shading, the pupil must observe that there are two kinds of shadows ; one is called the *shadow of incidence*, the other the *shadow of projection* : the shadow of projection is always defined, having a sharp decided edge ; the shadow of incidence is always soft, having no defined edge, but softening imperceptibly into the lights. The pupil must be careful to leave no hard edges ; for although the shadow of projection is decided, the edges are

not hard ; moreover, the deepest shadows are always nearest the highest lights. The drawing of the bust or figure will require a slight background to detach it from the paper. If any mistakes are made in sketching, a little stale bread will remove the defective parts.



SECTION III.

PERSPECTIVE DRAWING.

PART I.

INTRODUCTION — PRINCIPLES AND TERMS EXPLAINED.

THE aspect under which the art of drawing in perspective has usually been presented to the student has not been of a kind calculated to induce him to enter upon its pursuit, much less to inspire him with feelings of ardour in its acquirement. The repulsive and formal array of theorems, demonstrations, and corollaries, however convincing to those who will be at the pains to master them, are calculated rather to disgust than to allure the general reader; and the youthful learner of either sex turns with dismay from their strictly logical pages, and seeks a premature escape into those more flowery fields of drawing in which the hand and the eye are the sole, but often the fallacious guides.

That the study of perspective should thus be frequently avoided as a dry and scholastic problem, or an inexplicable chaos of lines and angles, is not so much the fault of the art itself, as of the uncouth garb in which it is often clothed. Divested of this, its principles are more easy of acquirement than those of many other arts which are sought after as recreations, and are quite as pleasing in their development. To take an example, for instance, from the study of music:—even to those whose natural taste and skill give them great facilities in the latter pursuit, the mental labour and manual application it demands are infinitely greater. The study and practice required before an approach to a pleasing effect can be produced from any musical instrument, are unquestionably much greater than those which are necessary for the ready handling of the pencil and T square: the compasses are more easily managed than the violin or piano; and the mazes of intersecting lines are less intricate than the perplexing varieties of crotchets, quavers, dots, and spaces. And when those beautiful laws by which objects arrange themselves, so to speak, before the human eye, in forms varying according to their positions relatively with the spectator, are once understood and reduced in the mind to principles of order, the pleasure obtained from their contemplation is of the same nature as that which we derive from listening to the performance in correct time of an elaborate musical composition.

Though, therefore, the art of correct delineation is more easily acquired than that of correct musical performance, its effects are not on that account the less pleasing. Pleasurable sensations affect the mind through the medium of the senses; and there seems to be no reason why those which obtain access through the eye should be of a less exalted character than those operating through the medium of the ear. The comparative

sensibilities of these organs in different individuals will in each case decide which organ is most acutely sensitive to such emotions in that particular case ; but as we know that with the deaf the eye, and with the blind the ear, is chiefly the medium through which such sensations enter the mind, and as persons thus deprived of different senses appear equally sensitive to them, we may safely conclude, as a general rule, that the pleasure derivable from contemplating a pictorial representation correctly delineated is equal to that obtained from listening to a piece of music correctly performed ; and *per contra*, that the want of that correctness which a knowledge of perspective rules alone can impart to the draughtsman, is as displeasing a defect in him as the perpetration of discord, or a defalcation in time, would be in the musical performer.

But the pleasures of perspective are not restricted to the beholder, any more than those of music to the listener. They are enjoyed, perhaps, in a higher degree by the artist himself, when he sees the objects he wishes to represent gradually emerge from his labyrinth of lines, and assume those fair and exact proportions in which the mirror of nature presents them to his view. Secure in the certainty of a truthful representation, and charmed as he proceeds with the beautiful simplicity of the process by which that truth has been attained, he contemplates the accurate counterpart of his original with the delightful consciousness of a success achieved ; a success which, less transient than that of sounds which die away as soon as heard, remains permanently inscribed in his drawing, and excites new pleasure whenever reviewed. When it is added, that this elegant source of enjoyment is open to either sex ; that its pursuit is attended with no expensive adjuncts ; that the art may be agreeably acquired within the limits of the family circle, and does not lead to the relinquishment of home,—it will not be necessary to adduce much that might yet be said to recommend its more general adoption, both in the instruction of youth and the amusement of the more mature.

But its value as an innocent gratification is even a smaller recommendation than its great utility in the practice of the arts, to most of which it is increasingly valuable. To the architect, its acknowledged worth requires no comment ; for though the plainer representations of plan, section, and elevation convey his ideas to the mind of the building artificer, the portraiture of the future structure, exactly as it will appear from some given point of view, is often necessary to satisfy the judgment of the employer. To the pictorial artist it is indispensable, for the scenes which he has to depict must often be impressed only on his memory ; and he will therefore be at fault, without a knowledge of the rules which regulate the forms under which they appear. To the engineer it is frequently highly useful in conveying correct impressions of his viaducts, his tunnels, or his bridges ; to the machinist, who would present an accurate likeness of wheels, rollers, and other mechanical complications ; to the upholsterer, whose chairs and tables require to be shewn in various points of view ; to the decorator, who must pre-inform the mind of the occupant as to the effect of his mural ornamentations ; in short, to the practitioners of almost every art, and to the makers of almost every article of daily use. The preposterous violations of perspective that may frequently be met with in commercial books of patterns, whereby the effect of the drawing is injured, shew that its rules are not sufficiently known ; and the neglect of them which spoils the highly-

finished paintings of some of the first masters of the old Flemish school, excites regret that the art of drawing was with them so far behind that of colouring. The unpleasing effect of the incorrect drawing beneath such elaborate colouring is a forcible plea in favour of every representation being depicted on the infallible basis of correct perspective.

It is important that the learner, before commencing the necessary instructions in this pleasing art, should have a correct idea of the critical meaning of the word Perspective, and of the purpose which it is more immediately intended to effect. Its meaning is, the exact appearance which objects assume when viewed from any given point or station; its purpose, the representation of such objects on a plane surface, as a sheet of drawing-paper, in exact accordance with such appearance.

In the work on Practical Geometry, instructions have been given how to describe squares, circles, and various other regular and irregular figures. But those instructions refer exclusively to their *geometrical* representation, as they would appear on a plane surface at right angles with the line of vision, that is, placed directly opposite to the eye. If, however, they be not exactly opposite to the eye of the spectator, they will assume different outlines, according as they may be situated above it, below it, towards the right hand, or towards the left. Now, in a view embracing a considerable number of objects, one only of those objects can be situated exactly opposite to the eye; the remainder will all be viewed more or less at an angle, according to their respective positions. Therefore one only of those objects, if truly represented exactly as they appear, can present a geometrical outline; the others will all have *perspective* outlines, presenting two or more of their sides to the view at the same time. This will be obvious after consulting the accompanying illustration, which

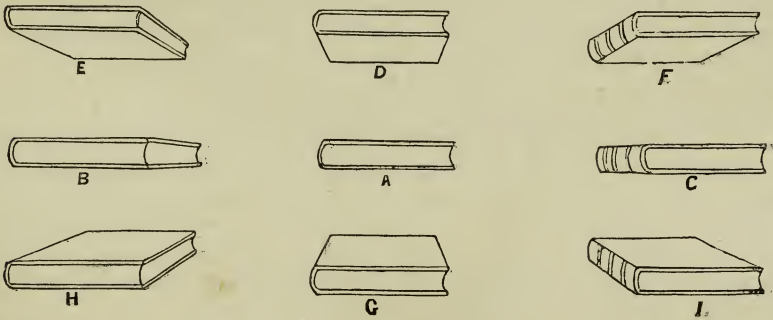

fig. 1.

gives a series of correct perspective representations of a thick book, which the reader is supposed to hold in his hands in various positions consecutively. If he hold it up level, with one of its edges opposite to his eye, its form and appearance will be that shewn at A, in which he will see nothing but a geometrical view of that edge; if, keeping it at the same level, he move it towards the left, a second edge will come into view, as at B; if towards the right, the last-named edge will disappear, but the back of the book will be seen, as at C. If he now bring it back to the first position A, and elevate it somewhat, the front and back edges will both disappear,

and the lower side will be seen, as at D ; by moving it at the same level towards the left, three of its surfaces will come into view, as at E, or towards the right, as at F, the lower side being in both these cases seen as well as the two edges. Let the book now be held, at G, as much below the eye as it was previously above it ; its lower side has now disappeared, and the upper side becomes visible ; and by moving it to the left (H), or to the right (I), three surfaces again become visible, as when the book was held at E and F ; with this difference, that the upper side of the book is now visible instead of the lower. It will be observed that, in each of these nine positions, a comparatively slight change of position has effected a material change in the outline of the figure presented by the book ; its boundary-lines assuming different slopes, and different sides or edges coming into view or disappearing, according as it has been shifted upwards or downwards, to the right or to the left. The main object of perspective is to discover and apply the rules which regulate these varying slopes and inclinations of the boundary-lines of objects, by which the draughtsman may be enabled to transfer to paper a faithful delineation of them exactly as they appear.

The student is recommended to go through this simple exercise with any thick book ; taking care, as he brings it into its successive positions, and observes the outline presented, to keep his head steady, so that his eye may retain its original level and position. A writing-desk, chess-box, or any object of similar shape that may be at hand, will answer the purpose quite as well ; and by thus making his observations and exercising his thoughts upon simple and familiar objects, he will easily acquire a clear idea of the change of outline produced by a change in the position of the object relatively with the spectator. This branch of the art is denominated Linear Perspective, inasmuch as it refers exclusively to the lines which constitute the boundaries of objects and determine their form. And as form is the basis of correct drawing or painting, which determines the position and extent of each of the various colours to be superadded to give increased effect to the form, the principles and practice of linear perspective will be first treated of ; reserving for the latter part of this section the more advanced subject of Aërial Perspective, which refers entirely to the various degrees of depth or force of colour and shadow, by which various distances can be more naturally and effectively denoted than is possible by mere diminution of size, and the knowledge of which is essentially necessary in every case where it is proposed to superadd to a correct copying of natural forms, those increased effects which result from the further imitation of nature, by adopting her gradations of colour and shade.

It will be obvious to any person standing at the end of a long straight street, and looking along it observantly, that the line of the curb-stones, which separate the pavement from the road-way, and also those lines of the pavement which run in the same direction as the curb-stones,—that is, along the street,—appear to draw nearer to each other as they recede from him ; and if the street be a very long one, they will approach each other so nearly as almost to meet in a point. If he look at the curb-line and other lines of pavement on the other side of the street, he will perceive in them a still greater inclination, all apparently tending towards the same point, and which point will appear to be somewhere in front of him. Turning his eye upwards, he will remark the same curious effect in the cornices of the houses ;

which, with the window-sills, the tops of the railings, the lintels of the doors, and the lines of the shop-fronts, all manifest the same tendency to approach each other, and meet at some remote point at the end of the street. He will observe, further, that lines on or near the ground all point rather upwards; those about as high as his own head are tolerably level; while those which begin much above his head, such as the cornices and heads and sills of the upper windows, all incline downwards; also, that the higher the latter are at any point near him, the greater is their slope downwards as they recede from him (fig. 2).



fig. 2.

A similar effect may be observed by any person standing at the end of a long avenue of trees, and looking along it. The convergence of the lines of the feet of the trees, the commencement of the foliage, &c., is almost equally manifest (fig. 3).

If, again, the observer walk on till he arrive at a crossing where the street is intersected by another street, and then cast his eye diagonally across it, so as to face the corner opposite to that at which he makes his observation, he will perceive a totally different result. None of the lines of the first-named street appear to meet *in front* of him, though they still manifest a tendency to approach each other, and meet in some distant point far away *on one side*; while those of the second street which has come into view appear all to tend towards some second point *at the other side*. This effect will be recognised with the aid of the street view in fig. 4.

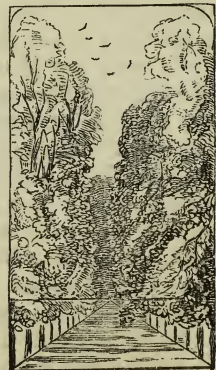

fig. 3.

The same effect may be observed in any room. Let the learner stand

at the end of an apartment, and note the direction of the lines of the ceiling, walls, and floor. He will find that those lines which are as high from the floor as his head are level or horizontal; those of the ceiling,



fig. 4.

which are above it, slope downwards as they recede from him; those of the floor, which are below it, slope upwards. The degree of this slope or inclination increases near the ceiling and floor, and continues to do so till, at one part of the room, the lines assume a vertical position; thus shewing that they all appear to converge towards some unknown point, though well known to be all in reality parallel and horizontal.

Now, since flat or plane surfaces are bounded by lines, it follows, that changes in the direction of such boundary-lines cause corresponding changes in the form of the planes which they enclose. The ceiling, floor, and sides of the room are planes whose perspective appearance and form are determined by the lines at which they meet each other; and such plane surfaces will seem to converge just as lines do. In the street-view (fig. 4), for instance, the sides of the houses form such converging planes.

After lines and planes, comes the consideration of solids. As planes are denoted by lines representing their external configuration, in like manner are solids denoted by planes representing the forms of their various sides. A house, a book, or other object composed of straight lines, may be looked on as a solid body whose external form is an arrangement of various planes; and the true perspective representation of such solid will be composed of perspective views of such of these planes as can be seen at once by the spectator from any given station. Thus in fig. 1, the sides and edges of the book are planes, of which one, two, or three, according to its position with respect to the spectator, are seen in perspective at once. And as the perspective appearance of planes is changed by any change in the

direction of their boundary-lines, so is that of solids changed by changes in the outlines of their constituent planes. And having shewn that lines and planes change their appearance according to the position from which they are viewed, it follows that the *point of view* has a corresponding effect on the outlines and appearance of solids.

It will next be our object to arrive at the rules by which the exact appearance of lines, planes, and solids, from any given point of view, may be laid down on paper; to which end, we must first ascertain the exact points towards which, as has been already explained, the lines of such objects converge, and at which they would meet if produced. These imaginary points are called *vanishing-points*; because if a plane were long enough to reach as far as the sight could extend, its top and bottom lines would meet at such a point, and the plane would seem to terminate or vanish at that point. These vanishing-points are of the greatest importance in perspective, and the most important of them all is the *point of sight*, which will therefore be the first explained.

The *point of sight* is the point in a picture which is exactly opposite to the eye of the beholder, and is always situated somewhere on the line of the horizon. The height of this *horizontal line*, and therefore of the point of sight, is dependent on the height from which the spectator is supposed to take his observation, which shews the horizontal line varying according to the height of the eye (fig. 5). In copying any scene from nature, it will be seen that the line of the horizon always maintains the same level as the eye of the draughtsman. If he takes a view standing

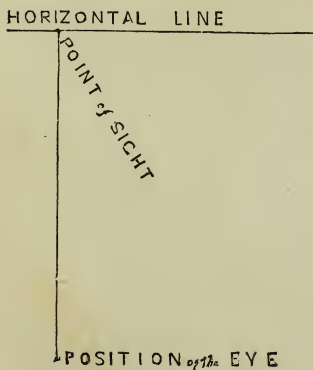

fig. 5.

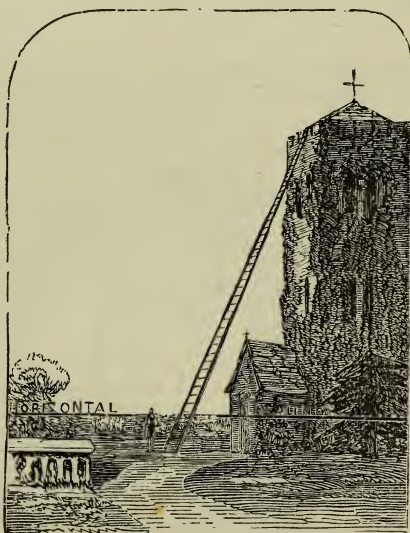

fig. 6.

on level ground, the horizon will seem low (fig. 6), and the view will embrace but a limited field; if from any considerable elevation, the horizon will be higher (fig. 7), and a wider range of objects will be visible; and from a still greater height, such as the top of a hill or of a tower, the horizon still maintains its level with the spectator, and the field of vision is correspondingly extended (fig. 8).

The space comprised between the horizontal line and the base of any

picture, whether it consist of land or water, or both, is called the *ground-plane*; which will represent a space more or less extensive according as the

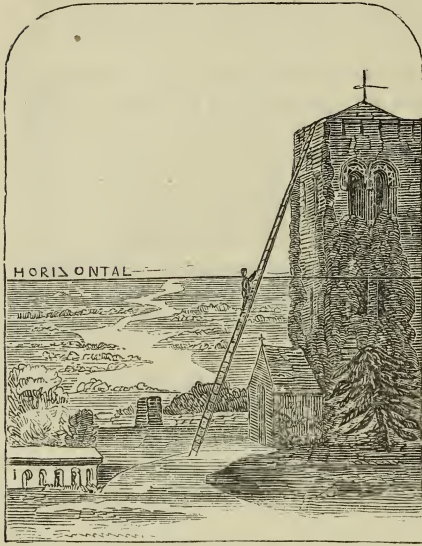

fig. 7.

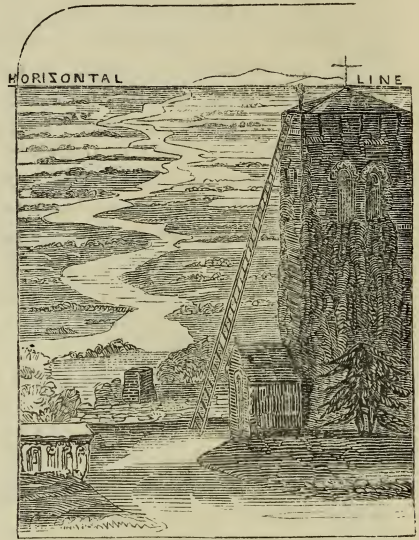

fig. 8.

spectator's position, and consequently the horizontal line, may be elevated, as in fig. 9, or of lower altitude, as in fig. 10.

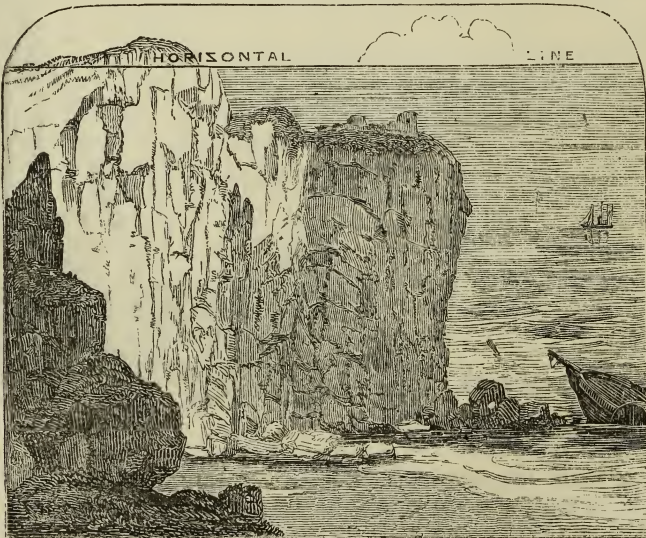

fig. 9.

In many cases where houses, trees, or other objects intervene, the view of the horizon will be intercepted, and it will therefore not be visible from

the spectator's position, which is termed in perspective the *station-point*. In such cases, however, the horizon exists, though not visible from the

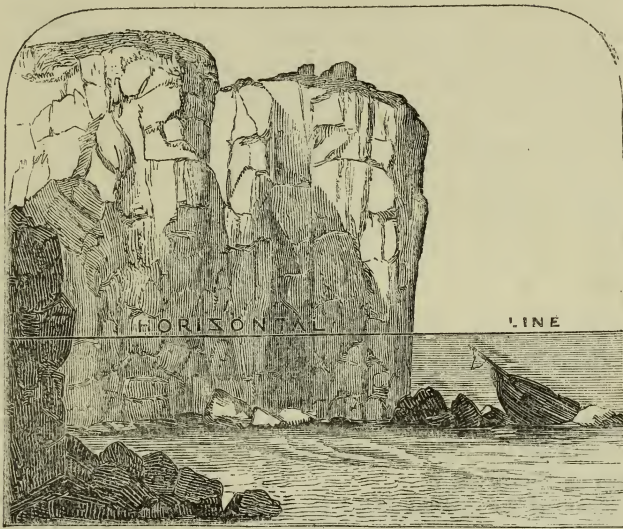

fig. 10.

station; and its position must be denoted by an imaginary, dotted, or occult line extending across the drawing, as on it will be found the proper situations of the point of sight and other vanishing-points.

If, when looking through a window, we could trace, with some instrument that would leave its marks on the surface of the glass, the lines of the objects seen through it, such lines would constitute a true perspective representation of those objects. Now, a window is a plane surface perpendicular to the ground-plane of such representation; and as a window represents, so any picture in its frame is supposed to represent the objects shewn therein, exactly as they would appear if the frame were glazed, and the objects beyond it were marked upon the surface of the glass. The space included by the frame, and here supposed to be filled with a flat sheet of glass, is called the *plane of delineation*, or by some draughtsmen the *plane of the picture*.

If a sheet of glass be set up on its edge on a flat table, with some object (say the pentagonal figure shewn in fig. 11) on one side of it, and the eye of an observer on the other, it will constitute a plane of delineation; and the line *ab* at which it rests on the table (which will represent the ground-plane) will be the *base-line of the picture*. Technically speaking, the base-line is the line at which the plane of the picture intersects the ground-plane. When the eye *E* is directed towards the object, rays of light will proceed in straight lines from every point of the object towards the eye. These are called *visual rays*; and the points at which these visual rays intersect the plane of the picture are the true perspective positions of those points as they appear from the station *E*. When the perspective places of any two points are found, a right line connecting those points will be the perspective representation of the corresponding line in the object. Thus, the five

visual rays E1, E2, E3, E4, E5, proceeding from the points 1, 2, 3, 4, 5 of the object, intersect the plane of delineation at the points similarly num-

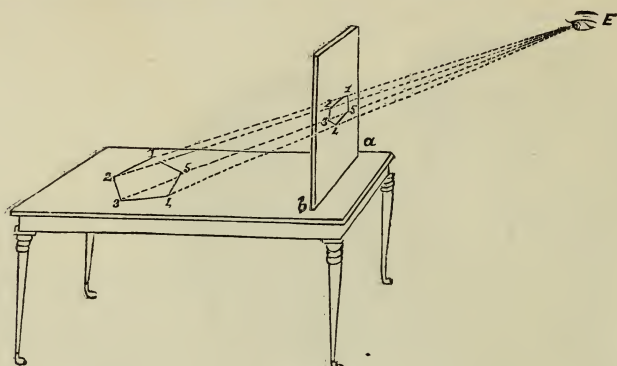

fig. 11.

bered ; and the lines connecting those points with each other will be the representation of the figure on the table, transferred in perspective to the said plane, as seen from E.

The plane of the picture, then, is an imaginary transparent plane supposed to exist somewhere between the spectator and the object ; and the picture itself is a copy of the view that would be seen through such plane.

It was just now stated that rays proceed from every point of an object towards the eye. They also diverge from any radiant point in every direction. It is not necessary for our purpose to enter into a minute explanation of the beautiful mechanism of nature by which representations of objects are conveyed to the mind through the medium of that organ ; but a glance at its principal parts may assist the reader to comprehend what is to follow. Transparent bodies of various forms are called *lenses* ; and it is known to opticians that rays of light passing through any lens undergo

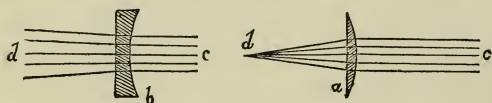

fig. 12.

certain changes in their direction, according to its form and density. Thus the tendency of a convex lens, *a*, figure 12, is to concentrate parallel rays passing through it, and bring them all to one point or focus ; whereas that of a concave lens, *b*, fig. 12, is to disperse them, by throwing them wider apart from each other. The density of the lens or transparent medium effects similar changes. A ray passing from a rarer to a denser medium, as from air into water or glass, is said to be refracted, which means that it is bent from its straight direction ; an effect which must have been observed by the student fond of aquatic amusements in the bent appearance of an oar when dipped into water. These properties of lenses are turned to useful account by opticians in their endeavours to assist defective vision. The glasses of the spectacles which they provide for the weak-sighted are lenses, the curvature of which is adapted to the defect to be remedied. If the individual have not a distinct perception of distant objects, owing to

extreme fulness of the curve of his eye, a concave lens interposed between it and those objects counteracts the detrimental effect produced on the vision by the excessive convexity. If, on the other hand, flatness of the ball of the eye impairs his perception of objects near him, the interposition of a more convex lens compensates for the deficiency. These ingenious contrivances are, however, only imitations of those more perfect arrangements adopted by nature in the eye, to enable it to perform its function of conveying to the brain or sensorium correct ideas of the forms, colours, sizes, and distances of objects. But it should first be explained, that any set of rays diverging from any point is called a *pencil of rays*; that the central ray of any pencil is called its *axis* (*c d*, fig. 12); that the axis of any pencil in passing through a lens undergoes so little divergence or refraction, that it may practically be said to continue a straight line; and lastly, that with a double lens equally convex on both sides, the distance of the *focus* will be equal to the radius of the curve. These optical facts being premised, let us examine the operation of such a lens (A B) when rays from any object (CE) pass through it. (Fig. 13.) From any three (C, D, E)

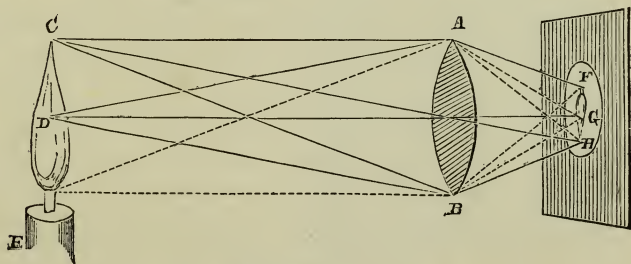

fig. 13.

of its innumerable radiating points, imagine three pencils of rays (A C B, A D B, A E B) to fall upon the lens. From the nature of a convex lens, as just explained, the axis of each pencil will pass straight through the lens, but its diverging rays will be collected on the axis in a focal line (F, G, and H) at a distance beyond the lens equal to its radius. If all light be carefully excluded except what passes through the lens, and a sheet of paper be placed at the focal distance, the rays from the object will present an inverted image of it on the paper. This may be easily proved in a dark room, by holding an ordinary spectacle-glass between a lighted candle and a sheet of paper, taking care that the paper is at the proper focal distance from the lens, which will be known by a clear but inverted image of the candle being visible on the paper.

Now this is but an imperfect imitation of what takes place in the human eye, of which fig. 14 is a diagram. Its principal apparatus is a double-convex lens, called the *crystalline humour*, consisting of a clear liquid contained in a transparent bag or membrane, and protected externally by a transparent coat, D, called the *cornea*. Between these, and surrounding the crystalline humour, is a membrane having a circular hole, P, called the *pupil*, furnished with a muscular provision by which its opening may be enlarged or diminished. In the back part of the eye is an expanded net-work of nerves lining the enclosing membrane, and called the *retina*, which is connected by means of the optic nerve with the brain.

The visual rays from objects pass through the pupil to the convex lens, which produces their inverted image on the retina, whence the optic nerve

communicates their impression to the brain or sensorium. In the candle experiment the spectacle-glass represents the cornea and crystalline humour, and the sheet of paper the retina. There is at the back of the eye a muscle attached, by which it may be moved towards either side, so as to direct the opening of the pupil and the face of the crystalline lens towards any desired object; but as perspective drawing only embraces such objects as can be seen at one time without moving the eye, further notice of this muscle is unnecessary here.

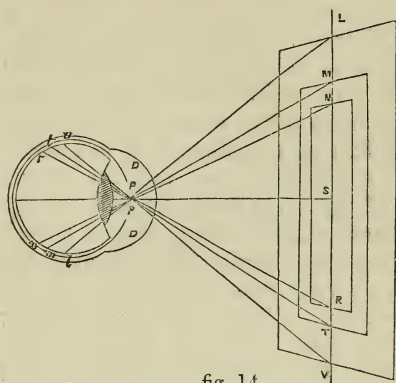

fig. 14.

A slight consideration of this diagram, elucidating the structure of the eye, will suffice to shew the reason why the range of vision towards either side of the spectator is limited; that is, why he can only see a certain number in proportion of the objects before him at once, and why he must turn his eyes either to the right or left before he can clearly perceive more of them. A line passing directly through the eye at right angles with the retina, as the line SP in fig. 14, is called the axis of the eye; and it is demonstrable that in proportion as visual rays are parallel to or coincide with such axis, so will the image they form on the retina be clear and distinct. A visual ray entering the orifice of the pupil in an oblique direction, as the line Ll in fig. 14, will also fall on the retina obliquely; and if this obliquity exceed a certain degree, the image of the object on the retina becomes indistinct or invisible. If the object be viewed from a point too near it, the visual rays from its extremities will enter the eye at too great an obliquity, and it cannot therefore be all viewed at one glance (fig. 14); but if it be removed to a greater distance,

the obliquity of the rays from its extremities will be diminished, as in fig. 15, and its entire width will come within the convenient range of vision at one view. Now it is found that the greatest obliquity of the extreme visual ray which will permit a comprehensive view of the whole object, or set of objects, at one glance, without turning the eye, is when that ray forms with the axis of the eye an angle of 30° ; and as objects are visible at an equal distance on both sides of that axis,



fig. 15.

the angle formed by the two extreme visual rays from both sides of the object should not exceed 60° , which is therefore denominated *the angle of vision*. The diagram, fig. 16, gives a correct idea of this angle, and of several others useful in the practice of perspective drawing. An angle of 60° is found by taking a line of any length, and with a pair of compasses set to that radius at each end forming an intersection, as in fig. 17.

This angle of 60° is the largest that should ever be chosen in fixing

the position of the eye with reference to any object to be drawn ; and where many objects must be included in the drawing, it is a very good

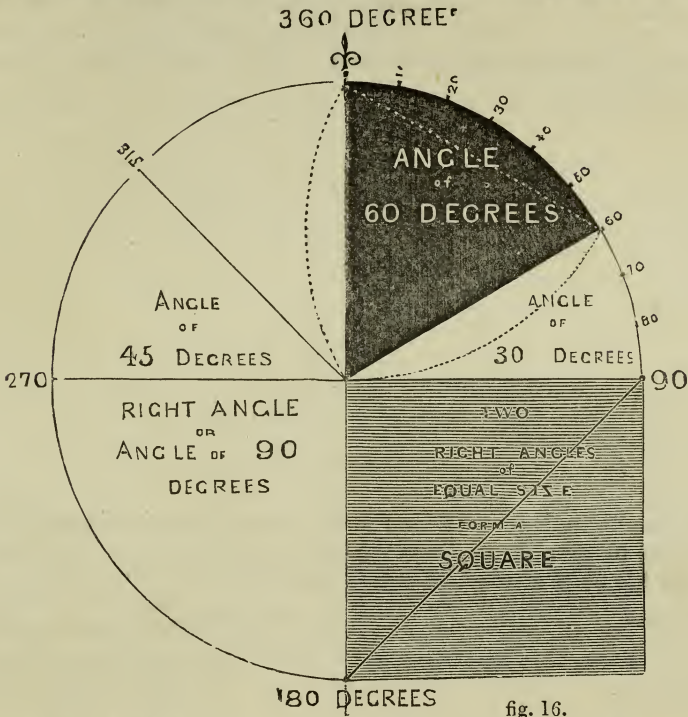

fig. 16.

one to adopt ; but when it is not desirable to take in many objects, a smaller angle will often be advantageous, as shewn in plan, fig. 18, where the adoption of a smaller angle, *d f e*, excludes the two objects *a* and *c* from the width embraced by the picture.

From what has been stated, it will be apparent that the width of the plane of delineation, that is, of the picture, and the lines which form the angle of vision, constitute a triangle, the apex of which is the station-point. It is important to have a clear conception of this, as it regulates the *distance of the spectator* from the plane of the picture, and this distance exercises an important influence in determining the forms of objects in perspective.

We have seen in the street-view, fig. 2, how objects of equal height and width diminish in their perspective *height* and *width* as they recede from the eye. A similar diminution takes place in their perspective *lengths* ; and these diminutions, by which their apparent bulk is reduced, depend on their respective distances from the spectator. The rule for determining dimi-

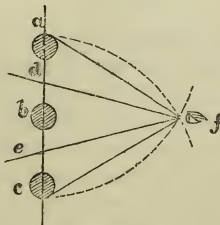

fig. 18.

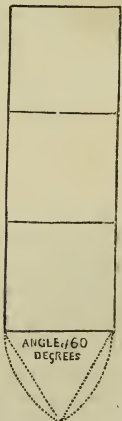

fig. 17.

nutions in the lengths of objects is obtained by the assistance of a point on the horizontal line, the distance of which from the point of sight represents the distance of the spectator from the plane of delineation, and is therefore called the *point of distance*. In the ground-plan, fig. 19, the position of the eye and its distance from the point of sight in the picture are denoted

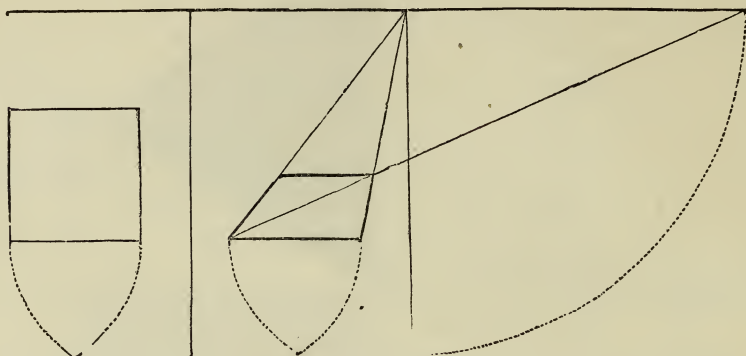

fig. 19.

by the line drawn between them; and if a space be set off upon the horizontal line to the right or left of the point of sight equal to the distance so denoted, the point at the end of that space will be the true distance-point,

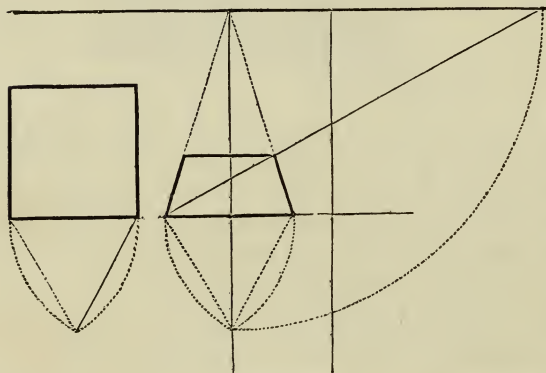

fig. 20.

which will determine the perspective lengths of receding objects, by rules to be hereafter laid down. This is made evident in fig. 20, which contains a ground-plan of a square on the left, while the right shews the same square in perspective, and the mode by which the point of distance is obtained. One leg of the compasses is to be placed at the point of sight, and the

other extended to the station-point or position of the eye; then with the point of sight as a centre, and the distance between it and the station-point as a radius, an arc of a circle from the station-point will intersect the horizontal line at a point which is the distance-point required. A line drawn from the corner of the square on the base-line to this distance-point gives the perspective diagonal of the square; and the square terminates at the intersection of the diagonal with the visual ray drawn to the point of sight. The same mode of obtaining the distance-point is shewn in fig. 19.

The diminishing effect of distance, palpable though it is to the eye, at every glance embracing objects more or less remote, may be made still more obvious by simply applying the eye to one end of any straight tube. In

this case the end of the tube near the eye is on the plane of delineation, AB (fig. 21); and though its further end is known to be of the same size exactly, yet its image CD on that plane is not half the size; and the longer the tube, the smaller will that image be. The respective apparent sizes of the two ends are shewn in the end view at E, which gives the exact appearance of such a tube to an eye so situated. A sheet of paper rolled into a tubular form will illustrate this diminution.

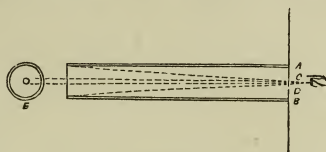
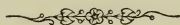

fig. 21.

The same effect may be observed on a larger scale by a person looking through a straight railway-tunnel from one end; the tunnel being, in fact, a large tube. If it be a long one, the apparent diminution caused by the distance of the further end will be very remarkable, although the two ends are known to be exactly the same size.

The objects of perspective drawing, its connexion with the functions of the eye, its general principles, and the principal terms used in its practice, having now been explained, so as to render its rules more easily comprehended, the student is advised to study and make himself master of the figures and descriptions which have been given, before proceeding further. A good understanding of them will save him infinite trouble hereafter, and will greatly conduce to his pleasure as he proceeds; and as nothing has been advanced requiring half the study and application that are requisite to master a single air on a musical instrument, it is hoped that the small delay caused by the enunciation of principles before dashing into practice, will be found to be compensated by the increased facility with which it will enable that practice to proceed.



PART II.

PARALLEL PERSPECTIVE — SQUARES — RECTANGLES — DIAGONALS —
 PARALLEL PLANES — SOLIDS — CIRCLES — PYRAMIDS — OTHER
 FIGURES — POSITION — OBLIQUE PERSPECTIVE — INCLINED PLANES
 — HEIGHTS, WIDTHS, DISTANCES — SCALE — AERIAL PERSPECTIVE.

AN object may be seen in two different points of view : the one being when one side of it is parallel with the plane of the picture, and therefore at right angles with the axis of the eye ; the other, when none of its sides are so circumstanced, and it must therefore be viewed at an angle, or obliquely. To the representation of objects thus differently circumstanced, different rules apply ; one set of rules being termed *parallel perspective*, the other *oblique perspective*. The difference lies chiefly in the management of the vanishing-points ; the point of sight, horizontal line, base-line, plane of picture, and some other details, being common to both. As being the most easily learned, and forming an appropriate introduction to the least simple of these two sets of rules, those of Parallel Perspective will be first treated of.

Let a square, each of whose sides is equal in length to the line AB,

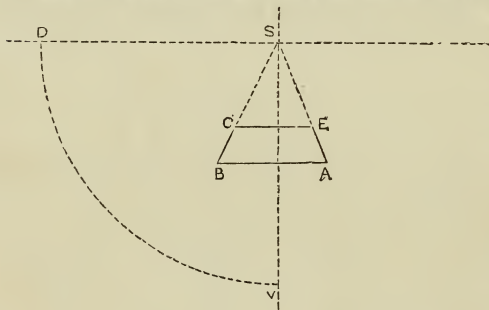

fig. 22.

fig. 22, be shewn in parallel perspective. Draw the horizontal line, and on it mark the point of sight S ; which, as we shall first suppose the spectator to stand directly opposite the square at the station-point V, must be perpendicularly over that point, as denoted by the line S V. From S, with the radius S V, set off the distance-point D on the horizontal line, by

drawing the arc D V. Draw the visual lines S A, S B, forming two sides of the square. Draw a line from A to D, which will give the perspective diagonal of the square ; and from the point C, where A D intersects S B, draw E C parallel to A B. The figure A B C E thus formed will be the perspective view of the square as seen from the station V.

Now, suppose this station, instead of being directly opposite to the side A B of the square, were situated towards the left of it, as in fig. 23. The effect of this will be, to remove the point of sight also to the left, which will produce a corresponding change in the direction of the visual lines S A, S B. Find, as in the last rule, the distance-point D^1 on the horizontal line, making $S D^1$ equal to S V ; with this difference, that in this case it will save space and paper if the distance-point be taken to the right of the point

of sight, instead of the left as in the last example. Proceed as in the last example, drawing EC, from the point of intersection E, parallel with AB.

In this figure two distance-points D^1 D^2 are taken, in order to shew that it matters not on which side of the point of sight the distance-point is chosen, except as regards the convenience of the draughtsman and the size of his paper. The distance-point D^2 gives the other perspective diagonal AC of the square, which will serve just as well for finding the true position of the line EC as the first diagonal EB, which has been found with the aid of the distance-point D^1 .

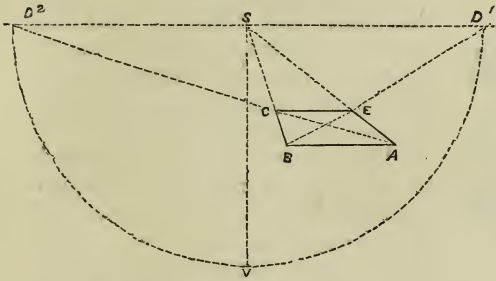

fig. 23.

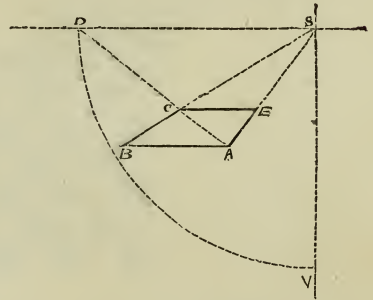

fig. 24.

Let us now suppose the station V to be removed to the right, instead of the left, of the line AB, fig. 24. In this case, the point of distance may be chosen to the left of the point of sight, to save space and paper. Set off SD equal to SV; draw the visual lines SA, SB, and the diagonal AD; the point of intersection C denotes the position of the further side EC of the square, which must be drawn parallel to AB. The figure ABCE is the perspective view of the square as seen from V in this third position.

It may be well here to explain, that lines merely drawn for the temporary purpose of obtaining other lines, and not forming part of the object to be shewn, are dotted in these figures, and are called imaginary or occult lines. In actual drawing, they are usually executed in pencil; and when the figure has been obtained by them and inked in, they are to be obliterated by india-rubber, in order to avoid the confusion arising from numerous lines.

It will not be necessary in future to draw the arcs VD of the last three figures. They have been given here for the sake of perspicuity; but in practice it will suffice to obtain the distance SV by compass, and mark the point D in its proper place with the pencil.

The three last figures should be carefully worked out, and compared with fig. 19, Part I. Such a study will greatly assist the learner in understanding the perspective of planes, and how it is affected by changes in the spectator's position.

Having shewn how one square is represented in parallel perspective, the study may be extended to numerous squares, as in a pavement. This is easily done by making AB equal to the width of the pavement, and dividing it into as many equal parts as there are squares in one side. Fig. 25 represents the plan and perspective of such pavement. The visual lines S 1, S 2, S 3, &c. represent the divisions of the pavement; the perspective

diagonal A D to the point of distance, at its intersection with the visual line S B, gives the further corner of the pavement ; from which the line E C, as before, drawn parallel to A B, completes its perspective outline. This

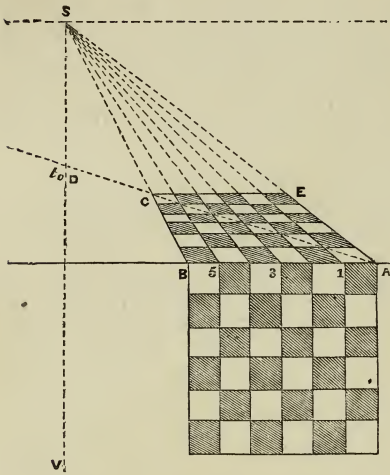

fig. 25.

diagonal also intersects every one of the visual lines S 1, S 2, &c. ; and a line parallel to A B, drawn through each intersection, completes the perspective outline of every square.

This example may also, for practice, be worked out with various station-points and distances ; but care must in all cases be taken that the horizontal lines be correctly drawn through the intersections, or an erroneous representation will result.

When only one row of squares is to be drawn, as in fig. 26, a diagonal must be drawn to the distance-point from the opposite front corner of each square ; such diagonal, by its intersection with the other side of that

square, will denote the back corner and position of the line E C, represent-

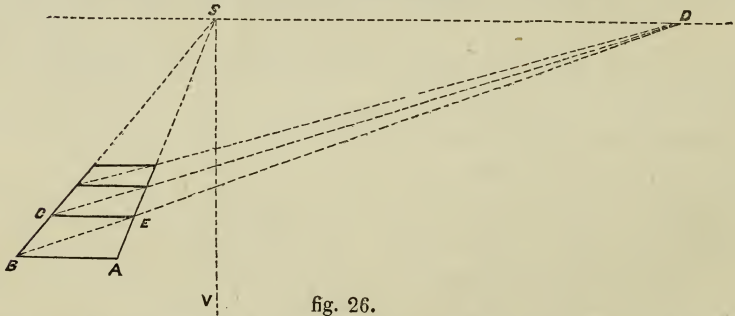

fig. 26.

ing its further side ; which line will form the front side of the next square, and so on for any number of squares.

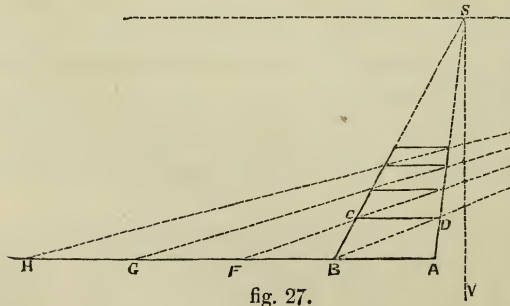

fig. 27.

the visual line SA, denote on that line the lengths of the sides of the respective squares.

The same object may be accomplished by prolonging the base-line on the side opposite the distance-point, and setting off on it the width of each of the proposed squares, as B F, F G, G H, fig. 27 ; a diagonal from each of the points F, G, H, to the distance-point, will, by its intersection with

The correctness of this rule may be proved, and another rule for the same object obtained, by prolonging the base-line to the right instead of the left, and marking off on the horizontal line to the left of the point of sight a distance-point D_2 , fig. 28, making SD_2 equal to SD ; the width of the squares set off in this line, as at l, j, k , and connected with the distance-point D_2 by diagonals, will denote the sides of the respective squares; and on comparing the figure thus obtained with fig. 27, the two will be found to be identical.

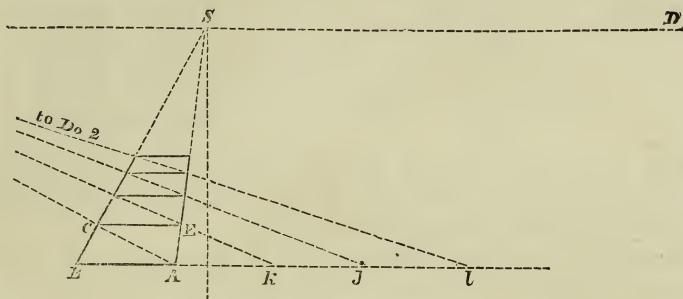

fig. 28.

The same rule is applicable to finding the perspective sides of parallelograms. Thus, for a perspective view of the parallelogram $ABCE$, the distance from the station-point

to the plane of delineation being assumed equal to SD , and set off accordingly on the horizontal line, fig. 29, set off BF on the base-line produced, equal to the side BC on the plan; a diagonal from F to the opposite distance-point D , intersecting the visual line SB at C , denotes the perspective length of the side BC . The same

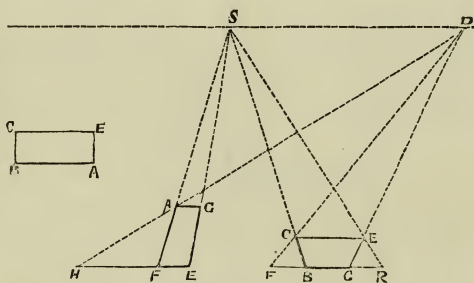

fig. 29.

object may be attained by using the visual line SR instead of SB , marking off RG equal to BC on the plan; and drawing the diagonal DG , intersecting SR at E , when RE will be the perspective view of that side on the plan.

But suppose the parallelogram is to be represented with its short side AE towards the spectator. Set off the length of that side on the base-line, draw the visual lines SF, SE (left hand, fig. 29), set off on the base-line FH equal to the long side, draw the diagonal DH from the distance-point, and its intersection at A with the visual line SF will denote the perspective length of the long side; complete the figure by drawing AG parallel to EF .

These rules will apply to the drawing of right-lined figures in parallel perspective, under every variety of arrangement. Thus, to draw in perspective a square enclosing two rectangles, as in the plan fig. 30, the spectator being opposite to the point S , and at the distance SD : first, find the

perspective view of the square $A B C E$, fig. 30, by preceding rules ; produce the sides of the rectangles till they intersect those of the square at

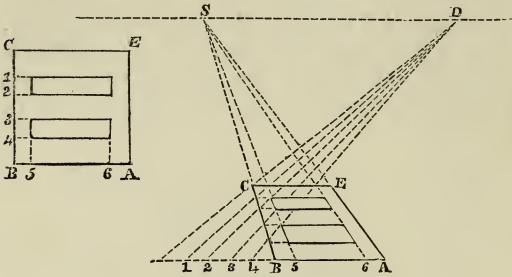

fig. 30.

1, 2, 3, 4, 5, 6 on the plan ; set off those points on the base-line of the perspective view ; draw the diagonals $D 1, D 2, D 3, D 4$; the points of intersection with $S B$ will denote the perspective positions of the points 1, 2, 3, 4 on the side $B C$. Draw lines from these points across the perspective square, and parallel with $A B$; these will give the longer sides of the rectangles. Draw the visual lines $S 5, S 6$ to the point of sight, which will give the shorter sides of the rectangles, and complete the figure.

The outline of a square being drawn in perspective, its perspective diagonals are obtained by simply drawing them from corner to corner. If

a smaller square be inscribed in a larger, its centre and diagonals will be identical with those of the larger ; and one visual line will suffice for determining the perspective of the smaller square. Thus, in fig. 31, the square $A B E C$ being obtained in perspective by preceding rules, draw its perspective diagonals ; produce one side $G H$ of the inscribed

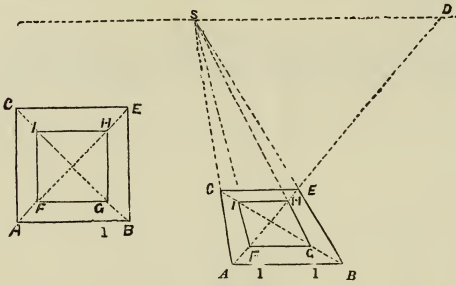

fig. 31.

square in the plan, intersecting $A B$ at 1 ; set off the distance $B 1$ or $A 1$ on the base-line of the perspective square, and draw the visual lines $S 1$, intersecting the diagonal $E A$ at F , and the diagonal $B C$ at G ; from these two points draw $H I$ and $G F$ parallel to $A B$; draw lines connecting $H G, F I$; and the perspective view of the inscribed square $F G H I$ is complete.

From these examples we may deduce the important rule in perspective, that *the proper distance and position of any point in a visual line terminating at the point of sight may be found by setting off its distance on the base-line, and drawing a diagonal from such distance to the distance-point on the horizontal line ; the intersection of the diagonal with the visual line being the point required.*

As a practical application of these rules, an example is here given (fig. 32) of the mode of drawing a chair in perspective. The distance-point is ascertained as before, by setting off the distance between the station-point and the point of sight upon the horizontal line. The seat of the chair is a square figure, found in the manner just described ; and the lines from one of its feet to the other form also a square, put into perspective by the same process.

Thus far, squares below the level of the eye have been alone treated of ; but the same rules apply to squares and rectangles situated above that

level, such as the ceilings of rooms, the upper windows of houses, &c. This is exemplified in a view of that useful article of furniture called a

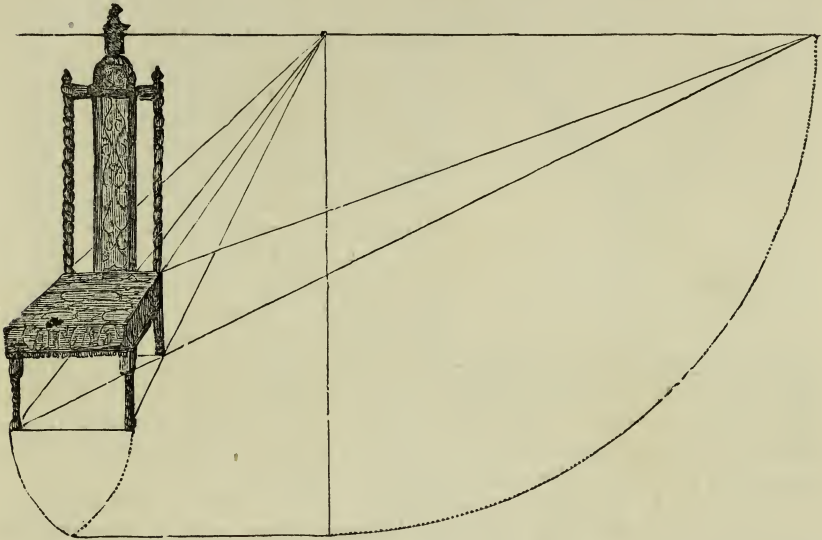

fig. 32.

“what-not,” supposing it to be raised so that its upper shelves are higher than the eye (fig. 33).

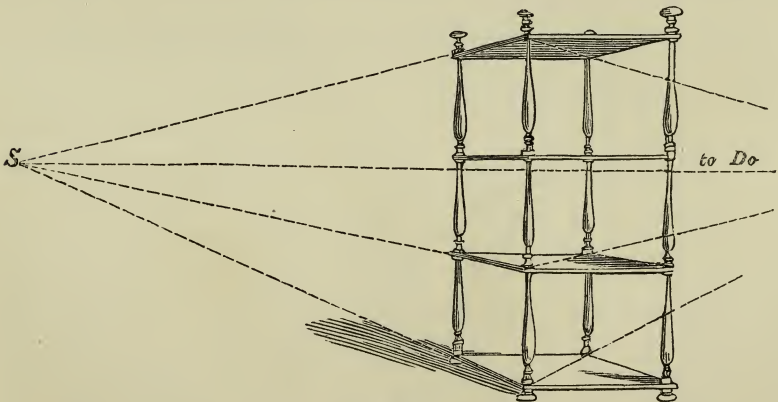

fig. 33.

The figures for which rules have been given thus far have been all supposed to be horizontally on the ground-plane, or parallel with it : but such figures frequently stand on their edges ; that is, in a vertical plane. Of this kind are the sides of a room, of a house, and of many solid figures. Their perspective form is determined on the same principles, by finding the point in the visual line at which they terminate. Thus, let such a

figure as is shewn in fig. 30, plan, be shewn edgewise in perspective, instead of flat, and let BC be the edge on which it is to stand. Draw a line AB , fig. 34, the exact length of AB on the plan, and perpendicular to the base-line of the picture. Draw the visual lines SA, SB , which denote the upper and lower edges of the figure. Set off from B on the base-line a distance BG equal to BC on the plan; the diagonal DG intersecting SB will denote by the point C the extremity of the figure; then draw CE parallel to AB , and the figure $ABCE$ completes the perspective square. Next, set off on the base-line other points 1, 2, 3, 4, taken from CB on the plan; and connect them with the distance-point by diagonals. From their respective intersections with BC draw lines parallel to AB , which will give the longer sides of the inscribed rectangles. Next, set off on AB the points 5 and 6, their distances from A and B being taken from the plan. Draw visual lines $S5, S6$, which, by their intersections with the vertical lines 1, 2, 3, 4, will denote the shorter sides of the rectangles; by which the whole figure is completed.

This rule is applicable to all vertical planes, and is very useful in drawing panels of wainscoting for interior planes, and in shewing the positions of doors and windows in the fronts and sides of houses. The places of the doors and windows, and also of the cross streets, shewn in fig. 2, Part I., were found in this manner.

By the combination of horizontal with vertical planes, we arrive at the perspective delineations of rectangular solids. Let it be desired to shew

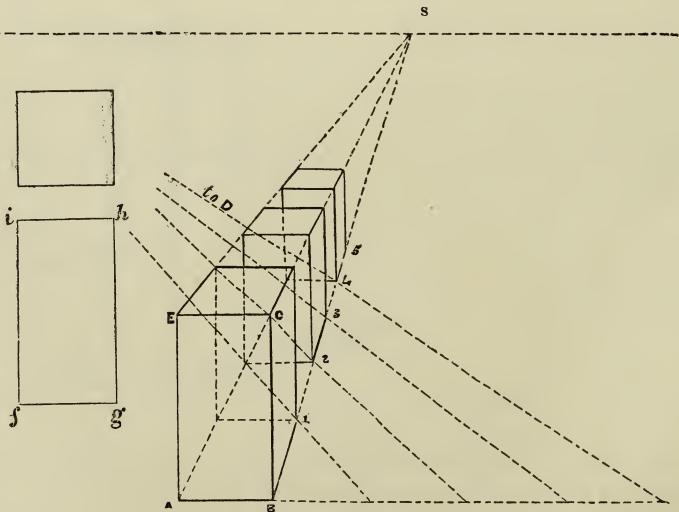

fig. 35.

in perspective a row of three square pillars of equal size, a plan of their bases being given in fig. 35, also an elevation of their sides; and let the

distance between them be equal to one of their sides. With the width of the base, on the base-line, draw by preceding rules three square horizontal planes representing the bases of the three pillars, and shade them for the sake of distinctness. On the base AB erect perpendiculars AE, BC , equal to fi, gh , which connect at the top by EC parallel to AB . Draw visual lines SE, SC ; at the points $1, 2, 3, 4, 5$, erect perpendiculars parallel to BC , meeting the visual line SC ; and from their intersections with that line, draw lines to SE parallel to EC . These lines, in connexion with the visual lines SE, SC , will denote the *horizontal* planes forming the tops of the pillars; and the perpendiculars $BC, 1, 2, 3, 4, 5$, in connexion with the visual lines SC, SB , will denote the *vertical* planes forming the sides of the pillars.

The same rule will apply to the forms of houses, boxes, and numerous other objects, whose external shapes may be considered as simple rectangular solids. On observing an object with a view to its perspective representation, the student should consider what geometrical figure it most resembles, and treat it accordingly. As he may now be supposed to have become sufficiently familiar with the parallel perspective of squares and rectangular figures, he may therefore proceed to that of other regular figures; and will first be introduced to *the circle*.

Every circle may be inscribed in a square (fig. 36), touching it at four points, $1, 3, 5, 7$, of the circumference, and cutting its diagonals at four other points, $2, 4, 6, 8$; and if the perspective positions of these eight points be found, a moderate proficiency in drawing and command of hand will enable the learner to draw such a figure through them as shall represent the perspective circle. These points are found by the method shewn in fig. 36, and called "squaring the circle." The diagonals 26 and 84 are drawn on the plan, and also the diameters 15 and 37 . The two lines 46 and 28 are also to be drawn through the points at which the circle intersects the diagonals; and the square with its lines may now be put into perspective by preceding rules, by which means the perspective positions of the points $1, 2, 3, 4, 5, 6, 7, 8$, through which the circle must pass, will be found at the intersections of the corresponding lines. The squares, diagonals, diameters,

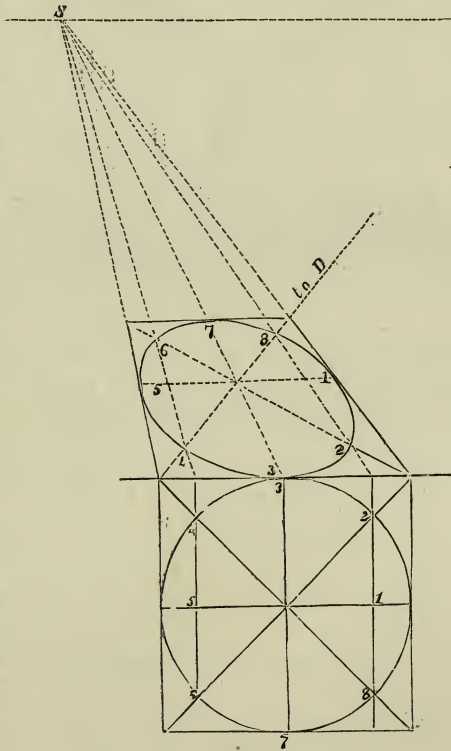

fig. 36.

The squares, diagonals, diameters, and lines 46 and 28 are drawn through the points at which the circle intersects the diagonals; and the square with its lines may now be put into perspective by preceding rules, by which means the perspective positions of the points $1, 2, 3, 4, 5, 6, 7, 8$, through which the circle must pass, will be found at the intersections of the corresponding lines. The squares, diagonals, diameters,

and other lines, being only drawn in order to obtain by their assistance the points 1, 2, 3, &c., may be obliterated as soon as the perspective circle is inked in. The above eight points will, in drawings of ordinary size, be sufficient guide to the hand in drawing circles; but for circles of very large dimensions, the principle may be extended, and twice the number of points easily found by doubling the number of cross-lines, 2 8, 4 6.

The last figure gives the perspective circle in a horizontal plane; the same rule applies to its projection on a vertical plane, with this difference only, that in the latter case it must be squared against the side of the picture, instead of against the base-line (fig. 37). This rule being highly use-

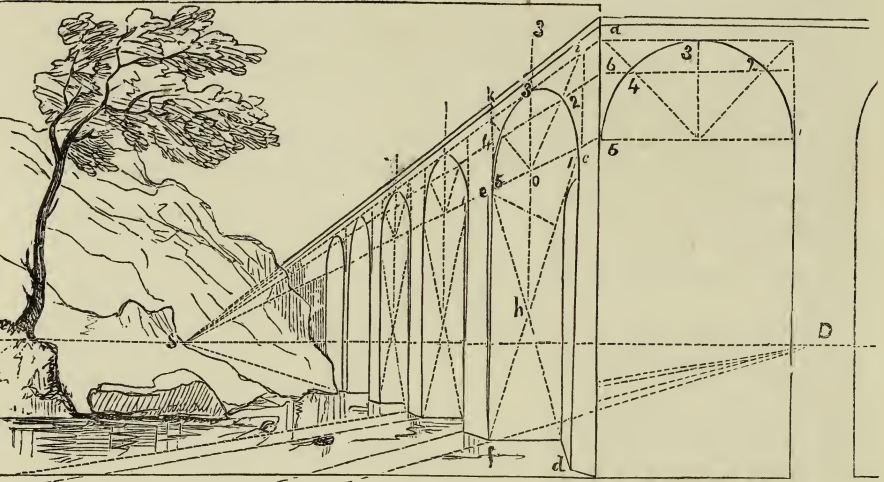

fig. 37.

ful in drawing bridges and viaducts with semicircular arches, an example is given, with a description of the process. The arches in the annexed viaduct being semicircular, the upper part only of the circle is to be squared by diagonals, diameters, and cross-line, as in fig. 36, by which means five points in the semicircle are obtained. Find the perspective lengths of the arches and piers by setting off the real lengths on the base-line, and drawing diagonals to the distance-point intersecting the visual line SD . At the intersections erect perpendiculars to the base-line denoting the piers. At the side of the picture set off dc , the height of the piers to the springing of the arch; draw the visual lines Sa , Sb , Sc , and the others denoting the top and bottom lines of the viaduct. To ascertain the perspective point representing the top of each arch, draw the diagonals ed , cf ; their intersection will be the perspective centre of the vertical plane $cdfe$, through which gh , drawn parallel to the side of the picture, will cut the visual line Sa at the top of the arch. Produce the two sides of the rectangle $cdfe$, to meet the line Sa , at i and k . Draw the lines io , ko , intersecting Sb at 2 and 4. The perspective semicircle may now be drawn through the points 1, 2, 3, 4, 5, thus obtained. Proceed in the same manner with each of the arches, using the same visual lines Sa , Sb , Sc , by which, with the aid of similar diagonals, they may all be completed.

Gothic arches of pointed form may be drawn in perspective by the same rule, varied only to suit the change in their form. The object of squaring the semicircle in the last figure was to obtain certain points of its outline which, drawn in their perspective positions, would guide the hand in forming the perspective outline; and points in any other curve will in like manner denote the perspective outline of such curve. In fig. 38 the elevation of the arch is drawn against the side of the picture as before, and points are

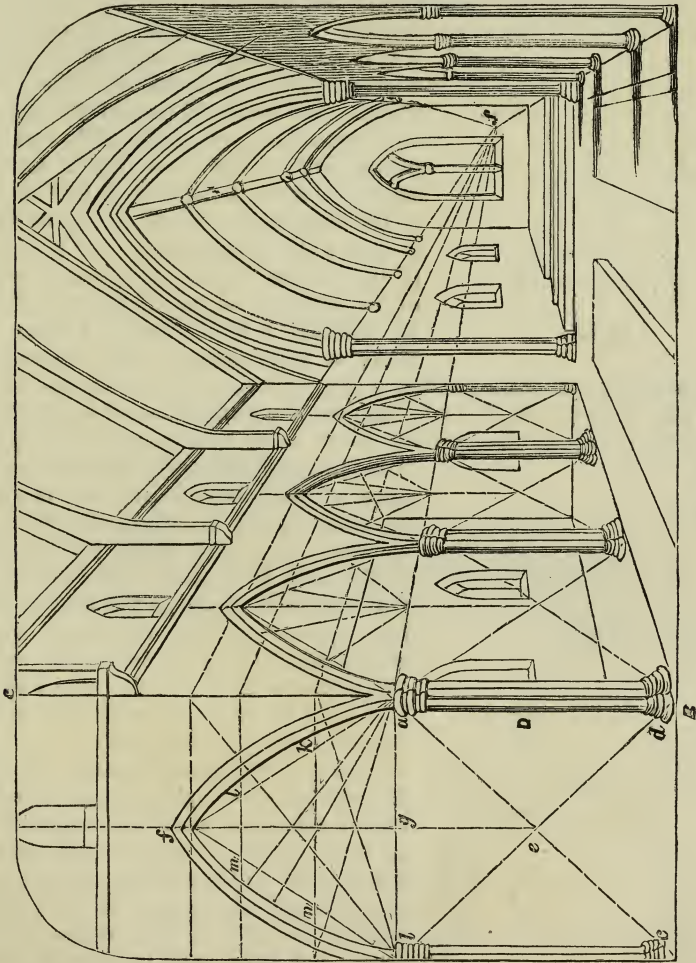

fig. 38.

found in its outline by a similar process. First join the two lower corners by a line ab , draw the diagonals ac , bd ; from their intersection draw ef , passing through the centre of ab at g . Draw fa , fb , divide each of them into three parts, and through each division draw lines from a and b to the opposite side of the arch; seven points, $aklfmnb$, will thus be found. Produce lm and kn to the side of the picture. From the points thus obtained

at that side, draw visual lines to the point of sight; find, as before, the perspective point, f , of each arch by diagonals; draw the perspective lines $f'a$, $f'b$, divide each of them into three parts, through the divisions draw lines from g , intersecting the visual lines at points which will denote the perspective curves.

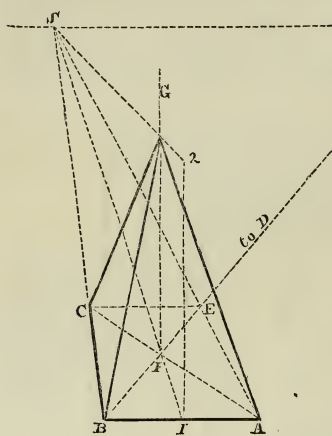

fig. 39.

to the base-line, and there erecting a perpendicular on which to set off the height 12. A visual line S 2 will intersect the central line of the pyramid at the required apex, whence lines drawn to its base complete the figure.

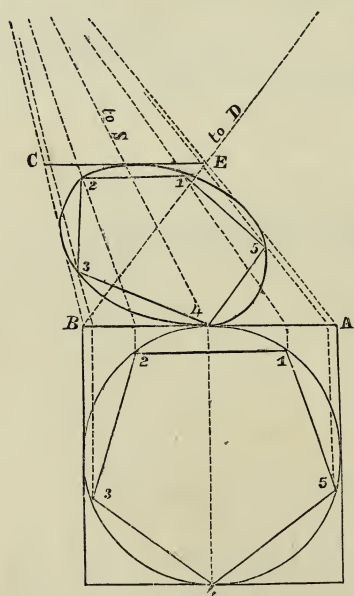

fig. 40.

The perspective centres of the vertical plane of the arches were found in the last two figures by the intersection of their diagonals. The perspective centres of horizontal planes may be found in the same manner, which is short, and often very useful. For instance, to find the apex of any pyramid or cone (fig. 39), find the perspective of the base, which we will suppose to be a square, A B C E, and at the intersection of its diagonals erect a line F G perpendicular to the base of the picture. The perspective height of the pyramid or conical object is found by drawing a visual line S 1 from the point of sight through that intersection

The same rule will apply, whatever be the form of the base and number of sides. In architectural drawings, the spires of churches are easily drawn by this rule. If the base be a circle, find its perspective centre by drawing the circumscribing square with its diagonals, whose intersection will be the foot of the central perpendicular line. In this case a single line from the apex to each side of the base will complete the figure.

Since all equilateral figures, whatever the number of their sides, may be inscribed in a circle and touch its circumference at their angles, it follows that, having found such circumscribing circle in perspective, and the points in its circumference touched by the angles of the figure, we have only to connect those points by right lines to obtain the perspective view of that figure. One illustration of this with the pentagon, which after the square is the simplest many-sided figure, will shew also the application of the rule to hexagons, octagons, or other polygonal figures.

Let the pentagon 1 2 3 4 5 (plan, fig. 40) be shewn in perspective.

First circumscribe it with a circle, and that circle with the square $A B C E$. Square the circle, as previously shewn (fig. 36), and draw its perspective view, the points of sight and distance being given. Ink in the square, circle, and pentagon in the plan, and the square and circle in perspective, and obliterate all the lines by which they were found, to avoid confusion. Proceed then to insert the perspective pentagon. From its points on the plan 1, 2, 3, 4, 5 draw perpendiculars to the base-line, and from their intersections with that line draw lines to the point of sight cutting the perspective circumference at the points correspondingly numbered. Connect the points thus found with each other by lines, and the result will be the perspective pentagon required.

The same mode of proceeding will apply to all regular equilateral figures. *Irregular figures* are shewn in perspective by finding their points or angles by means of visual lines and diagonals to the distance-point. An example of one such figure will sufficiently explain the mode of proceeding, to comprehend which, however, the mode of finding any point in perspective must first be shewn.

Let $B H C E$, fig. 41, be the plane of the picture, $S D$ the horizontal

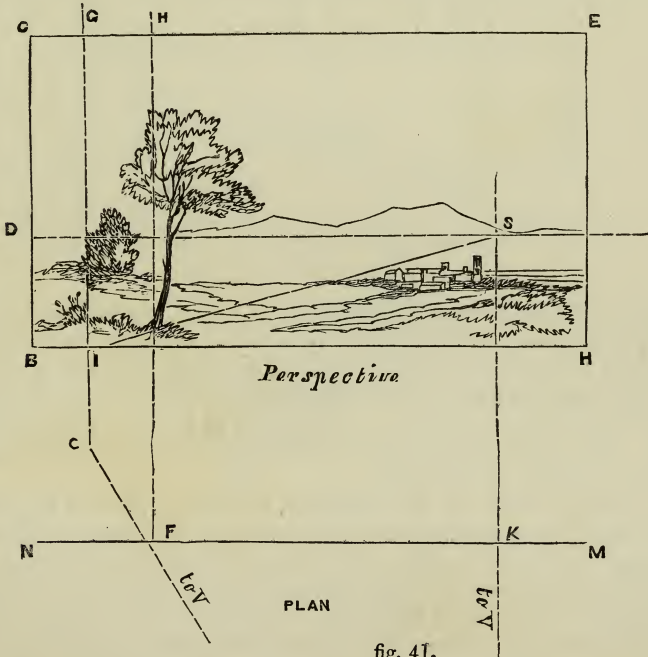

fig. 41.

line, $B H$ the base-line, S the point of sight, V the station, and D the point of distance; $S D$ on the picture being equal to $K V$ on the plan. Let $M N$ be the position of the plane of delineation on the plan, and C that of any object (say a tree) beyond that plane. Required the perspective position of such object.

Draw the visual ray $V C$, intersecting $M N$ at F . From C and F draw $C G$, $F H$, both perpendicular to $M N$ and $H B$. Draw the perspective

visual ray S I, which is a perspective view of V C. Its intersection with F H is the required point, representing the position of the object.

The same result may be attained in another way. In the following figure (42), the same letters refer to corresponding points as fig. 41. But

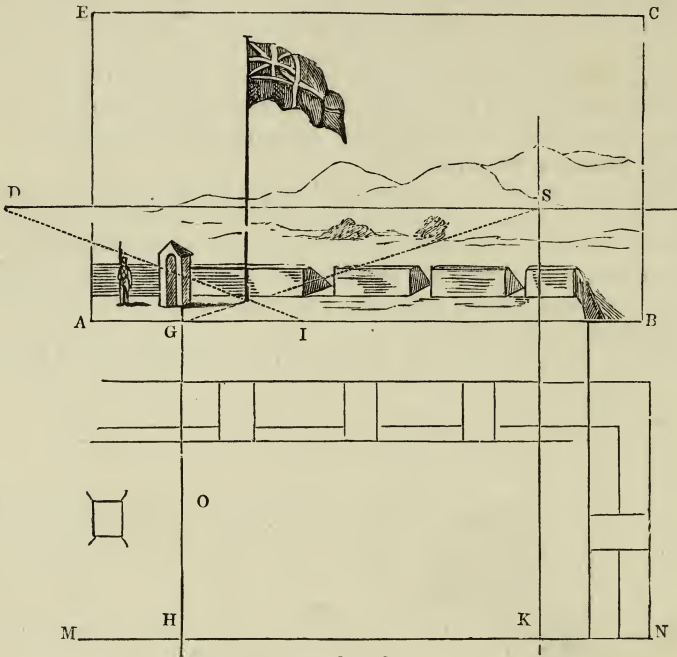

fig. 42.

the point of distance is now made use of, as in the perspective drawing of squares; its distance D S from the point of sight being made equal to K N. From the position or place of the object O (in this case a flag-staff) draw O G perpendicular to M N, intersecting it at H. From G, with the radius O H, describe an arc intersecting A B at I, and making G I equal to O H. The diagonal D I will intersect a visual line G S at the required perspective position of the object.

In drawings made on this principle, in which a plan of the object is first laid down, with the positions of the station and plane of delineation, paper more than twice the size of the proposed picture is required, which is sometimes inconvenient. This objection may in many cases be removed by inverting the plan, and making the base-line of the picture serve the double purpose of the base of the plane of delineation and of its position on the plan. In this case, the station-point of course is placed above the drawing, instead of below it, and the plan of the object is shewn inverted, below the drawing. By this means paper equal to the height of the picture is saved, as in fig. 43.

Having described two modes by which the proper positions of points may be found in perspective, the learner will easily perceive how irregular figures, whose plan is given, may be shewn in perspective by finding the places of their points or angles in the picture. Thus, let *abcdef* (fig. 43)

be a plan of a block of building, to be laid down in perspective previous to erecting thereon a view of them. From the station V draw a line perpen-

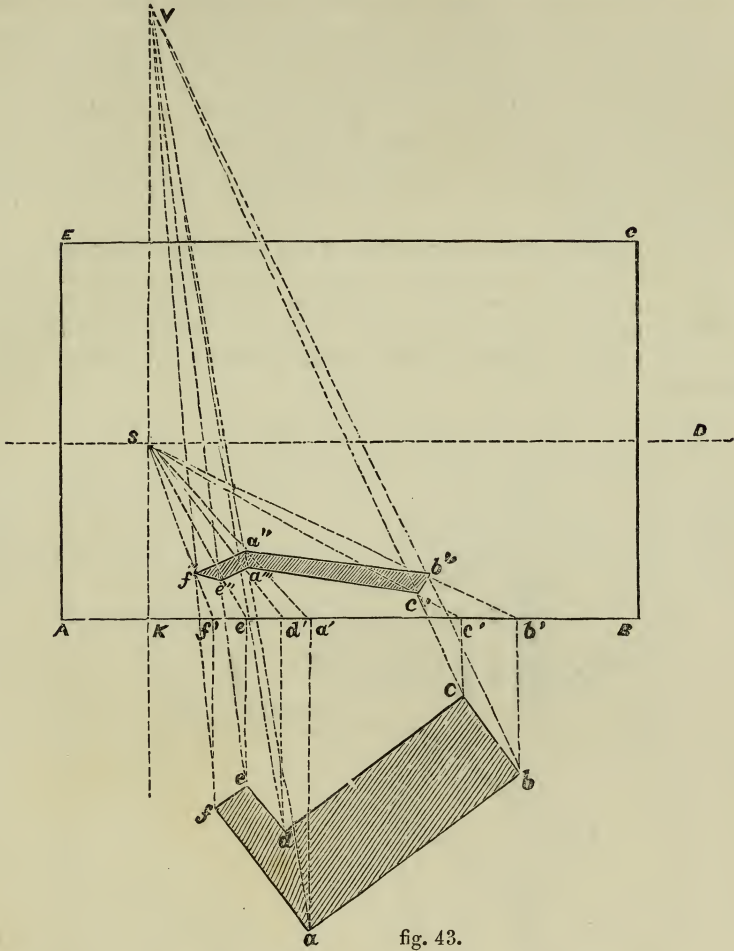

fig. 43.

dicular to the horizontal line, intersecting it at S , which will be the point of sight. On the horizontal line set off DS equal to KV , which makes the space between the points of sight and distance equal to that between the station and plane of the picture. Draw visual lines from V to every point of the object in plan. Draw also from every point of the object a perpendicular to the line AB , and from the points of intersection with that line draw perspective visual lines to the point of sight, which will intersect the visual lines of the plan at points $a'' b'' c'' d'' e'' f''$, which will be the perspective positions of the corresponding points in the plan; connect these points by lines, and the perspective figure will be complete.

When the size of the drawing, as compared with the extent of the paper or drawing-board, will not admit of the plan being drawn at all on the same sheet, it may be drawn on a separate sheet, with the station,

position of the plane of the picture, and visual lines in plan, laid down thereon. The intersections on the line denoting the position of the picture may then be transferred to the base-line of the drawing by the compasses; or an easy mode may be arrived at by placing the edge of a sheet of paper on the plan against the line of position, and with a pencil marking points on the edge of it corresponding with the intersections. The same edge being then applied to the base-line of the drawing, the points may be easily transferred by corresponding marks on the base-line. If there be many points to be transferred, it will facilitate and prevent confusion to number them consecutively, 1, 2, 3, 4, &c., marking similar numbers on the edge of the transfer-paper.

By the foregoing rules, the position of any point, the direction of any line, and the figure of any plane in parallel perspective may be found. But there is a class of cases yet to be spoken of which may be dealt with more simply than by any rules yet given. They are chiefly those in which objects are viewed angle-wise, and which therefore are called *oblique perspective*.

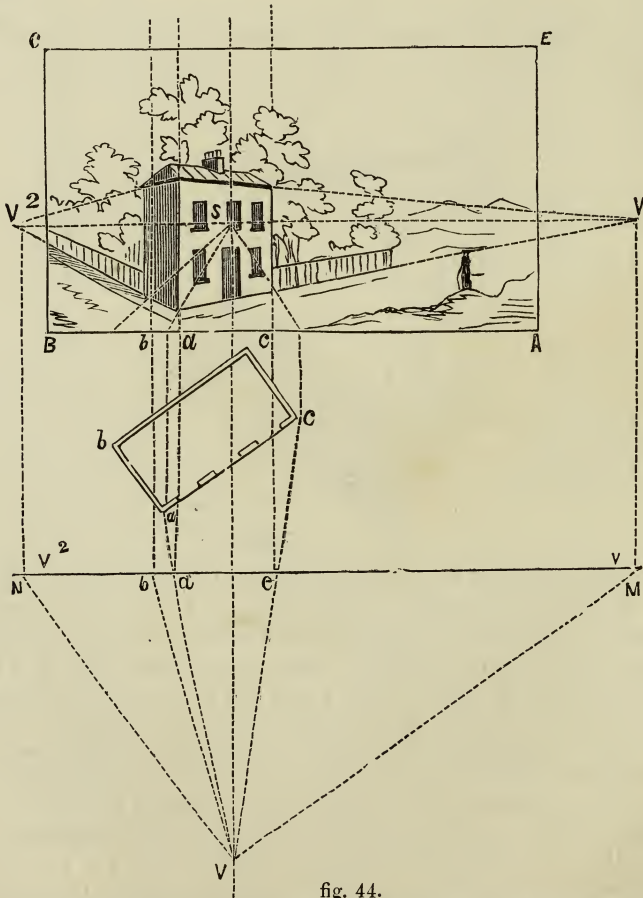

fig. 44.

In parallel perspective the points of sight and of distance have been

those chiefly made use of for determining outlines ; but in oblique views they are of comparatively little use, and the sizes and forms of objects are chiefly regulated by *vanishing-points*, the rules for finding which will now be explained. In the street-view, fig. 2, and in all views in which lines and plane surfaces are in plan at right angles with the plane of the picture, the point of sight is the vanishing-point of such lines and planes ; but in angular views, such as that in fig. 4, the vanishing-points of the various sides of objects will lie to the right and left of the point opposite to the eye ; and those of most objects will be found somewhere on the horizontal line. In the oblique view, fig. 44, the vanishing-points for the sides of the cottage are found in plan by drawing lines $V V^1$, $V V^2$ from the station to the position of the plane of delineation parallel with those sides ; thus, V on the plan is the vanishing-point of the long side, and V^2 that of the short side of the cottage. These points are transferred by perpendiculars to the horizontal line of the picture. The angles of the house, sides of door and windows, &c., are then connected with V , the station, by visual lines intersecting the plane of the picture, and from those intersections transferred by perpendiculars to the base-line of the picture itself. From their respective points on this line they are taken to the point of sight as a vanishing-point, and by their intersections with the last-named perpendiculars give the outline of the cottage at its lower part or base. To find the lines of the upper part, assume a height on the perpendicular line denoting its front angle, and from the assumed point draw the upper lines of the long side to the vanishing-point V , and those of the

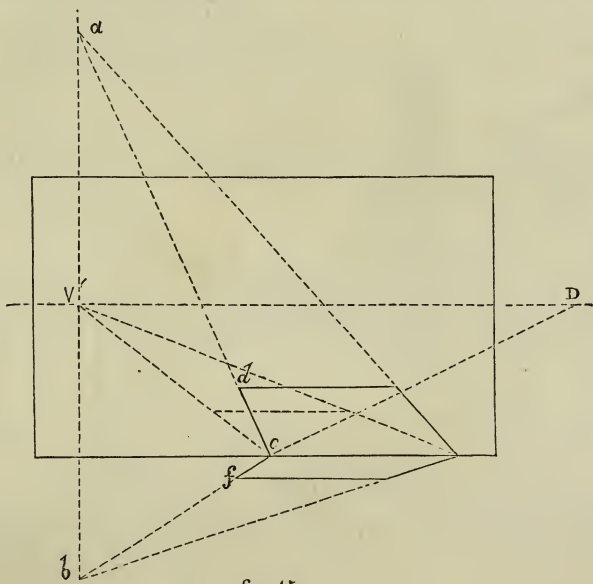

fig. 45.

short side to V^2 . The centre of the roof may be found by diagonals, as already described in preceding figures.

But the statement just made respecting vanishing-points, that they will generally be found somewhere on the horizontal line, is only true as respects

those of objects whose lines are parallel with the ground-plane. Many objects, and frequently the ground itself, are not parallel with the true ground-plane, but have various degrees and kinds of inclination. Thus, in the case

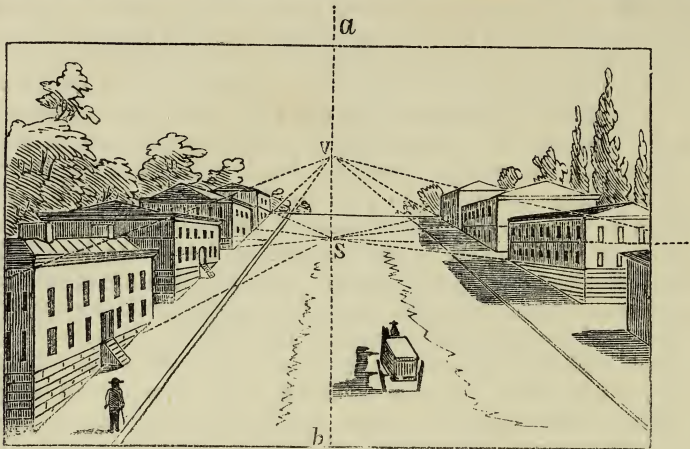

fig. 46.

of an *up-hill* view (fig. 46), in which the plane of the surface rises upwards from the spectator; or of a *down-hill* (fig. 47) view, in which the surface inclines downward from him; or of sloping objects, such as the roofs of

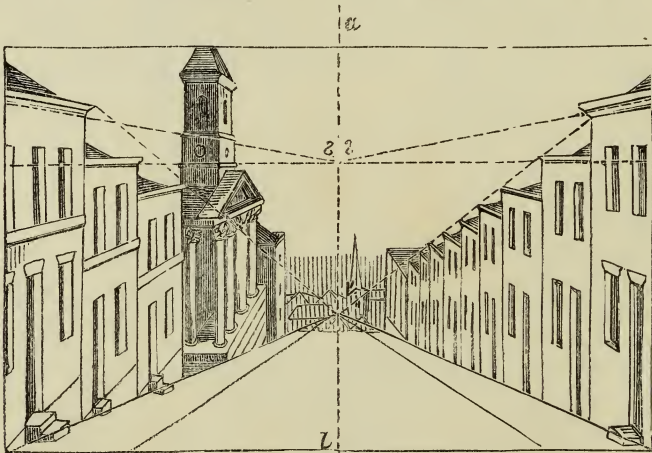

fig. 47.

many houses, which incline *side-ways* from him, the vanishing-points will obviously be either above or below the horizon, and the degree of their deviation from it will depend on the degree of the inclination. This brings us to the consideration of *inclined planes*, the vanishing-points of which are always perpendicularly above or below those points on the horizontal line which would be their vanishing-points if the plane had no inclination. This will be better understood by consulting fig. 45, which gives three different views of the same plane at different degrees of inclina-

tion; by which it will be seen, that to find the vanishing-point of any inclined plane, we have only to find the point V^1 on the horizontal line which would be its vanishing-point were it not inclined, to draw through that point a line ab perpendicular to the horizontal line, and produce one side cd or cf of the inclined plane. Its intersection with the perpendicular ab will be the vanishing-point of all inclined lines parallel with cd or cf , and a or b will be either above or below the horizontal line, according as the inclination of the plane from the spectator is upwards or downwards.

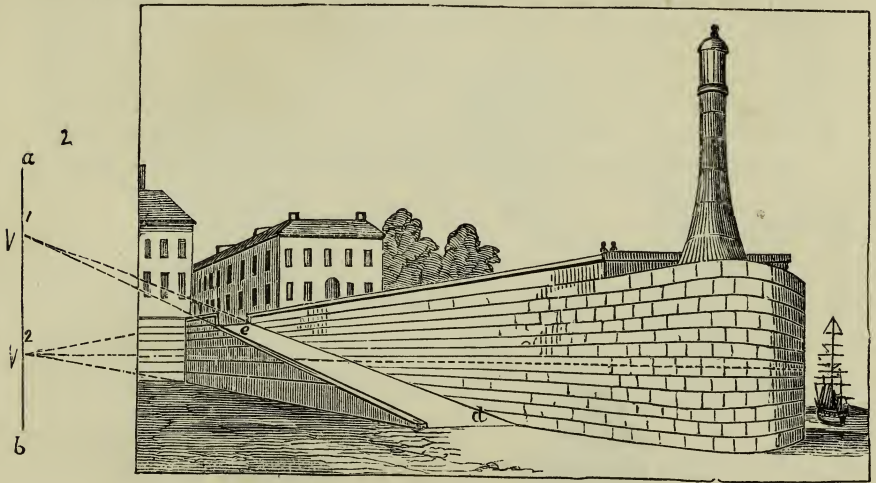

fig. 48.

The annexed figure (48), representing the jetty at Birkenhead as seen from the river, with the inclined ascent up to it, demonstrates the mode of

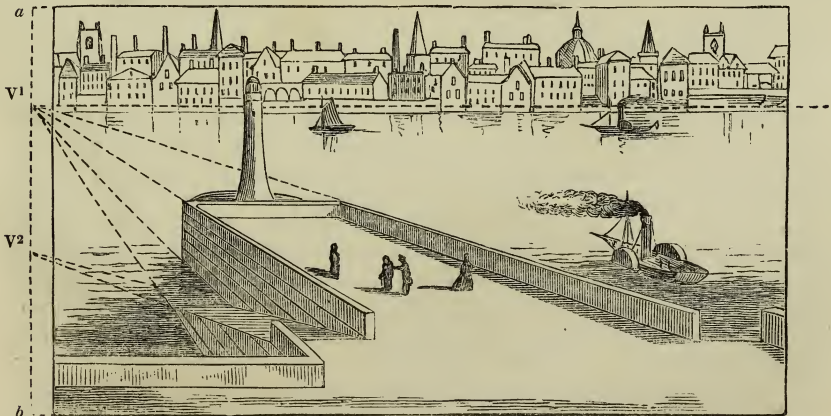

fig. 49.

finding the vanishing-point of the inclined plane, the points d and e being first obtained by the perspective lines of the jetty. Produce de , intersect-

ing ab at V^1 , which will be the vanishing-point of the incline ; while V^2 on the horizontal line, intersecting the same line, will be the vanishing-point of the horizontal lines of the jetty. This is an up-hill view, at an angle with the spectator.

In the next figure (49) the spectator is supposed to be on the land, looking towards the water ; in this case the inclined plane becomes a down-hill view, at an angle with the spectator. Its vanishing-point V^2 is still found on the line ab , but in this case below instead of above V^1 , the vanishing-point, on the horizontal line, of the level part of the jetty.

Up-hill and down-hill views opposite to the spectator are regulated on the same principle ; the point of sight being in these cases the vanishing-point of horizontal lines, while the inclined lines vanish at a point respectively above or below the point of sight, but on the same vertical line. A remarkable example of each of these cases may be seen by looking along St. Vincent Street, Glasgow, alternately from the upper and lower ends.

A slight consideration of these rules will suffice to shew that planes of

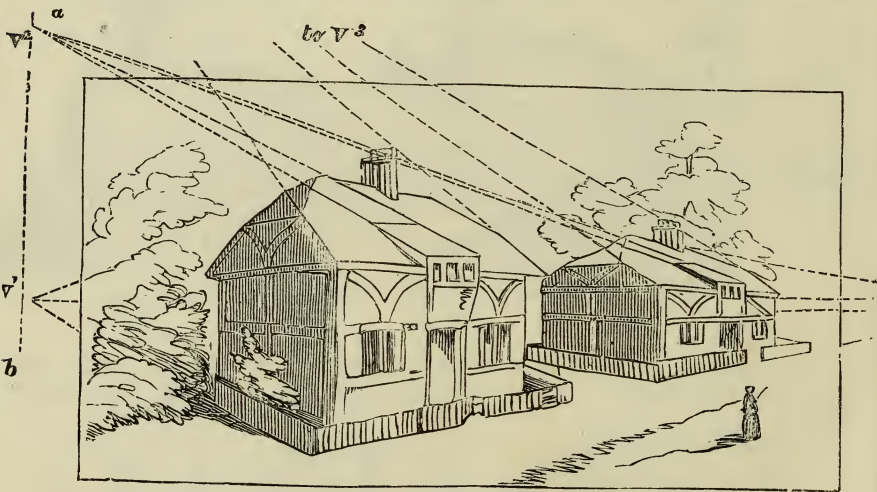

fig. 50.

various inclinations will have various vanishing-points, but that all these points will be found on a line perpendicular to the horizontal line, and passing through the vanishing-point of planes that are horizontal or parallel with the ground-plane. Thus in fig. 50, which is a view of two cottages near Welshpool in Montgomeryshire, the portions of the roofs over the upper windows are inclined planes, at a different degree of inclination from that of the other parts of the roofs, and therefore having a different vanishing-point V^2 on the line ab (which passes through V^1 , the vanishing-point of the ends of the cottages on the ground-plane), V^3 being the vanishing-point of the roofs, on the same line ab .

Inclined planes, however, which when drawn in elevation are parallel with each other in all their sides, have in the perspective view the same vanishing-point, whatever be their position in the picture ; if some only of the sides or lines be parallel, those sides or lines only will vanish at the same point ; and if none of them be parallel, then each will have a separate

vanishing-point of its own. An instance of this is seen in fig. 51, which is a view of the picturesque little church of Llandysilis in Wales. In this view, to produce it in correct perspective no less than five separate vanishing-points, 1, 2, 3, 4, 5, were necessary; which results from the planes o

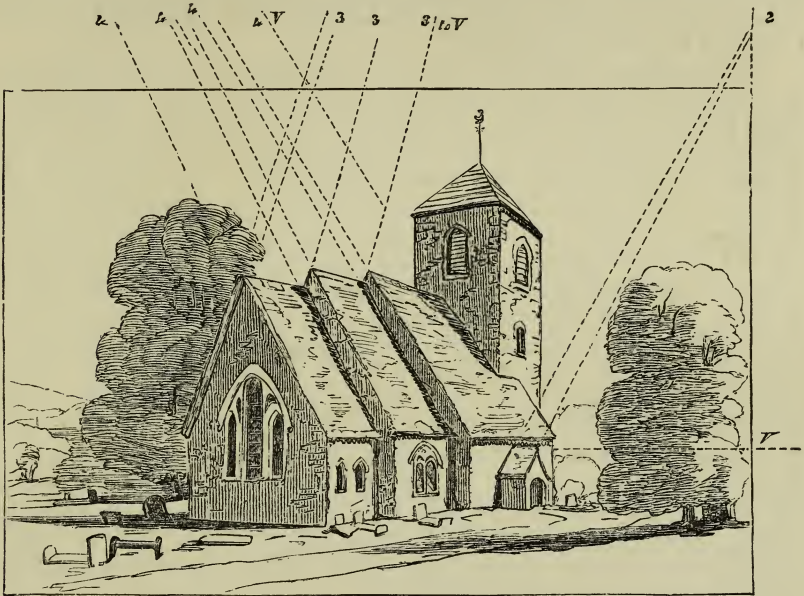

fig. 51.

the side, end, porch, and roofs tending in five different directions. The rule given at fig. 39 for finding the apex of a pyramid or cone will also be found useful for determining the point of the roof of the tower and the position of the weather-vane.

In fig. 33 an example was given demonstrative of the perspective of parallel *horizontal* planes at different elevations. That of parallel *inclined* planes has just been spoken of, and illustrated in figs. 50 and 51. That of parallel *vertical* planes is the same in principle, and must be dealt with in practice in the same manner. Their parallel sides will incline towards the same point, as in the street-view, fig. 2, where the fronts of the houses which form the two sides of the street may be regarded as two parallel vertical planes whose lines all tend towards the same point.

Having now described the general features and modes of proceeding in the delineation of lines, planes, and solids, including various regular and irregular figures, we have yet to consider the subject of solids with reference to their height. In parallel perspective, a large proportion of the lines of a picture are, in plan, at right angles with the plane of delineation, as was just now stated; and therefore the point of sight is the principal vanishing-point in such representations. In such cases, the proper way to obtain the perspective height of any object is, after having laid down the length of its elevation on the base-line of the picture, and connected the ends of that length by visual rays with the point of sight, to erect a per-

pendicular to the base-line at one end of that length ; set off thereon the exact height, and from the point so obtained draw another visual ray to the point of sight ; the space included between this visual ray and the one previously drawn from the bottom of the perpendicular will be the perspective height at any part of the picture. This has been already in part done in figs. 34 and 35, and is in all cases the mode of obtaining heights of objects in parallel perspective.

But in oblique perspective, very few, and frequently none of the lines in plan, lie at right angles with the plane of delineation. The point of sight and visual rays become therefore of less importance ; but the vanishing-points become the more useful auxiliaries for determining the heights of objects seen at any angle. Keeping this strongly in view, the student should well consider the manner of proceeding adopted in fig. 44, by which the outline of the house was obtained, as it shews in a simple manner the whole principle of oblique perspective as applied to solids by means of ground-plan and vanishing-points. But there is one point in which he will soon find that this figure is incomplete, inasmuch as it *assumes* the height of the house. In true perspective nothing should be assumed ; every part should be in its just and exact proportion ; and the height of the house in the drawing must bear that proportion to its other dimensions which it does in the object itself. The only way in which these proportions can be correctly maintained is by drawing a perpendicular of the proper height, according to the scale of the drawing, on the plane of delineation, and drawing lines from its angles to the respective vanishing-points. By this means a triangular vertical plane will be obtained, stretching from the horizon to the plane of delineation, representing the given height throughout its entire length.

When, therefore, the front angle of any rectangular object is obtained by a perpendicular b from the plan, as in fig. 44, which line is here transferred to fig. 52, and also the lower line ab of any of its sides, produce that line

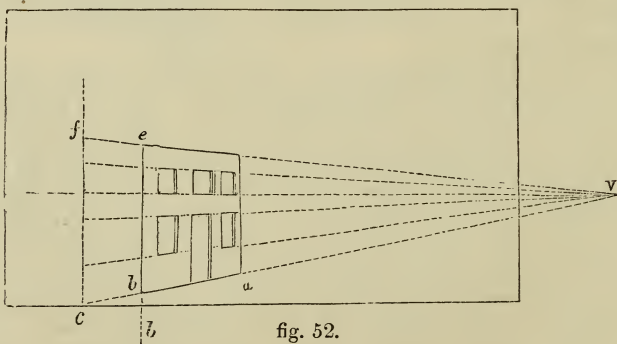

fig. 52.

to the base-line, as at c , and there erect a perpendicular, on which set off the proper height cf of the object to the same scale as the plan. In this figure the height of the front of the house is taken to be equal to the length. From this height draw to the vanishing-point a line fV , which will represent the upper line of the object ; and from the point e , at which it intersects the perpendicular b , the space on that perpendicular down to b will be the true perspective height of the front angle of the object. The

heights of the upper and lower lines of the windows and door are to be found in the same way by setting them off on the line cf .

When the perspective height of any one object in the picture has been found, that of any other object of the same height, in whatever part of the picture its position may be, may be easily found in parallel perspective by

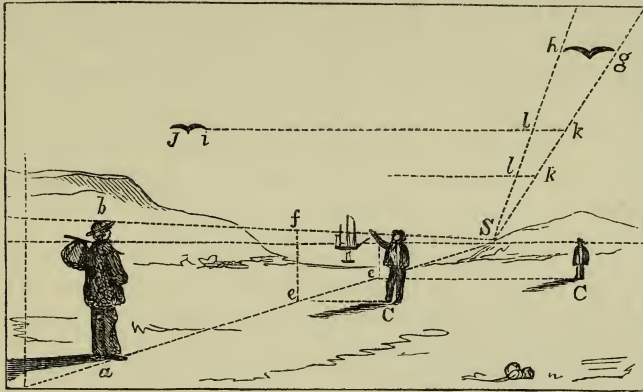

fig. 53.

means of visual rays to the point of sight. Thus in fig. 53, having by the last rule found the height ab of a figure standing at the position a , required the representation of another figure of equal height at the position c . Draw the visual lines Sa, Sb . From the position C draw Ce parallel to the base-line, intersecting Sa at e . From e draw ef perpendicular to Ce , intersecting Sb at f . The height ef thus obtained, transferred to a perpendicular on the position C , will be the perspective height of the figure at C . By this rule, the point of sight and perspective height in any one position being given, the perspective height for any other position may be readily found. Perspective widths may be found in a similar manner. In the same figure, 53, given the width of any object gh (say a flying bird), required the respective widths of a similar object in the position i . Connect the ex-

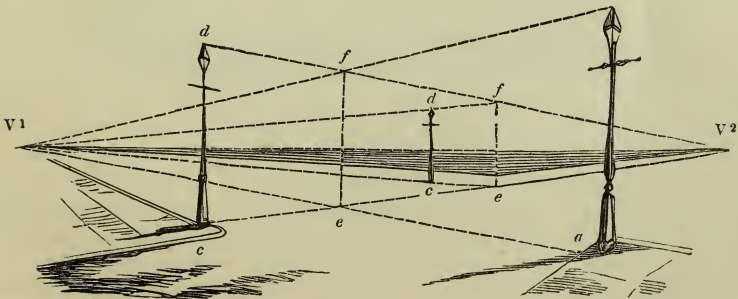

fig. 54.

tremities of the given width with the point of sight by visual lines Sg, Sh ; draw a line from the position i parallel with the base-line, intersecting the

visual rays at k and l ; the width kl , transferred to the given position, will be the width ij of the object at that position.

But in oblique perspective the point of sight needs not in all cases to be found for the other purposes of the picture; and where it is wanting, the same problem may be solved in a somewhat similar manner, using the vanishing-points instead of the point of sight, and vanishing-lines instead of the horizontal lines ce . Thus, in fig. 54, given the position and height of a lamp-post ab , required the respective heights of similar lamp-posts at cc . Draw vanishing-lines from V^1 to a and b . From the position c a line to the other vanishing-point V^2 will intersect $V^1 a$ at e . From the point e erect ef perpendicular to the base-line, intersecting $V^1 b$ at f . Draw $V^2 f$ and the perpendicular cd intersecting it at d ; ed will be the perpendicular height of the object at the position e . By this rule, the vanishing-points and perspective height at any one position being given, the proper height for any other position may be found.

In parallel perspective, the distances of objects or points on a visual line are found, as in fig. 35, by setting off their true distances on the base-line, and finding their corresponding distances on the visual line by diagonals to the distance-point. The same process is used in oblique perspective as in fig. 44, using the vanishing-point in the same way as the points of sight and of distance. But as the distance-points are often at a considerable distance outside the limits of the picture, and sometimes even of the paper, which renders this mode of obtaining the intersections in such cases inconvenient, the following method, by which a distance-point for the details of any object is obtained *within the picture*, is often practicable. To draw in oblique perspective the church $A B G H$, fig. 55,—which is a representation of St. Anne's, Manchester, before it was lately divested of its ornament,—required the perspective positions of the windows of the side $A B$. From the point A , parallel with the horizontal line, draw a line $A 7$, equal in length to the geometric length of $A B$ in the plan or elevation. From the point 7 draw a diagonal through B , which will intersect the horizontal line at a point D within the picture, which is the distance-point required. Transfer from the plan or elevation to the line $A 7$ the distances of the sides of the windows $A 1$, $A 2$, &c.; and from the points 1 , 2 , 3 , &c. thus obtained draw diagonals to the point D , which will intersect $A B$ at corresponding points, &c.; from which intersections vertical lines will represent the corresponding sides of the windows. In this method, the line $A 7$ may, if more convenient, be drawn from the upper corner E of the side whose details are to be laid in, as shewn at C , over the tower, and it may be made of any convenient length, provided it be made longer than $A B$; but in general it will be most convenient to make it the exact length of the given line on the plan or elevation. The upper and lower points of the windows may now be marked on the line $A E$, whence lines drawn to the vanishing-point of that side of the church will give the perspective positions of corresponding points in the vertical lines denoting the sides of the windows. If the window-heads be arched, draw the elevation of the arch to the left of the line $A E$, and proceed, as directed in figs. 37 and 38, to draw the perspective arch over each window.

In order to render the student more familiar with the principles of oblique perspective and its practice by the aid of vanishing-points, two

examples will now be given, and the manner of treating them explained ; the one being an interior view of a room, with its doors partially open, at various degrees of obliquity ; the other an exterior view of a house with a projecting cornice. Let the lower part of fig. 56 be the plan of that part of the room which comes within the range of vision, that is, which is comprehended within an angle of not more than 60° from the station-point ;

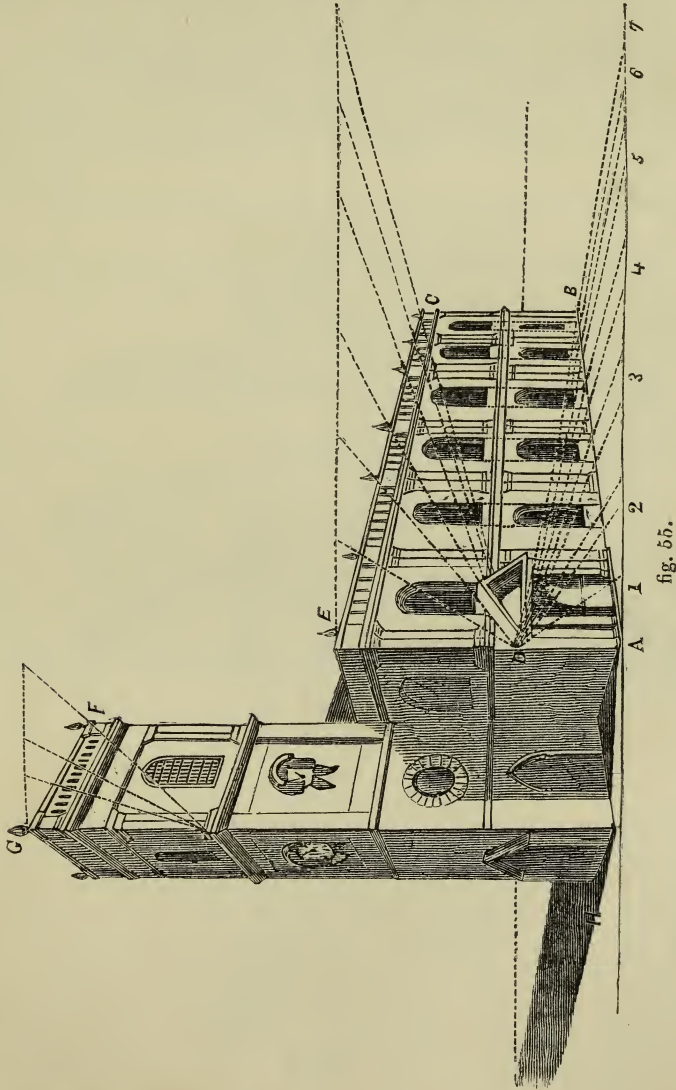

and let the upper part A B C E be the boundary of the proposed view. Draw the base-line A B of the picture in plan, with its ends produced, intersecting the plan at such a distance that the extremities A B of the

part beyond it, which is all that is to be included in the proposed drawing, shall form with the station-point V an angle not exceeding 60° . Parallel to the sides of the rooms and doors draw $V V^1$, $V V^2$, $V V^3$, intersecting the base-line at V^1 , V^2 , V^3 . From the points and angles of the plan draw visual lines to the station, and from every intersection 1, 2, 3, &c. on the plan, draw perpendiculars $a 1$, $b 2$, &c. to the picture, intersecting the base of the plane of delineation at a , b , c , &c. The plan is now prepared for

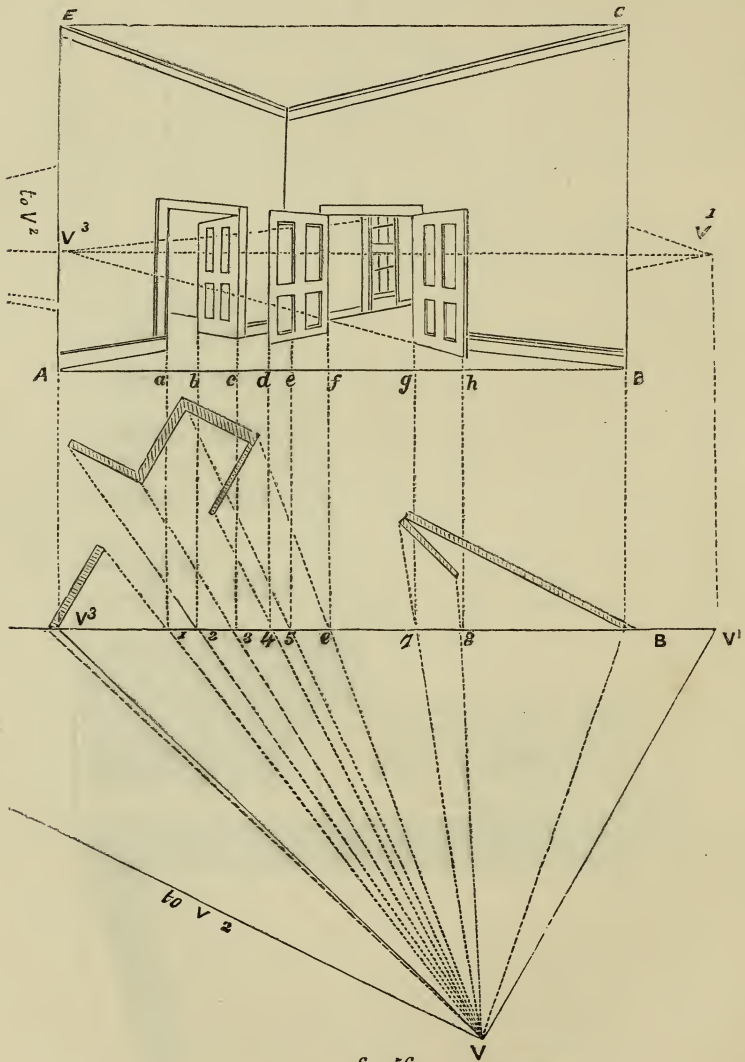

fig. 56.

transfer to the picture $A B C E$; across which draw the horizontal line at the proper height, and by perpendiculars transfer it to the vanishing-points V^1 , V^2 , V^3 . Transfer the points a , b , c , &c. in a similar manner to the

base-line AB of the picture ; perpendiculars through these points will give the respective sides of the doors and openings, and the corner of the room. On the sides of the picture mark the proper heights of the door-openings ; from which, lines to the opposite vanishing-points will denote the tops of the door-ways. In the same manner, lines from the respective vanishing-points of the doors, drawn through the upper and lower corners as far as the perpendiculars denoting their outer edges, will give the perspective lines of the upper and lower edge of each door. The heights of the skirtings and cornices must now be marked off on each side of the picture, and lines drawn from such marks to the vanishing-point of that side of the room will complete them. The panels of the doors may be found by lines to the vanishing-point of each door, denoting the upper and lower line of each panel, and the sides of the panels may be determined by the rule given at fig. 55.

Fig. 57 shews the manner by which the various lines of an oblique per-

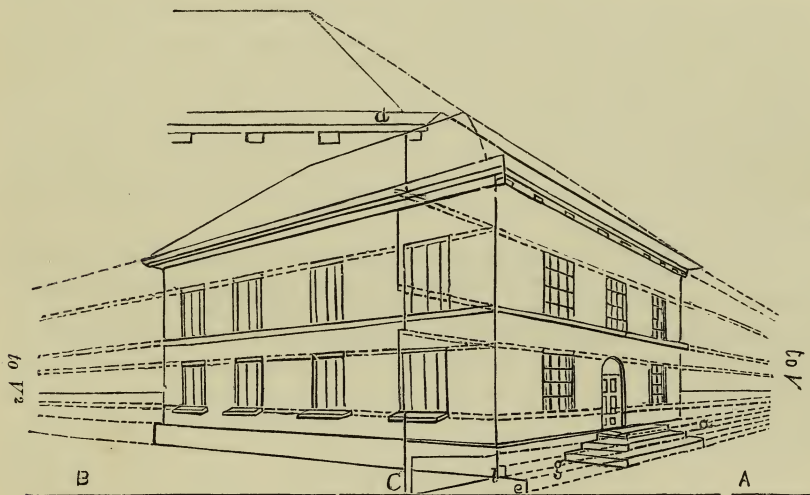

fig. 57.

spective view of a house are obtained. Let AB be the base-line, and let it be supposed that the perspective plan of the house has been obtained in the manner described at figs. 44 or 56, $V1$ and $V2$ being the vanishing-points of the two sides of the house : required to find the true perspective heights of the house and its various parts, namely, the roof, cornice, upper and lower windows, string-course, heads and sills of windows, and plinth, including also the three steps at the front door. Produce the lower line ab of one side of the house till it meets the base-line, and at the intersection C erect a perpendicular cd , as in fig. 52, on which set off, according to the scale, the proper heights of the various points and objects desired ; set off also from the same line, and in proper proportion, all projections from it, such as the steps, window-sills, and cornice ; and on the other side of it all depressions, such as the window-recesses. This will give the outline of the house in elevation ; and the true dimensions of these parts, according to

the scale, being thus obtained at the plane of delineation, must now be transferred to their perspective positions in the picture. From the various points and angles of the different parts on this line, draw lines to the vanishing-point V 1, which lines will denote the perspective heights of those points and angles at any distance in the picture. Obtain from the base of the plane of delineation on the ground-plan, in the manner shewn in fig. 44 or 56, the vertical lines denoting the three corners of the house; as also those shewing the front corners of the cornice, plinth, and steps. From the intersections of these front corner-lines with the vanishing-lines to V 1 draw similar vanishing-lines to V 2, which will give the perspective heights of the corresponding windows, sills, &c. on the other side of the house. The sides of the windows, sills, and door may now be determined by vertical lines obtained either as shewn in fig. 55 or 56, and the sides of the steps by lines from their points in the elevation to their respective vanishing-points V 1 and V 2.

The student will perceive that by this process not only perspective heights, but also breadths or widths are determined; for the points of the projections and recesses, as of the cornice, sills, and steps, are obtained in their horizontal as well as vertical distance from each other. Thus the breadth eC of the lower step is shewn in true perspective width at g ; and the same of the widths of the sills, projection of cornice, and depth of window-recesses. All these are determined by the intersections of perpendiculars from the base-line (transferred from intersections of visual lines with the base-line on the plan) with vanishing-lines from the elevation at the plane of delineation.

By the aid of the examples which have been given, it is hoped the student will have acquired a general idea of the principles and rules by which perspective drawings are regulated. He will find it advantageous to work out each example for himself, by the aid of the descriptions given, to a larger scale than has been admissible from the size of these pages: such a course will give him a much more intimate knowledge of the art than simply reading them over. As the vanishing-points and point of distance will be found frequently to have their situations far beyond the limits of his drawing, which would necessitate a much larger sheet of drawing-paper than the drawing itself actually requires, he is advised to stretch a sheet of common cartridge-paper on a board of large dimensions; and having cut his drawing-paper somewhat larger, but not very much so, than the size of the proposed drawing, to fasten it down on the centre of the board over the cartridge-paper by small brass-headed pins at each corner, taking care, by the aid of the T-square, that the sides of the drawing-paper are parallel with those of the drawing-board. By following this plan, those lines and points which are beyond the limits of the drawing will be continued on the cartridge-paper, and when the drawing is finished it may be taken off by loosening the pins; and if the lines on the cartridge-paper be then obliterated with india-rubber, and another piece of drawing-paper pinned down, the same cartridge-paper will serve for several successive drawings. Of course care must be taken that when a drawing has been pinned down and once commenced, it be proceeded with till finished; otherwise there is a chance that it may not be refixed in precisely the same position, which would alter the relative positions of all the points and lines with respect to the drawing.

The student being thus familiarised with parallel and oblique perspective,—which two terms comprise the representation of the forms of all objects at any distance and from any given point of view,—will find no difficulty in applying their principles and modes of proceeding to more complicated objects than have been here illustrated, keeping always the leading principle in view. In most of the examples, the existence of a ground-plan of the object has been pre-supposed; and this will generally be found the most convenient way of working (sometimes further aided in elaborate objects by an elevation). It will mostly be found in large drawings convenient to have the plan and elevation on separate paper, drawing a line across the plan to represent the situation of the imaginary transparent plane of delineation, marking the station in its assumed situation on the plan, and drawing thence visual lines to the points of the object. The intersections of these with the line of that plane may be transferred thence to the base-line of the actual drawing by compass or by an edge of paper, in the manner described at fig. 43.

When objects are to be drawn in perspective to a scale of feet or inches, which is necessary in architectural and some other subjects, the scale must in all cases be set off *at the plane of delineation*, that is, either at the upper, lower, or side lines of the drawings; and must never be set off on the objects themselves, unless they are supposed to be close to that plane. Thus, in fig. 52, the front edge of the house being supposed to be at some distance bc , beyond that plane, had the true height in feet been set off on the line eb , it would have made the house taller than its true perspective height. In all such cases the lines must be continued from their vanishing-points to one of the four lines denoting the boundary of the said plane. In the figure just referred to, the line ab is continued on to the base-line, and the height cf , according to scale, is laid down on the perpendicular there erected. The line Vf , by its intersection with eb , gives the true perspective height eb . The same rule is manifest in fig. 38, where the height of the arch and its various points, transferred by horizontals to the side of the picture from the elevation (which is supposed to have been drawn to a scale), gives the perspective heights of the corresponding points in the other arches of the series.

In most of the preceding illustrations the perspective view has been drawn with four lines, representing the boundary of the imaginary transparent plane through which the objects are seen; but in figs. 57 and 55 these lines are omitted, as they are in no way essential to the drawing, though often useful as a boundary, representing an opening or glazed frame, through which the picture is supposed to be seen. Drawings in which this boundary does not exist are called *vignettes*; and are in all cases supposed to be seen through such imaginary plane, though its outline be not represented by lines.

The elements of *linear* perspective being now explained, let us pass on to that which refers to the force and distinctness with which objects should be drawn in proportion to their supposed distance from the spectator, and which is called *aërial* perspective. As objects apparently diminish in size according to their distance, it follows that at a certain distance small objects, and at a greater distance those of somewhat larger size, will be so diminished as to be imperceptible. Lines, therefore, near the eye, of great thickness (speaking artistically, not with strict geometrical

truth), lose a portion of their apparent thickness as they recede from it, till they are altogether lost in the distance ; and if prolonged, would fade long before they reached the horizon. For this reason, objects at a certain distance lose a portion of their distinctness, and become more or less confused with each other. There is also another reason : the further an object is removed from the spectator, the greater is the quantity of air between it and him through which it has to be viewed ; and though the atmosphere is a highly rare medium, it still possesses a certain small degree of density, which tends still further to diminish the distinctness of distant objects, in proportion to the quantity of air through which the visual rays have to pass. In certain states of weather, such as a damp or cloudy day, this density is increased, and distant objects become consequently less distinct. These circumstances being duly kept in view by the artist, and having their proper influence on the strength of his lines and depth of his tints, materially enhance the perspective effect of his drawing. The lines of distant objects should be very lightly traced with a fine-pointed pencil, while the strength and breadth of those representing objects nearer the plane of delineation should be increased in proportion as they approach it. The same rule must apply to the depth of tints and shadows ; those of objects supposed to be at a great distance should be faint and light, those in the foreground must be dark and forcible, and those of the middle picture must have an intermediate strength. In short, in proportion as objects approach the plane of delineation from the horizontal line which forms the limit of the distance that can be taken in by the eye, so must the thickness of their lines and depth of their tints and shadows increase in the same proportion.



PERSPECTIVE DRAWING.

PART III.

SHADOWS—DEFINITION OF PRINCIPLES AND TERMS—LUMINARIES, NATURAL, ARTIFICIAL, AND SECONDARY—REFLECTION OF LIGHT—POSITION OF LUMINARY—SHADOW-PLANES, HORIZONTAL, VERTICAL, OBLIQUE, AND IRREGULAR.

LIGHT and shade are important aids to perspective effect, and, since all objects partake of them more or less, are necessary constituents of true representation. It is therefore intended here to superadd to the preceding explanation of the rules which regulate the correct delineation of objects, a statement of those further rules which must be observed to obtain a correct imitation of their shadows. This is the more necessary, since it sometimes happens in drawing, that the presence and shape of an object, hid perhaps by others intervening, can only be intimated by its shadow being so situated as to be visible. There is a remarkable instance of a similar use of the shadow in Collins's picture of "Rustic Civility," where the presence of a man supposed to be advancing on horseback towards the picture by a road in front of the plane of delineation, is solely denoted by the shadows of a man and horse partly thrown into view on the foreground. Before entering on the subject some definition of terms is necessary.

Shadows are those portions of surfaces which are debarred from those rays of light which would fall upon them but for the intervention of some opaque body. That side or part of such opaque body which is turned *from* the source of light is said to be *in shade*; that which is *towards* the light is said to be *illuminated*. The source of light in a picture is called a *luminary*. Luminaries are of three kinds,—natural, artificial, and secondary. A *natural* luminary is one which exists in nature, as the sun, moon, stars, or an illuminated piece of sky. An *artificial* luminary is the result of art, as a fire, lamp, lantern, or candle. A *secondary* luminary is an opening through which light enters from any natural or artificial one, as a window, door, or opening in a wall. The *place* of a luminary is its perspective situation on the plane of delineation, or, if beyond the limits of the picture, as is mostly the case, on any imaginary extension of it. The surface on which the shadow is cast is called the *shadow-plane*. In landscapes, the ground-plane is the principal shadow-plane. The *foot* of a luminary is a point on the shadow-plane produced, at which a line at right angles with that plane from the luminary would intersect it. But in the case of a secondary luminary, as of a window, which usually occupies considerable width in the picture, the foot of the luminary is not a point, but a line comprised between the intersections of two lines with the shadow-plane at right angles with it, one of those lines being drawn from each extremity of the luminary. Thus, in an interior view, fig. 58, the window is a secondary luminary, whose foot is the line comprised between the lines drawn from the extremities of the window, which are at right angles with the floor.

Since it is the intervention of an opaque body between the luminary and the shadow-plane which causes a shadow, it follows that the shadow

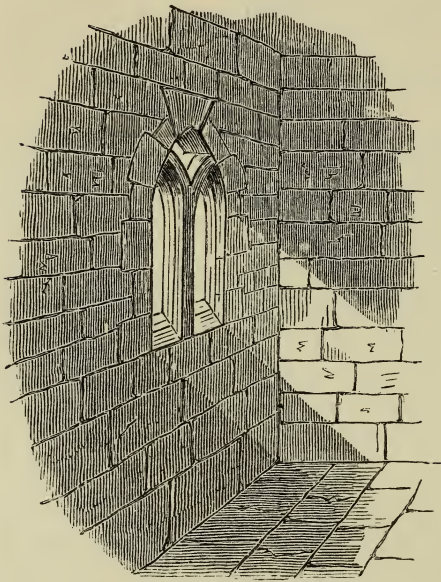

fig. 58.

will be always projected in a direction *from* the luminary; and since rays of light proceed from a luminary in straight lines, it follows that a straight line passing from a natural or artificial luminary through any opaque point to any plane, will intersect the surface of that plane at a point which will be the situation of the shadow of the opaque point on that plane. It is important to bear this in mind, because by finding the shadows of points in any object we can often determine the form of its entire shadow.

Rays of light, however, do not proceed from all luminaries in the same way. Those *natural* luminaries, the sun and moon (speaking of the latter when she is at the full), present to the earth's surface a luminous disc of much larger extent in reality, though rendered apparently less by their great distance, than any part of that surface which can be comprised within the limits of a picture. In such case the luminary is larger than the object illuminated; and since every point of the disc of those luminaries emits rays of light in straight lines, it follows that the rays will proceed in parallel lines from the luminary to the object. But parallel lines in perspective converge towards a point; and the converging point of such rays will therefore be that point on the plane of delineation which represents the centre of the luminary; in other words, the *place* of the sun or moon in the picture.

Artificial luminaries throw off their rays of light in a different manner. Being small, and the luminary generally within the picture, its rays proceed in all directions from it as a central point. Though this causes a material difference in the form of the shadow from that which would be projected by a natural luminary, the rule is the same, viz. that the rays converge towards the place of the luminary.

Secondary luminaries usually occupy a larger extent of the picture; and since the light they admit is a borrowed light, and diffused over the entire surface of the luminary, they generally admit a fainter light, and cast a feebler shadow. They must be dealt with by different rules from those which are natural and artificial; their greater surface forbids their being considered as points. Each point in that surface must be dealt with as a luminous point; and the form of the shadow must be determined by rays from each of the outer extremities of the luminary.

These definitions will become better understood as the student pro-

ceeds ; in the mean time it may be observed, that natural luminaries are generally adopted in landscape and architectural exterior subjects ; artificial ones in parlour-scenes, robbers' caves, and all that class of subjects in which Rembrandt delighted, many of his finest drawings of "The Nativity" being stable-scenes, with a candle or lantern for the luminary ; and secondary ones in interior daylight-scenes, such as occur in churches and dwellings.

Light is reflected from all opaque surfaces to others, less or more, according as they are rough or smooth, distant from or near to each other ; and the same law obtains with respect to reflected light as applies to solid bodies falling on any surface,—*the angle of reflection is equal to the angle of incidence*. For this reason less light is reflected to a distant than to a near object, as is manifested by fig. 59, in which three rays *a, b, c* of light are

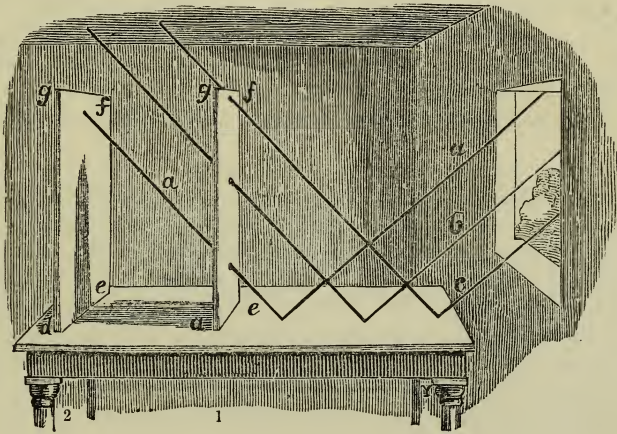

fig. 59.

supposed to pass through an opening in a wall, falling upon a table, and thence reflected to the plane *d e f g*, set up on it at the position 1, in which position all the three rays are reflected upon it. But if we suppose it moved backwards to the position 2, it can only receive one (*a*) of the reflected rays, the others passing away over it.

Another effect of reflection is, that the shadow of any object is always darker than the object itself, even than that side of it which is in shade ; for there is no light reflected upon the shadow itself ; while those parts of the shadow-plane which are illuminated do reflect a portion of their light upon the shaded side of the object, which will make it less dark than its own shadow.

Rays of light falling on any plane in a direction perpendicular to it, illuminate it to a higher degree than if they fell in an oblique direction ; the degree of illumination decreasing in proportion to the obliquity. In fig. 60, let *a, b, c, d* be four rays of light falling perpendicularly upon a plane *e f*. If the plane be moved to an oblique position *g f*, three only of the rays fall upon it ; if to a more oblique position *h f*, two only can take effect upon it, and so on.

In architectural and other subjects, where a ground-plan and elevation are prepared for the purposes of the perspective drawing, the easiest way

of drawing the shadows on the latter sometimes is to draw them first on the plan and elevation, and then put the points and lines of the shadows into perspective, by the rules given in Part II., in the same manner as though they were points and lines of the objects themselves. For this purpose no further rules are necessary, except that the place of the luminary as regards the plan, and its height as regards the elevation, must be given or assumed; this will determine the direction of the rays, and thence the geometrical forms of the shadows in plan and elevation, by which means their perspective forms will be easily obtained on the picture.

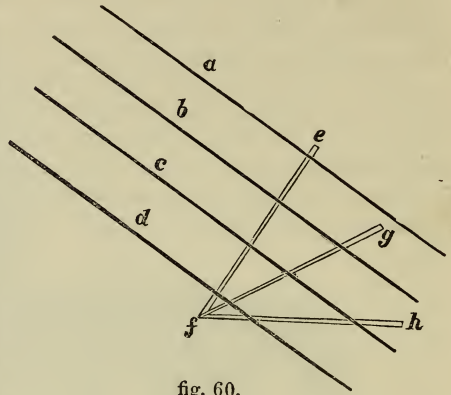

fig. 60.

But in many drawings no plan nor elevation has been necessary; for which reason rules are required by which perspective shadows may be found without them: as a safe guide to the true understanding of these, the learner must keep clearly in mind that the rays of light, on the direction of which the forms of shadows largely depend, are subject to all the perspective laws of parallelism, convergence, &c. which appertain to straight lines in general, and therefore that the shadows themselves are governed by the same laws. The principal circumstances influencing the form of a shadow are the form of the original object, the position of the luminary with respect to it, the nature of the luminary, and the direction of the shadow-plane. The following rules will be found to be of general application to these varying premises:

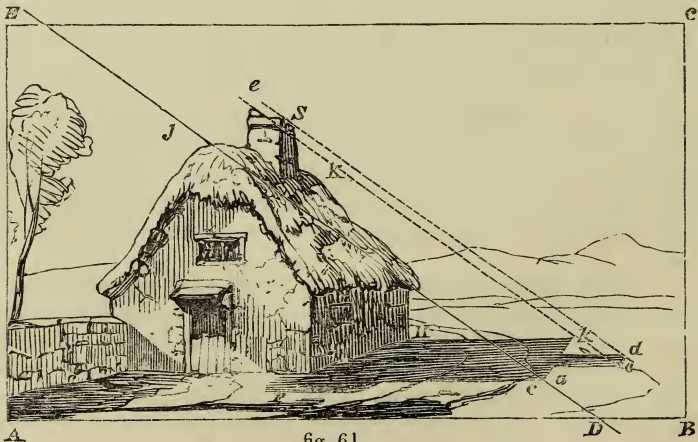

fig. 61.

Let it be required to project on the plane of delineation $A B C E$, fig. 61, the perspective shadow of the cottage drawn thereon; the direction of

the sun's rays being supposed to be parallel with that plane, and the sun's height denoted by the line ED , making the angle of inclination of his rays equal to EDA . From both ends of the base of the cottage on the side in shade, or furthest from the luminary, draw lines Fc , Hk on the ground or shadow-plane in the direction of the sun's rays, that is, parallel with AB by the supposition. Through the upper corners J and K of the cottage, draw lines Jc , Kk parallel with ED , intersecting the two first lines respectively at the points c and k . These points are the shadows of the points J and K , and by connecting them together by a line, a figure $ckHF$ is completed, which is the perspective shadow of the house. From the base of the chimney draw two similar inclined lines intersecting ck , a' , a and b , and from these intersections draw ac , bd parallel to AB . Draw ec , Sd through the points e S of the chimney parallel to ED , and join c to d , which completes the shadow of the chimney. The shadows of the wall, tree, &c. are found in the same manner.

In this illustration the luminary was supposed to be in such a position that the rays of light were parallel with the picture. In the following one, fig. 62, they are supposed to proceed from *behind* the picture, throwing



fig. 62.

the shadows rather towards the spectator; the moon is substituted for the sun as a luminary, and its place L , in this case within the picture, is given. Required the shadows of the arches and ruins. First find the foot of the

luminary, by drawing $L F$ through it perpendicular to the shadow-plane, intersecting it at F . Next, from F draw lines on the shadow-plane through the lower corners of the objects where they meet that plane. Then, from the luminary draw rays through their upper points or corners, the intersections of which with the lines on the shadow-plane at $a, b, c, \&c.$ will denote the shadows of those corners and points. Join these, and the figure of the shadow is completed.

Suppose now that the luminary, instead of being behind, is somewhat *in front* of the picture, which will cause the shadows to be thrown *from* the spectator; its place (in this example not within the picture) being given. In such case its position must be inverted, that is, placed as far below the horizontal line as its true position is above that line, and equidistant on the other side of the object (L , fig. 63). Draw $F a, F b, \&c.$

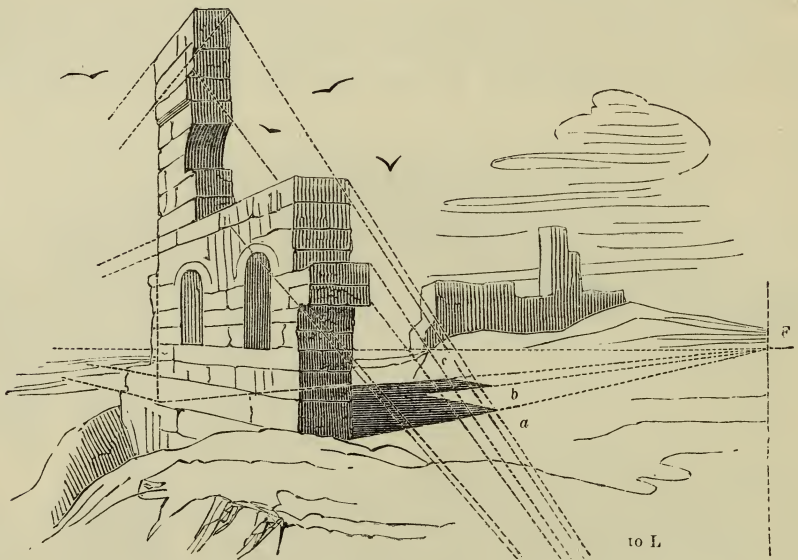

fig. 63.

from the foot of the luminary, as in the last example, and draw the rays from the inverted position through the upper corners of the object. Their intersections at $a, b, c, \&c.$ with the lines on the shadow-plane will give the shadows of those corners, by joining which the shadow is completed.

In fig. 61 the position of the luminary was such, that the rays were *parallel* with the picture; but in figs. 62 and 63 their direction with respect to the picture-plane was *oblique*; which is the reason why, in the former case, the lines on the ground-plane are drawn parallel with each other, while in the two latter they converge towards the foot of the luminary,—the one being a case of parallel, the other two of oblique perspective. From these three examples, the student will also perceive that the shadow of any point is found by drawing a triangular perspective plane, whose perpendicular is a line from the luminary to its foot, whose base is a line on the shadow-plane passing perpendicularly beneath the given point from the

foot of the luminary, and whose hypotenuse is a line from the luminary through the given point intersecting the base-line at the shadow of that point. A clear conception of this will give an insight into the whole principle of shadow-drawing ; for by obtaining perspective views of this imaginary triangular plane, as applied to the various prominent points of objects, we easily obtain, at the places where its hypotenuse meets its base, the perspective shadows of those points which denote the outline of the entire shadow.

Having found the shadow thrown by any one plane on another, it is easy to find those of others parallel with it thrown upon the same plane. It was stated (fig. 59) that rays of light, and therefore the lines of shadows,

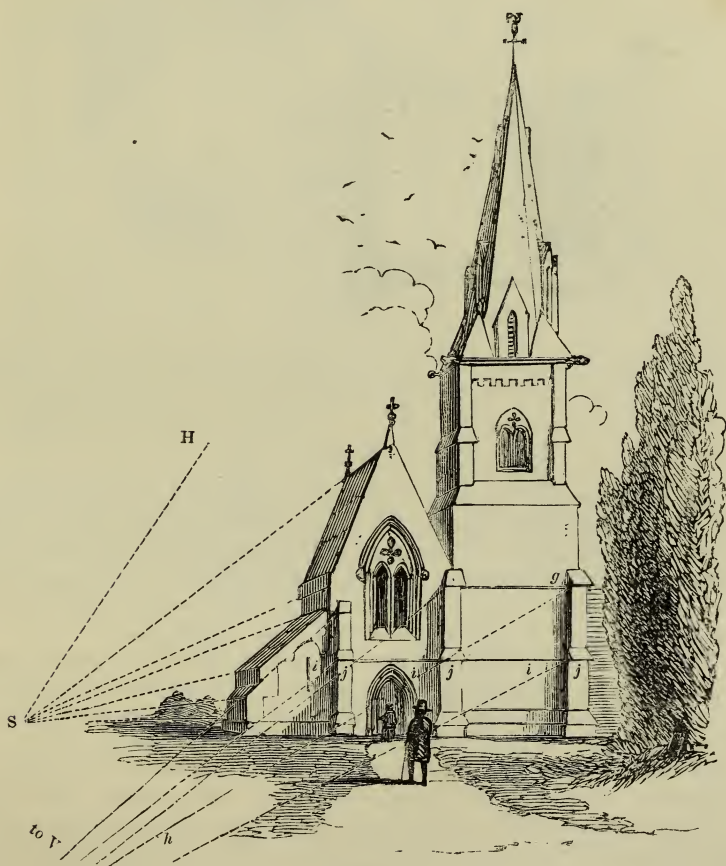

fig. 64.

are subject to perspective laws ; hence parallel shadow-lines have a common vanishing-point in oblique perspective, and often in parallel perspective. In the adjoining view of Birch Church, near Manchester (fig. 64), given the shadow of one of the buttresses, to find those of the outer buttresses on the parallel shadow-planes of the end of the church. Let S be the point

of sight on the horizontal line, and SH the inclination of the upper line of the given shadow, passing through S. Draw gh , intersecting SH at V, which will be the vanishing-point of all lines parallel with gh , and which will determine the situations i of the shadows of the various points j of the buttresses.

Shadows on vertical planes are determined by the same rules as when the shadow-plane is horizontal; care being taken that the line from the luminary denoting its foot, where it cuts the shadow-plane, be at right angles with that plane. Thus, in fig. 65, to find the shadow of the window-

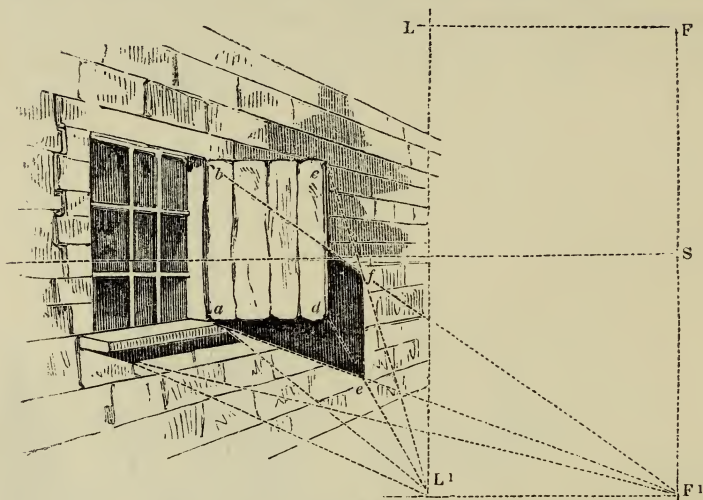

fig. 65.

shutter, as thrown on the wall from the sun's place L, in front of the picture, draw LF perpendicular to the shadow-plane, cutting it at F, which is the foot of the luminary. The shadow being in this case thrown from the spectator, invert the luminary, as in fig. 63. Draw F^1a , F^1b , and L^1c , L^1d , crossing each other respectively at e and f ; join e and f , and $efab$ is the outline of the shadow, part of which is hid by the shutter.

The same rule applies when the shadow is thrown towards the spectator from a luminary behind the picture, omitting the inversion of the luminary. In fig. 66, L being the sun's place, F the foot, and a sign-board the object whose shadow is required, produce the object to the shadow-plane; draw on the shadow-plane Fa , Fb , and the rays Lc , Ld , intersecting each other respectively at e and f ; join e and f , and $abef$ is the outline of the shadow.

When a shadow falls partly on a horizontal and partly on a vertical plane, the points at which the rays intersect the vertical plane, in conjunction with vertical continuations of the lines on the horizontal plane, determine the outline of the shadow. Let the shadow of the tombs (fig. 67) be intersected by a vertical plane; the sides of the shadow continued vertically upwards will intersect the rays at points, by joining which the outline of the shadow is completed.

When a shadow falls on an inclined plane, the rays must be drawn, as before, parallel with each other, if parallel with the picture-plane, but radiat-

ing from the place of the luminary if oblique with respect to that plane. In fig. 68, which is another view of Birch Church, Manchester, required

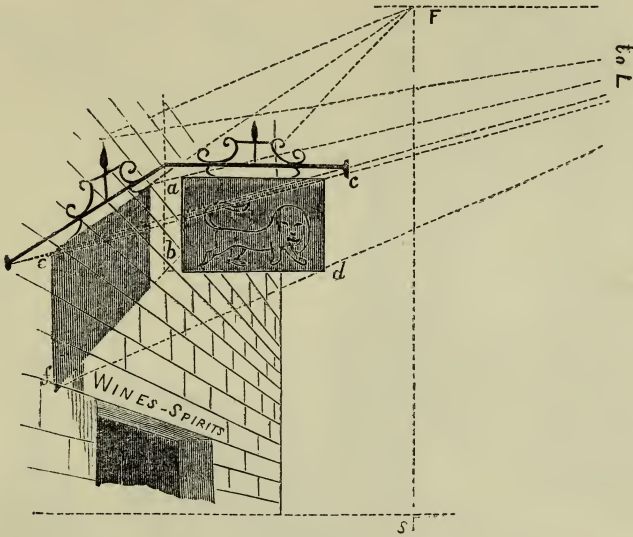

fig. 66.

the shadow of the tower on the slopes of the roof, L being the luminary's place, F its foot, and the shadow being thrown rather towards the spectator,

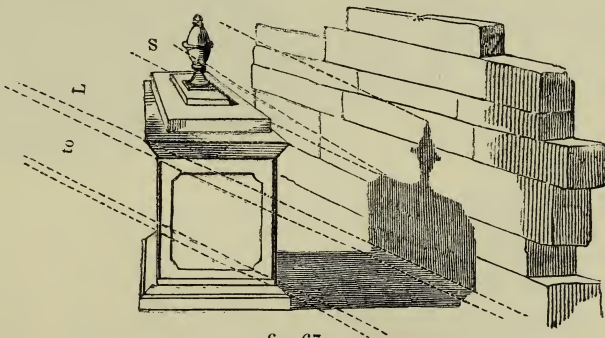

fig. 67.

the rays being at a small angle with the picture. From F draw ab across the ground-plane, from the front corner of the base of the tower, through the side of the church; on which carry up bc parallel with the angle of the tower to the roof of the side-aisle at c . From the point d on the ground-plane, where ab intersects the base-line of the clerestory wall, carry up de parallel with bc , intersecting the top line of the lower roof at f . Join c and f , which gives the shadow's outline on the inclined plane of the lower roof; next find the perspective centre-line of the plan of the church, perpendicularly under the ridge; and where ab intersects it, erect a per-

pendicular to k , intersecting the ridge-line at k . Join k and e , which continues the shadow's outline over the second inclined plane of the upper

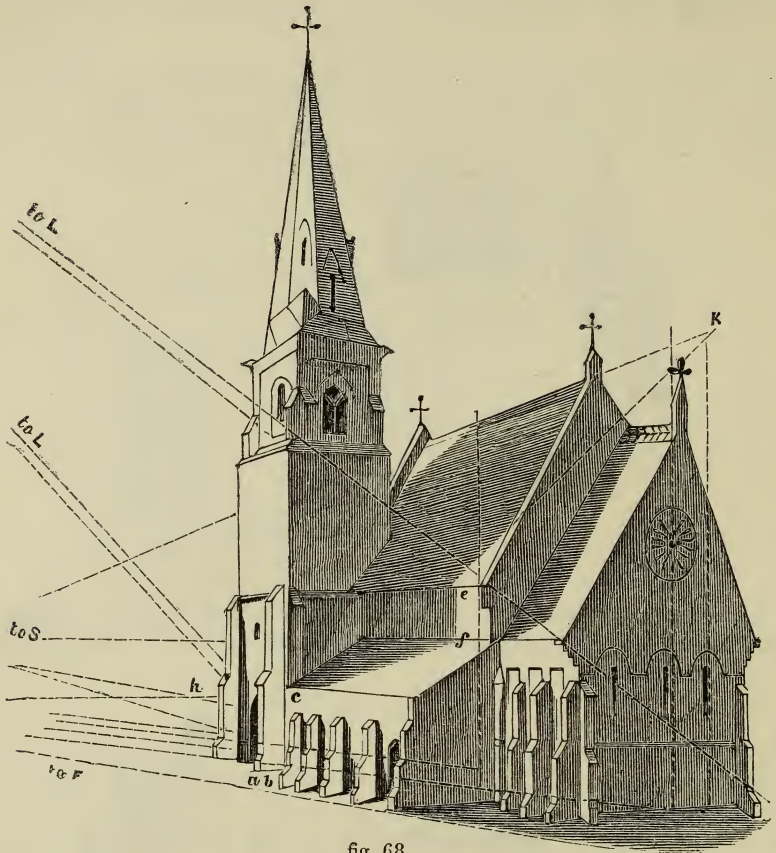

fig. 68.

roof; find the perspective position of the furthest angle of the tower; and by the same process of finding its shadow-line on the ground-plane, and erecting a perpendicular where it crosses the centre-line under the ridge, the intersection of the shadow with the ridge and the boundary-line of its other side are found. The shadows of the buttresses are found by the simple process shewn on a larger scale at fig. 69; and those of the church itself are obtained by preceding rules.

It will be observed, that the principle which has been acted on in this case to find the shadow of the tower on the irregular shadow-plane formed by the body of the church, has been to find the base and extremity of the triangular perspective plane, previously alluded to, in the position it would have assumed had the body of the church not intervened, and then by perpendiculars at proper points on that base to find the points at which that plane would intersect the building; by which means the irregular line into which the hypotenuse is thrown by the irregularities of the shadow-plane is found thereon.

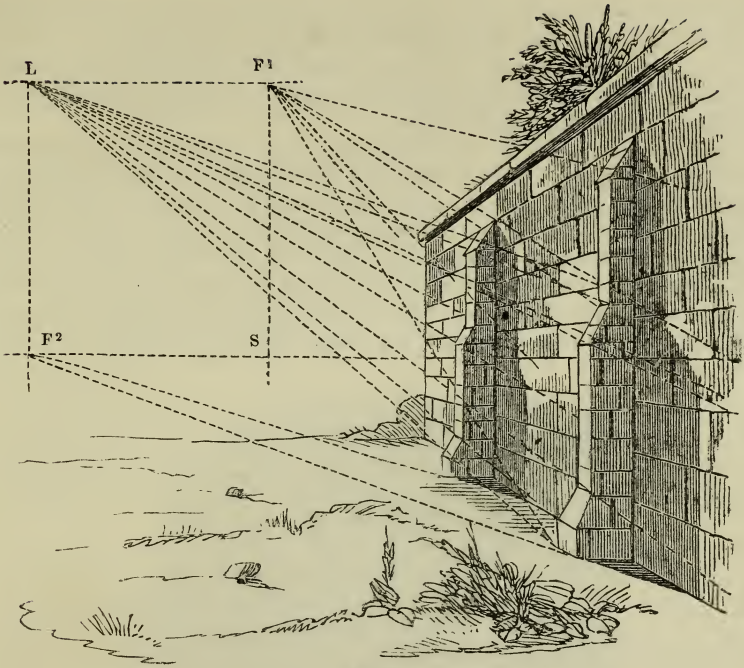

fig. 69.

In fig. 69, it must be noted that there are two feet of the luminary ; F^2 being the foot as regards the horizontal shadow-plane of the ground, and F^1 that for shadows on the vertical plane of the wall. The shadow of each

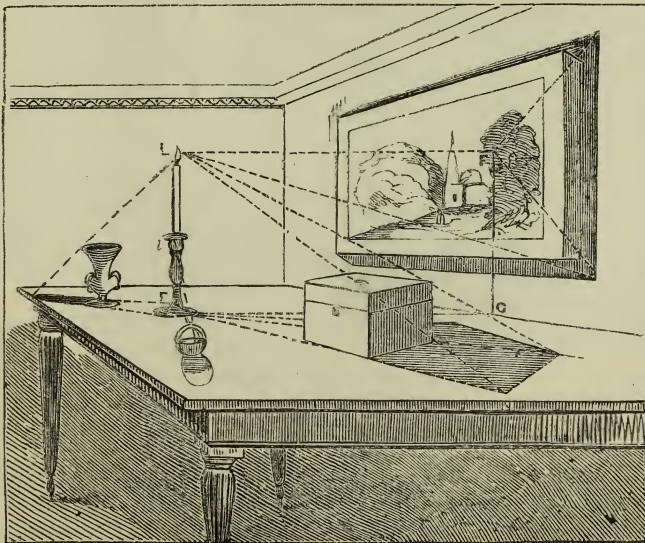

fig. 70.

point of the buttress is found by drawing through the foot of that point on the shadow-plane a line from the respective foot of the luminary, and intersecting it by a ray from the luminary through the point whose shadow is required. F^2 is on the horizontal line, and F^1 on a line perpendicular to it passing through the point of sight.

Artificial luminaries are less often introduced into drawings than either natural or secondary. A few examples will therefore suffice, especially as the rules are the same, though, from the fact of such luminaries radiating light in all directions, rather differently applied. In fig. 70, the shadow of the work-box is found on the shadow-plane, in this case a table, by means of intersections of the rays with the foot-lines, precisely as in the previous examples of natural luminaries, with their shadows towards the spectator; while that of the vase being on the other side of the candle is thrown

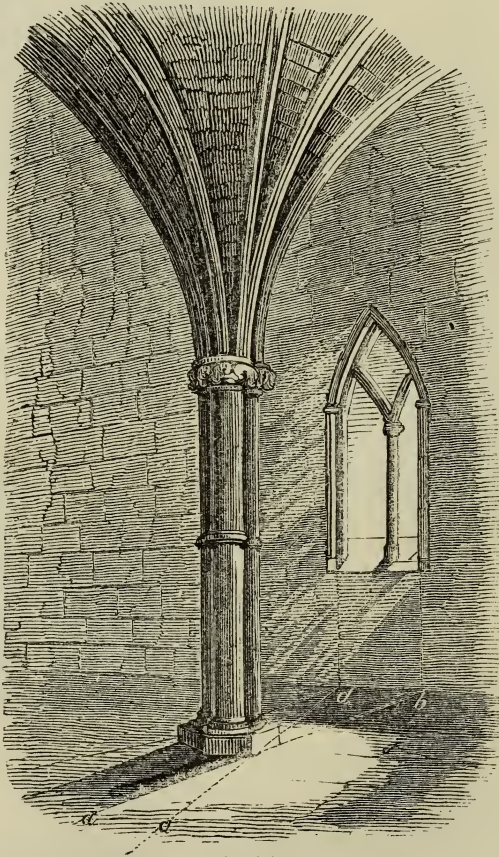

fig. 71.

from him. The shadow of the picture-frame on the wall being thrown on a vertical shadow-plane, the foot F^2 of the luminary on that plane is to be found by drawing $F'G$ to the wall, and there making $G F^2$ perpendicular to it; the intersection of this last with $L F^2$ is the foot for that plane, which

must be dealt with as previously directed. Foot-lines from it through the corners of the frame, intersecting rays from the candle, will give the extreme points of the frame's shadow.

Secondary luminaries not being points, but frequently large surfaces giving out rays from every point within them, require rather different treatment. The foot of such a luminary was shewn at fig. 58 to be not a point, but a line as long as the width of the luminary where its plane meets the shadow-plane. From each end of this line it may pass the object on either side, but there will always be a space behind the object in full shadow, and a space on each side in half-shadow. The rule for finding these spaces is shewn in fig. 71; a line ab drawn from each end of the foot of the secondary luminary past the *opposite* side of the object denotes the entire space occupied by the half-shadow; and another line ad from each end of the foot, past the *same* side of the object, denotes the part of that space in full shadow.

An object whose side that is in shade has less breadth than that of a secondary luminary, throws a shadow tapering to a point; whereas if the shaded side be broader than a luminary, the shadow continually increases in width. This is exemplified in fig. 72 by the tapering shadow abc of the

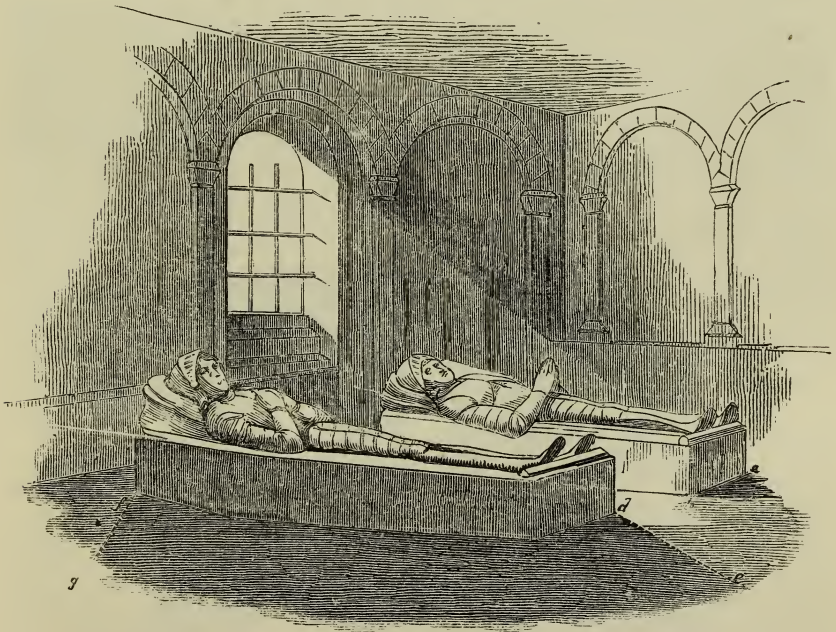

fig. 72.

second tomb, whose *end* is turned from the window, and by the widening shadow $defg$ of the first tomb, the *side* of which is turned from the light.

The foot of a secondary luminary, like that of the other kinds, is found by lines at right angles with the shadow-plane in fig. 73. There are three shadow-planes; the floor being a horizontal one, and each side-wall a ver-

tical one. The lower end of the steps is the luminary's foot as regards the shadow on the floor, and the sides of the doorway are its feet as regards those on the walls.

A most striking instance of the successful treatment of perspective effect produced by a secondary luminary is observable in a picture in the Duke of Devonshire's collection at Chatsworth entitled "Monks at Devotion," painted by Granet, a French artist, in 1817. The "dim religious light" is introduced into this picture through a small window at its further end, and the long dark shadows of the devotees, projected towards the spectator, greatly enhance the artistic effect of this remarkable work. An engraving from it in mezzotint, and another of its sister picture, "Nuns at Devotion," has been published with excellent effect, and may be studied with great advantage.

In interior views with many windows, as of churches, each window is a secondary luminary producing its own effect, yet affected in some degree by the others. In general, those on the sunny side of the building admit the stronger light and cast the deeper shadow; so much so, sometimes, as almost to neutralise the effect of the other. On this point precise rules can scarcely be laid down; the artist's attention being called to this effect, its imitation must be left to his judgment and observation.

The examples that have been given, if duly worked out by the student, will convey to his mind a tolerably clear conception of the mode of finding shadows under every variety of circumstances, as regards form of object, kind and position of luminary, and nature of the shadow-plane. They have been arranged with the view of fixing in his mind the principles on which he ought to proceed; an accurate knowledge of which is the surest guide to correct practice.



fig. 73.

PERSPECTIVE DRAWING.

PART IV.

APPLICATION OF PERSPECTIVE TO SKETCHING AND LANDSCAPE-DRAWING—CHIARO-SCURO.

THE rules which have been thus far given will enable the student, in most ordinary cases that occur, to give correct representations of objects and their shadows. They are, however, most applicable to those classes of subjects which depend for their effect on the exact fidelity with which their straight lines and plane surfaces are portrayed, which must therefore be drawn by strict rule. Of this kind are exterior and interior views of buildings, street-scenes, and the like. Architectural drawings are in most cases intended to be faithful representations of new buildings; their lines and angles must therefore be shewn with great exactness. But this is inadmissible in landscape-drawing, as it would communicate to natural scenery a stiffness and sharpness of outline which does not exist in the scene itself. In many drawings, even of buildings, truth to nature requires the artist to present them more or less worn and dilapidated by the effect of time, which destroys the sharpness of their angles, breaks up the straightness of their lines, and gives them that irregularity and rusticity which are essential properties of that quality called *the picturesque*. But even with scenes and objects such as these, perspective rules must not be violated; the general outlines must be consistent with those rules, into whatever deviations from strict right lines they may be thrown.

It is not expected, therefore, that the learner, when copying nature, will apply our rules in making his sketch. Having worked out the previous examples, he will have such a general idea of the direction his lines ought to take as will enable him, with care, to copy nature with tolerable fidelity; especially if he has well practised the examples in object-drawing in Sections I. and II., which must have given him a facility with his pencil and a command of hand. This copy being taken home, and pinned down on a drawing-board, as before recommended, he may prove his sketch and correct errors by applying exact perspective rules.

The first essential in sketching is the selection of a proper station. Its distance from the scene or object should not be less than the width of the latter; in many cases it may be greater; but when the distance equals the width of the scene, the angle of vision will be not much less than 60° , which was stated in Part I. to be the greatest that the eye can take in at one view. Having determined on, and taken his position at, the station,

and settled what objects are to constitute the front of his picture, the paper having previously been cut nearly to the size of the drawing, let him hold it up with his left hand before the scene, with its lower edge corresponding with the front line of those objects, and at such distance from his eye that its width may exactly comprise the scene to be drawn. With the paper in this position, let him first mark on both its sides the exact position of the horizon, which connect by a line across it, having a mark on it opposite to his eye denoting the point of sight; then on the sides and upper and lower edges let him mark the places, the heights, and the widths of the principal lines and objects. With the assistance of these marks and the point of sight, and frequent careful reference to the scene, he will be enabled to draw the objects in their proper places, and in tolerably good perspective; which he may afterwards verify and correct by rule at home.

The thickness and force of the various marks and lines must, as explained in Part II., be tinted to the distance of the objects they respectively represent. In sketching, this is a great aid to perspective effect; and by beginning first with the distance with a finely-pointed pencil, the marks as they approach the foreground will of themselves acquire increased thickness by the wearing down of the point. Care must be taken to avoid too many marks and lines, which will produce a confused effect, and is a common error with beginners, who should study to attain the smallest number of marks that will correctly denote the character of the object. Increased boldness in the outlines of the foreground may be attained by using a softer and blacker pencil, of the kind marked BB; this will often assist the perspective effect by increasing the idea of their nearness to the spectator.

These are the main points to be attended to in a sketch from nature, so far as perspective is concerned. They will be found to be embodied in the sketch, fig. 74, which the student is recommended to copy; producing



fig. 74.

the strong and dark lines of the foreground, not by a succession of marks laid one over another, which will produce a misty and indistinct effect, but by laying each of them on at one stroke boldly and with decision.

The character of the marks representing the various kinds of foliage appertaining to the different trees, as the ash, the oak, the elm, &c., should vary according to the distance of the tree, and will thus in some degree assist the perspective idea of distance. Thus, in the case of an oak in the foreground, the branches and separate small collections of the foliage may be each denoted,—the foliage by a number of small, decided, and angular markings, which convey the impression of that tree to the mind. But the same tree at a distance must be represented by marks of a less decided and different character; inasmuch as at that distance the outlines or separate small portions of foliage cannot be given, but only the general outline of the whole mass. At a greater distance these markings must lose their distinctive character; and a distant wood consisting of trees of various kinds may be denoted by marks all of the same character. A due attention to this effect of distance increases the perspective effect of a landscape.

It is not intended here to give precise directions as to the kind of marks to be used to denote trees of different species, as it does not come within the province of perspective. In this part of the art of drawing, nature will be found the best teacher; by observation of the objects themselves and frequent practice, the young artist will soon learn how to communicate to his trees their distinctive character. Almost every artist has a way or *touch* of his own, by which he conveys the idea that his tree is an oak, an elm, &c.; and by the study of the real foliage, which nature displays in profusion before him, better than by any lessons, will he acquire a facility for representing it.* After carefully considering and comparing the works of nature, however, he may with advantage refer to those of the best masters, should his opportunities permit. Among those works from which he may derive most valuable hints as to the treatment of foliage may be mentioned the paintings of Cuypp, Both, and Ruysdael, of the Flemish school; of Salvator Rosa in the Italian; and of Wilson in the English school, who attained great success in representing it under different effects of sunshine and storm; and of our Gainsborough, whose quiet rural scenes owe much of their beauty to the leafy masses therein depicted.

The proper management of *light and shade*, and their judicious arrangement into breadths and masses, called by painters *chiaro-scuro*, are also valuable aids to the perspective effect of a landscape. It is a common mistake with beginners to appropriate to each individual tree, figure, house, or other object, its own light and shade, irrespective of the general effect (fig. 75). The consequence is, that the picture is cut up, so to speak, into a great number of lights and shadows of nearly equal size and intensity, alternating over the entire surface of the picture; by which means the eye is distracted, and cannot rest with satisfaction on any portion of it, since all the objects depicted are thus made to present nearly equal claims to attention. The avoidance of too many small lights, the placing of the principal object in one larger and more intensely illuminated space, the keeping of other lights subordinate to it, and the proper regulation of the contrasts between light and shadow according to distance, all tend to direct atten-

* In Section II. the pupil will find examples of different kinds of foliage.

tion to the principal object, and to preserve the proper *keeping* of the picture. The same may be said of the shadows. There should be one principal shadow, to which the others should be subordinate; they should not be too much subdivided into numerous small shadows, but a proper degree of breadth of shade should be maintained undisturbed by intervening lights which will much contribute to the repose of the picture.



fig. 75.

The same scene is depicted in fig. 76 as in the previous figure, with more attention to the repose resulting from the observance of these few hints. On this subject a few general observations may be of service.

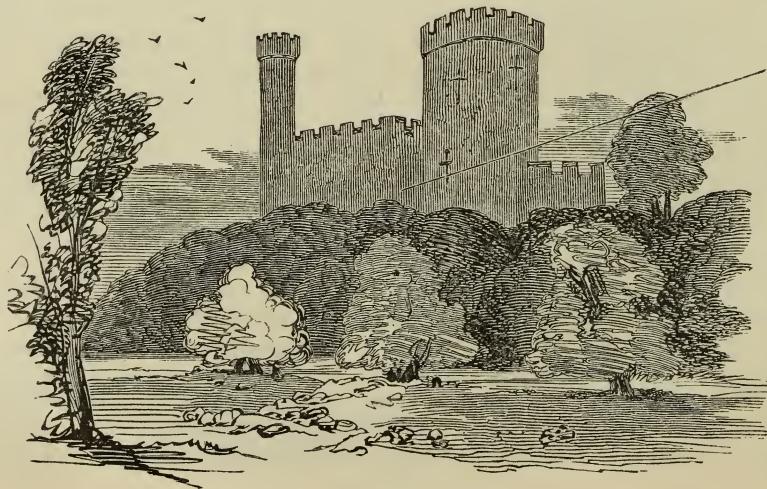

fig. 76.

Every landscape may be divided with greater or less precision into three parts, the distance, the middle-picture, and the foreground. As the effect of distance is to subdue both lights and shadows, the first of these



fig. 77.

seldom plays a conspicuous part in the general arrangement of the chiaro-scuro ; although the deep blue of a distant mountain in full shadow is



fig. 78.

sometimes effectively introduced. The largest breadth of shade is generally spread over the middle-picture, while the deepest shadows, as well as the strongest lights, naturally, from its proximity, occupy the foreground.

Sometimes, however, the foreground is in full shadow throughout, and the principal light falls on the middle-picture. In this case, a few strong and scattered touches of light falling on objects in the foreground contrast very effectively with its dark tints. In daylight scenes, in nature, the principal light is generally in the sky; but in a showery or stormy sky, when the sun is supposed to be shining, but not from within the limits of the picture, the entire sky may often be in half-shadow, and the principal light on the foreground or middle-picture. Fig. 77 represents a cloudy sky, with the principal light on the foreground, and the whole middle-picture in shadow. In fig. 78, the principal shadow, on the contrary, is on the foreground, the lights being on the sky and middle-picture.

Should a mass of shade be required for the sake of repose in a position where there is nothing naturally to produce it, a tree, a house, or other object may occasionally be introduced for that purpose. This, is, however, an artistic liberty which should be used sparingly, and with the utmost caution; and the painter will better display his judgment by selecting a station from which the objects and their shadows naturally produce a pleasing view, and may be represented to the best perspective and pictorial advantage, than by introducing others for the sake of effect. If no position can be found answering this condition, the object or scene may generally be abandoned as not admitting of picturesque representation, and some other chosen; although the ever-varying effects of light and shade caused by passing clouds, which may be introduced at pleasure, will often, under judicious management, produce a breadth and repose which will confer an interest on scenes otherwise wanting in pictorial effect.



PERSPECTIVE DRAWING.

PART V.

ISOMETRICAL PERSPECTIVE.

IN the Work on Architectural, Engineering, and Mechanical Drawing, we give the methods of drawing plans, elevations, and sections of various architectural and mechanical subjects. One decided advantage possessed by geometrical drawings is, that measurements from one scale will serve for all the views of an object, whether these be in plan, elevation, or section. While, however, presenting this desideratum, they are deficient in another respect; that is, the relative position of vertical to horizontal lines, or *vice versâ*, cannot be delineated on the same paper or plane. Thus, if one view is in plan, it is confined to plan alone, no lines delineating elevation being able to be drawn: hence the great variety of drawings required, to give the measurements and positions of an object or design having many points of view. The rules of perspective, which we have just considered, are applicable to the delineation of objects by which two or more sides can be seen. Thus, in the case of a box which is longer than it is broad, but having the bottom of the same dimensions as the top; to give drawings geometrically constructed, from which a workman might take measurements, three separate views would be essential, namely, one of the side, one of the end, these being in elevation, and one of the top, this being in plan; the bottom being of the same dimensions as the top, no plan of this would be requisite. Now by the rules of perspective, the box might be drawn in such a way that the side, end, and top would all be visible. The sketch of the box given in figure 23, Section I., is an exemplification of this. But as the reader will know, if he has studied the matter given in our section on perspective, that as the lines converge or recede from one another, in order that the idea of distance may be given, and as the lines to produce this effect are—even in comparatively simple subjects—numerous, the intricacy of the drawings renders it a matter of extreme difficulty to take measurements from the various parts with that ease and facility which ought to be an essential feature in mechanical operations. A method of drawing objects, then, by which two or more parts could be shewn in one drawing, and yet all measured from the same scale, is of considerable importance. By isometrical perspective or projection, this desideratum is attained with great facility. The term projection, in its widest sense, means, a plan or delineation of any object; but is also used by some writers and practitioners to distinguish the method of drawing in which the principle is evolved of delineating the objects as if viewed at an infinite distance; this resulting in all the parts being drawn without the converging or diminution visible in common perspective, from all the parts being viewed from the same distance. The methods by which ob-

jects are projected are very numerous ; but it is foreign to the scope of our work to enter into even a *cursor*y detail of them ; we shall confine ourselves to the elucidation of the simple rules of isometrical projection, which is the only mode by which the various parts of an object so delineated can be measured from the same scale. Professor Farish, of Cambridge, was the first publicly to elucidate the principles of this method of drawing ; and he gave the name isometrical, as indicative of its chief feature, from two Greek words signifying EQUAL MEASUREMENTS. Isometrical projection gives the representation of the three sides of the cube, all of which are equal ; and the boundary-lines of which are also equal. In the examples which we present to the reader will be found sufficient illustration of the ease with which objects can be represented by this mode of drawing, and the applicability of its principles to many of the details of architectural, engineering, or geometrical subjects. After the first principles are mastered, the method of adapting them is so obvious, that in many cases a mere inspection of the diagrams will be sufficient ; but whenever opportunity offers, we should further elucidate them by explanatory and suggestive remarks. We have deemed it better to give numerous illustrations, rather than enter into long theoretical investigations, preferring to run the risk of being thought over-minute in illustrative details, to incurring the charge of obscurity, which, if they were less numerous, might otherwise result.

The quickest method of forming a cube is by describing a circle, fig. 79, *i, d, g, h, e,* and *f,* of any diameter, and dividing its circumference into six equal parts, first drawing the diameter, *d e,* at right angles to the bottom edge of the paper or board on which the circle is drawn ; thereafter from either part,

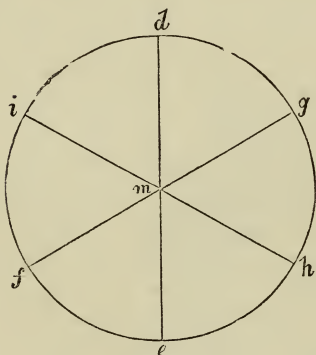

fig. 79.

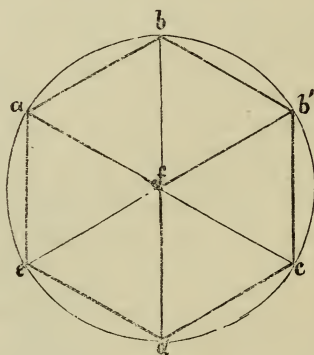

fig. 80.

as *d,* measuring three times to *e* ; and this on both sides ; join these points by lines *fg* and *ih*. Now to make the cube, join the lines as in the figure 80, annexed, as *ab, bb', b'c, cd, de, ea,* and *fd* ; the cube is complete. The square *ab b' f* is the top, the square *fb' c d* the right-hand, and the square *dfa e* the left-hand side of the cube. In isometrical drawings, all lines which are horizontal in the geometrical drawing are parallel to any of the lines *de, dc, fb', fa,* while those which are vertical are at right angles to these or parallel to *ae, fd,* and *b'c*. Thus, to give the representation of a block of stone, as in figure 81, a circle as in figure 82 may first be drawn,

and a cube formed by the rules given in figure 80; then to draw the representation of the right-hand face, measure off from d to a , and parallel to x in fig. 81 draw the lines ab, de , and from a measure the length to b , and from a and b draw lines parallel to he ; $abed$ is the right-hand side of the block:

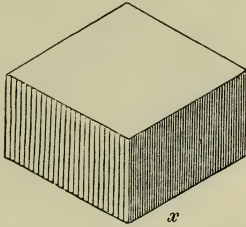

fig. 81.

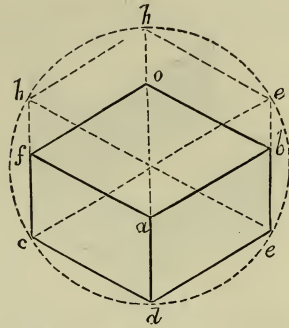

fig. 82.

next from a measure to f , and put in the left-hand side $ajcd$ as before; then from af and b draw lines fo, be parallel to hh, he , meeting in do ; $afob$ is the upper side of the block. Thus it will be seen that all the lines which are horizontal in the drawings are parallel to the top and bottom lines of the right and left hand sides of the cube; while those that are vertical are at right angles to these. In the formation of a cube in a circle, a hexagon is first made by joining the extremities of the diameters, as in fig. 80; $ab'b'c'd'e$ is a true hexagon, the cube being ultimately formed by the lines as in the diagram. But simple as this method of forming a cube is, it would be a tedious waste of time to draw each cube required in this way. Make a triangle, the base of which will be from two and a half to three inches long, the hypotenuse being at an angle of 30° to the base, the third side being at an angle of 90° to the base. Suppose it is desired to make a cube in the circle in fig. 80: draw db , place the T-square so that its edge be at right angles to db , and coinciding with the point d ; lay the base of the triangle on the edge of the square, and along its hypotenuse draw the line de , touching the circle at e ; parallel to ab draw eb' , touching the circle at b' ; move the square up towards b' ; lay the triangle so that its point shall be towards b' , and draw along its hypotenuse the line $b'b$, meeting db in b ; reverse the triangle, so that its point is towards a ; draw ab , and so on, the last line drawn being ed . By this means a circle and its diameter, as bd , being given, a cube can be speedily drawn by means of the triangle.

Having thus explained the simplest modes of making isometrical cubes and squares, we shall proceed to exemplify the system of these as applicable to the delineation of various objects and forms, first shewing how these are contained within circles and cubes without reference to any particular scale. Believing that the pupil will more speedily obtain a knowledge of the practice of the art by inspection and study of examples than by close attention to theoretical rules, which at the best are dry and uninteresting to the general reader, as before intimated, we shall be unsparing in our illustrations, these conveying very rapidly to the mind the nature of the principles.

To give the representation as in fig. 83. First draw the circle of any diameter, and put in the cube a, d, c, b, f , and e , fig. 84; put in the lines

bf , bc , and measure from b to g . From g draw a line parallel to bc to n , and from c a line to n ; next, parallel to fb , draw gh to h ; and from h

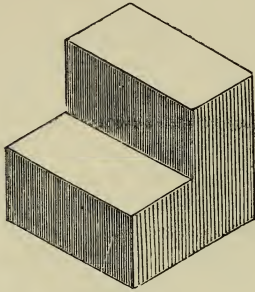

fig. 83.

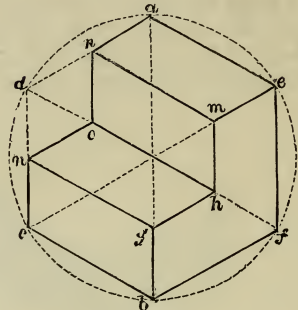

fig. 84.

draw hm ; draw fe , and from e and m draw lines a and n' parallel to gn or bc ; from nn' draw lines meeting in the point o , and put in the line ho : the drawing is complete. From an inspection of the figs. 85 and 86, the

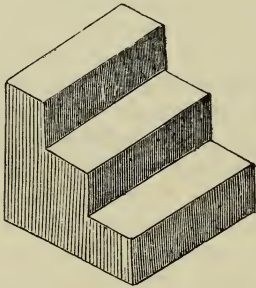

fig. 85.

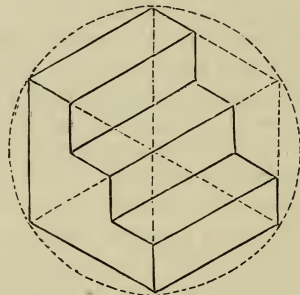

fig. 86.

pupil will be able to draw in the representation as given. Fig. 87 gives the isometrical representation of two blocks of stone. In fig. 88 a represents a block laid across two blocks placed in the position as in fig. 87. To copy this, draw the circle and cube as before, and put in the two

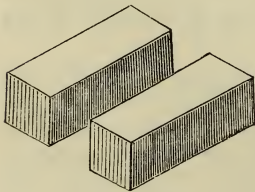

fig. 87.

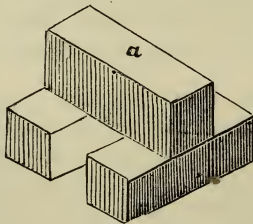

fig. 88.

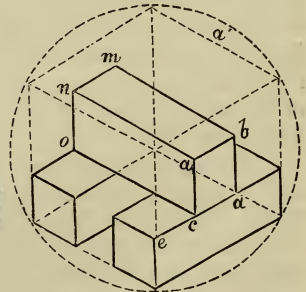

fig. 89.

blocks as in fig. 87; then from e measure to c , fig. 89, and from c to d ; measure and put in the height of the block from cd to a and b ; parallel to the side a' , draw from a and b to n and m , and from c to o ; join ab , nm , and no : the figure is complete. The two blocks on edge, repre-

ented isometrically in fig. 90, will be copied very speedily by proceeding as follows: draw in the circle and cube as formerly; and from a measure to b , and from b to c and a (fig. 91),—these give the thickness of the edge of the blocks, as in the copy; next measure from a to e ,—this gives the length; and from $a e$ to g and h ,—this gives the height of the block.

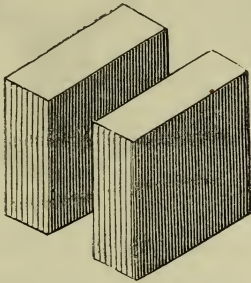

fig. 90.

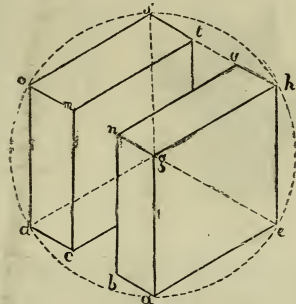

fig. 91.

From c and d and b draw the lines $b n$, $c m$, and $d o$, meeting the diagonal $o e$; from h draw $t v s$, parallel to $o g$, the lines $h v$ and $t s$; and from g , n , m , o , draw to h , v , t , and s : the representation is complete.

In fig. 92 is given the representation of an oblong block standing perpendicularly on a flat stone. The method of drawing it is shewn in fig. 93. From a draw to d and c ,—these give the length of the sides of the under block; from a measure to b ,—this gives the thickness; from this point parallel to $a c$, $a d$, draw lines meeting perpendiculars from d and c : the right and left hand faces of the under block are finished. From a measure to e , and from e to h and g , these lines being parallel to $a c$ and $a d$,

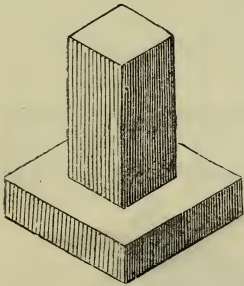

fig. 92.

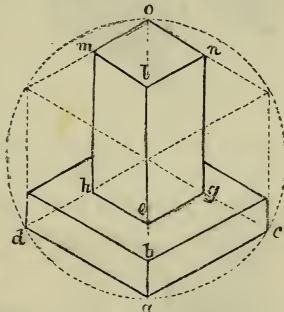

fig. 93.

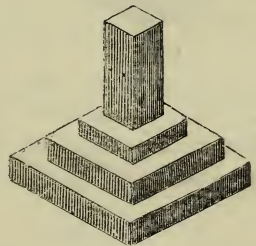

fig. 94.

and giving the breadth of the faces of the oblong block; from e measure to l , and put in the square $o m$, $l n$; join all the points, and the figure is complete, the distance $e l$ being the height of the block.

In fig. 94 the same subject is represented, but a succession of under blocks is given, gradually reduced in size. The method of putting this in will be deduced from a consideration of the mode of drawing the last problem in fig. 93. The representation of the cross given in fig. 95 is an exemplification of the foregoing lessons; the cross being, in a measure, formed of blocks properly disposed. The method of drawing it will be

seen by an inspection of fig. 96. In fig. 97 is given a representation of a block of stone *a*, supported by an oblong block, resting on one of the

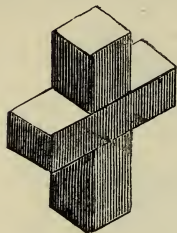

fig. 95.

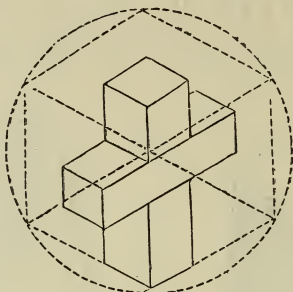

fig. 96.

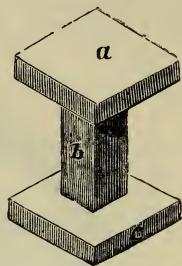

fig. 97.

same dimensions as *a*; the pupil should have no difficulty in drawing this, if he has attended to the foregoing lessons. A block of wood or stone with a square part, *a*, cut out of it in its upper face, *b c*, is represented in fig. 98. The pupil should draw it either enlarged or the same size. The representation of a similar block, but with the edges downwards, is given in fig. 99. The manner in which it is drawn is given in fig. 100. The

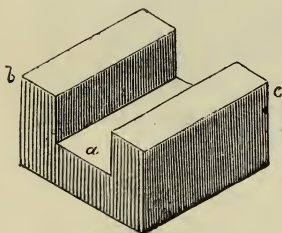

fig. 98.

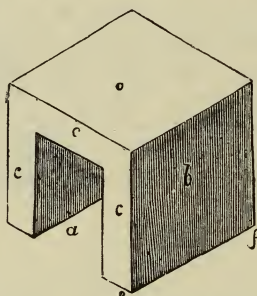

fig. 99.

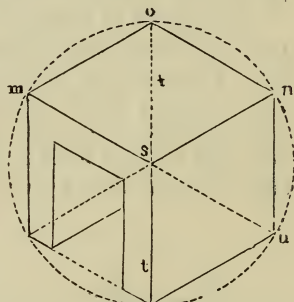

fig. 100.

faces *o* and *b*, fig. 99, are formed by the upper and right-hand sides of the cube *mons* and *stvn*, fig. 100, the parts *ccc* being drawn by lines parallel to *ms* and *st*, the line *d* being the line corresponding to *ef*. The

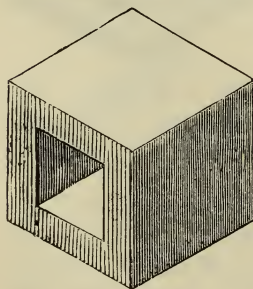

fig. 101.

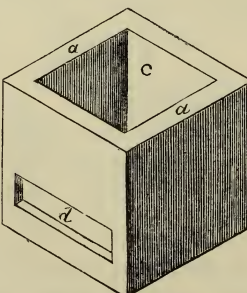

fig. 102.

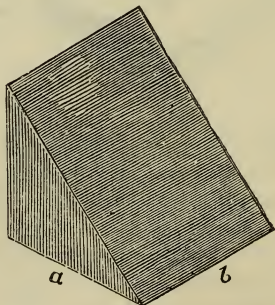

fig. 103.

representation given in fig. 101 is a modification of the previous lesson; it

shews the easy method of delineating the representation of apertures in walls, boxes, &c. Thus in fig. 102 a representation of a box is given, $a a$ being the thickness of the wood, c the size of the interior, and d the aperture for the drawer. In the foregoing lessons the examples have been confined to the illustration of objects having only straight lines in their outlines. We shall now shew the method of drawing angular surfaces, circles and cubes in all cases being previously described. Thus the representation in fig. 103 is drawn in the manner shewn in fig. 104. For the side a of the angular block draw the line $a b$, and for b , $b c$; measure the height of fig. 103; from d draw $d m$, equal and parallel to $a b$; join $e a$, $m c$: the figure is complete. Again, the representation given in figure 105 is drawn as in fig. 106: draw $c b$, $b d$ for the ends of the angular block; from a , the centre

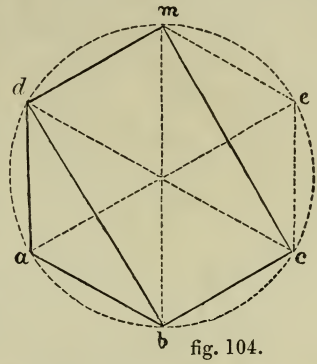

fig. 104.

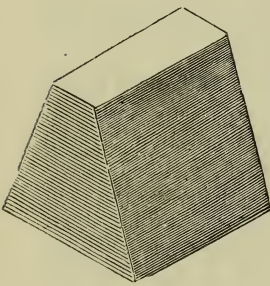

fig. 105.

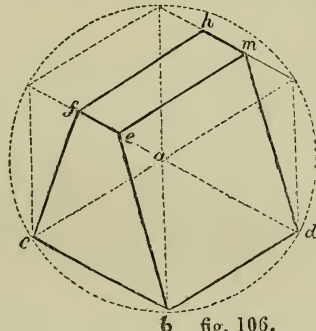

fig. 106.

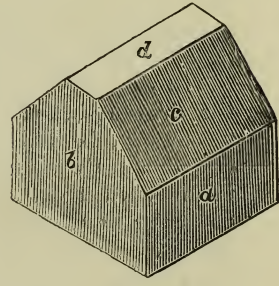

fig. 107.

of the circle, measure to e and f ; from e and f measure to h and m ; join $f e$, $h m$, $e b$, and $m d$: the figure is complete. The representation in fig. 107 exemplifies the system of putting in roofs of houses; fig. 108 shews

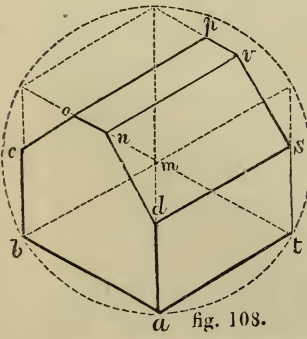

fig. 108.

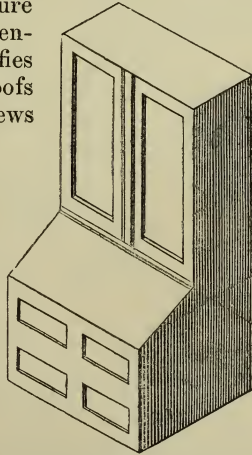

fig. 109.

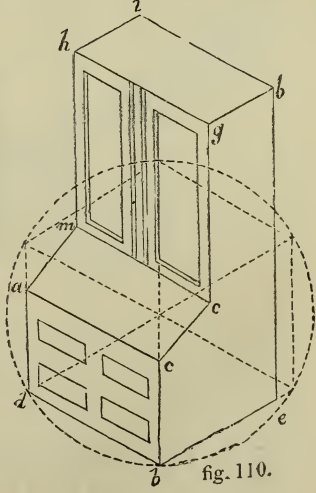

fig. 110.

the method in which it may be drawn. First draw the side a , fig. 107, as $a d s t$, fig. 108; then the side b , by measuring from a to b , and from a, b to c, d ; from m , the centre of the circle, measure to n and o ; from n, o draw parallel to ds, nv , and op ; join co, on, nd, pv , and vs : the figure is complete. The representation of the plain cabinet given in fig. 109 affords an exemplification of the use of the isometrical lines of the cube in drawing objects. Fig. 110 explains the mode in which the drawing is executed. The part $adcb$ should first be drawn, then $befgc$, next the top $gfih$, measuring from g and h to o and m ; and joining the parts hm, go, mo, am , and eo , the front is put in. After proceeding thus far, the details should next be drawn as in the diagram. The example here given will illustrate the extreme ease and rapidity with which such objects can be drawn isometrically; to draw the figure as given by the line of true perspective, would have involved an amount of operations truly puzzling to any one not thoroughly conversant with the principles and practice of the art. But simple as these illustrations seem, and easy as they are to be copied, the operations necessary are much simplified by the use of the isometrical rulers previously explained (p. 113). Thus in all the foregoing lessons, circles and cubes have been drawn, and this was necessary in order to obtain the proper direction of the lines. Now by the use of the isometrical rulers, the trouble and time expended in drawing an isometrical cube for every object to be represented is entirely obviated.

In drawing isometrically, the pupil is recommended in all cases to use the drawing-board and T-square, described in the work on Practical Geometry; he will find his operations thereby much facilitated. Place the edge of the ruler on the edge of the T-square, so that the lines drawn from f 4 will be at right angles to those drawn from 1 7; let the point of the ruler be towards the right hand, and along the edge draw left-hand isometrical lines 1, 2, 3, and 4 as may be required, and at the distances from each other deemed desirable; reverse the position of the ruler (the T-square remaining unaltered), so that the point shall be towards the left hand; then along the edge draw right-hand isometrical lines 5, 6,

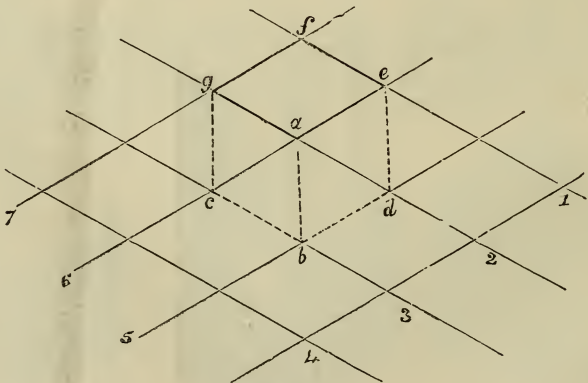

fig. 111.

7, &c.; the intersections of these, if all are drawn at the same distances from each other, form isometrical squares, and by joining the points cubes

may be formed. Thus, by joining the points gc , ab , and ed , a complete isometrical cube is formed; $ae fg$ being the upper side, $abcg$ the left hand, and $abde$ the right (fig. 111). Simple as this method is of obtaining the direction of the isometrical lines, when compared with the mode previously given of drawing circles for every example, it may be rendered more so by merely applying the hypotenuse of the ruler in such a way that the right and left hand lines may be drawn at once. Thus, in fig. 112, which represents the combination of timbers in a single floor, aa being the rafters, and bb the flooring-boards, the lines are at once obtainable by using the ruler, without forming cubes or isometrical squares.

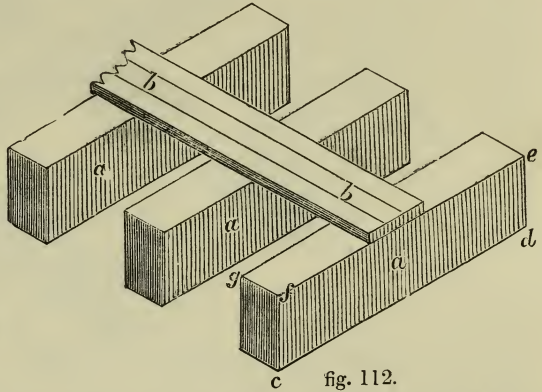

fig. 112.

Thus, by placing the ruler so that the point may be towards the left hand, the right-hand isometrical lines, representing the direction of the lines cd , ef , and all those parallel thereto, are at once drawn, the lengths being measured off in the usual way. Again, by reversing the position of the ruler, so that the point d shall be towards the right hand, the left-hand isometrical lines, representing the direction of the lines fg of the rafters, or line of direction of the flooring-boards bb , are in the same way easily drawn: the perpendicular lines are put in by the usual methods.

In fig. 113 two beams are represented, a being fastened to b by a notch. Now, instead of forming a cube or isometrical square, the whole of the lines may be put in by the ruler: all the lines marked 1, and those parallel thereto, are right-hand isometrical lines, and are drawn along the edge of the ruler, where the point is towards the left hand; the lines 2, and those parallel thereto, are left-hand isometrical lines, and are drawn on the edge, the point being towards the right hand. Base-lines, as cd , de , should first be drawn, from which to take measurements.

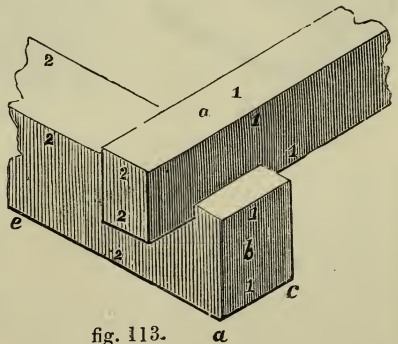

fig. 113.

The representation given in fig. 114 is a combination of timbers called a "double flooring;" aa being the "binding joists," bb the "bridging joists," and cc the "ceiling joists." The lines 1 1, and those parallel thereto, are left-hand isometrical lines, while 2 2 are right-hand ones. In fig. 115 the representation of part of an iron girder is given; and in fig. 116 an elevation of a chimney-stack having three chimney-vents. In

both, the lines 1 1 are left-hand, and 2 2 right-hand isometrical lines, and are all put in by means of the ruler.

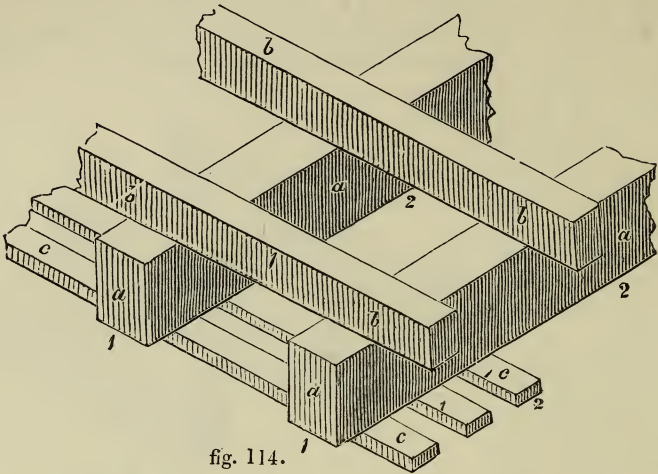

fig. 114.

We have hitherto described the construction of isometrical drawings without reference to the use of scales for taking measurements from. If

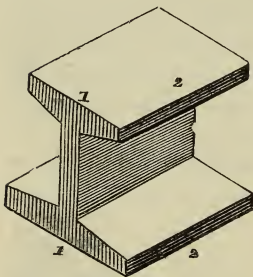

fig. 115.

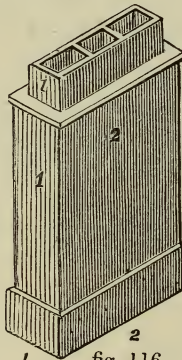

fig. 116.

an object be drawn geometrically to a scale, the isometrical projection is not expressible in the same way; thus, the isometrical projection of a square one inch in the side would not measure one inch, but considerably less: the proportion an isometrical line bears to one of which it is the projection is as 9 to 11. Thus, if the geometrical plan is drawn to a scale of say one inch and three-eighths to a foot, or eleven-eighths, the isometrical projection of the plan will be nine-eighths, or one inch and one-eighth. In fig. 117 a common scale and an isometrical one are given; the way in which the latter is constructed geometrically is as follows: draw the line *ab*, and divide it into any number of equal parts, as fifteen; each of these denoting any equal measurement, as eighths of an inch; divide this line again into

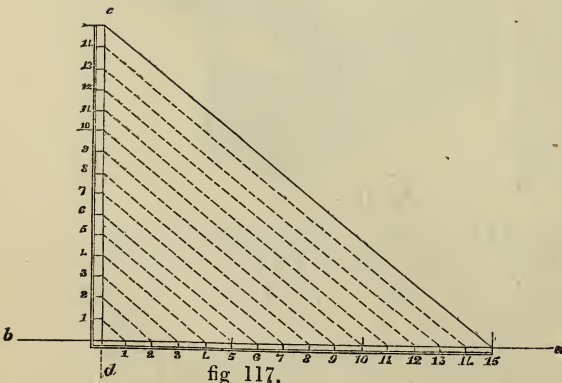
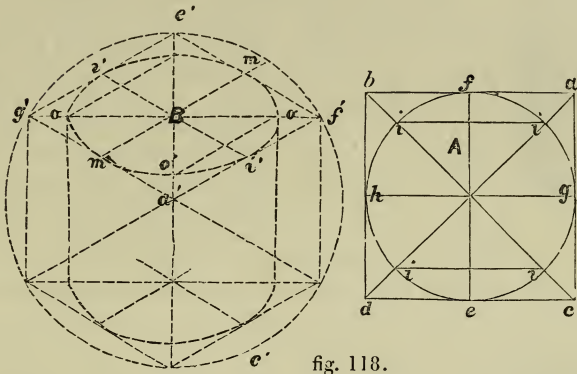

fig. 117.

eleven parts, and with nine of these make the line dc perpendicular to ab ; the line dc is in the proportion of 9 to 11 to the line ab . The line



dc is next to be divided into the same number of equal parts as ab , as 15. Hence it follows that any measurement taken from the scale of equal parts ab can be taken from the isometrical scale dc , and all measurements thus taken would be in strict isometrical proportion. Thus in figure 118, the line $a'mg'$ is the isometrical projection of the line agc of the square A; by measuring these, the line $a'mg'$ will be found to be shorter than agc . To put the circle A in isometrical projection, describe a square $abcd$ about it, and draw the diagonals ad, cb , and the diameters ef, gh ; at the points $i i i i$, where the circle cuts the diagonals, draw another square, of which the lines ii, ii are two sides. Now as the circle A is to be inscribed in a square which is the face of a cube, drawn in isometrical proportion to $abcd$, make the radius of the circle $f'c'g'$ and e' equal to the diameter of the circle A; this being 8, take 8 from the scale cd , fig. 117, and from a' describe the circle; by the usual method describe the hexagon; and from the cube, the upper face $a'g'e'f'$ is the isometrical projection of the square $acdb$. Through the centre of this draw the diagonals $f'oog', a'o'e'$,—these are the isometrical projections of the diagonals ad, bc of the square A; parallel to $a'g', g'e'$, draw the diameters $i'i', mm'$,—these are the isometrical projections of the diameters ef, gh of A. With the radius of the circle A, taken from the scale, from the centre B of the diagonals of the upper face of the cube, lay off on the diagonal $f'g'$ to $o'o$; from these points, with the ruler, draw the lines oo' parallel to $e'g', f'a'$, cutting the diagonal $a'e$ in $o'o$. Now, by the hand, trace through the points $o'i'o, m, a'i', om$, as shewn by the dotted lines; the curve, which is an ellipse, is the isometrical projection of the circle A. A cylinder is formed as in the diagram, making the ellipse at the bottom part of the cube, as partly shewn by the dotted lines. The circles in all figures are ellipses, the curves of which are found as in the diagram. Where the circles are large, and designed to be traced by the hand, more points may be found in the same way as above described; but where the hand cannot trace the outline sufficiently clear, the ellipse may be geometrically constructed by any of the methods we have given in the work on Geometry, the major and minor axis being found by the above method,

In figure 119 is given the representation of a cylinder, the method of drawing which will be learned from the construction of the preceding figure. In figure 120, a hollow cylinder B is represented, of which A is the geometrical plan. And in figure 121, a cylinder B, represented with a square hole D running in the direction of its length, and supported on a square plinth *c c*; this figure is an exemplification of the mode in

which pillars can be drawn isometrically.

The method of using the isometrical scale, for the purpose of giving

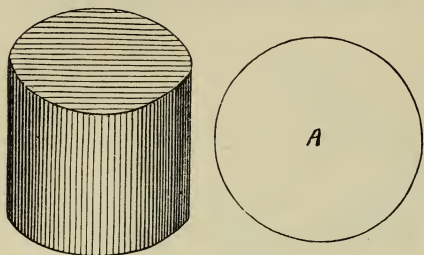

fig. 119.

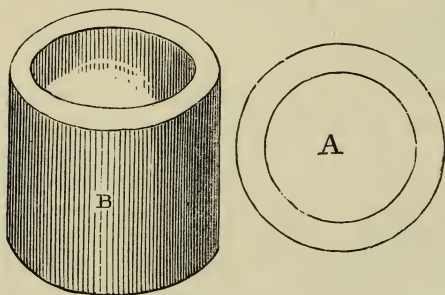

fig. 120.

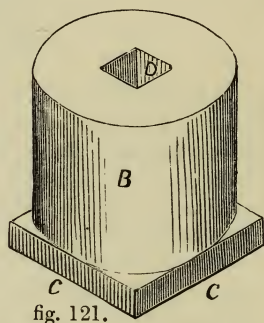

fig. 121.

isometrical proportions to geometrical plans, will be clearly evident from the preceding remarks. If, however, isometrical scales were used in every case, and which would be requisite if isometrical projections were wished to be accurately constructed, the labour of making them would be very considerable, as each geometrical plan would require an isometrical scale to be made for it; that is, if the scale happened in each to be different. It, however, happens, that this difficulty is at once obviated, and a simple method of drawing isometrically at once available. As we have already noticed, an isometrical line is smaller than a geometrical one, and consequently a series of lines isometrically projected appear, and are, less than those of which they are the projections; but suppose two isometrical lines to be enlarged so that they are equal to the geometrical one of which they are the correct isometrical delineations, although they are longer than formerly, they still bear the *same relative proportion to one another*; hence it follows, that if all the lines could be made equal to the geometrical ones, although larger, they would all be in strict proportion to one another, and be capable of being measured from the same scale as used in the plans of which they were an isometrical copy. It also follows, that an isometrical copy of any plan might be made in any proportion to the original copy,—as one-half, one-third,—by reducing or enlarging the original scale, and measuring the isometrical lines therefrom. But in order to draw isometrically, it is necessary that the directions of the lines be obtained. To draw these with facility, we have already given ample instructions. Our remarks on the subject have been confined almost exclusively to the expla-

nation of simple methods of delineating objects in this attractive and useful style of drawing, refraining purposely from entering into theoretical disquisitions regarding either the principles or the practice of "true projection." We trust that we have given easily attainable instructions of a truly practical—and shall we say popular?—nature. To those who prefer to study the subject mathematically, we cordially recommend the works on "Isometrical Drawing," by Mr. Sopwith of Newcastle, to be had of Mr. Weale, Holborn; and of "Isometrical Perspective," by Mr. Jopling, to be had of Taylor, Wellington Street, Strand. By even a moderate share of attention to the instructions we have given, the reader will be able to understand very speedily the principles of this style of drawing. In all cases we would advise him to persevere in the use of the instruments, and in copying all the illustrations; we can assure him that before he has proceeded far, the labour which at first may be looked upon as a task, will speedily be deemed a pleasure. We have been unsparing in our illustrations, believing that the pupil will find the principles carried quicker to the mind's eye when the bodily eye is assisted by illustrative delineations. We have ourselves experienced the great assistance derivable from this source, and have no doubt but that the reader will amply corroborate us in this opinion.

In figs. 122 and 123 are given further exemplifications of the mode of

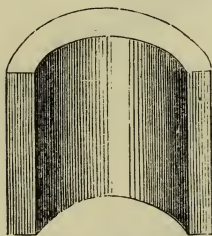

fig. 122.

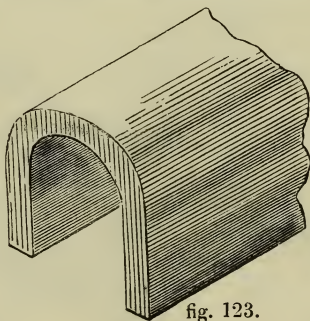

fig. 123.

delineating circular objects. Thus, fig. 122 is the representation of half a hollow cylinder; this form is applicable to the delineation of parts of machinery, as brasses, sections of pump-barrels, &c. &c.; while fig. 123 shews the method of drawing arches, &c.

Isometrical drawing is peculiarly useful in the delineation of architectural subjects, as elevations of houses, plans, and sections, as well as for the parts or details of the various arrangements: in the preliminary lessons we have given several exemplifications of the use of this mode of drawing for the latter purpose, as floors, &c. &c.; we now give in figure 124 an additional example, being the representation of a window. In fig. 125 we

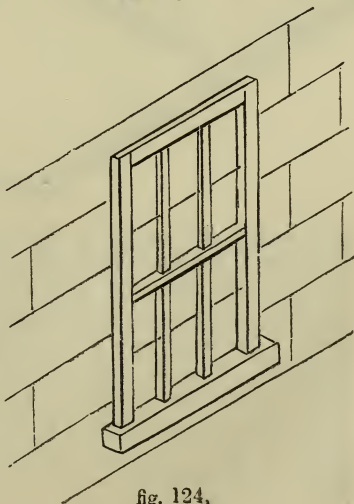

fig. 124.

give an isometrical plan of a house with three apartments, A, B, C. The isometrical plan gives the thickness of the walls, partitions, &c. &c. in a clear and distinct style; the height at which the walls stand being 12 or 14 inches. But the whole height of a wall may be shewn by this mode of drawing as well as its thickness; thus, in a future example the reader will find the isometrical drawing of a house with the height of the walls

delineated up to the second floor. This, in one view, serves the purpose of a plan and elevation; as the height of the rooms, doors and windows are plainly delineated, as well as the thickness of walls, position of partitions, fireplaces, flues, &c. In fig. 126 we give the drawing of the plan

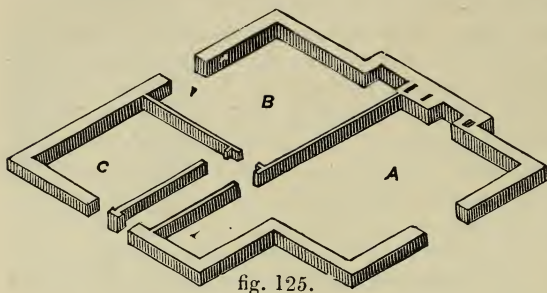

fig. 125.

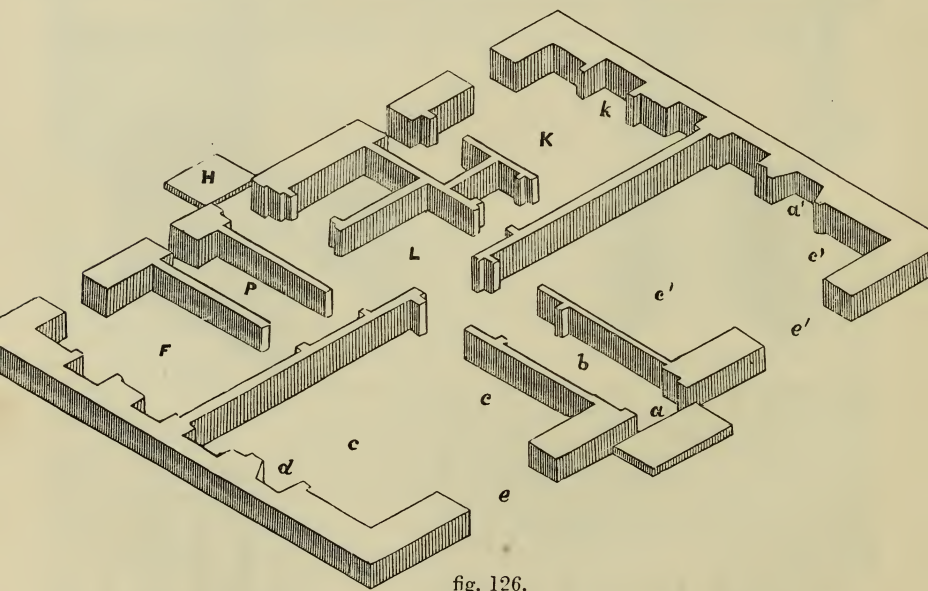

fig. 126.

of a house, the height of the walls being somewhere about one-fourth of the actual height. The whole measurements are taken from a scale of equal parts, feet and inches. Thus *a* is the main entrance-door, with the flag before it; *b* is the entrance-hall, *c c* the drawing-room, *d* the fireplace, *e* the window; *c' c'* is the dining-room, *a'* the fireplace, and *e'* the window. *F* is a study or small sitting-room, *P* a closet, *H* the back entrance, *L* the staircase-lobby, *K* the kitchen, *k* the fireplace. Fig. 127 shews the method of representing agricultural enclosures, or walls of gardens, &c.; a smaller enclosure is delineated in the centre. This diagram exemplifies the way in which the enclosures of a field or fields may be delineated, thus giving data by which not only the extent of the fields

may be measured, but also for the measurement of the enclosing erections.

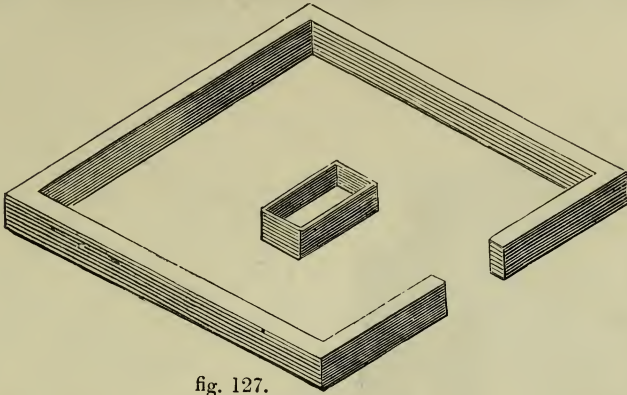

fig. 127.

Where the scale is sufficiently large to admit of the details being delineated, the gates and other objects may be drawn in the plan.

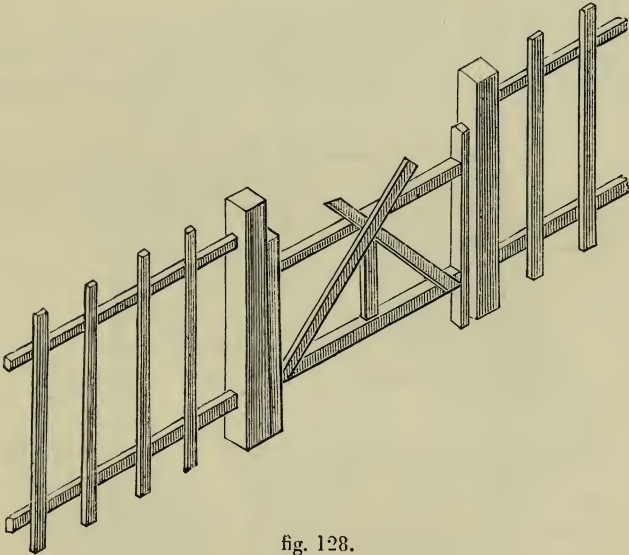

fig. 128.

In fig. 128 we have given the representation of a gate and part of the adjoining and connected fence. In fig. 129 the drawing of a house is given isometrically; the length and breadth of the house is shewn, as well as the height, position, and size of windows, chimney-flues, &c.: the parts may all be measured from a common scale. The method of applying this style of drawing to the delineation of horticultural edifices is displayed in fig. 130. The length, breadth, and height are all shewn in one view; the scantling and position of rafters, glass-door, also clearly delineated; drawn to a common scale by means of the isometrical ruler, the measurements of the various parts can easily be taken.

In fig. 131 the reader will find the geometrical plan, and in fig. 132 the isometrical drawing of the house previously referred to, the height of the

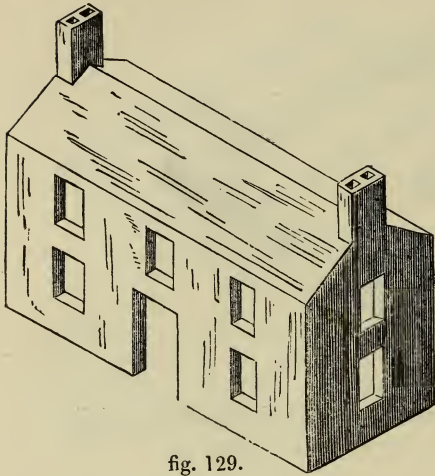

fig. 129.

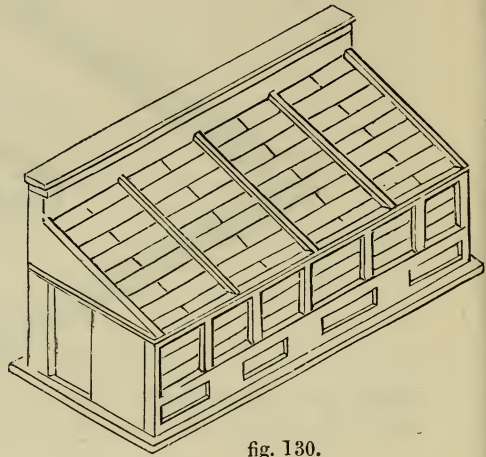

fig. 130.

walls being shewn up to the second floor; had not it tended to make the drawing appear confused, the size and position of the timbers of the flooring might have been shewn. All the lines in fig. 132 have been taken from

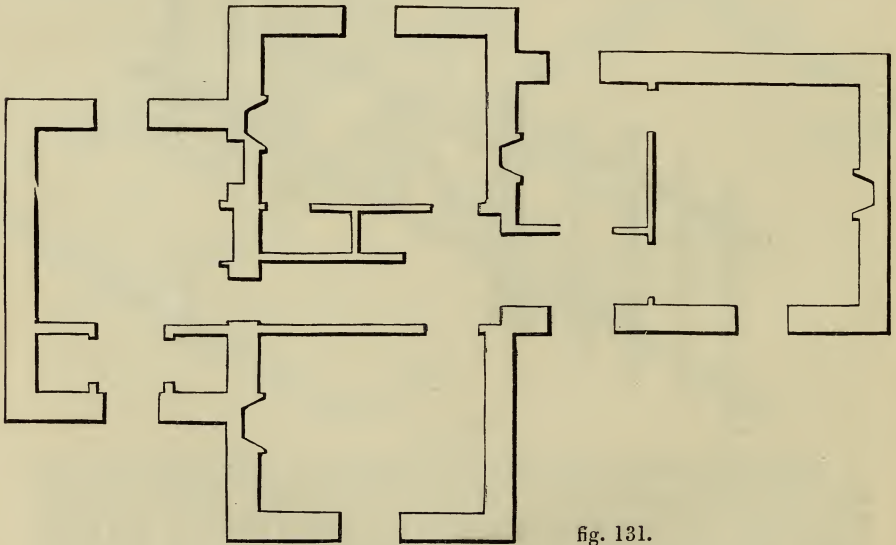

fig. 131.

the same scale used for the plan in fig. 131. The pupil should try to draw the geometrical plan from the isometrical sketch, and *vice versa*; if he can do this with facility and correctness, he will be able to proceed to the isometrical delineation of any geometrical plans which may be presented to him. In concluding this part of our present volume, we would earnestly advise the reader wishful of having an acquaintance with this attractive

style of drawing to use the instruments at every lesson,—to try and draw them as given, not merely to content himself with understanding the accompanying explanations : an hour's practice in drawing the lessons will be worth a day's reading on the subject.

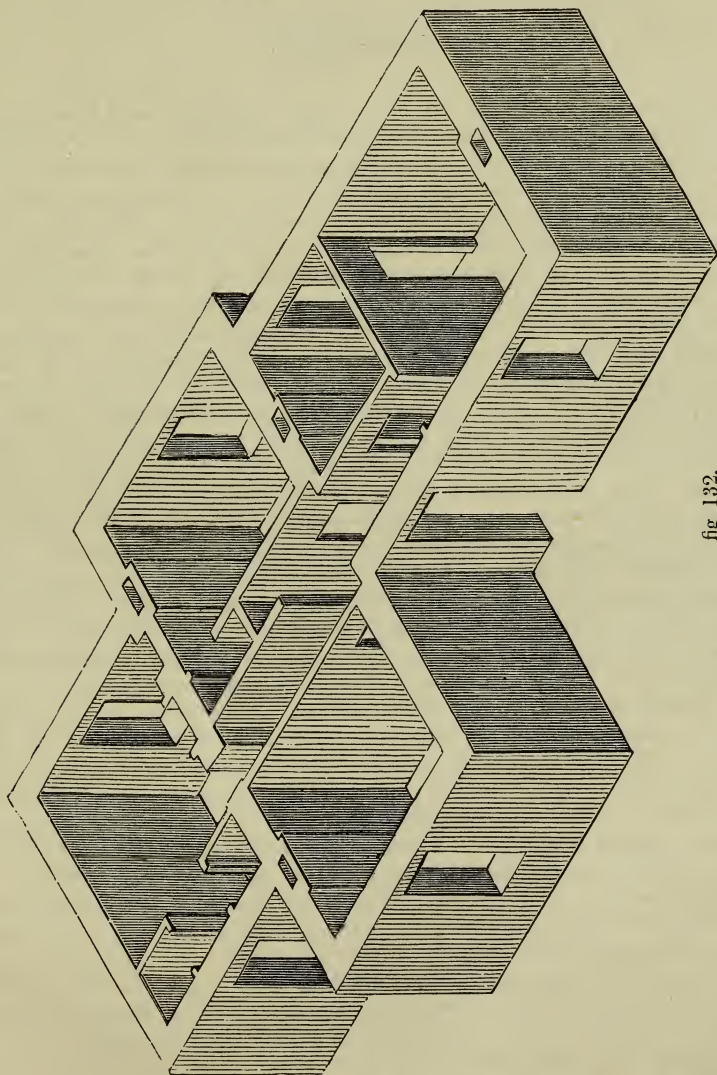

fig 132.

SECTION IV.

ENGRAVING.

IN the foregoing sections we have amply explained and illustrated the principles and practice of drawing in all its branches ; it now remains for us to describe the methods by which the emanations of the mind in conceiving, the eye in arranging, and the hand in copying, may, from one original source, be multiplied to any desired extent. This multiplication of copies of a single design is carried out by one of the numerous styles of engraving ; and this may be done either on wood, metal, or stone. The advantages which result from a well-arranged combination of pictorial illustrations with literature are so clearly shewn by the numerous journals and works issuing almost daily from the press, that it is scarcely necessary to detail them further ; not only have the facilities for multiplying designs by means of engraving been instrumental in conveying quickly knowledge through the medium of the eye, but the arts and sciences in all their varied branches have been highly indebted thereto. "Those whose office," says a recent writer, "it is to dispense instruction are practising a new art. Our great authors are now artists. They speak to the eye ; and their language is fascinating and impressive. Artists now dispute the palm with the most popular authors ; and however greatly some of the latter are favoured, they stand below skilful wood-engravers." Not here to enter into a notice of the causes of the change which has taken place in this respect, it will be interesting to the general reader, as well as important to the artist or draughtsman, to give the further remarks of the above writer : "The probable consequences deserve more notice from reflecting politicians than the causes of the change. Written or spoken language merely suggests thought ; and the thing suggested, or the several parts of it for which the words stand, must have been, as it were, in the mind before. The new thought suggested is merely putting together in a new form some scraps of old knowledge. But pictorial representation may at once convey totally different and totally new ideas to the mind. The artist speaks a universal language. A Turk or a Chinese understands him at once, though to make either of them understand a written or spoken description would require a long time and much instruction. Hence it has become practicable to establish in London French and German journals, which, by means of illustrations, speak at once to the natives of France and Germany. Pictures, then, have the great advantage over words, that they convey immediately much new knowledge to the mind : they are equivalent, in proportion as they approach perfection, to seeing the objects themselves ; and they are universally comprehended. They may make every one participate in the gathered knowledge of all. Artists cannot yet catch

and portray spiritual abstractions ; many of the thoughts of the great historian, of the philosopher, and the poet can only have symbolical and suggestive signs ; but all that can be seen—all the material world—may be represented by the artist ; and now that his skill can, by the improvements in art, be made cheaply available, it will in future be more and more employed to spread knowledge through every society.

“The great extent, also, to which the art may be applied is evident from the monuments of Egypt and Assyria, which, after a lapse of 3000 years, have restored to us a knowledge of the inhabitants of those countries, and of their manners and customs. The artist has handed down to us the information that there were then different races of men,—that one race conquered the other ; he has preserved records of battles won, and the number of prisoners taken, the number of scalps carried off, with something like an account of the royal prize-money. It is pretty clear, from those monuments, that even statistics may be made impressive to the eye. After a long deviation—necessary, no doubt, that we may prove all things, and hold fast only to the good—we are carried back to the principles of the art with which mankind were first inspired. We again have recourse to the mode of recording events, in use amongst the earliest people ; and now find the method of communication employed by the Mexicans to describe Cortes and his ships to be the best for diffusing knowledge amongst mankind. The art is, indeed, wonderfully improved ; and the rapidity and cheapness with which an object can now be sketched, engraved, and printed, suggests the possibility of obtaining an instrument for forwarding the improvement of mankind more powerful than the press for printing words.”

Seeing, then, the important place which the art of multiplying drawings holds in the social system, we need not offer an apology for briefly explaining the details of the practice of the more important branches in the pages of a work professedly devoted to drawing. Before engravings can be executed with taste and precision, the manipulator must himself be a draughtsman ; at all events, a merely mechanical engraver can never render accurately the works of an artist, so as to present them with that freedom of touch so essential in a good production. This section, however, is not designed for professional engravers ; it is chiefly for the use of those who have followed us through the various departments of our work, who have acquired a considerable facility in designing and drawing, and who are anxious to have a slight knowledge of the methods by which their labours may be multiplied,—a knowledge not deep enough to serve them in all the routine of extended or professional practice, yet so well arranged and practical that the desire above alluded to may be gratified with a moderate degree of success. In one respect the reader will have the advantage over the mere mechanical yet professional engraver ; he will be able to give his designs in all their integrity. If even the engraving be rude, from the hands of an artist, or one who has real knowledge of the subject he intends to represent, it will always be valuable. In objects of natural history, antiquity, or architecture, which require a nice expression of form, it often happens that the mere engraver alters the drawing so much that the representation is eventually mistaken for something else. We remember an instance of this which happened at a meeting of a learned society, when angry discussion and much per-

plexity were caused by an engraving of a weapon, which was wrong rendered. Now, if any one who had a knowledge of the subject had etched it himself, he could not have possibly fallen into the mistake; and although his engraving might not be so finished, still it would have enabled others to understand the form intended.

The art of engraving has been handed to us from the most remote ages of antiquity. Frequent mention is made in the sacred writings of its use. In 1 Kings vii., which contains an account of the building of Solomon's temple, is the following, which evidently alludes to a species of work different from the castings described in other parts of the same chapter: "For on the plates of the ledges thereof, and on the borders thereof, he graved cherubims, lions, and palm-trees, according to the proportion of every one, and additions round about."

Many specimens of the engraving by the Egyptians, Greeks, and Romans remain to the present day, and help to throw light on the dark pages of their history. The use of engraved gems by the Roman ladies was at one time carried to so great an excess as to merit the reproof of their philosophers; and it is said that it was not uncommon for them to wear on their fingers the value of large domains.

This country was famous for the manufacture of personal and other ornaments so far back as the Saxon period; and on these, in many instances, the engraver has shewn his skill. Some of this engraved work was filled with a species of black enamel, and was known through the civilised world by the name of "English work." The instance subjoined is a good example of this early style of art.

That the art of die-engraving was carried on in this country at this period is abundantly proved by the coins of Cineobelin; the art was probably introduced from Rome. From this period up to the reign of Alfred, engraving seems to have been almost entirely disused, it being extremely difficult to trace any evidences to the contrary. With reference to the state of the art in the reign of the above-mentioned king, Mr. Strutt says, that "the works of the Anglo-Saxon goldsmiths, who were the principal engravers of that day, were held in the highest esteem upon the continent, as well as in their native country. The caskets which they made for the preservation of the relics of the saints, and other pious purposes, were ornamented with precious stones and engravings, in so excellent a style as to excite the admiration of all who saw them." This latter sentence must be taken with some reservation; the standard of taste at that time could not

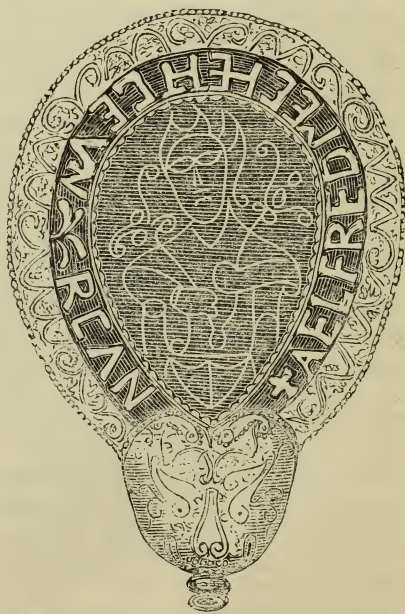

fig. a.

have been very high. That the art had attained to no mean degree of excellence is clearly proved from a specimen still extant, and of which we give an engraving (fig. *a*). It is a jewel of gold, ornamented with enamelling and a species of filagree; from the evidence afforded by its own legend, it is proved to have belonged to Alfred the Great. In the period immediately succeeding the glorious reign of Alfred, the art of engraving in England seems to have been nearly forgot: "In the tempest of war and the night of ignorance and superstition that succeeded, scarcely a glimmering of its light was seen. The mingled work of the engraver, chaser, enameller, and goldsmith, which is seen in Alfred's jewel, entirely disappeared; but die-engraving, as it afforded the means of coining money, became to the Anglo-Saxon princes an art of necessity, because inseparable from the existing system of government and polity; and hence, while other arts pined and perished, it was enabled to survive the inclemency of these barbarous ages, and to preserve and transmit to better times the art of the engraver."

It is easy to conceive, from the analogy of the processes, that engraving of seals was the result of the practice of die-engraving; and this branch of the art became of much importance in the early Anglo-Saxon times. About this period, however, an important advance was made in the art. Among the earliest evidences of the civilisation of a people is the endeavour to preserve the memory of the dead. On the introduction of Christianity into England the style of burial was altered. Instead of depositing the ashes of their relations in vases, &c., it became the practice to inter the remains of the departed entire, and mark the spot with a stone, on which was usually engraven a rude cross. As the skill of the people increased, the covers of the graves became more and more ornamented, and were made to assume an important feature in the decoration of churches.

These monuments were frequently placed near the altar, and in such situations as exposed them to the rubbing of feet, and in consequence became rapidly defaced. In order to make these tombs more durable, it became customary to fill the incisions with lead and other metals; and in the thirteenth century engraved brass-plates began to be substituted for stone. Many of these engraved monuments are of great beauty of design and of skilful workmanship, and may be considered as the earliest examples of a metal plate capable of throwing off an impression. And yet, notwithstanding their capability of being used for this purpose, and although there was thus placed in the hands of our ancestors a means of multiplying designs on the surfaces of their manuscripts, it is remarkable that this application was not thought of. Indeed, it was not till the year 1461 that the method of taking impressions from engraved plates was introduced. In what country this took place is unknown; as may be supposed, the honour of the idea has been claimed by several nations: the dispute lies mainly between the partisans of the Italian and German schools, although Mr. Strutt has endeavoured to prove that at least England may also advance her claim. Previous to the period above mentioned, the works of the Italian goldsmiths had obtained a high reputation for the beauty of their productions; many of these were workers in "niello." This art was the cutting or engraving the subject on the surface of silver plates or utensils, thereafter filling up the engraved portions with a mixture of silver and

lead : this mixture was called "nigellum ;" hence the contraction "niello." It appears that the artists were accustomed to take impressions of the outlines of their designs by previously smoking the engraved parts, and pressing a damp paper thereon. It is therefore probable that to this practice we owe that of printing from engraved plates. It would be extremely interesting to trace the history of the rise and progress of the art in this country ; but this the limits as well as the nature of our work preclude : we shall therefore at once proceed to the consideration of the various styles of engraving practised at the present time. In the department of engraving on metals we shall confine ourselves chiefly to the art of etching on copper ; this being the most attractive style of engraving, a knowledge of which is soonest obtained, and the principal requisite for which is the capability on the part of the operator to draw freely and accurately.

In this country the art of engraving on copper and wood has been carried to a high degree of perfection ; and in landscape-engraving on copper and steel the English school is without a rival. It is, however, to be regretted that our present style of landscape-engraving has lost much of the vigour and feeling which formerly distinguished it. This decline in art seems chiefly to have been caused by attempting to finish too highly, and has led to weakness, want of texture, and too much attention to the mere mechanical arrangement of lines, which gives to many modern engravings a cold and formal appearance, offensive to artistic taste. This fault of our engravers will be made evident by comparing their works with those of Woolett and some of the old engravers. In consequence of this decline, it is not to be wondered at that a demand should have arisen for a more truly artistic style of engraving. At various times eminent etchers have put forward their works with but limited success. This was likely to be the case, for we are slow to be convinced against that with which by long habit we have become familiar ; and the freedom and expression of these works did not seem, with the majority, to atone for the absence of what is called finish. This feeling has, to a great extent, been removed by a party of artists of distinguished ability having formed themselves into a club for the purpose of etching their own designs. The attempt was in every way successful. Without the mechanical skill of the engraver, they produced the most brilliant results, and shewed that to engrave a high work of art on copper did not require any set style, for nothing could be more varied than the means used by each to effect his purpose. After the eye had been accustomed to the machined skies and laboured tints of the "book" and other plates at present in use, the effect of these etchings was most refreshing, and, no doubt, has had a great effect in creating a spirit of imitation. On examining these etchings, it was seen that it was not necessary for a person already skilled in art to study a tedious process to enable him to multiply some favourite subject ; this knowledge, and the high example of her Majesty and her illustrious consort, together with the great utility of etching, have caused it to become a most useful and fashionable accomplishment. It will be our endeavour to describe the process in such a clear manner as to enable any one who has a knowledge of drawing to make a successful plate. It is scarcely necessary to mention the many uses to which this knowledge may be applied : by its means portraits, views of favourite scenes, objects of natural history or antiquity,

may be readily multiplied, and the great painter, by *his own hand*, be enabled to place before the public his designs in all their integrity.

The invention of the art of etching on copperplate, by means of aquafortis, is claimed by Parmegiano ; but this is not undisputed : a claim has also been brought forward by the Germans. Much discussion has been elicited on this point, and considerable research made to ascertain the dates of the productions of the early artists of both schools. With reference to this discussion and research, the writer of the article on "Etching" (*Enc. Brittan.*) remarks, that some portion of it at least might have been spared. "had the disputants reflected that etching, originally *Etzen*, is not an Italian, but a German word, and how very unlikely it is that an Italian invention should have been denominated by a German word."

Etching enables us to produce lines on a metal plate capable of throwing off an impression. To effect this, it is necessary to cover the plate with a preparation which will resist acid. If on such a preparation acid is applied, it will not act upon the copper ; but if a scratch is made through the preparation, and the acid thereafter applied, it will eat into a line, deeper or shallower according to the length of time the acid is allowed to remain. The metal generally used for etching is copper, the plates of which should be carefully prepared.

"The characteristic or local advantage of etching" (to quote the words of the writer of the article on "Etching" above alluded to), "for certain purposes, over lines cut with the graver, consists in the unlimited freedom of which this mode of art is susceptible. The etching needle meeting little resistance from the varnish, glides along the surface of the plate, and easily takes any turn that the taste of the artist may direct, or his hand accomplish ; and hence its peculiar adaptation to that class of objects which artists term picturesque, as trees, rocks, ruins, cottages, the shaggy hair of animals, broken ground, or other rough and irregular surfaces." Etching is not meant, as some suppose, to be an easy method of imitating line-engraving ; in fact, the grand distinction between the two styles is this, that in line-engraving the lines, however beautiful in effect, are produced by means more or less mechanical, while in etching the lines and effect are put in with a facility of drawing and freedom of touch which is displayed in free pencil-sketching on paper. In etching, the needle and the aquafortis are the only assistants ; the graver is seldom required, and the oftener it is used, the stiffer the drawing becomes, and more removed from that exquisite freedom and ease which is the characteristic of a true etching, representing, as it does, or ought to do, the ease with which the original design or subject is transferred to the paper or the canvass. It is not surprising that etching is considered by many as an imitation of line-engraving ; some of our early artists had this idea of it, and, as one writer appositely remarks, "connoisseurs gravely put on their critical spectacles, in order to see in what degree, and how dexterously, the etcher had imitated the clear and clean-cut lines of the graver ; just as the early printers with the letter-press merely endeavoured to imitate *ms. missals* and bibles, without perceiving the superior degree of perfection of which printing was susceptible."

We shall now proceed to the details of the practice of the art : and first, as to the "ETCHING GROUND." This is a preparation of wax, asphaltum, gum mastic, &c. As much depends on the quality of the ground, the

expense not being great, we would recommend our readers to purchase it ready-made. It is sold by Fenn, in Newgate Street, and by most of the dealers in engravers' tools, &c. In order to prevent any grit coming to the plate, it is better to enclose the ground in silk for the purpose of filtering any imperfection.

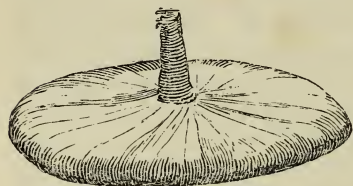

fig. b.

The following tools and implements are necessary. The "dabber," which is composed of silk of a fine texture, and evenly stuffed with wool until it assumes the form required (fig. b). It is necessary to place a circular piece of card at the top of the dabber, immediately below the handle. The "etching-point," the "graver," the "scraper,"



ETCHING POINT



GRAVER



SCRAPER



BURNISHER

fig. c

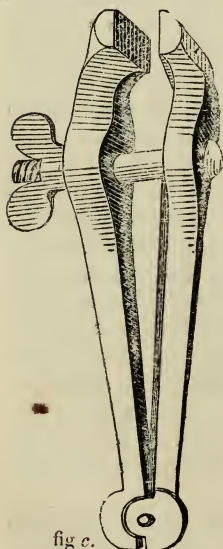

fig. c.

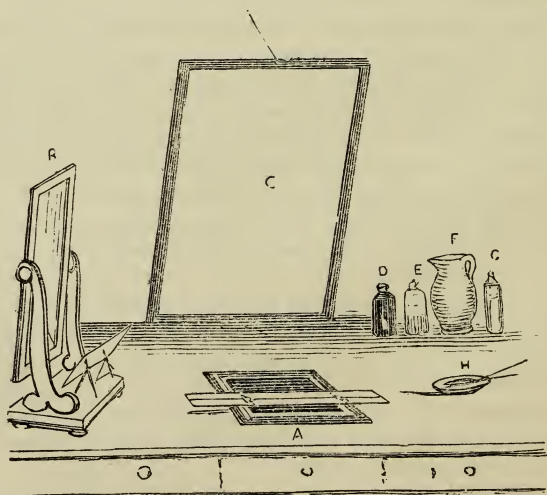

fig. d.

the "burnisher," and the "hand-vice." These are all delineated in the

annexed diagrams (fig. *c*). An etching-table must also be provided, with the following accessories :

- A, the plate on which the subject is to be etched, with support and ruler.
- B, Looking-glass for the purpose of reversing drawing.
- C, Tissue-paper strained on a thin frame to prevent the light from glistening too much on the plate.
- D, Black varnish for stopping out scratches and such tints as are "bit" sufficiently dark.
- E, Nitrous acid.
- F, Water.
- G, Spirit of turpentine.
- H, Plate and pencils for mixing the varnish (fig. *d*).

The first preparatory process is laying the etching ground.

The plate having been polished from tarnish, in order to remove all grease from the surface wash it well with spirit of turpentine, and after the plate is dry rub it carefully with whiting and wash-leather ; then fix the hand-vice, and proceed to heat the plate either on the top of a stove, or by any other process by which a steady and not too great a heat may be obtained ; in the absence of a stove, a piece of flat metal, heated and placed on bricks, is a good substitute. It may be known when the plate is sufficiently hot by placing the etching-ground on the plate with a gentle pressure, and, after allowing it to remain a few seconds, pass it slowly from one end of the plate to the other ; if a thin layer is equally left along the surface, the heat is proper. Continue to pass thin layers of etching-ground

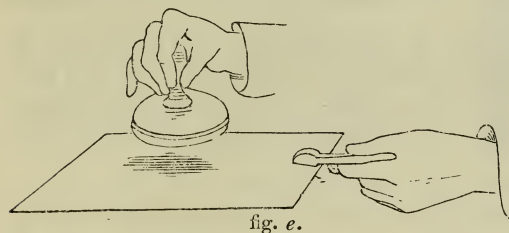

fig. *e*.

from end to end of the plate, at tolerably equal distances, and then, in the same manner, from side to side ; the object of this is to place an equal quantity of etching-ground, in order that the dabber may spread it more readily over the surface ; then take the

dabber (fig. *e*), now in requisition, and use it by constantly dabbing over the portion of the plate for the purpose of entirely covering

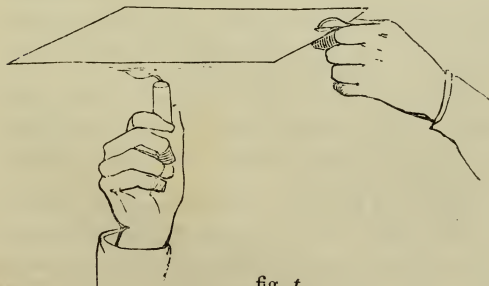

fig. *f*.

the portion of the plate required. On an even and complete layer having been obtained, take a wax-taper (fig. *f*), and next proceed immediately to smoke the ground ; the taper must be kept in motion, in order that the whole of the ground may be evenly blacked : if the flame of the taper is allowed to remain too long in the same position, the ground will

be burnt, and not offer sufficient resistance to the acid ; and if the plate, during the process of smoking, is too cold, the smoke will not incorporate

itself with the ground, but remain on the surface. The essentials of a good ground are—first, that the surface be *completely covered*; second, the covering to be as equal as possible, and not so thick as to prevent the free use of the etching-point; and third, that it shall present, when cold, a polished black surface. If when the plate is cold the surface appears in parts dull, it is caused either by the ground being burnt by using too much heat while spreading the ground, or that, when smoking, the plate has been too cold. It is easy, when the plate is cold, to discover from which of these causes the dulness of the surface proceeds, by rubbing the part slightly with a soft handkerchief: if the black is removed to the handkerchief, the plate has been too cold when the taper was applied; but if the dull black remains on the plate, the imperfection has been caused by heat. If the dulness arises from the smoke lying on the surface, it may be readily altered by slightly heating the plate; if from burning, the ground must be removed by heat and spirit of turpentine, and the plate again thoroughly cleansed.

The best method of getting the subject transferred to the plate is to send a careful outline, either in pencil or red chalk, to a copperplate-printer, who will slightly damp and pass it through the press. If this is not convenient, a piece of tissue-paper may be rubbed with powdered vermilion, and fixed with the coloured side towards the plate. The tracing must then be put in its proper place, and fastened with wax at the corners to prevent it shifting. The outline must be then gone over with a blunt etching-point. This process will leave a clear outline in red, on a black ground. When thus transferring, the pressure should not be so strong as to damage the etching-ground.

The student will observe that, in order that the plate may throw off a correct impression, the subject must be reversed. This difficulty may be remedied by placing the drawing so that it may be seen in a looking-glass, which will have the effect of giving it the same appearance that it would have on the plate.

The plate is now prepared for the etching process.

When etching, care must be taken to prevent any grease from coming into contact with the etching-ground; and it is proper to fix pieces of thin wood or folded paper round the edge of the plate, in order, with the help of a ruler, to form a sort of bridge on which to rest the hand. This precaution is necessary in order to protect the ground from scratches. These supports may be fastened with bordering wax. The etching-point is used in a similar manner to a blacklead-pencil; and it is very important to bring it into good working condition by rubbing it on a hone or leather strop. The point ought to be of such a degree of sharpness as to move freely on the plate; at the same time it is necessary that each line should go completely through the ground, otherwise the etching, after biting, will present a very rotten appearance.

Wax is now used for the purpose of forming a wall round the plate of about an inch high to confine the acid; it is composed of beeswax and Burgundy pitch, in the proportion of one pound of beeswax and a quarter of a pound of Burgundy pitch. The ingredients must be chopped into small pieces, and allowed to boil slowly in an earthen pipkin. As soon as the whole is dissolved, it is necessary to pour it into a basin partly full of warm water; it must then be worked by the hands until it becomes a

pliable substance similar to shoemaker's wax. When using the bordering wax, it may be placed in hot water for the purpose of rendering it more workable, and it is necessary to be very careful to press it closely to the plate in order to prevent the acid from escaping (fig. *g*). It is also better to varnish round the inside of the wax with great care, lest the ground underneath the wax may have been removed. If not thus protected, the margin will be filled with holes, which are troublesome to remove.

It is difficult to give any precise directions for biting, as much depends on the strength of the acid, the hardness of the copper, and the degree of pressure which has been laid on the point when etching.

The following figures illustrate the appearance of the plate at different stages of the biting-in process. Fig. *h* represents the etching as it would

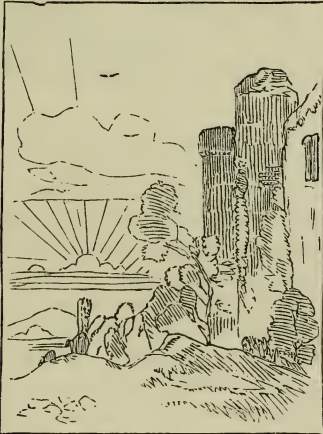
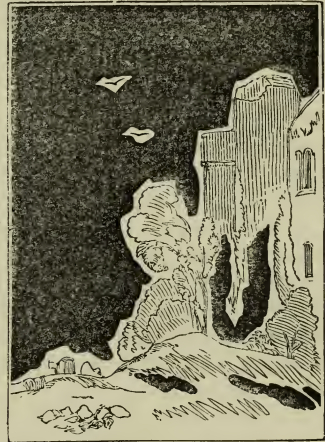
fig. *g*.fig. *h*.fig. *i*.

appear after the acid had been applied five minutes; fig. *i*, the etching with the lightest tints stopped up with varnish. Fig. *h* represents the etching as it would appear after the acid has been applied ten minutes; and fig. *l*, after it has been applied fifteen minutes.

Generally the nitrous acid sold by druggists may be diluted with a little more than twice the quantity of water; but until the student has by experience acquired a knowledge of the action of the acid, it will be advisable to make frequent examinations of the etching, lest the tints are bit too dark. In order to effect this, the acid must be poured off, and then the plate carefully washed with water, and dried either by blowing with a pair of bellows or by dabbing with a very soft handkerchief; a portion of the etching-ground can then be removed by the scraper (see page 134). If the line is not dark enough the plate can be stopped up with varnish, and when dry the acid can be again applied. It is, perhaps, well to mention that the common *Brunswick black*, used for blacking chimney-ornaments, is a very good varnish for stopping-out. This varnish may be had at any oilshop; but a very superior description is prepared by

Crease and Son, Cow-cross Street, Smithfield. A plate, if covered with this varnish and permitted to dry, will as effectually resist the action of



fig. k.



fig. l.

acid as if covered by the etching ground ; but it is not so proper for the purpose of etching, as it cannot be so neatly removed by the point. Care must be taken in all cases not to put the acid on the plate until the varnish is dry. If this is not attended to, the varnish, instead of protecting the plate, will rise to the surface of the acid, and the plate will bite into holes in such portions as the varnish has been removed from. It may be easily known when the varnish is sufficiently dry, by breathing on it : if the breath remains for some time on the surface, the acid may be applied with safety ; but if it rapidly passes off, then it is not safe. It is a consideration in biting to produce a clear deep line. This desirable quality is more likely to be produced by pouring a depth of at least half an inch of acid on the plate, and by carefully removing, with a very soft feather, the small globules which will be seen to congregate on the surface of the plate. The biting is the most uncertain portion of the process of etching, and the most experienced are liable to fail. For general purposes, however, a very little practice will ensure success. When it is considered that the etching has been bit to a sufficient colour, it is necessary to remove the bordering wax by heating the plate, and then clearing it with spirit of turpentine, and afterwards rubbing with oil and a soft rag ; it will then be necessary to send to the copperplate-printer for a proof.

The process of copperplate-printing is exactly opposite to that of printing from woodcuts and type. In the latter the ink is passed from the surface of the block, &c. to the paper by means of pressure ; in the former the impression is delivered from an incised line. In copperplate-printing the whole of the surface of the plate, and also the lines, are covered and filled with ink ; the printer then (with the assistance of heat and whiting), by passing his hands gently and repeatedly over the surface of the plate, removes the ink from the entire surface, but leaves it in the lines or scratches. Damp paper is then passed through the rollers of the press, between the upper roller and the plate are several layers of cloth,

and the ink from the lines is thus placed on the paper. If it is found, on examining the proof, that some portions of the etching are not sufficiently dark, the fault may be remedied by "rebiting."

The particulars of the discovery of this useful aid to the art of etching we will afterwards refer to, and endeavour at present to explain the manner of executing it. The lines on the plate *must be most carefully* cleaned from all remains of printing-ink, or any substance that would interfere with the proper application of the etching ground or acid. It is best to wash the plate well with spirit of turpentine and a perfectly clean rag; then rub the lines and surface of the plate with spirit of turpentine and bread, and afterwards with spirit of turpentine and whiting; after that with whiting and bread. If any portions of whiting remain in the lines, it can be removed by wash-leather and soft bread: the object of all this care is to free the lines from any impediment to the action of the acid, and to enable the student to cover the *surface of the plate* with etching-ground, so that, the surface being protected from the action of the acid, but the *lines left unfilled*, the parts which are already sufficiently dark can be stopped up with varnish and acid applied in the regular manner, and an increase of depth be got on any part of the plate that may be required. The principal things to be attended to in laying a rebiting-ground are, that the lines shall be left free from etching-ground, and the surface completely covered; if this is not attended to, the acid will fill the parts of the plate that are not covered with varnish or ground with numerous small holes, which will certainly produce impure tints: this appearance is known among engravers by the name of foul biting. The dabber used to lay the etching-ground may be used for the rebiting-ground; but it is perhaps well not to apply so much heat, as the ground, if too thin, is liable to run into parts of the lines: this produces, perhaps, as ill an effect as foul biting; for if the acid is placed on such a ground, it will cause an unsteady or rotten appearance, by biting the lines which are clear to a greater thickness than others.

Considerable finish may also be got by using the "dry-point," which is nothing more than an etching-point made sharper than it is required for the purpose of etching; indeed it is used for scratching such lines into the copper as will throw off an impression. On examining a line made with the dry-point, it will be found that the metal is not removed as if cut with a sharp graver, but merely pushed to one side; if this, which is called the burr, is allowed to remain, it will, by its roughness, collect the ink and form a blot on the impression. To remove this burr it is necessary to use the scraper in such a manner as not to drive the burr back into the line, but rather to cut it from the side, in order that each line may be thoroughly clean.

The graver is used to increase the darkness of small portions, and is used in the hand as follows:



fig. m.



WOOD-ENGRAVER AT WORK.

SECTION V.

WOOD-ENGRAVING.

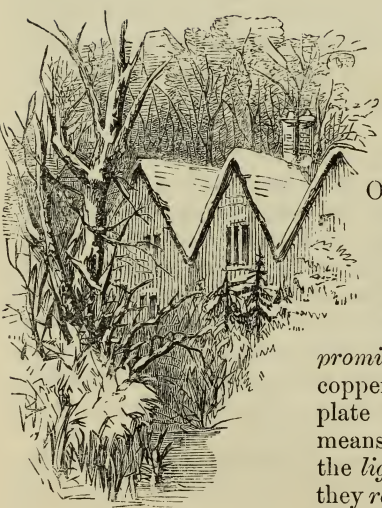

WOOD-ENGRAVING is the art of cutting figures on wood, for the purpose of their being printed upon paper. It differs in principle, and in its mode of operation, from engraving on copper and steel: the lines which form the impression being left *prominent* in the wood; while in engraving on copper or steel, the lines are either *cut into* the plate by means of a graver, or *bit into* it by means of a corrosive liquid. In wood-engraving the *lights* are *removed*; in copperplate-engraving they *remain*.

From this difference between wood and copperplate engraving arises the different manner of printing from a wood-block and from a copper-plate. Wood-blocks are printed in the same manner as the type for a book: their *prominent* lines are *covered* with ink, and an impression is formed by the paper being *pressed on to* them; while in steel or copper-plates the *hollow* lines are *filled* with ink, and an impression is obtained by pressing the paper *into* the inked lines.

Box is the wood mostly used by modern wood-engravers ; pear-tree, and other wood of a similar grain and fibre, being now only used in executing large cuts for posting-bills. Box, for the purposes of engraving, is sawn into rounds about an inch thick,—the height of type,—and the cross way of the wood. As the usual diameter of even the largest logs of box does not exceed five or six inches, it becomes necessary when a large block is wanted, to join several pieces together ; and to do this properly, so that the joinings may not be perceptible in the impression, requires very great dexterity on the part of the person who prepares the block ; indeed, the joining together of several pieces of box, so as to form one large compact block of uniformly smooth and level surface, requires as much skill as the most delicate piece of cabinet-work. Perhaps the largest block of this kind ever made or engraved was the large view of the interior of the Great Exhibition of 1851, presented by the proprietors of the *Illustrated London News* to their subscribers.

The best box is that which is of a yellow colour, like gold, throughout the whole surface, displaying neither specks of white nor reddish-coloured rings. Such box being of a close grain, and uniformly dense and tenacious, not only allows of the lines being cut with the greatest clearness and precision, but is also the least liable to display unevenness at the surface, which is usually occasioned by inequality in the density of the several layers of the wood. Wood of a red colour usually wants tenacity, and cuts soft and short ; and if it displays many distinct rings, it is extremely liable to shrink irregularly, and thus to render it difficult to obtain a perfect impression. Wood containing whitish specks or streaks is apt to break away under the graver in such places. All kinds of box are subject to warp, especially such as have not been well seasoned. When a block has warped in the progress of engraving, it will generally return to a level on being kept for a day or two with its face downwards on a table or shelf. Sometimes, however, it can only be remedied by means of overlays in printing, to bring up the hollow parts of the surface. Box is not only the best wood for engraving on, but is also the best for the purposes of printing, as no other kind so well resists the action of the press. In the latter respect it is even superior to type-metal ; for a greater number of good impressions can be obtained from an engraving on box than from a cast taken in type-metal. In the former, the lines, though liable to have small pieces broken out of them when thin and comparatively wide apart, retain for a longer time their distinctness and precision ; while in the latter, they are more liable to become thickened from pressure. Many of the cuts, engraved on box, printed in the *Illustrated London News* have shewn no defect even after eighty or one hundred thousand impressions have been taken.

Some artists, before they commence drawing on wood, whiten the smooth surface of the block with a slight wash of flake-white and gum-water ; others rub the surface with a little finely-powdered Bath-brick, mixed with water, rubbing it off when dry, to prepare the slippery surface of the block for drawing on with a black-lead pencil. All the lines which appear in a woodcut are generally drawn on the block by the designer or draughtsman in pencil, with the exception of what are technically called "tints," indicative of the atmosphere and the sky, such tints being merely washed in with Indian ink. The most faithful wood-engraving of an

artist's design is that in which the engraver has, without adding or diminishing, *worked out* a perfect fac-simile ; this, however, is rarely effected, there being always some alteration or omission made by the engraver. Wood-engravers admit the truth of this ; they also insist that drawings are often improved. They also further allege, that an artist who has but little knowledge of the practice of wood-engraving, and no idea whatever of adapting his drawing to the purposes of printing, will frequently produce a design which, though it may appear very pretty on the block, may yet take more time and pains to engrave than it is worth ; and prove, after great care in engraving, but an indifferent woodcut, which it may be very difficult to print well, even with the aid of overlays, by press, and utterly impossible to print by machine. From the want of such knowledge in the designer, it frequently happens that woodcuts, though carefully and elaborately engraved, yet appear very spiritless when printed ; and thus the engraver, who, closely adhering to the drawing, may have done for them all that his art could effect, is blamed for deficiencies which are entirely owing to the designer. For the production of a drawing that will print well, and display the full power of wood-engraving, something more is required than the ability to make it on paper or on wood : to succeed, it is necessary that the designer should know how to manage his subject, so that it may be capable of being properly printed ; he should always bear in mind that he is *working for the press*.

As all the lines in an engraved wood-block are in relief, their extremities, both at the edges and in the middle of the subject, are extremely liable to come off too heavy in printing, in consequence of the paper in such places being pressed not only upon, but, to a certain extent, down over them. In order to remedy this, when it is particularly desirable that certain parts should be lightly printed, and shew the lines gradually declining in strength, the block is lowered in such places before the drawing is made on it ; by which means the pressure of the platten or the cylinder on such places is reduced, and the desired lightness obtained. In vignette subjects, where the edges are required to be light, the lowering of the block in such places is extremely simple : lowering in the middle of the block, however, is not so easy an operation ; and before it can be properly done, it is necessary to have the parts intended to be light sketched in, as a guide to the operator. For lowering a block in this manner, a tool something like the burnisher of a copperplate-engraver is used. Sometimes, also, the lines in such places are lowered by means of a fine file, after the cut has been engraved on a perfectly flat surface.

The tools which a wood-engraver employs consist of gravers, to cut the lines defining the forms, and suggesting the idea of the varied tint and texture of his subject ; and of chisels and gouges, to cut or scoop out the larger masses of wood where the subject has to appear white. The gravers are of two kinds : gravers, simply so called, and "tint-tools." The gravers proper are used to cut the various lines, straight, crooked, curved, or crossing, which define the forms of the different objects, and indicate their character and texture ; tint-tools, which are thinner in the blade, and more acutely angular at the point than gravers proper, are used to cut the parallel lines which constitute what is technically termed a tint. In the use of those tools, in clearly cutting the more delicate portions of his subject, is displayed the engraver's skill ; if in the adaptation of lines

of all kinds to significantly convey as complete an idea of his subject as his art will allow, he displays both a knowledge of pictorial effect and a power of representing it by the means of wood-engraving, he is justly entitled to the name of an artist.

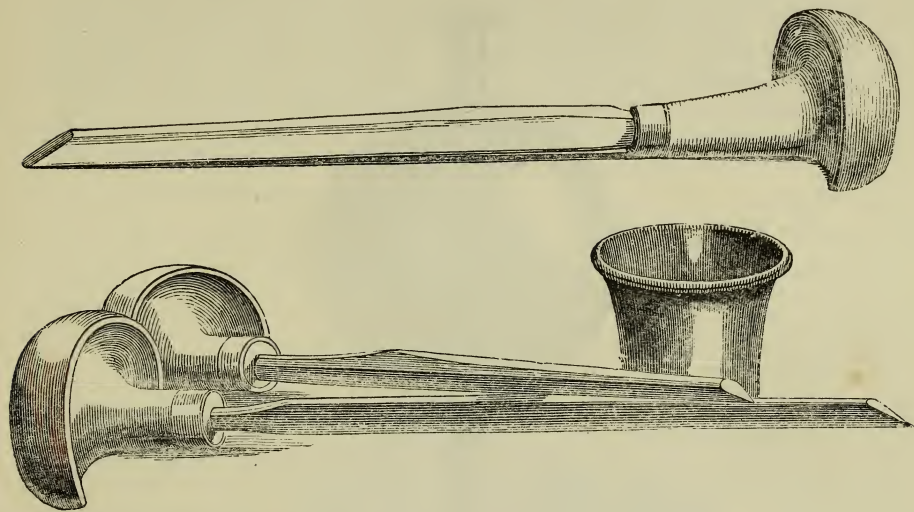

GRAVERS AND EYE GLASS.

Most wood-engravers, when at work, are accustomed to place the block on a leather sand-bag, which at once affords a firm rest, and allows of the

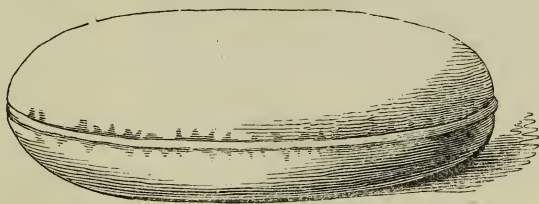

SAND-BAG.

block being turned with facility in any direction by the left hand, while the right is employed in cutting a line. Some, however, place the block on a kind of frame, on which it is movable by means of a pivot. On the comparative merits of these two modes of resting the block it is not easy to decide, seeing that each is adopted by some of the best wood-engravers of the day. Those who have been accustomed to the one mode rarely abandon it for the other: to us, however, the sand-bag appears preferable, as being the simplest, and affording the greatest facility of turning the block, and suiting it, by the motion of the left hand, to the action of the graver.

As the wood-engraver requires a strong and clear light, he generally, when working at night, employs either a glass globe filled with water, or

a large lens, to concentrate the light of his lamp, and to cast it upon the block which he is engaged in engraving. The advantage which the globe has over the lens consists in the greater clearness and coolness of the light which it transmits.

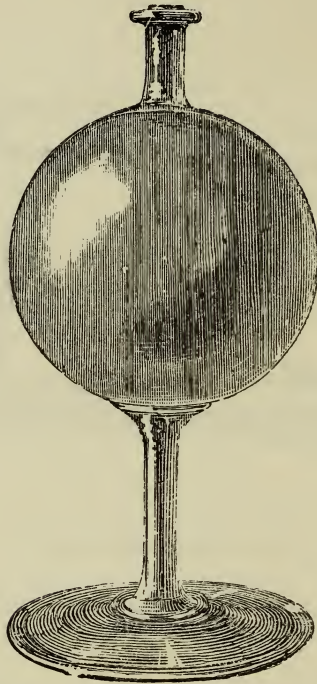

GLASS GLOBE.

In taking a proof, the wood-engraver employs a small ball to ink it, and a blunt-edged burnisher to rub off the impression, which is usually taken on India paper, a piece of card being placed above, to equalise the friction, and to prevent the lines being broken. The wood-engraver who bestows great labour in the execution of a cut which cannot be properly printed, not only mis-spends his time, but also deceives the person who employs him. The best mode of cleaning a block after a proof has been taken, or a certain number printed off, is to rub it with turpentine and a soft brush, and carefully wipe dry.

One of the great advantages which wood-engraving possesses over copper as a means of multiplying pictorial subjects, is the facility and cheapness with which its productions can be printed at the same time with letter-press. Wood-engravings are not to be estimated by a comparison with copper-plates, but are to be judged of by the power and significance with which they excite ideas in the mind, with reference to the means employed in their execution, and on a consideration of the thousands whose knowledge is thus extended, and whose pleasure is thus increased, compared with the few who can afford to purchase copperplate engravings. Though wood-engraving, in connexion with the press, has already done

much for the dissemination of both useful and entertaining knowledge, it has yet more to do. Artists of talent are not only every day becoming convinced of the advantages of wood-engraving as a means of communicating to the great body of the people a knowledge and a taste for works of art, but are also furnishing wood-engravers with new designs, and drawing them on the block themselves. The steam-engine, a mighty engine, multiplies their joint productions by tens of thousands, almost with the rapidity of thought; and yet the demand increases with the supply, as if in those for whose gratification they are intended, the "appetite increased with what it fed on."



HOUSE OF BEWICK, THE CELEBRATED WOOD-ENGRAVER.

LONDON :
PRINTED BY LEVEY, ROBSON, AND FRANKLYN,
Great New Street and Fetter Lane.

Illustrated Educational Works

PUBLISHED BY

INGRAM, COOKE, AND CO.

227 STRAND.

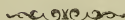

THE object of the Publishers of this Series of Educational Works is to supply at the cheapest possible rate a series of volumes, adapted both for Schools and Private Study, which shall be accurate and complete as text-books, and also contain numerous and appropriate pictorial illustrations.

The old system of instruction, by which the names of things only were presented to the mind of the pupil, has been long admitted to have been imperfect and unsuccessful. With the young it is necessary to speak to the eye as well as the mind—to give a picture of an object as well as a description; and the adoption of such a plan of tuition is not only far more effective than that which is confined to words, but is at the same time far less irksome to the teacher, and more pleasant to the pupil. A greater interest is excited, and the representation of the object remains clear and distinct in the mind of the child long after the verbal description has passed away.

The great success which has attended the works published in this series (about one-eighth of a million copies of one work alone having been sold) is sufficient proof that such a class of works is required by the wants of the age; and it will be the aim of the Publishers to seek a continuance of that success in the excellence of the text, the beauty of the illustrations, and the lowness of price in the works to be hereafter issued.

The volumes will be uniformly printed; but each will be complete in itself, forming a distinct and perfect work on the subject to which it relates. The preparation of the volumes will be confided to eminent men in each department, and to skilful artists.

WORKS ALREADY PUBLISHED.

ILLUSTRATED LONDON SPELLING-BOOK. 1*s.*

ILLUSTRATED LONDON READING-BOOK. 2*s.*

ILLUSTRATED LONDON INSTRUCTOR; being a Companion to the Reading-Book. Consisting of Extracts from English Classical Authors, from the earliest periods of English Literature to the present day. 2*s.*

ILLUSTRATED MODERN GEOGRAPHY. By JOSEPH GUY, Jun., of Magdalen College, Oxford; Author of numerous popular Educational Works. 2*s.*

THE ILLUSTRATED LONDON DRAWING-BOOK; comprising a complete Introduction to Drawing and Composition, with Instructions for Etching on Copper or Steel, &c. &c.; illustrated with above 300 Subjects for Study in every branch of Art. Edited by ROBERT SCOTT BURN. 2*s.*

THE FIRST SIX BOOKS OF EUCLID; with numerous Exercises. Printed on a New Plan, with accurately executed Diagrams.

THE ILLUSTRATED PRACTICAL GEOMETRY. Edited by ROBERT SCOTT BURN, Esq., Editor of the "Illustrated London Drawing-Book." 1*s.* 6*d.*

ELEMENTARY ARITHMETIC, on a New Plan. By HUGO REID, late Principal of the People's College, Nottingham; and Author of numerous Educational Works.

MECHANICS AND MECHANISM. By ROBERT SCOTT BURN, Esq. With about Two Hundred and Fifty Illustrations. 2*s.*

WEBSTER'S DICTIONARY OF THE ENGLISH LANGUAGE; exhibiting the Origin, Orthography, Pronunciation, and Definition of Words; comprising also a Synopsis of Words differently pronounced by different Orthoepists; and Walker's Key to the Classical Pronunciation of Greek, Latin, and Scripture Proper Names. A New Edition, revised and enlarged. In one volume, royal 8vo, extra Cloth, 1265 pages, price 16*s.*; strongly bound in russia, marbled edges, 1*l.* 4*s.*; half russia, 1*l.*; calf, gilt, 1*l.*; half calf, 18*s.*



