

RADIO
for
BEGINNERS

Acknowledgement is Hereby
made to

The Westinghouse Elec. & Mfg. Co.
General Electric Company
Radio Corporation of America
American Radio & Research Corp.
Clapp-Eastham Company
Wm. J. Murdock Co.
A. H. Grebe & Co., Inc.
Crosley Mfg. Co.

And all my friends in the industry
who in any way assisted me in
the preparation of this work.

RADIO FOR BEGINNERS

AN ELEMENTARY TEXT BOOK
WRITTEN SO THAT THE
AMATEUR CAN UNDERSTAND IT

By

JAMES R. CAMERON *Ph.D.*

Author of -

"Radio Dictionary"

"Motion Picture Projection"

"Elementary Electricity"

"Text Book on Wireless"

"Elementary Text Book on Projection"

"Pocket Reference Book for

Projectionists"

Etc.

1922

PUBLISHED BY

THE TECHNICAL BOOK COMPANY

130-132 WEST 42nd STREET, NEW YORK CITY

D621,338
C144

Egleston

Copyright in the United States 1922
Copyright in Great Britain 1922
Copyright in Canada 1922

BY JAMES R. CAMERON

*Entered at Stationers Hall
London, England*

AMERICAN
MUSIC COMPANY
NEW YORK

REC FEB 27 1946

RADIO

TO the oft asked question: "What is wireless and how is it possible for one to hear signs, speech or music from a source several miles away, without any apparent connection and certainly without any mechanical connection?" We are at first inclined to use the little boy's expression on seeing the giraff at the circus for the first time—"There ain't no such animal," but today this answer would immediately be ridiculed by the vast army of radio fans throughout the country who daily "listen-in" to the numerous musical selections and speeches broadcasted from the various broadcasting stations.

If we stop for a moment and think back to our elementary teachings regarding the nature and transmission of sound and light, we find that much of the mystery of wireless becomes very much matter-of-fact. Sound is merely some material body in motion.

The vibrating of a piano or violin string or of the prongs of a tuning fork gives off a musical sound which can be heard by the human ear within a reasonable distance. We easily hear the strains of a brass band playing some few blocks away while seated at home with the doors and windows closed, the discharge of a big gun or an explosion (which is merely violent motion of matter) can be heard many miles away. When matter is set in motion it sets up a series of waves and it is on these waves that sound travels to our ears, the loudness or intensity of the sounds received by the ear, depends upon the energy of the initial disturbance, and the distance the disturbance is from the ear.

The discharge of the big gun several miles away sets up a series of oscillations or waves in the ether, and these

waves carry the sound of the explosion to us at the rate of 1090 feet per second. When these waves reach the drum of our ear they produce the sensation we call sound. Much the same thing happens in radio:

A series of waves are set in motion by the creating of a disturbance in the ether by the transmitting aerial. The greater the disturbance, the further the waves will travel. These waves are termed "electro-magnetic waves," and travel at the rate of 186,000 miles per second. These waves produce no sound to our ear on account of their very high frequency. It is to bring down this high frequency that the radio receiving set is necessary and a phone receiver employed to make the sounds audible.

In a broad sense, we claim that wireless telephony is a series of communications carried on between the broadcasting station and the receiving station through the medium of the ether. No one as yet has been able to tell us just what the nature of ether is, though we do know some medium exists throughout space which has the property of transmitting both light and electro-magnetic waves.

Perhaps it would be as well at this point for us to study the question of light waves, as both the light waves and electro-magnetic waves have much in common. For most purposes it is sufficiently accurate to take the velocity of light as 186,000 miles a second, (this is also the speed at which our electro-magnetic waves travel).

A usual hypothesis which was first completely formulated by the great Dutch physicist—Huygens (1629-1695)—regards light like sound as a form of wave motion. This hypothesis met at first with two very serious difficulties; in the first place, light, unlike sound, not only travels with practical readiness through the best vacuum which can be obtained with an air-pump, but it travels without any apparent difficulty through the great interstellar spaces, which are probably infinitely better vacua than can be obtained by artificial means.

If, therefore, light is a wave motion, it must be a wave motion of some medium which fills all space and yet which

does not hinder the motion of the stars and planets. Huygens assumed such a medium to exist and called it "ether."

The second difficulty of the wave theory of light, was that it seemed to fail to account for the fact of straight-line propagation. Electro-magnetic waves, sound waves, water waves, and all of the forms of waves with which we are familiar bend readily around corners while light apparently does not. It was this difficulty, chiefly, which led many of the famous philosophers, including Sir Isaac Newton, to reject the wave theory of light. Within the last hundred years, however, this difficulty has been completely removed, and in addition other properties of light have been discovered, for which the wave theory offers the only satisfactory explanation.

If the wave theory is to be accepted, we must conceive with Huygens that all space is filled with the medium called the ether, in which both light and electro-magnetic waves can travel. This medium cannot be like any of the other forms of matter, for if any of these forms existed in interplanetary space, the planets and other heavenly bodies would certainly be retarded in their motion. As a matter of fact, we know that no such retardation has ever been observed. The medium which transmits light and electro-magnetic waves must, therefore, have a density which is infinitely smaller even in comparison with that of our lightest gases. The existence of such a medium is now universally assumed by physicists.

Light waves are disturbances set up in the ether, probably by the vibrations of the minute corpuscles or electrons, of which the atoms of ordinary matter are supposed to be built, while sound waves are disturbances set up in the air by the vibration of bodies of ordinary dimensions. Electro-magnetic waves are the waves used in wireless transmission, the waves being set in motion by the vibrations of the wires making up the aerial at the transmission station. These waves spread out in all directions with equal force, unless the direction of transmission be regulated by the use of directive aerials which

would tend to make the wave transmission greater in any desired direction.

We have all stood on the banks of some river or lake, and as the result of having thrown a stone into the water, noticed the ripples on the surface of the water, how they spread out continually in the form of a circle, the ripples gradually becoming less distinct the further they travel from the center. We can liken this to the transmission of wireless; the stone which disturbs the water corresponds to the transmission aerial which disturbs the air. The water of the lake to the ether, which we have already conceived fills all space, and the ripples on the surface of the water to the electro-magnetic waves. Just as the ripples on the water gradually die out the further they travel, from the source of the disturbance so do the magnetic waves become gradually weaker the further they travel from the transmission station.

As it has been shown that the electro-magnetic waves travel in every direction from its source, it is possible that any receiving station within range of the transmitting station will be capable of receiving the messages sent out, providing they are tuned up to the same wave lengths. The length of the electro-magnetic waves can be altered at will by altering the oscillatory circuit, but at present the waves vary in length from 150 to 20,000 meters. Most of the local broadcasting stations are sending out the concerts on a short wave length of 360 meters, while amateurs are restricted by the government to a 200 meter wave length for transmission.

That part of the wireless set that creates the electro-magnetic waves at the transmission station is called the transmitter. To be able to fully understand the working principles of the transmitter and its connections, it will be necessary to have at least an elementary knowledge of electricity.

Electricity

NO one knows exactly what electricity is, we do not even know what it consists of, we do know that electricity and magnetism are one and the same. Electricity is not matter nor yet is it energy, although it is a means of transmitting energy, and we know how to handle this force for this purpose.

It is an undeniable fact that energy cannot be created nor can it be destroyed, but we can convert one kind of energy into energy of another kind. For example, should we light a fire under a vessel containing water we will convert the heat energy from the coals to steam energy in the vessel containing the water, and we could again change this steam energy into mechanical energy, as is done with the locomotive.

It is also possible to convert mechanical energy into electrical energy, so by connecting the mechanical energy created by the steam to a dynamo we would produce electrical energy.

It is also possible to convert electrical energy into mechanical energy. A motor is used for this purpose.

The word dynamo is used to designate a machine which produces direct current as distinguished from the alternator or generator which produces alternating current. A dynamo does not create electricity but produces an induced electric-motive force which causes a current of electricity to flow through a circuit of conductors in much the same manner as a pump causes water to flow through a pipe. The point to be settled in the minds of those taking up electricity is that the dynamo merely sets into motion something already existing, by generating sufficient pressure to overcome the resistance to its movement.

Although we speak of alternating and direct current, it should be clearly understood that it is impossible to get a

continuous current with a dynamo. The current is really a pulsating one, but the pulsations are so small and follow each other so quickly that the current is practically continuous.

Electromotive Force. When a difference of electrical potential exists between two points, there is said to exist an *electromotive force*, or tendency to cause a current to flow from one point to the other. This electromotive force is analogous to the *pressure*, caused by a difference in level of two bodies of water connected by a pipe. The pressure tends to force the water through the pipe, and the electromotive forces tends to cause an electric current to flow.

Electromotive force is commonly designated by the letters *E. M. F.* or simply *E.* It is also referred to as *pressure* or *voltage*.

Current. A current of electricity flows when two points, at a difference of potential, are connected by a wire, or when the circuit is otherwise completed. Similarly, water flows from a high level to a lower one, when a path is provided. In either case the flow can take place only when the path exists. Hence to produce a current it is necessary to have an electromotive force and a closed circuit. The current continues to flow only as long as the electromotive force and closed circuit exists.

The strength of a current in a conductor is defined as the quantity of electricity which passes any point in the circuit in a unit of time. Current is designated by the letter *C* or *I.*

Resistance. Resistance is that property of matter, in virtue of which bodies oppose or resist the free flow of electricity. Water passes with difficulty through a small pipe of great length or through a pipe filled with stones or sand, but very readily through a large, clear pipe of short length. Likewise, a small wire of considerable length and made of poor conducting material offers great resistance to the passage of electricity, but a good conductor of short length and large cross-section offers very little resistance.

Resistance is designated by the letter *R*.

Volt, Ampere and Ohm. The *volt* is the practical unit of electromotive force.

The *ampere* is the practical unit of current.

The *ohm* is the practical unit of electrical resistance. The *microhm* is one millionth of an ohm, and the *megohm* is one million ohms.

The International ohm, as nearly as known, is the resistance of a uniform column of mercury 106.3 centimeters in length by one square millimeter in cross-section at a temperature of zero centigrade.

The ampere is the strength of current which, when passed through a solution of silver nitrate, under suitable conditions, deposits silver at the rate of .001118 gram per second.

The volt is equal to the E. M. F. which, when applied to a conductor having a resistance of one ohm, will produce in it a current of one ampere.

All substances resist the passage of electricity, but the resistance offered by some is very much greater than that offered by others. Metals have by far the least resistance, and of these, silver possesses the least of any. In other words, silver is the best conductor. If the temperature remains the same, the resistance of a conductor is not affected by the current passing through it. A current of ten, twenty or any number of amperes may pass through a circuit, but its resistance will be unchanged with constant temperature. Resistance is affected by the temperature and also by the degree of hardness. Annealing decreases the resistance of a metal.

Conductance is the inverse of resistance; that is, if a conductor has a resistance of *R* ohms, its conductance is

$$\text{equal to } \frac{1}{R}.$$

Resistance Proportional to Length. The resistance of a conductor is directly proportional to its length. Hence, if the length of a conductor is doubled, the resistance is

doubled, or if the length is divided, say into three equal parts, then the resistance of each part is one-third the total resistance.

Resistance Inversely Proportional to Cross-Section. The resistance of a conductor is inversely proportional to its cross-sectional area. Hence the greater the cross-section of a wire the less is its resistance. Therefore, if two wires have the same length, but one has a cross-section three times that of the other, the resistance of the former is one-third that of the latter.

As the area of a circle is proportional to the square of its diameter, it follows that the resistances of round conductors are inversely proportional to the squares of their diameters.

Specific Resistance. The specific resistance of a substance is the resistance of a portion of that substance of unit length and unit cross-section at a standard temperature. The units commonly used are the centimeter or the inch, and the temperature that of melting ice. The specific resistance may therefore be said to be the resistance (usually stated in microhms) of a centimeter cube or of an inch cube at the temperature of melting ice. If the specific resistances of two substances are known, then their related resistance is given by the ratio of the specific resistance.

Calculation of Resistance. It is evident that resistance varies directly as the length, inversely as the cross-sectional area, and depends upon the specific resistance of the material.

If a circuit is made up of several different materials joined in series with each other, the resistance of the circuit is equal to the sum of the resistances of its several parts. In calculating the resistance of such a circuit, the resistance of each part should first be calculated, and the sum of these resistances will be the total resistance of the circuit.

Resistance Affected by Heating. The resistance of metals depends upon the temperature, and the resistance

is increased by heating. The heating of some substances, among which is carbon, causes a decrease in their resistance. The resistance of the filament of an incandescent lamp when lighted is only about half as great as when cold. All *metals*, however, have their resistance increased by a rise in temperature. The percentage increase in resistance with rise of temperature varies with the different metals, and varies slightly for the same metal at different temperatures. The increase is practically uniform for most metals throughout a considerable range of temperature. The resistance of copper increases about .4 per cent. per degree Centigrade. The percentage increase in resistance for alloys is much less than for the simple metals. Standard resistance coils are therefore made of alloys, as it is desirable that their resistance should be as nearly constant as possible.

Quantity, Energy and Power

Quantity. The strength of a current is determined by the amount of electricity which passes any cross-section of the conductor in a second; that is, current strength expresses the *rate* at which electricity is conducted. The *quantity* of electricity conveyed evidently depends upon the current strength and the time the current continues.

The Coulomb. The coulomb is the unit of quantity and is equal to the amount of electricity which passes any cross-section of the conductor in one second when the current strength is one ampere. If a current of one ampere flows for two seconds, the quantity of electricity delivered is two coulombs, and if two amperes flow for one second the quantity is also two coulombs. With a current of four amperes flowing for three seconds, the quantity delivered is 12 coulombs. The quantity of electricity in coulombs is therefore equal to the current strength in amperes multiplied by the time in seconds.

Energy. Whenever a current flows, a certain amount of energy is expended, and this may be transformed into heat, or mechanical work, or may produce chemical

changes. The unit of mechanical energy is the amount of work performed in raising a mass of one pound through a distance of one foot, and is called the foot-pound. The work done in raising any mass through any height is found by multiplying the number of pounds in that mass by the number of feet through which it is lifted. Electrical work may be determined in a corresponding manner by the amount of electricity transferred through a difference of potential.

The Joule. The joule is the unit of electrical energy, and is the work performed in transferring one coulomb through a difference of potential of one volt. That is, the unit of electrical energy is equal to the work performed in transferring a unit of quantity of electricity through a unit of difference of potential. It is evident that if 2 coulombs pass in a circuit and the difference of potential is one volt, the energy expended is 2 joules. Likewise, if 1 coulomb passes and the potential difference is 2 volts, then the energy expended is also 2 joules. Therefore, to find the number of joules expended in a circuit, multiply the quantity of electricity by the potential difference through which it is transferred.

Power. Power is the *rate* of doing work, and expresses the amount of work done in a certain time. The horsepower is the unit of mechanical energy, and is equal to 33,000 foot-pounds per minute, or 550 foot-pounds per second. A certain amount of work may be done in one hour or two hours, and in stating the work done to be so many foot-pounds or so many joules, the rate at which the work is done is not expressed. Power, on the other hand, includes the rate of working.

It is evident that if it is known that a certain amount of work is done in a certain time, the rate at which the work is done, or the power, may be obtained by dividing the work by the time, giving the work done per unit of time.

The Watt. The electrical unit of power is the watt, and is equal to one joule per second; that is, when one

joule of work is expended in one second, the power is one watt. If the number of joules expended in a certain time is known, then the power in watts is obtained by dividing the number of joules by the time in seconds.

The power is obtained by multiplying the current by the voltage, or by multiplying the square of the current by the resistance.

The watt is sometimes called the *volt-ampere*.

For large units the *kilowatt* is used, and this is equal to 1,000 watts. The common abbreviation for kilowatt is K. W. The *kilowatt-hour* is a unit of energy, and is the energy expended in one hour when the power is one kilowatt.

Equivalent of Electrical Energy in Mechanical Units.

The common unit of mechanical energy is the foot-pound, and from experiment it has been found that one joule is equivalent to .7373 foot-pound; that is, the same amount of heat will be developed by one joule as by .7373 foot-pound of work.

As one horse-power is equal to 550 foot-pounds per second, it follows that this rate of working is equivalent to

$$\frac{550}{.7373} = 746 \text{ joules per second (approx.)}$$

Hence one horse-power is equivalent to 746 watts. Therefore, to find the equivalent of mechanical power in electrical power, multiply the horse-power by 746; and to find the equivalent of electrical power in mechanical power, divide the number of watts by 746.

Ohms Law. Ohms law is merely the fundamental principle on which most of electrical mathematics are worked.

A series of formulas used by electricians in figuring voltage, amperage and resistance:

FORMULA 1

To find the amount of current flowing in a circuit divide the voltage by the resistance, or

$$\text{Current} = \frac{\text{Electric Motive Force}}{\text{Resistance}}$$

For instance, if we have a line voltage of 100 and our circuit has a resistance of 5 ohms, then by dividing 100 by 5, we would get our amperage.

$$\begin{array}{r} 5 \) \ 100 \ (\ 20 \\ \underline{100} \end{array}$$

so we would have 20 amperes.

FORMULA 2

To find the amount of resistance in a circuit, divide the voltage by the amount of amperage drawn, or

$$\text{Resistance} = \frac{\text{Electric Motive Force}}{\text{Current}}$$

For instance, suppose we have a line voltage of 100 and are using 20 amperes, then by dividing the 100 by 20 we would get the amount of resistance we have in our circuit.

$$\begin{array}{r} 20 \) \ 100 \ (\ 5 \\ \underline{100} \end{array}$$

so we would have 5 ohms resistance in our circuit.

FORMULA 3

To find the voltage of a circuit, multiply the amount of amperes drawn by the amount of resistance, or
 Electric Motive Force = Amperes Times Resistance

For example: If we were using 20 amperes and our circuit was offering 5 ohms resistance, then by multiplying 20 by 5 we would get our voltage.

$$\begin{array}{r} 20 \text{ amperes} \\ 5 \text{ ohms} \\ \hline 100 \text{ volts} \end{array}$$

To find Volts. Multiply number of Amperes by amount of Resistance.

To find Resistance. Divide Voltage by Amperage.

To find Amperage. Divide Voltage by Resistance.

To find Watts. Multiply Voltage by Amperage.

To find Amps. Divide Watts by Volts.

To find Volts. Divide Watts by Amperage.

Generation of Electricity

EVERYONE is acquainted with the horseshoe magnet and the small pocket compass, and these two articles will serve as an illustration.

Now if one of the legs of the horseshoe magnet be brought near the compass, it will be found that one end of the needle will be attracted to it, whilst if the other leg be presented the other end of the needle is attracted. One leg, at its end, has north polarity, because it attracts the south pole of the compass needle, whilst the other end, having south polarity, attracts the north end of the needle, so that between the ends of the two legs there exists what is known as a "magnetic field," or space wherein magnetic lines of force are present. These lines of force are invisible, but if the magnet be laid on a table, and a piece of paper put over it, and if on the paper be sprinkled some iron filings it will be found, when the paper is tapped by the finger, that these filings group themselves around the ends of the magnet in circles, being closer together at the ends than further away, or higher up towards the bend of the horseshoe. The magnetic field is the most dense between the legs of the magnet at their ends. If a copper wire be passed up and down between the ends of the legs an electric current will be induced in the wire, its direction of flow varying with the upward and downward motion of the wire. In this case the electricity is obtained from the magnet by "induction," this being the elementary principle upon which all dynamos, whether for lighting or power, is based. In the dynamo the horseshoe is replaced by electro-magnets, the large stationary pieces of soft iron surrounded with covered copper wire, whilst the armature, the part which revolves, replaces the thin pieces of copper wire in the above simple experiment. The armature does not touch the magnets, and there is no friction except that in the bearings of the armature shaft, in

which it is necessary to revolve, and which is made as easy as possible by a liberal supply of oil. It will also be seen that the electricity is not pumped from the atmosphere, but is simply the revolution of a bundle of copper wires between the poles of a powerful electro-magnet. The ends of the electro-magnets are thickened out, and each one made semi-circular so that the armature may revolve between the north and south poles and the electro-magnets, consisting of soft iron, are wound round with insulated copper wire, so that a portion of the electricity generated in the armature may be shunted around them and so keep always, whilst the dynamo is in action, as powerful electro-magnets. When the dynamo is stopped, these magnets retain a small amount of magnetism, which is gradually strengthened to its maximum as the armature is started revolving, the dynamo "building up" as it is termed. Anyone who has watched the starting up of a dynamo will have noticed that when running slowly the lamp connected to it as "pilot" gradually shows a red filament, which becomes brighter as the revolutions increase, until, when the correct speed is reached for which the dynamo was designed, the right voltage will show on the voltmeter and the pilot lamp attain its full brilliancy.

The armature of the dynamo is the only part which revolves, and this consists of a steel shaft supported in bearings at each end, to which the pulley is attached to receive the belt for transmitting the power from the engine to the dynamo. On the shaft are built up thin sheets of soft iron provided with grooves in which the different sections of insulated copper wire are laid lengthwise, their ends being connected to what is called the "commutator" fastened to the shaft. This consists of bars of copper made into a drum, each bar being insulated from its neighbour by means of strips of mica, and on the commutator rest lightly the carbon or copper brushes to convey the electricity to the lamps or motors.

The number of coils of wire on the armature depends upon the voltage the dynamo is designed to give, and the speed at which it has to run, also upon the strength of the

magnetic field of the electro-magnets; and the thickness of these conductors will depend upon whether it has to give a large or small current strength. If the voltage is to be high, and small current strength, many conductors of fine wire are employed; if the voltage required is to be low, and large current strength, a few sections of thick wire are required.

A machine as above described is known as a continuous-current dynamo, to distinguish it from an "alternator," and the current obtained from it flows in a continuous circuit from the positive brush or collector on the commutator, through the lamps or motors, and completes the circuit to the other brush.

The mistaken notion of electricity being obtained by friction has probably arisen from the fact that, resting on the top and bottom of the commutator are carbon or copper brushes, but these are for the purpose of turning the currents, which are generated in the armature as alternating currents, into one direction. They also act as collectors to convey the electricity to the external circuit for lamps, motors, or other electricity-consuming devices, and do not offer practically any friction, only resting lightly against the surface of the revolving commutator.

For supplying extensive areas such as towns where the demand for electricity is scattered, alternating-current machines or "alternators" are employed which do not require commutators, the high voltage generated, 2,000 volts and upwards, being led to transformer stations, where it is reduced, by means of stationary transformers, to 110 and 220 volts for feeding lamps direct, or for motors and other uses. The field magnets of these alternators are energised by a continuous or direct current supplied from a small dynamo generally fixed on the alternator shaft, and running at the same speed.

A Book to Fit Your
Vest Pocket

RADIO DICTIONARY

WITH USEFUL
INFORMATION
AND TABLES

Price Fifty Cents

THROUGH ALL DEALERS

Alternating Currents

A CONTINUOUS or direct current is one of uniform strength always flowing in one direction, while an *alternating current* is continually changing both its strength and direction. The various principles and facts concerning direct current distribution apply also to alternating current systems. But in addition to the simple phenomena due to the resistance, which occur with direct currents, there are certain additional factors that must be considered in connection with alternating current transmission.

The flow of a direct current is entirely determined by the ohmic resistance of the various parts of the circuit. The flow of an alternating current depends upon not only the resistance, but also upon any *inductance* (self or mutual) or *capacity* that may be contained in or connected with the circuit. These two factors, inductance and capacity, have no effect upon a direct current after a steady flow has been established, which usually requires only a fraction of a second. In an alternating current circuit either or both of them may be far more important than the resistance and in some cases may entirely control the action of the current. Alternating current problems involving the consideration of three factors are usually more complicated and difficult to solve than those relating to direct currents. By an extension of the principles and methods employed for direct currents, however, alternating current systems can be designed correctly and without great difficulty.

The only reason practically for employing alternating currents for electric lighting and power purposes is the economy effected in the cost of transmission, which is accomplished by the use of high voltages and transformers. The cross section of a wire to convey a given amount of electrical energy in watts with a certain "drop" or loss

of potential in volts, is inversely proportional to the square of the voltage supplied; that is, it requires a wire of only one-quarter the cross-section and weight if the initial voltage is doubled. The great advantage thus obtained by the use of high voltages can be realized either by a saving in the weight of wire required or by transmitting the energy to a greater distance with the same weight of copper.

When the alternating current, or E. M. F., has passed from zero, to its maximum value, to zero, in one direction, then from zero, to its maximum value, to zero, in the other direction, the complete set of values passed through repeatedly during that time is called a *cycle*. This cycle of changes constitutes a complete *period*, and since it is repeated indefinitely at each revolution of the armature the currents produced by such an E. M. F. are called *periodic currents*. The number of complete periods in one second is called the *frequency* of the pressure or current.

The term *frequency* is applied to the number of cycles completed in a unit of time—one second. The word *alternations* is sometimes used to express the frequency of an alternator, meaning the number of *alternations per minute*. In practice the frequency is usually expressed in *cycles*. An alternation is half a period or cycle; since the current changes its direction at each half cycle, it follows that the number of alternations or reversals is twice the number of cycles.

If the current from an alternator performed the cycle sixty times a second, it would be said to have a *frequency* of 60 *cycles*, which would mean 120 alternations per second, or 120×60 seconds = 7200 alternations per minute.

The frequency of an alternating current is always that of the E. M. F. producing it.

Unless otherwise specified, *frequencies* are in the term of cycles, thus: a frequency of 60 means 60 cycles. The frequency of commercial alternating current depends upon the work it is expected to do. For power a low fre-

quency is desirable, frequencies for this purpose varying from 60 down to 25.

For lighting work frequencies from 60 to 125 are in general use. Very low frequencies cannot be used for lighting owing to the flickering of the lamps. A number of central stations have adopted a frequency of 60 as a standard for lighting and power transmission.

For wireless work the frequency must be very high, amateurs today are using a 1,500,000 cycle current for transmission.

Most of the peculiarities that alternating current exhibits, as compared with direct current, are due more or less to the fact that an alternating current is constantly changing, whereas a continuous current flows uniformly in one direction. When a current flows through a wire it sets up a magnetic field around the wire, and since the current changes continually this magnetic field will also change. Whenever the magnetic field surrounding a wire is made to change, an E. M. F. is set up in the wire, and this induced E. M. F. opposes the current. For example, when the current rises in the positive direction, the magnetism increases, in let us say, the clockwise direction about the conductor; after the current passes the maximum value and begins to decrease, the lines of force commence to collapse, reaching zero value when the current reaches zero; then when the current rises in the negative direction the magnetic lines expand in the counter-clockwise direction, and so on. The result is that the counter E. M. F. of self-induction, instead of being momentary, as when the current is made and broken through a conductor, is continuous, but varies in value like the applied E. M. F. and the current. The value of an induced E. M. F. is proportional to the rapidity with which lines of force are cut by the conductor, and as the lines of force vary most rapidly when passing the zero point (changing from + to —) or *vice versa*, the induced E. M. F. is maximum at the moment.

When the current, and therefore the magnetism, is at the maximum value in either direction, its strength varies

very little within a given momentary period of time, and consequently the *induced* E. M. F. is zero at the moment the current and magnetism is at maximum, the E. M. F. of self-induction not rising and falling in unison with the

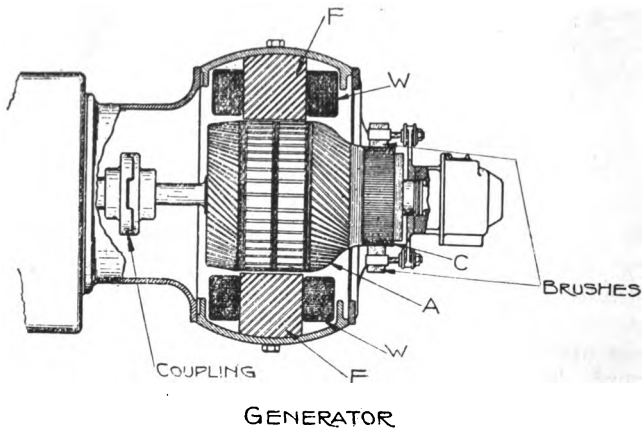

applied E. M. F. and the current, but lagging behind the current exactly a quarter of a cycle.

This property of a wire or coil to act upon itself *inductively* (self-induction) or of one circuit to act inductively on another independent circuit (mutual induction) is termed *Inductance*.

The *Unit or Coefficient* of inductance is called the *henry*, the symbol for which is L.

Many devices met with an alternating current work have this property of inductance. A long transmission line has a certain amount of it, as have induction motors and transformers.

The effect of *inductance* in an alternating current circuit is to oppose the flow of current on account of the counter E. M. F. which is set up. This opposition may be considered as an apparent additional resistance and is called *reactance* to distinguish it from ohmic resistance.

Reactance is expressed in ohms, like resistance, because it constitutes an opposition to the flow of the current. Un-

like the resistance, however, this opposition does not entail any loss of energy because it is due to a counter pressure and is not a property analogous to friction. Its effect in practice is to make it necessary to apply a higher E. M. F. to a circuit in order to pass a given current through it than would be required if only the resistance of the circuit opposed the current.

Electrical Resistance

Electrical resistance is that property of anything in an electric circuit which will resist the flow of current. The effect of resistance is to produce heat.

The unit of electrical resistance is the ohm, and is so named after Dr. G. S. Ohm who gave us the series of

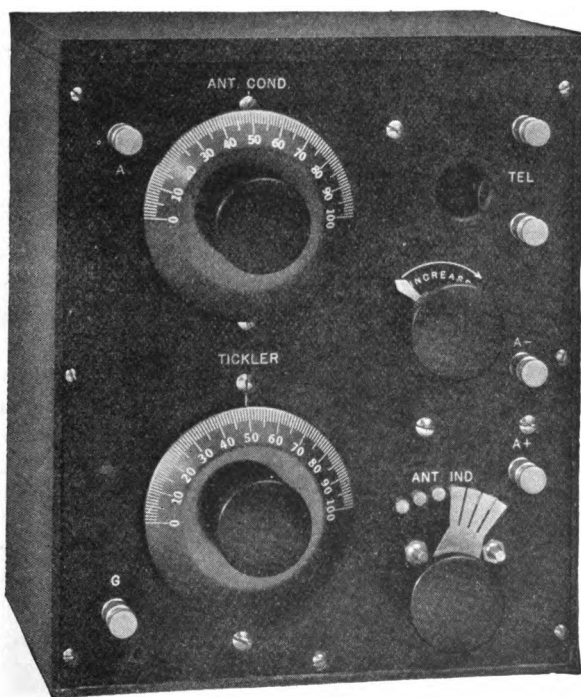

Clapp-Eastham Regenerative Receiver

formulas now known as Ohm's Law; it will be necessary to thoroughly understand the working of this law to be able to work out any of the numerous problems in electrical resistance. Ohm's Law states that: The current is directly proportional to the voltage and inversely proportional to the resistance. This means that if the voltage of a circuit be increased the current will proportion-

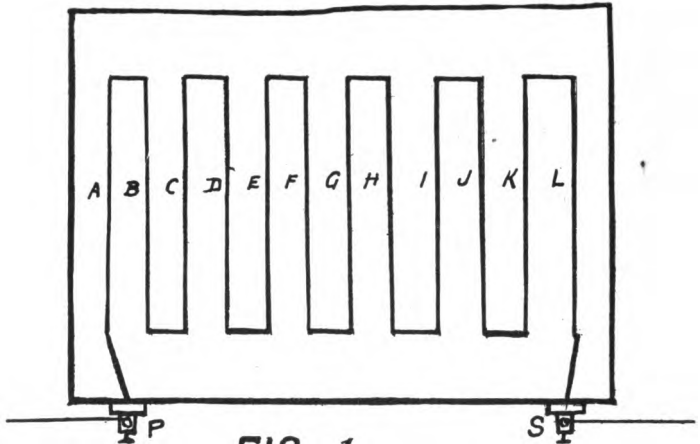

FIG. 1.

ally increase, and should the resistance of a circuit be increased then the current will be proportionately decreased. Should the voltage be decreased there will be a proportional decrease in the current, if the resistance in the circuit is decreased there will be a proportional increase in current. Expressed mathematically

$$\text{Current} = \frac{\text{Electric Motive Force}}{\text{Resistance}}$$

Current is equal to the Electric Motive Force (Voltage) divided by the Resistance (in ohms) or

$$C = \frac{E}{R}$$

If by dividing the voltage by the resistance we get the

amount of current, then by dividing the voltage by the current we will naturally get the amount of resistance in our circuit, or—

$$R = \frac{E M F}{C}$$

and so to find the voltage all we have to do is to multiply the current by the amount of resistance in our circuit, or—

$$E M F = C \times R$$

It will thus be seen that providing we have two known quantities the third unknown quantity can easily be obtained by the use of one of the above formulas; for in-

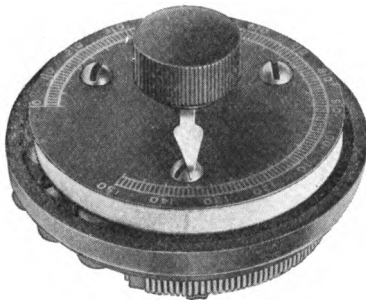

Murdock Filament Rheostat

stance, let us suppose that we have a line voltage of 100 and our circuit has a total resistance of 5 ohms, then by dividing the 100 (volts) by 5 (ohms) we find our current to be 20 (amperes).

Providing we knew there was a line voltage of 100 and we were drawing 20 amps, then by dividing the 100 (volts) by 20 (amperes) we would get the amount of resistance in our circuit which would be 5 (ohms).

By the foregoing it is evident that the amount of current we will get, depends on the E M F and the amount of resistance in our circuit.

Resistance is the inverse to conductivity.

Current encounters resistance when passed over any conductor. Copper, silver and aluminum are good con-

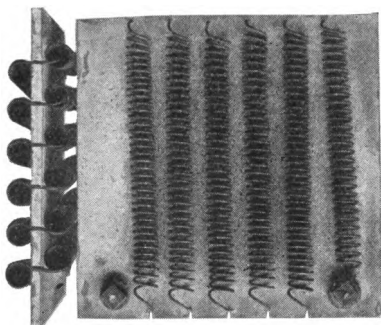

Resistance Coils, Connected in Series With Each Other

ductors, so offer very little resistance, while metals like iron and German silver are poor conductors and offer a much higher resistance to the flow of current.

The resistance of any conductor increases, as the length of the conductor is increased, as the diameter of the conductor is decreased; or as the temperature of conductor is increased (the resistance of insulating material and carbon decreases with an increase of temperature). To find the resistance of a copper wire, multiply its length in feet by 10.5 and divide the product by its area in circular mills.

A rheostat is constructed of a number of metal coils or grids (these coils or grids are made of some metal offering high resistance to the flow of current over them, gen-

erally iron or German silver) connected in series, these coils or grids are mounted on a metal frame from which they are insulated, the whole thing being covered with a perforated metal cover. The first and last coil are each connected to a terminal which allows for the connection of the conductors (see Fig. 1). The current enters the rheostat through terminal P, then passes through the coil or grid A to B, then to C and so on till it has passed through each of the coils in turn and leaves the rheostat through terminal S. Most of the rheostats manufactured

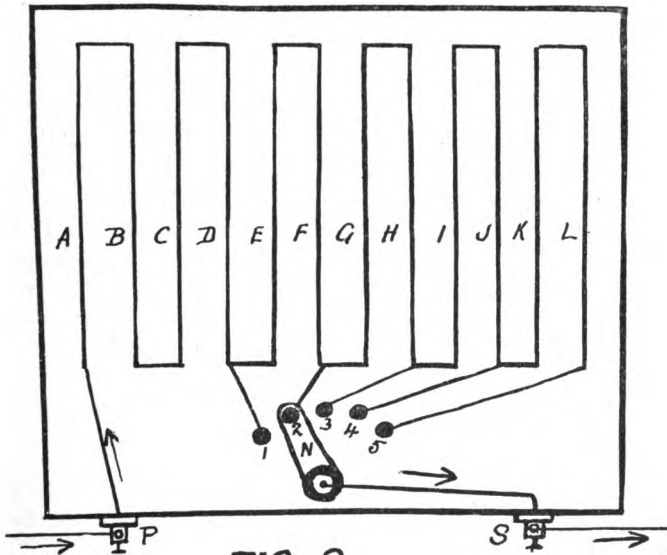
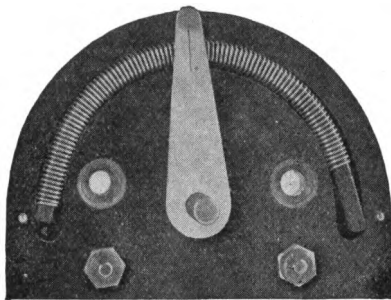

FIG. 2.

today are of the adjustable type, so constructed that by the turning of an adjustable lever a number of the coils can be cut in or out of the circuit, thus cutting in or out resistance, thereby lowering or increasing the amperage. Fig. 2 is an elementary drawing showing how this is ac-

completed. P is the terminal through which the current enters the rheostat, S the terminal through which it leaves after having passed through the series of coils or grids. As will be seen by referring to the diagram (Fig. 2) it



Adjustable Filament Rheostat—Rear View

depends on which contact points 1, 2, 3, 4 or 5, the adjusting lever N is placed as to the number of coils through which the current will pass. With the lever "N" or contact No. 1 the current will pass through coils A B C D only, by turning the lever to contact 4, two coils K and L will be cut out of the circuit; while if lever is placed on contact 5 the current must pass through all the coils or grids before leaving through terminal S.

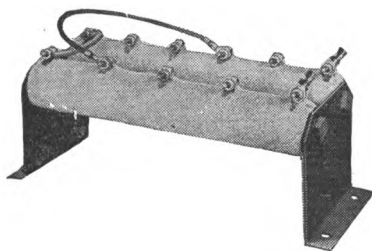

Amrad Adjustable Rheostat

Transformers

A TRANSFORMER is a device for changing the voltage and current of an alternating current circuit.

Transformers are spoken of as Step-up and Step-down transformers.

The three essential parts of a transformer are two copper coils known as the primary and secondary, and a laminated iron core.

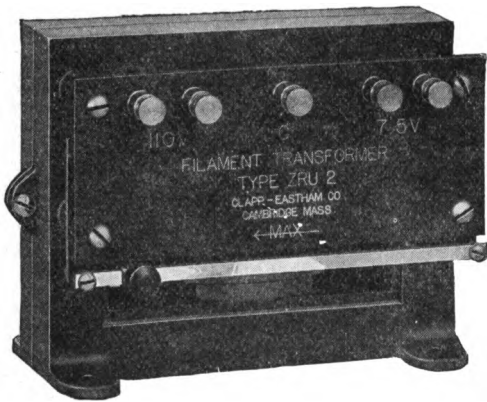

Filament Transformer

The core of the transformer is made up of a number of thin sheets of annealed iron; these sheets are very thin, generally running to one-hundredth part of an inch in thickness, the exact thickness depending upon the frequency of the circuit the transformer is to be used on. Each of the sheets is given a coat of some insulating compound, so that they are insulated from each other. The sheets are then built one upon the other in the form of a

hollow square till a core large enough is obtained, the sheets are then clamped together and are insulated with mica or some other insulating material, so that the two copper coils may be wound around the core without the copper wire of the coils coming in contact with the iron core. Figure 1 is a diagram of an elementary transformer, showing the primary coil wound around one leg of the core and the secondary coil wound around the opposite leg.

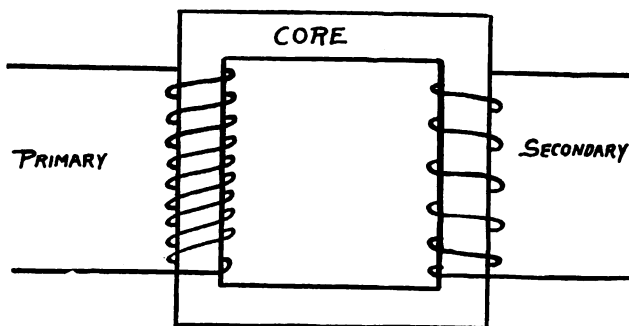

Fig. 1

When we close the circuit on the primary side of transformer the current passing through the primary coil magnetizes the iron core, this magnetism in turn induces an A. C. current in the secondary coil. So that while the primary and secondary coil are insulated from the core and from each other, there is a magnetic connection between both coils and core.

If we turn back to the basic principle of induction the working principle of the transformer is made clear.

If an A. C. current is passed through a conductor encircling a bar of soft iron, the iron will become a magnet and remain so just as long as current is passed through the conductor.

If a bar of iron carrying a conductor around it, be magnetized in a direction at right angles to the plane of

the conductor a momentary E. M. F. will be induced in the conductor; if the current be reversed another momentary E. M. F. will be induced in the opposite direction in the conductor.

The pressure induced in the secondary coil depends on the ratio between the number of turns in the primary and secondary coils. Suppose the primary coil has 100 turns of wire and is connected to a 100 volt line, and draws ten amperes, and the secondary coil has 50,000 turns of wire, the voltage on the secondary side of the transformer will be 50,000 but the amperage will be one-fiftieth of an ampere. So we see that the wattage on the primary is equal to the wattage on the secondary, assuming that there is no loss in transformation.

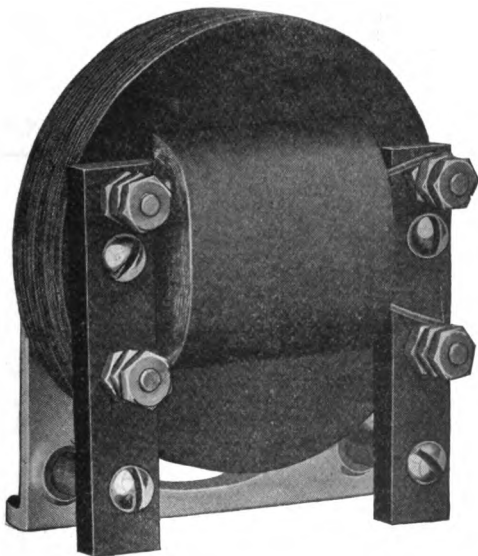

Maximus Amplifying Coil

We know that there are two forms of losses in all transformers, the iron or core loss and the copper or coil loss. These losses total about 10 per cent. The core losses are

going on as long as the switch on line side of the transformer is closed; in other words while the transformer is carrying a no-load current. The copper losses only take place while current is being drawn from the secondary coil.

Let us suppose the primary coil is drawing 20 amperes at a pressure of 100 volts, the wattage in the primary

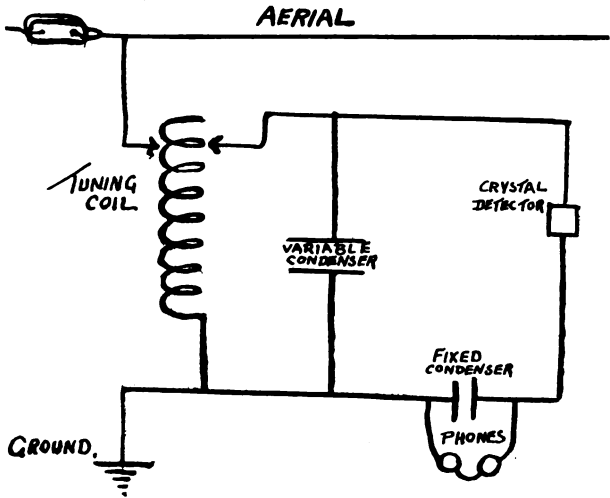

A Simple Hook-up

circuit would be $100 \times 20 = 2,000$ Watts. Let us assume that the losses in transformation is 10 per cent, this would mean that the wattage on the secondary circuit would be 2,000 Watts less 10 per cent or 1,800 Watts.

Reactance Coil

A reactance coil can be made by constructing a hollow coil of wire and sliding an iron core made of sheet iron in or out of it according to whatever adjustment is required. Number 10 wire is suitable for the coil and Number 12 wire for the primary coil. The coil is connected in series with the primary windings.

The Aerial

THE aerial is a wire or system of wires strung above the surrounding objects and insulated from them and connected to a radio set by means of a lead-in wire. The same aerial can be used for either sending or receiving the electro-magnetic waves. The purpose of the aerial is to radiate electro-magnetic waves when used as the aerial for a transmitting or broadcasting station and to receive or intercept waves when used with the receiving set. Practically any sort of wire will answer the purposes for a receiving aerial. Copper wire, phosper bronze, copper clad steel, in fact, we have seen used a metal smoke stack, wire netting, a tin roof, a metal bed spring and a number of other metal objects with varying degrees of success. However, for maximum results, we suggest that a single

"T" AERIAL

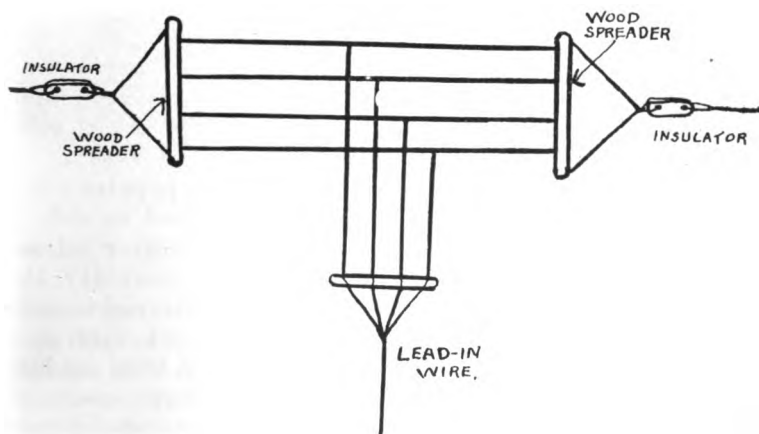

wire be used for receiving and that wherever possible the following dimensions be used:

Aerial Recommended For Various Wave Lengths

Wave length in meters	Height from ground in ft.	Length of aerial in ft.
150	30	75
200	50	80
200	60	50
200	30	90
250	40	100
300	60	100
400	80	130
500	60	180
600	80	230

Of course, local conditions must be taken into consideration, and probably a little experimenting with aerials of different lengths placed at different angles will assist to get ideal working conditions. Aeroplane wire makes an ideal aerial as it is flexible and easy to work with. As

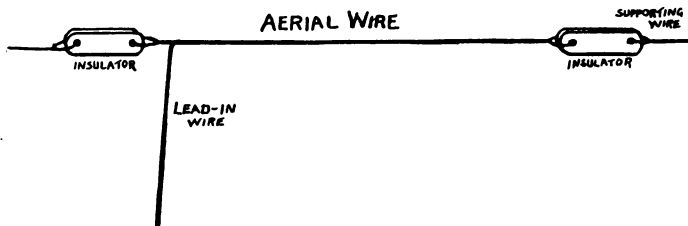

for indoor aerials, these are becoming more popular every day, and the day is not far off when we shall be able to have our receiving set, aerial and loud speaker all enclosed in a cabinet no larger than our present day victrola. It is my opinion that the best indoor aerial is made by winding about 20 or 30 turns of copper wire on a wood frame about 2 feet square. However, both outdoor and indoor aerials may take a number of shapes and each will be found to have its own characteristics and different effects will be obtained from different combinations.

The effectiveness of the antenna system depends largely upon the character of the ground connection. The most practical ground connection is the water supply system. Where this is not available, pipes connected with the heating or gas systems may be used. The drawback with these pipes, however, is that the joints of these pipes are sometimes cemented with insulating material. Ground

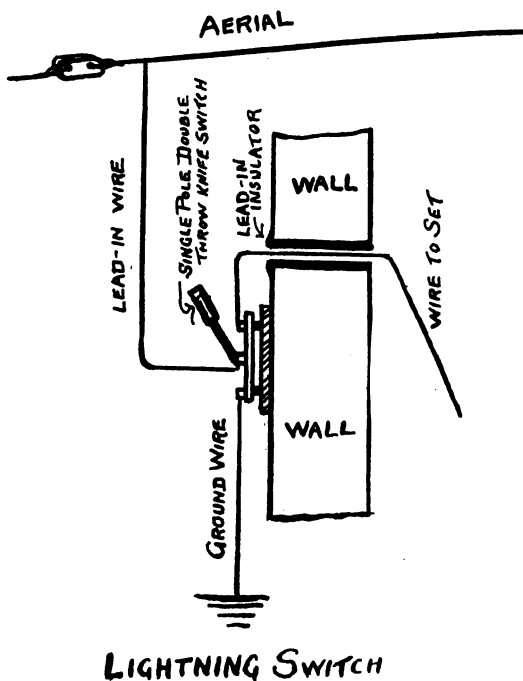

clamps for attaching the ground wire leading from the receiving set to the water pipes are obtainable at most dealers and electrical supply houses. The water pipes should be carefully scraped to remove all paint or corrosion before attaching clamp. Where the above mentioned means of ground connection is not available, wires

or metal plates may be buried in the earth and connected to the apparatus. Such wires or plates should include an area of at least 30 square feet.

A counterpoise consisting of at least the same number of wires as are used in the antenna may be suspended beneath the antenna and used in place of a ground connection for the receiving apparatus.

GROUND CLAMP.

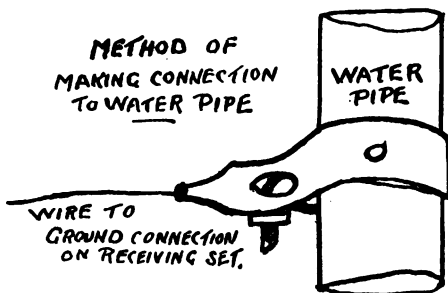
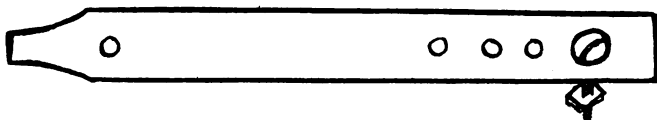

Aerial Outfit

The Westinghouse Electric & Manufacturing Company have provided a standard aerial outfit which is ideal for amateur and broadcasting reception. It is especially well adapted to use with their sets. The outfit consists of 150 feet of No. 14 Copper Weld Wire, one Splicer, two Micarta Aerial insulators, two Screw Eyes, three Porcelain Knobs with holding screws, one Porcelain Wall Tube, 50 feet of insulated Ground Wire, one Ground Clamp and one Receiving Aerial Protective Device.

The Aerial Protective Device consists of a carefully maintained safety gap and a fuse protector. The safety gap is so set and the value of the fuse such as to assure protection from lightning and power lines.

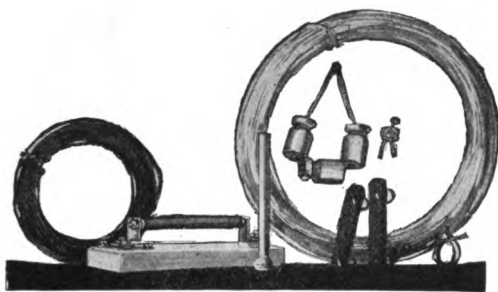

Westinghouse Complete Aerial Outfit

AMRAD TRANSMITTING SET

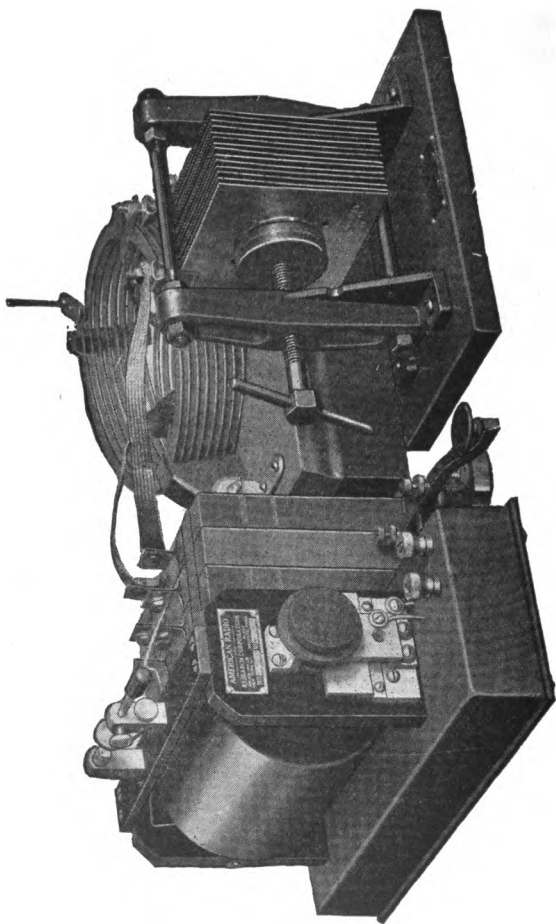

Fifty-Mile Transmitter, Consisting of Amrad 6 or 32-Volt Coil, Amrad $\frac{1}{4}$ K. W. Quenched Gap, Murdock Oscillation Transformer and Condenser

What Happens in a Transmitting Set

AN alternating current of low voltage enters the primary coil of the transformer, and sets up a magnetic field around the iron core. The secondary coil of the transformer cuts the lines of magnetic force and carries a new current of high voltage to the condenser. The condenser discharges a current of sufficient high voltage to jump between the terminals of the spark gap, and in so doing sets up an interchange of electrical energy between the condenser and coil No. 1. This ex-

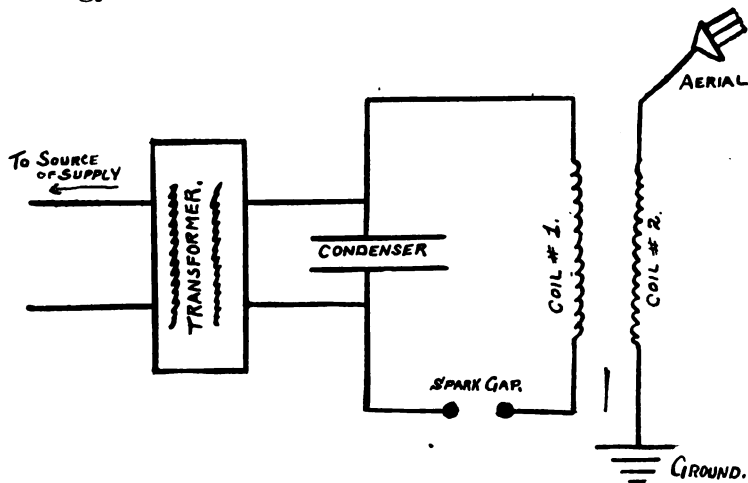

change of energy takes place at a frequency determined by the size of the coil No. 1 and the condenser. By regulating the size of coil No. 1 and the condenser, the size of the wavelength may be regulated as desired. This circuit is termed an "oscillating circuit" because the electrical energy oscillates between the condenser and the coil. The fluctuation of the current in coil No. 1 will induce an alternating current in coil No. 2, providing the two coils are in close proximity and are properly adjusted, and it will carry this current to the transmitting aerial, which will set up the desired disturbance in the ether and start off the electro-magnetic waves on their journey.

The Westinghouse Tube Transmitter

THE Type TF Vacuum tube transmitter is designed for Radio communication over distances of at least fifteen miles by telephone or one hundred miles by continuous wave telegraphy.

Four 5-watt Radiotron U.V. 202 tubes, or equivalent, are used. The four tubes being connected in parallel for continuous wave telegraphy. For telephone transmission two of the tubes are used as oscillators and two as modulators.

A four pole double throw anti-capacity switch is provided for throwing from telegraph to telephone. The filament of the tubes are heated by a step-down transformer, the primary of which is connected to the 105 to 115 volt lighting circuit, the primary being tapped for 105, 110 or 115 voltage supply. This transformer is contained within the set.

The plate voltage for the tubes should range between 350 and 500 volts and may be obtained from any direct current source. The Westinghouse Electric & Manufacturing Company's 100-watt motor generator set Style No. 307212 is especially adapted for this purpose. The plate voltage source is fed to the tubes through audio and radio frequency choke coils. A .75 mfd paper condenser is shunted across the generator leads.

The Grid bias voltage for the modulator tubes is obtained by connecting a resistance variable in steps of 50 ohms, from 50 to 150 ohms, between the negative generator lead and the filament of the tubes.

A relay is provided for continuous wave telegraphing, the contacts of which open the negative lead of the plate supply, the magnet coil of the relay being energized by the 6-volt microphone battery in series with the telegraph key. The relay contacts are shunted by a condenser of .05 mfd capacity.

For telephone operation a microphone is connected in series with the 6-volt battery and primary of the modulation transformer. The secondary of this transformer being connected to the modulation tube filaments and grids.

Coupling between the oscillator tube grids and plates is affected through mica condensers and taps on the Antenna Loading Inductance. The oscillating circuit consists of antenna, radio frequency ammeter, loading inductance and counterpoise.

Binding posts are provided on the panel for connecting the telegraph key, 6 volt battery and microphone. The 110 volt A.C. supply to the filament transformer is connected by means of flexible cord brought out at the left hand end of the set. Binding posts are provided within the set for connecting the plate voltage supply.

The loads from the antenna and counterpoise are brought into the set through bushed holes in the back of the box and connected to binding posts on the Antenna Loading Inductance.

Operation

Connect the 105, 110 or 115 volt supply to the proper posts on the primary of the filament transformer. Connect the plate voltage supply to the proper binding posts, positive lead of the generator to positive binding posts, Connect the antenna and counterpoise through the bushed holes of the box to the binding posts within the set marked antenna and counterpoise, connect the 6 volt microphone battery to the binding posts on the panel which are so marked.

Telegraphing

Throw the transfer switch to the position marked "CW" and bring the plate voltage up to 350 volts. Close the telegraph key and note radiation, ammeter should read 1.7 to 1.9 amperes. Oscillation should take place the instant the key is pressed.

Telephony

Throw the transfer switch to the position marked "Phone" and with 350 volts on the plate the radiation should be 1.2 to 1.4 amperes. When a loud tone is sounded into the microphone the antenna current should increase .1 to .2 amperes.

The speech as received on a crystal or a single tube detector, in the vicinity of the set, will be found to be very clear and understandable and the generator and 60 cycle hum will be negligible in volume compared with the speech.

When a higher voltage than 350 is used on the plate a further increase of grid bias within the set will be necessary.

The proper antenna for this set would be one of four wires spaced $2\frac{1}{2}$ ft. and 75 ft. in length. A counterpoise having the same dimensions as the antenna and separated from the antenna by 20 to 50 ft. would give much better results than a ground due to its having lower losses. The capacity of the above antenna would be approximately .0005 mfd.

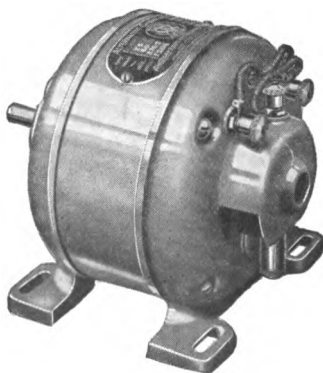

Synchronous Gap Motor

What Happens in a Receiving Set

THE aerial is placed in such a position that it can pick-up or catch the radio waves (electro-magnetic waves), these waves having been set in motion at the transmitting or broadcasting station and travel from this station through space at the rate of 186,000 miles per second. As soon as these waves set up oscillations in the receiving aerial, a current is passed from the aerial down the lead-in wire to the primary coil of the transformer. The action of the current in this coil sets up a magnetic field; this current is induced into the secondary coil of the

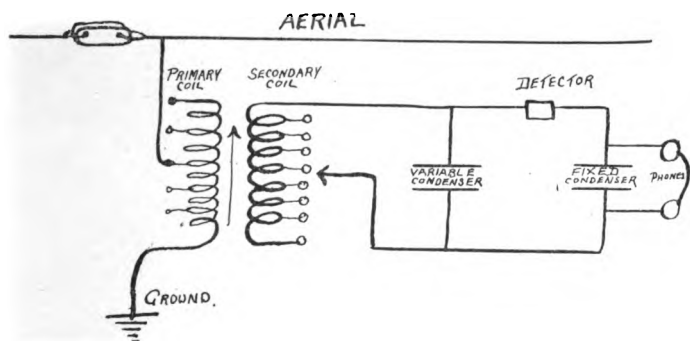

transformer and this produces a radio frequency current which is gradually built up by adjusting the primary and secondary in electrical resonance. The variable condenser is placed in the circuit to allow the secondary circuit to be adjusted to resonance with the primary circuit and also to allow of close adjustment. The induced current will overflow to the detector circuit as soon as the secondary circuit has been put in resonance with the primary circuit. The detector will then rectify this current by transforming the high frequency to low frequency. The current then passes to the condenser, where it is

stored; as soon as a single wave train has accumulated in the condenser the condenser will discharge the current into the phone receivers, where by its action in vibrating the diaphragm it makes the magnetic waves received by the aerial audible to the ear.

Tuning

The apparatus for tuning a receiving set consists of an adjustable circuit containing variable capacity and inductance. The operation of the tuning apparatus is very simple. We have already seen that this apparatus is used to vary the wave length of the receiving set, making it receptive to incoming signals. As in order to receive signals, the receiving set must be adjusted so that the

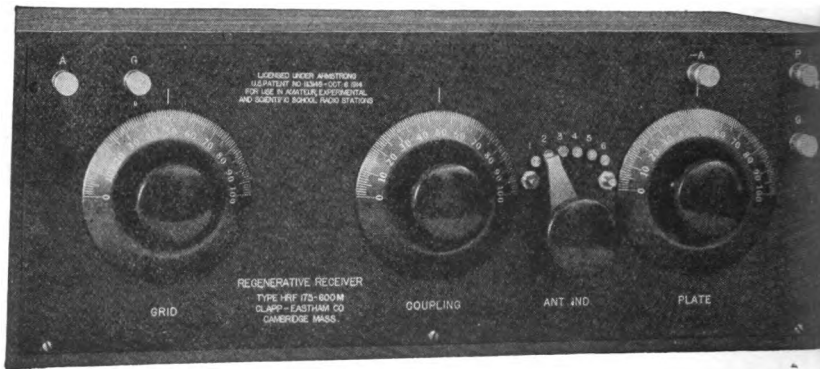

Regenerative Receiver

receiving circuits are in tune with the transmitting circuits. In other words, the time period of oscillation must be the same in both the transmitting and receiving circuits. Thus should we desire to receive the music or speeches from a broadcasting station using a 360 meter wavelength, then it would be necessary for us to adjust our receiving set to as near that wavelength as possible to get maximum results.

What Is Meant by Wavelength

Electro-magnetic waves like light waves travel at the rate of 186,000 miles or 300,000,000 meters per second, if we are using an alternating current of 25,000 cycles per second and cause a disturbance in the air of that frequency then each cycle will travel from the aerial through space at the rate of 300,000,000 meters per second. So that at the end of the second, just as we are

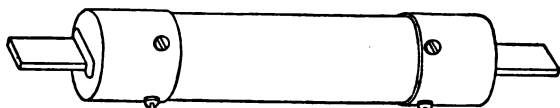

Enclosed or Cartridge Fuse



Section of Enclosed Fuse

causing the last of the 25,000 disturbances the first cycle or disturbance is 300,000,000 meters away. In one second we have made 25,000 separate disturbances, which have traveled 300,000,000 meters, each disturbance separated by the number of meters that 25,000 divided into 300,000,000 will give—300,000,000 divided by 25,000 equals 12,000 meters—it is this distance between the separate disturbances that is known as the wavelength.

Rule for Wavelength

Add the length of the aerial to the lead-in wire. Add to the sum the ground and if more than one wire, one-third of length of aerial. Divide this total by two and add the result to the addition above. The answer will give the approximate wavelength in meters. Example:

Length of aerial 100 feet, length of ground wire 40 feet, length of lead-in wire 20 feet; $100+40+20=160$ feet. One-third of 100= $33+160=193$; $193\div 2=96$; $193+96=284$, which is the approximate wavelength in meters.

Receiving Sets

WHILE the installation and operation of a receiving set is a simple matter, it means more than the connection of aerial and ground wires, and adjusting of the head phones. Thousands of owners of receiving sets are receiving the daily concerts, etc., but they are not getting the maximum results from the sets. The various makes of receiving sets each have their own characteristics, and we approached the manufacturers with the request that they supply us with the information necessary to help obtain the best results out of their instruments. On the following pages we describe the construction, operation and care of these sets, and would ask that these directions be followed. The writer of this book will be pleased to help solve your radio troubles if you will write him direct, in care of the publishers.

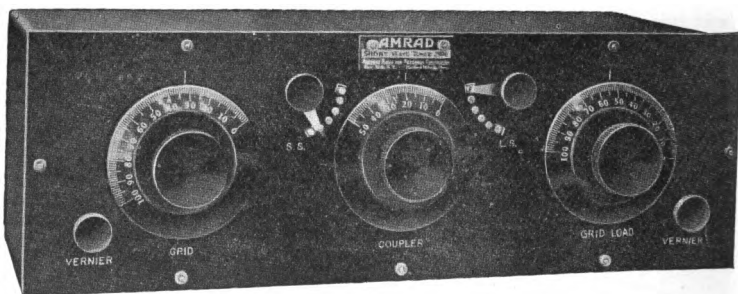

Amrad Short Wave Tuner

Westinghouse Crystal Receiving Set Construction

THE Aeriola Jr. consists of a variometer, a two-section fixed mica condenser, one telephone by-pass condenser and a crystal detector contained in a nicely finished wood box having a separate compartment for telephones, the telephones being sold with the set.

The variometer is made of micarta tubing and has a minimum amount of material in the field, thereby reducing dielectric losses. The small mica fixed condenser is connected in series with the antenna and the variometer, the small section of the condenser being used for the reception of wavelengths between 190 and 300 meters and the large section for wavelengths between 300 and 500 meters.

The crystal and telephones are shunted across a certain portion of the variometer, which gives the greatest volume of signal.

Operation

Connections from each section of the small mica condenser are brought out to separate binding posts permitting a change from one wavelength range of the set

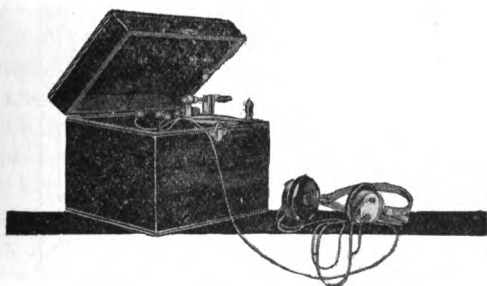

Westinghouse Crystal Detector Set

to the other by merely changing the antenna from one post to the other. With the aerial ground and telephones connected to their respective binding posts it is only necessary to adjust the crystal detector and tune with the variometer handle until the expected signal is heard. After a signal is tuned in further signal strength may be obtained by further adjustment of the detector.

RADIO TRANSMITTER TYPE "T. F." OUTPUT 10 WATTS MODULATED 20 WATTS "C. W."

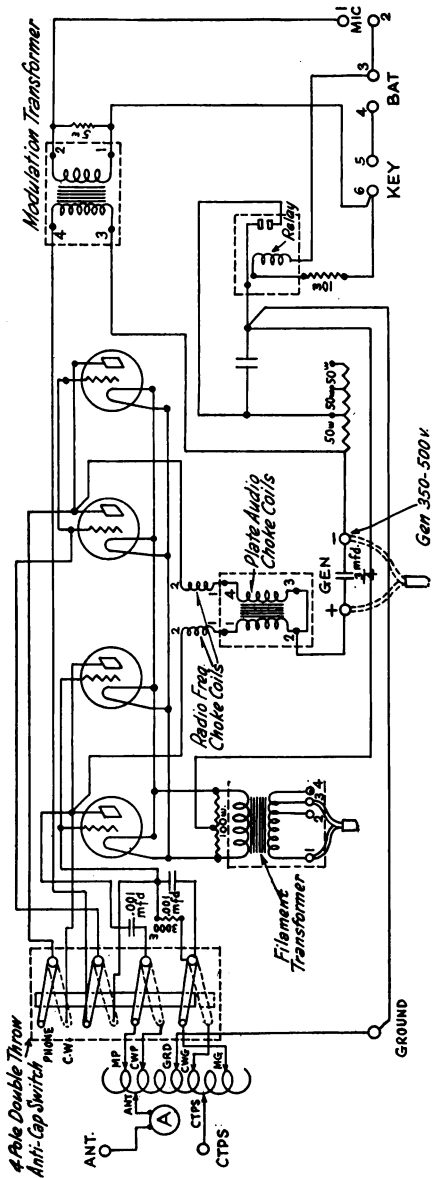

Westinghouse Type R. C. Set

THE type RC regenerative set was designed to be used for operation of a loud speaker and for long distance reception with the use of telephones.

Construction

This set consists of the type RA tuner, the type DA detector amplifier and the type CB loading coil. The wavelength range of the set is 180 to 700 meters, with the loading coil short circuited, and 1,600 to 2,800 meters with the loading coil in circuit. This range permits reception of amateur broadcasting, up to 700 meters, as well as commercial and time signals between 1,800 and 2,800 meters, with the loading coil in circuit.

The tuner consists of a variable condenser and variometer mounted on the same shaft, as a tuning unit. The capacity and inductance of the circuit is thereby increased simultaneously and in the proper L to C ratio. The tuning condenser is paralleled by a three-plate vernier condenser for sharp tuning. A tapped tickler is used on the type RC set and is wound on the same tube and alongside of the stator winding of the variometer. The tickler is so tapped as to permit a close adjustment of regeneration, thereby securing maximum sensitivity.

The amplifier used in this set consists of a socket for the detector tube, telephone by-pass condenser, two sockets for amplifier tubes, two special audio frequency transformers and two moulded porcelain base rheostats. The detector and amplifier tubes are mounted on a flexible rubber shock absorbing cradle, which prevents audio noises due to local vibrations from being amplified. Three jacks are provided so that the detector tube, first step of amplification, or second step of amplification may be used.

The loading coil used with the set consists of two universal wound coils, one used as a loading inductance and

the other as a tickler for regenerating the loading inductance. The two coils are mounted in a block moulded bakelite enclosed case which is equipped with a plunger type switch to short circuit the loading coil when using the short wavelength range of the set. The switch permits permanent installation of the loading coil on the set. The leads of the coils are brought out to the four legs of the switch blades, an extension of these blades also serve as a connection to be clamped under the binding posts of the set.

An electro-static shield is used to minimize the capacity effect of the operator's body, this shield is located on the back of the panel and is kept at ground potential.

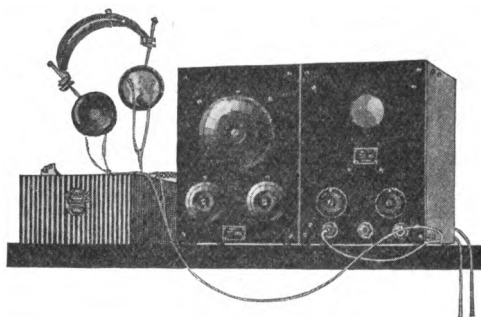

Westinghouse R. C. Receiving Set

The tickler and tuning knobs are secured to Micarta shaft extensions, thereby further minimizing capacity effect of the operator's body. The connections are brought out to the rear of the tuner and amplifier by means of extension rods, and the high potential connections are thereby kept away from the operator, avoiding the capacity effect of the body, and, detuning and howling, as consequent results.

The lead from the grid inductance is connected to the positive side of the filament of the detector tube and the transformer secondary winding is connected to the negative side of the filament of the amplifier tubes, with a bias of approximately one volt obtained by keeping a certain

WIRING DIAGRAM OF DETECTOR AND TWO STAGE AMPLIFIER

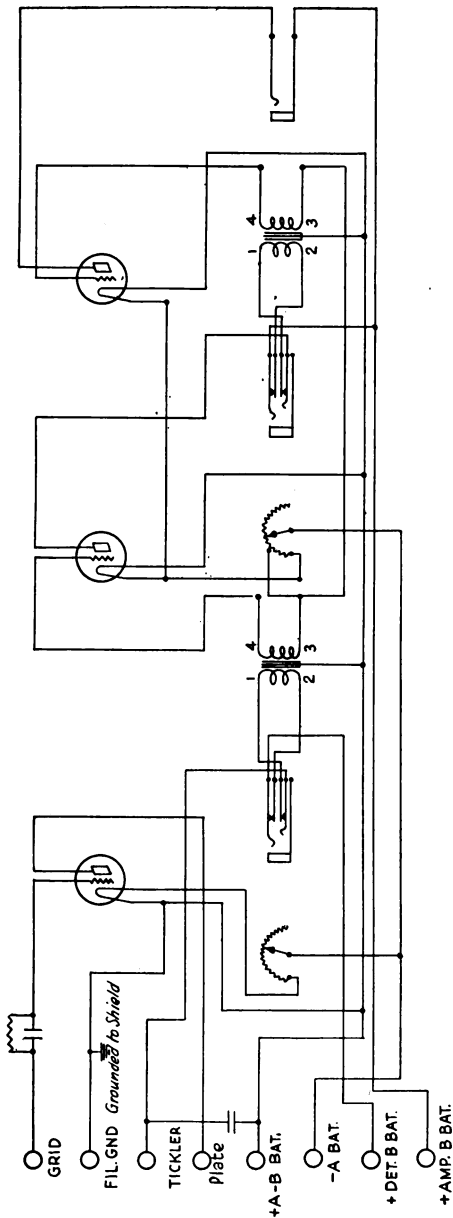

Westinghouse R. C. Receiving Set

WIRING DIAGRAM—SINGLE CIRCUIT TYPE RADIO RECEIVER

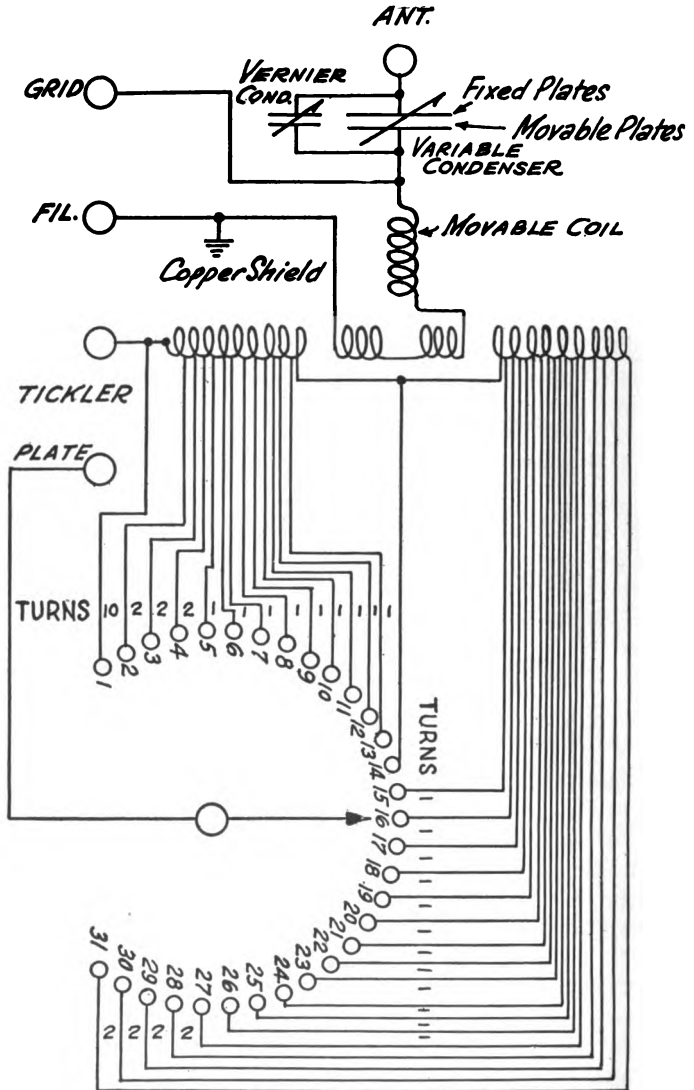

portion of the filament rheostat between the transformer winding and the filament of the tube. This grid bias allows a material increase in amplification, and is such as to cause the least amount of distortion in the reception of speech or music.

In connecting up the Type RC set it is necessary to put a jumper (furnished for that purpose) between the grid binding post of the tuner and the grid binding post of the amplifier, and also a jumper between the tickler binding post of the tuner and the tickler binding post of the amplifier. The loading coil is then connected between the filament post of the tuner and the filament post of the amplifier and between the plate binding post of the tuner and the plate binding post of the amplifier in such a manner as to have the loading coil switch handle vertical and at the top of the cabinet. (In the absence of a loading coil put jumpers in between the tuner and amplifier to replace the loading coil.) The aerial and "A" and "B" batteries are to be connected to their proper binding posts of the set and the ground connection taken off of the filament binding post of the amplifier. If a "soft" (low vacuum) tube is used as a detector, do not connect more than $22\frac{1}{2}$ volts across the detector "B" battery binding posts.

Operation

To operate the set, plug the telephones in on the detector, first step of amplification or second step of amplification, adjust the tickler for regeneration by means of the tickler dial on the panel and tune by means of the large tuning dial on the panel until the desired signal is heard. For a finer adjustment of tuning it is necessary to use the small vernier dial to the left of the tickler dial. After a signal has been tuned in accurately, a further adjustment of the tickler for maximum regeneration will increase the signal strength materially.

Care should be taken not to use too much amplification. If the music or speech being received is sufficiently strong on the first stage of amplification, do not attempt to use

more amplification. The use of more amplification would "block" the second amplifier tube and cause local atmospheric disturbances to be amplified in excess of the signal amplification. The blocking of the second tube causes the music or speech to be distorted, the amplification of atmospheric disturbances in excess of the amplification of signal, naturally does not improve the clearness of the music or speech received.

When using the loading coil to secure the wavelength range between 1,600 and 2,800 meters, the plunger switch is pulled up. To use the set for reception of wavelengths between 180 and 700 meters, the loading coil plunger switch must be pushed down, thereby shortening the loading coils out of circuit.

Aeriola Sr. Receiving Set

THE Aeriola Sr. a regenerative set, was designed to satisfy the demand for a vacuum tube set which did not require a storage battery to light the filament. A special tube, developed by the Westinghouse Electric & Manufacturing Company, which requires one 1½ volt dry cell and uses .23 amperes of current to heat the filament and using either 20 or 40 volts as a plate battery is used with this set.

Construction

The Aeriola Sr. consists of two variometers, the stator windings of each being wound on the same micarata tube, the distance between windings and the value of each stator and rotor winding being such as to give an even increase in regenerative control.

One variometer is used as a tickler winding for securing regeneration and the other variometer serves as a variable inductance which is used in conjunction with the two sections of the small mica condenser to secure the wavelength range of 190 to 500 meters.

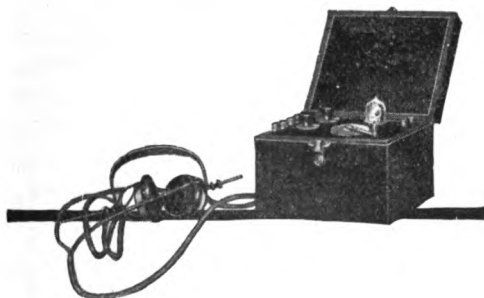

Westinghouse Aeriola Sr. Receiving Set

A rheostat having the resistance wire wound on special fibre support and the resistance unit secured to a moulded porcelain base is used to control the filament current.

DIAGRAM OF CONNECTIONS

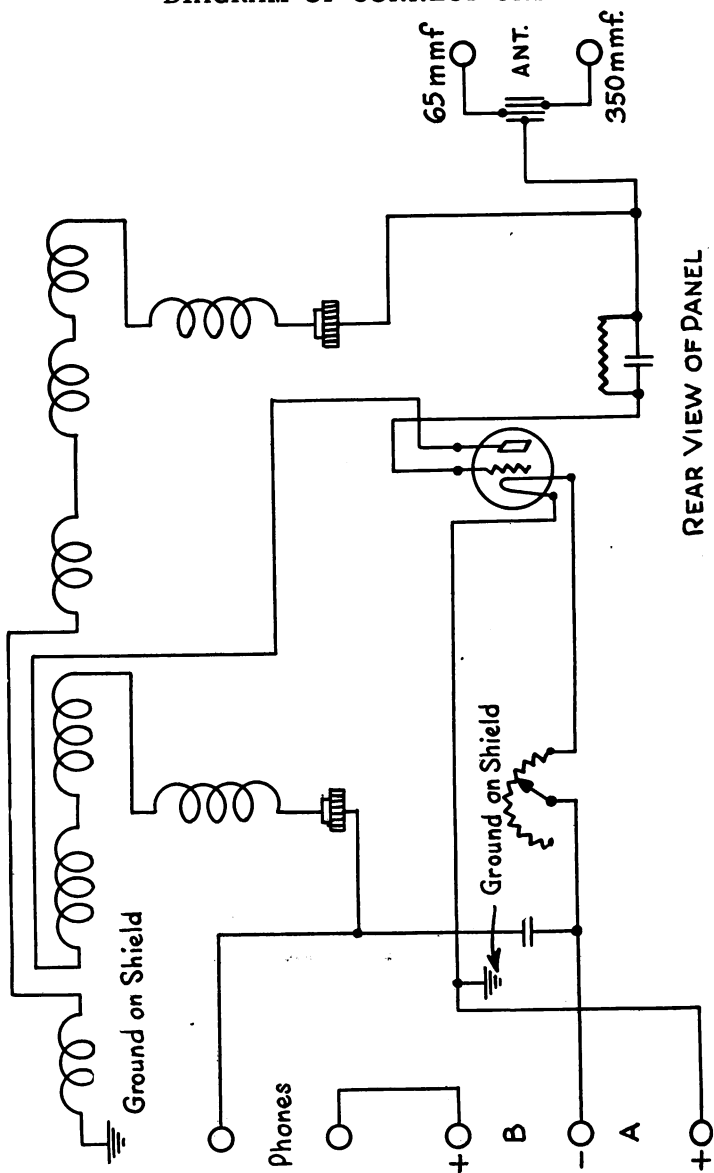

REAR VIEW OF PANEL

Aeriola Sr. Regenerative Receiver

The bulb socket is set back from the panel so as to allow the top of the tube to protrude through a hole in the panel far enough to permit removal of the tube, yet not so far as to prevent the lid of the box being closed when the tube is in the socket.

Operation

The lead from each section of the small mica condenser has been brought out to separate binding posts and the wavelength range of the set is determined by the post to which the antenna lead is connected, one post being the connection to the small section of the mica condenser and having a wavelength range of 190 to 300 meters and the other post being connected to the large section of the condenser and having a wavelength range of 300 to 500 meters.

Refer to the connection diagram in the lid of the box and connect the antenna, ground and telephones to the proper binding posts of the set. Connect the 1½ volt dry cell to the proper binding posts, positive lead of the battery to the positive binding post of the set. Connect the plate dry battery of 20 to 40 volts to the proper binding posts, taking care to have the positive lead of the battery to the post marked positive "B" battery of the set. Care must be taken NOT to connect the "B" battery to the filament battery posts of the set, doing so would burn the filament of the tube out.

Having made the above connections properly, the set is then ready for operation. Turn the filament rheostat knob until the filament of the tube glows a dull red. The filament is oxide-coated and must NOT be burned brightly. Tune the set by means of the variometer handle and increase the tickler until considerable regeneration is obtained. Avoid using sufficient tickler to cause the set to oscillate when receiving music or spark signals. In order to secure best results it is necessary to make a final adjustment of the tickler after the signal has been tuned in by means of the variometer handle.

Aeriola Grand

IN order to receive music or speech free of disturbing noises it is necessary that the signal be much stronger than local disturbances. It is not necessary that a set be extremely sensitive for such reception. To the contrary, it is not advisable to have a super-sensitive set, such a set would detect and amplify local disturbances, and a conglomeration of noises would accompany the reception of music and speech.

The Aeriola Grand Regenerative Receiving Set is a parlor outfit of extreme simplicity in operation.

It consists of a nicely finished box shaped very much like that of the modern phonograph. The set is panel mounted, the panel being what would ordinarily be the turn table of a phonograph. This panel being hinged at the rear forms a false lid for the box and permits the apparatus to be readily inspected. The plate batteries are placed in retainers within the box alongside of the loud speaking telephone, which is coupled to the sound chamber of the box. The panel is shielded to prevent the capacity effect of the hand from being troublesome.

The four vacuum tubes and four ballast resistance tubes are mounted so as to protrude far enough through the panel as to be readily removed, yet not so far as to interfere with closing the lid. A small push button switch, which is in the filament battery supply line, is located on the panel.

The tuning system consists of a fixed capacity, in the form of a small mica condenser, and a variometer which serves as a variable inductance, the handle of the variometer being located on the panel for tuning. The set is regenerative, due to a coil in the plate circuit, which is coupled to the variometer winding, this coil being tapped and pre-adjusted at the time of installation to give proper

WIRING DIAGRAM—WESTINGHOUSE AERIOLA GRAND

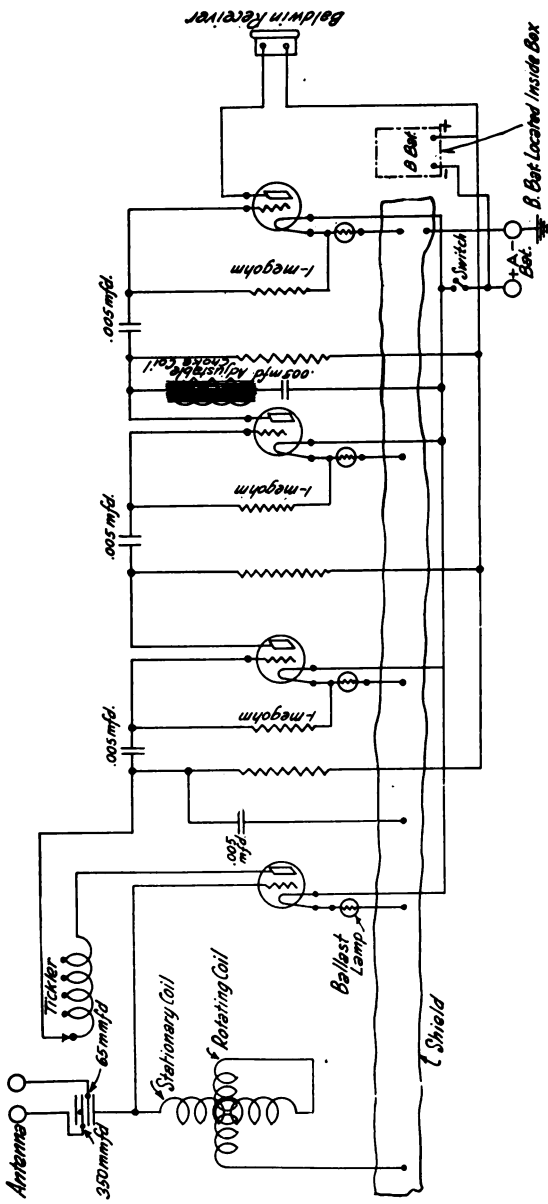

regeneration, no adjustment being provided from the panel.

One detector tube and three resistance coupled amplifier tubes are used in this set. The detector tube naturally serves as the rectifier and its grid is so maintained at a negative potential as to give the best rectification possible. The grids of the amplifier tubes are maintained at a constant D.C. potential with respect to the filament as to give the greatest amplification possible without distortion.

The last amplifier coupling resistance is shorted by a condenser and coil in series which has been pre-calibrated to the natural period of the loud speaking telephone, thereby lowering the telephone amplification of the audio note at the frequency which the telephone would respond to most strongly and keeping the efficiency of the loud speaker more uniform for all frequencies.

In order to simplify this set as much as possible, the filament rheostats are omitted and a separate ballast resistance tube placed in series with each filament. The ballast resistance consists of a certain length of iron wire in an atmosphere of hydrogen. The wire supported and the hydrogen gas maintained in a glass casing resembling a vacuum tube, but having two pins for contact on the base instead of the customary four. The function of the ballast resistance being to maintain a predetermined filament current throughout a wide range in voltage of the filament battery.

The Detector

ONE of the most important parts of the receiving set is the detector. The human ear cannot record frequencies above 15,000 cycles, and as we have already been shown that the cycles in radio work are very high, sometimes running as high as 1,500,000 cycles per second, it will be readily seen that some apparatus must be introduced to reduce the extremely high frequency used in wireless work to a frequency that will be audible by using the telephone receivers.

There are many forms of detectors. We shall first deal with the crystal type, which up to a few months ago was the one most commonly used. Crystal rectifiers consist of

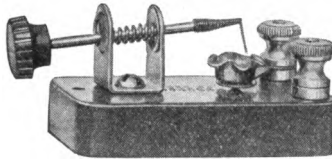

Murdock Crystal Detector

certain metal compounds having the property of rectifying the high frequency oscillations.

Galena (a sulphide of lead) is the mineral mostly used today.

The construction and operation of a crystal detector is simplicity itself. On a wood base mount a small piece of galena between two adjustable contacts in such a manner that the most sensitive part of the crystal can be easily located by searching the surface of the mineral with the end of a thin (catwhisker) wire.

Crystals must be kept clean to retain their sensitiveness. Washing with alcohol greatly improves them if they have been left standing without use for any length of time.

Crystal Detector

The type DB crystal detector was designed by the Westinghouse Electric & Manufacturing Company to fulfill the needs of amateurs and novices. This crystal detector consists of two sets of crystals with a switch to throw from one to the other. Necessary binding posts are provided for connecting the detector to the receiving set and to the telephones.

One set of crystals are of the heavy contact type, providing a stable adjustment.

These crystals abound with sensitive points and require no skill whatsoever to adjust.

The other set of crystals consist of a fixed crystal of tested galena and an adjustable catwhisker tipped with a special composition bead. This is a relatively light contact detector and super-sensitive. A signal may be detected on the heavy contact set of crystals without difficulty in making the adjustment and if greater volume is desired the switch may be thrown to the super-sensitive crystals and further adjustment made there.

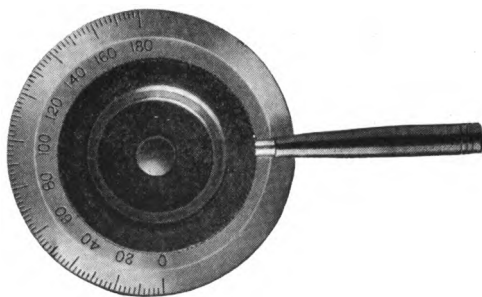

Knob and Dial Assembly

Vacuum Tubes

THE introduction of the vacuum tube is in a large way responsible for the great advancement of radio within the past few months. Most of the higher priced receiving sets made today are equipped with this wonderful tube. The working principles of the vacuum tube and its connections are far too involved to treat with in detail in this book.

The vacuum tube consists of three separate elements—enclosed in an evacuated glass bulb, (a) the filament (which is very similar to the filament in an ordinary in-

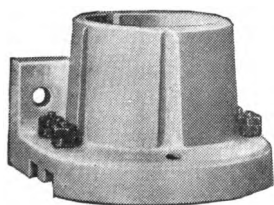

Radiotron Tube Socket



Vacuum Tube

candescent bulb), (b) the grid (a mass of wires), (c) the plate (a small solid plate of sheet metal). The tube is connected in the circuit and controlled by a small adjustable rheostat. It is highly sensitive and is used for both receiving and transmission.

Bear in mind that the receiving type of tube operates on six volts. In using a six-volt storage battery, especially where several tubes are employed, the voltage drop in the connecting leads may be such to spoil the operation of

the tubes. If No. 14 wire (Brown & Sharp) is used for the purpose the source of trouble will be practically eliminated.

Radiotron Tubes

When using the larger power tubes with transmission sets certain precautions are necessary to lengthen the life of the tube. Most of the damage to tubes is caused during the testing and adjustment of the circuit, and great care should be taken during these periods.

The life of radiotron tubes can be materially lengthened by mounting them in the proper position. Radiotron No. 13248, Type UV-202 and No. 13247, Type UV-203, should be installed in a vertical position, while radiotron No. 13246, Type UV-204, may be operated in either a

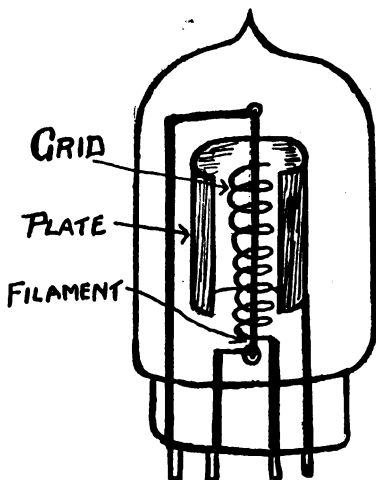

Diagram of Vacuum Tube

vertical or horizontal position. When mounted in a horizontal position the plates should be in a vertical plane, with the seal-off tip down. On any tube or group of tubes delivering over 50 watts A.C. or operated at a plate potential above 2,000 volts, a safety spark gap should be provided between the grid and filament terminals at or

near the tube socket or mounting. This gap should be adjusted to between 1-32 inch and $\frac{1}{4}$ inch, depending upon the plate voltage employed and the number of tubes and type of tubes used. The life of the filament of radiotron power tubes is dependant upon its temperature, a 3% increase in filament current will halve the life of your tubes, and a 5% decrease will double the life. Do not use a greater voltage on the filament than that specified, and do not overload the plate by using an excessive plate voltage. Power tube filaments should be burned at constant voltage rather than constant current.

Occasionally in the parallel operation of radiotrom power tubes ultra high frequency oscillations develop in the plate and grid circuits which prevent the realization of full output, and cause excessive plate and grid currents. This effect may be avoided by inserting an inductance of a few micro-henries (10 turns in one layer on a tube 1 inch in diameter is suggested) in one or more of the individual grid leads of each tube as close to the grid terminal of the socket as possible.

This protective gap should be placed between the coil and the grid terminal of the socket. The best arrangement is to mount the gap directly on the socket terminals and one terminal of the coil directly to the grid terminal of the socket.



Instructions for the Installation and Operation of Grebe Short-Wave Regenerative Receivers

Installation

THE Receiver should be placed in a position convenient for operating control. Connect the Antenna and ground leads to the terminals so marked. Connect a 6 Volt Storage Battery to the terminals marked "Filament Battery." Connect a 22½ Volt Battery unit to the terminals marked "Plate Battery."

Make certain that all battery leads are connected to the proper terminals and that the polarities are not reversed. Connect the telephones, or amplifier unit, to the terminals marked "Output." Turn the rheostat wheel to the "off" position and place the vacuum tube in the socket. The rheostat may now be rotated to 2.

Operation

To tune the Receiver to a given wavelength, the Antenna Inductance Switches and the Grid Variometer must all be adjusted to that wavelength, and the Wavelength Range Wheel set in the position indicating the upper limit of the wavelength band in use.

The figures opposite the contacts of the Antenna Inductance Switches represent the number of turns in the antenna circuit. Divide the wavelength desired by 14 to find the approximate number of turns to use.

The Plate Variometer Dial controls the regenerative action and its proper setting for spark signals is best determined by advancing the dial until the signal is of maximum audibility without distortion. For C. W. signals, the dial must be advanced beyond this point, i. e., until oscillations occur,—a condition easily recognized by a soft hissing sound in the telephones. The Coupler should be set at 50 for preliminary tuning and finally adjusted to tune out interfering signals.

As many signals are inaudible until the regenerative action takes place, it is advisable to adjust the Grid and Plate Variometers simultaneously, and make final adjustment of Antenna Inductance for maximum signal strength. The tangent-wheel verniers are indispensable in accurately tuning all weak signals, especially C. W. and telephones.

LOCATION OF FAULTS:

(a) If adjustment of Plate Variometer fails to produce regeneration, adjust filament current, plate voltage, or both.

(b) If adjustment of Plate Variometer produces regeneration but no appreciable increase in signal strength, adjust Antenna Inductance, Coupling, or both.

(c) If vacuum tube filament fails to light, or flickers, move the tube and clean the end of its four contacts with a file or sand-paper.

(d) Grinding noises are caused by:

1—Faulty Connections.

2—Defective Plate Batteries.

3—Defective Vacuum Tubes.

Unlike static disturbances, these noises persist when the antenna is disconnected, and they may be eliminated by tightening binding posts, cleaning the ends of the vacuum tube contacts, or replacing defective tubes or batteries.

Type CR-3

The operation of the Type CR-3 is essentially the same as the CR-8, with the exception that the detector is not included in the set. Four terminals are provided for externally connecting the detector unit. The combination of the Type CR-3 Receiver with the Type Rord detector-amplifier represents a complete receiving station equipment, the detector-amplifier unit being also available for use with other receiving circuits.

The Type CR-8 Receiver in combination with the Type Rord Two-Stage Amplifier unit is a complete station equipment in which the two stages of amplification are available for use with other receiving circuits.

Instructions for the Installation and Operation of Grebe Intermediate-Wave Regenerative Receivers

Installation

THE receiver should be placed in a position convenient for operating control. Connect the Antenna and Groundleads to the terminals so marked. Connect a 6 Volt Storage Battery to the terminals marked "Filament Battery." (Connect two 22½ Volt Battery units in series. Connect the junction of these batteries to the terminal marked "Detector." Connect the ends of these batteries to the remaining terminals marked "Amplifier."

Make certain that all the battery leads are connected to the proper terminals and that the polarities are not reversed. Connect the telephone terminals to one of the plugs supplied with the set.

Turn all three rheostat wheels to the "off" position and place the vacuum tubes in the sockets. Insert the telephone plug into the jack marked "Detector," and turn the detector rheostat wheel to 2.

Operation

Combinations of antenna inductance and antenna series capacity as indicated by the Inductance Switch and the Condenser Dial, result in the wavelength shown for these combinations on the Wave-length Chart. The Tickle Dial controls the regenerative action and its proper setting for spark signals is best determined by advancing the dial until the signal is of maximum audibility without distortion. For C. W. signals the dial must be advanced beyond this point, i. e., until oscillations occur, a condition easily recognized by a soft hissing sound in the telephone.

As many signals are inaudible until regenerative action takes place, it is advisable to adjust the Condenser and Tickler Dials simultaneously. The Vernier Wheels are essential in accurately tuning all weak signals, especially C. W. and telephones.

After tuning and detector adjustments have been made, the telephone plug may be changed to the 1st Stage Amplifier position and the corresponding rheostat adjusted for maximum signal strength. The same procedure is followed in adjusting the second stage. When it is desired to use a loud-speaker this instrument should be connected

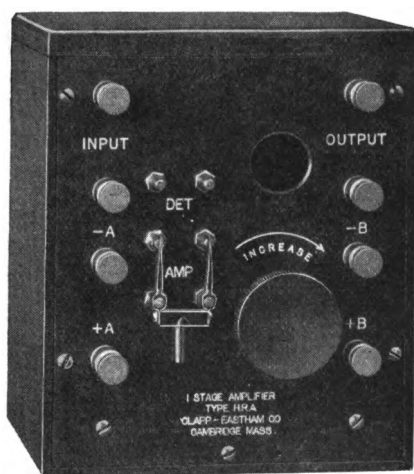

Clapp-Eastham One-Stage Amplifier Panel

to the terminals marked "loud-speaker," and the telephone plug inserted into the second stage just far enough to light all three filaments.

When it is desired to use the amplifier section in conjunction with external tuning and detector apparatus, connect the output of the external detector to the other plug supplied with the set. Also connect the filament leads of the external detector to the terminals marked

“external Filament.” Thus, when the plug is inserted into the jack marked “External Detector,” the automatic control device will cause the external filament to be lighted and the filament of the detector tube in the CR-9 to be extinguished.

Location of Faults

(a) If adjustment of Tickler fails to produce regeneration but no appreciable increase in signal strength, adjust Condenser.

(b) If vacuum tube filament flicker or fail to light remove the tubes and clean the ends of their contacts with a file or sand-paper. If this does not eliminate the trouble, it may be necessary to adjust the filament control blades of jacks.

Remove all plate battery connections before making these adjustments, to prevent short circuit resulting in the burning out of vacuum tube filaments.

(c) If both stages fail to produce amplification, the trouble may be traced to faulty plate batteries, or reversal of the filament battery leads. Defective tubes cause the majority of other troubles. It is desirable to try the tubes in various combinations for detector, 1st and 2nd stages.

Grinding noises are caused by:

- 1—Faulty connections.
- 2—Defective plate batteries.
- 3—Defective vacuum tubes.

Unlike static, these noises persist when the antenna has disconnected and they may be eliminated by tightening binding posts, cleaning the ends of vacuum tube contacts or replacing defective tubes or batteries. Type CR-5—The operation of the CR-5 Receiver is essentially the same as the type CR-9 with the exception that the amplifiers are not included.

The Type CR-5 Receiver in Combination with the Type Rork Two-Stage amplifier is equivalent to the Type CR-9.

Tuning Method for Three Circuit Receivers

WHILE excellent results may be obtained with approximate adjustments, the additional effort required for careful tuning is justified by the greatly improved reception, and in order to obtain maximum signals it is necessary to tune each of the three circuits to the wavelength of the desired signal. In all, there are five separate adjustments to be made.

- 1—Primary circuit (Antenna Inductance).
- 2—Secondary circuit (Grid Variometer).
- 3—Coupling (Coupler).
- 4—Plate circuit (Plate Variometer).
- 5—Detector (Vacuum tube).

Failure to make all the adjustments results in inaudibility of weak or distant signals, instability of audible signals, distortion of radiophone speech or music, due to improper amplification.

Tuning for Signals of Unknown Wavelength

Set the grid variometer dial to correspond with the desired wavelength.

Set the coupler dial to either 50 position.

Starting from the zero position gradually increase the plate variometer dial to the point where oscillations occur. (This condition is recognized by a soft hissing sound in the telephones.)

Adjust the antenna inductance switches to a combination which causes the cessation of oscillations. If a Variable Antenna Series Condenser is used, adjust the switches to a combination which will cause the oscillations to cease upon rotation of the condenser dial to some point between 70 and 90.

The desired signal should now be audible in the telephones and final adjustments may be made with the grid

variometer and coupler. The use of the tangent wheel verniers is essential in making these final adjustments.

Set the coupler on either 50 position.

Make approximate adjustment of the antenna inductance switches, setting them at a higher rather than a lower wavelength than is expected.

Using both hands, simultaneously rotate the grid and plate variometer dials over the entire scales. The dials should be rotated so as to keep the circuits on the verge of oscillating.

When the desired signal has been located on the grid variometer dial rotate the coupler dial toward zero until the signal is barely audible and then adjust the primary circuit.

Make a final adjustment on the Coupler dial.

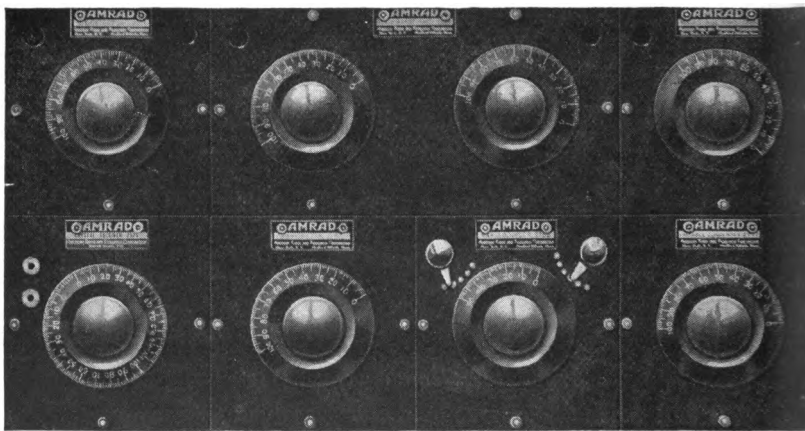

A Long-Distance Receiving Set

Tuning Method for Two Circuit Receivers

THE tuning of this type of receiver is more simple than the three circuit type. Maximum signal is obtained only when the wavelength control circuit is adjusted to the same wavelength as the desired signal, and the tickler is adjusted to the point of greatest amplification.

Tuning for Signals of Known Wavelength

Set the inductance switch for the desired wavelength range.

Set the condenser dial to the position corresponding to the wavelength desired.

Starting at zero gradually increase the Tickler dial reading to a position just below the oscillating point. (The oscillating condition is indicated by a soft hissing sounds in the telephones.)

The desired signal should now be audible in the telephones and final adjustments may be made with the tangent wheel verniers.



Flexible Armored Cable

Tuning for Signals of Unknown Wavelength

Set the inductance switch in the position corresponding to the range in which the signal is expected.

Using both hands simultaneously adjust the condenser and tickler dials over the entire range, maintaining the proportion necessary to keep the receiver on the verge of the oscillating condition. If the signal occurs below 10 on the condenser dial, move the inductance switch to the next lower point, and if the signal occurs above 90, move the inductance switch to the next higher point.

Special Tuning Instructions

Spark Signals

THE reception and amplification of spark signals will be most satisfactory when the regenerative action is controlled to a degree which will produce maximum amplification without causing an oscillating condition in the circuits. When the oscillating condition is reached, the tone of the spark signal will be destroyed and reception through interference will become almost impossible.

Modulated C. W. Signals

Modulated C. W. Signals, including I. C. W. Buzzer Modulated C. W. and Voice, may be received in a like manner, but a special condition may be obtained by allowing oscillations to take place in the receiver, producing the exact frequency of the incoming wavelength. This is known as the "zero beat" method and in this condition amplification is greatly increased due to the augmented feed-back of energy from the plate to the grid circuit. It is only possible to make one or this method while the incoming frequency remains constant and its successful application requires considerable skill.

C. W.

In the reception of continuous waves the plate circuit feed-back is to be increased to a point where oscillations are constantly taking place and this condition must be maintained throughout the entire tuning operations.

Receivers Used As Wavemeters

The wavelength of incoming signals or of any local oscillating circuit may be determined by noting the grid variometer dial setting. This applies to the CR-8 Receiver and the CR-3 Rord combination. Where the CR-3 Receiver is used in conjunction with non-standard detecting apparatus, the readings will be inaccurate. The wavelength of local oscillating circuits may be obtained with

the CR-5 or CR-9 Receivers by shunting the antenna and ground binding posts, noting the Condenser dial reading.

Elimination of Interference

The most successful means for reducing spark interference while receiving modulated C. W. signals is the use of the zero beat method described above. This will cause the spark signal to become distorted and suppressed while greatly increasing the amplification of the desired signal.

Eliminating interference from spark and modulated C. W. signals while receiving C. W. Signals.

As the oscillating condition is a pre-requisite in the reception of C. W. signals, it follows that spark signals are more readily suppressed than are the modulated C. W. signals. Where the carrier wavelength of the modulated C. W. signal and the wavelength of the desired signal are almost identical it will only be possible to suppress the modulated C. W. signal is beyond audibility. In the Types CR-3 and CR-8 receivers, an additional freedom from spark interference is to be gained by the use of the coupling adjustment.

The elimination of C. W. Signals while receiving spark signals is easily accomplished by reducing the plate variometer or Tickler dial setting until the oscillations cease, unless the C. W. station is very powerful and located nearby.



Wavemeter

Installation of Detector and Two-Stage Amplifier

THE Detector-Amplifier unit should be placed as close to the receiver as possible in order to avoid lengthy leads. The four terminals on the left are provided for externally connecting the amplifier with the receiver.

Connect a 6 volt battery to the terminals marked "Filament Battery."

Connect two 22½ volt battery units in series. Connect the junction of these batteries to the terminal marked "Detector." Connect the ends of these batteries to the terminals marked "Amplifier."

Make certain that all battery leads are connected to the proper terminals and that the polarities are not reversed.

Connect the telephone terminals to one of the plugs supplied with the unit.

Turn all the rheostat wheels to the "Off" position, and place the vacuum tubes in the sockets.

Insert the telephone plug in the jack marked "Detector" and turn the detector rheostat wheel to 2.

Operation

After tuning and detector adjustments have been made, the telephone plug may be changed to the 1st stage amplifier position and the corresponding rheostat adjusted for maximum signal strength. The same procedure is followed in adjusting the 2nd stage.

When it is desired to use a loud speaker, this instrument should be connected to the terminals marked "Loud Speaker" and the telephone plug inserted in the second stage jack just far enough to close the filament circuit of all three tubes.

When the amplifier section is used with external tuning and detecting apparatus, connect the output of the ex-

ternal apparatus to a telephone plug. Also connect the filament leads to the terminals marked "External Detector." Thus, when the plug is inserted in the jack marked "External Detector" the automatic control device will cause the external detector tube filament to light and the detector tube filament in the Rord will be extinguished.

Location of Faults

(a) If vacuum tube filaments flicker or fail to light, remove the tubes and clean the ends of the contacts with a file or sandpaper. If this does not eliminate the trouble, it may be necessary to adjust the automatic control jacks.

Remove all Plate Battery connections before making jack adjustments to prevent short circuit resulting in the burning out of vacuum tube filaments.

(b) If both stages fail to produce amplification, the trouble may be traced to faulty plate batteries, or the reversal of the filament battery leads. Defective tubes cause a majority of other troubles. It is desirable to try the tubes in various combinations for detector, 1st and 2nd stage.

Installation of Two-Stage Amplifier

Connect a six volt storage battery to the terminals marked "Filament Battery."

Connect two 22½ Volt Battery units in series; connect the ends of these batteries to the terminals marked "Plate Battery."

When this amplifier is used with the Grebe Type CR-5 or CR-8 Receiver, a connection may be made from the junction of the two 22½ Volt batteries to the Plate Battery Terminal on the receiver. With this circuit a single plate battery is made to serve both units. No connection need be made to the —"Plate Battery" terminal on the receiver as this circuit is completed through the positive side of the Filament Battery which is common to both Receiver and Amplifier. Connect the "Filament Battery" terminals of the receiver to the "External Filament" terminals of the amplifier. Connect the output or telephone terminals marked "Input" on the amplifier.

Fixed Condenser

FIXED condensers are used as shunts across the detector to intensify the incoming signals and to permit of fine tuning. To make a fixed condenser, first cut a number of strips of tin foil into sheets measuring 3 inches by 2 inches wide. Then lay two pieces of paraffined paper on a strip of cardboard measuring 3 inches long by 2 inches in width. On top of these sheets of paraffined paper lay one of the strips of tin foil, leaving about $\frac{1}{2}$ inch projecting over the end of the paraffined paper. Now, place another sheet of paraffined paper over this seeing that it coincides with the sheet of paraffined paper under it, and on top of this lay another strip of tin foil,

FIXED CONDENSER.

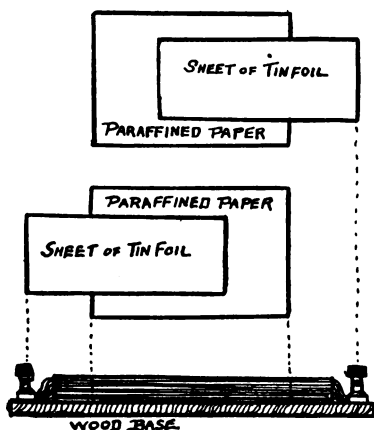

this time letting it project $\frac{1}{2}$ inch over the paraffined paper on the opposite end. And so on, the condenser being built with alternate layers of paraffined paper and tin foil, until the desired number of sheets have been built up. Place two pieces of paraffined paper on the top and over this a strip of cardboard, the same size as that at the bottom. The whole thing is then bound up with thread. Now, lay the condenser on a board fixing on two binding posts, so that they clamp down the projecting ends of tin foil to the wood base. The condenser is then ready for use in the circuit.

The Variable Condenser

THE variable condenser is an apparatus used in conjunction with the receiving set to make it capable of receiving weak signals. There are a number of types and models. The most common type consists of a

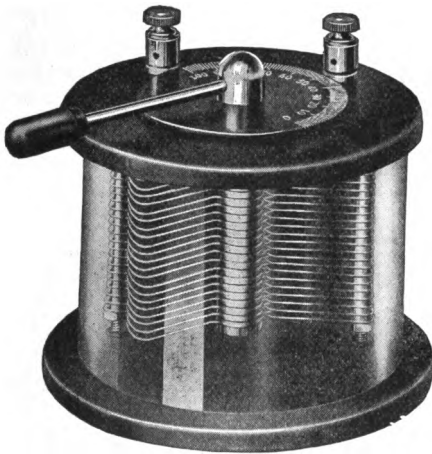

Variable Condenser

number of metal plates separated from each other by an air-gap, or insulated from one another by sheets of mica, the whole being mounted in a circular case. One set of the plates are fixed, while the other set is mounted on an insulated spindle, which can be turned through an angle of 180 degrees, thus permitting of any required amount of interleafing of the plates.

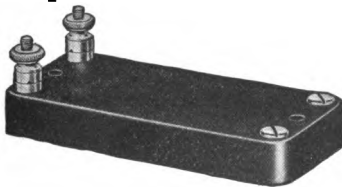

Murdock Fixed Condenser

There are other types on the market which use only two plates. The one illustrated on this page is made up of two plates, A and B. A is fixed; the plate B is free to move up and down, to or from plate A. The surface is covered with a thin circular sheet of mica C, and the plate B has secured to its underside a block of insulated material, which acts as a support for the guide rod and screw. The variation of the capacity is obtained by merely screwing the rod upward or downward on the shaft, which moves the plate B to or from plate A.

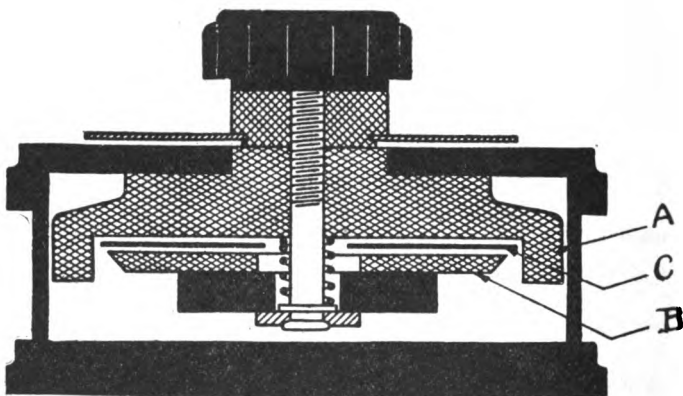

**INTERNAL CONSTRUCTION OF A TWO
PLATE CONDENSER**

A Variometer

A VARIOMETER is a tuner that depends on the coupling between its two parts, which are connected together. It generally consists of one fixed and one movable coil, connected in series with each other, and mounted so that the coupling between the two coils can be varied and readily adjusted. The inductance of the combination is changed by varying the relative position of the coils. There are a number of different types

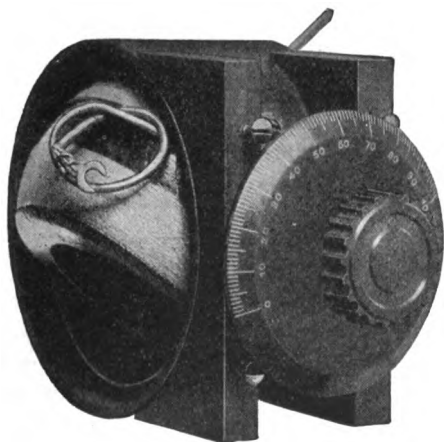

Clapp-Eastham Variometer

on the market all meeting with more or less success. One of the best is the basket-weave type of winding on spherical forms. This type can be mounted in any desired position. The variometer should not be connected in series with the secondary of the loose coupler, this adds resistance to the circuit and weakens the signals. The working principles of a variometer are the same as an inductance, or tuning coil.

The Variocoupler

AN ideal receiving set is made up of two variometers and one vario-coupler. To make a vario-coupler, first thoroughly dry and coat with shellac two cardboard tubes, one about four and the other about three inches in diameter, then wind the larger tube with about 60 turns of No. 24 cotton-covered wire, taking a tap off every tenth turn of wire. Next, take the smaller card-

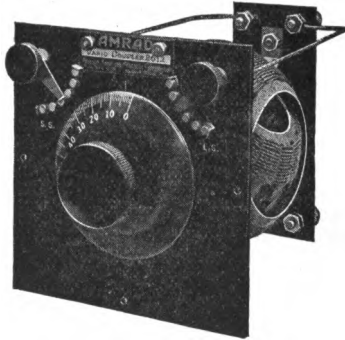

Amrad Basketball Vario-Coupler

board tube and wind about 50 turns of No. 24 cotton-covered wire on this. The tubes now have to be mounted so that the small tube can rotate inside the larger one. The large coil acts as the primary, and the small coil as the secondary. The flexible wire leads from the taps on the larger coil now have to be connected to a multipoint switch, while one end of the large coil is connected to the aerial.

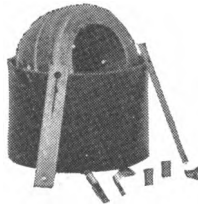

Units of Vario-Coupler

How to Make a Tuning Coil

A SIMPLE tuning or loading coil consists of a cardboard tube, around which a wire is wound, and so arranged that more or less of this wire can be cut in or out of the circuit by means of a sliding contact point. To build the coil you will need the following: A cardboard tube 18 or 20 inches long and about 4 inches in diameter, 1½ lbs. of No. 24 copper wire, 2 brass rods a trifle longer than the cardboard tube and approximately ¼ inch square. Two wood discs, ⅜ of an inch thick and just large enough to fit tightly into the ends of the cardboard tube, two wood pieces for ends, about 4½ inches square and a wood base to mount the whole affair on. First wind the wire tightly around the whole length of the cardboard tube, leaving a free end of wire at each end of the tube. Care should be taken to space the wind-

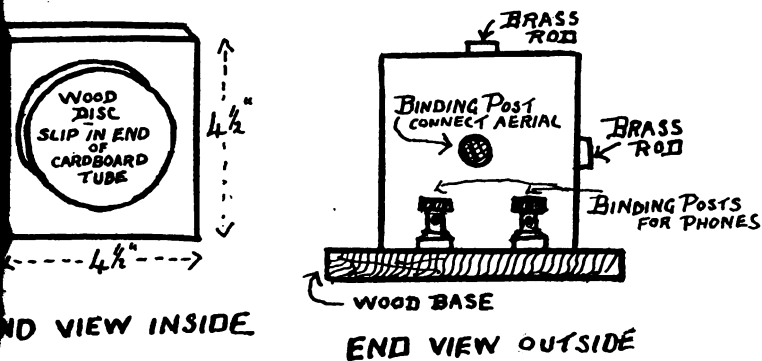

ing evenly. Next, mount the two wood discs in the center of the two wood end pieces. Then slip the discs one into each end of the cardboard tube and mount the whole affair on the wood base. It is now necessary to mount the brass rods in such a manner that the sliding contacts on the rod makes a good contact on the wire windings of the coil. One end of the wire windings is attached to a binding post, while the other end is passed through a hole in the cardboard tube, so that it will be out of the way. It will be

found advisable to dry all wood used in the building of radio apparatus, by leaving it for an hour or two in a warm oven, then giving it a coat of shellac. This will eliminate shrinking or warping of the wood. There are various makes of coils on the market and I do not think it advisable to go to the trouble of constructing one, as long as they can be bought so cheaply. A number of beginners, however, like to build their own, and it is for them that this article is written.

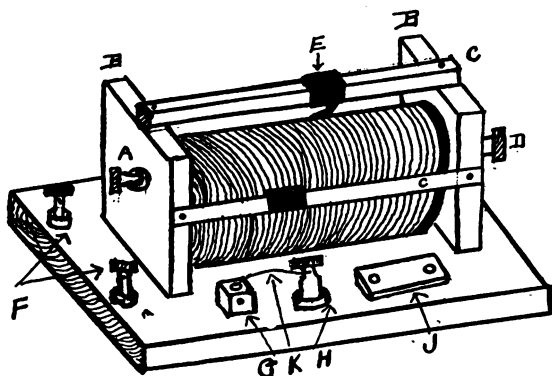

A COMPLETE RECEIVING SET ON A COMMON BASE

- A—Connection to Aerial
- B—Wood End Pieces
- C—Brass Rods
- D—Connection to Ground
- E—Sliding Contacts
- F—Phone Connections
- G—Crystal and Holder
- H—Adjustable Cat Whisker Holder
- J—Fixed Condenser
- K—Cat Whisker

Loud Speakers

TO make it possible for a number of people gathered together in one room to hear the concerts, etc., from one receiving set, a loud speaker must be employed. The loud speaker can be termed an instrument used to amplify radio signals. There are various types on the market all meeting with more or less success. A diagram of the "Telemegaphone" is here shown. A small coil of fine wire is placed in a circular air-gap between the poles

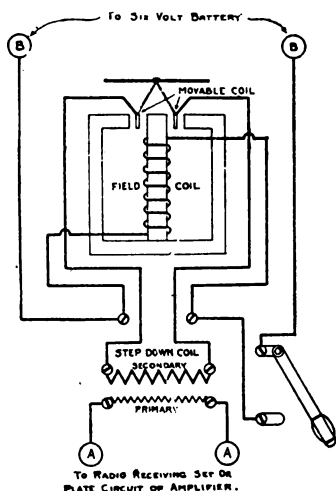

Telemegaphone

of a very powerful electromagnet, and this coil attached to the diaphragm. The magnetic flux across this air-gap is constant, and the current is sent through the small coil. Whenever a current flows through the coil it is either attracted or repelled, according to the direction of flow through the coil, and the motion thereupon transmitted to the diaphragm. There are no pole pieces to interfere

with motion, which may be as large as the elastic limit of the diaphragm. A large horn is attached immediately above the diaphragm, and the air column in that horn moved in accordance with the vibrations of the diaphragm. The "Vocaloud," another make of loud speaker, has met with great success. In this instrument, a balanced armature is employed, which is actuated by a magnetic field between four pole pieces, the field is caused to vary in accordance with the audio frequency component of incoming signal currents as the energy is passed through the single solenoid. The movement of the balanced armature is conducted to the mica diaphragm by a small connecting link.

Vocarola

The Westinghouse Vocarola is designed to be used with a set such as the type R.C. set. It is a scientifically designed sound amplifier and when connected in place of the telephones of the type R.C. set will deliver many times the volume of a pair of telephone receivers.

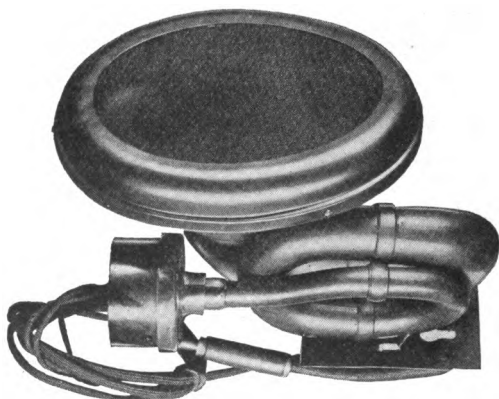

Westinghouse Loud Speaker

A diaphragm of aluminum with concentric circular corrugations is used in the telephone receiver of the Vocarola. The corrugations stiffen the diaphragm and prevents it

from vibrating with nodal patterns. As a result there is only one free period. The Vocarola, therefore, gives an excellent quality of reproduction for the reception of both music and speech.

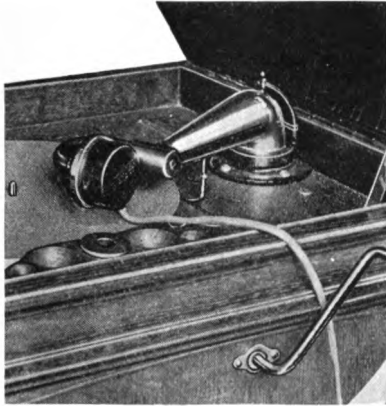

Loud Speaker—Victrola Attachment

Victrola Attachment

The Westinghouse Victrola or Grafanola attachment employs the same telephone receiver as the Vocarola and is provided with an attachment which permits its replacing the reproducer of the phonograph and thereby utilizing the sound chamber of the phonograph.

Storage Batteries

THE owner of a receiving set generally takes great care of the set itself and pays little or no attention to the battery. The battery must have attention if you desire maximum results from your set, and wish to save the life of your battery.

Care of the Battery

In the proper care of a storage battery if the following things are remembered you will escape 75 per cent of your battery troubles:

First—Test the specific gravity of all cells with a hydrometer two or three times a month. If any of the cells are below 1200, the battery is more than half discharged, and it should be recharged.

Second—Pure water must be added to all cells regularly and at sufficiently frequent intervals to keep the solution at the proper height. Add water until solution is one-half inch above top of plates.

Never let solution get below top of plates.

Plugs must be removed to add water, then replaced and screwed on after filling.

The battery should be inspected and filled with water once every week in warm weather and once every two weeks in cold weather.

Do not use Acid or Electrolyte, only pure water.

Do not use any water known to contain even small quantities of salts or iron of any kind.

Distilled water or fresh, clean rain water only should be used.

Use only a clean vessel for handling or storing water.

Add water regularly, although the battery may seem to work all right without it.

In order to avoid freezing of the battery, it should always be kept in a fully charged condition. A fully

charged battery will not freeze in temperatures ordinarily met.

Electrolyte will freeze as follows:

Sp. gr. 1,150, battery empty, 20 above zero F.

Sp. gr. 1,180, battery $\frac{3}{4}$ discharged, zero F.

Sp. gr. 1,215, battery $\frac{1}{2}$ discharged, 20 below zero F.

Sp. gr. 1,250, battery $\frac{1}{4}$ discharged, 60 below zero F.

Therefore, it will be seen that there is no danger of the battery freezing up if it is kept at a specific gravity of from 1250 to 1300 and it should be kept as near 1275 as possible. Under no circumstances should acid or electrolyte be added to the cells to bring them up to the required specific gravity. Nothing but pure water must be put in the cells after the battery has been once placed in commission and the specific gravity must be kept up by charging only.

General Storage Battery Data

A storage battery, secondary battery, or accumulator, as it variously called, is an electrical device in which chemical action is first caused by the passage of electric current, after which the device is capable of giving off electric current by means of secondary reversed chemical action. Any voltaic couple that is reversible in its action is a storage battery. The process of storing electric energy by the passage of current from an external source, is called charging the battery; when the battery is giving off current, it is said to be discharging. A storage battery cell has two elements or plates, and an electrolyte. The two plates are usually made of the same material, though they may be of two different materials. The material used in the construction of both plates of battery furnished is lead.

Polarity.—The terms positive and negative are employed to designate the direction of the flow of current to or from the battery; that is, the positive plate is the one from which the current flows on discharge, and the negative plate is the one into which current flows on discharge. In a lead battery the positive plate, on which the lead

peroxide is formed, has a comparatively hard surface of a reddish-brown or chocolate color, while the negative plate, which carries the sponge lead, has a much softer surface of a grayish color.

Electrolyte.—The electrolyte used with the lead type of battery is always a diluted solution of sulphuric acid. The specific gravity of the electrolyte when the battery is fully charged, varies from about 1.210 for stationary batteries to 1.300 for automobile ignition batteries and other portable batteries.

The proper specific gravity to use varies with the conditions, and the specific gravity may be found by the use of a hydrometer. When the cells of the battery shipped with this outfit are fully charged, the specific gravity of the electrolyte, as indicated by the hydrometer, should be 1.275 to 1.300 at 70 degrees F. The final density is the usual practice. None but sulphur or brimstone acid should be used. When diluting, the acid must be poured into the water slowly and with great caution.

Never Pour the Water into the Acid.—The specific gravity of commercial sulphuric acid is 1.835, and 1 part of such acid should be mixed with 5 parts (by volume) of pure water. Care should be taken that no impurities enter the mixture. The vessel used for the mixing must be a lead-lined tank or one of wood that has never contained any other acid; a wooden washtub or spirits barrel answers very well. The electrolyte when placed in the cell should come $\frac{1}{2}$ inch above the top of the plates. Before putting the electrolyte in the cells, the positive pole of each cell should be connected to the negative pole of the next cell in the series and the whole battery of cells should be connected, through a main switch, to the charging source—the positive pole of the battery to the positive side of the charging source, and the negative pole of the negative side. After adding the electrolyte the battery should be charged at once or at least inside of 2 hours. A little pure water should be added occasionally to the electrolyte to make up for evaporation, and a small quantity of acid

should be added about once a year to make up for that thrown off in the form of spray or that absorbed by the sediment in the cells. Do not use anything but pure distilled water in storage batteries because any impurities such as those commonly found in tap or well water will in a very short time absolutely ruin the battery.

Test of Specific Gravity.—The specific gravity of the electrolyte is the most accurate guide as to the state of charge of a leadtype storage battery. The test of the specific gravity is made by means of a hydrometer having a suitable scale for the type of cell to be tested. In all portable types of batteries, and ordinarily in vehicle batteries it is usually necessary to draw some of the electrolyte from the cell in order to test its specific gravity with the hydrometer, which should have a scale reading from 1150 to 1300.

Charging.—The normal charging rate is the same as the 8 hour discharge rate specified by manufacturers. The charge should be continued uninterruptedly until complete; but if repeatedly carried beyond the full-charge point, unnecessary waste of energy, a waste of acid through spraying, a rapid accumulation of sediment, and a shortened life of the plates will result. At the end of the first charge, it is advisable to discharge the battery about one-half, and then immediately recharge it. It is advisable to overcharge the batteries slightly about once a week, in order that the prolonged gassing may thoroughly stir up the electrolyte and also to correct inequalities in the voltages of the cells. If the discharge rate is very low, or if the battery is seldom used, it should be given a freshening charge weekly.

Indications of a Complete Charge.—A complete charge should be from 12 to 15 per cent greater in ampere-hours than the preceding discharge. The principle indications of a complete charge are: (1) The voltage reaches a maximum value of 2.4 to 2.7 per cell, and the specific gravity of the electrolyte a maximum of 1275 to 1300 per cell. If all the cells are in good condition and the

charging current is constant, maximum voltage and specific gravity are reached when there is no further increase for $\frac{1}{4}$ to $\frac{1}{2}$ hour; (2) the amount of gas given off at the plates increases and the electrolyte assumes a milky appearance, or is said to boil.

Voltage Required.—The voltage at the end of a charge depends on the age of the plates, the temperature of the electrolyte, and the rate of charging; at normal rate of charge and at normal temperature, the voltage at the end of the charge of a newly installed battery will be 2.5 volts per cell or higher; as the age of the battery increases, the point at which it will be fully charged is gradually lowered and may drop as low as 2.4 volts. All voltage readings are taken with the current flowing; readings taken with the battery on open circuit are of little value and are frequently misleading. After the completion of a charge and when the current is off, the voltage per cell will drop rapidly to 2.05 volts and remain there for some time while the battery is on open circuit. When the discharge is started, there will be a further drop to 2 volts, or slightly less, after which the decrease will be slow. Cells should never be charged at the maximum rate except in cases of emergency.

Direction of Current.—The charging current must always flow through the battery from the positive pole to the negative pole. If it is necessary to test the polarity of the line wires when no instruments are available, attach two wires to the mains, connect some resistance in series to limit the current, and dip the free ends of the wires into a glass of acidulated water, keeping the ends about 1 inch apart. Bubbles are given off most freely from the negative end.

Discharging.—Heavy overcharging rates maintained for a considerable time, are almost sure to injure the cells. The normal discharge rate should not be exceeded except in case of emergency. The amount of charge remaining available at any time can be determined from voltage and specific-gravity readings. During the greater part of a

complete discharge, the drop in voltage is slight and very gradual; but near the end the falling off becomes much more marked. Under no circumstances should a battery ever be discharged below 1.7 volts per cell, and in ordinary service it is advisable to stop the discharge at 1.75 or 1.8 volts. If a reserve is to be kept in the battery for use in case of emergency, the discharge must be stopped at a correspondingly higher voltage. The fall in density of the electrolyte is in direct proportion to the ampere-hours taken out, and is therefore a reliable guide as to the amount of discharge.

Miscellaneous Points

Restoring Weakened Cells.—There are several methods of restoring cells that have become low: (1) Overcharge the whole battery until the low cells are brought up to the proper point, being careful not to damage other cells in the battery; (2) cut the low cells out of circuit during one or two discharges and in again during charge; (3) give the defective cells an individual charge. Before putting a cell that has been defective into service again, care should be taken to see that all the signs of a full charge are present.

Sediment in Cells.—During service, small particles drop from the plates and accumulate on the bottom of the cells. This sediment should be carefully watched, especially under the middle plates, where it accumulates most rapidly, and should never be allowed to touch the bottom of the plates and thus short-circuit them. If there is any free space at the end of the cells, the sediment can be raked from under the plates and then scooped up with a wooden ladle or other non-metallic device. If this method is impracticable, the electrolyte, after the battery has been fully charged, should be drawn off into clean containing vessels; the cells should then be thoroughly washed with water until all the sediment is removed, and the electrolyte should be replaced at once before the plates have had a chance to become dry. In addition to the electrolyte withdrawn, new electrolyte must be added to fill the space left

by the removal of the sediment; the new electrolyte should be of 1.3 or 1.4 sp. gr. in order to counteract the effect of the water absorbed by the plates while being washed. If at any time any impurities, especially any metal other than lead or any acid other than sulphuric acid, gets into a cell, the electrolyte should be emptied at once and the cells thoroughly washed and filled with pure electrolyte.

Idle Batteries.—If a battery is to be idle for, say, 6 months or more, it is usually best to withdraw the electrolyte, as follows: After giving a complete charge, siphon or pump the electrolyte into convenient receptacles, preferably carboys that have previously been cleaned and have never been used for any other kind of acid. As each cell is emptied, immediately refill it with water; when all the cells are filled, begin discharging and continue until the voltage falls to or below 1 volt per cell at normal load, and then draw off the water.

Putting Battery into Commission.—To put an idle battery into commission, first make sure that the connections are right for charging; then remove the water, put in the electrolyte, and begin charging at once at the normal rate. From 25 to 30 hour continuous charging will be required to give a complete charge.

Sulphating.—Lead sulphate is practically an insulator. Some of this material is formed in all lead-sulphuric-acid storage cells on discharge and is reconverted to lead oxide or lead peroxide on recharging the cell. If present in excessive quantities, the sulphate adheres to the plates, especially the positive, in white soluble patches, preventing chemical action, increasing the resistance of the cell, and causing unequal mechanical stresses that may buckle the plates. The most frequent causes of sulphating are over-discharging, too high specific gravity of electrolyte, and allowing the battery to stand for a considerable length of time in a discharged condition.

Generator Troubles, Their Causes and Remedy

Methods for Locating and Repairing Break in the Armature of Generator

A BREAK in an armature must be located by the fall of potential method, which means that a current must be sent through the armature and the voltage tested across the various segments. First disconnect all the leads from the armature and lift all brushes except one on each pole, then connect the battery to these brushes through the resistance and ammeter shown in Fig. 1, connect the detector to one brush, and then to each segment in turn with a wire from the other terminal of detector until the break is located.

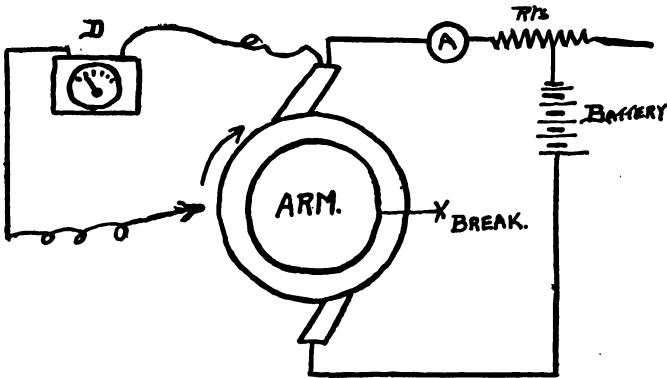

FIG 1.

If the two wires from the detector are connected to the segments that the brushes are standing on, a deflection will be seen caused by a fall of voltage through the coils. If we gradually draw the moveable wire over the segments toward the other brush, the deflection will gradually fall

to zero, providing it is on the side on which the break does not occur (Fig. 1). If, however, the wire is drawn over the segments on the other side, the deflection on the instrument will remain constant until the failing segment is reached, when the deflection will drop to zero as the wire passes over the break.

Instead of moving the testing wire around the commutator, a course that might not always be convenient, it could be held stationary against the commutator, say a few segments from one of the brushes, and the armature gradually pulled around till the break appeared.

In this case on the unbroken side a constant deflection will be obtained till the break passes a brush, when the needle will fall to zero. On the other side there will be no deflection till the break passes one of the brushes. So long as the break is between the movable testing wire and the brushes to which the detector is connected, there is a deflection; but not when the break is between the fire brushes and the testing wire. If the instrument gives a good reading between two adjoining segments, it will show a much larger reading across a break.

If a millivoltmeter is available, the matter is somewhat simplified, as a small current is sufficient for testing, such for instance as the current taken by an incandescent lamp. If, therefore, the armature be connected to a source of supply through a lamp, a millivoltmeter will give a good deflection across a break. Millivoltmeter is the instrument used as a shunted ammeter in conjunction with various law resistances called shunts; when used as a millivoltmeter in the manner above described, it is used alone, the armature itself taking the place of the shunt (Fig. 2).

Having found the broken section it must be examined till the actual break is discovered. In the case of a winding, the bad section can be taken out and a new one put in without much difficulty. In the case of a formed wound drum, it is generally an inaccessible bottom wire that breaks. In this case it is usual to strip the armature till the break is reached; this is not always necessary. Having found the defective section, cut out as much as can be

got at, that is the conductors on the surface of the core or in the slots. Leave the end crossing wires in, but with the ends separated and rewind the section with the end crossings on top of the others.

Overheating of the Armature

Several causes will cause overheating of the armature, the most common being—overload, grounds, eddy currents in the core, eddy currents in the conductors, short-circuit in the coils, sparking at the commutator, heat conducted from the bearings, low insulation. If the excessive heating is uniform over the whole armature, the machine is overloaded.

Should one or two of the coils be overheated, the trouble is due to a short circuit in the winding. If the core is hotter than the coils, the trouble is due to excessive eddy

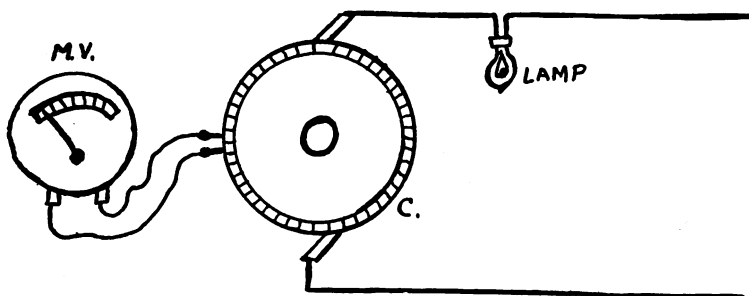

FIG. 2.

currents in the laminations, caused by the core rubbing up against one of the pole faces, or it may be caused by a number of the laminations being short-circuited, the slots having been filed too much when the core was built. Heating due to eddy currents either in the armature core or the conductors, cannot be remedied by the projectionist, the maker of the machine should be immediately notified. The test is to run the generator on open circuit and take note of the rise in temperature. To test for a ground in the windings, first disconnect the generator from the circuit, and then run it up to normal speed. Using an ordinary

test lamp, touch the opposite brushes to make sure you have the voltage.

Then connect the lamp terminals between the generator frame and the poles. Should there be a ground the test lamp will either glow or light. The cause of the ground should then be located and removed.

Locating Grounded Coil

To locate a grounded coil is a difficult job, and should not be undertaken by anyone who is not familiar with electrical apparatus.

The armature should be removed from the field and set on trestle, a current (not to exceed the normal current of the dynamo) should be passed through the armature from any one of the commutator segments to the shaft. A compass should be held near the conductors, and the needle will be deflected in a certain direction due to the flow of current. If the armature is slowly turned round, till such time as the compass needle reverses, this will indicate the proximity of the grounded coil.

Low insulation (insulation resistance) between the core and the armature winding, is generally caused by the presence of moisture, and often accompanied by vapor arising from the armature. This can be remedied by baking the armature in an oven at a temperature of about 200° F, or by running the machine unloaded for a few hours and sending a small current round the windings.

The short circuiting of the coils is generally accompanied by heavy sparking and a smell of burning may be caused by copper dust, oil on bits of solder lodged between the commutator arms.

Locating Short-Circuited Coil

To locate a short-circuited coil, use the same method to locate break in armature. It is best to test between each pair of segments, remembering that the readings will all be alike when connected across the good coils, and that a variation in the reading points to a fault.

The remedy for a short circuited coil is to strip the damaged parts and rewind.

A temporary repair job can be accomplished by disconnecting the short circuited coil from the commutator arms, and then bridging the arms, thus cutting out the defective coil.

Should the short circuiting of the coils be due to copper dust, oil, etc., between the commutator arms, all that will be necessary will be to dislodge the foreign substance.

When a generator is overloaded, the temperature of the armature will rise, and heavy sparking of the brushes will also result. If the machine is run without removing the overload, the insulation of the armature may be destroyed.

Overheated Bearings

A hot bearing may result from one or more of the following causes: Insufficient lubrication, faulty lubrication, grit or other foreign matter in the bearings; armature not centered with respect to pole pieces; side pull due to magnetic pull on armature; end pressure of collar against the

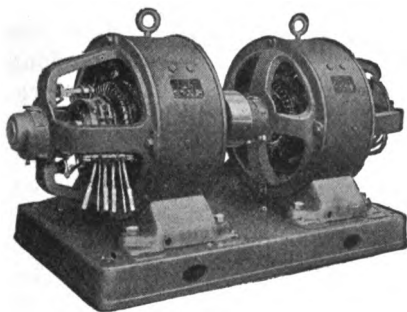

Motor Generator Set

bearing—due to machine being out of line, with its driving shaft, or to want of alignment in engine; to a bent armature shaft; shaft rough or cut, etc., etc.

Only the best of oil, free from sediment and grit should be used for lubrication, the ordinary machine oil supplied and used on the projector, is too thin for this class of work, all the oil cups should be kept clean and filled, the oil rings should be watched to see that they carry the oil up to the shaft.

When the heating of a bearing is due to the presence of dirt or grit, it should be cleaned with some thin oil or kerosene. If kerosene is used do not forget to use a good lubricant directly after the cleansing.

The bearing caps should just be tight enough to run freely, without any side play. If a bearing is too tight the oil cannot get through as the oil passage remains full. The same thing occurs if the oil passages become choked with dirt or grit.

Do not tighten up the bearing caps with pliers, as sufficient pressure can be brought to bear with the finger and thumb. After tightening up the caps the armature should revolve freely, and when in motion the armature should come gradually to rest. Should the armature stop quickly the bearings are too tight.

A bent shaft will cause the armature to rub pole pieces, and thus produce sparking, vibration and overheating. To overcome this it will be necessary to remove the armature from the machine and have the shaft straightened in what manner is most handy. It may be found necessary to withdraw the shaft from armature before this can be accomplished.

A rough shaft may be caused by dirt, grit or overheating. The roughness, if not excessive, can be taken out by the use of a little emery cloth, but care should be taken to remove all grit and filings when the job is finished. If the roughness is so great that it cannot be taken out with the use of emery cloth, it will be necessary to remove the armature, and smooth up the shaft in a lathe, using a very fine file and emery cloth.

Noise in a generator can be laid to one of the following causes: Bent or broken shaft; armature out of balance; brushes grinding commutator; armature hitting pole pieces; loose bearings. All screws and bolts should be periodically gone over and any loose one tightened. If the noise is due to the armature not being properly balanced, the makers of the machine should be notified, as this is due to faulty construction of the generator.

A grinding or squeaking noise from the brushes can

sometimes be stopped by the application of a very little vaseline to the commutator. If, however, the noise continues, the brushes should be removed and examined to see that a "hard place" has not developed. Should this be the case, the brushes should be filed down past the "hard place" and then replaced in the holders.

In the event of a short-circuit a fuse would naturally blow, and all generators should be fused up as near the terminals as possible.

A series-wound generator would spark and pull the engine up. It would not give any current to the arc.

A compound-wound generator would spark and show a drop in voltage.

A shunt-wound generator would lose its field and would not excite till such time as the short was removed.

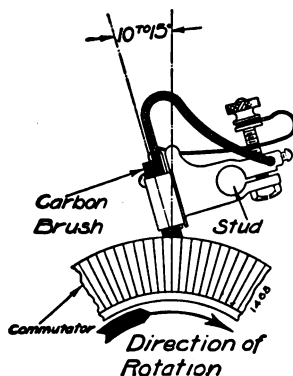

Showing Correct Method of Setting Brushes

Motor Troubles and Remedies

SPARKING may be due to overload, wrong position of brushes, broken coil, weak field, and to any of the causes named for dynamos.

Sparking

Symptom. Intermittent Sparking. On a varying load, in which the work comes on, at the beginning or end of each cycle, and then falls off during the remainder of the cycle, a motor often sparks just as the peak load comes on.

The cause is the heavy current taken at the instant of maximum load, which distorts and weakens the effective field and shifts the neutral point. This weakening of the field results in a still larger current in the armature, aggravating the evil.

Remedy. Add a compounding coil on the motor to assist the shunt, or exchange the motor for a compound-wound one, or one with interpoles.

Failure to Start

(1) *Symptoms.* Motor does not start. Little or no current passes on closing the D.P. switch and pushing starting handle over.

Probable Causes. Brushes not down. Switch not making contact in the jaws. Starting switch not touching the contacts. Fuse broken. Controller fingers not touching contact plates. Break in series coil (if a series motor). Terminal loose. No current on mains.

If the no-volt release coil excites, or if a long arc is observed on breaking circuit, it indicates that the shunt field gets its current and the probable cause of the failure to start is that the shunt is connected in series with the armature owing to two of the leads from the starter being reserved.

Remedy. Trace out the connections or use testing set.

Failure to Start

(2) *Symptom.* Motor does not start, but takes excessive current. Fuse or overload cut-out acts.

Cause. It is assumed the motor is not overloaded; this can be tested by taking load off and trying to start motor light. If a shunt motor there may be a short circuit in connecting cables or in field coil; or in armature; or a break in field coil.

Remedy for broken field. If field excites when brushes are up, but not when they are down, the symptoms point to a short circuit in or across armature, or brushes.

Examine brushes for short circuit to frame, for copper dust, oil, or broken down insulation.

Then disconnect armature and excite field. Move armature round quickly by hand. A drag will be felt as the short circuited coils pass the holes. If the armature can be driven at a fair speed by belt, with the field excited, the short-circuited coils will warm up and can probably be located in this way.

If the above symptoms occur with a series-wound motor, the cause may be a short in the field or armature, but not a break.

A fairly common cause is incorrect connecting up.

Another cause, particularly with machines that have been dismantled, is incorrect polarity of the field coils. Thus if the coils are connected up so that they are all of the same polarity, the effect is the same as with a broken field wire as the field is completely neutralized. If only one of the field coils is reversed in a four-pole motor, the motor would probably not start and would in any case take an excessive current.

Remedy. Test the coils for polarity.

Incorrect Speed

A certain amount of speed adjustment may be obtained by altering the position of the brushes. Moving the brushes backwards from the neutral point has the effect

of increasing the speed, whilst moving them forward reduces the speed.

Excessive Speed

Symptom. Motor starts, then speed gradually increases till motor runs at very excessive speed. This only occurs when a motor starts light or on a very light load such as a loose pulley.

Cause. If shunt or compound motor. Shunt coil connected in *series* with armature instead of in parallel.

On first switching on, the magnets excite, as the armature is stationary and allows the full shunt current to pass the coils. As the armature speeds up it puts a back E.M.F. in the circuit, gradually reducing the current passing and thus weakening the field. The faster the armature goes the weaker the field becomes. A short circuit in the shunt might produce same result if motor starts absolutely light.

Remedy. Connect up the shunt.

Fuse Blows

Symptom. Motor starts and runs up to its proper speed, but fuse or overload acts on putting load on.

Cause. This is a sign of overload. Probably belts too tight, bearings tight or dry.

If the fuse blows whilst starting up there may be a ground on the motor. This should be tested. If the starter is provided with shunt sector the fuse may blow whilst starting up, owing to a bad contact to this sector, due either to dirt or to a hollow place in the metal.

In the case of a compound-wound motor a cross connection or leakage between the series and shunt windings will cause the fuse to blow if the cross is in a position that the shunt is practically short circuited by the series.

Starter Overheats

Symptom. Motor starting against load takes excessive current. Last few coils of resistance overheat (prob-

ably smoke or get red hot). Fuse or overload acts, or motor sparks.

Cause. Overload; or starter too small.

When a motor starts against a load having considerable inertia, such as heavy line shaft with several large pulleys and tight belts, or against a heavily fly-wheeled machine, time must be given for it to get up speed. If the starter is moved over the contacts more quickly than the motor can accelerate, an excessive current will pass, causing the motor to spark. The starter must be put on more slowly and this will cause it to heat up unless it has been liberally rated.

Remedy. Exchange starter for one having more margin, that is one which permits of starting up slower. This does not mean a starter for a large H.P.

Starts Suddenly

Symptom. Motor does not start nor take current till most of resistance is cut out, then takes rush of current and starts suddenly.

Cause. A break in the starting resistance. *Temporary*

Remedy. Connect the contacts where break occurs, until resistance can be repaired.

Wrong Direction

Symptom. Motor runs in wrong direction.

Remedy. Reverse armature or field connections, whichever is the casier, but not both.

In a compound-wound machine both the shunt and series coil must be reversed if the field be reversed; but if the machine be provided with interpoles these must be treated as part of the armature and must therefore not be reversed when the field is reversed.

Motor Reverses

Symptom. Motor starts up and runs correctly on light load. On an overload, or reduced voltage, motor reverses and runs backwards.

Cause. This applies to a compound-wound motor, with the series or compound coil connected up in opposition to the shunt coil.

Remedy. Reverse the series coil.

Flashing

Symptom. Severe sparking or flashings apparently all round the commutator; over-heating of the armature and burning of the insulation between a couple of the segments.

Cause. The cause of the above is a broken wire in the armature winding.

Remedy. If the broken end cannot be located and repaired easily, the armature must be stripped until the break is found and the section re-wound. A temporary repair can sometimes be made sufficiently to enable the motor to continue working, by joining across the two segments on each side of the burnt mica with a short piece of copper wire, the wire being laid on the cars of the commutator and sweated in with a soldering iron. This practically converts two segments into one, and the motor will run in this way quite satisfactorily. If the commutator lugs are not readily accessible, a copper pin may be driven hard down between the two segments in a part not under the brushes.

Flashing Over

Symptom. On an overload and sometimes on a normal load a motor will flash from the brushes to a part of the commutator or to the rocker, and blow the fuses. This is more liable to happen with a weak field.

Cause and Remedy. The cause is that the motor has too much forward lead, and the brushes should be moved back a little.

Frequency and Wave Length Tables

W. L.—Wave Lengths in Meters. F.—Number of Oscillations per Second. O. or $\sqrt{\text{L. C.}}$ is called Oscillation Constant. C.—Capacity in Micro Farads. L.—Inductance in Centimeters. 1000 Centimeters = 1 Microhenry.

W.L.	F.	O. or $\sqrt{\text{L.C.}}$	L.C.
50	6,000,000	.839	.7039
100	3,000,000	1.68	2.82
150	2,000,000	2.52	6.35
200	1,500,000	3.36	11.29
250	1,200,000	4.19	17.55
300	1,000,000	5.05	25.30
350	857,100	5.87	34.46
400	750,000	6.71	45.03
450	666,700	7.55	57.00
500	600,000	8.39	70.39
550	545,400	9.23	85.19
600	500,000	10.07	101.41
700	428,600	11.74	137.83
800	375,000	13.42	180.10
900	333,300	15.10	228.01
1000	300,000	16.78	281.57
1100	272,730	18.45	340.40
1200	250,000	20.13	405.20
1300	230,760	21.81	475.70
1400	214,380	23.49	551.80
1500	200,000	25.17	633.50
1600	187,500	26.84	720.40
1700	176,460	28.52	813.40
1800	166,670	30.20	912.00
1900	157,890	31.88	1016.40
2000	150,000	33.55	1125.60
2100	142,850	35.23	1241.20
2200	136,360	36.91	1362.40
2300	130,430	38.59	1489.30
2400	125,000	40.27	1621.80
2500	120,000	41.95	1759.70
2600	115,380	43.62	1902.60
2700	111,110	45.30	2052.00
2800	107,140	46.89	2207.00
2900	103,450	48.66	2366.30
3000	100,000	50.33	2533.20
4000	75,000	67.11	4504.00
5000	60,000	83.89	7038.00
6000	50,000	100.7	10130.00
7000	41,800	117.3	13630.00
8000	37,500	134.1	18000.00
9000	33,300	151.0	22820.00
10000	30,000	167.9	28150.00
11000	27,300	184.8	34150.00
12000	25,000	201.5	40600.00
13000	23,100	218.3	47600.00
14000	21,400	235.0	55200.00
15000	20,000	252.0	63500.00
16000	18,750	269.0	72300.00

FEET PER POUND OF INSULATED MAGNET WIRE

Number of Wire	Single Cotton 4 Mils	Single Silk 1 3/4 Mils	Enamel
20	311	319	320
22	488	503	509
24	762	800	810
26	1,192	1,265	1,286
28	1,852	1,972	2,042
30	2,860	3,145	3,240
32	4,375	4,950	5,132
34	6,500	7,740	8,093
36	9,820	12,000	12,813
38	14,300	18,660	20,274
40	21,590	28,700	32,107

ENAMELED WIRE TABLE

Number of Wire	Turns per Linear Inch	Turns per Square Inch	Ohms per Cubic Inch of Winding
20	30	885	.748
24	46	2,160	4.61
28	73	5,400	29.20
30	91	8,260	70.90
32	116	21,000	7,547.00
36	178	31,820	1,098.00
40	294	86,500	183.00

TABLE OF SPARKING DISTANCES IN AIR

Volts	Inches	Volts	Inches
5,000.....	.225	45,000.....	2.95
10,000.....	.470	50,000.....	3.55
15,000.....	.725	60,000.....	4.65
20,000.....	1.000	80,000.....	7.10
25,000.....	1.300	100,000.....	9.60
30,000.....	1.625	120,000.....	11.85
35,000.....	2.000	140,000.....	13.95
40,000.....	2.450	150,000.....	15.00

**TABLE SHOWING CARRYING CAPACITY OF WIRES: DISTANCE TO WHICH FULL LOAD
MAY BE CARRIED AT 2 VOLTS DROP AND NUMBER OF LIGHTS EQUIVALENT
TO FULL CURRENT GIVEN**

B. & S. Gage	Rubber Insu- lation Amperes	Distance in Feet Causing a Loss of 2 Volts	Total Capacity in Watts		Total Number of Lamps of Different Voltages and Wattages that may be supplied											
			110 V.	220 V.	25-Watt		40-Watt		60-Watt		100-Watt		150-Watt		250-Watt	
					110 V. 220 V.	110 V. 220 V.	110 V. 220 V.	110 V. 220 V.	110 V. 220 V.	110 V. 220 V.	110 V. 220 V.	110 V. 220 V.	110 V. 220 V.	110 V. 220 V.	110 V. 220 V.	
14	15	26	1650	3300	66	132	41	82	27	54	16	33	11	22	6	13
12	20	30	2200	4400	88	176	55	110	36	73	22	29	14	29	8	17
10	25	38	2750	5500	110	220	68	137	46	91	27	55	18	36	11	22
8	35	43	3850	7700	154	308	96	192	64	128	38	77	25	51	15	30
6	50	50	5500	11000	220	440	137	275	91	183	55	110	36	73	22	44
5	55	56	6050	12100	242	484	151	302	100	201	60	121	40	80	24	48
4	70	70	7700	15400	308	616	192	385	128	256	77	154	49	99	30	61
3	80	61	8800	17600	352	704	220	440	146	292	88	176	58	117	35	70
2	90	68	9900	19800	396	792	247	494	165	330	99	198	66	132	39	78
1	100	67	11000	22000	440	880	275	550	183	366	110	220	73	146	44	88
0	125	78	13750	27500	550	1100	343	686	229	458	137	274	91	182	55	110
00	150	82	16500	33000	660	1320	412	824	275	550	165	330	110	220	66	132
000	175	89	19250	38500	770	1540	481	962	320	640	192	384	128	256	77	154
0000	225	87	24750	49500	990	1980	618	1236	412	824	247	494	165	330	99	198
200000	200	92	22000	44000	880	1760	550	1100	367	734	220	440	146	292	88	176
300000	275	104	30250	60500	1210	2420	756	1512	504	1008	302	604	201	402	121	242
400000	325	114	35750	71500	1430	2860	893	1786	596	1192	357	714	238	476	143	286
500000	400	117	44000	88000	1760	3520	1100	2200	733	1466	440	880	293	586	176	352
600000	450	120	49500	99000	1980	3960	1237	2474	825	1650	495	990	330	660	198	396
700000	500	130	55000	110000	2200	4400	1375	2750	916	1832	550	1100	366	732	220	440
800000	530	135	60500	121000	2420	4840	1512	3024	1008	2016	605	1210	403	806	242	484

CONVERSION TABLES

(1) Watts to Horse-Power

Watts	Horse-Power	Kilowatts	Horse-Power
1	.0014	.5	.670
5	.0067	.75	1.005
10	.0134	1.0	1.34
20	.0268	2.0	2.68
25	.0335	3.0	4.02
30	.0402	4.0	5.36
40	.0536	5.0	6.70
50	.067	6.0	8.04
75	.100	7.0	9.38
100	.134	8.0	10.0
200	.268	9.0	12.1
250	.335	10.0	13.4

(2) Horse-Power to Watts

Horse-Power	Watts	Horse-Power	Kilowatts
$\frac{1}{16}$	46.02	4	2.984
$\frac{1}{8}$	93.25	5	3.730
$\frac{1}{4}$	186.5	6	4.476
$\frac{1}{2}$	373.0	7	5.222
$\frac{3}{4}$	559.5	8	5.968
1	746.0	9	6.714
2	1492.0	10	7.460
3	2338.0	20	14.020

VOLTS LOST ON COPPER WIRE

Table of volts lost or drop per ampere per 1,000 feet of conductor
(Calculated by $E = I \times R$. Formula (29).) Copper wire, B. & S.
gauge (70° F.).

Size, B. & S.	Volts Drop per Ampere per 1,000 Ft.	Size, B. & S.	Volts Drop per Ampere per 1,000 Ft.
0000	.0493	17	5.088
000	.0621	18	6.415
00	.0783	19	8.089
0	.0987	20	10.20
1	.1242	21	12.86
2	.1570	22	16.22
3	.1980	23	20.45
4	.2496	24	25.79
5	.3148	25	32.52
6	.3970	26	41.01
7	.5006	27	51.72
8	.6312	28	65.21
9	.7958	29	82.23
10	1.040	30	103.7
11	1.266	31	130.7
12	1.696	32	164.9
13	2.012	33	207.9
14	2.537	34	262.2
15	3.200	35	330.6
16	4.035	36	416.8

DEPARTMENT OF COMMERCE
RADIO SERVICE

INTERNATIONAL MORSE CODE AND CONVENTIONAL SIGNALS

TO BE USED FOR ALL GENERAL PUBLIC SERVICE RADIO COMMUNICATION

1. A dash is equal to three dots.

2. The space between parts of the same letter is equal to one dot.

3. The space between two letters is equal to three dots.

4. The space between two words is equal to five dots.

A	• —
B	• • • • —
C	• • — •
D	• • • —
E	•
F	• • — •
G	• — • •
H	• • • •
I	• •
J	• — — —
K	• — • —
L	• — • •
M	— —
N	• —
O	— — —
P	• — — •
Q	• — — • —
R	• — •
S	• • •
T	—
U	• • • —
V	• • • —
W	• — —
X	• • • —
Y	• — — —
Z	• — — •
<hr/>	
Ä (German)	• — • —
Á or Å (Spanish-Scandinavian)	• — — • —
CH (German-Spanish)	— — — —
É (French)	• • — • •
Ñ (Spanish)	— — — —
Ö (German)	• — — •
Û (German)	• • — —
<hr/>	
1	• — — — —
2	• • — — —
3	• • • — —
4	• • • • —
5	• • • • •
6	• — • • •
7	— — • • •
8	— — — • •
9	— — — — •
0	— — — — —

Period	• • • •
Semicolon	— • • • — •
Comma	• — • — —
Colon	— — — • •
Interrogation	• • — — • •
Exclamation point	— — — • • — —
Apostrophe	• — — — — •
Hyphen	— • • • •
Bar indicating fraction	— • • — •
Parenthesis	— • — — — • —
Inverted commas	• — • • — •
Underline	• • — — — —
Double dash	— • • • —
Distress Call	• • • — — — • • •
Attention call to precede every transmission	— • • — • •
General inquiry call	— • • • — — — • •
From (de)	— • • •
Invitation to transmit (go ahead)	— • • —
Warning—high power	— — • • • — —
Question (please repeat after . . .)—interrupting long messages	• • — — — • •
Wait	• — • • •
Break (Bk.) (double dash)	— • • • —
Understand	• • • — •
Error	• • • • • • •
Received (O. K.)	• — • •
Position report (to precede all position messages)	— • • — • •
End of each message (cross)	• • • — •
Transmission finished (end of work) (conclusion of correspondence)	• • • — • •

LIST OF ABBREVIATIONS TO BE USED IN RADIO COMMUNICATIONS

Abbr- viation	Question	Answer or Notice
C Q	- . - . - . - . -	Signal of enquiry by a station desiring to communicate.
T R	- . - .	Signal announcing the sending of particulars concerning a station on ship-board (Art. XXII).
(I)	- . - . - . - . -	Signal indicating that a station is about to send at high power.
PRB	Do you wish to communicate by means of the International Signal Code?	I wish to communicate by means of the International Signal Code.
QRA	What ship or coast station is that?	This is
QRB	What is your distance?	My distance is
QRC	What is your true bearing?	My true bearing is degrees.
QRD	Where are you bound for?	I am bound for
QRF	Where are you bound from?	I am bound from
QRG	What line do you belong to?	I belong to the Line.
QRH	What is your wave length in meters?	My wave length is meters.
QRJ	How many words have you to send?	I have words to send.
QRK	How do you receive me?	I am receiving well.
QRL	Are you receiving badly? Shall I send 20?	I am receiving badly. Please send 20.
	for adjustment?	for adjustment
QRM	Are you being interfered with?	I am being interfered with.
QRN	Are the atmospherics strong?	Atmospherics are very strong.
QRO	Shall I increase power?	Increase power.
QRP	Shall I decrease power?	Decrease power.
QRQ	Shall I send faster?	Send faster.
QRS	Shall I send slower?	Send slower.
QRT	Shall I stop sending?	Stop sending.
QRU	Have you anything for me?	I have nothing for you.
QRV	Are you ready?	I am ready. All right now.
QRW	Are you busy?	I am busy (or, I am busy with). Please do not interfere.
QRX	Shall I stand by?	Stand by. I will call you when required.]
QRY	When will be my turn?	Your turn will be No.
QRZ	Are my signals weak?	Your signals are weak.
QSA	Are my signals strong?	Your signals are strong.
QSB	Is my tone bad?	The tone is bad.
	Is my spark bad?	The spark is bad.
QSC	Is my spacing bad?	Your spacing is bad.
QSD	What is your time?	My time is
QSF	Is transmission to be in alternate order or in series?	Transmission will be in alternate order.
QSG		Transmission will be in series of 5 messages.
QSH		Transmission will be in series of 10 messages.
QSK	What rate shall I collect for ?	Collect
QSL	Is the last radiogram canceled?	The last radiogram is canceled.
QSM	Did you get my receipt?	Please acknowledge.
QSN	What is your true course?	My true course is degrees.
QSO	Are you in communication with land?	I am not in communication with land.
	Are you in communication with any ship or station (or, with)?	I am in communication with (through).
QSP	Shall I inform that you are calling him?	Inform that I am calling him.
QSQ	Is calling me?	You are being called by
QSH	Will you forward the radiogram?	I will forward the radiogram.
QST	Have you received the general call?	General call to all stations.
QSU	Please call me when you have finished (or, at o'clock)?	Will call when I have finished.
QSV	Is public correspondence being handled?	Public correspondence is being handled. Please do not interfere.
QSW	Shall I increase my spark frequency?	Increase your spark frequency.
QSX	Shall I decrease my spark frequency?	Decrease your spark frequency.
QSY	Shall I send on a wave length of meters?	Let us change to the wave length of meters.
QSZ		Send each word twice. I have difficulty in receiving you.
QTA		Repeat the last radiogram.
QTE	What is my true bearing?	Your true bearing is degrees from DF station (Radio Compass Station).

RECAPITULATIONS

Definitions of Practical Electrical Units

Quantities to be Measured.	Synonyms.	Sym-bol.	Name of Practical Unit.	Comparative Values.	REMARKS Fundamental or absolute 51 C. G. S. Units are: Centimeter (C) for Length. Gramme (G) for Mass. Second S (S) for Time.
Current.	Strength. Intensity. Rate of Flow. Coulomb per Sec. Volume (obsolete).	I	Ampere.	Coulombs ÷ Seconds. Volts ÷ Ohms.	One Ampere deposits .0003-286 gramme, or .004991 grain of copper per second on the plate of a copper voltmeter.
Quantity.	Ampere-Second.	Q	Coulomb.	Amperes × Seconds.	One hour = 3,600 seconds; hence one ampere-hour = 3,600 ampere-seconds, or = 3,600 coulombs.
Electromotive Force Difference of Potential.	Pressure Tension.	E M F or E	Volt.	Amperes × Ohms. Joules ÷ Coulombs.	One volt = .933 standard Daniell cell (zinc sulphate of a density of 1.4 and copper sulphate of a density of 1.1).
Resistance.		E	Ohm.	Volts ÷ Amperes.	One legal ohm is the resistance of a column of pure mercury, 1 square millimeter in section and 106 centimeters long, at °Centigrade. 1 true ohm = 1.00283 legal ohms.
Capacity.		M	Farad.	Coulombs ÷ Volts.	The microfarad, one-millionth of a farad, has been generally adopted as a practical unit; the farad is too large a unit for practical use.
Power Activity.	Electrical H. P. Rate of doing Work. Effect. Work ÷ Time.	P or Pw. or HP.	Watt. (Volt-ampere).	Volts × Amperes. (Amperes) × Ohms. (Volts) ÷ Ohms. Joules ÷ Seconds.	One watt = 1/746 electrical horse power. One electrical horse power = volts × amperes $\frac{746}{\text{volts}} = \text{amperes}$ One electrical horse power = (amperes) × ohms $\frac{746}{\text{ohms}} = \text{amperes}$ One electrical horse power = (volts) $\frac{746}{\text{volts}} = \text{ohms}$
Work, Heat, Energy.	Power × Time.	W or Wj.	Joule (Volt-coulomb).	Watts × Seconds. Volts × Coulombs. (Amperes) × Ohms × Seconds. (Volts) × Seconds ÷ Ohms.	One joule is the work done or heat generated by a watt in a second. One joule is the heat necessary to raise .238 gramme of water 1° C.; or one joule = .238 calorie or therm. One joule = .7375 foot-pound in a second

KEY TO SYMBOLS OF APPARATUS

ALTERNATOR 

AMMETER 

ANTENNA 

ARC 

BATTERY 

BUZZER 

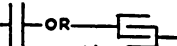
CONDENSOR 

VARIABLE CONDENSER 

CONNECTION OF WIRES 

NO CONNECTION 

COUPLED COILS 

VARIABLE COUPLING 

DETECTOR 

GALVANOMETER 

GAP PLAIN 

GAP QUENCHED 

GROUND 

INDUCTOR 

VARIABLE INDUCTOR 

KEY 

RESISTOR 

VARIABLE RESISTOR 

SWITCH S.P.S.T. 

" S.P.D.T. 

" D.P.S.T. 

" D.P.D.T. 

" REVERSING 

TELEPHONE RECEIVER 

TELEPHONE TRANSMITTER 

THERMOELEMENT 

TRANSFORMER 

VACUUM TUBE 

VOLTMETER 

D.C. MOTOR 

CARRYING CAPACITY OF COPPER WIRE

B. & S. Gauge	Circular Mils	Table A Rubber Insulation (Ampere)	Table B Other Insulations (Ampere)
18	1,624	3	5
16	2,583	6	8
14	4,107	15	16
12	6,530	17	23
10	10,380	24	32
8	16,510	35	46
6	26,250	50	65
5	33,100	54	77
4	41,740	65	92
3	52,630	76	110
2	66,370	90	131
1	83,690	107	156
0	105,500	127	185
00	133,100	150	200
000	167,800	177	262
0000	211,600	210	312
	200,000	200	300
	300,000	270	400
	400,000	330	500
	500,000	390	590
	600,000	450	680
	700,000	500	760
	800,000	550	840
	900,000	600	920
	1,000,000	650	1,000
	1,100,000	690	1,070
	1,200,000	730	1,150
	1,300,000	770	1,220
	1,400,000	810	1,290
	1,500,000	850	1,360
	1,600,000	890	1,430
	1,700,000	930	1,490
	1,800,000	970	1,550
	1,900,000	1,010	1,610
	2,000,000	1,050	1,670

The lower limit is specified for rubber-covered wires to prevent gradual deterioration of the high insulations by the heat of the wires, but not from fear of igniting the insulation. The question of drop is not taken into consideration in the above tables.

Radio Broadcasting Stations

Station	State	Call Letter	Controlled by
Newark	N. J.	WJZ	Westinghouse Co.
Jersey City	N. J.	WNO	Wireless Telephone Co.
New York	N. Y.	WJX	De Forest Radio Co.
New York	N. Y.	WDT	Ship Owners Radio Service
New Haven	Conn.	WCJ	A. C. Gilbert Co.
Hartford	Conn.	WQB	C. D. Tuska Co.
Springfield	Mass.	WBZ	Westinghouse Co.
Medford Hillside	Mass.	WGI	American Radio Research Co.
Washington	D. C.	WDN	Church of the Covenant
Washington	D. C.	WDW	Radio Construction Co.
Washington	D. C.	WJH	White & Boyer Co.
Atlanta	Ga.	4CD	Carter Electric Co.
Pittsburgh	Pa.	KDKA	Westinghouse Co.
Pittsburgh	Pa.	WPB	Newspaper Printing Co.
Indianapolis	Ind.	WLK	Hamilton Manufacturing Co.
Toledo	Ohio	WDZ	Marshall Gerken Co.
Cincinnati	Ohio	WMH	Precision Equipment Co.
Detroit	Mich.	WBL	Detroit News
Chicago	Ill.	KYW	Westinghouse Co.
Madison	Wis.	WHA	University of Wisconsin
Omaha	Neb.	WOU	R. B. Howell
Minneapolis	Minn.	WLB	University of Minnesota
Kansas City	Mo.	9ZAB	Western Radio Co.
Lincoln	Neb.	9YY	State University
Denver	Col.	9ZAF	Reynolds Radio Co.
Los Altos	Calif.	KLB	Colin B. Kennedy Co.
Pasadena	Calif.	KLB	J. J. Dunn & Co.
Los Angeles	Calif.	KQL	Arno A. Kludge
Los Angeles	Calif.	KYJ	Leo J. Meyberg Co.
Los Angeles	Calif.	KZC	Western Radio Electric Co.
Hollywood	Calif.	KGC	Electric Lighting Co.
Oakland	Calif.	KZM	Preston D. Allen
Oakland	Calif.	KZY	Atlantic & Pacific Radio Sup.
Sacramento	Calif.	KVQ	J. C. Hobrecht
San Francisco	Calif.	KDN	Leo J. Meyberg Co.
San Francisco	Calif.	KGB	Edwin L. Lorden
San Francisco	Calif.	KYY	Radio Telephone Shop
San Jose	Calif.	KQW	Charles D. Herrold
Stockton	Calif.	KJQ	C. O. Gould
Stockton	Calif.	KWG	Portable Wireless Tel. Co.
Sunnyvale	Calif.	KJJ	The Radio Shop.
Seattle	Wash.	KFC	Northern Radio Electric Co.
Dallas	Tex.	WRR	Police Department
Austin	Tex.	5ZU	State University

THE AUTHOR HAS IN
PREPARATION

Text Book on Wireless

AND
SHALL BE PLEASED
TO RECEIVE
SUGGESTIONS FROM
READERS

RADIO AND ELECTRICAL TERMS

A. C. ALTERNATING CURRENT—A current that changes its flow of direction so many times a second, according to the construction of the alternator.

ACCUMULATOR—A storage battery.

ACOUSTICS—The science of sound.

ACTINOMETER—A photometer; a meter for measuring the sun's rays.

ACTUAL HORSE POWER—The exact useful power given out by a machine; found by subtracting the power used by the machine itself from the indicated horse power.

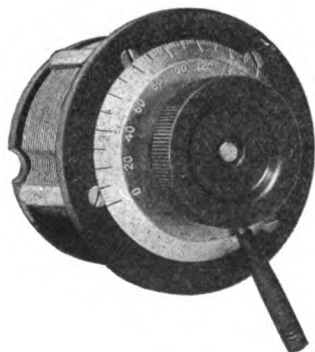

Variable Condenser

ADJUSTABLE CONDENSER—A condenser allowing any part of it to be cut in or out of the circuit; thus varying its capacity.

ADMITTANCE—One ohm has an admittance of one mho: the reciprocal of impedance.

AERIAL—A system of wires used to radiate or receive energy in the form of electro magnetic waves. The wire should be strung clear of, and insulated from all surrounding objects.

ALTERNATOR—An alternating current dynamo.

ALTERNATING CURRENT—See A. C.

AMMETER—An instrument used to measure the flow of current, is connected in series in the circuit.

AMPERE—The unit of current strength.

AMPERE HOUR—The quantity of electricity passed by a current of one ampere in one hour.

One ampere flowing for one hour.

Two amperes flowing for one half hour.

One half ampere flowing for two hours, all equal one ampere hour.

AMPLIFIER—An instrument to increase the volume of a receiving signal. There are a number of different types on the market such as vacuum tube, magnetic etc.

ANCHOR GAP—A spark gap used to disconnect the detector when using the transmitter.

ANODE—Positive terminal of a conducting current.

ANTENNA—A receiving aerial.



Antenna Insulators

ANTI-INDUCTION CONDUCTOR—A conductor so made that it avoids induction effects.

ANTI-SPARK DISCS—Discs made of Ebonite used to assist in preventing sparking on Bradfield tube.

APERIODIC—Not tuned.

AREOMETER—An instrument for finding the specific gravity of a fluid.

ARMATURE—A collection of pieces of iron designed to be acted on by a magnet; a part of a generator.

ARMATURE BORE—The space within which the armature revolves.

ARMATURE COILS—The wires wound on the core of the armature.

- ARMOR CABLE**—Wire enclosed in a metal protective covering.
- ARTIFICIAL MAGNETS**—A piece of iron or steel that has been magnetized.
- ATOM**—The smallest division of a substance.
- AUDION**—A relay operated by electrostatic control of currents flowing across a gaseous medium. Consists of a heated filament a grid electrode and a metal plate all enclosed in a highly evacuated bulb.
- ANDIOMETER**—A meter for measuring the strength of incoming signals.
- AUTOMATIC TRANSMITTER**—A transmitter operated by running a paper tape between small metal wheels.
- AUTOMATIC TRANSFORMER**—A transformer provided with one coil instead of two, part of the coil being traversed by the primary and part by the secondary current.
- AUXILIARY ANODE**—The third element of the amplifier.
- BALANCING SET**—A dynamo used in a three wire system to balance the electro motive force.
- BALLISTIC GALVANOMETER**—A galvanometer used for measuring short duration currents. Used for measuring a condenser discharge.
- BAR MAGNET**—A straight bar of steel with both ends magnetized.
- BAROMETER**—A meter for measuring the pressure of the atmosphere.
- BARS, COMMUTATOR**—The bars of copper or bronze making up the segments of a commutator of a dynamo or motor.
- BARRETTTER**—A thermal detector.
- BASE PLATE**—The plate used as a foundation.
- BATTERY**—A combination of elements for the production or storage of electrical energy.

BATTERY, DRY—An open circuit battery containing solified zinc oxychloride or gelatunous silica.

BEARING—The support on which anything rests.

BICHROMATE CELL—Two carbon plates immersed in a solution of sulphuric acid, bichromate of potash and water.

BIFURCATION—Spreading into two branches.

BILLI CONDENSER—A variable tubular condenser.

BINDING POSTS—Metal fixtures so fitted to receive the ends of wires and thus make electrical contact.

BISMUTH—One of the elements that is a conductor of electricity.

BLIND FLANGE—A plate used to cover an orifice.

BLUE STONE—Crystallized copper sulphate.

BOOSTER—A dynamo used to raise the pressure of another dynamo.



Copper Wire Measuring Gauge

BRADFIELD INSULATOR—A leading-in insulator, an ebonite tube filled with ebonite spark discs made to prevent rain running down and thus making a ground connection.

BRAZING—The process of joining metals together.

BRAZING METAL—An alloy of tin and zinc.

BREAKER—A switch or other device for opening a circuit.

BRONZE—An alloy of copper, tin and lead.

- BROWN & SHARPE GAUGE**—A wire gauge of American standard.
- BRUSH**—A rod of carbon held in a holder and pressed against the commutator.
- BRUSH HOLDERS**—An adjustable clamp into which the brushes are fixed and then held against the commutator.
- CALL BELL**—A bell used to attract the attention of the person called.
- CAM**—A revolving disc rotated on a shaft or spindle and shaped to give a variable motion to a driven element.
- CAMP FRICTION**—The friction between the cam and the element it actuates.
- CANADA BALSAM**—A gum used in cementing lenses obtained from the Balsam Fir.
- CAPACITY**—The extent of space, power of containing.
- CARRYING CAPACITY**—The capacity of an electrical conductor to carry current without overheating.
- CARBON**—One of the elements, exists in three forms, charcoal, graphite and diamond. It is used as an electrical conductor, for arc lamps and incandescent lamp filaments. The carbons used for arc lamps generally have a core of soft powdered carbon.
- CARBORUNDUM**—An artificial silicate of carbon produced under very high temperature often used as crystal detector.
- CARTRIDGE FUSE**—A safety device, the fuse wire is enclosed in a cardboard tube with metal ends.
- CATHODE**—The terminal of an electrical circuit.
- CAT WHISKER**—The fine wire used on a crystal detector.
- CENTIMETER**—Unit of length, 0.3937 inch.
- CENTRIFUGAL FORCE**—The force which draws a body constrained to move in a circular path, away from the centre of rotation.
- CHARGE**—A quantity of electricity at rest, measured by units of quantity such as the coulomb.
- CHOKE COILS**—Coils of wire wound on an iron core, sometimes called induction coils.

- CHRONOSCOPE**—An instrument for measuring very short intervals of time.
- CIRCUIT**—The path through which the current flows.
- CIRCUIT BREAKER**—Any apparatus for opening a circuit.
- CIRCUIT BREAKER, AUTOMATIC**—A device that automatically breaks the circuit in case of overload.
- CIRCUIT CLOSED**—A circuit closed so as to give the current a continuous path.
- CIRCUIT GROUNDED**—A circuit where the return wire is done away with so that the earth completes the circuit, as is done in wireless work.
- CIRCUIT OPEN**—A circuit with its continuity broken as by the opening of a switch.
- CIRCULAR MIL**—Unit of area, the area of a circle whose diameter is one mil.
- CLEATS**—A wood, porcelain or composition support for wires.
- CODE, CIPHER**—A code of pre-arranged words, letters or signs.
- CODE TELEGRAPHIC**—An alphabet made up of dots and dashes.
- COIL**—A series of rings or turns of wire.
- COIL, INDUCTION**, Built the same as a transformer, has a laminated iron core and a primary and secondary coil.
- COIL, RESISTANCE**—A coil of some poor conducting metal wire like German silver. Used to offer resistance to the flow of current. A rheostat.
- COMMUTATOR**—That part of a dynamo that changes the direction of the current.
- COMPASS, RADIO**—An apparatus used to find the location of a radio transmitting or broadcasting station.
- COMPOUND**—A mixture of two or more elements.
- COMPOUND WOUND GENERATOR**—A dynamo giving a constant electric motive force, on account of hav-

ing its field magnet winding partly in shunt with current generated.

CONDENSER—An appliance for storing up electrical energy, made of a number of thin sheets of tin foil laid on top of each other and separated from each other by an insulator. Condensers in multiple will increase the total capacity. Condensers in series will decrease total capacity.

CONDENSER, ADJUSTABLE—A condenser allowing any part of it to be cut in or out of the circuit thus varying its capacity.

CONDUCTANCE—The conducting property of any material.

CONDUCTOR—Anything that will permit the passage of electricity. A wire.

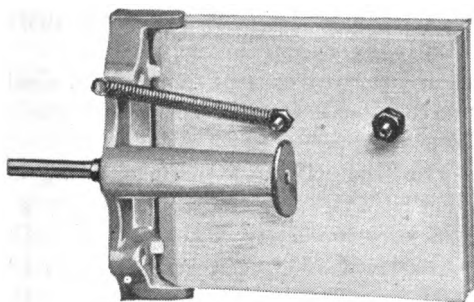

Variable Condenser

CONDUCTIVITY—The reciprocal of the ohm. Unit is the Mho, (ohm written backwards).

CONDUIT—A metal pipe through which electrical conductors are run.

CONTACT, ELECTRIC—A contact between two conductors giving a continuous path for the current.

CONTACT BREAKER—Any appliance for quickly opening or closing a circuit.

CONSTANT LOAD—A load whose pressure is steady and invariable.

CONTINUOUS—Uninterrupted, without break or interruption.

- CONTINUOUS CURRENT**—Direct current. A current that always run in the same direction. The opposite to alternating current.
- CONTINUOUS WAVES**—Waves whose amplitude are constant. Waves produced by frequency multiplying transformers.
- CONVERTER**—An electrical machine or apparatus for changing the potential difference of an electrical current.
- CORE**—The iron centre of a transformer, on which the primary and secondary coils are wound.
- CORE DISCS**—Thin metal discs used in building up armature cores, etc.
- COUPLING WAVES**—The two waves produced by coupling the oscillating circuits.
- CORROSION**—Chemical action which causes destruction of metals usually by oxidation or rusting.
- COULOMB**—The practical unit of quantity of electricity. It is the quantity passed by a current of one ampere intensity in one second.
- COUPLING**—The connection of two oscillating circuits.
- CRYSTAL DETECTOR**—A detector using a crystal and thin metal wire to rectify a number of oscillations.
- CURRENT**—A current of electricity is supposed to flow from the positive pole of a generator, through the various appliances in the circuit and back to the generator through the negative pole. The unit of current strength is the ampere.
- CURRENT, DIRECT**—A current that always flows in the same direction. The opposite to alternating current.
- CURRENT, ALTERNATING**—A current that is continually changing both its strength and direction. A current that changes its flow of direction so many times a second according to the construction of the alternator. These changes are called cycles.
- CURRENT FREQUENCY**—The number of times alternating current changes its flow of direction in a second. These changes are called cycles.

CURRENT, INDUCED—A current produced in a conductor by induction.

CURRENT, NEGATIVE—The current which deflects the needle to the left in a single needle telegraph system.

CURRENT, POSITIVE—The current which deflects the needle to the right in a single needle telegraph system.

CURRENT, REVERSER—Some appliance generally a switch for changing the direction of a current in a conductor.

CURRENT, SECONDARY—The current induced in the secondary coil of a transformer or induction coil.

CYCLES—A term given to the alternation of an alternating current circuit.

DAMPING—The weakening of amplitude in a train of electro magnetic waves owing to resistance and radiation from an oscillating circuit.

D. C.—Direct Current.

DETECTOR—An apparatus that changes the oscillations received by the aerial into audible sounds.

DIAPHRAGM—The thin iron discs in the telephone receivers which is thrown into motion by electric impulses and changes the vibrations to audible sounds.

DIELECTRIC—A non conductor of electricity.

DIFRACTION—The bending of electro magnetic waves around the earth's curvature.

DIRECT CURRENT—A current of uniform strength that always flows in the same direction.

DIRECTION—The direction of an electric current is supposed to be from the positive pole to the negative pole of the circuit.

DIRECT COUPLING—A coupling where the inductance coils of both currents are directly connected.

DIRECTION FINDER—See Radio compass.

DIRECTIVE AERIAL—See Bellini Aerial.

DIRECT LOOSE COUPLING—A coupling where the two inductance coils, though directly connected, are at a distance from each other, or a coupling where only a few turns are common to both circuits.

DIRECT TIGHT COUPLING—A coupling where one circuit has its inductance formed by tapping off a number of turns from the coil actually employed as inductance in the other circuit. Also called direct close coupling.

DISC CONDENSER—A variable condenser with its two sets of plates composed of semi-circular interleaving metal vanes separated by insulating discs or air; the whole being mounted in a circular case, one set of vanes is fixed the other mounted on an insulated spindle is capable of being turned through an angle of 180 degrees, thereby permitting of any desired amount of interleaving of vanes; thus regulating the amount of capacity.

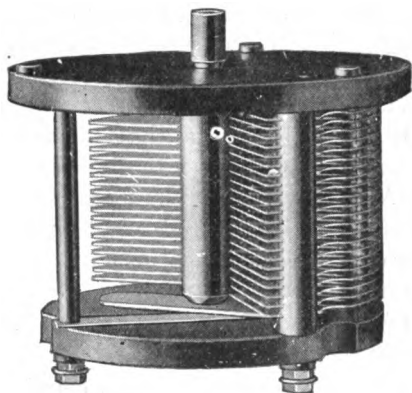

Plate Condenser

DISCHARGE—To dissipate electric energy from a condenser or battery.

DISTANCE, SPARKING—The distance between electrodes which a spark from some source will jump.

DOUBLE POLE SWITCH—A switch with two knife like blades, able to break both the positive and negative wires of a circuit.

DOWNLEAD—The wire connecting the aerial to the instruments.

DRY CELL—An enclosed battery used for open circuit work.

- EARTH**—Generally refers to a connection to the earth.
An accidental grounding of a conductor.
- EBONITE**—Vulcanized India rubber, a non-conductor of heat and electricity.
- ECONOMIZER**—A step down transformer.
- ELECTRICITY**—An unknown power; a powerful physical agent which manifests itself mainly by attraction and repulsion also by luminous and heating effects, by violent commotions, by chemical decompositions and many other phenomena. The word was first used by Dr. Gilbert in England during the sixteenth century.
- ELECTRIC HORSE POWER**—Equal to 746 watts.
- ELECTROLYTIC DETECTOR**—A fine wire making contact with an electriclyte.
- ELECTRO MAGNET**—A mass of iron magnetized by winding around it several coils of copperwire. The softer the iron the more easily it is to magnetize, but hard metals retain their magnetism longer.
- ELECTRO MOTIVE FORCE**—Another term for electric pressure or voltage.
- ETHER**—A name given by Huygens to the medium that fills all space and matter.
- EXCITER**—A dynamo used to excite the fields of a generator.
- FAHRENHEIT**—A thermometer scale. Freezing point is 32°. Boiling point 212°.
- FARAD**—Practical unit of capacity.
- FEEBLY DAMPTED**—A train of oscillations with many complete oscillatory motions.
- FEEDER**—A main wire or set of wires.
- FEEDER, POSITIVE**—The wire connected to the positive pole of a generator.
- FEEDER, NEGATIVE**—The wire connected to the negative pole of a generator.
- FEEDER, NEUTRAL**—The wire connected to the middle or neutral point in a three wire system. The wire common to both generators.
- FIELD MAGNETS**—Electric magnets that produce the magnetic field in which the armature of a generator rotates.

- FIELD REGULATOR**—A variable resistance.
- FLATS**—A commutator segment worn to a lower level than the rest.
- FLAT TUNING**—The considerable adjusting of tuning without altering the strength of the signals.
- FREAK**—The increasing or decreasing of range of signals that periodically happens to a receiving set.
- FREQUENCIES, RADIO**—Radio frequencies are very high, sometimes as high as 1,500,000 cycles per second.
- FUNDAMENTAL WAVELENGTH**—Ordinary wavelength of a circuit.
- GALENA**—A crystal sulphide of lead. When heated becomes lead sulphate. Used as a thermo electric detector.
- GEISSLER TUBE**—A vacuum tube having its electrodes in bulbs.
- GENERATOR**—An apparatus for maintaining an electric circuit.
- GERMAN SILVER**—Alloys of nickel and copper with a percentage of zinc. Used in resistance frames, rheostats, etc.
- GOLD**—One of the elements. A conductor of electricity.
- GRAPHIC TELLURIUM**—A crystal rectifier.
- GRAPHITE**—A soft form of carbon, used as a lubricant.
- GRID**—A frame of wire gauze found between the plate and filament of a vacuum tube. Perforated lead plate used in storage batteries.



Grid Leak

- GRID LEAK**—A form of rheostat to permit excess grid charges to escape to an external source.
- GROUND**—The contact of an electrical conductor with the ground or with some other conductor not in the circuit.

- GROUND CLAMP**—A strip of copper for making an easy and secure connection with a water pipe, etc.
- GROUND WIRE**—The wire leading from the aerial to the ground. The wire used as a return wire of the circuit in wireless work.
- GUY ROPES**—Ropes or wires used to steady the aerial supports.
- HAND OR WING NUT**—A nut with flanges allowing it to be tightened by hand.
- HELIOGRAPH**—A mirror for reflecting flashes of light, generally the sun's rays, used in signal work.
- HELIX**—A coil of wire.
- HEITZIAN WAVES**—Ether waves.
- HIGH FREQUENCY**—A current with a very great number of alternations per second.
- HIGH FREQUENCY, SLIDING INDUCTANCE**—Two metal bars connected by a sliding brass clamp used for making final adjustment in closed oscillatory circuits.
- HIGHLY DAMPED TRAIN**—A train with few oscillations.
- HORSE POWER**—A unit of rate of work. Equal to the raising of 33,000 pounds one foot in one minute. Equal to 746 watts.
- HORSE POWER HOUR**—One horse power exerted for one hour.
- HORSE SHOE MAGNET**—A steel bar shaped like a horse shoe with its ends magnetized.
- HYDROMETER**—An instrument used to test the specific gravity of a fluid. Used for testing the discharge of storage batteries.
- IMPEDANCE**—The total opposition of a circuit, due to reactance and resistance to a varying circuit.
- IMPEDANCE COIL**—Another name for induction coil, an iron core around which is wound a coil of wire.
- INCANDESCENCE, ELECTRIC**—The heating of a conductor to a white heat.
- INCH**—The twelfth part of a foot. A measure of length.

- INDUCTION COIL**—A transformer, an apparatus for changing low voltage to high voltage.
- INDUCTANCE**—The induction of a current in a non electrical body from an electrified or magnetized body, without metallic or electrical connection.
- INDUCTOR**—A step down transformer.
- INDUCTIVE COUPLING**—The coupling of two oscillatory circuits by arranging the inductance coil of one circuit into the lines of force of the other circuit.
- INDUCTIVE LOOSE COUPLING**—A coupling without metallic contact and where the inductances are well apart.
- INERTIA**—Property of matter at rest.
- INSULATOR**—Any material which will not allow the passage of electricity through it, except under very great pressure.
- INTERFERENCE**—Where more than one set of electro magnetic waves arrive in such a manner to nullify each other.
- INVERTED "L" AERIAL**—An aerial that is tapped at one end by the lead-in wire.
- JAMMING**—QRM. Interference from other stations.
- JIGGER**—An oscillation transformer.
- KEY TRANSMITTING**—An easily controlled switch which allows the operator to rapidly make and break the primary circuit.
- KILOWATT**—One thousand watts. Written KW.
- KNIFE SWITCH**—A switch with knife like blades, used on circuits carrying high amperage.
- LAG SCREW**—A wood screw with a square head.
- LAMINATED**—Made up of a number of fine sheets.
- LEADING IN INSULATOR**—An insulation tube used in the walls or roof through which the lead-in wire from aerial runs.
- LEAKAGE**—A loss of current due to poor insulation or other causes.
- LENZ LAW**—An induced current always tends to stop the current which produces it.
- LEYDEN JAR**—A static condenser.

- LIGHT**—Light waves travel at the same rate of speed as electro magnetic waves 186,000 miles per second. Light is merely ether vibrations.
- LIGHTNING ROD**—A metal rod connected with the earth, used on buildings as a safety device.
- LINES OF FORCE**—Imaginary lines showing the direction of attraction and repulsion in a field of force.
- LINK FUSES**—A link of fusible metal, introduced into the circuit as a protective device.
- LOCAL CURRENTS**—Currents within the metal parts of a generator.
- LODESTONE**—An iron ore which possess the properties of a magnet also known as Magnetite.
- LOW FREQUENCY**—A current where the alternations are low per second.
- LOOP AERIAL**—A frame around which several turns of wire are wound.
- MAGNET**—A piece of iron or steel that has the property to attract or repel other pieces of metal.
- MAGNET COIL**—The coil over an iron core in an electric magnet.
- MAGNETIC FIELD**—The field or space over which the magnet exerts its influence.
- MAGNETIC FLUX**—The lines of force which flow from a magnet; magnetic induction.
- MAGNETIC FORCE**—Force at any point in a magnetic field.
- MAGNET HORSESHOE**—A bar of steel shaped like a horse shoe with both ends magnetized.
- MAKE AND BREAK CURRENT**—A current continually broken and started again as is the action in an induction coil.
- MALLEABLE**—Capable of being worked into shape.
- MARCONI FILINGS COHERER**—A glass tube containing fine metallic filings used as a detector.
- MEGAPHONE**—An instrument used to help make the voice audible at a distance.

- METER, VOLT**—An instrument for measuring the pressure or voltage of a circuit. Connected in multiple on your line.
- METER, AMPERE**—An instrument for measuring the flow of current.
- METER, WATT**—An instrument for measuring the wattage. (Volts times ampercs.)
- MICROMETER**—An instrument for measuring small distances like the thousandth or ten thousandth part of an inch.
- MICROMETER SPARK CAP**—An adjustable spark gap used in the aerial circuit.
- MICROPHONE**—An apparatus to magnify sound.
- MIL**—A unit of length. The one thousandth part of an inch.
- MIL, CIRCULAR**—A unit of area. The area of a circle whose diameter is one mil.
- MIL FOOT**—A unit of resistance. A wire one foot long with a diameter of one mil.
- MILLIMETER**—A unit of length. One thousandth part of a meter.
- MORSE RECEIVER**—A receiver named after S. F. B. Morse.
- MORSE INKER**—An instrument that records the received message on a travelling paper tape.
- MOSCISKI CONDENSER**—A condenser in the form of a glass tube with a metal foil coating.
- MOTOR**—A machine to convert electrical energy into mechanical energy.
- MOTOR GENERATOR**—A combined motor and generator; a generator driven by a motor.
- MUTUAL INDUCTION**—The introduction of an electrical pressure in a circuit by another circuit not directly connected to it.
- NATURAL CURRENTS**—Earth currents.
- NATURAL WAVELENGTH**—The natural length of wave produced by the aerials' own capacity and inductance.

NEGATIVE—The opposite to positive. The pole to which the current seems to flow.

NEGATIVE CHARGE—One of the two electric charges, the opposite to positive.

OHM—Unit of electrical resistance. The resistance offered by a column of pure mercury 106.3 centimeters in length by one square millimeter in cross section at a temperature of zero centigrade.

OHMS LAW—The fundamental principle on which all electrical mathematics are worked. The current in amperes is equal to the voltage divided by the resistance in ohms. The resistance is equal to the voltage divided by the current in amperes. The voltage is equal to the resistance in ohms times current in amperes. Thus with two known quantities you can always find the third unknown.

OHMIC RESISTANCE—True resistance.

OSCILLATING CURRENT—An alternating current of high frequency.

OSCILLATOR, HERTZIAN—A device for producing oscillations.

OSCILLATORY INDUCTION—Induction produced by action of an oscillatory discharge.

PAPER CONDENSER—A condenser made with tin foil and paraffin paper.

PARTITION INSULATOR—A leading in insulator.

PERIOD—Time required to produce and complete one wave; time required to complete one cycle of an alternating current circuit.

POLARITY—Pertaining to the two opposite poles of a circuit the positive and negative.

POLYPHASE—More than one phase. Multiphase.

POSITIVE POLE—The pole from which the current is supposed to start on its journey around the circuit.

POTENTIAL—The pressure of an electric charge.

PRIMARY COIL—The coil of a transformer that is connected to the source of supply.

PRIMARY TUNING INDUCTANCE—A variable inductance in the primary closed oscillatory circuit.

PROTECTIVE ROD—A carbon rod of high resistance connected into the circuit as a safety measure.

QUENCHED GAP—A spark gap made of a series of metal plates insulated from each other.

RADIAL—Spreading from a centre.

RADIATION—The transmission of ether waves through space.

RADIATING CIRCUIT—The aerial circuit.

RADIO TELEPHONY—Transmission of speech by electro magnetic waves.

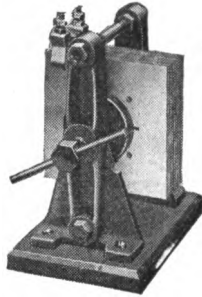

Quenched Gap

REACTION—Inverse action.

REACTANCE—The opposition offered to the flow of current by back electro motive force, etc.

REACTANCE COIL—An adjustable iron core around which is wound a coil of wire.

RECTIFIER—An apparatus for changing alternating current to direct current.

REFRACTION—The change in direction or bending of the electro magnetic waves.

REGENERATIVE CIRCUIT—A reaction circuit.

RECEIVING DETECTOR—A device to change the characteristics of incoming oscillations so as to make them audible.

RECEIVING TUNER—An oscillation transformer which allows the operator to receive electro magnetic waves of different lengths.

- RELAY**—An instrument consisting of an electro magnet which actuates upon receiving a current and in actuating opens and closes a circuit.
- RELUCTANCE**—The resistance offered to the flow of lines of force.
- RESISTANCE**—That property of an electrical conductor which tends to oppose the flow of current over it. Everything in a circuit offers resistance to the flow of current.
- RESONATOR**—A sound box.
- RETENTIVITY**—Coercive force.
- RHEOSTAT**—An instrument used to offer resistance to the flow of current. Made of a number of metal coils (German silver or iron) connected together in series and mounted on a frame from which the coils are insulated.
- RHUMKORFF COIL**—An induction coil.
- SECONDARY COIL**—The coil of a transformer into which the current is induced.
- SHELLAC**—A gum gathered from trees in India used in radio and electrical work in the form of a varnish as an insulator.
- SHORT CIRCUIT**—Two wires of opposite polarity coming in contact with one another without any controlling device.
- SHUNT**—A shunt for the receiving relay consisting of the coils of an electro magnet.
- SHUNT WINDING**—A system of winding where the armature winding is in parallel with the field winding.
- SILICON**—A mineral. Used as a detector.
- SIXTY CYCLE A. C.**—This is when the current changes its flow of direction sixty times a second. This frequency is used a great deal for lighting and power purposes.
- SOLENOID**—An electro magnet without the iron core.
- SPARK COIL**—An insulated wire wound around an iron core, used for producing a spark from a source of low pressure.

SPARK GAP—The space between the ends of an electric resonator across which the spark jumps.

SPECIFIC GRAVITY—The density of a solution against that of another, using water as a standard.

SPECIFIC RESISTANCE—Resistance of any material having a cube of one centimeter.

STAND BY—A position of tuning allowing the reception of waves of various lengths. **QRX.**

STATIC—Atmospheric disturbance.

STATIC CHARGE—An electric charge at rest.

STATIC LEAK—A coil of wire used in the aerial circuit of tuner to allow atmospherics to leak to earth.

STATIC TRANSFORMER—A transformer without moving parts.

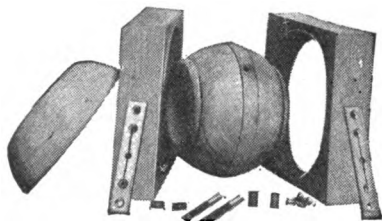

Variometer Units

STEP UP TRANSFORMER—A transformer that steps up the voltage and lowers the amperage; has a greater number of turns of wire in the secondary than in the primary.

STORAGE BATTERY—An accumulator. A number of cells for the storage of electricity.

STORAGE CAPACITY—The number of ampere hours that can be got from a storage battery.

SYNCHRONOUS—Simultaneous, to correspond in time.

SYNCHRONOUS MOTOR—A motor which runs in synchronism with the alternating current supply.

“T” AERIAL—An aerial where the horizontal span is tapped in the middle by the lead in wire; thus forming a letter “T.”

TELEFUNKEN—German name for radio telegraphy.

TERMINAL LUGS—Metal terminals for ends of wire used so that good and quick connection can be made.

TESLA COIL—An oscillating transformer.

TICKLER COIL—A coil in the circuit of a vacuum tube receiver to transfer a part of the oscillating plate current energy into the grid circuit to enable the vacuum tube to generate oscillations of high frequency.

TONE FREQUENCY—Spark frequency.

TRANSFORMER—An apparatus used on an alternating current circuit to either raise or lower the voltage. Made of two coils of wire named the primary and the secondary coils and a laminated iron core. The coils are insulated from the core and from each other. The current enters the transformer through the primary coil and sets up a magnetic flux around the core, the secondary coil cuts the lines of magnetic force and thus a new current is induced in the secondary.

TRANSFORMER, COILS—The two coils in a transformer, the primary and the secondary.

TRANSFORMER, CORE—A core made up of thin iron plates laid one on top of the other.

TUNING—The process of securing the maximum indication by adjusting the time period.

ULTRADION—An audion used in a circuit having a type of energy coupling so that a powerful relay action may be obtained. Its elements are connected in two circuits so arranged that the energy coupling may be obtained through a bridging condenser in its plate filament circuit.

VACUUM—A space destitute of all substance.

VACUUM TUBE—The name given to the highly exhausted glass tube containing three elements. Used for detector, etc., in radio work.

VARIOMETER—An apparatus used to find the relative values of the horizontal component of the earth's magnetic field in different places.

VARLEY'S CONDENSER—A static condenser.

VELOCITY—The rate of motion of a body.

VIBRATION PERIOD—In electrical resonance the period of a vibration in an electrical resonance.

VALVE AMPLIFIER—Audion type vacuum tube containing three electrodes.

VALVE TUNER—A tuner used with a valve detector.

VARIABLE CONDENSER—A condenser which allows of easy and quick adjustment.

VOLTAGE—Electric motive force or pressure.

VOLTMETER—An instrument used to measure the pressure of a circuit.

VULCANITE—A vulcanized India rubber.

WATT—The practical unit of electrical power. Amperes times voltage.

WAVE CHANGER—A transmitting switch to change from one wave length to another.

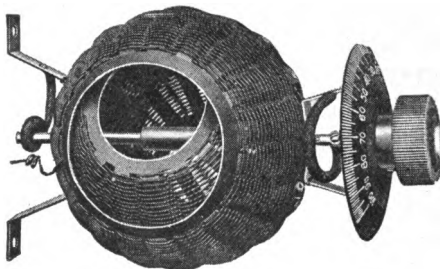

Basketball Variometer

WAVES, ELECTRO MAGNETIC—Ether waves due to electro magnetic disturbances.

WAVE LENGTH—The distance covered by a wave from the transmitting station before the next successive wave starts.

WAVE TRAIN FREQUENCY—The total number of waves being produced or received per second.

WAVE METER—An instrument to measure wave lengths.

INDEX

	Page
Abbreviations to be Used in Radio Communications.....	115
Adjustable Filament Rheostat.....	30
Adjusting Receiving Sets.....	48
Adjusting Transmitting Sets.....	42
Aerials	35
Aerial Outfit	38
Aerial Protective Device	38
Aerials for Various Wavelengths	36
Aeriola Jr.	48
Aeriola Sr. Receiving Set	57
Alternating Current	21
Ampere	11
Ampere Hour	122
Amplifying Coil	33
Amrad Long Distance Receiving Set	74
Amrad Short Wave Tuner	48
Amrad Transmitting Set	40
Amrad Vario Coupler	84
Amrad Wave Meter	77
Antenna Insulators	122
Balancing Sets	123
Basketball Vario-Coupler	84
Basketball Variometer	142
Batteries	90
Battery Polarity	90
Break in Armature	97
Broadcasting Stations	119
Calculation of Resistance	12
Care of the Battery	90
Care of Radiotron Tubes	65
Care of Receiving Sets	48
Carrying Capacity of Copper Wires	118
Cartridge Fuse	47
Cause and Remedy of Generator Troubles	97
Charging Batteries	93
Clapp-Eastham One Stage Amplifier Panel	71
Clapp-Eastham Regenerative Receiving Sets	45
Clapp-Eastham Variometer	83
Coefficient of Induction	10
Complete Aerial Outfit	39

INDEX (Continued)

	Page
Complete Receiving Set on Common Base	85
Condenser	80
Condenser, Fixed	80
Condenser, Murdock	81
Condenser, Two-Plate	82
Condenser, Variable	81, 121, 127
Conductance	11
Construction of Aerial	35
Construction of Aeriola, Sr.	57
Construction of Crystal Detector	63
Construction of Crystal Receiving Set	48
Construction of Fixed Condenser	80
Construction of Reactance Coil	34
Construction of Regenerative Receiving Sets	51
Construction of Rheostats	26
Construction of Tuning Coil	85
Construction of Transformers	31
Construction of Transmitting Sets	42
Construction of Vacuum Tubes	65
Construction of Variable Condenser	81
Construction of Vario Coupler	84
Continuous Waves	128
Conventional Signals and Morse Code	114
Conversion Tables	112
Copper Losses in Transformer	33
Copper Wire Measuring Gauge	124
Core Losses in Transformers	33
Correct Method of Setting Brushes	103
Coupling Waves	128
Crystal Detector	64
Crystal Receiving Sets	48
Current	10
Cycles	22
Definition of Practical Electrical Units	116
Detector	63
Diagram of Elementary Rheostat	25, 29
Diagram of Elementary Transformer	32
Diagram of Generator	24
Diagrams of Receiving Set	58, 54, 53
Diagram of Telemegaphone	87
Diagram of Vacuum Tube	66

INDEX (Continued)

	Page
Diagram of Westinghouse Radio Transmitter	50
Diagram of Westinghouse Detector and Two Stage Amplifier	53
Diagram of Westinghouse Single Circuit Type Receiver	54
Diagram of Westinghouse Aerials, Sr. Receiver	58
Direct Loose Coupling	129
Direction of Current in Battery	94
Disc Condenser	80, 82
Discharging of Battery	94
Drop of Voltage in Copper Wires	111
Electrical Resistance	10, 25
Electrical Terms	121
Electricity	9
Electrolyte	92
Electro-Magnetic Waves	7
Electro-Motive Force	10
Elementary Transformer	32
Elimination of Interference	77
Enameled Wire Table	110
Energy	13
Equivalent of Electrical Energy in Mechanical Units	15
Excessive Speed of Motor	106
Failure of Motor to Start	104
Feet per Pound of Insulated Magnet Wire	110
Fifty Mile Transmitting Set	40
Filament Rheostat	27
Filament Transformer	31
Fixed Condensers	80
Flexible Armored Cable	75
Freezing Point of Electrolyte	91
Frequency	22
Frequency and Wave Length Tables	109
Fundamental Wavelength	132
Fuses	47
General Storage Battery Data	91
Generation of Electricity	17
Generator	97
Generator Troubles—Their Cause and Remedy	97
Grebe Receivers—Installations of	68, 70
Grebe Receivers—Locations of Faults	69, 72
Grebe Receivers—Operation of	68, 70
Grid Leak	132

INDEX (Continued)

	Page
Ground Clamps	38
Ground Systems	38
Hertzian Oscillator	137
Horse Power to Watts	112
How the Waves are Picked up by an Aerial	35
How to Assemble a Receiving Set	48
How to Erect an Aerial	35
How to Install a Receiving Set	68
How to Locate Troubles in Receiving Sets	72
How to Make a Fixed Condenser	80
How to Make a Reactance Coil	34
How to Make a Tuning Coil	85
How to Make a Vario Coupler	84
How to Tune for Waves of Known Length	75
How to Tune for Waves of Unknown Length	73
How we Hear Music and Speech by Wireless	5
Idle Batteries	96
Indications of a Complete Battery Charge	93
Indoor Aerials	35
Inductance	24
Induction	23
Induction Coil Transmitting Set	40
Inductive Coupling	134
Inductive Loose Coupling	134
Installation of Aerial	35
Installation of Detector and Two Stage Amplifier	78
Installation of Grebe Receiving Sets	68
Installation of Intermediate Wave Regenerative Sets	70
Installation of Lightning Protective Device	37
Installation of Loud Speakers	87
Installation of Receiving Sets	48, 68
Installation of Short-Wave Regenerative Sets	68
Installation of Transmitting Sets	42
Installation of Two Stage Amplifier	79
Installation of Westinghouse Receiving Sets	48
Installation of Westinghouse Transmitting Sets	42
Instructions for Care of Batteries	90
Instructions for Care of Radiotron Tubes	66
Instructions for Care of Receiving Sets	48, 68
Instructions for Tuning	76
Interference—Elimination of	77

INDEX (Continued)

	Page
International Morse Code and Signals	114
International Ohm	11
Key to Symbols	117
Kilowatts	9
Knob and Dial Assembly	64
Laminated Core	31
Lenz Law	134
Life of Radiotron Tube	66
Light	6
Lightning Switch	37
Lightning Protective Device	37
List of Abbreviations to be Used in Radio Work	115
Location of Faults in Receiving Sets	79
Locating a Grounded Coil in Generator	100
Locating a Short Circuit Coil in Generator	100
Locating Faults in Detector and Two Stage Amplifier ...	79
Long Distance Receiving Sets	74
Loop Aerial	135
Loose Coupling	135
Loud Speakers	87
Marconi Coherer	135
Maximus Amplifying Coil	33
Method of Connecting Ground Clamps	38
Modulated C. W. Signals	75
Motor Generator Sets	97
Motor, Refuses to Start	104
Motor, Running in Wrong Direction	107
Motor, Sparking of	104
Motor Troubles and Remedies	104
Morse Code	114
Murdock Crystal Detector	63
Murdock Condenser	82
Murdock Filament Rheostats	27
Murdock Head Phones	67
Mutual Induction	21
Ohms Law	15
Operation of Aeriola, Sr.	58
Operation of Aeriola, Jr.	48
Operation of Crystal Sets	43
Operation of Detector and Two Stage Amplifier	78
Operation of Grebe Receiving Sets	70

INDEX (Continued)

	Page
Operation of Intermediate Wave Regenerative Receivers ..	70
Operation of Regenerative Receivers	55, 59
Operation of Westinghouse, R. C. Receiving Sets	59
Operation of Westinghouse Tube Transmitting Sets	43
Oscillatory Induction	137
Overheated Bearings	101
Overheating of Motor Starter	106
Periodic Currents	21
Plate Condenser	130
Polarity	9
Polarity, Storage Battery	90
Power	14
Pressure	13
Primary Tuning Inductance	137
Protective Devices	37
Putting Batteries Into Commission	95
Quantity	13
Quenched Gap	138
Radio Apparatus, Symbols	117
Radio Broadcasting Stations	119
Radio Frequencies	5
Radio Telephony	44
Radio Terms	121
Radiotron Tubes	66
Radiotron Sockets	65
Reactance	24
Reactance Coil	34
Recapitulations	116
Receivers Used as Wave Meters	76
Receiving Sets, Construction of	48, 51
Receiving Sets, Operation of	48, 51
Receiving Sets, Care of	48, 51
Receiving Sets, Faults and Remedies	49, 60
Receiving Set on Common Base	86
Regenerative Circuits	46, 51
Regenerative Receivers	46
Resistance Affected by Heating	12
Resistance Coils	28
Resistance, Electrical	10, 25
Resistance Proportional to Length	11
Resistance Inversely Proportional to Cross Section	12

INDEX (Continued)

	Page
Restoring Weakened Cells	95
Rheostats	25
Rule for Wave Length	47
Secondary Coil	31
Sediment in Cells	95
Self Induction	23
Simple Hook-up	34
Spark Signals	76
Sparking Distances in Air	110
Sparking of Motor	104
Specific Resistance	12
Storage Batteries	90
Sulphating	95
Switch, Lightning	37
Symbols of Radio Apparatus	117
Synchronous Motor	44
"T" Aerial	35
Table of Aerial Length	35
Table of Frequencies and Wave Lengths	109
Table of Sparking Distance	110
Telegraphing	43
Telemegaphone	87
Telephony	44
Test of Specific Gravity	93
Tesla Coil	141
Three Circuit Receivers	73
The Coulomb	13
The Joule	14
The Ohm	14
The Watt	14
Tickler Coil	141
To Find Amperes	16
To Find Resistance	16
To Find Resistance of Copper Wires	28
To Find Voltage	16
To Find Watts	16
To Find Wavelength	47
Transformers	31
Transmitting Sets	42
Tube—Care of	66
Tube—Construction of	66

INDEX (Continued)

	Page
Tube—Radiotron	66
Tube—Vacuum	65
Tube Transmitter	42
Tuning	46
Tuning Coil, How to Build	85
Tuning for Signals of Known Length	75
Tuning for Signals of Unknown Length	73
Tuning Instruction	73, 76
Tuning Method for Two Circuit Receivers	75
Tuning Method for Three Circuit Receivers	73
Two Circuit Receivers	75
Two Plate Condenser	82
Units of Vario Meter	140
Units of Vario—Coupler	84
Vacuum Tubes	65
Variable Condenser	81, 121, 127
Variocoupler	84
Variometer	83, 140
Victrola Attachment	89
Vocaloud	87
Vocarola	88
Volt	11
Volts Lost on Copper Wire	113
Voltage	11
Watts	14
Watts to Horsepower	112
Wave Length—What is Meant by	47
Wave Length—Rule for	47
Wavelength and Frequency Table	109
Westinghouse, Aerial Outfit	39
Westinghouse, Aeriola Grand	60
Westinghouse, Crystal Detector	49
Westinghouse, Loud Speaker	88
Westinghouse, R-C-Sets	51
Westinghouse, Receiving Sets	48, 57
Westinghouse, Tube Transmitting Sets	42
Westinghouse, Victrola Attachment	89
What Happens in a Receiving Set	45
What Happens in a Transmitting Set	41
What Happens in the Aerial	35
What is Meant by Wavelength	47

