

Moaty Tharp
from
Edin
Christmas 1894.

THE LOCOMOTIVE ENGINE
AND ITS DEVELOPMENT



Clement R. Shelton.

THE
LOCOMOTIVE ENGINE
AND ITS DEVELOPMENT

A POPULAR TREATISE ON
THE GRADUAL IMPROVEMENTS MADE IN
RAILWAY ENGINES BETWEEN

1803 AND 1893

BY
CLEMENT E. ^{Stretton} STRETTON, C.E.

AUTHOR OF "SAFE RAILWAY WORKING," "NOTES ON RAILWAY BRAKES," ETC., ETC.

WITH NUMEROUS ILLUSTRATIONS

Second Edition, Revised and Enlarged



LONDON
CROSBY LOCKWOOD AND SON
7, STATIONERS' HALL COURT, LUDGATE HILL

1893

PREFACE TO THE SECOND EDITION.

10-27-41 2177-
Re. C. 1-1-1
DURING the past twenty-two years the Author has given a very large number of lectures and addresses to persons interested in railway engineering, and especially to railway drivers and servants, upon the subject of the Development of the Locomotive; and his articles and communications to the mechanical journals upon the same subject will not be unknown.

In the preparation of those lectures and addresses he has been indebted to many railway companies and locomotive engine builders, who have given him facilities for examining or copying their earlier records, thus enabling him to complete and preserve the histories of several old or forgotten locomotives.

In compliance with resolutions passed at public meetings and with the expressed wishes of many friends, he, in the First Edition of this little book, placed the information thus acquired in a concise and convenient form, giving an outline of the various stages through which the locomotive, as we now have it, has passed.

The very cordial reception which was accorded to the First Edition has been very gratifying, the whole of a large impression having been completely sold out within a few months of publication. The public appreciation of the work, which was thus evidenced, has been reflected also in the very favourable opinions expressed in Engineering and other journals, both in this country and in America; and it may be noted that the only suggestion made has been that subsequent editions should be enlarged and extended.

In accordance with this suggestion, the work has now been carefully revised; some further details have been added with reference to ancient engines; and particulars inserted of the latest designs of engines now being constructed, both in this country and in America; the result being to increase the volume by about fifty pages. A large number of engines, which in the First Edition were simply described, are now clearly illustrated.

The illustrations and descriptions given of such noteworthy engines as the "America" (1829), p. 26; the "Hurricane," p. 76; the "Cornwall" as in 1847, p. 99; and the latest Great Western design, p. 167; will prove especially interesting to all who watch the Locomotive Engine and its Development.

SAXE-COBURG HOUSE,

LEICESTER. *February, 1893.*

CONTENTS.

	PAGE
INTRODUCTION:—The Early Use of Steam—Steam Carriages intended to run upon Ordinary Roads—Railway Speed	1
CHAPTER I.—EARLY LOCOMOTIVES USED UPON PRIVATE LINES FOR THE CONVEYANCE OF GOODS AND MINERALS:—Trevithick, the Father of the Locomotive—Rack-rails and Cog-wheels—George Stephenson's first Engine—Steam Springs—The Duke of Portland's Tram-road—Engines for the Hetton Colliery	5
CHAPTER II.—ENGINES EMPLOYED UPON PUBLIC RAILWAYS FOR THE CONVEYANCE OF PASSENGERS, GOODS, AND MINERALS:—The Stockton and Darlington the first Public Railway. Its Locomotive List—Wilson's Four-cylinder Engine—Hackworth's "Royal George"—The first Locomotive for America—Rainhill Trials—The Liverpool and Manchester Locomotive List—The Leicester and Swannington Locomotive List (<i>facing</i> p. 45)—Ancient Valve-gear—Grasshopper Springs—The first Steam Railway Whistle—A Bogie Engine—The first Six-coupled Goods Engine with inside Cylinders—Mr. Bury's Engines—Four Wheels <i>versus</i> Six—Forrester's Outside Cylinder Engines—Four Eccentrics introduced—Stephenson's "Standard" Passenger Engine—High Foundry Valve-gear	19

CHAPTER III.—THE COMMENCEMENT OF THE BATTLE OF THE GAUGES:—Ten-feet Driving-wheels a Failure—American Engines in England—McConnell's Tank Engine—Howe's Link Motion—The Long Boiler—Mr. Alexander Allan's Crewe Pattern—Crampton's Patent—A Three-cylinder Engine—The Battle of the Gauges at its height—Eighty-one Miles an Hour—Trevithick's "Cornwall"—Mr. Ramsbottom's Engines—The Narrow Gauge Engines as fast as the Broad—Kirtley's Designs for Midland Railway Engines .	72
CHAPTER IV.—MODERN LOCOMOTIVES FOR MAIN LINE TRAINS:—Steam-reversing Gear—Mineral Engines—Various Opinions on Compound Express Engines—Three Cylinders <i>versus</i> Two—Express Engines coupled in front—The latest Great Western Engines	122
CHAPTER V.—GOODS ENGINES HAVING EIGHT COUPLED WHEELS	177
CHAPTER VI.—THE LATEST AMERICAN, AND ENGLISH, DESIGNS .	181
CHAPTER VII.—LIST OF LOCOMOTIVES—RULES FOR GRADIENTS—SUNDRY APPLIANCES:—The Steam Sand-blast—A Single Engine the best for Fast Running—Slipping—Adhesion—Invention of the Injector—Giffard's Explanation of its Action—Modern Injectors—Table of Water supplied by various sizes—Valve Gear—Joy's Gear	186

LIST OF ILLUSTRATIONS.

	PAGE		PAGE
The First Locomotive, 1803.	5	Steam Trumpet	52
— "Blenkinsop," 1812 . . .	7	The "Experiment," L. & M. Ry. 1833 . . .	54
— "Puffing Billy," 1813 . . .	10	— "Earl of Airlie," 1833 . . .	55
Brunton's Engine, 1813 . . .	11	— "Hercules," 1833 . . .	57
Stephenson's First, 1814 . . .	12	— "Patentee," 1834 . . .	57
Do. Third, 1816 . . .	14	— "Atlas," L. & S. Ry. 1834 . . .	59
Do. end view . . .	15	— "Liverpool," L. & S. Ry. 1834 . . .	61
Do. "Puffing Billy," as in 1815 . . .	17	— "Swiftsure," 1834 . . .	63
The "Locomotion," 1825 . . .	20	— "Comet," N. & C. Ry. 1835 . . .	64
— "Experiment," 1826 . . .	23	— "Vulcan," L. & S. Ry. 1835 . . .	66
— "Twin Sisters," 1827 . . .	24	Stephenson's Standard En- gine, 1836 . . .	67
— "Royal George," 1827 . . .	24	The "Atlas," N. & C. Ry. 1836 . . .	68
— "Lancashire Witch," 1828 . . .	25	— "Ajax," L. & S. Ry. 1837 . . .	69
— "America," 1828 . . .	26	Sharp's Engine, 1837 . . .	70
— "Agenoria," 1829 . . .	29	The "North Star," 1837 . . .	73
— "Rocket," 1829 . . .	31	Grand Junction Railway Engine, 1838 . . .	75
— "Novelty," 1829 . . .	33	The "Hurricane," 1838 . . .	76
— "Invicta," 1830 . . .	35	— "Victoria," 1838 . . .	78
— "Northumbrian," 1830 . . .	36	— "Hector," 1839 . . .	79
— "Planet," 1830 . . .	38	— "Philadelphia," 1840 . . .	81
— "Mercury," 1830 . . .	40	— "Long Boiler," 1842 . . .	85
— "Samson," L. & M. Ry. 1831 . . .	41	Stephenson's Fork Motion . . .	86
— "George Stephenson," 1831 . . .	42	Howe's Link Motion . . .	87
— "Comet," L. & S. Ry. 1832 . . .	44	Mr. Allan's Goods, 1843 . . .	91
— "Phoenix," L. & S. Ry. 1832 . . .	46	The "Great Western," 1846 . . .	95
— "Wilberforce," 1832, <i>facings</i> . . .	47	— "Velocipede," 1847 . . .	98
— "Caledonian," 1832 . . .	49	— "Cornwall," 1847, <i>facings</i> Do. 1863 . . .	99
— "Ironsides," 1832 . . .	49		
— "Samson," L. & S. Ry. 1833 . . .	50		

	PAGE		PAGE
The "Liverpool" (Cramp-		Great Eastern Express . . .	141
ton's), 1848	100	Manchester, Sheffield, and	
— "Jenny Lind," 1849 . . .	103	Lincolnshire Express . . .	145
— "Bloomer," 1850	105	North-Eastern Express . . .	148
— "Problem," 1859	110	London and South-Western	
— "Pacha," 1862	113	Express	150
No. 30 class (Midland), 1864	115	Metropolitan District En-	
" 712 " "	116	gine	157
" 780 " "	117	Midland Express	161
" 800 " "	119	Section showing Gradients	
" 800 tender "	120	of Midland Ry.	163
" 890 class "	121	Mr. Webb's Latest Com-	
Glasgow and South-West-		pound	165
ern Express, 1873	122	Mr. Dean's Latest Design . .	167
The "Grosvenor," 1874 . . .	124	Small Shunting Engine . . .	175
Midland Mineral, 1875 . . .	126	Large Shunting Engine . . .	176
Brighton Express, 1882 . . .	130	Arrangement of Sand Blast	
Midland Goods	131	<i> facing</i>	192
Do. Tender	132	Details of Sand Blast, <i>facing</i>	192
Midland Express, 1885 . . .	134	Details of Injector	195
Caledonian Express, 1886 . .	136	Foot-plate View of Injec-	
Do. Tender	137	tors <i>facing</i>	195
Great Northern Express,		Joy's Gear <i>facing</i>	199
1870-1887	138	Joy's Gear. Actual Result . .	200

THE LOCOMOTIVE ENGINE AND ITS DEVELOPMENT.

INTRODUCTION.

THE name "locomotive" engine is derived from two Latin words, *locus*, a place, and *motio*, motion ; consequently a locomotive is an engine capable of moving itself from place to place.

Great and important improvements in railway and other industries are not the result of the work of one man, but of many minds. Therefore it frequently occurs that the person who works out the details, and brings an improvement to a practical success, is not the first inventor of the crude idea ; and it is a matter of regret to both engineers, passengers, and railway servants, that no one book has ever been published giving a full and complete history of the early development of the locomotive engine, showing exactly the part performed by each inventor. The quantity of information which is available is enormous, but it is unfortunately distributed over numbers of books, articles, and papers ; and constantly railway companies, even at the present day, discover amongst old documents the drawings and

official details of engines and carriages which for years past have been unknown and forgotten.

Attention should be directed to the fact, that in the early days of railways a very similar set of names was adopted by different lines, for instance a Comet, a Phoenix, a Samson, a Goliath, a Vulcan, an Atlas, a Liverpool were to be found on nearly all lines, and the official lists prove that in 1840 no less than *ten* engines were running in this country named "Liver" and "Liverpool." This shows that those who desire to investigate the history of certain engines must be extremely careful not to be confused by the similarity of names. Another difficulty is that several locomotive makers each built "trial engines" upon their own system or patent, and obtained the permission of certain companies to give them a trial on their lines; in some cases the railway companies afterwards purchased the engines, in others they did not. As an instance of this, Mr. Bury, in 1830, built an engine named "Dreadnought"; it was, by permission, tried on no less than five lines, then taken back to the works, altered or almost rebuilt, a new name, "Liverpool," was put on, and after a trial on two lines it was purchased by an American Railway Company in 1831, but a few months after its arrival it became known as the "Spitfire." The Author happens to have the maker's private number marked upon the drawings which corresponds with that stamped upon parts of the engine itself, or it would have been impossible to trace its history. In a similar way an engine named "John Bull" was sent from Newcastle to the Hudson and Mohawk Railroad in 1831, a year later it was renamed

“Robert Fulton,” and in 1845 it was rebuilt and renamed “Rochester.”

The question of railway speed is one which constantly engages the attention of passengers, and we often *hear* of 90 or 100 miles an hour. During the past twenty-five years the Author has ridden upon many engines, and has travelled in all the fastest trains upon all the railways in this country, for the special purpose of ascertaining their rate of speed. Upon a few occasions, and under favourable circumstances, he has recorded the very high speed of 79·9 miles an hour, but he has never been able to time a train or engine at actually 80 miles an hour.

As long ago as 1853, 81 miles an hour was run by engines upon the Bristol and Exeter Railway, but these have now been altered and their speed reduced. It is not wise to predict what *may* be done in the future, but at present 80 miles an hour is the maximum pace. The *average speed* of the fastest express train, over a long run, without a stop—say 70 or 100 miles—is 54 or 55 miles an hour, and to maintain this it is not necessary to run at more than 70 or 75 miles an hour upon any part of the journey.

As the newspapers often profess to record very extraordinary rates of speed, it may be advisable to point out one possible cause of error. We should beware of “speed indicators” which take their motion from the driving wheels of engines, as the Author, when the train was running no more than 55 miles an hour, has seen an indicator go up to 90 miles an hour, the increase being simply due to the “slipping” of the driving wheels.

The power of steam was known to Hero of Alexandria

about 200 B.C., or fully 2000 years ago, and a book he then wrote treated of the expansive force of steam, and described the cylinder, piston, slide-valve, and common clack-valve.

Although the power of steam was *known*, no attempts appear to have been made to turn it to useful and practical effect, even in stationary engines, until 250 years ago.

In the year 1759, Dr. Robinson suggested to James Watt the idea of steam carriages for running upon common roads, and models were made. Cugnot, in 1769 and 1771, constructed steam carriages. Murdoch, in 1784, followed by many others, also made "models" and "suggestions" for working carriages by steam on ordinary roads; but it was not until the year 1803 that the first tram-road or railway locomotive was constructed. This was built by Richard Trevithick with money provided by his cousin Vivian, and is here illustrated (on the adjoining page), upon a scale of one-eighth of an inch to a foot.

CHAPTER I.

EARLY LOCOMOTIVES USED UPON PRIVATE LINES FOR THE CONVEYANCE OF GOODS AND MINERALS.

TREVITHICK is undoubtedly the “father of the locomotive”; he employed high-pressure steam. He found by experience that flat wheels had sufficient

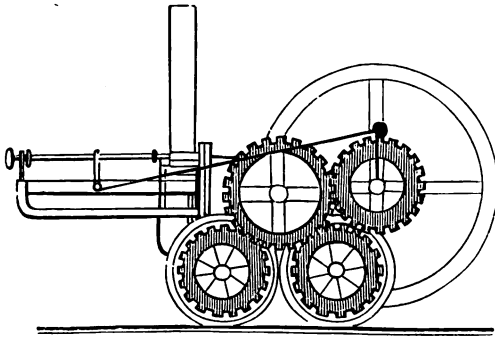

Fig. 1.—The First Locomotive, 1803.

adhesion upon smooth rails, and he conveyed the exhaust steam from the cylinder to the chimney by means of a pipe, which he turned upwards, and dis-

covered, by observing the practical result, that the blast of steam caused the fire to burn much better; he therefore called it the "blast-pipe." This engine ran upon four wheels, 4 feet 6 inches diameter, the boiler was 6 feet in length, and contained a return flue-tube, the chimney being consequently at the same end as the fire-door; the engine had one cylinder placed horizontally, 8 inches diameter, the stroke being no less than 4 feet 6 inches.

On the 24th February, 1804, it was tried upon the Penydarran cast-iron plate-way or tram-road, and conveyed trucks containing ten tons of bar iron and about seventy persons to Merthyr Tydvil, a distance of nine miles. The engine worked satisfactorily from a mechanical point of view, but commercially it was not regarded as a success, being more expensive than horse traction.

Trevithick does not appear to have followed up the development of the locomotive, but left to others the perfecting of those excellent principles which he introduced and discovered; probably it is on this account that he never has received the credit to which he was justly entitled for the construction of the first locomotive which ever ran upon rails.

During the early part of the year 1811, Mr. John Blenkinsop, the proprietor of the Middleton Colliery, near Leeds, decided to convey the coal over his tram-road to that town by means of locomotive engines instead of by horses, and gave an order to Matthew Murray, an engineer, of Leeds, to commence the construction of such an engine. Both Blenkinsop and Murray were under the impression that suffi-

cient adhesion could not be obtained between smooth wheels and smooth rails; and considering the gradients, loads required, and weight of their engine, which was only intended to be five tons, it is probable that their impression was correct. Mr. Blenkinsop, in April, 1811, took out a patent for a rack-rail and cogwheel driving-gear. The engine was completed by Murray, and ran its first trip upon the Middleton line in August, 1812, and at once commenced to convey coal daily from Middleton to the wharf at Great Wilson and Kidacre Streets, Leeds, the distance being about three-and-a-half miles.

The engine was named "Blenkinsop," and ran upon four supporting wheels of 3 feet 6 inches diameter, but they took no part in the driving of the engine. The boiler contained a flue-tube, 20 inches in diameter, having

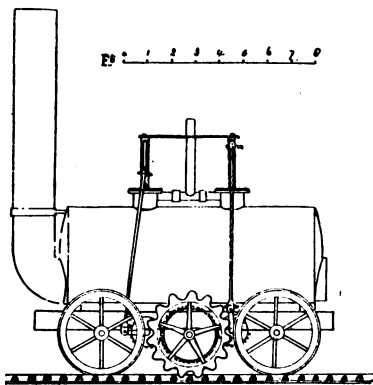

Fig. 2.—"Blenkinsop," 1812.

the fire-grate at one end and the chimney at the other. Two cylinders were employed, 8 in. in diameter, the stroke being 20 inches; the cylinders were placed vertically half within the boiler.

The connecting-rods conveyed motion to cranks, and by means of spur-wheels and gear communicated motion to the main cog or driving-wheel; that wheel

was placed outside the smooth or running part of the rail, and engaged with the outside rack on the rail. Murray placed the two cranks at right angles to each other, thus insuring that one piston was exerting its greatest power when the other was at the end of its stroke. This engine, and others which followed, worked well for many years, and were also a *complete commercial success*. The "Blenkinsop" evaporated eight cubic feet of water per hour, consumed 75 lbs. of coal per hour, and was capable of conveying 94 tons on the level at $3\frac{1}{2}$ miles an hour; its maximum speed being found to be about 10 miles an hour with a gross load of 20 tons.

Messrs. Chapman, in December, 1811, obtained a patent for a method of working the locomotive engine by means of a chain stretched along the whole length of a tram-road, and secured at each end; this chain was in connection with a grooved pulley upon the engine, consequently when this pulley was put in motion, the engine wound itself along the chain; in fact Chapman's chain acted the same purpose as Blenkinsop and Murray's rack-rail. Chapman's system was tried upon the Hetton Colliery tram-road, near Newcastle-on-Tyne, but in a very few weeks proved a complete failure.

Mr. Blackett, of the Wylam Colliery, near Newcastle-on-Tyne, encouraged by the fact that Blenkinsop's engine was a commercial success and conveyed coal at a cheaper rate than horses, decided to make experiments of his own in the same direction. Mr. Blackett and his coal viewer, William Hedley, having made themselves acquainted with the working of the rack-rail system at Leeds, found that to adopt the

Blenkinsop engine would require the Wylam line to be relaid with rack-rails at very great cost. They therefore turned their attention to Trevithick's engine of 1803 (Fig. 1), and ultimately Mr. Blackett remarked, “If Trevithick obtained adhesion with smooth wheels on smooth rails, I can.” To test the question, Blackett and Hedley constructed a frame upon four wheels provided with spur-gear and cranks to be worked by hand, and when this apparatus was tried on the Wylam railway, October, 1812, it was found that the smooth wheels gave the necessary adhesion.

Blackett at once gave orders to Hedley to place a boiler upon this frame, and attach connecting-rods to the hand-crank; in fact to turn the test frame into a locomotive. Hedley did so, and the new engine was tried on the Wylam line, February, 1813, but it was short of steam and proved a failure; the reason being that it was not provided with Trevithick's blast-pipe.

In spite of this failure Mr. Blackett had great faith in steam power, and instructed Hedley to pull off all the top part of the engine, and construct a new boiler and cylinders. The engine, as rebuilt, was completed in May, 1813, and tried on the Wylam line. It had a wrought-iron boiler, with a return flue, the chimney being placed at the same end as the fire-door (as in Trevithick's engine); it had two vertical cylinders, the piston-rods being connected to beams, from which motion was communicated to the four smooth driving wheels by means of toothed-gear; the exhaust steam from the cylinders was discharged by two blast-pipes into the chimney, and it was on account of the “puffing” noise caused by these blast-pipes that the engine was named “Puffing Billy.” (Fig. 3).

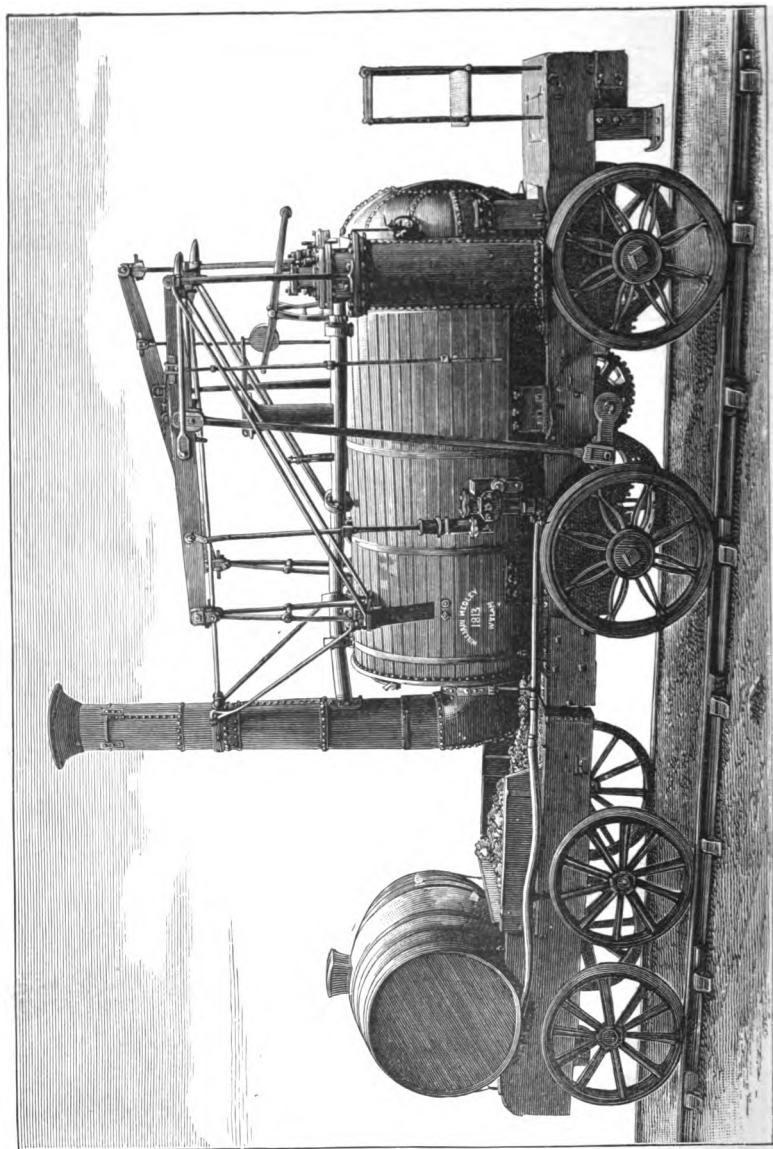

A second engine, similar in every respect to Fig. 3, was at once built, and was named the "Wylam Dilly." Mr. Blackett therefore in 1813 had two locomotives which were successful, so far as conveying coal cheaper than horse-power, but he had by no means arrived at the end of his troubles, as will be seen, page 16.

Mr. Brunton, of the Butterley Ironworks, Derbyshire, obtained a patent, in 1813, for a mode of accomplishing the locomotion of an engine without the aid of the adhesion of the wheels; it was, in fact, a "steam horse," having a pair of hind legs actuated by steam cylinders. It is hardly neces-

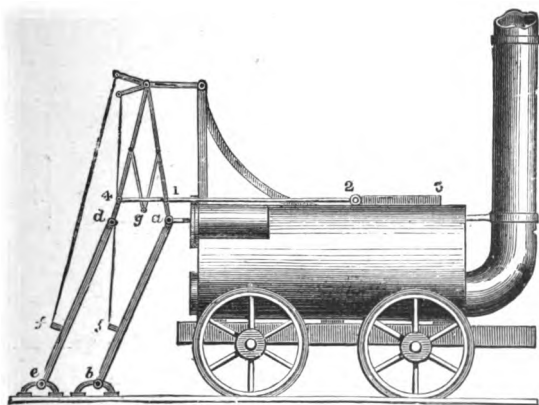

Fig. 4.—"Brunton's Engine," 1813.

sary to say that the arrangement proved a complete failure.

During the time that Blackett and Hedley were engaged at Wylam, Lord Ravensworth and the partners in the Killingworth Colliery, and their engine-wright,

George Stephenson, were anxiously studying the subject at Killingworth. Towards the close of the year 1813 Stephenson designed his first engine, and was at once entrusted by Lord Ravensworth and partners with money to construct a locomotive for their railway. The engine was built at the West Moor workshops of the colliery, and after being under

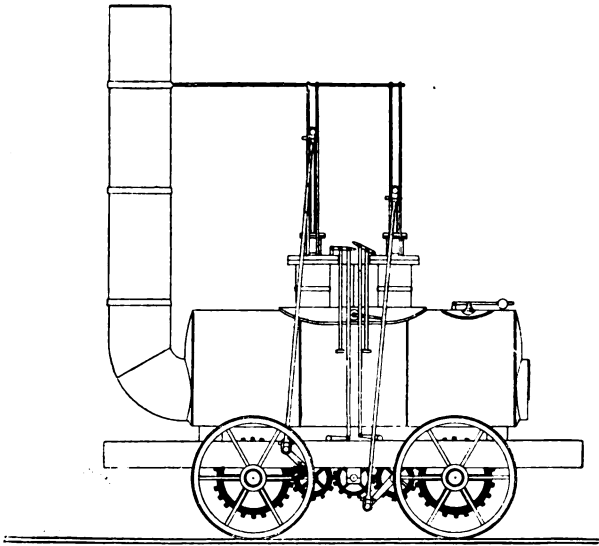

Fig. 5.—George Stephenson's First Engine, 1814.

construction for about ten months, was placed upon the Killingworth railway and tried for the first time on 25th July, 1814, being named or generally known as "Blucher." (Fig. 5.)

This engine ran upon four smooth wheels of 3 feet diameter, placed at a distance of 5 feet apart between

centres. The boiler was 8 feet long, 34 inches diameter, having a flue-tube passing through it, 20 inches diameter. The cylinders were 8 inches diameter, 24 inches stroke, and placed vertically, half within the boiler. The power of the two cylinders was communicated by cross beams and connecting-rods to cranks on the spindles of spur-wheels, which spur-wheels in turn actuated the large cog-wheels on the engine-axles. The small central spur-wheel was employed to maintain the cranks at right angles to each other.

The engine "Blucher," on the 27th of July, 1814, conveyed a train of eight waggons of coal, weighing 30 tons, up a gradient of 1 in 450, at a speed of four miles an hour, and afterwards continued in daily work. This engine was not provided with springs, and the cog-wheel gear becoming worn, Stephenson was entrusted with money to construct a second engine; it was built in 1815, under the protection of a patent granted to Stephenson and Dodd, 28th February, 1815.

In this second engine of Stephenson's the connecting-rods were attached directly to crank-pins upon the wheels, the exhaust steam was discharged into the chimney by two blast-pipes, and the four wheels were coupled together by rods. These coupling-rods, however, were not placed upon the crank-pins outside the wheels, but two double-cranked axles were employed having the cranks at right angles to each other, the two coupling-rods were therefore placed upon these inside cranks, between the wheels. In consequence of one of the crank-axles becoming bent, Stephenson abandoned the arrangement of inside coupling-rods, and

adopted an endless chain passing over a toothed wheel upon each axle.

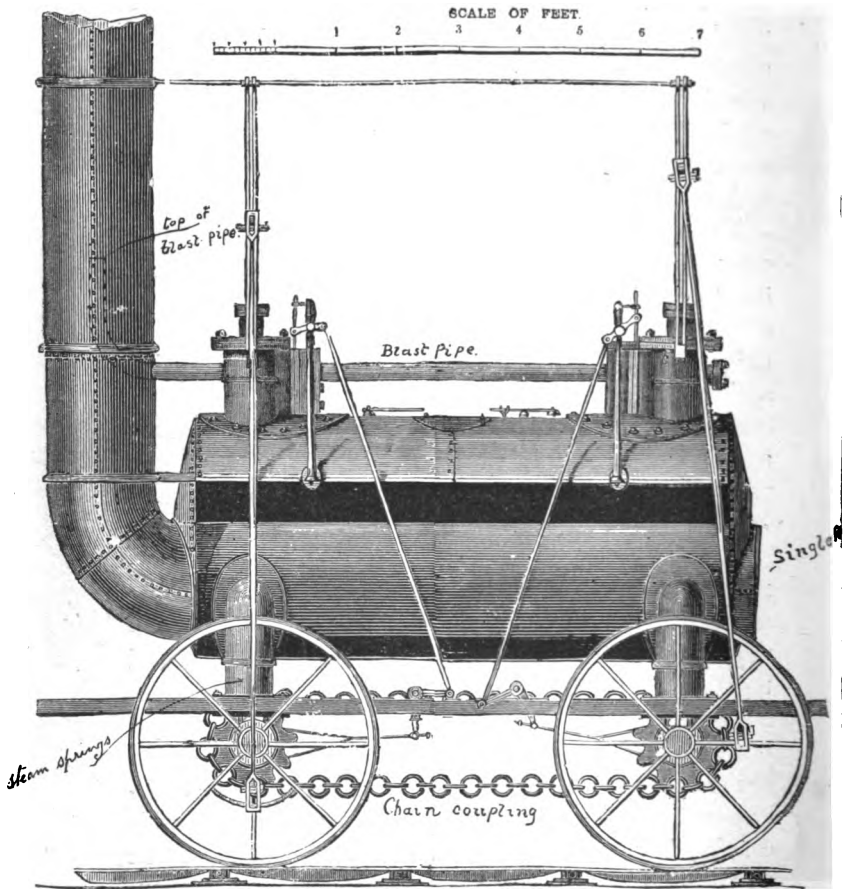

Fig. 6.—George Stephenson's Killingworth Engine, 1816.

George Stephenson constructed for the Killingworth railway a third engine (Figs. 6 and 7), which was

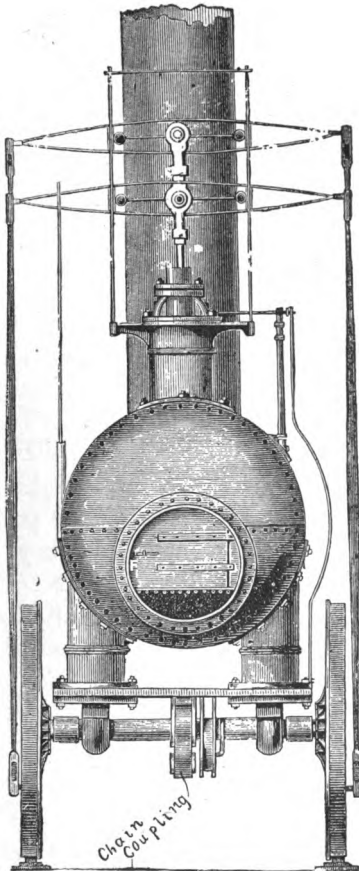

Fig. 7.—End view, Stephenson's Engine, 1816.

provided with steam springs, protected by the Losh and Stephenson patent of September, 1816.

In the illustration (Fig. 6) a portion of the boiler side is supposed to be removed in order to show the single fire-flue. The steam springs, chain system of coupling the wheels, and the blast-pipe are all clearly illustrated.

“Puffing Billy” (Fig. 3) and “Wylam Dilly” rested upon four wheels only, and their weight broke the Wylam cast-iron plate rails to such an extent, that it became necessary to carry half-a-dozen rails upon each engine, to replace those which might break on the journey. The owners of land in the district complained of the noise caused by the blast-pipes, and took counsel’s opinion whether the lease of the land for the colliery railway was not vitiated by the noise of the exhaust steam from the chimney frightening the cattle grazing near the line.

To prevent the breaking of the rails Blackett and Hedley placed their engines upon eight wheels, and in order to pass round the curves they put the wheels under two frames; in other words they placed each of their engines upon two *four-wheeled bogies!* and to overcome the blast-pipe difficulty they placed a cylindrical reservoir “S” between the cylinders and the chimney, in order that the steam might escape gradually and without noise by means of the pipe “R.”

The first of these engines thus altered, or rebuilt, is here illustrated as it was in 1815 (Fig. 8).

The Wylam railway having been re-laid, the engines were again returned to four-wheeled locomotives in 1830.

“Puffing Billy” remained at work upon the Wylam

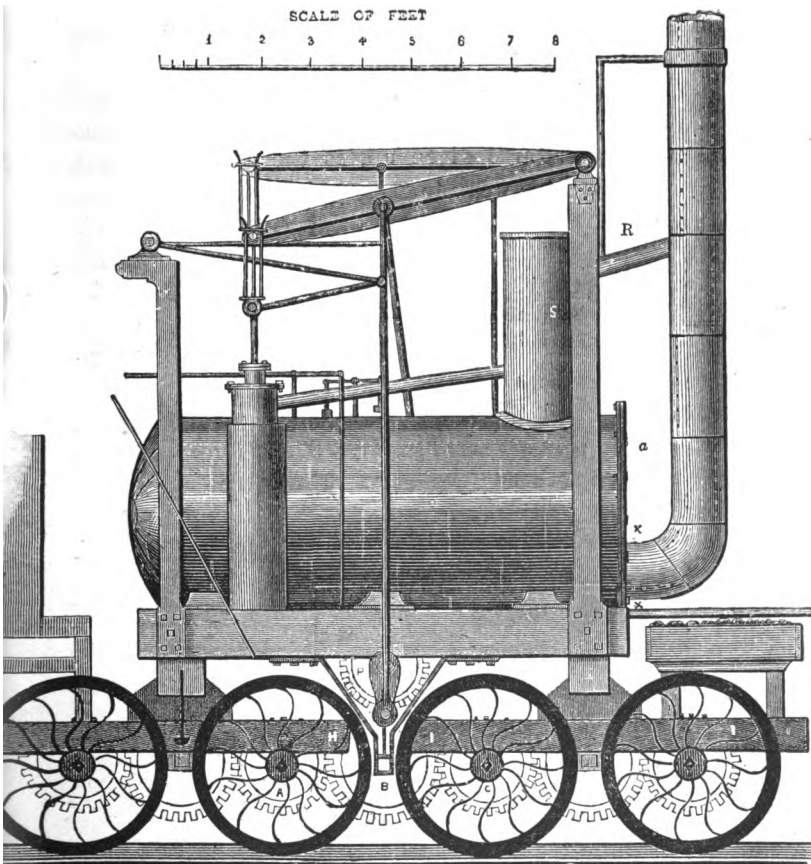

Fig. 8.—“Puffing Billy,” as rebuilt 1815.

line till 1862, when it was removed to the South

Kensington Museum; the "Wylam Dilly" is still preserved in the Edinburgh Museum.

The Duke of Portland, in 1817, ordered an engine from George Stephenson, similar in every respect to Fig. 6, for use upon his Kilmarnock and Troon tram-road. The engine worked the coal traffic from the collieries to the Troon harbour successfully, but its use was afterwards given up, as the cast-iron tram-plates proved too weak to carry any engine.

The owners of Hetton Colliery, near Sunderland, having seen the satisfactory working of Stephenson's locomotives upon the Killingworth line, decided, in 1819, to alter their old "horse tram-road" into a locomotive railway, and they employed George Stephenson as engineer, to lay out the line for them, and to construct the engines. At the opening of the Hetton railway on the 18th November, 1822, there were five of Stephenson's engines at work thereon, similar in design to Fig. 6.

CHAPTER II.

ENGINES EMPLOYED UPON PUBLIC RAILWAYS FOR THE CONVEYANCE OF PASSENGERS, GOODS, AND MINERALS.

Thus far, it will be observed, locomotive engines had simply been employed by private colliery owners for conveyance of coal upon their own lines. The Stockton and Darlington "Public Railway" scheme was therefore one of the important turning points in locomotive history. George Stephenson was appointed engineer, and application was made to Parliament in 1818. Twice the bill was rejected, but it passed in 1821, and on Tuesday, 27th September, 1825, this, the first public railway in the world, was opened for traffic. The engine which drew the first train, and, in fact, the only engine the company at that date possessed, was constructed by Messrs. Stephenson & Co., for the Stockton and Darlington line, in 1825, and was named "Locomotion." The handbill issued September, 1825, announcing the intended opening of the first public railway, proudly and emphatically describes "Locomotion" as "The Company's Locomotive Engine and the Engine's Tender."

This engine ran upon four wheels, had one large flue, or tube, through the boiler, the cylinders being placed vertically and half within the boiler; the

exhaust steam from the cylinders was discharged into the chimney by two blast-pipes, one for each cylinder, that one for the left-hand side being plainly shown in Fig. 9. The boiler, which was worked at a pressure of 25 lbs. per square inch, is 10 feet long by 4 feet diameter, and has 60 square feet of heating surface. The two vertical cylinders are 10 inches diameter, and the stroke 24 inches; the piston-rods being guided by parallel motions. By means of a cross-head and

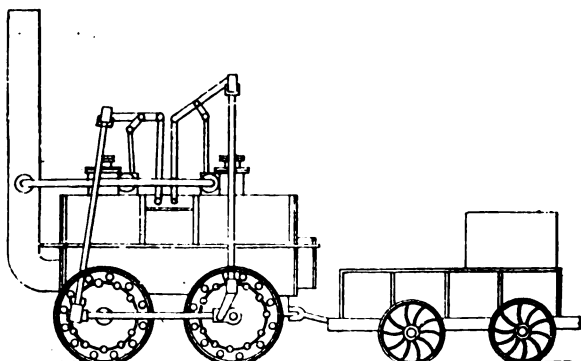

Fig. 9.—Stockton and Darlington Railway. "Locomotion," No. 1, 1825.

pair of connecting-rods the piston of the front cylinder is coupled to the crank-pins upon the leading wheels, the other piston being similarly coupled to the trailing wheels, while outside return cranks on the latter wheels enable the two pairs of wheels to be coupled with the main cranks at right angles. The wheels are 4 feet diameter, and the weight of the engine in working order is 6 tons 10 cwts. It was built at a cost of £600, and its speed was from six to eight miles an hour.

The tender ran upon four wheels of 2 feet 6 inches diameter, the frame being of wood, upon which is mounted a sheet-iron tank holding 240 gallons of water, the coal space being 15 cwt. Weight of tender in working order $2\frac{1}{4}$ tons.

“Locomotion” worked upon the Stockton and Darlington line from 27th September, 1825, to 1841, and after its retirement from active service it was placed upon a pedestal at the entrance to the North Road Station, Darlington, and in April, 1892, it was removed to Bank Top, Darlington. It is still in good working order, and capable of being put in steam. It headed the procession on the opening of the Middlesbrough and Redcar Railway; it was taken from its pedestal and worked upon the Darlington section of the North Eastern Railway, at the Stockton and Darlington Jubilee, September of 1875; it was sent to the Philadelphia Exhibition of 1876, to the “Stephenson Centenary” of 1881, the Liverpool Exhibition of 1886, and it engaged very considerable attention at the Paris Exhibition of 1889.

The following is a copy of the official list of the early Stockton and Darlington locomotives, dated 1833:—

No.	Name of Engine.	Date.	Designed by	Name of Builder.
1	Locomotion....	1825	Stephenson & Co.	Stephenson & Co.
2	Hope	1826	”	”
3	Black Diamond.	”	”	”
4	Diligence.....	”	”	”
5	Royal George*.	1827	T. Hackworth ..	Rebuilt Rlway Co.'s Works, Shildon.
6	Experiment....	1826	Stephenson & Co.	Stephenson & Co.
7	Rocket.....	1829	”	”
8	Victory	”	T. Hackworth ...	Railway Co.'s Works, Shildon.

* No. 5 was built by Messrs. Wilson & Co., 1826, and rebuilt by the Company's locomotive foreman, T. Hackworth, October, 1827.

No.	Name of Engine.	Date.	Designed by	Name of Builder.
9	Globe	1830	T. Hackworth ..	Stephenson & Co.
10	Planet	"	Stephenson & Co.	"
11	North Star	"	"	"
12	Majestic	1831	T. Hackworth ..	Railway Co.'s Works, Shildon.
13	Coronation	"	"	Hawthorn & Co.
14	William IV.....	"	"	Railway Co.'s Works, Shildon.
15	Northumbrian..	"	"	Railway Co.'s Works, Shildon.
16	Director.....	1832	"	Stephenson & Co.
17	Lord Brougham	"	"	Railway Co.'s Works, Shildon.
18	Shildon.....	"	"	Railway Co.'s Works, Shildon.
19	Darlington	"	"	Hawthorn & Co.
20	Adelaide.....	"	"	Stephenson & Co.
21	Earl Grey.....	"	"	Hawthorn & Co.
22	Lord Durham..	"	"	Stephenson & Co.
23	Wilberforce....	"	"	Hawthorn & Co.
24	Magnet.....	"	"	Railway Co.'s Works, Shildon.
25	Enterprise.....	1833	Kitching.....	Kitching.
26	Swift.....	"	Hawthorn & Co..	Hawthorn & Co.

Following the opening of the Stockton and Darlington Railway, Stephenson constructed for it three other engines of similar design to "Locomotion;" they were named "Hope," "Black Diamond," "Diligence;" and Mr. Timothy Hackworth, who had been a foreman at Stephenson's Works, Newcastle, was transferred to the Stockton and Darlington Railway Company's engine-shed at Shildon and became engine superintendent.

During the early part of the year 1826, Messrs. Wilson & Co., of Newcastle, designed and constructed an engine, No. 5, for the Stockton and Darlington Railway, and as that firm considered outside coupling-rods an objection, they placed their engine upon four wheels, and employed four cylinders, two to each pair. Thus the locomotive had two pairs of

independent driving-wheels, a plan more recently used upon the North-Western Railway.

Messrs. Stephenson & Co., early in the year 1826, designed and built “ Experiment,” No. 6 (Fig. 10), for the Stockton and Darlington line.

This engine had six coupled wheels, and outside inclined cylinders, 9 inches diameter; stroke 24 inches; wheels 4 feet diameter, boiler 10 feet long by 4 feet diameter. The boiler contained two fire-flue tubes, 18 inches diameter. The exhaust steam was conveyed

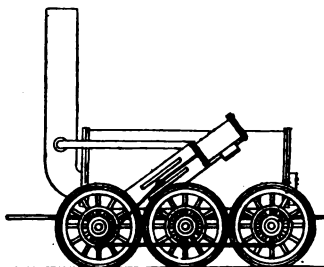

Fig. 10.—Stockton and Darlington, No. 6, 1826.

from the cylinders to the chimney by two blast-pipes, one for each cylinder.

“ Twin Sisters ” (Fig. 11) was built by Stephenson & Co., in 1827, as a contrac-

tor’s locomotive at the making of the Liverpool and Manchester Railway, and as it was required to work over very severe temporary gradients it was considered best to construct it with twin boilers, in order to insure that water should at all times cover the tops of the fire-boxes.

This engine ran upon six coupled wheels of 4 feet diameter, the cylinders being placed outside, in an inclined position; two blast-pipes were employed, one for each cylinder. After the completion of the Liverpool and Manchester Railway, “ Twin Sisters ” became

known as the "Liverpool Coke Engine," from the fact that it was employed to work trains of coke to that city for Mr. Hulton, who contracted to supply the railway company with locomotive fuel.

The four-cylinder engine, No. 5, for the Stockton and Darlington Railway (mentioned on page 22), having worked very unsatisfactorily, and also having been very seriously damaged in a collision at Stock-

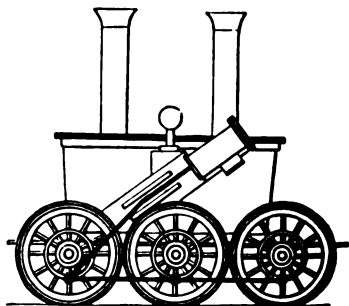

Fig. 11.—"Twin Sisters," Ballast Engine, 1827.

ton, Timothy Hackworth, in 1827, obtained the authority of the directors to remodel and rebuild it. The boiler was 13 feet long, and 4 feet diameter, and

into this Hackworth introduced a return flue-tube, similar to those previously employed by Trevithick and by Hedley.

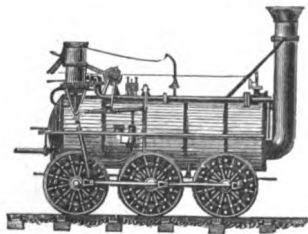

Fig. 12.—"Royal George."
Rebuilt, 1827.

The engine thus rebuilt at the Company's Shildon Works was named the "Royal George," No. 5, and

commenced work October, 1827. (Fig. 12.)

The "Royal George" had six coupled wheels of 4 feet diameter, outside vertical cylinders 11 inches

diameter, the stroke being 20 inches. The fire-door and chimney were both at the same end, consequently two tenders were provided, one at each end of the engine; the exhaust steam was discharged into the chimney by one blast-pipe for both cylinders.

The maximum performance of the “Royal George” was drawing 32 waggons of coal weighing 130 tons at five miles an hour on the level and nine miles an

hour on falling gradients. Weight of engine and its two tenders in working order, 15 tons. The “Royal George” worked regularly upon the Stockton and Darlington line from 1827 to 1842.

Stephenson & Co. in 1828 constructed a four-wheeled coupled engine named the “Lancashire Witch,”

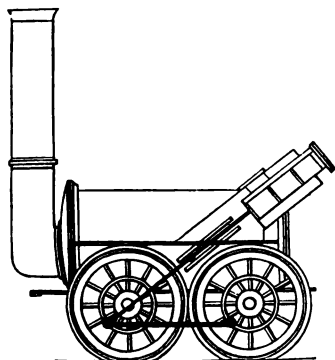

Fig. 13.—“Lancashire Witch,” Bolton and Leigh Railway, 1828.

for the Bolton and Leigh Railway. (Fig. 13.)

Cylinders	9 in. diameter.
Stroke	24 in.
Diameter of wheels	4 ft.
Boiler	9 ft. long.
Boiler	4 ft. diameter.
The boiler contained two fire-tubes or flues	1 ft. 6 in. diameter.
Heating surface of flues	66 sq. feet.
Four-wheeled tender.	

The “Lancashire Witch” was employed first as a ballast engine at the construction of the Bolton and Leigh line, and it was found by experiment that this

engine conveyed 58 tons up a gradient of 1 in 432 at

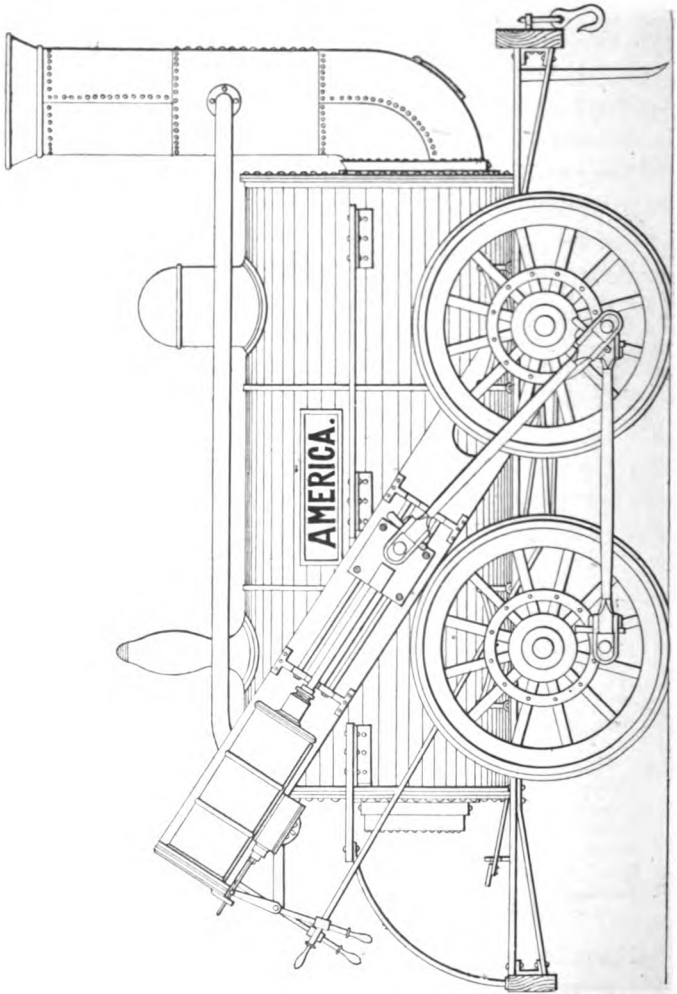

Fig. 14.—The First Locomotive for America, 1828.

a speed of $8\frac{8}{10}$ miles an hour ; it afterwards continued to work traffic for several years.

Early in the year 1828 the Delaware and Hudson Canal Company, having heard of the success of the Stockton and Darlington Railway, sent over Mr. Horatio Allen to England with instructions to obtain information and purchase rails and four locomotives. He gave an order to Messrs. Foster, Rastrick & Co., of Stourbridge, for three, also to Mr. Stephenson for one.

Stephenson's engine was named "America"; it was built in 1828, and arrived in New York, on board the ship "Columbia," about the middle of January, 1829. It was the first railroad locomotive ever seen in America, and is here illustrated. (Fig. 14.)

The following is the copy of the official description of locomotive engine "America," built by R. Stephenson & Co. for the Delaware and Hudson Canal Company, to the order of Mr. Horatio Allen, 1828, and No. 12 in the books of the makers:—

	Ft.	Ins.
Diameter of boiler	4	1
Length ,, ,,	9	6
Dimensions of fireplace	4ft. 0in. by	3 0
Diameter of steam cylinders	0	9
Length of stroke	2	0
Size of chimney	1	8
Size of hot-water pump	0	1½
Length of pump stroke	2	0
Wheels (wood) diameter	4	0
Number of wheels 4		
Angle of cylinders to the horizontal 33°		
Size of tubes	1	7
Number of fire tubes 2. Tubes were straight.		

Some persons have contended that the iron-bar-framing in general use in the United States was an American invention, but reference to the illustration, Fig. 14, proves conclusively that the "bar-frame"

was sent from this country. Although Stephenson's engine was the *first* to arrive, it was not the first to be run.

Messrs. Foster & Rastrick's engine, the "Stourbridge Lion" was built 1828, and arrived in New York May, 1829, but neither of the engines for America could be put to work for some months as the railway was not completed. Messrs. Foster & Rastrick's engine, the "Stourbridge Lion," was the first locomotive which ever ran upon rails in America; it was tried for the first time on 9th August, 1829, being driven by Horatio Allen upon a section of the Delaware and Hudson Canal Company's Railroad. The "Stourbridge Lion" was exactly similar to Fig. 15, but with a much shorter chimney. It is still preserved, and was exhibited at the Chicago Railway Exposition of 1884.

Messrs. Foster, Rastrick & Co. in 1829 constructed an engine (Fig. 15) for the Shutt End Railway, which extends from the Earl of Dudley's Colliery at Kingswinford, to the Staffordshire and Worcestershire Canal this locomotive was named "Agenoria," and opened the line on Tuesday, June 2nd, 1829.

This engine has upright cylinders working half beams, thus reducing the stroke of the pistons to the cranks. The cylinders are $7\frac{1}{2}$ inches diameter, with a stroke of 3 feet. There is a parallel motion to the piston-rod, and the feed-pump is worked from one of the half beams. The fire-grate is within a large tubular boiler, branching into two tubes, with the chimney at the end of the boiler, the barrel of the boiler being 10 feet long and 4 feet diameter. The eccentrics for driving the slide-valves are loose upon the axle, with a

clutch to drive either way, and there is hand-gear to the valves to cause the axle to turn half round to bring the required backward or forward clutch into action. The exhaust steam is discharged into the chimney,

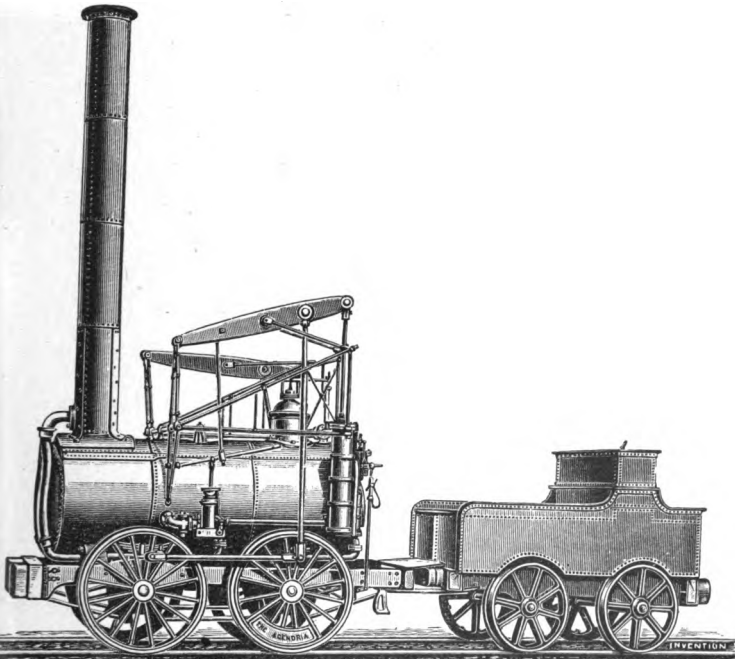

Fig. 15.—“Agenoria,” Shutt End Railway, 1829.

which, it may be mentioned, is of unusual height. “Agenoria” continued in regular work for fully 30 years, and is now preserved in the South Kensington Museum.

The Liverpool and Manchester has been truly

designated "The Grand British Experimental Railway." George Stephenson was appointed engineer, and the line was publicly opened 15th September, 1830.

Some time previously to the opening the question of locomotive or fixed engines and ropes naturally came before the directors, as it was necessary to arrange for "power" to work the traffic; they therefore decided to employ Messrs. Walker and Rastrick, engineers, to make a tour of inspection to examine all the railways then at work; but, notwithstanding the reports, the directors did not feel able to come to a decision, when one of their number, Mr. Harrison, proposed "that a reward be publicly offered for the most likely mode of effecting their object," and it was resolved to offer a prize of £500 for the best engine.

The trial took place on the Manchester side of Rainhill Bridge, upon a level portion of the line, and lasted from the 8th to the 14th October, 1829. Three engines competed for the prize, namely :

The "Rocket"	by G. and R. Stephenson.
The "Novelty"	by Braithwaite & Ericsson.
The "Sanspareil"	by T. Hackworth.

Each locomotive was required to run ten trips over the trial ground, equal to a journey of thirty-five miles, at full speed, the average rate to be not less than ten miles per hour. At the end of the first ten trips each engine was to be got ready again, and to repeat the test, the object being to prove that the engine would be able to perform a journey from Liverpool to Manchester and back.

The "Rocket" (Fig. 16) satisfactorily performed

all the tests required by the judges, and the prize was consequently awarded to Messrs. Stephenson.

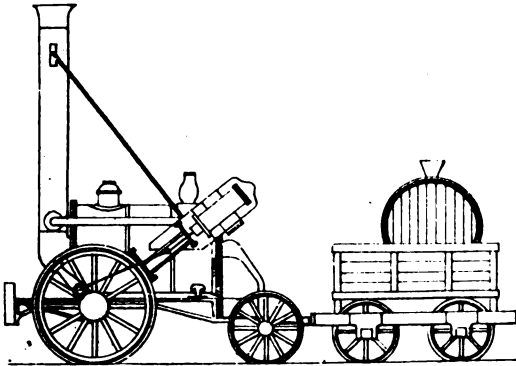

Fig. 16.—“Rocket,” Liverpool and Manchester Railway, 1829.

The dimensions of the “Rocket” were as follows:—

Cylinders, diameter	8 in.
Cylinders, stroke	16½ in.
Driving-wheels, diameter	4 ft. 8½ in.
Boiler	6 ft. long.
Boiler	3 ft. 4 in. diameter.
Pressure of steam in the boiler	50 lbs. per sq. inch.
Fire-box	2 ft. long inside.
Fire-box	3 ft. broad inside.
Fire-box	3 ft. deep inside.
Tubes, number	25.
Tubes, diameter	3 in.
Tubes, heating surface	117·75 square feet.
Fire-box, heating surface	20 square feet.
Total	137·75 square feet.
Area of fire-grate	6 square feet.
Weight of engine in working trim	4 tons 5 cwts.
Weight of tender, loaded	3 tons 4 cwts.
Total	7 tons 9 cwts.

The maximum speed attained by the “Rocket” at the Rainhill trials was 29 miles an hour. This engine,

although crude in appearance, possessed all those essential features which are necessary to the success of a locomotive—namely, the tubular boiler, direct connection between the piston and the crank-pin on the driving-wheel, and blast-pipes in the chimney, there being one pipe for each cylinder, as in the engine of 1815, and the “Locomotion” of 1825. It will be observed that so little progress had the locomotive engine made in public favour, that even in the year 1829 the directors of the Liverpool and Manchester Railway were divided in opinion as to fixed engines and ropes, horses and locomotives, and had not the locomotive engine proved itself a success at Rainhill, the result would have been the introduction of other means of working that line. It will therefore be seen that although George Stephenson was not, and of course never claimed to be, the inventor of the locomotive, still he it was who in 1829, at Rainhill, settled the question and made the locomotive a practical success, and thereby led to the introduction of railways throughout the world. It is hardly necessary to mention that the celebrated “Rocket” is preserved in the South Kensington Museum, and it may be added that the “Rocket” and “Sanspareil” have lately been placed upon some of the old original Liverpool and Manchester rails of 1829 which have been presented to that institution by the author for the purpose, and the full-sized models of these engines at the Chicago Exhibition will also stand upon similar old rails.

The “Novelty,” constructed by Messrs. Braithwaite and Ericsson, ran upon four wheels, and had a combined vertical and horizontal boiler; and bellows were employed to force air through the fire. In this engine, motion was communicated from the piston-rod to the

wheels by means of a bell-crank. The "Novelty" broke down and failed at Rainhill.

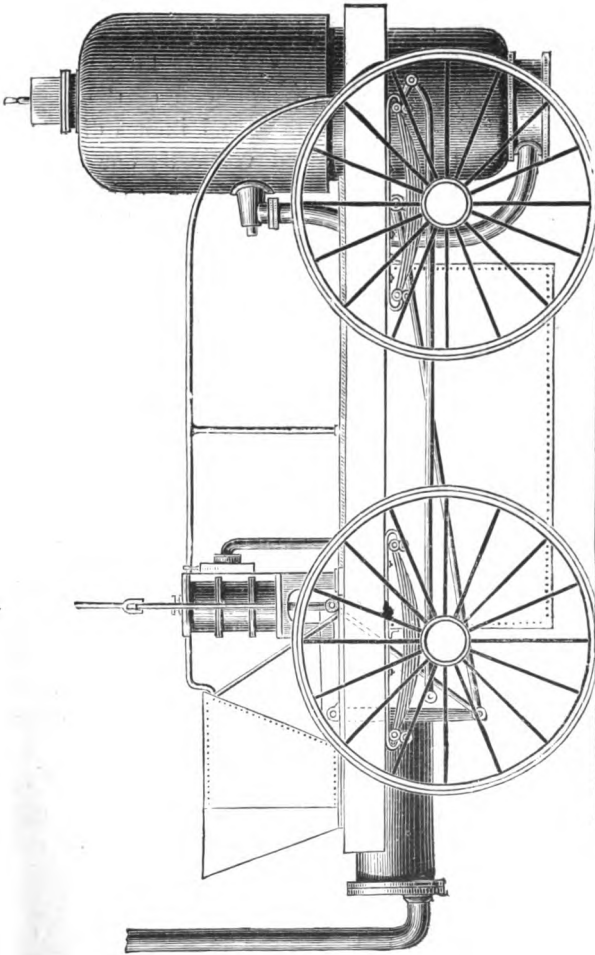

Fig. 17.—The "Novelty," 1829.

The "Sanspareil" was designed and constructed by

Timothy Hackworth, the engine superintendent of the Stockton and Darlington line, for the Rainhill competition. It ran upon four coupled wheels of 4 feet 6 inches diameter. The boiler was 6 feet long, and 4 feet 2 inches diameter, containing a return flue-tube, the chimney being placed at the same end of the engine as the fire-door. The cylinders were 7 inches diameter, and the stroke 18 inches, placed vertically one on each side of the boiler, immediately above one of the pairs of wheels; the exhaust steam from the cylinders was discharged into the chimney by a blast-pipe, similar to that of Trevithick's 1803.

When the "Sanspareil" was brought forward for trial at Rainhill, the judges found that it did not comply with the conditions issued, being of greater weight than was to be allowed to be placed upon four wheels, the engine therefore should have been upon six wheels. Strictly speaking, it was considered that Hackworth's engine was therefore excluded from competing for the prize, but the judges wisely decided to put the engine to the same trial as the others. However, it broke down and failed to obtain the prize. The "Sanspareil" worked upon the Bolton and Leigh Railway until 1844, and is now placed in the South Kensington Museum.

At the conclusion of the Rainhill trials and the victory of the "Rocket," Stephenson received orders to build seven other engines, to be ready for the opening of the Liverpool and Manchester Railway. They were constructed during the year 1830, and were very similar in design to the Rocket; they were named "Meteor," "Comet," "Arrow," "Dart," "Phoenix," "North Star," and "Northumbrian;" they all had outside cylinders and the driving wheels in front.

The Canterbury and Whitstable Railway was opened on the 3rd May, 1830, the first train being worked by the Company's only locomotive, which had been built by Stephenson & Co., and was named “Invicta.” (Fig.18.)

Cylinders	10 ins. diameter.
Stroke	18 ins.
Boiler	10 ft. long.
Boiler	3 ft. 4 ins. diam.
Pressure	40 lbs. per square inch.
Wheels	4 ft. diameter.
Wheel-base	5 ft.

The boiler contains a flue-tube 20 inches diam.
The tender ran on four wheels.

This ancient engine is preserved by the South-Eastern Railway Company at its Ashford Works; it was sent to the Darlington Jubilee, 1875, and to the George Stephenson Centenary, 1881.

The Liverpool and Manchester Railway was opened on the 15th September, 1830, upon which occasion the Company's eight engines and trains, and about 600 people, started in a procession from Liverpool in the following order :—

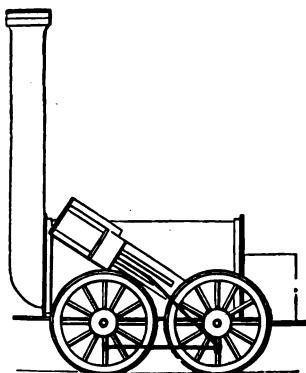

Fig. 18.—“Invicta,” Canterbury and Whitstable Railway, 1830.

Name of Engine.	Driven by
“Northumbrian”	George Stephenson.
“Phoenix”	Robert Stephenson.
“North Star”	R. Stephenson, Senr. (brother of George).
“Rocket”	Joseph Locke.
“Dart”	Thomas L. Gooch.

Name of Engine.	Driven by
"Comet"	William Allcard.
"Arrow"	Frederick Swanwick.
"Meteor"	Anthony Harding.

Therefore the engine which opened the Liverpool and Manchester Railway was the "Northumbrian" (Fig. 19).

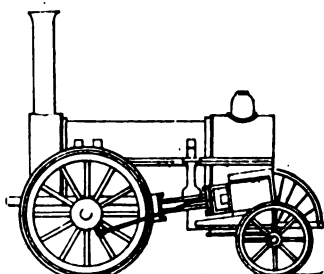

Fig. 19.—"Northumbrian," No. 8,
L. & M. Ry., 1830.

The engine, it will be observed, had a smoke-box, and the cylinders were placed outside, nearly horizontally, the driving-wheels, as in the "Rocket" and six other engines named,

were placed in front. The "Northumbrian" had—

Cylinders	11 ins. diameter.
Stroke	16 ins.
Driving-wheels	5 ft. diameter.
Total heating surface	411·75 sq. ft.
Weight in working order	7 tons 6 cwt. 3 qrs.
Weight on driving wheels	4 tons 1 qr.

On the opening day, when Mr. Huskisson was knocked down and run over at Parkside by the "Rocket," he was conveyed by the "Northumbrian" to Eccles, 15 miles in 25 minutes, or 36 miles an hour. On 16th September, 1830, when the regular traffic of the line commenced, the "Northumbrian" conveyed a train of 130 passengers from Liverpool to Manchester (Liverpool Road Station), a distance of 30 miles, in an hour and fifty minutes.

The following is a copy of the Company's official list of engines to the year 1834:—

No.	Name of Engine.	Date.	Maker.	Diam. of cylinders.		Length of driving-stroke.		Diam. of driving-wheels.		Design.	Remarks.
				Ings.	Ft. In.	Ings.	Ft. In.	Ings.	Ft. In.		
1	Rocket ...	1829	R. Stephenson & Co. ...	8	16 1/2	16 1/2	4 5/8		"Rocket" class	4 wheeled engines, outside cylinders, driving wheels in front.	
2	Meteor ...	1830	"	10	16	16	5 0		"		
3	Comet ...	"	"	10	16	16	5 0		"		
4	Arrow ...	"	"	10	16	16	5 0		"		
5	Dart ...	"	"	10	16	16	5 0		"	4 wheeled engines, inside cylinders, driving wheels behind	
6	Phoenix ...	"	"	11	16	16	5 0		"		
7	North Star ...	"	"	11	16	16	5 0		"		
8	Northumbrian ...	"	"	11	16	16	5 0		"		
9	Planet ...	"	"	11	16	16	5 0		"Planet" class	4 wheels coupled.	
10	Majestic ...	"	"	11	16	16	5 0		"		
11	Mercury ...	"	"	11	16	16	5 0		"		
12	Mars ...	"	"	11	16	16	5 0		"		
13	Samson ...	1831	"	14	16	16	4 6		"Samson" class	4 wheels coupled.	
14	Jupiter ...	"	"	11	16	16	5 0		"Planet"		
15	Goliath ...	"	"	11	16	16	4 6		"Samson"		
16	Saturn ...	"	"	11	16	16	5 0		"Planet" class		
17	Sun ...	"	"	11	16	16	5 0		"	4 wheels coupled.	
18	Venus ...	"	"	11	16	16	5 0		"		
19	Vulcan ...	"	"	11	16	16	5 0		"		
20	Etna ...	"	"	11	16	16	5 0		"		
21	Fury ...	"	Fenton, Murray & Co. ...	11	16	16	5 0		"	4 wheels coupled.	
22	Victory ...	"	R. Stephenson & Co. ...	11	16	16	5 0		"		
23	Atlas ...	1832	"	12	16	16	5 0		"Samson"		
24	Vesta ...	"	"	11	16	16	5 0		"Planet"		
25	Milo ...	"	"	12	16	16	5 0		"Samson"	4 wheels coupled.	
26	Liver ...	"	"	11	16	16	5 0		"Samson"		
27	Pluto ...	"	"	12	16	16	5 0		"Bury's"		
28	Caledonian ...	"	"	12	16	16	5 0		"Planet"		
29	Ajax ...	"	Galloway & Co. ...	12	16	16	5 0		(4 coupled)	Vertical cylinders.	
30	Leeds ...	"	R. Stephenson & Co. ...	11	16	16	5 0		"Planet"		
31	Firely ...	1833	Fenton, Murray & Co. ...	11	16	16	5 0		"		
32	Experiment ...	"	R. Stephenson & Co. ...	11	16	16	5 0		Roberts' design (6 wheels)		
33	Patentee ...	1834	Sharp, Roberts & Co. ...	12	18	18	5 0		"	Vertical cylinders. Inside cylinders.	
34	Titan ...	"	R. Stephenson & Co. ...	11	20	20	5 0		"		
35	Orion ...	"	Taylor & Co. ...	11	20	20	5 0		"		
36	Swiftsure ...	"	Forrester & Co. ...	11	18	18	5 0		"		

Dated 1834, Liverpool.

Towards the close of the year 1829 Stephenson completed the design for a new engine for the Liverpool and Manchester Railway, and it was placed upon that line on the 4th October, 1830.

⚙ This engine—the “Planet” (Fig. 20)—was a striking improvement upon all Stephenson’s previous ones. The cylinders were placed “inside” under the smoke-box,

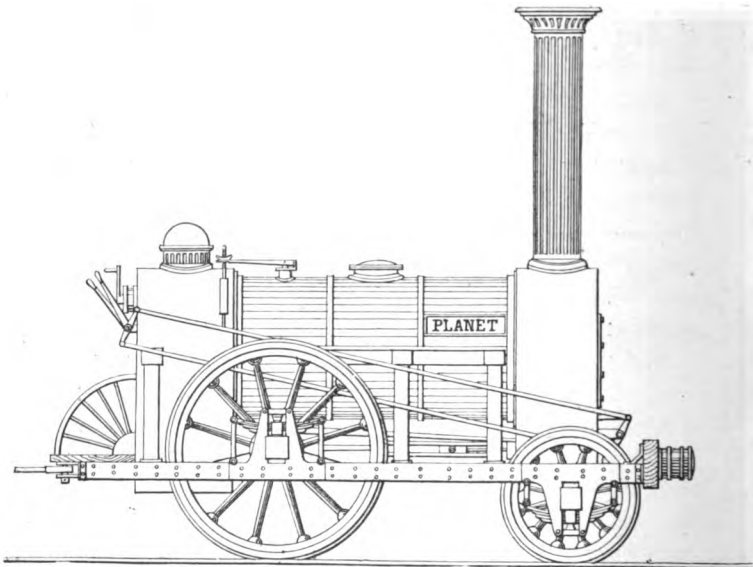

Fig. 20.—“Planet,” No. 9, Liverpool and Manchester Railway, 1830.

the driving-wheels were at the trailing end, and a double-cranked axle was employed, similar to one of those previously used for coupling the engine of 1815. The bar-frame is here abandoned, and an oak-frame employed, plated on both sides with iron : the framing and the axle-boxes were outside the wheels.

Cylinders, 11 ins. diameter; Stroke, 16 ins.; Between centres of cylinders, 2 ft. 6 $\frac{3}{4}$ ins.; Leading wheels, 3 ft. diameter.; Driving wheels, 5 ft. diameter.

Boiler	6 ft. 6 ins. long.
Boiler	3 ft. diameter.
129 tubes.. .. .	1½ inches.
Heating surface of tubes	370·41 square feet.
" " firebox	37·25 "
	<hr/>
Total	407·66 "
	<hr/>
Area of fire-grate	6·50 "
Weight in working trim	8 tons 0 cwts. 0 qrs.
On driving wheels.. .. .	5 " 2 " 2 "

This engine had also the usual four-wheeled tender, which weighed 4 tons fully loaded.

On the 23rd November, 1830, the "Planet" worked a special train to convey voters from Manchester to Liverpool for an election; the official report states that "the time of setting out was delayed, rendering it necessary to use extraordinary despatch, in order to convey the voters to Liverpool in time"—the journey was performed in 60 minutes, including a stop of two minutes on the road for water.

On Saturday, 4th December, 1830, the "Planet" drew a mixed train of passengers and goods weighing 76 tons (exclusive of the weight of the engine and tender) from Liverpool to Manchester in 2 hours 54 minutes, including three stoppages of 5 minutes each for water and oiling. This train ran at a rate of $16\frac{1}{2}$ miles an hour down the Sutton incline, and its greatest speed on the level was $15\frac{1}{2}$ miles an hour.

From another official report it is found that between 16th September and 7th December, 1830, the Company's engines conveyed 50,000 passengers, and ran a distance of 28,620 miles, or 954 trips between Liverpool and Manchester and back.

The "Mercury" No. 11 (Fig. 21) was constructed by Stephenson & Co., December, 1830; it was of the

"Planet" type, but with the improvement that the frame was raised so as to be *above* the driving-axle.

Stephenson's "Planet" class of engine, as developed in the "Mercury," became the standard pattern of English four-wheeled locomotives, and was copied in America and other countries shortly afterwards. In December, 1833, a small pair of trailing wheels was added behind the fire-box, and the "Mercury" became a six-wheeled locomotive.

During the year 1830 Mr. Edward Bury, engineer, of

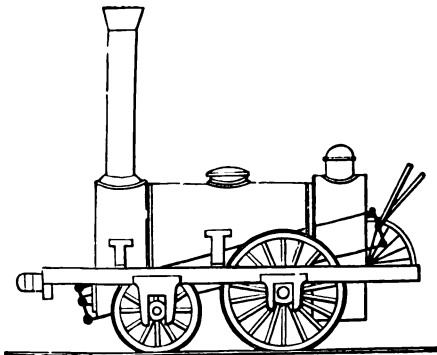

Fig. 21.—"Mercury," No. 11, Liverpool and Manchester Railway, December, 1830.

Liverpool, introduced his afterwards well-known class of four-wheeled engine, in which he employed the bar arrangement of framing, which is in general use to this day in America; and

Timothy Hackworth placed the "Globe" upon the Stockton and Darlington Railway having an inside frame, inside cylinders and four coupled wheels.

For the first few months after the opening of the Liverpool and Manchester Railway, some mixed trains of passengers and goods were run daily, drawn by the "single" engines of the "Rocket" and "Planet" classes; but as the goods traffic gradually increased it

became necessary to work goods trains, and Messrs. R. Stephenson & Co., in January, 1831, placed upon the line two goods engines which "had been specially constructed and were described as of extraordinary power;" they were named "Samson," No. 13 (Fig. 22), and "Goliath" (No. 15).

It will be observed, that practically the "Samson" and "Goliath" were a four-wheeled coupled development of the "Mercury" (Fig. 21), having cylinders 14 inches diameter, 16 inches stroke, and coupled wheels 4 feet 6 inches diameter. Total heating surface 457·10 square feet; weight of engine in working order 10 tons.

The "Samson," on 25th February, 1831, "accomplished the great feat," it is officially

recorded, of conveying a goods train of 164 tons (exclusive of weight of engine and tender), from Liverpool to Manchester in two hours and a half—the maximum speed being 20 miles an hour, and the consumption of coke was reduced to about a third of a pound per ton per mile.

During the time the "Samson" and "Goliath" were under construction, another engine of the same class was built by Stephenson for the Hudson and

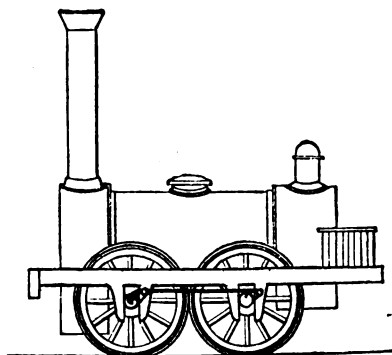

Fig. 22.—"Samson," No. 13, Liverpool and Manchester Railway, January, 1831.

Mohawk Railway, U.S.A., named "John Bull," and it was sent to America in 1831.

The Glasgow and Garnkirk Railway was opened in 1831, the first train being drawn by the Company's engine named "George Stephenson," which had been constructed at Newcastle, and was driven by Mr. George Stephenson upon that occasion.

This engine had cylinders 11 by 16 inches; coupled wheels 4 feet 6 inches diameter; wheel base 4 feet 9 inches. Boiler pressure 50 pounds per square inch.

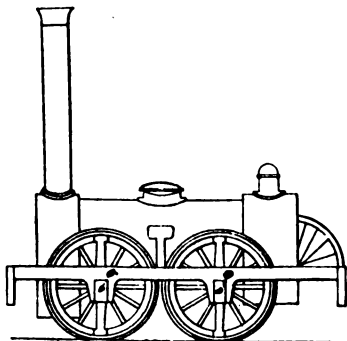

Fig. 23.—"George Stephenson,"
Glasgow and Garnkirk Railway,
1831.

The directors of the Monkland and Kirkintilloch Railway (near Glasgow), at the beginning of the year 1831, instructed their engineer, Mr. Dodds, to make out a plan and specification of two locomotive engines, able to drag 60 tons gross weight at the

rate of four or five miles an hour. The engines were built by Messrs. Murdoch and Aitken, Hill Street, Glasgow, the first being tried on the line on May 10th, 1831, and the second on September 10th, 1831. An official report issued to the shareholders stated that the engines were satisfactory.

On January 4th, 1831, the Baltimore and Ohio Railroad Company offered 4,000 dols. premium for the best American locomotive of $3\frac{1}{2}$ tons weight, which should

draw 15 tons at 15 miles an hour on a level. The boiler was to use as fuel anthracite coal ; it was to have four wheels, coupled together, 4 feet between centres, in order to pass around curves of 400 feet radius. The steam pressure was not to exceed 100 lbs. to the square inch above the atmosphere. The locomotives were to be delivered for trial upon the road, on or before June 1st, 1831, and the sum of 3,500 dols. was to be paid for the locomotive which should be adjudged to be best.

Three or four locomotives were entered for competition ; the prize was awarded to Messrs. Davis and Gartner, of York (Pennsylvania), whose engine was named the "York." The locomotive had a vertical-flue boiler and vertical cylinders, with four coupled wheels, 30 inches in diameter. It was altered considerably after being placed on the road.

The same firm afterwards built another locomotive, named the "Atlantic," being the first of what was known as the "Grasshopper" pattern, which was used for many years on the Baltimore and Ohio Railroad, and some of which engines were in use on that road as recently as 1883, and a few continued in service for a period of fifty years.

During the year 1831, the directors of the Leicester and Swannington Railway gave an order to Messrs. R. Stephenson & Co. for two locomotives. The first of these was named "Comet," being No. 4 in the list of the makers, and No. 1 in that of the railway company. It was shipped by sea from Newcastle to Hull, thence by canal to Leicester, where it was put upon the rails and ran its first trip 5th May, 1832, and after doing some preliminary ballasting, it worked the train, upon the opening of the line, from West Bridge, Leicester, to

Bagworth, driven by George Stephenson himself, assisted by his son Robert, and the regular driver Weatherburn.

The cylinders were 12 by 16 inches, the coupled wheels 5 feet diameter, and the wheel-base 5 feet 3 inches; total length of engine frame 16 feet.

The cylinders were placed low down, the piston-rods passing under the leading axle, and the valves were placed upon the tops of the cylinders.

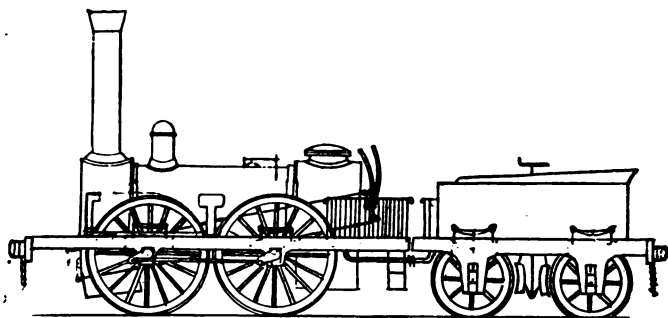

Fig. 24.—“Comet,” No. 1, Leicester and Swannington Railway, May, 1832.

The valve-gear consisted of a single eccentric for each valve, loose upon the driving-axle, motion being communicated by means of studs or “drivers.” These “drivers” were fixed to the crank-axle by collars. When the eccentrics were half-way between the two collars, the axle turned without communicating any movement to them, and the engine was out of gear.

By means of a “treadle” upon the foot-plate, the engineman moved the eccentrics lengthways upon the



REFERENCES TO ILLUSTRATIONS
IN THIS VOLUME:—

(See Fig. 24, p. 44) ..

(See Fig. 25, p. 46) ..

(See Fig. 29, p. 50) ..

(See p. 53)

(See Fig. 33, p. 57) ..

(See Fig. 35, p. 59) ..

(See Fig. 36, p. 61) ..

(See Fig. 39, p. 66) ..

(See Fig. 42, p. 69) ..

(See Fig. 48, p. 79) ..

Railway Co.'s No.	Name of Engine.	Name of Maker	Diam. of Coupler
1	COMET	R. Stephenson	5 ft. 1 in.
2	PHENIX	R. Stephenson	4
3	SAMSON	R. Stephenson	4
4	GOLIATH	R. Stephenson	4
5	HERCULES ..	R. Stephenson	4
6	ATLAS	R. Stephenson	4
7	LIVERPOOL ..	Edward	4
8	VULCAN	Taylor	4
9	AJAX	Haigh Fox	4
10	HECTOR	Haigh Fox	4

axle, causing them to engage with either the forward or backward "stud" at pleasure.

The starting or reversing of the engine was accomplished by the engine-driver opening the regulator, and placing his foot upon the "treadle" in order to disengage the eccentrics from the "stud;" another handle enabled him to lift up the small ends of the eccentric-rods, after which he took hold of the two valve levers on the foot-plate, and by moving them backwards and forwards admitted steam to the cylinders by the hand-gear; when the engine was fairly started, he by means of the treadle caused the eccentrics to engage with the opposite "stud" and it continued to actuate the valves; it therefore follows that the handles of the reversing gear upon the foot-plate were constantly moving backwards and forwards during the time the engine was in motion.

The rod of the tender brake passed in a tube through the water tank, and the handle could only be reached by climbing upon the coke.

The chimney of the "Comet," when constructed, was 13 feet in height from the rail level; but it was knocked down in the Glenfield Tunnel on the opening day, and was afterwards reduced to 12 feet 6 inches.

The weight of the "Comet" in working order was 9 tons 9 cwts. 2 qrs., and of the tender fully loaded $3\frac{1}{2}$ tons. In December, 1836, it was sold and sent to be a ballast engine at the making of the London and Birmingham Railway.

Full particulars relating to this engine are given in the annexed copy (see folding plate) of the Company's locomotive list, drawn up by Mr. John Nicholson, the engine superintendent, in 1839.

The second engine built by Messrs. Stephenson for the Leicester and Swannington Railway was the

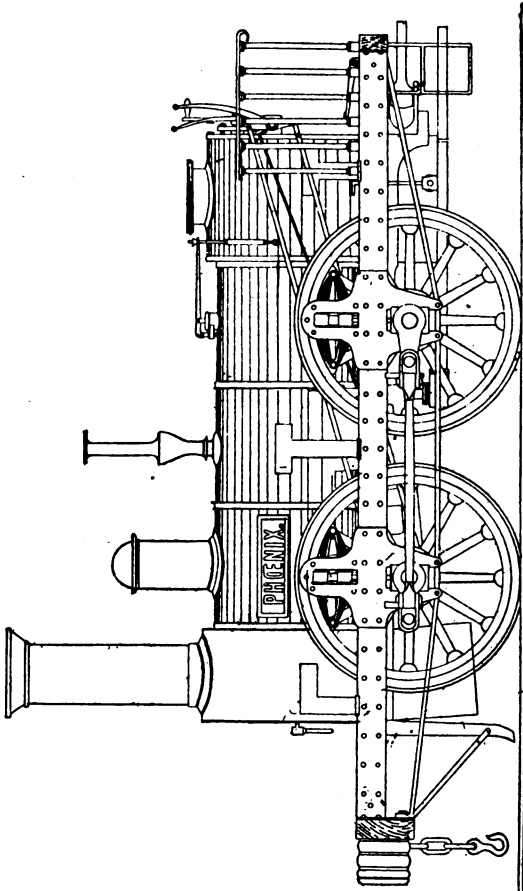
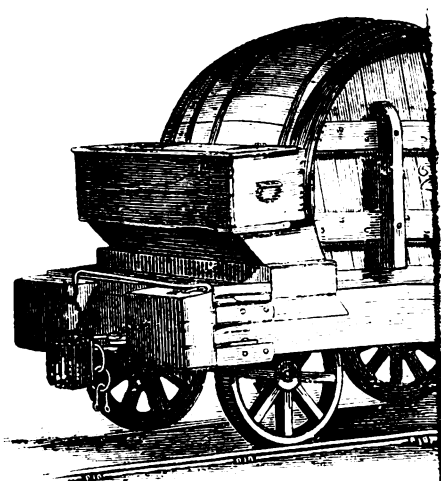

Fig. 25.—“Phoenix,” No. 2, Leicester and Swannington Railway, August, 1832.

“Phoenix,” delivered “in steam” at Leicester, 28th August, 1832.

The springs of “Phoenix” (Fig. 25) were of the Grasshopper pattern: but the experiments made by





Fig

Mr. Cabry, the Company's engine superintendent, showed that they possessed no advantages, and that pattern of spring was therefore not repeated.

In December, 1836, the "Phoenix" was sold and sent to the Birmingham and Gloucester Railway Company, to be used as a ballast engine at the making of that line.

Towards the close of the year 1831, and during the year 1832, several new engines were placed upon the Stockton and Darlington Railway numbered from 12 to 23 (see list, pp. 21, 22). They had boilers with either return-flues or return-tubes, and two tenders. No. 23 is illustrated (Fig. 26).

The "Wilberforce," No. 23, was designed by T. Hackworth, and constructed by Messrs. R. & W. Hawthorn for the Stockton and Darlington Railway, 1832. The chimney and fire-door were both at one end of the engine, the cylinders were placed vertically, and the connecting-rods attached to an intermediate crank. The cylinders were $14\frac{3}{4}$ inches diameter, the stroke 16 inches in length, and the wheels 4 feet diameter. With coal trains the engine burnt about 68lb. of coal per mile. The fire-basket, which did duty for a head or tail lamp, is shown at the back of the water-tender.

Mr. Edward Bury, of Liverpool, who afterwards became head of the well-known firm of Bury, Curtis, and Kennedy, and ultimately the locomotive superintendent of the London and Birmingham Railway was an engineer who took an important part in the early history of the locomotive, and he introduced several features which deserve to be placed on record. Mr. Bury became a locomotive builder shortly after the opening of the Liverpool and Manchester Railway.

He approved of the "bar-framing," of a circular fire-box, with the top of the fire-box casing formed in a large dome, and arranged the tubes in curved rows instead of straight; he also built up the wheels, the spokes being attached by screw bolts to the rim and the boss. Mr. Bury was the leading and most powerful advocate of the four-wheeled engine. He contended that it was less costly than that on six wheels, that it could be got into less space, was lighter and safer, as in his opinion it adapted itself better to the rails. The question of four *versus* six wheels engaged constant attention between the years 1832 and 1854; the competition was extremely severe, but ultimately Mr. Bury's "four-wheeled theory" was proved to be erroneous.

His first engine, named "Dreadnought," was built 1830, it was tried on some English lines experimentally, and in 1831 it was renamed "Liverpool" and went to America to the Petersburg Railroad, where, afterwards, it appears to have been known or renamed "Spitfire."

The Liverpool and Manchester Railway Company's list (see p. 37) shows that in 1832 Mr. Bury built one of his engines, the "Liver," No. 26, for that line, having cylinders 11 by 16 and 5 feet driving-wheels.

Messrs. Galloway, Borman & Glasgow, in 1832, constructed an engine for the Liverpool and Manchester Railway (Fig. 27); it ran upon four wheels of 5 feet diameter, coupled, and as the makers disapproved of the usual "cranked-axle," they placed the cylinders vertically in front of the smoke-box.

The engine was not successful, and after running off the rails upon several occasions, was rebuilt with inside cylinders and a cranked-axle.

Fig. 28 illustrates an old locomotive engine, named "Ironsides," built for the Philadelphia, Germantown, and Norris-town Railway Company. It is of interest, being the first railroad locomotive constructed by Mr. Baldwin, the founder of the now famous "Baldwin

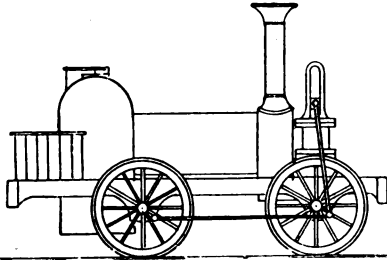

Fig. 27.—"Caledonian," No. 28, Liverpool and Manchester Railway, 1832.

Locomotive Works," Philadelphia, and it was completed and ran a trial trip on November 23rd, 1832.

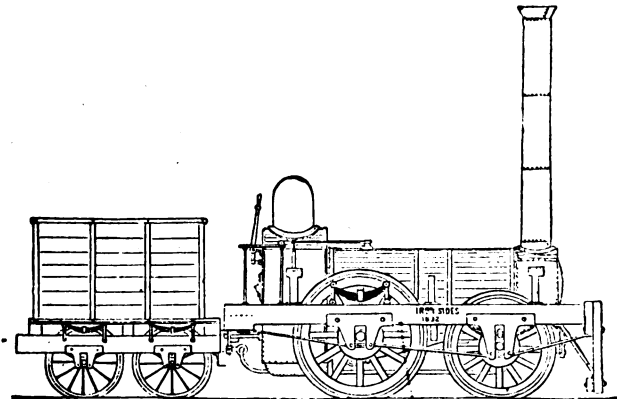

Fig. 28.—"Ironsides," an American Engine, November, 1832.

It will be seen that the "Ironsides" was a four-wheeled engine modelled essentially on the English practice

of that time, and was very similar to the "Planet" and "Mercury" class introduced upon the Liverpool and Manchester Railway by George Stephenson, in

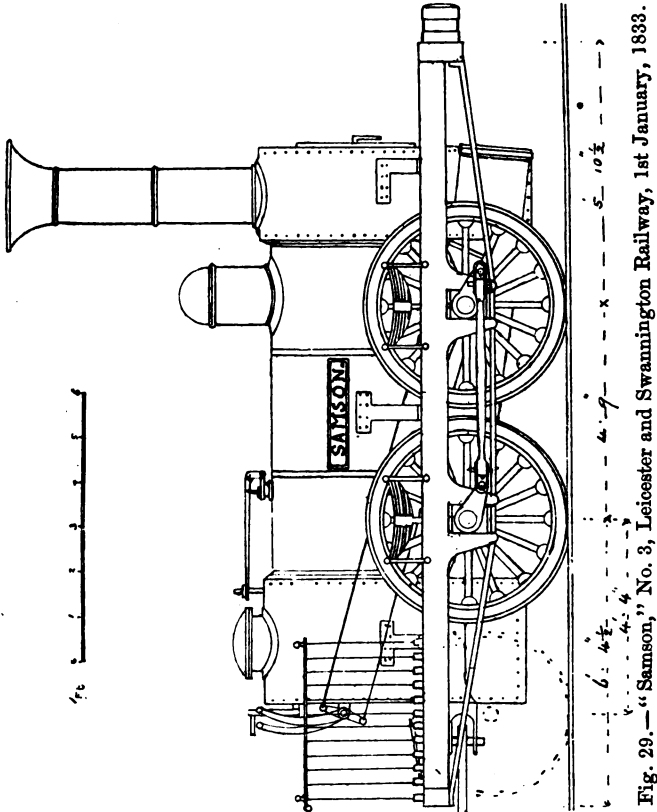

Fig. 29.—"Samson," No. 3, Leicester and Swannington Railway, 1st January, 1833.

1830; the cylinders being $9\frac{1}{2}$ inches diameter, 18 inches stroke, and the driving-wheels 4 feet 6 inches diameter.

In August, 1832, Messrs. R. Stephenson & Co. commenced the construction of two locomotives for the Leicester and Swannington Railway. These had cylinders 14 inches diameter, 18 inches stroke, and four coupled wheels of 4 feet 6 inches diameter, the wheel-base being 4 feet 9 inches, and the total length of the frame 17 feet. The first of these engines was named "Samson" (Fig. 29), and commenced work at Leicester, on 1st January, 1833; the other, "Goliath," followed 20th March, 1833.

One of the first events in the history of the "Samson" was that it ran into a horse and cart crossing the line at Thornton, the cart being loaded with butter and eggs for the Leicester market. The engine-driver had but the usual "horn," and could not attract attention. Mr. Ashlen Bagster, the manager of the railway, went the same day to Alton Grange to report the circumstance to Mr. George Stephenson, who was one of the directors and the largest shareholder. After various ideas had been considered, Mr. Bagster remarked: "Is it not possible to have a whistle fitted on the engine which steam can blow?" George Stephenson replied, "A very good thought, go and have one made," and such an appliance was at once constructed by a local musical instrument maker. It was put on in ten days, and tried in the presence of the board of directors, who ordered other trumpets to be made for the other engines which the company possessed. The following illustration (Fig. 30) is a copy of the official drawing.

The accident at Thornton was therefore the origin of the steam whistle, and the bell whistle, as we now have it, is an improvement upon the trumpet. When new

the "Samson" and "Goliath" had iron fire-boxes and copper tubes. These tubes were found to wear out very quickly, and the author has read correspondence addressed by Mr. Cabry to the makers, showing that within four months copper tubes were bursting and delaying the trains, and during the

[COPY.]

"LEICESTER AND SWANNINGTON RAILWAY.

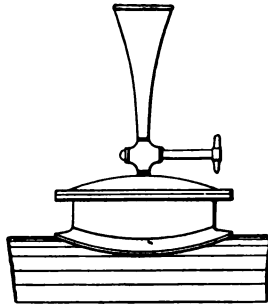

Height, 1 ft. 6 in. ; diam. of top, 6 in.

Engine Superintendent's Office, Leicester.

(Signed) HENRY CABRY.

May, 1833."

Fig. 30.—The Steam Trumpet.

summer of 1833 brass tubes were substituted in these engines.

During the year 1833 the portion of the Leicester and Swannington Railway extending from the top of the Swannington to the top of the Bagworth incline was opened by the "Samson" (Fig. 29), driven upon the occasion by Mr. Robert Stephenson.

It was very soon found in practice that the "Samson" and its fellow engine "Goliath," having a long frame

and short wheel base, caused considerable oscillation and threatened serious damage to the permanent way. It was therefore decided by the directors, acting upon the advice of one of their number, Mr. George Stephenson, to have a small pair of trailing wheels added behind the fire-box in the position shown on the diagram. The necessary pairs of wheels and axle-boxes were sent from Newcastle to Leicester, where they were attached by the company's fitters, under the direction of Mr. Cabry, engine superintendent.

Thus the Swannington Company's "Samson" and "Goliath," in the early part of the year 1833, became the first inside cylinder goods engines upon six wheels. The flanges were also taken off the middle or driving-wheels. The change from four to six wheels increased the wheel base to 9 feet 1 inch, and proved so satisfactory that Mr. George Stephenson, after riding upon the "Samson," decided never to build another four-wheeled engine, and he at once took steps to add similar pairs of wheels to the goods engines he had constructed for the Liverpool and Manchester Railway.

The South Carolina Railroad Company ordered an engine from Messrs. Stephenson, and it was placed on that line in 1833, named "Edgefield" and No. 54 in the books and records of the makers. It had cylinders 10 inches by 16 inches and four coupled wheels of 4 feet 6 inches diameter, its weight in working order being only 6 tons 4 cwts. Some writers have expressed surprise that such a small engine should have been built *after* others of larger dimensions. It is therefore necessary to record the fact that the rails were not suitable to carry an engine of either greater weight or longer wheel-base. Another engine built

by the same makers in 1833, for the Hudson and Mohawk Railroad Company, was named "Brother Jonathan;" it was also limited in size and weight.

Messrs. R. Stephenson & Co., in 1833, constructed an engine for the Saratoga and Schenectady Railroad of America; it had a leading bogie, and a single pair of driving-wheels placed behind the fire-box. The "bogie" was found to work very satisfactorily upon sharp curves, and has always been in use upon American passenger engines.

Mr. Roberts—of the firm of Messrs. Sharp, Roberts & Co., now Sharp, Stewart & Co.—in the year 1833 designed and constructed an engine for the Liverpool and Manchester Railway (Fig. 31).

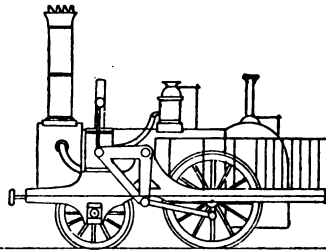

Fig. 31.—"Experiment," No. 32, Liverpool and Manchester Railway, 1833.

The cylinders were placed vertically over the leading wheels, the motion of the cross-heads being communicated to the crank-pins upon the driving-wheels by means of connecting-rods and bell-cranks. The leading wheels had outside, and the driving-wheels inside bearings; the cylinders were 11 inches diameter, the stroke 16 inches, and the driving-wheels 5 feet diameter.

This engine had no eccentrics to actuate the valves, short lever on the bell-crank giving the throw by an

long rod to rocking gear on the foot-plate. The valves were tubular, without lap or lead. The pistons had not the usual elastic packing rings, but were made nearly frictionless by exactly fitting the vertical cylinders, and having a white metal surface.

This engine was very unsteady when running, and

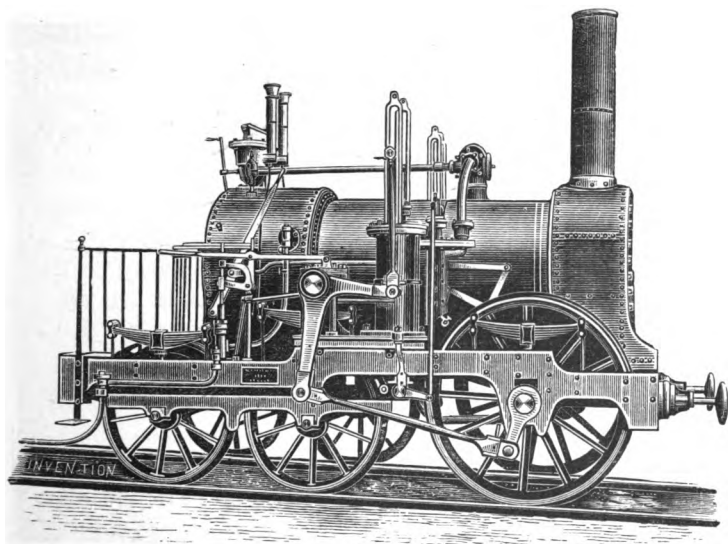

Fig. 32.—“The Earl of Airlie,” No. 1, Dundee and Newtyle Railway, 1833.

after running off the line it was rebuilt with the position of the cylinder and bell-crank altered, and another pair of wheels was afterwards added, but it proved a complete failure.

Fig. 32 illustrates an interesting link in locomotive history, showing as it does one of the first engines

having a "bogie" ever used on a railway in this country.

This engine was built by Messrs. Carmichael & Co., of Dundee, and commenced work upon the Dundee and Newtyle Railway, September, 1833, and during the same month "The Lord Wharncliffe," No. 2, was completed; followed by "The Trotter," No. 3, in March, 1834.

These three engines were in every respect similar, and had a single pair of driving-wheels 4 feet 6 inches in diameter, placed in front, and a four-wheeled bogie, the cylinders being vertical, 11 inches in diameter, and the stroke 18 inches. Weight of engine, in working order, without tender, 9 tons 10 cwts.; cost of engine, without tender, £700. Gauge of railway, 4 feet 6 inches.

The "Earl of Airlie" worked satisfactorily until 1850, when it was employed to pump water as a stationary engine. In 1854, Mr. Allan, when locomotive superintendent of the Scottish Central, had it properly cleaned, painted, and photographed, and it is from this photograph that Fig. 32 is produced.

Messrs. R. Stephenson & Co. delivered the "Hercules" to the Leicester and Swannington Railway Company, 17th December, 1833, being No. 36 in the books of the makers, and No. 5 in those of the Company (Fig. 33); it had copper-fire-box and brass tubes.

The cylinders were 14 inches by 18 inches, the working pressure of steam being 55lbs. per square inch, which was afterwards increased to 60lbs. When built, this engine had a flange upon the driving-wheels; this was, however, removed after it had been at work about three months.

Experience having proved that six-wheeled goods

engines were superior to four-wheeled, Messrs. Stephenson determined to apply the same principle to

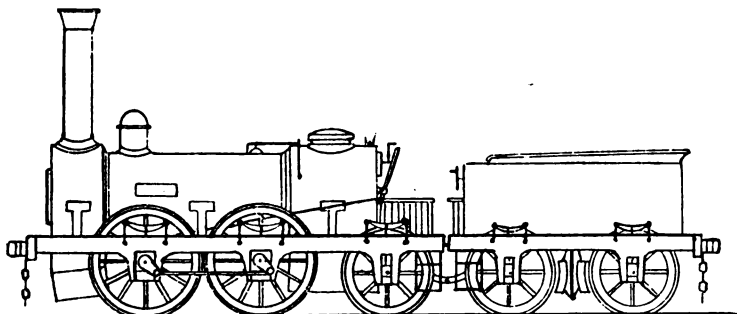

Fig. 33.—"Hercules," Leicester and Swannington, Dec., 1833.

passenger engines, and constructed the "Patentee" for the Liverpool and Manchester Railway, upon the model of the "Mercury" (Fig. 21), but with an addi-

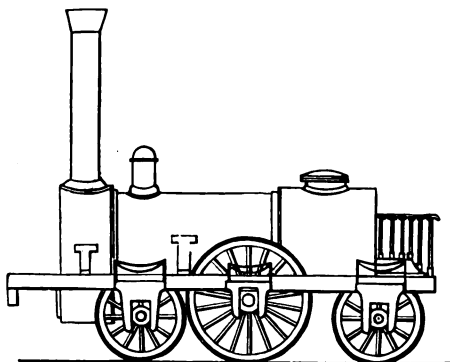

Fig. 34.—"Patentee," No. 33, Liverpool and Manchester Railway, January, 1834.

tional small pair of trailing wheels under the foot-plate. This engine (Fig. 34) was named "Patentee,"

on account of its being the first constructed by Stephenson under his patent of 1833, which provided that six-wheeled engines should have no flanges upon the middle pair of wheels, in order that they could easily pass round curves.

The cylinders were 12 inches by 18 inches, and the driving-wheels 5 feet diameter.

Special attention should be directed to this engine, which became a standard pattern, and was very extensively copied in this country and all parts of the world, and many of the modern passenger engines are "developments" of the "Patentee."

The large increase in the coal traffic upon the Leicester and Swannington Railway necessitated the use of more powerful engines to convey the trains over the rising gradients between the top of the Swannington incline and the top of the Bagworth incline. To overcome the difficulty, Mr. Stephenson decided to construct a new engine, having six coupled wheels; it was delivered at Leicester 8th February, 1834 (Fig. 35).

The "Atlas" had cylinders 16 inches by 20 inches, and weighed 17 tons, in working order, without the tender; it was, therefore, when built, the largest, heaviest, and most powerful locomotive running; its working was therefore watched with considerable interest, as shown by the reports which had to be sent weekly to the directors, and to the makers, for several months, and the copies we have seen in the railway company's books show that the "Atlas" was "highly satisfactory." It was stationed at the Long Lane, now Coalville, and worked for fully 25 years, becoming the property of the Midland Railway Company when the Swannington line was purchased. This engine was

afterwards let on hire to colliery owners, and was ultimately sold to a contractor, being finally broken up after working for more than 40 years.

It was the first goods engine ever built combining the six coupled wheels and inside cylinders—a pattern since very generally employed. The boiler was flush-topped, clothed with polished oak strips, bound round with brass hoops; a steam-trumpet was provided. The

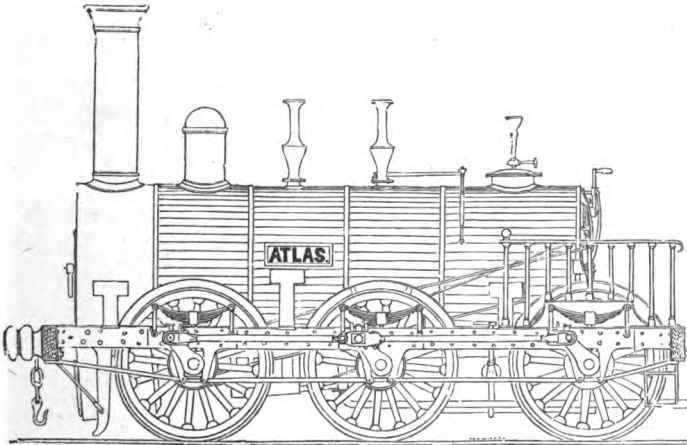

Fig. 35.—“Atlas,” Leicester and Swannington Railway, Feb. 1834.

wheels were 4 feet 6 inches diameter, the driving-wheels without flanges. A long and most complete series of experiments was carried out by Mr. Henry Cabry, the company’s engine superintendent, to ascertain exactly its performance, the result being that several other engines of similar design were built for other railways.

The Leicester and Swannington list (see page 45) shows that the first six engines for that line were built by Stephenson & Co. However, in 1833 some of the

directors desired to give a trial to Bury, Tayleur and the Haigh Foundry Company, but Mr. Stephenson being a director, they appear to have felt anxious to know the opinion of their colleague. It was, therefore, decided to write a private note on the subject, to which George Stephenson wrote the well-known reply:—
“Very well; I have no objection, but put them to this fair test; hang one of Bury’s engines on to one of mine, back to back; then let them go at it, and whichever walks away with the other, that’s the engine.”

The order was given to Mr. Bury in 1833, who personally assured the directors that “whatever Stephenson’s engine could do his could do,” and an engine named the “Liverpool” was placed upon the line during the year 1834 (Fig. 36).

The “Liverpool” (Fig. 36) ran upon four wheels, 4 feet 6 inches diameter, the cylinders being 12 inches diameter, and the stroke 20 inches. Weight of engine in working order 10 tons, weight of tender loaded 4 tons 10 cwt.

A peculiar feature in this engine was that the two eccentrics were placed upon the leading axle, and the eccentric rods passed in two spaces or boxes through the smoke-box to the valve-levers placed behind the buffer beam; it therefore followed that the admission of steam to the cylinders for working the driving-wheels was dependent upon the movement of the leading wheels and coupling-rods; consequently any failure of crank-pins or coupling-rods rendered the engine useless, and the books of the company recorded two or three such failures.

The engine was reversed by means of four handles, two to work the valves by hand, one gab-handle to

throw the small ends of the eccentric-rods into or out of gear, and one to move the two eccentrics.

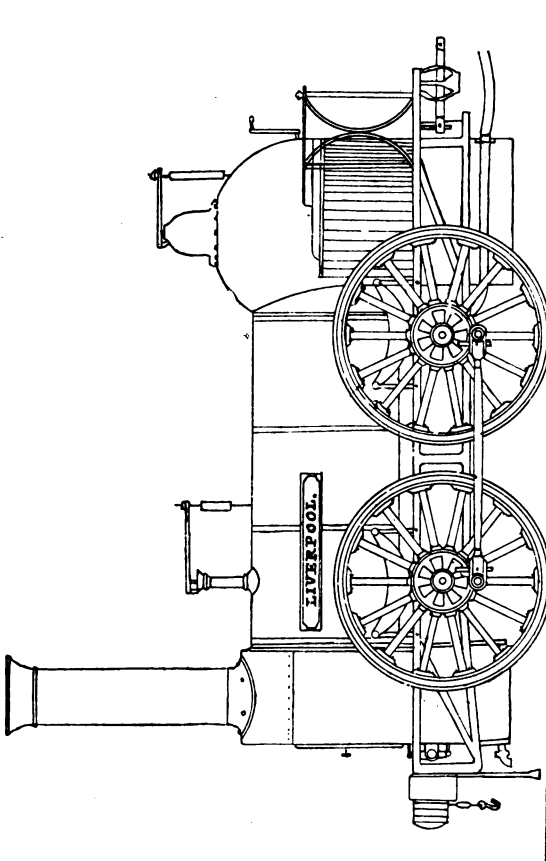

Fig. 36.—"Liverpool," No. 7, Leicester and Swannington Railway, 1834.

A series of practical trials were made with a train of waggons upon the Swannington Railway in the

presence of the directors, when Mr. Bury was ultimately obliged to admit that his engine (Fig. 36) was not equal to taking the trains conveyed by Stephenson's "Atlas" (Fig. 35).

In 1834, Messrs. Sharp, Roberts & Co. supplied three engines exactly similar to the "Experiment" (see Fig. 31), for the opening of the Dublin and Kingstown Railway, named "Hibernia," "Manchester," and "Britannia."

None of these engines were found satisfactory, and the firm abandoned the "bell-crank" design.

Mr. George Forrester opened the Vauxhall foundry at Liverpool in 1834, the first locomotive constructed by the firm being the "Swiftsure" (Fig. 37).

This engine was the first ever constructed combining *outside* horizontal cylinders and six wheels. The connecting-rod, it will be observed, worked upon an outside crank. The "Swiftsure" also was the first locomotive ever built with *four* eccentrics.

This valve gear was Forrester's patent, in which each of the four eccentrics was furnished with a fork or "gab-end," and placed vertically, as shown (Fig. 37.)

The chief dimensions of the "Swiftsure" were cylinders 11 by 18, driving-wheels 5 feet diameter, total length of frame 17 feet.

In consequence of the extreme distance apart of the cylinders, 7 feet 1 inch, and the unbalanced driving-wheels, this and other similar engines oscillated to a very serious and dangerous extent at even moderate speed. They were generally known as "Boxers," and proved a practical failure, as they could not be allowed to exert their full power or speed, as they either left the line or burst the rails.

During the year 1834 Messrs. Forrester built three four-wheeled engines for the Dublin and Kingstown

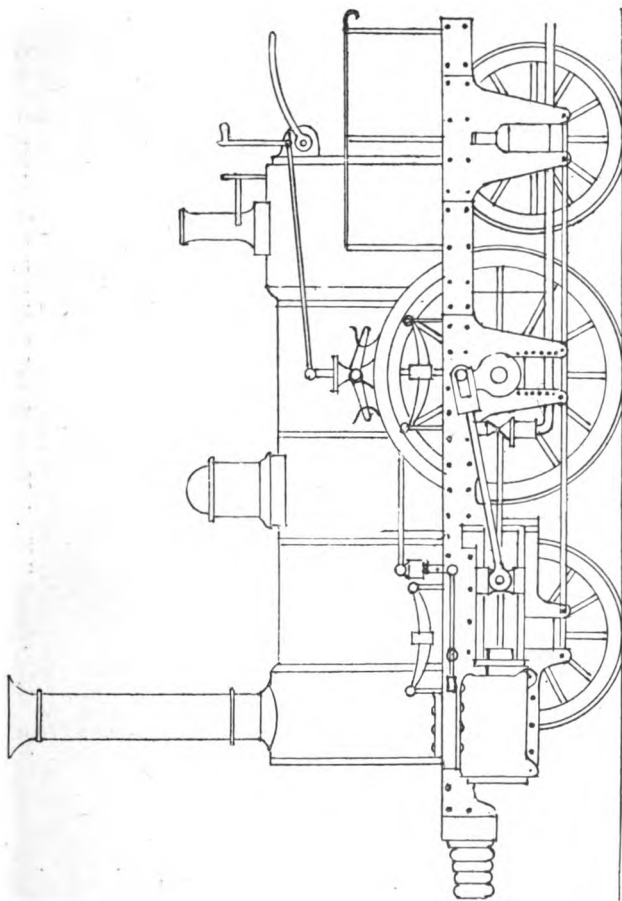

Fig. 37.—“Swiftsure,” No. 36, Liverpool and Manchester Railway, 1834.

Railway named “Dublin,” “Kingstown,” and “Vauxhall;” like the “Swiftsure,” they were very unsteady.

Messrs. R. & W. Hawthorn & Co., of Newcastle, designed and constructed in 1835 an engine for the Newcastle and Carlisle Railway (Fig. 38).

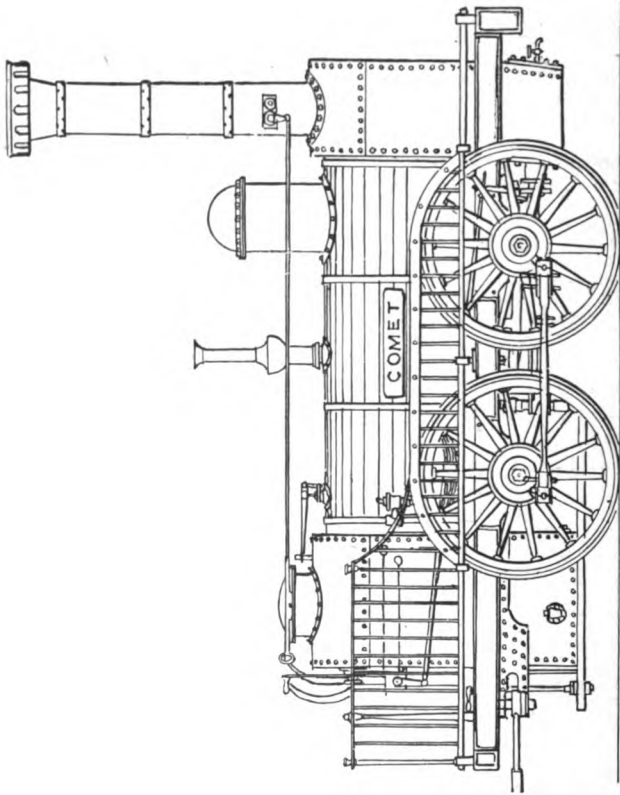

Fig. 38.—“Comet,” No. 1, Newcastle and Carlisle Railway, 1835.

The “Comet” (Fig. 38) conveyed one of the trains of passengers at the opening of the first section of the Newcastle and Carlisle Railway, March 9, 1835. It had four coupled wheels 4 feet diameter, the cylinders

were 12 inches diameter, and the stroke 16 inches; it will be seen that they were placed low down under the smoke-box, the piston-rod working under the leading axle. The valves of the "Comet" were actuated by Hawthorn's gear.

Heating surface of fire-box	35 square feet.
Heating surface of tubes	237 square feet,
	<hr/>
Total	272

Pressure of steam 60 lbs. per square inch. The tender ran upon four wheels and carried 680 gallons of water.

The "Comet" and several other engines of a similar design worked with great efficiency for many years upon the Newcastle and Carlisle Railway.

Another powerful locomotive being required for the Leicester and Swannington Railway, an order was given to Messrs. Tayleur & Co., of the Vulcan Foundry, near Warrington. The engine (Fig. 39) was delivered "in steam," at the West Bridge Station, Leicester, on the 2nd April, 1835. It had cylinders 16 by 20, and six coupled wheels of 4 feet 6 inches diameter, and was a very similar type to the "Atlas" (Fig. 35). The valve gear was of the loose eccentric type, described pages 44 and 45.

During the early part of the year 1836, Messrs. Tayleur & Co. completed the "Star" for the Liverpool and Manchester Railway, being the first of an order of ten "short-stroked" passenger engines. The cylinders were 14 inches diameter, only 12 inches stroke, the driving-wheels being 5 feet diameter. It was found in practice that the "short stroke" was not an advantage.

Messrs. R. Stephenson & Co. in 1836 constructed

several passenger engines upon a similar design to the "Patentee" (Fig. 34), but of larger size, one of which is shown in section (Fig. 40).

It will be observed (Fig. 40) that the steam dome was placed upon the fire-box casing, also that the engine had four fixed eccentrics, and forked-ends to the eccentric-rods; the two "forward" or two "back-

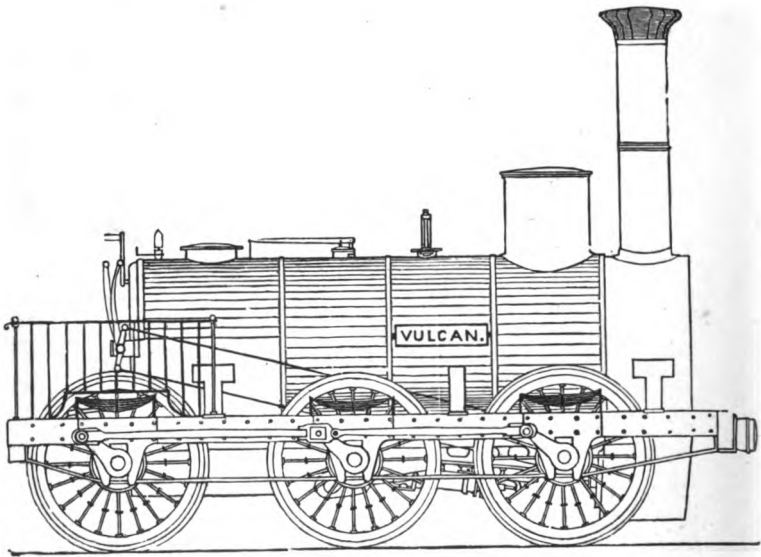

Fig. 39.—"Vulcan," No. 8, Leicester and Swannington Railway, 1835.

ward" forks were placed in or out of gear by one reversing lever; the valves were still retained above the cylinders.

The Newcastle and Carlisle Railway Company had the greatest objection to heavy engines, and to the concentration of weight; Messrs. R. Stephenson & Co.

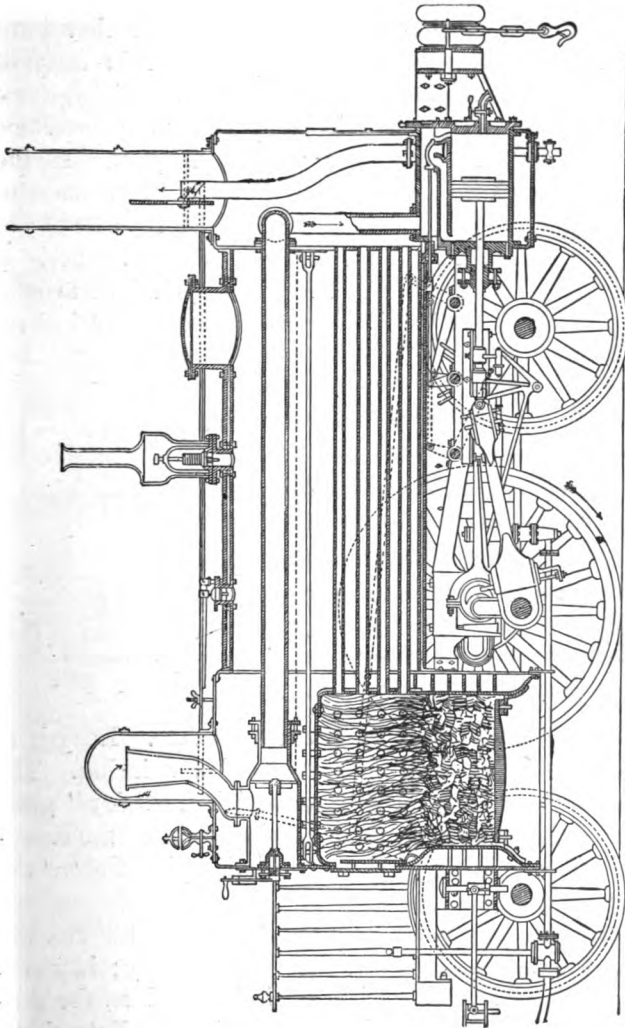

Fig. 40.—R. Stephenson's Standard Passenger Engine, 1836.

therefore built the "Atlas" (Fig. 41) for that line, in 1836, having cylinders 14 by 18, and six coupled wheels of 4 feet 6 inches diameter, the weight, however, in working order being only 11 tons 6½ cwts.

The "Ajax" (Fig. 42) was built by the Haigh Foundry Company, Wigan, and placed upon the Leicester and Swannington Railway, October, 1837; it had cylinders 14 by 18, and four coupled wheels 4 feet 6 inches diameter. The builders decided to employ tubes of 2¼ inches diameter instead of 1½ inches,

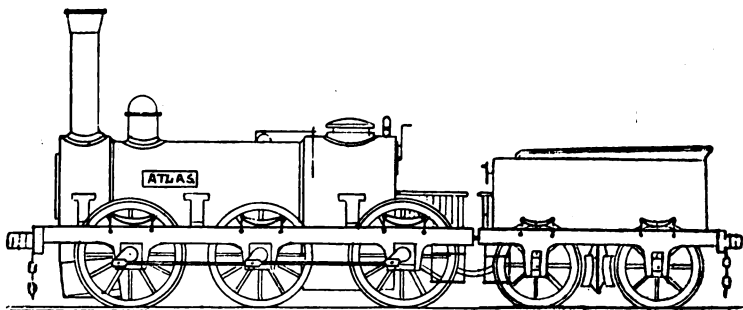

Fig. 41.—"Atlas," Newcastle and Carlisle Railway, 1836.

which was the usual practice at that date. Length of boiler between the tube plates 8 feet 8 inches. The valves were actuated by the "Haigh Foundry" gear, having four eccentrics and forked-ends to the eccentric-rods, the weight-bar shaft being placed *above* the eccentric-rod.

Messrs. Hawthorn constructed the "Swift," No. 26, for the Stockton and Darlington Railway; it was a four-wheeled engine with vertical cylinders, the connecting-rods working down to an intermediate shaft, coupled at each side to the wheel crank-pins by coup-

ling-rods. No. 27, for the same railway, was named the "Arrow," built by T. Hackworth in 1837, the cylinders were no less than 22 inches diameter, and the stroke only 9 inches. Neither of these engines was successful, and the designs were abandoned.

The first portion of the London and Birmingham Railway was opened July 20th, 1837, and the com-

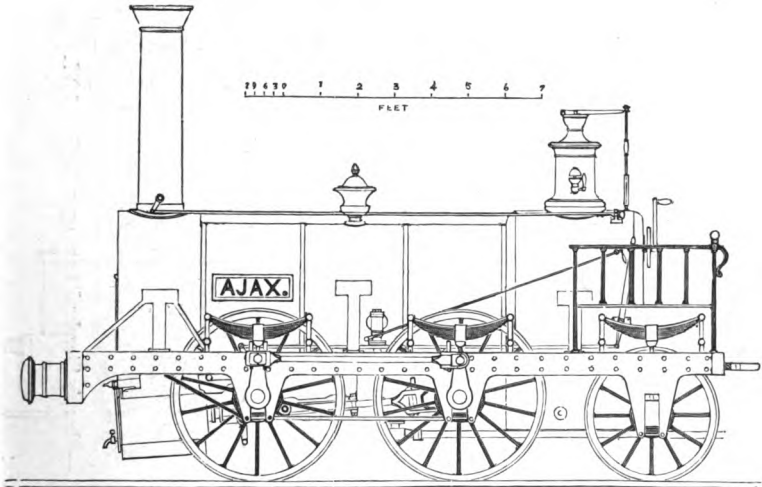

Fig. 42.—"Ajax," No. 9, Leicester and Swannington Railway, 1837.

pleted line September 17th, 1838. Mr. Edward Bury, of Liverpool, on becoming locomotive superintendent at Wolverton, unfortunately induced the directors to accept his views in favour of four-wheeled engines. The whole of that company's locomotive stock (with one exception) therefore had only four wheels. The passenger engines had single driving-wheels, 5 feet 6 inches diameter, and the "goods" had four coupled wheels, some 4 feet 6 inches and others 5 feet dia-

meter, the goods engines being of very similar construction to the "Liverpool," illustrated (Fig. 36).

Soon after Messrs. Stephenson adopted the engine

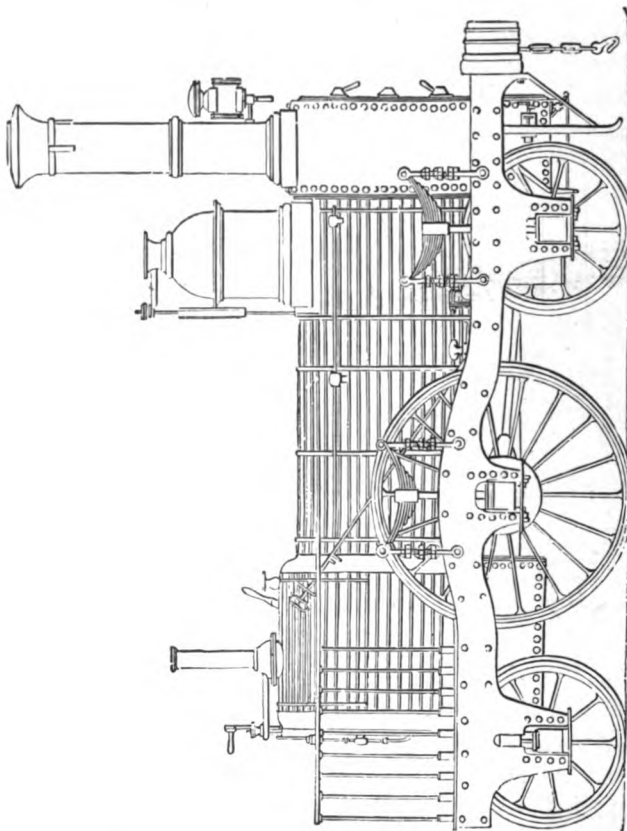

Fig. 43.—Sharp's Standard Passenger Engine, 1837.

(Fig. 40) as their standard passenger locomotive. Messrs. Sharp, Roberts & Co., of the Atlas Works, Manchester, adopted the design shown (Fig. 43).

During the year 1837 Sharp, Roberts & Co. placed several of their standard engines upon the Grand Junction Railway, named—

"Centaur" .. No. 12		"Wizard" .. No. 21
"Caliban" .. " 17		"Basilisk" .. " 22
"Cerberus" .. " 18		"Vizier" .. " 23
"Doctor Dalton" .. " 19		"Sirocco" .. " 24
"Eagle" .. " 20		"Harpy" .. " 25

All these had cylinders $12\frac{1}{2} \times 18$ and driving wheels 5 feet diameter, their weight when empty being 12 tons 5 cwts.

The design illustrated (Fig. 43) continued to be Sharp's standard pattern for nearly twenty years, and many hundreds of engines were built—their size and power of course increasing from $12\frac{1}{2}$ inch cylinders to 17 inches, and the driving wheels from 5 feet to 6 feet 6 inches; and several engines of this old design were at work till a very few years ago, and it is even believed that a few can be found on small branches at the present day.

CHAPTER III.

THE COMMENCEMENT OF THE BATTLE OF THE GAUGES.

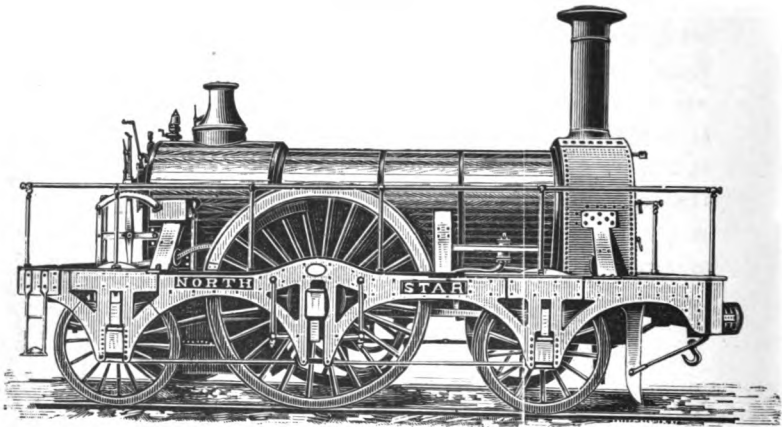

Fig. 44.—“North Star,” No. 1, Great Western Railway, 1837.

So far it has only been necessary to refer to engines running upon the ordinary 4 feet $8\frac{1}{2}$ inch gauge, that being the only width employed in this country, with the exception of a gauge of 4 feet 6 inches on a few Scotch lines. However, Mr. Brunel, when laying out the Great Western Railway, unfortunately decided to adopt a broad gauge of 7 feet, and Parliament unwisely permitted the introduction of various gauges.

The broad gauge, however, although practically unnecessary and financially a failure, did more than anything else to improve and develop the locomotive engine, by creating the rivalry known as the "battle of the gauges," which lasted for fully fifteen years.

The directors of the Great Western Railway having appointed Mr. (afterwards Sir Daniel) Gooch as locomotive superintendent, the duty devolved upon him to design and provide the necessary engines.

Mr. Gooch, having inspected all the locomotives on other railways, considered that 5 feet 6 inch wheels were far too small; he therefore designed the engines for the Great Western with driving-wheels of 6, 7, and 8 feet diameter, and placed orders for their construction with the leading builders of that time. The first engine delivered on the line was the "North Star" (Fig. 44), constructed by R. Stephenson & Co., 1837. It was No. 1 in the books of the railway company, and No. 150 in those of the makers, the following being the chief dimensions:—

Wheels—Diameter of driving	7ft.
Diameter of leading and trailing	4ft.
Cylinders—Diameter	16in.
Stroke	18in.
Boiler—Length of barrel	9ft. 5in.
Diameter of barrel	3ft. 11in.
Number of tubes	167.
Length of tubes	9ft. 10½in.
Diameter (outside)	1½in.
Copper—fire-box—Length	3ft. 5½in.
Width	3ft. 10½in.
Height	4ft. 4½in.
Heating surface—Fire-box	94 sq. ft.
Tubes	756 sq. ft.
Total	850 sq. ft.
Fire-grate area	11·76 sq.

The "North Star" ran a trial trip January 1st, 1838,

and commenced daily work when the first portion of the Great Western Railway was opened to Maidenhead, on June 4th, 1838.

It continued at work for thirty-two years, and ran a distance of 429,000 miles, and is still preserved at Swindon Works, and at the present time it is under consideration to place this interesting relic in the South Kensington Museum.

Messrs. Stephenson also constructed several other engines of very similar design, named "Morning Star," "Evening Star," "Dog Star," "Polar Star," for the same railway.

The "Vulcan," the "Æolus," and the "Bacchus," built by Tayleur & Co., 1837, had 8-foot driving-wheels, the axle-boxes for which were placed above the framing as in the "Planet" (Fig. 20), and on the opening day of the Great Western Railway "Æolus," ran the distance from Maidenhead to London at an average speed of twenty-four miles an hour, including three stoppages.

The Grand Junction Railway, opened 4th July, 1837, formed a very important link, connecting the London and Birmingham Railway, at Birmingham, with the Liverpool and Manchester Railway at Newton Junction. Mr. Locke, the company's engineer, decided that all the locomotives should run on six wheels. The passenger engines were designed and ordered to have driving-wheels of 5 feet 6 inches diameter, but in view of the larger wheels introduced by Messrs. Brunel and Gooch, and the taunts of the advocates of the broad gauge that the narrow gauge could not have large wheels, it was decided that a few of those engines (the construction of which had not proceeded too far) should

be provided with 6-foot wheels, one of which is illustrated (Fig. 45).

This locomotive was constructed by the Haigh Foundry Company, and delivered September 20th,

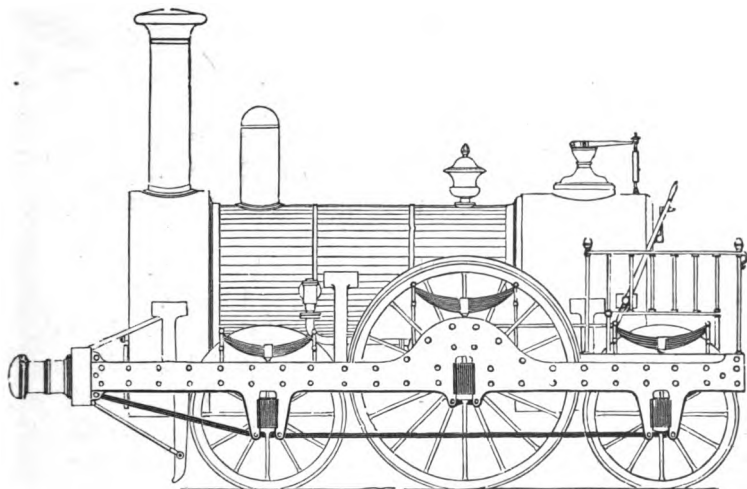

Fig. 45.—Grand Junction Railway, 1838.

1838, and is interesting, showing as it does a good specimen of narrow-gauge engine of that period.

Diameter of driving wheels	6 feet 0 inch.
Diameter of carrying wheels	4 ,, 0 ,,
Diameter of cylinders (13 $\frac{1}{2}$)	1 ,, 1 $\frac{1}{2}$,,
Length of stroke (18)	1 ,, 6 ,,
Number of tubes, 102	
Diameter of tubes inside	0 ,, 2 ,,
Heating surface of tubes	480 square feet.
Heating surface of fire-box	58 square feet.
Total	538 square feet.

The valve gear consisted of the Haigh Foundry pattern, having four fixed eccentrics. Engines of this class

THE LOCOMOTIVE.

worked with great efficiency upon the Grand Junction and other railways for many years.

Mr. T. E. Harrison, in December, 1836, designed, and during 1837-8, Messrs. Hawthorn constructed, two locomotives for the Great Western Railway. These engines had the cylinders and motion upon a separate frame and wheels from the fire-box and boiler.

One of these named, the "Thunderer," had wheels 6 feet diameter, but geared up, three to one, in order to be equal in effect to a wheel 18 feet in diameter.

The other, named "Hurricane," had a pair of driving-wheels 10 feet diameter, the largest ever made, illustrated (Fig. 46).

The boiler, fire-box, and frame upon which they were placed, also the tender, were of the same dimensions in each case. The cylinders and stroke were also similar.

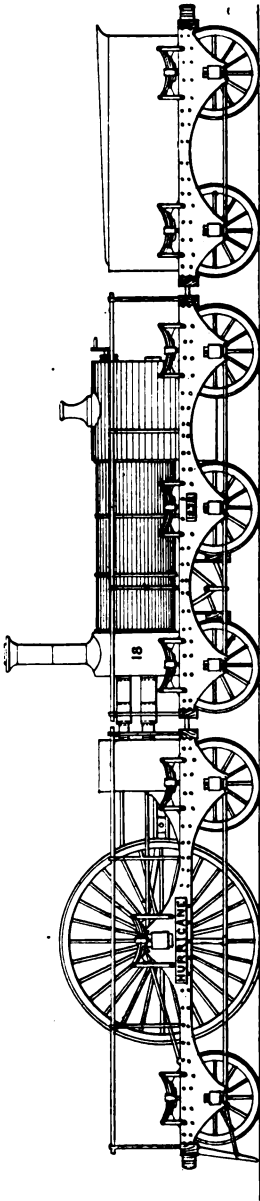

Fig. 46.—The "Hurricane," 1838.

The following are the dimensions of the "Hurricane."

Diameter of driving wheels	10 feet
Diameter of cylinders	16 inches
Length of stroke	20 inches

The boiler contained 135 brass tubes. The fire-box was of copper, and divided by a mid-feather.

Heating surface of tubes	516 square feet
Heating surface of fire-box	108 square feet
Total	624 square feet

Weight of the six-wheeled engine 11 tons, of which 6 tons rested upon the 10-foot driving wheels. The weight of the six-wheeled frame with the boiler and fire-box was 12 tons.

The steam from the boiler to the cylinders was conveyed by a jointed pipe and the exhaust steam was returned to the chimney by a similar pipe. The engine-driver stood upon the engine in front of the driving axle, and the fireman behind the fire-box in the usual way. Both of these extraordinary engines proved failures, one great cause being that there was so little weight available for adhesion.

An examination of Fig. 46 shows that the "Hurricane" had a good sound framing, and there is every reason to believe that if the boiler had been placed over the driving axle, instead of on an independent frame, the engine would have been considerably improved.

The Arbroath and Forfar Railway, when opened on the 3rd January, 1839, had a gauge of 5 feet 6 inches, and during the year 1838, Messrs. Stirling & Co., of Dundee, designed and constructed three locomotives for that line, named "Victoria" (Fig. 47), "Britannia," and "Caledonia."

Messrs. Stirling, having visited the Liverpool and Manchester Railway, and examined the "Swiftsure"

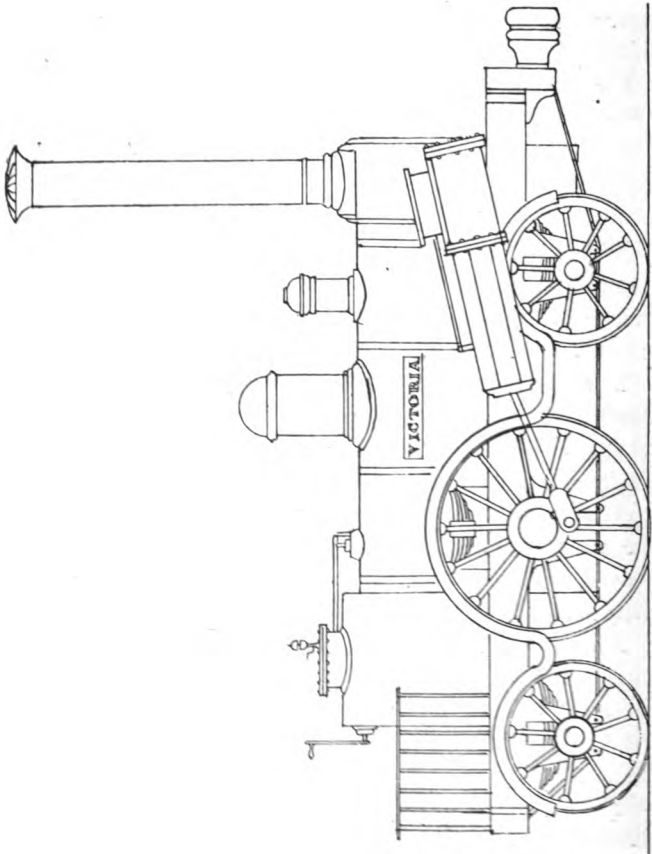

Fig. 47.—"Victoria," built by Stirling & Co., 1838.

(Fig. 37), came to the conclusion that an outside frame was unnecessary. The Arbroath and Forfar engines were therefore the first to combine inside bearings,

outside cylinders, and six wheels; they had cylinders 12 by 18; driving-wheels 5 feet diameter. These locomotives worked very satisfactorily for many years, and until the line was leased to the Caledonian Company and the gauge altered to 4 feet 8½ inches.

The Haigh Foundry Company, Wigan, constructed

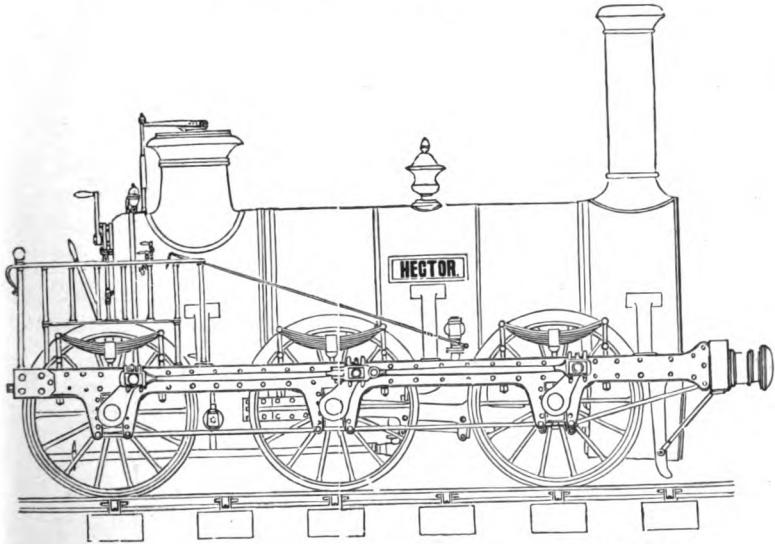

Fig. 48.—"Hector," No. 10, Leicester and Swannington Railway, September, 1839.

the "Hector" (Fig. 48), for the Leicester and Swannington Railway, and it commenced work upon that line, September, 1839.

"Hector" was a six-wheeled coupled goods engine, having cylinders 16 inches by 20 inches, and wheels 4 feet 6 inches diameter. Total heating surface, 688 square feet.

The valve gear was the "Haigh Foundry" pattern, having four fixed eccentrics, and forked ends to the eccentric-rods; the boiler was "clothed" with sheet iron plate instead of with polished wood, which was the usual practice at that time. The driving-wheels were without flanges. This locomotive was constructed to work with a steam pressure of 120 lbs. per square inch if necessary, but for the first few years it was only worked with 80 to 90 lbs. The urn-shaped vase upon the boiler contained a "lock-up safety valve" pressed to blow off at 91 lbs.

The "Hector," was regarded as such a powerful engine that invitations were issued to the locomotive officials of the other companies to witness its performance between Coalville and Bagworth, and as a result similar engines were ordered for the Manchester and Leeds, North Midland, Great Western, and Liverpool and Manchester Railways.

The first part of the Birmingham and Gloucester Railway was opened 24th June, 1840; this line was intended to form a portion of a great through-route between the north and west of England; it was, therefore, a very serious mistake on the part of the engineer, Captain Moorsom, to have designed and constructed the great Lickey incline of 1 in 37 for a distance of over two miles, extending from Bromsgrove to Blackwell, and it was an equal mistake to suppose that English locomotive builders could not construct an engine to ascend the incline. However, he ordered eight locomotives from Norris & Co., of Philadelphia, the first four to arrive being named "England," "Philadelphia," "Columbia," and "Atlantic." These engines had a four-wheeled leading bogie, a single

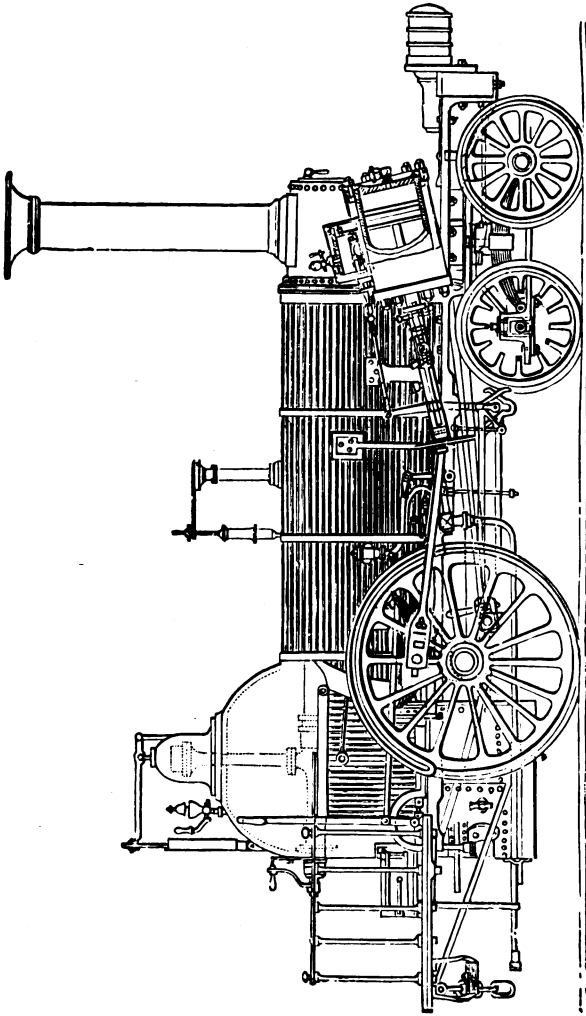

Fig. 49.—“Philadelphia,” Birmingham and Gloucester Railway, 1840.

pair of driving-wheels placed in front of the fire-box, and outside inclined cylinders.

Diameter of cylinders.. .. .	10½ ins.
Length of stroke	18 ins.
Diameter of driving-wheels	4 ft.
Weight in working order	9 tons 11¼ cwt.

Their usual performance up the "Lickey" was 33 tons at 12 to 15 miles per hour, 39½ tons at 10½ miles, or a maximum load of 53¼ tons at 8½ miles.

One of these American engines having 11½ cylinders was lent for a few weeks for trial upon the Grand Junction Railway, when it was ascertained that it conveyed loads of 100 to 120 tons on an incline of 1 in 330 at 14 to 22½ miles per hour; or on an incline of 1 in 177 at 10 to 14 miles per hour. The mean of seven journeys from Birmingham to Liverpool, with gross loads of about 100 tons, showed a consumption of 50 lbs. of coke per mile, and an evaporation of 4·27 lbs. of water per pound of coke.

The American engines having worked with great success upon the Lickey incline for a few weeks, Mr. Edward Bury, of Wolverton, wrote to the directors "to declare that whatever American engines could do his could do," and sent the London and Birmingham Company's engine named "Bury" to prove his assertion.

Mr. Bury, himself driving, started from Bromsgrove, and humorously called to Mr. Gwynn, who had come with the American engines, to join him. "No," he replied, "it's no use, you'll soon come back again," and back again Mr. Bury and his engine came, having stuck before getting half-way up the incline.

In consequence of the taunts which appeared in an

American newspaper, that "the English could make inclines, but had to come to America for engines to work them," Mr. J. E. McConnell, the locomotive superintendent of the Birmingham and Gloucester Railway, obtained the sanction of his directors to construct a powerful tank engine at the Bromsgrove works, and it commenced duty in 1845.

This engine had six coupled wheels of 3 feet 9 inches diameter, cylinders 18 inches diameter, a stroke of 26 inches, and a total weight of 30 tons loaded. This engine worked successfully for a number of years.

Mr. Robert Stephenson's attention was given, early in the year 1842, to the fact that the chimneys and smoke-boxes were very quickly destroyed; he therefore made some experiments with North Midland Company's engines at Derby to ascertain the degree of heat which was escaping. First he placed tin in small iron conical cups and suspended them in the "smoke box," and it was found to disappear quickly; next, lead was tried in the same manner, and was found to melt nearly as easily; and, lastly, zinc was tried, which was soon driven off in vapour, clearly indicating a temperature of 773 degs. in the chimney, and showing that a great waste was taking place. To overcome this evil, Mr. Stephenson decided to lengthen the tubes of locomotives from 9 ft. to 13 or 14 ft., but he found that to obtain a patent for the invention he would have to employ an unlimited term, as to fix a length would be useless, as a few inches more or less would enable others to evade the patent; he therefore adopted the name "long boiler," and placed all the axles under the barrel or circular part of the boiler.

In the first of these "long-boiler" engines, the

driving-wheels were placed between the fore and hind carrying-wheels, the cylinders being kept forward to

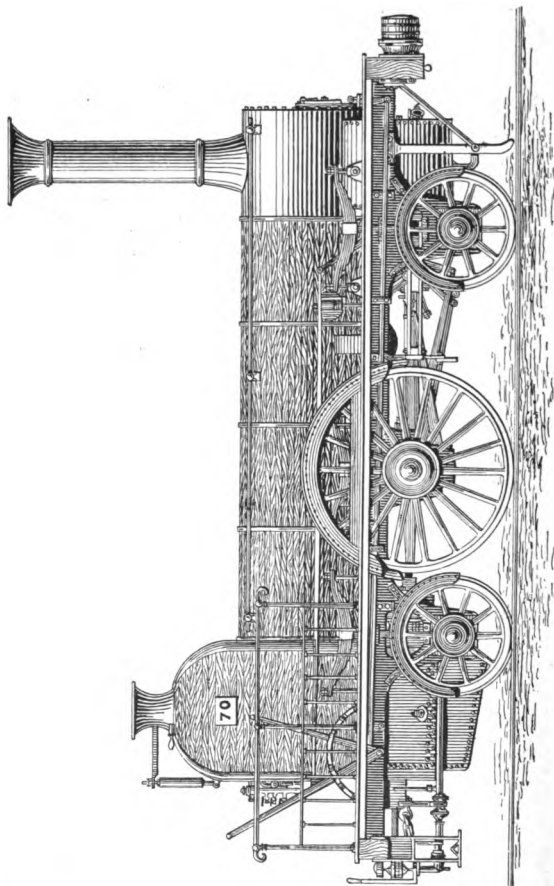

Fig. 50.—North Midland Railway, No. 70, 1842.

the outside of the smoke-box (Fig. 50). Several engines of this design were built for the North Midland Railway Company and other lines.

Further experiments at Derby in 1843 proved that the "long-boiler" was successful in reducing the heat in the chimney to very little over 442 degs., as upon placing tin in the smoke-box it was found just to melt at the corners.

In 1844 Mr. Robert Stephenson decided to place the four carrying-wheels in front and the driving-wheels close in front of the fire-box; in 1846 he added a pair of trailing wheels behind the fire-box, thus converting his long-boiler engine into an eight-wheeled locomotive.

In the year 1846 it was reported that at least 150 locomotives, according to this long-boiler pattern, were in constant use in this country and on the continental railways.

Valve-gear having loose eccentrics (described p. 45) was found to be far from satisfactory, and many other gears were tried—for instance, those of Carmichael, Hawthorn, Haigh Foundry, Stephenson, Gray, Dodd and others—but none of these fulfilled all that was necessary. The eccentric-rods in nearly all valve gears, previously to 1842, were provided with "forks" or "gabs," which engaged with pins attached to the arms of the valve rods. In practice these pins were frequently broken off.

Stephenson's valve-gear, generally known as "fork motion," is illustrated in Fig. 51, and shows the form of gear used by that firm between the years 1835 and 1842.

Mr. William Howe, who was a fitter in the employ of R. Stephenson and Co., decided to place a curved link between the ends of the forward and backward eccentric-rods to take the place of the forks. He

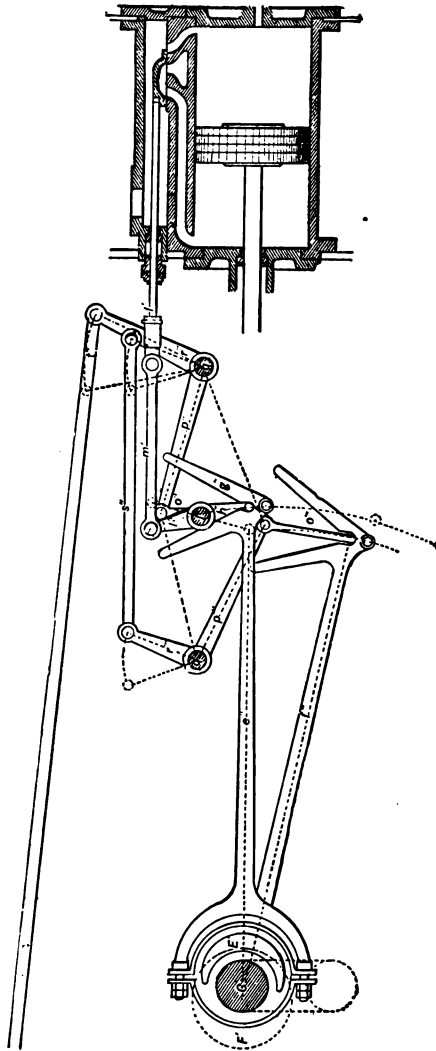

Fig. 51.—Stephenson's Fork Motion, 1835 to 1842.

made a pencil sketch and wooden model, which were shown to Mr. Robert Stephenson, who, seeing its merits, ordered it to be fitted to all engines constructed at his works. At that time (August, 1842) two locomotives were being built for the North Midland Railway, Nos. 70 and 71. No. 70 was already fitted with "fork motion," but No. 71 was supplied with Howe's link motion (Fig. 52), and commenced to run on September 10, 1842.

Some correspondents to newspapers have expressed the opinion that "the introduction of the 'link' was not an invention, but an improvement." By whichever name it be known, the fact remains that Mr. Howe's introduction of the link at once removed all the difficulties which had for years caused trouble with the "fork motion," and it did far more than this, by producing a complete and simple means of cutting off steam for expansive working.

It has also been contended that "the merits of the gear for 'cutting off' were probably not known at first." Now, as a fact, the reversing lever rack of the

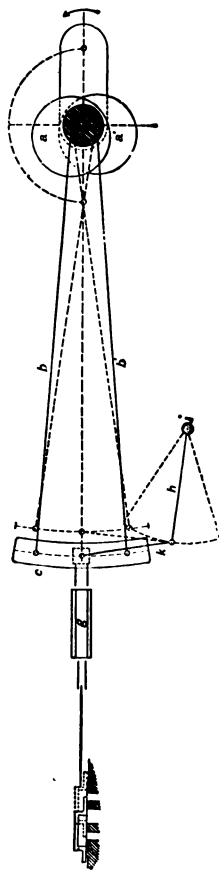

Fig. 52.—Howe's Link Motion, 1842.

first engine ever fitted with link motion had seven notches on either side of the centre, and steam could be cut off at various proportions of the stroke, from $4\frac{1}{4}$ inches to $17\frac{1}{8}$ inches. It is therefore perfectly certain that the expansive working of the gear was fully understood before the first engine left the Newcastle works, for had it not been intended to work expansively, "the seven notches on either side of the centre" would have been useless. There is also conclusive proof that the action of the gear was fully understood by Mr. Howe, for he came himself to the North Midland Railway with the engine No. 70 in order to instruct the engine-driver how to work his gear to the best advantage. Howe's link motion was at once adopted by nearly all locomotive builders, it is in use in all parts of the world, and to this day there is no valve gear to equal it. The "link motion" is frequently spoken of as Stephenson's, but this is an error, as Howe was the inventor, and Mr. R. Stephenson himself always spoke of it as Howe's.

Mr. Alexander Allan (whose death only took place in 1891) entered the service of the Grand Junction Railway Company, February, 1840, and took charge of that company's locomotive establishment at Edge Hill, Liverpool, under Mr. Buddicom, the chief mechanical engineer. From the copy of the official list in the writer's possession, it appears that, at the close of the year 1839, the Grand Junction Company possessed 59 engines. These all ran upon six wheels, had double frames and inside cylinders, 57 of them had "single" driving-wheels, and two, "Sirius," No. 30, and "Gorgon," No. 41, were the only "goods" engines, they having the leading and driving-wheels coupled.

Names and numbers of the Grand Junction Company's engines, 1837 to 1840 :—

1. Saracen.	21. Wizard.	41. Gorgon.
2. Hecla.	22. Basilisk.	42. Sunbeam.
3. Shark.	23. Vizier.	43. Vampire.
4. Hecate.	24. Sirocco.	44. Harlequin.
5. Falcon.	25. Harpy.	45. Sybil.
6. Stentor.	26. Æolus.	46. Medea.
7. Scorpion.	27. Merlin.	47. Vulture.
8. Wildfire.	28. Prometheus.	48. Oberon.
9. Alecto.	29. Alaric.	49. Columbine.
10. Dragon.	30. Sirius.	50. Hornet.
11. Zamiel.	31. Pegasus.	51. Torch.
12. Centaur.	32. Tamerlane.	52. Diomede.
13. Prospero.	33. Erebus.	53. Clio.
14. Witch.	34. Phœbus.	54. Medusa.
15. Phalaris.	35. Talisman.	55. Lucifer.
16. Lynx.	36. Thalaba.	56. Phantom.
17. Caliban.	37. Hawk.	57. Sultan.
18. Cerberus.	38. Camilla.	58. Syren.
19. Dr. Dalton.	39. Tartarus.	59. Vandal.
20. Eagle.	40. Jason.	60. Tantalus.

Upon taking charge, Mr. Allan found that three engines, namely, "Æolus," 26, "Tartarus," 39, and "Sunbeam," 42, were in a very bad condition, having broken crank-axles and defective framings; he therefore decided to rebuild them.

Mr. Allan's experience as manager of Messrs. Forrester's works had led him to become an advocate of outside cylinder engines; he therefore converted the three above-mentioned engines from inside cylinder to outside; the leading and trailing wheels had outside bearings as previously, but the driving-wheels had the outside bearings removed, and the connecting-rod placed direct upon a crank-pin upon the boss of the wheel. The broken crank-axle was of course in each case replaced by a straight axle.

The first of these rebuilt engines, "Æolus," was put to work towards the close of the year 1840, "Tartarus" and "Sunbeam" following in 1841. At this period the Grand Junction Railway Company decided to build locomotive works at Crewe, and to construct its own engines. The Crewe works were opened early in the year 1843, Mr. Allan taking charge thereof as superintendent, Mr. F. Trevithick being the company's chief mechanical engineer.

Mr. Allan designed and constructed the passenger engines upon the model of the rebuilt "Æolus," and employed driving-wheels of 5 feet 6 inches and 6 feet diameter, the cylinders placed outside, being 15 inches and the stroke 20 inches.

The goods engines (Fig. 53) were of a similar design, but the driving and trailing wheels were 5 feet diameter and coupled, the cylinders being outside and 15 × 20.

These two classes became generally known as the "Crewe pattern," and when, on July 16, 1846, the Grand Junction, London and Birmingham, and Manchester and Birmingham companies amalgamated and became the London and North-Western Railway, Mr. Allan continued to build his Crewe pattern for the northern division of that railway. He was also the inventor of the "Allan straight link motion."

The goods engines (Fig. 53) were 22 feet 5 inches in length over buffers, and their weight in working order $19\frac{1}{2}$ tons; they conveyed the goods and mineral traffic on the northern division of the London and North-Western Railway for many years, and, when superseded by Mr. Ramsbottom's six-coupled engines, they were converted into tank engines for

branch passenger traffic, and some of them are at work at the present day.

During the year 1843 the London and South-Western Railway adopted outside cylinder engines of similar design to those introduced upon the Grand Junction Railway at Crewe. The locomotive superintendent, Mr. John V. Gooch, constructed some of these engines with driving-wheels of 6 feet 6 inches, and others with

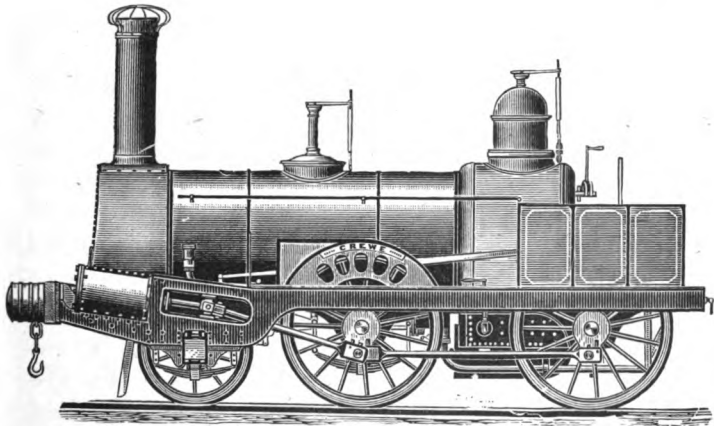

Fig. 53.—Mr. Allan's Goods Engines, Crewe Works, 1843 to 1857.

7 feet wheels, the largest then in use on the narrow gauge.

In December, 1845, a series of experiments was conducted upon the Great Western Railway, between London and Didcot, with an engine named "Ixion" having inside cylinders $15\frac{3}{4}$ inches diameter and 18 inches stroke; four carrying-wheels; driving-wheels, 7 feet diameter; grate, 13.4 feet; surface of fire-box, 97 feet; tubes, 2 inches diameter, 131 in number, surface

732 feet; total heating surface, 829 feet; weight, empty, 22 tons; weight of tender, empty, 8 tons. This engine attained a maximum speed of 62 miles per hour with an average load of $76\frac{1}{2}$ tons, and an average speed of 50 miles on a trip of 53 miles; the coke consumed was at the rate of 35.3 lbs. per mile, and water evaporated 201.5 feet per hour.

Mr. T. R. Crampton took out a patent in 1843 for an arrangement or position of locomotive wheels, in which the small, or carrying-wheels, were placed in front and the large driving-wheels at the trailing end, behind the fire-box; the cylinders being outside. It was claimed that this design solved the problem of obtaining a large driving-wheel with a low centre line of boiler. (The idea, however, was not quite new, as in 1833 Mr. Baldwin, in America, constructed several engines having the driving-wheels behind the fire-box.)

During the year 1846 Messrs. Tulk and Ley constructed two engines at the Lowca works, Whitehaven, from the designs of Mr. Crampton, for the Namur and Liège Railway, and they were named "Namur" and "Liège."

These engines ran upon six wheels, and had outside cylinders, 16 × 20, and a pair of 7 feet driving wheels placed behind the fire-box.

In practice the performance of these two engines was found to be equal to a load of 80 tons, exclusive of engine and tender, at 51 miles per hour on a level; and 50 tons at 62 miles per hour on the level.

Before exportation the "Namur" was tried experimentally upon the London and North-Western Railway, and attained a higher speed than any broad-

gauge locomotive at that period; this result giving the greatest satisfaction to the narrow-gauge advocates.

In 1846 Messrs. Stephenson and Howe patented a three-cylinder locomotive having two outside and one inside cylinder in order "to counteract the alternate lifting on the opposite side of the engine." Two of these engines were constructed and tried experimentally; they worked satisfactorily. As is the case with the three-cylinder locomotives in use at the present day, these engines had three sets of motion to be provided and maintained; however, when new they ran at a higher speed than the broad-gauge engines.

At this period the battle of the gauges was at its height and the rivalry was most keen; the Royal Commission had been appointed July, 1845, to decide between the "broad" and "narrow" gauges.

During the years 1838 to 1845, Mr. Bury was strongly urged by the narrow-gauge advocates to build some larger engines for the London and Birmingham Railway in order to compete with the Great Western Railway. This, however, he firmly refused to do, and was perfectly content to continue to place the small four-wheeled engines on that line, and a list now before us shows that even in August, 1845, the company had 89 four-wheeled engines and one six-wheeled ballast engine. There can be no question that the broad gauge gained many friends, in London especially, on account of Mr. Bury continuing to run small four-wheeled engines to London. The advocates of the broad gauge, of course, urged the public to compare the large six-wheeled engines at Paddington with the little four-wheelers at Euston. Thus it

will be seen that Mr. Bury, although himself opposed to the broad gauge, by his policy played into the hands of the broad-gauge advocates; indeed it was remarked at the time that Mr. Bury did more harm to the narrow gauge cause than any of its enemies.

The narrow-gauge engines were successfully maintaining their position (upon every line but the London and Birmingham), and proving that whatever could be done upon the 7 feet gauge could be equally well done on the 4 feet $8\frac{1}{2}$ inches gauge. It therefore became necessary for the Great Western Company to make some "striking improvement" in order to show what could be obtained upon the broad gauge, and Mr. (afterwards Sir Daniel) Gooch, the company's locomotive superintendent, accordingly designed and constructed at the Swindon works a new and very powerful class of express engine which he regarded as the "ultimatum" for the broad gauge.

The first of this class was named "Great Western," and commenced work April, 1846.

The engine (Fig. 54) has eight wheels—namely, four leading-wheels arranged in a group (but not in a bogie), a single pair of driving-wheels 8 feet diameter, having no flanges, and a small trailing pair of wheels. The cylinders 18 by 24, 300 tubes, and 1,767 square feet of heating surface. The valve gear was the well-known fixed link motion introduced by Mr. Gooch.

This splendid locomotive was highly successful, and was found capable of evaporating 300 cubic feet of water per hour, and it is a noteworthy fact that engines of this class appear to be among the most economical ever run, the consumption of coal being as low as $2\frac{1}{2}$ lbs. per horse-power per hour.

This engine upon several occasions started from Paddington and stopped at Didcot, $53\frac{1}{2}$ miles, in 47 minutes, and obtained a maximum speed of 78 miles

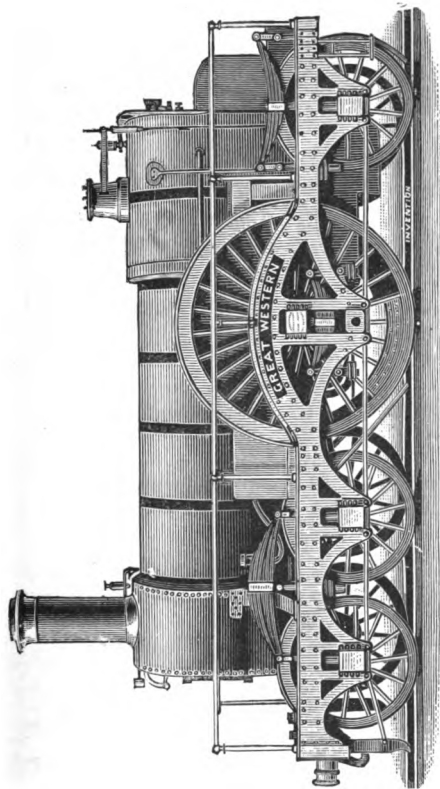

Fig. 54.—"Great Western," Great Western Railway, 1846.

an hour. 29 other locomotives were built between 1847 and 1855 similar to Fig. 54; most of these (of course with new boilers) were still at work till May, 1892.

Through the courtesy of Mr. William Dean, loco-

motive superintendent of the Great Western Railway, the complete list of the 30 engines is given, showing the miles run before being "rebuilt" :—

BROAD GAUGE ENGINES, "GREAT WESTERN" CLASS.

Name of Engine.	Builder.	Date.		Total mileage before renewal.
		Built.	Condemned or rebuilt.	
Great Western	G.W.R.	April.. 1846	Dec... 1870	370,687
Iron Duke	"	" .. 1847	Oct... 1871	607,412
Lightning	"	" .. "	April 1878	816,601
Great Britain	"	July .. "	Oct... 1880	403,644
Emperor	"	Sept... "	June 1873	690,225
Paaha	"	Nov... "	" 1876	613,038
Sultan	"	" .. "	Aug. "	727,300
Courier	"	June .. 1848	Nov. 1877	746,120
Tartar	"	July .. "	Aug. 1876	731,817
Dragon	"	Aug... "	Dec... 1872	670,757
Warlock	"	" .. "	June 1874	639,410
Wizard	"	Sept... "	Nov. 1875	711,908
Rougemont	"	Oct. .. "	Aug. 1879	772,401
Hirondelle	"	Dec. .. "	May 1873	605,010
Tornado	"	March 1849	March 1881	688,000
Swallow	"	June .. "	Aug. 1871	569,232
Timour	"	Aug... "	Nov. "	569,893
Prometheus	"	March 1850	June 1870	538,025
Perseus	"	June .. "	Dec... 1880	722,458
Estafette	"	Sept... "	June 1870	504,544
Rover	"	" .. "	" 1871	461,344
Amazon	"	March 1851	July 1877	729,840
Lord of the Isles, built 1850, commenced work July, 1852	"	July .. 1852	" 1881	789,300
Alma	Rothwell	Nov... 1854	June 1872	444,600
Balaclava	"	Dec. .. "	Nov. 1871	406,425
Inkerman	"	March 1855	Oct... 1877	650,220
Kertch	"	April.. "	Dec... 1872	326,246
Crimea	"	May .. "	Sept. 1878	605,701
Eupatoria	"	" .. "	Oct... "	618,275
Sebastopol	"	July .. "	" 1880	707,148

The "Lord of the Isles," built 1850, was sent to the Exhibition of 1851, also to the Edinburgh Exhibition of 1890, and with the removal of the broad gauge on the 23rd May, 1892, the whole of this type of engines necessarily ceased from their labours; but one is now being sent to the Chicago Exhibition.

The average consumption of coal of the whole of the engines of this class, when working on the Great Western Railway, was about 27 lbs. per mile.

Such facts as the above show that the late Sir Daniel Gooch took a very important part in the development of the locomotive.

The success of the "Great Western" (Fig. 54) at once caused the narrow-gauge lines to require larger engines. The London and North-Western Company gave orders to Messrs. Tulk and Ley for an engine, designed by Mr. Crampton; it was placed on the line in 1847, and named the "London"; this engine had cylinders 18 by 20, a single pair of 8 feet driving wheels and 1,529 square feet of heating surface; and it was claimed that with a light load she attained a speed of fully 74 miles an hour. The directors of the London and North-Western also gave instructions for the construction, at Crewe works, of three experimental engines:—

The "Courier," designed by Mr. Crampton, having a pair of 7-foot wheels placed behind the fire-box;

The "Velocipede," designed by Mr. Alexander Allan, the superintendent of the Crewe works, having a pair of 7-foot wheels; and

The "Cornwall," by Mr. F. Trevithick, the chief mechanical superintendent of the northern division; and they were all completed in 1847.

The "Courier" was a very similar engine to the "Namur" and others of Mr. Crampton's design.

Mr. Allan, of Crewe, held the opinion that the "battle of the gauges" was an absurdity, and that it was not wise to build engines simply to see *what could be done*; he therefore built the "Velocipede" (Fig. 55).

This engine had cylinders 15 by 20 and 7 feet wheels, and this class of engine proved highly successful in daily working on the northern division of the London and North-Western.

On the other hand Mr. F. Trevithick considered it a matter of the most vital importance that the "narrow gauge" should eclipse the performance of the broad gauge; he therefore decided to have a

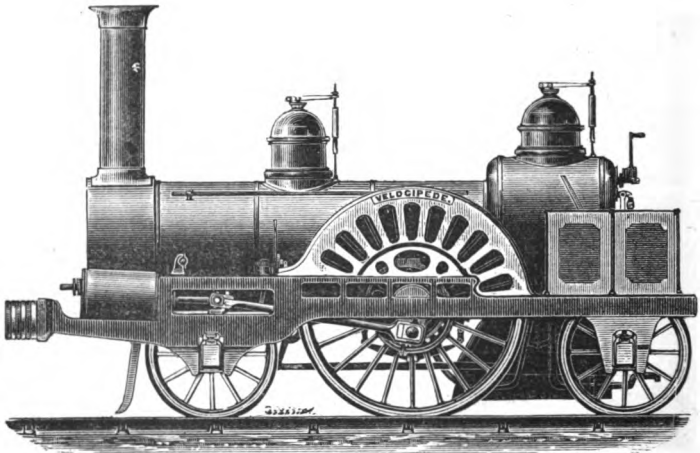

Fig. 55.—"Velocipede," No. 187, Crewe Works, Oct. 1847.

driving-wheel six inches larger than the "Great Western" (Fig. 54). In order to obtain a large driving-wheel and a low centre of gravity, he adopted the peculiar plan of placing the boiler *under* the driving axle. The driving-wheel of the "Cornwall" he designed of 8 feet 6 inches diameter, that being the largest size which had then, or has since, been tried upon the ordinary 4 feet 8½ inches gauge, the cylinders





Fig. 56.

being $17\frac{1}{2}$ inches diameter, and 24 inches stroke. The engine (Fig. 56) appears to have fully answered the expectation of her designer, for upon the trial trip a speed of fully 79 miles an hour was attained under favourable circumstances, thus beating the "Great Western" by one mile per hour.

This locomotive engaged very considerable attention at the Exhibition of 1851, but no engineer favoured the position of the boiler, and about 1862—1863, Mr.

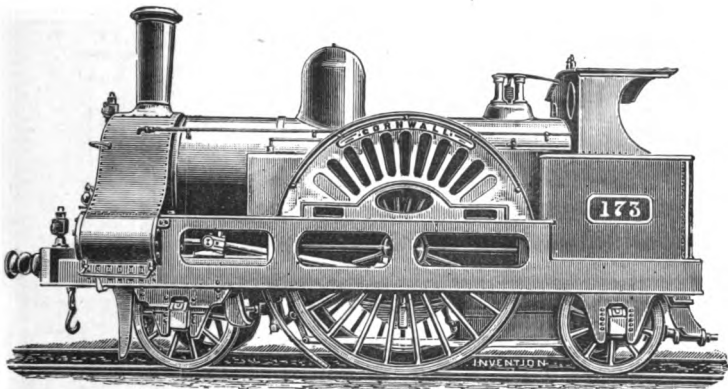

Fig. 57.—"Cornwall," London and North-Western Railway, 1863 to 1893.

John Ramsbottom constructed a new boiler and placed it *above* the axle.

Fig. 57 illustrates this fine engine as thus altered, and as it is running to-day.

The "Cornwall" is still working the "45 minute" expresses between Manchester and Liverpool, and carries us back to the year 1847, or for a period of over 45 years. It has now the largest wheel in the world, and it is stated that with a load equal to her power she

is capable of running at the highest possible speed yet attained.

The "Cornwall" appears capable of several years' more work, and, ultimately, when it rests from its labours it is understood that it is to be preserved as a relic of early locomotive construction.

Another large narrow-gauge engine intended to surpass the "Great Western" (Fig. 54) was designed by Mr. T. R. Crampton, and built by Messrs. Bury, Curtis and Kennedy, of Liverpool, for the London and

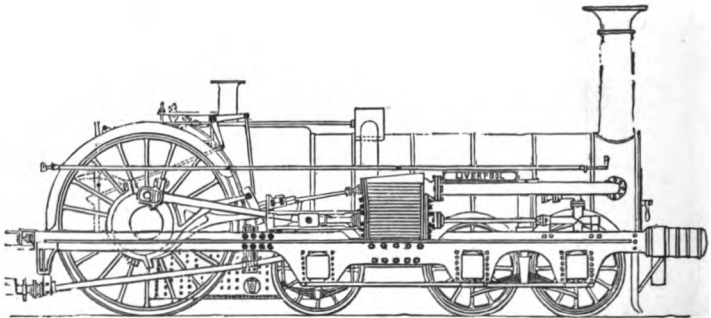

Fig. 58.—"Liverpool," London and North-Western Railway, 1848.

North-Western Railway, 1848, and named the "Liverpool" (Fig. 58), an engine generally considered as the "ultimatum for the narrow gauge."

The "Liverpool" had cylinders 18 inches diameter, 24 inches stroke; 292 tubes of $2\frac{3}{16}$ inches external diameter and 8 of $1\frac{3}{4}$ inch, 12 feet 6 inches long; surface of fire-box 154.434 feet; of grate $21\frac{1}{2}$ feet; of tubes 2136.117 feet; total heating surface 2,290 feet; two driving-wheels 8 feet diameter; 6 carrying-wheels 4 feet diameter; length between centres of extreme wheels

18 feet 6 inches; total length of engine 27 feet; weight of engine, charged, 35 tons, or 12 tons on the driving-wheels, 17 tons on the four leading wheels, and 6 tons on the two intermediate wheels; weight of tender 21 tons; total weight 56 tons. This engine conveyed the express trains between London and Wolverton for some time, and in one case took 40 carriages within time, thus exceeding the combined duty of three ordinary engines; and when tested for "speed" with a light load, the late Mr. Crampton informed the writer that it attained fully 79 miles an hour.

The permanent-way at that time was not strong enough to carry such a large engine, its weight and long rigid wheel-base therefore caused it to gradually retire from active service.

Had the rail-joints been "fished," and the four front wheels placed in a bogie frame, this would have been one of the most successful engines.

Shortly after the construction of the "Liverpool" Mr. T. R. Crampton, in 1849, designed a locomotive having inside cylinders but the driving-wheels fixed to a straight axle. He employed a double-cranked shaft, having also outside cranks and coupling-rod to communicate motion to the driving-wheels, which were placed behind the fire-box. Eight of these engines were ordered from Messrs. R. Stephenson and Co., and placed upon the South-Eastern Railway, and one of these, the "Folkestone," was sent to the Exhibition of 1851. Engines of this class took 44 tons at an average speed of $65\frac{1}{2}$ miles an hour, and attained $73\frac{1}{2}$ miles per hour upon a falling gradient of 1 in 264; they were, however, not satisfactory, and were rebuilt with driving-wheels upon the driving-shaft.

The past few pages have shown that during the "battle of the gauges" several remarkable engines were constructed simply to attain excessive speed, and to show what could be done on this or that gauge; some of these which worked well experimentally were practically unsuitable for the ordinary traffic.

The folly of this policy having at last made itself apparent, "the battle of the gauges" ended, and the various locomotive builders settled down to the construction of good useful engines, capable of working the ordinary trains of that period. Each builder or designer adopted a standard pattern of passenger engine, and although they were very similar in general design the special features of each were most marked; and even at the present day, no matter how much one of these old engines has been rebuilt, the original maker can be clearly determined by an examination of those parts which were made a speciality.

In 1849, Messrs. E. B. Wilson and Co., of Leeds, brought out a class in which there was an outside frame and outside bearings for the leading and trailing wheels, but inside bearings only for the driving axle: the first of these was named "Jenny Lind" (Fig. 59), and had cylinders 15 by 20 and wheels 6 feet diameter. Large numbers of these engines were built for the Midland and other railways.

Mr. Ross Winans, in 1849, constructed a celebrated engine at his Locomotive Works, Baltimore, for the Baltimore and Ohio Railroad. It had a four-wheeled leading bogie, a single pair of driving wheels 7 feet diameter, and a trailing bogie; the cylinders were placed outside. This engine was named the "Charles Carroll of Carrollton." It worked satisfactorily and

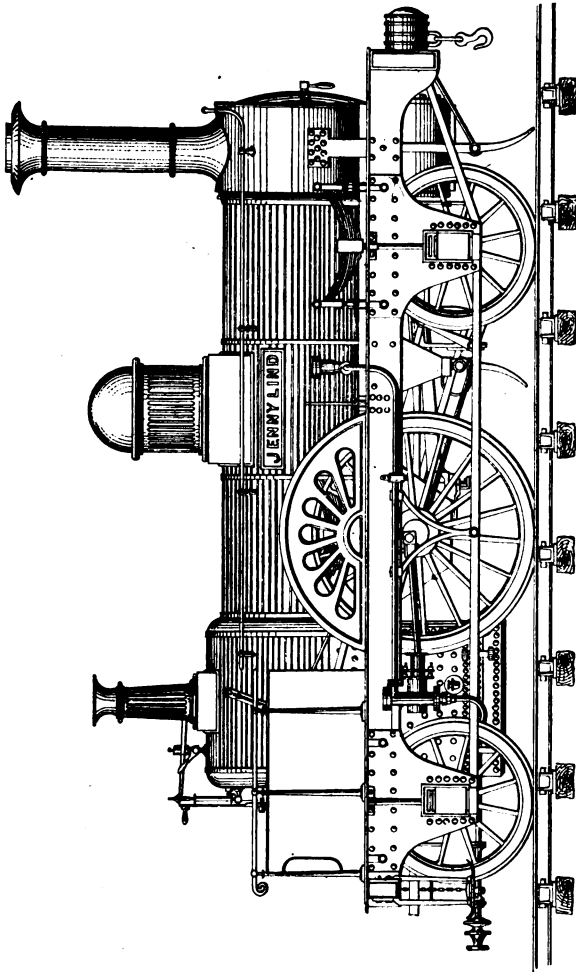

Fig. 59.—E. B. Wilson's Standard Pattern, 1849.

ran at very high speed, but it proved too heavy for the very light track over which it had to run.

At the same date, 1849, Messrs. E. B. Wilson & Co., of Leeds, built a trial engine for Mr. Crampton, in which he employed four large driving wheels of 6 feet 6 inches diameter, placed at a distance of 16 feet between centres. By means of outside coupling rods motion was communicated from the intermediate shaft to the four driving wheels. This engine weighed 32 tons, or 8 tons upon each wheel, which proved too much for the permanent way of that period. This engine was tried by Mr. Crampton upon the Midland Railway, and attained a speed of fully 75 miles an hour. It was also tried on other lines, but no railway company would purchase it on account of its great weight. Another engine of similar design was built, but much lighter. It ran upon the York, Newcastle, and Berwick for some years.

Messrs. Sharp Brothers, in 1849, built ten passenger engines for the Midland Railway, Nos. 60 to 69. The first six of these had cylinders 16×20 , and driving wheels 5 feet 6 inches diameter for the ordinary gauge. The Midland Company, having purchased the Bristol and Gloucester Company's line, required some broad-gauge engines to work thereon. Four of the engines by Sharp were therefore built "convertible"; they were, in fact, narrow-gauge locomotives having very long axles, and the wheels were placed quite outside the axle-boxes. The cylinders were 16×20 , driving wheels 6 feet 6 inches. Some years later, when the Midland Company removed the broad gauge between Bristol and Gloucester, the axles were shortened and the wheels placed between the double frames in the ordinary way.

Mr. J. E. McConnell, in 1844—5, designed and con-

structed at Bromsgrove some engines for the Birmingham and Gloucester Railway Company, in which he employed inside frames and inside bearings only. These small engines proved so satisfactory, that when he became locomotive superintendent of the southern division of the London and North-Western Railway, he retained the same design and built a large number of engines at Wolverton of the well-known "Blower" type. Some of these had cylinders 16×22 and

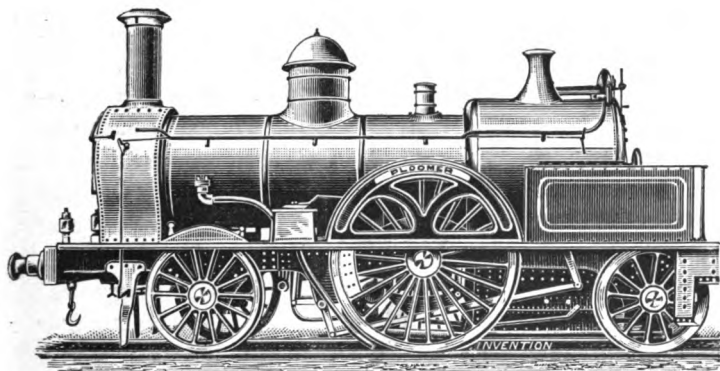

Fig. 60.—"Blower," Class 1850, L. & N.W.R., Southern Division.

6 feet 6 inches wheels—others similar to Fig. 60 had 7-foot wheels.

In November, 1852, Messrs. Fairbairn & Sons constructed a still larger engine from Mr. McConnell's design, for the southern division of the London and North-Western Railway, No. 300, having cylinders 18×24 , and driving wheels 7 feet 6 inches, the boiler being provided with his system of combustion chamber. This engine had double frames, and all the axles had *outside* axle-boxes, and weighed 31 tons.

Mr. McConnell also employed his patent design of boiler for the Wolverton goods engines, and placed all the six-coupled wheels under the barrel of the boiler.

It will have been observed that locomotive engineers for years had tried their utmost to obtain a large driving-wheel and a low centre of gravity. Mr. McConnell, however, disagreed most strongly with the "low boiler" theory, and maintained that a high boiler was no objection, and that engines having the highest boilers could run with the greatest steadiness. At that time his opinion was simply laughed at, now we see that he was correct, and only had the misfortune to be about thirty years in advance of his time.

During the year 1853, the London and North-Western Company employed Messrs. Woods and Marshall to test the efficiency of the Crewe and Wolverton engines (see Figs. 55 and 60), the result being that both were continued. It was strange that one company should continue to employ two locomotive superintendents and construct such different patterns of engines.

During the early part of the year 1852, Messrs. R. Stephenson and Co. constructed six express engines for the Midland Railway, having double frames, inside cylinders 16 by 22, and driving-wheels 6 feet 6 inches ; they were numbered 130 to 135 inclusive. One of these remained in use till 1892, and in 1853 Messrs. Sharp, Stewart & Co. built ten express engines for the same line having cylinders 16 × 22, and a single pair of 6 feet 6 inch driving-wheels, Nos. 120 to 129.

Mr. Archibald Sturrock, locomotive superintendent of the Great Northern Railway, in 1853 designed, and

Messrs. R. & W. Hawthorn built, a large express engine for that line, No. 215. This engine ran upon eight wheels, four in a group, but not in a bogie, a single pair of driving-wheels 7 feet 6 inches diameter, and a pair of trailing wheels. The cylinders were inside, 17×24 , and the engine had double frames. This engine appears to have been broken up about 1870, for at that date a new engine, No. 92, was built, having the old 7 feet 6 inch wheels, cylinders, and some other parts from old 215. No. 92 is still at work.

Mr. Pearson, the locomotive superintendent of the Bristol and Exeter Railway, and a very strong advocate of the broad gauge, "could not rest to think the narrow-gauge "Cornwall" (Fig. 56) had the largest wheel and attained the greatest speed." He therefore designed, and Messrs. Rothwell and Co., of the Union Foundry, Bolton, constructed, a class of broad-gauge tank engine in 1853 which ran upon 10 wheels, namely, a leading bogie, a single pair of driving-wheels 9 feet diameter, and a trailing bogie; the cylinders were $16\frac{1}{2} \times 24$, the driving-wheels were without flanges. The driving-axle was placed above the framing. The boiler contained 180 tubes of $1\frac{1}{8}$ inch diameter; the total weight of the engine in working order was 42 tons. The author remembers that at a speed of about 60 miles an hour the engine was remarkable for its very easy riding. American engineers have always maintained that these double bogie engines were a larger repetition of the Winans "Carroll" of 1849.

Mr. Pearson many years ago informed the writer that his engines had been officially tested at 81 miles an hour, and that the average consumption of

coke over a distance of 100,000 miles was only $21\frac{3}{4}$ lbs. per mile.

This maximum speed of 81 miles an hour was attained thirty-nine years ago, but it still remains the highest on record. In the year 1876 one of this class of engine ran off the line at Long Ashton, after which the driving-wheels were all reduced to eight feet and tenders were added. A few of these celebrated engines as altered were running until May, 1892.

In 1855 Mr. Gooch placed a new class of engine upon the Great Western Railway which had been constructed from his designs by Messrs. R. Stephenson; these engines were intended to be to some extent coupled "Great Westerns," being designed on the same general principles, but they had two pairs of 7 feet driving-wheels instead of one pair of 8 feet wheels. These were the largest driving-wheels ever coupled at that time. Only ten of these engines were built, and after running an average distance of about 500,000 miles each, it was not considered expedient to rebuild them.

Between the years 1853 and 1860 very much attention was given to the subject of burning coal instead of coke in locomotives. Messrs. Beattie, McConnell, Cudworth, and others, constructed most complicated fire-boxes and boilers having mid-feathers, combustion-chambers, or special forms of "grate."

All these proved perfectly unnecessary, for it was found by experiment on the Midland Railway that a brick-arch placed in the ordinary fire-box below the tubes; a deflector or baffle-plate within the door; a fire-door by which the supply of cold air can be properly regulated, and a steam-jet or blower in the

chimney, were all that were required to effectually consume the smoke in a locomotive.

At this period of locomotive history reference must be made to the works of a well-known engineer, who in times past took, and who still takes, an important part in the work. The Manchester and Birmingham Railway (or, more correctly, the line from Manchester to Crewe) had its locomotive department at Longsight, near Manchester, and as far back as May, 1842, Mr. John Ramsbottom was appointed as locomotive superintendent of that company. Upon the amalgamation, in 1846, he continued to hold the same position under the name of district superintendent of the north-eastern division of the London and North-Western Railway; and on August 1, 1857, we find him taking charge, as locomotive superintendent, of the northern division of the North-Western Railway, at Crewe works, in succession to Mr. Trevithick.

In the autumn of 1858, Mr. Ramsbottom turned out at the Crewe works a number of his new goods engines, having inside frames and inside bearings only, inside cylinders 17 inches by 24 inches, and six coupled wheels of 5 feet diameter; and in the following year, November, 1859, he placed his first express engine (Fig. 61) upon the northern division; it was named "Problem," and is still at work.

The "Problem" type, of which sixty were built between the years 1859 and 1865, all of which are still running, had cylinders 16 inches by 24 inches.

Diameter of driving-wheels (new)	7 ft. 7½ ins.
Weight of engine in working order.. .. .	27 tons.
Weight of tender in working order.. .. .	17½ tons.
Total	44½ tons.

“Problem” was also the first engine in this country fitted with Giffard’s injector for feeding the boiler.* An engine of this class, named “The Lady of the Lake,” was sent, when quite new, to the Exhibition of 1862, and was awarded the bronze medal, which it still carries. Mr. Ramsbottom also received a medal for his system of troughs between the rails, by which engines could, and do, pick up water when running.

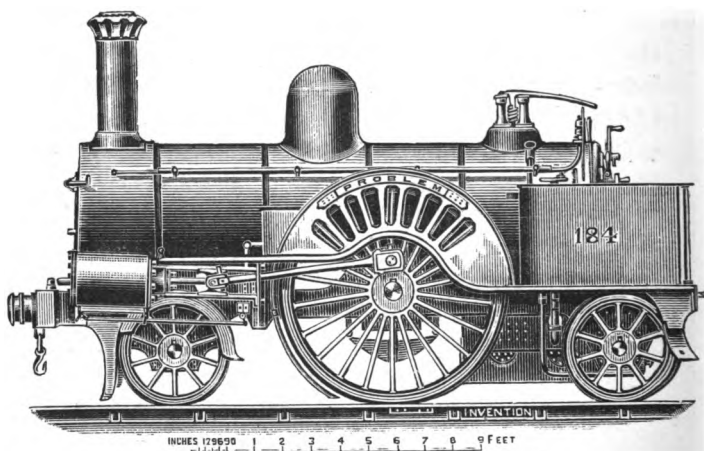

Fig. 61.—“Problem,” London and North-Western Railway, Northern Division, November, 1859.

This latter appliance proved of considerable value on January 5th, 1862, when an exceptionally fine and important run was made from Holyhead to Euston, the occasion being when answers were brought to the despatches sent by the English Government to Washington, requiring the immediate surrender of Messrs. Mason and Slidell, who had been taken off an English ship, the *Trent*. An engine of the “Problem”

* For particulars as to the injector, see p. 192.

type (Fig. 61), by means of the water-trough, ran from Holyhead to Stafford, $130\frac{1}{2}$ miles, without stopping, and occupied only 145 minutes, and another engine went forward to London; the whole distance, 264 miles, being performed in five hours, with only one stop; and on certain favourable parts of the line several miles were run at a rate of "just under, if not quite, 80 miles an hour."

It is also a fact worthy of note that in the great railway race of 1888, when it was required to run through without stopping, at the highest speed, from London to Crewe, the old engines of the "Problem" type, namely, "Waverley" and "Marmion," ran the racing trains. All the sixty engines of the class are now from 27 to 33 years old, but with a light load in proportion to their power they are at the present day capable of running as fast as any locomotive now at work on any railway in this country.

Mr. McConnell, at Wolverton, in 1861, constructed three very large engines of the "Bloomer" type, named "Delamere," "Caithness," and "Maberley," one of which, No. 373, engaged much attention at the Exhibition of 1862; their chief dimensions being,

Diameter of cylinders	18 ins.
Length of stroke	24 ins.
Diameter of driving-wheels (new)	7 ft. $7\frac{1}{2}$ ins.
Heating surface of fire-box	242·5 sq. ft.
Heating surface of tubes	980·3 sq. ft.
Total	<u>1222·8 sq. ft.</u>

The fire-box was constructed to burn coal, and had a combustion chamber.

Working pressure of steam	150 lb. per sq. in.
Height of centre line of boiler above the rails	7 ft. $5\frac{1}{2}$ ins.
Weight upon driving-wheels	14 tons.

	Tons.	cwts.
Total weight of engine in working order	34	14
Weight of tender loaded	25	0
Total	59	14

From these details it will be seen that these three engines were very fine specimens, and that Mr. McConnell successfully solved the problem of large wheels, large inside cylinders, high steam pressure, and high boiler. He proved that a high boiler was no objection, and that engines having the highest boilers can run with the greatest steadiness; he also proved, in 1861, that with a light load these engines could under very favourable circumstances run "*within a fraction of 80 miles an hour.*" Towards the close of the year 1861 Mr. McConnell resigned, and Wolverton was closed as a locomotive building establishment, Mr. Ramsbottom, of Crewe, in the early part of the year 1862, being appointed locomotive superintendent of the whole line.

Messrs. Neilson & Co. constructed an express locomotive (Fig. 62) to send to the Exhibition of 1862; it was in every respect similar to those previously constructed by the Caledonian Railway Company; it had double frames, outside cylinders, and a single pair of 8ft.-2in. wheels, and was, in fact, a larger edition of the Grand Junction Company's locomotives, as constructed at Crewe works in 1843 by Mr. Allan.

Diameter of cylinders	17½ ins.
Length of stroke	24 ins.
Diameter of driving-wheels	8 ft. 2 ins.
Total heating surface	1,172 sq. ft.
Weight on driving-wheels	14 tons 11 cwt.

This locomotive was purchased by the late Pacha of Egypt, who required an engine "to take him at an average speed of 70 miles an hour." This engine, by Neilson, also those built by Mr. Benjamin Connor, were

officially tested at 80 miles an hour, and some still remain in use on the Caledonian at the present time. They are good engines, but the existing loads and the Beatlock incline have necessitated their removal from main line expresses.

Messrs. Stephenson & Co., in 1862, constructed a large passenger engine named "Saltburn" for the Stockton and Darlington Railway, having a leading bogie, four coupled wheels of 7 ft. diameter, the

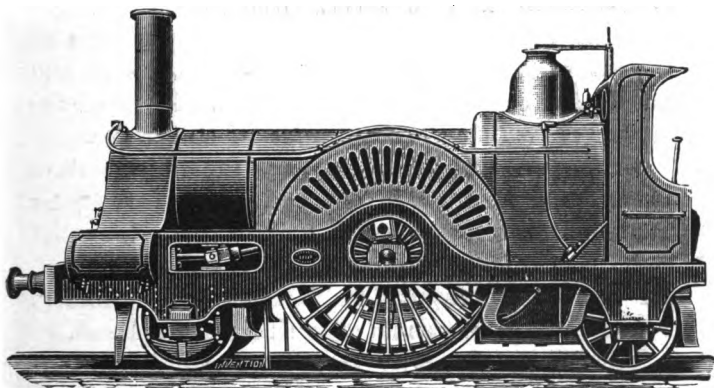

Fig. 62.—Express Engine, built by Neilson, 1862.

cylinders placed outside being 17×24 ; in this engine a small auxiliary tank was placed under the foot plate for heating the feed water by means of steam from the boiler.

About the year 1863 Mr. Sturrock introduced "steam tenders" upon the Great Northern Railway for the goods engines. These tenders had outside frames, six coupled wheels, and inside cylinders, steam being supplied from the engine boiler. The tender thus converted by Mr. Sturrock became practically a

second engine, having a water-tank in the place of a boiler. The cylinders were 12 inches diameter and 17 inches stroke, the cranked-axle being the middle one. The exhaust steam from the cylinders was discharged into a tubular condenser and heated the water in the tender tank. The weight of the tender empty was 18 tons, and loaded, 28 tons.

The steam tenders undoubtedly conveyed very heavy trains of coal, as the author saw when riding on one between Hitchin and London; and the Great Northern Company had about fifty in use, but they did not do the extra amount of work to pay for their cost, and practically they proved a great failure. Many of the tenders *without the steam apparatus* are still in use.

Mr. Matthew Kirtley, locomotive superintendent of the Midland Railway, in the early part of the year 1861 built several powerful tank engines to assist trains up the Lickey incline; these had double frames, six coupled wheels of 4 ft. diameter, and cylinders $16\frac{1}{2} \times 24$. They are still at work but renumbered.

Mr. Kirtley also, early in 1862, designed and constructed at Derby six powerful express engines to convey the anticipated heavy traffic to the exhibition of that year. These engines ran upon six wheels, the driving and trailing wheels being 6 feet 2 inches diameter, and coupled, the cylinders were $16\frac{1}{2}$ inches diameter, 24-inch stroke, and the steam pressure 140 lbs. per square inch; they were numbered 80 to 85 inclusive. On one occasion the writer rode from Leicester to King's Cross, London, upon one of these engines, when it drew 10 coaches, and on the return journey, with a much lighter load, a speed of 72 miles an hour was attained upon a falling gradient.

Previously to this date four-wheeled coupled engines

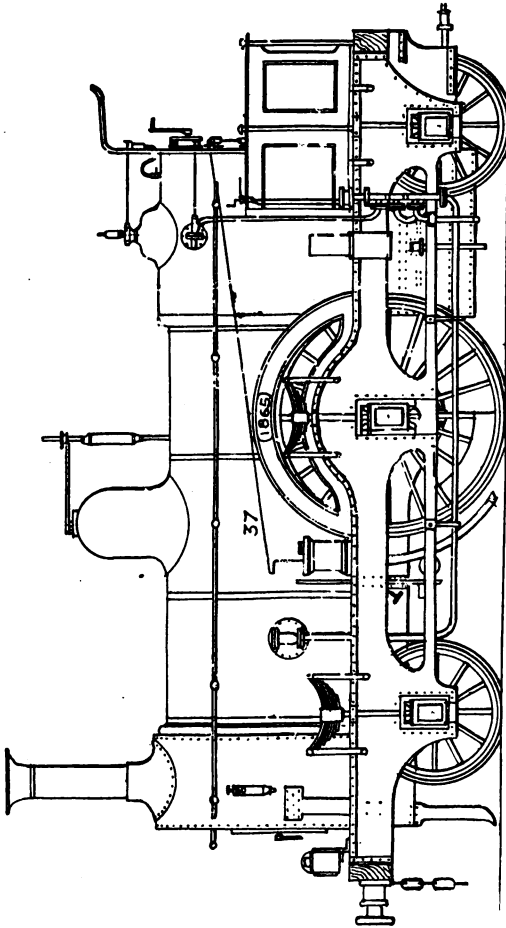

Fig. 63.—Kirtley's Express Engine, Midland Railway Company, 1864—5.

had been considered unsuitable for passenger traffic and high speed.

In 1864, Mr. Matthew Kirtley, the Midland Company's locomotive superintendent, decided to construct

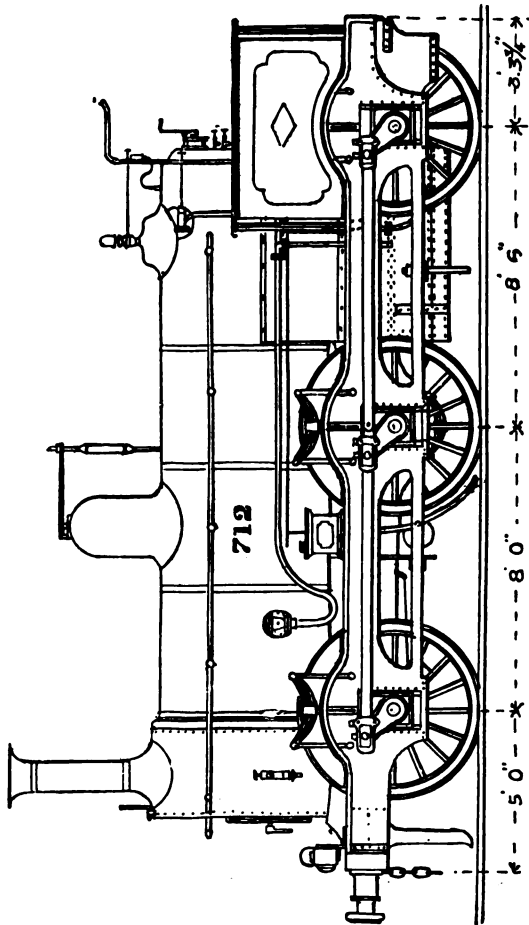

Fig. 64.—Kirtley's Goods Engine, Midland Railway Company, by Dübs & Co., 1869.

at the Derby Works 20 express engines, generally known as the "30 class," having cylinders $16\frac{1}{2} \times 22$,

and driving-wheels 6 feet 8 inches diameter (see Fig. 63).

These engines have been remarkable for the heavy work which they have performed, and for economy both in fuel and repairs.

With a load suitable to their power, they are still capable of running at the highest speeds, but of course they are not now sufficiently powerful for main line expresses.

From the formation of the Midland Railway Company in 1844 to the close of the year 1862, Mr. Kirt-

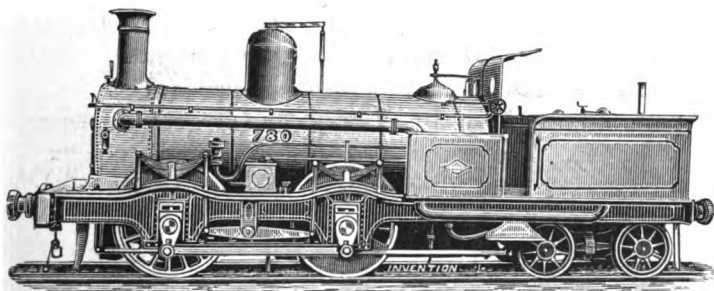

Fig. 65.—Tank Engine, No. 780, Midland Railway Company, 1870.

ley constructed the goods engines with cylinders 16 by 24, and 5 feet 2 inch wheels. From 1863 to 1869 he employed 16½ inch cylinders, and from 1869 to 1875, 17 inch cylinders (see Fig. 64).

For working the Midland Company's trains over the Metropolitan Railway, Mr. Kirtley designed, and Messrs. Dübs & Co. in 1870 constructed, twenty tank engines (Fig. 65) having cylinders 17 × 24, four coupled wheels 5 feet 2 inches diameter.

Mr. Kirtley also designed a powerful class of express

engine for the Midland Railway, of which forty-eight were built in 1870, thirty by Messrs. Neilson & Co., and eighteen at Derby, having cylinders 17×24 , and four coupled wheels of 6 feet 8 inches diameter; the tractive force which could be exerted for each pound of effective steam pressure per square inch upon the pistons being 86.7 lbs., or thus—

$$\frac{17 \times 17 \times 24}{80} = 86.7 \text{ lbs.}$$

The distance between the centres of the two cylinders is 2 feet 6 inches; this has always been a very great advantage to these engines, on account of the extra width available for steam and exhaust passages.

The boiler and fire-box were of the standard pattern, previously used by Mr. Kirtley for his goods engines (Fig. 64). The boiler contained 168 brass tubes of 2 in. diameter outside, and was fed by one injector and one pump.

Heating surface of tubes	sq. ft.
Heating surface of fire-box	993
	103
Total	1096

Two safety valves were placed upon the dome, pressed to blow off at 140 pounds per square inch.

A Roscoe lubricator was also provided.

Surface or area of fire-grate, 17 square feet; wheel-base of engine, 16 feet 6 inches.

Weight in working order—

Of engine	tons	cwt.	qrs.
Of tender	35	18	2
	24	15	2
Total	60	14	0

These engines have been remarkable for their excel-

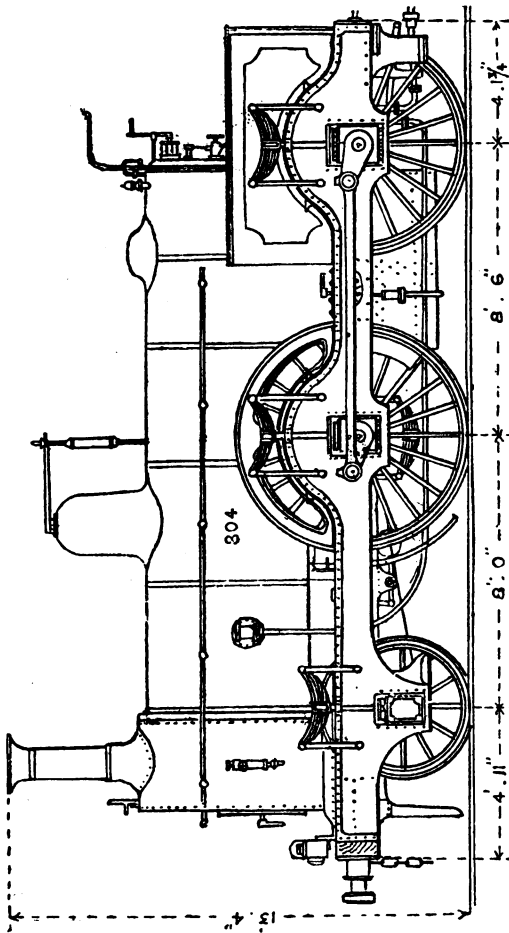

Fig. 66.--Midland Express Engine, "800 Class," 1870.

lent working, and since their cylinders have been en-

larged to 18 inches diameter, their efficiency has been still further increased.

The tender (Fig. 67) ran upon six wheels, and carried 2,000 gallons of water, and, if necessary, 4 tons of coal, and was provided with a hand brake applying a wooden block to each wheel.

In 1871, Mr. Kirtley introduced another type of ex-

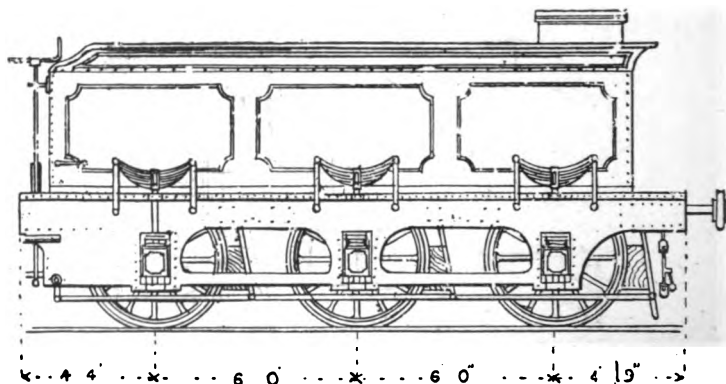

Fig. 67.—Midland Tender, 1870.

press engine on the Midland Railway, having inside bearings only for coupled wheels.

No. 890, the first of this class, had cylinders 17×24 and coupled wheels 6 feet 8 inches diameter. A very large number of engines of this type of framing have since been built and are all at work.

It will be observed that these engines had double frames, but the coupled wheels had inside bearings only; the chief dimensions being as follows:—

Diameter of cylinders	ft.	in.
Length of stroke	0	17
		0	24

Diameter of coupled wheels	ft. in.	
Number of tubes	232	
Diameter of tubes	0 1½	
Boiler pressure	140 lbs. per square inch.	
<hr/>		
Heating surface of fire-box	sq. ft. 92	
Heating surface of tubes	1,020	
<hr/>		
Total	1,112	
<hr/>		
Number of square inches of bearing surface on each pair of journals	} Leading 104· Driving 133· Trailing 129·	
Weight of engine in average working order		tons cwt. 36 14
„ tender „ „ „		26 4
<hr/>		
Total	62 18	

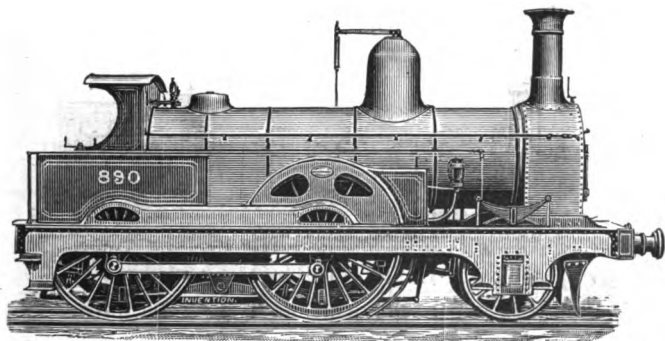

Fig. 68.—Kirtley's Express Engine, Midland Railway Company, 1871.

When the American Pullman car trains were first introduced into this country in 1874 engines of the 890 class were employed to work them, and were specially fitted with a central buffer at the back of the tender, as the cars had not side buffers.

CHAPTER IV.

MODERN LOCOMOTIVES FOR MAIN LINE TRAINS.

IT being difficult to exactly define what is meant by "modern locomotives," for the purposes of this chapter engines will be included which have been designed and constructed within the past twenty years.

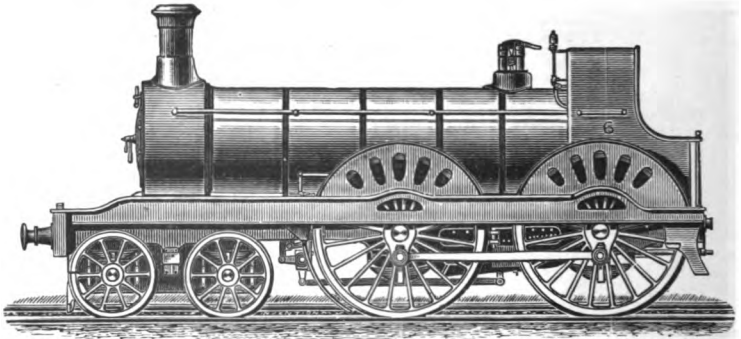

Fig. 69.—Glasgow and South-Western Express Engine, July, 1873.

Mr. James Stirling, locomotive superintendent of the Glasgow and South-Western Railway, at Kilmarnock, in 1873, was the first locomotive engineer to introduce a design or combination which included a leading-bogie, four coupled wheels 7 feet diameter, and inside cylinders 18 inches diameter.

The tractive force exerted for each pound of effective steam pressure per square inch in the cylinders being, therefore,—

$$\frac{18 \times 18 \times 26}{84} = 100.285.$$

It had been contended by many engineers that a pair of 18-inch cylinders with their valves between them could not be placed between the frames of an engine upon the 4 feet 8½ inch gauge, but Mr. Stirling proved that sufficient space existed by placing the cylinders thus in his new engine.

The boiler is flush-topped, having a Ramsbottom safety-valve placed over the fire-box casing, and is without a dome.

No. 6 (Fig. 69) was reversed by means of screw gear, but in May, 1874, Mr. Stirling completed a similar locomotive, No. 95, and it was the first to be fitted with his steam reversing gear. This gear consists of two small cylinders placed horizontally upon the right-hand side of the foot-plate, both the pistons being attached to one rod which passes out through the front cylinder cover and is connected to the rod working to the reversing gear. By means of a small handle the engine-driver can admit steam to either end of the steam cylinder, and thus put the engine in forward or backward gear at pleasure. Between the two cylinders the piston rod carries an index which works over a fixed scale showing the position of the gear and the proportion of the stroke at which the steam is being cut off in the main locomotive cylinders.

To retain the steam reversing gear in any required position the second small cylinder is completely filled

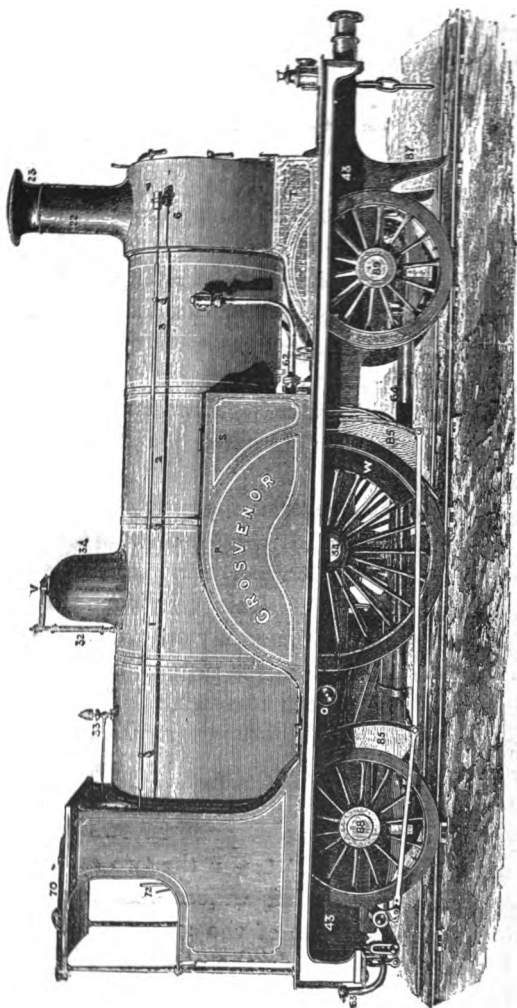

Fig. 70.—Brighton Company's Express Engine, 1874.

with oil, and its piston can only move when the driver permits a valve to open to allow the oil to pass from one end of the small cylinder to the other.

Therefore, without any manual labour the engineman can reverse the locomotive by means of a small handle upon the foot-plate, and as the one handle actuates both the steam valve and the oil valve, it follows that in whatever position the driver stops the supply of steam the oil will firmly hold the gear.

Engines of this type still remain the standard pattern upon the Glasgow and South-Western Railway, and Mr. Stirling has during recent years introduced a very similar design upon the South-Eastern Railway, but having cylinders 19 inches diameter, for working the express trains between Charing Cross and Dover.

In 1874 Mr. Stroudley designed and constructed at the Brighton Works an engine named the "Grosvenor," No. 151 (Fig. 70).

This engine has a single pair of driving wheels 6 feet 9 inches diameter, cylinders 17×24 , weight on driving-wheels 14 tons. The "Grosvenor," was sent with the Brighton Company's train to the Newark Brake trials in 1875; it also was the engine employed throughout Captain Galton's brake experiments in 1878—79.

When the "Grosvenor" was new the author rode several trips upon her foot-plate. On one of these 22 coaches were conveyed from London to Brighton by the five o'clock express without any loss of time.

Mr. S. W. Johnson, in 1875, introduced a powerful type of engine upon the Midland Railway for the conveyance of heavy mineral trains, No. 1448 (Fig. 71), being one of those built by Kitson & Co.

Engines of this class have cylinders $17\frac{1}{2} \times 26$, and

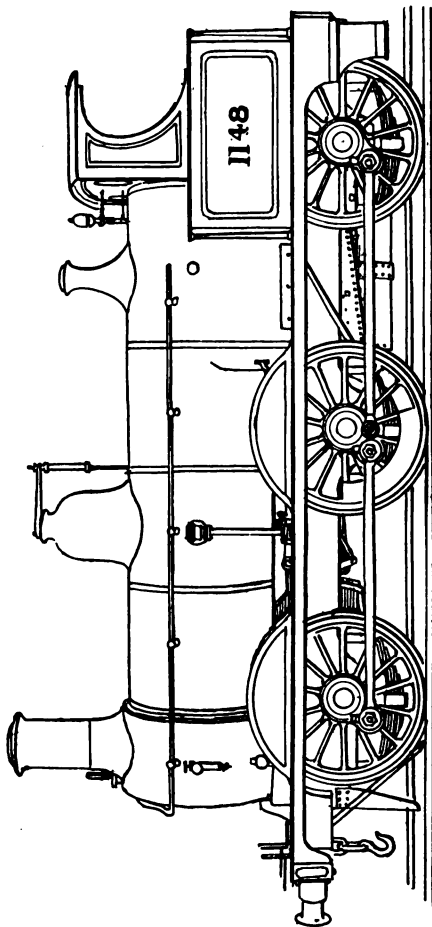

Fig. 71.—Midland Mineral Engine, 1875.

six coupled wheels of 4 feet 10 inches diameter; the

tractive force for each pound of effective pressure on the pistons being therefore—

$$\frac{17\frac{1}{2} \times 17\frac{1}{2} \times 26}{58} = 137.284.$$

Heating surface 1,225 square feet.

In 1878 Mr. F. W. Webb, of the London and North-Western Railway, converted one of the old engines on that line into a compound, on Mr. Mallet's system, the result of its working being that Mr. Webb in 1881-2 built at Crewe a compound engine of his own design named "Experiment," No. 66.

Mr. Webb's system employs three cylinders, namely two high-pressure cylinders of equal size, placed outside and arranged to drive the hind driving-axle, and one low-pressure cylinder placed inside, under the smoke-box, and arranged to drive the front driving-axle; the steam, of course, passing from the two high-pressure cylinders into the one low-pressure cylinder.

There is no subject relating to locomotive construction which has engaged so much attention and caused so much controversy as the introduction of "Compound" Express Engines. The advocates of the compound principle maintain that "as the steam is used twice over there must be a saving in fuel, and that even if some of the early engines built are not fully up to expectations the defects will be overcome in the next to be constructed."

On the other hand the advocates of the "Simple" system point out that two sets of cylinders and motion are cheaper to construct and cheaper to maintain than three sets; they hold the opinion that there is no

saving in coal, and that even if there were, it would be due to the high pressure of steam used, not to the compound principle; and with regard to the question of fast running they refer to the fact that at the time of the great railway race of 1888 the three-cylinder engines had to be withdrawn, and "simple two-cylinder" engines employed to perform the fast running.

The only possible way to prove what are the real capabilities of the "Simple" and "Compound" systems, respectively, is to have a complete and impartial trial. Let two engines be built, the one "Simple," the other "Compound"—the boilers, fire-boxes, heating surface, pressure of steam, and diameter of driving-wheels, being identical in each. Let the first cost, cost of maintenance, consumption of coal and oil, be carefully ascertained, and let the two engines be run over the same section of line with similar trains; in fact, have the trials made absolutely fair, and in a very short time the results would settle all the controversy.

The writer has watched the subject most carefully from the first, in an impartial spirit, but he cannot fail to observe that "facts" are in favour of the "Simple" engine. Whatever a "Compound" engine can do a "Simple" engine can do, and frequently with more efficiency. It is therefore not a matter of surprise that the locomotive superintendents of all the other important lines, after having made themselves fully acquainted with the "Compounds" in use in this country, continue to build large numbers of non-compound express engines, which give great satisfaction.

In 1881 the late Mr. William Stroudley, locomotive superintendent of the London, Brighton and South

Coast Railway, found that engines of increased power were required to work the Company's express trains, which were constantly increasing in weight; for instance, the 8.45 A.M. express from Brighton to London Bridge being a train often consisting of 25 coaches, the time allowed being 1 hour 10 minutes, the weight, including engine and tender, being fully 350 tons. The return train leaves London Bridge at 5 P.M., and arrives at Brighton at 6.5 P.M.

Mr. Stroudley, therefore, constructed in 1882, at the Brighton works, a powerful express engine named "Gladstone" (Fig. 72).

Diameter of cylinders ($18\frac{1}{4}$)	ft.	in.
Length of stroke (26)	2	2
Diameter of coupled wheels	6	6

The tractive force for each pound of effective pressure in the cylinders is therefore—

$$\frac{18\frac{1}{4} \times 18\frac{1}{4} \times 26}{78} = 111.020 \text{ lbs.}$$

Total heating surface	1,485	sq. ft.
Weight of engine in working order	38	tons.
Tender loaded	27	cwts.
Total	66	1

This engine is fitted with the Westinghouse automatic brake applying two cast-iron blocks to each of the coupled wheels, and one block to each tender wheel. The valves are actuated by the ordinary "Howe" curved link motion, the reversing being performed by the late Mr. Stroudley's arrangement, in which air from the Westinghouse brake is made to do the duty of a reversing lever or screw.

The position of the valves is under the cylinders,

therefore it follows that when steam is shut off, all friction between valves and their faces ceases. To reduce the wear of the leading wheels Mr. Stroudley arranged a pipe leading from the bottom of the exhaust, in order to turn a jet of steam against the flange of each leading wheel, the cold wheel condenses the steam and lubricates the flanges, and when running round sharp curves, especially in dry weather, the grinding noise of leading wheels, so often observed upon many lines, is consequently avoided.

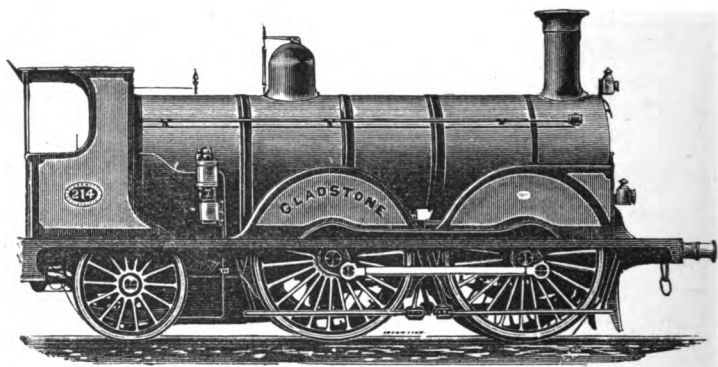

Fig. 72.—Brighton Company's Express Engine, 1882.

The tender runs upon six wheels, carries 2,250 gallons of water and two tons of coal, and has inside frame and inside bearings only.

A number of other similar engines have been built, one of which, named "Edward Blount," obtained a gold medal at the Paris Exhibition in 1889.

Engines of the "Gladstone" type have very successfully coped with the difficulty of conveying express trains of excessive length; however, in consequence of the increase of traffic and the generally-expressed wish of the passengers that "the journey from London to

Brighton should be performed in an hour," it is probable that at no distant date some of the heaviest trains will have to be run in duplicate.

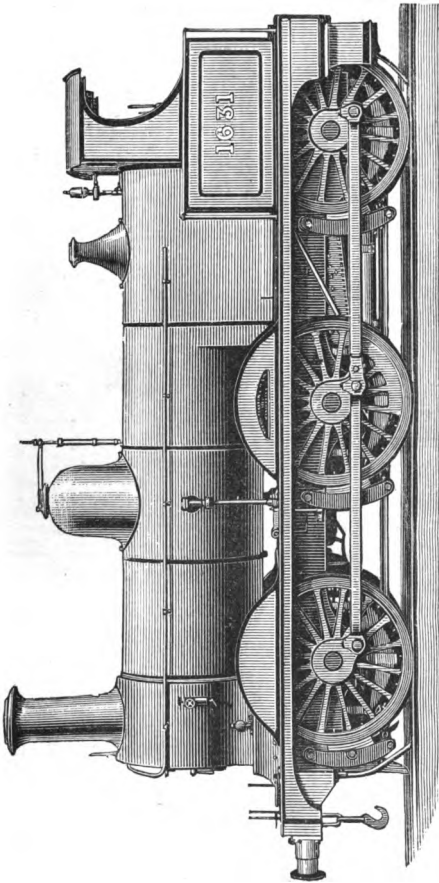

Fig. 73.—Modern Midland Goods Engine.

The line from London Bridge to Brighton is about $50\frac{1}{2}$ miles in length, and about three miles from London the New Cross incline of 1 in 100 for $2\frac{1}{2}$ miles com-

mences, after which the line rises and falls by gradients of 1 in 264 to three summits, one at Merstham tunnel, another at Balcombe tunnel, and the third at the Clayton tunnel. It therefore follows that with a train of fair average length, an engine having a "single" pair of driving wheels of 7 feet or 7 feet 6 inches diameter could, without difficulty, perform the journey of $50\frac{1}{2}$ miles in 60 minutes.

Fig. 72 shows that the "Gladstone" has the four large coupled wheels placed in front; this arrangement enables a very much shorter coupling-rod to be em-

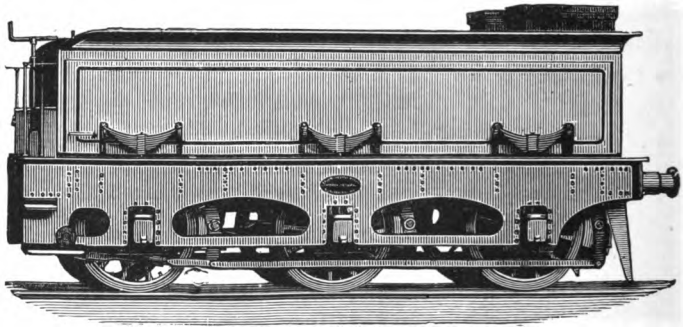

Fig. 74.—Midland Tender, No. 1631.

ployed, and leaves the length of the fire-box practically unlimited, which is not the case when the trailing wheels are coupled. However, for the fastest express work the writer would prefer an uncoupled wheel as leader.

The heavy express goods traffic upon the Midland Railway necessitates the employment of powerful locomotives. In 1877, Mr. Johnson introduced engines for this work having cylinders $17\frac{1}{2}$ by 26 inches, and wheels of 5 feet $2\frac{1}{2}$ inches diameter; his more recent

engines are of similar appearance, but have cylinders 18 by 26 inches, wheels 5 feet 2½ inches and a boiler pressure of 150 lbs. per square inch. Several hundreds of these engines are at work and giving good results.

The tender (Fig. 74) runs on six wheels, carries 2,200 gallons of water, and has a coal space of 144 cubic feet.

Mr. S. W. Johnson, the locomotive superintendent of the Midland Railway, introduced "bogie" express engines upon that line in 1876, and since that time 145 have been built of the same general design as Fig. 75, but with cylinders varying from 17½ to 19 inches diameter. Until 1885, the steam pressure employed was 140 lbs. per square inch, but in that year Mr. Johnson designed the 1738 to 1757 class, having steel boilers and a high pressure of 160 lbs. per square inch. Their dimensions being—

Diameter of cylinders	(18)	ft.	in.
Length of stroke	(26)	2	2
Diameter of coupled wheels		7	0

The tractive force exerted for each pound of effective steam pressure per square inch in the cylinders being, therefore, thus—

$$\frac{18 \times 18 \times 26}{84} = 100.285.$$

As the steam pressure carried is 160 pounds per square inch, and the weight available for adhesion is over 28 tons, it follows that the engine is capable of performing fast and very heavy work.

Distance apart of cylinders from centre to centre		ft.	in.
Length of boiler between tube plates		10	10 ⁹ / ₁₆
Mean diameter of boiler inside		4	1
Number of tubes	246		
Diameter of tubes		0	1½

Pressure of steam 160 lbs.
 Total heating surface 1,261 sq. ft.

Weight in working order—

	tons.	cwts.	qrs.
On bogie wheels	14	12	1
On driving wheels	15	0	0
On trailing wheels	13	2	2
Total	42	14	3

Weight of tender, full, 3,250 gallons of water and 2 tons of coal	36	1	1
Grand total engine and tender	78	16	0

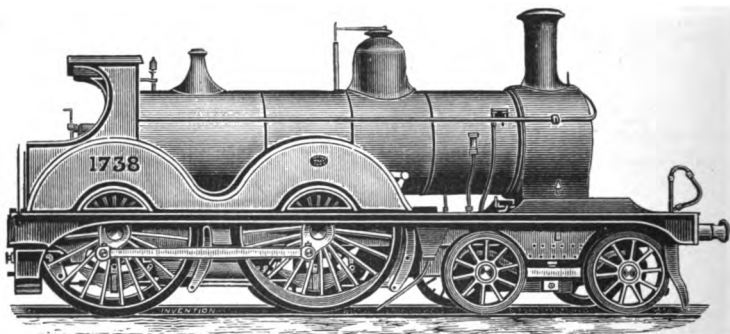

Fig. 75.—Midland Railway Express Engine, built 1885.

One of these engines, No. 1757, "Beatrice," was sent in 1887 to the Saltaire Exhibition, and has since been employed to work several royal trains.

For the purpose of working the Midland Company's trains over the Lancashire and Yorkshire Railway, *viâ* Hellifield, and thence to Carlisle, Mr. Johnson in 1888 designed the 1808 to 1822 class, similar to No. 1738, but with coupled wheels of only 6 feet 6 inches diameter.

The following is the complete list of the Midland Company's coupled bogie express engines, all of which are giving excellent results:—

Nos.	Builder.	Date.	Cylinder.	Stroke.	Coupled wheels.		Pressure of Steam.
			In.	In.	Ft.	In.	Lbs.
1312 to 1321	Kitson	{ 1876 } { 1877 }	17½	26	6	6	140
1327 to 1346	Dubs	1877	18	26	7	0	140
1562 to 1581	M.R. Co.	{ 1882 } { 1883 }	18	26	6	9	140
1657 to 1666	M.R. Co.	1883	18	26	6	9	140
1667 to 1676	M.R. Co.	1884	19	26	7	0	140
1738 to 1757	M.R. Co.	{ 1885 } { 1886 } { 1887 }	18	26	7	0	160
1808 to 1822	M.R. Co.	1888	18	26	6	6	160
11 and 14 } 80 to 87 }	M.R. Co.	1891	18	26	6	6	160
2183 to 2202	Sharp } Stewart }	1892	18½	26	7	0	160

The Caledonian Company's express engine No. 123 (Fig. 76), was constructed by Neilson & Co., and attracted much attention at the Edinburgh Exhibition of 1886, and during the "railway race" of 1888.

The following are the principal dimensions of the engine:—

Diameter of driving wheels	7 feet.
Diameter of cylinders	18 inches.
Length of stroke	26 inches.

The tractive force exerted for each pound of effective pressure per square inch in the cylinders being thus:—

$$\frac{18 \times 18 \times 26}{84} = 100.285 \text{ lbs.}$$

Working pressure of steam 150 lbs.
 Weight on driving wheels 17 tons.

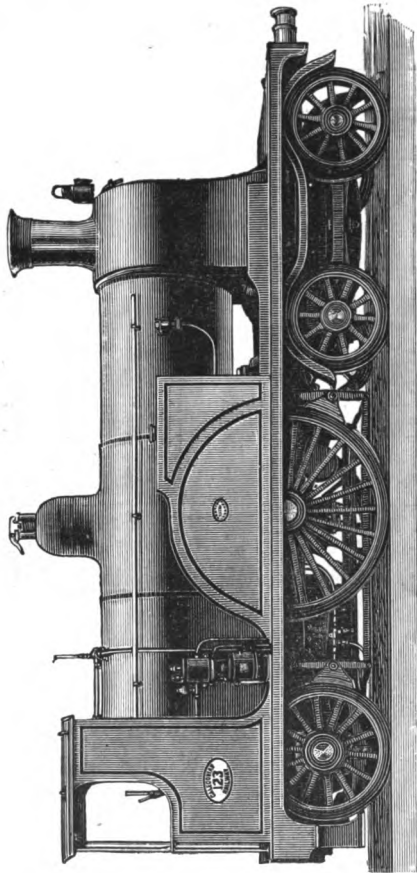

Fig. 76.—Caledonian Express Engine, No. 123, 1886.

	tons.	cwts.
Weight of engine in working order	41	18
Tender loaded	33	9
Total	75	7

The engine is provided with Adams' vortex blast-pipe, the Westinghouse automatic brake, a sand-blast, two injectors, and two water gauges.

No. 123, during the "railway race," worked the West Coast trains between Carlisle and Edinburgh.

The writer rode several trips in trains over this distance, and on one day timed the 101 miles covered in 104 minutes, some of the rising gradients being very severe, namely 1 in 75 on Beattock incline.

Number 123 was put into express traffic between Edinburgh and Carlisle on June 1, 1888.

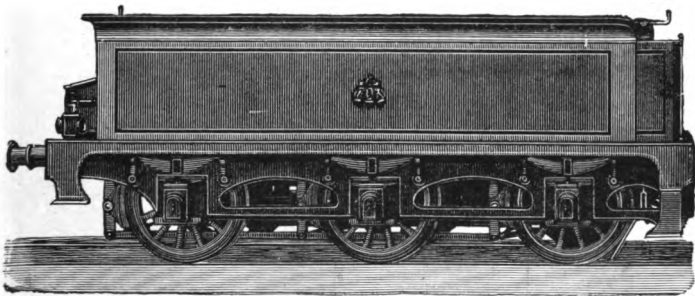

Fig. 77.—Caledonian Tender, No. 123.

The average number of vehicles was seven, six of which were 8-wheeled carriages, each 42 feet long, and one a 6-wheeled brake van, giving a total train weight of about 146 tons, exclusive of engine and tender.

The average consumption of coal during the "racing" months of August, September and October, 1888, was 31·8 lbs. per engine mile.

The tender (Fig. 77) runs on 6 wheels, and carries 2,850 gallons of water, and has a coal space of 210

cubic feet. The tender brake can be applied by either Westinghouse apparatus or by the usual hand-screw. Wheel-base of engine and tender, 42 ft. 6 in.

Mr. Patrick Stirling, locomotive superintendent of the Great Northern Railway, having employed express engines with cylinders 17 by 24 inches, and a single pair of 7 feet wheels, decided to design a much more powerful type of express engine, having a larger driving-wheel and larger cylinders; and, as he could not employ inside cylinders, in consequence of the

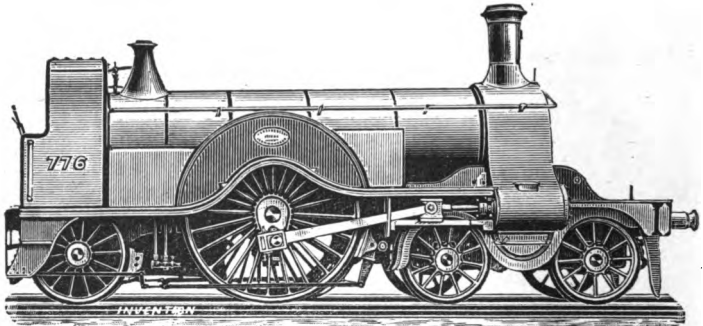

Fig. 78.—Type of Great Northern Express Engine, 1870 to 1887.

height of the cranks, he placed them outside, where he could get them between the wheels of the bogie, and in a horizontal line with the centre of the driving-wheel. The first of these was built in 1870, and forty-five of this pattern (Fig. 78) are now at work.

The particular engine illustrated was the "Jubilee" engine sent to the Newcastle Exhibition, 1887.

	ft.	ins.
Diameter of cylinders	0	18
Length of stroke	0	28
Diameter of driving wheels (nominal)	8	0

Therefore the tractive force exerted for each pound of effective steam pressure per inch in the cylinder is thus—

$$\frac{18 \times 18 \times 28}{96} = 94.5 \text{ lbs.}$$

Total heating surface 1,045 sq. ft.

Weight of engine in working order—

	tons.	cwts.
On front bogie wheels	8	2
On rear bogie wheels	9	9
On driving wheels	17	0
On trailing wheels	10	12
	<hr/>	
Total	45	3
Weight of tender loaded	<hr/>	7
	<hr/>	
Grand total, engine and tender	78	10

At the time of the “race,” engines of this type with loads of 7 to 9 coaches, weighing 120 to 140 tons, burnt only 22.6 lbs. of coal per mile, when working between London and Grantham, and Grantham and York. Nothing can more clearly show their economy in regard to fuel.

The line rises upon leaving London, King’s Cross, by gradients of 1 in 105 and 1 in 110 through Maiden Lane and Copenhagen tunnels, and from about the 4½ mile post to the 12¾ post is all rising one in 200. It is found in practice that engines similar to Fig. 78 can take from 16 to 20 coaches up hill to Potter’s Bar at an average speed of 40 miles an hour, and then they can run the remaining 92 miles to Grantham without a stop at an average of just under, or if necessary, fully 60 miles an hour. In 1888 No. 776 took an important part in the “race to Edinburgh,” and

engines of this type have been timed at a speed of "just under, or practically, 80 miles an hour."

Since 1886 Mr. Stirling has placed several new express engines upon the Great Northern Railway, known as the 230 class, in which he has returned to the inside cylinder pattern. These have 6 wheels, cylinders $18\frac{1}{2} \times 26$, and driving wheels 7 feet $7\frac{1}{2}$ inches when new.

The practical result of working is that both types are very efficient. The inside cylinder class is less costly to build, the coal consumption is the same in both; and with reference to the question of speed it is found that the 7 feet 6 inch engines can run equally as fast as the 8 feet engines. For extremely fast running an *inside* cylinder engine is more suitable than an *outside*; it is therefore probable that in future the inside cylinder class will become the standard.

A special series of comparative trips recently made between Doncaster, York, and Peterborough, with a "compound" engine, and a Great Northern "simple" engine resulted considerably in favour of the latter.

For working the Great Eastern Company's heavy express trains between London, Yarmouth, Cromer, Doncaster, &c., Mr. James Holden has designed and constructed at Stratford several engines of the type illustrated (Fig. 79).

These engines have four wheels coupled, 7 feet diameter, the leading end being carried by a pair of 4 feet wheels.

The cylinders are 18 inches diameter, and the stroke 24 inches; the tractive force exerted for each pound of effective steam pressure per square inch on the pistons is thereforc—

$$\frac{18 \times 18 \times 24}{84} = 92.57.$$

The axle of the leading wheels is provided with both inside and outside axle-boxes.

Total heating surface	1,230 sq. ft.
Weight in working order	42 tons
Weight of tender	30 tons 12 cwts.
	<hr/>
	72 tons 12 cwts.

The boiler is 4 feet 3 inches diameter inside, butt jointed, the plates being of steel $\frac{1}{2}$ inch thick, and the working pressure of steam 150 lb. per square inch.

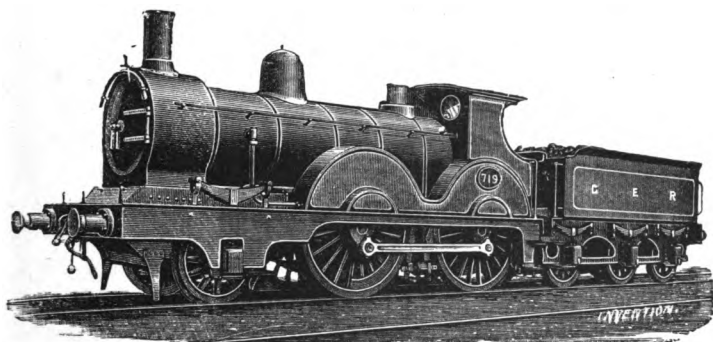

Fig. 79.—A Modern Great Eastern Express Engine.

The inside fire-box is of copper $\frac{1}{2}$ inch thick, except the tube plate, which is 1 inch thick at top and $\frac{1}{2}$ inch at the bottom. It is now the practice at Stratford to fit all engines having cylinders 17 inches diameter and upwards with $5\frac{1}{2}$ inches steam pipes and large regulators.

Indicator diagrams taken from the steam chest and cylinders show far less wire drawing at high speeds than formerly with the $4\frac{1}{4}$ -inch pipes.

The cylinders are cast in one, and placed with the

valve faces downwards. This arrangement allows of long axle bearings. The cylinders are well drained, and the valves can drop from the faces when running with steam shut off.

The valves are worked by the ordinary link-motion, counterbalanced by a spring and reversed by a wheel and screw. All engines now built at Stratford have single slide-bars, and cast-steel cross-heads, motion plates, spring hanger brackets, spring hangers, horn blocks, etc., and cast steel is now being introduced for all wheels. The coupling rods are made of wrought-iron of I section.

The tender is carried upon six cast-steel wheels of 4 feet diameter, the springs being outside the frames and (like all the new tenders) is now fitted with axle-boxes of a new pattern; the box is cast in one without keep, a large oil reservoir is arranged to slip in under the journal from the front, which is easily removed to change the oil pads as required; a dust shield is provided at the back or inner end of the box. These axle-boxes are found to work very satisfactorily, and there has not been any case of trouble from their heating. The tender carries 2,640 gallons of water and three tons of coal.

The whole of the passenger rolling stock upon the Great Eastern Railway, including, of course, engine 719, is fitted with the Westinghouse automatic continuous brake.

The express trains upon the Great Eastern Railway are heavy, more especially so during the summer months, when they are made up at Liverpool Street Station from 18 to 21, and sometimes even more, 6-wheeled carriages, the majority of which are third-

class six compartment vehicles, all fully loaded and drawn by one engine. The work which has to be performed by such engines is very greatly increased, as the writer observed when travelling with the trains, by the fact that at a distance of about half a mile from the starting point the Bethnal Green incline commences and continues for nearly three-quarters of a mile upon a gradient of 1 in 70; the gradients on both the company's main lines are severe, the curves both numerous and sharp, and the trains long.

In 1888 Mr. Holden designed a new type of express engines somewhat similar in appearance to 719, but having a "single" pair of 7 feet driving-wheels; these are also giving great satisfaction.

The Great Eastern Company has several locomotives at work fitted with Mr. Holden's system for burning liquid fuel. One of these, "Petrolea" (No. 760), is fitted to burn liquid fuel, but beyond the addition of an oil tank on the tender, and a few pipes leading to the liquid fuel injectors below the fire-hole door, there is nothing in its outward appearance to distinguish it from a coal-burning locomotive, to which it can be converted at any moment, there being no alteration in the construction of the fire-box. A special feature of the injector is an outer ring through which jets of steam pass, these jets impinging at the nozzle on the liquid fuel induced through a central cone, and breaking the fuel up into a very finely divided spray which ignites immediately. There is a passage in the injector through which air also is induced, and as the emission of steam, liquid, and air can be adjusted independently of each other, combustion is regulated to a nicety, and the slightest smoke

avoided. The fire is lit up with coal in the usual way, and a bed of incandescent fuel and chalk or broken bricks kept up, the weight of coal used in conjunction with the liquid fuel being about one-third of the total fuel consumed. The saving of labour to the fireman is, of course, very great, whilst the incandescent base enables the engine to lie practically inert for hours if required, yet ready to start into action directly the injector is worked. The "Petrolea" is employed to work some of the fastest and most important of the Company's trains, and the "fuel experiment" is being watched with great interest.

The Manchester, Sheffield, and Lincolnshire Company has recently constructed a new class of engine (Fig. 80), at its Gorton works, from the designs of Mr. Parker, locomotive superintendent.

These engines work the main line trains between Manchester, Retford, and Grantham. They have cylinders 18 × 26, coupled wheels 6 ft. 9 in. diameter, with pressure of steam 160 pounds. Total heating-surface, 1,278 square feet. The tractive force for each pound of effective pressure is 104 lbs. The piston speed when running at 60 miles an hour is thus—

$$\frac{26 \times 60 \times 56}{81} = 1,076 \text{ feet per minute.}$$

Weight of engine in working order	46 tons.
Tender in working order	35 tons.
Total	<u>81 tons.</u>

The tender carries 3,080 gallons of water and 4 tons of coal, and is provided with a special design of axle-box which is easily accessible.

The main line of the Manchester, Sheffield, and Lincolnshire Company forms a very considerable link in the through route between Manchester (London Road) and London (King's Cross); and to avoid an extra stop at Retford, the Sheffield Company's engines work these express trains over the Great Northern Railway as far south as Grantham, and it is upon this important service that No. 564 and its sister engines are employed.

The loads vary from 120 to 200 tons, equivalent to

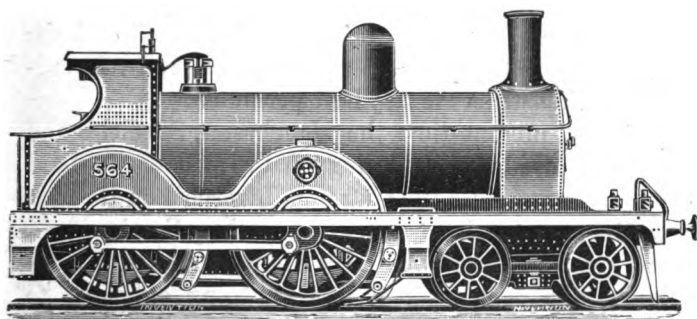

Fig. 80.—The Latest Design of M. S. & L. Express Engine.

nine to fifteen vehicles. The average speed, exclusive of stoppages, equals $44\frac{1}{2}$ miles an hour.

In order to fully appreciate the work which has to be performed, it is necessary to take into account the heavy gradients and also the very numerous curves which exist (the sharpest of which has a 7-chain radius), and which, of course, cause much extra flange friction. The writer has recently made several trips in trains over the route in order to carefully note the actual working of the engines upon the various gradients.

Leaving Manchester, the engine has one continuous up-hill pull of 22 miles to Dunford Bridge, the gradients being chiefly 1 in 100, 108, 97, 100, 177, 201.

Upon the return journey, after leaving Sheffield, the train has to climb up to Dunford Bridge, 19 miles of 1 in 132, 120, 131, 100, 135. Railway-men will see at a glance the work which these gradients imply, more especially when the long incline has to be faced after the engine has worked from Grantham to Sheffield, a distance of 56 miles, and made a start from that station.

The average consumption of coal per mile of the 564 type has been reduced to 24 lbs., and under favourable circumstances to $22\frac{1}{2}$ lbs., per mile.

At the present time the Manchester, Sheffield, and Lincolnshire line may be regarded as an extensive local system, its engines working from Liverpool on the west to Grimsby on the east, as far north as Scarborough, and south to Grantham. By a recent Act of Parliament, the company's system is being extended to Nottingham, and by means of a projected line through Leicester to Aylesbury it is now certain that at no distant date the Manchester, Sheffield, and Lincolnshire line will, in connection with the Metropolitan, become a great through route upon which its own engines will work trains to London.

The North Eastern Company exercises its running powers over the North British Railway between Berwick and Edinburgh, and provides the locomotive power for the through East Coast Joint Stock expresses between York and Edinburgh. For several years this service was worked by engines designed by Mr. Fletcher in 1870, having four coupled 7 feet

wheels and cylinders 17 by 24. In 1885 twenty express engines were built at the suggestion of Mr. Tennant, General Manager; these had 4 coupled 7-foot wheels, cylinders 18 by 24, and 1,250 square feet of heating surface; these proved remarkably fine engines, and still work the express trains between Newcastle and York.

In the early part of the year 1889 Mr. T. W. Worsdell, having become the Company's locomotive superintendent, made a new departure by constructing an engine—No. 1329—having a single pair of driving wheels 7 feet $1\frac{1}{4}$ inches diameter, and upon the compound principle. The working results of this engine proved thoroughly satisfactory to Mr. Worsdell; he therefore decided to construct five others of a still larger design, one of these being No. 1518 (Fig. 81).

Mr. T. W. Worsdell has laboured very energetically in the development of the "two-cylinder compound engine" (Fig. 81), which he maintains is better than the three-cylinder system.

The North-Eastern compound engines are worked upon the system of Messrs. Worsdell and Von Borries; the latest design (Fig. 81) has a high-pressure cylinder 20 inches diameter, and a low-pressure cylinder 28 inches diameter, the stroke in both cases being 24 inches. To place two such large cylinders between the frames it was found necessary to fix them at different levels, so that their axes are not parallel.

The driving-wheels are 7 feet $7\frac{1}{4}$ inches diameter.

The valves are worked by the Joy gear, through the medium of rocking shafts. There is also a special valve arrangement by which high-pressure steam can be admitted direct to the low-pressure cylinder. This

arrangement enables the engine to be started when the high-pressure cylinder is upon a dead point. The boilers have been built to carry a working pressure of steam of 200 pounds per square inch, but at the present time 175 pounds is the pressure used.

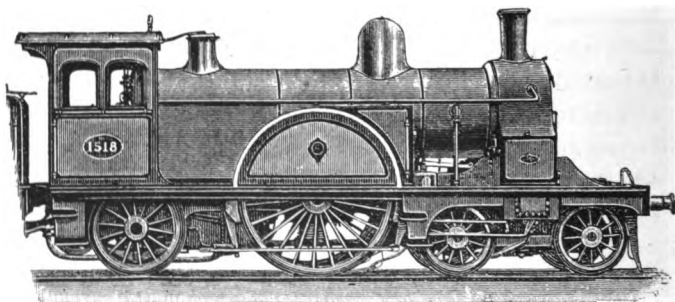

Fig. 81.—The Latest Design of North Eastern Engine.

Total heating surface....	1,139 sq. ft.
Weight on driving wheels	17 tons, 15 cwt.
Weight of engine (full)	46 13 2
Weight of tender (full)	40 1 0
Total	86 14 2

The weight of 17 tons 15 cwts. upon the driving-wheels, assisted by the sand-blast, is found amply sufficient to provide the necessary adhesion.

This is the heaviest class of engine and tender complete running in this country.

The tender carries 4 tons of coal and 3,940 gallons of water, which enables these engines to run through from Newcastle to Edinburgh, 124 miles 31 chains, without a stop.

Several of these engines have run at very high speed,

and the writer has timed them at just under 80 miles an hour.

No. 1,517 was put into traffic between Newcastle and Edinburgh early in October, 1889. The loads varied from ten to twenty-two vehicles. At the end of October the average coal consumption was stated to be 26·4 lbs. per mile. On one occasion a trial was made between Newcastle and Berwick with a train of thirty-two empty carriages; the distance—67 miles—was run in 78 minutes, or three minutes under the time of the Scotch Express, and this with a load of certainly not less than 270 tons, exclusive of engine and tender.

Mr. Worsdell has also conferred a boon upon the drivers and firemen of the North-Eastern Railway, by providing them with a good comfortable cab, as shown (Fig. 81).

A similar engine, No. 1,521, was sent to the Edinburgh Exhibition of 1890.

Mr. William Adams, locomotive superintendent of the London and South-Western Railway, has lately designed and constructed, at Nine Elms, twenty express engines (Fig. 82) of great size and power.

Diameter of cylinders	19 ins.
Length of stroke	26 ins.
The piston-rod passes through the front cover of the cylinder.	
	ft. ins.
Diameter of bogie wheels	3 9 $\frac{1}{4}$
Diameter of coupled wheels	7 1
Length of boiler barrel	11 0
Length between tube-plates	11 4
Diameter of boiler outside	4 4
Number of tubes	240
Diameter of tubes outside	0 1 $\frac{1}{4}$
The boiler is made of mild steel plates. Working pressure of steam, 175 lb. per sq. in.	
The boiler is fed by two No. 8 injectors.	
From rails to centre of boiler	7 9

Heating surface of tubes	1,245·60 sq. ft.
Heating surface of fire-box	122·16 "
Total	1,367·76 "
Area of fire-grate	18 "
	ft ins.
From front of buffer plate to centre of bogie ..	8 4 $\frac{3}{4}$
From bogie centre to centre of driving-axle ..	10 9
From driving to trailing	8 6
From trailing axle to back of frame	4 3

The frames are of mild steel, placed inside, and the axles have inside-bearings only; the driving and trailing springs are attached to a compensating beam;

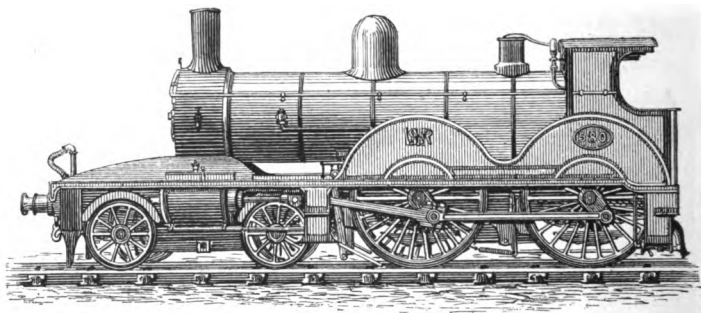

Fig. 82.—The Latest Design of London & South-Western Express Engine, No. 580.

the axles are of cast-steel; the tires of steel; copper fire-box and brass tubes; the coupling-rods are of wrought-iron of I. section.

The tender runs on six wheels of 3 ft. 9 $\frac{1}{4}$ ins. diameter, the capacity of the tank being 3,300 gallons.

Weight of engine in working order—

ENGINE—

				Tons.	cwt.	qrs.
On bogie wheels	18	4	0
On driving wheels	15	13	0
On trailing wheels	14	18	0
Total engine	48	15	0

TENDER—

					Tons.	cwt.	qrs.
On first pair of wheels	9	18	0
On middle	10	8	0
On third	11	14	0
<hr/>							
Total	32	0	0
Total engine and tender in working order	80	15	0
<hr/>							
Total wheel-base of engine and tender	44	3	$\frac{1}{8}$ ft. in.
Total length over buffers	53	8	$\frac{3}{8}$

One cast-iron brake-block is fitted to each coupled and tender wheel applied by "steam"; the engine is also provided with the necessary apparatus for working the automatic vacuum brake upon the train.

Mr. Adams has also designed and constructed another type of locomotive for either passenger or goods traffic, these new engines being employed to run express goods between London and Exeter, and also upon heavy excursion traffic.

They are tender engines running upon six wheels, having four coupled wheels in front and a small pair of trailing wheels under the foot-plate.

"530 CLASS."

Diameter of cylinders	18 ins.
Length of stroke	26 "
Diameter of coupled wheels	6 ft.
Length of boiler barrel	11 "
Number of tubes	218
Diameter of tubes (outside)	1 $\frac{1}{2}$ in.
Heating surface of tubes	1131.4 sq. ft.
Heating surface of fire box	116.7 "

Total 1,248.1 "

Area of fire-grate	17 sq. ft.
Pressure of steam	160 lb. per sq. in.

Weight in working order—

				Tons.	cwt.	qrs.
On leading wheels	15	6	0
On driving wheels	16	8	0
On trailing wheels	10	13	0
Total engine				42	7	0
Weight of tender loaded				30	2	0
Grand total of engine and tender				72	9	0
Length of wheel base of engine and tender				38 ft. 1½ in.		

The new class of tank engine, 62 type, for working local passenger trains, runs on eight wheels and has inside cylinders.

The four coupled wheels are 5 ft. 7 ins. diameter, placed in front, and a four-wheeled bogie is placed under the foot-plate. The cylinders are 18 by 26.

Weight in working order—

				Tons.	cwt.	qr.
On leading wheels	17	3	0
On driving wheels	18	0	0
On bogie wheels	17	0	0
Total				52	3	0
Total heating surface				1,248 sq. ft.		

The South-Western Company provides its engines with the Adams Vortex blast-pipe, which instead of being a simple tapered pipe, as generally employed, has a central tube through which the heated air from the lower rows of tubes is drawn. This blast-pipe is found to fully answer expectations, as will be seen from the following official statement.

From June, 1885, to June, 1889, the company mixed the coal in proportion of two-thirds Welsh coal to one-third hard coal; since that time, in consequence of the increase in price of Welsh coal, the proportion is reversed, and in consequence the consumption is increased, and thus destroys the means of comparison with former years. (See next page.)

The latest South-Eastern express engines are designed by Mr. James Stirling and constructed at Ashford; they have a leading bogie and four coupled 7-foot wheels; the cylinders, placed inside, are 19 inches diameter and the stroke 26 inches.

The results of the working of six of these engines stationed at Dover, and each running about 1,000 miles per week upon mail and express trains between Dover and London, were as follows, and show very clearly the influence of weather and working generally during three different seasons of the years since the design was introduced.

MAY.

Average load 12 vehicles = 120 tons	}	= 190 tons.
Engine and tender .. 70 ,,		
Average coal per train mile, 27.62 lbs.		

NOVEMBER.

Average load same as above, 190 tons.
Average coal per train mile, 30.37 lbs.

AUGUST.

Average load 15 vehicles = 150 tons	}	= 220 tons.
Engine and tender .. 70 ,,		
Average coal per train mile, 28.72 lbs.		

The London, Chatham, and Dover Railway employs express engines designed and constructed by Mr. William Kirtley at its Longhedge Works. They have a leading bogie, four coupled wheels of 6 feet 6 inches diameter.

The cylinders are $17\frac{1}{2}$ inches diameter, by 26 inches stroke, the coupled wheels being 6 feet 6 inches diameter, and the tractive force therefore—

$$\frac{17\frac{1}{2}^2 \times 26}{78} = 102 \text{ lbs.}$$

for every lb. effective pressure on the piston. The boiler pressure is 150 lbs. per square inch.

The weight on the coupled wheels is $27\frac{3}{4}$ tons, or 62,160 lbs., and a tractive force equal to $\frac{1}{3}$ of the weight

available for adhesion would be given by a mean effective pressure of—

$$\frac{62160}{102 \times 5} = 121.8 \text{ lbs.}$$

per square inch, for which the cut-off required would be about 65 per cent. of the stroke.

The boiler, barrel, and fire-box shell are of best Yorkshire iron, the barrel made in two plates only, the circumferential seams being lap jointed and single riveted, and the longitudinal seams butt jointed and double riveted.

The top and sides of the shell are formed of one plate. The inside fire-box is of copper, the crown and sides in one plate, and the crown stayed by wrought-iron bars, secured by studs screwed through the crown plate into the bar with nuts on the underside. The fire-box stays are of copper. The back plate of the shell and the front tube plate are stayed by direct longitudinal stays, and the fire-box tube plate to the barrel by palm stays riveted to the latter.

	ft.	ins.
Height of centre of boiler from rail	7	2
Length of barrel	10	3
Diameter of barrel outside at largest part ..	4	3
Thickness of plates		$\frac{7}{16}$
Length of fire-box shell outside	5	9
Width of ditto at bottom	3	11
Depth of ditto from centre of boiler ..	5	2
Thickness of ditto plates	0	$0\frac{1}{2}$
Water space between fire-box and shell at bottom	0	3
Thickness of fire-box plates	0	$0\frac{1}{4}$
Ditto tube-plate	0	$0\frac{1}{8}$
Number of tubes, 199 (brass)		
Diameter of ditto outside	0	$1\frac{3}{4}$
Pitch of ditto	0	$2\frac{1}{2}$
Heating surface tubes 963 square feet.		
Ditto fire-box 107 " "		
Total ..	1,070	
Grate area 16.5 square feet.		

The fire-box is fitted with brick arch and deflector plate on the inside, and sliding doors on the outside, these being fitted with an auxiliary door or valve for regulating the admission of air to the fire-box, the main or sliding doors being always closed when running, so that no glare or heat from the fire is thrown on to the footplate or into the cab, to incommode the men, or affect their clear view of the signals by night. The grate bars are $1\frac{1}{4}$ inches wide at the top, and of wrought iron with $\frac{1}{2}$ -inch air spaces.

The London, Tilbury and Southend Railway works its passenger traffic with large ten-wheeled tank engines, having a leading bogie, four coupled wheels of 6 feet diameter, and a trailing pair of small wheels, the cylinders placed "outside" and 17×26 . The total weight of these engines is 56 tons.

The latest tank engines for the North London Railway have been designed and built by Mr. Park at Bow; they have outside cylinders $17\frac{1}{2} \times 24$, a leading bogie, four coupled wheels, and a steam pressure of 180 lbs. per square inch.

The North London Company's main line extends from Broad Street station to the junction with the London and North-Western system at Chalk Farm, and it has branches to Poplar and at Bow which bring up the total length of the railway to twelve miles.

The Company also is joint lessee with the North-Western and Midland of the North and South-Western Junction Railway, and by means of running powers over portions of the Great Northern, London and North-Western, and other lines, its trains traverse the western, northern, and eastern suburbs of London.

The traffic is heavy, the gradients severe (being 1 in 59 at Highgate), and the stations about half a mile apart.

The average mileage of the whole of the North London Company's engines equals 46,000 miles per annum, and the average fuel is 30 lbs. of coal per train mile.

The North London was one of the first companies to see and take advantage of high steam pressure. When other lines were using 120 lbs. and 140 lbs. per square inch, this line employed 160 lbs. with excellent results.

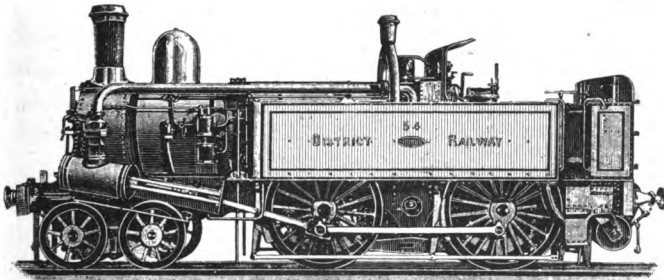

Fig. 83.—Metropolitan District Engine.

The Metropolitan and Metropolitan District Railways have both for many years worked their heavy and continuous passenger traffic with leading bogie, outside cylinder, four-coupled passenger tank engines, having cylinders 17×24 , and wheels 5 feet 9 inches. However, the latest Metropolitan engine has inside cylinders and a trailing bogie.

Fig. 83 shows that the engine has a leading bogie, four coupled wheels, and outside cylinders. This class of tank engine was originally designed for the underground railways by Sir John Fowler. On the opening

of the Metropolitan District Railway, the locomotive stock consisted of twenty-four of these engines, since increased to fifty-four, the whole of which have been built by Messrs. Beyer, Peacock & Co., of Manchester. These engines have proved remarkably satisfactory, as is clearly shown by the fact that when ordering new ones it has been found unnecessary to make any changes of importance in the dimensions. The chief dimensions of No. 54 are as follows:—

Diameter of cylinders (17)	ft.	ins.
Length of stroke (24)	2	0
Length of ports	1	1 $\frac{1}{2}$
Width of steam ports	0	1 $\frac{1}{2}$
Width of exhaust ports	0	2 $\frac{1}{2}$
Between centres of cylinders	6	0
Between centres of valve spindles	2	10 $\frac{1}{2}$
Diameter of piston rods	0	2 $\frac{1}{2}$
Lap of valves	0	0 $\frac{1}{2}$
Lead of valves	0	0 $\frac{1}{2}$
Throw of eccentrics	0	2 $\frac{1}{2}$
Diameter of bogie wheels (new)	3	0
Diameter of coupled wheels (new)	5	9 $\frac{1}{2}$
Total wheel base	20	9
Diameter of boiler (inside)	4	0
Length of boiler, between tube plates	10	6 $\frac{3}{4}$
Diameter of tubes	0	2
Number of tubes	164	
Working pressure of steam	130	lbs.
Diameter of blast-pipe	0	5 $\frac{1}{2}$

When working in tunnels the exhaust steam is discharged into the water tanks.

Weight in working order:—

On bogie wheels	tons.	cwts.
On driving wheels	10	17
On trailing wheels	18	1
					17	12
					Total	46 10

On journeys round the “inner circle” the author finds the number of booked stops is twenty-seven, in

addition to which there are always several due to signals; the distance is thirteen miles, and the time occupied in running sixty-eight minutes. The load hauled on all the circle trains and also over the gradients above mentioned is a train of nine coaches weighing from 75 to 87 tons empty. There are also a few local trains of five coaches running between High Street, Kensington, Putney Bridge, Earl's Court, Chiswick Park, and on the Hounslow branch.

The entire stock of the Metropolitan District Company, consisting of fifty-four engines and 350 carriages, is fitted with the Westinghouse automatic brake, and it is a fact worthy of note that although constantly stopping trains this brake works without a single fault or delay being caused.

The Company's locomotives undergo a general repair once in about two and a half years, and are practically in constant work from one general repair to the next, one shed day in seven being the only time they are cold.

The author finds the coal sheet to be remarkably good, considering the constant starting of trains, the heavy work, and severe gradients, the average consumption being less than 30 lbs. per mile. It must also be remembered that the entire railway consists of curves, there being hardly any straight road, and many of the curves are so sharp as to require check rails.

The Great Eastern Company has several useful classes of express engine, in addition to those illustrated, Fig. 79, namely the old "single" engines designed by Mr. Sinclair, and the large bogie express engines of the 602 class, having cylinders 18×26 and driving-wheels 7 feet 6 inches diameter.

There is also the Coupled Compound Engine, No. 230, built by Mr. Worsdell.

The Lancashire and Yorkshire Railway, having heavy gradients and frequent stoppages, requires engines of considerable power. That company, therefore, employs engines having a leading bogie, four coupled wheels of 6 feet diameter, and cylinders $17\frac{1}{2} \times 26$, also the latest class having cylinders 18×26 and 7 feet 3 inches coupled wheels.

The North British Railway is also one requiring power: we therefore find bogie express engines with four coupled wheels of 6 feet 6 inches diameter and cylinders 18 by 26.

On the Caledonian Railway several powerful engines are employed. Mr. Drummond has constructed bogie express engines with cylinders 18 by 26 and 6 feet 6 inches coupled wheels, and engine No. 124 has 19 inch cylinders. Boilers with various pressures from 150 to 200 lbs. per square inch have also been tried upon this railway.

The tank engines for working the passenger traffic between Liverpool and Birkenhead through the Mersey tunnel are of exceptional power, the gradient to be ascended being no less than 1 in 27; the engines of the No. 1 class have six coupled wheels of 4 feet 7 inches diameter and a trailing bogie, the cylinders are 21 inches diameter and 26 inches stroke, the total weight of this engine being 68 tons. This great power and weight enable these engines to stop at any point within the tunnel, and start away with their trains upon the heavy gradient of 1 in 27.

From the opening of the St. Pancras Station for the Midland Company's main line trains, in 1868, until the

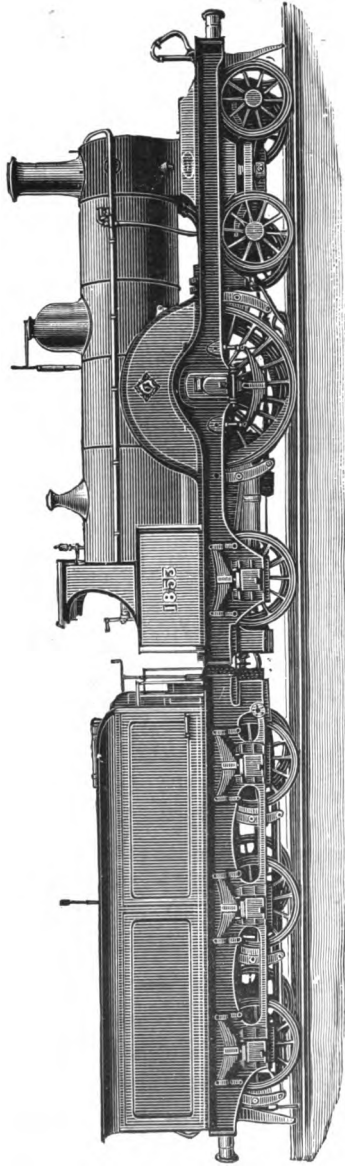

Fig. 84.—The Latest Design of Midland Express Engine.



year 1887, the whole of the express trains to London were worked by engines having four wheels coupled, but in that year Mr. S. W. Johnson designed and constructed some engines having a "single" pair of driving wheels, 7 feet 4 inches diameter, cylinders 18 by 26 and steam pressure 160 pounds. Two years later, 1889, he designed a still larger class (see Fig. 84) having cylinders $18\frac{1}{2} \times 26$, and 7 feet 6 inches wheels.

Total heating surface	1,240 sq. ft.
Pressure of steam	160 lbs.
Weight on driving wheels	$17\frac{1}{2}$ tons.
Weight of engine in average working order	43 tons.
Weight of tender	30 "
<hr/>	
Total	73 tons.
Tender, water capacity	3,250 gallons.

Fifty of these engines are now working between London and Leicester, London and Nottingham, and Liverpool to Marple, also between Bristol and Derby. The fact that engines of this type are working the main line express trains over the London line, having severe gradients (see Fig. 85), for instance, Irchester and Sharnbrook of 1 in 120, at high speed, and upon a coal consumption of 20 to 23 pounds per mile, is the most convincing proof of their great efficiency.

Considering the loads, speed, and gradients, the work which has to be performed between London and Leicester is as hard or harder than any locomotive work in the country. Leaving London, the line rises for about 12 miles to Elstree, thence followed by a fall of 1 in 200 for about two miles to Radlett, when the rise continues to Leagrave. The engine, therefore, has

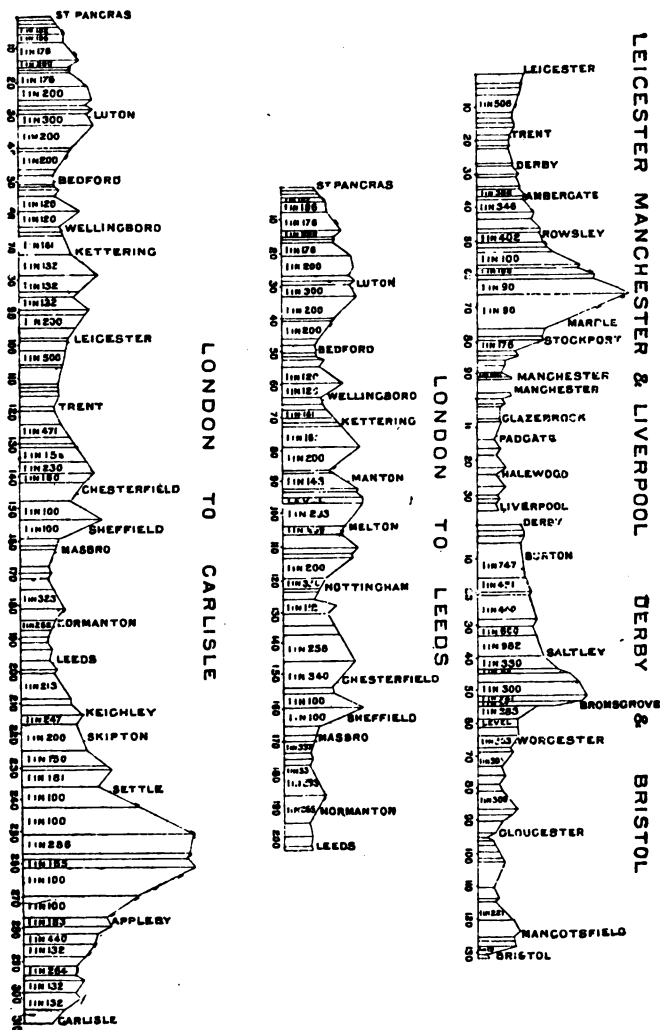

Fig. 85.—Section showing Gradients of Midland Railway.

practically a constant pull up 1 in 176, and 1 in 200, until it has run 33 miles, when the line falls to Bedford upon gradients of 1 in 200, and speed has to be reduced to 15 miles an hour passing that station, which is a bad beginning for the rise to Sharnbrook summit, which is the top of both the Sharnbrook and Irchester Banks, of 1 in 120. Having run down to Wellingborough, the up-hill work continues past Kettering to the Desborough North Box, which is at the summit of two banks, of 1 in 132, and from Market Harborough up-hill work follows to the summit at Kibworth North Box, thence (with the exception of a dip at Glen) the line falls to Leicester. It will thus be seen that there are long lengths of 176, 120, 132, and at Kibworth a short length of 1 in 100. The Scotch trains now perform the distance, $99\frac{1}{4}$ miles, with a load of $10\frac{1}{2}$ coaches, in 115 minutes.

The Nottingham expresses are allowed 80 minutes between Kentish Town and Kettering, $70\frac{1}{2}$ miles, or an average from start to stop of nearly 53 miles an hour; and when riding in the trains the writer has very frequently timed the run in less than 78 minutes, and upon no occasion has he been a passenger when one of these engines has ever lost any time.

The "Greater Britain," designed and constructed by Mr. Webb at Crewe, ran its first trip on the 4th November, 1891.

The general principle of the design of the "Greater Britain" is identical with the other compounds. The high-pressure cylinders are 15 inches diameter, and the low-pressure cylinder is 30 inches diameter, the stroke in each case being 24 inches. As far as tractive force is concerned, the engine is said to be equivalent

to a non-compound locomotive having a pair of 21-inch cylinders with a 2-foot stroke, the driving wheels being 7 feet 1 inch diameter.

The special feature in the “Greater Britain” is the design of the boiler, which has been made with a very long barrel to allow of both driving-axles being placed under it. The tubes are divided into two lengths by a combustion chamber, those extending from the firebox to the combustion chamber being 5 feet 10 inches long between tube-plates, while those forming the front group are 10 feet 1 inch long.

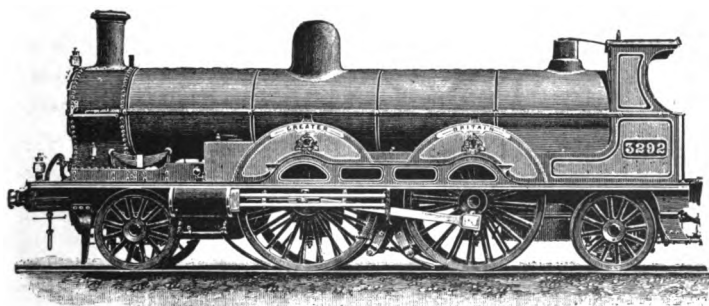

Fig. 86.—Mr. Webb's Latest Design of Compound Engine.

Heating surface of firebox	120.6 sq. ft.
" " combustion chamber ..	39.1 " "
" " tubes (front)	853.0 " "
" " tubes (back)	493.0 " "
	<hr/>
Total	1,505.7 sq. ft.
Pressure of steam	175 lbs. per sq. inch.
Weight of engine in working order ..	52 tons 2 cwt.
Weight of tender	25 " "
	<hr/>
Total	77 tons 2 cwt.

Sufficient time has not yet elapsed for this engine to prove her cost of maintenance ; but, so far, facts appear to show that the difficulties which attend "compound" express engines have not yet been successfully overcome.

The following particulars of the London and North-Western route show the gradients over which the engines work.

Leaving Euston the line passes under the Hampstead Road and immediately commences to rise upon gradients of 1 in 66, 1 in 110, 1 in 132, and 1 in 75 to Camden. Having once overcome the Euston incline, the engine has before it a splendid run to Crewe. There are summits at Tring, Blisworth, Kilsby, Atherstone, and Whitmore ; but with the exception of the rise near Whitmore, the engines upon either the up or down journey have practically to work throughout upon gradients of not more than 1 in 330, or 16 feet per mile.

North of Crewe the gradients become more severe until, upon passing the 243rd mile-post, the engine commences to ascend long and severe gradients, and from Tebay to Shap-summit, a "bank engine" is employed to assist the trains up the incline of 1 in 75, after which the line falls to Carlisle.

The most severe gradient is 1 in 75 going north, and 1 in 95 between Carlisle and Shap travelling south. It is under consideration to make a tunnel and new line under Shap-summit. If this plan be carried out, both these severe gradients will be avoided.

During the year 1891, and early part of 1892, thirty new express engines were built at the Swindon works of the Great Western Railway from the designs of Mr.

William Dean, to take the place of the broad gauge engines on the 23rd May, 1892.

The new engines are numbered from 3,001 to 3,030, and run upon six wheels, have double frames, a single pair of driving wheels, 7 feet 8 inches diameter, and a pair of inside cylinders no less than 20 inches diameter (Fig. 87).

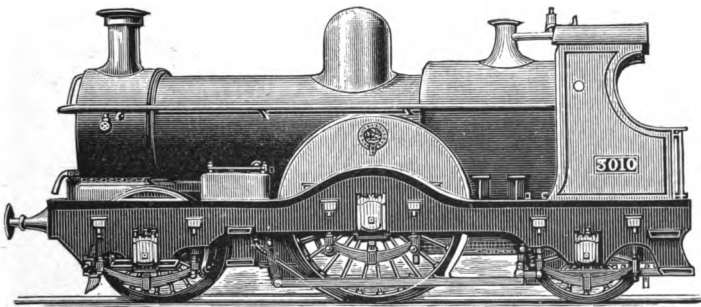

Fig. 87.—Mr. Dean's Latest Design.

The chief dimensions of these splendid locomotives being as follows:—

Diameter of cylinders	20 ins.
Length of stroke	24 "
Diameter of driving wheels	7 ft. 8 ins.

The tractive force exerted for each pound of effective steam pressure per square inch in the cylinders being, therefore, thus—

$$\frac{20 \times 20 \times 24}{92} = 101.3478$$

The steam pressure carried being 160 lbs. per square inch, and the weight available for adhesion 19 tons,

it follows that the engines are capable of performing fast and very heavy work. The boilers of these new engines are provided with a dome, an advantage which the old engines (Figs. 44 and 54) did not have.

Distance apart between centres of cylinders ..	2 ft. 3 ins.
Length of boiler between the tube plates ..	11 ft. 9½ ins.
Mean diameter of telescopic boiler inside ..	4 ft. 1¼ ins.
Number of tubes	245
Diameter of tubes (outside)	1¾ ins.
Pressure of steam	160 lbs.
Heating surface of tubes	1,321·04 sq. ft.
Heating surface of fire-box	123·88 „ „
	<hr/>
	1,444·92 „ „
Area of fire-grate	20·8 sq. ft.
Length of wheel-base	18 ft. 6 ins.

Weight of engine in working order—

On leading wheels	13 tons 4 cwts.
On driving wheels	19 „ 0 „
On trailing wheels	11 „ 18 „
	<hr/>
	Total 44 „ 2 „
Weight of tender full	32 „ 0 „
	<hr/>
Grand total, engine and tender ..	76 „ 2 „

The tender runs upon six wheels, and carries 2½ tons of coal, and 3,000 gallons, or 13 tons 7 cwts. and 96 lbs., of water.

It is an admitted fact that the “battle of the gauges” has ended completely in favour of the narrow gauge; however, now the Great Western Company has made the change, it has given proof that it intends to have some of the finest narrow-gauge express engines that can be constructed. When we see the fine new engines which Mr. Dean has built for the 4 feet 8½ inch gauge, we cannot help feeling great regret

that Mr. Brunel did not devote his great skill and energy to the perfecting of the narrow-gauge engine, instead of introducing a wide gauge which has now had to be removed.

The gradients upon the Great Western Railway between London and Bristol are, with two exceptions, extremely favourable.

Leaving Paddington the line rises very gradually for about 11 miles to near Hayes, thence there is a decline of one in 1,716; from West Drayton to Swindon there is a very gradual rise, but the gradients are only about 1 in 1,320, 1 in 660 being the most severe.

Near to Dauntsey, there is about $1\frac{1}{2}$ miles of 1 in 100, and through Box Tunnel the gradient is also 1 in 100, these inclines in both cases being against the up trains. From Box to Bristol the line falls upon easy gradients.

The rise of 1 in 100 through Box Tunnel has often been described as the *bête noire* of engine drivers; however, it is not likely that they will be much troubled by engines "slipping" when the driving wheels carry 19 tons and are provided with a good supply of sand.

Already these new engines have proved beyond question that the broad gauge was a mistake, and that whatever has or can be done upon the wide gauge can be equally well done upon the 4 feet $8\frac{1}{2}$ inch gauge.

Messrs. Sharp, Stewart & Co., of the Atlas Works, Glasgow, recently placed twenty new bogie express engines upon the Midland Railway, built from Mr. Johnson's designs, Nos. 2,183 to 2,202; they have cylinders $18\frac{1}{2}$ by 26, 7-foot driving wheels, 4 coupled, and a steam pressure of 160 lbs. per square inch;

they are also provided with the apparatus for warming the carriages by hot water, now adopted by the Midland; and for working local passenger traffic upon the same line a number of "bogies" tank engines have been built, having four coupled wheels of 5 feet 3 inches, cylinders 18 by 24, and a pressure of 140 lbs.

The Great Southern and Western Railway Company of Ireland owns the main line extending from the Kingsbridge station, Dublin, to Queenstown, the distance being $177\frac{1}{4}$ miles; and it is by this route that passengers and mails are conveyed to and from Queenstown in connection with the American liners.

The gauge of the Irish railways is 5 ft. 3 ins.

For many years past the Great Southern and Western Company has built all its engines and rolling stock at its Inchicore Works, near Dublin.

The latest express engine has inside cylinders, a leading bogie, and four coupled wheels.

				ft.	ins.
Diameter of cylinders	0	18
Length of stroke	0	24
Diameter of coupled wheels	6	6
Diameter of boiler	4	3
Length of boiler barrel	9	9
Diameter of tubes (outside)	0	$1\frac{3}{4}$
Length of tubes between tube plates	10	$0\frac{9}{16}$
Length of fire-box	4	10
Width of fire-box	3	11
Height of fire-box above grate	5	9
Pressure of steam	150 lbs. per sq. in.		
Number of tubes	204
Heating surface of fire-box	112	sq. ft.
Heating surface of tubes	938	„
				<hr/>	
		Total	..	1,050	„
Area of fire-grate	$18\frac{1}{2}$	„

Weight of engine in working order—

				tons.	cwt.
On bogie wheels	13	11
On driving wheels	12	17
On trailing wheels	12	16
				<hr/>	
Total		39	4
Weight of tender loaded	28	6
				<hr/>	
Grand total		67	10

The leading bogie is of the American swing-link pattern. The boiler and frame plates are of steel, and the motion plate is cast steel; the two cylinders are cast together in one piece, and have the back covers and air passages for the vacuum brake cast in; these passages being in communication with the ejector, which is placed in the smoke-box, in front of the blast-pipe.

The bearings of the small ends of the connecting-rods are iron, case-hardened, working on a case-hardened pin, this being the universal system of "little end" in use on the line. The four eccentric sheaves are cast in two pieces and put on the axle with four bolts; no keys are used, but a small dowel secures the correct position of the sheaves.

The tender runs on six wheels, and carries 2,700 gallons of water and four tons of coal.

The actual working upon the American mail and express trains between Dublin and Queenstown is as follows:—

On weekdays the mail starts from Dublin at 7.40 A.M., and arrives at Queenstown at 12.15 P.M. The time on the journey of $177\frac{1}{4}$ miles is, therefore, 4 hours 35 minutes, of which, however, 18 minutes are allowed at stations; the average speed, including stoppages, is therefore 42.16 miles an hour, which is found to mean

an average running speed of 45 to 50 miles an hour. On Sunday the mail is run at a somewhat higher speed. The average load is equal to $9\frac{1}{2}$ six-wheeled coaches.

	tons.	cwt.
Weight of engine and tender	67	10
Weight of $9\frac{1}{2}$ coaches .. .	120	0
Total weight of train	187	10

The consumption of South Wales steam coal is from 24 lb. to 26 lb. per mile with this load. The weight of train frequently exceeds this average, and the engines are capable of working fifteen to eighteen vehicles without difficulty.

The gradients are not considered severe, with the exception of the incline at Cork of 1 in 60, and at Dublin of 1 in 85. There are, however, several short lengths of 1 in 172, 180, 128, 140, and 151.

The latest express engines for the Great North of Scotland Railway have been constructed by Messrs. R. Stephenson & Co., and are required to run 4,000 miles consecutively without showing any defects in material or workmanship, and they have just completed this mileage to the entire satisfaction of the Great North of Scotland Railway Company.

The engines are eight-wheeled, there being two pairs of coupled wheels 6 ft. $6\frac{1}{2}$ in. diameter and a four-wheeled bogie at the leading end, the bogie wheels being 3 ft. $9\frac{1}{2}$ in. diameter. The engines have inside cylinders 18 in. in diameter and 26 in. stroke, the cylinders being cast together in one piece, the slide valves being placed on the top of the cylinders, and driven by a link motion and rocking levers. This is a very neat arrangement, designed by Mr. Manson, and has given every satisfaction. The engines are fitted

with balanced slide valves, also designed by Mr. Manson. The pressure on the back of the valve is relieved by a ring, which is held up to the casing door by a light tripod spring.

This arrangement greatly reduces the wear and tear of the valves and gear, and since adopted on the Great North of Scotland Railway, engines have run 100,000 train miles, the wear of the slide valves being only $\frac{3}{16}$ in.

The bogie is provided with the ordinary swinging arrangement, which enables the engine to pass round curves with perfect steadiness. The main frames, which are of steel, are set in at the front end to give sufficient clearance for the bogie wheels. The wheels are of wrought iron, and the coupled wheels have the balance weights forged solid.

The boiler barrel and fire-box casing are of best Yorkshire iron, the internal fire-box and tubes being of copper. There are 1,087 square feet of heating surface in the tubes, and 106 square feet in the fire-box, giving a total heating surface of 1,193 square feet. The grate surface is 18 square feet; the fire-box is fitted with sixteen copper air tubes, 3 in. external diameter, No. 7 w.g. thick, in two rows of eight in front and back, for conducting streams of air into the fire-box. This arrangement has been successfully used on the Great North of Scotland Railway for upwards of thirty years.

The tender is carried on eight wheels, the four hind wheels being connected to the main frame of the tender, and the four front wheels are connected to a bogie of the same design and construction as the engine bogie. The tank carries 3,000 gallons of water and about three tons of coal. The weight of the

tender when loaded with coal and water is 36 tons. These tenders are remarkable as being the only ones running on a bogie in this country.

The Great Eastern Railway Company has just placed upon its line some powerful six wheels coupled tank engines, designed by Mr. James Holden, to work the very heavy suburban passenger traffic to and from Liverpool Street. In order to ascertain the work done, the author has ridden with some of the trains, and finds that the booked time from Liverpool Street to Enfield is 40 minutes, the distance $10\frac{3}{4}$ miles with 16 stops. If each stop averages one minute, including stopping and starting, the actual running time is only 24 minutes, equal to a speed of 27 miles per hour. This, it must be remembered, includes no allowance for speed orders, stoppages or slowages due to adverse signals, &c. These trains average 15 carriages, with a gross load of 250 tons.

The cylinders are $16\frac{1}{2}$ inches diameter, the stroke 22 inches, and the coupled wheels 4 feet diameter, the tractive force being therefore—

$$\frac{16\frac{1}{2} \times 22}{48} = 124.7 \text{ lbs.}$$

Total heating surface	959 sq. ft.
Grate area	12.4 sq. ft.

Weight of engine in working order—

	tons.	cwt.	qr.
On the leading wheels	12	7	1
„ driving „	13	13	0
„ trailing „	13	19	3
Total	40	0	0
Capacity of tanks	1,000 gallons.		

These engines are working most satisfactorily, and

have considerably reduced the consumption of coal per mile.

For shunting purposes, and for working small branch lines, tank engines are usually employed.

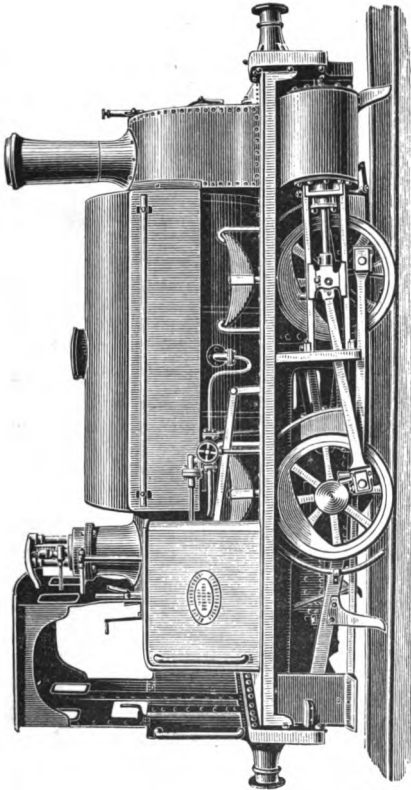

Fig. 88.—Four-wheeled Shunting Engine.

Fig. 88 illustrates a four-wheeled engine of the standard type manufactured by Messrs. Black, Hawthorn and Co., of Gateshead ; and Fig. 89 illustrates a

more powerful engine which runs on six wheels, built by the same firm. The dimensions are varied in accordance with the work required, but most generally

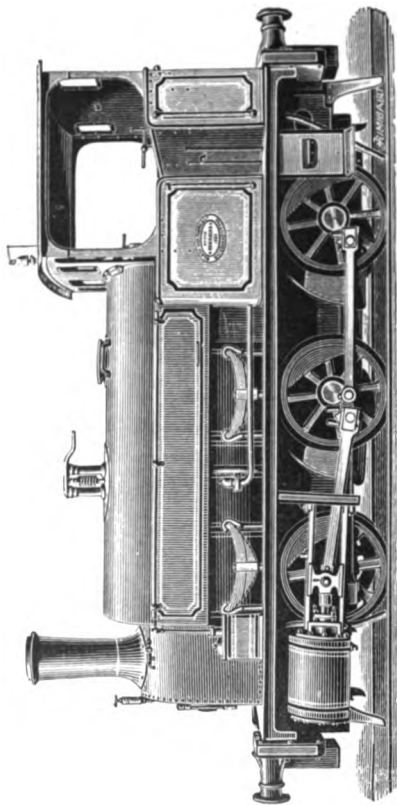

Fig. 89.—Six-wheeled Shunting Engine.

the cylinders are about 15 inches diameter, and the stroke about 20 inches, the coupled wheels being 3 feet diameter. A small but at the same time a useful and very powerful engine is thus obtained.

CHAPTER V.

EIGHT-WHEELED COUPLED GOODS ENGINES.

FOR some time past it has been apparent that, with increased working expenses, some important step will have to be taken in order to increase the receipts per mile, especially of mineral trains.

Many of the railways are so crowded with passenger traffic that it is only by running coal trains at a high speed that they can be "got along at all." Long lengths of goods lines have been within the past few years opened, and the question of increasing the length and reducing the speed of coal trains to London must very soon be seriously considered. In order that coal traffic can be made to properly "pay," it should be conveyed in train loads of fifty waggons.

Messrs. Sharp, Stewart & Co., during the year 1889, placed two very powerful mineral engines upon the Barry Railway, the working of which has been carefully watched and proves highly satisfactory.

These engines run upon eight coupled wheels and have outside cylinders, and are of very considerable power.

Diameter of cylinders	20 ins.
Length of stroke	26 "
Eight coupled wheels	4 ft. 3 , "

Total wheel-base 15 ft. 5 ins.
 The front axle has $\frac{1}{4}$ in. side play;
 The hind axle has $\frac{1}{2}$ in. side play; and
 The driving wheels are without flanges.

Total heating surface 1,410 sq. ft.
 Area of fire-grate 22.6 „

Weight of engine in working order without
 tender 49 tons.

From personal experience, the author can testify to the efficient manner in which these engines do their work, and it may be added that they are remarkably like the American well-known "Camel" class which for years has done such good work in America.

To Messrs. Sharp thus belongs the credit of introducing in this country the eight coupled engine with *outside* cylinders, and to Mr. F. W. Webb, of Crewe, in 1892, belongs the credit of introducing another eight coupled design but having *inside* cylinders.

This new engine runs upon eight coupled wheels and has two inside cylinders. The boiler is of great length, being similar to that of "Greater Britain," illustrated Fig. 86, the tubes being divided into two lengths by a combustion chamber, those extending from the fire-box to the combustion chamber being 4 feet 10 inches long between tube plates, and those forming the front group being 8 feet 1 inch long between tube plates. The cylinders, which are inside, are $19\frac{1}{2}$ inches diameter by 24 inches stroke, the valves being on the top and worked with Joy's gear. The springs on the first three pairs of wheels are connected together by equalising links, the trailing pair having an ordinary cross spring. The leading and trailing wheels have $\frac{1}{2}$ inch side play, which gives greater facility for running round curves.

Below are given a few leading particulars:—

Cylinders—19½ in. diameter by 24 in. stroke.			
Diameter of wheels with 3-in. tires	ft. in. 4 5½
Distance between centres of wheels	5 9
Total wheel base	17 3

Boiler—

Length of barrel	15 6
„ fire-box casing	6 10
Diameter of barrel (mean)	4 3
Number of tubes—156			
Diameter of tubes	0 2½
Pressure of steam	..	160 lbs. per sq. in.	

Heating surface—

Fire-box	114·7
Combustion chamber	39·1
Tubes (front)	683
Tubes (back)	408·5
Total	1,245·3 sq. ft.

Grate area	20·5 sq. ft.
Ratio of fire-grate area to heating surface	1 to 60·6

Weight of engine in working order—

			Tons.	cwts.	qrs.
Leading wheels	11	13	0
Driving „	12	14	0
Intermediate „	11	13	0
Trailing „	10	16	3
Total	46	16	3

Weight of tender in working order, 25 tons.

The tractive co-efficient is 172. The leading and trailing wheels have a certain amount of side play, so as to give greater facility for running round curves, though the total wheel base is not more than other engines which have not the same side play. The coupling-rod from wheel to wheel is complete in itself, and all of them are so arranged as to be interchangeable. The driving-axle has two bearings as usual, nine inches long, and in addition a central

frame and central bearing to withstand the great stress placed upon it. The total bearing surface for the driving-axle is $23\frac{1}{2}$ square inches.

Engines with eight coupled wheels are, of course, very common in America, but Mr. Webb's new design is the first eight coupled and *inside* cylinders that has been built in this country, certainly during the past sixty years. The first of these powerful mineral engines is giving the greatest satisfaction on the London and North-western Railway, and there is every reason to believe that it will do so, as it has large cylinders, high steam pressure, and is non-compound.

CHAPTER VI.

AN AMERICAN ENGINE.

It is usual for Englishmen to believe, and to take it for granted, that English engines are the best, and to ignore the fact that some very useful locomotives are at work in other parts of the world. The Exhibition at Chicago this year will undoubtedly form the greatest collection of locomotives which has ever been made, and already the details which have arrived in this country show that the Americans especially will have some extremely fine engines, both in the Exhibition and in daily working. It is, therefore, important that some brief reference should be made to them in this volume.

The standard American passenger engine has a leading bogie, four coupled wheels, outside cylinders, and the usual bar-framing similar to that at first used by Stephenson and Bury. Some extremely fine specimens of locomotive construction, for instance, are to be found on the Baltimore and Ohio Railroad.

On the New York Central and Hudson River Railroad the engines are built partly by makers, but the larger number are turned out at the Company's shops at West Albany. The following dimensions show

that the engines have very considerable size and power.

The boiler has 1,821.5 sq. ft. heating surface. The usual working pressure is 180 lbs. The cylinders are 19 by 24 ins., and the driving-wheels are 7 ft. 0 $\frac{1}{2}$ in. diameter.

The total weight of engine is 121,000 lbs., of which 81,000 lbs. are carried on the drivers and 40,000 lbs. on the bogie.

The tender weighs in service, 80,000 lbs. ; it carries 3,587 galls. of water and 7 tons of coal. It is provided with a scoop for taking up water from the track tanks without stopping. The total weight of engine and tender ready for service is thus 201,000 lbs.

These engines are employed in running the "Empire State Express" between New York and Albany, the schedule time of the train being 52 miles an hour. From some indicator diagrams taken while the engine was running at the rate of 76 miles an hour, it appears that at that speed there was 1,120 h.p. developed. The usual train is four cars.

The author has before him the particulars of a special run made on the 4th October, 1892, in which case another engine of similar design, with a tender weighing 201,000 lbs., and the weight of the train, 592,700 lbs., a total of 793,700 lbs. The train consisted of five ordinary passenger cars and five sleeping-cars. The run from Albany to Poughkeepsie was made in 1 hour 17 minutes, the average rate of speed being 54 miles an hour. The wind at the time was heavy, blowing from the west. The steam pressure during the run was kept at 160 to 170 lbs. The speed maintained was certainly remarkable, considering

the weight of the train. Two other fast long-distance runs were made by the Empire State Express in December, 1892. In one instance it ran 115.75 miles in 110 minutes, 51.67 miles being made in 46 minutes, or at the rate of 67.38 miles per hour. In the second case the train made 101 miles in 96 minutes, 28.43 miles being made in 25 minutes, or at the average rate of 68.23 miles per hour. In each case the train consisted of four cars and was hauled by an eight-wheel engine, with driving wheels 7 ft. $\frac{1}{2}$ in. diameter.

A two-cylinder compound engine has for some time been tried in America, and a few years ago one of the Webb compound engines was sent over from this country to America for use. However, the result of practical and perfectly fair tests is that the English engine was badly beaten.

The Baldwin Works has recently designed and built a large number of engines known as the "Vauclain compound."

In this system there are two high and two low pressure cylinders, but as each pair of cylinders works upon the same cross-head there are only two sets of connecting rods.

Cylinders, h. p.	13 X 24 ins.
Cylinders, l. p.	22 X 24 "
Boiler, form	wagon top.
" diameter	4 ft. 10 ins.
" height from rail to centre line	7 " 8 "
" pressure	180 lbs. per sq. in.
Fire-box (for hard coal)	11 ft. 0 ins.	X 3 ft. 6 ins.
Grate area	38 $\frac{1}{2}$ sq. ft.
Tubes, number	250.
" diameter outside	2 ins.
" length	11 ft. 10 ins.
Heating surface, tubes	1,530 sq. ft.
" " firebox	166 "
" " total	1,696 "
Height from rail to top of smoke-stack	13 ft. 5 $\frac{1}{2}$ ins.

Capacity of tender tank	3,500 gals.
" " coal space	7 tons.
Driving wheels, diameter	6 ft. 6 ins.
Bogie wheels "	3 " 0 "
Tender wheels "	3 " 0 "
Wheel base, driving to trailing	7 " 6 "
" " truck	6 " 10 "
" " total	22 " 3½ "
Weight on driving wheels	88,400 lbs.
" " truck	35,400 "
" " total	123,800 "
" of tender	82,000 "

Practical trials appear to prove that if compound engines are to be employed, the four-cylinder pattern is far better than those used in England: but it is still a question whether a "simple" engine with two cylinders of an equal area, or a four-cylinder high pressure engine would not give as good or even better results.

MR. WINBY'S DESIGN.

This fact appears to have induced Mr. F. C. Winby to design an English engine to send to the Chicago Exhibition, and at the time of writing it is nearly completed at the well-known works of Messrs. R. & W. Hawthorn, of Newcastle. This vast locomotive will be, in fact, a combination of a McConnell "Bloomer" and a Crampton "Liverpool."

The engine runs upon a four-wheeled leading bogie, and two pairs of independent driving-wheels of 7 ft. 6 ins. diameter. Two inside cylinders are placed under the smoke-box, 16½ by 24; they actuate the first pair of driving-wheels. Two outside cylinders are placed behind the bogie wheels; they are 17 by 22, and work the second pair of driving wheels.

The total tractive force exerted by the four cylin-

ders upon the four wheels is therefore 143 lbs. for each pound of effective pressure.

The boiler is to work at a pressure of 175 lbs., but it is constructed to carry 200 lbs. if necessary.

The boiler is of oval section in order that it may be placed between the tops of the driving wheels.

Number of tubes	189.
Diameter of tubes	2 $\frac{3}{8}$ ins.
Length of tubes	16 ft.
Heating surface of tubes	1,880 sq. ft.
Heating surface of fire-box	138 "
Total heating surface	2,018 "
Area of fire-grate	28 "

Weight in working order will probably be—

On bogie wheels	18 tons.
On 1st driving wheels	19 "
On 2nd driving wheels	18 "
Total	55 "

The tender when loaded will be fully 45 tons, so that the engine and tender complete may be expected to weigh about 100 tons.

The only means of knowing the capabilities of a new design of locomotive is by the actual results of its working; at present, therefore, it is impossible to express an opinion. Suffice it to say that Mr. Winby has designed, and Messrs. Hawthorn are constructing, the largest locomotive ever seen in England, and the fact that the engine uses high pressure steam in all the cylinders is a most important feature in its favour, and its construction is being watched both in this country and in America with the very greatest interest.

CHAPTER VII.

LOCOMOTIVES OF THE UNITED KINGDOM—USEFUL RULES AS TO GRADIENTS—CENTRE OF GRAVITY OF LOCOMOTIVE—SUNDRY APPLIANCES.

LOCOMOTIVES OF THE UNITED KINGDOM.

The following list, compiled by the author from official details, shows the locomotive engines possessed by each Company on the 31st December, 1891 :—

London and North-Western	2,648
Midland	2,020
*Great Western	1,660
North-Eastern	1,560
Lancashire and Yorkshire	1,127
Great Northern	907
Great Eastern	879
Caledonian	690
North British	677
Manchester, Sheffield, and Lincolnshire	655
London and South-Western	570
London, Brighton, and South Coast	410
South-Eastern	378
Glasgow and South-Western	301
London, Chatham, and Dover	201
Taff Vale	189
Great Southern and Western Ireland	178
Great Northern of Ireland	137
North Staffordshire	134

* The number of Great Western engines is given as stated by the Company, but the author is of opinion that there are a number of duplicates which have not been included.

Furness	123
Midland Great Western of Ireland	111
North London	104
Highland	85
Great North of Scotland	77
Metropolitan	71
Rhymney	66
Somerset and Dorset Committee	61
Belfast and Northern Counties	61
Cambrian	59
Hull, Barnsley, and West Riding	56
Metropolitan District	54
Barry	53
Dublin, Wicklow, and Wexford	51
Waterford and Limerick	42
Brecon and Merthyr	30
London, Tilbury, and Southend	30
Maryport and Carlisle	27
Newport and South Wales	24
Belfast and County Down	20
Cork, Brandon, and South Coast	16
Wrexham, Mold, and Connah's Quay	16
Mersey	15
City and South London (electric)	14
Severn and Wye	13
Waterford and Central Ireland	13
Seaham and Sunderland	11
Rhondda and Swansea Bay	10
West Lancashire	9
Festiniog	9
Isle of Wight	8
Isle of Wight Central	8
Midland and South-Western Junction	8
Cavan, Leitrim, and Roscommon	8
East and West Junction Committee	7
Pembroke and Tenby	7
Wirral	7
Manchester and Milford	6
South Wales Mineral	6
Portpatrick and Wigtownshire Committee	6
Londonderry and Lough	6
Waterford, Dungarvan, and Lismore	6
Clogher Valley	6
Cleator and Workington Junction	5
Neath and Brecon	5
Ayrshire and Wigtownshire	5
Dundalk, Newry, and Greenore	5
Sligo, Leitrim, and Northern Counties	5
Burry Port	4
Colne Valley and Halstead	4
Llanelly and Mynydd Mawr	4

Cork and Macroom	4
Waterford and Tramore	4
Cork and Muskerry	4
Tralee and Dingle	4
West Carberry	4
West Clare	4
Corris	3
Liskeard and Caradon	3
North Wales (narrow gauge)	3
Redruth and Chasewater	3
Ballycastle	3
Cork and Blackrock	3
Finn Valley	3
Listowel and Ballybunion	3
Bishop's Castle	2
East Cornwall	2
Garstang and Knot End	2
Glyn Valley	2
Mawddwy	2
Merrybent and Darlington	2
Ravenglass	2
Snailbeach District	2
Southwold	2
Tallylyn	2
Van	2
West Somerset	2
Bessbrook and Newry (electric)	2
Timoleague	2
Easingwold	1
Gorsedda Junction, Portmadoc	1
Milford Haven	1
St. Austell	1
Saundersfoot Railway	1
Storksbridge	1

TOTALS.

England and Wales	14,314
Scotland	1,841
Ireland	705

Total engines in the United Kingdom on 31st
December, 1891 16,860

USEFUL RULES RELATING TO GRADIENTS.

The *vis viva* of a train moving at any given speed is equivalent to the raising of the train to the height, by falling through which it would attain that velocity, and this is true whether the train is raised vertically (if it were possible), or by running it up an incline assuming friction as nil.

Therefore when a train runs up an incline, the engine has not only to overcome the resistance on the level, but also to raise the train to a certain height.

An incline of 1 in 200, for instance, is a rise of $\frac{5,280}{200} = 26.4$ feet per mile. To find the work done (in foot tons) in lifting a train of 200 tons through the vertical height of 26.4 feet, it is necessary to multiply the height by the weight, thus, $200 \times 26.4 = 4,280$ foot tons.

The rates of inclinations of gradients are also conveniently expressed as percentages, which represent the force of gravity acting on different inclines—1 in 200 being expressed as a gradient of 0.5 per cent.; 1 in 100 as 1 per cent.; and 1 in 50 as 2 per cent.

In this country, it is still the practice to express gradients in their proportion or ratio to 100, but in America, as in many other parts of the world, gradients are always given in proportion to their rise per mile. To find the rise in feet per mile for any given incline, it is only necessary to divide the feet in a mile (5,280) by the gradient to one; thus in a case of 1 in 264 we have

$$\frac{5,280}{264} = 20 \text{ feet per mile.}$$

When, therefore, the English engineer speaks of 1 in 264, the American engineer refers to it as “a 20-foot grade.”

The following table gives the same inclinations expressed by the two methods :—

Gradient to 100.	Equal rise in feet per mile.	Gradient to 100.	Equal rise in feet per mile.
1 in 2,000	2·64	1 in 165	32·0
„ 1,000	5·28	„ 132	40·0
„ 500	10·56	„ 120	44·0
„ 400	13·2	„ 100	52·80
„ 300	17·6	„ 88	60·0
„ 264	20·0	„ 70	75·42
„ 220	24·0	„ 50	105·6
„ 200	26·4	„ 37	142·7

CENTRE OF GRAVITY OF LOCOMOTIVE.

The horizontal centre of gravity of either a bogie or six-wheeled engine should be a few inches in front of the centre of the driving axle. To find this point, multiply the weight resting upon the leading wheels (or leading bogie, if one be used) by the distance in feet from the centre of the driving axle. Multiply the weight upon the trailing wheels by distance in feet from the driving axle. Find the difference, which divide by the total weight of the engine in tons ; the quotient is the horizontal distance in feet of the centre of gravity from the driving axle in the direction of the axle carrying the greater weight. As an example, if an engine weighs 41 tons 13 cwt. 2 qrs. ; on leading wheels, 14 tons 6 cwt. ; on trailing wheels, 12 tons 16 cwt.

14·3 tons \times 10 ft. (for leading end of engine) .. 143· ft.-tons
 12·8 tons \times 8 ft. 6 in. (for trailing end of engine) .. 108·8 ft.-tons

The difference (34·2), divided by the total weight of the engine (41·68), = ·82 of a foot. Therefore the centre of gravity of the engine is ·82 ft., or $9\frac{1}{8}$ in. in front of the driving-axle.

When a locomotive is running, that portion of the tread of the tire which is in contact with the rail at

any instant of time is at rest, while the corresponding point on the flange on the same radius is moving in the opposite direction to that at which the train is running. The speed being 60 miles an hour, or 88 ft. per second, and the diameter of the wheel over the tread 6 ft., and over the flange 6 ft. 2 ins., the point in the flange will move backwards at the rate of 1.59 miles per hour.

THE STEAM SAND-BLAST.

Every engine-driver is well aware that for fast running, easy riding, and economy both in coal and repairs, nothing can equal an engine having a "single" pair of driving wheels. On the other hand practical experience has taught them that for heavy trains running upon steep gradients, it is absolutely necessary to employ engines having four coupled wheels, in order to obtain the required amount of adhesion, or, as the drivers say, "to tie their legs together."

The useful work which an engine is capable of performing is, of course, limited by the co-efficient or proportion of adhesion which exists, or can be created, between the driving wheels and the rails; in other words, as soon as the effect of the steam in the cylinders produces a tractive force greater than the adhesion, "slipping" is the result. In ordinary practice the co-efficient of adhesion is found to be equal to one-sixth of the weight resting upon the driving wheels expressed as an adhesion of 16.66 per cent., or as an adhesion of 373.3 lbs. per ton.

If the rails be perfectly clean and dry, the adhesion is increased; if perfectly wet, it is but little reduced. A slight shower of rain, misty weather, and greasy

rails will often reduce it to about 280 lbs. per ton ; and in frosty or snowy weather the writer proved by a series of practical experiments that the adhesion became as low as 160 lbs. per ton. It is, therefore, not a matter of surprise that such a serious loss of adhesion should cause a considerable amount of "slipping." To overcome the difficulty the ordinary method of sanding the rails is by means of sand-boxes and pipes which allow sand to run down on to the rails, and in practice it is found that a considerable quantity of sand is used, but a large proportion of it does not fall on the rails, and a further quantity is blown off the rails by the wind: consequently the ordinary sanding arrangement is very inefficient and unsatisfactory.

One of the most important improvements in locomotive engineering is the recent introduction by Messrs. Holt and Gresham of their steam sand-blast (Figs. 90 and 91).

The general arrangement is shown (Fig. 90), as fitted to some of the Midland Company's engines of the 1,480 and 1,500 classes. By means of a handle, "A," steam can be admitted to the sand-ejector, "C," thus drawing a small supply of sand from the sand-box, "B," and projecting it in a powerful and constant sand-blast to the point of contact between the wheel and the rail. Fig. 91 shows the apparatus in detail, and it will be observed that the sand falls into the sand trap, and is then carried down in a fine jet by the inrush of air caused by the steam ejector.

THE INJECTOR.

In the early days of railways the boilers of the locomotives were supplied with water by means of force-pumps worked by hand-levers; afterwards the pumps

IVE.
per to
proved
esion be
not a
sion et
The
sandir
pes v
in pro
ad is
the
ls in
anger
some
Helic
nd
as
of
har
r,
ad-
me
w
de
o
ie
lee
ere
amp

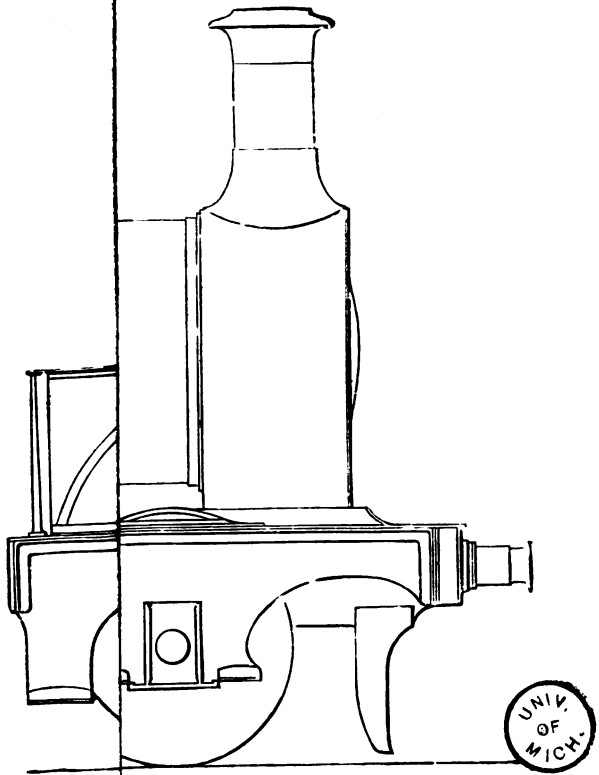

[To face p. 192.]

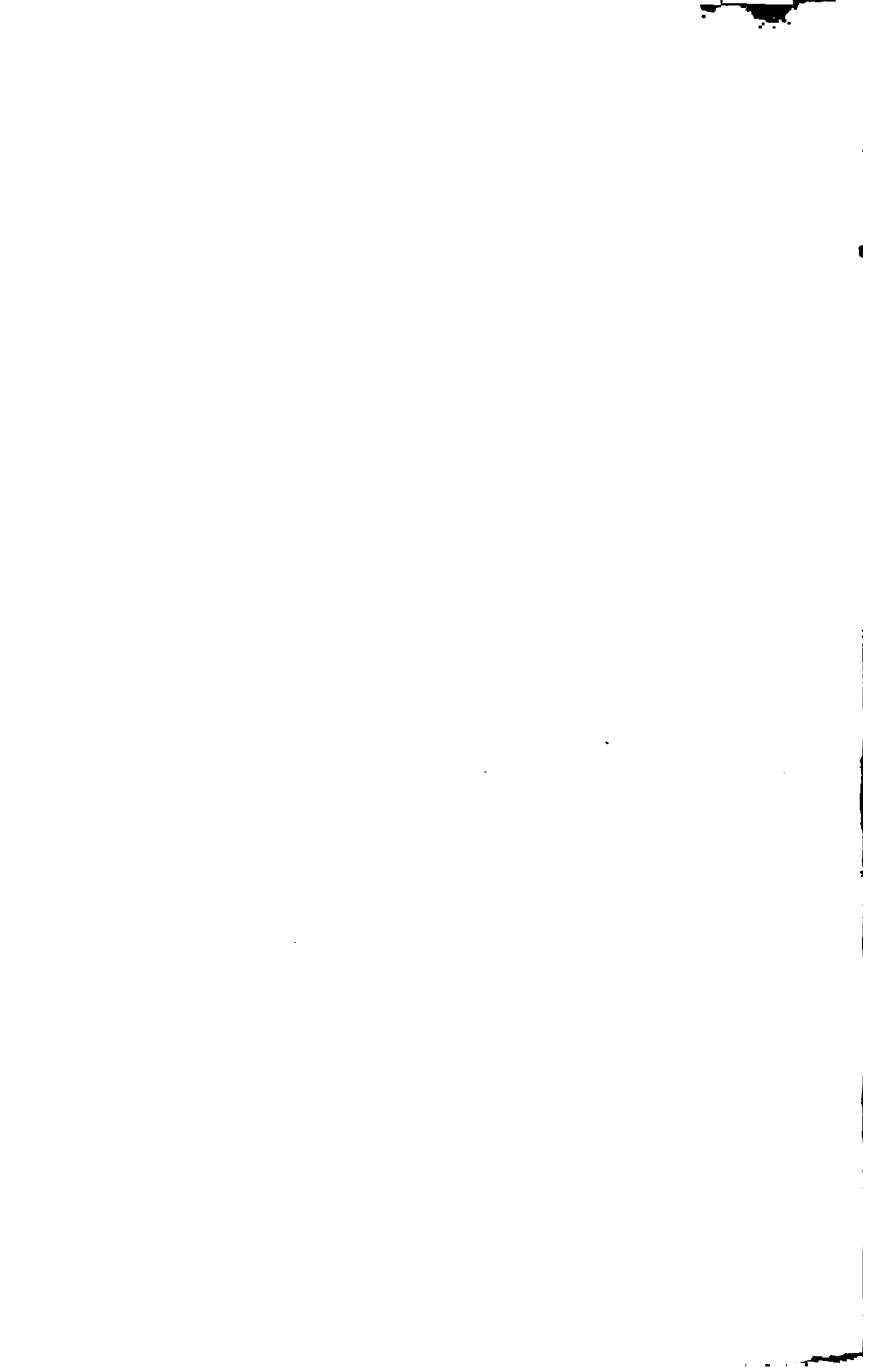

STEAM VALVE

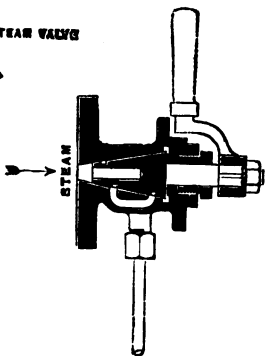

[To face p. 192.]

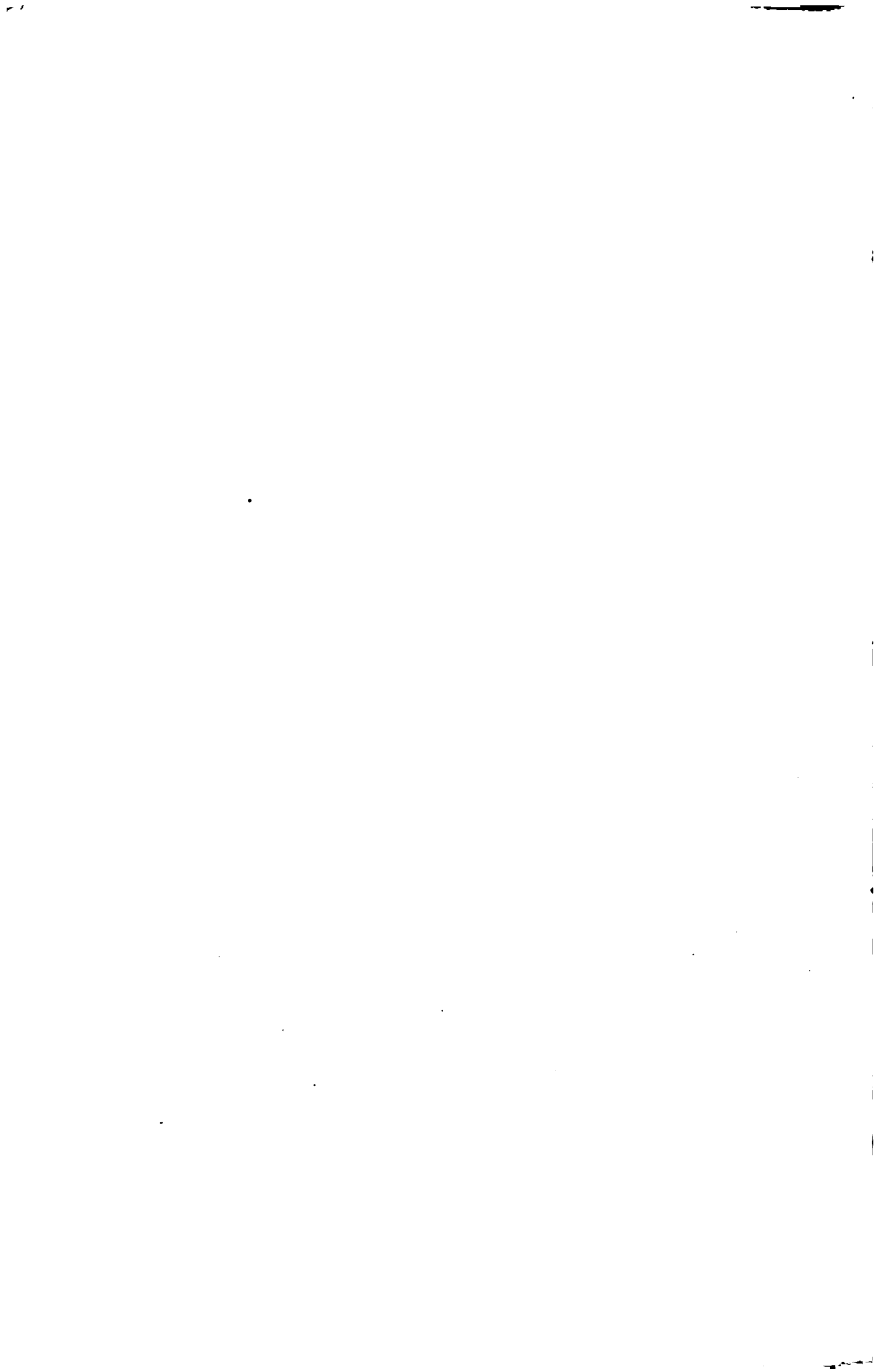

were worked by either eccentrics or rods attached to the cross-heads, and on the London and South-Western Railway an independent donkey pump was employed to feed the boiler, and at the present time some of the Brighton Company's engines are fed with water by means of a water pump, working in connection with the Westinghouse air brake pump.

Many of my "locomotive" readers will remember the time very well when engines had two pumps, and in order to supply water to the boiler it was necessary to run several times backwards and forwards for about a quarter of a mile to fill up the boiler.

They will also, no doubt, well remember seeing "single" wheeled engines standing in the sheds, with their tender brakes hard on, slipping upon oiled rails, in order to pump water into the boiler.

In July, 1858, Mr. H. J. Giffard, a French engineer, took out a patent for the "Injector"; he had discovered that the motion imparted by a jet of steam to a surrounding column of water was sufficient to force it into the boiler from which the steam was taken, and even into another boiler having a higher pressure.

When Mr. Giffard tried to introduce his new injector, locomotive engineers laughed at him; he was told to read about the first rules of motion, and that he must be mad to suppose that steam from one part of a boiler could force its way back into another part of the same boiler; he could not even obtain authority to try an injector on a locomotive till 1859, and then he was only granted permission as a favour and with a view to "let him prove his idea would not work," and thus put a stop to his constant letters and applications.

However, the injector worked successfully, and the

water entered the boiler, but even then people would not believe it.

Mr. Giffard explained that the action of his injector was similar to that of the blast-pipe in a locomotive: the rush of steam in that case formed a partial vacuum into which air was forced by the atmospheric pressure of about 15 lbs. per square inch.

To explain his theory Giffard took a pressure of 100 lbs. per square inch, and showed that a column of water 23-10 feet high presses upon its base with a force of 1 lb. per square inch, therefore 100 lbs. pressure is equal to a pipe of water 230 feet high.

Water from the bottom of a pipe 230 feet high would rush out at a speed of $121\frac{1}{2}$ feet per second, that is equal to no less a pace than 83 miles an hour.

Let it be clearly understood that a boiler having a pressure of 100 lbs. per square inch is just balanced by a jet of water rushing at 83 miles an hour: it then becomes certain that to overcome the steam in the boiler it is only necessary to increase the speed of the water to above 83 miles an hour, and the water will force itself into the boiler.

It is a well-known fact that the steam pressure in the valve-chest of a locomotive is actually greater than it is in the boiler, this being due to the momentum with which the steam rushes past the regulator and down the steam pipe.

In the same manner the velocity of the steam rushing through the injector is so great that it not only has force enough itself to rush back into the boiler, but also carries the water with it.

Giffard's patent has long since expired, and injectors are now made by various firms, principally by Messrs.

STEAM VALVE



face p. 195.

Gresham and Craven, who have upwards of 100,000 of their construction of injector in use. Fig. 93 illustrates the foot-plate of a locomotive, showing the position of Gresham's combination injectors.

Fig. 92 illustrates a section of the appliance, the

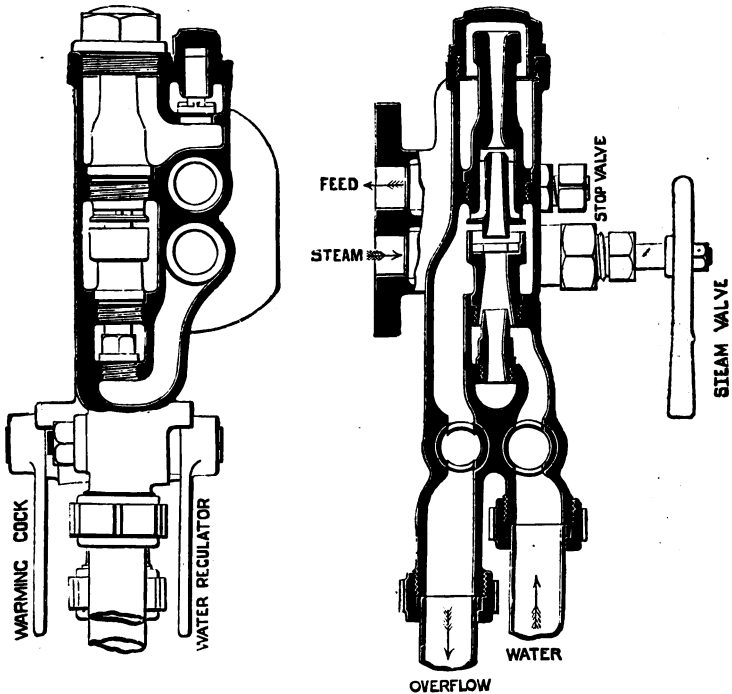

Fig. 92.—Details of Injector.

steam valve, back pressure valve, stop valve, and regulator being plainly shown.

The following are the instructions for working the Gresham combined injector:—

- (1) Open the water cock and turn on steam ;

(2) If there is any overflow, close the water regulator until it ceases. The injector is then at work. The water cock should be kept closed when the injector is not at work.

The water pipe can be drained to prevent freezing by closing the tender valve and opening drain cock fixed on water pipe.

Should steam be blown into the tender through the injector, the water pipe must be drained to clear it of hot water.

The back pressure valve must be kept ground tight upon its seat. This can be done, or the whole of the cones can be removed if required, whilst the boiler is under steam by first closing the stop valve.

It is well known to engine-drivers that injectors will not work with very hot water, and in practice it is not advisable for the water in the tender to be heated to above 120 deg.

Having thus considered the theory of the injector, we now turn to its practical results; the annexed table shows the sizes 7 to 10 which are in general use on locomotives, and the number of gallons of water which each will supply per hour at pressures of from 100 to 180 lbs., and of course if the quantity per minute is required it is only necessary to divide the gallons by 60.

TABLE GIVING THE SIZE AND DELIVERY OF COMBINATION INJECTORS.

Size of Injector in Milli- metres.	BOILER PRESSURE IN LBS. PER SQUARE INCH.									
	100	110	120	130	140	150	160	170	175	180
	DELIVERY IN GALLONS PER HOUR AT ABOVE PRESSURES.									
7 ..	970	1,020	1,060	1,110	1,150	1,190	1,225	1,255	1,265	1,275
8 ..	1,270	1,330	1,390	1,450	1,500	1,550	1,600	1,640	1,655	1,670
9 ..	1,610	1,680	1,760	1,830	1,900	1,970	2,030	2,080	2,100	2,120
10 ..	1,980	2,080	2,170	2,290	2,350	2,430	2,500	2,560	2,585	2,610

VALVE GEAR.

Reference has been made to several forms of valve gear, for instance, those described at pages 45, 62, and Howe's celebrated link motion (page 87). Whatever form of gear is employed, when the driver "reverses" the engine he moves one of the valves so as to open either the front or back port at pleasure. Now let us trace the action of the steam. Upon the regulator being opened, steam rushes from the dome or steam pipe down to the valve chest, where in consequence of the "lead" the valve is about one-eighth of an inch open when the crank is upon the dead centre (the two cranks are always made at right angles, so that one is in a position to pull the other past its dead point). The steam having entered past the valve, rushes into the cylinder, and the period of "admission" commences; the steam having forced the piston forward for a distance of let us say eight inches, the valve closes and no more steam is admitted; this is known as "cut off" or point of "suppression"; and for the next part of the stroke the piston is not forced by fresh steam from the boiler, but by the "expansion" of the steam which is imprisoned in the cylinder.

We will now suppose that "expansion" has done its work, and that the piston has been forced, say to 20 inches: the period of "release" then arrives, when the inside of the valve opens the port and permits the steam which has done its work to rush from the cylinder, through the inside of the valve to the exhaust port, and then up the blast-pipe and out of the chimney. The "lead" of the valve causes it to open before the piston arrives quite at the end of its stroke; this

serves two good purposes, first to form a cushion to reduce the force of the advancing piston, and secondly to enable steam to be entering the cylinder early, ready for the next stroke.

An express engine having wheels of 7 feet diameter, or 22 feet in circumference, passes over 88 feet, or four revolutions per second, when running at sixty miles an hour; thus in one second of time, there must be "admission," "cut off," "expansion," "exhaustion," and "compression," no less than four times from each end of the cylinder, or a total of sixteen "beats" or exhausts of steam up the chimney per second.

It is not necessary to tell engine-drivers that which they know perfectly well—namely, that to save steam and consequently coal, they, by carefully regulating the valve-gear and "cutting-off" the admission of steam to the cylinder *as early as possible*, can get the greatest amount of work and expansion out of the imprisoned steam in the cylinder.

JOY'S VALVE GEAR.

Fig. 94 illustrates Joy's valve gear, as fitted to a large number of engines.

The fundamental principle of this gear is that eccentrics are entirely dispensed with, valve motion being obtained from a point in the connecting-rod, produced by a combination of two motions at right angles to each other, and by the various proportions in which these are combined, and by the positions in which the moving parts are set with regard to each other, it gives both the reversal of motion and the various degrees of expansion required. By utilising independently the

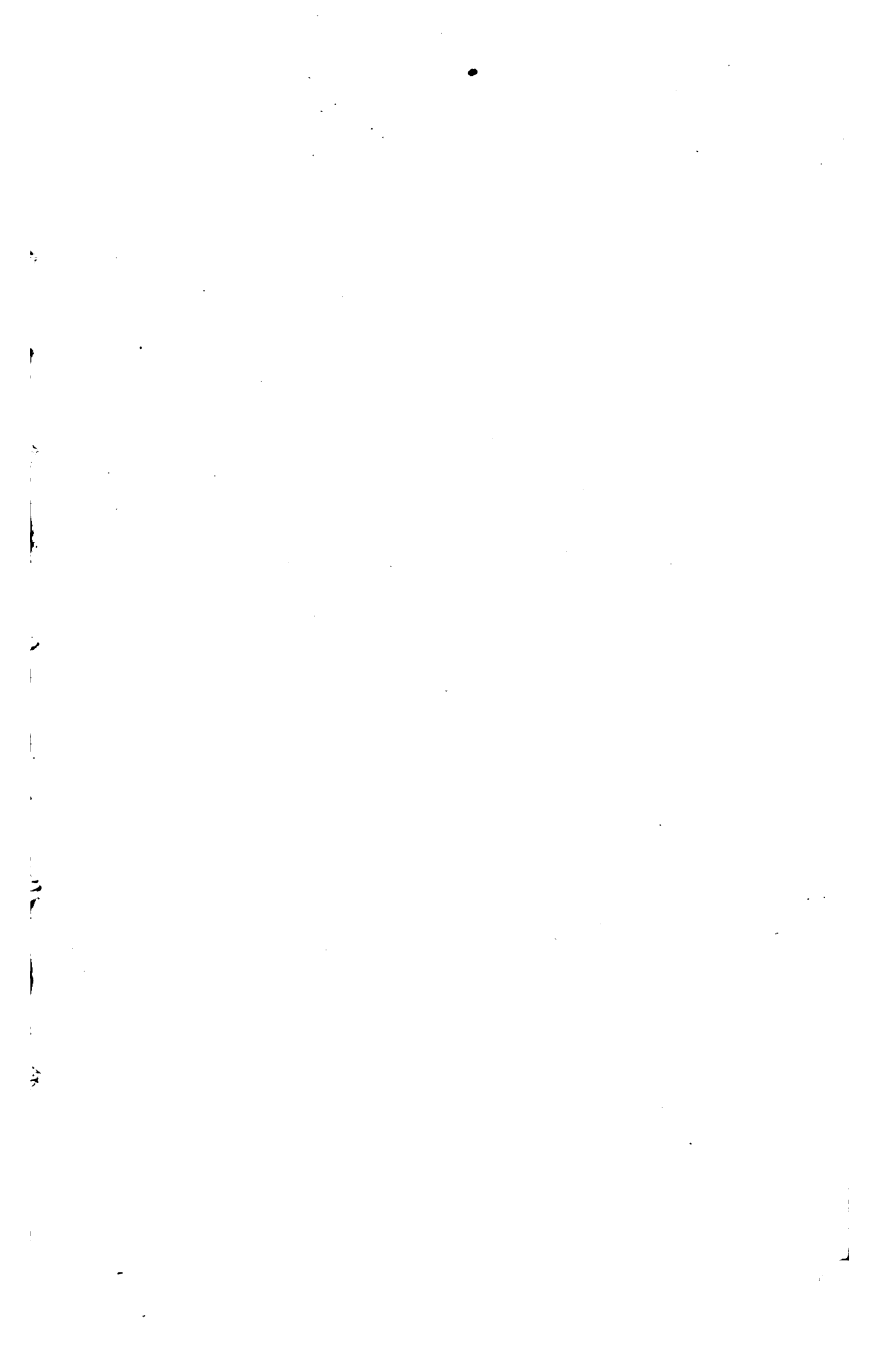

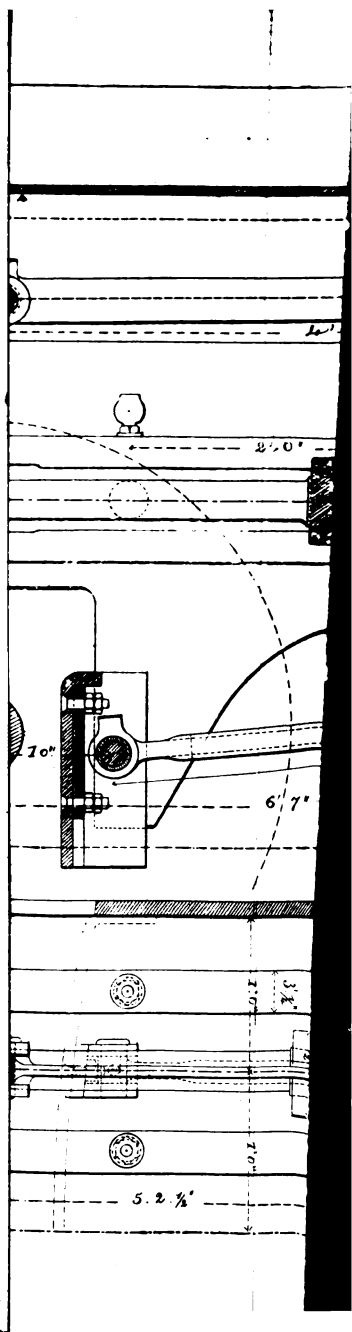

backward and forward action of the rod, due to the reciprocation of the piston, and combining this with the vibrating action of the rod, a movement results which is suitable to work the valves of engines allowing the use of any proportions of lap and lead desired, and giving an almost mathematically correct "cut off" for both sides of the piston, and for all points of expansion intermediately.

It will be observed (Fig. 94) that the main valve-lever is pinned to a link, one end of which is fastened to the connecting-rod, and the other end maintained in about the vertical position by a radius rod, which is fixed to the frame near to the leading axle. The centre or fulcrum of the valve-lever partaking of the vibrating movement of the connecting-rod, is carried in a curved slide.

From the upper end of the valve-lever motion is communicated direct to the valve by the valve-rod. It will thus be evident that by one revolution of the crank the lower end of the valve-lever will have imparted to it two different movements, one travelling in length in consequence of the stroke, the other up and down in consequence of the revolution of the crank, these movements differing as to time, and corresponding to the part of the movement of the valve required for lap and lead, and that part constituting the port opening for admission of steam.

The former of these is constant and unalterable, the latter is controllable by the angle at which the curved slide may be set by the driver. Fig. 95, p. 200, shows the actual opening of the valve and the cut-off for the various positions of the reversing gear screw or lever on the foot-plate.

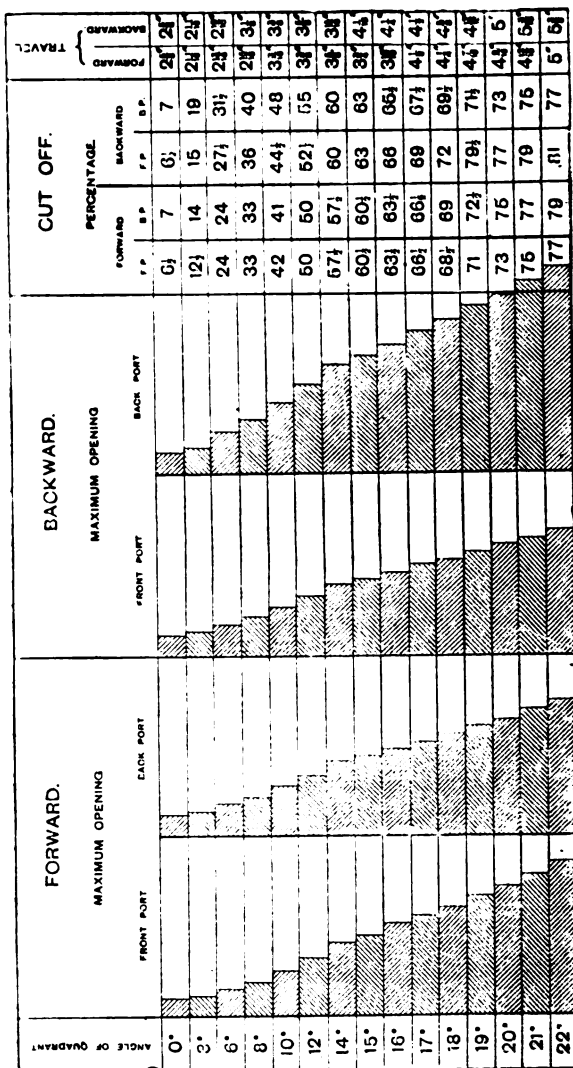

Fig. 95.—Joy's Valve Gear. Actual Result.

INDEX.

- A** DAMS, Mr. W., 149.
 " Agenoria," 29.
Allan, Mr. Alexander, 88, 98.
Allen, Mr. Horatio, 27.
American engines for England,
 81.
American engines, 181.
Arbroath and Forfar Railway,
 77.
- B**ATTLE of the gauges, 72.
 Beyer, Peacock & Co., en-
 gines by, for Midland, 131;
 Metropolitan, 158; Mersey,
 160.
Birmingham and Gloucester en-
 gines, 47, 81.
Blenkinsop, 7.
Bloomer type, 105.
Bolton and Leigh Railway, 25.
Brighton engines, 124, 130.
Bristol and Exeter engines,
 107.
Broad gauge, introduced, 72; re-
 moved, 167.
- Brunel, Mr., 72.
Bury, Mr. Edward, 40, 60, 61,
 69, 82.
- C**ABRY, Mr. Henry, 52.
 Caledonian Railway, 136.
Carmichael & Co., 55.
Coal burning, 108.
Collision at Thornton, 51.
Compound engines not successful,
 128, 140.
"Cornwall," The, 99.
Crampton's patent, 92, 100.
Crewe works opened, 90.
- D**EAN, Mr. William, engines
 by, 167.
Dome, an advantage, 168.
Dübs & Co., engines by, 116.
Dundee and Newtyle, 55.
- E**IGHTY miles an hour, 140.

FATHER of the locomotive, 5.
 Four-cylinder engines, 22,
 185.
 Four eccentrics, 62.
 Forrester & Co., 63.

GIFFARD injector, 193.
 Glasgow and South-Western
 engines, 122.
 Gooch, Sir Daniel, 73, 95.
 Gooch, Mr. John V., 9.
 Grand Junction Railway, 74,
 89.
 Great Eastern, 141, 174.
 Great Southern and Western en-
 gines, 170.
 Great Western engines, 72, 78,
 167.
 Grasshopper springs, 46.

HACKWORTH, Mr. T., 22.
 Haigh Foundry gear, 80.
 Harrison, Mr. T. E., 76.
 Hawthorn & Co., 47, 64, 185;
 valve gear, 65.
 "Hector," 79.
 "Hercules," 57.
 Hetton Colliery engines, 18.
 High boilers, 106.
 Holden, Mr., design, 141; liquid
 fuel, 143.
 Howe's link-motion, 87.
 "Hurricane," 76.

INJECTOR, 110, 192.
 Inside cylinders an advan-
 tage, 140.
 "Invicta," preserved at Ashford,
 35.

JENNY LIND type, 103.
 Johnson, Mr. S. W., en-
 gines by, 126, 131, 161.
 Joy's gear, 198.

KILLINGWORTH engines,
 12, 14.
 Kirtley, Mr. M., engines designed
 by, 115, 116, 117, 119.
 Kirtley, Mr. W., engines by,
 154.
 Kitson & Co., engines by, 126.

LANCASHIRE and Yorkshire
 Railway, 160.
 Leicester and Swannington Rail-
 way opened, 43; engines, 44,
 46, 50, 57, 59, 79.
 Link-motion invented, 87.
 Liquid fuel, 143.
 "Liverpool," 1834, 61.
 "Liverpool," 1848, 100.
 Liverpool and Manchester Rail-
 way, Rainhill trial, 30; opened,
 36; engines, 31, 33, 37, 49,
 57.
 Locke, Mr., 74.
 "Locomotion," 20.
 London, Tilbury, and Southend
 Railway, 156.
 London and North-Western en-
 gines, 90, 98, 100, 165.
 London and Birmingham Rail-
 way, 47.
 London and South-Western Rail-
 way, 91, 150.
 Long boilers, 84.

- M**ANCHESTER, Sheffield, and Lincolnshire Railway, 145 to London, 146.
- Marshall and Woods' report on Crewe and Wolverton engines, 106.
- McConnell, Mr., 83, 104, 105.
- Mersey engines, 160.
- Middleton Railway, 7.
- Midland engines, 114 — goods, 116, 131; mineral, 126; tank, 117; the latest "single," 161; the latest coupled, 134, 169; gradients, 163.
- N**EILSON & Co., engines built by, 113, 118, 121.
- Newcastle and Carlisle engines, 64.
- Nicholson, Mr. John, 45.
- North-Eastern engines, 147, 148
- North British engines, 160.
- North London engines, 156.
- North Midland engines, 84.
- P**ARK, Mr., designs for North London engines, 156.
- Parker, Mr., designs for Manchester, Sheffield, and Lincolnshire engines, 145.
- Pearson, Mr., designs, 107.
- R**AILWAY race, 137, 139.
- Ramsbottom, Mr. John, 109.
- Reversing, by steam, 123; by air, 129.
- S**AND blast, the, 191.
- Sharp, Roberts & Co., 54, 70.
- Sharp, Stewart & Co., 169.
- South-Eastern engines, 154.
- South Kensington Museum, engines preserved at: "Rocket," 31; "Sanspareil," 34; "Agenoria," 29; "Puffing Billy," 10.
- Speed, high, 99, 101.
- Speed, highest ever attained, 108.
- Steam springs, 14.
- Stephenson, Mr. George, first engine, 13; Hetton engines, 18; engineer, Stockton and Darlington line, 19; drove "Northumbrian," 35; the "Comet," 44; the "Stephenson," 42.
- Stephenson & Co., engines by, 19, 23, 27, 30, 38, 59; "Standard," 67.
- Stirling, Mr. P., engines for Great Northern Railway, 138.
- Stirling, Mr. James, 122, 154.
- Stirling & Co., 78.
- Stockton and Darlington Railway opened, 19; engines, 21.
- Stroudley, engines by, 124, 129.
- T**ANK ENGINE, 68 tons, 160.
- Tayleur & Co., 65.
- Ten-foot wheels, 76.
- Three-cylinder engines, 93.
- Four cylinders, 24, 183, 184.
- Trevithick, Mr. R., 5.

Trevithick, Mr. F., 98.
Tulk & Ley, Messrs., 92, 97.

UNION Foundry, Bolton, 107.

VALVE-GEAR, ancient, 45 ;
Forrester's, 63; Hawthorn's,
65 ; Roberts's, 54 ; Haigh
Foundry, 80 ; Howe's, 87 ;
Joy's, 198.

Vauclain Compound, 183.

"Velocipede," 98.

Vortex blast pipe, 152

"Vulcan," 66.

Vulcan Foundry, 60.

WEATHERBURN, Mr., 44.

Webb, Mr., latest designs,
165, 178 ; an impartial trial
necessary, 128.

Whistle, the first steam, 52.

Winby's design, 184.

Wilson, E. B. & Co., engines by,
103.

Wolverton, engines built at, 105,
111.

Worsdell, Mr., designs for North-
Eastern engines, 148.

