







The Locomotive

OF

THE HARTFORD STEAM BOILER
INSPECTION AND INSURANCE CO.



VOL. XL

PUBLISHED BY
THE HARTFORD STEAM BOILER INSPECTION AND INSURANCE CO.

HARTFORD, CONN.

1934-1935

1661.18

L76

V.45-41

1939-21

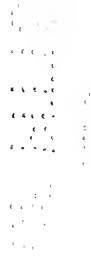

INDEX TO VOL. XL—1934-1935

THE LOCOMOTIVE

REFERENCES MARKED WITH A STAR (*) ARE TO ILLUSTRATED ARTICLES.

- Adams, S. B., Completes 42 Years Service, *January 1934*, 21.
Air Compressor, Two-Stage Air-Cooled, *April 1935*, 183.
Air Cooler Tube Rupture Leads to Diesel Accident, *October 1934*, 103.
*Air Line and Air Tanks, Accidents to, *October 1934*, 109.
Air Line, Vapor Explosion Reported in Large, *October 1934*, 112.
*Air Receivers, Combustible Vapor Explosions in, by William D. Halsey, *July 1934*, 66.
Air Receivers, Violent Explosions of Compressed, from "Vulcan," *October 1934*, 113.
Air Tank Explosions, *January 1935*, 151.
Air Tanks, California Finds Many Dangerous, *July 1935*, 218.
Ammonia Compressor Cylinder Bursts at Distillery, *October 1934*, 119.
*Ammonia Compressor, Steam Exhaust Chamber Bursts on, *October 1935*, 250.
Ammonia Pipe Rupture Shuts Down Cold Storage Plant, *April 1935*, 177.
Ammonia Tank Bursts, Convicts Killed When, *January 1935*, 157.
*Ammonia Vapor Blast, Wheel Bursting Leads to, *January 1935*, 152.
*Apartment Wrecked by Explosion, *July 1935*, 194.
*Bears, E. W.: Cleaning of Turbo-Generators, *April 1935*, 169.
*Blast Damages Cleaning Plants, *October 1935*, 238.
Blow-off Pipes Fail, Ells on, *October 1934*, 99.
*Blow-Off Tanks, by E. R. Fish, *July 1934*, 73.
*Boiler Blast Destroys Mill, *July 1935*, 204.
*Boiler, Church, Wrecked When Rear Boiler Wall Fails, *July 1934*, 93.
*Boiler and Engine, Home-Made, *July 1935*, 216.
*Boiler Explosion, Hertford, Takes Six Lives, *April 1934*, 41.
*Boiler Explosion Kills Two, *October 1935*, 226.
*Boiler Explosions Kill 17 Persons, *October 1934*, 98.
*Boiler Explosions, Major, *January 1935*, 142.
Boiler Feedwater, Novel Source of, *July 1935*, 206.
*Boiler Mishap, Two Men Die Following, *July 1935*, 203.
Boiler on Pressing Machine Explodes, *April 1935*, 185.
Boiler, Sawmill, Blast Kills Owner, *July 1935*, 204.
Boiler Scaling Tools, Damage Caused by Improper Use of, *April 1934*, 61.
Boiler Tube Fails, Hotel in Darkness When, *April 1934*, 40.
Boiler, Small, Explodes in Church, *April 1934*, 48.
Bowie, Hugh F., Death of, *October 1935*, 244.
Buried Return Line Leads to Cracked Boiler, *April 1935*, 184.

THE LOCOMOTIVE — INDEX.

- Bus Failure Indicates Unusual Chain of Circumstances, *October 1934*, 122.
- *Butler, John F., Death of, *April 1934*, 53.
- Case, Wm. O., Completes 43 Years Service, *January 1934*, 21.
- Cast Iron Boiler, New, Explodes, *January 1935*, 157.
- *Cast Iron Boiler into Solid Mass, Oil Burner Melts, *October 1934*, 121.
- Caustic Embrittlement, The High Cost of, *July 1934*, 77.
- Centrifugal Drier Bursts in Candy Factory, *April 1935*, 184.
- Cheney, Horace B., Gantt Medal to, *April 1935*, 182.
- *Chief Inspector at Seattle, New, *April 1934*, 56.
- Chief Inspectors Hold Discussion Sessions, *April 1934*, 56.
- Clogston, John B., Death of, *July 1935*, 212.
- Clowes, Sumter A., Death of, *October 1935*, 246.
- Coal Dust Diesel Engine, The, *July 1935*, 211.
- *Concealed Head, Failure of, Proves Costly, *January 1935*, 143.
- Consequential Loss, Meat Packer Has, *April 1934*, 57.
- *Cornell, Ward I., Death of, *April 1934*, 52.
- Corrosion of Boiler Drum Heads, *April 1935*, 175.
- *Corrosion Causes Hot Water Supply Boiler Explosion, *July 1935*, 207.
- *Crank, A Flaw in, Leads to Accident, *April 1935*, 176.
- *Crown Sheet Failure Results in Explosion, *July 1934*, 76.
- Curtis, W. S., Death of, *July 1935*, 212.
- Delap, George N., Completes 45 Years Service, *January 1934*, 21;
Retires, *October 1934*, 117.
- Diesel Accident, Air Cooler Tube Rupture Leads to, *October 1934*, 103.
- Diesel Engine, The Coal Dust, *July 1935*, 211.
- Diesel, Explosion in Air Inlet Manifold Damages, *October 1935*, 232.
- Diesel, The World's Largest, *April 1935*, 184.
- Digester Stock Opening Plate Blows Out, *October 1934*, 103.
- *Directors, New, Elected, *April 1934*, 53.
- *Drum Explosion Levels Boiler House, *January 1935*, 144.
- Electric Machines, Operating Temperature and Ventilation of Rotating, by J. B. Swering, *October 1935*, 233.
- Eleven Serve 40 Years or Longer, *January 1934*, 20.
- Ellison, Noel D., Death of, *October 1935*, 245.
- Embrittlement, F. G. Straub Reaffirms His Views on, *January 1934*, 6.
- Enger, Charles J., Completes 41 Years Service, *January, 1934*, 21.
- *Engine Alignment, A Method for Checking, by H. J. Vander Eb, *July 1935*, 208.
- Engine and Generator, Overspeed Accident Damages, *July 1934*, 81.
- Engine, Steam, Hartford Steam Boiler Hastens Repair Following Florida Accident, *July 1934*, 84.
- *Engine Wreck, Slug of Water Blamed for, *October 1934*, 107.
- Experiment with Fly-Ash to Clean Turbine Blades, *October 1934*, 105.
- *Explosion, Apartment Wrecked by, *July 1935*, 194.
- *Explosion, Six Die Following, *January 1935*, 144.

THE LOCOMOTIVE — INDEX.

- Feedwater Heater, Explosion of, *October 1935*, 239.
- *Feedwater Problems, Boiler, and Their Correction, *January 1935*, 130.
- Feedwater Trouble Traced to Ablutions, *July 1935*, 211.
- *Fifty Years of Service, *January 1935*, 148.
- *Fish, E. R.: Blow-Off Tanks, *July 1934*, 73; Care and Operation of Unfired Pressure Vessels, *October 1934*, 100; Furnace Explosions in Small Installations, *January 1934*, 23.
- Flywheel Accidents, Other, *July 1934*, 82.
- Flywheel Explodes, Operator Killed Instantly as, *January 1935*, 147.
- *Flywheel Explosions, Two Recent Steam Engine Accidents Involving, *October 1935*, 230.
- Flywheels, Both, of Gas Engine-Compressor Explode, *January 1935*, 153.
- *Francis, William M., Completes 49 Years Service, *January 1934*, 21; Fifty Years of Service, *January 1935*, 148.
- Fry, Jesse L., Appointed Chief Inspector at Denver, *October 1935*, 246.
- *Fuel Explosion Wrecks Boiler Setting, *October 1935*, 248.
- Fuel Explosion Wrecks Large Water Tube Boiler, *January 1935*, 151.
- Fuel Explosions, *April 1935*, 177.
- Furnace Explosion in School Causes Excitement, *July 1935*, 215.
- Furnace Explosion in Small Installations, by E. R. Fish, *January 1934*, 23.
- *Gale, Philip B., Elected Director, *April 1934*, 53.
- Gardiner, C. C., Completes 40 Years Service, *January 1934*, 21.
- Gear Wheels, Large Double Helical, *July 1934*, 83.
- *Generator Damage, Short Circuit Leads to, *April 1934*, 58.
- Generator End of Turbine Unit Explodes, *January 1934*, 19.
- Generator Field, Ground in, Brings Costly Shutdown, *April 1935*, 183.
- Generator, Over-speed Accident Damages Engine and, *July 1934*, 81.
- *Generator, Water-Turbine, Accident, *October 1935*, 247.
- *Graham, A. Paul, Appointed Manager at Boston, *April 1934*, 55.
- *Graham, Arthur F., Appointed Manager at Cleveland, *April 1934*, 55.
- *Graham, John J., Elected Director, *April 1934*, 53.
- *Guy, R. P., Appointed Chief Inspector in Baltimore, *January 1934*, 21.
- *Halsey, William D.: Combustible Vapor Explosions in Air Receivers, *July 1934*, 66; Vessels Subject to External Pressure, *October 1935*, 241.
- Hartford Steam Boiler Hastens Repair Following Florida Accident, *July 1934*, 84.
- Header, Rupture of, Puts Plant Out of Operation, *April 1935*, 168.
- Heads, Corrosion of Boiler Drum, *April 1935*, 175.
- *Heating Boiler Accidents, *April 1935*, 173.
- Heating Boilers, Steam, Low Water in, *October 1935*, 227.
- *Heating Plant Violence, Result of, *April 1934*, 51.
- *Home-Made Boiler and Engine, *July 1935*, 216.
- *Hot Water Heater Explosion Damages Drug Store, *April 1935*, 186.
- Hot Water Installations, Relief Valves on, *July 1935*, 196.
- Hot Water Storage Tank, Ordinary, Bursts in Bank, *October 1934*, 115.

THE LOCOMOTIVE—INDEX.

- *Hot Water Supply Boiler Explosion, Corrosion Causes, *July 1935*, 207.
- *Hot Water Supply Equipment Accidents, *October 1935*, 236.
- *Hot Water Tank Explosion Kills Housewife, *July 1934*, 90.
- *Hot Water Tank Explosion at School Kills Three, Injuries 11, *January 1934*, 11.
- Hotel in Darkness When Boiler Tube Fails, *April 1934*, 40.
- Hunt, J. F., Appointed Chief Inspector in New York, *January 1934*, 21.
- Hydraulic Brake Failure on Hoist Motor, *October 1935*, 247.
- Hydro-Pneumatic Tank Explodes at Air Port, *October 1935*, 240.
- *Inspection Department Transfers, *January 1934*, 21.
- Inspections, Benefiting Through, *January 1935*, 150.
- Inspector Finds Charred Human Bones in a Boiler, *July 1935*, 218.
- Insulation, The Problem of, by K. A. Reed, *July 1935*, 197.
- *Kier Accident, Brooklyn, *January 1935*, 146.
- *Lap Seam Crack Leads to Utility Boiler Failure, *October 1934*, 125.
- Locomotive Accident Kills Members of Train Crew, *October 1935*, 229.
- *Locomotive Blast, Sixteen Miners Killed by, *January 1935*, 142.
- *Locomotive, Freight, Blast Fatal to Three, *October 1934*, 108.
- Low Water in Steam Heating Boilers, *October 1935*, 227.
- *Magniscope, Hartford, Granted Letters Patent, *April 1934*, 49.
- *Managers at Boston and Cleveland, New, *April 1934*, 54.
- McLennan, A. D., Death of, *January 1935*, 150.
- Meat Packer Has Consequential Loss, *April 1934*, 57.
- *Method For Checking Engine Alignment, A, by H. J. Vander Eb, *July 1935*, 208.
- *Middlebrook, Louis F., Completes 49 Years Service, *January 1934*, 21; Fifty Years of Service, *January 1935*, 149.
- *Morrison, J. P., The Repair of Bulged Shell Plates and Drums, *April 1935*, 162.
- Motor, Hoist, Hydraulic Break Failure on, *October 1935*, 247.
- Motors Damaged by Molten Glass, *July 1935*, 204.
- Motors, Two Accidents to Chain Drive, *April 1935*, 176.
- Noec, William, Death of, *April 1935*, 182.
- Parrish, Harry, Veteran Inspector, Death of, *January 1934*, 21.
- *Parry, E. Mason, Decrease in Steam Pipe Friction Solves a Power Plant Problem, *April 1934*, 46.
- Penstock Accidents, *July 1935*, 201.
- Penstock, Huge, Bursts Open; Five Lose Lives, *January 1935*, 145.
- Perry, Clarence C., Death of, *April 1935*, 181.
- Piping Accident Damages Drug Store Stock, *April 1935*, 168.
- *Pittsburgh, Change of Managers at, *October 1934*, 116.
- *Power Boiler Accidents, *July 1935*, 202.
- *Power Boiler Accidents, Seven, Kill 7, Injure 32 Persons, *July 1934*, 78.
- *Power Boiler Explosions, *April 1935*, 167.
- *Power Boiler Explosions Take Toll of 16 Lives, *January 1934*, 2.
- Quigg, J. S., Completes 44 Years Service, *January 1934*, 21.
- Radiator, Plug in Steam, Blows Out, Kills Child, *April 1935*, 186.

THE LOCOMOTIVE—INDEX.

- Reed, Kenneth A., Death of, *April 1935*, 180.
 The Problem of Insulation, *July 1935*, 197.
- Relief Valves on Hot Water Installations, *July 1935*, 196.
- *Rendering Tank, One Killed When Seam Fails on, *October 1934*, 120.
- *Reynolds, George S., Retires as Pittsburgh Manager, *October 1934*, 116.
- *Rice, Thomas F., Appointed Assistant Manager at Boston, *April 1934*, 55.
- Richardson, T. B.: Dismantled Inspections of Steam Turbines, *October 1934*, 104;
 Failure of Turbine Emergency Trip, *July 1935*, 205; Testing the Speed Control Equipment of Turbines, *January 1934*, 7.
- Safety Devices, Inspections Emphasized by British Board, *April 1935*, 179.
- Safety Valve Spring, Broken, *July 1935*, 218.
- Scott, Drummond O., Death of, *October 1934*, 118.
- Scott, J. L., Appointed Chief Inspector in Cleveland, *January 1934*, 21.
- *Shaft, Steel Mill 15-Inch, Breaks at Progressive Crack, *October 1934*, 119.
- *Shell Plates and Drums, The Repair of Bulged, by J. P. Morrison, *April 1935*, 162.
- Shifted Core in Casting Leads to Accident, *July 1934*, 86.
- *Smith, William J., Appointed Chief Inspector at Seattle, *April 1934*, 56.
- *Soot-Blower Installation, Improper, Causes Boiler-Tube Failure, *October 1935*, 240.
- Steam Economy, High, Under Adverse Conditions, *April 1935*, 179.
- *Steam Engine Accidents, Two Recent, Involving Flywheel Explosions, *October 1935*, 230.
- *Steam Engine Wreck, Broken Gib Causes, *April 1935*, 185.
- Steam Pipe, A Curious Case of Blockage in a Small, *April 1934*, 57.
- *Steam Pipe Friction, Decrease in, Solves a Power Plant Problem, by E. Mason Parry, *April 1934*, 46.
- Steamship Records, Transatlantic, *July 1935*, 213.
- Stevens, Halsey, Completes 45 Years Service, *January 1934*, 21.
- *Still, Chemical, Explosion, *October 1934*, 101.
- *Straingage Is Used in Safeguarding Engines. How the Hartford Steam Boiler, by H. J. Vander Eb, *April 1934*, 34.
- Stromeyer, Charles Edward, Death of, *October 1935*, 245.
- Swering, J. B.: Operating Temperature and Ventilation of Rotating Electrical Machines, *October 1935*, 233.
- *Switchboard Ruined by Short Circuit and Fire, *October 1934*, 111.
- Talman, Aldin S., Death of, *April 1935*, 182.
- Tank Bursts, Welded Steel Cold Water, *July 1934*, 89.
- Tank, Hydro-Pneumatic, Explodes at Airport, *October 1935*, 240.
- Taps from the Old Chief's Hammer: *January 1934*, 27; *April 1934*, 59; *July 1934*, 91; *October 1934*, 123; *January 1935*, 155; *April 1935*, 187; *July 1935*, 219; *October 1935*, 251.
- Terroy, P. E., Appointed Chief Inspector in New Orleans, *January 1934*, 21.
- *"The House That Jack Built" in Accidents, *January 1934*, 17.

THE LOCOMOTIVE—INDEX.

- Thompson, Mary, Completes 42 Years Service, *January 1934*, 21.
Transatlantic Steamship Records, *July 1935*, 213.
Turbo-Blower Explosion Injures Operator, *July 1935*, 210.
Transformer Failure Shuts Down Metal Plant, *April 1935*, 172.
Transformer Oil Vapor Explosion Injures Three, *January 1935*, 154.
Transformer Oil Vapor Explosions, *October 1935*, 235.
Transmission Line Broken in Freak Accident, *April 1935*, 184.
Tube Blows Out in Steam Roller, Two Burned, *October 1935*, 250.
Tube, Collapsing, Causes Death, *October 1935*, 243.
*Tube Failure, Boiler, Improper Soot-Blower Installation Causes, *October 1935*, 240.
*Tube Failures Inconvenience Industrial Plants, *July 1934*, 88.
Turbine Blades, Experiment with Fly-Ash to Clean, *October 1934*, 105.
Turbine Emergency Trip, Failure of, by T. B. Richardson, *July 1935*, 205.
*Turbine Explosion, *April 1935*, 178.
Turbine Losses, Erosion, Fatigue Blamed for, *January 1935*, 141.
Turbine Over-speed Demolishes Unit, *October 1935*, 243.
Turbine Stops, Bearings Burned as, *July 1934*, 86.
Turbines, Small, Water in Casing and Slipping of Wheel Damages, *October 1934*, 106.
Turbines, Steam, Dismantled Inspection of, by T. B. Richardson, *October 1934*, 104.
*Turbines, Testing the Speed Control Equipment of, by T. B. Richardson, *January 1934*, 7.
*Turbo-Generators, Cleaning of, by E. W. Bearse, *April 1935*, 169.
Unfired Pressure Vessels, Care and Operation of, by E. R. Fish, *October 1934*, 100.
Use and Occupancy. Hartford Steam Boiler Hastens Repair Following Florida Accident, *July 1934*, 84.
*Vander Eb, H. J.: How the Hartford Steam Boiler Strainage Is Used in Safeguarding Engines, *April 1934*, 34; Method for Checking Engine Alignment, A, *July 1935*, 208.
Veigel, Alfred, Completes 41 Years Service, *January 1934*, 21.
Veneered Wood Damaged by Escaping Steam, *January 1935*, 154.
Vessels Subject to External Pressure, by William D. Halsey, *October 1935*, 241.
Vulcanizer, Steam, Explodes, *January 1934*, 29.
Vulcanizer, Tire, Explodes, *October 1935*, 243.
*Wallace, William P., Appointed Manager at Pittsburgh, *October 1934*, 116.
*Warner, J. B., Death of, *July 1934*, 87.
Water Heater Blasts Occur in Restaurants, *July 1934*, 83.
*Water Supply Tank Heaters, Other Accidents to, *January 1934*, 12.
*Water-Turbine Generator Accident, *October 1935*, 247.
Welded Steel Cold Water Tank Bursts, *July 1934*, 89.
*Wheel, Bursting, Leads to Ammonia Vapor Blast, *January 1935*, 152.
Williams, Dr. George C. F., Death of, *January 1934*, 20.

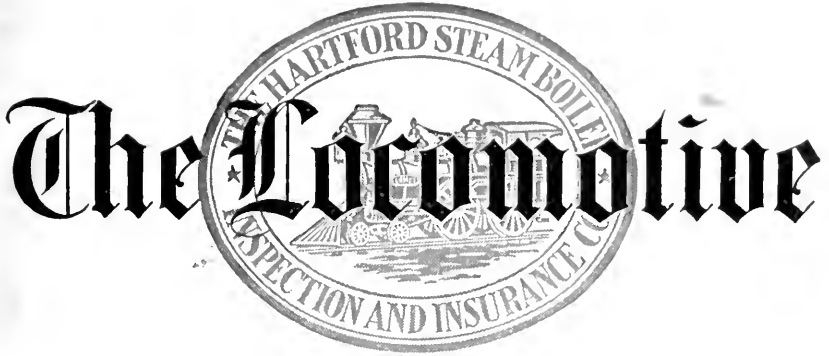

A QUARTERLY MAGAZINE
DEVOTED TO POWER PLANT PROTECTION

Published continuously since 1867
by The Hartford Steam Boiler
Inspection and Insurance
Company

Please show to your Engineer

Power Boiler Explosions Take Toll of 16 Lives

Six men were killed and nine were injured when a 72" horizontal tubular boiler exploded on January 13, 1934, wrecking buildings at a North Carolina cotton oil mill. A full account of this accident will appear in the April, 1934, issue of **THE LOCOMOTIVE**. Insurance under a "Hartford Steam Boiler" \$50,000 policy is applicable on the property loss.

EXPLOSIONS of power boilers in recent months have taken a toll of at least 16 lives, have injured a considerable number of persons, and in several instances have completely leveled the plants housing the boilers.

Perhaps the most serious accident from the standpoint of property damage occurred at an Indiana paper company's plant on December 22, 1933. An explosion there resulted in the death of a fireman and property loss variously estimated between \$35,000 and \$100,000. Workmen searched the wreckage from shortly after the accident at 11:00 P.M. until nearly noon the next day to recover the body of their comrade, the search being complicated by the fact that coal in bins above the boilers



After a corroded mud drum head blew out at an Indiana paper mill.



A bunker of coal collapses into the debris to complicate the search for a fireman's body.

fell upon the tangled mass of brick and steel. The accident shut down the plant and threw 150 employes out of work temporarily.

The explosion destroyed the 30' x 80' boiler house, and damaged a warehouse and several tons of paper. A fire followed the explosion. Besides the damage to the plant, the blast hurled pieces of the boiler and other debris more than two blocks. Sections of pipe were found on the roofs of buildings, several hundred feet away. Had the plant been operating at the time, the toll in personal injuries and deaths would probably have been much greater.

The boiler which exploded was one of a battery of four, and was of the bent-tube type with a rated capacity of 300 hp. Its safety valve was set to blow at 155 lbs.

Investigators were agreed that the boiler had been weakened because of corrosion on the outside of a lower mud drum at the "blind" end of the drum, concealed by the brickwork of the setting, and that this weakening led to the accident. All of the tubes were pulled from the mud drum and the drum itself was thrown a distance of approximately 75 ft, landing on the roof of a paper storage house. Examination of

this drum showed that the shell plates were not torn. The manhole head was intact, but part of the blank head had been blown out. There appeared to be no shearing of the rivets and most of the head skirt remained fast to the end of the drum. There was insurance against boiler explosion at this plant although not with "Hartford Steam Boiler".

Two generations ago steam boiler explosions were considered by many to be "acts of God" and undoubtedly there were some folk in the back mountain country about 15 miles south of West Liberty, Kentucky, on the second day of the new year, who attributed a serious boiler explosion to this cause. Probably no exact knowledge of what caused the explosion will ever come to light, but the known results were the deaths of five men and injury of 12 others, four of whom may die.

So remote was the location of this mill on Elk Fork creek that a man had to ride seven miles on horseback to get to a telephone to call a doctor. The doctor then traveled the 15 miles to do what he could. "Hartford Steam Boiler" insures some boilers in remote localities and its inspectors, in a good many instances, have found it necessary to travel by muleback or horseback from the railhead to a mine or mill deep in the mountains. The boiler at Elk Fork creek was not insured.

One man was instantly killed, another died three hours later and three others were mangled when a boiler exploded on August 24, 1933, at a Texas cotton gin. According to newspaper accounts the explosion came while preparations were under way to gin the season's first bale of cotton.

Rupture of a steam line at the top of a boiler led to the death on November 13, 1933, of two men who were working above the boiler in a Lowell, Massachusetts, building. The accident occurred a few minutes before one of the men was to go off duty. Both men were swept from the top of the boiler and died from scalds. Firemen had to wade through several feet of water to recover the bodies.

A ketchup canning factory at Front Royal, Virginia, was demolished, one employe killed and four others injured when a boiler exploded on October 28, 1933. One part of the boiler landed on the roof of a



Upper left—Camden, Tennessee, boiler in a cornfield 300 ft from its setting; the hole at the left shows where the shell first landed. Lower left—results of an explosion in a Hohenwald, Tennessee, sawmill. Right—found two days after its explosion in a Powellsville, Ohio, sawmill. This part of the boiler traveled over a hill near the plant.

house two blocks away and cut through all of the floors to the basement. Another part landed in a yard about a block distant after having cut down a large shade tree.

A boiler explosion that was attributed to the failure of a welded repair wrecked a sawmill, killed one man and injured two others at Powellsville, Ohio. The boiler was of the locomotive type, 42" in diameter by 12'6" in length. The repair had included the welding of a plate on the bottom of the firebox to join the wrapper and furnace sheet. The wrapper sheet was found two days later on the opposite side of a hill near which the mill stood. The barrel, ripped open longitudinally through the solid plate about 8" from the lap seam, landed in a creek about 180 ft. away.

Grooving just below the longitudinal seam of the middle course of a locomotive type wet-bottom boiler, was blamed for its explosion in a Hohenwald, Tennessee, sawmill on October 18, 1933. Employees of the mill reported that the steam gauge showed a pressure of 140 lbs shortly before the explosion, although the safety valve was supposedly

set to blow at 120 lb. The accident caused the death of two men, one of whom was hurled 400 ft and the other some 20 ft from the boiler room in which they were working. About half of the 150-foot mill shed was demolished. More persons would have been injured had not the mill run out of logs and the crew been dismissed for the day shortly before the accident. The boiler was torn into four pieces, the initial point of failure being along the inside lap of the longitudinal seam of the middle course.

The explosion of a horizontal tubular boiler in a stave factory at Camden, Tennessee, caused the death of a machine operator, injured 8 other workmen, and wrecked the mill building. The accident was attributed to unbeaded and thin tube ends. The front tube sheet pulled loose from all of the tubes. The boiler was operating at a pressure of about 80 lb at the time of the accident and the escaping steam was blown directly through the mill, scalding employes at work. The boiler itself skyrocketed 400 ft into a corn field.

F. G. Straub Reaffirms His Views on Embrittlement

The following self-explanatory letter appeared recently in several engineering magazines:

"During the last year I have received information from several sources that persistent rumors are being circulated to the effect that I have changed my opinion in regard to the cause of embrittlement in steam boilers and the use of sulphate to prevent this difficulty. One of these rumors is to the effect that a large power plant operating at a steam pressure in the neighborhood of 400 lb maintained the 3:1 sodium sulphate-to-total alkalinity ratio as recommended by the A. S. M. E. Boiler Code Committee, and that embrittlement cracking took place. Another is to the effect that I have admitted that caustic is not one of the contributing causes of embrittlement.

"It is extremely difficult to trace rumors to their source, and once a rumor is started, it spreads very rapidly. I have answered numerous inquiries in which men hearing these rumors have written to me directly. However, it becomes very difficult to stop these rumors by writing a few letters. I would like to make a public statement at this time to the effect that these rumors are not correct.

"I still believe that embrittlement in boiler plate is caused by the combined action of stress and chemical attack. The stresses are inherent in the construction and operation of the boiler, while the chemical attack is caused by the presence of sodium hydroxide in the boiler water. I also believe that the presence of sodium sulphate in the boiler water tends to retard the embrittlement effect of the sodium hydroxide, and if in proper proportions, will stop it entirely.

"I hold this opinion due to the fact that no evidence has been presented to the contrary. If at any time such evidence is produced, I will be willing to investigate the evidence and make a public statement as to the results. I would appreciate it very much if you could publish this statement.

"Urbana, Ill.

(Signed) "Frederick G. Straub.

"University of Illinois."

Testing the Speed Control Equipment of Turbines

By T. B. RICHARDSON, *Chief Engineer, Turbine and Engine Division*

TOO much stress cannot be laid on the importance of keeping steam turbine main governors, control valves and emergency governors in the best possible operating condition. The delicate balance of the turbine rotor and its efficiency at a speed not far from its maximum safe speed makes it absolutely necessary that not only the governor but the emergency governor as well function accurately. Emphasis in this article will be placed on the emergency governor, particularly with regard to the work of regular and safe testing procedure.

The speed at which a turbine operates from day to day under its maximum efficient load is commonly spoken of as the "normal" speed. For purposes of inspection and insurance an "approved" speed is named which is approximately 10 percent above "normal" speed.

During light load operation, or when the load is entirely removed, speed is held below the approved speed by the proper functioning of the main governor and the main steam control valves that are actuated by the main governor. If the main control valves leak excessively, when closed, the turbine speed may increase until the approved speed is reached. At this point, the emergency governor is intended to function and trip the throttle valve or other valve in the main steam line, or lines, to the unit.

The responsibility for holding the turbine down to "normal" speed in case of sudden loss of load, depends primarily on the proper functioning of the main governor and in turn on the control valves, which should be adequately tight so that when closed there will be no leakage of steam to cause a speed increase. For this reason the operator should test the control valves for tightness at least twice a year.

It should be remembered that the chain of events leading to most overspeed accidents starts with the failure of the main governor or its connections, including the control valves.

The emergency governor is an added safety device that, unlike the main governor, works only on comparatively rare occasions and is thus more likely to become inoperative. For this reason the emergency governor should be tested at regular intervals, preferably each time the unit is shut down, except that once a week is ordinarily of sufficient frequency. In no case should a machine be allowed to operate for more than three months without such a test.

The emergency governor mechanism consists of a rotating spring-opposed weight on the main shaft, and the trip valve and external links that lead from the rotating part to the trip valve. Both of these parts must function if the emergency governor is to be effective.

The emergency governors now generally employed by all manufacturers respond suddenly and with a full stroke to a predetermined change of speed. It is mounted on the turbine shaft and the center of gravity of its actuating device is slightly eccentric to the shaft. It is intended to be tripped by centrifugal force and a spring holds it in place until the operating speed of the turbine is sufficiently high to overcome the force of the spring. Centrifugal force increases rapidly as the weight starts to move outward, with the result that it completes its travel with a sudden snap.

It is recommended that this actuating device be tested about once in two weeks with the idea of preventing its plunger from becoming gummed with oil and thereby rendered inoperative. This testing procedure is considered beneficial for all types of installation except the clock-spring type, on which the springs have broken frequently while being tested. However, the frequent testing of the clock-spring type of emergency governor is not so important because it is not so likely to gum up with oil. Besides becoming gummed with oil deposits these plungers sometimes are bent in such a way that they will not function.

The methods for testing the rotating members of various types of emergency governors are:

1. Increasing the speed of the turbine to the approved speed.
2. With the oil-trip type, oil may be forced into the governor with sufficient pressure, or fed into the governor in sufficient quantity, to overcome the spring action, causing the plunger to move outward at the normal operating speed.
3. In some cases, provision is made so that the turbine, when shut down, can have a predetermined amount of weight attached to the emergency governor. This metal test weight will, when combined with the normal unbalance of the plunger, overcome the spring action and cause the plunger to move outward when the normal operating speed has been reached.

When the last mentioned method is employed, there is no necessity for bringing the turbine up to the approved speed at any time. The only disadvantage of using this method is that the turbine must be shut down to attach the test weight and again allowed to come to rest before the weight can be removed. In many recent cases, the

oil trip emergency has been substituted for the weight type of emergency.

The arrangements for testing emergency governors by oil have been applied more and more to turbines manufactured during recent years. Even with these types of emergency governors it is considered wise to trip the mechanism once each year by increasing the speed of the unit. The increase in speed should be gradual until the emergency governor operates and in *no case* should the speed of the unit be allowed to exceed the approved speed.

It is also important to test the trip valve regularly. If this valve is not operated at sufficiently frequent intervals, deposits may accumulate on the stem and prevent the valve from closing when relieved. This part of the emergency governor mechanism may be tested by hand tripping independently of the rotating member. If the turbine is shut down daily it is good practice to trip the valve by hand at that time to make sure that its stem is free in the packing. If the unit is run continuously for a week or more, it is desirable to turn the combined trip and throttle wheel a few turns daily during light load periods to make sure that the valve stem is free in the packing.

Procedure for Testing Emergency Governors

The procedure followed by operators in testing the complete emergency governor is important. The proper sequence of events is as follows:

1. Remove the load from the turbine. If a generator is being driven the main generator oil switch should be opened. It is desirable, although not absolutely necessary, to pull the field switch.

2. Observe the speed of the turbine with the load removed. If the speed continues to increase, it is an indication that the control valves are leaking excessively and measures should be taken at once to repair or replace them.

3. If the speed remains constant with the load removed, trip the throttle valve or the separate trip valve *by hand*. This test, if satisfactory, assures the operator that the valve and its mechanism, at least, are in good operating condition. If there is a separate trip valve, the throttle valve should also be closed by hand.

4. With the throttle closed, open one or more of the control valves. It is generally necessary to disconnect the main governor from the control valves to hold them open at speeds above operating speed. When the control valves are operated by cams, it is possible to pry up on one of the control valve levers and place a block of wood under the lever to open the valve temporarily. It is also possible to open the control valve by having another attendant pry on the governor

lever, if the throttle valve is sufficiently closed to hold down the speed.

5. With the control valve held open, *slowly* increase the turbine speed by opening the throttle valve by hand. While this is being done, the operator at the throttle should be kept informed constantly by another attendant regarding the speed at which the turbine is operating. In this manner the speed may be increased *slowly* and kept under control by hand at all times. If the rotating member of the emergency governor has not functioned by the time the approved speed has been

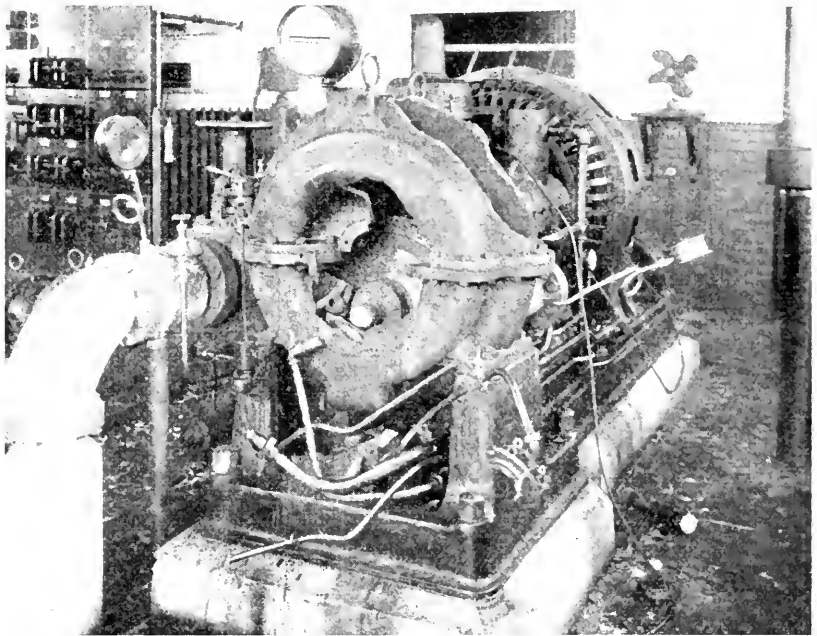

Two men were peppered with flying cast iron when the buckets came through the casing of this turbine. The shaft broke in three pieces during the accident, which was attributed to overspeed.

reached, the turbine should be shut down and proper adjustments made so that it will operate at, or somewhat below the approved speed. After the test has been satisfactorily completed, it is, of course, necessary to restore the control valves to their normal operating adjustments.

A turbine recently exploded during the test of the emergency governor, causing the complete destruction of the steam end of the unit and necessitating the renewal of the reduction gear casing and gears. The turbine shaft was severed at three places and the pinion

shaft at one place. None of the blades was left on the rotor and most of them came out through the casing. One man at the control valve and another in front of the turbine were slightly injured by flying pieces of cast iron.

This accident was caused by failure to observe in full the cautions outlined in the above summary of procedure, and the results are given here to illustrate what can happen when the turbine gets out of control for any reason during a test. It is advisable, of course, to have an experienced person in charge.

Hot Water Tank Explosion at School Kills Three, Injures 11

THREE hundred and fifty boys and girls said goodbye to their mothers on Thursday morning, November 8, 1933, and set off blithely to school in Forest, Mississippi.

Later in the day all parents who could do so drove or walked or ran in breathless fear to that same schoolhouse. They had heard that children were injured or dead there and they had heard rightly.

In the fifth grade class conducted by Miss Frances Bain about thirty 11 and 12-year old youngsters gave her their usual attention. Suddenly, there was a terrific noise beneath the room and with the energy of a high explosive shell something tore away the floor as if it had been matchwood. Desks struck the ceiling and fell back into a tangled mass of wreckage. Windows were shattered.

William Riser, a 12-year old, was thrown into the air and dropped through a ragged hole in the floor into the basement. Scalded by steam and hurt by the debris, the unconscious boy died half an hour later in a doctor's office.

Miraculously his schoolmates escaped his fate, although it was necessary to take one boy with serious injuries to a hospital, and about ten others were burned or cut or bruised. The teacher and the rest of her pupils were unhurt. For a moment following the explosion, the entire school was in chaos as the brick building shook, plaster and splintered glass fell and dust rose in clouds. Luckily there was no fire and cool-acting teachers and older pupils quickly inspired a semblance of order as class after class marched out to safety.

In the basement were two negroes, the janitors of the building, who had had no chance to escape. They had literally been blown from the boiler room, and neither lived long after the accident. About them was

a scene of wreckage, and from above light streamed in through the jagged holes in the floor of the fifth grade classroom.

Another chapter had been written in the book of disasters caused by the force of steam under pressure. Death, injury and wreckage had been caused by the failure of a small water tank 1' 6" in diameter and 3' 2" long. In it pressure had built up until the metal gave way to release the accumulated energy with sudden, terrifying force.

Firemen and others, who had been summoned by the noise of the explosion, frantically searched the ruins for the injured. When everyone had been accounted for the authorities started an investigation to determine what had caused the accident. The pictures with this article reveal something of the tragedy. At the top is the wrecked fifth-grade classroom and the hole in the floor through which the youthful victim fell. In the center is revealed damage to the brick building and a view of the fifth grade classroom floor from below. The bottom picture shows the parts of the tank after they had been dragged out-of-doors for photographing.

The tank which exploded was a round, butt-welded hot water tank of the range boiler type. While the explosion had destroyed much of the connecting pipe and fixtures, the conclusion reached was that either faulty manipulation of valves or stopped-up piping had made the tank a "closed" vessel in which pressure built up, as heat was given to it from a coil in the firebox of the school's cast iron heating boiler.

The shell of the tank was of 1/16" to 5/64" metal and the convex (plus) heads were 3/16" thick. Failure occurred in a welded head seam.

Besides the damage already described, one wall of the fifth grade room was bulged a foot out of line, plaster on walls and ceilings was damaged, and floors disturbed throughout the whole building. Outer walls were cracked in several places. In the basement the heavy sectional cast iron boiler was blown 6" off its foundation. Two sections were ruined and 6' of main steam piping was blown down. Brick walls on three sides of the furnace room were demolished.

School board trustees said they estimated damage to the building, erected in 1919 at a cost of \$30,000, to be about 50 per cent, and that rebuilding was contemplated. Insurance against loss from such an accident was not carried.

Other Accidents to Water Supply Tank Heaters

Anthony Massa and his brother-in-law, William Fiore, an eighteen-year-old youth, were working hard in the basement of a new bakery which Massa was starting in New York City. Massa was working in a



Scenes at Forest, Mississippi. Top and right center—pieces of the school-room floor. Left center—cracks in the building. Bottom—pieces of the tank.

far corner of the basement and Fiore was standing near a cast iron hot water heater in which he had built a coal fire a short time before. The fire was roaring under the small heater, which was about 2' in height, and Fiore was waiting to be sure that the fire was well under way when without warning the little heater exploded, breaking into hundreds of pieces which were hurled with terrific force in every direction. Fragments of the stove hit the walls and embedded themselves in the thick concrete. Several large pieces were driven deeply into the ceiling. Pieces of metal peppered the wall in the corner where Massa was working but he escaped unhurt. Dazed, he stumbled from the building. Quickly he realized that his brother-in-law was still in the basement and he called policemen who found the youth near death with both legs mangled.

The debris did not tell clearly what had happened, but the most likely theory considered was that the valves leading to and from the heater had become closed or had not been opened, as the installation was new, and that the fire had a chance to generate steam at high pressure in a boiler not intended to withstand pressure much greater than the regular water service pressure.

As water was being heated for a baptismal ceremony in the basement of a Baptist church on October 14, the water heater exploded and damaged windows, a door, and a wall. The heater itself was demolished. No one was in the building at the time of this accident.

Another accident to similar equipment occurred in a Pennsylvania hotel. In this case a slight leak had developed in a cast iron round hot water supply boiler located in the kitchen. A workman was repairing it with liquid iron cement which required that the water be brought to the boiling point to make the cement effective. About ten minutes after the fire was started, the boiler exploded, flying parts striking the workman and pinning him against a door frame. He received a fracture of the right leg, lacerations and burns of a serious nature. Another man who was watching the work also sustained injuries which necessitated his being taken to a hospital. A study of the evidence showed that the accident had probably occurred because of the freezing of water in the pipe leading from the boiler, as the room in which it was located was in a back kitchen and was not heated. The

presence of this ice would have made the vessel a "closed" one and could have led to an explosion of this violence. It was estimated that property damage would amount to approximately \$1,500. All of the windows in the back of the hotel were blown out and parts of the boiler tore up through the second floor, damaging partitions, doors, and furnishings.

One person was seriously injured and three others received hurts of a minor sort when a coal fired hot water heater burst in the basement of an Indiana service station. The seriously injured man, an

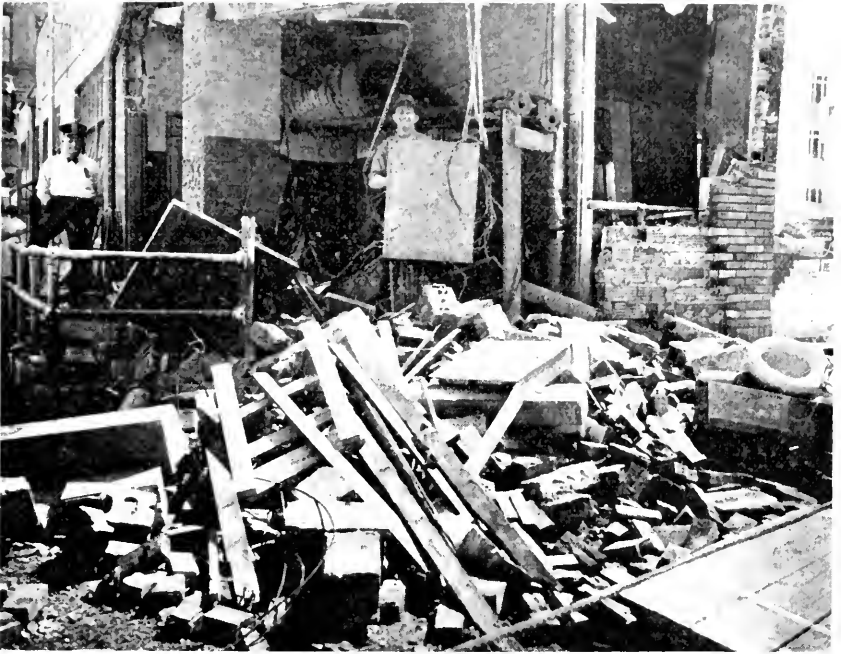

An Indiana automobile service station after a hot water heater burst.

attendant at the station, was eating his lunch in the basement where the explosion occurred. He was burned and cut. Two women who were inside of the station and a man on the sidewalk outside were struck by falling debris. The floor above the tank was blown upward, the foundation of the building was cracked and one of the walls blown off of its foundation so that firemen had to tear it down.

At Montevideo, Minnesota, the explosion of a hot water heater in the basement of a garage resulted in injuries to one man. Windows in the garage and in an adjoining café were blown out.



After a hot water tank exploded.

Members of a Norwood, Massachusetts, family were returning from a motion picture and had reached a point about 50 yards from their home when they saw a whole corner of it blown to splinters.

The ruin was caused by the explosion of a 30-gallon range boiler that was installed vertically with a side-arm electric heater, but which was not protected either by thermostatic control or relief valve. Unlike most explosions of vertical hot water tanks, which usually occur through a failure of the lower head skyrocketing the tank through the roof, this one blew off the top head, tore the shell from end to end, and exerted the energy thus released in a horizontal direction.

The system had a reducing valve in the supply line from the city main. This valve acted as a check and prevented the overpressure being relieved by the backing out of water into the main. In an investigation of the accident, Mr. Chetwood Smith, a consulting engineer of Boston, found that the bore of an iron nipple in the circulating line between the electric heater and the bottom of the tank had stopped up until it was about one-twentieth of its original area. He felt that this stoppage resulted in an abnormal temperature difference between the water in the top of the tank and that in the bottom, so that the solder of the upper head seam softened and let go.

Although the city water supply was under a pressure of only 60 lb, Mr. Smith concluded that a much higher pressure must have built up within the tank before the rupture occurred.

"The House That Jack Built" in Accidents

*This is the motor sound and sane
That bore the belt that snapped from its plane
That whipped the pipes with angry disdain
That gushed out water that fell like the rain
That wet the engine that felt the strain
That clanked and roared like a speeding train
That whirled the wheel
That burst its rim
That crashed and smashed
That cut and bashed
That shut down the plant that man built.*

SO UNUSUAL was the sequence of events leading to a serious flywheel explosion on November 12, 1933, that a familiar old nursery rhyme was brought to mind. Hence the somewhat unusual introduction to this article.

When water sprayed on the governor belt of a steam engine used by an Ohio paper board manufacturer, the belt slipped, allowed the engine to overspeed, and the flywheel exploded. The leakage of water was from an overhead sprinkler system which was damaged after a series of events that started with the breaking of a belt on a 500 hp motor. This belt whipped loose a guard rail and hurled it into the belt of the main engine. Either the flying guard rail or the motor belt struck and severed the sprinkler pipes.

The engineer on duty at the time said he was standing in front of the engine when he heard the belt on the motor break. He ran to the control panel and opened the switch. Immediately thereafter he noticed that the guard rail, torn down by the broken belt, was riding the main belt on the engine. He tried to shut down the engine to remove the guard rail, but he found that the electrically-operated safety stop would not work. Sending another employe to close the stop valve in the steam line at the boiler, he started toward the engine to close the throttle, but as he neared the front of the engine he saw that it had picked up speed and was running too fast for him to take a chance with the throttle. He then ran to make certain that the other employe would close the right valve. By the time he reached the boiler room the wheel exploded.

It was noted after the accident that the wires for the overspeed stop were torn down, and it was considered possible that these wires were broken by the belt which broke on the motor. This, of course, would account for the failure of the overspeed stop to operate.

The entire rim of the flywheel broke loose from the spokes and flew in pieces into other parts of the building. The engine itself was badly wrecked. One piece of the wheel weighing 1980 lb struck the jordan (a machine for slashing the pulp before it passes into the paper

machine), then the screen box in front of a paper machine and finally an 8" x 8" steel column. It came to rest 115 ft from where it started. Another piece of the wheel weighing approximately 1900 lb tore a hole 4' wide and 11' long in the 6" reinforced concrete slab forming the floor of the second story. Still another piece of metal followed the second and went through the roof and finally came down again through the roof at another point. In all the damage to property amounted to more than \$7,000.

No employes were injured by the flying parts although one fell down in the excitement and skinned his knee.

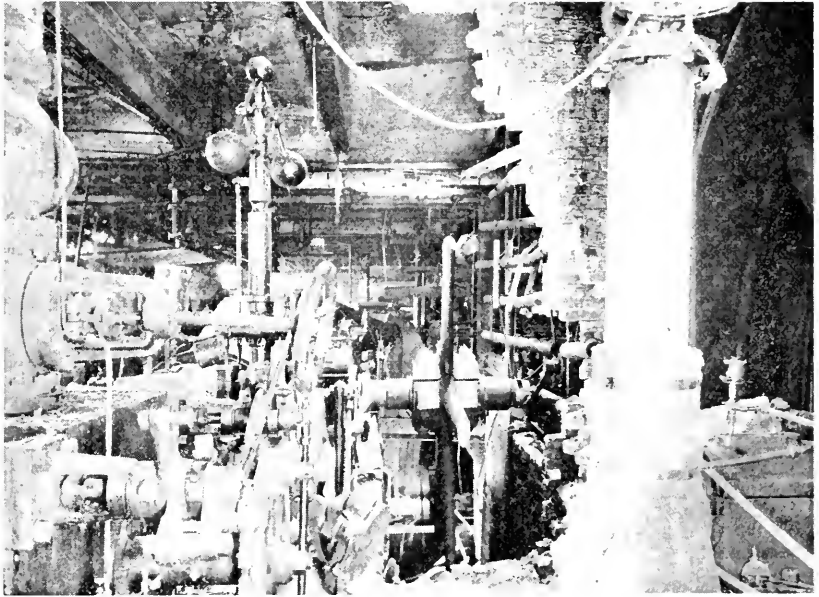

*"That whirled the wheel
That burst its rim"*

The wheel which exploded was 14' in diameter, of the belt type, and had a 31" rim.

Other Flywheel Accidents

How an exploding flywheel can damage property a long distance from the original installation was illustrated in an accident in a fuel yard at Hamilton, Ontario, when parts from a flywheel used in connection with a high speed saw traveled almost a quarter of a mile and crashed through the roof of a residence. A large piece of the wheel smashed through an attic window, burst through the floor and into

a bedroom, pierced an outside brick wall and finally buried itself a foot deep in the ground. The family was in the dining room at the time and thought that an airplane had struck the house.

A young Arkansas farmer who was watching the men start up the machinery of a cotton gin sustained a fractured skull when the fly-wheel of a natural gas engine exploded from overspeed. Parts of the wheel were found 100 yards away. The wheel was 5' in diameter. One piece of it struck a large cottonwood tree about 100 ft from the gin, shattering the tree like matchwood. Other parts of the wheel, with the exception of the piece which hit the young man, spent their energy without serious consequences. The 110 hp engine was not seriously damaged.

Generator End of Turbine Unit Explodes

The generator end of a 750 kw turbine was completely wrecked by an overspeed explosion at an Iowa sugar company plant on December 18, 1933. An employe who tried to stop the machine sustained fatal injuries when he was struck by a flying part, and another employe was seriously injured. The machine had been running in parallel with a 1250 kw turbine and for some reason, which has not been satisfactorily explained, the smaller turbine speeded up. The master mechanic, the man who died, closed the emergency valve but this failed to reduce the speed of the machine and the generator exploded, throwing the coils out through the casing. Damage was confined to the turbine itself.

Juries Award Verdicts Following Accidents

A jury in the St. Louis, Missouri, circuit court recently returned a verdict of \$20,000 in favor of a woman visitor who was injured when the heating boiler exploded in the store-home of the defendant tenant in December, 1927. The plaintiff claimed to have suffered fractures of both legs, severe burns and other injuries. The defendant contended there was no defect in the boiler and that the explosion occurred in the firebox of the furnace. The boiler was brought into court as evidence at the trial. At a previous trial the plaintiff had been awarded a judgment for \$35,000 but this verdict was reversed by the Missouri supreme court.

Following a four-day trial in the Harrison county, Mississippi, court at Gulfport, a jury on December 9, returned a verdict for \$20,000 for a woman plaintiff in her \$50,000 suit against a creamery company for the death of her husband. The plaintiff asserted that her husband died in an accident in 1932 when a pipe connection on an ammonia tank burst in the defendant company's plant where her husband was employed. At a former term of the court the plaintiff was awarded \$22,000, but the verdict was set aside and a new trial ordered. Mississippi is one of four states that do not have a workmen's compensation law.

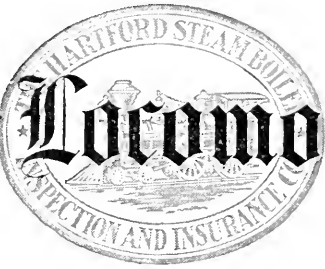

The Locomotive

A QUARTERLY MAGAZINE
DEVOTED TO POWER PLANT PROTECTION

George H. Prall, *Editor*

Copyright 1934 by The Hartford Steam Boiler Inspection and Insurance Company

HARTFORD, CONN., January, 1934

Single copies may be obtained free by calling at any of the company's agencies.
Subscription price 50 cents per year when mailed from this office.
Recent bound volumes one dollar each. Earlier ones two dollars.

Reprinting matter from this paper is permitted if credited to

THE LOCOMOTIVE of THE HARTFORD STEAM BOILER INSPECTION AND INSURANCE CO.

Dr. George C. F. Williams, Director

Dr. George C. F. Williams, a director of the Hartford Steam Boiler Inspection and Insurance Company since 1911, died on November 15, 1933. He was active in the business life of his community, and was a leader in city and state undertakings, particularly in connection with welfare work. After graduation from the scientific courses at Yale university, Dr. Williams began the practice of medicine in Cheshire, Connecticut, in 1878. Later he engaged in hospital work in New York and in 1887 came to Hartford and became connected with the Capewell Horse Nail company of which he was made president about 1910. He was head of this nationally known company until his death.

Eleven Serve 40 Years or Longer

January is a time for measuring achievement, particularly as such achievement has to do with long and competent service with the company. It is with pride that the Hartford Steam Boiler Inspection and Insurance Company acknowledges the forty-nine years of service com-

pleted by William M. Francis, manager of the Atlanta department, and wishes him many more active New Year's days in his association with the Company. Manager Francis entered the employ of "Hartford Steam Boiler" on January 1, 1885.

Two months later, on March 1, 1885, Louis F. Middlebrook, secretary, joined the Company and continues actively in its service, as does Halsey Stevens, assistant secretary who started with the Company on April 10, 1889.

In all, there are eleven individuals who have seen forty or more years of continuous service, the most recent achievement of this distinction being that of C. C. Gardiner, vice president and manager of the New York department, who came with the "Hartford Steam Boiler" on January 1, 1894.

The other individuals on the honor list are Geo. N. Delap, special agent, Hartford department, who came with the Company in June 1889; J. S. Quigg, clerk, New York department, May 26, 1890; Wm. O. Case, cashier, Hartford, October 5, 1891; S. B. Adams, chief inspector, Philadelphia department, March 15, 1892; Mary Thompson, supervisor stenographic department, Chicago department, April 4, 1892; Alfred Veigel, cashier, Cincinnati department, January 1, 1893, and Chas. J. Enger, inspector, Chicago department, May 5, 1893.

Harry Parrish, Veteran Inspector, Dies

Harry Parrish, associated with the inspection staff of the Philadelphia department since 1892, died November 5, 1933, slightly more than six months after he had retired from active service. Mr. Parrish was born at Chemnitz, Saxony, Germany, in 1866 and served his apprenticeship as a machinist in that country. His service with the Hartford Steam Boiler Inspection & Insurance Company began in 1892. Mr. Parrish was a quiet, unassuming man who was well liked by the many assured whom he served in Philadelphia and vicinity.

Inspection Department Transfers

Changes in chief inspectorships involving four departments of the Company were made during December. Under the new arrangement Chief Inspector J. F. Hunt is stationed in New York City, Chief Inspector J. L. Scott in Cleveland, Chief Inspector P. E. Terroy in New Orleans, and R. P. Guy, formerly assistant chief inspector at New York, becomes chief inspector in Baltimore.



R. P. GUY

Mr. Guy's promotion to the position of chief inspector marks a period of 23 years of successful service with the Company. He entered the Company's employ in 1910 as an inspector in the Hartford department and in 1920 was transferred to New York where he served as directing inspector until 1923 when he was made assistant chief inspector, a post which he held for ten years until the present change. He is a man of seasoned experience in the inspection and engineering of the boilers and power machinery which the Company insures.

Chief Inspector Hunt at New York succeeds J. M. Gorham, assistant to vice president, who

has been temporarily in charge of that department as acting chief inspector. Coming with the Company in 1921 Mr. Hunt was advanced to the position of directing inspector six years later and in 1929 became chief inspector at the Cleveland office. He is a man of much administrative ability and has a thorough technical background. Mr. Hunt was for some years a member of the Ohio Board of Boiler Rules.

Mr. Scott returns to the Cleveland office after about eight months as chief inspector at the New Orleans department. He is thoroughly familiar with the needs of Cleveland department assured, having come to that department in 1923 and having worked in it as an inspector, an adjuster and directing inspector until May of this year when he was promoted to the New Orleans chief inspectorship.

Mr. Terroy, former chief inspector at the Baltimore Department, succeeds Mr. Scott at New Orleans as chief inspector. He is well fitted to handle the problems of industries peculiar to the southern states, as he served some years as directing inspector in the Atlanta department prior to his going to Baltimore in 1928.

Furnace Explosion in Small Installations

By E. R. FISH, Chief Engineer, Boiler Division

TO A GREATER extent than most people realize, there is a hazard connected with the use of many kinds of fuel under all kinds of boilers that involves danger to property and persons in the vicinity of the equipment. This hazard consists of the detonation of an explosive mixture of gas and air in the furnace or gas passages leading to the chimney, and is ordinarily known as a "furnace explosion". These explosions vary through a wide range of severity, from a mere "puff" to a violent detonation that does very extensive damage and not infrequently causes loss of life and serious personal injury.

Because of the variety and combinations of equipment and conditions it is impossible in an article of this scope to do more than to indicate in a general way what causes furnace explosions and what precautions should be taken to prevent them.

During the last two years there have been reported to this Company 285 such explosions which include those that occurred with solid coal, pulverized coal, gas and oil fuel, and of which the Company had about 60 per cent covered with insurance against damage due to such explosions. Of the total number 203 were with oil, 51 with gas, 25 with solid fuel, and 6 with pulverized fuel. Two hundred were in connection with low pressure heating boilers of small or moderate sizes, using oil or gas as the fuel. Unfortunately boilers in heating service usually receive very little attention; and as they are almost invariably equipped with devices for controlling automatically the operation of the boiler, the owner does not deem it necessary to pay any particular attention to the equipment so long as the radiators are hot when they should be and the temperature of the building is kept at the desired point.

All of the oils which are used for fuel purposes will, when exposed to the atmosphere, give off gases and gradually evaporate. When mixed with air in certain proportions these gases form explosive mixtures which require only a spark to ignite. When gas is used as a fuel a comparatively small amount almost inevitably at once forms an explosive mixture, since the gas, of course, readily mixes with air.

It is the purpose of this article to dwell more on small installations than on large power plants, since the latter usually receive ample attention. However, all the disasters involving several thousand dollars of property loss have occurred in large installations.

Even if one's heating boiler is insured against furnace explosion and an explosion does occur, lack of heat always makes intangible losses

such as possible injury to the health of one or more of the members of the family, the inconvenience of having workmen around at uncomfortable times of the year, and the "messiness" of a more or less extended housecleaning. What is paid by the insurance company, of course, reimburses for the tangible material loss and it is, therefore, very desirable to be protected by insurance.

One of the principal advantages of furnace explosion insurance is that the insured gets the benefit of frequent inspections to ascertain the condition of the equipment. These inspections help to keep continuous the proper functioning of the installation, and in addition the inspector can often advise as to what changes are necessary or desirable. However, he has neither the time nor facilities to make needed repairs, changes or adjustments. These must be attended to by a service mechanic. As inspections are of value and importance, every assured should endeavor to see and talk to the inspector on the occasion of his visit. However, probably more frequently than not, the inspector can not find anyone in authority to talk to and the full value of his visit is, therefore, not obtained by the vitally interested party.

Automatic devices of any kind will not continue to function indefinitely without attention. With practically all heating apparatus there is a more or less extended period of idleness during which there takes place a deterioration that is of a different nature from that which occurs during operation. This deterioration during idleness may, and often does, make the apparatus partly defective, or possibly allows it to get into a condition in which it fails to function at all. It is highly important, therefore, that at the end of a period of idleness a heating plant of whatever size be checked by some one familiar with the equipment of the type with which the plant is provided in order that any deficiencies may be promptly repaired. Even this will not always avoid subsequent failures of some kinds, but it does help to minimize them. If arrangements can be made to carry out such servicing at the time of an insurance inspector's visit it is very much to be desired, although it is usually difficult to do this.

The one responsible for the operation of heating apparatus should become familiar with its appearance and with the normal sounds that are always present with oil or gas firing. It is particularly true of oil that there is a characteristic roar when the burner is operating properly. If there is any change in these characteristics it is an indication that something is out of order and needs attention. In such cases a service man should be sent for at once. Not infrequently a slight change in the quality of the oil will necessitate a change in some adjustment. Failure

to make such a change may result in the extinguishing of the flame and an accumulation in the furnace of oil that might ultimately result in a furnace explosion.

If there is ever any evidence of oil in the furnace or a suspicion of free gas, the furnace and gas passages to the chimney should be thoroughly ventilated before any means of ignition are put in operation. This ventilation can be easily done by opening any door which may give access to the firebox or furnace. Usually installations of this kind are provided with motor-driven fans but have doors that can be opened, although they are kept closed during normal operation. When the fan is on, the fuel supply is normally also on, but it is possible to cut off the oil and ventilate with the fan alone. However, this should be attempted only by one thoroughly familiar with the apparatus. It is important also that there be no obstruction anywhere between the furnace and the chimney that will prevent the free flow of gases of combustion. A single boiler using gas or oil as a fuel does not need a damper and if there is one in the flue leading to the chimney it should preferably be entirely removed or if that is not done it should be very securely fastened in the open position.

With some grades of oil the spark plug points or other electrical ignition devices may become so foul that they do not spark properly. Oil may thus be forced into the furnace without becoming ignited at first, but later the device may function and set off an explosive mixture. There are protective devices designed to stop the operation of the burner if such a condition arises, but some oil must inevitably have gone into the furnace and if the reset device is operated by the attendant the same thing may happen again. Thus a little more oil is introduced before the cut-out again operates, and in this way makes a still stronger explosive mixture. Electrical connections sometimes, for unknown reasons, become disconnected so that some one part of the apparatus fails to perform its function properly. When gas pilot lights are used it occasionally happens that they are turned so low that a reduction in the service pressure, which sometimes occurs, will extinguish the light so that oil is introduced into the furnace without being at once ignited.

In the larger heating plants such as are employed in smaller public buildings, churches and apartment houses, there may be two or more boilers, and a damper in the flue to each boiler may be necessary, although with gas and oil fuels this is not ordinarily the case. In such plants, however, it occasionally happens that there is a long and possibly more or less tortuous smoke flue, or breeching, which cuts

down the available draft and tends to set up conditions favorable to a furnace explosion. We have encountered a number of such cases. Improved conditions can be achieved by putting in an induced draft fan that will create a positive suction through the furnace, or by rectifying the flue conditions to eliminate the obstructing conditions, or by putting up a stack near the boiler. However, the two latter plans are usually not as practicable as installing a fan.

The protective devices that have been evolved to guard against furnace explosions are very ingenious and effective, although as stated above they cannot be expected to remain indefinitely in proper operating condition without attention.

We have had several instances where furnace explosions have taken place in connection with boilers insured only against boiler explosion and where the assured was under the impression that his policy covered also the accident in the furnace. The two kinds of explosion are, of course, of an entirely different nature. It has sometimes been difficult to make a non-technical person understand this difference. Furnace explosion must be specifically insured against in addition to any other insurance that is taken out. As a matter of fact it can be afforded only when insurance against boiler explosion, and in the case of cast iron boilers, insurance against cracking, is taken.

Furnace explosion rarely does any harm to the pressure parts of the boiler proper. It may and in general it does break or blow off the doors or blow out the front and damage the brick setting if there is any. Insulating covering on sectional cast iron boilers is frequently badly loosened and otherwise damaged. Smoke pipes or flues are often blown off or at least partially damaged. In many cases doors and windows of the boiler room are blown out. Fortunately personal injuries in these furnace explosions are not frequent because many of them happen when no one is present.

These explosive mixtures of gases cannot be seen any more than atmospheric air and as they are usually confined in the furnace of the boiler they cannot be smelled. If any of them escape into the boiler room the smell will indicate that something is wrong although it cannot be told whether or not they have reached the explosive stage. However, any such indication should be regarded with great suspicion and much care exercised not to produce an open light until the atmosphere has been cleared.

Everyone who has any contact whatsoever with boilers fired by oil or gas should be apprehensive that conditions may arise which will result in a furnace explosion. We, therefore, emphasize the thought—
A—B—C—ALWAYS BE CAREFUL.

Japs From the Old Chief's Hammer

THE Old Chief sat comfortably in the smoking car, puffing away at his pipe and watching the sunset.

He and his assistant, Tom Preble, were on the way to Smithton to look over a new installation at one of the company's risks.

The installation involved several pieces of equipment of new design and the plant management had requested the Chief's advice on an operating difficulty that had cropped up shortly after the new arrangement had been placed in service.

"Tom," the Old Chief said, "I'm glad matters worked out at the office so that you could come along with me on this trip. You'll have an opportunity to acquaint yourself with the details of this new design, and to get besides some first-hand experience in a branch of our work that is valued as highly by our assured as our regular inspections. I believe the extra service we render in the way of advice has done as much as any other thing to win for us the friendship and respect of our assured."

The veteran inspector lit his pipe which had gone out and cleared his throat. Preble knew a story was coming.

"Say, Tom," drawled the Old Chief, "did I ever tell you about the time they had up at the Merriwether News Print Paper Company a few years ago?"

"I don't think so, Chief. They have a hydro plant with an emergency connection to a high line, haven't they?"

"Yes, that's right. It's an installation similar in some respects to the setup at Smithton, and it shows that even the best laid of plans sometimes go astray.

"As you said, they have a hydro plant and a reserve power supply through a connection to a 57,100 volt high line. To step down this voltage for the plant they use a 4,000 kva transformer that gives them the required voltage of 480 on the secondary. But even with this safeguard against plant shutdown in the event of an accident to their own



power producing equipment, they would have been in a pretty bad fix if Inspector Short hadn't been Johnny on the spot.

"That summer it was dry. Rain didn't fall in any quantity for weeks and weeks and there wasn't enough water to keep the plant's turbines in operation. The plant engineers weren't very much worried, though, even with contracts that had to be filled within a fixed time limit. They just tapped the high line for their necessary power and the mill hummed along at capacity production.

"I dare say the plant men chuckled at their wisdom in erecting the high line, which was seven or eight miles long.

"About that time Inspector Short stopped at the plant to look at the electrical equipment. It wasn't long before he discovered that something was wrong. The oil temperature on the big transformer was 110° Centigrade. I don't have to tell you that he was alarmed, to say the least, and he was more alarmed before he was through.

"The cooling water inlet and outlet showed a negligible temperature difference. Load readings indicated that the transformer was being operated within its rated capacity. Something was wrong with the cooling apparatus, that was a certainty.

"Inspector Short talked the matter over with the plant superintendent, who realized fully the seriousness of the situation. With the water so low above the dam there was no further standby if the transformer failed to function. To examine the transformer thoroughly, however, involved shutting down the plant, which was running 24 hours a day, and would be for a week, if the production schedule was to be maintained.

"Both Short and the superintendent knew that there would be serious damage to the transformer if the over-heating wasn't stopped, so they set about finding a means to cool the oil.

"A battery of blower fans was set up and strong currents of cold air were thrown onto the unit. The results were not satisfactory. Additional radiation apparently was the only solution. A water tank was set up and several hundred feet of pipe was assembled and submerged in the water. The extra pipe was filled with transformer oil. Then, by means of a motor driven pump the oil itself was circulated from the transformer through the outside cooling pipe. The system was totally closed and could be used indefinitely. A considerable lowering of the oil temperature was promptly secured."

"Chief, did they ever find out what was the real trouble?" asked Tom Preble.

"Yes, and that's an interesting story in itself.

"Three weeks afterward the plant was able to shut down for a short time and a thorough search was made. The water cooling coils, when examined for scale deposits and obstructions, were found to be perfectly clean on the inside. Insulation tests showed no defects in the windings. Maybe you think Short wasn't mystified then, but he kept working.

"A little later he noticed that the outside of the coils didn't look just right. Further investigation revealed that they were coated with an insulating compound, but where it came from he didn't know. He realized that the compound must have come from within the transformer and finally traced it to some impregnated hard-wood spacer blocks. The compound, it happened, would dissolve in the circulating oil as a certain temperature was reached. When the oil containing the compound came in contact with the cooling coils, which were at a temperature lower than the oil, the compound would precipitate. The substance had gradually accumulated on the coils, and as it was an exceptionally poor heat transfer medium, it had destroyed the efficiency of the transformer cooling system and produced the overheating.

"Look, Tom. Here's Whitneyville and the sun has set. We'll be at Smithton in ten minutes and that's fine because I'm hungry. There's a cook in Smithton who knows as much about broiling meat as Short knows about transformers. What do you say to a nice juicy steak?"

"O. K., Chief. I'm hungry, too," Preble responded.

Steam Vulcanizer Explodes

When an electric hot plate used at a service station to vulcanize inner tubes exploded violently, according to an account in the *Jetmore, Kansas, Republican*, a piece of steel about 2' long and 6" wide was torn loose from the vulcanizer and thrown up through the ceiling, cutting the edge of a 2" x 4" wooden beam and crashing against the roof with enough force to tear a hole in it. The rest of the vulcanizer was forced downward, breaking the cast iron box holding the heating element, wrecking the bench on which it stood and breaking out all of the window glass in the room. No one was near the vulcanizer when the explosion occurred. The explanation given was that corrosion of the safety valve prevented relief of the overpressure that came about as the result of failure of an automatic thermostat to function. The machine itself was a total loss.

The Hartford Steam Boiler Inspection and Insurance Company

OF HARTFORD, CONN.

December 31, 1933

Capital Stock, \$3,000,000.00

ASSETS

Cash on hand and in banks	\$ 910,061.17
Premiums in course of collection (since October 1, 1933)	1,150,436.69
Interest accrued on mortgage loans	49,854.06
Interest accrued on bonds	112,262.21
Loaned on bonds and mortgages	851,381.55
Home Office real estate	437,474.66
Other real estate	298,889.83
Agents' ledger balances	18,365.44
Bonds on an amortized basis	\$8,702,210.61
Stocks at "Convention Values"	5,016,676.50
	<u>13,718,887.11</u>
<i>Total</i>	\$17,547,612.72

LIABILITIES

Premium reserve	\$6,027,478.25
Losses unadjusted	314,677.94
Commissions and brokerage	230,087.34
Other liabilities (taxes incurred, etc.)	502,686.77
Contingency Reserve, representing difference between value carried in assets and actual December 31, 1933, market quotations on all bonds and stocks owned	1,740,000.00
<i>Liabilities Other Than Capital and Surplus</i>	\$9,414,930.30
Capital Stock	\$3,000,000.00
Surplus over all liabilities	5,132,682.42
<i>Surplus to Policyholders</i>	8,132,682.42
<i>Total</i>	\$17,547,612.72

WILLIAM R. C. CORSON, President and Treasurer

BOARD OF DIRECTORS

LUCIUS F. ROBINSON, Attorney, Hartford, Conn.	EDWARD MILLIGAN, President Phoenix Insurance Co., Hartford, Conn.
JOHN O. ENDERS, Chairman Board of Directors, Hartford National Bank & Trust Co., Hartford, Conn.	WM. R. C. CORSON, President The Hartford Steam Boiler Inspection and Insurance Co., Hartford, Conn.
MORGAN B. BRAINARD, President Aetna Life Insurance Co., Hartford, Conn.	SAMUEL M. STONE, President Colt's Patent Fire Arms Mfg. Co., Hartford, Conn.
CHARLES P. COOLEY, Chairman Board of Trustees, Society for Savings, Hartford, Conn.	SAMUEL FERGUSON, President The Hartford Electric Light Co., Hartford, Conn.
HORACE B. CHENEY, Cheney Brothers, Silk Manufacturers, South Manchester, Conn.	HON. JOHN H. TRUMBULL, President The Trumbull Electric Mfg. Co., Plainville, Conn.
D. NEWTON BARNEY, Vice-President The Hartford Electric Light Co., Hartford, Conn.	CURTISS C. GARDINER, Vice-President The Hartford Steam Boiler Inspection and Insurance Company, 90 John Street, New York, N. Y.
JOSEPH R. ENSIGN, President The Ensign-Bickford Co., Simsbury, Conn.	JAMES L. THOMSON, Vice-President Terry Steam Turbine Co., Hartford, Conn.

Incorporated 1866



Charter Perpetual

Department

Representatives

ATLANTA, Ga.,	W. M. FRANCIS, Manager.
Citizens & So. Nat. Bk. Bldg.	C. R. SUMMERS, Chief Inspector.
BALTIMORE, Md.,	D. W. LITTLE, Manager.
704-9 Garrett Building	R. P. GUY, Chief Inspector.
BOSTON, Mass.,	WARD I. CORNELL, Manager.
87 Kilby Street	W. A. BAYLISS, Chief Inspector.
BRIDGEPORT, Conn.,	W. G. LINEBURGH & SON, General Agents.
City Savings Bank Building	A. E. BONNET, Chief Inspector.
CHICAGO, Ill.,	P. M. MURRAY, Manager.
175 West Jackson Boulevard	C. W. ZIMMER, Chief Inspector.
CINCINNATI, Ohio,	JAMES P. KERRIGAN, Manager.
First National Bank Building	W. E. GLENNON, Chief Inspector.
CLEVELAND, Ohio,	A. PAUL GRAHAM, Manager.
Leader Building	JOHN L. SCOTT, Chief Inspector.
DENVER, Colo.,	J. H. CHESNUTT, Manager.
Gas & Electric Building	F. G. PARKER, Chief Inspector.
DETROIT, Mich.,	L. L. COATES, Manager.
First National Bank Building	THOMAS P. HETU, Chief Inspector.
HARTFORD, Conn.,	F. H. KENYON, Manager.
56 Prospect Street	A. E. BONNET, Chief Inspector.
NEW ORLEANS, La.,	R. T. BURWELL, Manager.
333 St. Charles Street	P. E. TERROY, Chief Inspector.
NEW YORK, N. Y.,	C. C. GARDINER, Vice-President.
90 John Street	J. F. HUNT, Chief Inspector.
PHILADELPHIA, Pa.,	A. S. WICKHAM, Manager.
429 Walnut Street	S. B. ADAMS, Chief Inspector.
PITTSBURGH, Pa.,	GEORGE S. REYNOLDS, Manager.
Arrott Building	J. A. SNYDER, Chief Inspector.
ST. LOUIS, Mo.,	CHAS. D. ASHCROFT, Manager.
319 North Fourth Street	EUGENE WEBB, Chief Inspector.
SAN FRANCISCO, Cal.,	C. B. PADDOCK, Manager.
114 Sansome Street	L. E. GRUNDELL, Chief Inspector.
SEATTLE, Wash.,	E. G. WATSON, Manager
Arctic Building	and Chief Inspector.
TORONTO, Ont., Canada,	H. N. ROBERTS, President The Boiler In-
Federal Building	spection and Insurance Company of
	Canada.



It Is a Good Investment

"I want to tell you personally . . . for fifty years I have been insuring power equipment with 'Hartford Steam Boiler'. This is my first accident and my first claim on you for a loss.

"I consider your insurance a valuable investment . . . not merely because you pay losses, but because you help me avoid losses."

The president of a large manufacturing concern had just signed a receipt for payment of a turbine accident loss. He had told what 'Hartford Steam Boiler' protection had meant to him.

Half of the insured power equipment in the country, with all its varied operating conditions, comes under the observation of 'Hartford Steam Boiler' engineers. They also check the design and workmanship of 90 per cent of all new power boilers during the course of construction. The experience gained from such a volume and variety of work, together with constant technical research, has given them a specialized knowledge obtainable from no other source.

This knowledge of power equipment is used day in and day out by 'Hartford Steam Boiler' inspectors. Trained with such a back-

ground, the inspector can tell when the insulation of electrical machinery has begun to deteriorate; he understands when water is apt to work into an engine; and the tap of his hammer warns him when a flywheel is cracked, or when rivets are weakened in the seam of a boiler.

To help guard against boiler and flywheel explosions that would deal destruction and death, and machinery breakdowns that would tie up the plants of its policyholders, 'Hartford Steam Boiler' spends thousands of dollars yearly on its engineering and inspection activities in plants of its clients. Hundreds of the most prominent executives in industry know first hand the value of this. They feel, as does the gentleman mentioned above, that it gives 'Hartford Steam Boiler' insurance the quality of a tested investment.

Vol. XL No. 2

APRIL 1934



A QUARTERLY MAGAZINE
DEVOTED TO POWER PLANT PROTECTION

Published continuously since 1867
by The Hartford Steam Boiler
Inspection and Insurance
Company

Please show to your Engineer

How the Hartford Steam Boiler Straingage is Used in Safeguarding Engines

By H. J. VANDER EB, *Assistant Chief Engineer,
Turbine and Engine Division*

WITH the rapid increase of Diesel engines in the utility and industrial fields there has developed an increased scope of work for the H.S.B. Straingage. This useful instrument was developed by an engineer of the Hartford Steam Boiler Inspection and Insurance Company about 12 years ago to measure the elastic distor-

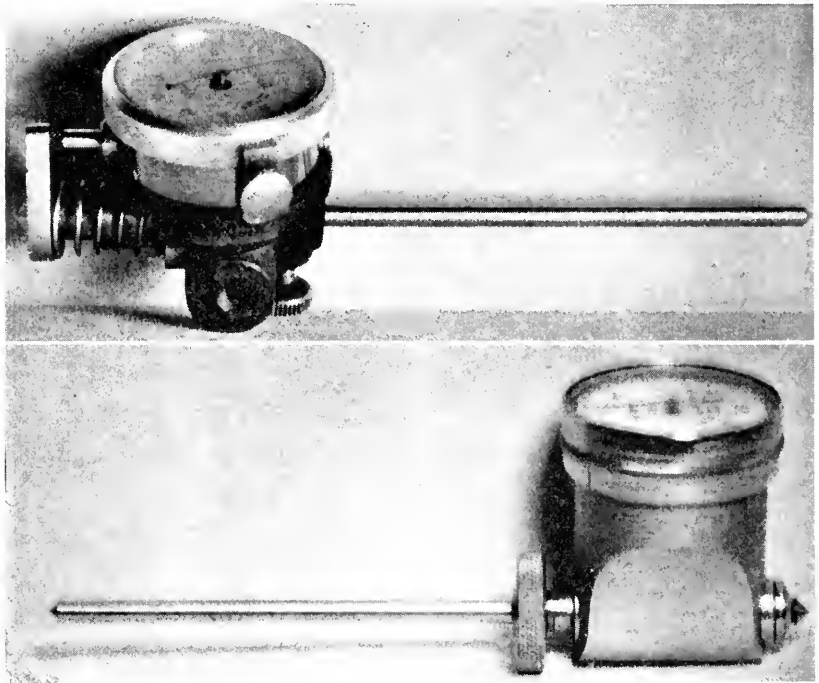

FIGURE 1—The H.S.B. Straingage, above as originally designed and below in the present modified form.

tion which occurs in center-crankshafts during each revolution.

Since that time the company's inspectors have come to rely on this instrument, not only for checking the distortion mentioned above, but also for other strain measurements of engine parts. Until this year the Straingage was made only on order for the "Hartford Steam Boiler" inspectors, but early in 1934 it was introduced in a prominent instru-

ment maker's line. Figure 1 (lower photograph) illustrates the present form of the Straingage and Figure 1 (upper photograph) the original instrument.

A brief discussion of the principles on which the H.S.B. Straingage has been developed will give a better idea of its purpose. The distance between the cheeks or webs of a center-crankshaft is not a constant value for different positions of the crank, particularly if the shaft bearings are not in perfect alignment, or if there is a heavy overhung flywheel or a heavy belt tension on a pulley that is supported on the end

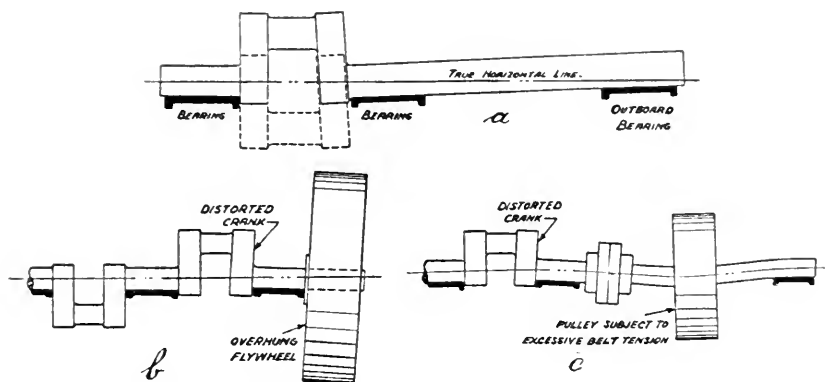

FIGURE 2—Crank distortions (exaggerated for purposes of illustration).

of the crankshaft. These three main causes of crank distortion are illustrated in Figures 2-a, 2-b and 2-c. These distortions may set up excessive stresses in the material.

It may not be amiss here to point out the difference between "strain" and "stress". These terms are sometimes misapplied or substituted for one another although they have quite different meanings. Strain is the result of a straining action on a body by an external force, such as a tension force. The resulting deformation, expressed in units of length, caused by the straining action is termed a strain. Stress (or fibre stress), usually expressed in pounds per square inch of section, is the force of cohesion between the molecules of the material which resists deformation. Within the limit of elasticity of steel, strain and fibre stress arise and vanish simultaneously and the fibre stress is directly proportional to the strain. This property of elastic metals is known as Hooke's law.

Therefore, by measuring the strain, or elastic deformation which a

center-crank undergoes during one complete revolution of the engine, we have, from the phenomenon explained above, an index to the amount of fibre stress to which the material of the crank webs is subject, so long as the fibre stress is below the elastic limit of the material.

The method of measuring the distortion of a crank with the Strain-gage is illustrated in Figure 3. When the Strain-gage is placed in position, with a sufficient amount of compression on the spring, the

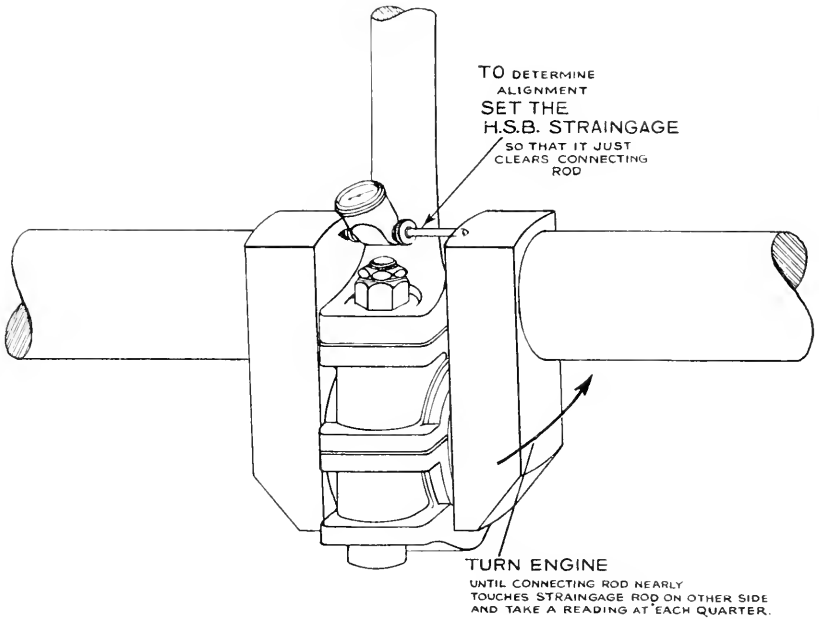

FIGURE 3.

pointed rods bear against the inside faces of the crank webs with enough pressure to sustain the weight of the gage. The crank is then turned slowly to four different positions without removing the gage and a reading on the dial is taken for each of these four crank positions, namely, in the bottom position, the back position, the top position and the front position. It should be observed that in one of the four positions the crank must be set slightly off center so that the Strain-gage will just clear the connecting rod as shown in Figure 3.

The maximum bending of the crank webs, as cantilever beams, is then the greatest difference found between any two of the four readings taken. From this the fibre stress in the crank webs can be

calculated by means of a simple formula which is based on Hooke's law.

This formula is as follows:

$$\text{Apparent fibre stress, lb per sq in.} = \frac{43.500 \times a \times t}{L^2}$$

in which: a =maximum difference between Straingage readings in two positions, expressed in mils.

t =thickness of crank web, in inches.

L =length of crank or $\frac{1}{2}$ engine stroke, in inches.

In the use of this formula it is assumed that the entire distortion takes place in one of the two crank webs, which is, of course, the worst condition that can exist. Actually the distortion of the crank as indicated by the Straingage may be divided between the two crank webs, so that the formula is intentionally on the safe side.

When the crank distortion is measured by this method, it is usual to find some distortion in any crank under the most favorable conditions of bearing alignment. The distortion may be only a fraction of a mil, or so small that it is just barely perceptible on the gage, or it may be as much as 20 mils. Just what the permissible limit of distortion in any given case should

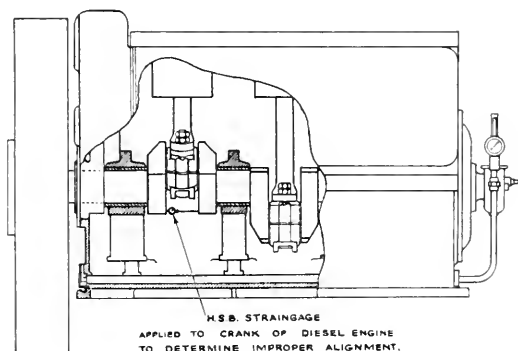

FIGURE 4.

be depends on the size of the shaft, the speed at which it rotates, the stiffness of the crank and the observed rate of wear of the bearings. For average conditions the assumed permissible limit of 5 mils (.005") may serve as a general guide but, in view of the several factors that influence the distortion, this is necessarily only a crude approximation. The formula, as quoted in the foregoing, is a more nearly exact criterion for determining the permissible safe limit of crank distortion. In order that the maximum useful life of the crankshaft may be obtained, it is desirable, when excessive stress is found, to make a correction promptly of the condition causing it.

When the apparent fibre stress in the crank webs exceeds 20,000 lb per sq in. by this method of investigation, the shaft should be taken out of service immediately, for it is reasonable to expect that dangerous progressive cracks will have already developed in the crank webs or in the fillets of the crank pin, or in the fillets of the journals.

By the regular periodic application of the Straingage to any center-crankshaft it is possible to prolong the useful life of the shaft very

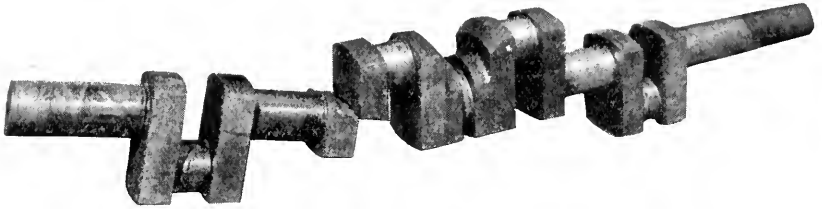
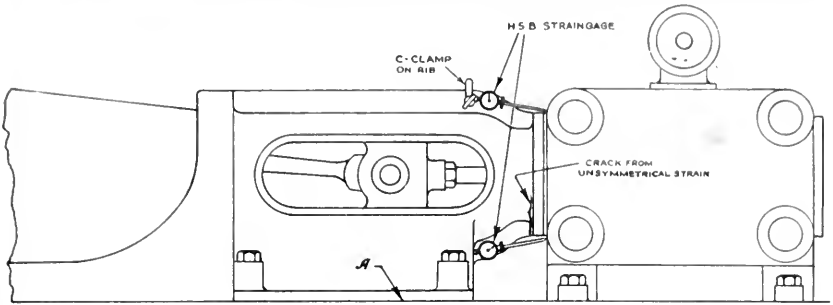

FIGURE 5—*The result of serious over-stresses in a crankshaft caused by bearing wear.*

considerably. Figure 4 shows how the gage is used between the webs of a Diesel crankshaft. The broken shaft shown in Figure 5 shows the baneful result of serious crank distortion caused by worn bearings.

Another useful application of the gage is the measuring of unsymmetrical strains caused by misalignment in the frame neck of horizontal engines. For this purpose the gage is applied as shown in Figure 6. While the engine is operating under a load, comparison of the readings taken in the upper position with the readings taken in the lower position gives a very definite idea as to whether the frame neck is subject to over stresses which would eventually lead to cracks. If, for example, a top reading is 2 mils and the bottom reading is 4 mils, it is evident that the frame neck is being bent at every revolution of the engine and that an undue amount of stress occurs at the bottom of the frame neck.

In determining where possible over stresses occur, the H.S.B. Straingage can, of course, be applied at locations other than the ones shown. It is, frequently, very enlightening to obtain a reading at different points of the movement of the frame up and down on the foundation. It is also desirable to ascertain the exact amount (in mils) of the endwise movement of the cylinder. This can be done by setting the Straingage between the cylinder head and some heavy object placed on the foundation or on the floor.



H. S. B. STRAINGAGE

APPLIED TO ENGINE FRAME (WHILE OPERATING)
DIFFERENCE BETWEEN TOP AND BOTTOM READINGS OF
THE STRAINGAGE INDICATES IMPROPER ALIGNMENT, CAUSING CRACKS.

FIGURE 6.

The misalignment that causes the overstress which results in cracking the frame neck, is generally due to softening of the grouting by lubricating oil at "A", Figure 6. In any installation where lubricating oil is allowed to run down the sides of the engine frame and to soak into the foundation, it is certain that serious misalignment will eventually result because concrete and brick become quite soft and compressible when saturated with oil. After some years of operation under these conditions it becomes noticeable that oil is pressed out from under the frame at point "A" when the crosshead moves over that end of the guide barrel, and the oil is drawn in again as the crosshead moves to the crank end. When this occurs it is clear that the engine frame is not being properly supported at point "A" because the grouting has become soft and compressed. The consequence is that the downward force of the crosshead, acting on the guide barrel, is transferred through the frame neck to the nearest support under the cylinder which produces a bending action in the frame neck that is almost certain to result in a cracked casting. An example of the results of unsymmetrical strain in the frame neck is shown in Figure 7.

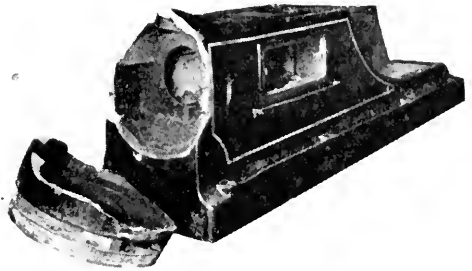

FIGURE 7—Result of crack in engine frame neck caused by unsymmetrical strain.

The vertical movement of the frame at the point where the grouting has become compressed has given some operators the erroneous impression that the nut of the nearest foundation bolt had worked loose. Tightening of the foundation bolt nut under such circumstances, while the engine was running, put such a severe bending stress in the frame neck in a few cases that it was only a matter of minutes before a long crack had formed. The tightening of foundation bolts of engines should never be undertaken without first carefully analyzing the real cause of the looseness of the bolts. The looseness as pointed out in the foregoing, may be the result of the softening of the grouting. If so, a re-aligning of the castings on the foundation and regrouting is necessary before the foundation bolts can be properly tightened.

As with any instrument of the sort, the skillful use of the H.S.B. Straingage and the interpretation of its readings are matters of experience. Not only does an inspector's expert understanding of Straingage readings help to prevent accidents by locating hazardous conditions, but the useful life of the engine may actually be increased by eliminating a condition of distortion before it has reduced the metal to a condition of fatigue with subsequent cracking. Straingage readings on any engine parts, where overstresses are likely to occur, are a regular feature of engine inspections by "Hartford Steam Boiler" inspectors.

Hotel in Darkness When Boiler Tube Fails

The rupture of one of the tubes in a water tube boiler used in a New York hotel caused a shutdown of the building's electrical generating apparatus on January 20, 1934, at 6:00 P.M. and threw the entire hotel into darkness. Damage to the boiler was confined to the tube which ruptured and to several of the cast iron headers.

The New York newspapers made much of the confusion and inconvenience which resulted in the hotel proper as the result of the lights being shut off. There were men in barber chairs with soap on their faces and women in the beauty parlors, some of them imprisoned in hair waving devices. Diners in the restaurants and lunch room were inconvenienced until candles were provided. Considerable walking was done, as the building's elevators were out of commission. Police were stationed on each floor of the hotel to protect the rooms. The generating plant was running again an hour and twenty minutes after the accident.

The hotel was equipped with a reserve boiler, but escaping steam prevented firing it promptly, according to the hotel manager.

Hertford Boiler Explosion Takes Six Lives

SIX men were killed, nine were injured and property damage in excess of \$44,000 resulted when a 150 hp horizontal tubular boiler exploded on January 13, 1934, at Hertford, North Carolina. The boiler was one of a battery of three used in a cotton seed oil mill, which was seriously damaged by the blast.

The property loss was covered by a "Hartford Steam Boiler" policy and a draft in payment of the claim of \$44,732.73 for this loss was given by the Company twenty days after the explosion occurred.

The mill and attached powerhouse were of brick. The power plant consisted of three 150 hp horizontal tubular boilers and a Corliss engine. In the mill building was apparatus used to drive machinery and handle the cotton seed, lint and oil. The power house was back of the mill building. Other buildings were grouped nearby.

At about 7:25 A. M. on the day of the explosion, the night boiler crew was just going off duty and the day crew was coming on. Some of the men were changing their clothes at lockers behind the boilers and others were near the front of the boilers. Six of these men, an engineer and five negroes, were killed by flying debris or by the scalding steam or hot water. The nine negroes who were injured were at various places in the mill and yard and were struck by debris, which literally rained over the entire area.

The boiler which exploded, a vessel 72" in diameter and 18' in length, was the center one in a battery of three, all the boilers being suspended from the same 20" I-beam girders. Operating pressure was about 125 lb and the safety valves were set to blow at 140 lb, which they were observed to do during the week of the accident.

The explosion was caused by a rupture at the bottom of the rear course of the boiler, the line of failure extending from the girth seam to the head seam in a comparatively straight line, passing through the opening for the blowoff pipe connection, and then across the skirt of the rear head flange and up into the rear head for a distance of about 8".

From the appearance of the sheet along the line of failure it was concluded that there had been two bulges and that the tear started at the apex of one of them. At two places along the line of failure the plate was reduced from its original thickness of $17/32$ " to $4/32$ ", and at other places the plate thickness varied from $14/32$ " to $4/32$ " because of stretching due to heat and pressure. Along the bottom of the rear course the metal showed evidence of overheating for a dis-

tance of from 4" to 8" on each side of the line of failure. The violence of the separation was sufficient to shear the 7 8" rivets in the girth seam. Rivets in the rear head seam sheared around three-quarters of the circumference with the exception of a short distance where the line of failure passed through the ligaments between the tube holes in the outer row. The tubes were pulled from the holes in the rear head.



Wreckage at Hertford, North Carolina. A one-story boiler room formerly stood at the right just beyond the tracks at about the spot where the steel smokestack is lying. Near the left center of the mill building is No. 1 boiler beneath which is the engine. On the roof of the mill building at the extreme left is the rear course of the No. 2 boiler which exploded. The breeching is in the foreground.

The reaction of the great amount of escaping steam and water against the bottom of the combustion chamber and against the steel-encased furnace wall, projected the rear end of boiler No. 2 upwardly as the shearing of the girth seam was taking place. The steam drum and the 20" I-beams to which all of the boilers were connected were forced upward, lifting boilers Nos. 1 and 3 from their settings. Boiler No. 1 was thrown through the engine room wall, striking and breaking the 16' flywheel and other parts of the running engine. This boiler

was turned end for end and came to rest 35 feet from its original setting.

Boiler No. 3 was under pressure, and when it was raised from its setting by the suspension girders and steam drum, the blow-off pipe, feed pipe, and possibly also the safety valve connections, were broken, releasing more energy to do damage. After the connections to the steam drum failed, this boiler was projected in a direction nearly opposite to that taken by No. 1 and fell upon the ground in the mill yard, about 45 feet from the boiler house. In its flight it knocked down the side wall of the setting, the side wall of the boiler room and the 100' steel stack.

The front head, front course and tubes of Boiler No. 2 came to rest about 100 feet from the setting. Manhole reinforcement rivets and brace rivets were sheared off or considerably distorted as the boiler hit the roof structure or the steel rails of a railroad track along which it skidded to its final resting place.

The rear course with the rear head attached unrolled and flattened out. It must have traveled in a nearly vertical direction as it soared over the roof of the power house. This part of the exploded boiler, weighing approximately 5 tons, came to rest upon the top of the east wall of the main building 46' above the ground and 100' from its setting. One end of the sheet extended over the wall and the other end pierced the mill building roof and rested on the upper end of the cottonseed elevator.

The steam drum and steam pipe with the throttle valve attached passed over the engine room and landed on a railroad switch track, damaging a cottonseed conveyor in its flight.

The one story brick powerhouse was demolished. Practically one-half of the two story 36' x 120' mill building was knocked down and there was considerable damage to the expensive mill machinery.

Men in the linter room on the second floor of the mill miraculously escaped with nothing more serious than cuts and bruises. The floor on which they were working was raised several feet and then crashed down onto machinery below. One man was buried in the debris but he was able to crawl out. Flying bricks and structural steel did considerable damage to surrounding buildings. An idea of the extent and character of the damage is portrayed in the accompanying photographs.

The chain of circumstances which led to the explosion probably never will be known, but there are certain facts which investigators feel had a bearing on the accident.

Hertford is in the extreme northeast section of North Carolina

about 40 miles west of Kitty Hawk and a little more than 20 miles south of the Virginia line. To the north of Hertford is the Dismal Swamp out of which runs the Perquimans River, along which the plant's wharfs were located. Water for the boilers was obtained from a well which connected with the river by a 24" diameter inlet. Last fall a storm of unusual severity raged along the Atlantic seaboard and as a result a new channel was cut by the waves from the ocean through to Albemarle Sound, into which the Perquimans River empties. At Elizabeth City, Hertford, and other towns along or near the sound there were complaints of increased brackishness of the water. The

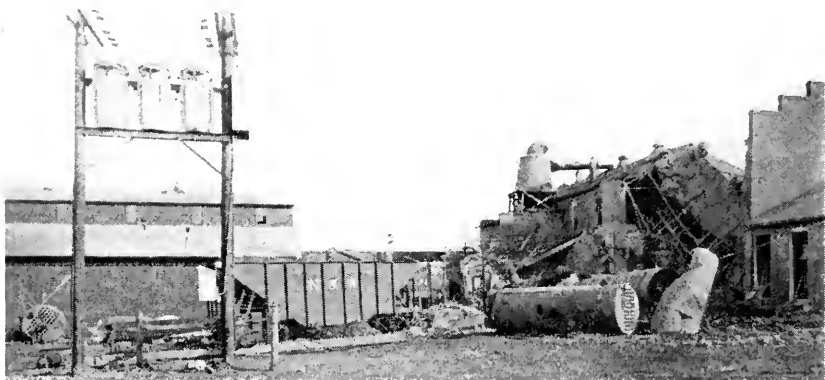

Another view of the mill at Hertford. In the foreground is No. 3 boiler and part of the stack. The front course of No. 2 boiler is shown at the extreme left where it fell after the explosion.

ivers which formerly had been fresh contained sea water. Feed water treatment changes became necessary and at some locations a revised cleaning procedure was called for by an increase in the amount of sediment.

It was reasoned from this that changes in the currents in Albemarle Sound and the Perquimans River which probably followed the storm of last fall, had caused a shifting of the fine sand and bog material deposited on the bottom of the river and had resulted in more of this insoluble material being conveyed to the boiler intake. A collection of it at the bottom of the boiler would lead to the conditions immediately preceding the explosion.

The accident had as its direct cause the weakening of the plate due to overheating. Overheating of a boiler comes about through two chief causes—low water or the presence of scale, sediment or oil within

the boiler and between the shell and the water. In this case the overheating was attributed to the unexpected rapid accumulation of scale and sediment, which it is believed was occasioned by a change in the feed water as a result of the storm. There was no evidence of low water. The fusible plug in the rear head of the boiler was in good condition. As a matter of fact the violence of the explosion, revealing the presence of a vast store of energy, showed that an ample supply of water was carried.

Scale in the boiler was about $1/16''$ in thickness on an average and was as thick as $1/8''$ in places. Loosened scale, in conjunction with a binder of black sediment, consisting of sand, iron and vegetable matter formed a coating as thick as $1/2''$ in places and was probably thicker than this on the plate which ruptured. The appearance of the ruptured plate after the accident indicated that loosened sediment had accumulated in two distinct mounds about 3 feet apart on the rear course, these mounds being connected by deposits of lesser thickness.

The accident was a good example of how quickly a boiler may become unsafe if conditions are such as to prevent the free, rapid transfer of heat through the plate and into the water from whatever cause. It also emphasizes the enormous amount of energy which may be released when failure occurs, and brings out the fact that the safety of a boiler may depend at times upon conditions, such as contamination of the feed water, which are not directly under the control of the operators.

Help, Fire, Murder, Police . . . !

A field inspector for "Hartford Steam Boiler" recently wrote to his chief inspector as follows:

"While making an inspection in a garage the other day I commented to a fireman on the fact that he was a new man. He said he was. I then asked him some questions about the boiler, and when I asked him at what pressure the safety valve blew, he said 15 lb and laughed. I asked what was funny about that, and then he told me he didn't know a thing about boilers when he started to work there three weeks ago.

"He said that on his first day he was firing up when there was a great roar, a cloud of hissing steam filled the small fire room, and when he stopped running, he was in the office trying to tell one of the operators of the garage about it. The garage operator said he would go and see what the trouble was, and went part way down the stairs. He then ran up, shouted that the boiler had blown up, and sent in a fire alarm. Two fire engines answered the call. The firemen put on gas masks and entered the boiler room. When they came up the garage operator asked if it had done much damage. The only answer he got from the fire lieutenant in the form of advice was to 'call the police homicide squad the next time.'

"An engineer from a plant nearby explained that the 'explosion' was only the safety valve going off."

Decrease in Steam Pipe Friction Solves a Power Plant Problem

By E. MASON PARRY, *Engineering Department*

ALTHOUGH the primary aim of the company's engineering and inspection department is to check insured equipment from the standpoint of safety to keep down the Company's losses, it is not uncommon for these departments to enable assured to make monetary savings greater than the cost of their power plant insurance. A recent case illustrates how plant difficulties, apparently insurmountable, can sometimes be solved by a little study of the engineering principles involved.

The steam generating equipment of a wood-working establishment consisted of two lap-seam horizontal tubular boilers, 60" in diameter and 16' in length, furnishing steam to a Corliss engine. These boilers were approved for a pressure of 85 lb per sq. in. and had spring-loaded safety valves adjusted to operate at that pressure. A pressure limit of 85 lb had been established by the application of a factor of safety of 5.5, this being the factor required by a state law or regulation for boilers of that age and type of construction.

In the state where the boilers were being used, as in all states having boiler laws or regulations, the allowable pressure for boilers of lap-seam construction must be reduced every five years, the extent of the reduction being determined by increasing the safety factor .5, and as these boilers had arrived at an age where a factor of safety of 6 was required, it became necessary to reduce the allowable pressure to 78 lb. When our assured was advised of this reduction in pressure, the safety valves were reset so that they opened freely at a limit of 78 lb, which proved unsatisfactory because the engine would not carry the load at the reduced pressure.

The assured called in our inspector and asked what could be done. It would have been an easy matter for us to have recommended that the management procure new boilers, supporting our recommendation by saying that the pressure then allowed was the maximum in accordance with the boiler laws of his state. Before making any such recommendation, however, the inspector decided to see if there were not some way to save the plant this expense without sacrificing safety. Satisfying himself by test that the steam gages were correct, he noted that they were so located that they registered the actual steam pressure in the boilers. His next step was to investigate the steam piping between the boilers and the engine. This piping was practically devoid of insulating

material and because of the presence of many 90° elbows, it was evident to the inspector that an appreciable drop in steam pressure was taking place between the boilers and the throttle of the engine.

The general layout as he found it, was as shown in the cross-hatched portion of the accompanying sketch. The length of the piping between the boiler outlets and the engine consisted of 7 ft of 5" piping and 60 ft of 4" piping, making a total of 67 ft. In this length of pipe were 4 elbows and 2 tee fittings. Figuring that the resistance to the flow of steam due to the presence of 6 right angle turns would be about equivalent to the frictional resistance set up by the addition of 96 ft of 4" diameter piping, he concluded that in its passage from the boilers to engine the steam actually met with frictional resistance equal to that which would be set up by 163 ft of 4" diameter pipe.

To determine the pressure at the commencement of the engine stroke, an indicator card was obtained. The inspector had anticipated a noticeable drop in pressure but he had not expected to find that with 82 lb pressure on the boiler gages, the pressure in the engine cylinder would be only 67 lb. At the inspector's suggestion, the assured obtained the long-turn bend shown in the sketch and had it installed over a week-end. Furthermore, the piping in its entirety was adequately clothed with insulating material.

On the following Monday morning the safety valves were set to release at 78 lb and when the engine was again indicated the card showed an initial pressure varying between 70 and 72 lb. Greatly to the satisfaction of every one, the engine was found capable of carrying the load quite comfortably.

With the exception of a 4" long-turn bend and the insulating material, the piping and fittings in position at the time of the investigation were utilized in a changed position. The indicator had brought to light evidence of a slight leakage of the engine admission valves, so

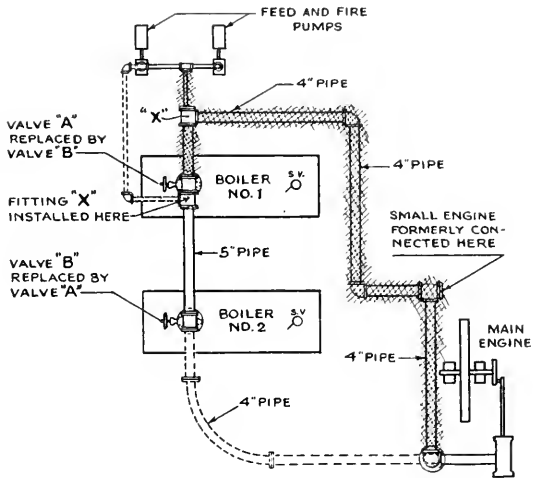

the assured was advised to have the cylinder ports rebored and new valves installed. This advice was followed and resulted in an appreciable saving of fuel.

Five years from the date when the pressure was reduced to 78 lb a further reduction in pressure will be necessary. At that time the pressure will be limited to 72 lb. We have reason to believe that even at that reduced pressure the boilers will be able satisfactorily to operate the plant for a further limited period of time.

In many plants there are conditions which, unrecognized by the operators, may lead to waste and continuous extra expense. "Hartford Steam Boiler's" inspectors are alert to be of assistance to assured in improving operating efficiency wherever they encounter such cases as the one here described.

Small Boiler Explodes in Church

A WOMAN was kneeling at the altar rail in St. Matthew's Church, East Syracuse, New York, about three o'clock Sunday afternoon, January 14, 1934. She and another woman and her baby were the only persons in the building, which a few hours previously had sheltered the morning congregation. Their participation in the quiet restfulness of the church at that hour was broken by a terrific explosion. Windows and doors were blown out, floors were shaken, parts of the altar rail and marble pillars were cracked, figures in a Christmas crib were broken and disarranged. The basement was a mass of debris and walls were weakened. The two women were stunned, but not otherwise injured. Property damage was estimated at between \$25,000 and \$30,000.

The cause of the catastrophe was the explosion of a small cast iron boiler of round vertical design, to which only four radiators were connected, the church proper being heated by a larger unit. A new fire had been started in the small boiler about two hours prior to the explosion.

An investigation by the division of inspection of the New York state department of labor revealed that the connection to the water glass, the bottom try-cock and condenser under the steam gage were partially or entirely choked with scale, and that the safety valve was rusted to its seat, opening only after a pressure of 75 lb was applied.

The St. Matthew's boiler was not insured.

Hartford Magniscope Granted Letters Patent

THE Hartford Magniscope, a magnifying periscope with a camera attachment used to photograph the walls of rivet holes in caustic embrittlement investigations, has been patented for the Hartford Steam Boiler Inspection and Insurance Company by Jared P. Morrison, assistant chief engineer of the boiler division. The patent was granted February 20, 1934, seven claims being allowed.

The patent papers describe the Magniscope as "an instrument for inspecting and recording the condition of walls of openings in metal

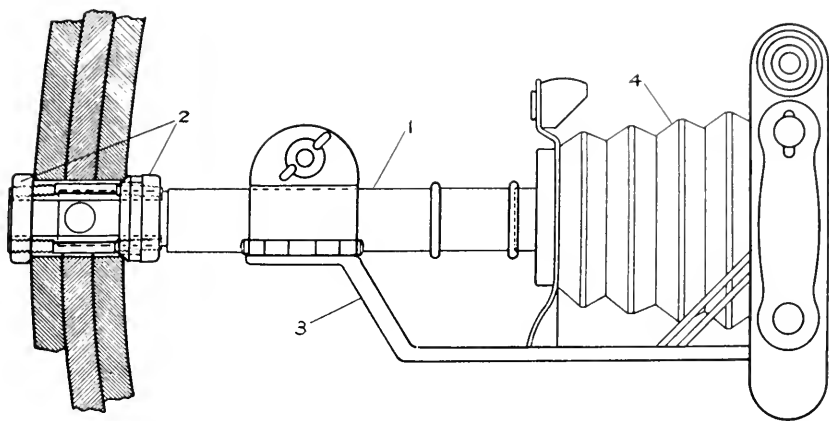

The Hartford Magniscope on which patents were granted. The circular opening at the left is aimed at the wall of a rivet hole.

plates." It comprises a "rigid tubular casing (See illustration, 1) containing magnifying lenses and a reflector for directing light rays upon the lenses, said reflector (prism) adapted to be inserted into and moved longitudinally and rotatorily in the opening to be inspected; means (2) adjacent to the reflector for firmly clamping said casing to the walls about the opening . . . and means (3) for the attachment of photographing apparatus (4) in front of the lenses."

The claims have to do with an "adjustable eye lens at one end and an object lens at the other" connected as explained above to the rest of the apparatus. The lenses are "adjustable with relation to each other" and with relation to the reflector, and the light rays are directed from one side to the lenses by means of the reflecting prism. An opening receives and directs the light rays. The patent also admits the claim for use of the microscope, reflectors, etc., in conjunction with

the photographing apparatus detachably mounted in front of the eye lens.

Use of the Magniscope is general among "Hartford Steam Boiler" inspectors. Its development has been the result of more than 20 years of painstaking research into the subject of caustic embrittlement, particularly as it affects the safety of large pressure vessels. This work was pioneered in the field by "Hartford Steam Boiler" inspectors directed by Mr. Morrison. The magniscope has been available for general industrial use since patents were first applied for. The government's allowance of patent claims definitely recognizes the contribution to industry made possible through the development of this instrument for discovering and recording embrittlement defects in metal plates.

Caustic embrittlement, the prevention and control of which led to the perfection of the Magniscope, is an insidious boiler disease which manifests itself in pressure vessels by the presence of microscopic cracks in the plate adjacent to rivet holes. Because these cracks are hidden within a seam of the boiler, it is practically impossible to discover them in their early stages without some means of magnification applied to the wall of the rivet hole. Thus, a trained observer working with the Magniscope, designed specifically for examining the walls of rivet holes, may locate the presence of caustic embrittlement in time to permit remedial measures. Caustic embrittlement defects in their advanced stages weaken the seam to the point of failure, and threaten the safety of all property and persons in the vicinity of the boiler.

The theory which is most widely accepted as to the cause of caustic embrittlement is that there occurs in the boiler a combination of stress and chemical attack, the former inherent in the operation of the vessel and the latter the result of sodium hydroxide in the boiler water. These conditions bring about a breaking down of the cement between the crystals of steel and cause a gradually developing network of minute cracks. Prevention has to do with feedwater treatment, but once the disease has been started, reconstruction or at least repair of the affected seam is necessary to save the boiler. The Magniscope has proved of most value to industry in making possible the discovery of microscopic cracks in slightly affected plate and in giving the signal that immediate remedial measures are necessary to save the boiler.

A city chap out on a hunting trip was crossing a large pasture. "Say there," he shouted to the farmer in an adjoining field, "is that bull safe?"

"Well," said the farmer, "I reckon he's a lot safer than you are just now."

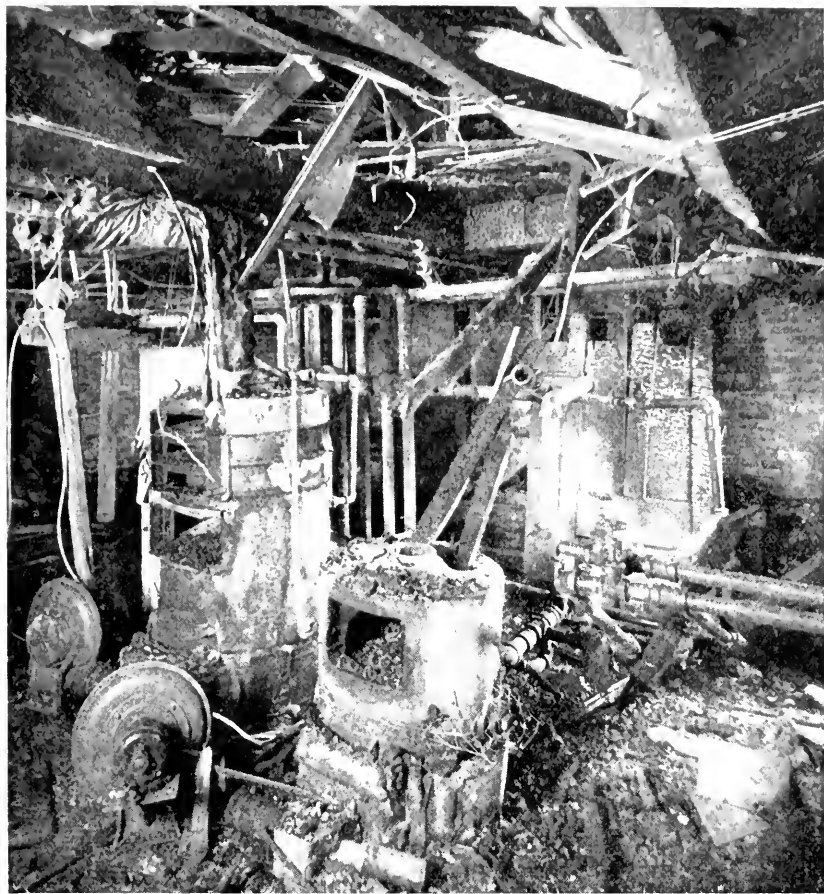
RESULT OF HEATING PLANT VIOLENCE

WHILE all available evidence indicated that an accident to cast iron sectional boilers used in an Ontario residence was due to the explosion of furnace gases, the investigators found it difficult to understand why the top section of the right-hand boiler was so badly shattered. The boilers were used in connection with a hot water heating system. The top section of the

smaller boiler went through two floors, hit the ceiling in the upper room and came to rest across the foot of the bed in which the housekeeper was sleeping. The opinion was expressed that internal steam pressure must have developed to some extent at least in a manner which available evidence did not make clear. No boiler insurance was carried.



A QUARTERLY MAGAZINE
DEVOTED TO POWER PLANT PROTECTION

George H. Prall, *Editor*

Copyright 1934 by The Hartford Steam Boiler Inspection and Insurance Company

HARTFORD, CONN., April, 1934

Single copies may be obtained free by calling at any of the Company's agencies.

Subscription price 50 cents per year when mailed from this office.

Recent bound volumes one dollar each. Earlier ones two dollars.

Reprinting matter from this paper is permitted if credited to

THE LOCOMOTIVE OF THE HARTFORD STEAM BOILER INSPECTION AND INSURANCE CO.

Ward I. Cornell

Ward Ireland Cornell, manager of the Boston department branch office of the Hartford Steam Boiler Inspection and Insurance Company, died of pneumonia early on the morning of February 7, 1934, after a brief illness.

Mr. Cornell had been in charge of the Boston department since July 1, 1919. He entered the Company's employ on December 1, 1907, as a special agent in the New York office, and except for a brief period during which he left to engage in business for himself, he served as special agent at New York and at Boston until he was appointed assistant manager of the latter office on July 1, 1916. He was born November 1, 1881, in South Orange, New Jersey.

Mr. Cornell was a man whose rigid integrity won and held the respect of all with whom he dealt.



WARD I. CORNELL



JOHN F. BUTLER

John F. Butler

John Franklin Butler, who had served the Hartford Steam Boiler Inspection and Insurance Company as assistant manager at the Chicago department since August 1, 1929, died on February 22, 1934, at Wheaton, Illinois, after a prolonged illness. Mr. Butler's long and competent service with the company began on April 3, 1899, when he became a special agent in the Chicago department. Prior to that time he had been a law and court stenographer. Mr. Butler was born in Harrisburg, Pennsylvania, September 3, 1877.

New Directors Elected

Philip B. Gale of Hartford, Connecticut, chairman of the board of directors of the Standard Screw Company, and John J. Graham, vice president of the Hartford Steam Boiler Inspection and Insurance Company, were elected as new members of the company's board of directors on February 13, 1934.

Mr. Gale is well known nationally in manufacturing circles and is



JOHN J. GRAHAM



PHILIP B. GALE

prominent in the business and financial activity in his home city. The firm of which he is the active head has as subsidiaries: The Hartford Machine Screw Company, Hartford, Connecticut; Chicago Screw Company, Chicago, Illinois; Detroit Screw Works, Detroit, Michigan, and Western Automatic Machine Screw Company, Elyria, Ohio.

Mr. Graham joined the Company in 1906 in the engineering branch of the business. He was later transferred to the business production end, and after several years as manager of the Pittsburgh department was called to the home office, in 1917, to become superintendent of agencies. In 1922 he was elected assistant secretary, and in 1927 he was made vice president in charge of all agency matters.

New Managers at Boston and Cleveland

Changes in executive personnel at the Boston and Cleveland department offices effective March 1, 1934, were announced by the Hartford Steam Boiler Inspection and Insurance Company, following the death on February 7, 1934, of Ward I. Cornell, manager of the Boston department.



A. PAUL GRAHAM



ARTHUR F. GRAHAM

A. Paul Graham, for the past 12 years manager of the Cleveland department, became the new manager at Boston, and Thomas F. Rice, for 15 years a special agent in the Boston department, became assistant manager. Mr. Graham's work in the Cleveland department has been outstanding and this promotion to a post of greater responsibility in a broader field is amply justified by his long and conspicuous previous service.

Mr. Rice's broad experience with the Company's coverages and his successful handling of responsible work during many years in the Boston department well fit him for his additional duties.

At Cleveland, Arthur F. Graham, for the past 9 years a special agent, has been promoted to the position of manager of that depart-



THOMAS F. RICE

ment. The new Cleveland manager came with the Company in 1912 as an inspector in the Cleveland department. His 22 years of service in engineering and underwriting affairs of the Company have afforded a groundwork of experience that qualifies him for the responsible post to which he has been called.

New Chief Inspector at Seattle



WILLIAM J. SMITH

William J. Smith, an inspector with "Hartford Steam Boiler" in Oregon and Washington since November 1, 1909, was appointed chief inspector for the Seattle department on March 1, 1934. The appointment permits a broadening of the scope of the Seattle department where E. G. Watson has been both manager and chief inspector. Mr. Smith had been acting as assistant to Mr. Watson on inspection matters. His thorough familiarity with the engineering problems on the Pacific Coast and the ability he has demonstrated as an inspector fit him well for

the responsibilities incident to his promotion.

Chief Inspectors Hold Discussion Sessions

In the interest of still better service to "Hartford Steam Boiler" assured the Company's chief inspectors from the sixteen department offices met in convention at Hartford from January 29 to February 3, 1934. They were joined in their discussion by the men in charge of engineering and inspection work for the Boiler Inspection and Insurance Company of Canada. The convention was under the direction of Dale F. Reese, vice president in charge of engineering.

Among the subjects discussed were: Developments in boilers and pressure vessels, turbines and internal combustion engines; cast iron

boiler problems, fusion welding with special field surveys of modern welding practice, inspection of electrical equipment, turbine construction and hazards and a variety of kindred subjects with respect to modern boiler and machinery practice.

By means of such meetings and in many other ways the Company maintains what amounts to a continuous training course for its field inspectors. The convention permitted rapid exchange of experience with respect to current inspection problems, and the findings of the meeting were transmitted quickly to the inspectors. Thus a nation-wide field force is kept constantly advised of anything which will contribute to greater safety in boiler or machinery operation.

While "Hartford Steam Boiler" inspectors are so stationed as to give prompt service even to the most remote plants, the field men are never out of close touch with their chief inspectors or with the Company's engineering department at Hartford.

A Curious Case of Blockage in a Small Steam Pipe

Our English contemporary, *Vulcan*, recently described a remarkable case of blockage of a small steam pipe. The pipe was of one-inch inside diameter and was used for supplying steam to a jacking-over engine. This auxiliary piping was connected to the underside of the starting valve of the main engine and normally there was no difficulty in obtaining an ample supply of steam for operating the smaller engine. Recently, however, the jacking-over engine failed to function when the valves were opened and investigation indicated that steam was not passing a certain bend in the range. When this bend was removed and cut in two it was revealed that a portion of a brass pin had found its way into the pipe and practically closed the thoroughfare. The pin had broken away from the starting valve of the main engine, one piece dropping into the auxiliary supply pipe to the small engine and eventually moving along to the bend. Before becoming wedged in the bend the pin had to pass through two other bends and a considerable length of straight pipe. As the pin head was practically the same diameter as the bore of the pipe, it is somewhat remarkable that it entered the pipe at all.

Meat Packer Has Consequential Loss

A Baltimore packing plant's store of 545,000 lb of meat was damaged to the extent of more than \$12,000 when, on January 24, 1934, the rupture of a brine pipe put the refrigerating system out of commission by flooding the ammonia with brine. Besides the damage to the meat, the plant sustained a considerable loss of ammonia. The damage to the meat was caused by a rise of not more than 15° in the temperature in the various storage rooms during the 36 hours that the refrigerating machinery was inoperative. The packer carried consequential damage insurance.

Short Circuit Leads to Generator Damage

THE generator end of a 5,000 kw turbine, operating at 3600 rpm, broke down on June 2, 1933, in the municipal power plant of Austin, Texas, and caused damage in excess of \$6,500. The burn-out was attributed either to a phase-to-phase short circuiting with subsequent damage caused by a balancing plug in the field becoming loose and protruding far enough to gouge out the coils of the armature, or else to the entrance of some foreign metal into the generator winding.

A small steel object resembling a part of a $\frac{1}{2}$ " bolt was found close to the radial end ring.

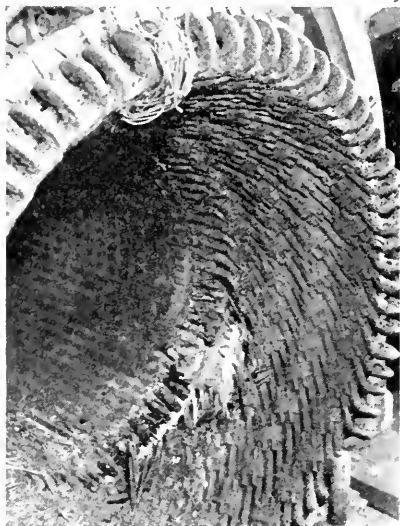

After Generator Burnout.

The unit was warmed up at a standstill from 7:30 A.M. to 8:00 A.M. on the morning of the accident. It was then brought up to speed and synchronized with two others that were already on the line. At approximately 8:10 A. M. the generator which failed was loaded to a capacity of approximately 3,300 kw. At 8:38 A.M. operators heard a noise similar to the popping of a relief valve and saw a large volume of smoke coming out of the generator at the end nearest the turbine.

After the fire had been extinguished it was found that the coils in 44 of the 72 slots were entirely or partly melted, as shown in the accompanying photograph, and the field was grounded. The cause of the ground was attributed to molten copper finding its way inside the radial end ring and burning the insulation. Repairs included rewinding of both rotor and stator and the replacement of some of the iron.

On arriving recently at St. Louis for a visit, a resident of Cincinnati suddenly recalled that she had left the gas burner going under the hot water supply coil in her apartment. Alarmed at the possible direful consequences, she immediately called the Cincinnati fire headquarters by long distance telephone, to request that firemen break into the apartment and turn off the burner. They found the tank in what they considered a dangerous condition, and turned off the gas.

Taps From the Old Chief's Hammer

THE Old Chief and Tom Preble, his assistant, sat smoking in the office at 10 P.M. To hear the Chief calmly talking about this and that an outsider would have noticed nothing unusual. But Preble was excited.



Two hundred miles away an inspector's automobile was tearing through the night to an isolated mill where there had been some kind of an accident to a boiler. The Chief was "on deck" because the company carried use and occupancy coverage at the mill, which was operating at top speed as the business was seasonal. The Company's policy carried an endorsement for payment of \$1,000 a day for each day of total shutdown, but the mill didn't want the \$1,000 a day nearly as badly as it wanted a quick repair. So the Chief and Preble were "standing by" to help in any way they could to rush men or parts to the scene without loss of time.

"Jenkins should be there by now," the Chief said.

Another 10 minutes passed. The Chief picked up a newspaper and began to read. Preble paced the floor.

After another 5 minutes the phone rang. Leisurely the Chief answered.

"Hello . . . yes, . . . talking . . . not so fast Jenkins, I don't get you . . . hot coals all over the floor . . . yes . . . lots of smoke . . . what about the boiler? . . . you think it's all right . . . can't find a thing wrong, eh. That's luck. Nice work, young man. You stay there until things are running smoothly again . . . How's Mrs. Jenkins and the youngster? . . . fine . . . all right, just send me a report tomorrow night . . . Good night, Jenkins."

The Chief leaned back in his chair. "Tom," he drawled, "we're in luck. Just a furnace explosion of a sort to scatter fire and ashes, but not to do any other damage. The luck's our way this time.

The Chief sat staring at the telephone, a twinkle in his eye. Preble knew a story was on the way, late as it was, but the Chief's stories were worth staying up to.

"Big Joshua didn't get off so easily," the Chief mused, apparently talking to the telephone.

"Do you mean Inspector Renner?" Preble asked.

"Yes, Big Joshua Renner . . . working his fingers off over at Castleburg in the middle of the night just because he is as conscientious as he is big.

"It was a case something like this one tonight . . . use and occupancy risk . . . busy plant.

"Renner had found on a previous inspection that the furnace wall lining had fallen down and had called the operating engineer's attention to the trouble. The plant had gone on operating and on this particular night they had decided to pull the fire and fix the lining. Just to be sure that the repair was right they called Renner to look at it. After he got to the plant, he crawled into the combustion chamber to look at the repair to the lining, which was found to be O. K. Then deciding that the middle of the night would be as good a time as any to make an external inspection of the boiler, he proceeded to examine the outside of the shell and the blowoff pipe and connections.

"Almost immediately he noticed that the blowoff pipe was badly corroded. In fact it was so thin that Joshua knew immediate repairs were necessary. A new blowoff pipe and elbow would have to be installed before the plant could start up again.

"Joshua went to the soot door and hollered to the night watchman who was to fire up the boiler and by that time was the only man at the plant.

"Renner knew that waiting until morning to make the repair would hold up production at least half a day, so he informed the watchman the pipe ought to be fixed that night.

"'Tonight!' the watchman told him. 'There's nobody here but me . . . no help and for that matter no blowoff pipe.'

"'Then let's get some pipe', said Joshua, 'and I'll help you put it in.'

"You know," the Old Chief said by way of explanation, "we don't do this kind of work ordinarily, but Joshua didn't like the thought of an idle plant the next day.

"After about an hour of searching he located some pipe, an elbow and fittings that he believed would do the trick. Then he telephoned the superintendent, told him what was wrong and received his permission to start the work. While the boiler was draining, Joshua went to the plant's machine shop, prepared the pipe for fitting and then he and the watchman set to work on the boiler itself.

"The outside connection was quickly broken and removed, but when

he tried the 30" length of vertical pipe that was threaded into the boiler flange, he was stuck. The biggest Stilson wrench he could find was too light for the job and an old pair of chain tongs, with badly worn teeth, refused to hold.

"Things like that don't stump old Joshua, though. He took the chain tongs to the machine shop, removed the bolts holding the jaws and ground the jaws so they would grip the pipe.

"While the watchman handled the tongs, Joshua hammered the pipe almost in two. It finally moved about a millionth of an inch or that's how Joshua described it. Anyway they kept on and about 2:30 A.M. had the old pipe out.

"The new pipe was installed and all outside connections made. Then Joshua helped fill the boiler and the watchman started the fire. By 6 A.M. steam was up and the boiler was ready for operation.

"Joshua cleaned up, went to breakfast and then caught the 7 o'clock train out of town.

"About 9:30 the plant superintendent called me from Castleburg and told me about Joshua's work. He was mightily pleased. Joshua came to the office when he reached town. I asked him how things were at Castleburg; he said, 'All right, Chief, we didn't have any trouble.'

"Then I lit into him, told him he was too modest for anybody's good, and asked him why the superintendent should be so tickled.

"A puzzled look came over Joshua's face. He said, 'Why, how do you know?' After I told him about the telephone call he gave me the whole story as if it was a good joke. That's Joshua all over . . .

"Golly, boy, its past 11 P.M. You and I had better be getting home. There's no broken blowoff pipes around here."

Damage Caused by Improper Use of Boiler Scaling Tools

The damage which can be done to the tubes of water tube boilers by the misuse of scaling tools was emphasized in a recent article in an English publication, *Vulcan*. In one case such damage to a 4" tube eventually resulted in a bulge made by the tool on about half of its circumference and the tube had to be removed and replaced. In another case a 3¼" tube of a vertical water tube boiler was damaged by a scaling tool of the "rattler" head type. It was evident that the "rattler" head had been allowed to batter for too long a time while in one position. The tube was completely punctured in several places. Scale of a thickness to cause overheating of the tube under normal working conditions should be removed with extreme care in order to avoid injury to the tube.

Police Magistrate: "Officer, what's the charge against this man?"

Officer: "I ketched this here mut pinchin' bananas off a fruit stand."

Police Magistrate: "Impersonating an officer, eh? Two years."

The Hartford Steam Boiler Inspection and Insurance Company

OF HARTFORD, CONN.

December 31, 1933

Capital Stock, \$3,000,000.00

ASSETS

Cash on hand and in banks	\$ 910,051.17
Premiums in course of collection (since October 1, 1933)	1,150,436.69
Interest accrued on mortgage loans	49,854.06
Interest accrued on bonds	112,262.21
Loaned on bonds and mortgages	851,381.55
Home Office real estate	437,474.66
Other real estate	298,889.83
Agents' ledger balances	18,365.44
Bonds on an amortized basis	\$8,702,210.61
Stocks at "Convention Values"	5,016,676.50
	13,718,887.11
<i>Total</i>	\$17,547,612.72

LIABILITIES

Premium reserve	\$6,627,478.25
Losses unadjusted	314,677.94
Commissions and brokerage	230,087.34
Other liabilities (taxes incurred, etc.)	502,686.77
Contingency Reserve, representing difference between value carried in assets and actual December 31, 1933. market quotations on all bonds and stocks owned	1,740,000.00
<i>Liabilities Other Than Capital and Surplus</i>	\$9,414,930.30
Capital Stock	\$3,000,000.00
Surplus over all liabilities	5,132,682.42
<i>Surplus to Policyholders</i>	8,132,682.42
<i>Total</i>	\$17,547,612.72

WILLIAM R. C. CORSON, President and Treasurer

BOARD OF DIRECTORS

LUCIUS F. ROBINSON, Attorney, Hartford, Conn.
 JOHN O. ENDERS, Chairman Board of Directors, Hartford National Bank & Trust Co., Hartford, Conn.
 MORGAN B. BRAINARD, President Aetna Life Insurance Co., Hartford, Conn.
 CHARLES P. COOLEY, Chairman Board of Trustees, Society for Savings, Hartford, Conn.
 HORACE B. CHENEY, Cheney Brothers, Silk Manufacturers, South Manchester, Conn.
 D. NEWTON BARNEY, Vice-President The Hartford Electric Light Co., Hartford, Conn.
 JOSEPH R. ENSIGN, President The Ensign-Bickford Co., Simsbury, Conn.
 EDWARD MILLIGAN, President Phoenix Insurance Co., Hartford, Conn.
 WM. R. C. CORSON, President The Hartford Steam Boiler Inspection and Insurance Co., Hartford, Conn.

SAMUEL M. STONE, President Colt's Patent Fire Arms Mfg. Co., Hartford, Conn.
 SAMUEL FERGUSON, President The Hartford Electric Light Co., Hartford, Conn.
 HON. JOHN H. TRUMBULL, President The Trumbull Electric Mfg. Co., Plainville, Conn.
 CURTISS C. GARDINER, Vice-President, The Hartford Steam Boiler Inspection and Insurance Company, 90 John Street, New York, N. Y.
 JAMES L. THOMSON, Vice-President Terry Steam Turbine Co., Hartford, Conn.
 PHILIP B. GALE, Chairman Board of Directors, Standard Screw Co., Hartford, Conn.
 JOHN J. GRAHAM, Vice-President The Hartford Steam Boiler Inspection and Insurance Co., Hartford, Conn.

Incorporated 1866



Charter Perpetual

Department

Representatives

ATLANTA, Ga.,	W. M. FRANCIS, Manager.
Citizens & So. Nat. Bk. Bldg.	C. R. SUMMERS, Chief Inspector.
BALTIMORE, Md.,	D. W. LITTLE, Manager.
704-9 Garrett Building	R. P. GUY, Chief Inspector.
BOSTON, Mass.,	A. PAUL GRAHAM, Manager.
87 Kilby Street	W. A. BAYLISS, Chief Inspector.
BRIDGEPORT, Conn.,	W. G. LINEBURGH & SON, General Agents.
City Savings Bank Building	A. E. BONNET, Chief Inspector.
CHICAGO, Ill.,	P. M. MURRAY, Manager.
175 West Jackson Boulevard	C. W. ZIMMER, Chief Inspector.
CINCINNATI, Ohio,	JAMES P. KERRIGAN, Manager.
First National Bank Building	W. E. GLENNON, Chief Inspector.
CLEVELAND, Ohio,	ARTHUR F. GRAHAM, Manager.
Leader Building	JOHN L. SCOTT, Chief Inspector.
DENVER, Colo.,	J. H. CHESNUTT, Manager.
Gas & Electric Building	F. G. PARKER, Chief Inspector.
DETROIT, Mich.,	L. L. COATES, Manager.
National Bank Building	THOMAS P. HETU, Chief Inspector.
HARTFORD, Conn.,	F. H. KENYON, Manager.
56 Prospect Street	A. E. BONNET, Chief Inspector.
NEW ORLEANS, La.,	R. T. BURWELL, Manager.
333 St. Charles Street	P. E. TERROY, Chief Inspector.
NEW YORK, N. Y.,	C. C. GARDINER, Vice-President
90 John Street	J. F. HUNT, Chief Inspector.
PHILADELPHIA, Pa.,	A. S. WICKHAM, Manager.
429 Walnut Street	S. B. ADAMS, Chief Inspector.
PITTSBURGH, Pa.,	GEORGE S. REYNOLDS, Manager.
Arrott Building	J. A. SNYDER, Chief Inspector.
ST. LOUIS, Mo.,	CHAS. D. ASHCROFT, Manager.
319 North Fourth Street	EUGENE WEBB, Chief Inspector.
SAN FRANCISCO, Cal.,	C. B. PADDOCK, Manager.
114 Sansome Street	L. E. GRUNDELL, Chief Inspector.
SEATTLE, Wash.,	E. G. WATSON, Manager.
Arctic Building	WILLIAM J. SMITH, Chief Inspector.
TORONTO, Ont., Canada,	H. N. ROBERTS, President The Boiler In-
Federal Building	spection and Insurance Company of
	Canada.

Big Gun

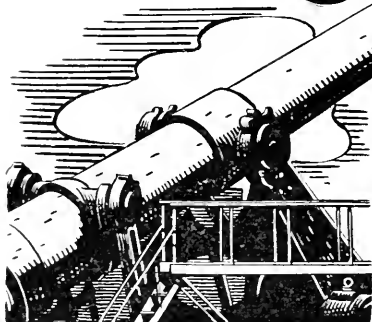

CARNEGIE LIBRARY
MAY 7 - 1934
OF PITTSBURGH

For all its wetness, water can explode like gunpowder. It has been calculated that a cubic foot of water, when heated to produce steam under 60 to 70 pounds pressure, contains about the same amount of energy as a pound of powder. Much of that energy can be transformed, in a twinkling, into a destructive force capable of spreading ruin in all directions.

● Consider that modern boilers contain tons of water; that an operating pressure of 200 pounds per square inch is common and 600 or even 1400 pounds is attained in some instances; that it is not so much the energy in the steam, as that contained in the water, that does damage in an explosion. Then you can see that many a factory is built around a big gun, and many a man and woman spends eight or more hours a day beside and over such a piece of industrial armament. The peril is great, because this gun cannot be aimed. When accident, or carelessness, or some unexpected defect suddenly releases the energy of this high-explosive water, the gun itself explodes, and death and destruction is wrought, near as well as far.

● You may have seen photographs of such a disaster. Few men have lived through one. Every plant owner and manager fears such an occurrence and wishes to avoid it if possible. So do we, and therefore we make it a practice to inspect frequently everything we insure. Through 68 years of constant experience we have learned where to look for danger signs, and how to find them often when they are invisible to the naked eye.

● Today some of the country's greatest companies insist on Hartford Steam Boiler policies; not because they cannot afford to carry their own insurance, but because they feel there is less likelihood of accident to the turbines, motors, boilers, and other power equipment which we inspect.

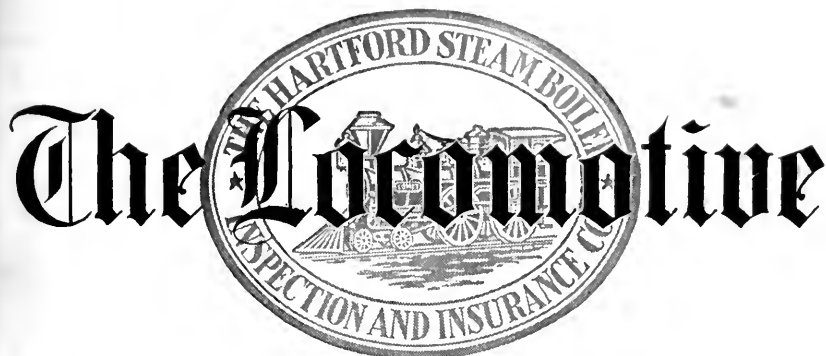

A QUARTERLY MAGAZINE
DEVOTED TO POWER PLANT PROTECTION

Published continuously since 1867
by The Hartford Steam Boiler
Inspection and Insurance
Company

Please show to your Engineer

Combustible Vapor Explosions in Air Receivers

By WILLIAM D. HALSEY, *Assistant Chief Engineer, Boiler Division*

So many conflicting theories have been advanced in an effort to assign a cause to the combustion explosions that occur in compressed air systems operating in the range of pressures upward of 80 pounds that no acceptable explanation has yet crystallized. The subject is still in the debatable stage, and in preparing this article the author does not assume to settle the question. However, he presents a line of reasoning which at some points is based on theory but which agrees closely with facts observed during investigations of exploded tanks. It is in accord, too, with the experience of many operators of air compressors that leaky discharge valves cause an abnormal rise in the temperature of the discharge air, and that vapor from the lubricating oil is the combustible and explosive substance to be contended with.—Editor's Note.

THE bursting of an air tank or of an air pipe system is, of course, due to the development of a pressure greater than the tank or pipe can withstand. This may result from a system becoming weakened through deterioration or because of the development of pressure beyond that which the system was intended to carry. Such overpressure may build up gradually because of inoperative safety devices, or it may come about with extreme rapidity by reason of a combustion explosion within the system.

That such combustion explosions may and do occur has been shown on many occasions by clouds of smoke and flashes of fire at the time of the explosion; and the ruptured parts of vessels have frequently shown evidence of having been at a high temperature. The danger of a combustion explosion in compressed air systems is considered one of the greatest hazards in their operation, and these accidents have occurred with such frequency that considerable study has been given to their cause and to their prevention.

In any investigation of this subject these questions always arise: What is it that explodes when a combustion explosion occurs in a compressed air system; and what is there to ignite any combustible mixture that may be present? Neither question has ever been answered beyond argument; but it has been demonstrated by experience that failure to observe certain precautions has been followed by explosions, so it may be assumed that these known factors are responsible for accidents of this kind. For instance, if too much oil or an improper oil is used, if the intake air carries much dust or dirt, or if there is a failure of the cylinder cooling system, or if insufficient care is given the valve mechanism of the compressor, there is danger of explosions.

There seems to be no doubt whatsoever that the oil used for lubrication must form the basis for an explosive gas or vapor. However,

the rate at which oil is ordinarily fed even with excessive lubrication would seem (when considered with the great amount of air passing through the cylinder) to be such as to form so weak a mixture of oily vapor and air that it would not ignite. This point will be considered again further along in the article. For the present we may assume that



Following the ignition of lubricating oil vapor.

an explosive mixture can exist and confine our attention to finding out, if possible, how ignition takes place.

Compression of air is attended with a rise in temperature which primarily is dependent on the "ratio of compression", that is, the ratio of the final pressure to the initial pressure. It makes no difference what the initial and final pressures are. The important point is the ratio between the two. Thus if air is compressed in the simplest manner possible, or by what engineers call adiabatic compression, from atmospheric pressure or 15 pounds gauge to 90 pounds gauge, the ratio of compression is six and the rise of temperature will amount to 354 degrees. However, if the initial pressure had been 100 pounds it would have

been possible to compress the air to 600 pounds before undergoing a temperature rise of 354 degrees.

It has been pointed out on occasion that, as the flash and fire points of some lubricating oils are as low as 500 degrees, these oils may become ignited by the temperature ordinarily obtained by compression. However, this theory does not hold up when it is considered that the "flash point" of an oil is the lowest temperature at which, under definite specified conditions, the oil vaporizes rapidly enough to form above its surface an air-vapor mixture which gives a flash or mild explosion when ignited by a small flame; and the "fire point" is the lowest temperature at which, under definite specified conditions, the oil vaporizes rapidly enough to form above its surface an air-vapor mixture which burns continuously for at least five seconds when ignited by a small flame. It is important to note the words when ignited by a small flame. Oils do not flash nor take fire spontaneously in the atmosphere by merely raising them to their flash or fire point temperatures. They must be ignited by a flame. The ignition temperature of an oil or gas is a figure quite different from the flash or fire point. It varies for different oils or gases but in general it is in the vicinity of 1,000° Fahrenheit at atmospheric pressure. This is very considerably higher than the temperature that could theoretically be obtained, at ordinary compression ratios, even by the poorest type of compression.

Viewed from the considerations given above it would appear to be impossible to obtain a temperature high enough to ignite such oil vapor mixtures as may be present in a compressed air system. Yet explosions do occur, so, obviously, ignition must take place.

It has been suggested at times that ignition may be brought about by a discharge of static electricity in the system. It is well known, of course, that if a jet of gas or vapor strikes an insulated object, that insulated object may become charged with static electricity and eventually discharge to some other object at a different potential. However, in a compressed air system there is metallic contact throughout and it is difficult to see how any one part of the system could attain a static potential sufficiently high to cause a static discharge. The theory of static discharge does not, therefore, seem tenable.

In considering the nature of a combustion explosion it must be borne in mind that it is merely the burning of a combustible mixture at such a rapid rate that the heat which develops cannot be carried away by the surrounding atmosphere or parts of the vessel in which the gas is contained, and that a sudden high pressure is thereby produced. To cause such an explosion the ratio of combustible and air must fall

within a certain rather narrow and definite range. If the ratio is such that a mixture exists either leaner or richer than those within this narrow range, then a comparatively slow burning will take place, or possibly none at all.

As a matter of fact it has been noted on many occasions that fires do occur in compressed air systems. This has been evidenced at times

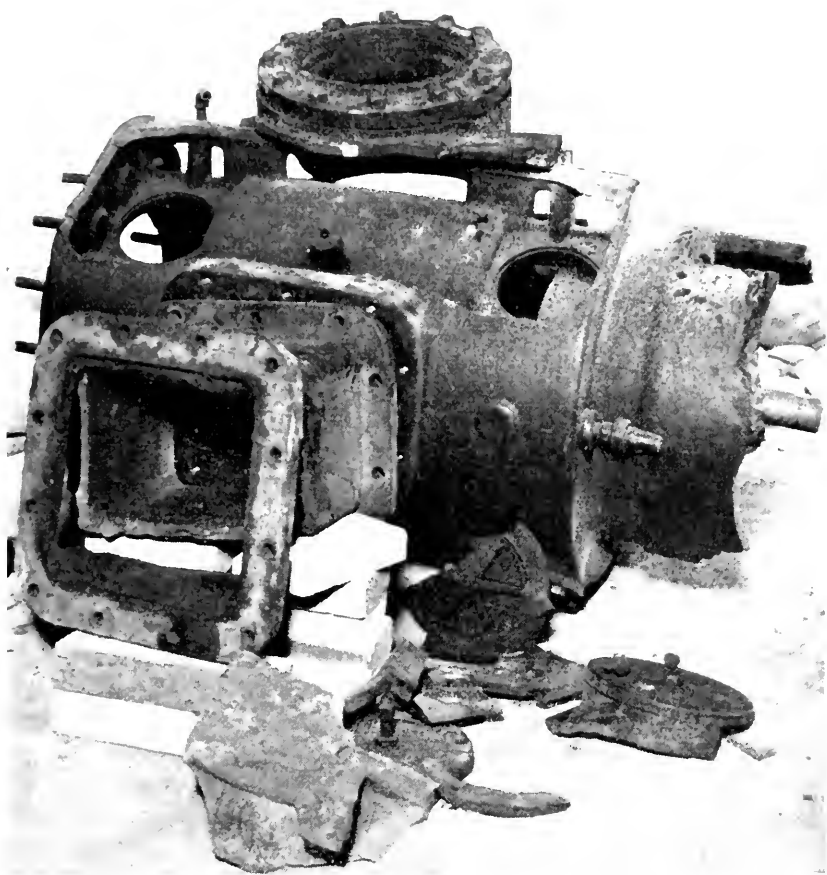

High pressure cylinder of an air compressor demolished by explosion of a mixture of oil vapor and air.

by the discharge line from the compressor becoming red hot. Not infrequently compressed air receivers are found with the paint on them blistered, and at times there has been a discharge of flame from the safety valves. Furthermore, it has often been noted by operators of air compressors that the discharge line becomes excessively hot and

when such evidence of high temperature appears, the remedy has been to overhaul the compressor—particularly the valve mechanism. The discharge valves have been found in poor condition, permitting leakage of air back into the compressor cylinder, and when such valves have been placed in proper operating condition the trouble from overheating has ceased.

A few years ago there was carried out, at the University of California, a test to determine the effect of a leaky discharge valve. Temperatures were taken of air at the two discharge ends of a compressor cylinder. In one end there was a leaky discharge valve, made so by drilling a hole in it; in the other the valves were in good condition. Compression was carried to 90 pounds gauge. The temperature of the discharge air in the end of the cylinder with good valves reached a value of approximately 235° whereas in the end with a leaky valve the temperature rose to 330° F. in slightly over 20 minutes.

Let us consider this condition of a compressor with leaky discharge valves. When a compression stroke has been finished, air at some temperature higher than the atmosphere has been discharged into the discharge line. On the suction stroke of the compressor the greater part of the air taken in will come through the suction valve, but with a leaky discharge valve some of the higher temperature air will slip back into the cylinder. As a result the next cylinder-full of air will start its compression at a higher temperature than the preceding one. Since this cylinder charge of air starts at a higher temperature it must necessarily finish at a higher temperature than before, and this repeated action will result in a cumulative increase of temperature until a point is reached where radiation from the cylinder and the surrounding pipes just balances the amount of heat put in.

It has been claimed that when the heated air in the discharge pipe leaks back into the cylinder it expands and, therefore, cools. In this connection, however, it is well to note that as the air which expands into the cylinder may not do any work it is possible that the drop in temperature is not as great as it otherwise might be.

Whatever may be the real explanation the fact remains that the temperature of the discharge air will increase abnormally if the discharge valves do not close tightly.

In the University of California experiment an investigation was also made of the effect of throttling the intake air. Theoretically it would seem that this throttling should increase the ratio of compression and thereby increase the discharge temperature. This was found to be the case actually.

It appears then that the temperature of the discharge air may, under certain conditions, rise to somewhat abnormal figures although it is difficult to see how it could reach $1,000^{\circ}$ F., which has been indicated as the ignition temperature of a number of gases. We must, therefore, look for another explanation.

The ignition temperature in the vicinity of $1,000^{\circ}$ has been given as that which pertains to gases when they exist at atmospheric pressure. It is known, however, that a mixture of gasoline and air, when compressed in an engine cylinder, will give difficulty with knocking and pre-ignition if the compression pressure is raised much above 80 pounds per square inch. However, the temperature of compression at 80 pounds could hardly be much greater than 370° . On the other hand it is only fair to assume that under compression (with the molecules of gas and oxygen crowded more closely together) the temperature required for ignition may be decreased.

An investigation along this line was conducted in 1924 by two Germans, Messrs. Tausz and Schulte. Their work has been reported in a publication of the National Advisory Committee for Aeronautics, Technical Memorandum No. 299. We find from their experiments quite definite indications that the ignition temperature is decreased by increase of pressure. For instance, a mixture of gasoline and air which under a pressure of 2 atmospheres ignited at 707° F. required a temperature of only 464° F. when under a pressure of 8 atmospheres. This series of experiments covered a number of different oils and it is interesting and also important to note that certain oils which have a comparatively low ignition temperature at atmospheric pressure may have a comparatively high ignition temperature when under a higher pressure. With other oils or gases the reverse is the case.

Messrs. Dixon and Higgins (*London Gas Journal*, Oct. 20, 1926) report a test indicating that a mixture of methane and air under a very slight pressure might show an ignition temperature of approximately 780° whereas if carried to 7 atmospheres pressure it would have the ignition temperature depressed to 633° .

While a number of experiments have been conducted by various investigators the results do not appear to be in complete agreement. However, it is very evident that increase in pressure may decrease the ignition temperature of vapor from some lubricating oils to the point where the abnormally high temperature caused by a leaky discharge valve would cause spontaneous ignition.

There is still another point to be considered in searching for an explanation of air receiver explosions, and that is: How may

sufficiently rich mixtures accumulate to provide for a violent combustion explosion?

When a compressor is new and in good working order there is, of course, very little dirt in the system. With the passing of time some dirt is drawn in and there is likely to be in this dirt a considerable accumulation of insect life and vegetable matter. This foreign material is covered with oil in its passing through the compressor cylinder and adheres to the inside of the discharge pipe. Under the action of heated, high-pressure air such deposits may decompose and provide combustible gases. With further passage of time dirt begins to accumulate under the discharge valves and they become leaky. This brings about an increased temperature of the discharge air and this in turn favors more rapid decomposition of the oil-saturated animal and vegetable matter on the sides of the discharge pipe. Possibly this decomposition may result in the evolution of highly explosive gases. At first the mixture may be so lean as to simply burn but with the greater temperature thus developed a progressive action may take place with more rapid decomposition and breaking up of the oily discharge into still greater accumulations of explosive gases. These gases would be carried along by the air stream ahead of the flame into the receiver and accumulate there in what would be a highly explosive mixture. An explosion might conceivably occur when the flame reached this mixture.

This may or may not be the actual case. It is given merely as an imaginative picture of what may take place. But whether it is so or not it is well known that leaky discharge valves cause an increase in the temperature of the discharge air, that accumulation of an oily deposit of animal and vegetable matter will generate gases when subjected to air at a high temperature, and that the ignition temperature of such gases will in all probability be greatly depressed by the pressure under which they exist. Thus it appears quite probable that under some circumstances an explosive mixture may result and may be ignited through the combination of rising temperature of the air from the compressor and a decreasing ignition temperature of the gaseous mixture. Because of the fact that no exact figures can be given it would appear that what may cause an explosion in one case might not do so in another. It seems likely, too, that it would be difficult to duplicate results from time to time.

The flash and fire points of any given oil should not be considered as the sole criterion of the suitability of that oil for air compressor lubrication. It is entirely possible that an oil with high fire or flash point might give difficulty because of a tendency to disintegrate under the

influence of highly heated air. Other oils with possibly lower flash and fire points may be more stable under the application of heat and pressure and thus not break up to form explosive gases. On this basis it is important to use an oil that has been found satisfactory for air compressor lubrication, and only an oil that is recommended by authorities on lubrication.

The supply of oil should be kept at the minimum possible to obtain satisfactory lubrication and the supply of intake air should be guarded to see that it is as clean as possible. With the use of excessive amounts of oil and dirty air the time is hastened when accumulations in the discharge line and under the discharge valves will increase to a dangerous point. Periodic examinations should be made of the discharge valves, to see that they are clean, free from deposits, and seating properly. Attention should always be paid to the supply of cooling water to see that it is of proper quality and fed in sufficient amounts to give adequate cooling.

Proper attention to these points cannot fail to reduce the frequency of combustion explosions in compressed air systems. Experience has proven this.

Blow-Off Tanks

By E. R. FISH, Chief Engineer, Boiler Division

IN order to prevent damage to the sewers, the laws of many cities prohibit the blowing of boilers directly into them. Where such laws are in force the boiler user must blow-down either through a pipe open to the atmosphere, or else into a blow-off tank. However, the use of the tank is advisable under all conditions, for it is a safety measure that lessens the danger of scalding persons who might be near the end of an open blow-off pipe or near a sewer manhole opening when the blowing takes place.

The principal function of a blow-off tank is to absorb the impact of the water issuing from the boiler and to provide a place for the liberation of the steam which forms when the pressure is reduced. Such a tank also affords temporary storage for the blow-down water, permitting its eventual disposition at a lower temperature.

There is no established practice as regards the size or design of these tanks. A good rule is to make them large enough to hold the amount of water represented by one gage of the largest connected boiler. Ordinarily, one tank in a plant is sufficient, all boilers being connected to it, but large plants might require two or more.

There is no general agreement as to the pressure for which a blow-off tank should be designed. That some pressure will build up is inevitable, as is evidenced by numerous failures, some of which were disastrous. The best practice is to design the tank to carry the boiler pressure, although there are very few tanks so constructed. Certainly they should be capable of safely sustaining at least half the normal



Result of cast iron blow-off tank explosion.

boiler pressure. Many light cast iron tanks are in daily service and their continued use should be discouraged. Steel tanks should preferably be built in accordance with the A. S. M. E. Code rules for unfired pressure vessels; and if fusion welded they should at least comply with Class 2 requirements.

To be insurable, blow-off tanks should not be buried but should be so installed that they can be completely inspected. They should be so located that water from the boiler will flow into them by gravity

and for this reason it is usually necessary that they be placed in pits. The pit should have good drainage facilities and should be large enough to permit a thorough inspection of the tank, as tanks of this kind are likely to be subjected to both internal and external corrosion and hence there must be ready access to both inside and outside surfaces. Therefore, a detachable cover or other means of access must be provided.

Blow-off tanks are usually closed; and for their safe operation they should be vented to the atmosphere. The vent pipe should have an area of about four times that of the inlet pipe. There should be no shut-off valve or other obstruction in the vent pipe, which should end in a safe place not less than 15' above the top of the tank. This pipe should also be as straight as possible, be well constructed and rigidly held in position. Since a considerable volume of steam under some pressure will issue at each blow-down, it is important that there be no pocket in which water can accumulate, freeze in cold weather and thus possibly obstruct the pipe.

The inlet pipe should enter the side of the tank near the top and the outlet or overflow connection should be at about the same height as the inlet. This outlet connection should have an internal pipe leading down to within a few inches of the bottom of the tank. There should be a drain connection at the bottom so that the tank can be completely emptied when desired.

It is obvious that a dangerous pressure will build up in a blow-off tank if there is any obstruction to the escape of either water or steam. When a tank is properly installed the pressure within it during the blowing down is only a small fraction of the boiler pressure; but conditions sometimes develop which cause the pressure to rise, and it is against any such unexpected condition that adequate provision should be made.

Within the past few weeks the Hartford Steam Boiler Inspection and Insurance Co. made an investigation of the explosion of a cast iron blow-off tank, which was not insured, although it was connected to insured boilers. This tank was found to have had an old crack in the side near the bottom head. The tank was in a brick lined pit but not accessible for inspection. The failure occurred at the cracked section and a part of the tank was projected upward, damaging some overhead piping and the roof. About one and a half gages of water had been blown down and the man watching the glass had just raised his hand to signal the assistant to shut the blow-off valve when the explosion occurred. The blow-off piping was torn apart and the assistant scalded to death. This tank had no vent pipe, the overflow pipe being depended upon to carry off both water and steam.

Crown Sheet Failure Results in Explosion

THE collapse of the crown sheet of a comparatively new 60" locomotive firebox boiler used at a Texas oil property hurled the boiler from its setting, caused property damage in excess of \$3,000 and burned a fireman about the face and arms. The boiler was the center one of a battery of three and in its flight it broke the steam connections to the other boilers and smashed the structure which held



After the crown sheet pulled off its stays.

them. It came to rest upside down, its dome embedded in soft earth.

The reason for this crown sheet failure was not ascertained, but it was evident that some operating condition had led to the weakening of the metal. The violence with which it occurred gave evidence that there was a considerable amount of water in the boiler at the time. The fact that the safety valve was reported to have functioned but a short time before the accident would indicate that the pressure carried by the boiler was close to the operating pressure of 250 lb.

The crown sheet failed by the tearing of both sides of the furnace sheet near the vertical seam joining it with the tube sheet. It was pulled from the radial stays and both side sheets were moved inward from the staybolts. The top half was pulled off the tube sheet and caused about 70 tubes to be loosened from the sheet. The boiler

house, which was of sheet iron construction, was completely demolished, the timbers being broken and the sheet iron twisted out of shape.

The High Cost of Caustic Embrittlement

CAUSTIC embrittlement has been discovered by "Hartford Steam Boiler" inspectors since January 1, 1930, in steam generating equipment with an estimated value of \$4,000,000. Evidences of "embrittlement" have been found in 160 boilers and one kier in 58 plants scattered over 24 states.

The cost of replacement or repairs in these boilers following the discovery of caustic embrittlement is estimated at \$750,000, the difference between this and the \$4,000,000 figure being due to the fact that in some cases boilers worth as much as \$500,000 have been repaired and have been continued in service with a careful watch maintained for any evidence of the disease extending its effects.

The boiler plants in which caustic embrittlement has been discovered since January 1, 1930, are scattered from Minnesota to Florida and from Washington to Maine as follows: Arkansas 1, Colorado 2, Connecticut 1, Florida 3, Georgia 1, Illinois 6, Indiana 1, Iowa 2, Louisiana 1, Maine 1, Massachusetts 2, Michigan 4, Minnesota 10, Mississippi 3, Montana 1, New York 5, North Dakota 1, Ohio 2, Oklahoma 2, Pennsylvania 1, Tennessee 2, Utah 1, Washington 1, Wisconsin 4.

In no case has "embrittlement" been discovered where there was a feedwater treatment record which indicated no departure at any time from the sodium carbonate to sodium sulphate alkalinity ratios at least as favorable as those recommended by the A. S. M. E. Boiler Code.

The feedwater in a number of the plants affected was from deep wells and was untreated. In other plants base exchange type of water treatment was employed for the entire supply or for the make-up water. In still other plants soda ash and lime treatment was used, while at some the treatment consisted of secret commercial compounds. Changes in feedwater treatment and the absence of records in some plants make it difficult, if not impossible, to attribute the development of "embrittlement" to any one particular feedwater.

Happily the danger signs which pointed to the existence of caustic embrittlement were caught by "Hartford Steam Boiler" inspectors in each of the 160 boilers affected before there was an accident, so that a violent explosion with subsequent loss of life and damage to property did not occur.

Seven Power Boiler Accidents Kill 7, Injure 32 Persons

SEVEN recent power boiler accidents resulted in the death of seven men and women and injury to thirty persons, according to official city investigations or to newspaper accounts of the accidents.

A man and a woman were working in the office of a Texas auto supply house when without warning the 8 in. tile wall of the building

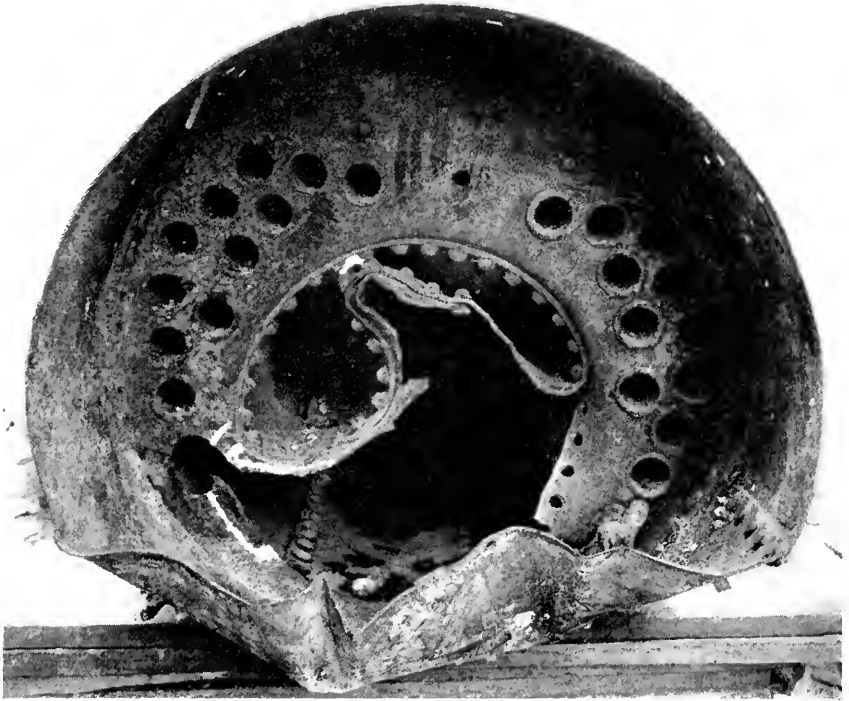

Caused by corrosion and over-pressure.

was crashed in and a 1,600 lb Scotch marine type boiler crushed the two workers as it passed on to the other side of the building. The woman was killed instantly and the man died an hour later from burns and other injuries.

The boiler had come from a dry cleaning plant across an alley. There, as well as in the auto accessory store, it had reduced the equipment to debris. Four persons who were either customers or employes of one concern or the other were injured. Besides damaging the auto accessory store directly, the accident set fire to some paint and broke



What a boiler did to its owner's dry cleaning establishment.

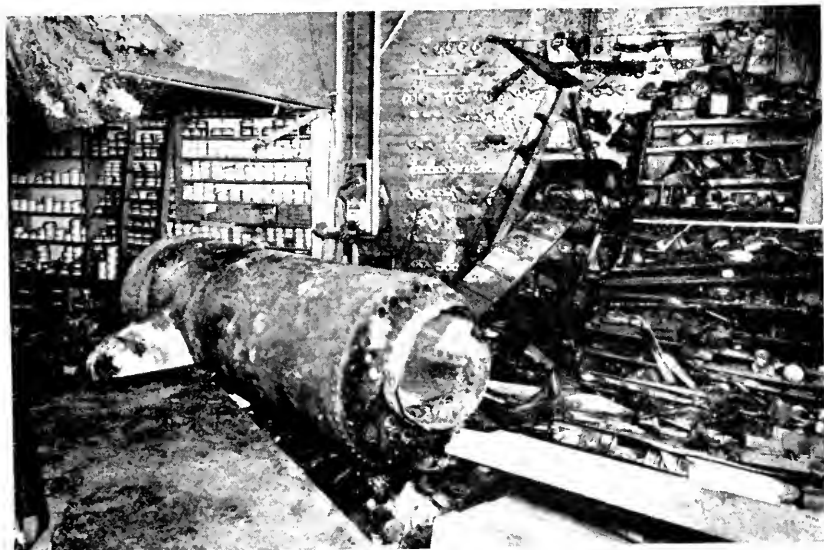

The 38" diameter boiler, where it landed in a neighboring store.

the sprinkler system, so that stock was damaged by fire and water.

An investigation was made of the exploded boiler, which had come to rest about 50 ft from its setting. It had ruptured in a small welded area in the lower sheet. A crack from the weld had extended 18 to 20 inches across the bottom and the furnace of the boiler had collapsed. The boiler was rated at 15 hp and carried from 60 to 90 lb of steam under normal operation. It was 38" in diameter and 7'4" in length. A test made by railroad boiler men following the accident showed that the safety valve began to blow at 200 lb instead of the 100 lb at which it was supposed to work.

The top picture on page 79 shows the interior of the dry cleaning establishment and gives a good idea of the debris. The bottom picture shows the boiler where it came to rest in the auto accessory building after it had crashed through the office, killing two persons. The picture on page 78 gives a close-up of the part of the boiler that failed.

Two men died as the result of a boiler explosion at a grist mill near Murphy, North Carolina, on March 17, 1934. The mill was wrecked and one of the men was hurled seventy-five feet from the boiler setting. The other suffered a broken arm and severe burns and internal injuries which led to his death the next day. Three other men were injured.

One man was burned fatally and three were injured, two seriously, on March 29, 1934, when a saw mill boiler exploded fifteen miles south of Birmingham, Alabama. Debris was scattered over a 300 foot area. The boiler itself was blown 180 feet.

A foreman at a Kansas oil lease was killed when a boiler in the engine house exploded on March 15, 1934, leveling the engine house and hurling the man's body more than 300 feet. Another man was hurt by flying timbers.

When the boiler of a saw mill operating at Baker, West Virginia, exploded on April 27, one man was blown 200 feet and killed, and another man was injured.

Twelve men were injured, several seriously, by a boiler explosion on March 16, 1934, at a zinc mine, near Caulfield, Missouri.

Six persons were injured on May 24, 1934, when a copper hot water heater connected with an incinerator of a wholesale grocery concern in South Boston, Massachusetts, exploded with such force as to wreck the rear of the building and damage several freight cars. The blast tore away the rear wall of the building, shattered a large section of the roof, knocked down a 40' chimney and broke many windows. It was attributed to an inoperative safety valve.

Overspeed Accident Damages Engine and Generator

TWO machinery accidents, occurring almost simultaneously as the result of overspeed, brought disaster on January 3, 1934, to the steam engine-generator unit for a large paper machine in a Pennsylvania factory. The 56" flywheel, which had a rim 21" wide and 2¾" thick, exploded. The six arms snapped off close to the hub and the hub was broken in two. Luckily the flying metal caused only minor damage. However, damage to the engine included a broken steam line, broken governor and loosened foundation fastenings. A 100 kw direct current generator, chain-driven by the engine, was overspeeded at the same time, and the coils were thrown out of the slots by centrifugal force. A generator bearing pedestal broke and the armature windings were completely destroyed.

The overspeed was blamed on the fact that the governor shaft had developed an undue amount of friction due to the improper use of grease in an oil cup. Although the governor was equipped with an automatic stop which would act in case the governor driving belt broke or slipped off the pulley, this device was not effective to prevent the overspeed as the belt did not slip off the governor pulley but simply slid over it when the governor slowed down under the excessive friction. Slipping of the belt thus prevented the governor from cutting down the steam supply. The situation finally led to a speed which neither the flywheel nor the generator rotor could withstand.

The problem of restoring production after this accident, which was covered by both direct damage and use and occupancy insurance in the Hartford Steam Boiler Inspection and Insurance Co., involved unusually intensive work. The accident occurred at 10 P. M. on a Wednesday, and an hour later the company had two experienced men at the plant. By the following Saturday at 4 A. M. eighty percent of the production had been restored by the installation of a temporary generator and a synchronous motor which the plant had intended to

use with the regular generator. By Monday morning the original generator had been repaired and full production was resumed by driving it with the motor, the base for which was already built although installation had not been completed at the time of the accident.

Other Flywheel Accidents

An 18' flywheel at an Illinois firebrick plant burst because of overspeed on May 17, 1934. No one was injured but there was property damage estimated at about \$2,000. While no one was in the engine room at the time of the explosion, the accident was blamed on defective operation of the governor. The steam engine normally operated at 200 r.p.m.

An 8' flywheel, used in connection with a 125 hp Diesel engine driving an ammonia compressor in a Massachusetts ice plant burst on May 3, 1934, caused extensive property damage, injured two men and endangered the lives of a number of other persons.

One piece of the flywheel catapulted through the roof of the building and crashed into a three-story wooden building occupied by three families.

On the third floor a woman was working at a kitchen table when a piece of the flywheel passed within a few inches of her, cut a hole through the floor and narrowly missed another woman who was also sitting at a kitchen table in her apartment on the floor below. The piece of metal finally lodged against a beam between the second and first floors.

Another piece crashed through an 8' door and then ripped off the roof of a heavy coupe which was parked outside the building.

Besides the damage to the roof of the one-story brick plant, the connecting pipe to an ammonia storage tank was broken and the building was saturated with ammonia fumes. This necessitated the use of a gas mask by a fireman before he could shut off the ammonia at the tank.

Three employees of the company were in the engine room immediately before the explosion. One of the men, the manager, said that they had just finished putting oil in the crank case of the engine when a rumbling sound was heard and the entire structure shook. He said he shouted, "We had better get out!" and they did. None of the

three was injured. The two persons who were hurt were on the sidewalk outside of the building. Neither was injured seriously.

A flywheel 15' in diameter and 26" wide on a Corliss type engine burst at an Ohio sugar plant on October 10, 1933, large pieces smashing through heavily reinforced concrete and breaking a 10" I beam. Two men out of the 40 or more in the building at the time of the accident were injured by flying debris. The accident was attributed either to the slipping of the governor belt or to the sticking of the governor itself, permitting the engine to run away. The plant was seasonally operated in connection with the sugar beet industry and the accident delayed the starting of the season's work for several days, interrupting all field operations of harvesting and hauling the beets.

Large Double Helical Gear Wheels

Two notable gear wheels, both of the double helical type, recently have been completed by British engineering firms. One of them is believed to be the largest gear wheel ever made in England. It has a diameter of nineteen feet, a face width of 50 inches and there are 222 teeth. The gear has been designed for transmitting 16,000 hp at 28 rpm in an Australian rolling mill.

The second wheel is notable in being probably the largest gear wheel of its kind ever cast in one piece. It weighs over 24 tons, finished, and has nine pairs of arms of channel section. The double helical teeth, of which there are 203, were machined from the solid. The face of the wheel is 40 inches wide and the overall diameter is 13 ft 7½ inches. It is now being incorporated in a single reduction gear for a rolling mill drive for overseas. The normal speed of the wheel will be 35 r.p.m. Peak loads of about 10,800 hp are likely to be transmitted by this drive.

Water Heater Blasts Occur in Restaurants

Two men and a woman were injured on April 5, 1934, when a 500 gallon water heater exploded in the basement of a New York restaurant. About 500 patrons were in the building when the explosion occurred. A wall dividing the kitchen from the boiler room was blown out and some other property damage was caused.

Fragments of cast iron were thrown in all directions by the explosion of an ordinary cast iron hot water heater used to supply heat to a restaurant in Springfield, Ohio. The blast shattered furniture and equipment in the restaurant and sent glass showering into the street. The five persons who were in the building at the time all escaped injury.

Seventy-nine per cent of Switzerland's railroad mileage is now electrified. Nearly 1,500 miles are operating electrically.

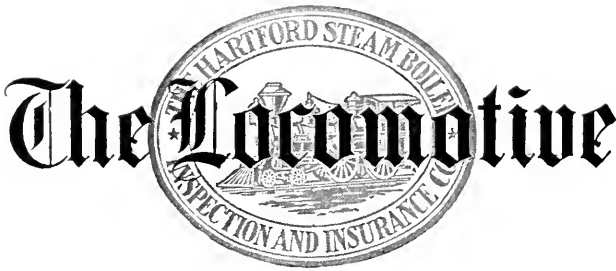

A QUARTERLY MAGAZINE
DEVOTED TO POWER PLANT PROTECTION

George H. Prall, *Editor*

Copyright 1934 by The Hartford Steam Boiler Inspection and Insurance Company

HARTFORD, CONN., July, 1934

Single copies may be obtained free by calling at any of the Company's agencies.
Subscription price 50 cents per year when mailed from this office.
Recent bound volumes one dollar each. Earlier ones two dollars.

Reprinting matter from this paper is permitted if credited to

THE LOCOMOTIVE of THE HARTFORD STEAM BOILER INSPECTION AND INSURANCE CO.

Hartford Steam Boiler Hastens Repair Following Florida Accident

WHEN "Hartford Steam Boiler's" countrywide engineering organization is called on to aid an assured in restoring plant operation after an accident, it sometimes is faced with difficulties that require ingenious and speedy solution. Such a case arose on November 2, 1933, when an accident occurred to the main engine of a Florida extract plant.

The accident completely demolished the rear cylinder head, and cracked the front head beyond repair. It was caused by stripping of the screw threads fastening the piston rod in the crosshead, this failure freeing the piston and permitting it to strike the rear cylinder head a shattering blow.

The engine manufacturer did not have in stock the parts necessary for repairs, and although patterns were available at Milwaukee, Wisconsin, 10 days would be required to cast, machine and deliver the parts to the plant.

The engine was used to drive wood-chipping machinery, and as the plant had on hand only a small supply of chips, enough for a day's operation, other departments would have to shut down until the engine was repaired unless some substitute drive for the grinding room was supplied.

There was a source of 2,300 volt electricity available but electrical machinery of a suitable size and type was not easy to locate. The assured was anxious that the company assist him in getting substitute equipment quickly for although he had use and occupancy coverage of \$900 a day, the plant was actually suffering a loss of about \$2,000 a day.

"Hartford Steam Boiler" men at Atlanta made inquiry of the large electrical manufacturers, and also of two or three electric shops and engineering firms in Atlanta but could not find motors large enough. An inspector knew of two 200 hp motors at another Florida location but they operated at 400 v and transformers to give the necessary voltage could not be found. Several 100 hp motors also were available but they were of a type on which it was difficult to fix pulleys. Finally at Birmingham, Alabama, two motors were found which together would develop 600 hp and operate on 2,300 v. The necessary starting and controlling equipment also was secured.

"Hartford Steam Boiler" rented these motors and arranged for their transfer to the Florida location by fast truck the night following the accident.

A company representative was put on the job to supervise repairs, and to help the shop through such difficulties as might be encountered.

The truck with the motors arrived on November 5 and the motors were set in place and connected.

The belts had been ordered from New Orleans, Louisiana, and were scheduled to arrive at 6:10 A.M. on Tuesday, November 6. Everything seemed to be in good order but, in anticipation of the possibility that the motors might not prove a successful method of drive, "Hartford Steam Boiler" authorized a local foundry to make up two new cylinder heads of cast iron and a machine shop was commissioned to bore out and rethread the rod opening in the crosshead, to turn down the 4" piston rod and thread it and to install a steel bushing in the crosshead neck. It was thought that, by using these parts, the engine would be able to carry about 60% of the load and assist one of the motors. Repairs to the engine with these emergency cast iron parts were well under way by the night of November 8. The plan was to operate continuously until all bins were filled and enough material had

been stored to run the plant about 48 hours; then to shut down and install the new engine parts that were coming from the factory.

It was found, however, that the two motors would be sufficient to take care of the plant's needs, so the temporary engine repair was not completed.

The cost involved in connection with the two rented motors was estimated at approximately \$1,375 and the temporary repair started on the engine was in the neighborhood of \$400. When the installation of the motors, and their operation, proved to be satisfactory, the machining of the cylinder heads was stopped, but since the front head had been completely machined it was held in readiness awaiting the arrival of a new piston, piston rod and rear cylinder head from the factory. "Hartford Steam Boiler's" activity at this plant cut down the interruption of business to the equivalent of four days, thereby saving an appreciable amount for the assured by bringing his plant to full production in a minimum of time and by assisting him in securing partial production during the repair period.

Shifted Core in Casting Leads to Accident

Overpressure, and a cast iron section which had a dangerously thin wall because of shifting of the core while it was being cast, resulted in a heating boiler explosion in a Davenport, Iowa, store on February 27, 1934. It had been in service about an hour when the shipping clerk noticed 30 lb of pressure on the gage. A few minutes later the explosion occurred. What the pressure actually was is not known, as a pin prevented the gage from registering more than 30 pounds. The safety valve was set at 15 lb, but was so corroded that a pressure of about 100 lb would have been necessary to have opened it. Because of the shifted core, the rear section where it blew out was only $3/16$ " thick. The boiler was blown from its setting but did not fly to pieces. No insurance was carried.

Bearings Burned as Turbine Stops

When a 100 kw turbo-generator coasted to a stop without lubrication at a Virginia municipal power plant on March 3, 1934, the three main bearings were burned, two beyond repair, and the thrust bearing was damaged so that re-babbiting of shoes was necessary. Both the impulse and the reaction blades on the turbine also were slightly damaged by rubbing. The steam supply line to the oil pump was not equipped with an automatic regulator. Instead, a hand operated valve was utilized for starting the auxiliary pump when the turbine was to be shut down. The operator failed to start the auxiliary oil pump and the damage was the result.

Lodger: "Madam, this morning when I bathed I found only a nail brush in the bathroom. I can't wash my back with a nail-brush."

Landlady: "Well, you've a tongue in your 'ead, 'aven't you?"

Lodger: "Yes, but I'm no swan."

The Weekly Telegraph (London).

J. B. Warner

Josiah Buell Warner, for over forty years a chief inspector with the Hartford Steam Boiler Inspection and Insurance Company, died on April 26, 1934, at his home in Alameda, California. Mr. Warner joined the company in 1884 when it extended its business to the Pacific Coast. He served in the west continuously until his retirement from active service in 1927. Previous to his connection with the company Mr. Warner had been a marine engineer.

Mr. Warner was a member of the committee which drafted the original Boiler Safety Orders in California and he held Certificate of Competency No. 1 of the Industrial Accident Commission, a deputyship from the Board of Mechanical Engineers of the City of Los Angeles, was an honorary member of the American Society of Marine Engineers, a member of the National Association of Power Engineers and of the National Board of Boiler and Pressure Vessel Inspectors. He held licenses from the United States Department of Commerce as a Second Assistant Engineer for ocean going vessels and as a pilot for vessels of limited tonnage on the San Francisco Bay and its tributaries. He was born in Hebron, Connecticut, December 14, 1857.



J. B. WARNER

Heater Blown Through Residence Roof

Members of a family in Cincinnati, Ohio, were in bed and asleep on the night of April 26, 1934, when a hot water supply heater exploded in the basement with such force as to hurl itself through the roof. The force of the blast damaged the house foundations, destroyed household goods in the basement and broke the furnace. It was reported that a check valve had been installed in the supply line in order to protect the water meter, and in the absence of a relief valve there was no protection against overpressure.

Tube Failures Inconvenience Industrial Plants

TUBE failures in water tube boilers and accidents to superheaters interrupted production or caused considerable inconvenience to power plant operators recently.

At a large New England silk mill one of the tubes in a water tube boiler overheated, bulged and ruptured, draining the boiler so rapidly that in spite of every effort to pump water, 44 tubes were damaged by the residual heat in the setting. This accident occurred on February 13, 1934. The split in the tube, as shown in the photograph, was about 12 in. in length. Other tubes damaged by the accident were not ruptured but were warped so badly that replacement was considered necessary.

One man was scalded and more than 2,000 shoes workers in five plants were inconvenienced on February 9, 1934, when a 4" tube in a 500 hp boiler burst, putting out the fire and filling the boiler room with steam. Some power and heating needs were supplied by two 300 hp boilers which were brought up to pressure following the accident. However, other power needs were not filled until some three and a half hours later when an electrical connection was made with a local utility line.



Tube failure which had serious consequences.

Scale which so filled thirty-eight tubes that it about cut off all circulation through them, was blamed for an accident to a boiler in a Wisconsin paper mill on March 6, 1934. The trouble was manifested by the pulling of one of the tubes from the tube sheet after it had been overheated and had warped. A fireman who mounted to the top of the boiler immediately after the accident to close the valve

was overcome by smoke and gas, but suffered no serious consequences. The repair of this accident was expedited by "Hartford Steam Boiler," and by intensive work 60 leaky tubes were tightened, 4 new ones installed, and the brick baffles completely rebuilt, within 24 hours after the accident.

Loss of the use of a water tube boiler at a Virginia utility plant for one and one-half days resulted from an accident to two superheater tubes on April 2, 1934. The failure was attributed indirectly to the quality of coal formerly used by the plant. The fuel had an ash with a low fusing point and this was blamed for the slag which was found on the outside of the superheater tubes. This slag closed up passages and by sending the gases through other passages brought about the overheating, bulging and leakage of certain of the tubes.

Overheating also was blamed for an accident to superheater tubes in a water tube boiler owned by a Maryland chemical company. On February 7, 1934, one tube ruptured, necessitating its immediate replacement. Six days later a tube in an adjoining superheater failed.

Welded Steel Cold Water Tank Bursts

THE EXPLOSION of a hydro-pneumatic storage tank several months ago, at Big Bay, Michigan destroyed a municipal pump house, badly damaged the 185-foot deep well pump, and caused a total interruption of the village water supply. The head of the tank was driven through a 10-inch concrete foundation wall.

The vessel was so located that one end was buried in the side of a hill. Failure of the head in the opposite end caused the tank to move ten inches into the solid earth. The 20' x 20' pump house was lifted and moved from its foundation and the foundation walls and concrete floors were wrecked beyond repair. Its roof was torn away and all windows were broken.

An investigator reported that the heads were without flanges or skirts and were installed so that they bumped outwardly, resembling large shallow saucers with their rims welded to the ends of the shell plate. Both heads were fitted inside the shell. No insurance was carried.

Automobiles of the United States plus the plants which build them, the garages to house and service them, the highways to run them on, and the petroleum to lubricate and propel them exceed in value the \$26,000,000,000 concentrated in the nation's steam railroad system.

Hot Water Tank Explosion Kills Housewife

AN ordinary hot water supply tank in the kitchen of a Virginia residence exploded and killed one woman instantly and almost totally wrecked the home on January 30, 1934. The accompanying illustration shows the damage done to the living room. All the rear and side windows were smashed and the front door with its frame



Home wrecked by bursting of hot water tank.

work forced on to the porch, while the stairs leading to the second floor were torn apart and even in the upstairs rooms sections of plastering were jarred from the walls.

The tank was heated by a coil water heater of the conventional type using kerosene as fuel. Freezing of the supply pipe of the tank was held to be the cause of the accident. As the water taps were closed, an excess pressure was evidently built up in the tank.

Taps From the Old Chief's Hammer

THE OFFICE force had gone and the Old Chief was about ready to call it a day when a telegraph messenger brought him a wire. The veteran whistled when he opened it.

"Whee," he exclaimed to his assistant, Tom Preble, who was just getting on his coat preparatory to leaving, "look at this. Glerron has my letter on that turbine case. I tell you, this air transportation is great . . . when it works . . ."

"Say, did I ever tell you about the time we had making repairs after that accident at Hibbard, Colo. . . . sort of an obstacle race it was."

The chief pulled his straw hat forward on his head, sat down, got out his pipe, filled it, lighted it and smiled a broad smile. Preble had planned to work in his garden that evening. Now he knew he'd be lucky if he caught the 6:15 for his suburban home. The Chief was indulging his hobby and another story from his wide experience was on the way. So Tom got out his pipe, too, for while it was a good day for gardening, the Chief's stories were usually worth the time.

"It was about two years ago," the veteran chief inspector said, "and the salt company at Hibbard had just made some extensive repairs to its steam engine. They had rebored the cylinder, put in oversize bull and piston rings, leveled the bed and grouted it with sulphur, renewed the main bearing and generally fixed up the machine. The plant superintendent wrote he saw no reason why the engine wouldn't give good service for years to come.

"Two days after we received the superintendent's letter, on a Saturday morning, the engine manufacturer's erector was making adjustments to the valve gear when he noticed an unusual noise in the cylinder. Because the indicator diagrams seemed to disclose serious leakage past the piston, he sensed that something had gone decidedly wrong with the piston assembly.

"When they took things apart they found that the bull ring was badly worn, a keeper spring had come loose and jammed and a piston ring had broken. The bull ring had been in operation only about 10 days, and had so worn down in that time from a thickness of



14/16" that the top sections of the ring were not over 5/16" thick, and steam was getting by pretty badly.

"Inspector Johnson reached the plant Sunday morning. He blamed the accident to lubrication difficulties, aggravated by highly superheated steam. They were using steam at from 457° to 500° F. He figured that no ordinary ring would stand up in this rebored engine and recommended the installation of a bronze ring which would have to be made by the manufacturers who were 1,000 miles away. The manufacturers were called by 'phone and their chief engineer readily agreed to Inspector Johnson's recommendation and promised continuous work until the ring was ready.

"The order for the ring was given Monday morning and our men laid plans to get the 50 pound part to the assured by air express. It was finished and shipped Tuesday morning, reaching Louisville, Kentucky, early that afternoon. At Louisville heavy weather was keeping all planes down, and there were no train connections in time for the night plane at St. Louis. The Cincinnati office, which had been keeping track of the shipment, wired St. Louis it was driving the ring through and that it would deliver it to a St. Louis man in time to catch the plane.

"Inspector Brinkman was detailed to make the drive. He 'stepped on it' and his automobile crossed the bridge to St. Louis with a half hour to spare. Then he came bump into a parade. It seems St. Louis each year has some kind of a festival that includes what is called the Veiled Prophet Parade—floats, bands, girls and all the rest. Brinkman had driven almost eight hours, and somehow that parade was a sort of last straw. He said afterward he sat there in his automobile watching the parade crawl along and talked to himself and wished he could throw the Veiled Prophet or whoever was responsible for all this fuss into the Mississippi river.

"Well, he missed the plane, by minutes. Tuesday at midnight a St. Louis man boarded the train for Kansas City with the ring. At Kansas City it was placed aboard a plane and reached the plant Wednesday noon. It was installed and tested that afternoon and the engine took over the full load that night.

"You know, Tom, when an assured buys expediting insurance or use and occupancy he has a right to expect extra quick service. With all the tangles and delays we had in this case we really made fine time in expediting that repair. The plant superintendent was one pleased man, and he wrote our office a nice letter. What he knew was that the bull ring had been delivered promptly. As is usually the case, the

assured didn't know anything about our headaches in the matter. That's our business. After all, results are what the assured wants."

"Chief, did the bronze ring hold up?" inquired Preble.

"It must have, Tom. We haven't had any trouble there since. Boy, look at the clock; it's six already. You better run for your train."

"O. K. Chief, I'm on my way. If I miss that local, I'm afraid there won't be much chance of airplane service to get me home for dinner."

Church Boiler Wrecked When Rear Boiler Wall Fails

THE explosion of a gas-fired cast iron heating boiler on November 10, 1933, at the First Congregational Church of Germantown, Pennsylvania, wrecked the boiler, resulted in a cold church the next Sunday and, because no insurance was carried, put the church to

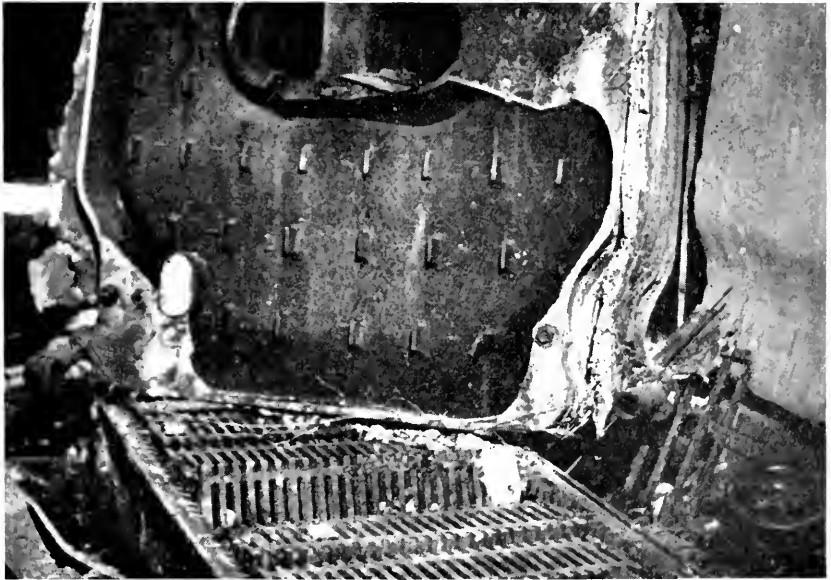

Church's cast iron boiler weakened by broken stays.

considerable expense for repairs. The boiler's failure was attributed to the fact that the bottom row of stays had broken some time prior to the accident. This so weakened the rear wall of the boiler that it failed under low pressure. The illustration clearly shows the outer ends of the cast iron stays which were detached from the rear section.

The Hartford Steam Boiler Inspection and Insurance Company

OF HARTFORD, CONN.

December 31, 1933

Capital Stock, \$3,000,000.00

ASSETS

Cash on hand and in banks	\$ 910,061.17
Premiums in course of collection (since October 1, 1933)	1,150,436.69
Interest accrued on mortgage loans	49,854.06
Interest accrued on bonds	112,262.21
Loaned on bonds and mortgages	851,381.55
Home Office real estate	437,474.66
Other real estate	298,889.83
Agents' ledger balances	18,365.44
Bonds on an amortized basis	\$8,702,210.61
Stocks at "Convention Values"	5,016,676.50
	13,718,887.11
<i>Total</i>	\$17,547,612.72

LIABILITIES

Premium reserve	\$6,627,478.25
Losses unadjusted	314,677.94
Commissions and brokerage	230,087.34
Other liabilities (taxes incurred, etc.)	502,686.77
Contingency Reserve, representing difference between value carried in assets and actual December 31, 1933, market quotations on all bonds and stocks owned	1,740,000.00
<i>Liabilities Other Than Capital and Surplus</i>	\$9,414,930.30
Capital Stock	\$3,000,000.00
Surplus over all liabilities	5,132,682.42
<i>Surplus to Policyholders</i>	8,132,682.42
<i>Total</i>	\$17,547,612.72

WILLIAM R. C. CORSON, President and Treasurer

BOARD OF DIRECTORS

LUCIUS F. ROBINSON, Attorney, Hartford, Conn.	SAMUEL M. STONE, President Colt's Patent Fire Arms Mfg. Co., Hartford, Conn.
JOHN O. ENDERS, Chairman Board of Directors, Hartford National Bank & Trust Co., Hartford, Conn.	SAMUEL FERGUSON, President The Hartford Electric Light Co., Hartford, Conn.
MORGAN B. BRAINARD, President Aetna Life Insurance Co., Hartford, Conn.	HON. JOHN H. TRUMBULL, President The Trumbull Electric Mfg. Co., Plainville, Conn.
CHARLES P. COOLEY, Chairman Board of Trustees, Society for Savings, Hartford, Conn.	CURTISS C. GARDINER, Vice-President, The Hartford Steam Boiler Inspection and Insurance Company, 90 John Street, New York, N. Y.
HORACE B. CHENEY, Cheney Brothers, Silk Manufacturers, South Manchester, Conn.	JAMES L. THOMSON, Vice-President Terry Steam Turbine Co., Hartford, Conn.
D. NEWTON BARNEY, Vice-President The Hartford Electric Light Co., Hartford, Conn.	PHILIP B. GALE, Chairman, Board of Directors, Standard Screw Co., Hartford, Conn.
JOSEPH R. ENSIGN, President The Ensign-Bickford Co., Simsbury, Conn.	JOHN J. GRAHAM, Vice-President The Hartford Steam Boiler Inspection and Insurance Co., Hartford, Conn.
EDWARD MILLIGAN, President Phoenix Insurance Co., Hartford, Conn.	
WM. R. C. CORSON, President The Hartford Steam Boiler Inspection and Insurance Co., Hartford, Conn.	

Incorporated 1866



Charter Perpetual

Department

Representatives

ATLANTA, Ga., Citizens & So. Nat. Bk. Bldg.	W. M. FRANCIS, Manager. C. R. SUMMERS, Chief Inspector.
BALTIMORE, Md., 704-9 Garrett Building	D. W. LITTLE, Manager. R. P. GUY, Chief Inspector.
BOSTON, Mass., 87 Kilby Street	A. PAUL GRAHAM, Manager. W. A. BAYLISS, Chief Inspector.
BRIDGEPORT, Conn., City Savings Bank Building	W. G. LINEBURGH & SON, General Agents. A. E. BONNET, Chief Inspector.
CHICAGO, Ill., 175 West Jackson Boulevard	P. M. MURRAY, Manager. C. W. ZIMMER, Chief Inspector.
CINCINNATI, Ohio, First National Bank Building	JAMES P. KERRIGAN, Manager. W. E. GLENNON, Chief Inspector.
CLEVELAND, Ohio, 311 Leader Building	ARTHUR F. GRAHAM, Manager. JOHN L. SCOTT, Chief Inspector.
DENVER, Colo., Gas & Electric Building	J. H. CHESNUTT, Manager. F. G. PARKER, Chief Inspector.
DETROIT, Mich., National Bank Building	L. L. COATES, Manager. THOMAS P. HETU, Chief Inspector.
HARTFORD, Conn., 56 Prospect Street	F. H. KENYON, Manager. A. E. BONNET, Chief Inspector.
NEW ORLEANS, La., 333 St. Charles Street	R. T. BURWELL, Manager. P. E. TERROY, Chief Inspector.
NEW YORK, N. Y., 90 John Street	C. C. GARDINER, Vice-President. J. F. HUNT, Chief Inspector.
PHILADELPHIA, Pa., 429 Walnut Street	A. S. WICKHAM, Manager. S. B. ADAMS, Chief Inspector.
PITTSBURGH, Pa., Arrott Building	GEORGE S. REYNOLDS, Manager. J. A. SNYDER, Chief Inspector.
ST. LOUIS, Mo., 319 North Fourth Street	CHAS. D. ASHCROFT, Manager. EUGENE WEBB, Chief Inspector.
SAN FRANCISCO, Cal., 114 Sansome Street	C. B. PADDOCK, Manager. L. E. GRUNDELL, Chief Inspector.
SEATTLE, Wash., Arctic Building	E. G. WATSON, Manager. WILLIAM J. SMITH, Chief Inspector.
TORONTO, Ont., Canada, Federal Building	H. N. ROBERTS, President The Boiler In- spection and Insurance Company of Canada.

*Yours
for
the
asking!*

*54 Years of
Experience*

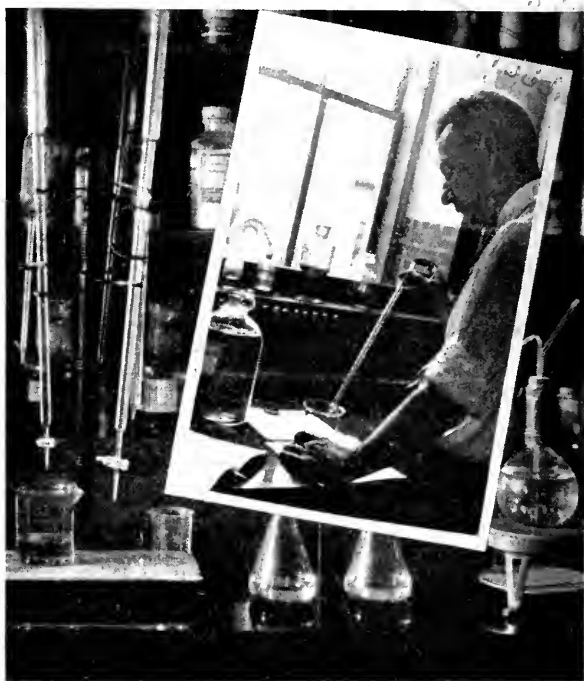

In Analyzing Boiler Feed Water

There are occasions when the Hartford Steam Boiler Inspection and Insurance Company's home office feedwater laboratory can be of valuable service to policyholders in analyzing the water they are using for boiler feed, and in giving them advice as to a treatment designed to avoid such troubles as scale, pitting and caustic embrittlement. In this modern laboratory, studies of our assureds' feedwaters are conducted with a knowledge of boilers, a long acquaintance with their operating difficulties and the peculiarities of the waters occurring in all parts of the country. Hartford Steam Boiler was the first company to inaugurate such a service, and its laboratory facilities have been constantly improved to keep pace with the developments in boiler practice.

It is the company's desire that its clients take full advantage of these facilities that are available to them at no cost. Arrangements for an analysis should, however, be made through the company's branch office that handles the inspection of the assured's equipment. That office will furnish instructions as to the preparation and shipping of the sample, and a form for giving the chemist certain essential information about the water. It is important that the chemist have this information in order to interpret his analyses most helpfully from the assured's standpoint.



A QUARTERLY MAGAZINE
DEVOTED TO POWER PLANT PROTECTION

Published continuously since 1867
by The Hartford Steam Boiler
Inspection and Insurance
Company

Please show to your Engineer

Boiler Explosions Kill 17 Persons

FIVE accidents during the summer to cotton gin or sawmill boilers brought death to 17 persons, injury to a number of others, and serious damage to property. Two explosions occurred as the operators were preparing to start the season's ginning operations.

The most severe of the accidents occurred at Neal, Georgia, in Pike County, on September 7, 1934. Eight men were killed as they were



*Above—Middle and rear courses of Neal, Georgia, boiler.
Below—Where eight were killed in cotton gin boiler explosion.*

working around a cotton gin, or were watching the start of work on the 1934 crop. The gin structure was destroyed, and the bodies of two of the victims were hurled several hundred feet. The front tube sheet of

the 54" horizontal tubular boiler landed 600 feet from its former location and other parts were widely scattered. It was not determined what caused the accident although it was evident that there was considerable pressure in the boiler when the failure occurred.

A similar scene was enacted in Waltham County, Georgia, near Gratis, where two persons, a man and a woman, were scalded by steam when a cotton gin boiler exploded on August 30. They were visiting the gin as the season's operation began.

Three men were killed and seven persons, including two children, were injured when a fire tube boiler of the stationary locomotive type exploded at a semi-portable sawmill installation in the Allentown district of New Hampshire on July 3. Fragments of the boiler were found 500 feet from the wrecked mill. The crown sheet collapsed because of overheating.

At a combination sawmill and cotton gin operated at Trotville, North Carolina, three men were killed on August 14, when the mill building was destroyed by a boiler explosion.

One man met his death and eight were injured on June 29, when a sawmill boiler exploded on Marrowbone Creek near Williamson, West Virginia. The man who was killed was crushed beneath the falling walls. Those who were injured were working nearby and all were scalded. Parts of the boiler were hurled through the air and buried in a hillside several hundred feet away.

Ells on Blow-Off Pipes Fail

Two recent accidents have been reported to ell of blow-off pipes. At a Tennessee coal mine, one of these fittings in the blow-off pipe of a horizontal tubular boiler exploded in the furnace, the blast sending flame and steam through the furnace doors. An ash handler who was in the pit in front of the boiler, loading ash into a wheelbarrow, was killed. After the accident, he was discovered about 15 feet from the boiler, where he had either crawled or been blown. His body was severely burned and scalded. The pipe and ell were believed to have overheated because of sediment.

A similar accident occurred at the plant of a Maine woolen company. This time a fireman who was standing near the furnace doors was blown across the floor, his face was burned, his hair singed, his lungs filled with gas and steam, and his left shoulder strained. The fractured ell was replaced, but four days later a similar accident occurred, fortunately without injury to any one.

In each case the piping was made of cast iron.

Care and Operation of Unfired Pressure Vessels

By E. R. FISH, *Chief Engineer, Boiler Division*

WITH modern methods of manufacture there has arisen an increased demand for unfired pressure vessels of varying sizes and shapes, some of them subject to great pressure, to attack by acids or caustics, and to wear from stirring devices. The safe operation of such vessels depends on precautions which start at the time the vessel is designed and continue until it is relegated to the scrap heap.

Safe operation often depends upon using materials and methods of fabrication which will permit long life without the exasperation of leakage and other minor failures, not to mention more serious difficulty. Troubles because of improper material and workmanship may be largely avoided by purchasing from reliable makers.

The various indicating and control devices, with which practically all pressure vessels are provided, must not be neglected. These may include safety, relief, reducing, inlet and outlet valves, and instruments for recording pressures, temperatures, liquid levels, etc. Such devices are for the guidance of the operators who must understand their functions and know how to handle the vessel accordingly. Particularly in the case of the more dangerous processes is this important, for there an increased hazard to life and property is involved.

Deterioration of a once sound vessel may occur because of corrosion, erosion or "fatigue of the metal". Defects may develop and be hidden because of inaccessibility or the presence of rubbish in contact with the vessel. Some processes also lead to objectionable accumulations within the vessel.

Corrosion is most often caused by every-day rusting due to the presence of moisture in rubbish or dirt which may be allowed to accumulate against the vessel. Of course, there is internal corrosion in food packing and chemical processes, but this corrosion is or should be definitely anticipated. It is the unexpected corrosion due to poor house-keeping that is most likely to escape notice. Erosion is caused by internal rotating parts (see *THE LOCOMOTIVE*, July, 1933, Page 194) and sometimes by the rapid flow of liquids, especially when charged with suspended solid matter. The inherent dangers to specific vessels from erosion should place their operators on guard. Changes in pressure and temperature which take place many times in the life of a vessel produce weaknesses which are not easily detected.

Every part of an unfired pressure vessel should be accessible for inspection. Not infrequently parts of vessels are embedded in concrete

as a convenient method of support. Because concrete and steel have different coefficients of expansion, space will develop between them and moisture and dirt will collect. Erection close to walls is another handicap to proper inspection of the exterior surface. Obviously the presence of rubbish in contact with such a vessel constitutes a hazard. With relation to accessibility, it is also necessary to provide one or more openings to the interior of the vessel in order to detect corrosion, erosion or the dangerous accumulation of process materials. Sometimes faulty erection results in this opening being obstructed in such a way as to render it useless. Where internal corrosion or erosion is noted, a trained inspector can direct the drilling of "telltale holes" (See THE LOCOMOTIVE, January, 1929, Page 136) from outside the vessel at points where the most serious weaknesses are suspected. Then, when the vessel has worn sufficiently from the inside it will cause leakage at the "telltale holes"—a signal that the vessel is nearing an unsafe condition. It should be emphasized that persistent leakage, the cause of which is not perfectly obvious and which does not yield to simple methods of repair, should be regarded as almost positive evidence of the presence of serious corrosion or cracks.

It is wise when unfired pressure vessels are required to:

1. See that they are properly designed.
2. Purchase them from reputable manufacturers.
3. Install them so they are accessible and free from deteriorating influences.
4. Entrust their care to competent operators.
5. Have all equipment inspected frequently by competent men.

Chemical Still Explosion

THE explosion of a still used at a chemical plant resulted some months ago in property damage exceeding \$5,000. The cause was the accidental blocking of the pipe connected to the pressure relief arrangement, and the subsequent building up of steam pressure in excess of that for which the vessel shell was designed.

As shown in the accompanying diagram, steam was supplied to a chest beneath the still proper at a pressure of about 150 lb. Steam also was supplied to coils within the still, and through a third connection steam could be introduced to mix directly with the chemicals at such pressures and in such amounts as the operators deemed desirable. Due to the tendency of the chemicals to congeal at room tempera-

ture, it was customary, when starting, to admit steam to the shell as well as to the coils and the jacket in order to liquefy all of the still's contents. It was thought by investigators that the safety relief pipe was stopped up by the congealed material in the still at the time of the accident. In any event the safety relief failed to work and pressure built up within the vessel until the head gave way.

The still was 5' 6" in diameter and 9' 8" long and the steam chest below it extended almost its entire length. Steam at the boiler pressure

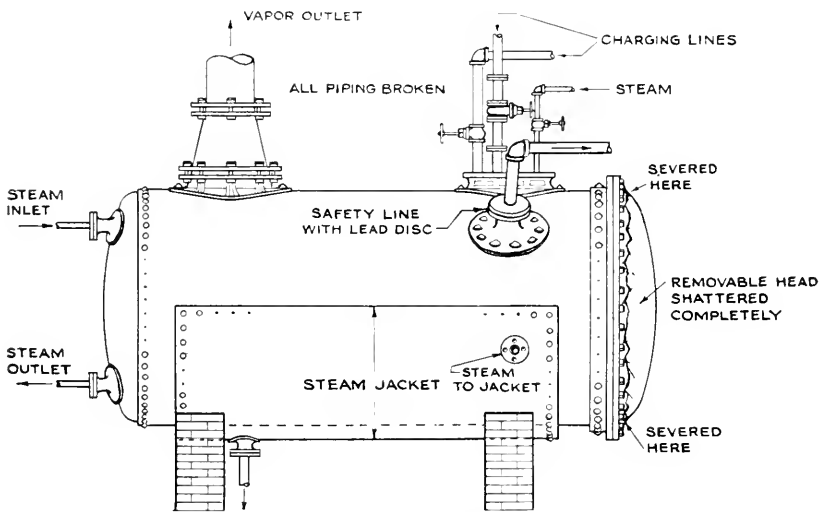

Figure 1—Diagram of still showing steam lines and head which failed.

of 150 lb was used in the jacket and coils; and as the supplementary line leading to the shell contained no reducing valve, it was possible, with the relief valve inoperative, to subject the shell of the still to boiler pressure.

The force of the explosion shattered a removable cast iron cover at one end of the still and caused the rest of the vessel to leave its foundation and go hurtling across the plant. The connecting piping, which included a 10" diameter vapor pipe, was completely severed and the vessel itself passed through a brick wall where its progress finally was checked by a large storage tank. The parts of the cover were blown through the building, causing considerable damage.

The relief pipe on the still contained a lead disc which was expected to act as a safety valve. It was the opinion of investigators

that the chemical mixture had congealed in this pipe as well as elsewhere in the still and had prevented the functioning of the emergency pressure-relieving disc. To minimize the risk of a similar accident in the future, it was deemed advisable that the safety relief pipe be installed near the steam inlet to the shell itself in order that steam would enter the still above the contents in such a way that the space under the lead disc would be kept clear. In addition, a safety valve and also a reducing valve set at about 30 lb were recommended to be installed on the steam line to the still. This would make it less likely that boiler pressure would build up within the shell.

Digester Stock Opening Plate Blows Out

Blowing out of a stock opening plate in a rotary digester in the plant of a Missouri paper board company on March 21, 1934, resulted in the death of one employe, injury to another and considerable damage to the plant.

The digester had been under pressure about one hour when one of the 60"x36" stock plate openings, originally made of 9/16" metal, failed. It was found that the plate had wasted to 1/8" at the edge, finally becoming so weak that it bent over on one side and blew out. There were two stock opening plates in this digester, one of which was always in use and in very good condition. The one which failed had apparently not been removed since the digester was installed.

The force of the explosion lifted the digester from its setting and damaged the steel supports and wooden planks of the second and third floors of the building. In addition, a portion of the corrugated iron wall was blown out.

The man who was fatally injured was hurled down a stairway from the second floor and landed very near the digester. He apparently inhaled some of the hot steam. The other man was not so near the object but suffered burns on the hands.

Air Cooler Tube Rupture Leads to Diesel Accident

A copper tube ruptured inside the intermediate air cooler of a compressed air system at a Texas cotton oil plant. The cooling water happened to be the same as that used in a Diesel engine. When the air tube burst, air at 250 lb pressure filled all water jackets of the Diesel and choked off the cooling water, causing the exhaust manifold "T" of one cylinder to overheat and to crack inside all the way around. The oil plant lost 31 hours' production as the result of the accident. The failure was attributed to a thin spot in the wall of the copper tube.

Dismantled Inspection of Steam Turbines

By T. B. RICHARDSON, *Chief Engineer, Turbine and Engine Division*

THE regular inspection of steam turbines at times when they may be dismantled is a factor that is absolutely essential in the interest of safe and continuous operation. The time that may elapse between these inspections is dependent upon many conditions and is not the same in all plants. Some may have more favorable steam conditions with less "carry-over" of deposits that form scale on the blades. In such plants a dismantled inspection of the turbine may not be required as often as in a plant having less favorable steam conditions. In general, however, it is desirable to dismantle the machine for a complete inspection once each year. This is necessary in order to obtain the highest possible efficiency of the unit, and should be made even though the unit may not have been operated continuously. Internal corrosion, as the result of a leaking throttle valve, may be more serious in an idle turbine than in one operated continuously.

The importance of dismantled turbine inspection is stressed because experience has shown that careful internal inspection frequently reveals serious conditions that could not otherwise have been detected. A recent good example of this was the case of a 2,000 kw turbine, the internal inspection of which probably avoided a costly accident. Following a serious unbalance of the rotor, the unit was shut down to determine the cause. Buckets were found to be broken off at three different places on the third stage wheel. The loss of these buckets was the evident cause of the unbalance. A close examination of this third stage wheel revealed a crack $7\frac{1}{2}$ " long which started from one steam equalizing hole near the rim of the wheel and extended circumferentially to a point within $1\frac{1}{2}$ " of the rim. The incident emphasizes the fact that every wheel should be closely examined and even subjected to a whitewash test following the breaking off of any of its buckets, for the lateral or nodal vibration of the disc which sometimes causes buckets to break off can also cause cracking in the disc.

In the above case it was fortunate that the buckets broke off first and caused the unbalance of the rotor before the crack extended through the wheel rim. Heavy property damage and possibly loss of life might have resulted if the crack had severed the wheel rim while the unit was in operation, thereby causing a section of the wheel to break out and come through the casing. This particular unit had not been dismantled for two years.

Unlike many other prime movers, a turbine is almost totally enclosed. The blading, the governor, the control valves, the thrust

bearings and other important parts are hidden from sight. For this reason it is necessary to dismantle the unit regularly to ascertain the actual condition of the vital parts. A thrust bearing failure, with its resulting serious damage to rotating parts, is frequently the result of buckets becoming clogged with deposits to such an extent that the area of the steam passages is decreased. This causes an increase in pressure ahead of the restricted areas which, in turn leads to additional end thrust. This overloading of the thrust bearing eventually brings trouble.

Of course, it is true that for any particular load a comparison of steam flows, and pressures that can be obtained beyond the steam inlet may indicate that internal changes of some sort are taking place. Nevertheless, there is no certain way of knowing, absolutely, the condition of all internal parts other than by dismantling the unit so that these parts may be seen.

During an internal inspection the condition of the valves should be definitely ascertained. It is important also to determine the extent of any erosion or corrosion, the wear of any part (with clearances measured), and the extent of any accumulation of deposit. To obtain this information the following parts should be examined:

Blading, nozzles, shaft packing, throttle valves, steam strainer, trip valves, control valves, main bearings, thrust bearings, main governor, emergency governor, flexible couplings, the atmospheric relief valve, non-return valves, the oil pumps and their worm and gear drives, and the auxiliary oil pump.

The oiling system, including the piping, should be given a thorough cleaning following the examination.

An inspector, trained in the work of detecting trouble signals, should be present at every such inspection. It usually is considered advantageous also to secure the services of the manufacturer's erector to direct the dismantling of a steam turbine and to confer with regard to any necessary changes or renewal of parts, and finally to direct the reassembly of the unit.

Experiment with Fly-Ash to Clean Turbine Blades

For removing the scale deposits that form on turbine blades over long periods of operation, sand blasting is effective, but also destructive of the blading itself, according to an article in *Electrical World*. Pulverized coal, blown with compressed air, will do the job, but the particles are not hard enough to do it speedily. Scraping by hand is satisfactory and also very slow.

At the Cahokia plant of the Union Electric Light & Power Company, St. Louis, Missouri, a new method of blade cleaning was recently tried. Fly-ash was used in a gunite blower to clean the turbine rotor of a 50,000 kw unit. Results were

very satisfactory, only two men being required to do the entire job in about half the time formerly required for scraping. To verify the expectation that the ash would not seriously wear away the metal, a spare blade was weighed on a laboratory balance before and after cleaning. Calculations, according to Edward Luxemburg of Union Electric Light & Power, showed that less than 0.0005 in. of metal was worn away.

Water in Casing and Slipping of Wheel Damage Small Turbines

SERIOUS wrecks caused by water entering the cylinder through the exhaust connection are encountered every now and then with steam engines. A case of this sort is described elsewhere in this issue. This cause, however, is not so commonly involved in steam turbine mishaps, so a recent accident to a 270-hp machine at an Ohio steel mill may be of interest to readers having small turbines under their care.

This turbine, which was used to drive a circulating pump, had its exhaust piped into two open water heaters. Failure of the device for regulating the level in one of the heaters permitted an influx of water sufficient to back up into the turbine. As a result both the lower and the upper casings were cracked. In order to avoid a recurrence of the accident the engineer has installed a device that is intended to give warning should the water in the heater rise beyond a safe level.

Another interesting turbine accident occurred on April 1, 1934, at an Ohio packing house. Strange noises had been heard in the 100 kw machine for several weeks before the date of the examination. When the casing was lifted, the wheel in the last stage was found to have moved longitudinally on the shaft about $1\frac{1}{8}$ inches, the key was out of the shaft, the buckets and shroud bands were dented, and the steam end roller thrust bearing was broken. Apparently, the key, which was found at the bottom of the casing, had dropped out of the shaft when the wheel became loose and moved lengthwise on the shaft far enough to release it. This key lodged between the wheel and the casing, causing the damage to the buckets. The slipping of the wheel on its shaft was attributed to the fact that there was an improper shrink fit which permitted the wheel to become loose when the unit was being started and before the shaft had reached the same temperature as the wheel.

CHARITY IN REVERSE

First 'Bo: "Some people ain't got no heart."

Second 'Bo: "Didn't you get nothin' at that house you just hit?"

First 'Bo: "Naw. You know my line about needin' help 'cause I was lookin' fer my family that I hadn't seen fer years? Well, she just said she didn't know my family but cert'n'y wasn't goin' to help bring any such calamity on 'em."

Slug of Water Blamed for Engine Wreck

A 350 hp single-cylinder steam engine with a 15' flywheel was totally wrecked on September 7, 1934, at a Virginia trunk manufacturing plant. The operator had stepped into the adjoining boiler room, when the crash occurred. By the time he had reached the engine it had come to a sudden standstill—in the condition shown in the photograph.

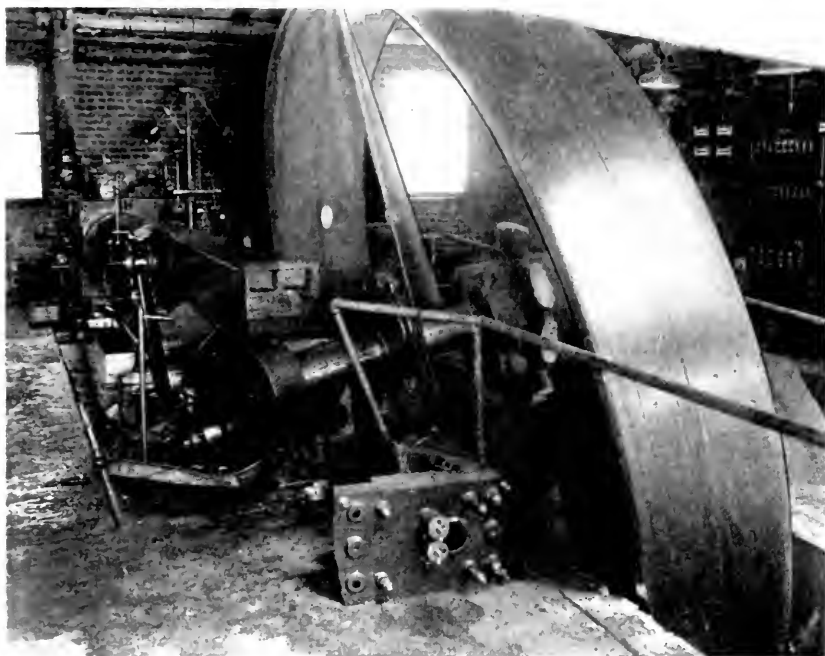

The engineer heard a crash; he returned to this wreck.

The frame was broken across the bottom of the main bearing pedestal, the shaft was bent, the wheel had dropped down into the pit and the sudden halt had caused all the arms to snap off. The cylinder was wrecked and most of the reciprocating parts were either bent or broken. The engine, the cylinder of which was 18" in diameter, seemed to have been operating smoothly at the time of the accident under a light load and at a speed of about 90 r.p.m.

Although it was difficult to assign a definite cause for the accident, its characteristics seem to point to the occurrence of a sudden shock, probably from a slug of water entering the cylinder. The engine exhausted into an open type feedwater heater and the installation was

such that water flowing back from the feedwater heater could have been sucked back up into the engine cylinder under just the proper conditions. It was reasoned that in some way the load was lost from the engine, and as the steam was cut off the piston acted to a certain extent as in a pump and drew water back into the cylinder.

Freight Locomotive Explosion Fatal to Three

The explosion of a large freight locomotive operated by the Denver and Rio Grande Western Railroad, near Price, Utah, on August

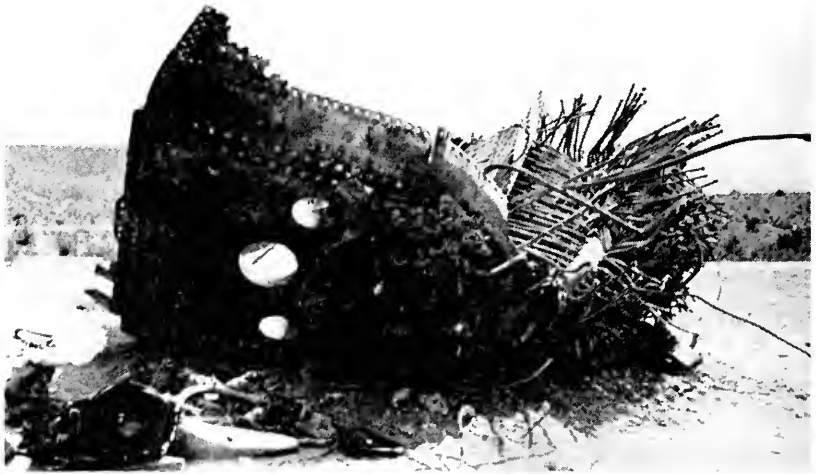

Part of locomotive's crown sheet and left wrapper sheet.

18, 1934, caused the death of three trainmen, and resulted in the derailment of eight cars and damage to freight and livestock.

The men who were killed were the engineer, the fireman, and the brakeman. There were between 65 and 70 transients on the 61 cars that made up the train, but none of them was injured.

The entire rear of the locomotive was blown away and the barrel of the boiler was hurled 1,200 feet. The running gear traveled some distance on the tracks before it derailed and overturned, tearing up tracks for a distance of between 500 and 600 feet, and causing an interruption of passenger service on the line.

The engine had been climbing a 2% grade from Greenriver, Wyoming, and had traveled about 200 feet on the level track when the explosion occurred.

Accidents to Air Line and Air Tanks

VIOLENT accidents to an air line and to air tanks in recent months should serve as reminders of the hazard that exists in such containers.

Where investigations were made, the lack of or failure of a safety valve was blamed in several instances; one accident was attributed to defective welding of the tank and another to corrosion.

At a Pennsylvania colliery a 4" pipe line in the engine room at a power plant burst and pieces were hurled through the roof. Every pane of glass in the building was broken and the town was shaken by the explosion. The line carried compressed air into the mine. Except for putting the engine out of running order the accident did little damage.

Garages and oil stations seemed to sustain the largest number of accidents, probably because there are so many places of that class using compressed air apparatus.

Buildings in the vicinity of the county fair grounds at Valparaiso, Indiana, were shaken when an air tank on the second floor work shop of a highway department garage exploded. The tank was 3' long and 1' in diameter, and according to witnesses was blown 100 feet into the air, scattering shingles in all directions. This explosion was attributed to the fact that the automatic cut-off failed to shut down the compressor at the proper time.

Metal walls were twisted and glass was shattered when a compressed air tank used in a filling station at Louisville, Kentucky, blew up. Strips of metal tore holes in a frame house across an alley. According to the newspaper account, there was no safety valve on the tank.



The air tank happened to go upward.

The explosion of an air compressor tank in a Kansas garage tore a hole as large as a door through a brick wall, caved in a furnace and blew the doors of the room outward.

At St. Louis, Missouri, such a tank, 2' in diameter and 6' long, smashed a three-foot hole in the roof of the one-story garage where it was housed. The vessel shot up about 100 feet into the air, according to witnesses, and in its descent plunged halfway through the roof of another part of the building. The tank was intact except for a rent in the lower head.

In a New York garage a similar accident shattered windows, damaged the stairway and several cars in storage.

At Davenport, Iowa, the wife of a service station proprietor narrowly escaped serious injury when a tank for storing the air used in cleaning radiators exploded while she was near it. The force of the explosion hurled a 100-lb can of grease into the air and it came down beside the woman. The tank itself was thrown against the ceiling, breaking rafters and tearing out a section of the wood floor of the attic. Bricks were knocked from the outside wall of the building and fell to the street below. Defective welding was blamed. This tank was 5' long and 2' in diameter. It was intended for a pressure of 300 lb. The original rupture occurred, apparently, in the longitudinal seam close to the bottom head, this head blowing out.

A 150-lb head of an air receiver was hurled more than a block and through two roofs when the tank exploded at a Denver monument works. The back of the building was blown away, and all windows in the plant and in two nearby houses were shattered. The head went out through the roof of the works and came down on the roof of a residence, tearing a hole 6' in diameter in the latter and narrowly missing two children.

An explosion of a vertical air tank in a bakery at Belleville, Illinois, resulted in approximately \$2,000 damage to the building. The vessel, which was connected to a compressor in the basement, was projected upwards through two floors and crashed against the ceiling of the third floor. The tank was about 18" by 60". The lower head blew out. One theory was that the safety valve was inoperative.

When a portable air tank used on repair work in front of a Hudson, New York, store exploded, parts of a machine to which it was attached were hurled in all directions, smashing plate glass windows and doing other damage to stores on both sides of the street. The fact that the accident happened at 3:30 A. M. probably explained why no persons were injured.

Switchboard Ruined by Short Circuit and Fire

AN UNUSUAL load change which they noted on the instrument board of a main station caused operators of a Michigan utility to rush to an automatically controlled hydro-electric station shortly before midnight on July 22, 1934. There they found the rear of the switchboard ablaze and the room filled with smoke. When they had put

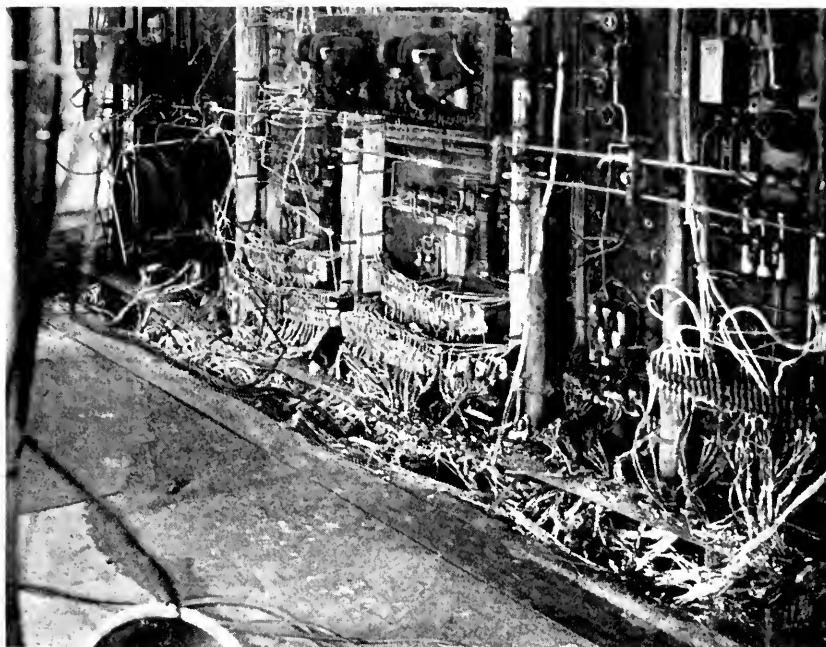

Switchboard wrecked by a short circuit and fire.

out the fire with chemical extinguishers, they saw that practically all equipment on the rear of the board had been ruined. The accident, which led to approximately \$3,000 loss, was attributed to a short circuit in wires in a trough at the foot of the board.

The operators discovered also that a 3,500 kv-a generator which was on the line was running as an induction motor, the fire having burned off the leads to the governor trip coil, thereby de-energizing it and moving the governor to full "off" position which closed the water wheel gates. The generator was removed from the line by tripping the main oil circuit breaker by hand.

A switchboard was improvised after about 24 hours of work and the generator returned to service.

Vapor Explosion Reported in Large Air Line

FOLLOWING the publication in the July issue of THE LOCOMOTIVE of an article on "Combustible Vapor Explosions in Air Receivers" by W. D. Halsey, Assistant Chief Engineer of the Boiler Division, a letter was received from the plant engineer of a large eastern manufacturing concern, commenting on the article and mentioning the fact that the experience of his company had led to conclusions essentially the same as those reached by Mr. Halsey.

That company had its attention directed to this hazard when about 700 feet of extra heavy 12" pipe, which was a part of the compressed air system, exploded. The pipe was buried three feet deep in the earth and for a considerable distance was laid under a concrete roadway. The force of the explosion opened up a trench from six to ten feet wide along the entire length of the pipe, which was torn to pieces. Considerable damage was done to adjoining buildings by the flying blocks of concrete from the road.

The explosion occurred when very little air was being used. The engineer in charge had just filled the lubricator on the compressor and was walking back to the discharge end when the pipe outside the powerhouse blew up with a roar. Fortunately no one was injured.

The two factors which the engineer regarded as significant in his investigation were the presence of lubricating oil in the pipe in some quantity, and the fact that little air was being used at the time of the explosion.

It appears that the compressor had for some months been running continuously, and doubtless more lubricating oil had been fed into the machine than was necessary. It is possible, therefore, that there were in all parts of the system considerable accumulations of oil and greasy deposits. With continuous operation of the compressor, leaky discharge valves could readily develop, thereby causing an increase in temperature of the discharge air. The theory is that this high temperature air in continuous contact with the oily deposits would cause slow decomposition of those deposits, and at some time an explosive mixture would develop. With a continuing increase in temperature of the discharge air, the point would finally be reached where the explosive mixture in the pipes would be ignited spontaneously. An ignition of an explosive mixture at one point in the line may set up pressure waves which will cause rupture of the pipe at other points, even though no actual explosion occurs at those points.

Sea water pumped at the rate of 26,000 gallons a minute through a plant on the North Carolina coast is yielding half a million pounds of bromine a month.

Violent Explosions of Compressed Air Receivers

(Reprinted from *Vulcan*, Journal of the Vulcan Boiler & General Insurance Co., Ltd., Manchester, England)

WITHIN the last few months two explosions of receivers containing compressed air occurred at two different works in the same town, and they demonstrate in no uncertain manner that the hazard of explosions from this type of pressure vessel is a real one, and should be guarded against by taking all possible precautions.

The first explosion was from a vertical air receiver of riveted construction, 5' in diameter and about 10' high, the upper end plate being outwardly dished and the lower end plate inwardly dished.

The compressed air was supplied by two air compressors, one of which was steam-driven and the other belt-driven. The former compressor had an automatic valve in connection with the air receiver which operated the throttle valve of the steam cylinder when the air pressure exceeded 80 lb per sq in. The belt-driven compressor was provided with an automatic valve operating the suction valves on the compressor. In addition to these two cut-out devices, the air receiver was fitted with a safety valve.

At the time of the explosion only the steam-driven compressor was charging the receiver, and compressed air was being used from the receiver for the usual works purposes.

Without previous warning, the receiver, with the exception of the bottom end plate, shot through the roof of the building, in which it was housed, to a height of about 100', and in its flight came in contact with some obstruction which damaged the shell.

The bottom end plate was found embedded in the ground with its original inward camber reversed and the rivets which secured the end of the cylindrical shell torn away. Considerable damage was done to surrounding property, but fortunately there was no serious personal injury.

It is reported that the cylindrical shell and end plates appeared to be free from wasting to any serious extent, and that only a slight trace of oil could be seen on the bottom end plate, while the cylindrical shell was quite clean. Owing to the bottom inwardly dished end plate being blown out, it is unfortunate that the exact (original) curvature of the plate could not be determined. From the information available however, it is evident that the dished end had a very large radius as compared with the diameter of the vessel, and on account of this formation it is probable that failure was due to bulging at the normal working pressure.

Inwardly dished ends require careful consideration in design in order to insure that they will not bulge when subjected to the working pressure. The determination of the safe working pressure primarily depends upon the following:—

1. Radius of curvature of end plate.
2. Thickness of end plate.
3. The ratio of radius of curvature and the thickness of end plate.
4. Radius of knuckle at the flange connecting the end to the cylindrical shell.
5. Tensile strength of the material.

Each of the above should be taken into consideration when assessing the safe working pressure. Many inwardly dished ends have bulged and failed through a lack of a proper understanding of the conditions which affect their strength and resistance to bulging and collapse.

The second explosion, which occurred in the same town four weeks after that just described, was from a vertical air receiver of riveted construction, 3' 6" in diameter and 8' high, with the upper end plate outwardly dished and the lower end plate inwardly dished.

The compressed air was supplied by a steam-driven air compressor. The compressor was not provided with an automatic valve, but there was a safety valve which lifted at 100 lb per sq in. attached to the air receiver. This safety valve was stated to be in satisfactory and free working condition, and frequently lifted at a pressure of 100 lb per sq in.

At the time of the explosion the air compressor was charging the receiver and compressed air was being withdrawn from the latter. As a consequence of the explosion the bottom end plate collapsed, and its original inward curvature was bulged to outward curvature, and 64 of the 72 rivets failed in the circular seam. The rivet heads on the outer side of the shell left the rivet shanks. As a result of the explosion, damage was done to the wall and roof in which the compressor was housed and to adjacent property.

As far as could be seen there was no wasting of any extent in the air receiver, either internally or externally, but an appreciable amount of grease deposit was found inside the receiver. The end plate which failed appears to have been of sufficient strength for withstanding the normal working pressure, and it is probable that excessive pressure was produced by an explosive mixture resulting from ignition of oil fumes.

It may be remarked that the air receivers above referred to were not under independent inspection, and insurance.

Another explosion damaged an air receiver of somewhat less dimensions than the two cases previously described. In this case the receiver was 2' 6" in diameter and 6' high, and the joints were riveted throughout. The bottom end was provided with an inwardly dished end plate, and the normal working pressure varied from 75 lb to 100 lb per sq in. Shortly before the explosion, which occurred without warning, the pressure gauge indicated 75 lb per sq in. As a result of the explosion, the bottom end of the vessel was blown clean out, while the vessel itself was projected upwards and fell some distance away.

Upon examination it was found that the camber of the blown-out end had been reversed, showing that the pressure had been excessive. The rivets and part of the flange were also torn away.

From a consideration of the circumstances there can be little doubt that this explosion was due to the sudden ignition of gases given off by an accumulation of grease which had collected in the receiver. It may be mentioned that after the explosion the receiver was found to be coated with grease to a thickness of at least 1/16".

Accumulation of grease and carbonaceous dust is not an infrequent cause of air receiver explosions, the grease being derived from the lubricant used in the air compressor. Deposits of this kind under the influence of the heat due to air compression are liable to undergo a process of spontaneous combustion and the gases generated combining with the compressed air eventually ignite, causing a sudden and intense pressure which the vessel is quite incapable of resisting as in the case under review.

Ordinary Hot Water Storage Tank Bursts in Bank

When the top head seam of a hot water storage tank used in a Dorchester, Massachusetts, bank broke out, several hundred dollars property damage occurred, but luckily no employes or others were injured. The tank was of the ordinary storage variety with the hot water supplied by a gas-fired coil water heater operating under city pressure of about 70 lb. It was found that the heater had been started early in the evening, and apparently had been forgotten. The tank exploded after the heater had been operating for about 1¼ hours. It destroyed a toilet room and fixtures, breaking sewer pipes, and blowing an iron sink across the room. Considerable plastering was dislodged and light partitions were displaced. Basement doors and windows were blown from their hinges, one of the plate glass windows in the front of the building was broken, and the ventilating duct in the basement collapsed due to the concussion. Starting at the top head, the rupture ran downward through the shell about 18". The shell then tore open spirally in a long strip from 12" to 18" wide to within about 3" of the bottom seam. The bottom head was left intact at the end of the long strip.

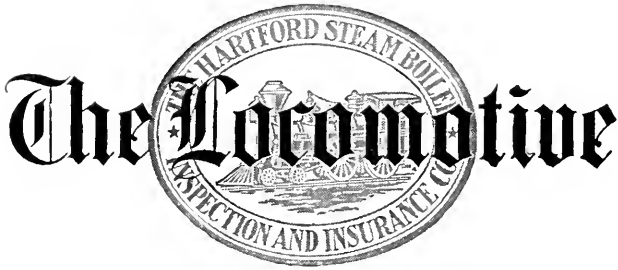

A QUARTERLY MAGAZINE
DEVOTED TO POWER PLANT PROTECTION

George H. Prall, *Editor*

Copyright 1934 by The Hartford Steam Boiler Inspection and Insurance Company

HARTFORD, CONN., October, 1934

Single copies may be obtained free by calling at any of the Company's agencies.

Subscription price 50 cents per year when mailed from this office.

Recent bound volumes one dollar each. Earlier ones two dollars.

Reprinting matter from this paper is permitted if credited to

THE LOCOMOTIVE of THE HARTFORD STEAM BOILER INSPECTION AND INSURANCE CO.

Change of Managers at Pittsburgh

George S. Reynolds, manager of the Pittsburgh department of the Company for more than 15 years, retired from active service on October 1. During his years of service, Manager Reynolds gained the respect and friendship of a host of agents and business men in his territory, his unusual personal endowments fostering a close feeling between the Company and its clients. Mr. Reynolds was born in England on November 19, 1866. He joined the Company as a special agent in the Pittsburgh department on October 15, 1913, and on July 1, 1919, was promoted to the rank of manager.

The Company has selected as his successor one who has been closely associated with him, William P. Wallace, who has been identified with the Company for nearly 40 years and who for several years has been the Pittsburgh department's assistant manager. His broad knowledge of the business and his competent handling of responsible work over a long period thoroughly equip him for his new duties. He is personally known to many policyholders in the Pittsburgh territory, who



GEORGE S. REYNOLDS



WILLIAM P. WALLACE

recognize his thorough knowledge of the Company's lines and his administrative ability.

Manager Wallace began his long period of work with the Company July 5, 1895, serving first in a clerical capacity and later as a special agent. Transferred to the Pittsburgh office on August 16, 1929, he has remained there since that date as assistant to Manager Reynolds.

The Pittsburgh department serves policyholders in Southwestern Pennsylvania and West Virginia.

George N. Delap Retires

After more than 45 years of service with The Hartford Steam Boiler Inspection and Insurance Company, George N. Delap, dean of special agents, retired on October 1. More than 81 years of age, Special Agent Delap has kept active to the day of his retirement, continuing till then his excellent sales record. Mr. Delap served manufacturers and business men in western Massachusetts and eastern Connecticut where he had formerly worked as an inspector for the Company. He has won a host of friends through the years of his service. They are sorry to miss his contacts, but congratulate him on his well-earned rest.

Mr. Delap was born December 1, 1852, in Nova Scotia. He joined the Company as an inspector in June, 1889. His appointment as special agent in March, 1917, was the natural outcome of his efficient and satisfactory service to policyholders as an inspector.

A Thirty-third degree Mason, Mr. Delap's friends in Masonic

bodies are legion. His Masonic history is impressive. He was raised in St. John's Lodge No. 4, A. F. and A. M., Hartford, Conn., November 16, 1892. He is a member of the Chapter, Past High Priest of the State Grand Chapter, at present Grand Treasurer of the Grand Chapter; member of the Council; member of the Commandery, of which he was Eminent Commander in 1899, is at present Lieutenant Commander of the famous order of Malta Degree Team of Washington Commandery, a post he has held for 35 years; is a member of Charter Oak Lodge of Perfection, Hartford Council Princes of Jerusalem and Cyrus Goodell Chapter of Rose Croix of which he was Most Wise Master from 1901 to 1905, a member of the Connecticut Valley Consistory, a Noble of Sphinx Temple and Honorary Member of the Supreme Council, A.A.S.R., Northern Masonic Jurisdiction, 33°.



GEORGE N. DELAP

Drummond O. Scott

Those clients of the Company who became acquainted with Inspector Drummond O. Scott during his many years of activity in the Chicago district will receive with regret this announcement of his death. Mr. Scott passed away on July 31, just five days before his eighty-sixth birthday. He was retired August 5, 1925, after having served the Company's interests in the Chicago department forty-three years. Prior to his coming with this Company, he was successively a marine and stationary engineer.

Dr. Dayton C. Miller of the Case School of Applied Science has announced a more accurate determination of the speed of sound. His figure: 1,087.13 feet a second.

Steel Mill 15-Inch Shaft Breaks at Progressive Crack

A progressive crack with stresses localized at the keyways was blamed for the fracture of a large shaft 15" in diameter and 17' long, used in connection with a mill roll train in an Ohio steel mill. The accident occurred on May 4, 1934, and consisted of a break in the connecting or extension shaft from the low speed gear coupling to the mill roll train. The part of the shaft which broke was enclosed in a bearing and the accident shattered the pedestal bearing cap, the shell and the pedestal itself.

The two pictures indicate the presence of an old crack at the keyway extending circumferentially about 9" and about 7" toward the center of the shaft. At the opposite keyway there was likewise an old crack which opened up about 1/16" and extended toward the center of the shaft several inches and circumferentially about 5".



Result of progressive crack in 15" shaft.

Ammonia Compressor Cylinder Bursts at Distillery

An operator was killed and two other men severely injured by flying parts of the cylinder of a 12-ton capacity ammonia compressor operated by a California distillery company. The compressor was one of a battery of motor-driven machines of the opposed piston type with the crankshaft in the center. The accident came about when the compressor was started with the discharge valve closed. The cylinder broke girthwise in the center, allowing its head end to break off. The machine was equipped with a relief valve, but this evidently was inoperative.

Glass "silk" or glass "wool" is now used as sound and heat insulation.

One Killed When Seam Fails on Rendering Tank

THE failure of the welded seam on a rendering tank head on May 2, 1934, near Wayne, Nebraska, led to an explosion, which killed an employe, burned the proprietor of the plant, and caused considerable property damage when the head went through the roof. An



Close-up view of welded seam failure.

examination of the seam showed that the welded joint had pulled apart all the way around the head, which was of the unflanged disc type 48" in diameter with a 3" crown. There was a manhole in the head. The tank was 66" deep from head seam to head seam and at the bottom there was a cone 29" long. All joints were welded. The welding was of the butt type both inside and out. At the time of the accident the tank was being operated at a pressure of 60 lb. The character of the failure is shown by the accompanying photograph. The tank did not conform to A.S.M.E. standards for such vessels, and was not insured.

"How has your potato crop turned out, old chap?" asked one ardent amateur gardener of his neighbor.

"Splendid, old man," replied the other, "some are as big as marbles, some as big as peas, and, of course, quite a lot are little ones." *St. Louis Globe-Democrat.*

Oil Burner Melts Cast Iron Boiler into Solid Mass

WHEN leakage developed in the sections of an oil-fired cast iron boiler that was not equipped with a low water cut-out switch, the boiler drained completely and much of the metal comprising the eight sections was fused into a shapeless mass.

The condition was discovered early in the morning in a four story brick apartment building in Waterbury, Connecticut. One

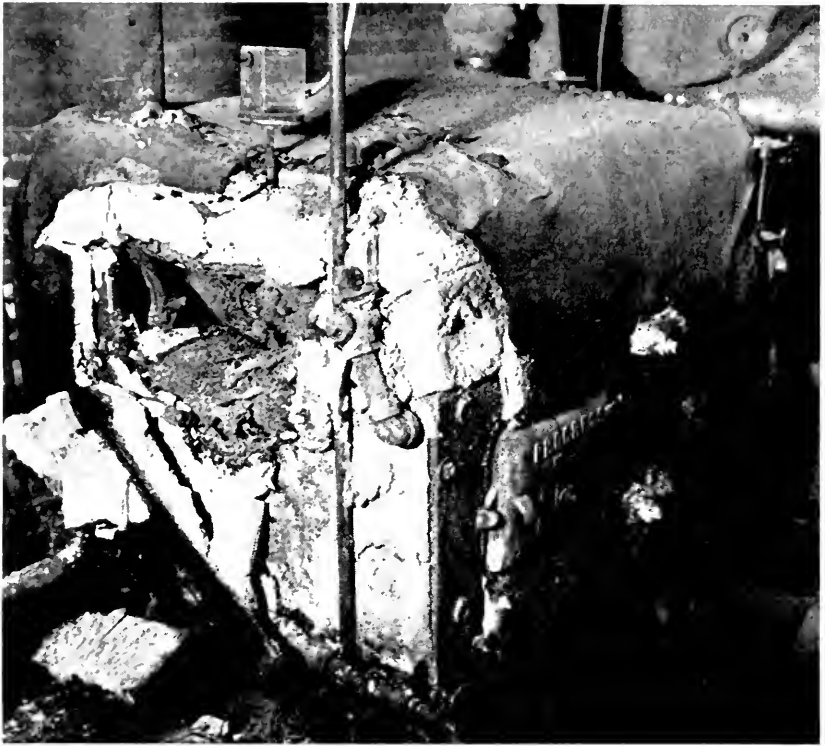

After the boiler drained the oil burner kept on operating. The sections were fused into a shapeless mass.

of the tenants was awakened by the intense heat in his room, which was directly above the boiler. He called the fire department and when the firemen opened the basement door they found the boiler red hot. Because of the intense heat it was difficult to get to the oil burner control switch, but this was finally reached and the burner shut off. That the ceiling of the room had not caught fire was due to the heavy covering of asbestos over the top of the boiler.

Six hours after the oil burner stopped operating the ceiling was still hot and the brick walls of the basement were so warm that the heat could be felt on the outside of the building. The accident and damage had taken place after 2 o'clock in the afternoon of the day previous, at which time an attendant had last visited the boiler room. The water was then at its proper level in the gage glass and the oil burner was in good order.

The boiler and the oil burner were completely ruined and considerable time was lost in getting the remains from the building as they constituted one solid mass of iron. During this time tenants were without heat other than from the gas ranges in their apartments. It cost \$1,200 to replace the heating plant.

Bus Failure Indicates Unusual Chain of Circumstances

The serious damage that occurred to a bus structure during a severe electrical storm some months ago in Northern Ontario followed a chain of circumstances considered by investigators to be unusual. The owners were thought to be fortunate as the loss was only about \$5,500, whereas it might have been many times that amount had the generators been involved.

The cause of the accident probably will never be known, though the indications are that it was associated with lightning. At the time of the occurrence one of the most violent electric storms ever known in the district was raging along the line of the transmission towers. During the storm something occurred on one of the disconnects controlling a 16,500 kva generator operating at 6,600 volts. Evidently the insulator supporting a disconnect failed and the line went to ground. What happened after this occurrence is somewhat uncertain but it is reasoned that four 16,500 kva generators remained on the line supplying energy for the arc, inasmuch as bus bars and disconnecting switches of very heavy capacity were vaporized under the arc and some of them were completely destroyed.

Some burning of the control wiring and the switchboard and bus structure took place and some extraordinary things happened under the failure. For instance, the glass fronts of some of the instruments were blown across the powerhouse floor. These glass fronts were sheared off in a perfect circle as if they had been cut with a diamond.

Her: "You remind me of the ocean."

Him: "Because I am deep, restless and romantic?"

Her: "No, you make me sick."

Taps From the Old Chief's Hammer

THE Old Chief sat looking from the lofty window of his office as lights in the city below him came on through the late afternoon rain. Gusts of wind drove raindrops against the windows with a clatter, but the Old Chief puffed contentedly on his pipe. When the rain stopped he'd go home, but there was no reason he could see for leaving the interesting window only to get drenched on his way to the station.



Tom Preble, his assistant, put his head in the door and commented, "Chief, I'm following your lead. It's raining too hard to leave now. Say, but the city takes on a fascinating look with the rain falling into all those lights."

"Doesn't it, Tom," agreed the Chief. "I like this kind of a rain, even if it does keep me from going home."

"Speaking of rain, though, did you ever know Beadle?"

"No, Chief. Any relation to J. S. at New York?"

"Same man and one of the best inspectors we ever had. I was glad to see him promoted, but hated to lose him here.

"But man alive, how that fellow hated rain! Coincidence or not, he was called out oftener in unpleasant weather than any inspector on the force. Rain to him got to mean trouble.

"Beadle—in those days we called him Beagle because he seemed to have a hound dog's nose for smelling out things that most men would overlook—was one of the best trouble shooters I ever knew, and electrical stuff was his specialty then just as it is now.

"Did I ever tell you about the job he cleaned up down at Harrison?"

"No, Chief," said Preble, thinking that it was a perfect time for one of the Old Chief's interesting stories from his wide experience.

"They had some of those new fangled electric furnaces for making steel castings," said the Chief, plunging into his story. "Ordinarily they handled four heats a night, but some sort of trouble developed and they were having difficulty in getting heat enough for more than three.

"They called the power company serving them, and also wired for a factory service man. When our own agent at Harrison learned about it, he asked us to send an inspector at once, his telegram reaching us

about 4:30 P. M. on a day something like this. Cress, who was handling electrical inspections in the territory, was in the north woods on vacation. There was no chance to reach him, so we telegraphed Beadle.

"Good sport that he is, he replied, 'LEAVING IMMEDIATELY FOR HARRISON STOP ITS RAINING HARD.' He drove most of the night, stopped for a few hours sleep at Champlain and reached the plant about 4:00 P.M. the next day.

"Meanwhile we had been trying to find him to call off the trip. The agent had wired us that the trouble had been located. We later learned that the power company men believed the trouble was in the transformer reactor, but that the factory engineer found the reactor in good condition and blamed the automatic regulator and control to the furnace electrodes. They made some changes and the furnace appeared to be operating better. The agent wired us to that effect.

"I tried to stop Beadle, but he was tearing along through the wet, and Harrison was his destination.

"When he reached Harrison, he was told that the trouble had been corrected, but he decided that having come this far, he'd see the equipment anyway. He found that the operators were still complaining.

"After observing the operation of the furnace transformer and its control, Beadle noted that the reactor tank was operating rather warm for a load of 1100 kv-a on a 1259 kv-a reactor. The cover was removed, but the oil was clear and clean and the terminal connections tight.

"Beadle wasn't satisfied.

"'Have you checked the oil switches?' he asked them.

"Well, no they hadn't done that, but they were going to shut down the furnace. When it was off the line, he could see the switches.

"So the oil switch tanks were lowered, and it didn't take Beadle long to see that there was still something decidedly wrong. His inspection showed that a breaker used to connect the coils in delta was in bad condition, that the movable breaker arm was out of position and had dropped to the bottom of the tank, and that the wood support, threaded at the top and screwed into the metal arm, was damaged, the threads having pulled.

"With the arm on the oil switch broken, the transformer and reactor were operating with only two coils energized instead of three, which accounted for the trouble originally being blamed on the reactor. In addition to everything else the terminal connections were loose.

"Of course, it wasn't difficult to make repairs, as the power company had parts for the switch, but Beadle stayed at the plant, saw a heat through the furnace and was told that things appeared to be operating

normally. I don't think Beadle knows to this day that the oil switches weren't insured, or would he care if he did know, for when once he started on the trail of a thing he stuck with it until he had the answer. The job was one of the sweetest bits of service with a big 'S' that I ever saw.

"But say, Tom, the rain's letting up. Let's go home."

Lap Seam Crack Leads to Utility Boiler Failure

A lap seam crack in a 44" diameter vertical tubular boiler brought about an explosion in a New England utility plant on August 2, 1934, forcing the boiler

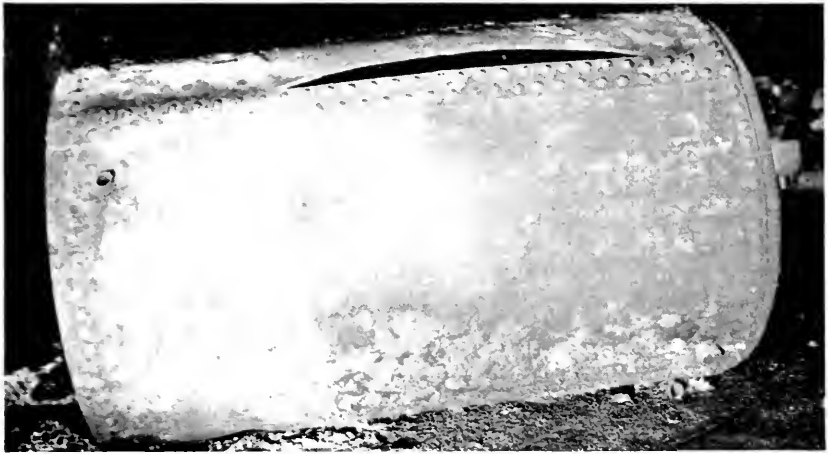

Lap seam crack inconveniences utility.

from its setting and projecting it across the boiler room. The accident caused little damage except to the boiler itself. The nature of the failure may be seen in the accompanying photograph. Following along the edge of the inside lap a distance of 41", the rupture extends from about 7½ inches below the top head seam and to within about 3 inches of the top staybolt. The boiler was under pressure of about 40 lb of steam at the time of the accident.

Two colored boys were having an argument about ghosts. One of them claimed to have seen a ghost as he passed the cemetery the night before.

"What was dishere ghos' doin' when you las' seen him?" asked the doubtful one.

"Jes fallin' behin', mistah; fallin' behin' rapid." *The Associated Magazine.*

Panhandler: "Say, buddy, could you spare a buck for coffee?"

Navy Cook: "A dollar for coffee? Preposterous."

Panhandler: "Just tell me yes or no, Sailor, but don't try to tell me how to run my business."

The Hartford Steam Boiler Inspection and Insurance Company

OF HARTFORD, CONN.

December 31, 1933

Capital Stock, \$3,000,000.00

ASSETS

Cash on hand and in banks	\$ 910,061.17
Premiums in course of collection (since October 1, 1933)	1,150,436.69
Interest accrued on mortgage loans	49,854.06
Interest accrued on bonds	112,262.21
Loaned on bonds and mortgages	851,381.55
Home Office real estate	437,474.66
Other real estate	298,889.83
Agents' ledger balances	18,365.44
Bonds on an amortized basis	\$8,702,210.61
Stocks at "Convention Values"	5,016,676.50
	<hr/>
	13,718,887.11
<i>Total</i>	\$17,547,612.72

LIABILITIES

Premium reserve	\$6,627,478.25
Losses unadjusted	314,677.94
Commissions and brokerage	230,087.34
Other liabilities (taxes incurred, etc.)	502,686.77
Contingency Reserve, representing difference between value carried in assets and actual December 31, 1933, market quotations on all bonds and stocks owned	1,740,000.00
<i>Liabilities Other Than Capital and Surplus</i>	\$9,414,930.30
Capital Stock	\$3,000,000.00
Surplus over all liabilities	5,132,682.42
	<hr/>
<i>Surplus to Policyholders</i>	8,132,682.42
<i>Total</i>	\$17,547,612.72

WILLIAM R. C. CORSON, President and Treasurer

BOARD OF DIRECTORS

LUCIUS F. ROBINSON, Attorney, Hartford, Conn.	SAMUEL M. STONE, President Colt's Patent Fire Arms Mfg. Co., Hartford, Conn.
JOHN O. ENDERS, Chairman Board of Directors, Hartford National Bank & Trust Co., Hartford, Conn.	SAMUEL FERGUSON, President The Hartford Electric Light Co., Hartford, Conn.
MORGAN B. BRAINARD, President Aetna Life Insurance Co., Hartford, Conn.	HON. JOHN H. TRUMBULL, President The Trumbull Electric Mfg. Co., Plainville, Conn.
CHARLES P. COOLEY, Chairman Board of Trustees, Society for Savings, Hartford, Conn.	CURTISS C. GARDINER, Vice-President, The Hartford Steam Boiler Inspection and Insurance Company, 90 John Street, New York, N. Y.
HORACE B. CHENEY, Cheney Brothers, Silk Manufacturers, South Manchester, Conn.	JAMES L. THOMSON, Vice-President Terry Steam Turbine Co., Hartford, Conn.
D. NEWTON BARNEY, Vice-President The Hartford Electric Light Co., Hartford, Conn.	PHILIP B. GALE, Chairman, Board of Directors, Standard Screw Co., Hartford, Conn.
JOSEPH R. ENSIGN, President The Ensign-Bickford Co., Simsbury, Conn.	JOHN J. GRAHAM, Vice-President The Hartford Steam Boiler Inspection and Insurance Co., Hartford, Conn.
EDWARD MILLIGAN, President Phoenix Insurance Co., Hartford, Conn.	
WM. R. C. CORSON, President The Hartford Steam Boiler Inspection and Insurance Co., Hartford, Conn.	

Incorporated 1866



Charter Perpetual

Department

Representatives

ATLANTA, Ga., Citizens & So. Nat. Bk. Bldg.	W. M. FRANCIS, Manager. C. R. SUMMERS, Chief Inspector.
BALTIMORE, Md., 704-9 Garrett Building	D. W. LITTLE, Manager R. P. GUY, Chief Inspector.
BOSTON, Mass., 87 Kilby Street	A. PAUL GRAHAM, Manager. W. A. BAYLISS, Chief Inspector.
BRIDGEPORT, Conn., City Savings Bank Building	W. G. LINEBURGH & SON, General Agents. A. E. BONNET, Chief Inspector.
CHICAGO, Ill., 175 West Jackson Boulevard	P. M. MURRAY, Manager. C. W. ZIMMER, Chief Inspector.
CINCINNATI, Ohio, First National Bank Building	JAMES P. KERRIGAN, Manager. W. E. GLENNON, Chief Inspector.
CLEVELAND, Ohio, 311 Leader Building	ARTHUR F. GRAHAM, Manager. JOHN L. SCOTT, Chief Inspector.
DENVER, Colo., Gas & Electric Building	J. H. CHESNUTT, Manager. F. G. PARKER, Chief Inspector.
DETROIT, Mich., National Bank Building	L. L. COATES, Manager. THOMAS P. HETU, Chief Inspector.
HARTFORD, Conn., 56 Prospect Street	F. H. KENYON, Manager. A. E. BONNET, Chief Inspector.
NEW ORLEANS, La., 333 St. Charles Street	R. T. BURWELL, Manager. P. E. TERROY, Chief Inspector.
NEW YORK, N. Y., 90 John Street	C. C. GARDINER, Vice-President. J. F. HUNT, Chief Inspector.
PHILADELPHIA, Pa., 429 Walnut Street	A. S. WICKHAM, Manager. S. B. ADAMS, Chief Inspector.
PITTSBURGH, Pa., Arrott Building	WILLIAM P. WALLACE, Manager. J. A. SNYDER, Chief Inspector.
ST. LOUIS, Mo., 319 North Fourth Street	CHAS. D. ASHCROFT, Manager. EUGENE WEBB, Chief Inspector.
SAN FRANCISCO, Cal., 114 Sansome Street	C. B. PADDOCK, Manager. L. E. GRUNDELL, Chief Inspector.
SEATTLE, Wash., Arctic Building	E. G. WATSON, Manager. WILLIAM J. SMITH, Chief Inspector.
TORONTO, Ont., Canada, Federal Building	H. N. ROBERTS, President The Boiler In- spection and Insurance Company of Canada.

HARTFORD STEAM BOILER'S

Feedwater Laboratory

A SERVICE TO POLICYHOLDERS
FOR MORE THAN 50 YEARS

Which one of several available feedwaters is best for use in my boiler?

What is an economical and efficient method of treatment for my installation?

Why does my boiler foam and how can this difficulty be stopped?

Why does my boiler pit and corrode and how can I guard against this danger?

Is my present feedwater treatment correct?

Is the water or treatment I am using of the sort that could cause embrittlement?

How best can I avoid deposits of scale in my boiler?

These and many similar problems are submitted to the Hartford Steam Boiler Inspection and Insurance Company laboratory through the 16 department offices of the Company. If you, an assured, have such a question, you are welcome to the assistance of our laboratory, at no cost to you. The Chief Inspector of the department serving you will be glad to discuss your problem. He also will give proper directions for preparing and shipping a feedwater sample.



Vol. XL No. 5

JANUARY 1935

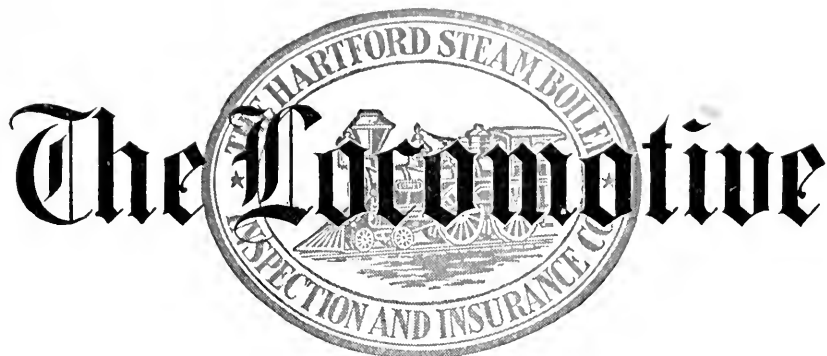

A QUARTERLY MAGAZINE
DEVOTED TO POWER PLANT PROTECTION

Published continuously since 1867
by The Hartford Steam Boiler
Inspection and Insurance
Company

Please show to your Engineer

Boiler Feedwater Problems and Their Correction

THE problem of securing satisfactory boiler feedwater has been an important one since boilers were first used. As far back as 1867 when THE LOCOMOTIVE made its initial appearance, there were extensive discussions in this magazine on subjects relating to scale prevention, corrosion and allied problems. Boilers in use during these earlier periods were operated at relatively low temperatures and pressures and at low rates of evaporation. Under these conditions, the harmful effect of feedwater of poor quality was not severe. As a result of recent trends toward high ratings and pressures in boiler operation, the thorough conditioning of feedwater has become increasingly necessary in some plants and now constitutes one of the major items of control in many forms of industrial activity where the generation of steam is required. However, feedwater is less of a problem in some plants than in others, so that in determining the extent to which any particular plant is justified in equipping itself for the improvement or control of boiler feed, the management must consider its own set of conditions from the economic standpoint. It is the purpose of this discussion to present for our readers some of the more important phases of the problems most commonly encountered, and to suggest procedures for the control and correction of these difficulties—doing this in such a way that the article should be of help in sizing up the problem as it may exist in individual plants.

The Hartford Steam Boiler Inspection and Insurance Company early realized the need for feedwater conditioning, and inaugurated advisory service to assist in improving the efficiency of boiler operation as influenced by adequate feedwater control. The Company was a pioneer in rendering such service and in 1881 established the first feedwater laboratory in the field of insurance inspection. The laboratory established at that time has continued to assist in correcting the feedwater problems encountered by the Company's clients. As developments have occurred in boiler design and operating practice, the laboratory facilities and the service rendered have been expanded to keep pace with such developments. The purpose of this activity is to make readily available, to the Company's policyholders, advice in this field based on its extensive experience and upon research in problems which modern trends have engendered.

The appreciation of this comprehensive service is indicated by the fact that samples of water for analyses and interpretation have been forwarded from companies over an extensive territory and from every state in this country as well as from Canada and from the West Indies.

The many requests for analyses and for technical assistance cover a variety of problems resulting from the use of unsatisfactory feedwater or from inadequate feedwater conditioning. The magnitude and value of the Company's activities is indicated by the fact that during the last six months investigations have been made and assistance rendered to assured companies in matters relating to the following:

- A—The cause and correction of priming and foaming.
- B—The specific reason for excessive corrosion and advice for the correction of this problem.
- C—Adequate control procedure to assure inhibition of "caustic embrittlement."
- D—Analyses of various samples of water to indicate their relative qualities with respect to scale forming or corrosive properties.
- E—The determination of the presence of oil in condensate.
- F—Requests for specific advice on the efficiency and suitability of methods of water analyses, adaptable to the specific operating conditions encountered.
- G—Advice on the relative value of several available sources of water supplies with specific recommendations for use of the waters best suited for boiler feed purposes.

Sources and Composition of Water

The sources of natural water may be divided into two groups:

- A. Waters from the surface.
- B. Waters from underground.

In the first group are to be classed rivers, small streams and lakes, while in the latter group are the spring and well water supplies. The chemical composition of waters varies greatly, not only in supplies of widely scattered districts, but in those supplies which may be in close proximity to each other. For this reason, it is obvious that there can be no generalized water purification system that will be equally satisfactory under all conditions. As a rule, however, surface waters will contain much greater amounts of suspended matter than the underground supplies. The nature and amounts of the chemical constituents dissolved in the water will, also, be greatly influenced by the geology of the territory from which the waters are obtained. The characters of waters are affected further by organic matter extracted from soil or from swamp areas and many supplies, especially surface waters, are affected detrimentally by industrial and domestic wastes.

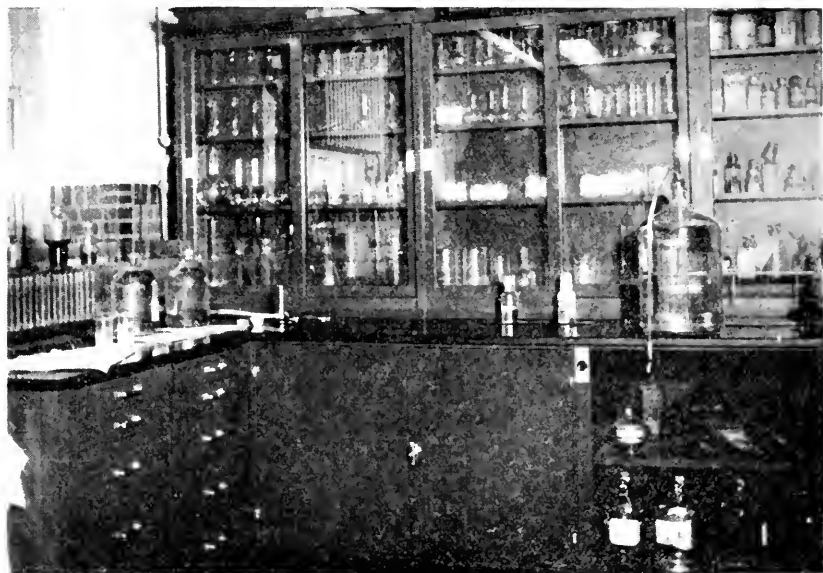

A corner of the Feedwater Laboratory.

There is a great variety of mineral salts or acids which may be present in natural waters. The majority of these constituents are present in such small amounts as to be unimportant from the standpoint of suitability for boiler feedwater. There are, however, a number of ingredients which are highly objectionable and which lower the value of waters for steam generating uses, even when present only in relatively small amounts. The objectionable constituents may be classified into three groups, namely, (a) scale forming solids, (b) acids, or salts which break down into acids at high temperatures, and (c) alkalis which may result in cracking of boiler steel under certain conditions, or cause priming and foaming.

Removal of Scale-Forming Solids

A perfect water for boiler use is one which will not deposit any scale-forming substances, will not corrode the metal of the boilers or fittings, will not lead to "embrittlement", and will result in neither priming nor foaming. A supply of water such as this is never obtainable except by artificial purification, whereby troublesome impurities are removed or changed to less objectionable forms.

INTERNAL TREATMENT—The treatment of water, by boiler compounds or other chemicals, for the prevention of scale is the earliest

and most extensive form of water conditioning. A great variety of chemicals have been used for this purpose and under some conditions are justified and have a particular sphere of usefulness. In some instances, they may produce fairly satisfactory results, while in others they have little value or may be definitely harmful when used in boilers. The majority of these substances contain sodium salts, usually caustic soda, soda ash or sodium phosphates combined with organic matter or inert substances.

In many small plants where boilers are operated at low ratings and where all or most of the feed is fresh make-up, the system of treatment commonly employed for scale prevention is to introduce a quantity of boiler compound when the boiler is being filled up after each periodic cleaning. This method may sometimes do some good, but obviously it is very crude and inefficient, for the boiler water will be greatly over-treated at times and under-treated at others. A somewhat improved way is to inject once a day through the feed pump a quantity of whatever chemical solution is prescribed as suitable for the particular water. A still better way is to use an arrangement whereby the chemical can be fed in gradually over the full operating period, instead of all at once. The purpose of the chemical here referred to is to change certain mineral matter in the water, which otherwise would form a hard, adhering scale, into a permanently soluble form or to one that will precipitate as a sludge, and may be easily removed.

Assuming that the prescribed chemicals are correct for the water being used, and the boiler operator is faithful in adhering to his schedule of treatment, this system is usually considered practicable for plants which find it adequate. However, *indiscriminate* dosing of boiler feedwater with chemicals cannot be too strongly condemned.

As a general proposition, in plants operating at higher ratings than the ones referred to above, it is preferable to remove as much of the soluble and suspended material as possible from boiler feedwater before it is fed to the boilers. Where this procedure is not economically practical, certain forms of internal chemical treatment are justified. Such treatment, in general, should be limited to boilers operated at relatively low pressures. The more extreme operating conditions generally preclude the use of internal chemical treatment, except as a supplementary treatment to water conditioned outside of the boilers. Many chemists or engineers do not have sufficient knowledge of the reactions which take place under high temperatures and pressures to warrant intelligent opinions as to the best type of feedwater treatment to employ. Considered broadly, boiler compounds of secret formulas for

conditioning boiler waters should be used cautiously, since frequently these products will not produce the desired results or may be positively harmful to boilers and auxiliary equipment. In some cases these materials, although they may inhibit the deposition of scale, will markedly increase the priming and foaming characteristics of the boiler waters, increase the danger of "embrittlement" of the boiler steel or set up severe corrosion and pitting of the equipment. To avoid these objectionable operating conditions, no chemical should be employed that is offered on a cure-all basis, for it is very necessary that the formula for use at any one plant be chosen to meet that plant's specific needs, unless the user knows the nature of the product or has definite assurance that the chemicals recommended will not cause trouble.

Where internal treatment of feedwater is employed, it is necessary, to obtain best results, to proportion the dosage to the scale-forming solids contained in the make-up water and to control the treatment by simple routine tests. This procedure, if intelligently performed, will avoid under- or over-treatment and compensate for variations in the quality of the raw water and for fluctuating loads on the boilers. The routine tests referred to are relatively simple and may be performed by any intelligent operator. The cost of the equipment necessary for making these tests is small and is justified by the saving effected in boiler maintenance, because of the more accurate conditioning of the water which is made possible by such control.

EXTERNAL TREATMENT—The removal of scale forming solids from water, outside of boilers, by means of chemicals has been practiced for many years and is now an accepted method of feedwater treatment. The basic principles of such processes are relatively simple, and consist of the addition of chemicals to the water to convert the soluble scale forming salts into insoluble compounds, and of the removal of these precipitated solids by settling or by filtration. Lime, soda ash, caustic soda, barium and other chemicals are generally employed, and when the softening reagents are properly adjusted, a fairly satisfactory feedwater is obtainable. Such processes are now standardized and the only important recent development, other than changes in mechanical equipment, is the use of certain coagulants. These latter chemicals are for the purpose of speeding up the chemical reaction, of assisting in better clarification, and for deaeration. There are some other incidental advantages but a more extensive discussion of their usefulness does not come within the scope of the present article.

Occasionally, preliminary water treatment by chemicals is followed by zeolite softening. The purpose of these combination systems is the

removal of the gross amount of scale-forming solids by the lime or lime-soda treatment and the elimination of the remainder by zeolites, sometimes termed base exchange softeners. Under some conditions, combination systems of this type are preferable to either type of the softening processes used alone. Where such feedwater conditioning methods are employed, the treatment must be carried out in cold water, since zeolite softeners may not be used for softening hot water.

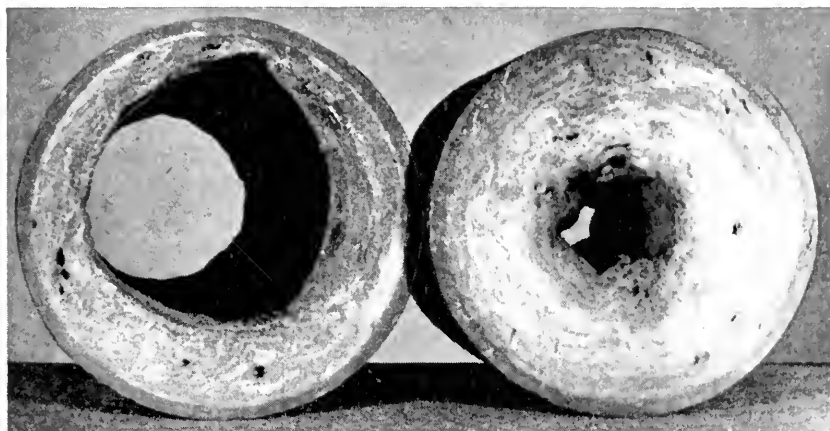

An extreme example of scale in boiler tubes.

In general, chemical softening is effected by the addition of lime and soda ash to the water. Hydrated lime is usually used for this purpose and is applied to the water alone or in combination with soda ash, caustic soda, or other softening reagents as the chemical content of the water requires. The lime precipitates the bi-carbonates of calcium and magnesium, while the soda ash converts the sulphates of these scale forming solids into insoluble compounds which are readily precipitated. Lime-soda softening is carried out in specially designed tanks outside of the boiler. The reaction takes place either in hot or cold water, and the system may be operated on a continuous or intermittent basis. In general, the hot process softener will effect a much higher removal of scale forming solids than the cold process. In either case complete softening is not possible. The reason for this is that calcium and magnesium salts, which are the scale-forming substances, are soluble to a small extent in both hot and cold water, so that even though the right proportions of the softening chemicals have been used, some residual hardness will remain in the water. The residual hardness after chemical softening will be small, however, providing the softening

system has been properly designed and controlled, and little difficulty from scale accumulations will be experienced when boilers are operated at relatively low pressures.

In boilers operating at high pressures, however, chemical softening alone will not always be sufficient to insure complete elimination of incrustations on tubes or drums. Such elimination is very necessary in the case of water wall tubes. Under high pressure conditions, supplementary internal treatment, or combinations of chemical softening and zeolite treatment, must be used to insure perfectly clean surfaces. Various chemicals may be used for supplementary internal treatment, following external softening systems. Phosphates are now being extensively employed for this purpose and, when the quantities are carefully controlled, boilers can be kept sufficiently clean to eliminate turbinizing and cleaning by other mechanical means.

Zeolite Water Softening

Zeolite water softening is now widely practiced for conditioning feedwater and for the treatment of water in industries where complete softening is essential. The process is relatively simple, and consists in passing water through a bed of zeolite material, sometimes called base exchange mineral. These substances occur naturally as mineral deposits, or may be manufactured, and possess the unusual properties of extracting calcium, magnesium and other scale-forming solids from water, replacing them by sodium salts, which are non-scale-forming. After a given amount of water has passed through a zeolite bed and the sodium has been exhausted from the mineral, the apparatus must be cut out of service and the mineral regenerated, that is, be renewed with more sodium salts. This is done by adding a brine solution (common salt) to the bed. The sodium which has been exhausted by the water during the softening process is again chemically fixed in the mineral, and calcium and magnesium salts which have been removed from the hard water are given up by the zeolite and are washed from the softener. When the zeolite is regenerated, the excess salt not fixed by the mineral is removed by washing the bed with fresh water, and the softener is again ready for service.

The mechanical design of zeolite softeners is practically the same as that of a filter and consists merely of an open or closed tank provided with a proper strainer system in the bottom, over which is placed the zeolite mineral. The water to be softened may be passed either downward or upward through the bed, but in either case softening will be effected.

This method of treatment is not suited to waters that contain large amounts of lime and magnesium, as these salts are replaced by sodium, and excessive amounts of sodium salts will then be present in the softened water. High concentrations of sodium salts are to be avoided, since they increase the priming and foaming characteristics of the water and, it is believed by many, tend toward "embrittlement" of the boiler steel if proper precautions are not taken to prevent such destructive action.

Although zeolite water softening may be, and frequently is, used for conditioning feedwater, still the choice of this or some other system requires engineering judgment and experience to decide which is adaptable to the specific conditions encountered. In general, zeolite softeners are satisfactory where the hardness of the raw water does not exceed 100 parts per million. If this amount is exceeded, consideration should be given to the employment of other or additional forms of feedwater correction. Furthermore, water to be softened by zeolites must be free from suspended matter, and if it is turbid it must be filtered. Consideration should be given, also, to the ratio of sulphates to total sodium alkalinity in the water. This is required since, if the alkalinity is high in proportion to the sulphates, there may be danger of "embrittlement", unless corrective treatment is given. Likewise, acid water must be neutralized before passing through natural or synthetic zeolite minerals.

Corrosion

The mechanism of corrosion, or the way in which metals corrode, is a complicated phenomenon involving a number of factors. Many theories have been advanced to account for destruction of metals in contact with water. An amplified discussion of the subject is beyond the scope of this article. Briefly, however, the theory of corrosion may be stated in the following way. All metals in contact with water have a specific solution tension, that is, they exert the power to dissolve or go into solution. This action takes place even when the metal and water are chemically pure. Under the latter conditions, the rate at which the metal dissolves is very slow. The tendency for the metal to dissolve, however, is influenced greatly by impurities in the metal and in the water. In the presence of oxygen, corrosion of iron is greatly accelerated, and although oxygen alone will not cause this action, it will, when dissolved in water, greatly promote the rate at which iron dissolves. Practically all natural waters contain oxygen and, as such, are corrosive to a greater or lesser degree. Because of this fact, the inhibi-

tion of corrosion in boilers requires the removal of dissolved oxygen from the feedwater. The rate at which corrosion proceeds in boiler waters containing a specific amount of oxygen will not be the same in all cases. This process is influenced by the hydrogen-ion concentration (acidity) of the water, the incrusting solids in the water supply, the method of operation of the boiler, and many other factors.

The rate of corrosion is influenced, also, by the presence of gases other than dissolved oxygen, principally carbon dioxide. Actually, the latter gas possesses the properties of an acid so that when carbon dioxide is present in feedwater, corrosion of boilers and appurtenant equipment is to be expected in much the same way as though the water contained small amounts of a mineral acid.

Both carbon dioxide and dissolved oxygen may be readily removed from water by raising the temperature and providing means for the escape of the gas from the equipment in which the water is heated. Thus, the problem of minimizing corrosion has focused attention upon the deaeration or de-gasification of the feedwater. Feedwater

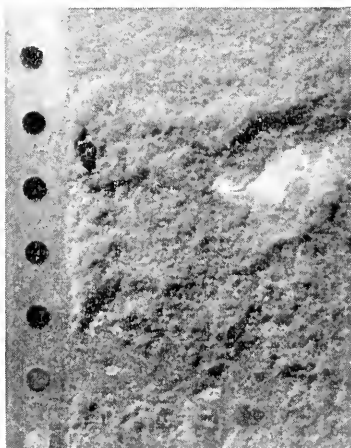

The result of corrosion.

heating has been widely practiced for many years. Originally, the heating was accomplished in closed heaters without providing for release of the dissolved gases. In recent years, however, the importance of providing for the removal of these gases by means of open heaters has been demonstrated. Raising the water to a temperature of 212°F will expel most of the dissolved gases and in low pressure boilers corrosion difficulties will be greatly reduced if a minimum feedwater temperature of 212°F is maintained. Where boilers are operated under high pressures and where economizers are installed, open heaters, alone, will not assure sufficient removal of the dissolved gases to eliminate corrosion entirely. For this reason, deaerating heaters have come into use in recent years. These are specially designed open heaters but so constructed as to provide for more effective removal of the non-condensable gases expelled from the water. Under extreme conditions, even this type of de-gasification has not been completely satisfactory and supplementary chemical treatment for the absorption of small

residual amounts of oxygen has been required to prevent corrosion.

A chemical deaeration process which has been employed to some extent abroad, and to a lesser extent in this country, consists in passing the water over iron or steel. In this method, de-oxygenation is brought about by chemical combination of the oxygen and iron, thereby exhausting the oxygen from the feed supply prior to its use in the boilers. Certain chemicals have also been used for absorbing oxygen. Those used most extensively are iron salts and sodium sulphite. The latter material is now being quite widely adopted for the complete removal of the residual oxygen which is left in the water after mechanical deaeration. Sodium sulphite has merit also for fixing oxygen as it is absorbed by water in idle boilers, thus reducing the tendency toward active corrosion in stand-by equipment.

“Embrittlement” of Boiler Steel

There are still some differences of opinion concerning the fundamental cause, or causes, responsible for the form of failure of boiler steel which is now commonly known as “embrittlement”, or more frequently as “caustic embrittlement”. However, the condition is invariably accompanied by the presence, in the boiler water, of sodium carbonate, which, in the absence of neutralizing sulphates or certain other substances, and in the presence of heat and pressure, leads to the formation of sodium hydroxide. It is quite generally agreed that two conditions must be present simultaneously to produce “embrittlement”: First, the high concentration of sodium hydroxide in the seams or

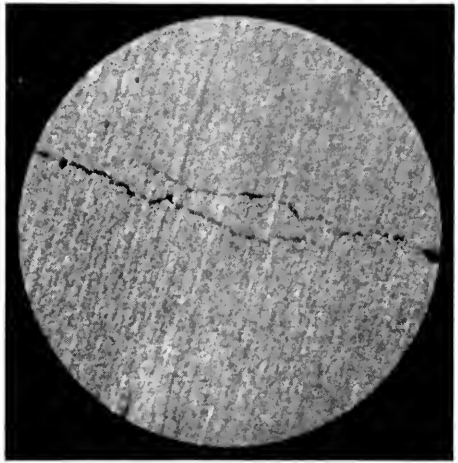

“Caustic embrittlement” under the Magniscope.

under the rivet heads; and second, stressing of the metal to about the yield point. It is an established fact that the zone of greatest stress in fabricated boiler seams is in the riveted area, and it is there that deterioration of the boiler steel, resulting from “embrittlement”, occurs.

The presence of sulphate in sufficient quantities has been shown to prevent this action.

The concentration of sulphates required depends upon the pressure at which the boilers are operated and the quantities of soda ash and caustic soda present in the water. Scientific research, confirmed by practical operating experience, has led to the belief that for boilers operated at pressures up to 150 pounds, "embrittlement" can be prevented by keeping the sodium sulphate concentration equal to the total alkalinity in the concentrated boiler water. Where the pressure is from 150 to 250 pounds, the sodium sulphate in the concentrated boiler waters should be double the alkalinity, while above 250 pounds it should be three times the alkalinity. If these ratios are not maintained by normal concentration of solids in the feedwater by evaporation, then it is necessary to add an additional amount of sulphate to the feedwater to secure the necessary quantity. The choice of a material to be used for supplying the sulphates depends on the quality of the water and on local operating conditions. Sodium sulphate is used more extensively for this purpose than any other chemical. Sulphuric acid, sodium bi-sulphate, magnesium sulphates, and other products are sometimes applied but should be used only under competent technical advice.

There have been indications, based on laboratory research, that phosphates, tannins, chromates and other materials possess value for inhibiting "embrittlement" of boiler steel. At a few steam stations some of the materials, especially the phosphates, are now being employed, under competent supervision, and the recommended sulphate ratios disregarded.

At first "caustic embrittlement" was limited, or at least recognized, only in sections of the country where boilers were supplied with feedwater naturally high in sodium carbonate or bicarbonate. Within recent years, however, it has been demonstrated that this trouble is not confined to any specific area of the country and boilers have developed the characteristic of "embrittlement" when the treated feedwater has become unbalanced with respect to the ratios between sulphates and alkalinity. This condition can be brought about by any water softening process that results in concentration of alkaline salts.

Caulking of the riveted plates on the inside of the boiler and leaving the outside uncaulked aids in inhibiting "embrittlement", since it tends to prevent local concentration of the soluble alkaline salts in the seams. Forged or welded drums, as now being used in high pressure installations, further lessen the danger from "embrittlement", but such construction does not justify ignoring the prescribed ratios, since concentration of the objectionable alkaline salts may occur where the tubes are rolled into the drums.

In recent issues of THE LOCOMOTIVE, these problems have been discussed at some length and attention has been drawn to the discovery of numerous instances of this sort. Advice has also been given concerning the danger signs which precede this type of trouble, and directions outlined for investigating suspicious cases. "Embrittlement" of boiler steel generally is accompanied by certain characteristic symptoms. Such trouble may be indicated by loss of rivet heads due to cracking, or by persistent leaks around rivets or at seams. Where these conditions are prevalent a thorough and complete examination of the boilers by a qualified investigator is justified.

The personnel of The Hartford Steam Boiler Inspection and Insurance Company's laboratory and engineering staff are available to policyholders for consultation and guidance in all problems directly or indirectly related to boiler feedwater conditioning.

Erosion, Fatigue, Blamed for Turbine Losses

WHEN a 3,750 kva steam turbine, of the combined impulse and reaction type, could not be brought up to speed recently, an investigation disclosed a serious case of blade erosion. The second row stationary reaction blades were eroded through at points opposite the grid valve ports, the second row revolving reaction blades were crushed flat together and the third, fourth and fifth rows of stationary and revolving reaction blades were seriously dented. Several of the stationary reaction blades which were seriously eroded in the second row had broken off and had gone into the revolving blades, crushing and denting the latter, as stated above. The erosion was attributed to wet steam. Property, and use and occupancy loss, exceeded \$7,000.

A New Jersey company sustained a loss of over \$4,000 a short time ago as the result of an accident to a 2,500 kw steam turbine. A piece of the third stage wheel about 8" long broke out where the buckets were attached, the break being blamed on fatigue of the metal. The broken section contained about twelve of the buckets and some of these were thrown down on the condenser tubes, puncturing two and denting several others.

The operator at a New York carpet plant heard a grinding noise inside the steam casing of a 500 kw turbo generator. He shut down the machine, and when the casing was opened, it was found that very severe erosion of a retaining ring had caused it to loosen and make contact with an adjoining row of revolving buckets. This resulted in the bending and breaking of the latter.

Major Boiler Explosions

SIXTEEN MINERS KILLED BY LOCOMOTIVE BLAST

SIXTEEN men lost their lives and forty-two were injured, some of them seriously in the early morning of December 27, 1934, when a railroad locomotive boiler exploded, hurtling in the air and crashing down on a wooden passenger coach.

The accident occurred at McDunn, near Powellton, West Virginia.

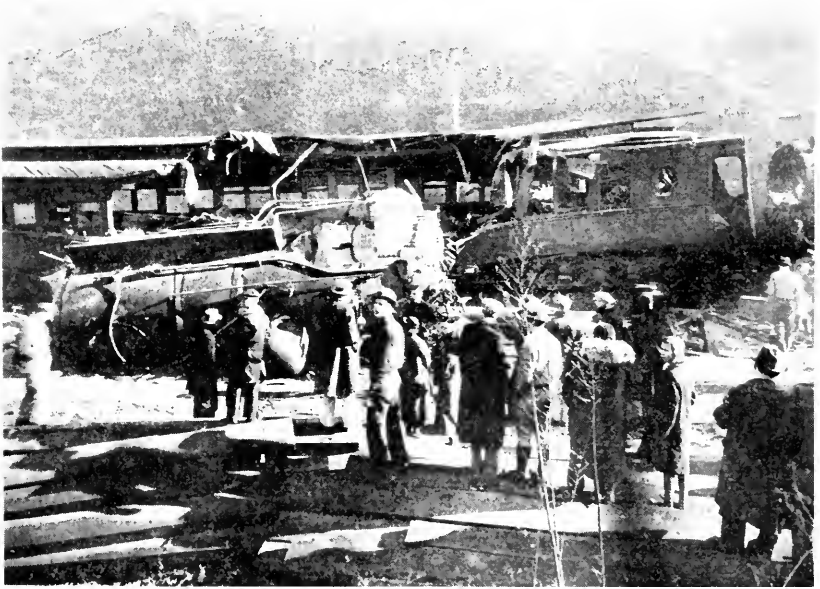

Where 16 miners lost their lives in locomotive boiler tragedy.

as about three hundred workmen were being taken from their homes to a mine. The killed and injured were in the first car of a four car train.

Failure, which was attributed to low water and overheating, evidently occurred in the crown sheet, the released steam tearing off the engine's smoke box cover and hurling it into the first car, which was coupled to the front end of the locomotive. Simultaneously the boiler was blown up into the air, and came down in the center of the leading coach, tearing away the top and one side. The cab was hurtled through the roof of a nearby house.

* FAILURE OF CONCEALED HEAD PROVES COSTLY

BRISTOL, on the border between Virginia and Tennessee, was plunged into darkness at 7:45 P. M. Sunday, November 25, 1934, when a violent boiler explosion at the city gas plant tore down power lines. The force of the explosion was so terrific that the concussion shook buildings and caused excitement throughout the city. It was almost an hour before emergency repairs put the lighting system back into service. At the gas plant the boiler house was completely demolished and the city fire department was obliged to fight a blaze which for a time threatened two large gas holders.

The explosion was attributed to the failure of the concealed head

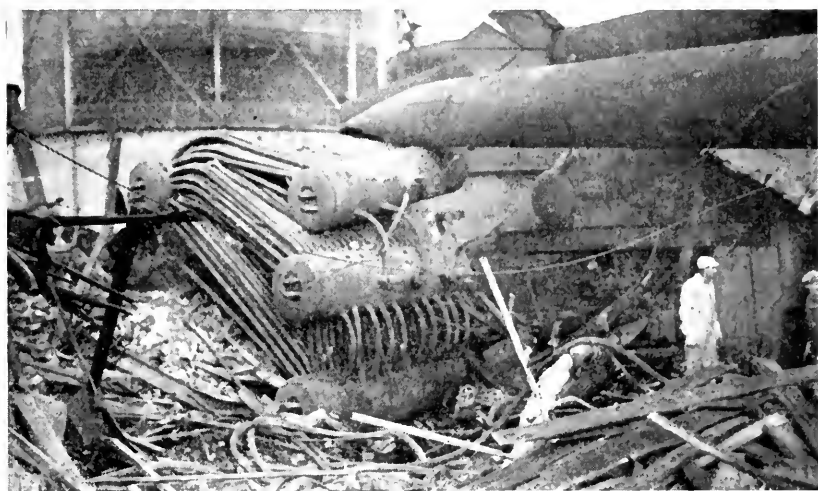

Wreckage after failure of concealed mud drum head.

of the lower drum in a 250 hp bent tube type boiler. The blank head is reported to have plowed through the setting of a second boiler, bending the shell, smashing through the tube banks and passing out through the setting on the other side.

Those near the scene of the accident reported that the exploding boiler turned a complete somersault before it came to rest. Flying debris demolished a switchboard, two 300 kw transformers, and the condensers for two 300 kw turbines, but fortunately missed the turbines. Although one of the large gas holders was bombarded from top to bottom with flying bricks, it was not punctured.

The roof of the power house was blown off, two sides of the building were torn away, and the plant's stacks were knocked down.

At the time of the explosion a fireman was cleaning the fire. He was blown across the boiler room and lived only a short time after the accident. Another workman sustained minor injuries.

SIX DIE FOLLOWING EXPLOSION

SIX men lost their lives when a second-hand horizontal tubular boiler exploded at the scene of hard-wood lumber cutting operations near Baggs Bay, 15 miles south of Claxton, Georgia, on December 12, 1934. The photograph shows a section of one of the heads and some of the tubes. An investigation revealed that the initial rupture probably occurred in the rear tube sheet around the manhole opening. The sheet had become thin at that spot as the result of corrosion from a leaking manhole gasket. The boiler was of the horizontal tubular type, 48" diameter and 12' long. Its two courses had double lap riveted longitudinal seams.



*Part of exploded sawmill boiler
in Georgia forest.*

DRUM EXPLOSION LEVELS BOILER HOUSE

THE top rear drum of a bent tube type boiler operating at 89 lb exploded on October 22, 1934, at a southern cooperage works, causing property damage and minor injuries to three men. Failure started in the double-riveted lap-joint of the longitudinal seam. The tear ran through the row of rivets next to the caulking edge for about 6 feet, then through the solid plate to the heads at each end

and finally into the heads themselves. So severe was the blast that it demolished the setting of an adjacent boiler, blew down the sheet-iron boiler shed, and brought the steel smokestack crashing down on the ruins.

The night watchman who was passing through the boiler room was burned and cut, a negro fireman was burned and a stranger in the yard was struck by a piece of concrete. The engineer, who had been working

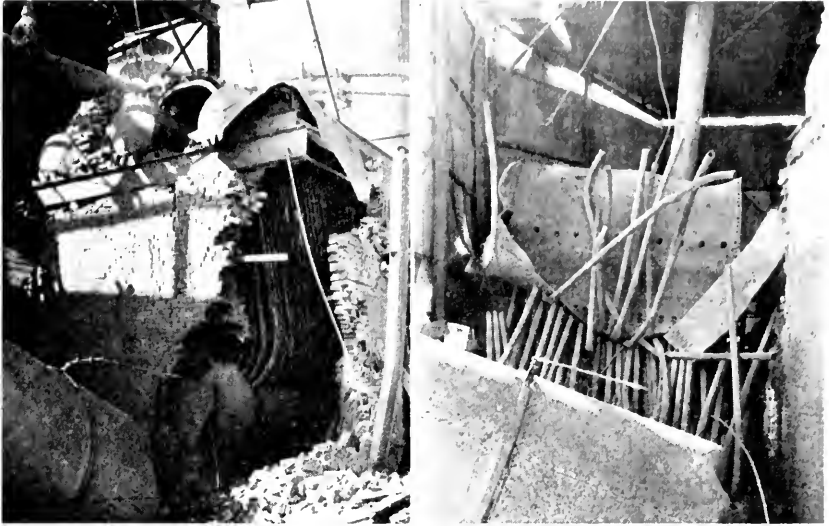

Damage from explosion of water tube boiler after seam failed.

on top of the boiler only a short time prior to the explosion, said more persons probably would have been injured had not the accident occurred between shifts.

Preliminary findings indicate that this accident may have been the result of caustic embrittlement and an investigation is being made to determine more exactly how the metal became weakened.

Huge Penstock Bursts Open; Five Lose Lives

Surging through a great rent 6' wide and 12' long, water from a penstock 14' in diameter drowned a resident construction engineer and four workers on November 1, 1934. The big pipe, which was being tested at the time under a pressure of approximately 115 lb, was one of four, each about 30' long, carrying water from a tunnel to the powerhouse of a hydraulic development at Hawks Nest, West Virginia.

Brooklyn Kier Accident

WHEN the cover of a cloth treating kier blew off on September 27, 1934, at a Brooklyn dry goods establishment, the explosion draped streamers of cloth on nearby city buildings in a confused array and injured six persons who resided in the neighborhood. For the thirty girl employes it was fortunate that the accident



Empty kier and contents. The head landed in a nearby street.

occurred during their lunch hour. Otherwise, some of them would undoubtedly have been injured.

The kier was 6' in diameter and 8' deep, and was one of two which were used for boiling the dirt and cotton residue out of newly woven goods, about a ton of cloth being put into each kier and boiled for two days.

In the bottom of the vessel was a grating which prevented the material from resting on the lower head. A circulating pipe went up through the center of the tank, carrying steam and water upward in such a way that the action somewhat resembled that in a coffee percolator. Normal operating pressure was not in excess of 10 lb and there

was a relief valve to prevent overpressure. Besides the relief valve there was a pressure regulator in the line from the boiler and this was set to hold the pressure in the kier at 10 lb. The boiler furnished steam at about 40 lb.

The accident blew the 1000 lb cover over an adjacent one story building, the heavy metal disc coming to rest in a street about 80 ft away. The contents, which happened to be 30,000 yards of cheesecloth, were hurled in the opposite direction and strewn over nearby buildings, draping them in fantastic fashion much to the interest of the residents of the thickly settled neighborhood. The brick walls and roof of the building housing the kiers were wrecked, and bricks and large stones, which were hurled onto the roofs of four adjacent houses, resulted in some damage to them and in minor injuries to their occupants.

The train of events which led to the explosion probably never will be accurately known, but probably the circulating pipe became clogged, thereby permitting pressure to accumulate in the lower part of the vessel to such an extent that the entire contents were moved upward toward the top of the kier, eventually closing the relief valve outlet and the outlet to the steam regulator. This would have caused the regulating device to remain in full open position and admit boiler pressure to the vessel, which was more than the head of the kier could stand.

Operator Killed Instantly as Flywheel Explodes

An operator's effort to stop an overspeeding engine at a Virginia furniture factory cost him his life when the 12' belt wheel exploded and cut him down as he struggled to close the throttle. Parts of the wheel flew a quarter of a mile, over another factory and across a state highway. The other damage to the 250 hp Corliss engine was such that it could be easily repaired and a new wheel could be installed. Plant officials were at a loss to understand why the engine ran away, as the governor and valve gear apparently had been in good condition. The engine was not equipped with an independent automatic stop, and no engine insurance was carried.

In Russia, it is possible to get a permit to buy railroad tickets without standing in line. One man having this privilege pushed his way to the window, and when the others waiting protested, he said, "But I have a permit to buy a ticket without standing in line."

"So have the rest of us," came the retort. "This is the line for persons who have permits to buy tickets without standing in line." —*Boston Transcript*.



A QUARTERLY MAGAZINE
DEVOTED TO POWER PLANT PROTECTION

George H. Prall, *Editor*

Copyright 1935 by The Hartford Steam Boiler Inspection and Insurance Company

HARTFORD, CONN., January, 1935

Single copies may be obtained free by calling at any of the Company's agencies.

Subscription price 50 cents per year when mailed from this office.

Bound volumes one dollar each.

Reprinting matter from this paper is permitted if credited to

THE LOCOMOTIVE of THE HARTFORD STEAM BOILER INSPECTION AND INSURANCE CO.

Fifty Years of Service

This year two executives of the Hartford Steam Boiler Inspection and Insurance Company are celebrating the completion of fifty years of active work in the organization. On New Year's day, William M. Francis, manager of the Atlanta Department, celebrated his fiftieth anniversary, and on March 1 Secretary Louis F. Middlebrook will have completed his half century of prominent service.

Secretary Middlebrook has been connected with the home office and the administrative end of the business since 1885. He began as a clerk and stenographer under the late Secretary J. B. Pierce, and was promoted to the rank of assistant secretary under Mr. Pierce in 1897. His appointment to the position of secretary was made in 1921.

Manager Francis began his career at the age of 16 as office boy at the home office. Five years later he was transferred to the inspection force, and in 1893 began his work with southern assured, first as an inspector and special agent, and later in charge of inspection activities in the Charleston territory. In 1898 Mr. Francis was transferred to



SECRETARY LOUIS F. MIDDLEBROOK

Will Have Served 50 Years on March 1; Officer Since 1897.

the Atlanta office, where, in 1900 he was made chief inspector. With the consolidation of the Charleston and Atlanta departments in 1909, Mr. Francis was made manager and chief inspector, carrying on the dual responsibilities until 1914, when the growth of the department led to the appointment of C. R. Summers as chief inspector.

Three generations of the Francis family have chosen careers with the Hartford Steam Boiler Inspection and Insurance Company. Manager Francis' father, Charles D. Francis, was for many years a member of the home office inspection force, and his son, A. P. Francis, is now assistant manager of the Atlanta department.

The Atlanta department serves owners of pressure vessels and power machinery in Alabama, Florida, Georgia, South Carolina, and parts of North Carolina and Tennessee.



MANAGER WILLIAM M. FRANCIS

Celebrates 50th Anniversary of Active Work January 1.

Benefiting Through Inspections

Most boiler operators need not be told that there is no money saved by neglecting repairs to a boiler when it is in an unsafe condition. Even in the past few years, when the need for economy has been felt in so many quarters, the Company has had remarkably fine co-operation by boiler users in this respect. However, every rule has its exception.

Some months ago an application for boiler insurance was made by a small mill equipped with a single horizontal tubular boiler. An inspector went over the boiler carefully and sent in a report to his Chief Inspector which described certain weaknesses brought about by severe corrosion. The owner was told that the condition was unsafe and that the equipment would be insurable only after the completion of certain repairs. Unfortunately he decided against making the repairs, and several months later the boiler exploded. The plant was demolished and several persons were killed.

A. D. McLennan

The death of Inspector A. D. McLennan of the Atlanta Department on October 17, 1934, ended a service of 34 years with The Hartford Steam Boiler Inspection and Insurance Company. Born in Louis-

ville, Alabama, on May 6, 1869, Mr. McLennan joined the Company's inspection staff on April 1, 1900. He was regarded as extremely competent in the work to which he was assigned, and enjoyed the respect and friendship of many of the Company's clients in the south.

Air Tank Explosions

A filling station attendant was killed and three persons were injured when an air tank burst at Cheyenne, Wyoming, on October 17, 1934. The injured were a boy of 17 who was visiting with the attendant, and a building contractor and his helper who had just finished installing a window pane. After an investigation had been made by Cheyenne police, the accident was attributed to an automatic switch which failed to shut off the compressor when the maximum safe operating pressure was reached.

Failure of a welded head seam on a 20" by 60" air tank in a New Orleans garage resulted in no fatalities but did cause considerable property damage. As the tank was mounted vertically, the head was hurtled upward through the floors of the two-story structure and came to rest in the attic, 35 ft above. The shell of the tank was blown about 50 ft from its setting, through the side of the building. The tank was in use at a pressure of 200 lb.

A cast iron air tank, used in connection with a high pressure outfit for spraying liquid cement, exploded on October 21, 1934, at a Minnesota food products plant. One of the operators was struck by flying pieces of metal and he was taken to a hospital. His treatment was complicated by the fact that the explosion released the entire supply of cement which literally covered him.

Fuel Explosion Wrecks Large Water Tube Boiler

A Texas lighting plant suffered a power interruption on November 28, 1934, when a violent explosion of gas fuel in the combustion passages of a bent tube type water tube boiler wrecked the boiler setting and severed water lines, including those to feed pumps for other boilers. The entire plant had to be shut down until the feed lines could be plugged. A property loss of more than \$5,000 was covered by insurance in The Hartford Steam Boiler Inspection and Insurance Company.

Bursting Wheel Leads to Ammonia Vapor Blast

ONE of the most disastrous accidents of its kind occurred on October 12, 1934, at the plant of an Illinois cold storage company, when a bursting steam engine flywheel ruptured an ammonia condenser, releasing liquid ammonia which vaporized, mixed with air, and exploded with great violence. Two men were killed, seventeen were injured, and property was damaged to an extent estimated at \$80,000. The steam engine, direct connected to a generator, had been brought up to speed and the generator had just taken over the load when there was a flash in the generator and it started to burn. The engineer immediately closed the throttle, but at that instant the 5'2" engine flywheel burst.

It is impossible to say in just what order subsequent events occurred. However, it was reported that when an oil separator broke under the impact of a fragment of the wheel, the oil was ignited and caused an explosion of minor violence. A little while later, ammonia gas having been released from an ammonia condenser and from a high pressure ammonia pipe, both damaged by the flywheel, there was another explosion of extreme violence which shook the surrounding neighborhood and greatly damaged the buildings of the cold storage company. Girders were blown from their moorings and tossed against a building across the street, a part of the lower floor wall was hurled down, and a stretch of concrete sidewalk was torn up for almost the full length of a city block. A part of the damage outside the building is shown in the accompanying photograph.



Result of ammonia explosion in cold storage warehouse.

Several theories were advanced to explain the wheel's bursting. It was possible, according to one opinion, that the wheel failed at or under

normal speed, being shattered by the governor's inertia arm striking the rim when the throttle was suddenly closed. If this occurred, the breaking out of a segment may have so unbalanced the remainder of the wheel that it shattered. Another theory is, of course, that the engine over-speeded.

Both Flywheels of Gas Engine-Compressor Explode

THE recent explosion of both flywheels of a 90 hp direct-connected gas-engine-driven compressor was reported in a recent issue of the California Safety News. The overspeed, which threw pieces of the wheel out through the roof and sides of the engine house for distances varying up to 750 feet, occurred when a small taper pin in the governor assembly sheared off. This rendered the governor inoperative.

No persons were injured, but there was some property damage. The machine was used in gas lift service for compressing dry gas from 14 to 600 lb pressure.

A piece from one of the flywheels ruptured the discharge header at a point just outside the building, releasing high pressure gas to the atmosphere. Another piece tore off the intake line to the low stage compressor and still another removed a two-inch engine fuel line. Other damage was done to rigging on the tank, pipe line and other property in the vicinity. One of the fragments struck a 110-volt service line, severed it and caused one end to whip up across a 10,000-volt power line. This killed both lines instantly and automatically removed a fire hazard, namely, the possible ignition of free gas in the engine room, by the damaged electric power and lighting system.

The article, by J. C. Herron, gas engineer, discussed the cause and force of the accident as follows :

"A study of the fractures failed to show any defects in either flywheel to which the cause of the accident could be attributed. In fact, the nature of the breaks led rather definitely to the conclusion that the flywheels exploded as a result of excessive rim velocity.

"Upon removing the governor for inspection it was discovered that a small taper pin which secures the bevel pinion to the vertical spindle had sheared off, leaving the pinion free to revolve without engaging the governor mechanism. It might be added that with the governor at rest the fuel control was maintained in the wide open position. The fact that a piece of flywheel was found at a distance of 750 feet from the station, is, perhaps, the best evidence of what followed.

"As a matter of interest, the minimum theoretical initial velocity at which this piece was traveling as it was thrown from the flywheel was calculated. The piece, a section of the rim of the left hand flywheel, was assumed to have been projected tangentially at an angle of 45° in the plane of the wheel, in order to produce the maximum possible range. The horizontal distance of travel was approximately 750 feet and the point where the piece landed, was about 131 feet lower in elevation than the compressor station. The outside diameter of the flywheel is 66

inches and, since the rim is about 6 inches thick, the mean rim diameter is assumed to be 60 inches. The calculations show that the piece had an initial velocity of 143.29 feet per second, or a mean rim speed of 8597.4 feet per minute. This, in turn, corresponds to an engine speed of 547 r.p.m. The normal rated speed of this unit, namely, 240 r.p.m., is equivalent to a mean rim velocity of 3,770 feet per minute, or 62.83 feet per second. It is quite apparent that the actual speed of the wheel at the instant of disruption was in excess of 547 r.p.m. as calculated, since an ideal case was used in order to produce maximum range with minimum initial velocity. Inasmuch as the force tending to disrupt the rim varies as the square of the rim velocity, it is evident that by increasing the engine speed 2.28 times, as in this case, we multiplied the force by 5.2."

To prevent recurrence of such an accident the use of a Woodruff type key was recommended as a precaution against shearing, in addition to the small taper pin for securing the bevel pinion to the governor spindle. Likewise, the installation of a positive overspeed device, which would ground the magneto in case the engine should ever exceed a safe rate of speed, would be an additional precaution.

Transformer Oil Vapor Explosion Injures Three

AN EXPLOSION of vapor from transformer oil, resulting in burns to three persons, was described by a southern Ohio newspaper a few weeks ago. The three victims, two men and a woman, were standing on a grating near a store entrance, when a blast of fire rose out of the grating, burning them so severely that they required hospital treatment.

The explosion occurred in a 300 kva transformer of the conventional subway type that was housed in a vault under the sidewalk and supplied power to the downtown distribution system.

Subsequent investigation indicated that an internal short circuit or "flash over" occurred between the transformer's high tension leads. The resulting arc vaporized a large amount of oil, and when the vapor ignited, it built up sufficient pressure to lift the relief plate in the transformer cover, sending flame traveling upward through the sidewalk. One theory with regard to the cause of the trouble was reported to be that flakes of rust from the internal surfaces of the transformer cover dropped on to the terminal board, accumulating to such an extent that the "flash over" resulted. It was reasoned that the rust flaked off because of a continued breathing action.

Veneered Wood Damaged by Escaping Steam

The damage which an apparently minor accident sometimes can cause was well illustrated in the following case. Recently, a plug blew out of a 1¼" to 1" reducer in a steam line in the basement of an Arkansas furniture manufacturer's plant. Before the steam could be shut off moisture had damaged a large stock of expensive veneered wood.

Taps From the Old Chief's Hammer

THE Old Chief and his assistant, Tom Preble, were returning from lunch on a mild day in December. They paused a moment at a street corner to watch a group of relief workers washing slush and dirt from the street into a sewer opening.



"That's one way to get rid of unpleasant evidences of winter," Preble commented. Then he shouted, "Look at that man!"

In some way or other a man had slipped on the slushy pavement, had fallen into the stream from the heavy fire hose and was bowled along for some distance before the two men holding the nozzle diverted the stream.

"Chief," said Tom, "if they'd washed him down that manhole he would have been out of luck."

"It *was* a narrow squeak," the Old Chief said as they started back to the office, "but serious as it appeared for a minute, I can't help being reminded of Billy Donahue's yarn about his inspection at the Pine Grove Planing Mill at Southington. Did I ever tell you about that?"

"I don't think so, Chief."

"Well, you'd remember if I had, Tom. There isn't another case like it on record.

"It was summer and Southington is always mighty pleasant then. Bill had arranged to make an internal inspection of the mill's two horizontal tubular boilers on a Sunday morning, so that the work at the mill wouldn't be inconvenienced. Then he expected to drive down the valley and make a call on a certain young lady—now Mrs. Donahue. She still laughs at Bill whenever the manager of a certain Pine Grove Planing Mill is mentioned, but Bill doesn't appreciate it.

"Anyway, Bill got to the plant as agreed. The two boilers were set in such a way that the manholes in the rear heads were just above a sort of mezzanine floor and entrance to them was easy.

"Bill was changing his clothes when the manager came in—all spick and span in a clean white linen suit, on his way to church. He said he had just dropped in to watch the start of the work.

"As it happened, just before he arrived the boiler attendant had

been making free use of the hose and, as was expected, a cloud of vapor was coming out of the manholes. Bill thought nothing of it. To him those two boilers were just two boilers, still fairly warm.

"The vapor from the manholes didn't look so innocuous to the manager, though. He saw Bill start to crawl into one of the boiler openings. Before Bill knew what was what, he was grabbed around the hips and dragged back. He looked around in amazement to hear the manager shout, 'Man, are you crazy? To get into that boiler now is just plain suicide. It's too hot. Can't you see all that steam? . . . !!'

"Bill said there was a lot more he couldn't remember. When the air had cleared, he and the attendant found it no easy task to assure the excited man that there was no danger. The manager finally agreed to leave the matter to the good judgment of the inspector, but he was still worried and insisted on a safeguard. It wasn't in his nature to stand by while our man did what he considered a terribly foolhardy thing, so after some more conversation, a plan finally was agreed upon—the only sort of a plan the manager would even consider. He would permit Bill to enter the boilers, but he would squat on the platform outside the manhole with the hose in his hand and with water up to the valve at the nozzle ready for instant use.

"The plan was that Bill should whistle all the time he was making his inspection. As long as he whistled, the manager would know he was all right. If it 'got too hot,' to use the words of the manager, Bill was to stop whistling and the manager would use the hose.

"Bill said he had trouble whistling. The more he whistled the more he wanted to laugh. But he stuck to it and went over the interior of the first boiler in his usual thorough fashion, whistling all the while. Everything seemed to be in good shape, so he crawled out and entered the other one. The manager reminded Bill again about the whistling, and assured him that he would be ready with the hose in case of trouble.

"So Bill worked away, whistling as loudly as he could. Then he noticed what appeared to be evidence of a crack. That knocked all thought of whistling out of his mind, and while he was intently studying the point under suspicion, he was suddenly overwhelmed in a veritable Niagara.

"Bill frantically whistled and whistled!!

"The water sloshed, and roared, and soaked and trickled down, drowning out the whistle and nearly drowning Bill.

"There was only one thing to do, according to Bill, and that was to back into that torrent of water coming through the manhole.

"Finally he reached the opening and started to back out of it.

"When his feet emerged from the interior of the boiler the manager assumed that help was needed and he grabbed hold of Bill's legs and began to pull.

"The more Bill kicked the harder the manager and the boiler attendant, who had been called on to help, pulled.

"Bill says he still wonders why he wasn't pulled apart and claims that to this day one leg is longer than the other.

"Bill ended the story this way when he told it to me:

"'Chief, I finally got out of that boiler and collapsed from sheer fatigue. I was grimy and I was wet, but I was dressed for the grime and the water would dry. Then I looked for the manager. He was grimy and he was wet, and what his morning's work hadn't done to that nice white suit! He waited around just long enough to assure himself that I was O. K. and then left. I heaved a sigh of relief, crawled back into that boiler and finished the inspection. By the time I saw Mary that afternoon, the funny part of the morning's work got the upper hand. I told her about it—but now sometimes I wish I hadn't. You know how women are—always reminding a fellow of things.'"

Convicts Killed When Ammonia Tank Bursts

The explosion of an ammonia receiver in the ice and cold storage plant of the State's Prison at Huntsville, Texas, resulted in the death of two convicts on December 6, 1934. Both men died because of exposure to ammonia gas. The receiver, a welded vessel built in the prison by convict labor, was a part of a compression system of about 10 tons capacity. From a review of the facts, it was concluded that the electric driven condenser pump had stopped, permitting an excessive pressure to build up. This pressure burst the tank at the welded girth seam in the middle of the receiver.

New Cast Iron Boiler Explodes

An employe was killed and a new cast iron boiler destroyed on December 8, 1934, at an Indiana factory. Operated with the safety valve set at 35 lb, the boiler was used to heat the building and to supply steam for process work. No condensate was returned to the vessel. The boiler was 24" wide, 42" high, and 44" long, rated at 9 hp.

Carpenter: "You hammer nails like lightning!"

Apprentice: "Thanks—you mean I'm fast?"

"No, you never strike twice in the same place."

—Powerfax.

The Hartford Steam Boiler Inspection and Insurance Company

OF HARTFORD, CONN.

December 31, 1933

Capital Stock, \$3,000,000.00

ASSETS

Cash on hand and in banks	\$ 910,061.17
Premiums in course of collection (since October 1, 1933)	1,150,436.69
Interest accrued on mortgage loans	49,854.06
Interest accrued on bonds	112,262.21
Loaned on bonds and mortgages	851,381.55
Home Office real estate	437,474.66
Other real estate	298,889.83
Agents' ledger balances	18,365.44
Bonds on an amortized basis	\$8,702,210.61
Stocks at "Convention Values"	<u>5,016,676.50</u>
	13,718,887.11
<i>Total</i>	<u>\$17,547,612.72</u>

LIABILITIES

Premium reserve	\$6,627,478.25
Losses unadjusted	314,677.94
Commissions and brokerage	230,087.34
Other liabilities (taxes incurred, etc.)	502,686.77
Contingency Reserve, representing difference between value carried in assets and actual December 31, 1933, market quotations on all bonds and stocks owned	1,740,000.00
<i>Liabilities Other Than Capital and Surplus</i>	\$9,414,930.30
Capital Stock	\$3,000,000.00
Surplus over all liabilities	<u>5,132,682.42</u>
<i>Surplus to Policyholders</i>	<u>8,132,682.42</u>
<i>Total</i>	<u>\$17,547,612.72</u>

WILLIAM R. C. CORSON, President and Treasurer

BOARD OF DIRECTORS

LUCIUS F. ROBINSON, Attorney, Hartford, Conn.	SAMUEL M. STONE, President Colt's Patent Fire Arms Mfg. Co., Hartford, Conn.
JOHN O. ENDERS, Chairman Board of Directors, Hartford National Bank & Trust Co., Hartford, Conn.	SAMUEL FERGUSON, President The Hartford Electric Light Co., Hartford, Conn.
MORGAN B. BRAINARD, President Aetna Life Insurance Co., Hartford, Conn.	HON. JOHN H. TRUMBULL, President The Trumbull Electric Mfg. Co., Plainville, Conn.
CHARLES P. COOLEY, Chairman Board of Trustees, Society for Savings, Hartford, Conn.	CURTISS C. GARDINER, Vice-President, The Hartford Steam Boiler Inspection and Insurance Company, 90 John Street, New York, N. Y.
HORACE B. CHENEY, Cheney Brothers, Silk Manufacturers, South Manchester, Conn.	JAMES L. THOMSON, Vice-President, Terry Steam Turbine Co., Hartford, Conn.
D. NEWTON BARNEY, Vice-President The Hartford Electric Light Co., Hartford, Conn.	PHILIP B. GALE, Chairman, Board of Directors, Standard Screw Co., Hartford, Conn.
JOSEPH R. ENSIGN, President The Ensign-Bickford Co., Simsbury, Conn.	JOHN J. GRAHAM, Vice-President The Hartford Steam Boiler Inspection and Insurance Co., Hartford, Conn.
EDWARD MILLIGAN, President Phoenix Insurance Co., Hartford, Conn.	
WML. R. C. CORSON, President The Hartford Steam Boiler Inspection and Insurance Co., Hartford, Conn.	

Incorporated 1866



Charter Perpetual

Department

Representatives

ATLANTA, Ga., Citizens & So. Nat. Bk. Bldg.	W. M. FRANCIS, Manager. C. R. SUMMERS, Chief Inspector.
BALTIMORE, Md., 704-9 Garrett Building	D. W. LITTLE, Manager. R. P. GUY, Chief Inspector.
BOSTON, Mass., 87 Kilby Street	A. PAUL GRAHAM, Manager. W. A. BAYLISS, Chief Inspector.
BRIDGEPORT, Conn., City Savings Bank Building	W. G. LINEBURGH & SON, General Agents. A. E. BONNET, Chief Inspector.
CHICAGO, Ill., 175 West Jackson Boulevard	P. M. MURRAY, Manager. C. W. ZIMMER, Chief Inspector.
CINCINNATI, Ohio First National Bank Building	JAMES P. KERRIGAN, Manager. W. E. GLENNON, Chief Inspector.
CLEVELAND, Ohio 311 Leader Building	ARTHUR F. GRAHAM, Manager. JOHN L. SCOTT, Chief Inspector.
DENVER, Colo., Gas & Electric Building	J. H. CHESNUTT, Manager. F. G. PARKER, Chief Inspector.
DETROIT, Mich., National Bank Building	L. L. COATES, Manager. THOMAS P. HETU, Chief Inspector.
HARTFORD, Conn., 55 Prospect Street	F. H. KENYON, Manager. A. E. BONNET, Chief Inspector.
NEW ORLEANS, La., 333 St. Charles Street	R. T. BURWELL, Manager. P. E. TERROY, Chief Inspector.
NEW YORK, N. Y., 90 John Street	C. C. GARDINER, Vice-President. J. F. HUNT, Chief Inspector.
PHILADELPHIA, Pa., 429 Walnut Street	A. S. WICKHAM, Manager. S. B. ADAMS, Chief Inspector.
PITTSBURGH, Pa., Arrott Building	WILLIAM P. WALLACE, Manager. J. A. SNYDER, Chief Inspector.
ST. LOUIS, Mo., 319 North Fourth Street	CHAS. D. ASHCROFT, Manager. EUGENE WEBB, Chief Inspector.
SAN FRANCISCO, Cal., 114 Sansome Street	C. B. PADDOCK, Manager. L. E. GRUNDELL, Chief Inspector.
SEATTLE, Wash., Arctic Building	E. G. WATSON, Manager. WILLIAM J. SMITH, Chief Inspector.
TORONTO, Ont., Canada, Federal Building	H. N. ROBERTS, President The Boiler In- spection and Insurance Company of Canada.

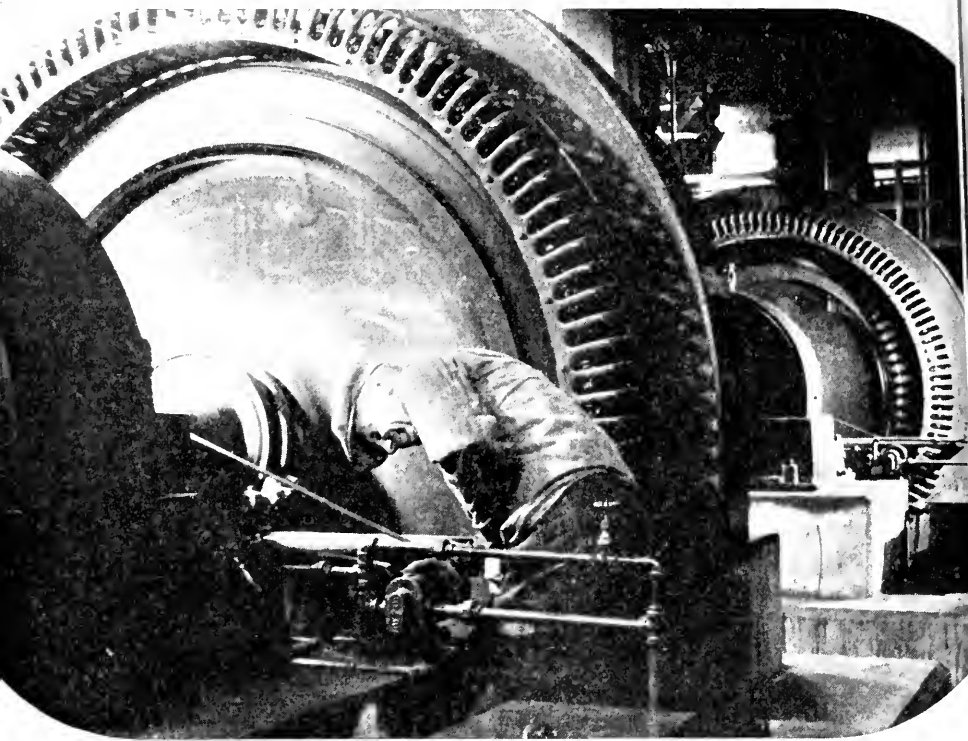

—to keep Industry's Wheels turning

Hartford Steam Boiler Inspection and Insurance Company inspectors, on their daily rounds, uncover many defects which, because they could cause costly accidents and lengthy shutdowns, might mean thousands of dollars lost through property damage and hampered production.

To maintain the effectiveness of their work, the Company con-

stantly gives its field men the newest accident prevention findings from the experiences and research of its directing engineers, who are recognized throughout the country as authorities on the safe operation of power equipment.

Practical, useful information and tested inspection procedure help to keep power equipment running smoothly.



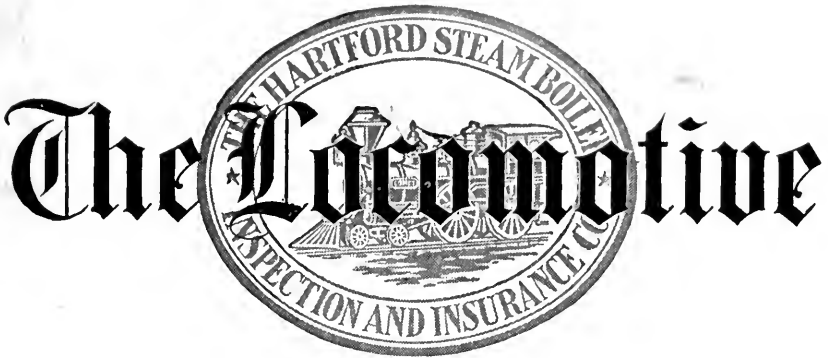

A QUARTERLY MAGAZINE
DEVOTED TO POWER PLANT PROTECTION

Published continuously since 1867
by The Hartford Steam Boiler
Inspection and Insurance
Company

Please show to your Engineer

The Repair of Bulged Shell Plates and Drums

By J. P. MORRISON, *Assistant Chief Engineer, Boiler Division*

WHILE bulges in boiler plate are usually serious weaknesses, it is often possible to make repairs which will permit the continued safe use of the vessel. In order to design such repairs, however, it is necessary to know accurately what caused the bulge and to determine definitely whether the plate is weakened over more than a small area. The cause and extent of the defect, therefore, are important, because there are certain conditions which make the scrapping of the affected plate the only safe remedy.

It is a fundamental fact that bulged or distorted boiler plates are the result of stresses greater than the metal could withstand without a change in shape. The overstressed condition may have been attributable to one of three causes:

1. Decrease in the yield point of the steel as the result of high temperature.
2. Decrease in the thickness of the plate.
3. Defective material.

Decrease in Yield Point.

The kind of bulge most frequently encountered occurs in a shell plate or drum surface which is exposed to furnace temperatures. Such a bulge is the result of overheating because of low water or the presence of scale or oil.

Oil used for the internal lubrication of steam engines or steam pumps is a poor conductor of heat. This oil reaches the boiler in condensate from the engine's exhaust steam, unless adequate steps are taken to remove it before the condensate is returned to the boiler. An exceedingly thin coating of such oil inside the lower plate surfaces of the boiler will prevent intimate contact of the water with the metal, thereby retarding the passage of the heat through the shell plate to such an extent that the plate will reach a temperature where deformation will occur under normal working pressure.

A bulge in the fire sheet of a horizontal tubular boiler, if caused by overheating because of oil, is frequently of considerable area but may be more or less shallow. The distorted area may extend longitudinally from girth seam to head seam and girthwise through an arc of 90° or more. If the depth of the bulge does not exceed the thickness of the plate and the oil can be entirely eliminated, no repairs, save perhaps the caulking of the seams, are necessary since the reduction in the thickness of the plate has been negligible. Any effort to "set

up" or to "drive back" a bulge of great area is likely to produce a number of comparatively small pockets in which sediment can accumulate—a condition which is considered more dangerous than the slightly distorted plate. If the depth of the bulge indicates a dangerous reduction in the thickness of the plate, a new fire sheet may be necessary.

When a new fire sheet is installed, the longitudinal seams must be located well above the fire line. It is good practice to attach the new

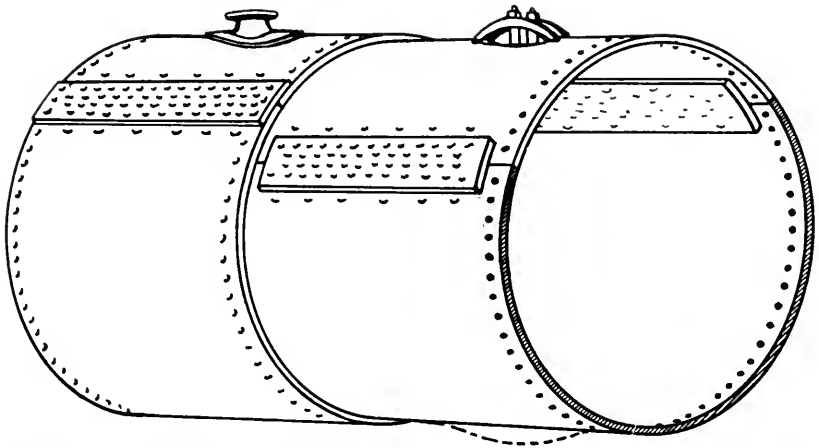

Figure 1—Repair of a bulge caused by overheating because of an oil deposit on the plate.

sheet on one side at the original longitudinal seam of the course. On the other side the new seam should be located so that it will "break joint" with the longitudinal seam of the adjoining course, that is, the two seams should not be at the same point on the circumference of the boiler. (Figure 1). The cost of a repair of this kind, when made with the boiler in place, may exceed the cost of putting on a complete new course at a well equipped boiler shop. The expense of removing the boiler from its setting, shipping it to and from the boiler shop, the repair work (which is likely to include a number of new tubes), and the reinstallation of the boiler will probably equal, if not exceed, the cost of a new bare boiler. All of these factors, in addition to the question of safety, must be taken into consideration when deciding upon what repairs to make and how to make them.

The repair of bulged metal weakened by overheating because of the accumulation of scale is often of a less extensive nature than that described above. A coating of scale on the fire sheet of a boiler may be of considerable thickness without causing dangerous overheating of the

plate. As scale increases in thickness, a point is reached at which it ceases to be merely a cause of added fuel expense and becomes a hazard as well. What this dangerous thickness is depends on the nature of the scale. Sometimes scale in dangerous amounts does not adhere persistently to the plate, but breaks off in flakes and accumulates in a loose form. Indeed, it may not deposit as scale at all, but may remain as suspended matter that accumulates as a sludge



Figure 2—An example of an extreme bulge because of scale.

which gradually settles on the heating surfaces. In either the solid or the loose form, this foreign substance within the boiler may retard the heat transfer to such an extent that overheating occurs. Then the pressure tends to force the plate out of shape. Such a change frequently causes the scale to break off or to shift its position, thus permitting the water to reduce the temperature of the plate to normal. In such cases, the bulge is not of great depth, and the material has not been seriously damaged. Consequently, a crew of skilled workmen can heat the distorted part and restore the sheet to practically its original contour.

If the accumulation of scale is not dislodged when the shell plate bulges slightly, the overheating and bulging may continue until the plate ruptures and leakage develops at the apex of the bulge. Bags or bulges resembling the crown of a derby hat are not uncommon where poor feedwater is used and where the boilers are not cleaned as thoroughly or as frequently as they should be. A bulge, because of overheating due to scale, is shown in Figure 2.

If the depth of such a bulge is not more than 25% of its diameter, it may be possible to restore the plate to practically its original shape by proper heating and hammering. Even if there is no rupture at the apex of the bulge it is well to drill a hole of about 1" diameter at that point in order to determine the thickness of the plate and to facilitate the upsetting of the bulged metal. A welding torch, secured to a long

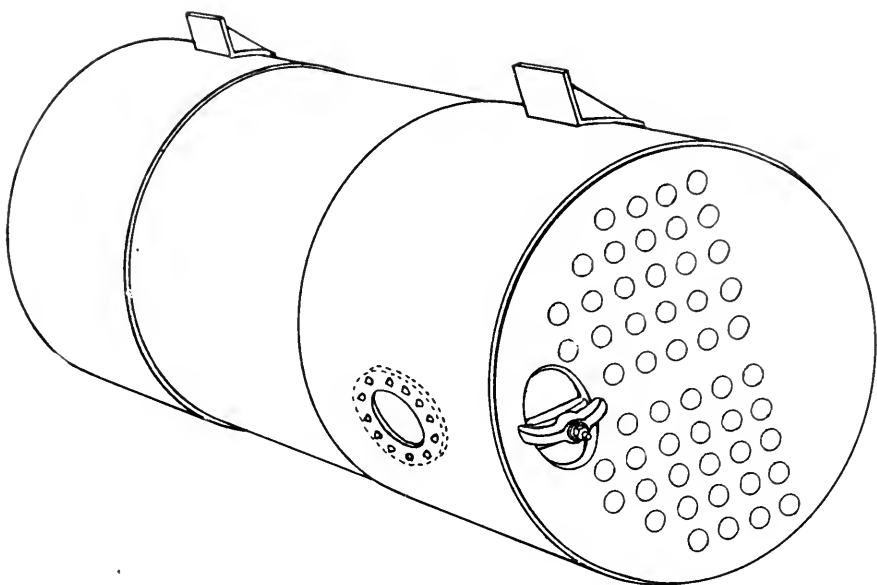

Figure 3—Repair of a bulge caused by overheating because of scale.

handle, may be used to heat the plate on the inside surface while the outside surface is hammered. A cast iron form of proper shape can be used to advantage inside the boiler as a face plate. After the bulge is "set up," the hole that was drilled in its apex should be reamed and closed with a rivet.

Patching should be a last resort, although it cannot be avoided if the bulged material has been "burned," if a considerable area of the plate has been seriously reduced in thickness, or if the bulge has a rupture too large to be closed with a rivet.

Since a patch should be no larger than is absolutely necessary, it is better and cheaper to heat the bulged portion of the plate and straighten it as much as possible before cutting out whatever area must be removed. Assuming that the bulge is near the center of one of the courses of the shell plate, the patch may be practically round or some-

what oval, depending upon the shape of the bulge and the extent of the thinned material. (See Figure 3). The patch must be of such size that it will pass through the manhole, or, if larger, it must be of such shape that it will pass through the opening it is to close. The patch should be secured to the inside surface of the shell plate, unless the blow-off pipe is to be connected to it.

The strength of a patch seam is frequently questioned. Theoretically, a circumferential seam will withstand twice the boiler pressure of a longitudinal seam of similar design. A seam in a diagonal or circular position will withstand a greater pressure than a longitudinal seam, but less pressure than a circumferential seam. To obtain adequate strength, patches are usually of crescent or horseshoe shape with the dimension lengthwise of the boiler not more than half of the dimension crosswise of the boiler.

Decrease in Thickness of Plate.

When the normal working pressure causes a bulge to form in a plate that has been reduced in thickness and in strength by internal or external corrosion, the distortion of the plate is likely to be followed by a rupture extending across the entire corroded area. This may result in a serious, if not an extremely violent, accident.

If the condition is found before a serious rupture occurs and the value of the boiler justifies it, repair by patching is permissible, provided the other parts of the boiler are not damaged or weakened. Regardless of whether the boiler is repaired or replaced by a new one, it should not be operated under conditions that will permit internal or external corrosion again to develop undetected.

Defective Material.

A bulge in the shell of a steam boiler constructed of modern material is seldom due to an initial defect in the plate. However, the steel-making processes in use some years ago resulted frequently in such defects as laminations, which were due to gas pockets in the ingot. These weaknesses are difficult to detect until overheating causes a blister to form.

If the gas pocket was small, the lamination and any resultant blister or bulging of the outer part of the shell plate, due to overheating, is also comparatively small and may be properly repaired by cutting off the outer surface of the plate with a chisel. Usually such a blister is near the middle of the plate thickness and it is generally circular or oval in shape. As the greatest dimension seldom exceeds 10 in., a defect of this kind may be considered as satisfactorily repaired when the bulge is removed.

Power Boiler Explosions

FOUR men lost their lives as the result of a sawmill boiler explosion at Woodman, Kentucky, on January 2, 1935. A crack in a lap seam of a locomotive firebox type boiler opened up with force sufficient to blow the boiler over a slab pile 20 feet high. A steam engine nearby was demolished. The men, who were eating their lunch



Parts of mine boiler following its explosion.

near the boiler, were hurled from 30 to 300 feet. Three of them were killed instantly and the fourth died later in a hospital. An element of irony was added by a report that a few seconds before the accident the men had jokingly told a small boy to "get out of here as the boiler is going to explode and kill everyone within a mile of the place." The boy ran to a grist mill on the property where his father was eating his lunch and as he entered the door the boiler exploded.

When a boiler blew up at an Arkansas mine, on November 22, 1934, two men who were in the boiler room were killed, the engine room was

demolished and three automobiles parked outside were damaged. The parts of the boiler were scattered about the vicinity, some of them being shown in the photograph. About 50 men had been standing near the boiler a few minutes previously, warming themselves before going into the mine.

A laborer was fatally injured at an oil well near Hutchinson, Kansas, on December 17, 1934, by the explosion of a locomotive type boiler, one unit of a battery used in oil field operations. The boiler, which was set between two others, traveled upward, coming to the ground about 150 feet from its original location. The boiler shed was demolished, parts of it falling on the man who was injured.

The explosion on November 16, 1934, of a track locomotive boiler belonging to a West Virginia coal mining company injured the engineer and fireman and wrecked the locomotive. The initial failure occurred in the crown sheet while the engine was engaged in shifting cars below the coal tippie. The force of the explosion was enough to lift the locomotive off the track and throw it on the embankment. The engineer was able to crawl from the wrecked cab after the accident while the fireman was knocked unconscious and had to be rescued by the train crew. Indications were that the crown sheet failed due to overheating caused by low water.

Rupture of Header Puts Plant Out of Operation

After a front end header had blown out on an Ohio paper mill's water tube boiler of approximately 10,000 square feet heating surface, an examination showed fourteen other headers to be leaking at the bottom seam where the ends were forge welded. The accident was attributed to the fact that the protecting brick wall and the baffle had been allowed to burn until the fire came in contact with the ends of the headers, which were choked with scale. The accident shut down the plant, causing an appreciable use and occupancy loss.

Piping Accident Damages Drug Store Stock

Steam pouring from a fissure in a five-inch pipe in the basement of a Butte, Montana, drug store recently damaged the stock and fixtures to an amount estimated at several thousand dollars.

Heat from the steam proved sufficient to blister varnish on the shelves, caused corks to pop from bottles and boil out their contents, peel off leather from cameras, explode bottles of high priced perfume, melt candy bars and crack thick glass in show cases, windows and mirrors. The temperature even proved too great for a number of valuable clinical thermometers, bursting them open.

Bo: "Say, what is limburger cheese composed of?"

Joe: "Limburger cheese ain't composed of nothin'. It's decomposed."—*What-you-may.*

Cleaning of Turbo-Generators

By E. W. BEARSE, *Directing Inspector*

IN the majority of plants it is general practice to dismantle turbo-generators at least once each year of operation to clean, inspect and overhaul them. Experience with this routine, as it is handled in some plants, indicates that there is a considerable lack of adequate information relative to the proper cleaning procedure. An inspector, called to a plant on receipt of advice that a unit has been dismantled, completely cleaned and the winding sprayed with insulating varnish, receives somewhat of a shock to find, in some instances, that the cleaning of the stator, for example, has not been properly carried out and that varnish has been sprayed over an accumulation of dirt on the winding. This procedure "seals in" foreign material and makes it a permanent addition to the surface of the insulation, thereby defeating the basic purpose in cleaning—to *remove* dirt or other foreign materials from the insulation.

Generators equipped with closed ventilating systems usually need only minor cleaning, which can, in most cases, be accomplished by the use of dry compressed air. The dryness of the air, however, is extremely important. When plants do not have suitable facilities for removing moisture from compressed air, the moisture is blown into the generator in the process of cleaning, an obviously poor practice. Units operating without closed ventilating systems are not so fortunate in escaping heavy deposits of dirt. In some instances the accumulation of dirt in the revolving member has been sufficiently heavy to influence the balance of the unit. Oftener it affects the insulation resistance.

Accumulations of dirt vary greatly in conductivity, which is dependent upon the nature of the adhering substances. Frequently insulation resistance readings will be found at a very low value, on some units as low as zero, because of dirt or other foreign material on the windings. The lower the insulation resistance, the greater will be the leakage current from the conductor to the iron. This leakage current may be of a cumulative nature which will gradually carbonize a path through the foreign material and eventually result in a very low resistance leakage path to ground. Often an incandescent lamp can be lighted, when placed in series with a supposedly insulated winding and the frame of the generator. In making any such test care must be taken to determine whether one side of the supply circuit is grounded. If such is the case, the grounded side should, of course, be the placed in contact with the frame of the unit.

In many instances where the ventilation is not of the closed type, cleaning with dry compressed air is all that is necessary to bring up the low insulating resistance. In other cases, waste oil may be found mixed with the dirt because of leakage from the lubrication system of the unit or as a result of oil vapor given off by industrial processes. Under such conditions compressed air alone is of little value. An attendant may spend much time and effort in attempting to clean such oily dirt from the winding with air alone and find that he has made no progress.

Where the dirt is of a sticky nature and is difficult to remove with air, a suitable solvent should be sprayed on the winding along with the compressed air. Naphtha may be used, but as it is highly inflammable, particular attention should be given to adequate ventilation in the vicinity of the machine, and open flames or open lights must be avoided. The same comments, of course, apply to gasoline or any other inflammable solvent. Ordinary gasoline is not highly recommended for cleaning electrical equipment as there is likely to be a certain percentage of non-volatile residue. The use of ethyl gasoline for cleaning windings should be particularly avoided. Another solvent which is more expensive, but which gives very excellent results, is carbon tetrachloride. Care is required when this liquid is used in excessive quantities or when the insulation is flooded for long periods of time, because it is a mild solvent for insulating varnish, shellac and many forms of lacquer as well as for grease and oil.

The stator windings of turbo-generators should be given particular attention at the ventilating ducts throughout the laminations, at the points where the coils leave the slots at the ends of the core, and at those sections of the coils that are in the bottoms of the slots. Satisfactory cleaning of the upper halves of the coil ends is usually accomplished. Occasionally, however, the lower halves of the coils, which must be reached from the braced side of the overhang of the coils, are entirely neglected.

The revolving fields are notorious dirt catchers on open ventilating systems, and they are so generally enclosed by the retaining rings over the end turns of the coils that they seldom receive more than a superficial blowing out by station attendants. A handy tool for this part of the cleaning is a goose neck copper tube or small pipe, as illustrated in Figure 1. When using it, a comparatively light spray of solvent is, in general, sufficient, although there may be instances where a heavier spray is necessary. The spraying should be done with considerable judgment and it should be constantly kept in mind that with the removal of dirt, there is a certain amount of insulating varnish and binder for

the mica liners, within the shroud rings, that may also be removed.

Where low insulation resistance readings are obtained on a revolving field, considerable effort may frequently be saved by first making a test of the collector ring assembly with the leads to the field winding disconnected, and also by carefully investigating the condition of the leads from the rings to the winding where they are carried in channels in the shaft. It is also advisable to lift the cover plates from over these channels for

inspection of the lead insulation. It should be noted that



Figure 1

such work is best done by a service engineer of the manufacturer.

In case this procedure does not reveal the source of the low reading, it is fair to assume that the low resistance is in the winding of the field itself, and spraying with a solvent is then in order. The intensity of the spray should be varied to suit the conditions.

During the spraying of the field winding the dirt is carried away in a muddy stream and may tend to accumulate in puddles in the lower interior part of the field. To guard against this possibility, it is recommended that the field be very slowly rotated so that such accumulations will be carried out of the field through the ventilating openings.

In particularly obstinate cases, where the winding in general has the appearance of being clean and yet there persists a low insulation resistance (judged to be the result of a pocket of dirt at some point), it is found extremely helpful to keep an ohmmeter connected to the winding during the spraying process. An attendant should watch the deflection of the pointer while the spray is being directed into the winding. In this way it is often possible to note a momentary increase in insulation resistance as the spray of solvent is directed against that part of the winding which is responsible for the low reading. In such cases the attendant can give notice to concentrate the spraying on that particular section. Unless the ohmmeter is kept in operation, that part of the winding may escape suitable attention. Use of an ohmmeter is not recommended when the cleaning solvent is inflammable.

It is also obvious that the attendant must exercise special precaution in spraying during the time the ohmmeter is in use, because many revolving fields have bare edge conductors and should the spray nozzle come in contact with the bare copper at a time when the attendant is in contact with the frame of the machine, he would receive a harmless

but very disagreeable shock from the potential supplied by the ohm-meter.

If a low reading persists, it will be necessary to call on the manufacturer to clear up the difficulty by removing the retaining rings or by whatever other course of procedure may be required. Where retaining rings are shrunk on, their removal is frequently a task most economically performed by the manufacturer. In spite of the inconvenient features of this major operation the increased reliability of the revolving field with high insulation resistance is a consideration which justifies the expense and delay.

Following extensive use of a solvent, it is strongly recommended that a winding be sprayed with air-drying insulation varnish, even in those cases

where the winding is already heavily coated, because such heavy coatings of varnish, in almost all cases,

develop cracks or crevices which, if not filled again, become the "weak points" in the winding. A coat of insulating varnish is also very desirable for cementing together the edges of mica insulation to prevent flaking

Insulating varnish can best be applied by means of a compressed air spray. If a spray device is used, such as that illustrated in Figure 2, which can be obtained from any electrical jobber, the work can be done expeditiously by drawing the supply of varnish directly from a commercial shipping container.

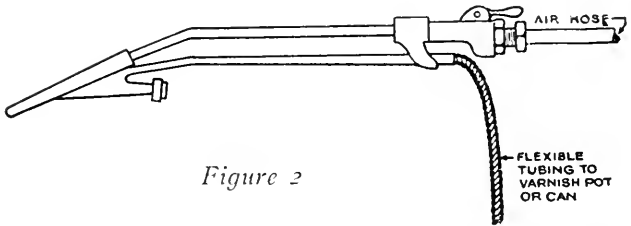

Figure 2

Transformer Failure Shuts Down Metal Plant

Transformers often are key parts of a manufacturer's power apparatus. When they fail, they may result in costly shutdowns. Such was the case recently at an Ohio metal factory which had protected itself against just such a loss by electrical and use and occupancy insurance. The secondary coil of one phase failed on a 1200 kva transformer connected to an electric melting furnace and prevented its use. More than \$4,500 was paid by The Hartford Steam Boiler Inspection and Insurance Company as the plant's production was dependent on the output of the furnace.

Heating Boiler Accidents

SERIOUS accidents to heating equipment have occurred during the past winter in many cities and towns. A few of them, either because of their severity or some particularly interesting condition, will be described in this article.

As is the case in every winter season, the freezing of pipes, through which there should be circulation of steam or water, figured in some of



Wreckage following a heating boiler explosion at Clifton, N. J.

the more violent accidents. This was the case at Monessen, Pennsylvania, on January 23, 1935, when a hot water boiler exploded in the kitchen of a modest residence. Three little girls were playing near the boiler, and the father of two of them was sitting at a table across the room. Because the weather was severe, the boiler had been fired up to raise the temperature in other rooms. Bursting without warning, a piece of iron broke out and was blown across the room, striking the man on the leg. The girls were all killed by escaping steam and hot water. An investigation revealed that a relief pipe, which discharged

outside the dwelling, had become plugged by ice. At the time of the accident the boiler was operating as a closed vessel and accumulated a pressure which it was not built to withstand.

The explosion of a cast iron heating boiler in an apartment-business block in Clifton, New Jersey, on February 11 resulted in the death of an 11-year old boy who had gone into the basement to tend the heating plant. The blast shattered the boiler and one of the heavy parts fell on the boy. A further complication was the spreading of live coals from the furnace in such a way that fire broke out in several parts of the basement, the blaze resulting in additional loss. Walls were bulged and shaken, windows were broken and much of the stock in a drug store in the building was knocked from the shelves. Because the boiler was so badly shattered, it was not possible to determine the cause of the blast.

What happens when steam is generated in a boiler with no outlets was illustrated by an explosion in Newark, New Jersey, on November 15, 1935. A fire was built in a new boiler to which the radiators had not been connected, it was reported by city firemen. The resulting explosion led to the death of a man who was sleeping in a room which was directly above the boiler room. He was thrown from his bed, according to newspaper accounts, and fell into the path of the released steam.

With the thermometer in the vicinity of zero, a heating boiler in a fraternity house at Columbia, Missouri, cracked on January 23, when low water resulted because of the failure of an electrically operated circulating pump. The students spent several days hugging fireplaces, oil heaters and other heating devices before new sections were in place.

At Lewiston, Illinois, an accident late in November at the high school brought about an enforced vacation for all students. The heating plant burst in such a way that a new boiler was required.

Four milk company drivers, a plant superintendent and the vice president of a Mount Vernon, New York, dairy company were injured on November 27, 1935, when a hot water heating boiler exploded in a distributing station. The boiler room was wrecked, a wall blown down and debris scattered through the building. The heating plant had been installed but a few weeks and up to the date of the explosion had been used only intermittently because of the mild weather. It was learned

that when severe weather set in only part of the system produced heat, the offices being overheated and the delivery men's room, where the expansion tank was located, being cold. It was reasoned that some obstruction prevented proper circulation of the water, and that pressure built up in the boiler and in the part of the system which was in circulation. The system was equipped with a water control device, but it was not learned definitely that a relief valve had been installed.

Twenty out of the twenty-six half sections of a large cast iron steam boiler operated in a Waterbury, Connecticut, apartment house cracked on the night of December 11, 1934, when the boiler was overheated because of low water. It was reasoned that one of the sections developed a leak and the water became low. Then the return pump admitted cold water to the hot boiler and the stresses caused by the rapid change in temperature cracked the other 19 sections. This boiler was insured by the Hartford Steam Boiler Inspection and Insurance Co., which paid \$1,472 for the replacement of the sections.

Corrosion of Boiler Drum Heads

MUCH has been said in THE LOCOMOTIVE about the dangers involved in the corroding of concealed boiler drum heads, particularly of the so-called "mud-drums" of boilers of the vertical bent-tube type. In fact, this condition is so hazardous that closely bricked-in heads are a rarity in the plants of well informed operators.

It should be emphasized, however, that the uncovering of so-called "blind" heads does not entirely overcome the danger of corrosion wherever brick or mortar prevents a ready examination of the drum, either at the closed end or at the manhole end.

Recently, an inspector discovered a condition of a manhole head which might have caused a disastrous accident. Two bent tube type boilers had been offered for insurance. The preliminary inspection resulted in numerous recommendations, and while it was not possible, at the time to disturb the brickwork and examine the ends of the mud drums carefully, such an examination was strongly advised at the first convenient opportunity. Soon after the first inspection, the boilers were retubed, and, while under the hydrostatic test, considerable leakage occurred at the seam of a manhole head. This led to the tearing away of part of the brickwork. The head was found to be badly corroded and drilling revealed that at some points it was only 1/16 in. thick. Continued leakage at the manhole cover was blamed for the corrosion.

A Flaw in Crank Leads to Accident

AN old and originally small flaw in the metal gradually extended in the crank of an air compressor at a North Carolina mill until the crank could no longer sustain the load and broke suddenly with the result shown in the accompanying photograph. The break caused a

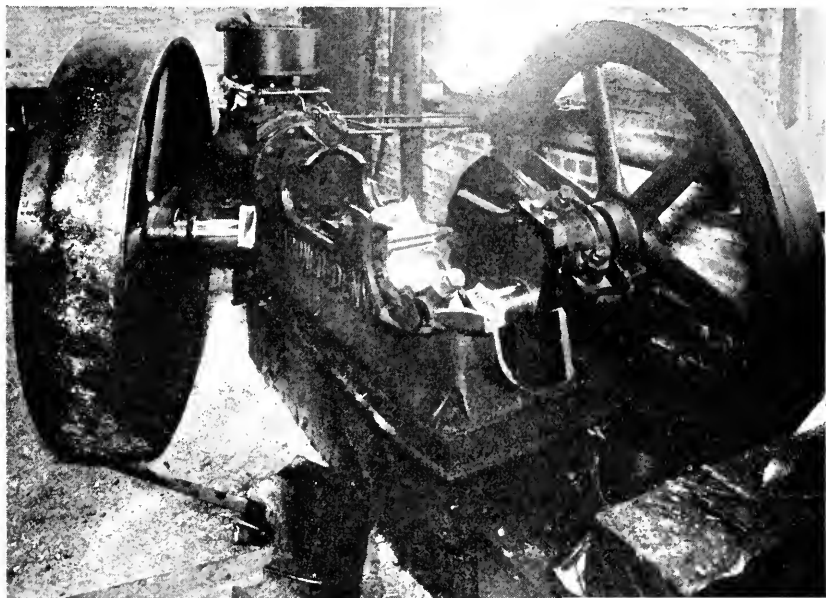

An air compressor wrecked when the crank broke as shown.

complete smash-up of the frame and main journals, and the bending of the piston and connecting rods. As is clearly shown, the fracture took place in the crank arm on the driving pulley side of the compressor. This machine had a 12" cylinder and was driven by a 75 hp motor.

Two Accidents to Chain Drive Motors

Two recent accidents to electric motors demonstrate ways in which equipment of this sort may sustain severe mechanical damage. The first mishap, which resulted in a cracked frame and end bells and a bent rotor shaft on a 200 hp chain-drive motor, was caused by the jamming of a beater used in the plant of a roofing manufacturer. The chain was broken.

In the second accident a 150 hp motor slipped on its base, until the driving chain was so slack that the top caught on the bottom and wrapped the chain around the pinion in such a way as to bend the 4½" rotor shaft approximately 5" out of line.

Fuel Explosions

EXPLOSIONS of accumulated mixtures of air and unburned gases in oil or gas-fired boiler installations in recent months serve to show that the hazard of fuel detonations within the furnace of the boiler is of major importance.

A milling company employe at Visalia, California, lost his life when a natural gas explosion occurred as he was "lighting off", following the usual week-end shut down. It is assumed that gas collected in the furnace of the boiler over Sunday and that the furnace was not thoroughly ventilated before the torch was introduced. The blast damaged the setting and blew open the doors, one of which struck the boiler attendant, injuring him fatally. In such installations the ventilation of the furnace, preparatory to lighting off, is of great importance. Where fans are not used the stack damper and all air inlets should be left wide open for at least 10 minutes before applying the torch. (See THE LOCOMOTIVE April 1933, Page 183).

Five school children and a teacher sustained minor injuries in the hurried exit of 1,200 children from a Biddeford, Maine, school following a furnace explosion which shook the structure and admitted smoke to halls and rooms. Cool-headedness on the part of teachers and older pupils prevented more serious consequences. The blast itself blew down a wall, broke windows and caused some other damage. An investigation revealed that the probable cause was an air leak at a nipple close to the pump in the oil suction line. This would have tended to produce an intermittent flow of oil, permitting the burner to go out. As additional fuel reached the furnace it vaporized but did not ignite until the control mechanism again introduced fire to the furnace, detonating a mixture of oil vapor and air which had collected there.

Two fuel explosions in oil-fired installations in residences reveal the amount of damage which may be caused by smoke and soot resulting from furnace explosions. In both instances the explosion blew open the furnace doors but failed to extinguish the flame. The subsequent outpouring of soot and smoke damaged expensive rugs, draperies and upholstery, wallpaper and paint, and even clothing which was exposed to the smudge.

Ammonia Pipe Rupture Shuts Down Cold Storage Plant

When an ammonia pipe of a brine cooler owned by a Washington cold storage firm failed, the result was an eight-day partial shutdown involving a business interruption loss of approximately \$3,000. The direct damage, which exceeded \$2,000, was caused by leakage of ammonia, which so damaged the tank full of calcium brine that the brine could not be salvaged.

Turbine Explosion

We are indebted to our contemporary, the British Engine Boiler and Electrical Insurance Company, for the accompanying interesting

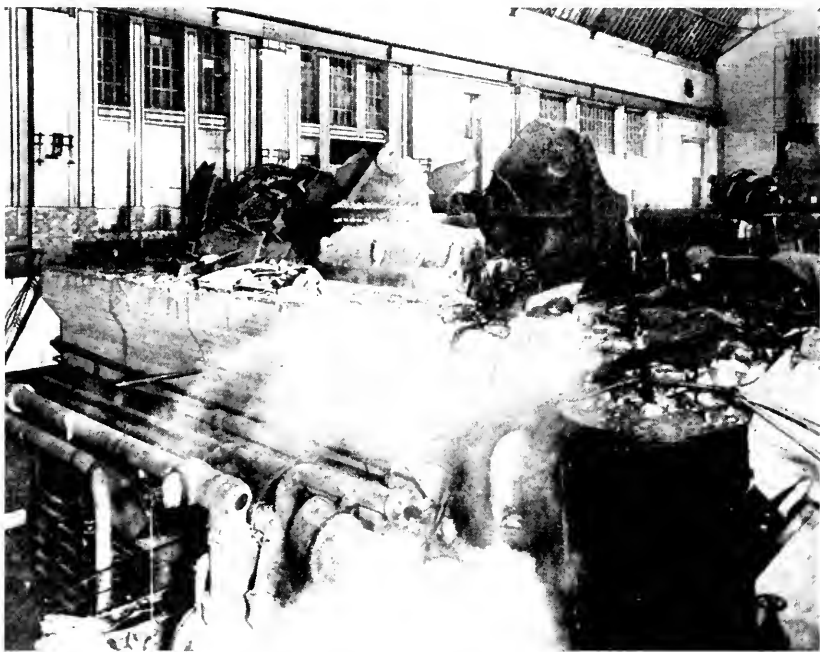

photograph of a turbine that exploded some months ago in a power station at Stettin, Germany. This 23,000 kw unit was undergoing a 10 per cent overspeed trial when it let go, severely injuring two attendants and causing damage estimated at \$200,000.

*Test Safety Devices**

The mere fact that a machine has run sweetly for years is no proof that trouble will not come tomorrow. Remember the "one hoss shay." Certain types of equipment may go out suddenly and without warning. A case in point is a recent turbine failure reported from South Wales. A 5,000 kw. machine designed to operate at 3,000 rpm was completely wrecked. The unit, installed in 1923, had been in service for four months without shutdown prior to the accident. Governor and overspeed stop both failed to function and the machine crashed before the operator could close the stop valve. The governor had been damaged and clogged with sediment and dirt.

Had the safety devices been tested at regular intervals, regardless of their apparent condition, this accident would have been avoided. Continuous operation for long periods, without shutdown for inspections, may make nice records, but unquestionably it's playing with fire.

*From "Power Plant Engineering".

Safety Devices, Inspections Emphasized by British Board

After investigating an explosion of a jacketed process vessel, the British Board of Trade recently took occasion to emphasize the need not only of adequate safety devices for such pressure vessels but of periodic inspections by men qualified for that work. In reporting the result of the investigation *Vulcan* quotes the Board as asserting that the plant where the explosion occurred "failed in the duty incumbent on it of seeing that the jacketed pan was properly equipped with the necessary safety appliances, and was periodically inspected by qualified persons".

The accident resulted in the death of one person and the serious scalding of another. It was caused by a corrosion leak which permitted steam from the jacket to build up pressure underneath an inner pan not intended to withstand such pressure. The inner pan blew out and escaping steam and water injured attendants.

High Steam Economy Under Adverse Conditions

Of the dozen or so power stations in the United States which consistently produce a kilowatt hour in energy for each pound of coal consumed, the great majority employ high pressure turbines and boilers; some use steam or boiler reheat and almost all carry a nearly constant load. In the Lincoln Wharf Station of the Boston Elevated Railway, however, conditions which tend to increase the amount of fuel consumed, such as fluctuating load and the nightly shutdowns, are encountered, and it is thus remarkable that in this case the pound of coal per kilowatt hour condition should prevail.

Several practices followed by this station with regard to its 35,000 kw unit have helped to reduce fuel consumption according to the *Electric Journal*. When the turbine is shut down for six or eight hours, as it is every night, a motor-operated turning gear keeps the spindle revolving at about 34 rpm, and insures its uniform cooling. Otherwise, unequal cooling would occur in the turbine at rest after being shut down and would result in a hump in both stationary and moving parts. Such distortion would likely cause blade rubbing and serious vibration when the turbine is started again.

Oil is supplied to the unit while the spindle is being slowly turned by a motor-driven auxiliary pump which reduces the steam consumption during the shutdown period. Also, the reduction in the time required to bring the unit to speed, when the rotor is kept true, results in a considerable saving of steam.

To reduce cylinder distortion caused by non-uniform heating during the starting period, steam from the primary valve enters a jacket extending completely around the cylinder and heats up all parts equally.

Three other features help to increase efficiency and dependability: (1) turbine elements have been so proportioned that wide load fluctuations can be imposed without materially affecting the water rate; (2) the elimination of joints and use of a single-piece carbon-steel forging for the spindle has been adopted, and (3) the installation of a water catcher opposite each of the revolving rows of blades near the exhaust to extract moisture improves the efficiency and reduces erosion.

The combination of these several features has definitely contributed toward cutting the cost of operation of the plant by reducing both maintenance expenditure and steam consumption.



A QUARTERLY MAGAZINE
DEVOTED TO POWER PLANT PROTECTION

George H. Prall, *Editor*

Copyright 1935 by The Hartford Steam Boiler Inspection and Insurance Company

HARTFORD, CONN., April, 1935

Single copies may be obtained free by calling at any of the Company's agencies.

Subscription price 50 cents per year when mailed from this office.

Bound volumes one dollar each.

Reprinting matter from this paper is permitted if credited to

THE LOCOMOTIVE of THE HARTFORD STEAM BOILER INSPECTION AND INSURANCE CO.

Kenneth A. Reed

Kenneth A. Reed, chief engineer of the electrical division of The Hartford Steam Boiler Inspection and Insurance Company's engineering department, died on March 23, 1935, at his home in Hartford following a prolonged illness. It was Mr. Reed who created the engineering and inspection procedure now followed by the Company with relation to all electrical apparatus which it insures. His achievements in that direction were founded on a wide experience in the manufacture and operation of such objects, strengthened by unceasing efforts to further safety in the design and operation of new equipment.

President Wm. R. C. Corson issued the following statement to the press with regard to Mr. Reed and his contribution to the Company's success in the insurance of electrical apparatus:

"Mr. Reed's death takes from our company a man who has had an important part in the broad expansion of its business since the war. When he joined our organization in 1921 he was a technically educated and trained engineer, with a broad experience in the mainte-

nance and operation of all classes of electrical machinery. He came to us then to help in the creation of a new line of underwriting, which we had in contemplation, namely, the insurance of electrical machinery, with a service for accident prevention similar to that which we had so successfully practiced with steam boilers. It was a new field of underwriting, of which the problems and hazards could only be roughly estimated at the start. Mr. Reed's judgment and broad experience were of an inestimable aid in this necessarily pioneer work, but his principal responsibility was the determination of the technique of inspections and the creation of an organization to make these inspections in such a way that they would protect the company and its clients against preventable losses. In the accomplishment of this purpose Mr. Reed's service to the company was an outstanding one. To him in large measure is due the successful underwriting of electrical machinery insurance which is now a large portion of our company's business."

Mr. Reed was born in Gregory, Arkansas, on January 30, 1883. He was a graduate of the engineering courses of the University of Arkansas in the class of 1907. An associate member of the American Institute of Electrical Engineers, Mr. Reed served that organization on its electrical machinery committee. For several years he was a member at large of the electrical apparatus committee of the National Electric Light Association, and in his work with these bodies he made valuable contributions to the safe design and operation of power machinery. His views on problems of maintenance and operation were frequently consulted and he was on many occasions asked to deliver papers before engineering and technical societies.

Clarence C. Perry

Clarence C. Perry, from July 1, 1912, to December 1, 1919, the editor of THE LOCOMOTIVE, died in New York City on January 30, 1935. He had been associated with various insurance companies and at the time of his death was superintendent of the engineering and inspection department of the Standard Surety and Casualty Company of New York.

Mr. Perry was born in New Britain, Connecticut, was a graduate of the Sheffield Scientific School of Yale University, class of 1904, and served on the faculty at New Haven until he became editor of THE LOCOMOTIVE.

In 1919 he joined the engineering staff of the Ætna Casualty and Surety Company, resigning in 1926 to become head of the machinery and boiler department of the Ocean Accident and Guarantee Company. At the time of his death Mr. Perry was a resident of Tuckahoe, New York.

Aldin S. Talman

Aldin S. Talman, for many years an inspector in the Philadelphia Department, died on March 19, 1935. He was well known to many of the Company's clients in the vicinity of Camden, New Jersey, his home, as well as to assured in other parts of Pennsylvania and New Jersey. Beginning his association with the Company in 1902, Mr. Talman served as an inspector until ill health resulted in his retirement in 1931. He was born in 1868 at Allentown, New Jersey.

William Noee

William Noee, former inspector with the company at St. Louis, died on February 7, 1935, the day being his 78th birthday. Mr. Noee entered the employ of the company in 1889 and left it to accept a position with General Motors in 1920. He was well known to many "Hartford Steam Boiler" clients in the territory served by the St. Louis Office.

Gantt Medal to Horace B. Cheney

Horace B. Cheney, a director of The Hartford Steam Boiler Inspection and Insurance Company since 1909 and until recently general manager of the Cheney Mills and vice president of Cheney Brothers at South Manchester, Connecticut, has been awarded the Gantt gold medal for 1934. Established by friends of Henry Lawrence Gantt "to memorialize the achievements of this great management engineer, industrial leader, and humanitarian," the medal is presented each year to an individual in recognition of "distinguished achievement in industrial management as a service to the community." The award is made by representatives of the Institute of Management and the A. S. M. E. Management Division.

The presentation of the medal to Mr. Cheney took place at a session of the A. S. M. E. annual meeting and was in recognition of his distinguished industrial leadership, and his part in making possible Mr.

Gantt's notable work at the Cheney Mills, in supporting him in the development of that work, and in continuing it successfully through the succeeding years. As personal contributions to this work, Mr. Cheney's endeavors in the field of fair job assignments, studies of interference, and watching time and quality standards have brought him special recognition in industrial management circles.

Ground in Generator Field Brings Costly Shutdown

The development of a ground in the field of a 20,000 kw turbo-generator at a Virginia power plant recently caused damage in excess of \$7,000. The generator had given no evidence of abnormal behavior until it became noisy and started to vibrate at the outboard end. Sparks and smoke issued from the air vent. Operators shut the machine down, and an investigation disclosed that the inner coil on one of the poles had become grounded to the steel retaining ring.

Two-Stage Air-Cooled Air Compressor

A notable change in air-compressor design, which not only reduces power losses but enables cooling water to be dispensed with has recently been effected, according to an article in *Engineering*. The cardinal feature of the design is the employment of two stages of compression with an air-cooled intercooler, air cooling being employed also for the cylinders and heads. At present the new machines are made in four sizes having actual air deliveries ranging from 90 cub. ft. to 249 cub. ft. per minute at a pressure of 100 lb. per square inch. Compared with single-stage water-cooled compressors of the same piston displacement, the two-stage air-cooled compressor is claimed to require 15 per cent less power for the same amount of air compressed, or to deliver 23 per cent more air at 100 lb per square inch pressure. The article points out that when these advantages are considered along with the fact that the troublesome problem of water supply is eliminated, it will be realized that an advance of considerable importance has been made in compressor design. Subsidiary advantages are that, due to two-stage compression with intercooling, the air discharge is at least 150°F. cooler than with a single stage water-cooled machine, while, due to the same features, no carbon forms on the valves which, in consequence, retain their original efficiency.

Low Voltages for Hazardous Locations

It is well known from experience that a person subjected to a 110 or 120 volt current while caught in the cramped interior of a boiler may sustain a severe and perhaps fatal shock. There have been enough accidents of this sort to show that when the body is shorted between two wires or between a wire and another good conductor such as a damp floor or a grounded piece of metal, the consequences can be serious unless the person is able to free himself quickly.

In a discussion of recent experiments leading to the conclusion that a man cannot take more than from 12 to 20 volts and retain complete muscular control, the *National Safety News* points to the desirability of having 6 volt lines for extension lights in boiler rooms and similar places. When this is not feasible, it urges utmost care in using only high grade extension cords and fittings and in seeing that they are well maintained.

Transmission Line Broken in Freak Accident

An accident that came from a rather unusual cause recently halted activities in a plant manufacturing textile machinery. The plant was dependent on purchased current which came in on a high tension line that was strung above tracks on which a moveable crane operated. On the day of the accident the crane operator was easing his machine down a steep grade when the swaying of the extended boom began to lift the rear wheels from the rails. To prevent a wreck, the operator raised the boom quickly, but in so doing, brought it up against the overhead power line, tearing down the three cables. The firm was insured against loss from this accident by a policy in "Hartford Steam Boiler".

Centrifugal Drier Bursts in Candy Factory

The explosion of a centrifugal drying machine in a Massachusetts candy company's plant killed one man and seriously injured two more, as metal fragments were thrown about a room in which employees were at work. The machine had just been loaded with candies to be dried.

Buried Return Line Leads to Cracked Boiler

An interesting difficulty, due to peculiarities of installation, was disclosed recently following an investigation prompted by the cracking of cast iron sections of a boiler supplying steam heat to a West Virginia industrial plant and an apartment house some distance away, across a road and a creek. The return line from the apartment house to the boiler was buried in the ground for a distance of 150 ft, passing beneath both the road and the creek. This line had corroded through somewhere underground, preventing a certain amount of the condensate from returning to the boiler. Over a matter of hours, the condition resulted in low water and the consequent overheating of the boiler.

A very ingenious method was used to locate the leak. One end of the line was blanked off, and a fire hose attached to the other end. When a water pressure of 80 lb was applied to the buried line and maintained for a period of 1½ hours, water was found seeping out of the ground at the side of the creek, about 75 ft from the boiler. The buried line was uncovered at that point and two holes, each about ½" in diameter, were found to be corroded through the wall of the pipe.

The World's Largest Diesel

The recent installation of a 15,000 kw unit at Copenhagen gives Denmark the distinction of possessing the largest Diesel engine in the world. This engine is 50 per cent larger than its nearest rival and is part of a 145,000 kw plant which supplies power for all of Denmark, the *Electric Journal* points out.

The Diesel is a double acting, two-stroke, "uniflow scavenger" type with mechanical injection. It operates at 115 rpm and the fuel tank is of 1,000 tons capacity. With 8 cylinders 840 millimeters (33 inches) in diameter and a piston stroke of 1,500 millimeters (59 inches), the guaranteed fuel consumption at 1,500 kw is 0.25 kilograms per kilowatt hour (0.55 lb per kw hr.).

Broken Gib Causes Steam Engine Wreck

HOW the failure of a minor part can bring about a complete breakdown of a reciprocating engine was illustrated some weeks ago by an accident at a New York worsted mill. The engine, a 500 hp tandem compound unit, was operating normally when the gib in the crank end of the connecting rod broke, permitting the rod to

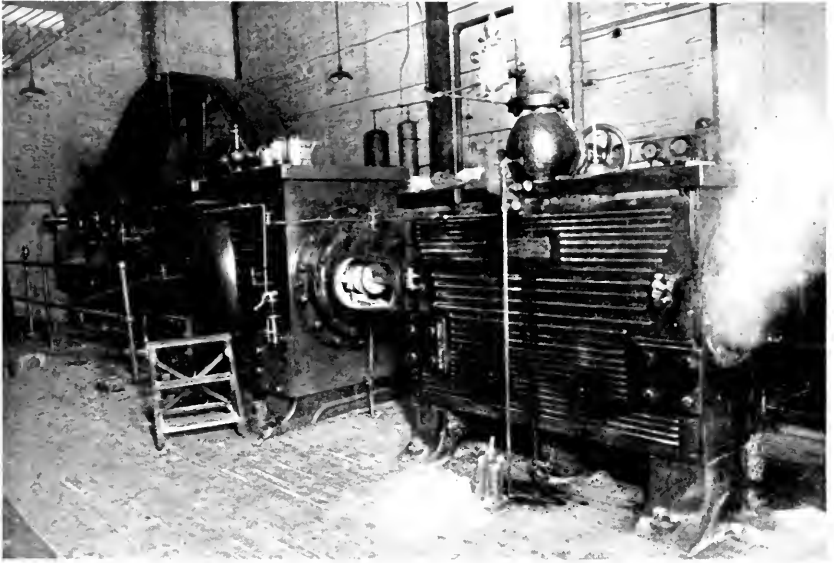

What unharnessed reciprocating parts can do to a steam engine

come loose from the crank pin. The connecting rod dropped and allowed the pistons to slam against the front end cylinder heads so that both heads were knocked out.

While not showing the full extent of the damage the accompanying photograph gives a good idea of the location of the broken parts. The bolts holding on the high pressure cylinder head were all snapped off and the piston was broken. The low pressure head was blown out and the cylinder was cracked. Insurance was carried on the flywheel of this engine but was not carried on the engine itself, which suffered all of the damage.

The operator of a Kansas City, Missouri, cleaning shop saw the boiler used in connection with his pressing machine explode and tear a coat which he had been pressing, blow a hole three feet wide in the floor, burst out the front and rear windows and otherwise damage the building. He was uninjured.

Hot Water Heater Explosion Damages Drug Store

A small hot water heater in the basement of a Chicago drug store exploded on January 6, 1935, and caused a loss estimated at several thousand dollars. The vessel struck steel beams and piping, bending the former 7 inches out of position and shearing off the piping. The force of



Part of drug store floor damaged by hot water heater blast.

the explosion cracked the cement floor of the store for 60 feet, broke plate glass, and damaged stock.

A janitor who was about to go into the basement narrowly missed being beside the heater when it burst.

Although the interior surfaces of the heater were badly pitted, a condition which might have accelerated the failure, it is believed that probably the pipe connections were clogged in such a way as to permit an unusual pressure to develop and that the regulating appliances failed to function properly.

A two-year-old girl was recently scalded to death when the plug blew out of a steam radiator at her home in Knoxville, Tennessee.

Japs From the Old Chief's Hammer

THE Old Chief and assistant, Tom Preble, were having lunch together when the conversation turned to children and the Chief's grandson in particular.

"Bobby's getting to be quite a lad," the veteran commented, "and he's a tickled kid this morning. Somebody left a pup tied to the front door and his daddy and mother have told Bobby he could keep it."

Preble noticed that the Chief's eyes seemed to have more than their usual sparkle.

"Know anything about the dog, Chief?" he asked.

"Quite a bit, Tom. You see, I tied it there, early this morning."

"Good work. What kind of a dog was it?"

"Brindle bull."

"Fine. Bobby will have a lot of fun with a pup."

The Chief made no comment for a few seconds. Then he grinned, pushed back his coffee cup and leaned on the table.

"Tom," he said, "did I ever tell you about Fred Jenkins and the papa and mama bull dogs down at Augusta?"

Preble knew a yarn was coming, and another from the Chief's wide experience that he hadn't heard.

"I'll try to tell it to you as it was told me by Jenkins, who, you know, used to be our man at Johnstown," the older man began. "He was fond of telling the story which was about like this:

"I'd just crawled into the furnace of that big fire tube boiler at the cooperage plant, when I heard a snuffling and then a growl. I looked out and there was a female bull dog, one of those heavy shouldered, bench leg, projecting jaw type, telling me in no uncertain terms that she didn't think I belonged. I knew that dogs of her breed weren't supposed to be dangerous, but I was nervous just the same.

"Git, dog," I yelled, good-naturedly, but the canine was in earnest. Instead of gittin' she started for me through the furnace door. In some way I stopped her and pulled the door almost shut.

"Then I scrambled over the bridge wall to the rear clean-out door



to be sure it was fastened. It was. The dog couldn't get in that way, but I couldn't get out either. So I went back to the front of the boiler where the dog was barking its displeasure at being cheated of its prey. Cautiously, I opened the furnace door. She saw me and lunged, but succeeded only in banging the door against the lug. I nearly had heart failure, for if she had landed a little harder, the safety latch would have caught and there I'd have been, for I don't know how long.

"To make matters worse, Mrs. Bull Dog's barking had brought Mr. Dog to the boiler room. It didn't take more than a peek around the corner of that furnace door to see that they both thought I shouldn't be where I was.

"I agreed with them, but didn't fall in with their idea that I should leave just then. So I lay on the grates and once in a while I'd open the door slightly. One or the other of the dogs would see the door move and jump at it, pushing it shut again. I'd stuck my hammer in the opening so they couldn't latch it, but it made me nervous just the same.

"This door opening and closing business went on for quite a while. I had just one thought and that was to get out. The dogs had one thought and that was to get me out. But we couldn't agree on procedure.

"Finally after what seemed an hour (I guess it was about 20 minutes), the barking attracted the attention of the boiler room foreman, who had gone to another part of the plant on some errand. He got the picture at once, I think, but it struck him so funny he just stood there for a while to enjoy it. It wasn't until he laughed that either I or the dogs knew he was there.

"As soon as they saw him, they stopped barking and ran over to him wagging their tails. I pushed open the furnace door, but back came the dogs with a rush. He called them and I opened the door again.

"I must have looked sheepish, for the fellow just rocked with laughter.

"Hey, inspector!" he said, "my dogs wouldn't hurt you. Come out here and meet them." After a little more talk I climbed out and somewhat gingerly petted the dogs and they wagged their silly tails gleefully.

"The foreman lived near the plant and said he'd go up to the house and take the dogs with him, but for me to come up there when I was through.

"Then I *did* feel foolish. I'd been lying on those grates for nearly half an hour when I might just as well have been inspecting the boiler as poking my head out of a furnace door.

"I finished the job, though I suspect I hammered harder than was necessary, and then went up to the foreman's house. The dogs were nowhere in sight.

"The foreman met me at the door and said he wanted to show me something. I was still a little suspicious, but walked with him to a barn nearby. There were Mr. and Mrs. Bull Dog snoozing in a corner and nearby was a basket in which were four wee puppies. Everything was happy and peaceful, and I could begin to understand the earlier actions of the dogs. It made me feel a lot better about the whole experience."

"The upshot of it was," the Chief added, "that Jenkins took a bull dog home to his little girl, and brought us one of the best laughs we've ever had.

"Well, let's get back to the office. You know, Tom, dogs will be dogs."

NODDING TERMS

A knotty old Yankee was in his garden one morning when the town's religious zealot, passing on horseback, called:

"Brother, have you made your peace with God?"

He didn't hear and inquired: "What say?"

The question was repeated and, resting on his hoe, he drawled:

"We ain't come to no open break yit." *New York American.*

OBSCURE TEXT

A young wife, wishing to announce the birth of her first child to a friend in a distant city, telegraphed:

"Isaiah 9:6." Which passage begins, "For unto us a child is born, unto us a son is given."

Her friend, not familiar with the Scriptures, said to her husband:

"Margaret evidently has a boy who weighs nine pounds and six ounces, but why on earth did they name him Isaiah?" *The Congregationalist.*

Marine Corporal (at dance): "Do you know that ugly sap of an officer standing over there? He's the meanest egg I have ever seen."

She: "Do you know who I am? I am that officer's daughter."

Corporal: "Do you know who I am?"

She: "No."

Corporal: "Thank God."

"Who's that talkative woman over there?"

"My wife."

"Sorry. My mistake."

"No, mine."

The Hartford Steam Boiler Inspection and Insurance Company

OF HARTFORD, CONN.

December 31, 1934

Capital Stock, \$3,000,000.00

ASSETS

Cash on hand and in banks	\$1,085,468.05
Premiums in course of collection (since October 1, 1934)	852,355.70
Interest accrued on mortgage loans	40,174.71
Interest accrued on bonds	111,929.51
Loaned on mortgages	649,172.77
Home Office real estate and Philadelphia branch office	542,474.66
Other real estate	240,365.29
Bonds on an amortized basis	\$9,499,059.29
Stocks at market value	<u>4,831,568.00</u>
	14,330,627.29
Other admitted assets	<u>20,485.35</u>
<i>Total</i>	\$17,873,053.33

LIABILITIES

Premium reserve	\$7,628,631.73
Losses in process of adjustment	404,166.50
Commissions and brokerage	170,471.14
Other liabilities (taxes incurred, etc.)	<u>539,438.80</u>
<i>Liabilities other than capital and surplus</i>	\$8,742,708.17
Capital stock	\$3,000,000.00
Surplus over all liabilities	<u>6,130,345.16</u>
<i>Surplus to Policyholders</i>	<u>9,130,345.16</u>
<i>Total</i>	\$17,873,053.33

WILLIAM R. C. CORSON, President and Treasurer

BOARD OF DIRECTORS

LUCIUS F. ROBINSON, Attorney, Hartford, Conn.

JOHN O. ENDERS, Chairman Executive Committee Hartford National Bank & Trust Co., Hartford, Conn.

MORGAN B. BRAINARD, President Aetna Life Insurance Company, Hartford, Conn.

CHARLES P. COOLEY, Chairman Board of Trustees Society for Savings, Hartford, Conn.

HORACE B. CHENEY, Manchester, Conn.

D. NEWTON BARNEY, Vice President The Hartford Electric Light Co., Hartford, Conn.

JOSEPH R. ENSIGN, President The Ensign-Bickford Co., Simsbury, Conn.

EDWARD MILLIGAN, President Phoenix Insurance Co., Hartford, Conn.

WM. R. C. CORSON, President The Hartford Steam Boiler Inspection and Insurance Co., Hartford, Conn.

SAMUEL M. STONE, President Colt's Patent Fire Arms Mfg. Co., Hartford, Conn.

SAMUEL FERGUSON, Chairman Board of Directors, The Hartford Electric Light Co., Hartford, Conn.

HON. JOHN H. TRUMBULL, President The Trumbull Electric Mfg. Co., Plainville, Conn.

CURTISS C. GARDINER, Vice President The Hartford Steam Boiler Inspection and Insurance Company, 90 John Street, New York, N. Y.

JAMES L. THOMSON, Vice President Terry Steam Turbine Co., Hartford, Conn.

PHILIP B. GALE, Chairman Board of Directors Standard Screw Co., Hartford, Conn.

JOHN J. GRAHAM, Vice President The Hartford Steam Boiler Inspection and Insurance Co., Hartford, Conn.

Incorporated 1866



Charter Perpetual

Department

Representatives

ATLANTA, Ga., Citizens & So. Nat. Bk. Bldg.	W. M. FRANCIS, Manager. C. R. SUMMERS, Chief Inspector.
BALTIMORE, Md., 704-9 Garrett Building	D. W. LITTLE, Manager. R. P. GUY, Chief Inspector.
BOSTON, Mass., 87 Kilby Street	A. PAUL GRAHAM, Manager. W. A. BAYLISS, Chief Inspector.
BRIDGEPORT, Conn., City Savings Bank Building	W. G. LINEBURGH & SON, General Agents. A. E. BONNET, Chief Inspector.
CHICAGO, Ill., 175 West Jackson Boulevard	P. M. MURRAY, Manager. C. W. ZIMMER, Chief Inspector.
CINCINNATI, Ohio First National Bank Building	JAMES P. KERRIGAN, Manager. W. E. GLENNON, Chief Inspector.
CLEVELAND, Ohio 1040 Leader Building	ARTHUR F. GRAHAM, Manager. JOHN L. SCOTT, Chief Inspector.
DENVER, Colo., Gas & Electric Building	J. H. CHESNUTT, Manager. F. G. PARKER, Chief Inspector.
DETROIT, Mich., National Bank Building	L. L. COATES, Manager. THOMAS P. HETU, Chief Inspector.
HARTFORD, Conn., 56 Prospect Street	F. H. KENYON, Manager. A. E. BONNET, Chief Inspector.
NEW ORLEANS, La., 333 St. Charles Street	R. T. BURWELL, Manager. P. E. TERROY, Chief Inspector.
NEW YORK, N. Y., 90 John Street	C. C. GARDINER, Vice-President. J. F. HUNT, Chief Inspector.
PHILADELPHIA, Pa., 429 Walnut Street	A. S. WICKHAM, Manager. S. B. ADAMS, Chief Inspector.
PITTSBURGH, Pa., Arrott Building	WILLIAM P. WALLACE, Manager. J. A. SNYDER, Chief Inspector.
ST. LOUIS, Mo., 319 North Fourth Street	CHAS. D. ASHCROFT, Manager. EUGENE WEBB, Chief Inspector.
SAN FRANCISCO, Cal., 114 Sansome Street	C. B. PADDOCK, Manager. L. E. GRUNDELL, Chief Inspector.
SEATTLE, Wash., Arctic Building	E. G. WATSON, Manager. WILLIAM J. SMITH, Chief Inspector.
TORONTO, Ont., Canada, Federal Building	H. N. ROBERTS, President The Boiler In- spection and Insurance Company of Canada.

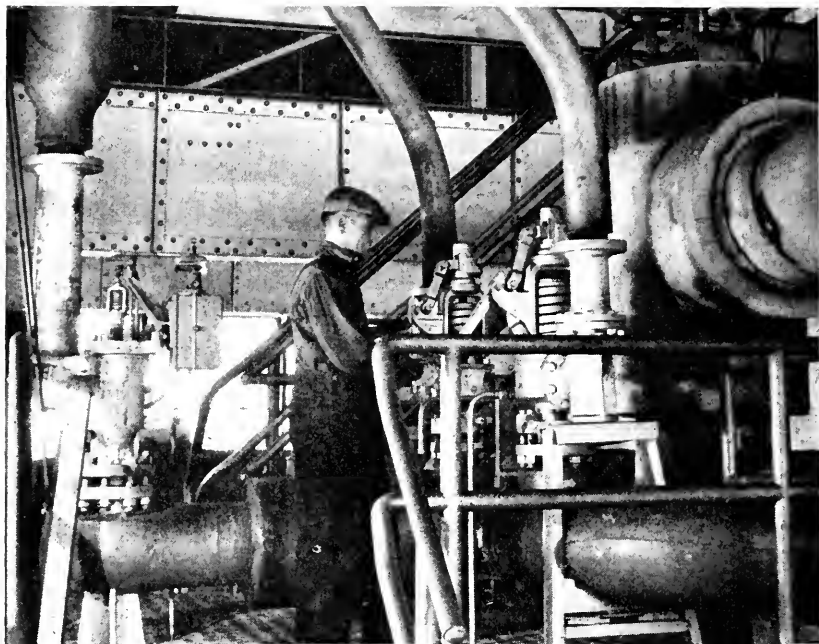

• • • To minimize the occurrence of accidents, over 350 trained inspectors check regularly all Hartford-protected equipment. Danger signals caught by the field inspectors mean boilers that do not explode, turbines that do not crash, engines that do not wreck. Altogether, Company men have built a record of more than 15,000,000 inspections. From this laboratory of vast experience the Company's engineering staff has developed its effective methods for the safeguarding of power equipment.

These are some of the reasons why executives of many of the largest industries, as well as the heads of thousands of smaller plants, insist on Hartford Steam Boiler coverage.



Vol. XL No. 7

JULY 1935



A QUARTERLY MAGAZINE
DEVOTED TO POWER PLANT PROTECTION

Published continuously since 1867
by The Hartford Steam Boiler
Inspection and Insurance
Company

Please show to your Engineer

Apartment Wrecked by Explosion

A STEEL heating boiler exploded in the fashionable Castlewood Apartments in Seattle on April 25, 1935, destroyed the living quarters of several families, caused more than \$30,000 property loss and resulted in minor injuries to occupants of the building. The boiler was part of a hot water heating system of the closed type.

Failure occurred by the unpeeling of the wrapper sheet. Driven



Part of \$30,000 damage after heating boiler exploded in Seattle apartment.

upward through the three-story building with terrific force, the boiler and the debris carried with it then crashed down into the opening, thus adding to the damage and confusion. Wooden beams, a foot

square, were snapped as if they were matchsticks, and the interior of the building around the path of the boiler's flight was completely wrecked.

In addition, brick veneer walls were blown out and bricks and plaster hurled in all directions. Windows were broken, floors twisted and interior walls bulged. Furniture and clothing were damaged. The accompanying photographs give an idea of the extent of the loss.

Even though there were several persons in the apartments at the



Debris inside apartment following the accident.

time, the boiler traveled in such a direction as to avoid hitting them. Several, however, received minor injuries in the scattering of debris and other damage that accompanied the blast.

As is the case in most such accidents, it was a combination of occurrences which brought about the explosion. The amount of damage was so extensive that the arrangement of the piping and the location of the several appliances could not be definitely determined.

There was, however, a half-inch diaphragm type relief and regulating valve apparently connected to the return piping. This valve controlled the pressure in the system and, when functioning properly, relieved any excess pressure. When the valve was examined, it was noted that connections were closed practically solid with deposits.

The hot water supply for the building was heated by a circulating type heater connected to the boiler, and the boiler was fired for this hot water supply even when the heating system was not in use. It was learned that there had been some difficulty on the day of the accident in obtaining a sufficient supply of hot water, and the burner had been adjusted and relighted about 45 minutes prior to the explosion. In this period, it is believed, a steam pressure built up, and since it was not relieved, either through radiation (which was turned off as the day was warm) or through the emergency valve, it finally caused the 36" diameter steel boiler to burst.

The loss was not covered by insurance.

Relief Valves on Hot Water Installations

VIOLENT explosions of hot water heaters and boilers are usually caused by excessive pressures. In spite of this, there are many instances in which relief valves are not provided—a practice based on the idea that, because the water heater is strong enough to withstand the ordinary service water pressure and is piped so as to be in open communication with the cold water main, a pressure in excess of that in the cold water main cannot accumulate, regardless of whether the outlet is open or closed.

However, in many cities the municipal water works are putting check valves on the house side of water meters to prevent them from being injured by overheating. This procedure protects the meter, but in the absence of a relief valve there is no longer any means for release of excessive pressure in the heater through the cold water mains. Furthermore, the pressure within the water heater will always exceed the service pressure when water is being heated, but not used, or is used only in small quantities. The expansion of the water when heated will cause a rise in pressure with a relatively slight change in temperature and so subject the water heater to a continuous, but unknown, over-pressure which the combination of a hot fire and closed faucet may bring to the danger point.

In view of what has happened, it is surprising that many plumbers and heating contractors belittle the need for proper protective devices on hot water heating equipment. A relief valve, the operative condition of which can be checked occasionally, should be provided on every closed hot water supply system.

There have been a sufficient number of violent explosions to this kind of equipment, with attendant property damage and personal injury, to offer indisputable evidence that relief valve protection is needed.

The Problem of Insulation

*By KENNETH A. REED, *Chief Engineer Electrical Division.*

PROPER protection of the insulation of electrical apparatus is one of the major problems of the operator of such apparatus and the importance of this problem to the industry is second only to the development of better insulation by the manufacturer. Despite the fact that tremendous advancement has been made in the improvement of insulating materials, in the technique of applying them and in their maintenance, insulation is still the most vulnerable part of an electrical machine.

While improvements in insulation have brought about higher safe operating temperatures for some classes of insulating materials and some increase in life, it appears that developments in this connection have not kept pace with the developments applying to other parts of electrical machinery.

The fact that the manufacturer loses contact with the machines he builds as soon as they are turned over to the customer makes it difficult for the designer to build up experience on the component parts of his apparatus that will enable him to determine how the insulation, for example, is being maintained in service. A complaint may come in that a relatively new winding burned out, but there is no definite information as to the operating temperature, whether or not the machine was kept clean, free from moisture, etc. With respect to such matters, the "Hartford Steam Boiler" renders a real service not only to the owners of electrical equipment and to itself, but to the manufacturer as well by insisting that proper operating conditions be maintained on equipment which it insures.

It is the general practice of the Company to make several inspections each year of all insured objects and, of course, recommendations are made for correcting improper conditions that may tend to shorten the life of the insured equipment. Sometimes a case arises where a machine is found to be in a questionable condition because of improper installation, or because some other unusual hazard exists. In such cases the plant is visited as often as may be necessary in order to make the risk a normal one.

The field inspections of electrical apparatus are made by trained engineers, a large majority of whom have had technical experience and have spent considerable time on manufacturers' test floors. In

* This article was written shortly before Mr. Reed's death on March 23, 1935.

many cases, they have done considerable erection and trouble work on the road for such manufacturers.

Embodied in the inspection of each object are the following: A survey of the general layout, the suitability of the object for its work, the condition of the foundation, protection from the weather, temperature conditions, insulation resistance, speed, cleanliness, the condition of insulation, and many other details.

The electrical apparatus that the company insures is distributed throughout the United States, and the Company is, therefore, in a position to observe the behavior of apparatus under varied climatic conditions, in many altitudes and in all classes of industrial and utility plants. Consequently, the company's representatives come in contact with electrical equipment, some of which enjoys the best of maintenance, some average, and some poor. Observations over a long period of time, indicate that moisture and lightning are probably responsible for more electrical failures than any other two causes and it is difficult to determine which of these two causes brings about the larger number of failures. The other predominating causes of failure are: Excessive temperature, shrinkage of insulation, dirt or other foreign matter on the windings, exposure to chemicals, the soaking of windings with excessive quantities of lubricating oil, deterioration and age.

The general items of lightning, excessive temperature and lubricating oil on windings, require no comments, and while it is questionable whether moisture actually causes more insulation failures than does lightning, there is no question about it being one of the greatest detriments to the normal life of insulation.

It is difficult to prevail upon the average motor user to keep his equipment clean and the effects of accumulations of dirt and other foreign matter on the insulation are well known. It has been found, however, that a persistent campaign of educating the owners of electrical apparatus in the care of their equipment bears fruit, as it has resulted in a steady reduction in the accident frequency of insured machinery.

Many insulation failures are brought about by the shrinkage of insulation and probably the most prolific cause of accident from this source is the shrinkage of insulating collars, or filler material, on the rotating field poles of synchronous apparatus. The shrinkage of this material permits movement of the coils on the poles and the turn insulation is gradually worn to the breakdown point. Many cases arise, however, where slot insulation or wedges and fillers shrink, thereby permitting coils to move in their slots, and the resulting chafing of the

coil insulation grounds the winding and causes a failure. Insulation shrinkage on the rotors of wound rotor motors or D. C. armatures, etc., causes the loosening of many bands, which finally results in serious winding failures of both rotating and stationary elements.

The general deterioration of insulation, due to age and service, accounts for many electrical failures and, aside from emphasizing the need for unusual care and maintenance, there is nothing that can be done with existing insulation to improve matters along this line. There is, of course, a wide difference of opinion as to the insulation life that should be expected and, since there are so many variables that have to be taken into account, it is a very difficult matter to set up any accurate life figures. However, the Company's observation of a great many objects over a long period of years indicates that a fair "average" life for insulation on the general run of low and medium speed rotating machines is about twenty years. The average life of insulation on high speed rotating machines, such as turbo-generators, is materially less than twenty years, probably nearer fifteen years, and that for transformers is probably about twenty-five years.

Ever since studies were begun for this line of insurance nearly fourteen years ago, a means has been sought to determine the internal condition of coil insulation. To date, however, no practicable and reliable method has been evolved for producing the desired results and the nearest approach to the objective in this connection, is checking the insulation resistance of windings at each inspection.

While it is recognized fully that insulation resistance is affected by many external things, such as moisture, cleanliness, whether the winding is hot or cold, etc., insulation resistance readings, when properly taken and when all variables are given due consideration, do give us better information about a given winding than any other method of procedure with which the Company is familiar, that can be simply and readily applied in the field.

The Company is chiefly interested in a minimum insulation resistance value for each object, based upon its voltage rating. This value is one megohm per thousand volts rating of the object, as shown on its nameplate, with a minimum of one megohm for objects, or parts of objects, that are rated at from 100 to 1000 volts. Such a minimum value applies to the windings of all types of rotating machines, transformers, starting apparatus, etc.

During the past twelve years, the company has taken more than three-quarters of a million insulation resistance readings on objects located throughout the United States. These readings were taken on

objects of many types and capacities, they were taken under a variety of weather and load conditions and the tests were applied by experienced engineers. It has been found invariably throughout this entire experience that when the windings of a piece of electrical apparatus are in proper operating condition, a minimum insulation resistance reading of at least one megohm per thousand volts rating of the object can always be obtained.

Any inspection scheme that applies to large numbers of objects scattered over a wide area must, of necessity, include the use of light weight, dependable instruments of a portable type. It has been found that ohmmeters and meggers are the instruments most suitable for checking insulation resistance readings in the field and they are, accordingly, employed by the Company's men.

A recent brief analysis of 3,439 failures of electrical apparatus shows that insulation was the cause of 2,917, or 84.8 per cent. A segregation of these losses shows that the following causes were responsible for a major portion of the failures:

CAUSE OF FAILURE	NUMBER OF LOSSES
Loosening of band wires, wedges, etc.	140
Accumulation of oil, grease, or other foreign substance on windings	142
Carelessness, negligence or ignorance of operator	57
Overheating due to sustained overload and other causes.....	133
Excessive moisture in the air	139
Flooding and inundation	80
Lightning or line surges	506
Single phasing from all causes	150
Breakdown of insulation—between turns	202
Breakdown of insulation—between coils and ground	232
Breakdown of insulation—between commutator bars or collector rings	95
Breakdown of insulation—between commutator or collector rings and ground	56
Short circuits in control apparatus, switchboards, etc.	100
Miscellaneous causes not otherwise classified	233
Undetermined	652

(The large number of "undetermined causes" will be considerably reduced in the future, due to changes in the method of classifying causes of failures.)

While lightning is charged with the greatest number of failures in the above list (aside from the undetermined causes), a great many of the failures due to a breakdown of insulation between turns, between coils and ground, etc., as well as those due to flooding and inundation were, in reality, brought about by moisture in some form. It is accordingly, (as previously mentioned) impracticable to determine definitely whether lightning or moisture causes the greater number of electrical failures.

In reviewing this group of failures it may be interesting to note the most prominent "initial parts" broken, which are briefly summarized as follows:

INITIAL BROKEN PART	NUMBER OF FAILURES
Rotor or armature winding	555
Stator winding	1128
Field coils	82
Brush holder rigging	19
Commutator or collector ring	346
Band wires or wedges	22
Brake coils	46
High tension winding (of transformers)	72
Low tension winding (of transformers)	28
Busses, bushing or insulator, potential or current transformer, compensator or auto-transformer used for starting	137
Low voltage releases, relay, overload, coil, etc.	174

Penstock Accidents

A SEVERE accident to a penstock, which was a part of the hydraulic development at Hawks Nest, West Virginia, was described in the January, 1935, "Locomotive". Two other similar accidents were reported in a recent issue of *Power*, one in France and the other in Spain. The former occurred on January 4, 1934, when the main pipe line to the Lac Noir hydro-electric plant ruptured and caused serious damage to both the plant and equipment. (This plant, when completed, will have four 40,000 hp vertical shaft units.)

A single tunnel and penstock about half a mile long and 18 to 15 ft. in diameter connects Lac Blanc with the plant on Lac Noir, giving a maximum head of about 400 ft. Two units had been in operation about two months when a manhole connection failed and caused a rupture about 25 ft long by 8 ft wide in the main penstock. The fracture was in sound metal outside of all welds. This pipeline had been tested after erection to twice maximum static pressure for 3 hours and the welds subjected to a hammer test.

The second accident was in Spain at the Esla River project of the Saltos del Duero Co. The power house is at the foot of the dam and is designed for four 37,000 kva units, two of which have been installed. A penstock 11.5 ft in diameter extends through the dam, which is 328 ft high, to each unit. When the accident occurred, two units were installed. The other two penstocks had their upper ends closed with stoplogs. On June 8 the stoplogs failed. Although the plant was not seriously damaged, it was necessary to drain 35 billion cubic feet of water to replace the stoplogs.

The three accidents resulted in a loss of 23 lives.

Power Boiler Accidents

THREE men were killed and three were injured by the explosion on February 11, 1935, of a horizontal tubular boiler operated by a Georgia cooperage company. The exploding boiler was demolished, as were the setting of an adjacent boiler, the boiler shed and fuel house. Two smokestacks were blown down and several adjacent buildings damaged to some extent.

Just prior to the explosion, according to employes, the steam gage showed a pressure close to 200 lb, which was nearly twice the approved

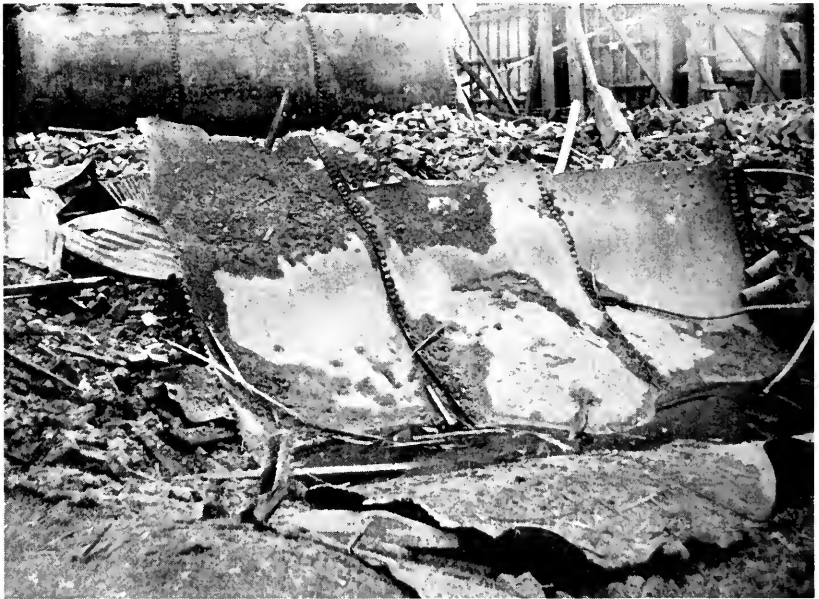

Partial view of wreckage from Georgia boiler blast.

pressure. The boiler tore itself to pieces, parts of it traveling 700 feet. The shock and noise were reported as having been noticed several miles distant.

The three men who were killed and two of the injured were working near the boiler, and the other injured man lived nearby.

As is shown in the photograph, the shell flattened out, sending other parts of the boiler in all directions. The boiler in the background was dented and some of the tubes were bowed.

TWO MEN DIE FOLLOWING BOILER MISHAP

When a 5" circulating tube between the lower drum of a bent tube type boiler and a water back pulled loose from the drum on March 21, 1935, at an Indiana plant, two men who sought to leave the boiler room were fatally scalded. They were working on another boiler about 100 feet away from the circulating tube and tried to get out of the building in the confusion following the release of the steam. Besides

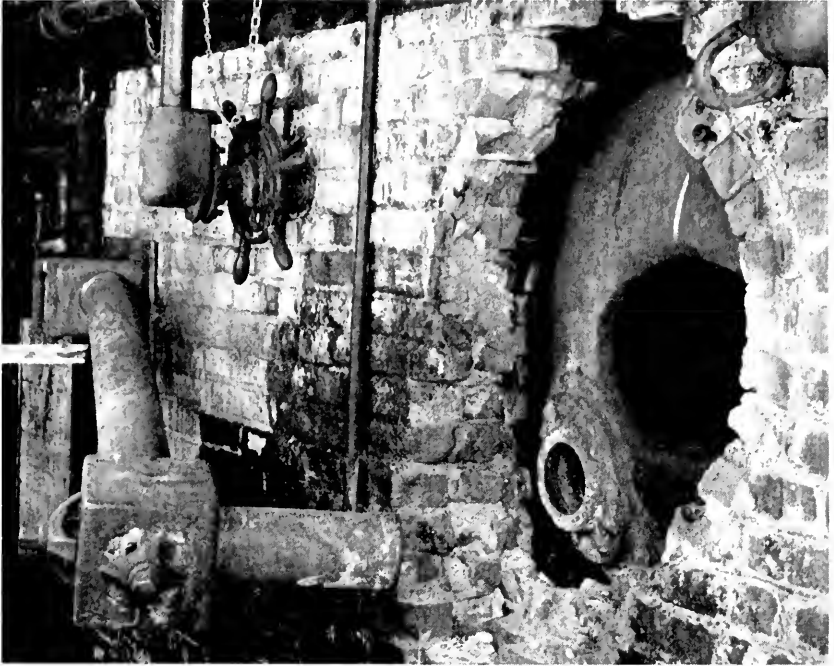

Circulating tube which pulled out of drum. Prompt drawing of the fire prevented serious overheating of the draining boiler.

injuring the men, the accident resulted in damage to the water back and the overheating of some of the tubes. However, an alert boiler room crew was successful in drawing the fire before the rapidly draining boiler was damaged more seriously.

The automatic non-return valve on the damaged boiler functioned immediately after the accident and prevented four other boilers which were under pressure from emptying themselves into the damaged unit. In the excitement, all of the boiler feed valves must have been shut

at one time and the feed pumps continued in operation. Because they were not able to relieve themselves through their safety valves, a momentary excessive pressure was built up and cracked one of the cast iron headers on an economizer.

BOILER BLAST DESTROYS MILL

A Mississippi hardwood mill was completely destroyed, as is shown in the accompanying photograph, when its boiler blew up some weeks



Complete destruction of a southern mill by a boiler explosion.

ago. Attention was called to the boiler by its safety valve blowing. As the negro fireman went to attend to the boiler, it exploded, killing him instantly. Overheating and rupturing of the fire sheet because of low water was given as the cause of the accident.

SAWMILL BOILER BLAST KILLS OWNER

The owner of a West Virginia sawmill was killed and three men were injured, one of them seriously, when a sawmill boiler exploded early in April, according to a newspaper account. The body of the man who was killed was hurled about 100 ft.

Motors and other equipment at an Ohio glass factory were damaged some weeks ago when 200 tons of molten glass flowed out from a broken tank and encased motors, pipes, wires and other equipment.

Failure of Turbine Emergency Trip

By T. B. RICHARDSON, *Chief Engineer, Turbine and Engine Division.*

EVERY steam turbine operator appreciates the proper functioning of the trip valve on his turbine when it acts to prevent dangerous overspeed. Sometimes, however, a feeling of confidence is engendered by continued smooth operation of the turbine, but this fact should not interrupt the practice of regularly testing the emergency control devices.

A recent accident which caused approximately \$24,000 loss might have been prevented, had the speed control devices been kept in proper adjustment.

Summarized, the accident occurred as follows:

1. The turbine lost its load.
2. The inlet control valves were held partly open, permitting the speed to increase rapidly.
3. A combined trip and throttle valve failed to stop the admission of high pressure steam, and the speed increased until one of the end rings on the rotating field of the generator stretched and caused unbalance—which resulted in violent vibration.

The turbine operator then closed the throttle valve by hand.

The turbine is a 3,600 rpm, 6,000 kw condensing unit, from which steam is automatically extracted for process purposes. The operation of the bleeder control mechanism is such that any drop in extraction pressure will open the inlet valves and close the grid valve to build up the extraction pressure.

At the moment the turbine lost its load, the speed governor partly closed the inlet valves, thereby reducing the extraction pressure, but, as there was no decrease in the demand for process or bleeder steam, the regulator functioned to open the inlet valves. A condition, therefore, was created in which the speed governor was attempting to *close* the inlet valves and the regulator was *opening* them. Since the links of the extraction control mechanism were improperly adjusted, the inlet valves were held partly open by the regulator, even when the speed governor had reached the limit of its travel in the closing direction. This condition permitted steam to flow through the unit and the speed increased rapidly because there was no load on the generator to hold the speed in check. After the accident the links in this mechanism had to be changed so that the inlet valves could not be held open by the bleeder regulator when the speed governor ordered them full closed.

When the speed reached the emergency tripping point, the emergency

overspeed devices, the second line of defense against overspeed, failed because the trip valve did not drop to interrupt the flow of steam through the unit. The speed kept increasing until the end rings on the field of the governor became deformed and caused the unbalance mentioned above. It is assumed that the violent vibration caused by the unbalance acted as a brake to prevent the complete destruction of the unit. It has been estimated that the turbine reached a speed of approximately 5,200 rpm before the operator closed the throttle valve by turning the hand wheel.

This accident emphasizes the importance not only of the correct adjustment of the inlet control valves, but also the testing of the second line of defense, the emergency governor with its trip valve.

The loss, which was paid by The Hartford Steam Boiler Inspection and Insurance Company, was divided approximately four-fifths use and occupancy and one-fifth property damage to the turbine. A considerable expense was undergone in expediting the repair of the turbine and generator rotors (weight about 18 tons) which were shipped from the plant in the South to the manufacturer by express. The turbine rotor was returned by fast freight and the generator rotor by express. Representatives of "Hartford Steam Boiler" were assigned to all transfer points to hasten the shipment. Repairs included the balancing of both rotors, the checking of the generator field windings and the installation of new retaining rings. The accident occurred on December 8 and the unit was returned to service on December 31, 1934.

Novel Source of Boiler Feedwater

SOMETHING new in feedwater supply has been reported as the current practice at a Stockton, California, milk condensing plant. Two wells, intended for the feedwater supply in a new plant, proved salty and unfit for boiler feed. Lacking city water service, the engineers decided to utilize water which is extracted from the milk during the process of evaporation.

After being extracted from the milk, the water is collected in a tank where solids are settled out. The sludge is drawn off through a bottom blowoff pipe and any oil or fat is skimmed off with an open surface blow arrangement.

Because the plan is new, the company has arranged for frequent inspections of the boilers and also has retained a competent firm of feedwater chemists to make frequent analyses of both the raw feedwater and the water from the boiler.

Corrosion Causes Hot Water Supply Boiler Explosion

DETAILED on April 29 to examine boilers and pressure vessels on which a Connecticut institution had applied for insurance, a Company inspector found on his arrival that one of the hot water supply boilers had exploded just a few minutes before. He assisted city firemen in getting the water turned off and in giving the owner such other emergency assistance as was required.

The boiler had been so wasted by pitting and grooving that in places its furnace sheet was scarcely thicker than paper. When this fire sheet

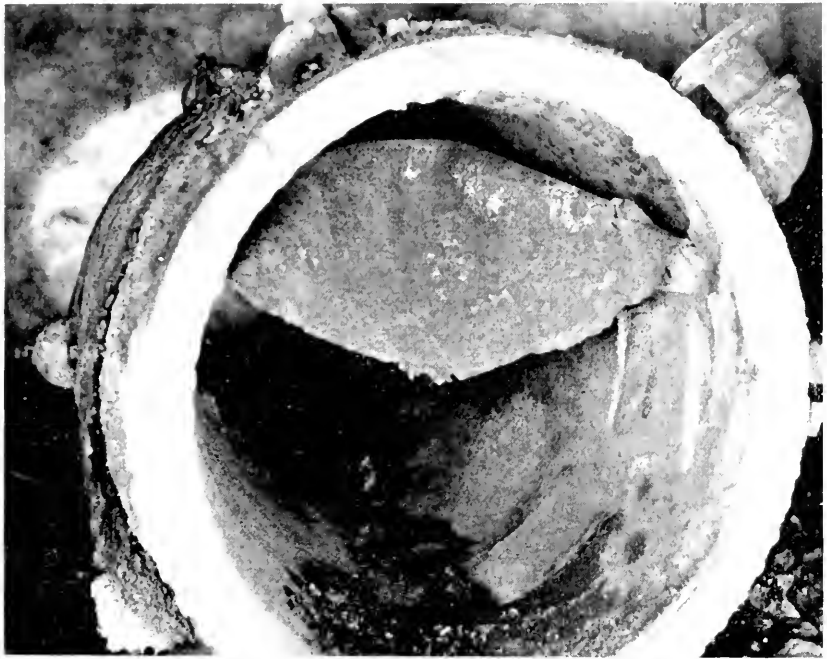

An accident clearly attributable to corrosion.

ruptured, the resulting explosion was sufficiently violent to damage a building column and break out windows. Fortunately, no persons were within the range of the flying debris.

It will be observed from the photograph that the torn edge of the furnace sheet was of knife-like thinness. The initial rupture evidently took place there, although the accident also cracked the outer shell of the boiler around its entire circumference just above the row of foundation ring rivets.

A Method for Checking Engine Alignment

By H. J. VANDER EB, *Assistant Chief Engineer, Turbine and Engine Division.*

THE smoothness with which an engine runs is very largely dependent on its alignment. When an engine operates with excessive noise and it is impossible to reduce the noise appreciably by taking up on the bearings, or when the bearings cannot be tightened

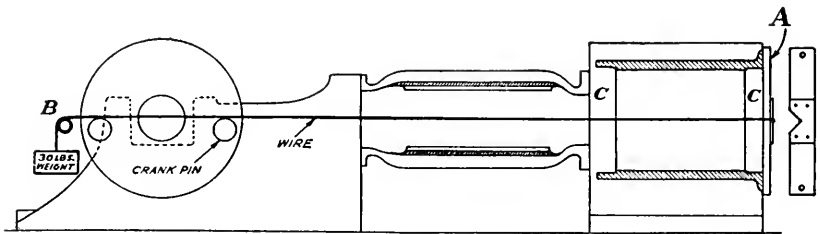

Figure 1.

up without undue risk of overheating, it is very likely that the engine parts are not in good alignment and possibly are being subjected to undue strains. Under such conditions it is desirable to check the alignment by running a line through the engine.

The most logical time to make such a check is when there is need for dismantling the reciprocating parts for inspection and maintenance repairs. Obviously, in order to run a line through an engine it is necessary to remove the connecting rod, cross head, piston and piston rod. While the line can be placed in position in a number of ways, the arrangement shown in Figure 1 has been found very convenient and it is easily applied. At "A" is placed a bridge of hard wood held in position by two of the cylinder-head studs and nuts. This bridge is provided with a small piece of sheet metal having a V-notch, as shown, for the purpose of locating the line at the exact center of the cylinder counterbore.

For small engines the line may be a fine silk cord or a fish line. For larger engines, where the distance between supports of the line is more than 10 feet, it is desirable to take into consideration the sag of the line and therefore a steel wire should be used. The wire commonly employed is the so-called No. 6 music wire which is .016" wire. The sag of such wire has been experimentally determined using a 30 lb

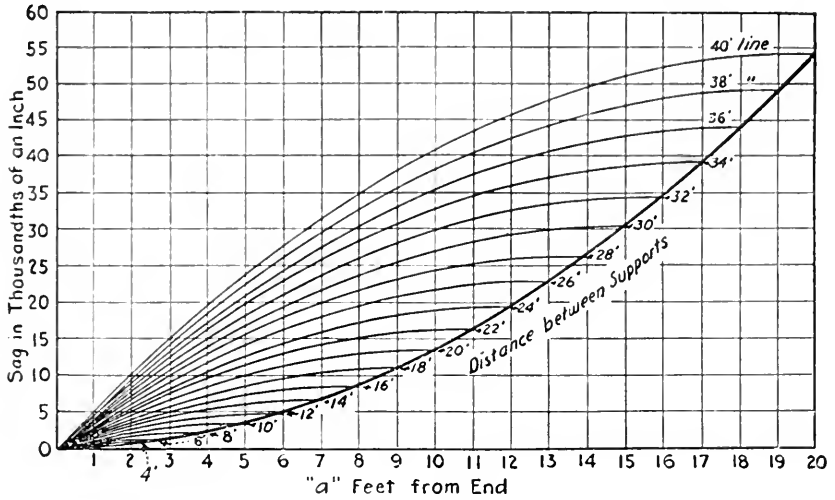
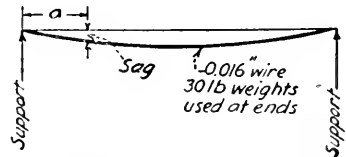

Figure 2.

weight either at one or both ends of the line. From Figure 2 the sag in mils can be found for any distance in feet from the ends.

It should be noted particularly that the location of the line in the cylinder must be central to the counterbores "CC" and not to the cylinder bore proper. This, of course, is because the cylinder bore on old engines is usually worn out-of-round while the counterbores always remain as they were originally and, therefore, they should form the basis for any alignment tests of the guide barrel and the shaft. At "B" some blocking should be set up to support a short piece of pipe or shaft as shown. The line then should be placed over this support and on the end of the line a weight should be suspended.



The line is now in position to check the alignment of the guide barrel by means of a tram or an inside micrometer. In order to determine whether the shaft is exactly at right-angles to the center-line of the cylinder, the crank pin should be brought up to, and nearly touch the line near dead center, for both head end and crank end positions, as shown in Figure 1. If it is found that the line divides the crank pin in the same proportions in both positions of the pin, this is an indication that the position of the outboard bearing is correct and that the shaft center-line is exactly at 90° angles with the cylinder center-line.

In many old engines the shaft is found out of the true 90° position in relation to the engine center-line and under such conditions the outboard bearing should be shifted until, by trial with the crank pin under

the line as shown in Figure 1, the correct position for the outboard bearing is found. Troubles with maintaining the main bearing are frequently caused by the position of the outboard bearing being such that the shaft is not at right-angles to the centre-line of the engine.

It is not important if it is found that the center of the shaft is slightly below or above the line, and there is no need for raising or lowering the shaft so as to bring its center to exactly the same level as the center-line of the cylinder. However, it is very necessary that the shaft be perfectly level, regardless of the vertical position of its center with respect to the line. To determine whether the shaft is perfectly level a good machinist's spirit level should be applied on the shaft. The spirit level should be at least 10 or 12 inches long and its accuracy should be checked by reversing it.

Turbo-Blower Explosion Injures Operator

THE EXPLOSION of a turbo-blower supplying forced draft to two horizontal tubular boilers in a New York laundry on April 6, 1935, destroyed the unit and resulted in serious injuries to a watch engineer.

Because the turbo-blower had not been running properly, the operator decided on an overhaul, which was made. When again started the unit became noisy and the watch engineer was just about to shut off the steam when the explosion occurred. Pieces of metal struck and severed one man's leg and bruised another operator who was assisting the first.

While there was no evidence as to the cause of the failure, four possibilities were suggested: A flaw in the rotor metal; the presence of some foreign matter such as a bolt or a nut left in the casing when the unit was reassembled; a seizure of a repaired bearing with subsequent shearing of bearing fastenings; and overspeed followed by seizure of the shaft. Investigators recommended that in the maintenance of such high speed units as this the best practice in overhauling is to seek the advice or services of the manufacturer, particularly if the operators are not familiar with the details of design and construction.

Going North for Power

Building a hydro-electric plant in rough country, distant many miles from a railroad, is difficult enough—but is hardly to be compared with building one where for several months each year the snow is five to ten feet deep, where the temperature seldom rises to zero and goes as far down as 45° below. Such is the Rapide Blanc plant on the St. Maurice River, 160 miles above Montreal. The equipment was transported over a specially constructed road on truck-drawn trailers capable of carrying 105 tons. Four 36,000 kva generators were installed.

The Coal-Dust Diesel Engine

ALTHOUGH the immediate outlook for the coal-dust Diesel engine is not very promising, future developments may give this class of engine an important place in the industrial picture, according to a recent article in *Mechanical Engineering*.

Originally the Diesel engine was designed to run on this kind of fuel, but little was ever done to perfect the coal-dust engine. Recent investigations by German engineers have led them to believe that these engines may be particularly adapted for use in central stations located at the source of the fuel supply. Much must be done, however, before coal-dust Diesels can be operated efficiently. While the former great handicaps of slow ignition and combustion have been overcome by the use of a "fore-chamber" in which some of the fuel is gasified and its combustion in the main chamber accelerated, and while the harmful effects of the non-combustible ash in the engine have been overcome by the use of special materials for the moving parts, the main need at present is a better method of cleaning the coal.

Due to fuel difficulties and to the slow speed at which coal-dust Diesels run, they are not adapted to vehicular or marine purposes. While it has long been known that the logical place for a central station is at the mouth of the mine or in the midst of the coal fields, the lack of water necessary for the present steam-turbine power plants has generally prevented this economical set-up. With the coal-dust Diesel very little water would be needed. Further, their slow speed would not be a handicap in the generation of electricity. Another feature in their favor is the fact that their output would be limited—probably not to exceed 20,000 kw. This would simplify the peak-load problem, because with as many units as necessary being used at a given time, each Diesel could be operated at full load. Under these conditions power plants would show a large degree of flexibility.

It must be considered, however, that both the efficiency and the output per unit of a given size of engine would be somewhat lower with coal-dust than with oil, and the first cost of the coal-dust engine would be higher than that of an oil-fired one. The ultimate saving would not be in the engine itself, but in the reduction in the cost of transporting fuel.

Feedwater Trouble Traced to Ablutions

Locomotives operating near Hopkinsville, Kentucky, were experiencing a great deal of trouble because of foaming. The reason therefor was not understood until employes caught four small boys taking daily baths with soap and using a railroad water tank for a bathtub. The boys were warned to bathe at home.

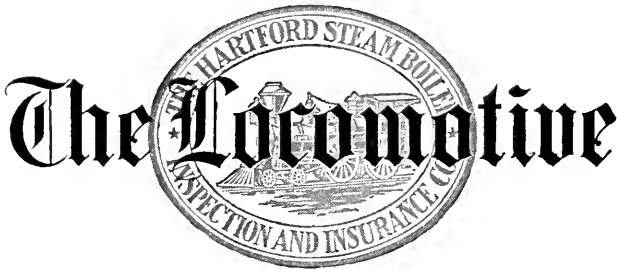

A QUARTERLY MAGAZINE
DEVOTED TO POWER PLANT PROTECTION

GEORGE H. PRALL, *Editor*

Copyright 1935 by The Hartford Steam Boiler Inspection and Insurance Company

HARTFORD, CONN., July, 1935

Single copies may be obtained free by calling at any of the Company's agencies.

Subscription price 50 cents per year when mailed from this office.

Bound volumes one dollar each.

Reprinting matter from this paper is permitted if credited to

THE LOCOMOTIVE of THE HARTFORD STEAM BOILER INSPECTION AND INSURANCE CO.

W. S. Curtis

W. S. Curtis, retired resident agent of Omaha, Nebraska, died May 28, 1935, in Omaha. He had been associated with the Company since March 15, 1888, and had been active in the territory surrounding Omaha until February 1, 1927, when he retired. His 39 years of active service, during a period of development in the industrial life of the middle west, brought him into active association not only with the insurance agents and brokers, but with many of the industrial and business leaders of the section. Mr. Curtis was born December 6, 1858, at Cortland, New York.

John B. Clogston

John B. Clogston, for 30 years an inspector with the Hartford department of the Company, died on April 19, 1935, at his home in Hartford.

Mr. Clogston was well known among the company's clients in western Massachusetts and particularly near Springfield, in which territory he was employed until his retirement in 1931. Mr. Clogston was 71 years of age.

Transatlantic Steamship Records

ONE HUNDRED SIXTEEN years ago the *Savannah*, the first ship to use steam in crossing an ocean, took 26 days to go from Savannah, Georgia, to Liverpool, England, a distance of approximately 4,000 nautical miles. The passage established a record of 6.4 knots an hour, although the *Savannah* used her side paddles on only 18 days of the 26.

Records were steadily lowered until, in 1889, when the first crossing in less than 6 days had just been made, the editor of THE LOCOMOTIVE, in an article on transatlantic steamship records, wrote ". . . people hint that they hope to reach 5 days, 12 hours on some trip when the *City of Paris* has gotten fairly at work, and when she has favorable weather; but 5 days and 12 hours is yet a long way off".

On November 3, 1893—just a little over four years after that statement was made, the *Campania* crossed from New York (Sandy Hook) to Liverpool (Roche's Point) in 5 days, 12 hours and 15 minutes.

Two decades passed before a crossing was made in less than 5 days. In 1909 the two marvelous sister ships, the *Lusitania* and the *Mauretania* were launched and the former immediately set a new record from Queenstown to New York of 4 days, 11 hours, and 42 minutes. The next year, 1910, the *Mauretania* cut one hour and one minute from this time and established a record which no vessel other than she, herself, was able to break for another 20 years. When in January, 1920, the *Mauretania* was changed over to an oil burner, she again increased her speed to 27.22 knots. This record was soon surpassed, however, for in July of the same year the *Bremen* averaged 27.83 knots on an Atlantic crossing. Since then the rate per hour has steadily increased, and the famous *Mauretania* recently became a victim of this race for greater speed, being retired and sold to a wrecking firm in Scotland last April.

The most recent record was set by the new *Normandie* on her trip from New York (Ambrose Light) to Southampton (Bishop's Rock)—4 days, 3 hours and 28 minutes, averaging 30.31 knots. This surpasses the *Bremen's* record of 4 days, 16 hours and 15 minutes at an

average rate of 28.51 knots. A crossing in less than 4 *days* now does not seem far distant. On her westbound trip the *Normandie* attained a maximum speed of 31.39 knots for one hour.

The story of the development of steam as applied to the propulsion of passenger vessels is shown in the following table:

Successive Records Established by Transatlantic Steamships

<i>Steamship</i>	<i>Date</i>	<i>From</i>	<i>To</i>	<i>Days</i>	<i>Hrs.</i>	<i>Min.</i>	<i>Nautical Miles</i>	<i>Knots per hr.</i>
Savannah	1819	Savannah	Liverpool	26	4,000*	6.40
Sirius	1838	England	New York	18	12	..	3,000*	6.75
Britannia	1840	Liverpool	New York	14	8	..	3,153*	9.75
Great Western	*1845	England	New York	10	10	15	3,000*	11.95
Pacific	1851	England	New York	9	19	25	3,000*	12.75
Persia	1856	Queenstown	New York	9	1	45	2,780*	12.78
Scotia	1866	Queenstown	New York	8	2	48	2,780*	14.26
City of Brussels	1869	Queenstown	New York	7	22	3	2,780*	14.62
Baltic	1873	Queenstown	New York	7	20	9	2,780*	14.76
City of Berlin	1875	Queenstown	New York	7	15	48	2,780*	15.12
Arizona	1880	Queenstown	New York	7	7	23	2,780*	15.82
Alaska	1882	Queenstown	New York	6	18	37	2,780*	17.10
Etruria	1888	Queenstown	New York	6	1	55	2,780*	19.10
City of Paris	1889	Queenstown	New York	5	19	18	2,788	19.95
Majestic	1891	Queenstown	New York	5	18	8	2,777	20.11
Campania	1893	Liverpool	New York	5	12	15	2,799	21.17
Lucania	1894	Queenstown	New York	5	7	23	2,780*	21.80
Deutschland	1900	New York	Plymouth	5	7	38	3,116	24.40
Lusitania	1909	Queenstown	New York	4	11	42	2,780*	25.81
Mauretania	1910	Queenstown	New York	4	10	41	2,826	26.60
Mauretania	1929	New York	Plymouth	4	19	55	3,145	27.22
Bremen	1929	Cherbourg	New York	4	17	42	3,163	27.83
Bremen	1932	New York	Plymouth	4	14	30	3,116	28.10
Bremen	1932	New York	Southampton	4	16	15	3,200	28.51
Rex	1933	Gibraltar	New York	4	13	58	3,181	28.92
Normandie	1935	Southampton	New York	4	11	33	3,195	29.68
Normandie	1935	New York	Southampton	4	3	28	3,250	30.31

* approximate

Combining these records into ten year periods, it is interesting to note how consistent the increase in knots per hour has been in the last hundred years. Except for two periods of rapid development (1838-1845 and 1885-1895) and two periods of stagnation (1845-1865 and 1915-1925), the speed of steamships has increased a little more than 2 knots per hour per decade for the last century, and has, at this writing, nearly quintupled the speed of the first passenger steamship.

Increase in Knots per Hour

Period	Successive Records	Increase
1838-1845	6.75 to 11.95	5.20
1845-1855	11.95 to 12.75	.80
1855-1865	12.75 to 12.78	.03
1865-1875	12.78 to 15.12	2.34
1875-1885	15.12 to 17.10	1.98
1885-1895	17.10 to 21.80	4.70
1895-1905	21.80 to 24.40	2.60
1905-1915	24.40 to 26.60	2.20
1915-1925		no increase
1925-1935	26.60 to 30.31	<u>3.71</u>
Total increase for 97-year period		23.56

It remains to be seen how long the *Normandie* will manage to hold the blue pennant in the face of assaults on her record by vessels of competing lines. It is thought by many that neither the German ships *Bremen* and *Europa*, nor the Italian *Rex* and *Conte di Savoia* have yet been pushed to their maximum speeds. They, with Britain's *Queen Mary*, now being fitted out at Clydebank, constitute a fleet of formidable challengers.

Of interest is the fact that while the *Normandie* is the first turbine-electric propelled merchant ship in the trans-Atlantic service, the builders of the *Queen Mary*, also designed for a speed of 30 knots, have retained the older method of geared turbines for the main drive.

Furnace Explosion in School Causes Excitement

PUPILS of a West Virginia school were thrown into confusion on March 8, 1935, when a fuel explosion occurred in the furnace of the institution's gas-fired cast iron boiler. Several windows were broken and the janitor was severely injured, but no fire ensued and the pupils were unhurt. Newspaper accounts described unusual coolness on the part of the teachers who succeeded in lining up the children in the halls preparatory to leaving the building. School was dismissed to give the building a chance to ventilate and to permit necessary repairs. In explaining the cause of the explosion, fire department officers said that when school opened gas was turned on on one side of the large furnace. There was a request for more heat and the janitor turned on the other burner, the pilot light for which was not operating. Enough gas accumulated in the furnace to form an explosive mixture which detonated when ignited by the other burner. The janitor was blown across the room.

Home-Made Boiler and Engine

IN THE course of their travels to the thousands of plants for which "Hartford Steam Boiler" carries insurance, the company's inspectors occasionally encounter very unusual pieces of power equipment. It is seldom, however, that one finds anything quite so unorthodox as the steam power plant which Inspector C. B. Bailey came upon while traveling through the mountains of West Virginia.

This power plant consisted of a boiler and an engine which had been entirely home-made by a young farmer. In spite of many dangerous features, which seemed to worry its ingenious creator not a bit, it was regularly used by him for grinding corn and sawing wood.

A general view of the "power plant" shed is shown in Figure 1. Concealed by the setting of mud and rock, the boiler itself consists of a galvanized hot water tank, 12" in diameter and 5' long. It is supported from four wooden posts by strands of ordinary iron baling wire that loop under the vessel and are exposed to the full heat of the furnace. Its only appurtenance is a home-made safety valve. No provision is made for noting the pressure, for keeping track of the water level, or for introducing feed water without cooling the boiler down. The operator's practice, he said, is to fill the boiler at the start of the run and to "call it a day" when the engine slows down because of a lack of steam. One filling lasts him about five hours.

In making the safety valve shown in Fig. 3, the builder used an old lead musket ball so fastened to the lever that it is intended to lift from its seat in the open end of a pipe when pressure reaches 80 lb. Figure 2 shows the furnace entrance.

The engine cylinder is made of a piece of brass pipe with an inside diameter of 2" and a length of 10". This is entirely encased in wood, and blocks of wood tied together by four long bolts form the two cylinder heads. The valves are large stop cocks, the handles of which are actuated by a rocker arm driven from a special crank disk on the main shaft. The valve timing is so arranged that when one cock is in position for admitting steam to the cylinder, exhaust steam escapes to the atmosphere through a hole cut in the casing of the other cock. The piston is a disk of babbitt fastened to a rod of cold rolled steel, and the connecting rod is made of wood and has brass bushings for both the wrist and crank pins.

Lack of space prevents our giving a detailed description of the engine, although from Figures 4 and 5 the reader may get an idea of its construction. The flywheel was taken from a wheelbarrow.

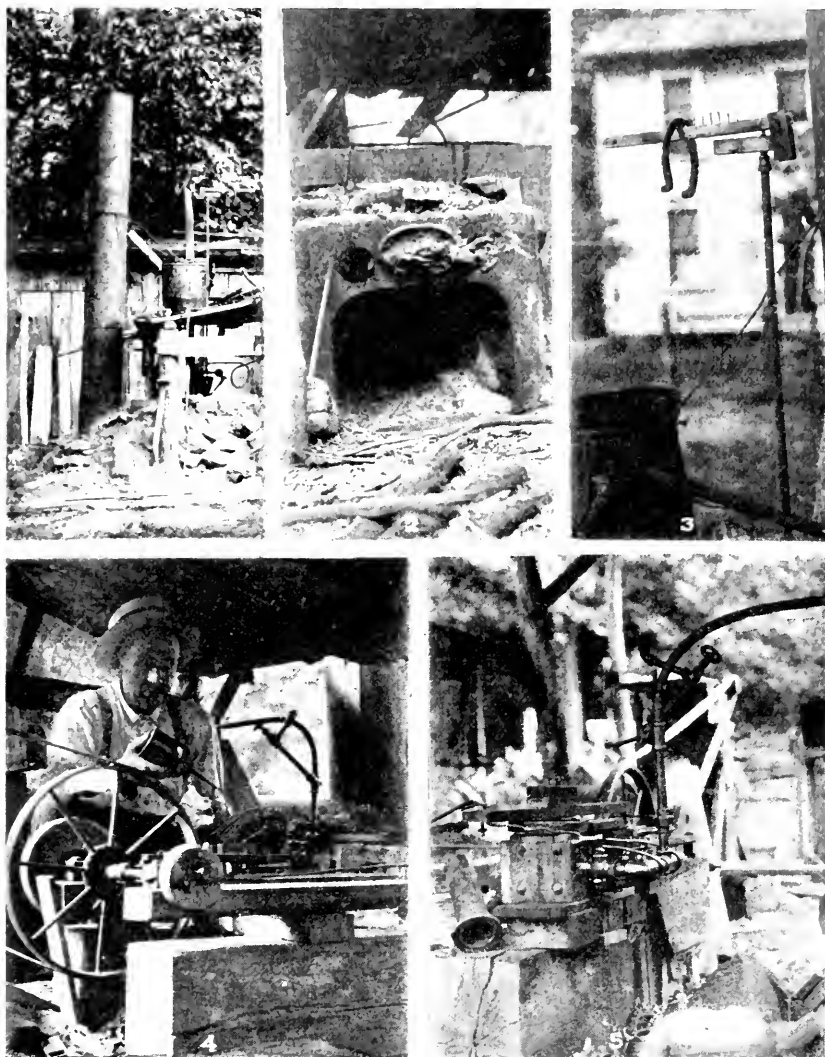

Figure 1—Stack of home-made boiler. On the roof of the boiler shed is a 10-gallon can used to feed water to the boiler by gravity.

Figure 2—Front of the boiler fashioned from the top of a cook stove.

Figure 3—The safety valve. Half-inch pipe is used up to the reducer and eighth inch pipe at the top. An old musket bullet was used for the disc of the valve.

Figure 4—The flywheel. The man is oiling the crosshead and guides. The wooden wheel in the foreground operates the valve mechanism.

Figure 5—The engine. At the left is a portion of brass pipe of the kind used in making the cylinder.

California Finds Many Dangerous Air Tanks

CALIFORNIA'S Industrial Accident Commission in recent months has discovered numerous unsafe air tanks. In fact, the commission's inspectors over a 12-month period found that 17 per cent of the 3,074 tanks inspected were "positively dangerous to operate" and that in excess of 25 per cent were considered unsafe for one reason or another. Included in the inspectors' findings were 239 instances in which there were no safety valves and 50 instances in which the existing valves were inoperative. There were 36 tanks without pressure gages and 26 with neither safety valves nor pressure gages. Other dangerous conditions noted by the inspectors were shut-off valves between the safety valves and tanks, absence of drains, excessive pressure and tanks deformed because of over-pressure.

Inspector Finds Charred Human Bones In Boiler

Many queer experiences are the lot of "Hartford Steam Boiler" inspectors while on their daily routine in the country's power plants. The climax of such experiences, and a gruesome climax it was, occurred at a southern plant in April while an inspector was making his periodic examination of a horizontal tubular boiler. He was inspecting the furnace of the boiler, when his interest was aroused by the discovery of a footprint in the ashes behind the bridge wall. A further investigation revealed some bones, which he at first thought were those of some animal, but which examination revealed were those of a child about 14 years of age. The coroner was notified, but no clues were forthcoming. The remains gave evidence that they had been subjected to the furnace temperatures for some time prior to their discovery.

Broken Safety Valve Spring

Shortly after the safety valves on a large industrial boiler had been tested by hand and had all closed properly, one of them resumed blowing and continued without cessation. It soon became evident to attendants that something was wrong and an investigation showed that the valve spring had broken, permitting the valve to attain its maximum lift and to discharge steam in large volume.

A gag was not readily at hand, and while one was being obtained, a long, heavy board was rigged up on top of the valve stem, which fortunately projected above the yoke. Using the board as a lever, the valve was kept closed until the board broke. The gag finally was found, adjusted and screwed down on the stem until the valve was reset.

An entirely unanticipated accident of this kind emphasizes the need for some provision to avoid injury to any one who might be in the vicinity. A pipe connection on the discharge opening of a safety valve, to carry the escaping steam to a point where it can do no harm, is a good arrangement. The case also demonstrates one reason for the rule that two or more safety valves be used on boilers of considerable size.

The valve which failed was a modern, new outside spring valve set to blow at 450 lb.

Japs From the Old Chief's Hammer

THE OLD CHIEF, a veteran inspector, and his assistant, Tom Preble, were returning to the office one noon.

"Tom," he said, "I want to stop a minute and get some more smoking tobacco."

"O.K.," Tom responded, "I'll wait here on the street."

He watched the older man walk up three well-worn steps into the lobby of a building and wondered how many times his superior had entered that building for his favorite brand of smoking tobacco—years and years, and once a week regularly.

Tom got to musing over those three steps into the building. How worn they were! How many persons must have passed that way to hollow out the stone like that! When the chief came back, Preble mentioned the steps.

"Yes," his superior remarked, "I've probably helped some. I've been going up and down those steps for 15 years and longer. Speaking of wear, though, those steps remind me of a nice piece of work Inspector Honnecker carried out at the G. B. W. Paper Mill back in 1925. Have I told you about it?"

"I don't think so, Chief," Preble said, and as they walked along the older man unwound another story from his wide experience with pressure vessels.

"I told you those worn steps brought this story to mind," he began, "but anybody can see that those stair treads are thin. They're scooped out in the center and flat at the ends. Discovering thinness in a pressure vessel isn't so easy.

"Honnecker feared that seven digesters which he inspected were worn, but proving conclusively that he was right was another matter. His suspicions were aroused by his experience with various kinds of pressure vessels. For some reason the situation brought to mind a worn rendering tank he had seen back in Detroit. Over a 10-year period the metal on that vessel had gradually been reduced in thickness until it was dangerously thin, and yet neither the outside nor the inside gave any visible clue. The outside looked much the same as it always had and the inside was smooth and apparently in good condition. What



had occurred was a uniform wear which could be detected only by boring test holes.

"The digesters Honnecker was so worried about were of a fair size. As I remember it, 9 feet in diameter and about 30 feet high, and a vessel that large at the 125 pounds pressure carried can cause an accident of major proportions, as you very well know.

"Honnecker went over those digesters with a fine tooth comb every time they came up for inspection. He reported pitting along the so-called liquor line, but could detect no appreciable wear. The plates presented a practically smooth, even surface.

"I didn't like those 25-year-old digesters any better than Honnecker did, so between us we succeeded in getting the owners to consent to the drilling of test holes. The owners had been reluctant to make such tests because they had had trouble in keeping the openings tight.

"On the next inspection three men were placed at Honnecker's disposal. The plan was to fill the vessel with chips, a little at a time, so that the men who were doing the drilling would have something to stand on and thus eliminate the necessity of building a scaffold.

"Just as the chips were about to be put in the digester, Honnecker got an inspiration. He wondered what path the chips took as they entered the vessel.

"'Hey, you fellows,' he called, 'I want to watch those chips as they come in, wait until I get inside.'

"The helpers thought he was getting himself into an unnecessary mess, but 'it was his funeral' they said, and Honnecker climbed into the digester.

"He noticed, as the chips were admitted, that they struck on one side and slid down to the bottom. He reasoned that if the plate was worn anywhere it most certainly would be on the side where the chips struck.

"So he directed that the drilling be concentrated in this area. The result was the discovery that the plate had been reduced from its normal thickness of three quarters of an inch to an average of about half that over an area 20 feet high and 8 feet wide.

"The plates then gradually thickened up on each side of this area until the wear on the opposite side of the digester was negligible.

"The owners were notified and this digester was removed from service."

Preble interrupted, "What about the other six digesters, Chief?"

"Coming to that, boy," the veteran replied. "Of course, the other six were drilled. All of them had become dangerously thin. Some of

them were even worse than the first vessel.

"The plant owners were pretty worried, for other digesters they had wouldn't supply anywhere near the demand. So the digesters were operated at a reduced pressure and one by one they were replaced with new and safe vessels.

"Then everybody concerned heaved a sigh of relief, I can tell you.

"Well, here we are back at the office and some more worn steps, and Tom, I expect to see those stairs worn down considerably before I'm done with them."

"So do I, Chief," said Tom.

Caught in the Separator

Wife: "Did you have a hard day at the office, dear?"

Mr. Begtostate: "In reply to your query of even date as to my day at the office, regret to say that business matters were pressing, and I am very tired."

Wife: "You poor dear; well, come on now, dinner is ready."

Mr. Begtostate: "In re your statement concerning immediate preparations to serve dinner, beg to advise that it will be five minutes before I can act on this, owing to the fact that I have just lighted a cigar. Regretting my inability to comply promptly with your request, and trusting that the delay will not seriously inconvenience you—"

Wife: "Lay down that cigar and come to dinner at once! It's getting cold."

Mr. Begtostate: "Your complaint regarding delay in attending to your recent order has been called to my personal attention, and I beg to assure you same will receive immediate handling. Feeling sure you will be pleased and—"

Wife: "Thank heavens! Won't you have some potatoes, dear?"

—*Union Electric Magazine.*

Customer, impatiently: "Waiter, have you forgotten me?"

"No, no, sir! You are the stuffed tomato."

A newspaper in speaking of a deceased citizen said: "We knew him as Old Ten Per Cent, the more he had the less he spent; the more he got the less he lent; he's dead—we don't know where he went—but if his soul to heaven is sent, he'll own the lot and charge 'em rent."

"I sent my little boy, Johnny, for five pounds of apples, and you only sent four and a quarter pounds."

"My scales are right, Madam. Have you weighed your little boy?"

"Here, Aunty," called out a man as he was passing a negro shack, "do you have to whip that boy so hard? What's the matter?"

"He's let them chickens out," answered the old negress.

"Is that all?" queried the man. "Don't you know chickens always come home to roost?"

"Come home! He done let them go home!"

—*Forbes.*

The Hartford Steam Boiler Inspection and Insurance Company

OF HARTFORD, CONN.

December 31, 1934

Capital Stock, \$3,000,000.00

ASSETS

Cash on hand and in banks	\$1,085,468.05
Premiums in course of collection (since October 1, 1934)	852,355.70
Interest accrued on mortgage loans	40,174.71
Interest accrued on bonds	111,929.51
Loaned on mortgages	649,172.77
Home Office real estate and Philadelphia branch office	542,474.66
Other real estate	240,365.29
Bonds on an amortized basis	\$9,499,059.29
Stocks at market value	4,831,568.00
	14,330,627.29
Other admitted assets	20,485.35
<i>Total</i>	\$17,873,053.33

LIABILITIES

Premium reserve	\$7,628,631.73
Losses in process of adjustment	404,166.50
Commissions and brokerage	170,471.14
Other liabilities (taxes incurred, etc.)	539,438.80
<i>Liabilities other than capital and surplus</i>	\$8,742,708.17
Capital stock	\$3,000,000.00
Surplus over all liabilities	6,130,345.16
<i>Surplus to Policyholders</i>	9,130,345.16
<i>Total</i>	\$17,873,053.33

WILLIAM R. C. CORSON, President and Treasurer

BOARD OF DIRECTORS

LUCIUS F. ROBINSON, Attorney, Hartford, Conn.	SAMUEL M. STONE, President Colt's Patent Fire Arms Mfg. Co., Hartford, Conn.
JOHN O. ENDERS, Chairman Executive Committee Hartford National Bank & Trust Co., Hartford, Conn.	SAMUEL FERGUSON, Chairman Board of Directors The Hartford Electric Light Co., Hartford, Conn.
MORGAN B. BRAINARD, President Aetna Life Insurance Company, Hartford, Conn.	HON. JOHN H. TRUMBULL, President The Trumbull Electric Mfg. Co., Plainville, Conn.
CHARLES P. COOLEY, Chairman Board of Trustees Society for Savings, Hartford, Conn.	CURTISS C. GARDINER, Vice President The Hartford Steam Boiler Inspection and Insurance Company, 90 John Street, New York.
HORACE B. CHENEY, Manchester, Conn.	JAMES L. THOMSON, Chairman Finance Committee Hartford Fire Insurance Company, Hartford, Conn.
D. NEWTON BARNEY, Vice President The Hartford Electric Light Co., Hartford, Conn.	PHILIP B. GALE, Chairman Board of Directors Standard Screw Co., Hartford, Conn.
JOSEPH R. ENSIGN, President The Ensign-Bickford Co., Simsbury, Conn.	JOHN J. GRAHAM, Vice President The Hartford Steam Boiler Inspection and Insurance Co., Hartford, Conn.
EDWARD MILLIGAN, President Phoenix Insurance Co., Hartford, Conn.	
WM. R. C. CORSON, President The Hartford Steam Boiler Inspection and Insurance Co., Hartford, Conn.	

Incorporated 1860



Charter Perpetual

Department

Representatives

ATLANTA, Ga.	W. M. FRANCIS, Manager.
Citizens & So. Nat. Bk. Bldg.	C. R. SUMMERS, Chief Inspector.
BALTIMORE, Md.,	D. W. LITTLE, Manager.
704-9 Garrett Building	R. P. GUY, Chief Inspector.
BOSTON, Mass.,	A. PAUL GRAHAM, Manager.
87 Kilby Street	W. A. BAYLISS, Chief Inspector.
BRIDGEPORT, Conn.,	W. G. LINEBURGH & SON, General Agents.
City Savings Bank Building	A. E. BONNET, Chief Inspector.
CHICAGO, Ill.,	P. M. MURRAY, Manager.
175 West Jackson Boulevard	C. W. ZIMMER, Chief Inspector.
CINCINNATI, Ohio	JAMES P. KERRIGAN, Manager.
1904-12 Carew Tower	W. E. GLENNON, Chief Inspector.
CLEVELAND, Ohio,	ARTHUR F. GRAHAM, Manager.
1040 Leader Building	JOHN L. SCOTT, Chief Inspector.
DENVER, Colo.,	J. H. CHESNUTT, Manager.
Gas & Electric Building	F. G. PARKER, Chief Inspector.
DETROIT, Mich.,	L. L. COATES, Manager.
National Bank Building	THOMAS P. HETU, Chief Inspector.
HARTFORD, Conn.,	F. H. KENYON, Manager.
56 Prospect Street	A. E. BONNET, Chief Inspector.
NEW ORLEANS, La.,	R. T. BURWELL, Manager.
333 St. Charles Street	P. E. TERROY, Chief Inspector.
NEW YORK, N. Y.,	C. C. GARDINER, Vice President.
90 John Street	J. F. HUNT, Chief Inspector.
PHILADELPHIA, Pa.,	A. S. WICKHAM, Manager.
429 Walnut Street	S. B. ADAMS, Chief Inspector.
PITTSBURGH, Pa.,	WILLIAM P. WALLACE, Manager.
Arrott Building	J. A. SNYDER, Chief Inspector.
ST. LOUIS, Mo.,	CHAS. D. ASHCROFT, Manager.
319 North Fourth Street	EUGENE WEBB, Chief Inspector.
SAN FRANCISCO, Cal.,	C. B. PADDOCK, Manager.
114 Sansome Street	L. E. GRUNDELL, Chief Inspector.
SEATTLE, Wash.,	E. G. WATSON, Manager.
Arctic Building	WILLIAM J. SMITH, Chief Inspector.
TORONTO, Ont., Canada,	H. N. ROBERTS, President The Boiler In-
Federal Building	spection and Insurance Company of
	Canada.

REGIE LIBRARY
AUG - 3 1935
OF THE UNIVERSITY OF TORONTO

Put it down to profit and **LOSS**

A BUSINESS is only as big as its orders — and its ability to fill those orders! What if the plant itself, disrupted by a sudden disastrous boiler explosion or power-equipment break-down, must delay shipment or cancel? What would have been profit now turns out to be *loss*!

HARTFORD STEAM BOILER insures against loss from accidents to power, pressure or refrigerating apparatus — direct loss on boilers, turbines, engines, etc. This company insures, also, against loss from business interruption such accidents cause.

HARTFORD STEAM BOILER seeks first to *prevent* accidents. Over 350 inspectors, directed and guided by the largest engineering staff of its kind anywhere, periodically examine equipment insured by the Company.

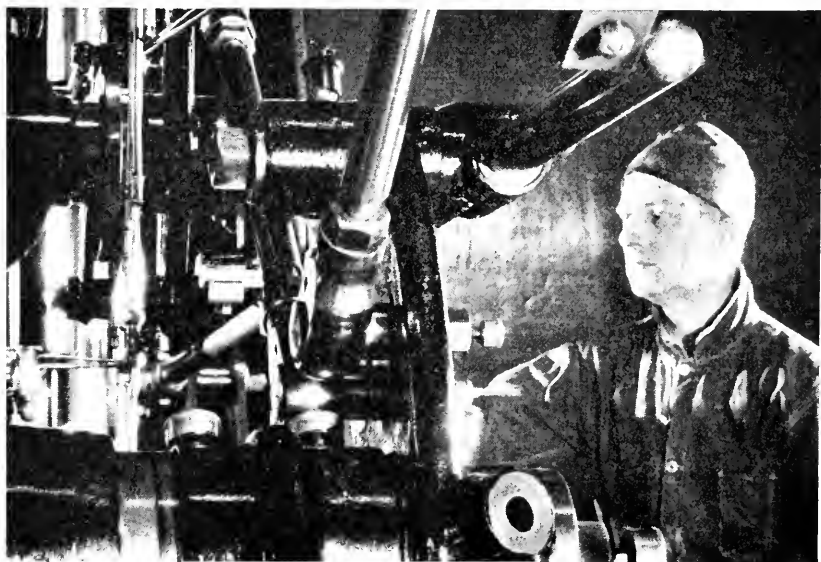

Vol. XL No. 8

OCTOBER 1935



A QUARTERLY MAGAZINE
DEVOTED TO POWER PLANT PROTECTION

Published continuously since 1867
by The Hartford Steam Boiler
Inspection and Insurance
Company

Please show to your Engineer

Boiler Explosion Kills Two



The above photograph shows wreckage after a boiler explosion at a Southern lumber mill in June. Two persons were killed instantly and four seriously injured. Property loss was estimated at \$5,000.

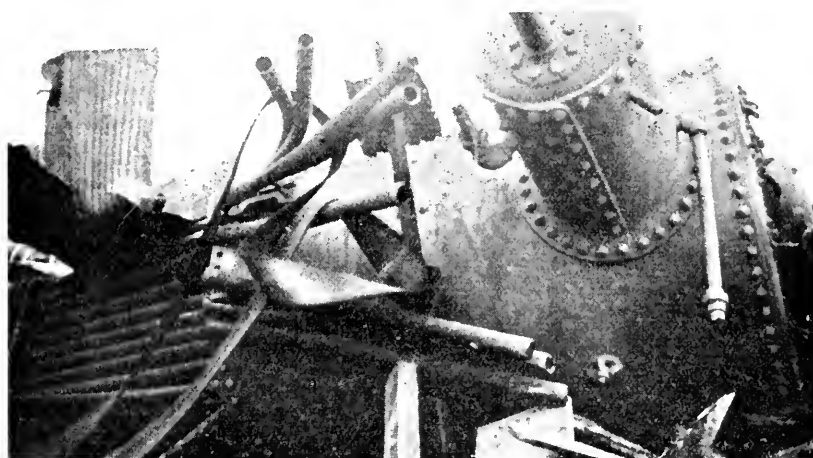

This boiler caused the wreckage in the picture at the top of the page. It is a dry back marine type and was mounted on wheels. An investigation revealed that the accident was caused by the cracking of the shell plate along the edge of the inside butt strap. The plate gave evidence that there was an old interior crack which had spread through the plate as the result of flexing action. The force of the explosion hurled the boiler about 25 feet.

Low Water in Steam Heating Boilers

NEARLY one-third of all accidents to steam heating boilers are the result of low water and subsequent over-heating. Most of these accidents may be blamed on conditions outside the boiler itself, and for this reason their detection involves a careful watch on the entire steam and water circulating system. There is, however, one alarm signal which should be given first-rank importance in connection with every installation, and that is the amount of make-up water the boiler requires. Little, if any, make-up water should be needed in a properly installed and properly operated steam heating system, and the reason for a deficiency of water in the boiler, as shown by low water in the gage glass, should immediately be traced.

It is obvious that an empty boiler will be damaged if a fire is built under it, and yet such carelessness frequently occurs, both in the heating season and during the summer. When this happens, it is usually the result of the disposal of papers and other burnable rubbish. The burning of trash under an empty boiler by uninformed persons has often caused costly damage in the form of cracked sections or distorted tubes and shell plate. Accident investigations show, in addition, that on many occasions insult has been added to injury by admitting cold water to the over-heated boiler in a misguided attempt to cool it.

This type of accident is most prevalent during the summer, but it occurs during the heating season in plants operated intermittently, such as those in schools, churches and public halls. One example will suffice to illustrate what has happened on several occasions. A school janitor, after the Christmas holidays, built a roaring fire under an empty boiler on his arrival at the building. He then went about the other work of reopening the school for the day. Soon he smelled "something burning" and on returning to the boiler room found the boiler red hot. Instead of cooling it down by pulling the fire and allowing the boiler to stand, as he should have done, he immediately turned cold water into it with the result that every section was cracked.

During every heating season it is repeatedly demonstrated that some operators do not recognize the important significance of a steadily lowering water level. One of the commonest causes of low water is leakage from some part of the system. Such leakage, most often in some part of the return piping, usually occurs with sufficient slowness to give ample warning. *The fact that make-up water is required daily, or even weekly, is sufficient warning that leakage is taking place.* Pipes buried in the ground or embedded in cement, and therefore not easily accessible for examination or maintenance, are likely places for such

leakage. It has been argued that the cost of repairing a small leak in a location not readily accessible could be saved by opening the make-up water inlet a little while each day. However, heat losses alone in time would result in an extra expenditure for fuel equal to the cost of the repair—a repair which must be made eventually in spite of any delays as the defect grows steadily worse. In addition, the admittance of raw water may bring about a dangerously rapid accumulation of scale and sediment in a boiler that is not so designed that it can be cleaned.

Another common reason for loss of water is leakage of steam either from the safety valve, or from a defective connection in an unused or seldom used room. In one instance enough steam escaped through a leaky radiator plug in a vacant office room during a single day and night to lead to the very serious damaging of the boiler.

Accident investigations reveal repeated instances of blow-off valves and drain valves left open, of the drawing off of water for cleaning purposes, and of the more inconspicuous losses of water because of cracks in cast iron sections or in minor leakage at tube ends and seams. Sometimes the last named low water causes are not noted until a thorough internal inspection of the boiler is made.

The evidence of a steady loss of water from the system is usually so obvious that an attendant who is at all observant will detect the condition. Not so obvious are the dangers which arise when water in the system is not returned promptly to the boiler. Closed radiators, piping stopped up by deposits or because of freezing, radiators and piping below the water line of the boiler, sags in return piping, and long horizontal runs of pipe may so retard the return of condensate to the boiler that the water level will at times become dangerously low.

Sometimes under such conditions the relatively cool condensate will return in a rush to the over-heated boiler and damage it seriously.

At the other extreme is the condition of sudden forced firing by which water is evaporated faster than it can normally be returned from the system. In cast iron boilers, particularly when they are automatically fueled and thermostatically controlled, forcing can uncover the top sections, and result in cracking.

Surprising as it may seem, there are a large number of cases on record in which stop valves in return lines have been closed by the operator and the mistake not noted until after the boiler has become dry or nearly so. Low water has also been caused by opening the valve of the drain instead of the intake valve, leaving the boiler while "blowing-down" and forgetting the open valve, and similar "impossible" occurrences which, extreme as they are, stand out in each year's summary of boiler losses as red ink stands out on the pages of a ledger.

Accidents caused by failure of water to return properly in a system free from leaks, may be classified in four groups: (1) Retardation of return flow; (2) closed return pipe stop valves; (3) freezing of a part of the system, and (4) failure of the return pump (or its motor) or of the return trap. Of these four causes, the last named results in the most accidents. A typical illustration occurred in a small Mid-west factory. The plant operated only during the day and there was no night attendant. A low pressure oil-fired water tube boiler was used for heating only. About 7 A. M. when the foreman arrived for work, he found the oil burner in service, and the boiler empty and badly burned. In this installation an electric pump, normally controlled by a float in the receiver, was depended on to return condensate from the receiver to the boiler. However, the float had stuck in the closed position, preventing the return of the condensate, and all the radiators were filled with water. As the oil burner was not equipped with a low water cut-out, the burner continued in service until practically all the water had evaporated from the boiler.

In the class of accidents under discussion the list also includes a goodly number caused by failure of relays, switches, and motors.

In a few instances, there have been low water and over-heating accidents because automatic devices worked too well after being tampered with by persons unfamiliar with heating equipment. In a Southern store, in December, one of the clerks felt cold. He sought the janitor, but found that that individual had left the building. As the story was pieced together, the clerk then "adjusted" the pressure regulator and stoker cut-off, endeavoring to get more heat. When the janitor returned he found a very hot boiler and water all over the floor. The tubes had bowed until leaks permitted the boiler to drain.

Accidents because of low water cause widespread discomfort because the heat source is interrupted, and in connection with business locations and places of professional entertainment, they may lead to appreciable losses if it is necessary to suspend operations while repairs are being made. The fact that so many costly accidents due to low water are easily preventable, by the exercise of ordinary care on the part of the operators, makes their frequency lamentable.

Locomotive Accident Kills Members of Train Crew

The explosion of a locomotive boiler killed the engineer and the brakeman of a train operating near Rockmart, Georgia, on June 29, 1935. Two other members of the crew were injured and the locomotive was demolished. According to an International News Service report, the blast left only the truck on the rails, and the train continued on its way nearly a mile before it stopped.

Two Recent Steam Engine Accidents Involving Flywheel Explosions

WHEN a crank disc of a paper mill engine broke on May 22, 1935, the engine and its 6' belt wheel stopped suddenly, the wheel flew to pieces and the 200 hp variable speed twin engine was wrecked beyond repair. Large paper machines rolled to a stop and a New Jersey mill faced costly delays because it could not fill its orders. Insurance took care of the direct damage loss to the machine and of the use and occupancy losses, but the mill wanted to make paper. Its customers wanted delivery.

Hartford Steam Boiler set about expediting the restoration of power. There was no hope of repairing the old engine and it would require

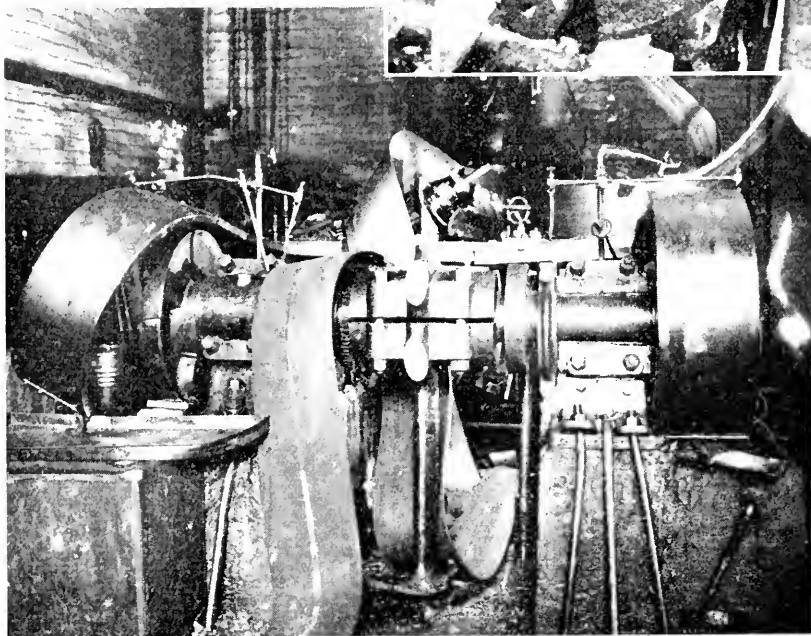
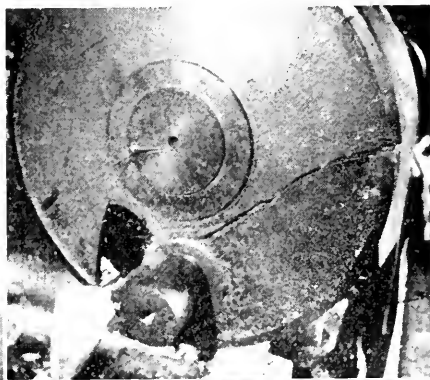

Spoke stumps and a tangle of belts and machinery after the engine stopped suddenly. Above—The cracked crank disc.

more than two weeks to complete and erect a new engine, which fortunately had been ordered some weeks prior to the accident. A temporary electric drive seemed the best solution, but paper mill drive motors must have special characteristics and suitable machines had to be found.

The accident occurred early in the afternoon of a Tuesday. By the following Monday a motor-generator set, an 80 hp compound wound D. C. motor, a motor-driven exciter set and necessary rheostats and switches, had been installed and paper was being manufactured. This equipment made it possible to produce about two-thirds of the average daily output, permitting the mill to fill its urgent orders.

From the time of the accident until the plant was running with power from the new engine, 20 days after the accident, Hartford Steam Boiler representatives were at the mill continuously, first, to assist in the rapid installation of temporary equipment, second, to supervise its operation, a matter which required constant attendance, and third, to assist

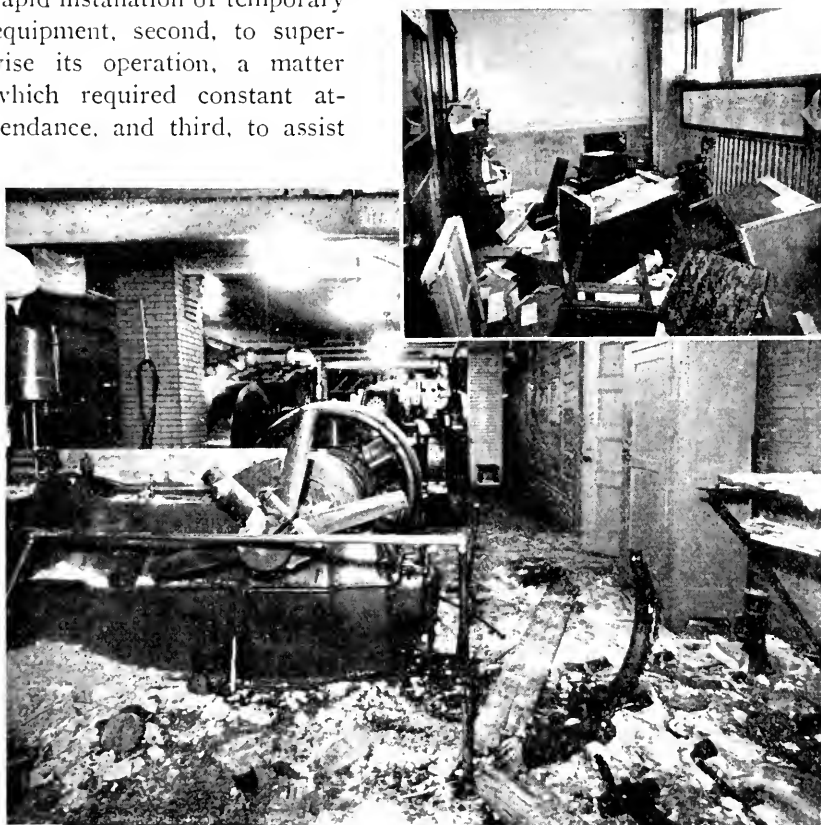

Only the spokes remain. Part of the wheel jarred the room shown above by heaving the concrete floor.

in the quick erection of the new engine. Property damage as a result of the accident was more than \$2,800 and use and occupancy indemnity more than \$7,000.

In another accident, occurring in New York City on June 30, 1935, the breaking of one of the links of the shaft governor rendered the governor inoperative and permitted the engine to over-speed. The watch engineer said he heard something snap and that the engine immediately began to race. He tried to shut off the steam supply, but before he could reach the valve, the 4' 6" balance wheel exploded. In addition to the wheel and the governor mechanism, the engine frame, cylinder, crankcase, foundation and various reciprocating parts were damaged. A piece of the flywheel rim pierced 18" of concrete and lifted the floor above, wrecking an office. Other parts of the rim damaged the engine room wall, piping and fixtures.

Explosion in Air Inlet Manifold Damages Diesel

A SOMEWHAT unusual Diesel engine accident, the explosion of the scavenging air manifold, occurred some weeks ago at a Mid-west utility plant. Pieces of casting were blown across the engine room and tore the clothing and cap of an operator. Fortunately he escaped without injury.

The 840 hp two-cycle engine was used to handle peak loads and had not been operated for a week prior to the accident. An attendant was at the controls for starting the machine when the manifold went to pieces just over his head.

After priming the cylinders, the operator admitted the starting air to them and almost immediately there was an explosion. Following the accident, a quantity of both fuel oil and lubricating oil was found in the manifold and it was noted that the scavenging air port of No. 1 cylinder was burned as though flame had entered it from the cylinder.

It is understandable how lubricating oil and possibly fuel oil could have gotten into the manifold, but the source of ignition of an explosive mixture is not so readily explained. One possibility is that there may have been a back-fire through the scavenging port, particularly if No. 1 cylinder had been over-primed. The intake to the scavenging pump was piped from the outside of the building and there was nothing in connection with this pipe between the outside of the building and the pump that could have caused the trouble. Other theories were advanced, but they did not lead to an adequate explanation of the accident.

Operating Temperature and Ventilation Of Rotating Electrical Machines

By J. B. SWERING, *Assistant Chief Engineer, Electrical Division*

THE quick and effective removal of heat from the windings of rotating electrical machines is essential to their safe operation. In fact, the limit of load of an electrical machine is determined by the temperature developed under specific operating conditions. Factors controlling the safe operating temperature of such machines are their ventilation, the class of the insulation, the ambient (room) temperature, and cleanliness.

Because ventilation has so important a bearing on a machine's operating temperature, careful consideration should be given to any factors which may interfere with normal ventilation.

The location of a rotating electrical machine is vitally important and should be carefully studied. If the machine is to be located above boilers or in other places where high normal room temperature exists, this condition must be considered in both the construction and ventilation of the machine. Where trouble is experienced with machines not particularly designed for operation with high room temperatures, sometimes the remedy lies in a relocation of the unit. In other cases a baffle between the object and the source of heat will reduce the operating temperature. Housing the object and bringing the ventilating air from the outside is another remedy.

In many instances ventilating air contains harmful elements such as dirt, lint, moisture and fumes from battery chargers or from other process work. While such air is a cooling medium, the foreign substances in it may be harmful to the insulating material when drawn through the machine. A heavy collection of foreign matter on the windings and in the ventilating ducts acts as a heat insulator and usually causes the machine to operate at a dangerous temperature. Cleanliness is an absolute necessity for normal operation.

The quantity of air passing through the ventilating system is also important. Air supply ducts to all types of machines must be installed properly, for the resistance of the ducts to the passage of air is influenced by the number and shape of the bends, elbows and the duct lines themselves. Cases are on record where as much as 30 to 40 per cent of the available pressure has been taken up by improperly designed inlet ducts. Dampers located in duct lines must be so installed that the free flow of air from some source to the machine can never be shut off. An ample supply of air should always be available, and the mechanical

parts such as blowers, air shields, and baffles should be kept in good condition. The volume of air required for cooling a specific machine should conform to the manufacturer's specifications.

For turbo-generators or large rotating machines in general, the most satisfactory method of cooling is by means of a closed ventilating system.

It is obvious that the characteristics of the insulating material have a decided bearing on the temperature at which an electrical machine may be operated and careful consideration should be given to this feature where machines are operated at high ambient temperature.

There are two classes of insulation which are most commonly used in electrical rotating machines. They are designated in the A. I. E. E. Standards as Class A and Class B insulating materials. Class A insulation consists of cotton, silk, paper and similar organic materials, when impregnated or immersed in oil; also enamel as applied to conductors. Class B insulation consists of mica, asbestos and similar inorganic materials, in built-up form combined with binding cement. If Class A material is used in small quantities for structural purposes only in conjunction with Class B insulation, the combined materials may be considered as Class B, provided the electrical and mechanical properties of the insulated winding are not impaired by the application of the temperature permitted for Class B material. (The word "impair" is here used in the sense of causing any change which could disqualify the insulating material for continuous service.)

To determine whether a machine is being operated within its rated guaranteed temperature rise, it is necessary to know the limiting observable temperature. This temperature may be determined by three methods: (1) Thermometer method, (2) resistance method, and (3) embedded-detector method. The following are the standards adopted for the limiting observable temperatures with respect to each of the different methods stated above.

Limiting Observable Temperatures

	CLASS A MATERIAL	CLASS B MATERIAL
Thermometer Method	90°C	110°C
Resistance Method	95°C	115°C
Embedded-Detector Method	100°C	120°C

It is recognized that temperatures recorded by any of these three methods do not accurately indicate the "hot spot" temperature—the temperature of the portion of the winding embedded in the slot. In order to determine the highest operating temperature of an electrical winding the following values must be added to the maximum value

obtained by any of the above methods: Thermometer method, 15°C ; resistance method, 10°C , and embedded-detector method, 5°C .

The maximum ambient upon which the temperature rise of an electrical machine is determined is 40°C . Therefore, the maximum over-all operating temperature for a 40° rise machine will be 80°C . While the majority of rotating electrical machines are rated on the 40° rise basis, there are a number of 50° rise machines in operation and for such machines the maximum over-all operating temperature will be 90°C . There is a tendency on the part of manufacturers today to build some of the larger machines to operate at a still higher temperature rise than even the 50° .

In all temperature problems of machine operation it is safest to follow the name-plate rating because this is established from the actual "heat run" made on the machine in the manufacturer's plant. It should be remembered, however, that this rating is safe only when the machine is clean, is operated in a location and at the kind of work for which it was built, and is properly ventilated. Any well-built rotating electrical machine will give better service if its operators understand and protect against the hazards arising from improper temperature conditions.

Transformer Oil Vapor Explosions

FOUR men died from burns as the result of the explosion of transformer oil vapor on July 2, 1935, at Washington, D. C. In this instance workmen were removing a thermometer from an energized 300 kv-a subway type transformer. A short circuit resulted when the metal thermometer tubing they were handling accidentally touched a high tension terminal within the transformer case. An arc developed to all three terminals of the transformer, the disturbance causing the transformer oil to volatilize and explode, bulging the tank and burning the four men who were in the vault, and resulting in some damage from fire. Further disaster, it was said, was averted by the operation of a circuit breaker controlling the transformer feeders. The relay which was being installed was to have operated a fan to cool the transformer whenever the temperature of the oil reached a specific point. The accident illustrates the dangers of working on any sort of electrical equipment while it is energized.

Another transformer explosion, also in Washington, occurred on August 14, 1935. Newspaper accounts reported that a woman who was walking on the sidewalk above the transformer vault was painfully burned and that flames rose two stories above the street.

Hot Water Supply Equipment Accidents

RESIDENCES, a municipal garage and shop, and a hotel were damaged by recent hot water equipment explosions caused by pressures higher than the vessels could withstand.

Forgetfulness in leaving non-automatic burners in service was blamed for the two accidents to small hot water tanks in residences pictured on this page. That at the left occurred in a Middle Western residence which was lifted from its foundations. The hot air furnace



After hot water tanks hurtled upward.

was demolished and several rooms damaged as the tank forced its way through floors and the roof. The photograph at the right shows the living room of a New York residence, after a hot water tank had exploded. Passing through two floors and the roof, the tank landed 70 feet from the house. The force of the explosion and actual physical damage by the tank itself virtually wrecked the dwelling. Both accidents were attributed to a combination of over-heating and over-pressure. On automatically controlled installations and on an increasing number of manually operated burners, pressure and temperature relief valves are being used to reduce the likelihood of accidents of this sort.

The operation of a Texas hotel was seriously disturbed when the explosion of a hot water supply boiler of the garbage burner type caused the breaking of gas and water lines, damage to switchboards and the flooding of the elevator pit. In addition to destroying the burner, the accident resulted in approximately \$5,000 damage to walls, doors, decorations, elevators and cables, heating boilers, and other equipment.

The hotel garbage burner was auxiliary to the regular hot water heating equipment and was fired up each morning. This oil-fired boiler



Once part of a hot water supply system.

was of fusion welded construction and was operated without automatic control, although there was a relief valve set at 105 lb. The normal service water pressure was 90 lb.

The cause of this accident was not readily evident, but the condition of the boiler indicated that the welded seams had failed because of excess pressure. After the explosion the boiler was cut up and removed from the building. A part of the vessel pictured herewith (from the lower section of the boiler) shows how the firebox plate was forced inward when the seam and staybolts failed.

A municipal garage and shop in California was damaged and an oil-fired cast iron hot water supply boiler completely demolished by an explosion on July 12, 1935. Piping connecting the boiler to a tank was

broken and the tank was knocked from wall brackets which supported it. Flying metal caused most of the property damage. One piece tore out the seat of a blacksmith's trousers, but otherwise did not injure him, although he and another man were showered by dust and soot. Some aspects of the accident indicated that there might have been a furnace explosion, but the character of the blast and the fact that steam had issued from a tap shortly before the accident brought the conclusion that a failure occurred because of over-pressure. The initial break seemed to have been at the base ring.

Blasts Damage Cleaning Plants



At 7:01 A. M. on June 2, 1935, the boiler operator of a Southern cleaning and dyeing company was attending his boiler. At 7:02 A. M. he was 30 feet in the air looking over buildings at traffic in a street some distance away. Then he plunged back to a friendly plot of soggy earth. His injuries proved slight. The 42" dry back marine boiler, which had caused the trouble, went 200 feet, demolishing part of the building housing it, carrying off a porch, and damaging a store and an apartment kitchen in its flight. The injured operator said the explosion occurred just as he was about to "turn some steam into the plant pipes." Apparently the furnace of the boiler collapsed as pressure rose. Part of the damage is depicted in the photograph.



The woman proprietor of another Southern cleaning establishment sustained serious injuries when the small vertical boiler, 20" in diameter and 4' high (shown above), exploded on June 4, 1935. Corrosion just above the base ring, a common cause of failure in this type of boiler, was blamed for the accident. The woman's shop was wrecked.

Explosion of Feedwater Heater

In the routine of normal plant operation, closed feedwater heaters operated at low steam pressures seldom fail, except when they are subjected to pressure in excess of that for which they were built. However, the possibility of feedwater heater explosions exists in any plant in which the pipes are so connected that high pressure steam may be admitted to the heater. An accident to such a feedwater heater in an English utility plant was brought about through a mistake by a steam-fitter.

The official report, as summarized by *Engineering* (London), described an accident at a power plant in which both high pressure and low pressure feedwater heaters were used. The high pressure heater was normally supplied with extracted steam, a practice which proved inefficient. The plant engineer therefore ordered the high pressure heater connected to the exhaust of an air ejector and the turbine drains. In making the change, the piping, which carried a higher pressure than that for which the low pressure heater was designed, was

erroneously connected to the cast iron, low pressure heater instead of to the high pressure heater. When operations were resumed, the low pressure heater, on which there was no relief valve, exploded and escaping steam scalded five men, one of whom died as a result of his injuries. The heater which burst was 2' in diameter and a little over 7' long between the tube plates.

The deputy-engineer-surveyor-in-chief commented on the accident as follows: "Those with experience in large plants will appreciate that in spite of care and organization, mistakes and unforeseen circumstances will sometimes occur, and it is fortunate for the peace-of-mind of those responsible that such accidents are not always followed by the serious consequences which obtained in this case."

Improper Soot-Blower Installation Causes Boiler-Tube Failure

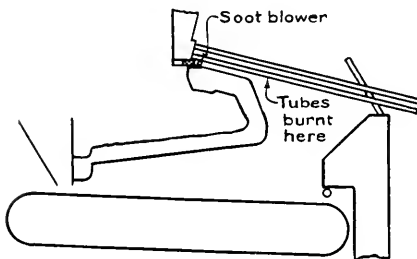

Repeated burning out of the bottom-row tubes in a battery of water tube boilers caused much speculation at a Springfield, Illinois, plant. Failures always occurred at some distance from the front header, and looked as if a blow-torch had been directed on the tubes. The trouble, according to Julius Brodsky in *Power*, was traced to the soot-blower. The arrangement of the soot-blower steam jets was such that it was impossible to keep an air seal

between the bottom of the header and the ignition arch. With air flowing through this opening and contacting unburned gases from the furnace above the back end of the ignition arch, combustion occurred with blow-torch intensity and damaged the tubes. The soot-blower arc of travel was changed so that steam would not impinge on the header, and an air seal was provided under the front header by laying a row of brick, caulking with asbestos rope and finishing with asbestos fire-clay plaster. Provisions were also made for admission of additional air over the fire, so as to complete combustion of gases before they struck the tubes. After correcting the conditions, no further tube failures occurred.

Hydro-Pneumatic Tank Explodes at Airport

One man was killed and another injured, when a hydro-pneumatic tank exploded at an Ohio airport. The air pump used with the tank had not been working properly and the pressure gage failed to register. One man had gone into the pit to determine the trouble and the other was standing looking down into the pit when the tank exploded, killing the man on the ground and blowing the other man out of the pit, but not injuring him seriously.

Vessels Subject to External Pressure

By WILLIAM D. HALSEY, *Assistant Chief Engineer, Boiler Division.*

IN THE 1934 edition of the A. S. M. E. Code for Unfired Pressure Vessels, new rules are given for the design of cylindrical vessels subjected to external pressure. The code makes available in workable form a composite of information which long had been desired by designers of such equipment. The Hartford Steam Boiler Inspection and Insurance Company took an active part on the special research committee that prepared this material. With the publication of the rules, the Company has announced its adoption of them as its recommended standard for the calculation of allowable pressures for such vessels. A summarized discussion of the principles involved may enable owners of such equipment to understand better the problems of safe design in a class of vessel that is in more or less common use among process industries.

The behavior of a vessel under external pressure is different, in many respects, from its behavior under internal pressure. Internal pressure results, for the most part, in tensile stress and the vessel tends to change to a shape of greater strength, that is, it seeks to become a sphere. On the other hand, a vessel under external pressure tends to change to a weaker shape. As the change in shape occurs, its ability to withstand the external pressure is very much reduced, and failure will occur at a pressure very much less than the vessel could safely withstand in its original form.

The action of vessels under either internal or external pressure may be compared to the action of test specimens of steel under tensile stress or under compression. The material in the shell of a vessel under internal pressure acts in much the same manner as a specimen under tension. A vessel under external pressure acts in a manner quite similar to a specimen under compression. This comparison may be carried a little further by considering the action of long and short columns under compression. Columns in which the thickness or diameter is small, as compared with the length, will, under compression, tend to bend easily. Some bending may take place before the stresses reach the yield point or elastic limit of the material. If the load is removed, when a certain amount of deflection has occurred and before the yield point of the material is reached, the specimen will return or spring back to its original condition. However, when the specimen bends, it immediately loses strength, it very soon passes the yield point because of the change in shape, and the continued application of the load causes

it to fail. Columns which have a large thickness or diameter as compared to their length will not bend under a compressive load but will "upset" or change shape by increasing in diameter or cross section.

A column in which the thickness or diameter is small as compared with the length is said to fail by "instability". On the other hand, a column that has a large diameter as compared with the length is said to fail by "yielding". Pressure vessels under external pressure may fail in either of these ways.

The *ratios* of plate thickness to diameter and also length of cylinder to diameter are very important in the analysis of vessels subject to external pressure. Vessels with walls that are relatively thin as compared to the shell diameter change shape readily under external pressure and, by such action, become weaker and deflect still further from the original shape. However, until actual permanent change in shape takes place, the stresses in the material do not reach the yield point. Such vessels are said to fail by "instability". Other vessels which have walls that are relatively thick as compared with the shell diameter do not lose strength until the stress in the metal reaches the "yield" point. They then start to deflect and thus become progressively weaker.

The "yield" strength of a short thick column is easy to calculate, it being simply a matter of dividing the load by the cross sectional area of the specimen. It is also easy to calculate the strength of a vessel that will fail by "yielding", as the computation is the same as that used for vessels under internal pressure. However, just as the strength of a slender column depends upon both its length and its cross sectional dimensions, so also does the strength of a vessel, that has a thickness small in comparison with its diameter, depend upon its length, thickness, diameter, and, of course, upon the physical properties of the material.

The heads of a cylindrical vessel under external pressure, by maintaining the circular shape of the vessel at its ends, tend also to strengthen the entire structure. Therefore, the distance between the heads, or supporting rings, of a vessel enters into the determination of its strength. On the other hand, when the length of a vessel reaches a certain value the heads no longer help support the middle portion, so that the collapsing pressure remains unchanged for any further increase in length.

The calculation of vessels under external pressure involves some very complex mathematics and the details of this will not be treated here but may be obtained in the code itself. The new rules for external pressures in the code relate only to vessels built of ordinary boiler

steel or materials having practically the same physical properties. Furthermore, these rules relate only to plain cylindrical vessels of three general classes: (1) The plain cylindrical vessel such as the vacuum tank, the external pressure being that of the atmosphere; (2) the typical cylindrical jacketed vessel or autoclave, and (3) the double cylindrical jacketed vessel, such as a fat melter in the packing industry. The last two classes are subjected usually to steam pressure from the outside.

In a vessel under external pressure, one that is perfectly cylindrical will be stronger than one of eccentric shape. However, since it is impossible from a practical standpoint to construct a vessel that is perfectly cylindrical, the code gives certain tolerances or limits for variations from the true cylindrical shape. Vessels under external pressure may be strengthened by the use of reinforcing rings. Rules for the size of such rings and their permissible spacing are also given in the code. In addition, the method of supporting the vessel under external pressure is of importance, and the code gives consideration to this matter.

Turbine Over-speed Demolishes Unit

An inoperative governor led to the explosion and demolition of a 300 hp steam turbine on May 20, 1935. Failure was brought about by over-speed when the turbine lost its load. Examined after the accident the horizontal type turbine governor was found to be in the wide open position. It could not close because tension on the governor spring had been relieved by the accidental loosening of two studs holding the diaphragm casing in position. The loss to the machine, which was less than a year old, was covered by insurance.

Collapsing Tube Causes Death

The collapsing of a boiler tube in an ice manufacturing plant in Alabama resulted in the death of one man and serious injury to another from escaping steam at about 80 lb pressure. The boiler was being used to supply the peak ice demand due to the strawberry season when many cars of berries were being iced for shipment to northern markets. One of the men was in front of the boiler at the time of the accident and the other was on top of it. The man who was killed was the engineer and the other the manager.

A manually operated gas-fired tire vulcanizer of the three-well type exploded in a Connecticut tire shop a few weeks ago, destroying itself and damaging the building. The force of the explosion blew the operator out through an open door, but did not injure him. It was evident that over-pressure caused the accident.



A QUARTERLY MAGAZINE
DEVOTED TO POWER PLANT PROTECTION

GEORGE H. PRALL, *Editor*

Copyright 1935 by The Hartford Steam Boiler Inspection and Insurance Company

HARTFORD, CONN., October, 1935

Single copies may be obtained free by calling at any of the Company's offices.
Subscription price 50 cents per year when mailed from this office.
Bound volumes one dollar each.

Reprinting matter from this paper is permitted if credited to

THE LOCOMOTIVE of THE HARTFORD STEAM BOILER INSPECTION AND INSURANCE CO.

Hugh F. Bowie

Inspector Hugh F. Bowie, who for nearly four decades represented Hartford Steam Boiler in Milwaukee and vicinity, died on September 10, 1935, at the home of his daughter, Mrs. Winifred Hewitt of Milwaukee.

Thoroughness as an engineer, combined with outstanding personal qualities brought Mr. Bowie extraordinary recognition while he was in active service. One instance in particular has been recorded previously in THE LOCOMOTIVE (April, 1926, Page 44). For thirty years Mr. Bowie had inspected the boilers and engines at the Horlick's Malted Milk Corporation plant at Racine, Wisconsin. It had long been that company's practice to name its engines, and on February 1, 1926, Mr. Bowie was invited to the plant to witness the unveiling of a new engine, for which he had been asked to suggest a name. Much to his surprise, when the unveiling took place, Mr. Bowie discovered that the new engine was not to be christened "Coolidge," as he had suggested, but was to be named for him. The esteem in which he was held is re-

vealed by the names of the other engines at the plant: William H. (Horlick), James H. (Horlick), Edison, Victoria, Gladstone, Lincoln, Washington, Christian IX, and Amundsen.

The veteran inspector retired August 1, 1932, after 38 years and eight months of service. He was a member of the Hartford Steam Boiler Old Timers' Club and a favorite with fellow employees and assured as well.

Mr. Bowie was born in Paisley, Scotland, October 29, 1856. He entered the Company's employ with the Chicago Department on December 15, 1893, and remained in that department's service until his retirement.

Noel D. Ellison

Noel D. Ellison, for the past five years an inspector in the Detroit and Cleveland Departments, was fatally injured August 27, 1935, when an automobile he was driving was struck by a railroad locomotive near Steubenville, Ohio. Mr. Ellison, whose home was at Newark, Ohio, was serving plants in the central part of Ohio. He was born in Fredericksburg, Iowa, October 6, 1892, and was graduated from the Iowa State College as a mechanical engineer. In his death the Company loses one who was highly regarded by his associates and by the clients with whom he came in contact.

English Boiler Expert Dead

News was published in July of the death of Charles Edmund Stromeier, who for more than 30 years was chief engineer for our British contemporary, the Manchester Steam Users' Association. Regarded as an expert on the subject of steam boilers, Mr. Stromeier's work is exemplified in the annual reports of the Association and in the large number of papers which he contributed not only on the subject of steam boilers, but on such subjects as the working and aging of steel, the fatigue of metals, and the effect of caustic soda on steel vessels under pressure.

Born at Sutton, England, in 1856, he served his apprenticeship in engineering works in London, studied engineering and graduated at Aix-la-Chapelle. In his early years he was employed in marine engineering works on the Tyne, and as a sea-going engineer, becoming in 1880

engineer-surveyor to Lloyd's Register of Shipping. He was a past member of the Council of the National Physical Laboratory and of the Institution of Naval Architects. He was a past president of the Manchester Association of Engineers, a member of the general committee of the British Association for the Advancement of Science, and a member of the following institutions: Civil Engineers, Mechanical Engineers, Iron and Steel Institute, and Manchester Association of Engineers.

Sumter A. Clowes

Word has been received from the Cleveland Department that Sumter A. Clowes, retired inspector known to many policyholders in Ohio, died October 2, 1935, at his home near Cleveland. Mr. Clowes was born in 1866 at Allegheny, Pennsylvania. He joined The Hartford Steam Boiler Inspection and Insurance Company on May 10, 1902, after several years of experience in boiler shops, and worked as a member of the Cleveland inspection staff until his retirement on June 1, 1933. His passing takes from the ranks of Company veterans one who enjoyed the respect and affection of a wide circle of friends.

New Chief Inspector at Denver

Announcement has been made of the appointment of Mr. Jesse L. Fry as Chief Inspector of the Company's Denver Department. Mr. Fry succeeds Mr. Frank G. Parker who, effective September 1, 1935, was transferred to other responsible duties in the Boston Office. With Hartford Steam Boiler for the past 15 years, Mr. Fry has had a wide experience in the inspection and engineering work of the Company, an experience which fits him well for his new responsibilities. He joined the Company in 1920 as an inspector in the St. Louis Department. In 1931 he was transferred to the Hartford Department as adjuster and about a year later took over this work in the Boston Office. As Chief Inspector at Denver, Mr. Fry will direct the Company's engineering activities and inspection in Colorado and other states in the immediate vicinity.

A scientist has distinguished himself by discovering that singing increases the temperature of the blood. Shucks, we knew it all the time. There are certain kinds of singing that actually make our blood boil.

Water-Turbine Generator Accident

SHORT circuiting and fire in a water-turbine generator at a New England power plant some months ago, resulted in a loss of more than \$8,000 to the unit and smudge and fire damage in the room housing it. The 3-phase, 2,300 volt machine had been re-wound only a few months before the accident. This fact, coupled with an excellent system of maintenance, made the possibility of gradual breakdown of the insulation remote. The immediate cause of the accident, however, was a short circuiting which originated in the leads between the winding and the machine terminals. Investigators blamed the trouble on an electrical disturbance outside the plant, which produced a line surge that broke down the lead insulation. Repairs involved the reinsulating of 12 field coils and 202 bar conductors, and replacement of damaged wires, cables, conduits, and lightning arrestors. The loss was covered by insurance.



Windings and leads damaged by short-circuiting and fire

Hydraulic Brake Failure on Hoist Motor

IN CONNECTION with hoisting motor installations in coal fields, quarries and similar locations, conditions require the use of auxiliary brake mechanisms. The very fact that such safety devices are necessary is evidence that their maintenance is important. How important is revealed by a recent accident to a 500 hp hoist motor geared directly to a hoisting mechanism and installed at the head of a 4800 ft incline. The accident necessitated a complete rewind of the rotor and stator of the motor, a \$3,350 repair which required six days.

The motor and hoist are so arranged that loaded cars are lowered from the mouth of the mine to the tippie. As loaded cars are lowered,

empty cars are brought up the incline, and the difference between the loaded and empty cars represents the load on the hoist. To brake the load the motor operates regeneratively and is supplemented by an emergency hydraulic braking mechanism which is controlled directly from an over-speed trip. When this trip functions, the hydraulic brake is automatically set, thus stopping the hoist.

At the time of the accident some external trouble on the line supplying the substation distributing power to this hoist resulted in a low voltage condition. The low voltage protection tripped the oil switch in the substation on the feeder circuit supplying the hoisting motor, thus removing all power from the motor.

The hoist then over-speeded, setting the emergency hydraulic brake, but owing to its defective condition and poor adjustment, this brake was not effective. As a consequence, the rotor coils fanned out and the stator winding was destroyed. An examination of the auxiliary emergency brake showed that this safety device was exerting only about a third of its normal braking power.

Fuel Explosion Wrecks Boiler Setting

IN USING natural or manufactured gas as a boiler fuel, straight way plug cocks are necessary in the lines to each burner, if the proper degree of safety is to be maintained. A recent furnace explosion accident in the West was directly attributable to a leaky globe valve which permitted gas to accumulate in the setting of an idle boiler. The resulting mixture of gas and air was accidentally exploded with force sufficient to blow down the boiler setting, as shown on Page 249.

Two water tube boilers were connected to the same breeching and separated by a center wall. Both boilers were off the line and the furnace brickwork of boiler No. 2 was being repaired. In order to dry out the brickwork, a small fire had been built in the furnace. It was this fire which ignited the gas in No. 1 boiler setting.

The installation was in a large canning plant, and the boilers were scheduled to go on the line eight days after the accident to care for the apricot crop. Since furnace explosion and use and occupancy insurance were carried, the repair was expedited by The Hartford Steam Boiler Inspection & Insurance Company, which authorized the employment of three shifts of workmen and suggested other emergency measures to hasten the work. As a result, the boiler went on the line as scheduled and none of the crop was lost.

The installation of plug cocks had been recommended in this instance prior to the accident, but a suitable time for their installation

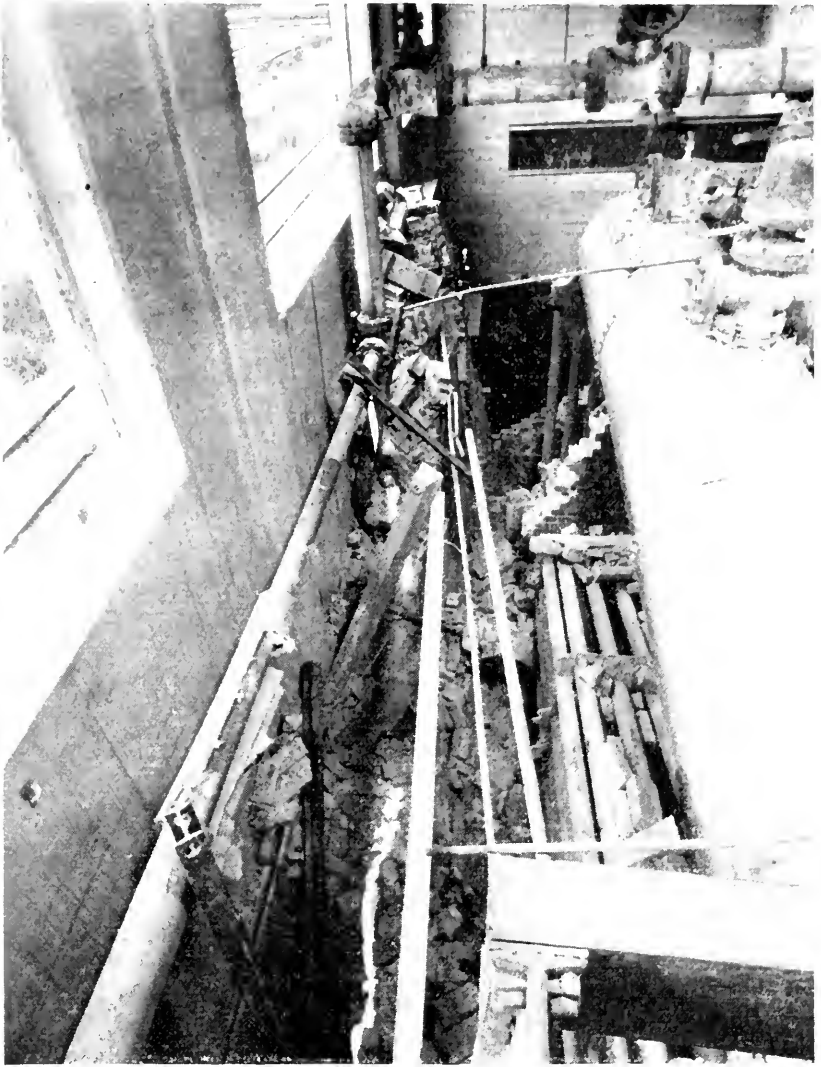

Brick masons worked night and day to rebuild this setting.

had not presented itself. In any gas-fired installation the pipe to each burner should be provided with a straight-way plug cock marked in line with the passage, and there should be a rising spindle gate valve or some equivalent device which indicates positively whether the valve is open or closed, and which can be seen from a distance.

Steam Exhaust Chamber Bursts on Ammonia Compressor

AN ACCIDENT of an unusual sort, the explosion of the exhaust-steam cylinder-jacket of a Corliss-type steam-driven ammonia compressor, necessitated extensive repairs to the unit at a Pennsylvania brewery in July of this year. The operator heard an unusual sound and immediately began closing the throttle valve, but before he

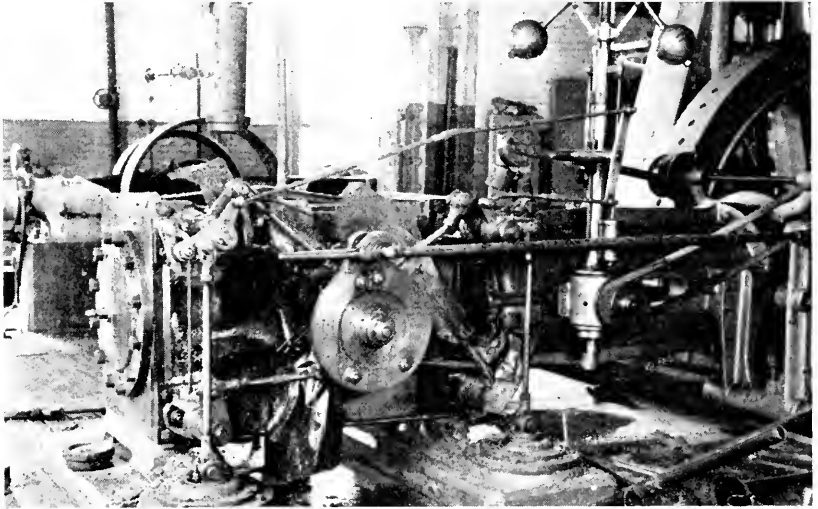

Steam end of compressor after the blowing out of the exhaust-steam cylinder-jacket.

could finish the operation, the exhaust steam chest blew off the cylinder, bending various reciprocating parts and breaking the throttle valve and piping.

In seeking the cause of the accident, investigators considered several contributing factors. Although the steam pipe was well drained by traps, they felt that water may have gotten into the cylinder at some prior time and the "bump" then sustained may have started cracks in the cast iron. The face of the break showed two old defects, each about 2" long, but otherwise the metal was clean. A new 18" steam cylinder, a new throttle valve and the repair of the valve gear and other parts were necessary to restore the compressor to service.

Two men operating a steam roller on a New York street were burned recently when one of the tubes in the machine's boiler blew out. Passengers in a bus which was passing were badly frightened, but escaped injury from the steam.

Japs From the Old Chief's Hammer



TOM PREBLE, assistant to the Old Chief, sat, an annoyed look on his face, scratching and scratching the fleshy part of his leg. His persistent actions attracted his superior's attention.

"What's wrong Tom?"

"I don't know, Chief. I must have picked up a hungry autumn spider. At least, some insect has given me something to scratch." And Preble went for his leg again.

The older man laughed heartily and then he chuckled, "Tom, your spider or whatever it is reminds me of something. Spider! Ho! Ho! Wait until I tell you about McCarcher at the big school up the river."

Tom knew a good story was coming. The Chief's store of yarns from his wide experience seemed inexhaustible.

"Mac, as you know, has been inspecting the heating plant at the school for better than 20 years," the Old Chief began. "One autumn about 10 years ago he was making his usual thorough examination. He had finished with the boilers and other equipment in the power house and had started his inspection of the piping.

"You remember the layout. There is the power plant with tunnels to each of the buildings. They are not more than about 3 feet in diameter, but a man can crawl through them easily if he is careful. Mac had finished one of the tunnels and had started through a second when he noticed what he thought was a leak and stopped to examine the pipe more in detail."

"As he was working, he thought he heard a noise farther up the tunnel. He flashed his light and let out a yell.

"'Chief,' he told me afterward, 'I had always thought that the expression about a scared man's hair standing on end was just a figure of speech, but I found out then that it wasn't. My hair went right up like wires, I guess, and I raised up quickly and bumped my head on the top of the tunnel. Then I saw stars and that added to my confusion. My hand shook so I could hardly hold my light steady . . . and that thing in there kept coming at me. Great big eyes, they were. The

only thing I could think of was a gigantic snake, because the eyes were low down in the tunnel. . . . I got control of myself somehow and backed out of that tunnel faster than I ever came out of a pipe before.

"Once in daylight, I hollered for help. The engineer heard me and came across the room. No doubt I looked pretty funny and he began to laugh. He didn't laugh quite so hard, though, when I told him what I'd seen, but it was plain he didn't believe me.

"All right," I said, "take the light and see for yourself." He didn't want to go into the tunnel, then, but he had laughed too hard and had to take a look himself to save his face. He crawled in a little way and I heard him talking to himself.

"Then he backed out and laughed some more, and I began to get a bit provoked."

"What was it, a skunk?" asked Tom.

"No," replied the chief, "it was an alligator."

"Alligator! What . . . ?"

"Oh, it was easy enough to explain *what* it was, but nobody could figure out how the critter got into that tunnel, unless somebody had let it in.

"As it turned out, the 'gator was famous on the campus. It even had a name—Shoes, I think it was. Somebody had given the alligator, a fine 6-foot specimen, to one of the professors. The reptile had lived all summer in a pool in a big rock garden, but one night early in September it disappeared. A search that lasted several days failed to locate the critter.

"The only way they could figure the thing was that some one had opened the power house door, and induced Mr. Shoes Alligator to enter. It was warmer there and, I suspect, still warmer in the tunnel.

"I don't know for sure, Tom, but I suspect some undergraduates laughed until they cried about the sequel to their fun.

"Mac laughs now, but he says if whatever he thought he saw had opened up those jaws and his light had played on those long rows of teeth, he'd have passed out sure. I tell you, Tom, in this boiler inspecting game you're likely to run into some queer reptiles. For my own part, I've had several interesting brushes with water moccasins. If you haven't struck anything worse than a spider, you still have a few experiences coming to you."

Bill: "I told the doctor about my absent-mindedness."

Jack: "What did he say?"

Bill: "Asked for his fee in advance."

Caught in the Separator

"Now, boys," said the teacher, "tell me the signs of the zodiac. You first, Thomas."

"Taurus, the Bull."

"Right! Now you tell another one."

"Cancer, the Crab."

"Right again! And now it is your turn, Albert."

The boy looked puzzled, hesitated a moment and then blurted out:

"Mickey, the Mouse."

—*Trumbull Cheer.*

Wife (At head of stairs, 2:00 A. M.): "Is that you, John?"

John (Ominously): "Who were you expecting?"

Wife: "John, is it true that money talks?"

Husband: "That's what they say, my dear."

Wife: "Well, I wish you would leave a little here to talk to me during the day. I get so lonely."

What we need is less war and less war talk, and more righteousness, Christian charity, turkey and pumpkin pie.

Donovan (returning from golf game): "What do you suppose my score was today, dear?"

Mrs. Donovan: "Double."

Mr. Donovan: "What do you mean, double?"

Mrs. Donovan: "Double what you're going to tell me." —*Enka Voice*

Many an explosion has been caused by powder on the old man's coat-sleeve!

The butcher was rather surprised when a slim young woman entered the shop and asked for 25 pounds of beef. All the same, he cut off a joint and put it on the scale.

"Will you take it with you, or shall I send it to your house?" he asked.

"Oh," she murmured, blushing prettily, "I don't want to buy it. You see the doctor said I had lost twenty-five pounds and I wanted to see what it looked like in a lump."

—*Charivari.*

What this country needs is a dollar which will not be so much elastic as it will be adhesive.

—*Judge.*

First Kangaroo: "Annabelle, where's the baby?"

Second Kangaroo: "My goodness, I've had my pocket picked."—*Whatyoumay.*

The turtle is a good example of how useless stream lines are without a good engine!

The Hartford Steam Boiler Inspection and Insurance Company

OF HARTFORD, CONN.

December 31, 1934

Capital Stock, \$3,000,000.00

ASSETS

Cash on hand and in banks	\$1,085,468.05
Premiums in course of collection (since October 1, 1934)	852,355.70
Interest accrued on mortgage loans	40,174.71
Interest accrued on bonds	111,929.51
Loaned on mortgages	649,172.77
Home Office real estate and Philadelphia branch office	542,474.65
Other real estate	240,365.29
Bonds, on an amortized basis	\$9,499,059.29
Stocks at market value	4,831,568.00
	14,330,627.29
Other admitted assets	20,485.35
<i>Total</i>	\$17,873,053.33

LIABILITIES

Premium reserve	\$7,628,631.73
Losses in process of adjustment	404,166.50
Commissions and brokerage	170,471.14
Other liabilities (taxes incurred, etc.)	539,438.80
<i>Liabilities other than capital and surplus</i>	\$8,742,708.17
Capital stock	\$3,000,000.00
Surplus over all liabilities	6,130,345.16
<i>Surplus to Policyholders</i>	9,130,345.16
<i>Total</i>	\$17,873,053.33

WILLIAM R. C. CORSON, President and Treasurer

BOARD OF DIRECTORS

LUCIUS F. ROBINSON, Attorney, Hartford, Conn.	SAMUEL M. STONE, President Colt's Patent Fire Arms Mfg. Co., Hartford, Conn.
JOHN O. ENDERS, Chairman Executive Committee Hartford National Bank & Trust Co., Hartford, Conn.	SAMUEL FERGUSON, Chairman Board of Directors The Hartford Electric Light Co., Hartford, Conn.
MORCAN B. BRAINARD, President Aetna Life Insurance Company, Hartford, Conn.	HON. JOHN H. TRUMBULL, President The Trumbull Electric Mfg. Co., Plainville, Conn.
CHARLES P. COOLEY, Chairman Board of Trustees Society for Savings, Hartford, Conn.	CURTISS C. GARDINER, Vice President The Hartford Steam Boiler Inspection and Insurance Company, 90 John Street, New York.
HORACE B. CHENEY, Manchester, Conn.	JAMES L. THOMSON, Chairman Finance Committee Hartford Fire Insurance Company, Hartford, Conn.
D. NEWTON BARNBY, Vice President The Hartford Electric Light Co., Hartford, Conn.	PHILIP B. GALE, Chairman Board of Directors Standard Screw Co., Hartford, Conn.
JOSEPH R. ENSIGN, President The Ensign-Bickford Co., Simsbury, Conn.	JOHN J. GRAHAM, Vice President The Hartford Steam Boiler Inspection and Insurance Co., Hartford, Conn.
EDWARD MILLIGAN, President Phoenix Insurance Co., Hartford, Conn.	
WM. R. C. CORSON, President The Hartford Steam Boiler Inspection and Insurance Co., Hartford, Conn.	

Incorporated 1866



Charter Perpetual

Department

Representatives

ATLANTA, GA. Citizens & So. Nat. Bk. Bldg.	W. M. FRANCIS, Manager. C. R. SUMMERS, Chief Inspector.
BALTIMORE, Md., 704-9 Garrett Building	D. W. LITTLE, Manager. R. P. GUY, Chief Inspector.
BOSTON, Mass., 87 Kilby Street	A. PAUL GRAHAM, Manager. W. A. BAYLISS, Chief Inspector.
BRIDGEPORT, Conn., City Savings Bank Building	W. G. LINEBURGH & SON, General Agents. A. E. BONNET, Chief Inspector.
CHICAGO, Ill., 175 West Jackson Boulevard	P. M. MURRAY, Manager. C. W. ZIMMER, Chief Inspector.
CINCINNATI, Ohio 1904-12 Carew Tower	JAMES P. KERRIGAN, Manager. W. E. GLENNON, Chief Inspector.
CLEVELAND, Ohio, 1040 Leader Building	ARTHUR F. GRAHAM, Manager. JOHN L. SCOTT, Chief Inspector.
DENVER, Colo., Gas & Electric Building	J. H. CHESNUTT, Manager. JESSE L. FRY, Chief Inspector.
DETROIT, Mich., National Bank Building	L. L. COATES, Manager. THOMAS P. HETU, Chief Inspector.
HARTFORD, Conn., 56 Prospect Street	F. H. KENYON, Manager. A. E. BONNET, Chief Inspector.
NEW ORLEANS, La., 333 St. Charles Street	R. T. BURWELL, Manager. P. E. TERROY, Chief Inspector.
NEW YORK, N. Y., 90 John Street	C. C. GARDINER, Vice President. J. F. HUNT, Chief Inspector.
PHILADELPHIA, Pa., 429 Walnut Street	A. S. WICKHAM, Manager. S. B. ADAMS, Chief Inspector.
PITTSBURGH, Pa., Arrott Building	WILLIAM P. WALLACE, Manager. J. A. SNYDER, Chief Inspector.
ST. LOUIS, Mo., 319 North Fourth Street	CHAS. D. ASHCROFT, Manager. EUGENE WFB, Chief Inspector.
SAN FRANCISCO, Cal., 114 Sansome Street	C. B. PADDOCK, Manager. L. E. GRUNDELL, Chief Inspector.
SEATTLE, Wash., Arctic Building	E. G. WATSON, Manager. WILLIAM J. SMITH, Chief Inspector.
TORONTO, Ont., Canada, Federal Building	H. N. ROBERTS, President The Boiler In- spection and Insurance Company of Canada.

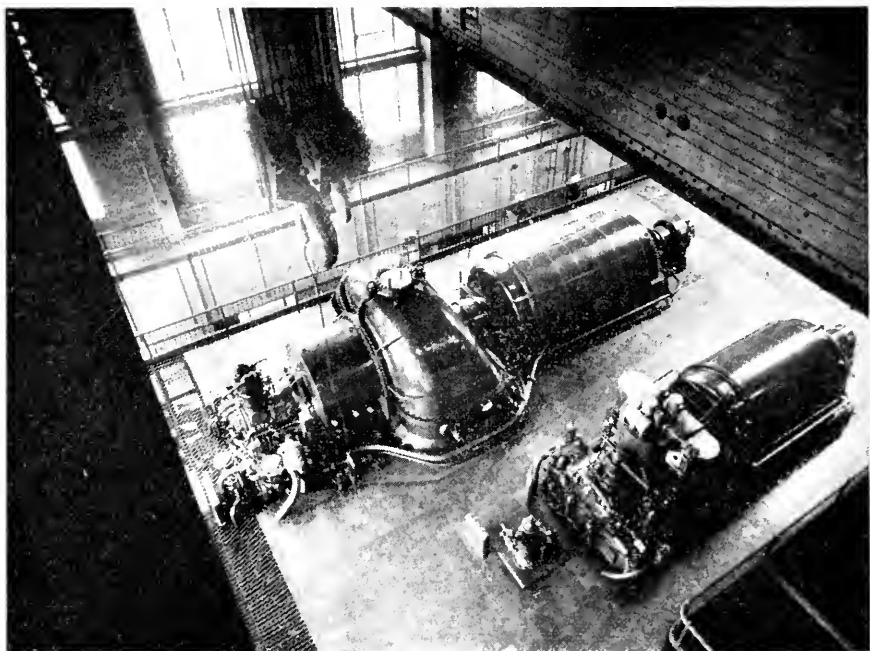

LIFE is too short, competition too intense, to worry about power equipment disaster. It is easy to provide the peace-of-mind that comes from comprehensive Hartford Steam Boiler insurance policies — policies which protect against losses from accidents to boilers and other pressure vessels, turbines, engines, electrical equipment. With such policies in effect there is added peace-of-mind in the knowledge that throughout the policy term expert inspectors are seeking to prevent accidents and to keep the plant running.

The Locomotive

OF

THE HARTFORD STEAM BOILER
INSPECTION AND INSURANCE CO.



INDEX
to
VOL. 41

PUBLISHED BY
THE HARTFORD STEAM BOILER INSPECTION AND INSURANCE CO.

HARTFORD, CONN.
1936-1937

INDEX TO VOL. 41—1936-1937

THE LOCOMOTIVE

REFERENCES MARKED WITH A STAR (*) ARE TO ILLUSTRATED ARTICLES.

- *Advantages of Closed over Open Systems of Diesel Cooling, by H. J. Vander Eb, *April 1937*, 165.
- Agency Department Appointments, *April 1937*, 185.
- Air Conditioning Unit, Large, Installed, *October 1936*, 122.
- Air Lines, Two Explosions in Compressed, *October 1936*, 109.
- *Air Receivers, Explosions of Compressed, *January 1936*, 22.
- Air Tank Accidents, *July 1937*, 207.
- Air Tank Explosion, *April 1937*, 179.
- Algae on Spray Ponds, *July 1936*, 93.
- *Alloy, Explosion of Welded Vessel Built of Non-Ferrous, *July 1937*, 208.
- Ammonia Container Accidents, *July 1936*, 83.
- Ammonia Drums Explode in City Street, *January 1936*, 19.
- Ammonia Fumes, Apples Damaged by, *October 1936*, 101.
- Apples Damaged by Ammonia Fumes, *October 1936*, 101.
- Autoclave, Explosion of High Pressure, *April 1936*, 42.
- *Barney, Austin Dunham, New Directors, *April 1937*, 184.
- Barney, D. Newton, Director, *April 1936*, 52.
- Bearing Failures and Their Prevention, *April 1936*, 47.
- *Berry, Edward Sidney, *October 1936*, 116.
- *Blake, C. Edgar, Elected Secretary, *April 1937*, 185.
- *Blow-Off Tank, Buried, *January 1936*, 7.
- *Boiler Accidents, *July 1937*, 210.
- *Boiler Explosion Wrecks Mine Buildings, *April 1937*, 170.
- Boiler Fuel, Using Coal and Oil Mixed for, *July 1936*, 73.
- *Boiler and Pressure Vessel Accidents, 34 Dead, *October 1937*, 241.
- *Boilers, Protecting Idle, against Corrosion, by J. P. Morrison, *April 1936*, 38.
- Boiler: See also, Power Boiler, Heating Boiler, Hot Water Supply Boiler.
- Brainerd, Lyman B., Appointed Asst. Supt. of Agencies, *April 1937*, 185.
- British Station Installing 1900-Pound Boilers, *January 1937*, 151.
- Brooklyn Man Says Boiler Blast Stopped His Business, *April 1937*, 189.
- *Burnout of Turbo-Alternator at Rest, by W. L. Hartzell, *January 1936*, 8.
- Butler, James William, *July 1937*, 213.
- *Cables, Corrosion of Lead Covered, by J. B. Swering, *October 1937*, 226.
- *California Sawmill Illustrates Man's Ability to Make Much from a Little, by P. J. Rauch, *July 1937*, 216.
- Cellophane Being Used for Insulation, *October 1936*, 115.
- Cheney, Horace Bushnell, *October 1936*, 118.

THE LOCOMOTIVE—INDEX.

- Clunk, Mark, *April 1937*, 182.
- Coates, Sidney B., Appointed Editor of *The Locomotive*, *April 1937*, 185.
- Condenser Explosion, Electrocutation of Rat Leads to, *April 1937*, 179.
- *Connecting Rod Failures, *October 1937*, 244.
- *Cook, John R., New Directors, *April 1937*, 184.
- *Corrosion, External, by J. P. Morrison, *April 1937*, 171.
- *Corrosion of Lead Covered Cables, by J. B. Swering, *October 1937*, 226.
- *Corrosion, Vulcanizer Explodes because of, *April 1937*, 177.
- *Cotton Compress Explosion, *January 1936*, 13.
- *Cylinders, Over-Heating and Distortion in Diesel Engine, *October 1936*, 105.
- Davidson, W. S., *April 1937*, 183.
- *Diesel Cooling Systems, The Advantages of Closed over Open Systems of Diesel Cooling, by H. J. Vander Eb, *April 1937*, 165.
- Diesel Engine Bed, Warped, Leads to Breakdown, *April 1936*, 53.
- *Diesel Engine Cylinders, Over-Heating and Distortion in, *October 1936*, 105.
- *Diesel Engine Damaged Because of Over-Load, *January 1937*, 147.
- *Diesel Engines, Two, Break Down at Remote Mine in Nevada; Repairs Involve Unusual Difficulties, Hartford Steam Boiler in the Desert, *October 1937*, 237.
- Diesel Insurance Rating Plan, New, *April 1936*, 53.
- Dry Ice Containers, *July 1937*, 214.
- Dust Hazard in Machines, Building Construction Adds to, *July 1937*, 206.
- Eighty-Year-Old Steam Engine, *July 1936*, 84.
- *Electrical Equipment, Rehabilitation of, Following the 1936 Floods, by J. B. Swering, *July 1936*, 66.
- Electrical Storm Leads to Failure of Ten 2,600 hp Motors, *April 1937*, 188.
- Electrocutation of Rat Leads to Condenser Explosion, *April 1937*, 179.
- *Embrittlement, *April 1936*, 43.
- *Embrittlement, A Recent Accident Which Demonstrates the Subtlety of, *October 1936*, 102.
- Embrittlement, Silicon and, *October 1936*, 120.
- *External Corrosion, by J. P. Morrison, *April 1937*, 171.
- *Factory and Mill Boiler Accidents, *January 1937*, 153.
- *Fan, Turbo-Generator Wrecked by Exploding, *July 1937*, 205.
- *Feedwater Heater, Explosion of Open Type, *October 1936*, 114.
- *50 Accidents per Day; \$4,000,000 Loss per Year, *October 1937*, 231.
- *Fish, E. R., Safety in Fusion Welded Joints, *July 1936*, 75.
- Flares Protect Parked Motorists, *October 1936*, 115.
- *Flywheel Explosion, *July 1936*, 74.
- Fuel, Using Coal and Oil Mixed for Boiler, *July 1936*, 73.
- *Furnace Explosion, Leaking Valves Cause, *October 1936*, 121.
- *Fusion Welded Power Piping, by Wm. D. Halsey, *January 1937*, 133.
- Gears, Helical, in Use Before the Discovery of America, *July 1936*, 85.
- *Generator, Burnout of Turbo-Alternator at Rest, by W. L. Hartzell, *January 1936*, 8.

THE LOCOMOTIVE—INDEX.

- Generator, D. C., Building Construction Adds to Dust Hazard in Machines, *July 1937*, 206.
- *Generator, D. C., Failure, *October 1936*, 111.
- Generator Failure, 125 kw, 2300 volt, 3 phase, 60 cycle, *July 1937*, 206.
- Generator, 40,000-Kilowatt Hydrogen-Cooled, *January 1936*, 21.
- Generator, Over-Heating of, Due to Outside Causes, *July 1937*, 206.
- *Generator, Over-Speed Wrecks, After Primary and Secondary Defenses Fail *January 1937*, 130.
- *Generator, Turbo-Generator Rotor Breaks in Half, *October 1937*, 226.
- *Generator, Turbo-Generator Wrecked by Exploding Fan, *July 1937*, 205.
- Going North for Power, *April 1936*, 56.
- *Grist, Saw and, Mill Boiler Accidents, *July 1936*, 87.
- *Halsey, Wm. D.: Inspection of Welded Seams in Pressure Vessels, *January 1936*, 2; Fusion Welded Power Piping, *January 1937*, 133.
- *Hartford Steam Boiler in the Desert, *October 1937*, 237.
- *Hartzell, W. L., Burnout of Turbo-Alternator at Rest, *January 1936*, 8.
- Heating Boiler Danger Signals, *January 1936*, 25.
- *Heating Boiler Explosion, *January 1936*, 26.
- *Heating Boiler, Hot Water, Accident, *October 1936*, 122.
- *Heating Boilers, 50 Accidents per Day; \$4,000,000 Loss Per Year, *October 1937*, 231.
- *Heating and Hot Water Supply Equipment Accidents in an Apartment, a Residence, a Business Block and a Store, *January 1937*, 144.
- Helical Gears in Use Before the Discovery of America, *July 1936*, 85.
- Hogan, John J., *July 1937*, 213.
- *Hoist Motor Accident in Remote Location Followed by Quick Repair, *January 1936*, 17.
- *Hot Water Heating Boiler Accident, *October 1936*, 122.
- *Hot Water Supply Boiler, Accident to, *October 1936*, 113.
- Hot Water Supply Boiler, Brooklyn Man Says Boiler Blast Stopped His Business, *April 1937*, 189.
- *Hot Water Supply Boilers, 50 Accidents per Day; \$4,000,000 Loss per Year, *October 1937*, 231.
- *Hot Water Supply, Heating and, Equipment Accidents in an Apartment, a Residence, a Business Block and a Store, *January 1937*, 144.
- *Hot Water Tank Explosion Kills School Teacher, *April 1936*, 55.
- *Hydro-Pneumatic Tank Fails Due to Poor Weld, *April 1936*, 42.
- *Inspection of Welded Seams in Pressure Vessels, by Wm. D. Halsey, *January 1936*, 2.
- Inspection of Welded Seams by Trepanning, *January 1937*, 151.
- Inspections, Value of, in Preventing Accidents, *October 1936*, 104.
- Inspector, An, Recommends the Obvious, *July 1936*, 73.
- Insulation, Cellophane Being Used for, *October 1936*, 115.
- Internal Combustion Engine, Serious Accident to, *October 1936*, 125.
- Iron, Oxidation of, Rust Growth, *July 1936*, 93.

THE LOCOMOTIVE—INDEX.

- Jordans, Accidents to Motors Driving, *April 1937*, 164.
 Laboratory Accidents Fatal, *April 1936*, 42.
 Largest Boilers, *January 1937*, 157.
 *Leaking Valves Cause Furnace Explosion, *October 1936*, 121.
 Leavitt, Bard, *January 1936*, 20.
 Locomotive Boiler, Welded, *April 1937*, 183.
 *Locomotive Explosion, *January 1937*, 154.
 Locomotive, A Steam-Electric, *April 1937*, 164.
 Manhattan Power Interruption, *April 1936*, 57.
 Merchant, Charles, *January 1936*, 20.
 *Middlebrook, Louis Francis, *April 1937*, 180.
 Milligan, Edward, *July 1937*, 212.
 *Morrison, J. P.: Protecting Idle Boilers against Corrosion, *April 1936*, 38;
 External Corrosion, *April 1937*, 171; Riveted Patches, *July 1937*, 194, *October*
 1937, 235.
 *Motor, Hoist, Accident in Remote Location Followed by Quick Repair, *January*
 1936, 17.
 Motors, Accidents to, Driving Jordans, *April 1937*, 164.
 Motors, Electrical Storm Leads to Failure of Ten 2,600 hp, *April 1937*, 188.
 *Nicol, Wilbur Carl, *October 1937*, 243.
 *Oil Field Boiler Explosions, *July 1936*, 86.
 Open Flame Ignites Gas in Steam Engine Piston, *April 1936*, 61.
 *Over-Heating and Distortion in Diesel Engine Cylinders, *October 1936*, 105.
 *Over-Speed Wrecks Generator after Primary and Secondary Defenses Fail,
 January 1937, 130.
 Oxidation of Iron, Rust Growth, *July 1936*, 93.
 Paragraphs of Progress, *July 1937*, 218; *October 1937*, 249.
 *Patches, Riveted, by J. P. Morrison, *July 1937*, 194; *October 1937*, 235.
 *Piping, Fusion Welded Power, by Wm. D. Halsey, *January 1937*, 133.
 Piping, High Pressure Steam Stops Broadway Traffic, *January 1936*, 7.
 Piston, Steam Engine, Open Flame Ignites Gas in, *April 1936*, 61.
 *Portable Sawmill Boiler, *April 1936*, 44.
 *Power Boiler Accidents, *July 1936*, 86.
 *Power Boiler, Boiler Explosion Wrecks Mine Buildings, *April 1937*, 170.
 *Power Boiler Difficulties, *April 1936*, 43.
 Power Boiler, Thresher Boiler Blast Injures Seven, *April 1936*, 46.
 *Power Boilers, Accidents to, *January 1936*, 14.
 Power Boilers, British Station Installing 1900-Pound Boilers, *January, 1937*, 151.
 *Power Boilers, Explosions and Other Accidents to, *January 1937*, 152.
 Power Boilers, Largest Boilers, *January 1937*, 157.
 Power Interruption, Manhattan, *April 1936*, 57.
 *Power Piping, Fusion Welded, by Wm. D. Halsey, *January 1937*, 133.
 Prall, George H., Appointed Supt. of Agencies, *April 1937*, 185.
 *Protecting Idle Boilers against Corrosion, by J. P. Morrison, *April 1936*, 38.
Queen Mary sets New Trans-Atlantic Steamship Records, *October 1936*, 119.

THE LOCOMOTIVE INDEX.

- Rapide Blanc—Hydro-Electric Plant, *April 1936*, 56.
- *Rehabilitation of Electrical Equipment following the 1936 Floods, by J. B. Swering, *July 1936*, 66.
- *Rice, Thomas F., Appointed Manager, *July 1937*, 215.
- *Riveted Patches, by J. P. Morrison, *July 1937*, 194, *October 1937*, 235.
- *Rotary Converter Burnout, *October 1936*, 110.
- Rust Growth, *July 1936*, 93.
- *Safety in Fusion Welded Joints, by E. R. Fish, *July 1936*, 75.
- *Sawmill, California, Illustrates Man's Ability to Make Much From a Little, by P. J. Rauch, *July 1937*, 216.
- *Scotch-Marine Furnaces Collapse, *April 1936*, 45.
- *Shafting, Wheel and, Accidents, *January 1937*, 146.
- Silicon and Embrittlement, *October 1936*, 120.
- Steam-Electric Locomotive, A, *April 1937*, 164.
- *Steam Engine, Connecting Rod Failures, *October 1937*, 244.
- Steam Engine, 80-Year-Old, *July 1936*, 84.
- Steam Engine Piston, Open Flame Ignites Gas in, *April 1936*, 61.
- Steam Engines, One of the World's Smallest Workable, *July 1936*, 74.
- *Steam Turbine Accidents, *April 1936*, 34.
- Steamship Records, *Queen Mary* Sets New Trans-Atlantic, *October 1936*, 119.
- Stickney, George Henry, *July 1937*, 213.
- *Swering, J. B.: Rehabilitation of Electrical Equipment following the 1936 Floods, *July 1936*, 66; Corrosion of Lead Covered Cables, *October 1937*, 226.
- Swett, Frederick J., *April 1937*, 183.
- Taps from the Old Chief's Hammer: *January 1936*, 27; *April 1936*, 59; *July 1936*, 91; *October 1936*, 123; *January 1937*, 155; *April 1937*, 186; *July 1937*, 220; *October 1937*, 250.
- Thresher Boiler Blast Injures Seven, *April 1936*, 46.
- *Trepanned Plugs from Welded Seams, *October 1936*, 98.
- Trepanning, Inspection of Welded Seams by, *January 1937*, 151.
- *Turbine Accidents, Three, That Caused \$250,000 Damage, *April 1937*, 162.
- *Turbine Accidents, Two Recent, *January 1937*, 130.
- *Turbine, Steam, Accidents, *April 1936*, 34.
- Turbine, Steam, Unit Failure, *April 1936*, 52.
- *Turbo-Generator, Burnout of Turbo-Alternator at Rest, by W. L. Hartzell, *January 1936*, 8.
- *Turbo-Generator Rotor Breaks in Half, *October 1937*, 236.
- *Turbo-Generator Wrecked by Exploding Fan, *July 1937*, 205.
- Value of Inspections, *October 1936*, 104.
- *Valves, Leaking, Cause Furnace Explosion, *October 1936*, 121.
- *Vander Eb, H. J., The Advantages of Closed over Open Systems of Diesel Cooling, *April 1937*, 165.
- *Vertical Tubular Boiler Explosions, *April 1936*, 46.
- *Vulcanizer Explodes because of Corrosion, *April 1937*, 177.
- Vulcanizer, Small, Burst, *April 1936*, 42.

THE LOCOMOTIVE—INDEX.

- Warped Diesel Engine Bed Leads to Breakdown, *April 1936*, 53.
- *Water Causes Breakage of Blades, *January 1937*, 132.
- Welded Locomotive Boiler, *April 1937*, 183.
- Welded Pressure Vessels—1937, *January 1937*, 148.
- *Welding, Explosion of Welded Vessel Built of Non-Ferrous Alloy, *July 1937*, 208.
- *Welding, Fusion Welded Power Piping, By Wm. D. Halsey, *January 1937*, 133.
- *Welding, Hydro-Pneumatic Tank Fails Due to Poor Weld, *April 1936*, 42.
- *Welding, Inspection of Welded Seams in Pressure Vessels, by Wm. D. Halsey, *January 1936*, 2.
- Welding, Inspection of Welded Seams by Trepanning, *January 1937*, 151.
- *Welding, Portable Sawmill Boiler, *April 1936*, 44.
- *Welding, Safety in Fusion Welded Joints, by E. R. Fish, *July 1936*, 75.
- *Welding, Trepanned Plugs from Welded Seams, *October 1936*, 98.
- Welding, Welded Locomotive Boiler, *April 1937*, 183.
- Welding, Welded Pressure Vessels—1937, *January 1937*, 148.
- What a Bullet Did!—*July 1936*, 90.
- *Wheel and Shafting Accidents, *January 1937*, 146.

XLI No. 1

JANUARY.

The Locomotive



A Quarterly Magazine Devoted to Power Plant Protection

Please Show to Your Engineer



Inspection of Welded Seams in Pressure Vessels

By WILLIAM D. HALSEY, *Assistant Chief Engineer, Boiler Division.*

THE many violent accidents to fusion welded vessels not built in accordance with the A. S. M. E. Code or equivalent standards have caused The Hartford Steam Boiler Inspection and Insurance Company to be very cautious in affording insurance on vessels of this sort. The Company has knowledge of so extensive property damage and so many injuries and deaths from such accidents that it

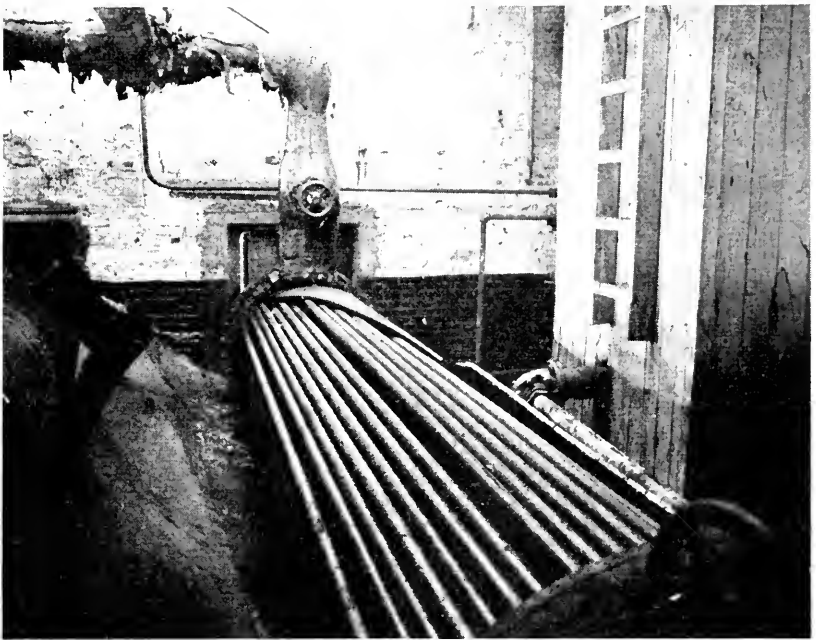

Figure 1—Caused by an unsound weld.

cannot take any other course. In reviewing those accidents it may be said that, in general, they were caused by unsound welds. The term "unsound" is used here not in reference to weld metal of poor physical properties, but to a fusion welded *joint* in which the weld metal is not properly fused to the base material. In other words, there is no adequate bond between the weld metal and the plate.

It should not be inferred that failures have never occurred because of poor weld metal. On the other hand, weld metal of adequate tensile strength and ductility will be of no value if that metal is not properly

fused to the base material. Illustrations almost without end could be given of failures of such seams. An examination of them almost invariably shows lack of fusion, either because the metal was merely cast in the welding groove or because of slag being entrapped between the weld metal and the base material. An illustration of one such failure is shown in Figure 1. The vessel in this case was a brine cooler 42" in diameter and 16' long used in an ammonia refrigerating system. The vessel had been in service for about twelve years when it suddenly

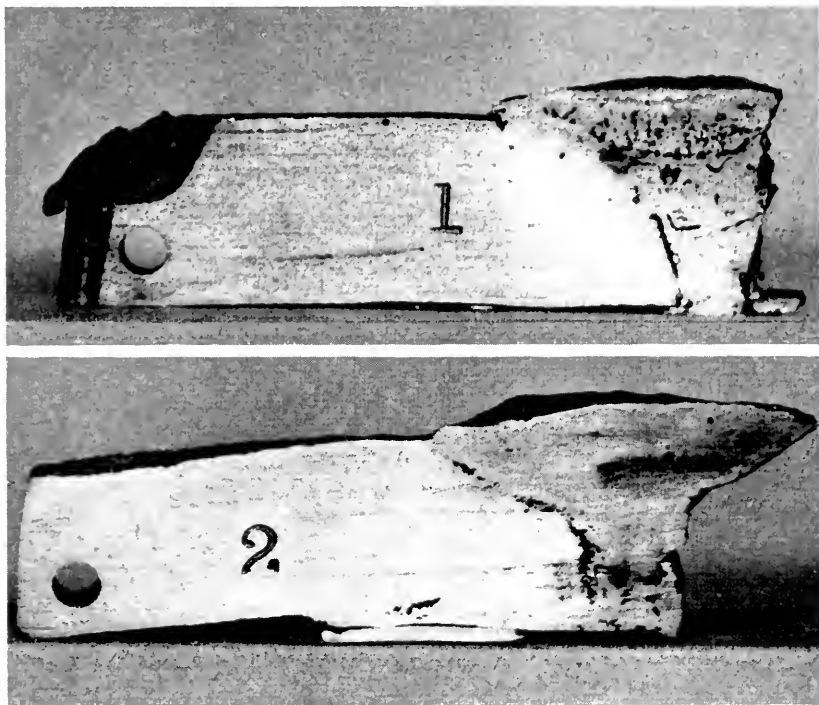

Figure 2—Etched specimens of the seams from the vessel shown in Figure 1.

burst, and from the information that was subsequently obtained, failure apparently took place at little more, if any, than the normal working pressure. The accident caused property damage of \$8,000, one man was killed, and two were seriously injured.

After the accident, specimens were cut from the longitudinal welded seam, polished, and etched. These etched specimens are shown in Figure 2 from which it will be clearly seen that there was a serious lack of

fusion between the weld metal and the plate. The failure of the welded seam occurred partly between the weld metal and the plate and partly through the weld itself.

Seriously defective welds are almost invariably due to lack of control of the welding procedure or inadequately trained welding operators. For this reason, it is the intent of most of the codes relating to welding to provide means that will disclose inherent defects in methods of welding and lack of ability on the part of the operators. This statement is particularly true of the A. S. M. E. Code for Unfired Pressure Vessels.

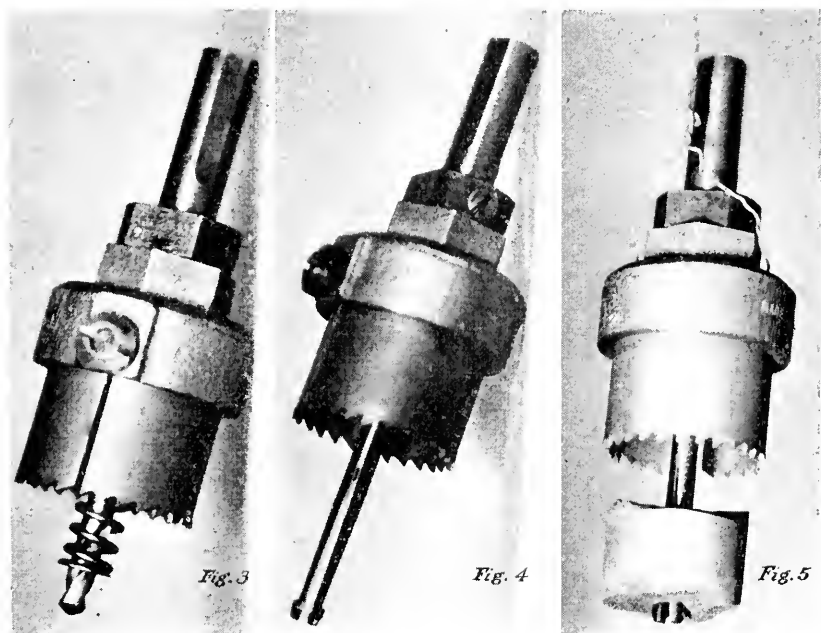

Figure 3—Tool used for trepanning a plug from a welded seam.

Figure 4—Special spring and split pilot developed for trepanning tool.

Figure 5—How the plug is withdrawn from the hole.

However, before the adoption of that code, many vessels had been built by fusion welding, and there was often but little, if any, knowledge on the part of manufacturers of a proper procedure for welding or of the ability of their operators. Furthermore, a great number of fusion welded vessels being built today are not constructed in accordance with any Code requirements. All such vessels have given insurance companies great concern because, unfortunately, no one can determine the sound-

*Fig. 6**Fig. 7**Fig. 8*

Figure 6—Specimens from a fusion welded ammonia brine cooler.

Figure 7—Plugs cut from a fusion welded ammonia generator.

Figure 8—Plugs from a fusion welded soap kettle.

ness of a welded joint by a mere visual examination of its exterior surfaces.

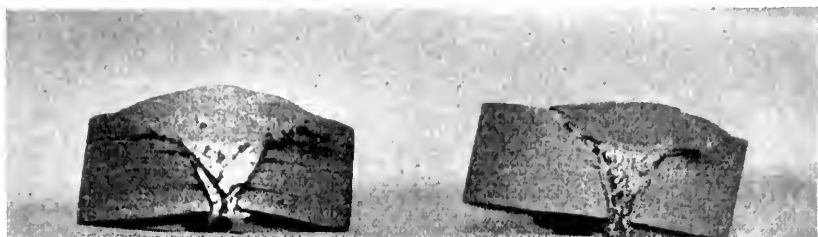
The Hartford Steam Boiler Inspection and Insurance Company has recently investigated a number of questionable vessels by trepanning, at several points, plugs from the welded seam and then etching these plugs to detect lack of fusion or slag inclusions. The idea of trepanning plugs is, of course, very old but the method has only recently been extensively used in the examination of welded seams.

The tool used for the purpose is shown in Figure 3. While similar

tools have been on the market for some time, it is only recently that the cylindrical saw has been available in high speed steel. A tool that will withstand severe service is quite necessary for this kind of work.

One of the problems that was encountered in using a tool of this kind was how to retain the plug after it had been cut through. The answer to this was the development of the special spring end split pilot or mandrel shown in Figure 4. With such a pilot the plug is held and is withdrawn from the vessel with the trepanning tool or hole saw as shown in Figure 5. The plug is then sectioned, polished, and deep etched in a boiling solution of equal parts of hydrochloric acid and water.

It is a simple matter to close the opening in the vessel by tapping the hole and screwing in a pipe plug. If the weld is sound, the strength of the vessel is no more impaired by this procedure than it would be by drilling and tapping a hole for a pipe connection in the solid plate. Two sizes of cutters have been found satisfactory for the general run of fusion welded vessels. One size cuts a hole suitable for tapping for a 1" pipe plug. The other is for a 1¼" pipe plug.

Some examples of plugs that have been cut from questionable vessels will be of interest. Figure 6 shows specimens removed from a fusion welded ammonia brine cooler which had been in service for several years. It is interesting to compare these plugs with the etched cross section of the weld shown in Figure 3. What might have happened if the vessel, from which the plugs were cut, had remained in service may readily be conjectured.

Figure 7 shows plugs cut from a fusion welded ammonia generator in an absorption system. After seeing these plugs, the owner decided to replace the vessel.

Figure 8 shows specimens cut from a fusion welded soap kettle. The defective seam of this vessel was rewelded by a competent operator.

A large number of vessels have been examined by this method and in the great majority of cases the welds have been found defective to some extent. In many cases, the defects were so serious that the vessels were considered to be in a really dangerous condition for operation and were either retired from service or satisfactorily repaired.

It may be argued that, in cutting plugs from a vessel, specimens might be obtained that do not represent the true condition of the entire welded seam. It has been the practice, however, to cut not one but several plugs from each vessel. Invariably, the same degree of defectiveness or soundness has been revealed in all plugs. It is hardly conceivable that a welded seam could be dangerously defective and not have that condition exist to some degree throughout its length.

Sufficient information about an "unknown" vessel is thus secured so that its acceptability from an insurance standpoint can be decided. Insurance company standards, however, are no more than reasonably safe operating standards. It goes without saying that owners of welded pressure vessels would neither continue their use if definite and serious hazards were known, nor would they be satisfied to operate them if there is a reasonable doubt as to their soundness. The foregoing development is another of Hartford Steam Boiler's engineering activities for greater safety in the operation of power plant equipment.

Buried Blow-Off Tank

What will eventually happen to any tank buried in the earth is illustrated here. This is a blow-off tank recently dug up at the suggestion of a Hartford Steam Boiler inspector. It is absolutely impossible to tell what the external condition of a buried tank may be, even though it is known that, when buried, it was covered with some sort of a protective coating. These coatings do not last indefinitely and it is only a question of time before some vulnerable point will be attacked by corrosion. Failure of a buried tank may cause serious inconvenience, particularly if the tank is expected to carry pressure.



High Pressure Steam Stops Broadway Traffic

Clouds of steam which poured under pressure from a broken steam main at the southwest corner of Broadway and Forty-sixth Street, New York City, blocked Broadway traffic for an hour and attracted thousands of pedestrians to witness the spectacular sight. No injuries were reported but it was an hour before the street could be used by traffic.

The break was in a connecting joint between two sections of 12" pipe. The steam rocked manhole covers like tea-kettle tops until they were pulled out of position to ease the pressure. White clouds of vapor rose 60 feet into the air. The steam ordinarily passed through this main at a pressure of 150 lb per sq. in.

Burnout of Turbo-Alternator at Rest

By W. L. HARTZELL, *District Engineer*

AN IDLE 10,000 kw turbo-alternator suffered a complete burnout of both rotor and stator early on the morning of March 2, 1935, following a chain of circumstances that should be of interest to all operators of electrical equipment. The loss, which occurred at a blast furnace plant, exceeded \$38,000.

The damaged alternator and another like it utilize steam from waste heat boilers to furnish power for blast furnace operation. The machines are alternated in service, so that one is always idle. Excess electrical output is fed to the lines of a large utility.

At one time it was the practice to keep the idle generator as a spinning reserve. Because of this, the operators had formed the habit of keeping the hand-operated disconnecting switches between the main oil switch and the bus in the closed position, so that when the standby generator was idle the motor-operated circuit breaker to the bus was the only open switch between the generator and the power line. The circuit breaker was operated from the control room, and the disconnecting switches were located in the switch room at some distance away from the control board. At the time of the accident, the practice of spinning the standby unit had been discontinued and the machine was at rest, but the arrangement of the switches had not been changed. This condition played an important part in events leading up to the burnout of the generator.

The accident occurred at 3:28 A. M. One of the 10,000 kw turbo-alternators was delivering 5500 kw to the power company over No. 1 Edison feeder and 2500 kw to the blast furnace plant.

With the plant's equipment apparently operating normally, and without warning, a rumbling explosion was heard in the switch room. Simultaneously with the explosion, the switch room door was violently blown open and clouds of black smoke and flame burst into the turbine room.

The switchboard operator ran from the control gallery to ascertain the source of the trouble, and found that the oil switch of the alternator in service was on fire and heavy arcing was taking place in the oil switch compartment. He immediately returned to the control room and pulled the controls for the generator oil switch, the generator field rheostat, and No. 1 Edison feeder. By this time the smoke in the power house had become so thick that the operator crawled out of a window to the switch room roof. He was taken off of the roof later by the fire department.

It was found afterward that neither the generator oil switch had been opened nor had the field control functioned because this equipment had been damaged by the arcing and ensuing fire at the control box on the oil switch. While the switchboard operator was attempting to clear the board, the turbine floor operator tripped the throttle on the turbine driving the alternator which was feeding power into the arc at normal frequency until the steam was shut off, and then at a decreasing frequency until the turbine unit came to rest. The No. 1 Edison feeder

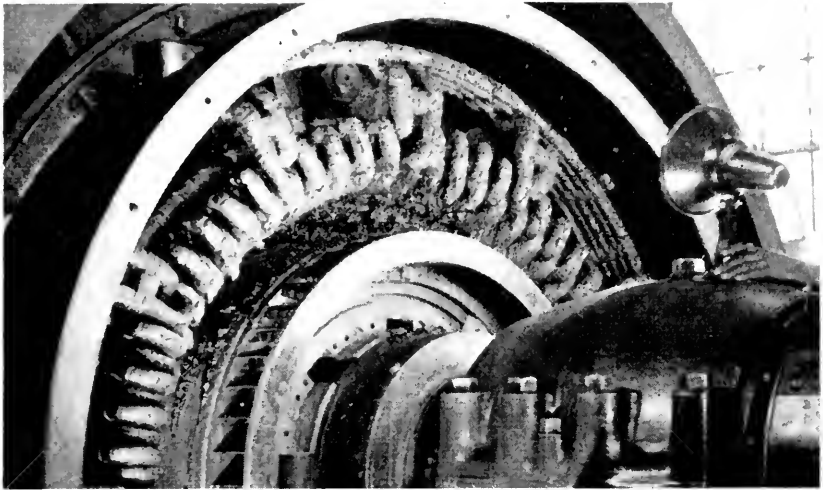

Collector ring end of the idle alternator after its electrical burnout.

had ceased to feed the arc when the circuit breaker was tripped.

The arc generated such terrific heat that it burned holes through the concrete barriers of the bus structure and also melted away a large part of the oil tanks. By the time the arcing had ceased, practically all of the oil had been vaporized out of the switch tanks and the fire had subsided. Only a quiet burning of the last remnants of the oil from the switch tanks remained and this was extinguished by the fire department chemicals.

The power house was now in utter darkness except for a couple of lanterns and firemen's lights. By their light a survey was made of the switch room, and the disconnecting switches for the generator which had been operating were opened. The No. 1 Edison feeder breaker was then closed and the power house again lighted.

Upon the restoration of power, an unsuccessful attempt was made

to start a 1500 kw synchronous motor-generator set for supplying direct current to the furnace plant. During the ten minutes the power was on, several attempts were made to start this motor without success. The No. 1 Edison feeder was then tripped out, putting the power house again in darkness for about three minutes during which time attendants made the changes necessary for connecting No. 2 Edison feeder to the auxiliary bus. After this change normal power conditions were obtained and the synchronous motor was started without difficulty.

Meanwhile, the idle alternator had been given no thought. At about 4:30 A. M., smoke was seen coming out through the joints around the end bells, and the generator frame was very hot. An end bell handhole was opened to permit inspection, but the air thus admitted started heavy combustion within the machine. The fire in the generator was finally quenched by water from a hose after an attempt had been made to smother it with chemicals.

The reason for the damage to the idle alternator was not readily evident in view of the fact that the oil switch for this machine was in the open position at the time of the disturbance. On examination of the oil switch, however, it was found that heat from the arc at the other oil switch had burned through two of the wooden operating rods, thereby permitting two of the switch contacts to drop into the closed position, thus connecting the generator single phase to the power supply. The chart on the graphic wattmeter indicates that No. 1 Edison feeder oil switch tripped out from three to five minutes after the breakdown had developed into an interphase arc. The chart also shows that power was restored to the No. 1 Edison feeder approximately thirty minutes after the initial disturbance and that a load of 4,000 kw was carried for ten minutes. Unknown to the operators, this 4,000 kw was supplied single phase to the idle generator and was being transformed into heat. This generator took severe punishment as it, in effect, functioned as a single phase induction furnace. These conditions were what had pre-

Top—View of oil circuit breakers for both generators. Notice the wooden rod in the open position at the upper left. The brackets for the other two rods are in the open position, but the rods have burned away, permitting two of the contacts to the idle 10,000 kw machine to close. The three brackets at the right on the switch mechanism for the operating machine are in the closed position. Lower Left—Lower part of circuit breaker cell where arcing is believed to have started. Lower Right—Oil tanks and motor operating mechanism of the circuit breaker where the disturbance originated.

vented the blast furnace motor-generator sets from starting. (See the voltage chart on Page 12.)

The heat induced in the idle generator under the circumstances would be mostly concentrated on the outside surface of the field core. In this

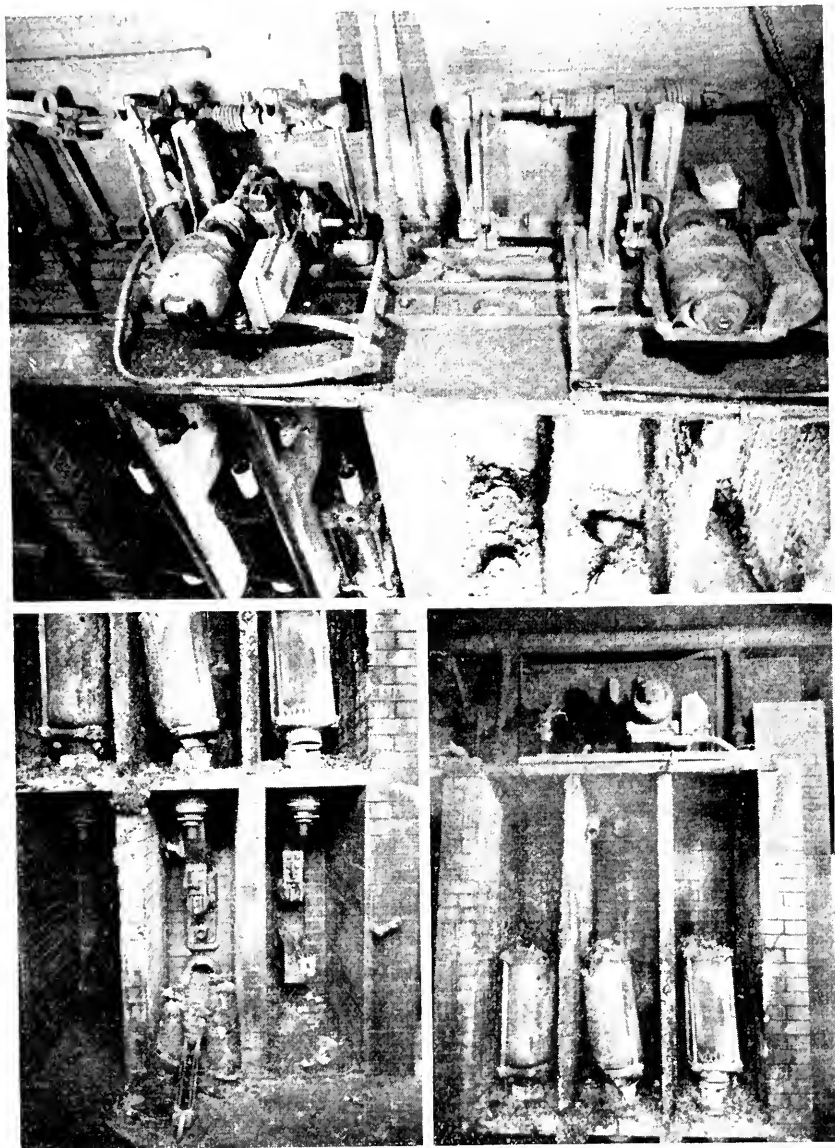

case the heat was so intense that, due to unequal expansion between the outside surfaces and the internal parts of the core, the steel forging was cracked. The accident necessitated an entirely new field. The damage to the stator winding was apparently caused by radiant heat from the core of the field, as the coils indicated that they had been exposed to a very high external temperature.

What started the series of events which led to this accident is still undetermined. The following is probably the correction sequence:

A terminal connection in the middle cell of the oil switch for the generator in operation heated and started little pin arcs. This trouble gradually grew until a sufficient arcing developed to vaporize some of the brass or copper. The arcing followed the vaporized metal and finally involved all three phases. The energy for the arc was supplied from the operating 10,000 kw alternator and the No. 1 Edison feeder. The arc-

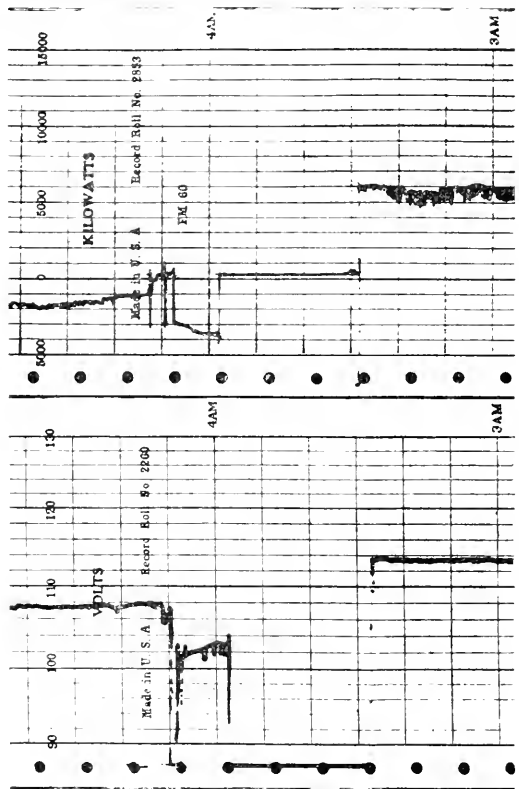

An accident in graph form. Above—Wattmeter chart showing power conditions on No. 1 Edison feeder. The generator stopped supplying power at about 3:28 A. M. The plant was dark until 3:58 A. M., when utility power was admitted for ten minutes, burning out the idle alternator. Below—Bus voltage chart for the same period revealing why the plant's direct current motor-generator sets would not start during the 10-minute interval mentioned above.

ing was confined to the oil switch structure, but the heat generated was so intense that the oil in the switch tanks was vaporized and set afire.

This accident exemplifies the hazards that are ever-present in the operation of electrical machinery. A study of the above circumstances should be of definite assistance in the protection of other machines at rest, whether standby, or idle for any other reason.

Cotton Compress Explosion

THE steam cylinder of a cotton compress exploded on November 13, 1935, in a Texas warehouse with the results shown in the accompanying illustration. The cylinder was made of cast iron and was 81" in diameter without an upper head.

Soon after the day's work had started and only 10 bales had been compressed, the cylinder exploded without warning. Fortunately neither the operator, who was in the control booth, nor some six or seven men grouped about the machine were injured. Damage to the press, which was not covered by insurance, amounted to approximately \$5,000.

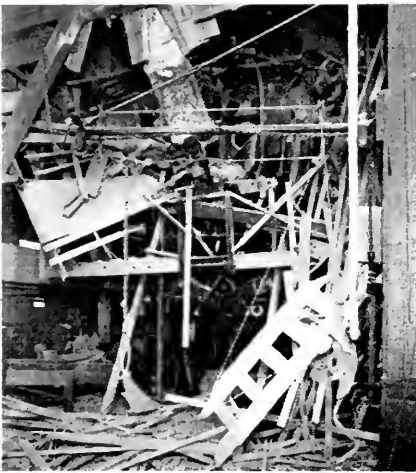

*Cotton compress after explosion
of its steam cylinder.*

The cause of this accident was undetermined, but it is probable that a crack had weakened the cylinder, which is open at the top and is of massive construction with girthwise reinforcing ribs and a heavy flange at the top. The cylinder broke into four pieces, each of them weighing many hundred pounds.

When starting up and to a lesser degree during the operation

of the machine, the cylinder is subject to severe temperature changes. As a result of the stresses caused by changes in temperature, it is conceivable that, in the absence of a supporting top head, a crack had developed at some point and had so weakened the cylinder that it failed at operating pressure. This explanation of the accident is theoretical, but it seems to be the only one that fits the facts determined after the accident.

Accidents to Power Boilers

FIVE men were injured on July 29, 1935, when a locomotive fire box type boiler at an Illinois saw mill exploded, supposedly because the safety valve was corroded in its seat. When the rising pressure could not be relieved by normal means, it blew out the lower sheet of the barrel. The force thus released virtually demolished the mill. One man was thrown against a shed, the blast tearing off his overalls



Scene of logging locomotive explosion.

and one shoe. He sustained severe head injuries. His roll of bills (\$124) was unrolled and scattered over a wide area. Another man was hurled through a window and landed in a sawdust pile. He received internal injuries. Two men were scalded, one of them seriously, and the fifth man, a bookkeeper who was standing at some distance from the boiler, was plastered with mud and light debris. He escaped with minor burns.

Low water and lack of attention were blamed for the explosion of a track locomotive at the scene of Western logging operations on August 5, 1935. The engineman and fireman were thrown from the cab and sustained minor injuries. When the crown sheet pulled loose from the staybolts, the force of the explosion caused the engine to fall over on its side, and hot fire brick and coals were scattered over the adjacent area. The locomotive was backing up a considerable grade at the time of the accident, a fact which would have made a condition of low water additionally hazardous because the crown sheet would be uncovered

more quickly than on a level track. The illustration gives an idea of the wreckage following the explosion.

A locomotive firebox type boiler at a Southwestern oil test well exploded because of low water and overheating on September 27, 1935. The fireman sustained painful burns, and the boiler was blown from its foundation. Because of the accident, drilling operations were suspended until another boiler could be installed.

In THE LOCOMOTIVE for April, 1935, there was an article on "The Repair of Bulged Shell Plates and Drums" in which were mentioned several accidents caused by over-heating of shell plate as the result of accumulations of scale and sediment. Such an accident occurred because of scale accumulation in a 60" diameter horizontal tubular boiler at a



Bagged plate showing bulges and scale accumulation.

Southern lumber mill on October 5, 1935. The bagged area was on the rear course near the blow-off flange and extended approximately 50" girthwise of the boiler and 40" lengthwise. The most serious bulge was 8" in depth and there were two ruptures, one 3" long and another 3½" long, at the bottom of the bag. The bulging had caused the rear tube sheet to pull forward about 2" and the lower rows of tubes to distort. According to the plant manager, the first warning of the trouble was the fireman's report that he could not keep water in the boiler. It is evident from the photograph that the inside of the plate carried a heavy coating of adhering scale. In addition to this, however, there undoubtedly was a large accumulation of loose scale which fell off when the section was removed.

How a high and low water alarm may be unexpectedly rendered useless is shown by the official inquiry into the explosion of a bent tube type boiler at a London, England, sugar manufacturing plant as reported in *Engineering*. The boiler was fitted with a high and low water

alarm of the balanced-float type. The boiler always showed a tendency to prime when worked hard, and apparently there was difficulty at times in maintaining a proper water level. On August 10, 1934, while the boiler was under steam, a tube suddenly ruptured, and subsequent examination showed that other tubes were swollen, hogged or sagged. The front drum had sagged $5/16''$, and a large number of tube holes were distorted. The only conclusion possible was that there had been serious over-heating through lack of water. The feed arrangements and the gauge glasses were found in a satisfactory condition, but through frothing or priming, deposits had collected on the high-water float to such an extent that it required 3 lb 6 oz on the low-water float to effect a balance when the boiler was empty. Under these circumstances, the low-water float was unable to fall with the water level, and for all practical purposes the alarm was inoperative. The damage to the boiler was considerable, but fortunately no very serious personal injuries occurred to members of the staff. "Low-water alarms of good construction," said the Engineer Surveyor-in-Chief, "are appliances of proved utility, but, as shown in this case, they may actually be a source of danger if relied on to the exclusion of indications given by the water gauges, regarding the correctness of which there should be no uncertainty while the boiler is allowed to continue under steam." He might also have added that all automatic appliances must be frequently examined and maintained in proper operating condition.

A small vertical tubular boiler, 18" in diameter and 30" in length used to drive an oil pump for a large boiler at a Southern milk plant, caused extensive property damage on October 27, 1935, when it exploded. After passing through the engine house and over several residences, the shell, which had torn free from the top head and flue sheet, landed a block and a half from the plant. The core shot like a bullet into a neighboring house, which was severely damaged. Windows in several residences were broken by flying debris or by the explosion itself. While the cause of the accident was not definitely determined, it was learned that the explosion occurred soon after the auxiliary boiler had been lighted preparatory to starting the main boiler.

When two tubes blew out on a yacht cruising off Newport, Rhode Island, on September 4, 1935, the ship was disabled.

Londoner: "I went bald, so I spent a small fortune on hair restorer."
Scotchman: "When I went bald, I sold my brush and comb."

Hoist Motor Accident in Remote Location Followed by Quick Repair

IN THE mountains about 200 miles from Oakland, California, where the lumbering activities of a Hartford Steam Boiler policyholder require incline railways operated by large motors, a 900 hp motor hoist is used to pull cars up a 4,000-foot canyon slope which ends with about 800 feet of 62 per cent grade.

Usually, the car and its load of logs weigh from 60 to 65 tons, but on September 18, 1935, a loading crane was being transported. Its weight, with the car, was about 73 tons. When the car had been pulled nearly to the top of the canyon, the input to the motor was 1650 kw at 2150 volts, with a car speed of 600 feet per minute, when the 2300-volt oil switch was tripped out by the overload relay, thereby removing all power from the hoist.

The emergency brake was automatically set on the drum. The momentum of the car probably carried the load forward a few feet, permitting the cable to sag. Freed from the upward pull, the car started down the incline and when the cable became taut, the shock loosened the grip of the brake.

Sensing what was happening, the operator decided to try to close the oil switch and make the motor operate regeneratively as an auxiliary brake. As he rushed down a flight of steps to close the circuit breaker, a terrific crash was heard and the coils in the rotor windings flew out, so damaging the machine that it was necessary to rewind both rotor and stator, make up a new ventilating fan for the collector ring end of the rotor, repair the bearing housings and the bearing supports in the housings, as well as the ring supports used for mounting the over-speed device.

The flaring out of the rotor windings, as is shown in the photograph, added to the braking effect of the slipping band brake so that the car with its heavy load slid to the bottom of the grade without developing such speed as to cause damage. It was estimated that the maximum speed of the motor was between $2\frac{1}{2}$ and 3 times normal.

The lining on the emergency brake was 14" wide and $\frac{3}{4}$ " thick and was of asbestos and brass wire composition. An examination showed that a strip 6" to 8" wide and 1 fabric thick had been torn off of the lining surface the entire length of both shoes. The two outside strips were smooth and glazed, but there was no oil on the surface of the drum. The only reason that can be advanced for the brake lining not holding is the fact that it was probably glazed. In the regular operation

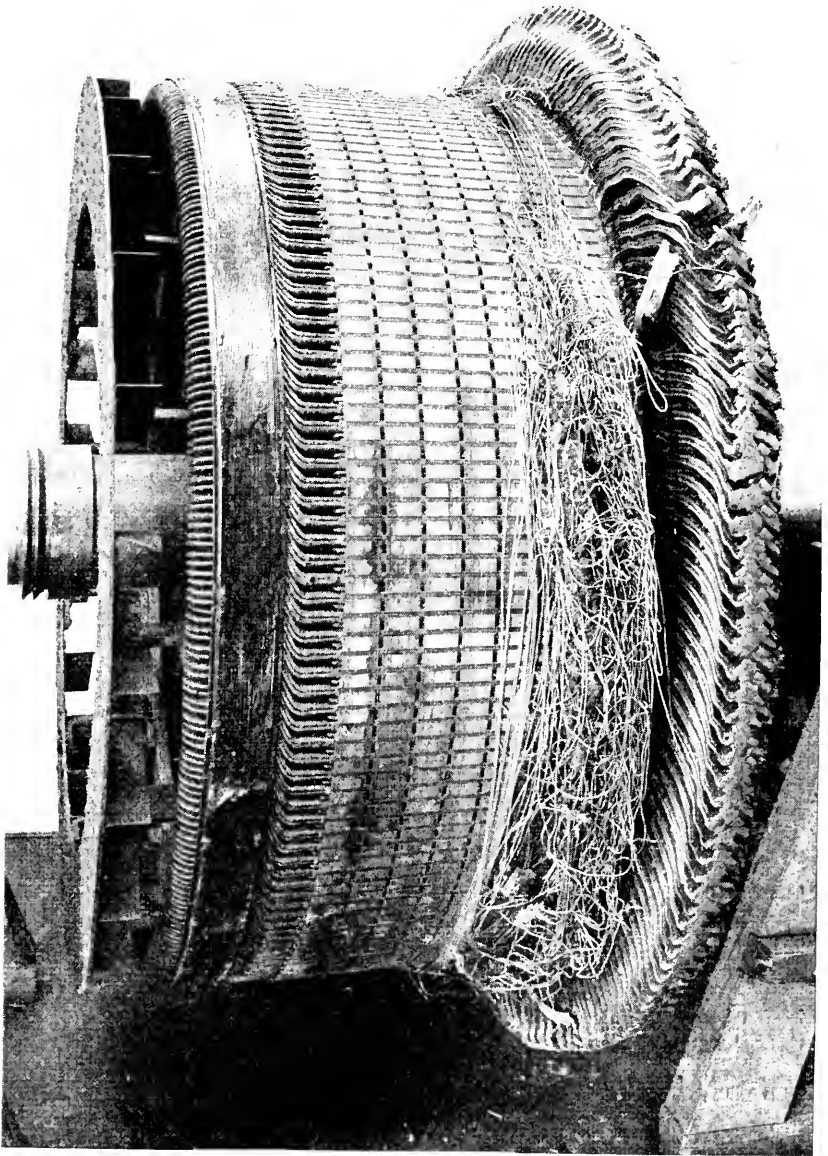

900 Hp Hoist Motor Damaged Because of Overspeed.

of this hoist the brake operates only to hold the drum stationary, as the speed of the descending cars is controlled almost entirely by the motor operating regeneratively.

The accident brought lumbering operations to a halt, and as use and occupancy insurance was carried, Hartford Steam Boiler undertook the direction of the repair. It was soon evident that the work would require the services of the motor manufacturer's shop in the city of Oakland, and the 3½ ton rotor and 4½ ton stator were trucked there. As copper of the proper size was not available at the repair shop, an order was telegraphed to the manufacturer's plant in the East, and a 24-hour work schedule was authorized. Shipment across the continent to the West coast was made via air express, a plan which saved between 4 and 5 days.

Both the manufacturer and the manufacturer's repair organization gave a maximum of efficient cooperation, using all possible labor and equipment on a day and night schedule. The result was that the big motor left Oakland at 4:30 P. M. September 27 and arrived at the hoist the next morning. There, all was in readiness to reinstall the motor, which was operating at 3:00 P. M. on September 28, 10 days, 3½ hours after the accident.

The 2,200 lb airplane shipment of the new coils from the manufacturer in the East was the largest such shipment on record. This fact made the case somewhat unusual. The way in which it was handled, however, is typical of Hartford Steam Boiler's expediting in connection with a use and occupancy loss.

Ammonia Drums Explode in City Street

As several drums of ammonia were being transported through New York streets on October 17, 1935, one of them opened up lengthwise of the drum. The shock caused other drums to explode, flooding a busy street with ammonia fumes. A score of persons were overcome by the gas and many others suffered discomfort because of it. Police emergency squads at the scene of the accident revived some of those who had been overcome and the worst cases were taken to hospitals.

The drums contained 150 lb of ammonia each and were being transported by truck from one plant to another. It was understood that each of the containers had been charged and tested by an inspector, as is the regular operating procedure with such vessels.

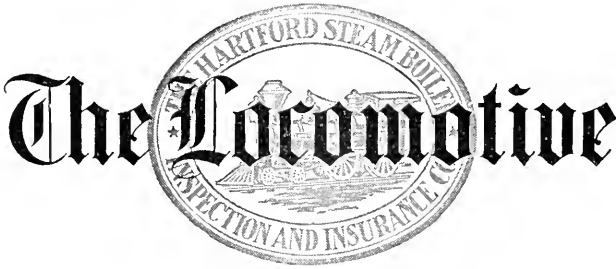

A QUARTERLY MAGAZINE
DEVOTED TO POWER PLANT PROTECTION

Published continuously since 1867

GEORGE H. PRALL, *Editor*

Copyright 1936 by The Hartford Steam Boiler Inspection and Insurance Company

HARTFORD, CONN., January, 1936

Single copies may be obtained free by calling at any of the Company's offices.

Subscription price 50 cents per year when mailed from this office.

Bound volumes one dollar each.

Reprinting matter from this paper is permitted if credited to

THE LOCOMOTIVE of THE HARTFORD STEAM BOILER INSPECTION AND INSURANCE CO.

Bard Leavitt

Bard Leavitt, retired inspector of the New York Department, died October 16, 1935, at his residence in Buffalo, New York. Mr. Leavitt was born in Bradford, Mississippi, March 18, 1857. He joined the Company as an inspector in the New York Department on January 18, 1899, and was retired on December 1, 1925, after nearly 27 years of service to policyholders in New York State.

Charles Merchant

Charles Merchant, for 31 years an inspector in the New York Department and serving for many of those years in plants in northern New York State, died December 7, 1935, at St. Peter's Hospital, New Brunswick, New Jersey, where he was taken two days before his death. Mr. Merchant had been ailing because of heart complications for several months. Born in Glasgow, Scotland, December 28, 1863, he served

an apprenticeship in one of the large shipyards in that city and continued for some years in marine engineering. His work with the Company began on August 1, 1901, and he was retired August 1, 1932. For the past 12 years, Mr. Merchant had been a resident of New Brunswick, New Jersey.

40,000-Kilowatt Hydrogen-Cooled Generator

HYDROGEN will be used to cool the generator for the 40,000 kw 1,250 lb pressure 925° F. steam turbine ordered from the General Electric Company by the Appalachian Electric Power Company for its plant at Logan, West Virginia. The unit is said to be the largest ever built for 3600 r.p.m. The installation is expected to be completed by the middle of 1937.

The advantages of hydrogen cooling over air cooling are a reduction of windage losses, faster conductivity of heat from the windings, a water-tight construction which permits its use out-of-doors, freedom of dirt and moisture because of the tight construction, and elimination of the damaging effect of corona on insulation—all of which increases the capacity of the machine about 25 per cent. The disadvantages are chiefly the necessity for additional auxiliaries to handle the hydrogen, the need for replacing such hydrogen as leaks out, and some danger because of the explosive nature of a mixture of hydrogen and air. As long as the pressure within the housing is greater than that of the atmosphere, air cannot gain admission. Automatic regulating devices solve the problem of keeping up this pressure. When it is necessary to shut down the machine, the housing is scavenged with carbon dioxide or other inert gas before air is admitted. Similarly the air is removed with an inert gas before a new supply of hydrogen is introduced.

Hydrogen has been used for some time successfully in synchronous condensers, which are self-contained units. Experiments during the past few years by several manufacturers have led to a solution of the problem of sealing in the hydrogen, even when the shaft of the machine extends through the hydrogen-sealed housing, as in the case of a turbine-generator installation.

I have spent nearly \$20,000 on that girl's education," complained the aggrieved father, "and here she goes and marries a young fellow with an income of only \$1,000 a year."

"Well," said the friend of the family, "that's 5 per cent on your investment. What more can you expect in these times?" —*Vancouver Province.*

Explosions of Compressed Air Receivers

COMBUSTIBLE vapor explosions played a leading part in recent reports of air receiver accidents which caused heavy property damage and in some cases led to injury and death.

In a Maryland plant, manufacturing trailer bodies, such an explosion killed one man and injured two. The tank, to which air was supplied by a belted compressor, was 30" in diameter and 10' 4" long, with one plus and one minus head. It was made of $\frac{1}{4}$ " plate and seams were lap-riveted.

The force of the explosion caused the minus head to reverse and tear off, and the receiver hurtled upward, smashing through the roof and landing in a field about 150' from the building. Most of the windows in the building were broken, as were panes in neighboring residences; there also was damage to the compressor and piping.

The man who was killed was working near the receiver when the explosion hurled him across the building against an iron girder. A safety valve set at 145 lb functioned properly when tested after the accident.

A similar explosion occurred recently in Cleveland. There an air receiver 3' x 8' 4", supplied by a motor-driven compressor rated for 125 lb pressure, reversed its minus head and tore a hole 50" wide and 19' long in the floor above. In addition, a building wall 45' by 15' was blown out, as is shown in the accompanying illustration. Internal surfaces of the tank after the accident were covered with a dry powder-like coating, and there was unburned oil on the minus head which remained on its wooden foundation after the rest of the receiver had rocketed. These and other details, such as the observance of flame at the time of the accident, gave evidence that there was an explosion of combustible vapor, the oil for which was probably an accumulation of several years, since the tank had no openings for cleaning except the usual water drain. Occurrences of this sort emphasize the fact that to prevent such accidents an air tank must be kept clean, and not merely

AIR TANK ACCIDENTS

Top—Side of building blown out by the explosion of the tank shown at the lower right. Upper right—Minus head reversed by oil vapor explosion. Center right—Failure caused by corrosion of rivets. Lower left—One man died and two were hurt when an air tank exploded and soared through the roof.

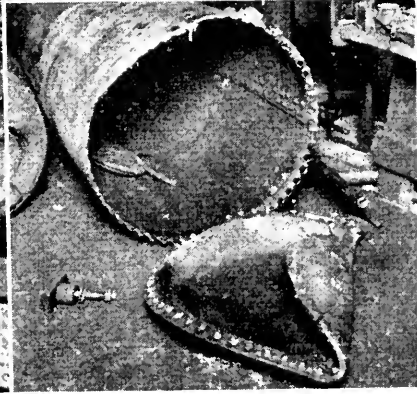
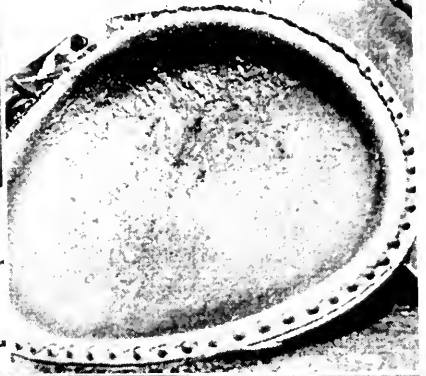
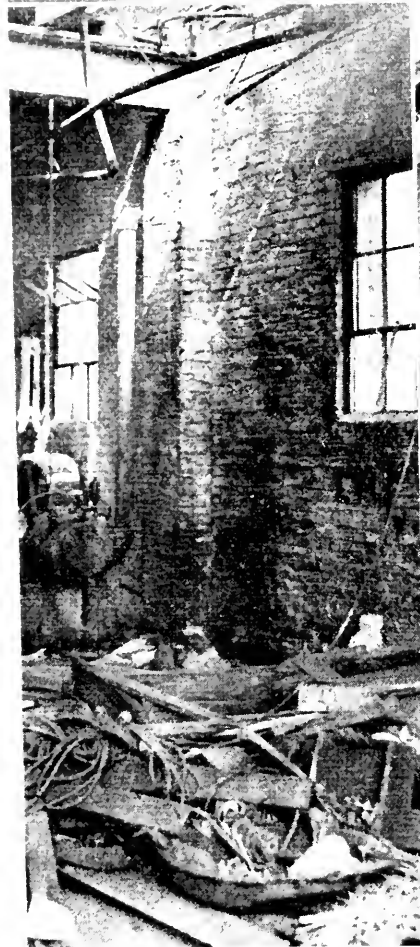

drained, since the latter routine removes only such oil as is in a fluid state in the bottom of the tank. The vessel was equipped with a 1" safety valve apparently in good condition, but it is doubtful if any safety valve could have relieved the pressure developed by the explosion.

An Ohio scrap-iron baling plant was wrecked by the explosion of an air receiver 3' 6" by 7' with a minus head $\frac{3}{8}$ " thick. Again it was the reversal of the minus head because of an oil vapor explosion which tore open the tank. In this case, just prior to the blast, flame was noted issuing from the safety valve. Employees also reported that the safety valve had been operating intermittently and that the discharge pipe from the compressor was red hot. The air compressor was definitely in need of extensive repairs, and as its large oil feeders were filled at least twice a day, it may be assumed that an abnormally large amount of lubricant was used. The head of the tank is shown in the accompanying illustration.

In the prevention of such oil vapor explosions, proper maintenance of the compressor is essential. It is important to use the correct lubricant, to see that discharge valves are kept in good condition, and to have a clean water jacket. Leaky discharge valves on the compressors probably were responsible for the temperature rise leading to at least one and perhaps all of the above accidents. (For a discussion of air compressor explosions because of combustible oil vapor see THE LOCOMOTIVE, July, 1934, Page 66).

Use of a 42" x 74" air receiver too lightly constructed for the 100 lb operating pressure put on it, led to the explosion of the tank at a West Virginia coal mine. The vessel was built in two courses of .175" steel and had single riveted lap seams. Heads were slightly dished, one plus and one minus, and were stayed by means of four small tie rods running through the vessel from end to end. Failure of the threads on one or more of the tie rods was the cause of the explosion. As the minus head reversed, all but 7 of the rivets broke where corrosion had weakened them between the plates, and after the accident the halves of each rivet were still in place. As it rose, the tank dented the sheet metal side of the engine room, broke rafters and tore off part of the roof. This tank had evidently been designed by some one who had no conception of the stresses involved in a pressure vessel.

One man was killed and another critically injured at a Western boiler works when a 7,000-gallon tank, intended for use in a brewery,

exploded as it was being tested under air pressure. The failure occurred in the welded seam between a head and the shell. Tanks of this sort should be tested hydrostatically, a safer procedure, but as there were several tanks, the builders may have sought to save on metered water by using air and a solution of soap suds at the seams. Air was supplied from the regular shop system at 150 lb pressure and it is probable that a greater pressure had built up than the design of the tank could withstand, as beer-aging tanks are not subject, in normal operation, to more than 12 or 15 lb carbonic acid gas pressure.

Heating Boiler Danger Signals

AS WAS pointed out in an article on "Low Water in Steam Heating Boilers" in THE LOCOMOTIVE for October, 1935, Page 227, the need for an abnormal amount of "make-up" is always a sign that something is wrong. A recent case which eventually resulted in the cracking of 14 half sections in a large cast iron heating boiler illustrates how repeated indications of trouble will not lead to a remedy unless the operators recognize the danger signals as such.

In this instance, danger signs over a period of two days did not serve to prompt the proper corrective steps. The low water cut-out shut off the stoker several times during those two days and additional water was put into the boiler each time. Water was unsteady in the gage glass. The fusible plug melted out. The low water cut-out was taken apart and reassembled and the boiler filled to the proper level. The low water cut-out soon stopped the stoker again, but still the only remedy that seemed to occur to the operators was to put in more water.

The story told by any of the above occurrences should have been understood at once. The boiler was pump fed through a one-way valve. If this valve operated properly no water could back out of the boiler, but the boiler was losing water in an amount all out of proportion to normal steam requirements. On reaching the plant, an inspector came quickly to the conclusion that water had been backing into the return pipes, and an examination of the valves showed that he was right, as a collection of sediment had prevented the closing of the check valve in the return line. About 50 per cent of the radiation was below the boiler water level and the return line was 500' long.

The first time the low water cut-out stopped the stoker, the operators should have recognized that as a sign of trouble, started a search for the cause, or else called for the assistance of an experienced boiler inspector. In this case a short shutdown and an economical repair would have taken care of the situation.

Heating Boiler Explosion



A cast iron boiler explosion on November 18, 1935, injured four persons and wrought damage estimated at \$10,000 to these stores.



Parts of the boilers which were picked up after the accident. The boiler, which was one year old, was not insured.

Taps From the Old Chief's Hammer

TOM!" called the Old Chief to his assistant. "Come here, I want to show you something."

When Tom Preble entered his superior's office he found the Old Chief looking out of the window toward the west.

"Worth while, Tom," was the older man's only comment.

What had attracted his attention was a superb sunset, bank on bank of great clouds diffused with the light of the midwinter sun. Against the background of gray and white and gold were silhouetted skyscrapers and on top of one of them were two tall radio masts, delicately etched in the sky.

The Chief said nothing more. He just stood, apparently drinking in the majesty of the scene. Then he turned back to his desk.

"Tom, the mind is a funny thing. A second ago I was thinking great thoughts and right in on top of them came a train of ideas that brought me sharply back to shop. It was those radio towers, I got to thinking about the regularity of the broadcasts that come from the aerial they carry. From that I jumped to the transmitting apparatus. You know the station here has a remarkably good record for continuous broadcasting. It seems particularly fortunate in its freedom from outages.

"Did I ever tell you about the experience we had with that big station down-state and the freak climax to a regular epidemic of interruptions?"

Preble sensed a story in the offing. "No, Chief," he said, "I thought that most of these radio stations did pretty well about keeping on the air."

"We were interested in this case," the Old Chief said, "because we carried a power interruption policy. The station had eight major interruptions in a single year. As I remember it the series started with a blown fuse in a high tension line which caused low voltage in the power supply at the transmitter.

"Another time some children had thrown a wire on to public service company lines. Once a fuse was blown out by lightning, and three



times storms led to interruptions. In one of these cases a large tree was blown over the line to the station, which is about 10 miles from the city. In the others, severe electrical and wind storms caused voltage disturbances and breakdown of wires and poles or both. The station seemed jinxed.

"One of the interruptions, however, was funny. In the middle of the broadcasting one afternoon the power suddenly failed. There was no storm and the utility could give no immediate reason for the failure, but sent its trouble crew along the 10 miles of wire to the radio station. They found nothing out of order anywhere on the line until they got to a substation near the radio station. As they neared this they heard the sound of pounding and there, to their consternation, they saw a husky fellow with a sledge hammer busily engaged in breaking up the equipment.

"Everybody got pretty excited and I guess there were some fireworks. The man said the public service company had sent him out to break up the equipment and cart it away for junk. The crew told him otherwise and put a stop to his work. While part of the men started to repair the damage, the surprised and very eloquent junk man was led shouting and gesturing to a telephone. The crew couldn't understand this business of breaking up equipment that was being used, so they phoned their office.

"My, Tom, but I'd have enjoyed listening in on that conversation. The engineering department said they had authorized the man to break up the equipment!

"That was a puzzler until more questioning at both ends of the wire developed that things weren't quite as they seemed.

"The utility had connected the radio station to part of the substation equipment. The rest of the equipment had been used by a traction company which was no longer in operation. As the idle equipment was obsolete, the utility had authorized the junk man to go and get it.

"His mistake was that he selected the wrong end of the substation at which to do his hammering. It took five hours to undo what the junk man and his hammer had done in a few minutes."

"Did we pay for the interruption?" asked Preble.

"Sure thing. We pay when there is an interruption of power because of any accident to utility equipment supplying electrical current. The whole thing was accidental. Of course, it was somebody's blunder, but you know as well as I do that plenty of the losses we have are from accidents because of someone's carelessness or ignorance.

"Jumping cats. Look at the clock. Five minutes to my train time

and company for dinner. If I don't make that train, I'll have a hard time explaining what interruption kept *me*. Why, Tom, my better half might even accuse me of broadcasting."

Rules for Handling a Woman by Electricity

If she talks too long—Interrupter
 If she wants to be an angel—Transformer
 If she is picking your pockets—Detector
 If she will meet you half way—Receiver
 If she gets too excited—Controller
 If she goes up in the air—Condenser
 If she wants chocolates—Feeder
 If she sings inharmoniously—Tuner
 If she is out of town—Telegrapher
 If she is a poor cook—Discharger
 If she is too fat—Reducer
 If she is wrong—Rectifier.
 If she gossips too much—Regulator
 If she becomes upset—Reverser

"Where is Jimmy this afternoon?"

"If he knows as much about canoeing as he thinks he does, he is out canoeing; but if he doesn't know any more about it than I think he does, he's swimming."

—*Union Electric Magazine.*

First burglar: "I need eye glasses."

Second burglar: "What makes you think so?"

First burglar: "Well, I was twirling the knobs of a safe and a dance orchestra began to play."

—*Boston Evening Transcript.*

My grandpa notes the World's worn cogs
 And says we're going to the dogs
 His grandpa in his house of logs
 Said things were going to the dogs
 His grandpa in the Flemish bogs
 Said things were going to the dogs
 His grandpa in his hairy togs
 Said things were going to the dogs;
 But this is what I wish to state,
 The dogs have had an awful wait.

—*West Penn News.*

The hotel clerk was growing impatient as the prospect took so long to read the names on the register.

"Just sign on that line, please," said the Clerk.

The prospect was indignant in return: "Young man, I am too old a hand to sign anything without reading it."

—*Kansas City Star.*

Examiner: "What was the most you ever weighed?"

Prospect: "154 lbs."

Examiner: "Then, what was the least you ever weighed?"

Prospect: "8 $\frac{1}{4}$ lbs."

The Hartford Steam Boiler Inspection and Insurance Company

OF HARTFORD, CONN.

December 31, 1934

Capital Stock, \$3,000,000.00

ASSETS

Cash on hand and in banks	\$1,085,468.05
Premiums in course of collection (since October 1, 1934)	852,355.70
Interest accrued on mortgage loans	40,174.71
Interest accrued on bonds	111,929.51
Loaned on mortgages	649,172.77
Home Office real estate and Philadelphia branch office	542,474.66
Other real estate	240,365.29
Bonds on an amortized basis	\$9,499,059.29
Stocks at market value	4,831,568.00
	<hr/>
	14,330,627.29
Other admitted assets	20,485.35
	<hr/>
<i>Total</i>	\$17,873,053.33

LIABILITIES

Premium reserve	\$7,628,631.73
Losses in process of adjustment	404,166.50
Commissions and brokerage	170,471.14
Other liabilities (taxes incurred, etc.)	539,438.80
<i>Liabilities other than capital and surplus</i>	<u>\$8,742,708.17</u>
Capital stock	\$3,000,000.00
Surplus over all liabilities	<u>6,130,345.16</u>
<i>Surplus to Policyholders</i>	<u>9,130,345.16</u>
<i>Total</i>	\$17,873,053.33

WILLIAM R. C. CORSON, President and Treasurer

BOARD OF DIRECTORS

LUCIUS F. ROBINSON, Attorney, Hartford, Conn.	SAMUEL M. STONE, President Colt's Patent Fire Arms Mfg. Co., Hartford, Conn.
JOHN O. ENDERS, Chairman Executive Committee Hartford National Bank & Trust Co., Hartford, Conn.	SAMUEL FERGUSON, Chairman Board of Directors The Hartford Electric Light Co., Hartford, Conn.
MORGAN B. BRAINARD, President Etna Life Insurance Company, Hartford, Conn.	HON. JOHN H. TRUMBULL, President The Trumbull Electric Mfg. Co., Plainville, Conn.
CHARLES P. COOLEY, Chairman Board of Trustees Society for Savings, Hartford, Conn.	CURTISS C. GARDINER, Vice President The Hartford Steam Boiler Inspection and Insurance Company, 90 John Street, New York.
HORACE B. CHENEY, Manchester, Conn.	JAMES L. THOMSON, Chairman Finance Committee Hartford Fire Insurance Company, Hartford, Conn.
D. NEWTON BARNEY, Vice President The Hartford Electric Light Co., Hartford, Conn.	PHILIP B. GALE, Chairman Board of Directors Standard Screw Co., Hartford, Conn.
JOSEPH R. ENSIGN, President The Ensign-Bickford Co., Simsbury, Conn.	JOHN J. GRAHAM, Vice President The Hartford Steam Boiler Inspection and Insurance Co., Hartford, Conn.
EDWARD MILLIGAN, President Phoenix Insurance Co., Hartford, Conn.	
WM. R. C. CORSON, President The Hartford Steam Boiler Inspection and Insurance Co., Hartford, Conn.	

Incorporated 1866



Charter Perpetual

Department

Representatives

ATLANTA, Ga., Citizens & So. Nat. Bk. Bldg.	W. M. FRANCIS, Manager. C. R. SUMMERS, Chief Inspector.
BALTIMORE, Md., 704-9 Garrett Building	D. W. LITTLE, Manager. R. P. GUY, Chief Inspector.
BOSTON, Mass., 87 Kilby Street	A. PAUL GRAHAM, Manager. W. A. BAYLISS, Chief Inspector.
BRIDGEPORT, Conn., City Savings Bank Building	W. G. LINEBURGH & SON, General Agents. A. E. BONNET, Chief Inspector.
CHICAGO, Ill., 175 West Jackson Boulevard	P. M. MURRAY, Manager. C. W. ZIMMER, Chief Inspector.
CINCINNATI, Ohio 1904-12 Carew Tower	JAMES P. KERRIGAN, Manager. W. E. GLENNON, Chief Inspector.
CLEVELAND, Ohio, 1040 Leader Building	ARTHUR F. GRAHAM, Manager. JOHN L. SCOTT, Chief Inspector.
DENVER, Colo., Gas & Electric Building	J. H. CHESNUTT, Manager. JESSE L. FRY, Chief Inspector.
DETROIT, Mich., National Bank Building	L. L. COATES, Manager. THOMAS P. HETU, Chief Inspector.
HARTFORD, Conn., 56 Prospect Street	F. H. KENYON, Manager. A. E. BONNET, Chief Inspector.
NEW ORLEANS, La., 333 St. Charles Street	R. T. BURWELL, Manager. P. E. TERROY, Chief Inspector.
NEW YORK, N. Y., 90 John Street	C. C. GARDINER, Vice President. J. F. HUNT, Chief Inspector.
PHILADELPHIA, Pa., 429 Walnut Street	A. S. WICKHAM, Manager. S. B. ADAMS, Chief Inspector.
PITTSBURGH, Pa., Arrott Building	WILLIAM P. WALLACE, Manager. J. A. SNYDER, Chief Inspector.
ST. LOUIS, Mo., 319 North Fourth Street	CHAS. D. ASHCROFT, Manager. EUGENE WEBB, Chief Inspector.
SAN FRANCISCO, Cal., 114 Sansome Street	C. B. PADDOCK, Manager. L. E. GRUNDELL, Chief Inspector.
SEATTLE, Wash., Arctic Building	E. G. WATSON, Manager. WILLIAM J. SMITH, Chief Inspector.
TORONTO, Ont., Canada Federal Building	H. N. ROBERTS, President The Boiler In- spection and Insurance Company of Canada.

BUSINESS no longer asks whether it shall
insure its power plants. Too much is at stake to
jeopardize lives, investments, profits by sudden
explosions or breakdowns. Business *does* ask, "With
which company shall we insure?" . . . and
answers, in about half all cases, "Hartford Steam
Boiler." Impartial judges consider Hartford Steam
Boiler protection as standard the country over.
Policyholders know that because Hartford *handles*
this kind of insurance alone it can devote full ener-
gies to it, and through its engineering and inspec-
tions can anticipate problems arising from today's
use of higher pressures, speeds, capacities; and lock
worry out of engine and boiler room. They have
learned that their money invested in a Hartford
policy returns to them the best kind of dividend.

V. LLI No. 2

APRIL, 1936

The Locomotive

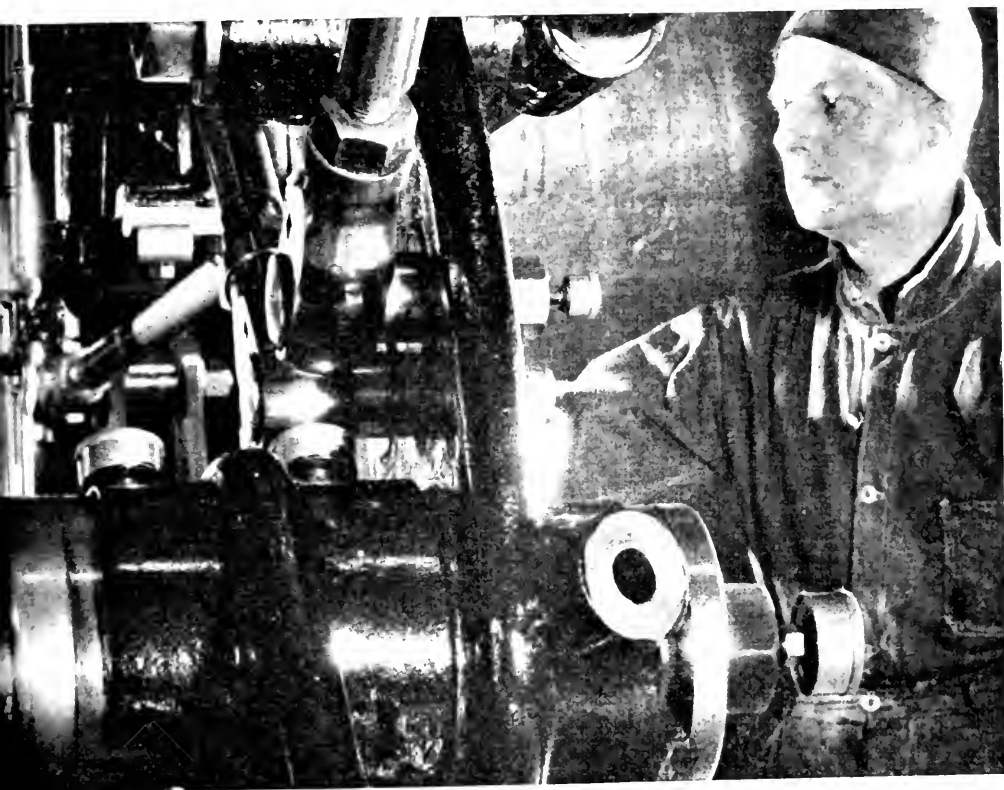

A Quarterly Magazine Devoted to Power Plant Protection

Please Show to Your Engineer

Steam Turbine Accidents

FIVE recent turbine accidents, caused by fatigue of the metal, loosening of parts, or distortions due to cooling produced direct property loss of about \$150,000 and additional indirect losses of several thousands more because of inability to operate. The accidents were to turbines ranging from 750 kw to 6,000 kw of both the impulse and reaction types.

A 3,500 kw impulse turbine driving a generator at a Southern cotton mill was destroyed when the 3rd stage disc exploded because of

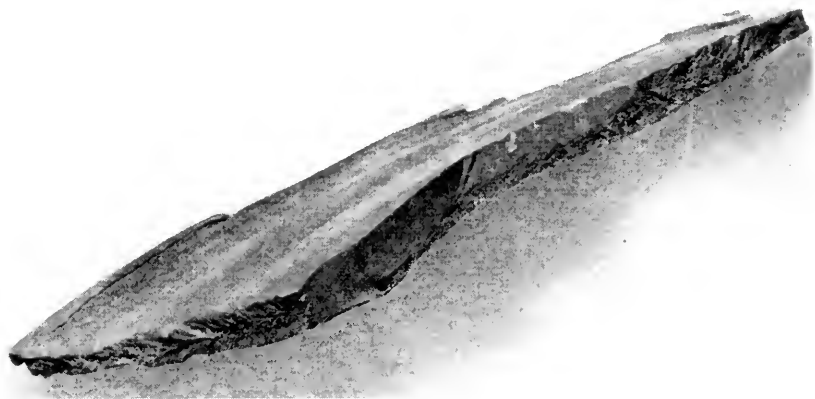

Section of turbine disc which exploded because of a fatigue crack.

a progressive crack. Replacement of the machine, which was about 12 years old, involved an estimated cost of more than \$100,000. The explosion took place while the emergency governor was being tested. When the machine reached 8 per cent above its operating speed, vibration suddenly increased and the accident occurred. The steam end was wrecked, there was serious damage to the generator because of the distortion of its shaft and the rubbing of the field against the stator, the foundation was cracked in several places, and extensive damage was suffered in the condenser room. As the severed section of the wheel did not go through the steel turbine casing, there was no loss of life or serious injury to the operators, although the jolt knocked a helper off his feet. It was felt that, although the testing of the emergency governor may have hastened the time of the ultimate failure, the accident would have occurred at some later date under ordinary

operating conditions, with possible additional property damage and perhaps personal injury.

An accident to a 6,000 kw reaction type steam turbine-alternator at an Ohio steel mill resulted in the stripping of all but one row of blades on the spindle and the stripping or bending of all of the stationary blades. This, with other damage, caused a loss estimated at approximately \$40,000.

The 6,000 kw turbine-alternator was connected through a feeder to another power house, in which there were other alternating current

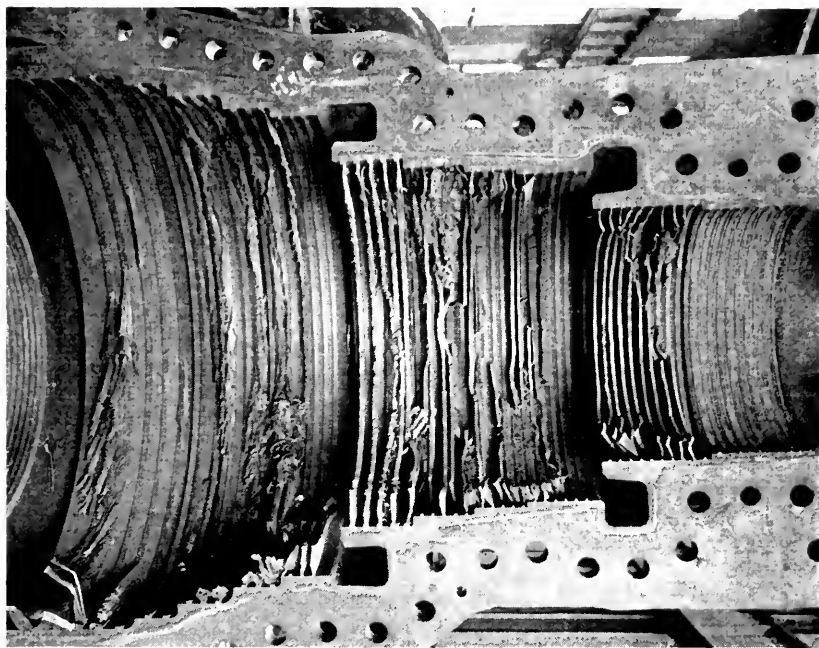

Mashed rows of reaction blading after temperature strains had contracted the casing and rotor unevenly.

generators. In the power house with the 6,000 kw unit was a 1,500 kw direct current turbine-generator which supplied, among other equipment, a motor-driven exciter for the larger machine. The events leading up to the accident started when an oiler reported that the vacuum on the direct current machine had dropped to 20 inches. The engineer went to the floor below. While he was there, some condition in the plant caused the direct current circuit-breaker to trip out, thereby

interrupting the field current for the 6,000 kw unit, which, of course, lost its excitation and load and the regulating devices shut off the steam.

However, because the 6,000 kw unit was on the line with the other turbines, the current reversed and operated the generator as a motor, causing the turbine to continue to revolve, a condition which the graphic voltage chart showed lasted about 3 minutes before the engineer cut the switch, it having been necessary for him to run from the floor below, after a whistle signal sounded. Because the governor shut off all steam to the turbine, the vacuum from the condenser immediately extended to the head end of the cylinder and the temperature dropped from about 458° to 115°F. The subsequent contracting of the metal was sufficient to move the front end of the cylinder toward the exhaust where the casing was anchored. On account of its bulk, the spindle did not contract as rapidly with the result that the low pressure water impeller was pulled against the generator side of the impeller casing. The movement also caused the high pressure dummy packing to rub against the revolving dummy strip which, in conjunction with the rubbing of the low pressure impeller, caused a severe vibration of the unit. It was this vibration which led to the serious damaging of the turbine, the damage, besides the stripping of the blades, including the breaking of the governor casting, the cracking of the bearing casting and of the cast iron exhaust casing, and the distortion of the shaft.

Following the accident various means were discussed to prevent its repetition. The method decided upon was to furnish the turbine with a direct-connected exciter mounted on its shaft, instead of relying on the direct current generating equipment for the excitation of the field through a motor-driven exciter unit.

An accident to an impulse type turbine in a Michigan paper mill resulted in interruption of business for nearly a month. The trouble was first noted when the turbine started to vibrate excessively. On shutting it down, the crew found that seven buckets on the third stage wheel had broken off in the dovetail and part of the shroud band had become detached. Five other buckets were cracked. As the machine was sorely needed, it was decided to take out all of the buckets in the third stage wheel and to run the turbine. In this way the plant was able to operate at about 70% capacity. By expediting the manufacture of the new buckets in every possible way and by shipping them by airplane the plant was back on full production about four weeks after the accident.

While the damage to the turbine amounted to only \$500, there were use and occupancy losses of \$7,500.

Temperature differentials in the spindle of a 1,500 kw reaction type turbine, used in a Pennsylvania factory, were blamed for the breakdown of the machine. The turbine was of a special type and was used primarily for reducing steam pressure from 600 lb, 775°F. at the intake, to 150 lb. Because the need for steam was not uniform, the turbine was shut down at more or less regular intervals. On the day of the accident repairs to a steam line necessitated shutting down the machine for a short time. When it was started again, an unusual vibration was noted and rubbing was heard at about 3,000 rpm. The machine had to be taken out of service again and when the casing was lifted, it was seen that all of the reaction blading, both stationary and revolving, had rubbed and the profile of the blades had been reduced about 50 per cent. There was also damage to the packing ring gland, and the spindle had been bent.

On account of the high temperatures after shutting down, the bottom of the spindle cooled more rapidly than the top, resulting in sufficient temperature differential to cause distortion. Then, when the turbine was started after being idle for only 2 hours instead of the usual 12 to 24, the distorted spindle caused the blading to rub. Possibly this same distortion occurred every time the machine was shut down, but probably it did not become permanent because the spindle had a long enough time to cool to a uniform temperature throughout before it was returned to operation.

Excessive vibration of a 750 kw steam turbine driving a generator at a Southern cotton mill, led to the shutdown of the unit. On dismantling the machine, it was found to need a new 10th stage disc and a number of minor repairs, the damage having been caused by the rubbing of the 10th stage wheel on the diaphragm after the shrouding had warped. The blades were loose in their slot and small cracks were evident at several places on the circumference of the disc. One of the 10th stage diaphragm partitions could be moved by hand and two pieces of other partitions were broken out. The inspection following the accident also revealed the presence of a piece of cast iron $\frac{1}{4}$ " in cross-section and 4" long in one of the nozzles. The unit had no steam strainer.

Absent Minded Professor: Waiter, half an hour ago I ordered some lamb chops. Have you forgotten them, or have I had them?"

Protecting Idle Boilers against Corrosion

By J. P. MORRISON, *Assistant Chief Engineer, Boiler Division*

IT is a maxim of dental hygiene that "a clean tooth never decays." Similarly, a clean, dry boiler will not corrode. Power and heating boiler owners who recognize this fact and take advantage of it when boilers are idle during seasons of non-operation find that their boiler investment is longer-lived and their equipment freer from the widespread evils that grow out of extended periods when corrosion is given a freer hand.

To get a boiler absolutely clean and absolutely dry is not an easy accomplishment, but it is one which improves operating experience and prevents accidents. Clean, dry plate in idle boilers is important alike on the internal and external surfaces, and it is the purpose of this article to outline some of the practices which are helpful in achieving the desired end.

Metals in contact with moisture are subject to corrosion, and this action is more rapid in the presence of oxygen, which is found in practically all waters. For an extensive discussion of the subject of boiler feedwater with relation to corrosion and other hazards, see *THE LOCOMOTIVE*, January, 1935, Page 130. Corrosion is further accelerated by carbon dioxide gas which also may be present. Bearing these facts in mind, it is not difficult to picture the action which takes place in an idle boiler that is filled with water to the normal working level, entirely filled with water, or "empty" but not perfectly dry. Under each of those conditions both moisture and gases are present to cause the iron to go into solution and form the "scabs" and "pits" that are so frequently found in many boilers.

External corrosion develops quite rapidly when a boiler is taken from service, and when all of the surfaces exposed to the products of combustion are not thoroughly cleaned. The moisture in the atmosphere will condense on a boiler when it contains water that is cooler than the air and this moisture combines with the sulphur in the soot and ash to form a corrosive acid. As a result, there is deterioration evidenced by the presence of a hard substance composed to a considerable extent of the rust from the plates, tubes, headers, etc. The extent of the deterioration is limited only by the amount of moisture, the quantity of soot, and the length of time the boiler is idle.

Unquestionably, there is great advantage and no vital disadvantage in emptying and opening the boiler as soon as the idle period arrives, and some one should be charged with this duty. This work should pref-

crably be done while the boiler is warm so that any moisture will evaporate and be carried off by the natural circulation of the air or, in the case of some parts such as superheaters, by forced circulation, for which a fan or air hose may be used.

Boilers that are to be idle for any length of time should be cleaned thoroughly both inside and outside, using a wire brush on tubes, heads, headers and shell plates, wherever those surfaces can be reached. The

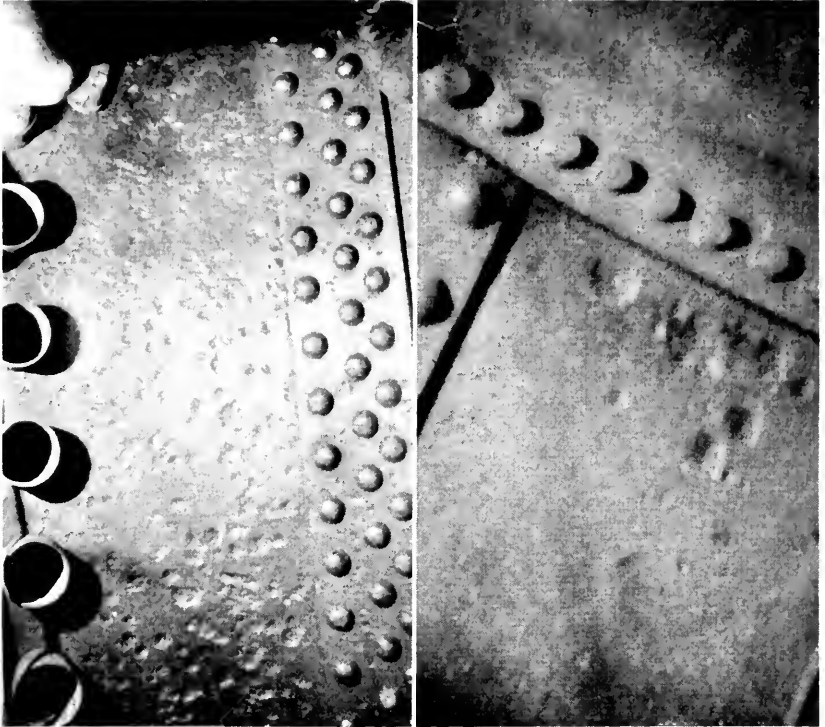

Characteristic pitting in boilers operated intermittently.

superheater, reheater and economizer should be treated likewise. All soot and ash should be removed from the furnace.

These may seem to be extreme recommendations, but they are fully justified since any moisture remaining in the boiler and any soot on the external surfaces increases the rate of deterioration and hastens the need of repairs. These practices have been followed successfully in many cases, even to the extent of using a feather duster on accessible external surfaces.

After the boiler has been thoroughly cleaned and is dry internally, a quantity of unslaked lime may be placed on trays within the boiler to absorb any moisture remaining in the air. The manhole and hand-hole plates should then be placed in position. If this plan is followed an examination of the lime should be made at about 60-day intervals. A bushel (about 75 lbs) of unslaked lime for a boiler having 2,000 sq. ft. or less heating surface with an extra bushel for each additional 2,000 sq. ft. of heating surface should be sufficient where the atmosphere is not excessively humid.

After the external surfaces have been cleaned by removing all soot and ash clinging to the shell-plates, tubes and headers, and after the furnace and combustion chambers have been properly cleaned, all access doors should be closed. If the boiler is used for heating purposes, the fire door should be secured in the closed position so there will be no possibility of a fire being built in the furnace of the empty boiler.

As an aid to "drying out" an empty boiler, for the idle period, the use of a small low-temperature fire of light material, such as excelsior or thin strips of wood, is frequently suggested. There is no question but that such a plan operates satisfactorily if properly carried out under the direct supervision of a responsible engineer, but the temperature of the boiler should be increased slowly and uniformly. At no time should the temperature of any of the surfaces exposed to the heat be excessively uncomfortable to the hand. When there is much atmospheric moisture, salamanders, coke-jacks, or fire pots of other descriptions have been used in boiler furnaces to prevent the condensation of moisture on the external surfaces.

Prevention of corrosion by the application of oil has been discussed by engineers for a great many years. The external surfaces of boilers of some types are accessible and if properly oiled after being thoroughly cleaned may be protected so that no corrosion takes place. However, it is not possible to apply oil to all of the internal surfaces of any boiler. Any surfaces not properly coated with oil are likely to be seriously affected by pitting if there is moisture present.

Oil having a base of animal fat is likely to cause over-heating if not thoroughly removed before the boiler is fired up.

The practice of placing a quantity of oil on top of the water and expecting the oil to coat the internal surfaces of the boiler, as the water is drained off, is of practically no value, as oil will not coat a wetted surface.

The fire surfaces of fire tubes, after being sprayed with kerosene to loosen any coating and after being well scraped, may be oiled to

prevent corrosion. Of course, when the boiler is placed in service the oil will be burned off, so that no effort is required to remove it prior to starting up.

A "stand-by" or "emergency" boiler offers a somewhat different problem. The size of the boiler, the quality and quantity of the water available for refilling, as well as the probability of needing the boiler without advance notice, must be considered.

In some cases such a boiler must be held with a banked fire and carry approximately full working pressure even when it is not placed on the line daily, and must be cared for about the same as if it were in continuous service.

In some central stations where emergency or peak load boilers are kept under pressure, the temperature and pressures are maintained by the use of live steam from the main steam header instead of depending upon banked fires. Boilers operated under such conditions will accumulate little, if any, scale but may be affected by corrosion to even a greater extent than if they were delivering steam.

A stand-by or emergency boiler, that for thirty days or more is not likely to be in service, or which is definitely out of service, should receive the same attention necessary to prevent deterioration that it would if it were located in a seasonally operated plant.

An idle boiler set in a battery with one which is in continuous service may be warmed sufficiently to prevent condensation of atmospheric moisture even when the idle boiler is filled with water and if each boiler is of sufficient capacity to operate the plant, it is much better to operate on an alternate schedule for periods of about thirty days.

With the "wet boiler" plan, which does not require draining, the boiler, immediately after being taken out of service, should be cleaned and examined by the maintenance crew so that any repairs which are needed can be made promptly. The unit, including the boiler, economizer, and superheater, then should be completely filled with the regular feed water which we shall assume has been treated to produce an alkalinity sufficient to prevent corrosion.

In order to absorb the oxygen contained in the water, sodium sulphite may be added at a minimum rate of about 30 parts per million, which is approximately 2 grains per gallon. The amount of water contained in boilers of various horsepower ratings depends to a great extent upon the type of boiler and will vary from 5 to over 10 pounds of water per sq. ft. of heating surface. The average is about 8-1/3 lb. of water per sq. ft. of heating surface. With this ratio in mind a minimum of about 1/2 lb of sodium sulphite is required for a 150 hp boiler. It is

necessary to test the water frequently to make certain that an excess of sodium sulphite is being maintained.

To obtain satisfactory results, all boiler valves, and particularly the feed valve, should be absolutely tight, and the automatic non-return valve alone should not be depended upon to keep the boiler closed from the header. If the feed valve leaks, water entering the boiler will increase the pressure and may result in opening the safety valve or possibly discharging water into the steam header.

Taking all facts into consideration, the logical conclusion is that the "dry boiler" plan of caring for an idle boiler is preferable and, furthermore, a boiler cared for in that way is always in condition for inspection. The expense of laying up a boiler dry is probably no greater than when the "wet boiler" plan is followed. The chief advantage of the "wet boiler" plan is that a boiler filled with water can be returned to service in less time and at less expense, provided deterioration during the idle period does not make immediate repairs necessary.

Hydro-Pneumatic Tank Fails Due to Poor Weld

This hydro-pneumatic tank with its saucer-shaped head failed because of a poor weld. The pressure at the time of failure was 35 pounds. The dimensions of the vessel were 14' by 42", and both the shell and the heads were of $\frac{1}{4}$ " thickness.

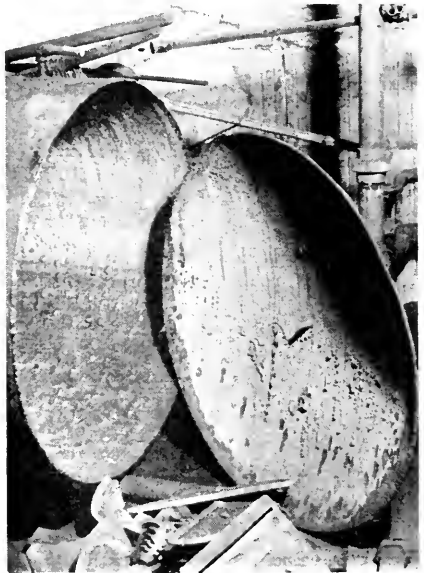

Laboratory Accidents Fatal

The explosion of a high pressure autoclave at a Nitro, West Virginia, experimental laboratory on February 6, 1936, caused the death of C. O. North, founder of the laboratory. At Camden, New York, Dr. Edwin R. Smith, a dentist, was killed when a small vulcanizer burst in his office on September 28, 1935.

Power Boiler Difficulties

Embrittlement

ON inspecting a power boiler at a Mid-West plant, the insurance of which Hartford Steam Boiler was recently asked to take over, the inspector discovered a leaky seam which showed evidence of having been caulked repeatedly in a fruitless effort to make it tight. He noticed, too, that several new rivets had been driven in the seam. Inquiry developed the information that the seam had been giving trouble for some time and that rivet heads had been found broken off

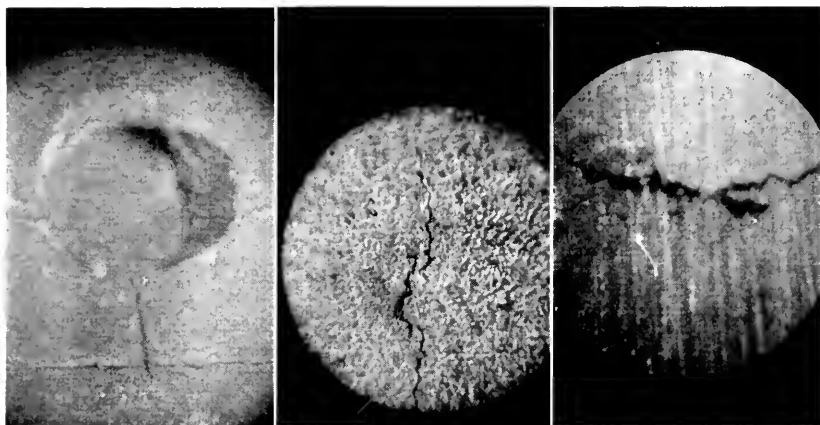

Left—crack which caused the leakage. Center—the crack at the left as it appeared in the rivet hole. Right—characteristic embrittlement cracks with which the plate was affected.

from time to time. As these symptoms pointed to the probable existence of serious distress, the inspector took steps to verify his suspicion. His investigation led to the discovery of a case of plate embrittlement which had progressed to a dangerous degree.

The boiler was of the bent tube type, and of medium size. Its seams were of double-riveted lap construction. The leakage came from a crack in the plate under the lap of the longitudinal seam and since it did not extend beyond the caulking edge of the seam, its presence would not have been suspected by one not conversant with this type of failure. Each time the seam had been recaulked the defect had progressed and further leakage had been increasingly difficult to stop. When the drum was examined in detail, the seam was found to be seriously weakened

for most of its length by a multitude of embrittlement cracks. A test of both the raw and the treated feedwater showed that either could have led to the development of the condition.

Portable Sawmill Boiler

One man was killed and another injured at a portable sawmill in Virginia, when a welded repair broke loose on a locomotive type boiler, causing a rupture the entire length of the longitudinal seam. The barrel of the boiler tore away at the front head and at the throat sheet, demol-

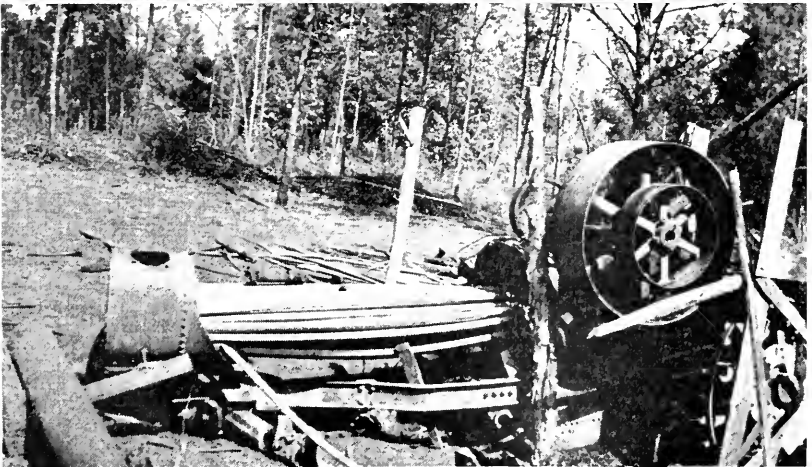

Above—The barrel of the boiler where it came to rest 400 feet from the sawmill. Below—The remainder of the boiler, showing the torn plate.

ished the engine, and came to rest in the forest more than 400 feet away. The internal surface of the shell plate along the longitudinal seam was pitted and grooved throughout most of its length. In the middle of the joint was a $\frac{1}{2}$ " wide weld that had been applied externally parallel to the seam for about 2 feet, obviously to stop leakage, because the pitting and grooving had extended through the plate. The man who was killed was thrown more than 30 feet and the other workman sustained a broken leg and a scalded thigh. The boiler was uninsured.

Scotch-Marine Furnaces Collapse

Two corrugated furnaces in a 103" diameter Scotch-Marine type boiler collapsed at a Pennsylvania textile mill early this year. The fires had been banked, but the fireman had been directed to bring the boiler up to pressure—125 lb. The fireman said that because the gage glass



Collapsed Scotch-Marine boiler furnaces, the result of overheating.

was full of water, he had opened the blow-off valve, letting the water down to about half a gage, but had not disturbed the banked fire. About a half hour later he observed smoke issuing from the front of the boiler and on opening the fire doors saw that the furnaces had collapsed and were pressing against the grates. Whatever the train of events, it was evident that the furnaces, each 36" in diameter and 13'3" in

length, had collapsed because of a condition of low water and over-heating, brought about, probably, because of failure to close the blow-off valve tightly. The replacement of both furnaces was necessary.

Vertical Tubular Boiler Explosions

The explosion of a 48" diameter vertical tubular boiler at a New Jersey laundry caused the death of a watchman and an oil burner mechanic and the severe injury of a boilermaker on January 17, 1936, as they were making repairs to the burner. The upper tube sheet bulged outwardly, breaking away from the tube ends and projecting the stack and breeching upward. The explosion blew off the roof, and broke a large plate glass window about 80 feet from the boiler. The men were blown against the wall of the boiler room and were sprayed with burning oil. This accident was attributed to low water and over-heating in a vessel which, it was reported, was not covered by insurance.

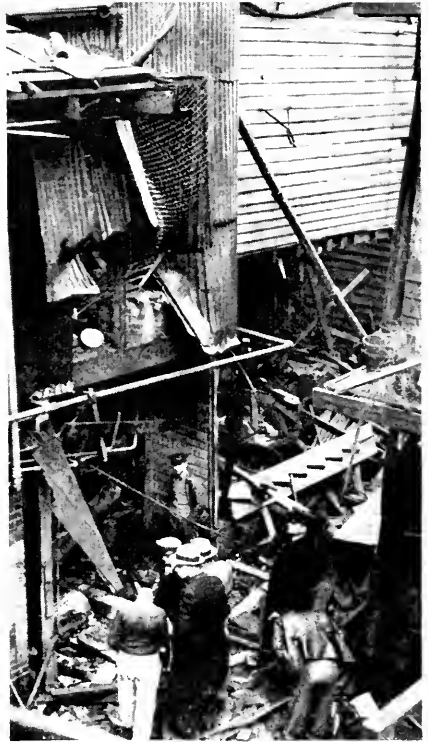

Damage following explosion of vertical tubular boiler.

The explosion of a vertical tubular boiler 30" x 7' at a Southern ice cream plant damaged three buildings, one of which is shown in the accompanying photograph. There was no evidence of over-heating, and the accident was attributed to operation of the boiler at a pressure in excess of that for which it was built. The boiler traveled about 10 feet after the furnace sheet failed.

Thresher Boiler Blast Injures Seven

Seven men were hurt, two of them seriously, when a wheat thresher boiler exploded near Mt. Carmel, Illinois. A newspaper report said a man 100 feet from the thresher was knocked down by the force of the explosion.

Bearing Failures and Their Prevention

AS bearings are common to all sorts of machinery, and as many of the accidents to which machines are subject involve their failure, a discussion of bearings and of practical ways for the avoidance of accidents to them may be of value to many of our readers.

Good bearing experience, of course, is dependent first upon proper design by the manufacturer. It is the manufacturer who usually decides whether sliding contact or roller bearings will be used, how large they will be, of what metals the bearing and the shaft will be made, and what type of lubricant will give the best results. He has a choice of a comprehensive selection of ball or roller bearings, and of several hundred different bearing metal alloys for sliding contact bearings, and he can make his bearings, journals, pivots or other parts in keeping with his views as to efficient and safe operation.

Assuming that a vast majority of bearings are correctly designed for their respective jobs, the difficulties which are encountered in operation fall roughly into four general groups: (1) lubrication failures; (2) breakage, distortion, misadjustment or wear of parts; (3) electric currents in bearings, and (4) miscellaneous troubles caused by faulty maintenance, improper repair, or by carelessness.

I. Lubrication

Just as the design of machines and bearings has improved, so have the manufacturers of lubricating oils and greases brought out better products. In spite of advancements in oil manufacture and educative programs as to lubrication, however, more accidents occur to bearings because of failure of lubrication than for any other reason. Chief among the causes are:

1. Use of the wrong lubricant.
2. Presence of water or other foreign substance, and deterioration of the lubricant.
3. Clogging of oil lines or oil passages.
4. Failure of the oiling devices or oiling system.
5. Loss of oil because of leakage.

Lubrication failure in bearings implies that for one of the above reasons the oil film necessary for the protection of the journal and its bearing has been broken, that the metal surfaces no longer are separated and that the fluid friction of the oil has been replaced by the friction of rubbing metal surfaces.

Every operator is aware of the dangers of substituting incorrect lubricants for the proper lubricant which has been recommended by

the machinery or oil manufacturer. The worst departures come to light in winter when bearings burn out because the oil will not flow due to the cold. Sometimes a heavy oil will get so thick that in ring oil bearings the rings will not turn at all.

At the other temperature extreme, in turbines and engines, sometimes heat radiating through the shaft and other parts has a tendency to over-heat the oil and gradually carbonize it, especially if it is not of the proper grade to withstand the temperatures to which it is subject.

Wherever water-cooled bearings are used, the cleanliness of the water jackets bears a direct relationship to the combined ability of the oil (assuming it is of the correct grade) and the water to carry away undesirable heat.

Oil is rendered less effective by its emulsification with water. This occurs particularly in steam turbines and engines. The water gets into the oil through leaky glands or stopped up sealing gland drains, broken or poorly fitted gaskets on water-cooled bearings, leakage at main shaft packing on turbines, leaks in cooling coils, from the stuffing box in steam engines in the form of emulsified cylinder oil, or as the result of condensation. Tight glands and packing, freedom from water leaks, a double stuffing box or bulkhead on steam engines, and a well-filled oil reservoir will reduce the likelihood of emulsification.

Sludge in lubricating oil is caused by combinations of dirt, acids, precipitated gums from the lubricant, lint and other foreign matter. The presence of excessive sludge puts an added burden on the oil strainers and filters, and because some of the sludge precipitates out at reduced temperatures, it deposits in the cooling coils, oil lines and reservoir. Sludges still soluble at the lower temperatures are carried back into circulation to form deposits in oil pipes and passages in the bearings themselves. Such materials are effective heat insulators and interfere with the cooling process. As the temperature rises the rate of carbonization increases with the eventual result that the oil ceases to lubricate, the bearing metal runs and the shaft seizes. Of course, where the oil is not strained or filtered the results of sludging are accelerated.

The problem of dust and dirt is ever-present. It is particularly troublesome wherever the air contains an appreciable amount of coal dust or such dusts as exist in cement mills, chemical plants, lime and plaster of paris mills, ground stone mills, chocolate factories, cotton gins and similar industries. Some of these dusts act as abrasives; others saponify the oil and help to increase sludging. Various dust-protective devices are necessary to reduce the hazard to bearings in dusty installations.

Accident data also reveals that other things besides dirt now and then cause oil stoppage. A 2" oil line flange gasket wadded in the line of a 12,500 kw turbine, chips of wood in a bearing and in its oil reservoir, sugar in the oil supply of a 250 hp turbine, and sediment introduced from an oil barrel are examples.

Another prevalent cause of bearing seizure is the loss of the oil through leakage from some part of the bearing or the oil lines. Recent examples of this are the breaking of a motor bearing housing, a loose drain plug, a loose sight overflow cup, a broken joint in copper tubing, partly open pet cock on a generator oil gage, broken oil lines on both steam and internal combustion engines, and the loosening of a by-pass valve on a Diesel engine in such a way that all of the oil by-passed back into the crankcase and none of it reached the bearings.

For the avoidance of lubrication difficulties three simple rules should be borne in mind:

1. Use the proper grade and kind of lubricant.
2. Keep the oil and its passages clean.
3. Examine the machine frequently enough to catch leaks and overheating before damage is done, and be sure that oiling devices are functioning properly.

II. Wear, Misalignment, Breakage

While most accidents to bearings are directly or indirectly attributable to lack of lubrication, there are accidents which originate in the failure of some part of the bearing or machine. Among these accidents are those resulting from wear. Some designs of bearings are subject to normal wear which is compensated for by adjustment. If adjustment of such a bearing is not made, however, the result is likely to be unusual vibration or pounding, and excessive wear.

Where oil rings or oil chains are used, particular care should be taken on starting to be sure that the ring or chain is turning. Rings may slip on the journal so that lubrication is impaired and chains and rings have caught on the bearing with serious damage to both bearings and journal. Rings of the hinge type have failed because of the cracking of riveted clamps, and screws in split oil rings have worked out far enough to stop the rings from turning.

Water-cooled bearings sometimes crack if the water is not turned off promptly when the machine is stopped, and sometimes this causes a bowing of the shaft. If the shaft is operated in a bowed condition before its temperature becomes uniform, vibration and permanent distortion may result.

Often softened or ground-up babbitt blocks the oil grooves and holes. The bearing metal may contain tin oxide, a hard substance which is formed when the alloy is "burnt" in melting, or antimony which is not properly distributed. Either may score the journal. With respect to the various alloys, either the manufacturer's recommendations should be followed implicitly or, as is possible in some large plants, a competent metallurgist should be consulted. The practice of locally pouring babbitt is discouraged, except as an emergency measure. A better plan is to have on hand spare bearings supplied by the manufacturer.

Ball and Roller Bearings

Failures of ball and roller bearings, because of their construction and method of operation, are chiefly due to breakage and wear of parts.

Rust, grit, sand, dirt or other similar impurities will bring about quick wear and early failure of such bearings. Therefore, precautions should be taken to keep such bearings clean, if reasonably long service is to be expected.

Accidents to ball and roller bearings are all of the same sort; they involve the inherent mechanism of the bearing. The race becomes loose, the rollers jam, the ball retainer breaks. Irregularities on any of the parts will promptly affect the other bearing parts. It is important when fitting a bearing that no hammer blows be used, as this is likely to result in injury to the races, the balls or the rollers. Overloading and excessive side thrust are also to be avoided, for they are likely to be detrimental.

III. Electrical Currents in Bearings

Occasionally in large electrical machines there is injury to the bearing and journal because of so-called shaft currents. These currents are induced in the shaft and flow through the bearings unless the latter are properly insulated from the base. The resultant arcing from the journal to the bearing causes pitting of the bearing or the shaft or both. Small metallic particles from the pitting pollute the oil and in an aggravated case there is apt to be a burnout of the bearing and injury to the shaft. Large electrical machines are insulated against this trouble by the manufacturer, but difficulties have arisen when the insulation under the pedestals or brackets is not properly installed or when the current finds a path through improperly insulated piping, over-speed devices, hand-rails and other accessories. Injury of the bearing and shaft because of shaft currents can take place slowly or rapidly, depending on the amount of flow, so that discovery of the first evidence of such currents calls for prompt attention.

IV. Maintenance

Bearings are so important to the satisfactory operation of a machine that a few fundamental matters of maintenance should be kept in mind by all operators.

These are as follows:

Select the proper lubricant and thereafter continue its use.

Keep a reserve supply of this lubricant on hand in clean containers.

Check the bearing lubrication *each time* the machine is started. If the machine has been idle for any length of time, remember that the oil has probably squeezed out from between the bearing surfaces. Check self-oiling bearings daily. Keep an adequate quantity of oil in each cup, well or reservoir.

Be sure that oil holes, oil grooves and oil passages are free and that oil is surely getting to the bearing. Clean the bearings and all oil passages, etc., as often as necessary. After cleaning be sure to reassemble the system correctly. Accidents have been caused because check valves were put in backwards, and lines connected so as to by-pass the oil cooler.

The smell of burnt oil is a danger signal. Act promptly.

Burnt bearings are sometimes an indication of some other serious condition, and the reason for the bearing failure must always be investigated.

Stop leaks. Any oil escaping from the system or bearings, either by dripping or atomizing depletes the oil supply and, if electrical machines are present, may damage the insulation. In any event, it represents a waste of oil.

In starting a cold machine, bring it up to speed slowly enough to warm the oil thoroughly and insure proper flow.

Be sure that the bearing itself and lubricating system are properly adjusted, following the manufacturer's instructions in this regard.

Keep oil pumps in good condition and work out a routine which will not permit the starting or the stopping of the machine without adequate oil supply.

If emergency re-babbiting is done in the plant, be sure that the workmen are competent and their direction expert.

Watch bearing wear carefully, especially on rotating electrical machines where a worn bearing may permit the rotor to rub the stator and damage the windings.

Don't neglect bearings on machines in places that are not easily accessible.

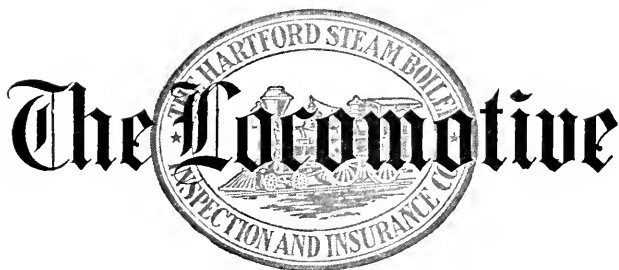

A QUARTERLY MAGAZINE
DEVOTED TO POWER PLANT PROTECTION
Published continuously since 1867

GEORGE H. PRALL, *Editor*

Copyright 1936 by The Hartford Steam Boiler Inspection and Insurance Company

HARTFORD, CONN., April, 1936

Single copies may be obtained free by calling at any of the Company's offices.
Subscription price 50 cents per year when mailed from this office.
Bound volumes one dollar each.

Reprinting matter from this paper is permitted if credited to

THE LOCOMOTIVE OF THE HARTFORD STEAM BOILER INSPECTION AND INSURANCE CO.

D. Newton Barney, Director

D. Newton Barney, a director of The Hartford Steam Boiler Inspection and Insurance Company since 1911, died on February 22, 1936. Prominent in the social and business life of his community, he participated earnestly and tirelessly in the development of many of its financial and industrial enterprises. For thirty years, from 1894 to 1924, Mr. Barney served as treasurer of the Hartford Electric Light Company, and from 1924 until his death, as vice-president. He was a director of several Hartford companies including Colt's Patent Fire Arms Manufacturing Company, and had formerly been on the board of directors of the New York, New Haven and Hartford Railroad and the Ætna Life Insurance Company.

The failure of a lacing wire in the seventh row of blading of a 1250 kv-a. steam turbine unit at a San Francisco paper mill caused the last seven rows of stationary and rotating blading to be stripped, and necessitated extensive repairs. The turbine was out of service for two weeks.

New Diesel Insurance Rating Plan

Although the Diesel engine is not a newcomer among prime movers, in most sections of the country Diesel installations were relatively few until very recently. In the last decade, however, the Diesel has demonstrated beyond question its practicality, and the number of installations has increased at an accelerating pace.

This more general use of the Diesel has centered the attention of operators on the importance of the installation requirements and operating practices necessary to insure satisfactory service. It has also resulted in the development of improved cooling systems and of auxiliaries to the point where a more uniformly lower accident frequency can be anticipated. In view of this, there have been formulated a new rating plan and new insurance rates, which will in general afford substantial reductions over rates previously in force for owners of such installations as conform to improved standards. The new rating plan has been announced as effective on May 1.

The increased use of Diesel engines during the past few years has been accompanied by an increasing demand for insurance on them. Many applications come from plant owners who have Hartford Steam Boiler insure their boilers and steam engines and who thus are familiar with the benefits to the owner arising not only from the indemnity for loss, but also from the periodic inspections for the purpose of reducing the likelihood of accidents to power equipment. The Company furnishes to its Diesel policyholders the same standard of service which characterizes its work with other power equipment, and it aims, as with its other lines, to see that rate changes are made for Diesels as experience proves feasible from time to time. The present rate modification is in keeping with this and should, it is felt, be reflected by an increase in the number of installations protected by the Company's insurance.

Warped Diesel Engine Bed Leads to Breakdown

A RECENT accident to a 1,000 hp Diesel engine illustrates how warping of the engine bed on its foundation can cause vibration and serious damage.

Hartford Steam Boiler learned of the accident when it was asked to insure the engine, which was of the 4-cycle air injection type with eight 17½" cylinders. The engineer in charge said that from the time of its erection the engine had vibrated badly. There had been speculation as to the cause of the vibration, but no complete investigation

had been made. After about nine months of operation, a connecting rod bolt at the wrist pin end of the rod had broken, damaging the engine to the extent of \$25,000.

The inspector first visited the plant shortly after this accident. He found that some of the bearings were being renewed because of excessive wear. While the old bearings were being taken out, a serious crack was discovered in one of the crank pins, necessitating the installation of a new half crankshaft. The necessity for the repair and the history of the engine's performance convinced the inspector that there was some basic difficulty which, unless found and corrected, would cause a recurrence of the failure.

In view of the bad vibration and the breakdown so early in the operating life of the engine, he considered it likely that the alignment of the engine bed was at fault. He knew that it was not unusual for long engine beds to be sprung out of true. With this in mind, he decided that before the crankshaft was replaced he would make a complete check of the alignment. For a distance of about 9 ft. from its free end the bed was perfectly level, but from that point on there was a rise of 8 mils per foot of length, the rise from the true horizontal plane totaling 118 mils or nearly $\frac{1}{8}$ ".

The point where the bed became out of level coincided with the location of the connecting rod in which the bolt had broken with such disastrous results. The crankpin in which the crack had formed was adjacent to this point so that there is little doubt that the excessive misalignment of the bed had been the cause of both failures. It was further found that the generator outboard bearing was out of line with the engine bearings so that the crankshaft was actually raised free of the last engine bearing. This had caused a permanent bend in the generator shaft.

To correct the defects of the installation the engine was raised off the foundation and all the grouting chipped away. Then the engine bed was releveled. The results more than justified the additional cost and loss of time, for the vibration had disappeared completely and the engine operated with no more noise than the smooth hum of a large electric motor.

Had the inspection been made when the unusual vibration was first noticed, nine months of unsatisfactory operation and a costly accident would, no doubt, have been avoided.

Simms: Are you independent on your new job?

Binms: I should say so! I go to work any time I want to before 7 and quit any time I get ready after 5.

Enka l'oice.

Hot Water Tank Explosion Kills School Teacher

A YOUNG music teacher was killed when a hot water supply tank exploded in the boiler room of the consolidated school at Horn Lake, Mississippi, on the morning of February 17. Fortunately a recess saved the children. The sixth grade had left the music room, situated over the boiler room, barely five minutes before the explosion, and the school quartet was due there for rehearsal in another

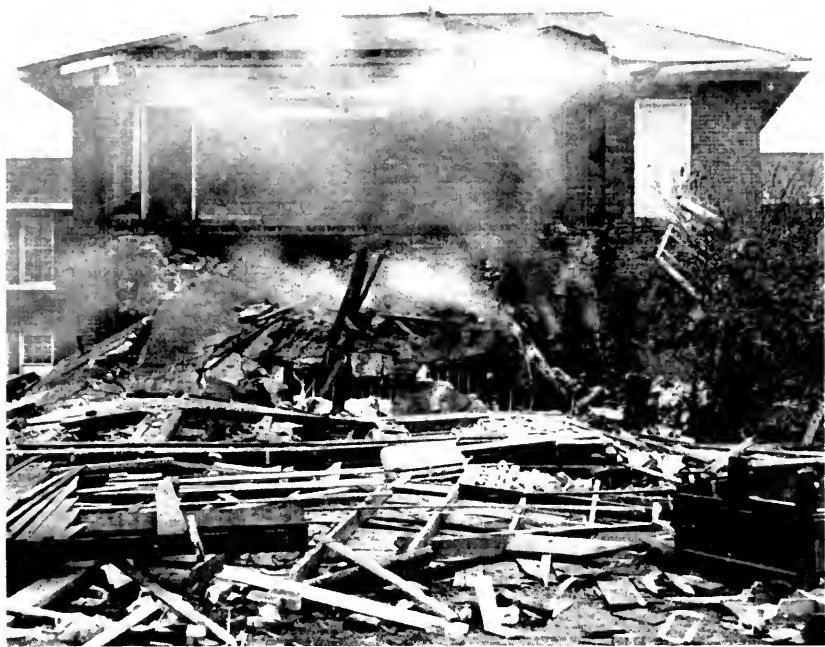

Wreckage of music room and boiler room after explosion.

five minutes. The teacher had just returned from the school cafeteria when the explosion occurred.

Three walls of the boiler room were blown out, the music room was completely wrecked and the teacher was buried under a pile of debris. Students attempting to rescue her were nearly caught by the falling chimney. Both boilers were damaged. In addition to the two rooms which were wrecked, other parts of the building were damaged by falling plaster; walls were cracked and windows were broken. The property loss was estimated to exceed \$5,000. No boiler insurance was carried.

The tank which caused the damage was 24" in diameter and 5' long, and was tested for 75 lbs. working pressure.

Water for it was heated in pipe coils in the fire box of one of two cast iron sectional steam heating boilers. Inquiry subsequent to the accident revealed that there had been a check valve in the cold water supply to the tank and that there had been no relief valve on the sys-

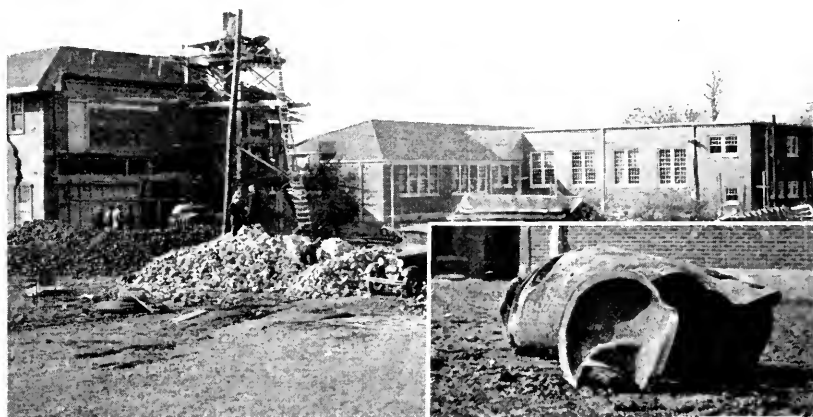

Repairing damage after explosion. Observe the 3' hole (boarded up) in brick wall of gymnasium, extreme right of picture by small double windows. Inset—Remains of tank showing reversed minus head.

tem. As it was a cold day, both boilers were in operation, but due to stoppage of drains in the shower room, no hot water was being used. Pressure built up in the tank until the minus head reversed and tore away, striking one of the boilers. The rest of the tank broke its way through the six-inch reinforced concrete floor of the music room, ripped down one of the brick side walls and hurtled across 150 feet of lawn to the gymnasium where it knocked a large hole in the wall, showering bricks and debris on boys who were playing basketball there.

Going North for Power

Building a hydro-electric plant in rough country, distant many miles from a railroad, is difficult enough—but is hardly to be compared with building one where for several months each year the snow is five to ten feet deep, where the temperature seldom rises to zero and goes as far down as 45° below. Such is the Rapide Blanc plant on the St. Maurice River, 160 miles above Montreal. The equipment was transported over a specially constructed road on truck-drawn trailers capable of carrying 105 tons. Four 36,000 kva generators were installed.

Rapide Blanc is the fifth and northernmost hydro-electric plant on the river, bringing the total power developed to 779,000 hp.

Manhattan Power Interruption

THE contention that no switching equipment is proof against every possible combination of hazards seems to have been borne out by an accident at the Hell Gate station of the United Light and Power Corporation in New York City on the afternoon of January 16, 1936. This up-to-date station was not only completely shut down, but found itself without immediate means of using the ties through which it could serve its district with power from other metropolitan power plants or up-state power sources. There was available enough capacity to supply the system, but so much switching equipment and so many transformer fuses had been affected by the disturbance and by attempts following it to restore current quickly that not until early the next morning was service generally normal.

Manhattan between 59th and 129 Streets was the area worst affected because of a lack of alternating current. Lights were out, the "Independent Subway" was tied up for lack of signal lights, many elevators would not run and the bells for others were silent, water pumps could not be worked, some movie theatres were dark; stores, radio stations, telegraph offices, police communications—all were inconvenienced. It was estimated that 125,000 New Yorkers were late to dinner and that when they did arrive, dinner was by candlelight.

What operators of power plants everywhere have been studying ever since the accident was how it could have occurred in the face of the manifold precautions against trouble, and what could be learned from the accident to prevent such occurrences in the future.

When the Hell Gate station was built, one of the most conspicuous electrical characteristics was the method of installing the buses and the switching equipment. Phase isolation of all electric currents and equipment, and the introduction of circuit breakers and disconnecting switches with operating mechanism on the floor above were provided. These innovations were considered outstanding and it was believed that the possibility of a phase to phase breakdown had been entirely eliminated.

On January 16, the station was operating normally under a load of 700,000 kw supplied from the station generating equipment and from the company's other stations through inter-connections. At 4:11 P. M. an operator passed through the electrical gallery and noted that all switching equipment was apparently operating normally. At 4:16 P. M., when the station was at peak load, brought about by the time of day and the fact that it was raining and dark, the operators in the control

room noted a power disturbance. The automatic switches on the tie lines immediately opened, thus clearing all inter-connections with other generating stations. Almost simultaneously the feeder circuits opened and stopped all power output.

Evidently faults to ground occurred on opposite phases of the main and auxiliary buses, but which fault originated the trouble could not be determined. Ensuing fire destroyed any evidence that may have remained after the electrical disturbance. The two grounds resulted in a phase to phase fault and it was further discovered that sufficient current was carried to ground through the No. 9 generator neutral to burn it open. Owing to the location of the neutral switches for the other generators, these switches were damaged at the time of the failure of the oil switch in No. 9 generator neutral ground. This failure set fire to the whole switch structure in the basement.

Quite extensive damage was done to the electrical gallery in the locality of the grounds on the bus system and, on further investigation, it was found that the rotor wedges of one of the 160,000 kw generator fields were damaged, indicating that this generator received a heavy single phase load or else a decidedly unbalanced polyphase load of such current magnitude as to cause the damage.

Immediately after the accident an attempt was made to place in service the Sherman Creek Plant, located in Harlem, in an endeavor to pick up some of the distribution load. However, in attempting to place load on this plant, steam pressures dropped, and a reduction in frequency and voltage caused many fuses in the secondary circuit to blow on the distribution transformers feeding various areas, the most important of which were those supplying large power customers such as industrial plants, apartment houses and office buildings. In addition there was damage to outside oil switches, among them a 132,000-volt oil circuit breaker located at the Mt. Vernon sub-station several miles distant. This circuit breaker exploded.

To overcome the difficulty of restoring service because of failure of the secondary fuses on the distribution transformers, the power company allotted each available member of its personnel a certain district in which they were instructed to open all entrance switches of the larger light and power customers. Then the load was picked up customer by customer by successively closing the entrance switches at each customer's connection. In this way the facilities assimilated a gradually increasing load and thus ultimately took over the normal needs of the area.

Did you ever see anybody who did not have a weakness for punching the fire?

Japs From the Old Chief's Hammer



THE Old Chief sat chuckling over a couple of inspection reports he had saved out from the day's batch. Tom Preble, his assistant, heard him mumbling amusedly, "A black cat, an owl and a black widow spider . . ."

"What are you going to use them for — witches'

broth?" asked Tom, grinning over at the old fellow.

"Huh?" snapped the Chief. "Oh, was I talking out loud? Well, here are a couple of reports that gave me quite a kick. Just listen to this, will you!

"Jim Dakin went over to Manville to find out about that hot water tank explosion. The tank wasn't insured, but as he wanted to study the cause of the accident, he visited the place and then wrote me as follows:

"The explosion was in the basement of a general store, and when I arrived a day or two afterward much of the debris had been cleaned away. In the meat department of the store was a very big and very old black cat contentedly eating from the meat scrap box. I commented to the butcher about the cat's size and his obvious age.

"Sure, and he's a good old fellow, too," said the butcher. "I just got him back. Several days ago I gave him to a fellow up the road, but after that boiler exploded, I went after him and brought him back. Believe me, I'm going to keep him this time. No boiler ever exploded while he was here."

"I thought at first he was joking, but one look at him convinced me that he wasn't. He was downright serious. It wouldn't have done any good to point out that what he called a boiler was just a hot water tank, that it had no safety or relief valve and that the explosion was undoubtedly caused by over-pressure."

"You know, Tom," the Old Chief commented, "there's something eerie about black cats. I'm not superstitious any more than you are, but didn't you ever drive along and see a black cat by the side of the road, and just sort of hope the rascal wouldn't cross the road in front of you?"

"I don't know, Chief," Tom said, "I'll notice next time. But what about the rest of the menagerie? The owl and the spider."

"That's a good yarn, too," replied the Old Chief. "Sam Renner tells about it in this other report. He was making a regular inspection of a small Scotch Marine boiler of the dry back type with the man-hole in the front head above the tubes. His report does the story justice. I'll read it.

"The boiler room was rather dark," Sam writes, "and I was using my flashlight. I opened the smoke box door and proceeded head first up under the breeching. This particular boiler room always has a plentiful supply of black widow spiders. I killed one on my last visit there. As the manhole opening is a favorable place for a spider web, I ran my hammer handle around inside the opening, as a precaution before crawling in. I didn't go very far, for just then, like a hand reaching out of the Beyond, something clutched at my boiler suit hood.

"Needless to say, I could not have ducked faster had Joe Louis aimed a right hander at my chin. Having fully recovered, I flashed my light up into the breeching and found that a large bird was perched on the edge of the breeching at the foot of the stack. Now, how should I get him out of the stack without injuring him? As necessity is the mother of invention, I decided on a hook—(this is NOT a fish story)—so found a piece of wood and some wire and made a hook out of the wire and attached it to the stick.

"Gingerly, Mr. Bird was hooked by one talon and I carefully pulled him out of the breeching. Applying a full Nelson on both wings, I was able to get a look at him. He was a large owl and had taken on a rather black outlook on life for which he could not be blamed, considering the sooty condition of the breeching. Face to face, the first thing he did was to wink one eye at me. To make a long story short, I deposited my new friend outside the boiler room where he made a perfect take off, and the last I saw of him he was sailing over an adjacent grove. He must have gone to considerable trouble to enter the smoke stack as this stack is fitted on top with a spark arrestor.

"By this time my hands had become sooty so I picked up a rag lying on the boiler room floor to wipe my hands of the whole sordid affair, and believe it or not, out of the rag dropped a black widow spider'."

"Tom," commented the Old Chief, "if I didn't know Jim and Sam so well I'd be apt to suspect the influence of a man named Baron Munchausen, but fact always has been stranger than fiction."

Open Flame Ignites Gas in Steam Engine Piston

EVERY automobile user knows that it is dangerous to hold a lighted match over the gasoline tank opening in order to see if there is any gasoline left in it, but few people would expect that a hollow piston of a steam engine could contain explosive gases. An unusual and freakish accident occurred recently to prove once more that the use of an open flame to light a space that has been hermetically closed for some time may be a dangerous procedure.

It was found that there was a detonating mixture in the 13" hollow piston of a 25-year-old steam engine. The piston was taken out of the cylinder and, together with the rod, was placed in a vise. There were four screwed plugs in the end of the piston. A mechanic unscrewed one of the plugs and lit a match to inspect the interior. As soon as the flame was held in front of the hole there was an explosion and a flame shot out of the hole for a distance of about 4 feet. The engineer of the plant, who had served for some years in the Navy, remarked that the explosion was like the discharge of a 6" gun. The piston did not break apart but the explosion of the gases discharged numerous small pieces of metal and carbon. Pieces of carbon were embedded in the mechanic's face and he was badly burned. It was only by the fortunate fact that he was wearing glasses that his eyesight was saved, but his glasses were broken and the frame was bent.

An assistant, who was standing about 6 feet away but directly in front of the piston, was hit by solid particles of carbon and metal which passed through his clothing and became embedded in the skin of his chest.

It is interesting to speculate what strange gas mixture was in this piston to explode with such great violence after 25 years.

"Are you positive," demanded counsel, "that the prisoner is the man who stole your car?"

"Well," answered the witness, "I was until you cross-examined me. Now I am not sure whether I ever had a car at all."
Trumbull Cheer.

Wash: Yo' hear 'bout dat new car ah got? Boy she got some speed!

Mose: How fast is she?

Wash: Boy, she's so fast dat when Ah streaks down de line all de hogs side de road look like link sausage.
The Standard.

An old Indian came to town one day, and for the first time he saw a man riding a bicycle.

"Ugh!" he exclaimed. "White man heap lazy. Sits down to walk."

Quaker Crax.

The Hartford Steam Boiler Inspection and Insurance Company

OF HARTFORD, CONN.

December 31, 1935

Capital Stock, \$3,000,000.00

ASSETS

Cash on hand and in banks	\$601,612.42
Premiums in course of collection (since October 1, 1935)	1,121,318.19
Interest accrued on mortgage loans	40,086.52
Interest accrued on bonds	103,099.37
Loaned on mortgages	518,545.00
Home Office real estate and Philadelphia branch office	542,474.66
Other real estate	264,909.47
Bonds on an amortized basis	\$9,382,820.63
Stocks at market value	<u>6,537,479.36</u>
	15,920,299.99
Other admitted assets	<u>30,706.39</u>
<i>Total</i>	\$19,143,052.01

LIABILITIES

Premium reserve	\$7,215,766.14
Losses in process of adjustment	272,174.24
Commissions and brokerage	224,263.64
Other liabilities (taxes incurred, etc.)	<u>565,861.62</u>
<i>Liabilities other than capital and surplus</i>	\$8,278,065.64
Capital stock	\$3,000,000.00
Surplus over all liabilities	<u>7,864,986.37</u>
Surplus to Policyholders	10,864,986.37
<i>Total</i>	\$19,143,052.01

WILLIAM R. C. CORSON, President and Treasurer

BOARD OF DIRECTORS

LUCIUS F. ROBINSON, Attorney, Hartford, Conn.	SAMUEL M. STONE, President Colt's Patent Fire Arms Mfg. Co., Hartford, Conn.
JOHN O. ENDERS, Chairman Executive Committee Hartford National Bank & Trust Co., Hartford, Conn.	SAMUEL FERGUSON, Chairman Board of Directors The Hartford Electric Light Co., Hartford, Conn.
MORGAN B. BRAINARD, President Etna Life Insurance Company, Hartford, Conn.	HON. JOHN H. TRUMBULL, President The Trumbull Electric Mfg. Co., Plainville, Conn.
CHARLES P. COOLEY, Chairman Board of Trustees Society for Savings, Hartford, Conn.	CURTISS C. GARDINER, Vice President The Hartford Steam Boiler Inspection and Insurance Company, 60 John Street, New York.
HORACE B. CHENEY, Manchester, Conn.	JAMES L. THOMSON, Chairman Finance Committee Hartford Fire Insurance Company, Hartford, Conn.
JOSEPH R. ENSIGN, President The Ensign-Bickford Co., Simsbury, Conn.	PHILIP B. GALE, Chairman Board of Directors Standard Screw Co., Hartford, Conn.
EDWARD MILLIGAN, President Phoenix Insurance Co., Hartford, Conn.	JOHN J. GRAHAM, Vice President The Hartford Steam Boiler Inspection and Insurance Co., Hartford, Conn.
WM. R. C. CORSON, President The Hartford Steam Boiler Inspection and Insurance Co., Hartford, Conn.	

Incorporated 1860



Charter Perpetual

Department

Representatives

ATLANTA, Ga., Citizens & So. Nat. Bk. Bldg.	W. M. FRANCIS, Manager. C. R. SUMMERS, Chief Inspector.
BALTIMORE, Md., 704-9 Garrett Building	D. W. LITTLE, Manager. R. P. GUY, Chief Inspector.
BOSTON, Mass., 87 Kilby Street	A. PAUL GRAHAM, Manager. W. A. BAYLISS, Chief Inspector.
BRIDGEPORT, Conn., City Savings Bank Building	W. G. LINEBURGH & SON, General Agents. A. E. BONNET, Chief Inspector.
CHICAGO, Ill., 175 West Jackson Boulevard	P. M. MURRAY, Manager. C. W. ZIMMER, Chief Inspector.
CINCINNATI, Ohio, 1904-12 Carew Tower	JAMES P. KERRIGAN, Manager. W. E. GLENNON, Chief Inspector.
CLEVELAND, Ohio, 1040 Leader Building	ARTHUR F. GRAHAM, Manager. JOHN L. SCOTT, Chief Inspector.
DENVER, Colo., Gas & Electric Building	J. H. CHESNUTT, Manager. JESSE L. FRY, Chief Inspector.
DETROIT, Mich., National Bank Building	L. L. COATES, Manager. THOMAS P. HETU, Chief Inspector.
HARTFORD, Conn., 56 Prospect Street	F. H. KENYON, Manager. A. E. BONNET, Chief Inspector.
NEW ORLEANS, La., 333 St. Charles Street	R. T. BURWELL, Manager. P. E. TERROY, Chief Inspector.
NEW YORK, N. Y., 90 John Street	C. C. GARDINER, Vice President. J. F. HUNT, Chief Inspector.
PHILADELPHIA, Pa., 429 Walnut Street	A. S. WICKHAM, Manager. S. B. ADAMS, Chief Inspector.
PITTSBURGH, Pa., Arrott Building	WILLIAM P. WALLACE, Manager. J. A. SNYDER, Chief Inspector.
ST. LOUIS, Mo., 319 North Fourth Street	CHAS. D. ASHCROFT, Manager. EUGENE WEBB, Chief Inspector.
SAN FRANCISCO, Cal., 114 Sansome Street	C. B. PADDOCK, Manager. L. E. GRUNDELL, Chief Inspector.
SEATTLE, Wash., Arctic Building	E. G. WATSON, Manager. WILLIAM J. SMITH, Chief Inspector.
TORONTO, Ont., Canada Federal Building	H. N. ROBERTS, President The Boiler In- spection and Insurance Company of Canada.

CARNEGIE LIBRARY
JUN 1936
OF PITTSBURG.

Send Inspector Jones!

Flood waters had inundated the industrial section of an eastern city. As they receded plant officials and engineers were fighting desperately to restore their equipment to service. Machines that had been flooded presented a serious problem. Help was needed. The telephone system was out. . . . And then two plants, almost simultaneously, got word to the local broadcasting company—"Send out a call for Inspector Jones of Hartford Steam Boiler."

Inspector Jones received the message, got to the plants, and rendered the sort of service which Hartford Steam Boiler's organization is designed to give its policyholders in times of trouble. These two cases were spectacular as to the method by which the call for help was sent. However, they did not differ otherwise from hundreds of instances in which Hartford Steam Boiler helped its assured during the recent disastrous floods. The Company is justifiably proud that for all its policyholders some "Inspector Jones" is "always on call."

Vol. 41 No. 3

JULY, 1936

The Locomotive

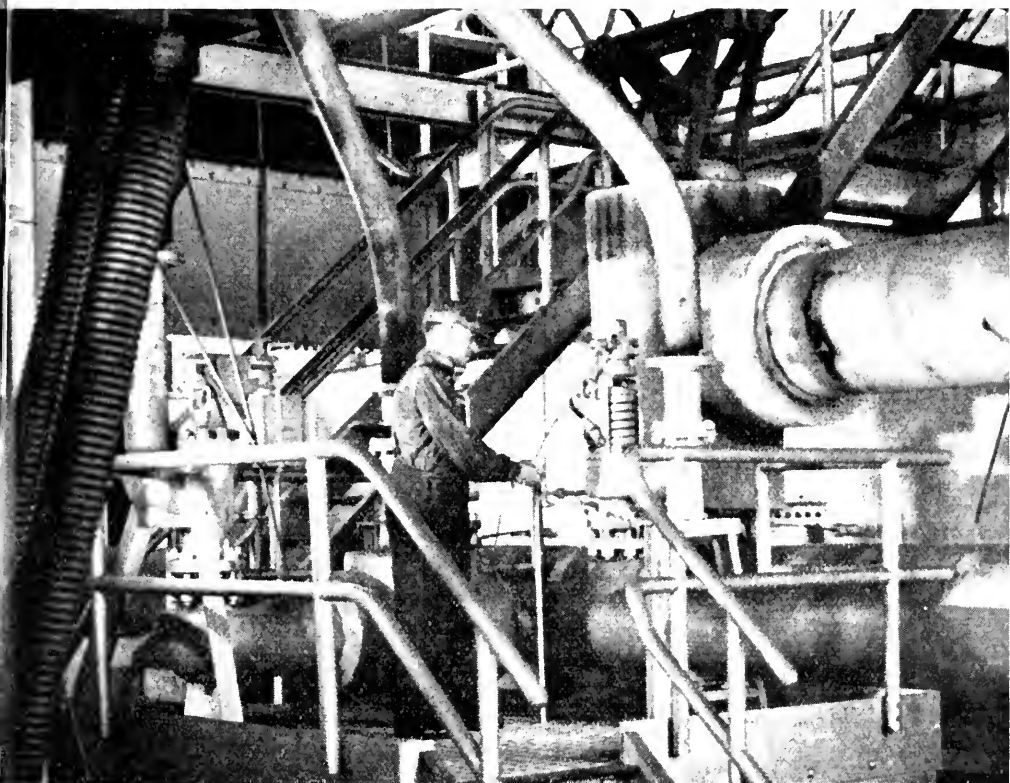

A Quarterly Magazine Devoted to Power Plant Protection

Please Show to Your Engineer

Rehabilitation of Electrical Equipment Following the 1936 Floods

By J. B. SWERING, Chief Engineer, Electrical Division

BECAUSE the 1936 flood levels in many localities topped all previous records, many of the more modern utility and industrial plants, which heretofore had felt secure from flood damage, were inundated in spite of the fact that engineers had designed and waterproofed many of their structures well above any previously known high water-level. Precautions which had been considered more than ample in the past proved no bulwark against persistently rising streams. Silt laden water, carrying destructive debris, slogged and battered through dikes and, in spite of all that men could do, made plant operation impossible.

Included in the damaged property were hundreds of rotating electrical machines and other electrical apparatus, so that when the flood waters receded, operators were confronted with a problem of staggering proportions, which had to be solved quickly and safely. While the water was still rising, "Hartford Steam Boiler's" engineers were being concentrated in flooded areas, and assured were being contacted. Manufacturers of equipment that had been inundated and electrical service organizations were doing likewise. As soon as the water level permitted, every available facility was called upon to contribute to the rehabilitation.

Initial efforts in the rehabilitation of stricken areas were concentrated on pumping plants, first because drinking water was needed, and second because water, clean water, was essential for the clean-up work. Silt, mud, and debris covered everything that had been flooded, and water under pressure proved the most effective initial cleaning agent. Tons of mud and other debris had to be removed before the job of drying out and reconditioning damaged electrical equipment could begin. While water under pressure usually was advantageous for flushing the silt from electrical apparatus, in a few isolated cases the normal pressure was too great, and the insulation was impaired.

Some of the easily movable equipment had been disconnected and moved to high ground before the flood waters could reach it. However, much remained in place, and such equipment, including small motors and other miscellaneous electrical apparatus, later had to be removed from foundations and taken to service shops where cleaning and drying out facilities were available.

It was in connection with large electrical machines, which it was

inadvisable to move, that the ingenuity of the owners and outside service organizations was required. There was no established procedure which could cope with all the situations encountered. In each case, it was obvious that in some way heat had to be applied to the windings to drive out the moisture. The ideal condition was a combination of heat and vacuum, but as the latter was impractical except in specially equipped service shops, the only drying medium available in most instances was a clean supply of heated air. External heat was supplied from charcoal burners, space heaters where electric current was available, and unit steam air heaters and steam coils when there was a steam supply. In some plants all of the above heat sources were used. The heated air was circulated through the machine which in some cases was covered by a vented tarpaulin. In other instances the machine was totally housed in a hurriedly built temporary enclosure that was so vented as to permit moist air to escape.

In a few cases heat treating ovens in steel mills were used to dry out electrical equipment. Some damage resulted because too high temperatures were accidentally permitted; operators found it difficult to control such ovens at the required drying out temperatures which were much lower than those at which the ovens normally operate.

If facilities were available, the machine was driven to produce a fanning effect which helped materially in drying the external surfaces of the insulation. It was important to start the drying out process at low temperatures, and then gradually increase the heat to the maximum safe temperature for the class of insulation in the machine.

A separate log was kept for each machine. Operators recorded the temperature, insulation resistance and other information of value hourly in judging the progress of the drying out and the machine's fitness for actual service. Graphs illustrating drying out routine are shown on page 71. Where the machine was equipped with Class "A" insulation (cotton, silk, paper, and similar organic materials that have been impregnated), a temperature of from 80° to 85° C. maximum was maintained. Class "B" insulation (mica, asbestos and similar inorganic materials in built-up form combined with binding cement) permitted the use of maximum temperatures as high as 90° to 95° C. It was found that the older type windings in many instances dried out quickly, while considerable difficulty was experienced in getting moisture out of comparatively new windings. Where the insulation consisted of mica and asbestos tape well impregnated, the higher maximum temperatures could be maintained but the drying out time was longer.

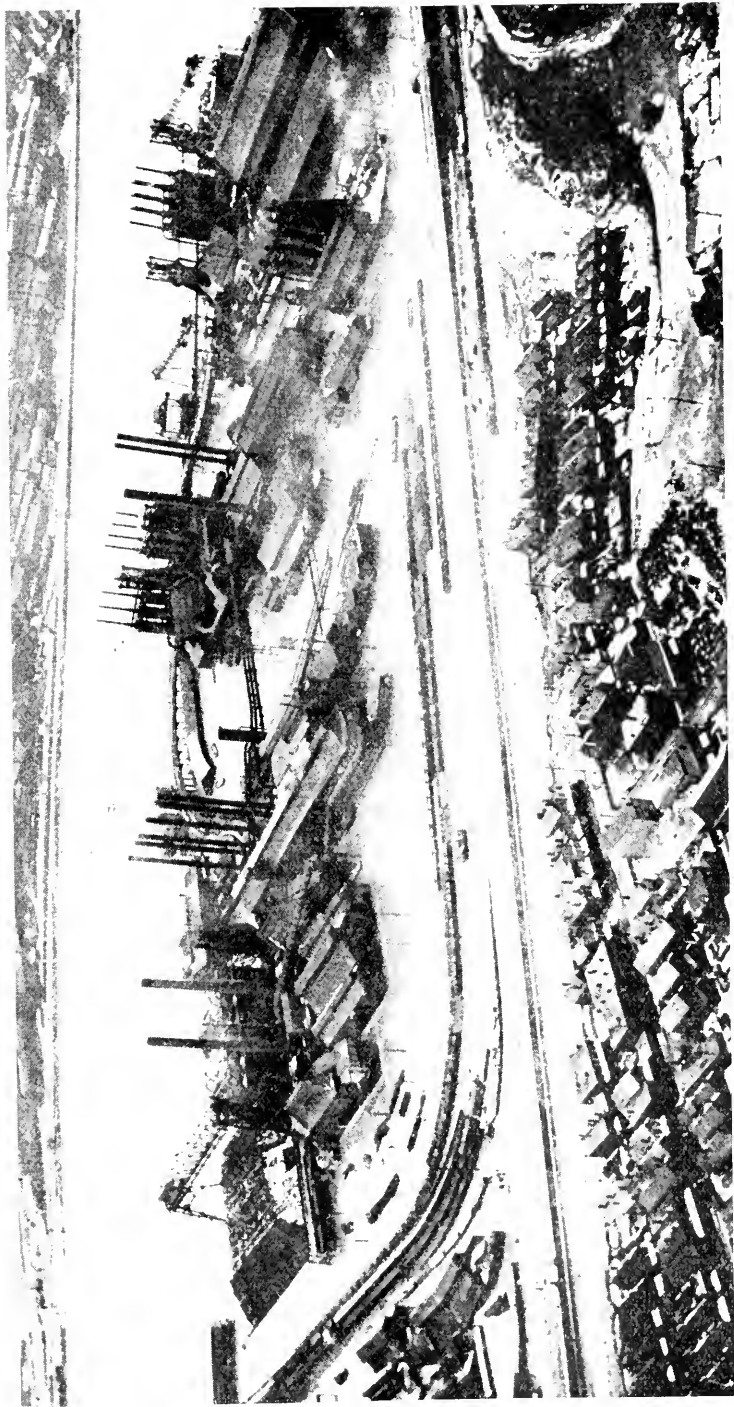

Part of the flooded area in the Pittsburgh section. Hundreds of electrical machines were inundated in these steel mills and in many other industrial plants both in this and in other areas.

The temperature of the windings at the time of inundation had a bearing on the amount of moisture absorbed by the insulation. For instance, in one case three turbo-generators were involved. The No. 1 unit was cold and had not been in operation for several days; No. 2 unit was taken off the line a few hours before it was flooded, and No. 3 unit was shut down only a few minutes before the water reached it. In drying out these machines, satisfactory insulation resistance readings were obtained first on unit No. 1, then on No. 2 and last on No. 3.

Generators with cooling systems were dried out first by blowing heated air through the regular air ducts. When the drying out process had reached a point where it was considered safe to circulate current through the windings, the leads of the machines were short-circuited and excitation gradually increased to bring up the temperature of the insulation. With full load circulating current flowing in the windings, it was necessary in some instances to adjust the gates in the air ducts to maintain maximum temperature of the windings.

In drying out some of the smaller machines, where exciters were not available, the excitation was obtained from storage batteries.

No current was applied to a winding that showed a grounded reading or an insulation resistance value less than 50,000 ohms. In fact, a reading of at least 50,000 ohms was required for several hours before it was considered advisable to apply circulating current, even at low voltage.

In each case, when the motor or generator had been thoroughly dried out, it was recommended that it be dismantled, and the windings further cleaned and treated with insulating varnish. The brush rigging also was dismantled and the insulation thoroughly dried and examined for faults.

When the windings had been exposed to oil and grease, carbon tetrachloride or some other suitable grease solvent was used to clean them. Caution was exercised to protect workmen using these cleaning fluids from injury from possible fire or harmful gases.

The laminations were cleaned with brushes and special attention was given to the ventilating ducts or passages.

Reports from some plants were that oily windings did not absorb as much moisture as clean windings. In the cases observed, the presence of oil and grease apparently made no difference.

The procedure followed in drying out a large reversing blooming mill motor was typical of the work. Steam being available, four unit steam heaters were placed, one in each corner of the motor pit. Baffles were built to direct the air to the bottom of the pit, and the

motor was covered with a vented tarpaulin. In order to obtain the higher temperature required to dry out the commutator, space heaters were installed about the commutator surface. (Further comment on commutators in general will be found later in this article.) When the condition of the shunt field indicated that it was safe to apply circulating current, a welding generator was used to supply this power.

In some instances in drying out the rotors of large wound rotor motors, it was found helpful to occasionally rotate them about 180° . The change in rotor position seemed to have a definite effect on the time required to dry out the machine.

Among the equipment handled were several direct current generators which had seen many years of operation. They were dried out, reconditioned and returned to service. These generators are still operating and the insulation resistance values so far have been satisfactory.

Machines equipped with bands occasionally required new bands, as these parts were found loose due to the shrinkage of the insulation after drying out.

Difficulties were experienced with field coils due to warped or cracked insulating washers after drying. In many cases it was necessary to remove the field coils from the pole pieces, thoroughly dry them, reinsulate and reassemble.

Wedges proved troublesome on a number of machines. The fine silt carried by the flood waters was deposited beneath them in such a manner that they had to be removed and the slots carefully cleaned. Sometimes wedges were found to be cracked, warped or had loosened in their slots.

Bearings were dismantled, and oil reservoirs and oil lines thoroughly cleaned. Dismantling of ball and roller bearings was important, as the silt was extremely fine and entered even the smallest of openings.

The drying out of commutators presented other problems. It was necessary to take out a few of the V-ring bolts in order to expel the moisture from the internal parts of the assembly. Temperatures as high as 130° to 135° C. were used, depending on the size and type of the commutator. This heat was obtained by using space heaters clamped to the commutator surfaces. In one instance on an 83" diameter commutator fifty-five 500-watt space heaters were clamped around the external periphery of the commutator. To permit the escape of moisture one V-ring bolt was taken out, the next two left in, and so forth around the commutator. No short cuts were found for this work, or for that matter for any of the drying out, and in some instances the process required from 10 to 12 days.

In one case operators erected a large brake around the upper part of the commutator and the commutator was rotated against the brake shoe in an effort to dry the commutator by the friction method. This was not entirely successful. Gas torches also were used against the rotating commutator, but with this method there was always the possibility of unequal heating and fire. A practical test for moisture in commutators was obtained by holding eyeglasses near the open bolt holes. If the glasses clouded, it was a clear indication that moisture was being driven off.

After a commutator was dry, as indicated by an insulation resistance test, the bolts were replaced and all of the bolts tightened. The bolts which had not been touched previously often could be tightened by as much as a flat to a flat and a quarter on the bolt

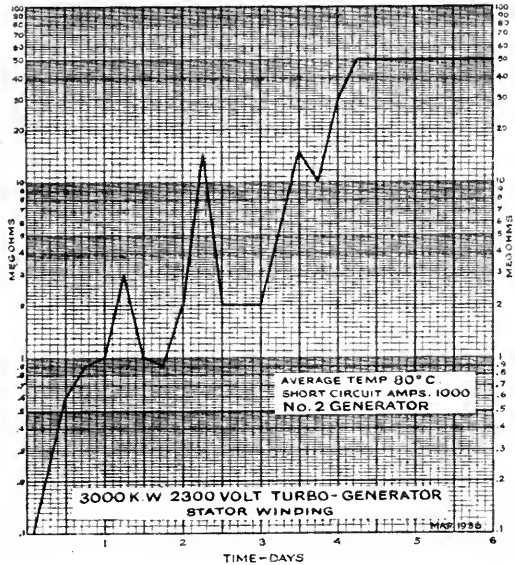
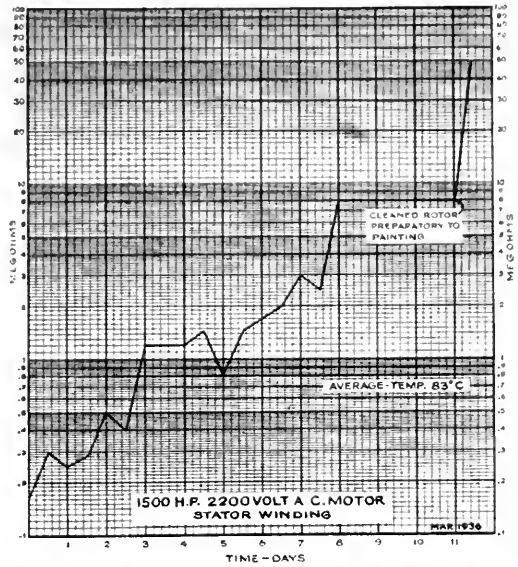

Representative graphs from log readings taken while drying out rotating electrical machines.

heads. Following this, the commutator was turned and polished.

The matter of drying out control equipment did not offer so many difficulties. In most instances the coils could be removed and dried, re-insulating being done where necessary. Relay coils were replaced wherever new ones were available; otherwise they were dried out and retaped, as usually it was found that the old insulation was brittle and unserviceable when dry.

All parts of relays had to be dismantled, thoroughly cleaned, re-lubricated, re-assembled and adjusted.

Lead covered cables in many instances were difficult to dry out as they could not be pulled from their ducts satisfactorily. Ordinary rubber covered wire proved easier to handle. In most cases rubber covered wire was pulled, and the ducts were cleaned of silt. The wire was reeled and placed in an oven, thoroughly dried and then repulled into the conduit. Control wiring was pulled from its conduit, the conduit cleaned and usually new wiring installed. In some cases even new cable protected with potheads was not proof against moisture, and it is expected that the flood experience will tend to encourage better cable installation and perhaps some improvement in construction.

Some of the submerged meters were beyond repair. Jewels and rotating elements were badly damaged, shafts and pointers were corroded. When repair of such instruments was possible, it was recommended that the meters be returned to the manufacturer.

Transformers for the most part escaped the serious damage suffered by other electrical equipment because most of them were located high enough to be safe. When transformers were flooded, it was necessary to remove the oil and dry them out thoroughly.

Some concern is expressed for equipment in certain areas where the flood waters were highly corrosive. It is questionable whether the drying out has eliminated entirely the danger of chemical attack. Only time will show whether the damage from this cause is serious.

Time also will be required to determine whether the drying out processes themselves have done any harm.

A tribute is due the men who fought the flood, in some cases knowing that their homes were under water as they worked faithfully at the plants serving their communities. Commendation also is in order for the thoroughness and care with which they went about their work. Not a single electrical accident has been reported in which men were hurt. It is amazing in view of the high tension, long hours, and adverse conditions that so few errors were made in wiring and other details. In fact, it was observed that the emergency for the most part led

to even more care in reassembling controls and other parts than is normally found in such work. Checking and rechecking of equipment as it was prepared for service revealed extremely few mistakes. Plant men and manufacturers and other service engineers deserve unreserved praise. At no time was any complaint heard with respect to hardships and long hours. There was a job to do, and it was a pleasure to see how well it was done.

Using Coal and Oil Mixed for Boiler Fuel

A process for the production of liquid coal, a mixture consisting of coal particles suspended in oil, is being operated at the works of Wyndham's Marine Patents, Ltd., Cardiff. The proportion of the constituent coal and oil can be varied. The most satisfactory mixture for general use is said to be 50 per cent coal and 50 per cent oil, although satisfactory results have been obtained with 60 per cent coal and 40 per cent oil. No stabilizer is required to keep the coal particles suspended in the oil.

The plant consists of a hopper, from which washed fine coal is fed into a chamber where it is mixed with a corresponding amount of heavy oil and discharged into a mill. Here the paste is combed and straightened out on its way to a pump which passes it on to another mill. The size of the particles leaving this second mill is, roughly, 100 per cent through a standard 60 mesh. The mixture, now fairly stable is pumped to other mills where the particles are further reduced to a fineness of 99 per cent through a 200 mesh.

To obtain the best results in raising steam, the fuel is pre-heated on its way to the burner to about 200° F., the pressure on the fuel being from 15 to 20 lb per square inch and the air pressure 2 lb. Among the advantages claimed for the process are: The complete absence of by-products, no chemical processes involved, and low production costs and maintenance charges. The plant at Cardiff is capable of producing 100 tons of fuel in a week of 160 hours.

It is claimed, on account of the fineness of the ground particles of coal and the construction of the burner, that combustion of the coal and oil takes place almost simultaneously. The fuel is stable for a minimum period of four months at normal temperatures (and for much longer periods if sealed containers are employed) and can be pumped at all ordinary temperatures—even at freezing point. Seventy per cent of the coals mined in Great Britain are said to be suitable for the process.—

Industrial Power.

An Inspector Recommends the Obvious

A Hartford Steam Boiler inspector entered the boiler room of a hospital one cold morning last winter and found the fireman anxiously watching the water glass of the No. 2 boiler and the water glass of the feedwater tank. The engineer, the attendant explained, was down at the river where for several hours he had been trying to thaw out the pipes that supplied all of the water for the institution. The inspector's inquiries revealed that the fire service tank was frozen and the boiler would have to be taken out of service within half an hour if they could not get water. This, said the fireman, would leave the hospital without heat.

"Why not use the water in No. 1 boiler?" asked the inspector. The fireman looked at the standby unit as if it had just appeared from some distant land. But water was what he wanted and in No. 1 boiler there was plenty.

Flywheel Explosion

PROCESSING machines in a Southern textile mill in February began to speed up to such an extent that the operators shut them down. The reason for the trouble was made manifest a few seconds later when the 14' flywheel on a Corliss type steam engine exploded because of over-speed, the accident wrecking the engine,

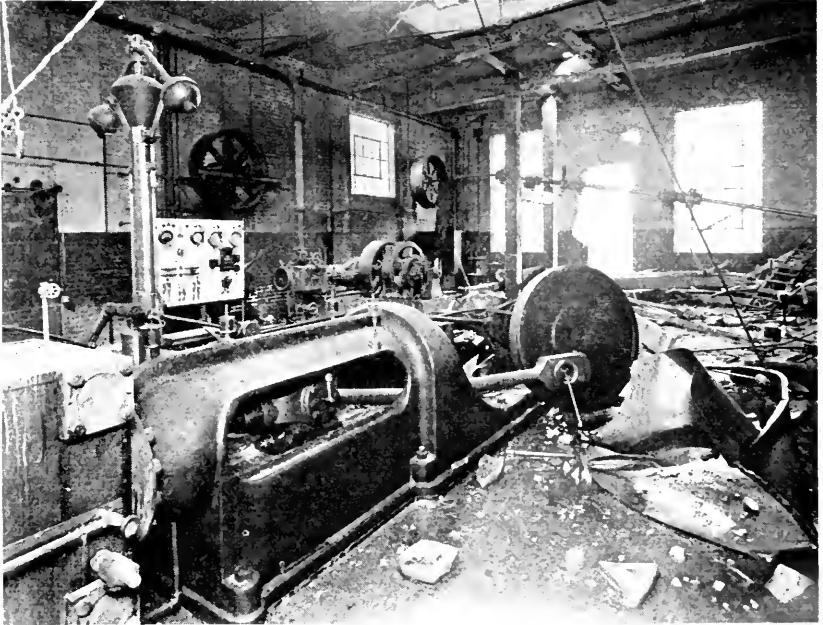

Engine room after the flywheel exploded and wrecked the engine.

and damaging other machines, shafting, belting, sprinkler pipes, walls and roofs. The damage exceeded \$12,000. Parts of the wheel cut great gaps in the engine room roof, and metal and other debris was scattered over the property adjacent to the plant. A piece of the wheel about 70 lb in weight was found 1600 ft from the engine room. While several theories were advanced as to the cause of the accident, the facts obtainable with respect to it did not lead to a conclusive explanation. The most likely cause was the failure of the governor belt.

Carl P. Leckner, Littleton, N. H., jeweler, recently completed one of the world's smallest workable steam engines. His masterpiece has a cylinder 7-16 of an inch long, 3-4 of an inch high, made from a .22 cartridge. A tablespoonful of water will half fill the boiler and run the engine for 10 minutes.

Safety in Fusion Welded Joints

By E. R. FIRST, *Chief Engineer, Boiler Division*

EVERY purchaser of welded vessels (and many users of pressure vessels ranging from large water tube boilers to small air tanks are today such purchasers) should know of the efforts which have been and are being made in their behalf to secure welds which conform to the service requirements of the vessels they buy. In discussing the subject two points will be emphasized: (1) The steady improvement of welding procedure which gradually is overcoming shortcomings of much of the work; and (2) the fact that good work can be done and that properly welded pressure vessels are safe and can be depended upon to give long life and service. Previous articles in THE LOCOMOTIVE on welding have covered in detail certain particular phases of the subject. In this article the various activities now under way are described in a more condensed fashion and some comment is made as to the trend the standards of welding safety appear to be following.

Welding Rods

It is a matter of common knowledge that up to within six or eight years ago most welding was done with bare wire, and without giving much, if any, thought to the various factors that contributed to the production of welds with the characteristics now regarded as essential. Although there were some who realized the shortcomings of the method and did much research work to determine how welding should be properly done, it was not until after the necessity of protecting the fluid metal from the action of the atmosphere was learned, that welds with the desirable properties were attained. The use of special rods in connection with both gas and electric arc methods of welding is now practically universal for the welding of pressure vessels. Nevertheless, without proper precautions, improper work still may very easily result, even though the materials are entirely suitable to the purpose.

Welding Procedure

It is absolutely necessary that each concern engaged in welding establish a definite technique or procedure by which its welding operators must be guided. After it has been demonstrated, through experimentation and research, that a certain procedure will result in strong, sound and ductile welds, that procedure must be adhered to.

Manufacturers generally have learned that, because a mechanic claims to be a welder and shows some proficiency in making smooth appearing welds, there is still no certainty that his work will meet modern standards. In general, these men are desirous of doing good work and take pride in doing so. However, because they have not had the advantage of facilities for making the kinds of investigations necessary to determine whether or not their work is what they hope it to be, they cannot be blamed for any failure to produce good work.



A check-up of the welding in a patch that failed might have prevented this \$25,000 boiler accident.

It is primarily the function and duty of the manufacturer to determine what materials and technique must be used in making welded joints. On the other hand, it is the function of the welding operator to carry out the prescribed procedure in a skillful manner, once a procedure has been established.

Unfortunately, it is absolutely impossible to determine, by external visual examination, what the character of a joint is. Externally it may look rough and unattractive and yet internally be perfect and have all the desirable physical qualities. And, vice versa, a weld that is attractive looking on the outside may be full of objectionable defects internally. For these reasons various effective tests have been devised.

Code Requirements

The fundamental idea back of the Code prescribing the characteristics of welded joints is that the resulting welds shall be reasonably perfect.

Among the provisions for the construction of power boilers and unfired pressure vessels used for the most hazardous service is that of making test plates for each object at the same time that the seams of the vessel are welded, so that the welding can be properly investigated as to its physical properties. The presumption is that, if these test plates are acceptable, the quality of the welded joints in the vessel itself may be accepted as meeting the requirements. In addition, X-raying is required for the purpose of showing, within the limitations of that process, the soundness of the weld metal. Radiographic determination does not in any way disclose the physical qualities of the weld metal. It does show the presence of gas pockets, slag inclusions, and lack of fusion, when this last is so located as to be picked out by the X-rays.

In the case of welded power boilers and U-68* pressure vessels, it is reasonable to assume, when they are completed in accordance with the code provisions, that there is little or no doubt that the joints of the structure can be depended upon. We need have little or no apprehension about the safety of such structures.

Many U-69* vessels are used for important and oftentimes quite hazardous service, but the provisions for assuring the proper fabrication of U-69 vessels are not nearly so searching as for U-68 vessels. No special test plates are required or is X-raying prescribed.

How may we, then, be reasonably certain that the welded joints of vessels in this category have the proper qualities? It should be demonstrated beyond reasonable doubt that welded vessels of this class have the kind of joints that they are presumed to have.

One requirement of the Code is that all welders engaged in the fabrication of U-69 vessels must have demonstrated their ability to produce welds with the prescribed physical characteristics before these workmen are permitted to fabricate vessels which are to bear the Code stamping. It is on the basis of these demonstration tests alone that the character of the welds, including the soundness thereof, is judged. They are depended on to indicate the integrity of the welds.

* U-68 pressure vessels may be used for any purpose. U-69 vessels are limited to 400 lb per square inch pressure and 300° F. temperature for liquids and 700° F. for gases. U-70 vessels are limited to 200 lb per square inch pressure and 250° F. temperature. See A.S.M.E. Unfired Pressure Vessel Construction Code.

The foregoing remarks with respect to U-69 vessels are applicable also to U-70 vessels. The question now arises as to what extent the dependence on the ability of the welder is justified.

Insurance Company Findings

Investigations by "Hartford Steam Boiler" of welded vessels constructed anywhere from five to twenty years ago have disclosed positively that there were as many questionable welds as good ones produced, if, indeed, there were not many more poor ones. These questionable welds were made not because of any negligence on the part of



Fusion welded ammonia condenser which failed; welding procedure and testing have advanced greatly since this vessel was built.

the fabricator, but rather because at the time there were no established requirements for making welds.

The disclosures of these investigations have made the Company's engineers feel that, without knowing with relative certainty the character of the welded joints of these vessels that they are asked to insure, they should hesitate to accept the risks.

Furthermore, in investigations of vessels, presumably built in accordance with the present Code requirements, there have been found welds that did not have the prescribed characteristics, the welded seams oftentimes lacking in penetration and having unfused areas.

How then, could the exact condition of the welded joints, either old or new, be determined in order to be assured that they were in a reasonably safe condition? Apprehension as to their character prompted considerable thought on this point, with the result that several ideas were suggested. Both old and new structures were and are involved in the plan now used.

It must be conceded that only by making an actual examination of the seam by a destructive test, can its exact character throughout be determined. Manifestly this is entirely impracticable. However, it

is reasonable that a sample, taken from one section of the weld, may be presumed to be fairly representative of the whole weld and it was on this idea that the development of an investigatory method proceeded. The first proposal was to cut an opening across the welded seam about the size and shape of a handhole and then to close this by means of a plate, larger than the hole, placed on the inside and fillet welded for tightness. The idea was that the section of plate removed could be subjected to such tests as would show the soundness of the weld. However, very little progress was made with this particular idea and it was soon abandoned.

The next step was to drill a hole large enough to cover the entire width of the weld, and smooth and etch the walls of the hole so as to bring out any imperfections there might be. This was not very satisfactory because of the difficulty of properly preparing and etching the metal and of making a proper examination. However, some few seams were examined in this way with fairly satisfactory results.

In recent months the practice has been to trepan a small plug or button from across the weld.* This plug or button, say an inch or an inch and a quarter in diameter, is taken to a shop or laboratory, sawed into sections, the edges properly prepared, and etched. The etching is done by immersing the specimen in boiling 50-50 hydrochloric acid solution. This brings out, in a most illuminating fashion, the presence of slag inclusions, gas pockets, and lack of fusion. There is no doubt about the character of the weld at that point. When such plugs are studied by those familiar with the characteristics of welds, the story of the soundness or the defectiveness of the weld is apparent.

The preferred method of closing a trepanned hole is by means of a threaded plug. The tapping may be either straight or tapered. In either case tightness can be secured by a light bead of seal welding on the outside. With a straight thread this is absolutely necessary. Different kinds of welded-in plugs have been suggested, but the threaded type now seems best. By finishing off the outside the location of the plug will not be noticeable.

Numerous welds in non-code vessels have been examined by the trepanning method and of them a surprisingly large number have been found to be seriously defective. In only a few cases were the welds sound. In the great majority of cases defects of some extent were noted and in many cases the defects were so serious that the vessel was considered unsafe to operate.

*For a detailed explanation of this process as developed by "Hartford Steam Boiler" and the results obtained, see THE LOCOMOTIVE, January 1936, Pages 2-7.

The great advantage of the trepanned plug is that the person or persons in responsible charge of the vessels can be shown exactly what the condition is at the point from which the plug is removed. There is no theorizing, guesswork, or opinion involved. There is the actual, incontrovertible evidence of the weld itself. On the basis of such an examination of a weld at specific points, a very good opinion can be formed as to the general soundness of the seam. Furthermore, it has taken examinations of this sort to prove to many manufacturers, who

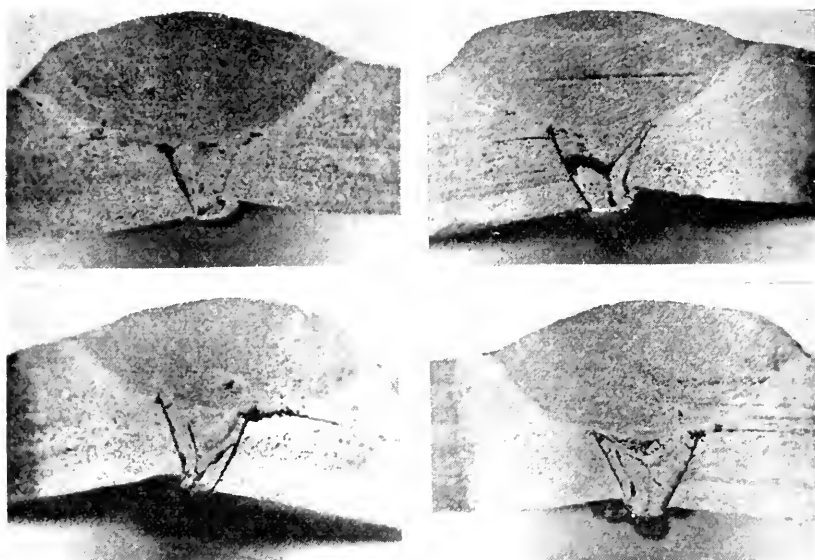

Samples of characteristic defects in welded seams.

sincerely thought their work was above criticism, that they were not doing the kind of welding they thought they were. There have been many instances of this.

How Cracks Develop When Fusion Is Not Complete

If it is necessary to have sound plates, free from laminations and other defects, is it not just as important that the weld metal that joins together the edges of the plate should be as sound as the plate itself?

That, for practical purposes, this is not possible is recognized by the provisions for joint efficiencies in the Code. It is an admission that 100 per cent perfect welds are not to be expected from a prac-

tical point of view. Some defects will occur, but there is a definite limit beyond which they should not be permitted.

In practically all types of pressure vessels minute variations of shape are continually taking place because of pressure and temperature changes. These changes set up stresses of unknown magnitude and distribution which are very likely to be highly concentrated at weak points. If there is a lack of fusion, the surfaces are close together but are not bonded together. The resultant minute parting makes an ideal condition for a real crack to start through the weld, beginning in the metal where the parting ends. Evidences have been found that such cracking does take place. Also in the process of cooling and shrinking there is a considerable tendency for the weld metal to crack so that such defects as lack of fusion form a starting point for a crack. These points of possible future failures should be discovered and rectified before the vessel leaves the shop.

The Testing of Welds in the Manufacturer's Shop

In addition to the use of the trepanning method for determining the quality of welded seams in vessels already in service, it might, very logically and appropriately, be made a feature of shop inspections. In other words, after a U-69 or U-70 vessel has been completed in the shop, why should not the final item of inspection be the trepanning of a plug from each unit of a predetermined number of feet of welded joint?

The adoption of this plan would greatly stimulate both the manufacturer and the welding operator to do only the best of work all the time. Not knowing from what points the plugs would be taken, it would be necessary that all the welding be of uniformly good quality, if the penalties attached to the discovery of imperfect workmanship were to be avoided. The psychological effect thus created would be a most important incentive to good work and would do more to maintain a high standard of workmanship than any other one item.

In the past, due to the lack of confidence in welding, there has been established a rule that no opening should be made in a weld. However, the added security in a weld which has been tested by having plugs trepanned from it will more than offset any weakening effect caused by the openings.

As an alternative to the trepanning method, it has been suggested that a thin slab be sawed out across the weld. This method has been used to a limited extent, but special tools must be devised for its convenient use. As only a narrow slot is made in the girthwise direc-

tion it can be easily closed by welding. The examination of the removed slab would be exactly the same as for the trepanned plug, and there would be exactly the same beneficial results.

Complicated Fittings and Piping

The construction by fusion welding of complicated pipe fittings not otherwise possible, as well as the welding of pipe lines of all sizes and for all pressures, is rapidly becoming more general. Much of this work has to be done in the field and under circumstances requiring

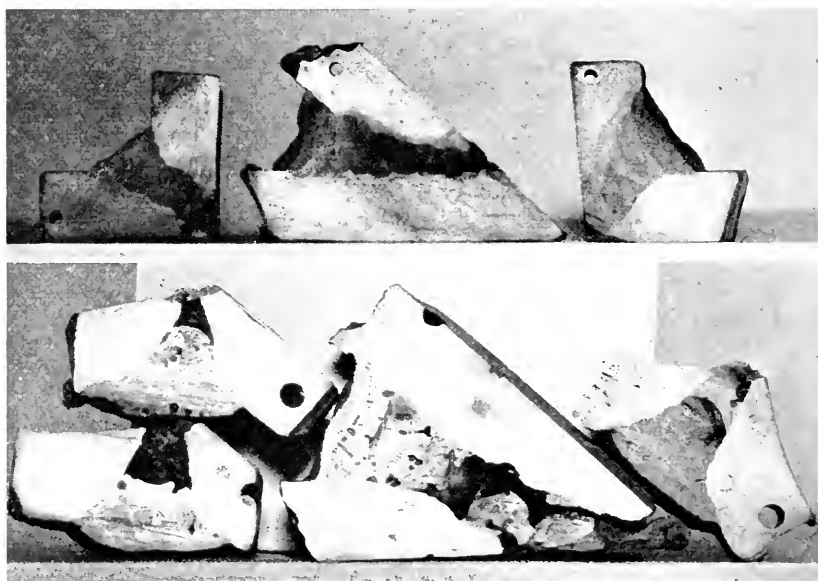

Good and bad fusion in pipe joints.

special ability on the part of the welding operators to do work in all positions. Furthermore, although welding can be done only from the outside of the pipe, it is important that full penetration be obtained throughout the thickness of the pipe wall and without the formation of "icicles" inside the pipe.

Qualification of each welder is of great importance in this work, because here again the dependence for the production of acceptably sound welding rests on the skill of the men.

There has been less effort expended in this field, to find out how to produce good welded pipe joints, than in the case of pressure ves-

sel construction, and much imperfect work has been produced. To check the kind of work done many specifications now require that an occasional joint be removed. Such sections are cut up and tested by bending, etching, etc. One such examination will give a good indication of the character of the joints generally, but a specimen of each man's work is necessary.

As there are many stresses of unknown magnitude and distribution set up in piping, in addition to those due to internal pressure, it is necessary that practically perfect welds be produced, and that the work be frequently checked. Knowing that any joint may be removed for testing, the men are inspired to do their best work on every joint. Removing a joint, of course, necessitates making two joints in replacing the section, but that is relatively of little importance when the advantage of knowing what kind of work is being done is considered.

The trepanning or slotting method may often also be used either alone or in addition to the removal of joints. By combining the methods some examination of every important joint in the pipe line is possible. In the case of welded fittings of the larger sizes, samples may be taken out at certain points.

It is only by some such methods as have been outlined, of actually investigating the character of welded joints of all kinds, that their soundness and ability to withstand continued service indefinitely and safely can be determined. It is to be hoped that the ideas set forth will be fruitful of results beneficial to all concerned.

Ammonia Container Accidents

An accident to a vessel containing ammonia recently resulted in the injury of six persons and threatened a large number of others.

In New York City, on February 3, 1936, two men dropped an ammonia cylinder which they were unloading from a truck. The resultant explosion drove scraps of steel in all directions. Four men were burned by escaping ammonia, a fifth was struck down by a steel fragment and the sixth required treatment for hysteria.

In Baltimore scores of persons fled the neighborhood when the welded minus head of an ammonia receiver failed, permitting a cloud of ammonia gas to be released. The fact that there was a crowded market near by added to the confusion. The accident was attributed to incomplete fusion of the welded seam.



A QUARTERLY MAGAZINE
DEVOTED TO POWER PLANT PROTECTION

Published continuously since 1867

GEORGE H. PRALL, *Editor*

Copyright 1936 by The Hartford Steam Boiler Inspection and Insurance Company

HARTFORD, CONN., July, 1936

Single copies may be obtained free by calling at any of the Company's offices.

Subscription price 50 cents per year when mailed from this office.

Bound volumes one dollar each.

Reprinting matter from this paper is permitted if credited to

THE LOCOMOTIVE of THE HARTFORD STEAM BOILER INSPECTION AND INSURANCE CO.

80-Year-Old Steam Engine

FOR a man to continue actively occupied to the age of 80 is a notable achievement, but for a steam engine to remain in continuous operation for this length of time is truly remarkable. Such an engine supplies power for Samuel H. French and Company, Philadelphia paint manufacturers.

The early history of this engine was described in *Dodge Idea*, in part, as follows:

"In 1855 the concern, for the purpose of grinding paint, installed a steam plant, consisting of one cylindrical boiler and a 100 hp engine. This outfit was strictly up-to-date at the time of its installation, and because of the fact that, excepting the boiler which has been renewed several times, it has been in continuous operation, the equipment has especial interest as showing the changes which have occurred in engineering practice.

"The engine is of the horizontal slide valve type, with a cylinder 20" in diameter by 36" stroke.

"With so long a stroke the engine necessarily is large and the castings are massive, entirely out of proportion to modern practice. It has a peculiar rocker-arm movement which actuates the boiler-feed pump, though this no longer is used for boiler feed. The only important change or repair which has been made was the installation of a new cylinder some forty years ago, the original cylinder having been destroyed by the excessive use of tallow as a cylinder lubricant.

"Power is transmitted from the engine driving pulley, 15' in diameter, to a pulley 8' in diameter on the floor above, through the original double leather belt, running at an angle of 45 degrees, and approximately 1780 ft per minute, a speed that seems ridiculous in these days. The belt originally was 33 inches wide, but it has been reduced by stretch and attrition to 31½". Power is then carried further to the second floor through another belt 24" wide. The belts for the installation were made by a small leather shop in the neighborhood at the time the engine was purchased.

"Probably no little part of this long life of the belts may be attributed to the care with which the plant had been managed by Mr. Peter Boyle, the engineer in charge." (Mr. Boyle died a few years ago, after half a century of service in this single location). "His treatment of the belts was to keep them clean and to wipe them off occasionally with neat's-foot oil, avoiding all other belt dressings.

"These two belts surpass in length of service any other of which we have knowledge. To be sure, they have operated under a light load, and at a low speed, but the fact that any material can be found that will flex around the pulleys, day after day, for 71 years" (now 80 years), "and still possess enough strength to hold together, is most remarkable."

The article from which the above is quoted was published 9 years ago, but all of the facts mentioned are still true. This venerable engine is daily furnishing power through the same old belts. While there are quite a number of antique engines to be found, it is rare to come across one with such an outstanding record of satisfactory service rendered.

Helical Gears in Use Before the Discovery of America

A helical gear cut from stone some eight or nine centuries ago was recently discovered in the ruins of an old castle in Sweden by Otto Lundell, President, Michigan Tool Co., Detroit. The supposition is that it was probably a part of a gear train for driving a community grain crusher. The gear shows a startlingly clear conception of gear design for so ancient a period; for instance, it is thicker at the hub than at the teeth to provide adequate bearing area. The striking resemblance to modern design can be seen by comparing it with the efficient worm gear of today.

—*Electric Journal.*

Power Boiler Accidents

Oil Field Boiler Explosions

EIGHT persons were injured and property over a wide area (as shown in the sketch) was damaged when a locomotive type boiler exploded at a Texas oil well location in April. The accident, clearly a case of over-pressure, tore the boiler into several pieces and resulted in damage to property as far distant as 1200 feet from the boiler setting.

Surrounding the boiler house were buildings as shown in the sketch. The negro huts and other buildings marked with an "X" were dam-

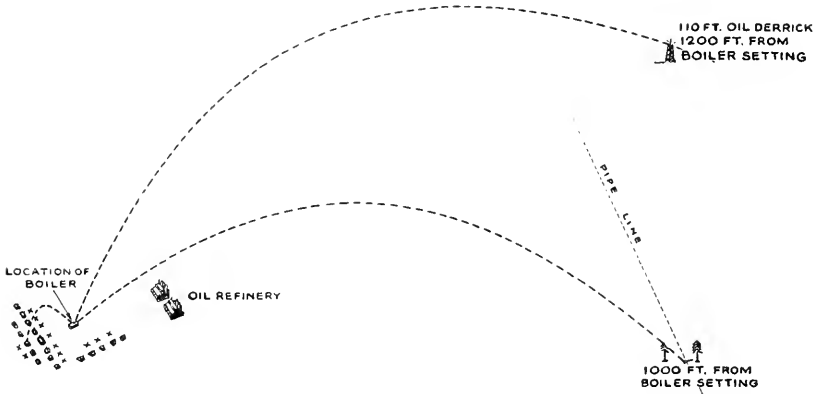

Path taken by parts of boiler which exploded at a Texas oil well location. The boiler was used to furnish power for pumping oil through various pipe lines.

aged. One piece of metal passed over a two-story hotel and crashed into a hut behind it, the metal falling in such a way that a negro woman was pinned in bed, but was not seriously injured. Other pieces hurtled over the refinery building, one whole course passing through the top of a large pine tree 1000 feet distant, cutting a 6" oil pipe buried about 2 feet underground, and making a deep gash in a second tree. Another piece of the boiler broke off the top of a 110' oil derrick which was 1200 feet from the boiler.

A refinery boiler explosion in the same vicinity in March sent parts through a house, severed a power line and damaged two automobiles.

At other Texas wells four men were killed and five others were injured by boiler explosions early in April. At one location the boiler was tossed 300 feet when the crown sheet failed. Two men were killed and one was injured. At another well two boilers exploded, causing two fatalities and injury to three workmen. It was reported the safety valve had failed to operate.

The numerous explosions which occur in the oil fields are due largely to the character of the work and in many cases to a disregard for safety. Persons traveling through some oil fields for the first time are surprised at the number of discarded boilers in the vicinity of the wells—these vessels being in almost every case mute testimony as to what happens when inferior feedwater is used, or the water in the boiler gets low and the crown sheet pulls loose from its stays because of over-heating. In oil well drilling, there is a desire to avoid unnecessary interruptions until the well is finished. This leads to the adoption of questionable practices which increase the operating hazards even to the extent of assigning to the boiler operators additional duties around the derrick which prevent them from giving proper attention to the boiler. Sometimes, when a boiler requires two safety valves, only one valve is installed. If there is occasion to run at a light load, and the fire is not reduced, the single valve will not protect the boiler and whether or not the pressure reaches the danger point simply depends on whether a subsequent demand for steam will take the strain off the boiler. Also, accidents have occurred when boilers intended for a pressure of only 150 lb were used at nearly double this pressure as more and more steam was needed to drive the well deeper. There is a growing tendency throughout the oil fields to raise the standards of boiler operation by providing suitable feedwater, by insisting on more watchfulness on the part of the operators and by using boilers built to carry higher pressures. The newer boilers in use in well drilling work are built for pressures ranging up to 350 lb.

Saw and Grist Mill Boiler Accidents

Six explosions of boilers operated in rural sections for saw mill or grist mill power caused 11 deaths and injury to as many other persons in February, March and April.

In the isolated Backus Mountain section of West Virginia on April 18 a grist mill boiler accident caused the death of the fireman, his

8-year-old son and three boys about 16 years of age. Another man and two youths were burned. Parts of the boiler were scattered over the mountain side. Of the wet bottom horizontal firebox type, the boiler was 32" in diameter and was built with a large firebox door for wood burning. The explosion was caused by the failure of the firebox crown sheet, which stripped off the staybolts due to serious corrosion. When the firebox door and door frame blew off, the fireman and two of the



Left:—Boiler after 300 ft. journey. Right:—The shattered engine house where the eight persons who were killed or injured had gathered.

boys were killed. The other two fatalities were caused by burns. Rocketing through the board wall of the boiler room, the boiler demolished a board fence, uprooted one apple tree and broke down another, and came to rest 300 feet from its starting point.

At Mt. Vernon, Illinois, in February one man was killed and another seriously injured by a sawmill boiler accident. Parts of the boiler and engine driving the saw were scattered as far as 300 feet. The fatality was caused by a piece of the flywheel, and the injured man

was struck by a heavy timber. The equipment was of the sort used in threshing operations.

An old crack in the rear course of a 36" diameter horizontal tubular boiler, used at a Southern sawmill, in April brought about the result shown in the accompanying photograph. The vessel was projected 60

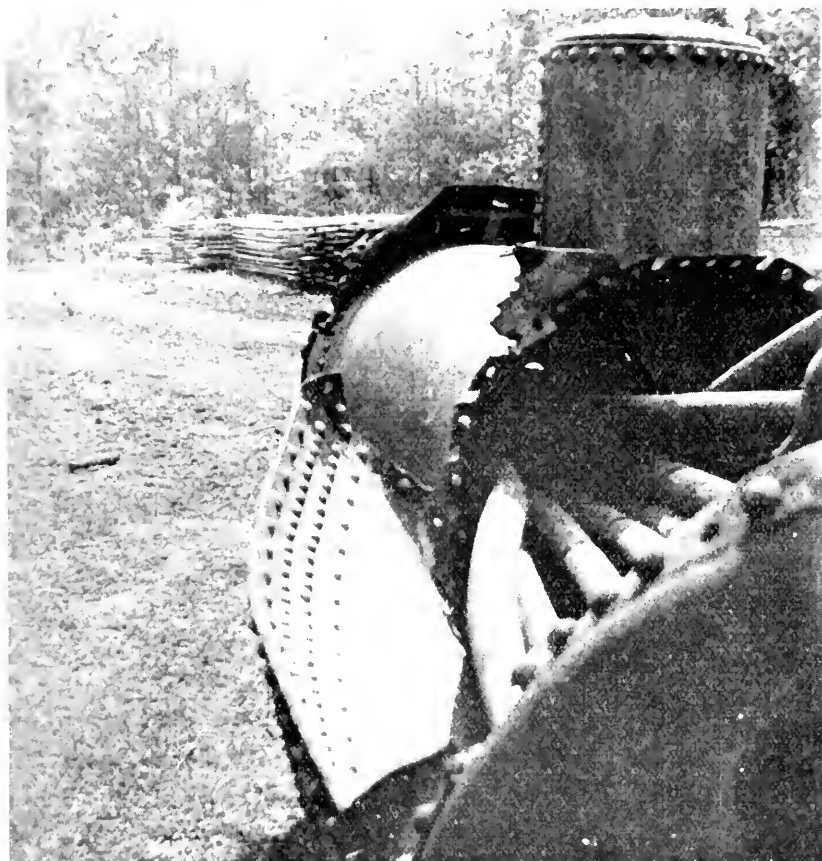

After the boiler had traveled 60 ft.

feet from its setting. Although the setting was made of mud and stones and was scattered over a wide area, only one of the nine men about the mill at the time was injured. A pair of mules escaped injury when the shell landed immediately in front of them. The 20-year-old boiler had been idle for two years. It had been fired up only a few hours when the shell tore along the crack which extended for almost

the full length of the 6' course and nearly through the plate. The photograph shows the inside of the butt strap and the line of failure adjacent to the top edge of the strap. The crack bore evidence of having existed for a long time and the metal adjacent to it was reported to be nearly as brittle as cast iron. The accident was attributed to inferior metal and excess pressure over a prolonged period.

In Harlan County, Kentucky, a portable saw mill boiler explosion caused three fatalities and injured five persons on April 8.

At Lake City, Michigan, on April 13 a similar accident killed the fireman. He was blown 50 feet into a neighboring field, got up and walked 200 yards to his home, but died a short time later because of head injuries. The owner of the mill suffered greatly from shock and he was cut and bruised.

Near Emanuel in Knox County, Kentucky, on March 21, a farmer was killed by a boiler explosion in a corn mill. A boy who was nearby was burned about the legs.

Many accidents such as the above are chargeable to two things: (1) the fact that the owners and operators are not conversant with safe operating procedure, and (2) that the intermittent and unskilled use of the vessels leads to more than average corrosion and wear of other sorts. Many of the failing boilers are purchased secondhand and if they will hold water in many cases, they are operated at any pressure necessary for the sawing or grinding operations, the operating pressures often being in excess of 100 lb. Almost always such vessels have makeshift repairs done by persons not familiar with boiler construction and it is almost a rule that the plate has been badly thinned because of corrosion. Reports of insurance company inspectors, who study these accidents for any information they may reveal with respect to accident prevention, repeatedly contain such statements as, "Neither the owner nor the fireman appreciated the danger that existed."

What a Bullet Did!

A bullet fired near Berneck, Franconia, wrecked a turbine in an electricity generating station at Roehrenhof, several miles away. This (says Reuter) is how it happened:

A man saw a vulture sitting on an electricity pylon near Berneck. He set his gun to shoot it. The bird perched on a porcelain insulator. The man missed the bird and hit the insulator. The insulator burst. The high tension wire snapped. The current short-circuited. All the fuses in the power station burned out. The turbine freed of its load, began to roar. Screws flew off and were hurled into the mechanism. Then turbine blades were smashed—and the plant was put out of action.

Taps From the Old Chief's Hammer

(On June 30, 1936, The Hartford Steam Boiler Inspection and Insurance Company observed its 70th Anniversary.)



THE Old Chief sat watching the country-side from the windows of a Diesel-powered "flyer." An accident to equipment of one of the Company's policy-holders had necessitated a difficult repair and the Chief had been asked to lend his advice. As the

need for the repair was urgent, he and Inspector Walter Bradfield were taking the quickest available means of making the journey.

The Chief had apparently been deep in thought for several minutes when he interrupted his silence with, "Walt, there is something inspiring in an ageless thing."

"Ageless thing; what do you mean, Chief?" replied the younger man. "Doesn't everything grow old sooner or later?"

"I'd hate to believe it. I'll try to illustrate what I mean by using this railroad as an example. When it was established it carried persons and produce between one city and another. It does that today, and between the same cities as when the first locomotive puffed and chugged over the original rails.

"When it was created back in the last century, that creation was the result of vision on the part of a small group of men. They secured money, purchased right-of-way, rails, rolling stock, built the physical evidence of their railroad. None of the original equipment exists today, but the railroad still goes on—apparently without limit as to its existence.

"What the founders of the road saw in the then comparatively new mode of transportation was the opportunity to perform a necessary service. Those founders were men of vision and they were succeeded by men of the same sort who didn't hesitate to discard obsolete or unprofitable equipment in keeping abreast of the times, and who kept

in mind the fundamental policy of the road—that successful, continuous service could be maintained decade after decade only by anticipating the needs of the railroad's patrons.

“Generation after generation the railroad has kept to its policy of furnishing the best available transportation. That's the reason for this train. It's the finest that man has been able to build—to date. Some day it, too, will be retired from service but the railroad will go on just the same.

“It takes time to train men to keep constantly on the alert for changes in the public's requirements. That's why, for the most part, older men are in the directing positions. What is it that these older men have learned that makes a railroad continue successfully year after year?”

“They know how, that's all,” Bradfield said.

“Not entirely. If you could talk intimately with the president of the road, you wouldn't find him nearly so concerned about cars and rails and engines as something else. His concern is you and I and everybody else who uses this railroad. He knows, if he is a good executive, that the railroad will survive, will be ageless, only if it gives us service of the best possible sort, and finer service than we can get in any other way. . . .

“Walt, did you know that on June 30th of this year our own company will be 70 years old?”

“That's right, Chief, we started in 1866, didn't we?”

The older man didn't answer at once. A smile played about his lips, and his eyes seemed to see further than the evening sky at which he looked. His reply was, “Yes, Walt, *we* did.”

“Chief, I hadn't thought about ‘Hartford Steam Boiler’ like that,” Bradfield said. “What you said about the railroad is just as true of us. President Allen and his staff who directed this Company in its early years must have had that service idea uppermost or we wouldn't be here. He taught his men and they taught others just as you are showing me. Chief, the Company is more than any of us, isn't it?”

The older man didn't answer the question. Instead, he continued, “This business of giving service is an illusive thing. We and the others like us all over the country have got to find effective ways to safeguard the constantly changing forms of power equipment we are called on to insure. New problems come in a steady stream, and we do our best to meet them. . . .”

“But Chief, there is more to it than that,” and a torrent of thoughts poured from the younger man's mind in a way to delight his superior,

who gave no sign. "Chief, whenever I do an especially good job for somebody I get a thrill out of it. I don't think so much about the Company then as I do out of giving that assured of ours better service than he ever had before. That's why I like this job. I wonder whether I'll get a thrill out of it when I've been with the Company as long as you. I . . ."

The Old Chief interrupted, "I hope you will, Walt."

The Chief knocked out a pipe he had been smoking and stood up. "I've got a letter to write," he said. "I guess I'll go and write it."

He left Bradfield staring out the window at shadowy fields and an occasional light in the distance. The younger man continued along the line of thought his Chief had interrupted. After a time he mused, "Yes, the Chief's right."

Rust Growth

A contributor recently rummaged among old volumes and in the Annual of Scientific Discovery for 1860 ran across the following comments on the oxidation of iron, particularly with regard to two unusual examples of rust growth:

"At a late meeting of the Manchester Philosophical Society, H. M. Ormerod produced two specimens of iron used in buildings, which have become so oxidized as to injure the structures in which they had been used. An iron cramp, taken from a buttress of the Manchester parish church, had become treble its own thickness by rust, and had thus split the building in center, and lifted about twelve feet of the wall. It was inserted about ninety years ago. The other piece of iron was a small wedge, taken from the steeple of St. Mary's church; it was three-eighths of an inch thick originally, but had increased to seven-eighths of an inch with the rust. There were several wedges used, and these had lifted the stones which they were meant to keep in their places, and some of them had even been split by the slow but certain force of rust expansion. The steeple was erected in 1756, and the upper part had become so ruinous by these wedges, that it had to be taken down by the city surveyor."

Algae on Spray Ponds

In some districts the growth of algae on spray ponds, cooling towers and even condensers is very bothersome. In small ponds such as are connected with ice or Diesel engine plants, potassium permanganate can be employed to advantage. This is a powerful oxidizing agent and literally burns the life out of the algae so that they turn white and can be brushed off. The dosage will vary from 1 to 5 pounds, depending upon the size of the system and the chemical content of the water. A solution made up in pound lots is convenient. The chemical can be added to the system as a solid if desired, but better distribution can be obtained if it is dissolved first and then added to the water either at the suction of the pump or in the distributing trough, depending upon the arrangement of the system and ease of handling. The solution should be added until the water turns pink and stays that way for a few minutes—in a bad case as long as 10 minutes.—*Southern Power Journal*.

A traveler saw a boy hoeing corn in the hot sun, so he drove up to the fence and asked, "What do you get for hoeing corn?" The boy wearily replied as he raised his sunburned hand, "Nothing if I do; only if I don't."

The Hartford Steam Boiler Inspection and Insurance Company

OF HARTFORD, CONN.

December 31, 1935

Capital Stock, \$3,000,000.00

ASSETS

Cash on hand and in banks	\$601,612.42
Premiums in course of collection (since October 1, 1935)	1,121,318.19
Interest accrued on mortgage loans	40,086.52
Interest accrued on bonds	103,099.37
Loaned on mortgages	518,545.00
Home Office real estate and Philadelphia branch office	542,474.66
Other real estate	264,909.47
Bonds on an amortized basis	\$9,382,820.63
Stocks at market value	6,537,479.36
	15,920,299.99
Other admitted assets	30,706.39
<i>Total</i>	\$19,143,052.01

LIABILITIES

Premium reserve	\$7,215,766.14
Losses in process of adjustment	272,174.24
Commissions and brokerage	224,263.64
Other liabilities (taxes incurred, etc.)	565,861.62
	\$8,278,065.64
<i>Liabilities other than capital and surplus</i>	\$8,278,065.64
Capital stock	\$3,000,000.00
Surplus over all liabilities	7,864,986.37
<i>Surplus to Policyholders</i>	10,864,986.37
<i>Total</i>	\$19,143,052.01

WILLIAM R. C. CORSON, President and Treasurer

BOARD OF DIRECTORS

LUCIUS F. ROBINSON, Attorney, Hartford, Conn.	SAMUEL M. STONE, President Colt's Patent Fire Arms Mfg. Co., Hartford, Conn.
JOHN O. ENDERS, Chairman Executive Committee Hartford National Bank & Trust Co., Hartford, Conn.	SAMUEL FERGUSON, Chairman Board of Directors The Hartford Electric Light Co., Hartford, Conn.
MORGAN B. BRAINARD, President Aetna Life Insurance Company, Hartford, Conn.	HON. JOHN H. TRUMBULL, President The Trumbull Electric Mfg. Co., Plainville, Conn.
CHARLES P. COOLEY, Chairman Board of Trustees Society for Savings, Hartford, Conn.	CURTISS C. GARDINER, Vice President The Hartford Steam Boiler Inspection and Insurance Company, 60 John Street, New York
HORACE B. CHENEY, Manchester, Conn.	JAMES L. THOMSON, Chairman Finance Committee Hartford Fire Insurance Company, Hartford, Conn.
JOSEPH R. ENSIGN, President The Ensign-Bickford Co., Simsbury, Conn.	PHILIP B. GALE, Chairman Board of Directors Standard Screw Co., Hartford, Conn.
EDWARD MILLICAN, President Phoenix Insurance Co., Hartford, Conn.	JOHN J. GRAHAM, Vice President The Hartford Steam Boiler Inspection and Insurance Co., Hartford, Conn.
WM. R. C. CORSON, President The Hartford Steam Boiler Inspection and Insurance Co., Hartford, Conn.	

Incorporated 1866



Charter Perpetual

<i>Department</i>	<i>Representatives</i>
ATLANTA, Ga., Citizens & So. Nat. Bk. Bldg.	W. M. FRANCIS, Manager. C. R. SUMMERS, Chief Inspector.
BALTIMORE, Md., 704-9 Garrett Building	D. W. LITTLE, Manager. R. P. GUY, Chief Inspector.
BOSTON, Mass., 87 Kilby Street	A. PAUL GRAHAM, Manager. W. A. BAYLISS, Chief Inspector.
BRIDGEPORT, Conn., City Savings Bank Building	W. G. LINEBURGH & SON, General Agents. A. E. BONNET, Chief Inspector.
CHICAGO, Ill., 175 West Jackson Boulevard	P. M. MURRAY, Manager. C. W. ZIMMER, Chief Inspector.
CINCINNATI, Ohio, 1904-12 Carew Tower	JAMES P. KERRIGAN, Manager. W. E. GLENNON, Chief Inspector.
CLEVELAND, Ohio, 1040 Leader Building	ARTHUR F. GRAHAM, Manager. JOHN L. SCOTT, Chief Inspector.
DENVER, Colo., Gas & Electric Building	J. H. CHESNUTT, Manager. JESSE L. FRY, Chief Inspector.
DETROIT, Mich., National Bank Building	L. L. COATES, Manager. THOMAS P. HETU, Chief Inspector.
HARTFORD, Conn., 56 Prospect Street	F. H. KENYON, Manager. A. E. BONNET, Chief Inspector.
NEW ORLEANS, La., 333 St. Charles Street	R. T. BURWELL, Manager. P. E. TERROY, Chief Inspector.
NEW YORK, N. Y., 90 John Street	C. C. GARDINER, Vice President. J. F. HUNT, Chief Inspector.
PHILADELPHIA, Pa., 429 Walnut Street	A. S. WICKHAM, Manager. S. B. ADAMS, Chief Inspector.
PITTSBURGH, Pa., Arrott Building	WILLIAM P. WALLACE, Manager. J. A. SNYDER, Chief Inspector.
ST. LOUIS, Mo., 319 North Fourth Street	CHAS. D. ASHCROFT, Manager. EUGENE WEBB, Chief Inspector.
SAN FRANCISCO, Cal., 114 Sansome Street	C. B. PADDOCK, Manager. L. E. GRUNDELL, Chief Inspector.
SEATTLE, Wash., Arctic Building	E. G. WATSON, Manager. WILLIAM J. SMITH, Chief Inspector.
TORONTO, Ont., Canada Federal Building	H. N. ROBERTS, President The Boiler In- spection and Insurance Company of Canada.

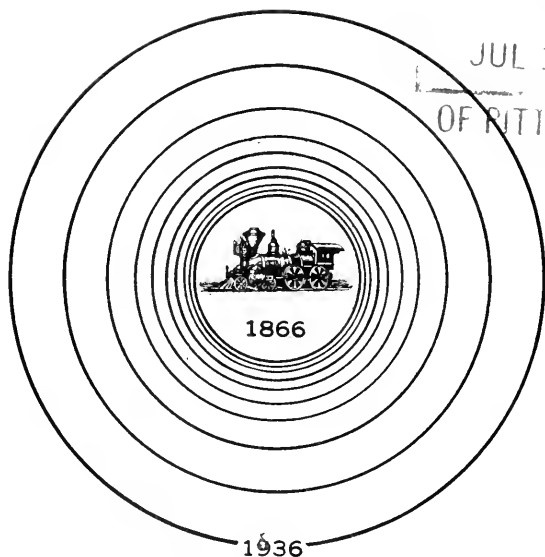

HARTFORD STEAM BOILER KEEPS PACE WITH THE EVER-BROADENING USES OF POWER

On June 30, 1936, The Hartford Steam Boiler Inspection and Insurance Company completed 70 years of service to users of power. In these seven decades the Company has held steadfastly to its fundamental purposes: TO LESSEN ACCIDENTS to boilers, pressure vessels, turbines, engines, electrical machinery; TO SAFEGUARD ITS POLICYHOLDERS against loss because of accidents. The first is accomplished through a constantly improving engineering and inspection organization. The second is accomplished through the bulwark of the Company's large financial reserves.

Vol. 41 No. 4

OCTOBER, 1936

The Locomotive

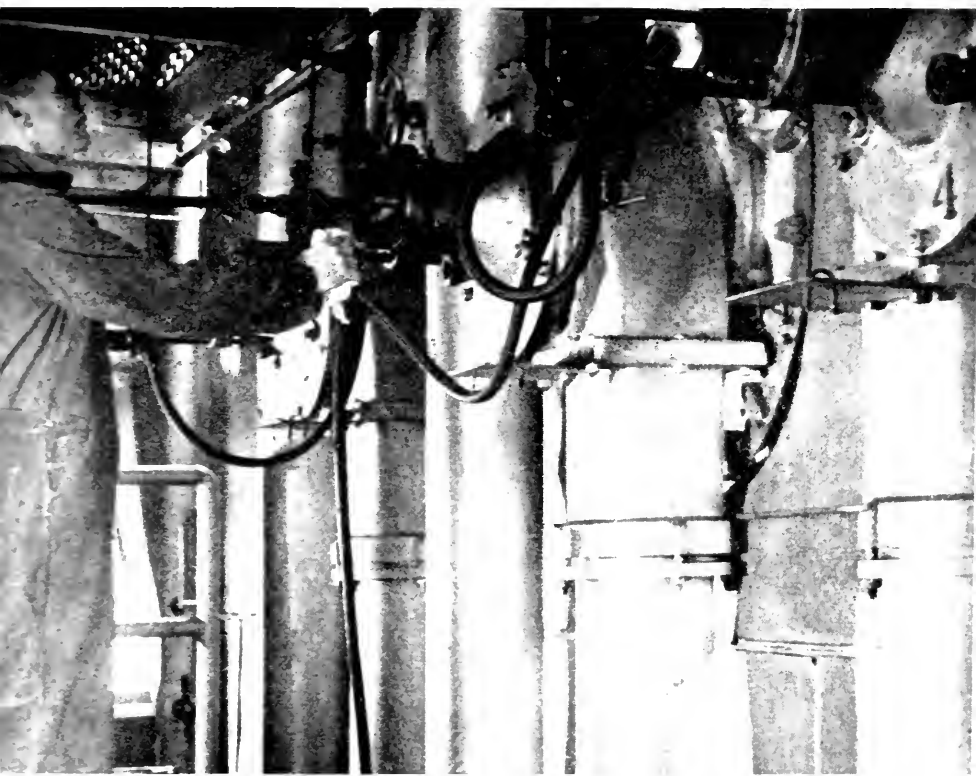
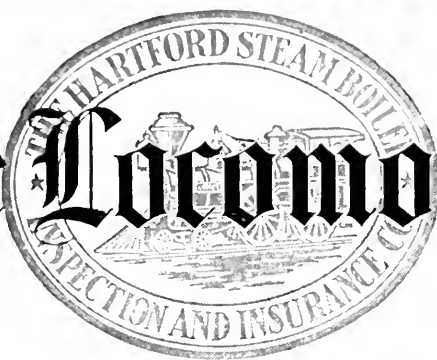

Quarterly Magazine Devoted to Power Plant Protection

Please Show to Your Engineer



Trepanned Plugs from Welded Seams

ALMOST two years have passed since this Company first trepanned a plug from the fusion welded seam of a pressure vessel for the purpose of judging the quality of the weld and deciding upon the acceptability of the vessel for insurance. Since that time many such plugs have been removed for examination but there is yet to be found one which shows a perfectly sound weld. While some of the defects have been very minor, nevertheless they were imperfections. In fully three-quarters of all plugs examined there have been found extensive defects and at least one half of the cases showed dangerous conditions because the defects extended through 50 per cent or more of the plate thickness.

Pictures of some representative plugs are given on pages 99 and 100.

Prior to its adoption of the practice of shop inspecting welded vessels during their construction, "Hartford Steam Boiler" viewed all such vessels with considerable suspicion. The same attitude still prevails with respect to welded vessels that are being built today by manufacturers who have not exercised proper control over the process of welding and where the welding operators are neither trained nor tested. Some of the plugs shown in the accompanying illustrations were removed from vessels built within the past few months. It is, therefore, evident that the Company's attitude in refusing to take for granted the soundness of welded seams has been and is justified. By these investigations the Company has been able to judge as to what may reasonably be expected in certain types of fusion welded seams, and on the basis of this, revised standards of acceptance have been made possible.

The point is sometimes raised that the plug reveals the condition of the seam at only one place. While this is true, it can be said that the conditions shown by a plug removed at any point will be reasonably certain to be typical of the whole seam. In a number of instances, where several plugs have been removed from the same seam, the same general characteristics have been found in all the plugs.

This condition can be clearly seen in Groups 1, 2, 4 and 6 of the illustrations. Likewise when one plug shows a comparatively sound seam, the same condition has been found in the other plugs. Since plugs are removed at random, they may be expected to reveal the average condition of the seams and it is on that condition that judgment should be based.

A brief analysis of each of the weld specimens illustrated on Pages 99 and 100 is given below:

Figure 1. Although the weld is well fused the metal contains con-



Figure 1

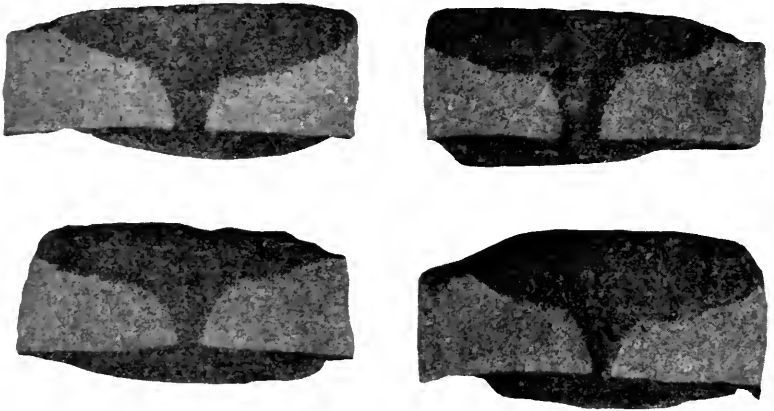

Figure 2



A

B

C

Figure 3

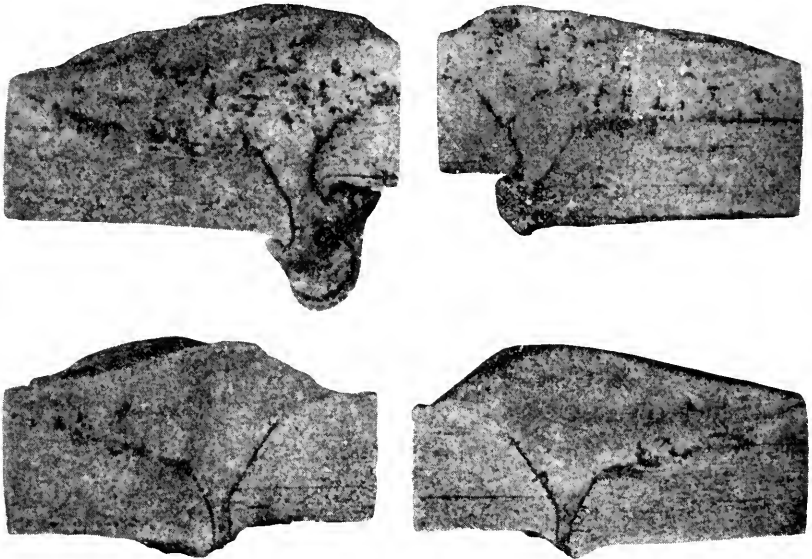

Figure 4

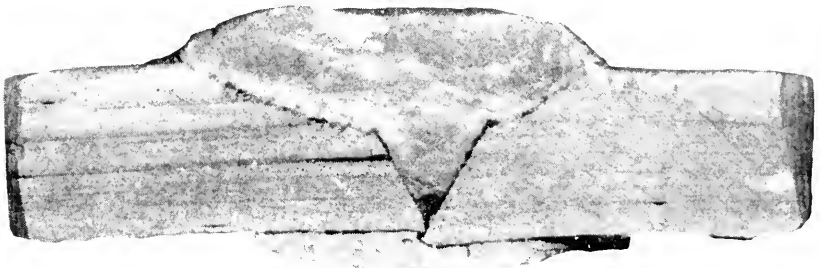

Figure 5



Figure 6

siderable impurities. The four sections are from two plugs removed from the same seam.

Figure 2. Weld metal is fused to base material through its entire thickness, but the reinforcing bead on the underside is very poorly fused. The weld metal itself is somewhat poor. These illustrations represent four sections of two plugs from the same seam.

Figure 3. Three plugs from a vessel constructed in the spring of 1936. Plug A has but few defects. Plug B shows good fusion, but some porosity in the weld. Plug C shows two slag inclusions and some porosity.

Figure 4. Illustrates a commonly found condition. Poor fit-up of plates, no fusion of weld metal in lower half of welding groove, and dirty weld metal. This illustration represents four sections of two plugs from the same seam.

Figure 5. Illustration of an extreme case of lack of fusion in the lower half of the welding groove, slag on the fusion line and almost entire lack of fusion of reinforcement on the underside.

Figure 6. An example similar to that shown in Fig. 4. The two plugs are from the same seam.

Whenever sample plugs have been removed from fusion welded vessels, the holes have been closed by tapping and screwing in pipe plugs. This method, in general, has been satisfactory, although some trouble that has been experienced with leaks has shown the necessity for using cast or wrought steel plugs so that they may be seal-welded for tightness should leakage occur. There has been no real difficulty in persuading owners of welded equipment to remove plugs when they have been shown the conditions that have been disclosed by this method of examination in other vessels of unknown construction.

Apples Damaged by Ammonia Fumes

THE rupturing of a defective nipple between the oil trap and drain valve on an ammonia refrigerating system recently permitted enough ammonia to escape to damage a large quantity of apples which were in cold storage at Phoenix, Arizona. On dark apples the discoloration from the ammonia fumes took the form of black spots, and on lighter colored apples, green spots. Apples which had been in storage for several weeks turned dark brown. While the apples were not entirely spoiled, they could not be sold as No. 1 fruit, so that the damage to them, due to the fumes, resulted in a loss of more than \$700, which amount was covered by insurance.

A Recent Accident Which Demonstrates the Subtlety of Embrittlement

EVIDENCE seems to show that when boiler plate has once been in contact with feedwater conducive to the development of caustic cracking, the danger from this boiler ailment is never entirely eliminated even though use of the unsatisfactory water be discontinued. For this reason, in any program for the prevention of boiler accidents, it is desirable not only to be sure that the feedwater in use

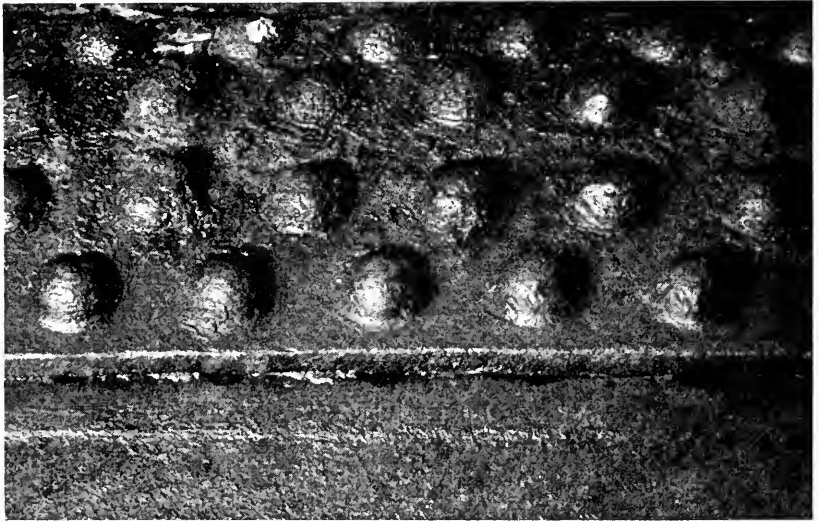

Figure 1—Seam which pulled apart for 6 feet after embrittlement had developed to a serious extent.

has a proper sulphate to carbonate alkalinity ratio, but also to study the feedwater history with respect to water used in the past.

The fact that this is good practice and that a lack of full information is dangerous was shown by a recent accident which, only by good luck, escaped being a major explosion. The compensating feature of this accident was that it served as a warning that other boilers in the battery probably were defective, a surmise which was proved true by subsequent investigation.

In the case under consideration the plant had 8 bent tube type boilers operating at about 150 lb pressure. Some of them were rated at 823 hp and the others at 324 hp, the boiler which failed being of the larger size. The first indication of trouble was a noise such as

would be made by the rupturing of a small tube, but the accident obviously was more serious than a tube failure since a sufficient volume of water escaped to put out the fire. An examination of the boiler after the accident brought to light the condition shown in Fig. 1. The metal of the shell plate had separated as much as $1\text{-}5/16''$ in places until the rivet holes were actually visible where they had pulled out from beneath the butt strap of the lower or mud drum. This drum was $48'' \times 16' 9''$, and seams were double riveted with $1\text{-}1/32''$ diameter rivet holes and $3''$ pitch. The plate had cracked for a distance of $6'$ along the outer row of rivets and there were also cracks in the outer butt strap between

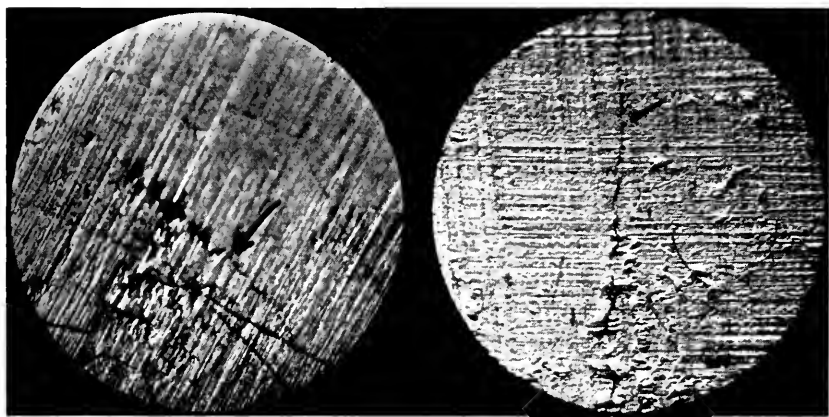

Figure 2—Characteristic embrittlement in another boiler of the same battery as the affected vessel.

the rivet holes in the top row. These cracks were characteristic of embrittlement in its final stages.

Other boilers were examined for traces of embrittlement and the telltale fissures were readily visible when the Hartford Magniscope was used in the rivet holes. Photographs of these fissures in one of the boilers are shown in Figure 2. The serious condition necessitated the purchase of a new boiler.

Several facts of value to all operators of boilers were emphasized by this case. The boilers which were affected had none of the usual symptoms of embrittlement such as broken rivet heads, deposits of caustic or evidences of leakage. Rivet heads did not break when they were hammered. The presence of the ailment could not have been discovered except by an actual Magniscope examination following the removal of rivets in a boiler which apparently was sound. Moreover, the treated feedwater had a sulphate ratio higher than that recommended

under the A.S.M.E. Boiler Code. The plant was following accepted procedure with respect to the avoidance of embrittlement.

When the history of the boiler was reviewed, however, facts came to light which explained the development of the trouble.

Installed in 1924, the boilers were operated until 1929 with raw well water for makeup, which amounted to about a third of that used. This water had a high carbonate but low sulphate content, and since it was not treated to correct this unfavorable ratio, conditions were right for the metal to be affected. In 1929 a feedwater treating system was installed, but the trouble, while not then evident, had been started. It required only time to cause the progressive weakening of the plate until the failure eventually occurred.

THE value of inspections in preventing accidents was clearly demonstrated recently by an occurrence at an ice manufacturing plant. The plant had a new 400 hp synchronous motor, with direct connected exciter, for driving its ammonia compressor, and during the summer months this unit was operated 24 hours a day, 7 days a week. In examining the motor while it was in service the inspector found that there was a line potential from one side of the exciter circuit to ground and zero with respect to the other, which indicated that the latter side was "grounded."

The conduit cover on the exciter was removed with the unit still in operation, and a ground was found to be caused by a bare exciter terminal connection in contact with the cover. The bare terminal was re-taped and the cover replaced. However, another test of the circuit showed that all trouble had not been eliminated. Because the machine was in continuous use, its owner was reluctant to shut it down, but finally did so. A second ground was quickly traced to the top of one field coil where ordinary dust and collector ring and brush wear accumulation had created a path to ground. The insulation fibre collar was badly charred and the insulation at the top of the field coil turns impaired, conditions which, if allowed to persist, would undoubtedly have resulted in a failure of the field within a few weeks' time.

Inasmuch as the owner desired to return the machine to service immediately, the accumulation of dust and dirt and other foreign matter was cleared away, the charred insulation removed by scraping and the machine again placed on the line. It was recommended that at the first opportunity the affected parts be more thoroughly cleaned and heavily coated with air drying insulating varnish. The discovery of the two grounds undoubtedly saved this plant a major business interruption.

Over-heating and Distortion in Diesel Engine Cylinders

OVER-HEATING of cylinders in Diesel engines usually manifests itself as "growth" of the cylinder or piston or both, scoring, warping, cracks, burning, or leakage from cooling jackets. Because such over-heating is a common reason for shutdowns, the cause and prevention of these manifestations is important to every Diesel owner. Several accidents from over-heating, investigated recently, will be discussed here as illustrations.

In a two-cycle engine with four 14" cylinders, over-heating led to growth of the metal on the exhaust side of both the No. 1 piston and its cylinder, and to cracks in the cylinder, piston and head. The damage

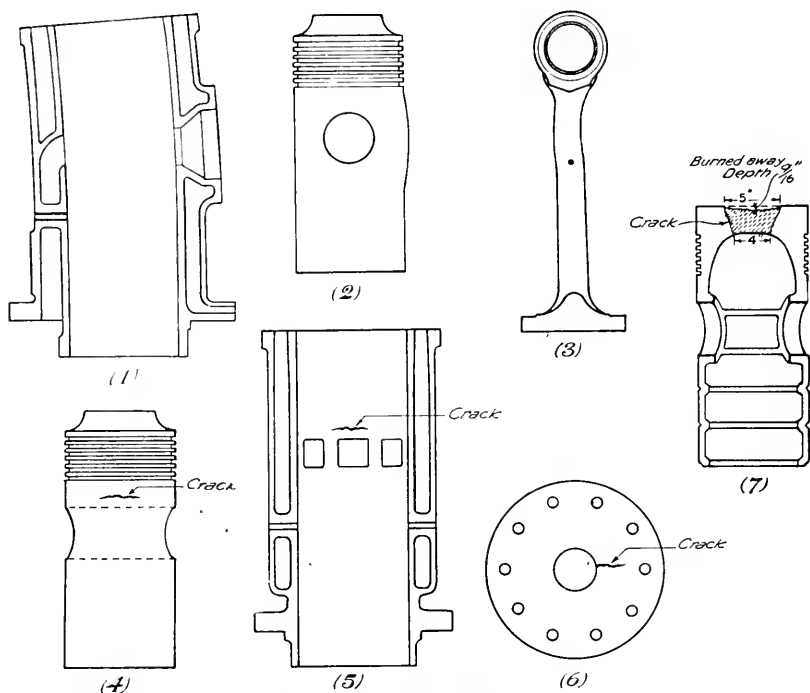

Six evidences of over-heating in a single Diesel cylinder—(1) Distortion of the cylinder because of "growth"; (2) "Growth" of piston; (3) Bend in connecting rod; (4) Crack in piston; (5) Crack in cylinder; (6) Crack in cylinder head; (7) Another evidence of over-heating in another piston. The head was burned to a depth of 9/16" and a crack had extended through the top of the piston.

was discovered after the piston had seized. The cylinder and piston were distorted, as shown greatly exaggerated in Sketches (1) and (2); the connecting rod was bent as in Sketch (3), and cracks were formed as shown in Sketches (4), (5) and (6).

Of special interest with respect to this accident was the apparent "growth" of the cast iron of both cylinder and piston. This phenomenon, as revealed in Sketches (1) and (2), is actually a "puffing up" or local raising of the normal surface of the metal, in this case to such an extent as to cause rubbing and seizure.

Because the highest temperatures in such engines are found at the exhaust side of the cylinder, it is in the metal surrounding the exhaust ports and in the piston metal adjacent to these ports that the growing action most often occurs. This action is hastened when impurities in the cooling water form scale in the jackets or when the design of the engine does not provide adequate cooling. Piston friction at the exhaust port bridges, because of growing action, can be anticipated and avoided by slightly under-cutting the cylinder wall in the areas likely to be affected. On some of the larger engines avoidance of this difficulty is sought by coring the exhaust port bridges and circulating the cooling water through them. The circulation through these cores is sluggish, however, because the major flow actuated by the pump seeks the path of least resistance which is through the main jackets, rather than through the restricted bridge cores.

In the past it has been assumed that the growing action would not cause any further difficulty once it had been anticipated by under-cutting. However, it has been known to recur periodically. Avoidance of the trouble is obtained only through careful periodic inspections and regrinding of the affected parts.

When piston seizing occurs in one of the cylinders of an engine and it is found that the original relief or enlargement has already disappeared because of growing action, it is important that the other cylinders be carefully examined to see whether the relief against "growth" in these cylinders still exists.

The phenomenon of "growth" of cast iron parts exposed to heat is a fact not yet accounted for to the full satisfaction of metallurgists. There are several theories regarding it, and considerable research, particularly in England, has been carried on in an effort to determine just what happens. Perhaps the most widely accepted explanation, and one justified by laboratory tests for certain irons in certain temperature ranges, is that the carbon in solid solution in the metal separates from cementite and collects on the graphite plates of the casting. This action

causes the graphite to enlarge or build up gradually. As a result of this action the structure of the casting is made more porous, permitting the entrance of oxidizing gases which cause interior corrosion. Meanwhile the "growing" of the graphite plates causes a distorted surface which cracks, permits further corrosion by the entrance of additional oxidizing gases, and accelerates the enlargement until it is discovered by measurement or manifests itself as seizing. Elaborate experiments have seemed to show that the presence of silicon up to 3 or 4 per cent accelerates "growth" and that the presence of manganese retards the



Figure 8—Piston and part of cylinder which broke off due to over-heating. The machine was a small two-cylinder engine.

effect of the silicon. It may well be asked why this action does not take place on the surface of the piston. The theoretical explanation of this is that the separated carbon is re-fused into the solid solution by the higher temperatures at the top of the cylinder and further, that the oil which comes in contact with the piston top saturates it and acts as a protective influence. At any rate the distortions because of "growth" in Diesel engines occur as is shown in Figures (1) and (2). From these it will be seen that the "growth" itself is only part of the difficulty, as its presence leads to a distortion of the entire cylinder, which distortion is contributory to the eventual seizing of the piston.

It was mentioned above that growing action did not evidence itself on the piston tops. These parts, however, are subject to another form of damage from over-heating, as is illustrated in Figure (7). Such damage—a saucer-shaped burning of the piston top to a depth of 9/16" and the formation of a crack to the under side of the piston top—occurred in a six-cylinder Diesel, operated on a seaboard dredge. Engines in this type of operation are likely to be subject to over-loading.

A further complication in the case illustrated was the use of sea water for cooling in an open system. This led to the forming of some scale, and there was also retardation of cooling because of sea grass and other matter normally present in the Florida waters where the dredges operated. In addition, it was considered likely that faulty fuel injection and unbalance of load on the various cylinders contributed to the failure. These defects of operation eventually led to the scoring of one of the 16-inch cylinders. To prevent a recurrence of the trouble, steps were taken to improve the cooling facilities and to obtain better fuel injection.

Frequently over-heating of water-cooled surfaces, which have become insulated by a layer of scale, dirt or oil, causes cracks which let the cooling water into the cylinder. This condition is particularly apt to occur in water-cooled cylinder heads, which are rather complicated castings and which may be damaged by strains that less complicated castings could withstand.

In the discussion of "growth" in this article, mention is made of the exhaust port bridges. Most small engines and many of the larger types of 2-cycle engines in use throughout the country are equipped with solid exhaust port bridges. Through the development of improved design, better metals and more adequate cooling, exhaust port trouble is being alleviated to some extent. However, in existing engines built only a few years ago periodic difficulty is experienced both with solid and cored bridges, the former cracking with greater frequency. When a port bridge of the solid type cracks, it is often distorted in such a manner that a portion is raised above the cylinder wall surface. If the defect is not remedied, scoring of the piston is likely to occur. When cored bridges crack, water leakage does not always result because the cores are usually formed by means of pipe, and even when leakage does occur it sometimes is possible to repair the break by welding the pipe. For this reason the life of a cylinder with water-cooled bridges is apt to be longer than one with solid type bridges.

The above illustrations are only a few of the many manifestations of over-heating that occur. They are, however, characteristic and while the failure often is not apt to be so localized as in the above instances, the causes of over-heating are generally due to conditions which are easily summarized. The presence of any foreign substance—scale, mud, oil, plant or animal matter—will in time retard the cooling functions and can lead to over-heating. An inadequate supply of cooling water has similar results. Combustion difficulties arise from the use of the wrong fuel, improper injection, and wrong timing, any of which can

lead to deposits in the cylinder and subsequent over-heating. Inadequate lubrication brings about eventual seizing, and an excess of lubrication leads to serious gumming of the rings and, if continued, to carbon deposits and "blow-by." Over-loads and unbalance of load on the cylinders are common causes of trouble. Poor combustion, due to insufficient air or to air that is badly contaminated by exhaust gases from the preceding stroke, accelerates temperature rise within the cylinder and leads to carbon deposits which add to the operating hazard.

Thus, there are many causes of over-heating, but with well designed and properly erected engines many of these troubles can be avoided through careful operation, which involves frequent checking of temperature, an adequate supply of uncontaminated cooling water, use of correct fuel and lubricants, and periodic expert inspections which locate trouble in its early stages and make possible the adjustments and changes in operating practices necessary to prevent serious accidents.

Two Explosions in Compressed Air Lines

FATALITIES occurred in two metal plants recently when air line accidents occurred in rooms where employees were working.

One of the failures was attributed to a combustion explosion in a high pressure 2" diameter line carrying air at 500 lb pressure for use in die casting machines, the pipe failing at several points. A 2" forged steel elbow was split cleanly, and two safety valves were shattered. The operator of one die casting machine was killed and there was considerable damage to piping, valves, fittings, equipment and walls adjacent to the exploded lines. While the cause of the accident could not be definitely determined, it is believed reasonable that some of the lubricating oil from the compressor was carried over into the system and ignited, probably at one of the die casting machines where the air was in contact with molten metal. The compressor supplying the system was equipped with both an intercooler and an aftercooler and the piping was tested at intervals in the interest of safety. After the accident double extra heavy pipe of 7/16" thickness was installed, and to minimize the possibility of a similar occurrence an oil separator was placed between the aftercooler and the receiver. It also was advised that oil being fed to the compressor be kept at an absolute minimum.

The other accident occurred to piping used in connection with air hammers at a Pennsylvania steel mill. When the air line broke, an air receiver toppled over on a workman with fatal results.

Rotary Converter Burnout

A SHORT circuit between the collector rings of a 300 kw rotary converter led to an electrical burnout and fire on April 27 at a Mid-West rubber plant. This machine, on which the plant depended for power for calendering operations, was badly damaged and all manufacturing processes were eventually stopped as other departments used up the available calendered stock. While the original burnout probably could not have been averted, the failure of protective

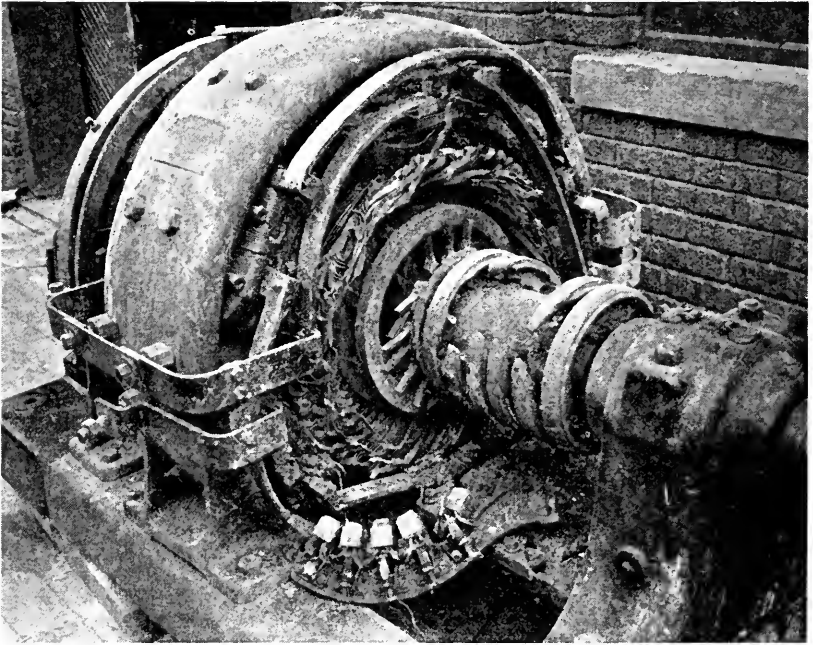

Rotary converter damaged by short circuit and fire.

devices permitted the machine to continue on the line after the short circuit, thus causing the fire to spread and complete the destruction.

How widespread the loss was is illustrated by the photograph. The machine was so badly damaged that it was considered inexpedient to repair it.

When the fire was noticed in the rotary converter room, an effort was made to get to the switchboard on the other side of the rotary converter to stop the machine, but the heat was too intense. It was necessary to go to a penthouse on the roof to de-energize the feeder sup-

plying this unit. Meanwhile the fire had spread to the whole machine and was fanning out into the room. All available chemicals were played from the doorway of the converter room and after a time the fire was extinguished.

D. C. Generator Failure

AN attendant's mistake in closing the wrong switch recently played havoc with the armature coils of a 500 kw D.C. generator. The machine was part of an engine-generator set used by a large Mid-West concern to handle peak loads.

Just prior to the accident a 2000 kw D.C. turbo-generator was carrying full load, and a similar unit had been brought up to speed and

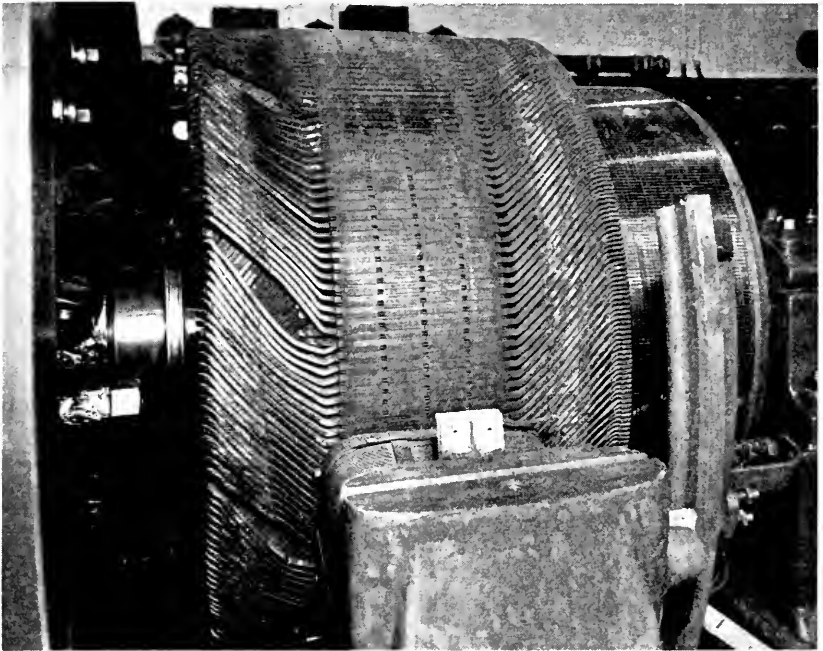

Distortion of coils on a 500 kw direct current generator caused by a surge when the operator threw the wrong switch connecting the idle machine to the station bus.

normal voltage, ready to be paralleled with the station bus. Evidently the operator became confused, for, instead of paralleling the 2000 kw D.C. turbo-generator, he closed the switch connecting the idle 500 kw

engine-generator to the station bus. When the recording voltmeter chart was studied later, it was noted that the bus voltage had dropped from 250 volts, normal, to 10 volts just prior to the tripping of the 2000 kw turbo-generator from the bus.

When the 500 kw generator was suddenly motorized, the resulting jolt brought about the unusual coil distortion shown in the photograph. The coils were thrown into 10 groups of 23 coils each, the number of groups corresponding to the number of poles in the machine. It was said that the armature moved approximately 6", measured at the periphery, during the time the generator was motorized.

There were from 6 to 8 coils "kinked" severely at varying points on the armature core, due to bending of the over-hanging part of the coils opposite the commutator end, at the point where they leave the slots. These coils are indicated in the photograph by chalk marks. The insulation at these points was badly cracked. Distortion on the commutator end did not exceed $\frac{3}{4}$ ", as the distance between the commutator riser connections and the end of the slots was short and the coils were to a certain extent held in place by a heavy 4" band of No. 10 wire.

No major repair would have been required if the distortion at the commutator end had represented the extent of the damage to the armature winding. However, the distortion of the coils at the end opposite the commutator was so severe that it was necessary to remove all the coils from the armature so that they might be reformed and reinsulated. While the coils were heavily banded to keep them from moving out radially, their over-hang outside the slots was such that they were moved circumferentially by the forces involved.

Following the accident, an insulation resistance of 100 megohms was obtained on the armature winding, which indicated that there was no failure of insulation to ground. Furthermore, the physical condition of the insulation, as far as could be observed with the unit assembled, did not indicate any breakdown between coils. However, the turn insulation had undoubtedly been much abused because of the coil distortion. This point was carefully investigated before the coils were reinsulated.

The accident, in addition to the loss resulting, was a most unfortunate circumstance, for the engineer responsible for the error had just celebrated his forty-fourth year as an employe with the company a day or two before the accident. His record prior to this occurrence does not show any operating difficulty on his shift during his long period of service as a station operator.

Judge—But you didn't feel the thief's hand going into your pocket?
Absent-Minded Professor—Yes, but I thought it was my own.

Accident to Hot Water Supply Boiler

IMPROPER manipulation of inlet and outlet valves combined with a rust-choked relief valve to cause a severe explosion of a garbage burning hot water supply boiler at a Mid-West apartment on June 9. The janitor was killed and property damage was considerable, as may be judged from the accompanying illustration.

In order that some work could be done on the boiler, the janitor had closed the two valves in the lines connecting it to the storage tank



Wreckage of garbage burner—An accident which illustrates the need for a relief valve in operative condition and of care in the manipulation of valves in the pipe connections.

so as to permit draining the boiler without emptying the system. However, tenants requested hot water before the work could be done, so the janitor built a fire in the burner. In doing so, he forgot to open the valves to the storage tank. As the safety valve was inoperative a pressure was generated far above that for which the boiler was designed and a violent failure resulted.

Forgetfulness or lack of understanding by attendants of the functions of valves and other parts of heating systems are not uncommon causes of such accidents as this one.

Explosion of Open Type Feedwater Heater

AN open type feedwater heater under normal operation is not subject to pressures exceeding a few pounds, but the piping is often connected so that it is possible for the heater to receive steam at full boiler pressure. When this occurs, even with the feedwater heater relief valves operating, pressure may not be relieved rapidly enough to prevent an explosion.

Such an accident occurred some months ago at a dairy where a feedwater heater of the open type was used with two large horizontal tubu-



Damage caused by the explosion of an open type feedwater heater.

lar boilers operated at 120 lb pressure. The heater was six years old, of fusion welded plate steel construction, and was supplied with exhaust steam when enough was available. It also was connected to the high pressure steam lines through a pressure regulating valve, so that when exhaust steam was not available the feedwater was heated by live steam.

Experience with this regulating valve had not been entirely satisfactory. It had given trouble for several months preceding the accident by sticking in such a position that the required 5 lb maximum pressure in the heater could not be maintained. Then it would open suddenly, causing the heater to pound and vibrate until the regulating valve was made to function properly. On one occasion this pounding

caused a seam to open so that it had to be rewelded. The heater was equipped with a 3" atmospheric relief valve adjusted to operate at 8 lb. Further protection was supplied by a $\frac{3}{4}$ " spring-loaded safety valve adjusted to operate at 10 lb pressure.

Without warning, in the early evening as the fireman was about to add chemicals to the feedwater, an explosion threw him from a platform above the heater, the vessel was shattered and several thousand dollars damage was caused to the dairy and its equipment. The injured fireman received severe lacerations which laid him up several days in the hospital. Those who investigated the accident considered that he was, indeed, lucky to have escaped with his life. Two walls were blown down, some of the damage being shown in the photograph.

Over-pressure in the heater could have occurred if the regulating valve in the high pressure steam line failed to operate and remained open, and, if, at the same time, the 3" atmospheric relief valve had not opened. The regulating valve was found in the open position after the accident, and the atmospheric relief valve was sluggish in its action. These facts led to the conclusion that this valve had not operated at all or had operated inadequately. The $\frac{3}{4}$ " safety valve was in good condition, but its capacity was entirely insufficient to prevent practically full boiler pressure building up on the heater.

Cellophane Being Used for Insulation

Copper wire for coils, long accustomed to jackets of cloth, rubber, or asbestos, covered over with insulating varnish, is now being dressed up in cellophane. This is being done to save bulk, as cellophane-wrapped wire is smaller in over-all diameter than cotton-insulated wire, for instance. Cellophane for this purpose comes in ribbons less than $\frac{1}{1000}$ " thick and from $\frac{1}{32}$ " to $\frac{1}{4}$ " wide. The manufacturer claims that tests show that the cellophane-insulated coils are of smaller gage, smoother, and more efficient heat dissipaters.

Another interesting electrical application of cellophane is in connection with wire for use in appliance cords and small industrial cables. In the former usage, the Underwriters Laboratory specifications for rubber covered wire call for a "separator" between the wire and the rubber. This is to add insulation qualities and more particularly the ability to "crimp" the ends for connection without damaging the tiny strands. As cellulose film is included in these specifications, household electric cords are now appearing with such modern insulation.

—*Electric Journal.*

Flares Protect Parked Motorists

The Universal Atlas Cement Company takes a tip from the railroads in making its contribution to highway safety. Every Universal salesman has been given a box containing 4 red flares which burn 30 minutes each. The salesman is instructed that if he has occasion to stop along the road at night for any reason whatsoever, he is to place a flare in back of his car as quickly as possible after stopping. Salesmen who have had occasion to employ this safety measure say it's a fine idea.—*Business Week.*

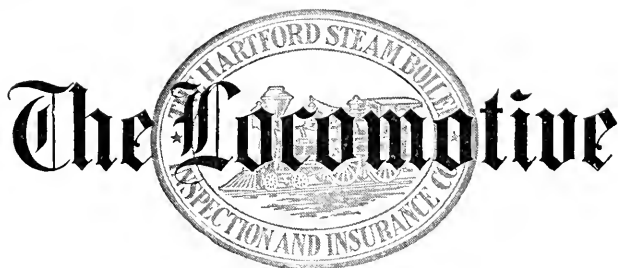

A QUARTERLY MAGAZINE
DEVOTED TO POWER PLANT PROTECTION

Published continuously since 1867

GEORGE H. PRALL, *Editor*

Copyright 1936 by The Hartford Steam Boiler Inspection and Insurance Company

HARTFORD, CONN., October, 1936

Single copies may be obtained free by calling at any of the Company's offices.

Subscription price 50 cents per year when mailed from this office.

Bound volumes one dollar each.

Reprinting matter from this paper is permitted if credited to

THE LOCOMOTIVE of THE HARTFORD STEAM BOILER INSPECTION AND INSURANCE CO.

Edward Sidney Berry

The death, on August 16, of Mr. Edward Sidney Berry, vice president and general counsel of this Company, brought to an end a career of loyal and devoted service that for more than 28 years had had an important influence in the successful conduct of the Company's affairs.

Joining the Company as its counsel on April 1, 1908, Mr. Berry brought to that position a thorough knowledge of, and a broad experience in, insurance law. Eight years later, he was made an assistant secretary and counsel and on March 1, 1922, was elected vice president and made general counsel.

Mr. Berry was widely known as an authority on many phases of boiler and machinery insurance and because of this he was in many cases called on in a consulting capacity to aid in the framing of state laws governing the safe construction and operation of boilers.

His death brought a keen sense of personal loss to all his associates. With respect to his work, President William R. C. Corson said:

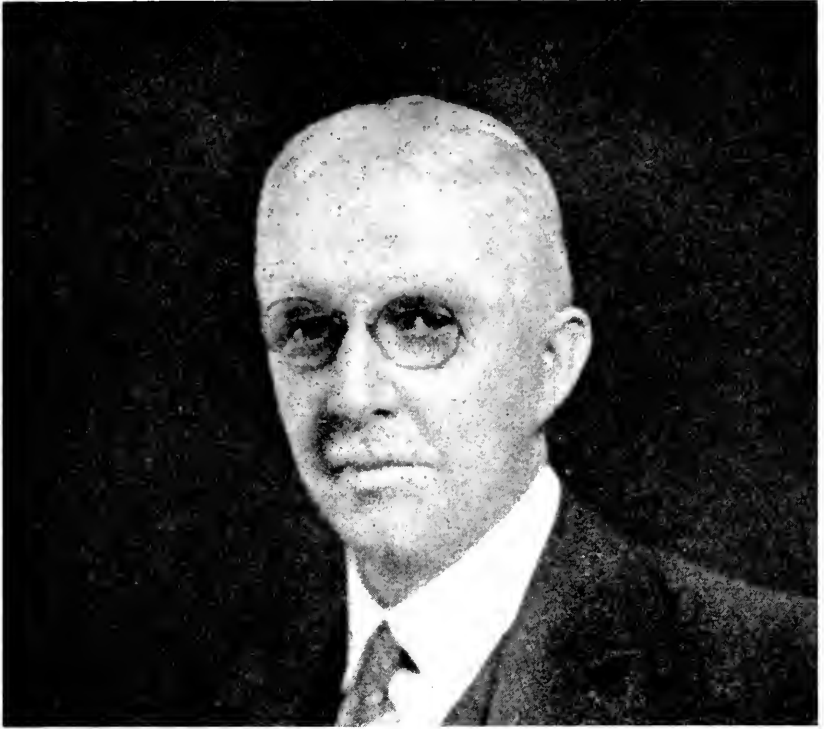

EDWARD SIDNEY BERRY.

“Not only did Mr. Berry serve the Company faithfully and well in the direction of the legal and claim departments, but he was keenly interested and intimately acquainted with every phase of its business. He willingly gave the benefit of a mind that thought clearly, weighed accurately and was marked for its breadth of vision. A man of strong convictions but tolerant and considerate of the opinions of others, of warm and understanding sympathies, rigorously fair in all dealings, his character and ability have left a deep imprint on the Company.”

Born at Titusville, Pa., December 3, 1866, Mr. Berry was graduated from high school there and engaged in an editorial capacity on a newspaper, the *American Citizen*, and at the same time started the study of law. In 1887 he entered Harvard College, there completing the four year course in three years. He then entered Harvard Law School, graduating in 1894 and being admitted to practice as an attorney in Massachusetts a year later.

From 1898 to 1903 Mr. Berry was secretary of the Library Hall Association of Cambridge, one of the original municipal good-government organizations in the country. In that capacity he was active in drafting and securing the enactment of legislation regulating municipal election laws.

While still in college, Mr. Berry was engaged to assist in legal work at the Boston office of the Employers' Liability Assurance Corporation, Ltd., of London, and during 13 years in this capacity he acquired a broad knowledge of the personal injury laws and litigation throughout the country, and of the causes of accidents covered by liability insurance.

In 1903 he took charge as attorney of record of litigation arising in New York City and vicinity under liability policies of the Ætna Life Insurance Company and was active in trial and appellate court work there until in 1908 he was assigned to organize the company's Florida department for appointing attorneys and handling claims in that state. He came to The Hartford Steam Boiler Inspection and Insurance Company after completing that work.

Horace Bushnell Cheney

Mr. Horace Bushnell Cheney, a director of The Hartford Steam Boiler Inspection and Insurance Company, and prominent in New England industrial circles, died at Santa Fe, New Mexico, on August 15 from injuries sustained in an automobile accident. He had been a member of the board of directors since 1909 when he succeeded his father, the late Colonel Frank W. Cheney, who had served on the board continuously from the Company's organization in 1866.

Mr. Cheney was born in Hartford in 1868 and his entire business life was identified with Cheney Brothers, prominent silk textile manufacturers, of South Manchester, Connecticut. He was a vice president of that organization prior to his retirement about a year ago. In his career with his company Mr. Cheney contributed materially to the improved technique of its manufacturing processes and in the development of its policies of scientific management. He was recognized as a leader of influence in the silk textile industry and, as chairman of the legislative committee of its trade association, he for many years rendered effective service in securing tariff legislation favorable to the growth and development of that business. Besides being a director of this Company, he also was on the board of the Ætna (Fire) Insurance Company.

A resolution adopted by his fellow directors said, in part:

"He was a high-minded, public spirited man, keenly conscious of his civic, social and business responsibilities and earnestly conscientious in meeting them. It has meant much to this Company to have had a man of Mr. Cheney's standing and ability on this board and the benefit of his experienced judgment in the direction of its affairs."

Queen Mary Sets New Trans-Atlantic Steamship Records

Setting new records for both eastbound and westbound trans-Atlantic crossings in less than two weeks was the unusual accomplishment of the *Queen Mary*, pride of the British merchant fleet and newest of the Cunard ocean greyhounds.

On August 24, 1936, she made the fastest westbound crossing from any European port to New York on record. Her time, from Cherbourg Breakwater to Ambrose Light, was 4 days, 7 hours, and 12 minutes, surpassing her own previous record of 4 days, 8 hours, and 37 minutes over a course of 3,098 miles made on July 22. The best previous time for that run was 4 days, 17 hours, and 42 minutes for 3,163 miles, made by the *Bremen* in 1929.

During this record-breaking trip the *Queen Mary* also maintained the fastest average westbound speed made to that time—30.01 knots, thereby bettering the *Normandie's* record of 29.64 knots set in June, 1935, over a slightly longer course, from Southampton to New York.

On August 31, the *Queen Mary* fulfilled a prophecy* made in THE LOCOMOTIVE for July, 1935, by crossing the Atlantic in less than 4 days. This was on the eastbound trip from New York. She reached Bishop's Rock at Southampton, England, in 3 days, 23 hours, and 57 minutes, the fastest time for any crossing in either direction. The *Normandie*, again taking a longer course, had previously held a record for this crossing of 4 days, 3 hours and 28 minutes.

Maintaining an average of 30.63 knots for 2,929 miles, the *Queen Mary* set a new high for the fastest average speed on any crossing, beating the *Normandie's* 30.31 knots averaged on an eastward crossing in 1935. The *Queen Mary* must hold the highest knot average for 3 months in order officially to bring back to England the supremacy of the sea, lost to Germany in 1929 (*Bremen*) and lost in turn by that country to France in 1935 (*Normandie*).

*"A crossing in less than 4 days now does not seem far distant."

The *Normandie* still holds the record for the highest speed made, having attained a maximum of 31.39 knots for one hour on an eastbound crossing in 1935.

Successive Records Established by Trans-Atlantic Steamships

<i>Steamship</i>	<i>Date</i>	<i>From</i>	<i>To</i>	<i>Days</i>	<i>Hrs.</i>	<i>Min.</i>	<i>Nautical Miles</i>	<i>Knots per hr.</i>
Savannah	1819	Savannah	Liverpool	26	4,000*	6.40
Sirius	1838	England	New York	18	12	..	3,000*	6.75
Britannia	1840	Liverpool	New York	14	8	..	3,153*	9.75
Great Western	*1845	England	New York	10	10	15	3,000*	11.95
Pacific	1851	England	New York	9	19	25	3,000*	12.75
Persia	1856	Queenstown	New York	9	1	45	2,780*	12.78
Scotia	1866	Queenstown	New York	8	2	48	2,730*	14.26
City of Brussels	1869	Queenstown	New York	7	22	3	2,780*	14.62
Baltic	1873	Queenstown	New York	7	20	9	2,780*	14.76
City of Berlin	1875	Queenstown	New York	7	15	48	2,780*	15.12
Arizona	1880	Queenstown	New York	7	7	23	2,780*	15.82
Alaska	1882	Queenstown	New York	6	18	37	2,780*	17.10
Etruria	1888	Queenstown	New York	6	1	55	2,780*	19.10
City of Paris	1889	Queenstown	New York	5	19	18	2,788	19.95
Majestic	1891	Queenstown	New York	5	18	8	2,777	20.11
Campania	1893	Liverpool	New York	5	12	15	2,799	21.17
Lucania	1894	Queenstown	New York	5	7	23	2,780*	21.80
Deutschland	1900	New York	Plymouth	5	7	38	3,116	24.40
Lusitania	1909	Queenstown	New York	4	11	42	2,780*	25.81
Mauretania	1910	Queenstown	New York	4	10	41	2,826	26.60
Mauretania	1929	New York	Flymouth	4	19	55	3,145	27.22
Bremen	1929	Cherbourg	New York	4	17	42	3,163	27.83
Bremen	1932	New York	Plymouth	4	14	30	3,116	28.10
Bremen	1932	New York	Southampton	4	16	15	3,200	28.51
Rex	1933	Gibraltar	New York	4	13	58	3,181	28.92
Normandie	1935	Southampton	New York	4	11	42**	3,195	29.64**
Normandie	1935	New York	Southampton	4	3	28	3,015**	30.31
Queen Mary	1936	New York	Southampton	3	23	57	2,929	30.63

* approximate

** corrected figures

Silicon and Embrittlement

In recent months the subject of embrittlement has taken on new interest because of laboratory experiments which seem to show that chemically pure caustic apparently does not produce inter-crystalline defects in boiler steel, although if the caustic contains silicon in some form as an impurity it will bring about the characteristic fissures known as embrittlement.

Commercial caustic soda as used in boiler compounds is seldom chemically pure, one of the impurities commonly occurring in it being silicon. The discovery that the presence of silicon is evidently a factor contributes to a more complete understanding of embrittlement and should aid in the effort to control what is regarded as the most insidious of all boiler ailments. Elsewhere in this issue (Page 107) is mentioned the fact that silicon also is blamed for the development of the action in cast iron known as "growth." The apparent role of this element as a catalyzing trouble-maker would seem to warrant further intensive study of it.

Leaking Valves Cause Furnace Explosion

A LEAKY stop valve on the pilot light and a leaky plug cock on the main burners of a gas-fired power boiler—No. 2 of a pair in a California plant—caused a furnace explosion which did \$2,500 damage to the boiler setting. The escaping gas, which had filled the furnace and flues of the idle boiler, was ignited through cracks in the center brick wall between the two boilers five minutes after the No. 1 burner had been lit. The rear wall was budged and pushed back about nine inches. The right side wall was blown out entirely, leaving no support under that side of the boiler, as the boilers were set on brickwork instead of being supported from the beams. This caused an excessive strain on the main steam pipe which held the boiler in place. Fortunately, there was no water in the boiler at the time, for that added weight would probably have caused the piping to break and the boiler to fall.



View of right side wall of No. 2 boiler showing the damaged setting. The boiler is 72" in diameter and 16' long of the horizontal return tubular type.

Hot Water Heating Boiler Accident



Above is pictured a wrecked living room, part of the damage caused by the explosion last spring of a small round type cast iron hot water heating boiler in a Buffalo residence. Its explosion led to the injury of three women who were knocked to the floor by the blast or were struck by flying glass or other objects. Damage to the house, which was a two-story frame dwelling, included that shown in the living room, the breaking of all the windows, and the demolition of the heating plant. The property damage was estimated at about \$2,000.

Large Air Conditioning Unit Installed

Air-cooling of an office building in Wilmington, Delaware, requires a 600-ton capacity refrigerating system to condition 167,000 cubic feet of air a minute. The unit is one of the largest air conditioning installations in the country.

Taps From the Old Chief's Hammer

I WISH some folks could realize that you just can't keep over-loading a machine any more than you can a horse," sputtered the Old Chief late one afternoon as he was cleaning up his desk. "Here's another accident at Nagle's factory, and I know as sure as I'm sitting here that he over-loaded that motor."



The Old Chief addressed these remarks to his assistant, Tom Preble, who replied, "Why do you say that, Chief?"

"Because I know Nagle," snapped back the older man. "His plan always has been to stint on machines and crowd the ones he has. When one breaks down he gets all excited for a few days, purchases enough new equipment to meet his needs, and then settles back to his old tactics. His habit costs him plenty in interruptions, but he never seems to anticipate them.

"Tom, Nagle's motor reminds me of another case of over-loading which proved considerably more of a mystery. It was at Fallsville in the big metal plant there. Did I ever tell you about Inspector Bill Cradle's work in connection with it?"

"I don't think so, Chief," Tom replied, and he knew that another true story of power plant experience was about to be told.

"Cradle had been inspecting the motors at the Fallsville plant for years," the Old Chief began, "and his record, as you know, was mighty good. Then one day on his regular inspection he noticed that the 500 hp motors driving the aluminum finishing rolls were running hot. He checked and rechecked the machines. As far as he could learn there had been no change in operating conditions, yet these motors that had previously given no trouble were over-heating dangerously.

"He called me long distance telephone, and told me the story. Of course, some condition *had* changed. Of that I was sure, and I had confidence in Cradle's ability to determine what it was. So I told Bill to stay at Fallsville until he found out what was the matter.

"Bill worked up and down that mill room. He tested and re-tested

the motors, he talked with the foremen and with the engineers, but none of them gave him the clue he needed.

“‘Have you tightened up the rolls?’ he asked the engineers.

“‘Certainly not,’ was the answer, and the answers to many other questions brought nothing in the way of constructive help.

“‘But Cradle pondered and searched and kept on asking questions. After a few hours of this he began looking around the shop for anything that might give him the extra facts he needed. The machines certainly were running too hot, but the engineers said there had been no change in the process; the lubrication apparently was efficient; it all seemed a riddle.

“‘He came upon the production manager watching a group of men at their machines. Cradle had known him for years and the two were very friendly.

“‘Bill,’ the production chief said. ‘What’s your idea as to why those 500 horsepower motors are running so hot? Have you solved the thing, yet?’

“‘No, Mac, but that’s why I’m back here, and I’m going to stay until I find out what’s wrong.’

“‘The conversation shifted from subject to subject. After a time the manager remarked, ‘We are certainly getting the stuff through faster since we put the men on a piece-work basis.’

“‘Bill was all attention. Here was something that might help him.

“‘What do you mean, Mac,’ he said. ‘Aren’t the men on the old wage plan?’

“‘Yes,’ was the answer, ‘but we are paying them a bonus for all production above a certain minimum.

“‘But I always understood your bottle neck was the capacity of your rolls. How are you getting around that?’

“‘That’s what pleases us. There must have been a lot of waste motion there at the rolls, because the sheets are coming through fine—did so within a day or two after we made the change.’

“‘Bill’s mind worked fast. Here, he felt was the solution of his problem. He was sure that the motor trouble and the production line bonus went together.

“‘Mac,’ he said, ‘it must be that.’

“‘Must be what?’

“‘Your bonus to the men is being paid by the motors, or will be soon.’

“‘What motors?’

“‘The motors driving those rolls. I think they are running hot be-

cause they are doing more work somehow, and they're not built to stand it.'

"'But the motors aren't working any harder. The rolls haven't been tightened . . . or . . . nobody has ordered any change like that. You know we considered that last year and decided the motors couldn't stand it. Let's check those rolls right away. You may be right.'

"The long and the short of it was that the operators had done what they thought was a smart thing, and profitable for them, too, under the new bonus system. Without saying anything to anybody they had reduced the number of passes necessary to obtain the finished sheet, hoping I guess that there was enough extra power in the motors to stand the change. Of course, setting the rolls at each pass to obtain a greater gauge reduction lessened the number of passes necessary to roll the plate to the desired thickness and get more finished sheets through per hour. Everybody was happy. The line was moving faster; the operators were getting their bonus, and the motors seemed to be doing their job—until Cradle called to make his regular inspection. It's certain that there would have been some expensive burnouts before long that would have stopped the lines and raised plenty of rumpus."

"That was keen work on Cradle's part," Preble commented.

"Sure it was," the older man mused, "but Bill kicked himself because he hadn't figured the thing out right away when he first found out those motors were running hot."

Serious Accident to Internal Combustion Engine

A LOSS estimated at close to \$20,000 occurred at a Mid-West ice plant in June when the crankshaft of a 350 hp gas engine broke and wrecked the machine. Repairs entailed by the breakdown amounted to about \$10,000, and six weeks of production (100 tons of ice a day) were prevented. None of the loss was covered by insurance.

Failing in the center of one of the crank webs, the shaft actually parted. The broken ends of the crank web interfered with each other and one was crushed into the engine base. One shaft section moved about 6" horizontally, shearing the bearing brackets and breaking the bearing caps. The shaft itself was badly distorted, as was the stub shaft. The connecting rods were bent, and the engine base was ruined.

The cause of the accident was not definitely determined, although it is considered likely that a progressive crack in the crank web, the result of misalignment, was responsible.

The Hartford Steam Boiler Inspection and Insurance Company

OF HARTFORD, CONN.

December 31, 1935

Capital Stock, \$3,000,000.00

ASSETS

Cash on hand and in banks		\$601,612.42
Premiums in course of collection (since October 1, 1935)		1,121,318.19
Interest accrued on mortgage loans		40,086.52
Interest accrued on bonds		103,099.37
Loaned on mortgages		518,545.00
Home Office real estate and Philadelphia branch office		542,474.66
Other real estate		264,909.47
Bonds on an amortized basis	\$9,382,820.63	
Stocks at market value	6,537,479.36	
		15,920,299.99
Other admitted assets		30,706.39
<i>Total</i>		\$19,143,052.01

LIABILITIES

Premium reserve		\$7,215,766.14
Losses in process of adjustment		272,174.24
Commissions and brokerage		224,263.64
Other liabilities (taxes incurred, etc.)		565,861.62
<i>Liabilities other than capital and surplus</i>		\$8,278,065.64
Capital stock	\$3,000,000.00	
Surplus over all liabilities	7,864,986.37	
<i>Surplus to Policyholders</i>		10,864,986.37
<i>Total</i>		\$19,143,052.01

WILLIAM R. C. CORSON, President and Treasurer

BOARD OF DIRECTORS

LUCIUS F. ROBINSON, Attorney, Hartford, Conn.	SAMUEL M. STONE, President Colt's Patent Fire Arms Mfg. Co., Hartford, Conn.
JOHN O. ENDERS, Chairman Executive Committee Hartford National Bank & Trust Co., Hartford, Conn.	SAMUEL FERGUSON, Chairman Board of Directors The Hartford Electric Light Co., Hartford, Conn.
MORGAN B. BRAINARD, President Aetna Life Insurance Company, Hartford, Conn.	HON. JOHN H. TRUMBULL, President The Trumbull Electric Mfg. Co., Plainville, Conn.
CHARLES P. COOLEY, Chairman Board of Trustees Society for Savings, Hartford, Conn.	CURTISS C. GARDINER, Vice President The Hartford Steam Boiler Inspection and Insurance Company, 90 John Street, New York.
JOSEPH R. ENSIGN, President The Ensign-Bickford Co., Simsbury, Conn.	JAMES L. THOMSON, Chairman Finance Committee Hartford Fire Insurance Company, Hartford, Conn.
EDWARD MILLIGAN, President Phoenix Insurance Co., Hartford, Conn.	PHILIP B. GALE, Chairman Board of Directors Standard Screw Co., Hartford, Conn.
WM. R. C. CORSON, President The Hartford Steam Boiler Inspection and Insurance Co., Hartford, Conn.	JOHN J. GRAHAM, Vice President The Hartford Steam Boiler Inspection and Insurance Co., Hartford, Conn.

Incorporated 1866



Charter Perpetual

Department

Representatives

ATLANTA, Ga., Citizens & So. Nat. Bk. Bldg.	W. M. FRANCIS, Manager. C. R. SUMMERS, Chief Inspector.
BALTIMORE, Md., 704-9 Garrett Building	D. W. LITTLE, Manager. R. P. GUY, Chief Inspector.
BOSTON, Mass., 87 Kilby Street	A. PAUL GRAHAM, Manager. W. A. BAYLISS, Chief Inspector.
BRIDGEPORT, Conn., City Savings Bank Building	W. G. LINEBURGH & SON, General Agents. A. E. BONNET, Chief Inspector.
CHICAGO, Ill., 175 West Jackson Boulevard	P. M. MURRAY, Manager. C. W. ZIMMER, Chief Inspector.
CINCINNATI, Ohio, 1904-12 Carew Tower	JAMES P. KERRIGAN, Manager. W. E. GLENNON, Chief Inspector.
CLEVELAND, Ohio, 1040 Leader Building	ARTHUR F. GRAHAM, Manager. JOHN L. SCOTT, Chief Inspector.
DENVER, Colo., Gas & Electric Building	J. H. CHESNUTT, Manager. JESSE L. FRY, Chief Inspector.
DETROIT, Mich., National Bank Building	L. L. COATES, Manager. THOMAS P. HETU, Chief Inspector.
HARTFORD, Conn., 56 Prospect Street	F. H. KENYON, Manager A. E. BONNET, Chief Inspector.
NEW ORLEANS, La., 333 St. Charles Street	R. T. BURWELL, Manager. P. E. TERROY, Chief Inspector.
NEW YORK, N. Y., 90 John Street	C. C. GARDINER, Vice President. J. F. HUNT, Chief Inspector.
PHILADELPHIA, Pa., 429 Walnut Street	A. S. WICKHAM, Manager. S. B. ADAMS, Chief Inspector.
PITTSBURGH, Pa., Arrott Building	WILLIAM P. WALLACE, Manager. J. A. SNYDER, Chief Inspector.
ST. LOUIS, Mo., 319 North Fourth Street	CHAS. D. ASHCROFT, Manager. EUGENE WEBB, Chief Inspector.
SAN FRANCISCO, Cal., 114 Sansome Street	C. B. PADDOCK, Manager. L. E. GRUNDELL, Chief Inspector.
SEATTLE, Wash., Arctic Building	E. G. WATSON, Manager. WILLIAM J. SMITH, Chief Inspector.
TORONTO, Ont., Canada, Federal Building	H. N. ROBERTS, President The Boiler In- spection and Insurance Company of Canada.



Through the night to banish worry

Under a black and dour sky a motorcar heads for the hills. In a remote factory town a main steam-header has exploded, spreading destruction in the engine room. Roused at midnight by a call from the owner, the Hartford Steam Boiler inspector speeds to the plant—to size up the trouble, gives his counsel, pledge his Company's aid in helping to get machines back on schedule and men back on jobs!

Emergency action is all in the day's—and night's—work for Hartford men, in keeping with the Company's tradition. They are always on hand when wanted—always near enough to aid when trouble comes fast.

41 No. 5

JANUARY, 1937

The Locomotive



Quarterly Magazine Devoted to Power Plant Protection

Please Show to Your Engineer



Two Recent Turbine Accidents

OVER-SPEED WRECKS GENERATOR AFTER PRIMARY AND SECONDARY DEFENSES FAIL

SIMULTANEOUS jamming of the throttle trip-valve and breaking of a pipe in the oil line serving the controls recently permitted over-speeding of a 3,000 kw turbine in a manufacturing plant and resulted in an accident that would have been even more serious had not attendants been in position to close the steam valves manually.

The machine had been dismantled for repairs and reassembled, the accident occurring during a test preparatory to putting the turbine back into service. Fortunately, the damage was confined to the wrecking of the generator. But for the fact that those present were able to act quickly to check the runaway, it is probable that the whole unit would have gone to pieces, wrecking the steam end and perhaps damaging surrounding property.

It was one of those accidents which cannot be anticipated, and it illustrates how, with every reasonable precaution taken by experienced operators, things may go wrong. The accompanying photograph of the generator rotor shows how near the unit came to flying apart.

Because they had found it difficult to keep old brass oil-pressure piping tight, the owners had substituted seamless steel tubing with welded joints except for three pieces of stainless steel piping, one of which was a $3\frac{3}{8}$ " nipple screwed into the cast iron primary oil relay cylinder of the governor. This nipple broke at the bottom of the thread at the point of entrance to the cylinder. Why it broke was not definitely decided, but it is believed possible that the nipple may have been cracked at the time the joint was assembled, the fracture becoming a definite break under vibration at a speed greater than normal, so that its failure coincided with the jamming of the throttle valve.

As the nipple supplies oil to the primary pilot valve of the relay which comprises a pilot valve and a double oil-actuated piston, oil pressure is necessary to move this piston in either direction. Should the oil pressure fail, no closing force is available for actuating the piston which in turn closes the valves, so that, when the nipple broke, the primary steam control valve remained open.

The unit had been brought up to speed (3,600 rpm) and had operated normally without trouble or excessive vibration for approximately 15 minutes. Frequent checks were made with a hand tachometer. Then the governor lever was moved to produce speed variations to test governor stability, a normal procedure. During this check the speed

reached the tripping range (4,000 rpm on the hand tachometer) and the over-speed device on the shaft functioned, tripping the combination throttle and emergency stop valve, which, instead of closing, jammed in a partially-open position because of a chip of foreign material which had scored the guide. Incidentally, the erector had tested this trip valve by hand before bringing the unit to speed and it had closed satisfactorily. The erector heard the over-speed device operate, but as the turbine

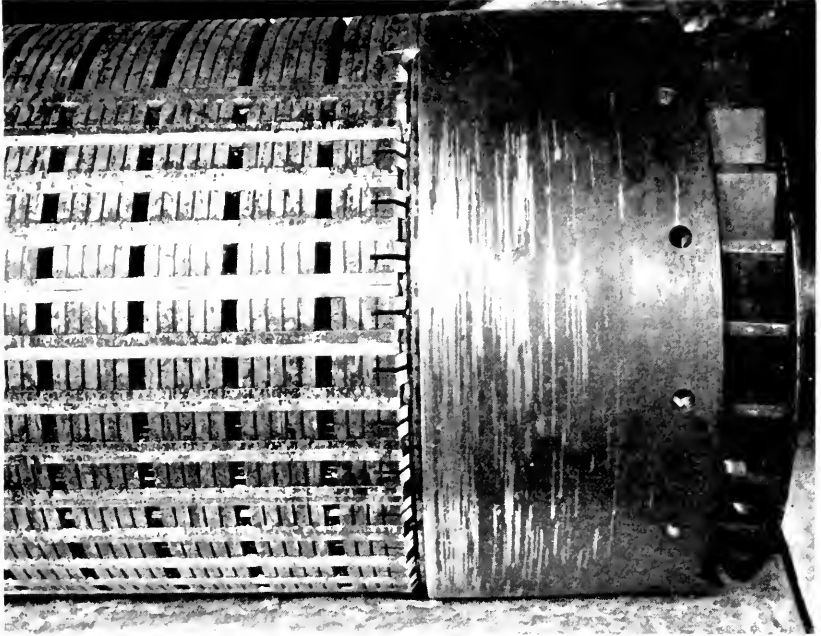

Damaged rotating field after over-speed. The core is a solid steel forging so machined that the forged steel end rings are fitted into a rabbet-joint on the ends of the rotor forging. The centrifugal forces exerted against this rabbet were sufficient to break off sections of the steel rotor forging, which immediately jammed between the field and stator where they were rolled into small balls or were embedded in the stator laminations.

did not slow down, he and an operator who were at the head of the unit and near the throttle stayed with the machine and succeeded in forcing the jammed valve to close. At the same time two other operators closed the header valve feeding steam to the turbine.

The steam end of the unit came through the ordeal nicely, but the

generator was so damaged that new stator coils and laminations, and a complete new rotor were necessary if its use was to be continued. The coupling was damaged as was the generator foundation. It also was necessary to re-align the turbine and the generator. Fortunately the owners had an idle generator of the same capacity on hand and installed it in place of the wrecked unit. The loss of more than \$13,000 was covered by insurance in Hartford Steam Boiler.

WATER CAUSES BREAKAGE OF BLADES

Water in an amount sufficient to move the wheels of a 600 hp steam turbine axially on the shaft caused the second row buckets to rub on the intermediate stationary buckets and 24 of the former to break at a

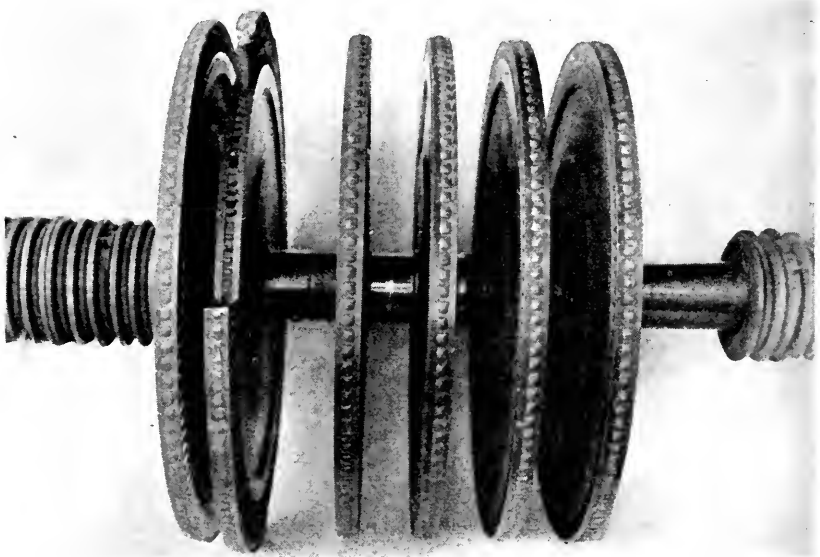

Wheel from which 24 blades were broken when water forced it out of line and permitted it to rub.

paper mill in May. This accident resulted in a loss of more than \$8,000 of which two-thirds was Use and Occupancy loss occasioned by reason of the stopping of the paper machine while repairs were being made. The loss was covered by insurance in Hartford Steam Boiler.

Fusion Welded Power Piping

Standards for Quality of Welding and Methods of Inspection*

By WM. D. HALSEY, *Assistant Chief Engineer, Boiler Division*

IN RECENT years there has been an increasing use of fusion welding in the fabrication of power plant piping, particularly for piping subject to the higher pressures and temperatures. For numerous reasons it will be apparent that such lines must be absolutely free from leakage and, because of troubles that have been experienced in the past in trying to keep mechanical joints tight, fusion welded high pressure lines have become a practical necessity in most cases.

A high pressure pipe line should be designed by consulting engineers or by others who have experience in such design. The proper thickness of pipe, the quality of pipe material, and the general layout with suitable provisions for expansion and contraction are the designer's responsibility.

It is the responsibility of the contractor who installs the line to meet the requirements of the designer and also to see that the required quality of welding is obtained.

As an organization making inspection of fusion welded pipe lines, Hartford Steam Boiler is interested primarily in safety, and it will be apparent that the physical properties of the fusion welded joints are a large factor in the safety of a fusion welded pipe line.

Considerable thought has been given to the quality of welding which should be required in high pressure pipe line work. Many purchasers, having in mind the classification for fusion welded pressure vessels adopted by the A. S. M. E. Code, have specified "Class 1" for the quality of the welding. The intent of the Code in referring to classes was primarily for a distinction in the degree of severity of service for a vessel rather than for the quality of the welding, although there was some difference in the requirements for weld quality. Because of the improper interpretation placed upon the designations "Class 1," "Class 2," and "Class 3," the Unfired Pressure Vessel Code has discontinued these designations and now refers to paragraph designations such as "U-68," "U-69," and "U-70." There is little difference in the tensile strength, ductility, and soundness requirements of welds for U-68, (formerly Class 1) and U-69 (formerly Class 2) pressure vessels.

*From a paper presented before the convention of the International Acetylene Association, St. Louis, Mo., November 15-20, 1936.

The outstanding difference between the two lies in the manner of accomplishing the end desired. For U-68 vessels a test weld must be made for every vessel, the major seams must be radiographically examined, such as by X-ray, and all vessels must be stress-relieved by heating. For U-69 vessels the intent is that a procedure for welding must be adopted by the manufacturer, which procedure must be investigated by making sample welds and testing such welds for tensile strength, ductility, and soundness. Every welding operator must then be examined for his ability to make, by the procedure that has been adopted, welds which will have the required tensile strength, ductility, and soundness. It is assumed that if the adopted procedure of welding is followed and only qualified welding operators are used, the results obtained in actual construction will conform to the results obtained under test.

In a fusion welded pipe line, to meet completely the requirements of the A. S. M. E. Code for "Class 1," or what is now known as U-68, it would be necessary that every welded joint be examined by X-ray. Obviously such a procedure would be impractical and in most cases, impossible, because, to obtain the best results in X-ray examination, the film must be placed close to the weld being examined and *on the side opposite the X-ray tube*.

To meet the stress-relieving requirements every section of pipe containing a weld would have to be placed in a stress-relieving furnace after the welded joint between the sections had been completed, and for every group of welded joints it would be necessary that a test weld be made for determination of tensile strength, ductility, and specific gravity—a procedure which is manifestly impracticable.

When consideration is given to all the requirements of the A. S. M. E. Code as it applies to fusion welded boiler drums and U-68 vessels, it will be apparent that they cannot be met from a practicable standpoint, nor are they applicable to fusion welded pipe line construction. The proper procedure for fusion welded pipe lines is to call for a specified technique of welding, an investigation of that technique to determine that it will produce certain desired results, qualification of the welding operators under such procedure of welding, and an insistence that that procedure be followed in actual construction. It is upon this principle that the requirements for welding in the American Standards Association Code for Pressure Piping are based, although certain recent developments have brought about some changes with respect to the method of qualifying welding operators, which might well be incorporated in the A. S. A. Code.

Within the near future Hartford Steam Boiler will adopt a new inspection procedure for pipe lines it is called upon to inspect. The first requirement will be, as heretofore, that the fabricator or piping contractor adopt a specific procedure for welding and that he demonstrate to the Company's representative that such procedure will produce welds having satisfactory tensile strength, ductility and soundness. The method to be followed to determine these factors is outlined in the "Tentative Rules for the Qualification of Welding Processes and Testing of Welding Operators," as published by the American Welding Society and which appeared in the October, 1936, issue of the *American Welding Society Journal*.

The second requirement will be for the fabricator or contractor to demonstrate that all welding operators employed on the work can make sound welds when they follow the outlined procedure that has been investigated and found satisfactory. The procedure for the qualification of a welding operator is outlined also in the "Tentative Rules" referred to above.

The third requirement will be that a representative of the Company make a sufficient number of visits of inspection during the fabrication of the pipe line for the purpose of checking upon the procedure for welding. Particular attention will be paid to the materials that are used, as such materials determine to a large degree the quality of weld metal that will be obtained.

It will be required that all welding operators be assigned an identifying number or symbol, which number or symbol must be stamped adjacent to every weld which the operator makes. Upon the completion of the work, the inspector will remove from the pipe line a complete welded joint or a specimen from a joint for each welding operator, and these welds or specimens will be examined for soundness.

As long as such examinations show that the individual operator is doing acceptable work by the prescribed procedure, no re-qualification tests will be required. In other words, the individual operator must pass an initial examination to demonstrate his ability, and will be held fairly close to that quality of workmanship through the medium of a check on his work on the job. In unusual cases some other method of inspection may be agreed upon by the owner or purchaser and the inspecting company.

The final step in the inspection will be, of course, the hydrostatic test.

Some points of the above procedure in the inspection of fusion welding on pipe lines are worthy of further discussion.

It is of particular interest to note that the American Welding Society's "Tentative Rules" recognize the principle that tensile strength and ductility in weld metal are determined by the procedure or technique of welding. This procedure or technique involves all the variables encountered. Consideration is given, not alone to the question of whether the gas or metallic arc process is used, but also to the specific kind of welding wire, to the shape of the welding groove, to the quality of flame, to the number of beads deposited, and several other items. When it has been determined that a given procedure will produce certain tensile strength and ductility of weld metal, it is then useless to test every operator's work for tensile strength and ductility because those qualities are predictable under the given procedure. For the qualification of a welding operator under any given process it is necessary to know, not whether he can produce welds of a certain tensile strength and ductility, but rather, whether he can make a *sound* weld by that process. By a sound weld is meant one that is properly fused and without excessive slag inclusions or porosity.

The "Tentative Rules for the Qualification of Welding Processes and Testing of Welding Operators" give suggested forms for the writing of specifications for different methods of welding, but no specific instructions for welding are given. It is the duty of the person or persons having responsible charge of the welding to write the specifications setting forth in detail the method to be followed. No limitations are placed on the methods to be used and there is entire freedom for the development of new ideas.

For the qualification of a process, it is necessary that welded pipe joints be made in those positions which are to be encountered in actual construction, and the welding of these joints must be done in accordance with the specifications. From each of these test joints there are removed two reduced section tensile specimens, two free bend specimens for ductility, two root break specimens, two side break specimens, and two nick break specimens. The specimens for the reduced section tensile tests are prepared for testing as shown in Figure 1. The specimens for the free bend are shown in Figure 2, those for the root break specimens in Figure 3, those for the side break specimens in Figure 4 and those for the nick break specimens in Figure 5.

The methods for testing the tensile, free bend, and nick break specimens have been in general use for several years and need no comment here. The methods of testing the root break and side break specimens are shown in Figures 6 and 7 respectively.

In the case of pipe lines which are welded with backing strips or

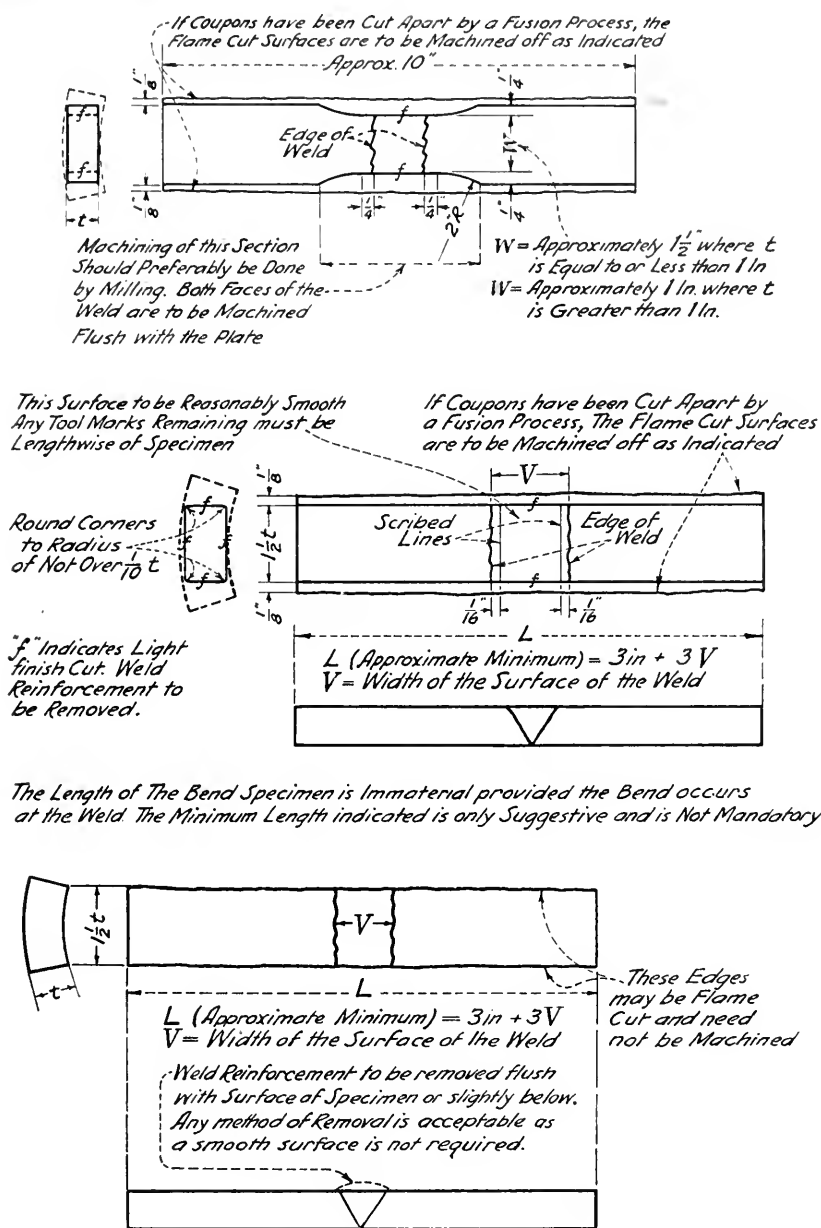
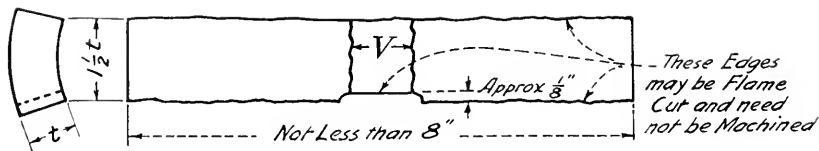

Figure 1 (Top). Figure 2 (Center). Figure 3 (Bottom).



Note: If the weld reinforcement exceeds $\frac{1}{4}t$, it shall be removed flush with the surface of the base material. Any method of removal may be used provided the resulting surface on the specimen is reasonably smooth.

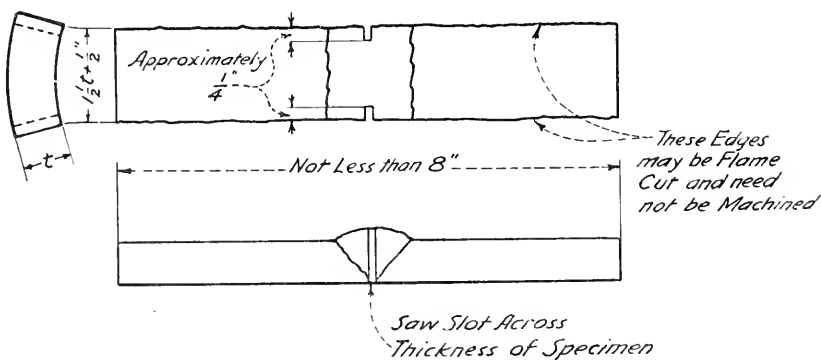

Figure 1 (Top). Figure 5 (Bottom).

chill rings on the inside of the pipe, the specimens shown in Figure 3 are polished on the sides and etched in a boiling solution of 50 per cent hydrochloric acid and water. This method of testing is used instead of the root break to determine what penetration into the chill ring has been obtained.

The side break test is somewhat new. It had been felt that the nick break specimen might not reveal defects that might exist on the side walls of the welding groove. To investigate this matter a defective weld was made in which there was a slag streak of somewhat minor proportions on the side wall. The weld was X-rayed and it was found that the defect continued throughout the length of the weld. Four nick break specimens and three side break specimens were removed. Two of the nick break specimens were broken in the customary manner with a quick, sharp blow, and the other two nick break specimens were broken by a slow bending. All of the nick break specimens broke directly through from notch to notch as shown in Figure 8. The side break specimens broke through the side wall defect as shown in Figure 9.

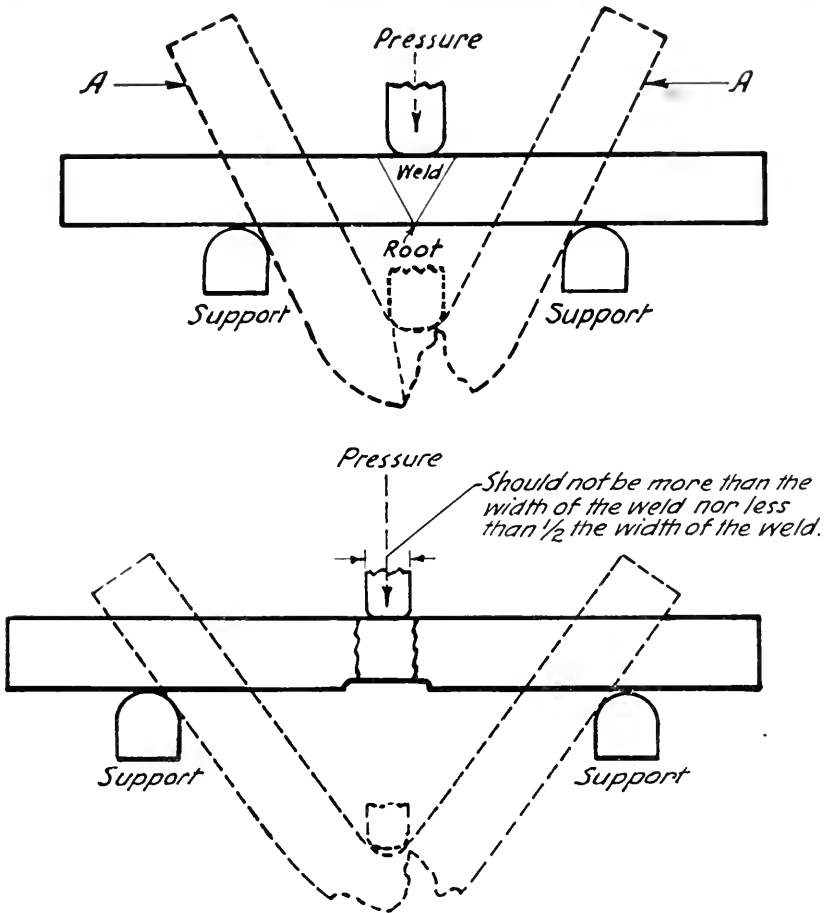

Figure 6 (Top). Figure 7 (Bottom).

In the qualification test for welding operators only the face break, root break, side break, and nick break specimens are used. The face break test is made in the same manner as the free bend test except that no measurement is made of ductility.

It is not to be expected that perfect welds will be demanded. There must be some tolerance and, therefore, there must be some method of evaluating lack of soundness. Thus, consideration must be given to what constitutes a defect.

The Company has adopted the following standards for welded joints in pipe lines:

TENSILE TEST—The reduced section tensile test specimen shall show an ultimate tensile strength not less than 90 per cent of the tensile strength of the pipe material.

FREE BEND TEST—The ductility by the free bend method shall be not less than 20 per cent.

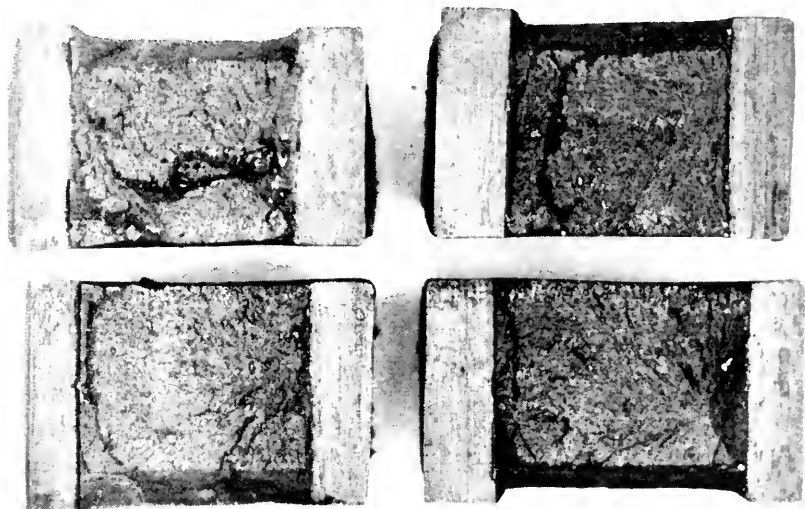

Figure 8



Figure 9

SOUNDNESS—The permissible total depth of all zones of defects on any plane parallel to the throat of the weld shall not exceed 10 per cent of the specified weld throat dimension in the case of fillet welds, or of the thinner of the two parts jointed in the case of butt welds.

Defects are defined as gas pockets, slag inclusions, and lack of fusion exceeding $1/16''$ in greatest dimension. Typical cases of zones of defects are shown in Figure 10. For single welded butt joints without backing rings, all defects in a zone of 10 per cent of the pipe wall thickness at the root of the weld may be disregarded.

The length of any permissible defect, measured on a line perpendicular to the throat of the weld, shall not exceed $1/2''$.

The following sketches illustrate typical views of the face of fractures in broken specimens of any type.

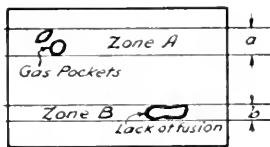

Total depth of defective zones = $a + b$

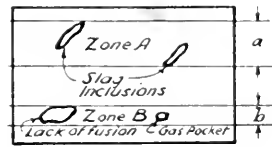

Total depth of defective zones = $a + b$

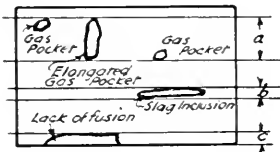

Total depth of defective zones = $a + b + c$

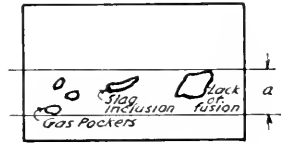

Total depth of defective zone = a

The sketches below illustrate typical views of the cross sectional surface through a welded joint as shown in an etched specimen.

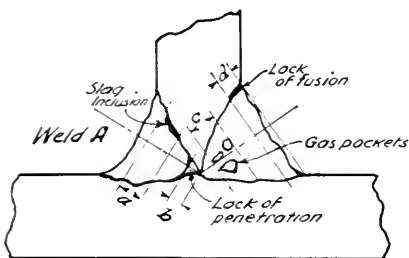

Total depth of defective zones
Weld A $a + b$ Weld B $c + d$.

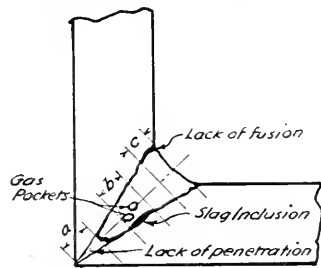

Total depth of defective zones = $a + b + c$

Figure 10

When joints or specimens of joints are removed from the completed line for examination, no single zone of defect in excess of 10 per cent or a total of all zones in excess of 20 per cent of the pipe wall thickness will be permitted. The 10 per cent zone at the root of the weld in single welded joints without backing-up strips will be disregarded and the 1/2" limitation on the length of a defect will not apply to lack of fusion between layers of welding.

If the defects found exceed 50 per cent of the wall thickness the work of that welding operator will not be accepted. If the defects

exceed the 20 per cent limit given above but not the 50 per cent limit, two additional joints or specimens for each welding operator will be removed. Should these additional joints meet the 20 per cent requirement the work of that welding operator will be accepted. However, if either one of the additional joints or specimens shows defects exceeding the 20 per cent limit, the work of that operator will not be accepted.

When a complete joint is removed from the pipe line, examination will be made by a root bend test of specimens taken at the top, bottom and two sides of the joint and all specimens must meet the requirements. If they do not, the remainder of the joint may be subjected to the root bend test and judgment of the joint made upon the average condition of all specimens.

It must be understood, however, that even though the specimens may technically meet the requirements, the inspector shall have the right to call for additional specimens, if, in his judgment, further investigation is necessary to determine satisfactorily that the welding is safe.

The matter of position in which the welding is done is of paramount importance and a procedure of welding should be investigated, not in one position but in all positions which may be encountered in actual construction, and each and every welding operator should be examined for his ability in all positions. Furthermore, it must be borne in mind that the average welding qualification test is made under the most advantageous conditions and surroundings. Frequently the welding operator must encounter much more difficult conditions on the actual job.

When the oxyacetylene process is used, the average welder is apt to secure better results by the use of multiple layer welding.*

Those who have responsible charge of welding should give serious thought to these matters and determine to their own positive satisfaction, and not by the word of any other person, that a certain technique of welding is proper and that it is followed in the execution of work for which they are responsible.

As regards the requirement that a welded joint or sample from a welded joint be cut from the work of every welding operator, there are some very pertinent facts to be considered. A welding operator may demonstrate his ability to make a sound weld by a given process and under the most adverse conditions. Human beings, however, are at times peculiar in that, while they may have the ability to do a certain job, they do not always extend themselves to accomplish the results of which they are capable. In several instances welded pipe lines

* This subject was discussed in two papers given before the American Welding Society at Cleveland in October, 1936.

have been constructed by operators who had demonstrated their ability to make sound welds, yet joints cut from the line have revealed unsound welds. Figure 11 shows an example of this. A constant prodding thought in the mind of a welding operator, to encourage him to do his best work at all times, will have a most beneficial effect and will be the most effective instrument that can be used to secure properly welded joints



Figure 11

Certainly no competent and conscientious welding operator could possibly object to such a procedure. Both employer and employe, knowing that a sample will be taken, are stimulated to continuously endeavor to avoid the penalties attached to unacceptable work.

There is a bright future for fusion welded pipe lines. That future will be safeguarded if every possible effort is made by all concerned to make doubly sure that all welding be consistently of high quality.



THE COVER

The photograph shows an inspector making an insulation resistance test of the windings of a turbo-generator. Such tests often reveal faulty insulation conditions in time to prevent serious burn out. They have proved extremely valuable in preventing accidents to all types of rotating electric machines.



Heating and
Supply Ed
cidents in a
a Residence
Block and S

Upper Left—One
and another inju
of a cast iron st
12-family apartm
The photograph
damage. Lower
tures of wreckag
residence. A ho
when it was fig
burner had bee
was estimated t

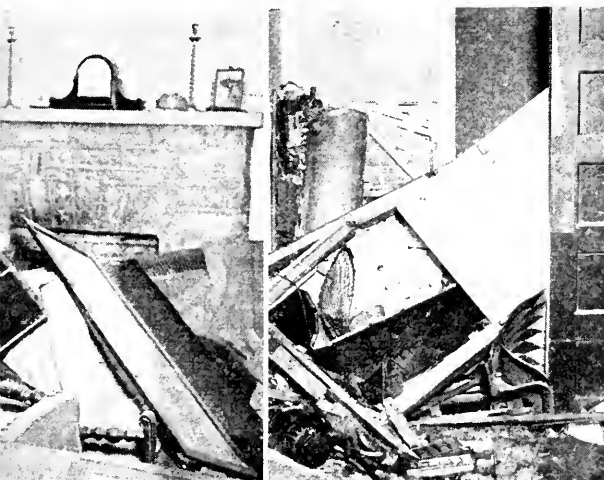

MOTIVE

Hot Water Apartment, Apartment, a Business Store.

oman was killed
by the explosion
onal boiler in a
t in California.
veals part of the
eft—Three pic-
n a Pennsylvania
water tank burst
otten after the
ighted. Damage
about \$7,000.



Upper Right—A hot water heater failure in a Pennsylvania business block injured a woman and resulted in property damage estimated at \$5,000. The blast tore loose the 750-gallon hot water tank shown in the photograph. **Lower Right** — A welded quill pipe steam radiator exploded, scalding an employe and damaging equipment, walls and show window of an Iowa shop. Windows were shattered in automobiles parked in the street in front of the store.



Wheel and Shafting Accidents

THE SUPPLY of power to drive a paper machine at a Canadian mill was interrupted on June 6, when a lineshaft about 6" in diameter parted at an old flaw which was hidden inside of a coupling. This caused a 48" belt to break and led to the explosion of a 15' flywheel and the wrecking of a 750 hp steam engine. The property damage involved the engine, its flywheel and the rest of the drive, the paper machines and the building. While the shaft was not insured, the engine and the flywheel were covered, the property loss because of

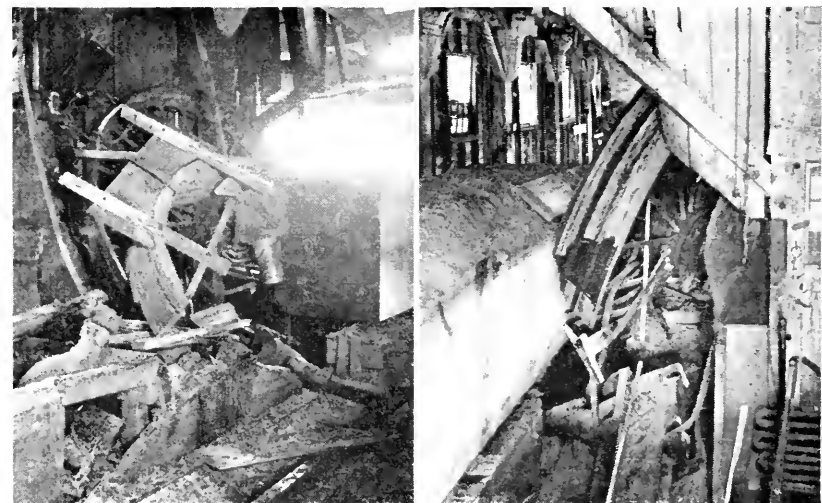

Wreckage following a band saw wheel explosion at a Western mill.

their breakdown amounting to about \$25,000 and Use and Occupancy losses to another \$25,000. It was nearly six weeks before the plant could again operate at full capacity, that length of time being required to obtain and install another engine.

At a paper mill in New Jersey on June 19, a receiving pulley 37" in diameter collapsed, apparently because of failure of bolts. Half of the pulley rode the belt and so jammed the 72" wheel on the engine that this wheel broke. An engineer was killed and a fireman injured by escaping steam, and the wheel and other engine parts were damaged. The combined direct and Use and Occupancy losses of \$19,400 were covered by Hartford Steam Boiler insurance.

An employe who saw the accident, shouted a warning to the engi-

neer. The latter started to run, but changed his mind and returned to the engine, evidently in an effort to get to the throttle, only to be cut down by escaping steam after the large wheel broke.

A top band saw wheel 8' in diameter exploded at a Western mill on May 18, with the result illustrated on Page 146. As all of the fractures in the wheel casting appeared to be new and as there were no old flaws discernible, the only reasonable explanation of the wheel failure was a possible jamming of the saw that may have placed an excessive stress on the wheel rim or on the main bearing support. Property replacement necessitated by the accident was estimated at \$5,000. Flywheel insurance was not carried.

Diesel Engine Damaged Because of Over-load

When an 8-cylinder Diesel engine on a dredge in Southern waters was operated for a considerable time under an over-load, its 11½" pistons became so over-heated and distorted that one of them broke, as shown in the photograph. Each of the other pistons was scored and at least one ring on each piston was broken. The photograph shows the piston head and skirt, separated by a bar to bring out the peculiar burning away of the top land, which permitted the top ring to break and become distributed in small fragments in the cylinder. Obviously the cylinder liners were all so badly scored that they needed replacing.



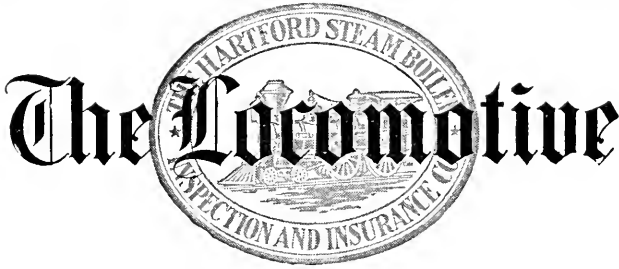

A QUARTERLY MAGAZINE
DEVOTED TO POWER PLANT PROTECTION

Published continuously since 1867

GEORGE H. PRALL, *Editor*

Copyright 1937 by The Hartford Steam Boiler Inspection and Insurance Company

HARTFORD, CONN., January, 1937

Single copies may be obtained free by calling at any of the Company's offices.
Subscription price 50 cents per year when mailed from this office.
Bound volumes one dollar each.

Reprinting matter from this paper is permitted if credited to

THE LOCOMOTIVE OF THE HARTFORD STEAM BOILER INSPECTION AND INSURANCE CO.

Welded Pressure Vessels—1937

(An Editorial)

FUSION welding today occupies a merited place of importance in the fabrication of all kinds of pressure vessels. In their construction, the fundamentals of good welding technique are rigorously followed by many shops, but, unfortunately, this condition of adherence to good technique is not universal.

The somewhat sporadic growth of welding has led to serious misunderstanding with regard to it, and to its abuse by those who are uninformed respecting the factors that control the production of acceptable welds. At the other extreme, because of their experience with or knowledge of welding failures, another group holds to the view that welding is inadequate, and forthwith condemns everything of welded construction. The number of the latter group is decreasing, but men of this viewpoint are still to be found in industrial circles, and their contentions are valuable. They help to keep the over-enthusiastic advocates of welding nearer to the middle way.

Among the adherents of the "middle way"—adherents of sound welding consistently achieved—are the insurance company engineers. Even two decades ago they were in agreement with forward thinking manufacturers and plant engineers that welding had distinct advantages. Properly controlled, said they, welding may some day be a reliable aid to pressure vessel fabrication. Their predictions are being fulfilled.

It was not until a decade after the war that pressure vessels of welded construction were generally insured, and then only after careful consideration of the shop standards that had to do with their construction, coupled with knowledge of the use to which each vessel was to be put. A more general acceptance of fusion welded vessels for insurance came still later, after standards for the construction of fusion welded pressure vessels had been outlined by the insurance companies, the American Welding Society, the A. S. M. E. Boiler and Unfired Pressure Vessel Codes and the manufacturers themselves through their individual efforts.

The Hartford Steam Boiler Inspection and Insurance Company, as its contribution to the work of obtaining welded vessels of proper construction, has insisted and continues to insist that finished welds be of proper soundness, strength and ductility. Concurrently with the adoption by the Company of standards of acceptance for fusion welded pressure vessels, engineers on the A. S. M. E. Committees revised the Boiler and Pressure Vessel Codes so that they permitted construction by welding in addition to other methods of fabrication.

The Company since has adopted the A. S. M. E. Code for Boilers and Unfired Pressure Vessels as its recommended standard of construction. Any vessel built to the requirements of that Code and shop-inspected by the Company is acceptable for insurance, provided, of course, that the conditions of service also meet the Company's requirements for insurance. However, the fact that a manufacturer has demonstrated that his process is proper and that his welders are competent to weld ordinary low carbon steels does not necessarily mean that this same manufacturer is experienced in the construction of welded vessels of the new corrosion-resistant and other alloy steels or for the welding of any of the many non-ferrous alloys which are coming into use because of their superiority for certain specific purposes.

The need for greater care in the welding of pressure vessels has been reflected by the engineering press during 1936. More detailed specifications are given in articles than ever in the history of welding, and the writers further make it evident that they consider it not only good engineering to say that some factors are not known, but find it abso-

lutely necessary to do so if the papers that they present to men who know welding are to be given credence. The atmosphere of "cocksureness" has nearly disappeared, and there are being published many carefully written papers on the subject of welding which are backed by tireless research. These contributions to the subject are helping to give sturdy impetus to the advancement of safe welding. Attesting this advancement is the fact that welding is being used for pressures in excess of 1,000 pounds for boiler drums and piping, that it is proving acceptable in the fabrication of unfired pressure vessels subject to high pressures and temperatures and serious corrosive influences, and that piping fabricated by the welded method is both safe and economical of construction. Of course, in all such applications of welding it is essential that the work be done by proper methods and by welders whose ability has been proved not alone by their years of experience but by proper tests and periodic checks on their work.

Welders of pressure vessels and piping (as well as of machinery) in 1937 will range all the way from the owner of \$50 worth of equipment and a pair of goggles to the plant which has spent thousands of dollars on the development of its technique of welding and of its methods of testing the finished work. If his experience is inadequate, the owner of the \$50 worth of equipment and the goggles, or for that matter of much finer equipment, may not know that he doesn't know how to weld—and neither will the persons who hire him for welding realize that he doesn't know—until a weld fails and discloses a lack of fusion, the presence of slag or porosity.

Having in mind all this, reliable manufacturers and many individual operators have come to the conclusion that the sooner users of welded vessels know that welding can be either skillfully or poorly done, according to the technique of the welder, the more quickly will the standard of all welding be improved. If all who weld and all who use welding will inform themselves of its correct employment and will insist on compliance with established standards of quality and safety, the advancement of welding in 1937 should be the most satisfactory thus far made in the history of that process of construction.

Hartford Steam Boiler today is backing good welding technique with insurance accident limits in large amounts on policies covering losses from accidents to welded boiler drums. The Company also is insuring welded piping and welded unfired pressure vessels of many kinds. It expects to insure many more such vessels, but it will continue in the future, as it has in the past, to insist, if insurance is to be written

on them, that welded vessels be designed and fabricated in accordance with established safe practices.

Inspection of Welded Seams by Trepanning

Recent articles in *THE LOCOMOTIVE* have discussed at length the methods used and the results obtained from inspecting welded seams by the trepanning method, that is, by cutting out suitable samples of the welded seam for examination to determine whether defects are present. An inquiry with respect to this method of testing asks whether it is to be used in connection with U-68 (Class 1) vessels and boiler drums, the welded seams of which are required to be examined by X-ray.

Trepanning, of course, is not needed in connection with such vessels when built and tested in accordance with the A. S. M. E. Code because the soundness of the weld has already been determined by X-raying. The field of usefulness of trepanning lies (1) in checking the welded seams of U-69 (Class 2) and U-70 (Class 3) vessels as a shop procedure and (2) in ascertaining the character of the welded seams of pressure vessels which were built in the early days of welding before the A. S. M. E. Code was issued, or which were not subjected to shop inspection.

Trepanning permits an "at random" check of each welder's work from seams which he has made, and it further spurs each individual welder to do his best at all times because he knows that test samples may be taken from any part of his work.

British Station Installing 1900-Pound Boilers

What will be the highest pressure installation in England is described in *The Electrical Times*. This refers to the rebuilding of Brimsdown "A" Power Station of the North Metropolitan Electricity Supply Company, London, for which two 210,000 lb per hr Loeffler boilers have been ordered.

These will generate steam at approximately 1000 lb pressure, 940° F. total temperature and will supply a 50,000-kw turbine generator. The high-pressure element of this turbine, of 20,000 kw, will exhaust at 195 lb to both live-steam and flue-gas reheaters, from which the steam will be returned to the 30,000-kw low-pressure element. Inasmuch as a Loeffler type boiler must be started by an auxiliary supply of steam, some of the newer existing 150-lb boilers will be left for this purpose, and for supplying some steam to the low-pressure element of the turbine in an emergency.

A certain enterprising poultryman has crossed his hens with parrots to save time. He used to hunt around for the eggs, but now the hens walk up to him and say, "Hank, I just laid an egg. Go get it."

Explosions and Other Accidents to Power Boilers

CATASTROPHE AT MIDDLE-WESTERN UTILITY

WHEN the lower drum of a bent tube type water tube boiler failed on October 30, a Middle-Western utility's power plant was demolished, five employes lost their lives, and a sixth was injured. Damage to the building, two engine-generators, electrical equipment, two other boilers, and auxiliaries involved a replacement cost estimated at \$100,000 and seriously hampered the utility's service. The



Wreckage following a lower drum failure at a Middle-Western utility.

supply of electricity for five towns was cut off and light, power, telephone and water service interrupted until supplementary hookups could be completed or emergency power plants, long out of service, could be started. The photograph illustrates the extent of the demolition.

The explosion was clearly the result of a corroded head of the lower drum, the $\frac{1}{2}$ " head material being reduced in places to $\frac{3}{32}$ " adjacent to the lower part of the head flange, with an average thickness of $\frac{1}{4}$ " to $\frac{3}{16}$ " for 36" circumferentially around the bottom of the head at the turn of the flange. The end of the shell at the head had been reduced to approximately $\frac{3}{16}$ " in thickness and the rivet heads at this point were 75 per cent wasted.

Any low-set bent tube type boiler, with one head hidden by brickwork, is subject to the corrosive influences which caused this accident.

Hartford Steam Boiler, although not insuring this boiler, made a detailed investigation of the accident as a part of its campaign against this particular type of explosion which in the past few years has caused several severe accidents.

FACTORY AND MILL BOILER ACCIDENTS

Deep grooving of the under plate of a horizontal tubular boiler and a sticking safety valve were causes contributory to an explosion at a West Virginia mill on June 4. A workman was on top of the boiler trying to fix the safety valve when the boiler exploded, tearing the shell from head to head, shearing off the front head completely and



After a sawmill boiler explosion in West Virginia. The scene is typical of wreckage following this type of accident.

ripping about nine-tenths of the way around the rear head. The illustration gives an idea of the accompanying wreckage. The man on top of the boiler and another workman were killed and a third was seriously injured. The mill was wrecked and parts of it and the boiler were strewn as far as 500 feet.

Five men were injured, two of them seriously, in a New York City boiler explosion and subsequent fire on September 16 at a furniture factory. Sixty-five employes fled to the street after the accident.

Scale deposits in a Scotch marine type boiler at a Pennsylvania dairy permitted over-heating and led to the collapse of the furnace on September 11. While the boiler did not explode, a bulge 5' in length occurred and a new furnace was required.

LOCOMOTIVE EXPLOSION

The engineer, fireman and head brakeman of a freight train traveling at about 15 miles an hour near Alexander, New York, on May 7, were killed when the crown sheet dropped, probably because of low



Main shell of locomotive after explosion which probably was caused by low water.

water. Several cars of live steers and calves piled up in a ditch or were strewn over a 25-foot embankment.

Witnesses said they heard a heavy dull thud and an instant later a terrific explosion which sent the cab, its three occupants and parts of the boiler to an estimated height of 100 feet. The main shell of the boiler came down on the track, skidded almost 50 feet and went over the bank, tearing up a rail as it went.

Japs From the Old Chief's Hammer

THE Old Chief and his assistant, Tom Preble, were returning to the office after having visited a new utility power plant. As they rode along talking about the installation Preble's attention was called to the silhouette of wires against the early winter sunset.



"Chief," he said, "those wires make a nice design against the sky, don't they?"

"Right, Tom," answered the older man, "and speaking of orderly arrangements of wires, did you notice how simple the wiring appeared at the plant this afternoon? Somebody put a lot of gray matter into the designing of that system, and that's a detail that doesn't always get such painstaking attention.

"I remember a case in an office building where the cable installation gave several people headaches."

Knowing full well that his Chief had another good yarn in the back of his head and that a little manifestation of interest would start the tale, Preble asked, "When was that, Chief?"

"Several years ago—when the United Building was finished—in fact, just before you joined up with us.

"As you know, the building has two motor-generator sets. When the installation was completed and the machines running, a low insulation resistance was noted on one of the sets. The difficulty was puzzling because, immediately after a day's run, the machine, including all connections to the switchboard, showed an insulation resistance of only about 150,000 ohms, and the reading increased to about 7 megohms after the machine had been idle for several hours.

"Obviously, the installation wasn't satisfactory and the owners had refused to pay for it. The general contractors, sub-contractors, an electrical service company and the operators themselves apparently weren't able to find the difficulty. Repeatedly the various engineers went through the laborious and time-consuming procedure of disconnecting, in turn,

each part of the unit and its connecting cables. Insulation resistances consistently were $1\frac{1}{2}$ megohms or better by the time they were able to test the various individual parts. Similarly, the generator would test satisfactorily, but at the end of the next day's operation the low value of 150,000 ohms would again be obtained.

"Meanwhile the building owners applied for insurance on the generators. Inspector Jim Stafford was assigned to inspect the units and on his first visit confirmed the findings of the engineers with respect to the low insulation resistance.

"The leads from the troublesome unit and its companion generator were all installed in fibre conduit and entered a shallow pit back of the switchboard. They were crowded together in a confused array—quite different from the orderly arrangement of cables we saw today at the big plant.

"Because it had required quite some time to disconnect the heavy cables to the generator for the previous tests, Jim reasoned that it was possible the temperatures had decreased with correspondingly high insulation resistance. This condition could have accounted for the 150,000 ohms to 7 megohms insulation resistance difference the contractors had found in testing the cables and generator after the generator was shut down. He felt that the easiest way to get at the problem was to insulate each cable from the others and from ground so that insulation resistance tests of the various parts could be made immediately on stopping the machine. The plan also would permit certain definite conclusions to be reached with respect to cables with the machines operating at full load.

"As the contractors were willing to do almost anything to get the installation approved, Jim's recommendation that all the cables be insulated from each other and from ground, was agreed to, even though the contractors knew it would be somewhat of a job. The cables were heavy, of short span within the pit back of the switch-board, and therefore quite stiff and difficult to handle. After several hours of work, the insulation was accomplished by installing dry maple blocks or several thicknesses of varnished cambric where they were needed.

"The work was started of necessity with the unit in service and was completed after the set had been idle for about an hour. When insulation resistance readings were taken, they showed 100 megohms between all cable sheaths and between each sheath and ground, and 7 megohms for the generator and its connecting cables."

"Didn't that prove Inspector Stafford's theory?" Preble remarked.

"Yes, in part," the older man answered, "but he still wasn't satisfied

that the heart of the trouble had been located. No more testing was done until after the next day's run. Then the generator was unloaded and disconnected from the control panel, but was operated at normal speed. There was no potential to ground and an insulation resistance reading of 8 megohms was obtained.

"The unit was then loaded in order to maintain full load temperatures. Tests were made with a voltmeter between pairs of cable sheaths and between each sheath and ground. These tests disclosed that while there was no potential between pairs of sheaths, on two of the cables there was substantial potential from the cable sheaths to ground, which indicated a weakness of insulation between the copper and the lead sheaths. Ohmmeter readings were then taken between copper and corresponding lead sheaths on the two cables and low values were obtained with respect to both of them. The two faulty cables were replaced by new ones and thereafter satisfactory insulation resistance readings were obtained."

"What was wrong with the cables?" asked Preble.

"Jim learned that the cables had been 'pulled' while the building construction was still in progress and all cement work was still 'green.' He reasoned that the two faulty cables had become defective, because they had absorbed moisture through the open ends as the concrete cured."

The two men rode along for some miles. After a time Preble said, "Chief, there aren't many real short cuts in getting at electrical troubles, are there?"

"No," was the quiet answer, "and I've never found a real good substitute for practical common sense in electrical work or anything else."

Largest Boilers

In their search for higher economy in the generation of power in large quantities, utility engineers have resorted to larger and larger boilers until today there are in this country six units capable of producing 1,000,000 lb of steam per hour or more. Three of these giants are in the East River Station of the New York Edison Company, one in Kips Bay Station of the New York Steam Company, and two at the Hellgate Station of the United Electric Light and Power Company. A seventh boiler of this size is being constructed at the Logan, West Virginia, plant of the American Gas and Electric Company, this last boiler to generate steam at 1425 lb per sq in. pressure and 925° F. temperature.

These great steam generating units are as tall as a ten story building. They are of the multi-drum type with water walls, superheaters, economizers, and air pre-heaters. When operating at the capacity of 1,000,000 lb of steam per hour, one such boiler can furnish steam sufficient to meet the electric utility power requirements of a city of about 500,000 persons.

To date only two boiler manufacturers have built boilers of this capacity. All of the boilers have been shop inspected by the Hartford Steam Boiler Inspection and Insurance Company.

The Hartford Steam Boiler Inspection and Insurance Company

OF HARTFORD, CONN.

December 31, 1935

Capital Stock, \$3,000,000.00

ASSETS

Cash on hand and in banks	\$601,612.42
Premiums in course of collection (since October 1, 1935)	1,121,318.19
Interest accrued on mortgage loans	40,086.52
Interest accrued on bonds	103,099.37
Loaned on mortgages	518,545.00
Home Office real estate and Philadelphia branch office	542,474.66
Other real estate	264,909.47
Bonds on an amortized basis	\$9,382,820.63
Stocks at market value	6,537,479.36
	<hr/>
	15,920,299.99
Other admitted assets	30,706.39
<i>Total</i>	<hr/>
	\$19,143,052.01

LIABILITIES

Premium reserve	\$7,215,766.14
Losses in process of adjustment	272,174.24
Commissions and brokerage	224,263.64
Other liabilities (taxes incurred, etc.)	565,861.62
	<hr/>
<i>Liabilities other than capital and surplus</i>	\$8,278,055.64
Capital stock	\$3,000,000.00
Surplus over all liabilities	7,864,986.37
	<hr/>
<i>Surplus to Policyholders</i>	10,864,986.37
<i>Total</i>	<hr/>
	\$19,143,052.01

WILLIAM R. C. CORSON, President and Treasurer

BOARD OF DIRECTORS

LUCIUS F. ROBINSON, Attorney, Hartford, Conn.	HON. JOHN H. TRUMBULL, President The Trumbull Electric Mfg. Co., Plainville, Conn.
JOHN O. ENDERS, Chairman Executive Committee Hartford National Bank & Trust Co., Hartford, Conn.	CURTISS C. GARDINER, Vice President The Hartford Steam Boiler Inspection and Insurance Company, 90 John Street, New York.
MORGAN B. BRAINARD, President Aetna Life Insurance Company, Hartford, Conn.	JAMES L. THOMSON, Chairman Finance Committee Hartford Fire Insurance Company, Hartford, Conn.
CHARLES P. COOLEY, Chairman Board of Trustees Society for Savings, Hartford, Conn.	PHILIP B. GALE, Chairman Board of Directors Standard Screw Co., Hartford, Conn.
JOSEPH R. ENSIGN, President The Ensign-Bickford Co., Simsbury, Conn.	JOHN J. GRAHAM, Vice President The Hartford Steam Boiler Inspection and Insurance Co., Hartford, Conn.
EDWARD MILLIGAN, President Phoenix Insurance Co., Hartford, Conn.	AUSTIN DUNHAM BARNEY, Vice President The Hartford Electric Light Co., Hartford, Conn.
WM. R. C. CORSON, President The Hartford Steam Boiler Inspection and Insurance Co., Hartford, Conn.	JOHN R. COOK, President Arrow-Hart & Hege- man Electric Co., Hartford, Conn.
SAMUEL M. STONE, President Colt's Patent Fire Arms Mfg. Co., Hartford, Conn.	
SAMUEL FERGUSON, Chairman Board of Directors The Hartford Electric Light Co., Hart- ford, Conn.	

Incorporated 1866



Charter Perpetual

Department

Representatives

ATLANTA, Ga., Citizens & So. Nat. Bk. Bldg.	W. M. FRANCIS, Manager. C. R. SUMMERS, Chief Inspector.
BALTIMORE, Md., 704-9 Garrett Building	D. W. LITTLE, Manager. R. P. GUY, Chief Inspector.
BOSTON, Mass., 87 Kilby Street	A. PAUL GRAHAM, Manager. W. A. BAYLISS, Chief Inspector.
BRIDGEPORT, Conn., City Savings Bank Building	W. G. LINEBURGH & SON, General Agents. A. E. BONNET, Chief Inspector.
CHICAGO, Ill., 175 West Jackson Boulevard	P. M. MURRAY, Manager. C. W. ZIMMER, Chief Inspector.
CINCINNATI, Ohio, 1004-12 Carew Tower	JAMES P. KERRIGAN, Manager. W. E. GLENNON, Chief Inspector.
CLEVELAND, Ohio, 1040 Leader Building	ARTHUR F. GRAHAM, Manager. JOHN L. SCOTT, Chief Inspector.
DENVER, Colo., Gas & Electric Building	J. H. CHESNUTT, Manager. JESSE L. FRY, Chief Inspector.
DETROIT, Mich., National Bank Building	L. L. COATES, Manager. THOMAS P. HETU, Chief Inspector.
HARTFORD, Conn., 56 Prospect Street	F. H. KENYON, Manager. A. E. BONNET, Chief Inspector.
NEW ORLEANS, La., 333 St. Charles Street	R. T. BURWELL, Manager. P. E. TERROY, Chief Inspector.
NEW YORK, N. Y., 90 John Street	C. C. GARDINER, Vice President. J. F. HUNT, Chief Inspector.
PHILADELPHIA, Pa., 429 Walnut Street	A. S. WICKHAM, Manager. S. B. ADAMS, Chief Inspector.
PITTSBURGH, Pa., Arrott Building	WILLIAM P. WALLACE, Manager. J. A. SNYDER, Chief Inspector.
ST. LOUIS, Mo., 319 North Fourth Street	CHAS. D. ASHCROFT, Manager. EUGENE WEBB, Chief Inspector.
SAN FRANCISCO, Cal., 114 Sansome Street	C. B. PADDOCK, Manager. L. E. GRUNDELL, Chief Inspector.
SEATTLE, Wash., Arctic Building	E. G. WATSON, Manager. WILLIAM J. SMITH, Chief Inspector.
TORONTO, Ont., Canada, Federal Building	H. N. ROBERTS, President The Boiler In- spection and Insurance Company of Canada.

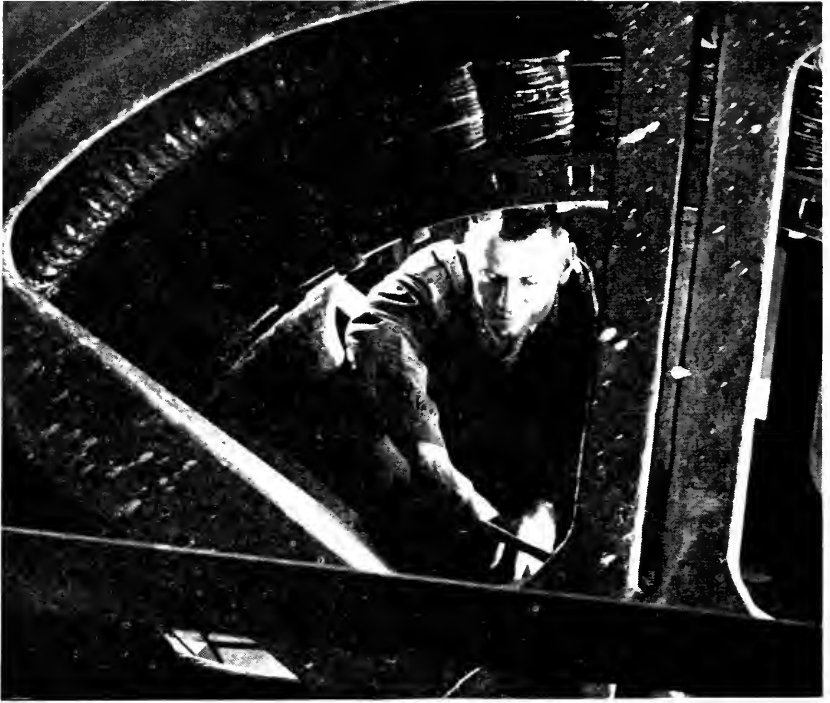

37,500 Years of Inspections

for 1,500 Companies

Over 1,500 businesses — some of them
managing as many as 100 different
plants — have insured their power
equipment continuously with Hartford
Steam Boiler for 25 years or longer.



41 No. 6

APRIL, 1937

The Locomotive

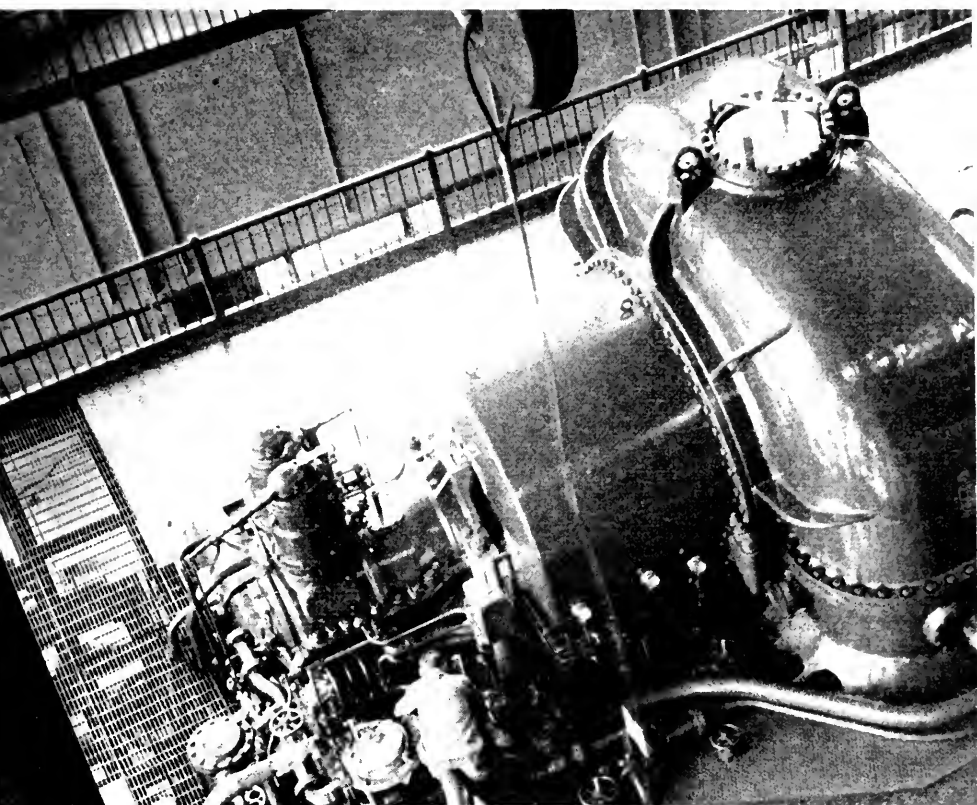

Quarterly Magazine Devoted to Power Plant Protection
Please Show to Your Engineer

Three Turbine Accidents That Caused \$250,000 Damage

THREE utility turbines suffered major breakdowns in recent months because of the failure of parts, namely, a disc of an impulse turbine, several rotor blades in a reaction turbine, and two vane guides of a sliding-vane type oil pump. In each case the steam end of the turbine was seriously damaged and in at least one of the accidents there was extensive Use and Occupancy loss. Total losses, only part of which were covered by insurance, amounted to approximately \$250,000.

Of this amount, it is estimated \$150,000 will be required for the repair of a large impulse type machine in which a section of the last



Figure 1—The broken disc. The dovetail arrangement of fastening the blades is clearly visible at the left.

stage wheel broke out for approximately 14" in the rim inside the inverted dovetail buckets, as is illustrated by Figures 1 and 2. Fourteen buckets were thrown through the casing.

As the machine was operating under full load, the vibration became severe after the disc broke and even though the emergency governor



Figure 2—Closeup of the break in the part which went through the casing. A progressive fracture is clearly visible here, but it was so hidden before the accident that no inspection procedure short of taking out the blades could have led to its discovery.

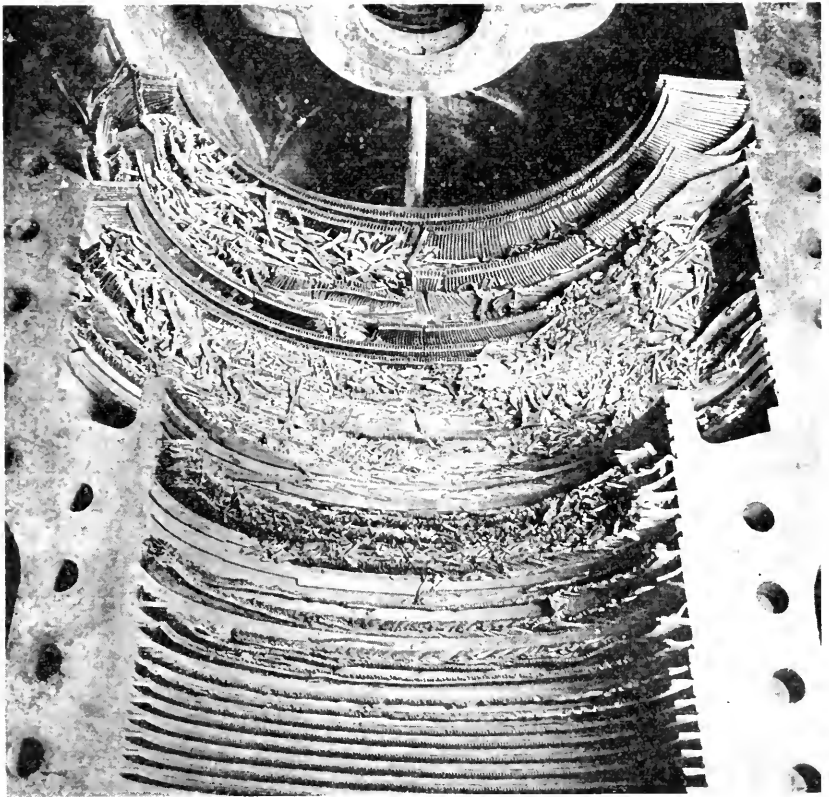

Figure 3—Casing of 1875 kva turbine after several blades broke out. The rotor was stripped of practically all of its blading.

was tripped by the vibration, the diaphragm packing rubbed, diaphragm supports were broken, and the governor was torn loose from its support-

ing spider. Bearings and their pedestals were damaged, and the main oil pumps were wrecked beyond repair.

After blading in the intermediate stage of an 1875 kva reaction type turbine broke out, the resulting vibration brought about the destruction of all moveable and stationary blading. (See Figure 3).

The sequence of events in the third accident, which involved a 12,500 kw reaction type machine, started with the jamming of the main oil pump after two vane guides had broken. For some undetermined reason the reciprocating type auxiliary oil pump did not function in time to save the bearings. When the babbitt melted, the shaft dropped and whipped, damaging most of the reaction blades and the strips in the lower half of the dummy ring.

A Steam-Electric Locomotive

ANOTHER page in the history of modern railroading is being turned this year with the appearance on the test tracks of General Electric of a new steam-electric locomotive which is being built for the Union Pacific Railroad.

This new passenger unit will carry a condensing steam turbine-generating plant feeding electric power to traction motors of the usual electric locomotive design, and the turbine will operate with condensers that will use the same water over and over, with small additions to make up for leakage. The problem of picking up water is thus largely done away with, and clean distilled water is expected to insure long life and permit long runs without boiler repairs.

This new type of locomotive is built in two sections, each of 2,500 hp. Each unit consists of a high pressure steam boiler, a condenser, a steam turbine-generator, and auxiliary equipment, which includes a compact control switchboard. When in service, the locomotive will haul a 1,000-ton train between Omaha and Los Angeles.

Accidents to Motors Driving Jordans

Two recent synchronous motor failures illustrate hazards that may be eliminated in connection with paper mill jordan drives. In one instance the jordan packing gland leaked badly, the motor windings were soaked, and a failure resulted which required a complete rewind. In the other case the cover plate for the inspection opening in the jordan casing was carelessly installed with a result identical with that described in the first instance, namely, complete failure of the windings.

The Advantages of Closed over Open Systems of Diesel Cooling

Experience with Diesel engine operation for the past 20 years has shown conclusively that many of the principal hazards are greatly lessened when the closed system of cooling is employed. This article explains the differentiation that Hartford Steam Boiler makes between the two general types of Diesel cooling and illustrates the various systems to which the terms "open" and "closed" are applied. —Editor's Note.

By H. J. VANDER EB, *Assistant Chief Engineer*
Turbine and Engine Division

THE terms "open system" and "closed system" are sometimes misunderstood. "Closed system" does not mean that the cooling system is hermetically closed, or even practically so. All closed cooling systems must have some form of "breather" to permit the expansion of the water when it is heated. This may be provided by a vent or a surge tank (see Figures 4, 5 and 8), and many closed cooling systems have a sump in which a larger area of the water is open to the atmosphere (see Figures 1 and 2), but these arrangements do not make the systems "open systems." Although there is in closed systems this contact of the cooling water with the atmosphere, the evaporation which occurs is slight because the maximum temperature of the water is comparatively low, being seldom higher than 130° F. Consequently, the required amount of make-up in any closed cooling system is negligibly small.

There are two main types of open systems, namely:

1. The continually wasting type (see Figures 9 and 14);
2. The recirculating type (see Figures 10, 11 and 13).

The vital difference between the closed system and the open system is the manner in which the recirculated water is cooled. In the open system of the recirculating type the jacket water is cooled by purposely evaporating a part of it. This evaporation is obtained by spraying the water through nozzles in a cooling pond or by finely dividing it over splash boards in a cooling tower. It is this evaporation that causes the drop in temperature of the remaining water. The evaporation removes a considerable amount of the recirculated water, usually about 5 per cent, and this constant loss requires a steady inflow of make-up. Consequently, the recirculated water becomes more and more concentrated in mineral salts and suspended matter. The resulting deposits of mud

Examples of typical CLOSED TYPE Diesel Cooling Systems.

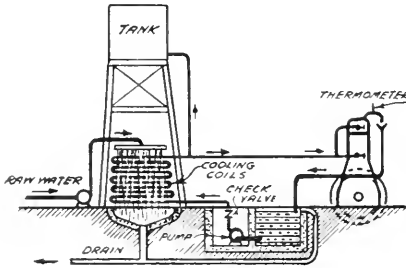

Figure 1.

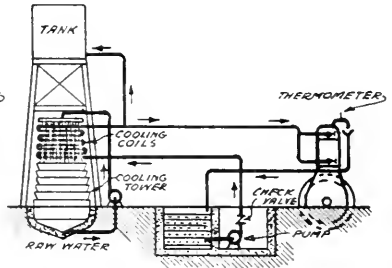

Figure 2.

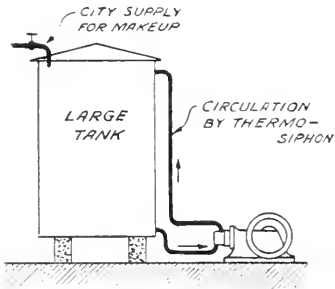

Figure 3.

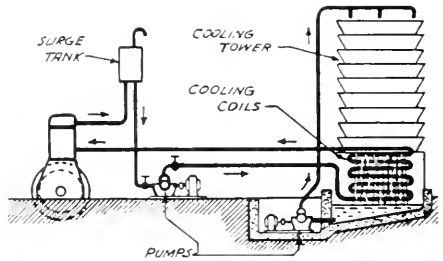

Figure 4.

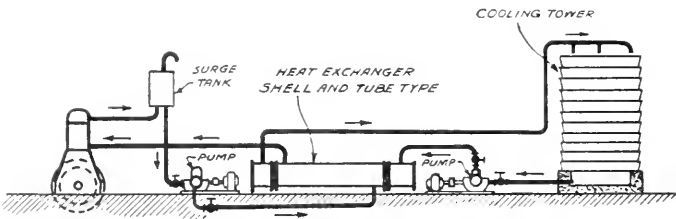

Figure 5.

and scale in the water jackets constitute the main objection to the use of the open system.

Another disadvantage of the open system is that a dangerous deple-

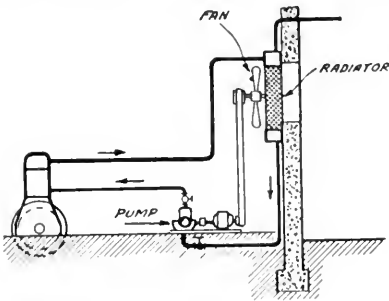

Figure 6.

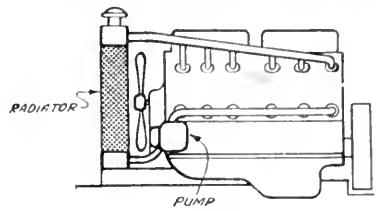

Figure 7.

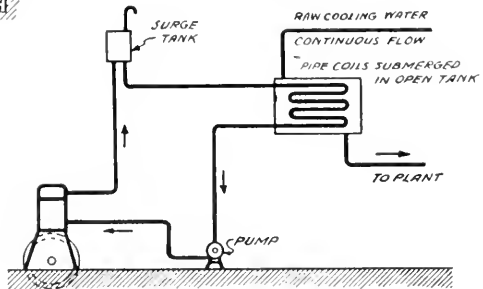

Figure 8.

tion of cooling water can occur in a few hours, and any neglect by the operators or any occurrence which causes an interruption of the make-up supply constitutes a serious menace. On the other hand the amount

of make-up water for a closed system is so small that it takes a long time before the depletion of the circulating water becomes dangerous.

An open system is somewhat cheaper than a closed system in first cost, but in practically all cases it is a mistaken economy to use an open system for the cooling of Diesel engines. From the standpoint of engine safety and reasonable freedom from forced shutdowns, it is basically a poor arrangement. Hence, its use is not recommended by the Diesel Engine Manufacturers' Association and other authorities on the subject. A large number of engine failures are directly traceable to the use of an open system where there should have been a closed system. From an analysis of these accidents, which often occur early in the history of the engine, it is evident that certain characteristic troubles can be expected where open type cooling systems are used.

In open system installations, where the water needs chemical treatment, protection against scale formation depends entirely on the human element. Frequently, the water-softening apparatus is neglected. In other cases, where chemicals are added to the recirculated water to prevent scale by forming an easily-removed soft sludge, failure to wash out this sludge at properly timed intervals will lead to over-heating.

As many engine operators have found, even those waters that are ordinarily free from scale-forming ingredients may, during certain

*Examples of typical OPEN TYPE
Diesel Cooling Systems.*

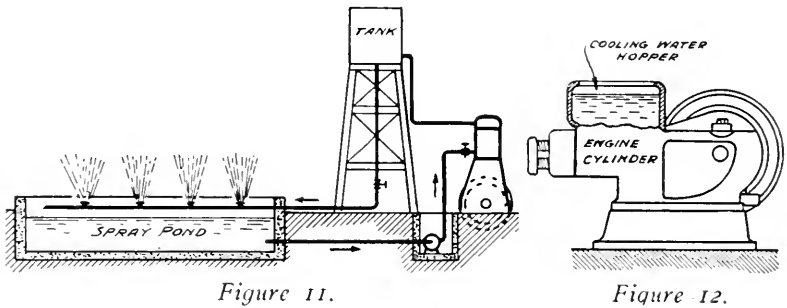
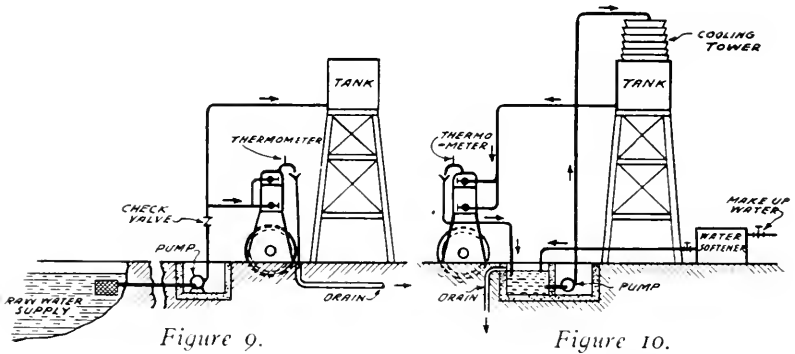

seasons of the year, contain large quantities of suspended matter which are deposited in the cylinder jacket as a soft mud. There have been many piston seizures, excessive cylinder distortions and cracked heads directly caused by a water source becoming suddenly very muddy after a long spell of heavy rains. This hazard is present in connection with the continually wasting type of open system, as shown in Figures 9 and 14, as well as with the recirculating type of open system shown in Figure 11.

Another serious trouble that has been experienced with the use of the recirculating type open system is the obstruction of the piping and water passages through the jackets by foreign material such as lint and dust from manufacturing processes. Such material drifts into spray ponds and into open receptacles under cooling towers.

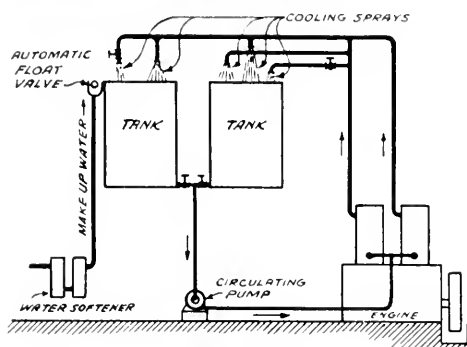

Figure 13.

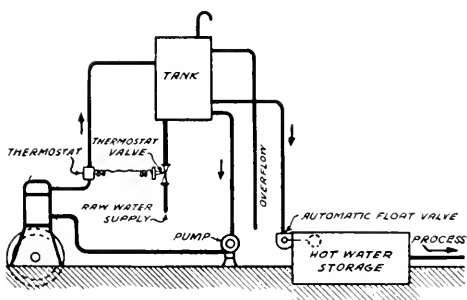

Figure 14.

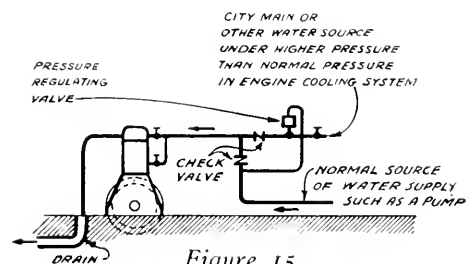

Figure 15.

The closed systems of Diesel engine cooling (see Figures 1, 2, 3, 4, 5, 6, 7, and 8) are as a rule free from the unfavorable features discussed in the foregoing paragraphs. In addition, the temperature of the cooling water is more easily controlled. The temperature of the water entering the jackets should be approximately 85° F. to 100° F. and it is very desirable that the temperature be constant, because an abrupt change of inlet temperature of any appreciable amount is distinctly harmful and has caused many piston seizures. The temperature differential between inlet and outlet of the cylinder jackets should not be greater than 20° F. for best results as regards durability of cylinder heads, cylinder liners, and pistons. In a closed system the proper relationship of the temperatures is more easily maintained, as the sudden inflow of raw make-up water

in large quantities, such as frequently takes place with open systems, is entirely avoided.

Finally, wherever the available water has corrosive tendencies, the control or prevention of internal corrosion of the engine jackets and the circulating piping is a much simpler problem with a closed system, for the reason that there is no need for continually treating new water.

The prospective Diesel engine owner should consider well such of the various points discussed as may affect his particular plant before deciding on the type of cooling system to be used.

Boiler Explosion Wrecks Mine Buildings

SUNDAYS are quiet days at the ——— mine in West Virginia. No coal comes to the surface, and only a few men are on duty. Their work is for maintenance and safety purposes and they go about it quietly and carefully. January 24 was such a Sunday. Included in the maintenance work on that day was the operation of a steam-



Wreckage at the mine following the boiler explosion.

driven hoist which was used when the motor-driven main hoist was idle.

Providing steam for the hoist engine was a 72" diameter horizontal tubular boiler. On week-days this boiler heated water for about 100 shower baths, but on Sundays, when the main power plant was idle, it was used to make steam at 55 pounds pressure. The boiler was thus operating on January 24 when it exploded, the blast wrecking the boiler house and killing four men. A subsequent fire so damaged the adjacent substation and the electrical equipment installed there that the mine, which employed several hundred men, was shut down for two days until a temporary source of power was secured.

While the explosion and fire damaged buildings and equipment in an amount estimated at approximately \$50,000, the mine tippie itself and the main hoist escaped extensive injury, a circumstance considered unusually fortunate.

The accident occurred after the top shell plate of the boiler became unduly thin because of hidden external corrosion which attacked the metal under the brick insulation.

External corrosion, as it may affect any fired or unfired vessel, is discussed in the following article.

External Corrosion

By J. P. MORRISON, Asst. Chief Engineer, Boiler Division

CORROSION of ferrous surfaces is a prolific source of weakness in pressure vessels of all kinds, but it can be decreased by "good housekeeping," since serious external wasting develops only after a considerable lapse of time. External corrosion may be traced, invariably, to moisture in contact with surfaces exposed to the atmosphere, and, if there is soot, ash, or dirt present, especially in an idle period, the deterioration of the metal is more rapid. Obviously the dangers from external corrosion are minimized if surfaces are kept both clean and dry.

Surfaces sprayed with water or steam, such as from a leaking tube, handhole gasket or soot blower, are sure to give trouble if the spraying action is permitted to continue. For instance, it was necessary recently to remove six bent tube type boilers from service because the shell plates for the entire length of the mud drums had been dangerously reduced in thickness by the action of soot blowers. The blowers had become so disarranged that they no longer rotated properly and were so located in recesses in the bridge walls that they discharged against the shell plates when steam was turned on.

In water tube boilers of the bent tube type, external corrosion occurs mostly on tube surfaces near the tube sheet or header, or on those tubes which support baffles where soot and fly ash can accumulate. Unless those surfaces, as well as the surfaces of the plates which the tubes enter, are thoroughly cleaned, the corrosion will continue, necessitating new tubes and perhaps causing a violent failure. Another danger point is in the steam circulating tubes which support the roof of the boiler setting, since they invariably become coated with material of a corrosive nature if moisture is present. Of course, tight baffles, a

tight building roof and tight valve stems do much to avoid the corrosion of the circulating tubes, but cleaning and periodic inspections are absolutely necessary if trouble is to be avoided.

In general, if a tube which has corroded until its wall thickness, over a section having any dimension equivalent to the tube diameter, is not greater than 75 per cent of the original wall thickness, it is too thin to be depended upon, and should be replaced with a new tube.

External corrosion has been responsible for so many boiler explosions, because of failure of the lower drum heads, as to make their



Result of external corrosion of a blank head in a bent tube type boiler.

examination absolutely necessary. By far the greatest hazard exists in the blank heads, which, as has been frequently pointed out, should never be embedded in the setting walls. Of approximately 6,500 drum heads once concealed in setting walls, 10 per cent were found to be corroded appreciably and about 1 per cent were in a very dangerous condition and no longer serviceable. Had any of these boilers failed in service, the property damage would have been severe and there probably would have been loss of life. There have been a number of such failures in the past.

The mud drums of bent tube water tube boilers, the lower drums of vertical water tube boilers, and the rear headers and mud drums of horizontal water tube boilers, all suffer from external corrosion, as do also the ends of the tubes and nipples entering those parts. The bottom

wrapper sheet and rivet heads of the front and rear headers of box header type water tube boilers suffer from corrosion where the soot and ash which accumulate are moistened because of tube cap leakage or from any other cause.

Investigation of the condition of a vertical straight tube type boiler in a recent case led to the discovery that the heads of the crown bar bolts were worthless, although the oxide of iron that had formed gave the bolt heads the appearance of being full size. However, a tap of a hammer was sufficient to dislodge the rust and expose the weakened condition of the crown bolts. The lower ends of many of the tubes were so reduced in thickness that they were no longer dependable, so new tubes, as well as new bolts, were required.

Boiler operators can do much to assist the inspectors in the constant program of safety being waged by all industry. Preparation of a boiler for inspection should include removal of soot, ash, and rust from the tube sheets, headers, and other surfaces wherever moisture may be present. It is particularly important not to neglect the less accessible parts as it is often at such locations that serious corrosion is progressing.

While water tube boilers are subject to external corrosion, they are by no means the only vessels seriously affected by this menace. The upper tube sheet of the vertical tubular boiler, particularly those of the submerged type, always accumulate some soot which, in connection with atmospheric moisture, will produce the corrosive conditions necessary to cause deterioration and ultimately require extensive repairs.

The grates of a vertical tubular boiler or of a locomotive type boiler may hold wet ash in contact with the fire box sheets, and the resulting corrosion may cause such a reduction in thickness that patching or other repair must be made to prevent a disastrous failure.

In one recent case, the shell of a vertical boiler on a locomotive crane formed a part of the coal bunker and, of course, the moist coal caused the shell plate to corrode. Unfortunately, the coal was not removed to permit a thorough examination of the shell plate until leakage had developed.

In another case, an opening in the lagging and jacket of a vertical tubular boiler was not of sufficient size to permit a proper examination of the plate surrounding the handhole. Leakage at the handhole gasket resulted in excessive corrosion of the shell plate, which a thorough inspection would have disclosed.

External corrosion of horizontal return tubular boilers is usually local in character and is caused by leakage of some kind, particularly around manholes and handholes. Of course, if there are places where

soot and ash can accumulate in the presence of moisture, corrosion is almost inevitable. When such corrosion occurs in places which are difficult of access, the dangers of neglect are apt to be particularly serious. The tubes of horizontal return tubular boilers are subject to corrosion when they become coated with siliceous and carbonaceous substances which in periods of idleness collect moisture. Dangerous corrosion results. There are on record many instances of tubes corroded to a point where they have collapsed.

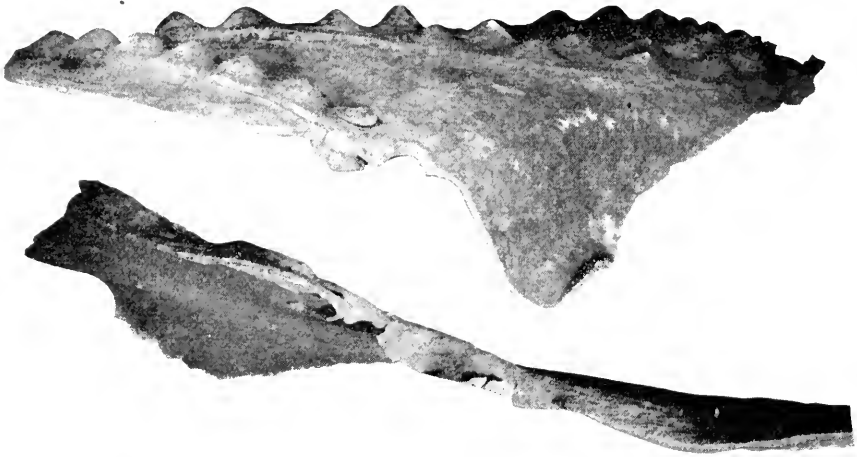

Typical thinning because of external corrosion in boiler plate originally $7/16''$ in thickness. In places this plate had thinned to less than $1/8''$.

Evidences of corrosion in the form of flakes of rust or iron oxide should serve as warning that tubes in any type of boiler are becoming thinner. The determination of the exact condition of tubes is often difficult, but where there is an uncertainty it is justifiable to have one or two tubes removed for the purpose of determining the general condition.

While cast iron is generally less susceptible to corrosive action than soft rolled steel, external corrosion is also a problem of importance with respect to cast iron objects. External surfaces of many cast iron boilers receive little or no maintenance with the result that the operating life of the object is shortened and its safety while in operation decreased. A dry, clean, well lighted boiler room is just as important for the good maintenance of heating boilers as it is for power boilers, not only because of the direct benefit to the boiler, but also because of the good

influence on the attendant. As in the case of steel, the presence of moisture or dirt, or both, leads to corrosive attack on cast iron, so that the elimination of any leak, no matter how slight, is good practice. Surfaces exposed to the products of combustion are affected rapidly by corrosion when moisture from any source is present, especially if those surfaces are coated with soot.

Serious leakage should make itself evident by the telltale path of the water, even though the surfaces are dry when examined. A slight leak,



Extreme external corrosion in a buried blow-off tank. Conditions with respect to this form of wasting away are particularly serious whenever a vessel is installed underground.

however, is more difficult to locate. Sometimes the contraction of a cooling boiler may close capillary openings through which water escapes when the boiler is in service. Thus corrosive action is furthered throughout periods of service, and even when there are evidences of the leakage with the boiler idle, much experience is necessary to determine the exact opening.

There is also the danger from the accumulation between rigidly held parts of iron oxide in an amount which may crack the parts of the metal under stress. This accumulation in some cases may be due

to a slight leakage from push nipple or threaded connections, but because the difficulty occurs most frequently when the boiler room is damp during an idle period, the iron oxide in general is attributed to the presence of atmospheric moisture and not leakage.

With cast iron boilers used for hot water supply service, in which a fire is kept throughout the year, cleanliness is extremely important if corrosion is to be checked. Frequent cleaning of the heating surfaces is especially helpful.

In addition to trouble with boilers, external corrosion is a problem with many other kinds of pressure vessels. When objects are so located that rubbish and dirt may accumulate against them, there is likely to be serious corrosion, but, as in the case of boilers, presence of moisture is the governing factor. This does not mean that wetness must be apparent, for considerable amounts of moisture, absorbed from the atmosphere or otherwise, may be present without being very evident.

Allowing unheated boilers or other vessels to stand when filled with water or other liquid will cause "sweating". As a body of water in the vessel cannot change temperature as rapidly as atmospheric changes occur, whenever the outside temperature rises, condensation on the exterior surfaces of the vessel is almost inevitable. Some corrosion must result, and if there is soot or other foreign substance present, the rate of corrosion will be greatly increased. Unless there is a real necessity for keeping idle vessels filled, they should be emptied when not in use.

Recent accidents to such objects as rendering tanks, cookers, air tanks and water tanks demonstrate in ways that are both convincing and costly that neglect of cleanliness and the growth of external corrosion have serious results.

This whole problem of external corrosion requires constant watchfulness on the part of every one connected with any vessels constructed of ferrous materials. Gradual wasting may not make itself troublesome until replacements are necessary, but to permit conditions conducive to the continuation of external corrosion eventually leads to increased operating expense, and, if serious accidents occur, to extensive property damage and loss of life.

THE COVER



Checking the operating conditions of a large utility turbine. Only the steam end of the low pressure unit is shown on the cover, but the miniature at the left shows both the high and low pressure turbines. Through such work as this inspector is doing, Hartford Steam Boiler gathers important data which is used to increase the safety of all insured turbines.

Vulcanizer Explodes because of Corrosion

HOW corrosion can bring about the rapid wasting of a steam pressure vessel when acid is present in water within the vessel is illustrated by a recent vulcanizer explosion at an Eastern manufacturing plant. The manufacturing procedure requires that some of the material to be processed be subjected to steam and rotated in such a way that it is kept wet by passing through water at the bottom of the vessel. Acids from the processed material are absorbed by the



Figure 1. Remains of the vulcanizer after its explosion.

water, vaporize and circulate throughout the vessel. This condition was blamed for the corrosion which caused the accident and a loss of several thousand dollars.

Figure 1 shows the wreckage. Figure 2 is a side view of a section from a seam, showing clearly the serious wasting of the plate and the rivets. Figure 3 is a view looking down on the seam on the inside of the vessel.

The vulcanizer was manufactured in 1934 and was 48" in diameter and 13' long. It was made up of two courses of 5'16" plate with a single riveted girth seam and double riveted lap seams. When the vessel

exploded at its normal operating pressure of about 100 lb, the outer lap of the rear course tore along a line about $\frac{3}{4}$ " from the edge of the inner lap and parallel with the girth seam. The fracture extended through the girth seam and then tore almost all the way around the other course.

Although the vessel had been in use for only two years, the plate had been reduced on the average to about half of its original thickness and the wasting was quite general.

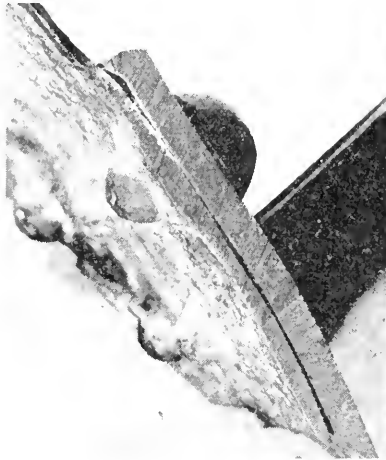

Figure 2

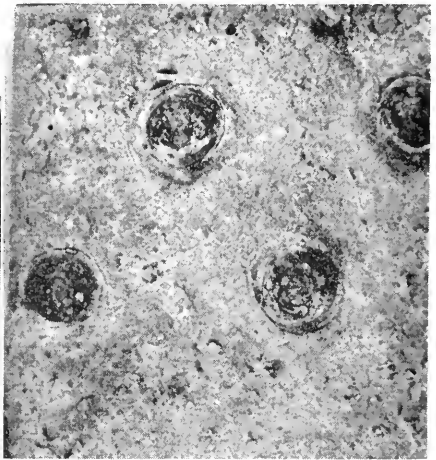

Figure 3

The vessel was destroyed by the explosion, its contents were badly damaged, asbestos was scattered throughout the large room, (120' by 165') and condensed steam saturated all the equipment there. Many panes of glass were broken and the metal sash supporting them was bent. Of the 22 men in the room at the time 20 escaped without injury. The other two received minor cuts and bruises.

The difficulties in the operation of such vulcanizers arise directly from the use to which they are put. Because the process accomplishes the desired result on the material used, the solution of the difficulty is being sought in a metal which will be more corrosion- and acid-resistant. Until this is developed, the safety of such vessels can be checked only by frequent inspections and the drilling of test holes, as is done with vessels subject to the erosive action of stirring devices or with such vessels as digesters where chemicals or erosion may thin the plate.

Electrocution of Rat Leads to Condenser Explosion

THE invasion of a bus structure by a rat recently started a sequence of events which brought about the explosion of a steam turbine condenser.

Said rat grounded a circuit fed by three turbines, of 4,000 kw, 5,000 kw and 15,000 kw capacity. Governors opened up to take care of the over-load and following this, the two smaller turbines over-speeded and tripped out because of a sudden decrease in load brought about possibly by the termination of the short circuit. The 15,000 kw machine remained on the line.

Meanwhile, because the short circuit burned out the leads to the motor driving the condenser circulating pump, the flow of cooling water stopped. The governor of the 15,000 kw turbine, however, was admitting steam to take care of the load. Pressure quickly built up in the condenser, which exploded when a 30" atmospheric relief valve apparently failed to open.

The upper half of the cast iron condenser shell broke in many pieces and the lower half was so cracked that an entire new shell was necessary. The tube sheet and the lower half of the turbine casing also were cracked.

Although Hartford Steam Boiler insured neither the condenser nor the turbine, it was privileged to make an investigation. This revealed that in this particular installation there was an auxiliary turbine in addition to the motor to drive the condenser pump, but there was no automatic device to bring the auxiliary turbine into operation should the motor fail. Had there been such a device or had the atmospheric relief valve been in operating condition, it is likely that this accident would have been averted. Repairs or replacements were to include a steel condenser shell and patches on the turbine casing, the latter being decided upon because construction of a new lower half would take about 32 weeks.

A short news item on page 154 of the January, 1937, LOCOMOTIVE told of an accident in which several men were injured at a furniture factory in New York city. It was based on a report by the metropolitan press that the accident was a boiler explosion. A subsequent investigation, however, revealed that the vessel which exploded was an air tank used in a lacquer spray room. The explosion and a subsequent fire forced the employes to the street. The accident was attributed to the ignition of lacquer fumes which had found their way into the tank through the air compressor intake.



A QUARTERLY MAGAZINE
DEVOTED TO POWER PLANT PROTECTION

Published continuously since 1867

SIDNEY B. COATES, *Editor*

Copyright 1937 by The Hartford Steam Boiler Inspection and Insurance Company

HARTFORD, CONN., April, 1937

Single copies may be obtained free by calling at any of the Company's offices.
Subscription price 50 cents per year when mailed from this office.
Bound volumes one dollar each.

Reprinting matter from this paper is permitted if credited to

THE LOCOMOTIVE of THE HARTFORD STEAM BOILER INSPECTION AND INSURANCE CO

Louis Francis Middlebrook

The passing of Louis Francis Middlebrook on February 1 brought sorrow to a multitude of friends, to every employe who had been so fortunate as to know him, and to the many agents and policyholders who were acquainted with him personally or had been served by him in his official capacity as Secretary.

Had Mr. Middlebrook lived until March 1, he would have completed 52 years of active service with the Company. For 40 of those years he was one of its executive officers.

In a tribute to him President Wm. R. C. Corson has written as follows:

"His knowledge of every phase of the Company's business and his love for its history and traditions especially equipped him for the administrative duties he so long and so well performed.

"We, his associates, have a deep sense of the loss our Company



LOUIS FRANCIS MIDDLEBROOK—1866-1937.

has sustained in the ending of his service, but far deeper is the sorrow that lies in our hearts in the passing of a warm friend and delightful companion who has meant so much in our lives."

Mr. Middlebrook was born at Trumbull, Connecticut, in 1866, the year in which the Company obtained its charter from the Connecticut Legislature. He and it were of the same age, accordingly, when on March 1, 1885, he joined its home office force. That force then was a small one and the varied duties assigned to its few members gave each opportunity of insight into every phase of the Company's business. That Mr. Middlebrook fully availed himself of this opportunity and gained the confidence of its officers and directors by his proficient performance of his duties is evidenced by their selection of him in

1897 for the position of Assistant Secretary. His election as Secretary came in 1921.

The minutes of the Board of Directors' meeting of February 23 give recognition to the contribution he made to the Company's progress in part as follows:

"His capable conduct of the affairs under his charge, his thorough performance of every duty and his loyal devotion to the Company's interests have contributed greatly to its successful growth and development. . . . It is with grateful memories of his service and of the happy fellowship with him that we are joined in the sorrow which his passing brings to his associates in our Company, to his family and wide circle of friends."

Mr. Middlebrook was greatly interested in maritime history, particularly as it related to Connecticut, and he devoted much of his spare time to the study of dormant historic evidence from sources both in this country and in England. His findings have been published in a number of works, the most comprehensive of which is "The Maritime History of Connecticut during the Revolutionary War" in two volumes. In addition to this history, his writings include: "Old Navigation," published by the U. S. Naval Institute, Annapolis, Maryland; "Seals of Maritime New England"; "The Frigate South Carolina"; "Sketch of the Life of Captain Samuel Smedley of Fairfield"; "Captain Gideon Olmstead," and "Salisbury Connecticut Cannon of the Revolutionary War."

When the War with Spain was declared in 1898, Mr. Middlebrook was commissioned an ensign in the United States Navy and was granted leave of absence from the Company.

Mark Clunk

Mark Clunk, for nearly 40 years an inspector on the Company's staff at Pittsburgh, died January 23, 1937, following a short illness. Inspector Clunk was born July 7, 1858, at Lisbon, Ohio, and prior to joining the Company on August 15, 1889, was engaged in power plant work in Ohio. Throughout his active period with the Company, which terminated with his retirement on March 1, 1929, Mr. Clunk had made many friends among the clients he had served so long in Pittsburgh and vicinity. The veteran inspector used to say that he had crawled into so many two-flue boilers in the old days—27 or 28 feet forward and then back the same distance—that he felt he had "traveled a distance equal to about one-half the circumference of the earth" in this fashion. It is

certain that he actually did travel many miles on his knees within the flues of boilers.

Frederick J. Swett

Another veteran, Inspector Frederick J. Swett of the New York department, passed away on January 6, 1937. His faithful service to the Company's policyholders from April 17, 1899, to January 1, 1928, was marked by many evidences of the high regard with which he was held by both his clients and his associates. Inspector Swett was born August 15, 1855, at Canton, Maine.

W. S. Davidson

W. S. Davidson, inspector serving clients in Minneapolis and vicinity, died January 3, 1937, following a short illness. He had been in the employ of the Company since 1924 and was highly respected throughout his territory. Inspector Davidson was born at Rayne, Scotland, on October 2, 1885. Shortly before his death his wife asked him whether he wished to be taken back to Scotland. His reply was, "No, I will stay here; this country has been so good to me, I would like to remain."

Welded Locomotive Boiler

A WELDED steel boiler, said to be the first of its type ever adapted to railroad locomotive use, was inspected by railroad, government, insurance and other interested engineers recently at the American Locomotive Company plant at Dunkirk, New York. This boiler, according to the *Dunkirk Evening Observer*, is being developed by the Delaware and Hudson Railroad Company in conjunction with the locomotive manufacturer. While the new boiler is an experimental one, the manufacturer's engineers have expressed themselves as confident that welded boilers for locomotive use will prove practicable.

According to the newspaper, it is claimed that the welded boiler is not only actually stronger than riveted boilers for the same use, but that it has certain other advantages. Its smooth contour affords a surface more readily lagged and jacketed on the outside and more easily kept clean on the inside. Furthermore, a considerable weight-saving is achieved by welding. All welding conforms to A. S. M. E. requirements for power boilers, including X-ray examination of seams.

New Directors

Austin Dunham Barney, vice president and general counsel of the Hartford Electric Light Company, and John R. Cook, president of the Arrow-Hart & Hegeman Electric Company, both of Hartford, Connecticut, have been elected members of the Board of Directors of The Hartford Steam Boiler Inspection and Insurance Company.

Besides his association with the Hartford utility, Mr. Barney is general counsel of the Connecticut Power Company, and is prominent



AUSTIN DUNHAM BARNEY



JOHN R. COOK

in other business and financial capacities. He has held several public offices and has been active in special work on tax matters. At the present time he is president of the State Public Welfare Council. Mr. Barney is a graduate of the Yale Law School.

Mr. Cook, as head of a firm of national prominence, is widely known in manufacturing and business circles. He became associated with the Hart and Hegeman Company in 1918 as service manager, and was elected president of the Arrow-Hart & Hegeman Electric Company in 1932. Mr. Cook is active also in connection with other business and financial interests of his home city.

Orator: "And now, gentlemen, I wish to tax your memory."
Man in Audience: "Good heavens, has it come to that?"

C. Edgar Blake Elected Secretary

Mr. C. Edgar Blake was elected secretary to succeed Mr. Middlebrook at the annual organization meeting of the directors on February 23. He joined the company as assistant counsel in December, 1919, and was advanced to his new post from the position of assistant treasurer which he had held since 1926.



C. EDGAR BLAKE

Prior to his coming to Hartford Steam Boiler, Mr. Blake was member of the law firm of Schutz and Edwards, of Hartford. He is a graduate of Yale College in the class of 1911 and of Harvard Law School in 1914. In the Mexican Border Campaign of 1916 Mr. Blake served with Troop B, 1st Separate Squadron, Connecticut Cavalry, and during the World War was a lieutenant with the 302nd Field Artillery. After the armistice he attended Emmanuel College, Cambridge University, England, on detached service, being one of a group selected from the A. E. F. by the United States government to study in British universities.

Mr. Blake's father, Mr. Charles S. Blake, for 10 years was President of The Hartford Steam Boiler Inspection and Insurance Company and from 1927 until his death in 1931 served as chairman of the board of directors.

Agency Department Appointments

Three appointments to positions on the Company's Agency Department staff have been announced by President Wm. R. C. Corson and confirmed by the Board of Directors. Effective March 1, Mr. George H. Prall became Superintendent of Agencies; Mr. Lyman B. Brainerd was made Assistant Superintendent of Agencies, and Mr. Sidney B. Coates took over the editorship of THE LOCOMOTIVE. Mr.

Pral has been Editor of THE LOCOMOTIVE since 1928, and Assistant Superintendent of Agencies since July 1, 1935. Mr. Brainerd has been identified with the Company since 1930, serving in the Underwriting and Claim Departments and as Special Agent in the Hartford Department. Mr. Coates has been a member of THE LOCOMOTIVE staff since 1933.

Taps From the Old Chief's Hammer



THE Old Chief sat at his desk early one evening reviewing reports from the flooded areas in his territory. For days he had kept close to his telephone telling anxious policyholders what to do to protect equipment as the waters rose, consulting with his staff in the field about

this plant or that, and now, with the flood past its crest, laying his campaign to get damaged boilers and machines back in service.

Floods and their problems were not new to him, but never before had so many plants in his territory been inundated. He knew first-hand what conditions were, and how discouraging it was in the valley. He saw in his mind's eye chimneys rising bleakly from plants in which the only sounds were the sloshing of the water and the grinding of ice and debris against walls and equipment. He knew that a layer of mud was settling over everything under water and that the cleaning and drying out, particularly of electrical machines, would be long and arduous.

But that was ahead of him, and while the Chief planned carefully, he had faced explosions, other accidents and other floods too long to be worried. As he stacked up his neatly arranged memoranda, he said to his assistant, Tom Preble, who was working on the opposite side of his desk, "Tom, can you think of any plant we haven't checked?"

"Not one, Chief. The list is complete."

"Good, and we'll use the drying out routine that worked so well in the Pittsburgh territory last season."

"Tom," continued the Old Chief, "talking about high water, it doesn't necessarily take a flood to give our men excitement. Did I tell

you about Frank Hudson's experience on the Missouri?"

Preble was interested at once. The Chief hadn't been his usual genial self for days, and a story meant that things were easing up.

"No Chief, I didn't know that he had anything to do with Missouri except an occasional inspection of a boat or barge tied up to the shore."

"He doesn't now, but he may again. I'll tell you his story about as he wrote it to me.

"The inspections he wanted to make were internals of two 56" diameter locomotive type boilers used on pile drivers. He telephoned the field office of the assured and was told that neither driver could be reached except by boat, but that the superintendent would arrange for transportation. That afternoon the superintendent secured a skiff with an outboard motor, and the two craft, which were about eight miles apart, were visited and external inspections made. It was arranged to make the internals that same night and the Chief Engineer had agreed to pilot a small motor launch.

"On arrival at the first driver, reached about 9 P. M., the fire was out, but there was 15 pounds of steam pressure showing on the gage, because the craft had broken loose from its moorings and the night watch had had to fire up quickly for power to drive the winches and draw up the lines. The boiler was emptied and the inspection completed at about 11:30 P. M.

"Shortly before midnight Frank and the engineer set off upstream for driver No. 2. Before they had gone far the lights on the launch failed.

"As you can well realize, the Missouri is not a pleasant river to navigate on a moonless night with no lights, especially when the water is rising rapidly.

"Hudson said he rode the bow, his flashlight furnishing the only illumination. As he watched for snags and other floating debris, the engineer, a real riverman, handled the boat. For more than one hour Frank peered ahead into the darkness, shouting such warnings as he could. The engineer kept to his course, apparently by instinct.

"At about 1 A. M. the driver was reached. There, too, the watchman was in trouble. Because the hull of the barge was leaking badly and the gasoline pump had failed, he had been forced to fire up and use the steam pumps to save the rig from sinking. The engineer and the nightwatch fixed the gasoline pump while Frank prepared the boiler and completed the internal."

"What a night!" exclaimed Preble.

"I agree, but no worse than several of the men experienced in the

valley this last week."

"But that was an emergency," Preble replied.

"Yes and no," commented the Chief. "The general public considers it an emergency, but our men have to take it in stride. You know Tom, emergencies are our routine."

Electrical Storm Leads to Failure of Ten 2,600 hp Motors.

HOW electrical disturbances due to storms may lead to damage by causing a temporary suspension of the power supply is illustrated by a recent Canadian paper mill accident. The windings of ten 2,600 hp synchronous motors were destroyed by fire under such circumstances despite the fact that their circuits were protected in several ways.

Besides causing property damage conservatively estimated at \$75,000, the accident led to a serious curtailment of paper-making facilities, as spare equipment was available to supply only enough stock for one of four paper machines.

The case was interestingly described in *Pulp and Paper* magazine as follows:

"On July 28th at 10:30 P. M. the windings of the ten 2,600 hp synchronous motors then operating in the grinder room were seriously damaged by fire. With only a small amount of stock in the chests, it was but a question of time before the four paper machines would be compelled to shut down. Fortunately two motors which were not operating at the time were available, one of which was started up shortly, and the second as soon as a stone was placed and coupled. These motors made possible the grinding of enough stock to enable one paper machine to continue operating at a reduced speed.

"The trouble started with a violent electrical storm, which eventually caused an outage on both incoming lines. The oil breakers of these two transmission lines tripped at the source of power, but for reasons which will be explained later, the main breakers of these two lines, as well as all feeders at the mill's sub-station, remained closed.

"As in practically all modern generating stations and sub-stations, the control bus in the substation is fed by direct current both from a motor-generator set and from batteries.

"At the time of power outage, the batteries had been disconnected from the control bus for repairs, and the motor-generator set, alone, was supplying voltage. It discontinued doing so, when the no-voltage release tripped this set on power outage.

"The ten grinder motors, in operation prior to the accident, remained on the line, since their running oil circuit breakers had not been tripped out by their protective relays. The latter are known to have functioned properly, but to have been unable to operate the tripping circuit due to absence of power from the direct current control bus.

"It is significant to note, in this connection, that the grinder motor circuits are protected against: (1) Low voltage on energized feeders, (2) over-load on energized feeders, (3) unbalanced load between phases, and (4) failure of direct current supply for field excitation.

"With the exciter motor-generator set off the line and with the batteries disconnected, the return of system voltage tended to start the grinder motors as squirrel cage motors. As the motor rotors were held in a stationary position due to pressure of wood on grindstones, the impressed line voltage caused electrical burnout of the cage or starting windings.

"The heat thus generated caused a fire in the ends of the stator coils and the field coil insulation.

"The stator coils, as revealed by later inspection, showed no internal damage from heating, as might obtain from heavy current due to electrical over-load, but were sufficiently damaged by fire to require complete renewal by repair and replacement.

"The grinder motor circuits were opened by the re-energizing of the D. C. control bus, but in the four to five minutes following the return of power, and before the D. C. control bus was re-energized, the motors burned out."

Brooklyn Man Says Boiler Blast Stopped His Business

According to the *New York Herald Tribune*, a boiler in the basement of a Brooklyn lodging house and baths exploded on February 3, the accident causing considerable damage to the building and injuries to two men. It was said that the janitor was scalded so severely as to require hospital treatment.

The newspaper reported "that two windows were shattered by the explosion, a shed in the rear of the building was blown down and part of the flooring on the first story was damaged."

Although a Hartford Steam Boiler inspector was denied permission by the owner to enter the building, he was told by the owner that the vessel which exploded was a horizontal cast iron boiler used for heating water and that it was not equipped with a safety valve. The owner said that he never had purchased boiler insurance and that this accident had permanently put him out of business.

The Hartford Steam Boiler Inspection and Insurance Company

OF HARTFORD, CONN.

December 31, 1936

Capital Stock, \$3,000,000.00

ASSETS

Cash on hand and in banks	\$904,668.68
Premiums in course of collection (since October 1, 1936)	1,000,760.69
Interest accrued on mortgage loans	4,169.65
Interest accrued on bonds	88,854.77
Loaned on mortgages	290,275.00
Home Office real estate and Philadelphia branch office	642,331.05
Other real estate	332,274.83
Bonds on an amortized basis	\$8,970,348.42
Stocks at market value	7,154,705.00
	16,125,053.42
Other admitted assets	6,903.34
<i>Total</i>	\$19,395,291.43

LIABILITIES

Premium reserve	\$6,765,042.57
Losses in process of adjustment	463,395.19
Commissions and brokerage	200,152.14
Difference between market and book values of stock	507,096.59
Other liabilities (taxes incurred, etc.)	504,352.01
<i>Liabilities other than capital and surplus</i>	\$8,440,038.50
Capital stock	\$3,000,000.00
Surplus over all liabilities	7,955,252.93
<i>Surplus to Policyholders</i>	10,955,252.93
<i>Total</i>	\$19,395,291.43

WILLIAM R. C. CORSON, President and Treasurer

BOARD OF DIRECTORS

LUCIUS F. ROBINSON, Attorney, Hartford, Conn.	HON. JOHN H. TRUMBULL, President The Trumbull Electric Mfg. Co., Plainville, Conn.
JOHN O. ENDERS, Chairman Executive Committee Hartford National Bank & Trust Co., Hartford, Conn.	CURTISS C. GARDINER, Vice President The Hartford Steam Boiler Inspection and Insurance Company, 90 John Street, New York.
MORGAN B. BRAINARD, President Aetna Life Insurance Company, Hartford, Conn.	JAMES L. THOMSON, Chairman Finance Committee Hartford Fire Insurance Company, Hartford, Conn.
CHARLES P. COOLEY, Chairman Board of Trustees Society for Savings, Hartford, Conn.	PHILIP B. GALE, Chairman Board of Directors Standard Screw Co., Hartford, Conn.
JOSEPH R. ENSIGN, President The Ensign-Bickford Co., Simsbury, Conn.	JOHN J. GRAHAM, Vice President The Hartford Steam Boiler Inspection and Insurance Co., Hartford, Conn.
EDWARD MILLIGAN, President Phoenix Insurance Co., Hartford, Conn.	AUSTIN DUNHAM BARNEY, Vice President The Hartford Electric Light Co., Hartford, Conn.
WM. R. C. CORSON, President The Hartford Steam Boiler Inspection and Insurance Co., Hartford, Conn.	JOHN R. COOK, President Arrow-Hart & Hege-man Electric Co., Hartford, Conn.
SAMUEL M. STONE, President Colt's Patent Fire Arms Mfg. Co., Hartford, Conn.	
SAMUEL FERGUSON, Chairman Board of Directors The Hartford Electric Light Co., Hartford, Conn.	

Incorporated 1866



Charter-Perpetual

Department

Representatives

ATLANTA, Ga., Citizens & So. Nat. Bk. Bldg.	W. M. FRANCIS, Manager. C. R. SUMMERS, Chief Inspector.
BALTIMORE, Md., 704-9 Garrett Building	D. W. LITTLE, Manager. R. P. GUY, Chief Inspector.
BOSTON, Mass., 87 Kilby Street	THOMAS F. RICE, Manager. W. A. BAYLISS, Chief Inspector.
BRIDGEPORT, Conn., City Savings Bank Building	W. G. LINEBURGH & SON, General Agents. A. E. BONNET, Chief Inspector.
CHICAGO, Ill., 175 West Jackson Boulevard	P. M. MURRAY, Manager. C. W. ZIMMER, Chief Inspector.
CINCINNATI, Ohio, 1904-12 Carew Tower	JAMES P. KERRIGAN, Manager. W. E. GLENNON, Chief Inspector.
CLEVELAND, Ohio, 1040 Leader Building	ARTHUR F. GRAHAM, Manager. JOHN L. SCOTT, Chief Inspector.
DENVER, Colo., Gas & Electric Building	J. H. CHESNUTT, Manager. JESSE L. FRY, Chief Inspector.
DETROIT, Mich., National Bank Building	L. L. COATES, Manager. THOMAS P. HETU, Chief Inspector.
HARTFORD, Conn., 56 Prospect Street	F. H. KENYON, Manager. A. E. BONNET, Chief Inspector.
NEW ORLEANS, La., 333 St. Charles Street	R. T. BURWELL, Manager. P. E. TERROY, Chief Inspector.
NEW YORK, N. Y., 90 John Street	C. C. GARDINER, Vice President. J. F. HUNT, Chief Inspector.
PHILADELPHIA, Pa., 429 Walnut Street	A. S. WICKHAM, Manager. S. B. ADAMS, Chief Inspector.
PITTSBURGH, Pa., Arrott Building	WILLIAM P. WALLACE, Manager. J. A. SNYDER, Chief Inspector.
ST. LOUIS, MO., 319 North Fourth Street	CHAS. D. ASHCROFT, Manager. EUGENE WEBB, Chief Inspector.
SAN FRANCISCO, Cal., 114 Sansome Street	C. B. PADDOCK, Manager. L. E. GRUNDELL, Chief Inspector.
SEATTLE, Wash., Arctic Building	E. G. WATSON, Manager. WILLIAM J. SMITH, Chief Inspector.
TORONTO, Ont., Canada, Federal Building	H. N. ROBERTS, President The Boiler In- spection and Insurance Company of Canada.

The Locomotive

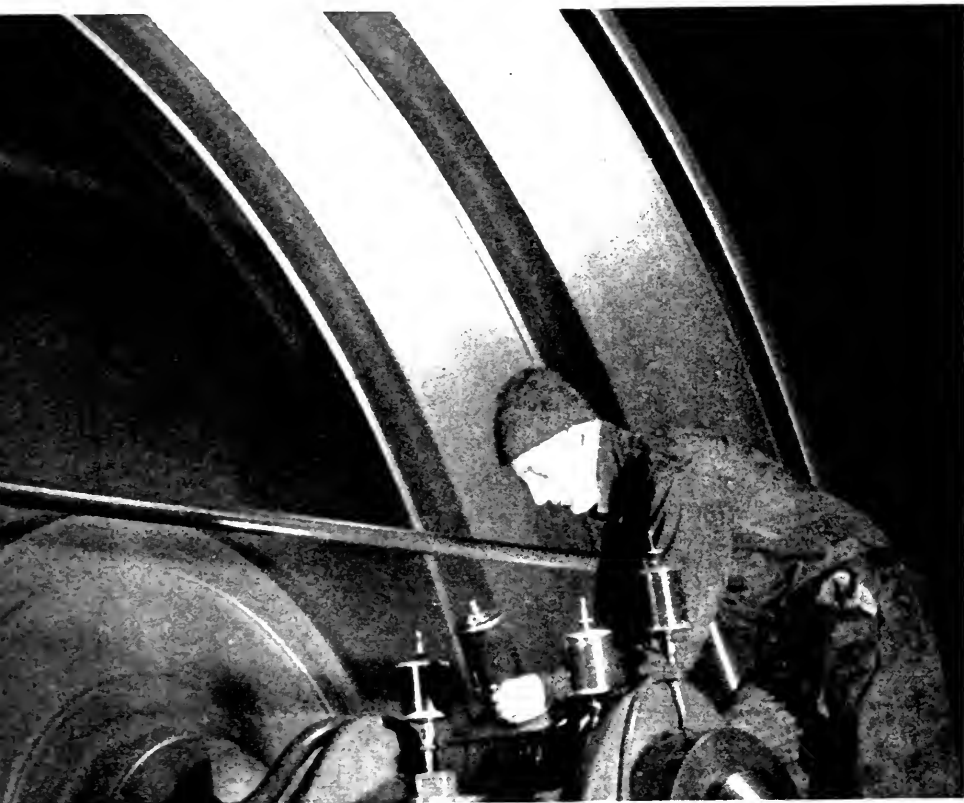

Quarterly Magazine Devoted to Power Plant Protection
Please Show to Your Engineer



Riveted Patches

Recent work on the part of engineers interested in more definite rules for determining the strength of riveted patches has accomplished results which the engineering staff of The Hartford Steam Boiler Inspection and Insurance Company believes should be of general value, especially to operators of boilers of the fire tube type. The article which follows discusses the recent work interpretatively, explaining tables of factors and other data which, experience has shown, have an influence on the success of repairs. —Editor.

By J. P. MORRISON, *Assistant Chief Engineer, Boiler Division*

RIVETED patches have for many years been recognized as an economical and practical repair of boiler shells and boiler drums containing localized defects. When trouble has been experienced with patches after they have been installed, it has been traceable to the conditions responsible for the original defect; to details of the repair procedure in the preparation of the plates forming the patch seam, such as poor fitting, improper drilling and insufficient scarfing; or to defects in the metal of the shell or patch.

The following discussion of riveted patches deals with material, workmanship, and design, in that order.

Material

Patch material should be fire-box or flange steel, never steel of unknown or inferior quality, and should be of the same thickness as the plate to be repaired. If the original plate is dangerously reduced in thickness because of corrosion, patching should not be attempted, even to continue the boiler in service until new equipment can be obtained, without the approval of persons fully experienced in judging the dependability of such temporary repairs. Boiler shops must be prepared to produce a copy of the steel maker's test reports for all material used in boiler repair work. If it becomes necessary to divide a plate so that a part of it will not bear a "steel maker's brand," an authorized boiler inspector or steel manufacturer's representative should be called to witness the transfer of the brand before the plate is cut.

Rivets, patch bolts, and staybolts must be made of material of good quality.

Workmanship

In each case the distorted sheet should be straightened to the greatest extent its condition will permit, so that the section removed and the patch will be no larger than necessary. A patch should be placed on the inside of the sheet when it is possible to do so, except

that if a blow-off connection is included, the patch should be placed on the outside of the sheet. If the part of the shell that needs strengthening is not exposed to the products of combustion nor affected by deposits from the boiler feedwater, it is not necessary, when applying a patch, to remove the defective plate, unless it is greatly distorted.

All rivet holes should be drilled full size or the holes may be punched not to exceed $\frac{1}{4}$ " less than full size for plates over $\frac{5}{16}$ ", and $\frac{1}{8}$ " less for plates $\frac{5}{16}$ " or less in thickness, and then reamed to full size with the patch in place. Rivet holes are usually $\frac{1}{16}$ " greater in diameter than the normal diameter of the rivet, but a $\frac{1}{32}$ " difference is preferable when rivets are of uniform size. The foregoing specifications for riveted work are those in the A.S.M.E. Boiler Code, covering new construction.

Rivet holes for patch seams may be countersunk, if desired, but the angle of the chamfer with the longitudinal axis of the hole should not exceed 45 degrees and the depth should be no greater than $\frac{1}{2}$ the thickness of the plate. The excess strength of the ligaments between the rivet holes over the strength of the rivets, is such that no deduction in the calculated efficiency need be made on account of material removed in countersinking the holes.

Rivets, patch bolts, or staybolts may be used in "riveted" seams in stayed or braced surfaces such as are found in locomotive type and vertical tubular boilers. If staybolts are used in lieu of rivets in a seam, there should be a rivet or a patch bolt between each staybolt and the next adjacent staybolt, and the staybolts should be installed after the riveting or patch-bolting has been completed.

When possible, the edges of a patch should be chipped or planed to the proper bevel for caulking before the patch is fastened to the boiler.

A riveted patch should be tight under a hydrostatic test equivalent to the working pressure before any seal welding is done. In the event that seal welding is applied, the metal should be deposited in a single bead having a throat not less than $\frac{3}{16}$ " nor more than $\frac{5}{16}$ ", since contraction stresses resulting from the use of numerous and heavy beads of seal welding contribute to failures. The plate should be at a temperature of at least 60°F when any welding is done. A properly applied patch, however, should not have to be seal welded to secure tightness.

When three or more plates over-lap at a seam, it is necessary to scarf the center plate to a feather edge (a reduction in thickness to $\frac{1}{32}$ " or less) the entire width of the lap. The thickness of the

scarfed plate may be reduced to one-half of its normal thickness at the lap rivet hole next to the scarfed edge.

The width of the lap of two plates forming a single-riveted patch seam has been the subject of disagreement. Some designers hold to the rule of three times the diameter of the rivet hole, which applies to longitudinal seams, while others favor a narrower lap, such, for instance, as one meeting the requirements for a girth seam, which is 2.5 times the diameter of the rivet hole. Those ideas are based upon the crushing load, tending to disturb the section of the plate between each rivet hole and the caulking edge or the edge of the inside lap, and take into consideration stresses due to poor operating conditions such as over-heating, rather than the stresses due to pressure alone.

The resistance to heat transfer through two plates forming an excessively wide lap is greater than through plates forming a narrower lap. Accordingly, there is an advantage in using a comparatively narrow lap, that is, one approximately 2.5 times the diameter of the rivet hole to avoid over-heating the edge of the plate and consequent fire cracks. The over-heating in any case is reduced to a minimum by keeping the inside surfaces clean, but, as a general statement, the original difficulty develops as the result of scale or oil or both, so that the patch is likely to be subjected to the same over-heating as the shell plate.

Seams of patches not exposed to the products of combustion may be similar to the corresponding seams of the boiler, and in most cases should be at least double-riveted.

Design

IN THE LOCOMOTIVE for July, 1897, and again for July, 1908, there were articles on the design and strength of diagonal joints. The thoughts then expressed were directed toward the use of helical seams in boiler construction, rather than to the design of diagonal seams of patches, but the subjects are so closely allied that in a general way stresses developing in one kind of seam are found in the other.

In patch terminology the "length" of the patch is the dimension parallel to the longitudinal seam and the "width" is that parallel to the girth seam, regardless of which dimension may be the longer.

Experience with patches indicates that, if the maximum length of the patch between rivet center lines (the dimension "L" as shown in Figures 1, 2, and 3) does not exceed 24", it is not necessary to give specific consideration to the strength of the diagonal patch seam, if the proper materials are used, the workmanship is good, and the diameter and spacing of the rivets is normal for the thickness of plate.

When a patch is being designed, it should be kept in mind that the best results are obtainable with crescent, oval, triangular or diamond shaped patches *with a width at least twice the length* and all "corners" well rounded.

Writers have applied various terms to the relation between the efficiencies of circumferential, diagonal and longitudinal seams when comparing one with the other. In the interest of simplicity, reference herein will be made to circumferential efficiency, diagonal efficiency or longitudinal efficiency, when referring to the efficiency of a seam.

In determining the required efficiency of a diagonal seam, it is necessary to know the angle that this seam is to make with a seam of known efficiency. Some writers refer to the angle formed with the girth seam, while others refer to the angle made with the longitudinal seam or with a line parallel thereto. The diagonal efficiency should be based upon the latter angle, because the longitudinal efficiency is of most importance in the calculations made to determine the maximum safe working pressure of the boiler.

The present boiler rules in some jurisdictions use the diameter of the boiler in determining the angularity of a diagonal seam. However, since the angle of a seam depends upon the angle given it when the sheet is laid out "in the flat" and since that angle remains constant regardless of the diameter of the boiler upon which the patch is placed, the diameter of the boiler is not a contributing factor.

In order to simplify the designing of patches and to avoid the necessity for dealing with angles and the trigonometric functions of angles, tables of efficiencies and factors (Tables I and II, Pages 202 and 203) have been prepared.

The necessity of designing a patch occurs after weakening or distortion of the boiler shell. The size and shape of the patch are, therefore, predetermined to a large extent by the area of the defect. In addition, the "length" and "width," as herein defined, determine the direction of the patch seam. Accordingly for the practical designing of patches, the plan recommended is based on the relation of the longitudinal dimension "L" and the circumferential dimension "W" in the following formula:

$$*L/W=K,$$

thereby eliminating the necessity for measurement or calculation of angles.

*In the interpretation considered and approved by The National Board of Boiler and Pressure Vessel Inspectors, the formula $W/L=C$ and the angle made by the diagonal seam with the girth seam are used. This method requires different factors for Table II, but the results in solving any problems are the same.

The factors upon which the diagonal efficiencies of the seams are based are shown in Table II, Column K, Page 203, for as many combinations of "L" and "W" as are necessary for any desired shape or size of patch. The closest factor should be used if the formula $L/W=K$ gives a factor between two of those given in the table, or, the factor may be determined by interpolation. (See problem 3, Page 204.)

If a patch is oval or diamond-shaped, it may be considered as two patches, using half the longitudinal dimension as "L" in determining the constant "K." Also, if a patch of that description projects in both directions from the girth seam, as illustrated in Figure 1, "L" should be measured in each direction from the line of rivet centers of that seam.

Table II, Column F-1 (for vessels in which approximately 75 per cent of the end load is carried by head to head braces, tubes or an internal furnace) and F-2 (for vessels in which the heads and shells carry the entire load) give factors representing the relation of the efficiency of the longitudinal seam of a boiler which is to be repaired and the efficiency of the patch seam appearing in column "e" of Table I, Page 202. That relation or factor of relative efficiency is found by dividing the boiler seam efficiency by the patch seam efficiency thus:

$$\text{F-1 or F-2} = \frac{\text{longitudinal efficiency of the boiler seam}}{\text{longitudinal efficiency of a seam similar to the patch seam}}$$

The longitudinal efficiency of the boiler seam is calculated in accordance with the A.S.M.E. Boiler Code rules, while the normal or longitudinal efficiency of the patch seam is readily obtained by the use of Table I, using the same plate thickness, diameter of rivet hole and pitch of the rivets for the patch as for a similar seam for the vessel itself. Efficiencies in Table I are for single-riveted seams.

The factors of relative efficiency in Column F-1 are based upon the following formula for F-1, developed to include consideration of those longitudinal forces over and above the load carried by the tubes, through-rods, and similar head-to-head supports. Of course, no credit can be given for diagonal braces, unless such braces extend from the head to the shell in such a way as to support the surface to be patched.

$$\text{F-1} = \frac{1}{\sqrt{\cos^2 a + .015625 (\sin^2 a)}}$$

The factors of relative efficiency in Column F-2 were calculated from the formula for F-2, which appeared in the July, 1908, issue of

THE LOCOMOTIVE, and apply to diagonal seams of patches to cylinders with unbraced heads, such as a drum of a water tube boiler.

$$F-2 = \frac{2}{\sqrt{1 + 3 \cos^2 a}}$$

The formulas for determining F-1 and F-2 are given here merely as a matter of information. The use of the tables of factors simplifies the calculations.

The values for the efficiency of the seam given in the fourth column of Table I represent the strength of the rivets in some cases and the strength of the net section of the plate in others, depending upon which is weaker. There may be cases in which the range of combinations of plate thickness, rivet diameter, and rivet pitch, is such that the choice of one rivet diameter results in a weak net section and a high rivet shear, while the choice of a smaller rivet has the opposite result. In such cases it is best to select the larger rivet, because the shearing stress in the rivet of a diagonal seam is relatively greater than the tension stress in the diagonal ligament between the rivet holes.

Given certain of the items necessary for the specifications of a patch, it is possible from Tables I and II to derive the other information necessary, whether for the purpose of designing a satisfactory patch or for checking the strength of a patch already in place. The problems at the end of the article illustrate the procedure to be followed.

The relation between the longitudinal efficiency and the diagonal efficiency of a seam, or the factor representing that relation, depends upon the relation between the girthwise stress seeking to tear the object apart along a horizontal line, and the longitudinal stress seeking to separate the plate or seam in a girthwise direction.

A water tube boiler having unbraced heads has a girthwise stress twice the longitudinal stress, and accordingly a standard design girth seam may be said to be twice as efficient as a *similar* longitudinal seam.

A diagonal seam making an angle of 45 degrees with the longitudinal seam and the same angle with the girth seam would have an efficiency 26 per cent greater than the efficiency of a longitudinal seam of the same design, as shown in Table II, F-2 for the factor .500 which is that for the 45 degree angle made by a patch having a width equal to twice the length.

However, if the tubes and through-rods of a horizontal tubular boiler, for example, are carrying 75 per cent of the longitudinal or

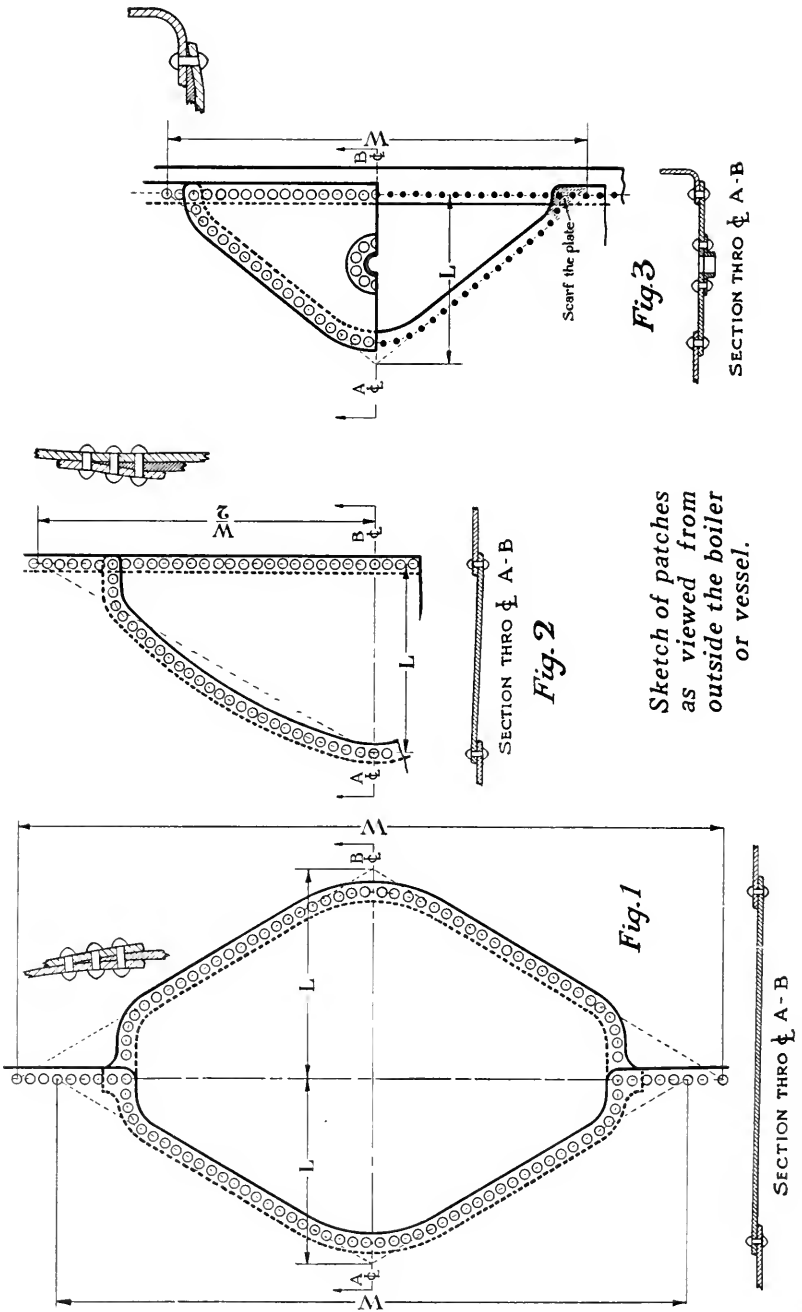

Sketch of patches as viewed from outside the boiler or vessel.

end stresses, a diagonal seam forming a 45 degree angle would have a diagonal efficiency 40 per cent greater than the efficiency of a *similar* longitudinal seam, because the diagonal seam carries no more than 25 per cent of the end load. (See Table II, F-1 opposite .500 for K.)

If the length of a patch is to exceed 60", consideration should be given to the use of a sheet, having a width equivalent to $\frac{5}{8}$ of the circumference of the boiler, and with longitudinal seams of a design similar to that of the original boiler seams.

When rebuilding the furnace walls after a repair of this kind, dependable means should be provided to protect the new longitudinal seams from the products of combustion.

In designing any patch, three or four rivets on a longitudinal line should not be considered as affecting the diagonal efficiency of the patch seam, because it is almost impossible to secure tightness by caulking a sharp corner, and it often is necessary to have from one to four rivets on a line at right angles to the girth seam in order to round out the circumference of the patch. Figures 1 to 3 show the characteristic rounded corners necessary for good patch design.

If a patch having diagonal seams is riveted to the shell of a boiler in which the head-to-head braces or tubes or both carry 75 per cent of the end load, and the diagonal seam forms an angle of 60 degrees or more with the longitudinal seam of the boiler (in which case L/W would be less than .288), the strength of the seam may be disregarded, provided the workmanship is satisfactory and the design is normal for the vessel to be patched.

If the diagonal seam forms an angle of 30 degrees or less with the longitudinal seam of the boiler (in which case L/W would be .866 or over), the factor expressing the relation of the strength of that diagonal seam to a longitudinal seam of similar design is so small that the diagonal efficiency may be disregarded and the strength of the boiler as a whole based upon the efficiency of such a seam considered as a longitudinal joint. When such a repair is contemplated and a material reduction in pressure is not desired, it is recommended that one of three things be done: (1) That a patch be installed having an L/W factor "K" not more than .500 (for a 45 degree angle), (2) that a $\frac{5}{8}$ ring or a complete ring be substituted, or that (3) a new boiler be installed.

The three figures presented on the opposite page illustrate how patches of proper design may be correctly installed.

Figure 1 represents a method of applying a patch to include a part of each sheet adjacent to a girth seam. It will be assumed that there

has been serious deterioration as the result of over-heating, bulging, fire cracking and corrosion, so that repairs are needed to both sheets. The use of a single patch, somewhat oval in shape, simplifies the repair, but the scarfing of the patch plate where it is inserted in the old sections of the girth seam requires extreme care. The patch sheet forms the inside lap of the front seam and forms the outside lap of the rear seam. It will be noted that the calculation of the strength of the diagonal or oval seam is based upon L/W considering "L" as the length of the patch in each direction measured from the center line of rivets of the girth seam. This same sort of a patch may be easily adapted to a location away from any riveted seam by following the principles heretofore outlined.

Figure 2 shows a crescent shape patch with the girth seam used as one of the patch seams.

Figure 3 illustrates a method of patching the rear course of a horizontal tubular boiler where the patch is to include the blowoff connection. It will be noted in this case that it is necessary to scarf the boiler shell plate where the patch, shell plate and head lap at each end of the patch.

TABLE I

Riveted Patches--Seam Efficiency
Single-Riveted Seams

PLATE THICKNESS	RIVET HOLE DIAMETER	PITCH OF RIVETS	LONGITUDINAL EFFICIENCY OF PATCH SEAM
t	d	p	e
1/4	11/16	1 7/8	63.3
9/32	3/4	1 7/8	60.
5/16	3/4	1 7/8	60.
11/32	13/16	1 15/16	58.
3/8	13/16	1 15/16	57.
13/32	7/8	2 1/16	57.5
7/16	15/16	2 1/4	56.
15/32	15/16	2 1/8	55.5
1/2	1	2 1/4	52.5
9/16	1 1/16	2 3/8	53.
19/32	1 1/16	2 1/4	52.8
5/8	1 1/16	2 1/4	50.5
21/32	1 1/16	2 5/16	51.4
11/16	1 1/8	2 5/16	51.4

TS 55000 lbs. SS 44000 lbs.

TABLE II

Patch Seams—Table of Factors

L/W=K	F-1	F-2
.866	1.15	1.11
.832	1.16	1.11
.800	1.17	1.12
.769	1.18	1.13
.741	1.20	1.14
.714	1.21	1.15
.688	1.23	1.16
.663	1.25	1.17
.640	1.26	1.18
.617	1.28	1.19
.596	1.30	1.20
.575	1.32	1.21
.555	1.34	1.22
.536	1.36	1.24
.518	1.38	1.25
.500	1.40	1.26
.482	1.42	1.27
.466	1.45	1.29
.450	1.48	1.31
.434	1.51	1.32
.419	1.54	1.34
.404	1.57	1.35
.390	1.60	1.36
.376	1.64	1.38
.363	1.68	1.40
.350	1.72	1.42
.337	1.76	1.43
.325	1.80	1.45
.312	1.85	1.47
.300	1.90	1.49
.288	1.96	1.51

L=Longitudinal dimension of patch between rivet centers.

W=Circumferential dimension of patch between rivet centers.

F-1=Factor where 75 per cent of the end load is carried by through braces or tubes.

F-2=Factor where heads and shells carry entire load.

K=L/W; L=WK; W=L/K.

Examples of Calculations of Riveted Patches

Problem 1. Design of Patch

A triangular patch is to be placed on the fire sheet of a horizontal return tubular boiler having shell plate 7/16" thick, and longitudinal seam efficiency 74 per cent. The length of the patch is to be 36" and a reduction of pressure is to be avoided.

Find the width "W" of a patch to be applied, using a single-riveted seam of normal design.

Referring to Table I, we find that a 7/16" plate with 15/16" diameter rivet holes and pitch of 2-1/4" gives a seam efficiency of 56 per cent.

The factor of diagonal efficiency is found by dividing the longitudinal efficiency of the boiler seam by the longitudinal efficiency of a seam similar to the patch seam or $.74/.56=1.32$.

From Table 2 in Column F-1, we find a factor of 1.32 requires an L/W constant of .575.

As $L/K=W$, $36"/.575=62.5"$.

Accordingly, as the length of the patch is 36", its girthwise dimension or width must not be less than 62.5", if the boiler is to be permitted to carry its present pressure.

Problem 2. Pressure Allowance on an Existing Patch

A horizontal tubular boiler has a patch 30" long x 48" wide. The patch is of crescent shape and has single-riveted seams.

The boiler shell plate is $3/8"$ thick, the longitudinal seam is of the double-riveted butt strap type having an efficiency of 82 per cent, and the safety valve pressure is 125 lb, but can be reduced to 110 lb without interfering with the operation of the plant.

What maximum working pressure may be allowed on the boiler, if the single-riveted patch seam has $13/16"$ diameter holes pitched 1 $15/16"$ apart, giving a longitudinal efficiency of 57 per cent?

The constant, from which a factor of diagonal efficiency for the single-riveted seam is found, is determined by dividing the length of the patch by the width. ($L/W=K$) or $30/48$ equals .625.

There is no constant .625 in Column K so the closest constant is selected which is .617 and the corresponding factor in Column F-1 is 1.28.

Since the patch seam would have longitudinal efficiency of 57 per cent and a diagonal factor of 1.28, its diagonal efficiency is $.57 \times 1.28$ which equals .73 or 73 per cent.

The pressure permitted on a boiler varies directly as the seam efficiency. Accordingly, $.73/.82 \times 125$ equals 111 lb pressure.

The boiler may be continued in service with the safety valve adjusted to 110 or 111 lb.

Problem 3. Design of a Patch for a Water Tube Boiler Drum

A patch is required for the shell of a longitudinal drum water tube boiler. Sections of the plate having a total length of 36" (making "L" 18") are to be removed on each side of a girth seam. The patch will be oval in shape. A reduction in pressure would necessitate replacing the boiler.

The shell plate is $7/16"$ in thickness with a double-riveted butt strap longitudinal seam having an efficiency of 82 per cent.

What will be the width of an oval patch?

From Table I we find a single-riveted lap seam in $7/16"$ plate, $15/16"$ diameter rivet holes, $2\frac{1}{4}"$ pitch, has an efficiency of 56 per cent.

The factor of diagonal efficiency is found by dividing the longitudinal efficiency of the boiler seam by the longitudinal efficiency of the single-riveted patch seam; therefore $.82/.56$ equals 1.46.

Table 2, Column F-2, has no factor 1.46, but there is a factor 1.45 which corresponds to the constant .325 and there is a factor 1.47 which corresponds to constant .312, so by interpolation, a constant for factor 1.46 would be .318.

As the patch is to be oval, the width of the patch would be $W=L/K$ or $18/.318=56.6"$.



THE COVER

An inspector examining the lubricating appliances in connection with an outboard bearing supporting the shaft of a large steam engine. Improper maintenance at bearings may be responsible for excessive wear, for misalignment, and subsequent failure of the shaft, the balance wheel or some other part of any engine.

Turbo-Generator Wrecked by Exploding Fan

WHEN an air circulating fan on a medium sized 3600 rpm A.C. turbo-generator burst a few weeks ago at a Western utility plant, the stator winding was so badly damaged that it had to be renewed. The insulation on most of the coil ends was cut to the copper by flying pieces of the fan, and the ends of all of the coils were distorted. The relays cleared the unit from the bus, and the machine,

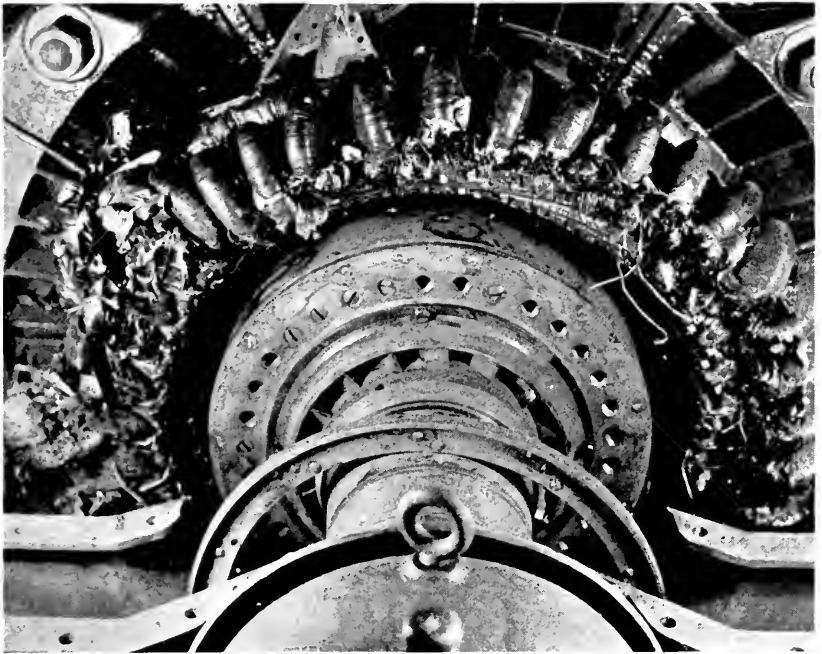

After the cooling fan cut into the windings. A piece of the broken fan may be seen at the top of the stator.

turning freely, came to rest. After the removal of the end bells, the pieces of the broken fan were found to be distributed about the coil ends and eleven of the studs mounting the fan were sheared off. This unit had been given an over-speed test on several occasions, and was said to have been operating normally just prior to the accident. Because the adequacy of the design had been proved in many installations, it was felt that the accident probably was caused by some weakness in the metal, although a definite reason for the failure has not yet been determined.

Building Construction Adds to Dust Hazard in Machines

Whenever machinery and particularly electrical machinery is exposed to excessive dust as the result of construction work or building repairs, unusual efforts should be made to keep the machinery clean. More frequent attention is necessary than would be given under ordinary maintenance routine. Although dust is attendant on most major building repairs, it is not always anticipated and the proper safeguards may not be supplied until the damage has been done. A recent accident is typical. Dust from construction work so affected the commutation of a 200 kw D.C. generator supplying power to a paper machine motor that the generator and paper machine had to be stopped until repairs were made. Production was held up for several hours.

*A*S most power plant operators know, the cause of an accident to a machine can sometimes be a condition that must be sought entirely outside of the machine itself. Such was the case recently with respect to trouble occurring in a 125 kw, 2300 volt, 3 phase, 60 cycle generator. After the failure of the field winding, an extensive examination of the machine was made both in the manufacturer's shop and in the plant, but no cause for the trouble could be definitely assigned. The unit was returned to service, and immediately the condition of over-heating manifested itself again.

A Hartford Steam Boiler inspector was called. After he had checked the condition of the windings, the air gaps, winding connections and insulation resistance and found them all satisfactory, he suggested that the machine be placed in service. When half-load had been applied to the unit at a potential of 2350 volts, **according to the switchboard voltmeter**, it was observed that the field current was 65 amp, while the maximum current rating of the field winding, as shown on the nameplate, was only 58.5 amp. The switchboard voltmeter was then checked by the inspector and was found to be 500 volts low. In other words, the machine was being over-excited to obtain 2850 volts, a condition of operation which it was not designed to fulfill and which readily accounted for the over-heating of the original field winding and consequent failure.

Airman (after landing in a tree): "I was trying to make a new record."

Farmer: "You did. You're the first man to climb down that tree before climbing up it."—*Whitley Weekly Record*.

He who laughs—lasts.—*Quaker Crax*.

Air Tank Accidents

An air tank explosion that occurred shortly after an attendant had started the compressor following a week-end shutdown, caused such damage that an Ohio manufacturing plant did not operate for several days. The tank was an old 54" by 12' horizontal tubular boiler and was being used at 100 lb pressure. The force of the explosion hurtled heavy machinery 20 feet to and through a concrete wall, leaving a hole 40' long and 16' wide. Electric and gas connections were severed, and the property damage was estimated at \$4,000.

The compressor had been started at about 6:30 A. M. preparatory to the beginning of the day's operation at 7:00 A. M. The explosion occurred about 6:40 A. M. and came at a time when there were few persons about the plant. Had the accident occurred thirty minutes later, ten men would have been in the room with the tank, and others would have been working at machines which were struck by flying metal and debris from the walls. Because the discharge line was reported to be unusually hot prior to the explosion, and because there was a thick coating of oil on the internal surfaces of the tank, it was reasoned that probably there was a fire in the discharge line and that this detonated an explosive oil vapor mixture in the tank.

"(200 TEST)" was stenciled on an air tank which failed at an Indiana garage and caused the death of a man working nearby. While this may have been the pressure at which the vessel was tested hydrostatically in the maker's shop, the operators understood it to mean the "safe working pressure." They said they were carrying only 150 lb. The tank was 18" in diameter and 60" long with one plus and one minus head and all seams welded. The explosion blew out both heads and tore the shell the full length of the welded seam. Inspectors frequently find misunderstanding as to the meaning of "TEST" pressure and the Company advocates that if only one pressure is to be indicated on the vessel, it be the safe working pressure. In some instances the test pressure has been painted out and replaced by the safe working pressure. The tank, as are thousands like it, was used to supply air to inflate tires and operate grease guns.

Over-pressure was blamed for an air tank explosion at a West Virginia automobile top and body shop—an accident followed by fire which ruined two automobiles, scorched others and destroyed a quantity of paint, thinner and lacquer.

Explosion of Welded Vessel Built of Non-Ferrous Alloy

THE failure of a welded seam in a vessel constructed from a corrosion resistant non-ferrous alloy demonstrated what can happen when an inadequate technique is employed in welding such alloys.

Because the process for which the vessel was to be used involved

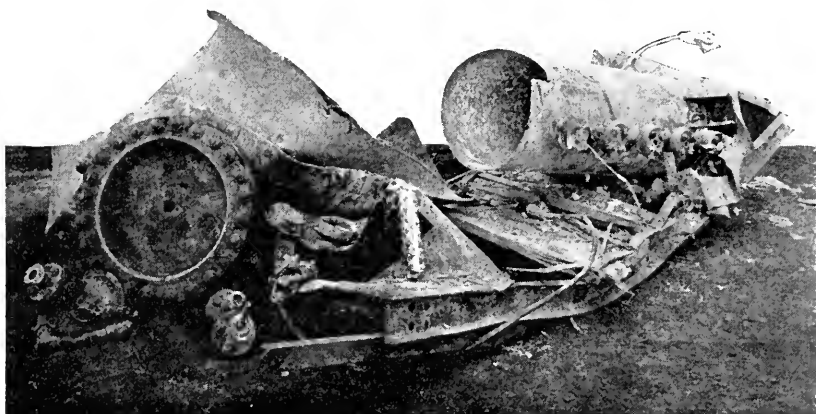

Figure 1. Parts of the destroyed vessel gathered together after the accident.

the presence of acids which corrode steel, it was necessary to build it and its fittings of the special material. This was done and early in 1936 the vessel was placed in service at an approved pressure of 250 lb.

Except for necessitating the special materials, the process itself had nothing to do with the explosion, nor was the vessel more complicated than numerous other specialized autoclaves and digesters used in the chemical industries. It was 1' 10" by 14' mounted vertically with a removable top head of alloy-lined steel, bolted to a steel flange. The sides of the vessel, as is shown in Figure 1, contained a number of connections for the introduction of steam during the process. Seams, including the bottom head seam, were welded. The seam which failed was the vertical seam of the upper of two courses, and it was a double "V" butt weld.

Examination of the weld metal, as illustrated in Figures 3-6, revealed a definitely defective weld, which, coupled with the fact that the vessel was subject to periodic fluctuations of pressure and temperature, may have combined to bring about the failure which occurred during its normal operation.

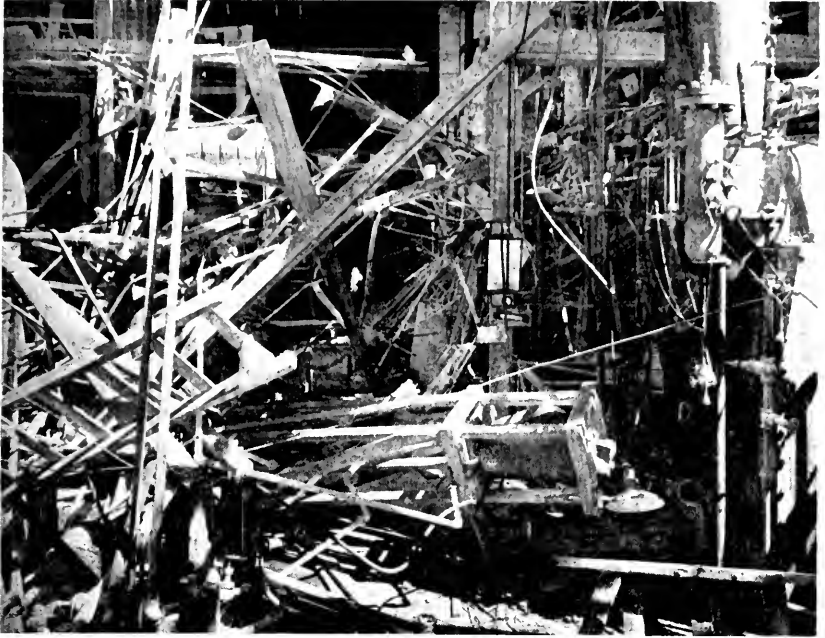
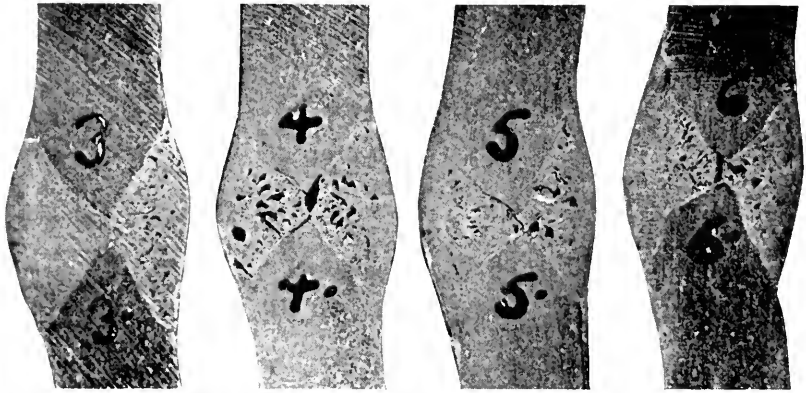

Figure 2. Wreckage caused by the explosion and the subsequent collapse of the building.



Figures 3-6. Etched specimens of welds from the vessel which failed, showing lack of fusion and general porosity in specimens 4, 5 and 6.

As the contents of the vessel was largely water, the release of energy because of the failure caused the solid plate to tear from the defective seam girthwise adjacent to the fillet welded flange seam

at the top of the digester, so that the flange and head were severed from the rest of the vessel. The girth seam between the courses also ripped open.

An idea of the damage that followed can best be obtained from Figure 2. The entire building was reduced to tangled debris when the steel head and other parts of the vessel crashed into building supports and caused the roof to cave in. Much specialized equipment was destroyed. The direct damage to property amounted to more than \$15,000 and six men were injured.

Boiler Accidents

TWO employes and a visitor were killed and another employe was seriously injured when an uninsured boiler exploded recently at a North Carolina sawmill. The visitor was decapitated and the other men were scalded.

In an investigation of the accident, it was learned that the failure started at a crack in the plate near the butt seam, as revealed by the



Part of the boiler plate after an explosion which killed three.

accompanying photograph. The white line along the edge of the plate indicates the thickness of the metal, which measured from $1/16''$ to $1/8''$ instead of the normal $11/32''$. It was said that the boiler had leaked at the crack for some time prior to the accident.

The nature of the failure seemed to indicate that the boiler had been in use at a pressure considerably higher than that for which it was

built, although the inspector learned that the pressure on the boiler at the time of the accident was less than the pressure at which it could have been used, had it been sound.

Newspaper accounts of a boiler explosion on a launch in Hong-kong Harbor on May 17 said that 70 Japanese emigrants were killed, 18 persons were sent to hospitals and 20 were missing. The damaged craft sank.

Vertical tubular boilers, when they fail, are apt to take the path of a skyrocket. Such was the case of the boiler shown in the photograph. It formerly was the steam source for a small Wisconsin cheese factory, but at the time the picture was taken it had demolished the boiler shed, had traveled over a house and had come to rest 340 feet away in a plowed field.

The fireman had filled the boiler, built a fire, opened the drafts and had gone to his home nearby. The first signs of trouble were the



This 39" diameter boiler buried itself 14 inches in a field after traveling 340 feet.

noise of the explosion and the appearance of the boiler in the air. (A farmer estimated it rose 300 feet.)

An examination of the boiler revealed a rupture near the girth seam where the vertical section of the furnace sheet joined the cone section.

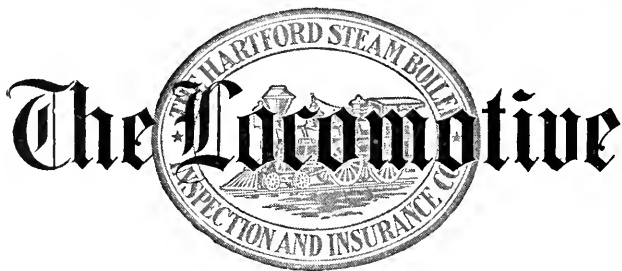

A QUARTERLY MAGAZINE
DEVOTED TO POWER PLANT PROTECTION

Published continuously since 1867

SIDNEY B. COATES, *Editor*

Copyright 1937 by The Hartford Steam Boiler Inspection and Insurance Company

HARTFORD, CONN., July, 1937

Single copies may be obtained free by calling at any of the Company's offices.

Subscription price 50 cents per year when mailed from this office.

Bound volumes one dollar each.

Reprinting matter from this paper is permitted if credited to

THE LOCOMOTIVE OF THE HARTFORD STEAM BOILER INSPECTION AND INSURANCE CO.

Edward Milligan

Mr. Edward Milligan, prominent insurance executive who had been a director of The Hartford Steam Boiler Inspection and Insurance Company for more than 22 years, died on May 1 at University Hospital, Philadelphia.

President of the Phoenix Insurance Company, director in many Connecticut corporations, active in the interests of fire insurance at large, and supporter of community endeavor, he led a busy, useful life.

Mr. Milligan was born in Haddonfield, New Jersey, June 1, 1862. At the age of 17 he entered the insurance business as a clerk in the office of J. B. Kremer & Durban in Philadelphia, became a surveyor for the Ætna Insurance Company in 1884, and joined forces with the Phoenix Insurance Company in 1888 as a special agent. He was transferred from Philadelphia to Hartford in 1896 to become secretary, was made vice president in 1907 and president in 1913.

A man of sound and experienced judgment, exceptional integrity and kindly impulse, his rich personality and unselfishness made him not only a leader, but a friend of all with whom he came in contact.

George Henry Stickney

Mr. George Henry Stickney, a member of the Home Office engineering staff for nearly 18 years, died suddenly on April 11, at the home of friends in Marlboro, Massachusetts. He was born at Worcester, Massachusetts, September 20, 1887, and attended school there. Until he joined Hartford Steam Boiler in 1914 as an inspector in the Boston Department, his principal engineering activity had been at sea, and until his death he continued his marine interest as a member of the United States Naval Reserve. When the World War began, he was called to active service and, with the rank of lieutenant, was made Chief Engineer of the U.S.S. Transport Pensacola. In July, 1919, he returned to the Company at the Home Office. Mr. Stickney was a mechanical engineer in the Boiler Division of the Engineering Department at the time of his death.

In commenting on Mr. Stickney's association with the Company, President Wm. R. C. Corson said, "Mr. Stickney's ability and experience in steam engineering made him a most valued member of our Company's technical staff. Earnest and conscientious in his work, and loyal and devoted to the Company's interests, of a happy, cheerful disposition, he had won and held the respect and warm affection of all his associates. By his death our Company has suffered the loss of a faithful servant and all of us a delightful companion and friend."

James William Butler

James William Butler, an inspector with Hartford Steam Boiler for nearly 18 years, died on February 23, following a prolonged illness. Joining the Company in its Chicago department in 1919, he served there until 1928, when he was transferred to Detroit. Mr. Butler's work was characterized by a spirit of co-operation and cheerfulness that made him many friends.

John J. Hogan

Mr. John J. Hogan, for many years an inspector in the St. Louis Department of the Company, died on April 20 at the home of relatives in Pittsfield, Massachusetts. Except for a short interval from 1918 to

1920, Mr. Hogan had served continuously with Hartford Steam Boiler from 1909 until the illness which culminated in his death. Mr. Hogan's years of loyal, friendly service were appreciated by many in the section of the Middle West where he operated.

Dry Ice Containers

IN basements below soda fountains, in stores dealing with perishable foodstuffs and in a variety of storage and industrial establishments there are vessels, usually called convertors, in everyday use carrying sub-zero temperatures. They are charged with dry ice (carbon dioxide in solid form), which changes to liquid carbon dioxide and carbon dioxide gas as the temperature rises. The dry ice is used for refrigeration purposes, to supply CO₂ gas for refrigerating systems, and also as a compact and convenient supply of gas for carbonating drinks.

Because of the pressures that result when confined liquid carbon dioxide is gasified by a rise in temperature and because of the hazards due to possible rough treatment of CO₂ vessels at low temperatures (CO₂ snow forms at -109°F.), CO₂ containers should be built of special metals tested for impact strength and fabricated with a minimum number of openings. As these vessels, particularly in commercial use, are not apt to be large—less than a foot in diameter and only a few feet long—they are often of seamless construction, but welded vessels are also widely used. Such vessels must be safe for pressures of over 1000 lb per square inch and be suited to withstand impact stresses at sub-zero temperatures.

Because of the dangers involved, most manufacturers of dry ice, as well as most of those making vessels to contain it, realize the need for extreme care respecting container design and for directions for the use of the substance. However, there is a likelihood that unsuitable containers may be used and a word of warning may be worth while to emphasize the serious dangers of confining dry ice in a vessel not correctly made of material of the proper characteristics.

This warning is all the more important because dry ice containers are often installed beneath places frequented by the public, as in basements under stores and soda fountains. The failure of such a vessel in a crowded store could be disastrous.

To assist in the safe use of dry ice the A.S.M.E. recently added to its Unfired Pressure Vessel Code rules for containers for gases and liquids at temperatures from -10° to -150°F. Provision is made for both seamless and welded construction, and certain impact prop-

erties, tests, safety devices and identification are prescribed. Such vessels, subject to Interstate Commerce Commission regulations because of their transportation on common carriers, have for some time been required to conform to special I.C.C. specifications as to construction.

Properly under control, dry ice is a very useful substance, but its extreme cold and its potential expansion pressure between the liquid and the gaseous state, in the presence of heat, make it a substance not to be handled carelessly or entrusted to persons not instructed as to its use.

Thomas F. Rice Appointed Manager



THOMAS F. RICE

Mr. Thomas F. Rice was appointed manager of the Boston Department of the Company on March 22 to succeed the late A. Paul Graham, whose death was recorded in the April issue of THE LOCOMOTIVE.

His promotion to this position follows more than 31 years of active service with Hartford Steam Boiler, which he joined on February 20, 1906. After working in various clerical capacities at the Home Office in Hartford, he was transferred to Boston in 1919 as special agent, and in 1934 was appointed assistant manager.

In announcing the appointment President Wm. R. C. Corson said, "His competent handling of a wide variety of duties in the time he has been associated with us and his broad knowledge of our business well fits Mr. Rice for the added responsibilities he now assumes. I am confident that he will so administer our Boston Department as to merit a continuance of the friendly relations which our Company enjoys with those it serves there."

Golfer (far off in the rough): "Say, caddy, why do you keep looking at your watch?"

Caddy: "It isn't a watch, sir; it's a compass."

California Sawmill Illustrates Man's Ability to Make Much from a Little

By P. J. RAUCH, *Inspector.*

RECENTLY it was my pleasure to inspect the boiler of a California sawmill which employs 5 men and cuts between 15,000 and 19,500 feet of lumber in an 8-hour day, a record that many a larger and better equipped sawmill would be proud to have. The mill is particularly interesting because of its unusually ingenious arrangement of scrap parts.

The saw head rig engine consists of two single-cylinder threshing machine engines mounted on timber beds and connected to a common main shaft on which is the balance wheel. The cylinders are opposed and each has an individual belt-driven fly-ball governor. There is also an additional balance wheel mounted on a separate shaft driven from the main shaft to furnish additional momentum to the circular saws when a particularly thick or tough log is encountered. The windlass used to turn the logs on the saw carriage is also driven from the main shaft by means of a belt, the tension of which is controlled by means of a counter-balanced idler. When a log is to be turned, the sawyer pulls down on a lever connected to the idler, thereby increasing the tension on the belt and causing it to contact the windlass pulley and wind up the rope on the drum. The upper circular saw is kept in motion by a light tension of the belt controlled by another counter-balanced idler, which is operated by the saw tail-off man by means of a rope. When a thick log engages both saws, the tail-off man pulls down on the idler rope and increases the tension on the belt, causing the upper saw to maintain the same speed as the lower saw.

An edger saw, saw table and deep well pump are operated by a slide valve engine that might have been obtained from DeWitt Clinton's steamboat. The source of all power for the mill is a 72" by 18' horizontal tubular boiler with allowable working pressure of 150 lb. The boiler is suspended in the orthodox manner of outside suspension, particular care being observed to protect the supporting columns from the products of combustion. This care, I believe, has been carried to extremes, for the owner even omitted the ordinary boiler setting and installed a "dutch oven" at the rear of the boiler where the furnace rear access door should be. All products of combustion, as well as incomplete combustion make one pass through the boiler by means of the tubes and are drawn off through the stack at the rear (which should be the

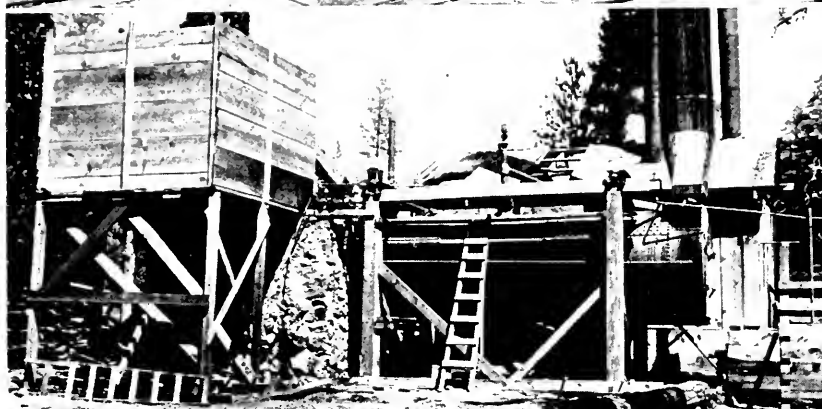
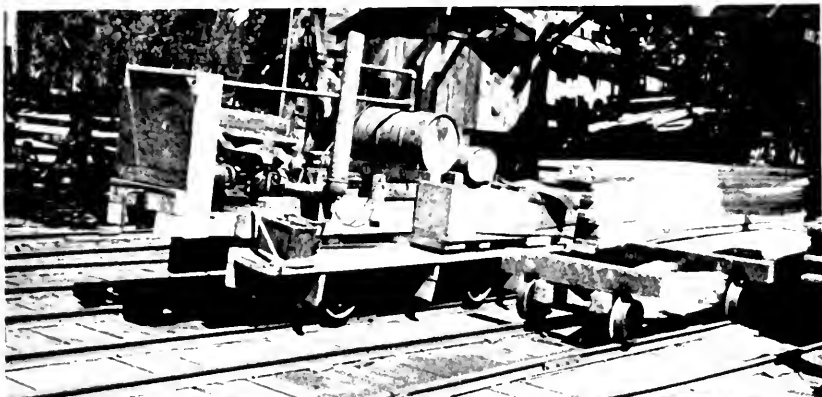

Top—The “crowning glory”—The sawmill locomotive made from parts of this and that. Center—Boiler with its open air setting and sawdust bin. Bottom—The saw carriage, showing the arrangement of two saws for extra large logs.

front). Fuel consists of wet sawdust fed to the "dutch oven" by a chain conveyor.

The saw carriage is operated by a two-cylinder engine connected to a drum on which the wire cables pulling the carriage are wound and unwound. It is controlled by means of a floating valve arrangement operated by the sawyer. The carriage, when on the return trip, gains a very considerable speed and comes to a rather abrupt stop. If the floating valve ever sticks in the open position when the carriage is on the return trip, the carriage man is apt to take sudden flight.

The track locomotive is the crowning glory of the entire mill and was assembled from parts of hand cars, railroad speeders and old automobiles. It consists of four wheels and a wooden plank chassis loaded down with scrap iron, and is used to pull the loaded lumber cars to the drying yard. The details of operation are intricate and require considerable team work on the part of the lumber grader. The track at the mill has an uphill grade and the locomotive is too light to furnish sufficient traction for starting the loaded car. The engineer, after coupling fast to the car, signals the lumber grader who then steers one of the boards coming from the edger saw under its own power to the end of the car which is thus given a push to start it on its way. The locomotive is then able to proceed to its destination.

Paragraphs of Progress

"SUPERTOPS"

Higher speeds, pressures and temperatures are subjects that are repeated frequently in the news about turbines. Non-condensing units of approximately 60,000 kw to operate at 3600 rpm are being built, and a wide variety of "standard" designs permit greater capacities and better efficiencies in both 3600 rpm and 1800 rpm machines of all sizes. Such progress is possible because of more suitable alloys, aluminum windings, better understanding of vibration problems, hydrogen cooling—to list a few of the many influencing factors. Temperatures to 950° F. and pressures of 1250 lb without reheating are beyond the experimental stage. The topping or superposed unit has come into its own. Meanwhile, boiler manufacturers are reported working on 2,400

lb units. Evidently "supertops" for the "tops" are a possibility one of these days when metallurgical and other problems have been solved.

HYDROGEN

Hydrogen cooling of rotating electrical machines is being more and more widely used, and 1937 will see a number of generators and other machines installed with this aid to efficiency. Also, air cooled generators have been successfully remodeled for hydrogen cooling, thereby raising their rated capacities approximately 17 per cent.

1,040,000 LB PER HOUR

In the January, 1937, LOCOMOTIVE were listed several boilers capable of producing 1,000,000 lb of steam, or more, per hour. To this list now must

be added the Ford Motor Company high pressure boiler which, in a recent test run, supplied 1,040,000 lb of steam per hour at 1215 lb, 900°F—a record at this pressure and temperature. The boiler has a guaranteed rating of 900,000 lb of steam per hour. During the test, the 110,000 kw vertical compound turbo-generator carried a peak of 116,225 kw. Mr. Ford approved the test, and ordered another similar high pressure boiler and turbine, which will make three such units at the River Rouge plants.

ASPHALT SNUFFER

Storage of coal by the Milwaukee Electric Railway and Light Company at Port Washington, Wisconsin, proved troublesome because of spontaneous heating. Since there was no room for cooling by rehandling and as the coal was not to be immediately used, asphalt-ing was decided upon to shut out the air. First the top was covered, but the temperature continued to rise until it reached 800°F., when it was decided to asphalt the sides. This was done—on 35 degree slopes of a 50' high pile in sub-zero temperatures—thus snuffing out the tendency to ignite. The achievement, as described inscribed in *Combustion*, protected 120,000 tons of coal.

PULP BY-PRODUCT

Paper pulp making involves the separation of wood fibres by chemically removing the resinous material which cements them together. This resinous material, which has a high heat value, is "recoverable" in pulverized form by means of a newly developed process. *Power Plant Engineering*, in commenting on this process, points out that the method permits a fuel output in excess of mill heat requirements.

OUT-RUBBERING RUBBER

Neoprene is the name that has been given to a synthetic rubber produced by du Pont. Coal and limestone are heated in an electric furnace, producing calcium carbide, from which, with the addition of water, acetylene gas is made. This acetylene gas is then treated with a catalyst, and a previously unknown chemical substance, monovinyl-acetylene, is formed. In another catalyzing chamber this substance is caused to combine with hydrogen-chloride gas, producing a liquid called chloroprene.

By means of a polymerization process this liquid is converted into a tough, rubber-like solid known as neoprene. It looks like crude rubber, and, according to the manufacturers, has the same properties and may be processed in the same way as rubber. Apparently the chemical product goes the natural one "one better," for it is said to resist the action of oil, gasolines and solvents which affect rubber, and is less subject to heat and direct sunlight. Its principal uses today are for the handling of gasolines, oils, chemicals, and for belt coverings and tank linings. A simpler method of manufacture is now being sought.

WELDED STACKS

Welding has been found to be usable in the erection of stacks, three such projects being reported by *The Welding Engineer* as under way. The largest stack described is 8' in diameter and 165' high.

ALARM PAINT

To the alarms such as bells, buzzers and red lights, has been added another alarm, in the form of a paint which changes color when exposed to heat, according to *Diesel Power and Transportation*. A series of seven retroactive color paints has been worked out to change color at various temperatures from 104° to 464°F. These paints are said to change color from 25 to 50 times, before renewing is necessary. Another line of paint changes color when it is heated beyond a certain temperature, but repainting is necessary in order to restore the original color.

SENTENCES OF PROGRESS

Tachometers are available for speeds up to 30,000 rpm.

A new centrifugal pump for handling abrasive and acid slurries protects the gland by maintaining a vacuum on it under all possible conditions of operation.

An English process removes the salt from sea water by taking out caustic soda in one filter and hydrochloric acid in another.

Sulphur mining has as one of its problems the treating and heating of several million gallons of water daily to melt the sulphur in the wells so that it can be pumped to the surface.

Taps From the Old Chief's Hammer

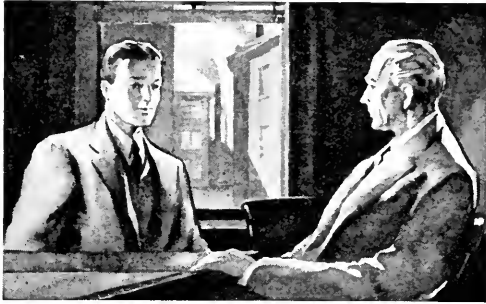

THE Old Chief and his assistant, Tom Preble, were traveling early in the morning to avoid the heat. From the roadsides came the sound of birds; the early sunlight sparkled the dew; mists clung to the creek valleys. It was a pleasant morning, but it would be a hot day,

and it would be still hotter on the turbine floor of the Standard Utility plant where the two men were going.

A particularly saucy wren reminded Tom of a birdhouse his son had built. "Chief," he said, "they do interesting things at school these days. Tommy met me the other night with a wren house he'd made—in 'shop,' he said. It was a medium sized inverted flower-pot, was roofed with tin and had a wooden floor fastened to the pot by right angled screw hooks. The base, flower-pot and top were held together by a long eyebolt. Tommy said the hard part was to put the entrance hole in the flower-pot and not break the clay.

"Do you think the wrens will make a nest in the house," he asked me, and I said, 'Certainly,' although I must admit that with my limited knowledge of bird-lore my answer was purely a guess. We hung the house in an apple tree, and a family of wrens really did approve of it, so I guess somebody knew a lot more about wrens and their habits than I."

"Good for Tommy," was the older man's comment.

"Say, Tom," he continued, "did Bill Delton ever tell you about his experience with the birds up at Wincklerville?"

"I don't believe so, Chief," replied Tom.

"Then I'll tell you about it," chuckled the older man.

"Bill had gone to the mill to inspect two boilers for the first time—one an internal inspection and the other an external, as one of the boilers was operating. After he had completed the internal, the engineer came up and Bill told him about a thing or two that needed attention.

"When Bill started looking at the second boiler, the engineer asked

a lot of questions about the reasons for inspecting the various boiler parts.

"Bill is very methodical and follows the same routine on each boiler; he says it saves him time and does a better job, and I think he's right. Anyway, in due time, he asked the engineer to have the fireman test the safety valve.

"'Oh, that will be all right,' the engineer said, 'the men have been told to test the safety valves every day.'

"'Fine,' said Bill, 'but I'm fussy about those valves and so is the Home Office.' So the engineer sent the fireman up on top of the boiler to test the valve."

Preble knew what was coming. It was an old story among the inspectors, and he had heard it before, but it would bear repeating, so he said, "I suppose the valve wouldn't work at all."

"It worked all right," said the Chief. "The exhaust blew out into the yard at a point where Bill could see it through an open door. However, with the first discharge of steam, he noticed something shoot across the yard."

"Curious, he walked over to see what had blown out of the relief pipe. To his amazement, he found that the object was a bird's nest . . .

"You know, Tom, there is apt to be quite a gap between the giving of instructions and carrying them out. I suspect some of the trouble at the big plant we're heading for might be traced to good advice not taken."

Doesn't the Bible give some advice about "first take the mote out of thine own eye"? Here is a very good example of the workings of an average busybody.

Stranger: How many cigars do you smoke a day?

Native: About ten.

Stranger: What do they cost you?

Native: Twenty cents apiece.

Stranger: My, that's two dollars a day. How long have you been smoking?

Native: Thirty years.

Stranger: Two dollars a day for thirty years is a lot of money.

Native: Yes it is.

Stranger: Do you see that office building on the corner?

Native: Yes.

Stranger: If you had never smoked in your life you might own that fine building.

Native (looking at the building as he smokes): Do you smoke?

Stranger: No, never did.

Native: Do you own that building?

Stranger: No.

Native: Well, I do.—*Enka Voice.*

We can't understand how the ant acquired such a reputation for being so industrious. Nearly all we ever saw were on a picnic.—*Kreolite News.*

The Hartford Steam Boiler Inspection and Insurance Company

OF HARTFORD, CONN.

December 31, 1936

Capital Stock, \$3,000,000.00

ASSETS

Cash on hand and in banks	\$904,668.68
Premiums in course of collection (since October 1, 1936)	1,000,760.69
Interest accrued on mortgage loans	4,169.65
Interest accrued on bonds	88,854.77
Loaned on mortgages	290,275.00
Home Office real estate and Philadelphia branch office	642,331.05
Other real estate	332,274.83
Bonds on an amortized basis	\$8,970,348.42
Stocks at market value	7,154,705.00
	<hr/>
	16,125,053.42
Other admitted assets	6,903.34
	<hr/>
<i>Total</i>	\$19,395,291.43

LIABILITIES

Premium reserve	\$6,765,042.57
Losses in process of adjustment	463,395.19
Commissions and brokerage	200,152.14
Difference between market and book values of stock	507,096.59
Other liabilities (taxes incurred, etc.)	504,352.01
	<hr/>
<i>Liabilities other than capital and surplus</i>	\$8,440,038.50
Capital stock	\$3,000,000.00
Surplus over all liabilities	7,955,252.93
	<hr/>
Surplus to Policyholders	10,955,252.93
	<hr/>
<i>Total</i>	\$19,395,291.43

WILLIAM R. C. CORSON, President and Treasurer

BOARD OF DIRECTORS

LUCIUS F. ROBINSON, Attorney, Hartford, Conn.	HON. JOHN H. TRUMBULL, President The Trumbull Electric Mfg. Co., Plainville, Conn.
JOHN O. ENDERS, Chairman Executive Committee Hartford National Bank & Trust Co., Hartford, Conn.	CURTISS C. GARDINER, Vice President The Hartford Steam Boiler Inspection and Insurance Company, 90 John Street, New York.
MORGAN B. BRAINARD, President Aetna Life Insurance Company, Hartford, Conn.	JAMES L. THOMSON, Chairman Finance Committee Hartford Fire Insurance Company, Hartford, Conn.
CHARLES P. COOLEY, Chairman Board of Trustees Society for Savings, Hartford, Conn.	PHILIP B. GALE, Chairman Board of Directors Standard Screw Co., Hartford, Conn.
JOSEPH R. ENSIGN, President The Ensign-Bickford Co., Simsbury, Conn.	JOHN J. GRAHAM, Vice President The Hartford Steam Boiler Inspection and Insurance Co., Hartford, Conn.
WM. R. C. CORSON, President The Hartford Steam Boiler Inspection and Insurance Co., Hartford, Conn.	AUSTIN DUNHAM BARNEY, Vice President The Hartford Electric Light Co., Hartford, Conn.
SAMUEL M. STONE, President Colt's Patent Fire Arms Mfg. Co., Hartford, Conn.	JOHN R. COOK, President Arrow-Hart & Hege-man Electric Co., Hartford, Conn.
SAMUEL FERGUSON, Chairman Board of Directors The Hartford Electric Light Co., Hartford, Conn.	

Incorporated 1866



Charter Perpetual

Department

Representatives

ATLANTA, Ga., Citizens & So. Nat. Bk. Bldg.	W. M. FRANCIS, Manager. C. R. SUMMERS, Chief Inspector.
BALTIMORE, Md., 704-9 Garrett Building	D. W. LITTLE, Manager. R. P. GUY, Chief Inspector.
BOSTON, Mass., 87 Kilby Street	THOMAS F. RICE, Manager. W. A. BAYLISS, Chief Inspector.
BRIDGEPORT, Conn., City Savings Bank Building	W. G. LINEBURGH & SON, General Agents. A. E. BONNET, Chief Inspector.
CHICAGO, Ill., 175 West Jackson Boulevard	P. M. MURRAY, Manager. C. W. ZIMMER, Chief Inspector.
CINCINNATI, Ohio, 1904-12 Carew Tower	JAMES P. KERRIGAN, Manager. W. E. GLENNON, Chief Inspector.
CLEVELAND, Ohio, 1040 Leader Building	ARTHUR F. GRAHAM, Manager. JOHN L. SCOTT, Chief Inspector.
DENVER, Colo., Gas & Electric Building	J. H. CHESNUTT, Manager. JESSE L. FRY, Chief Inspector.
DETROIT, Mich., National Bank Building	L. L. COATES, Manager. THOMAS P. HETU, Chief Inspector.
HARTFORD, Conn., 56 Prospect Street	F. H. KENYON, Manager. A. E. BONNET, Chief Inspector.
NEW ORLEANS, La., 333 St. Charles Street	R. T. BURWELL, Manager. P. E. TERROY, Chief Inspector.
NEW YORK, N. Y., 90 John Street	C. C. GARDINER, Vice President. J. F. HUNT, Chief Inspector.
PHILADELPHIA, Pa., 429 Walnut Street	A. S. WICKHAM, Manager. S. B. ADAMS, Chief Inspector.
PITTSBURGH, Pa., Arrott Building	WILLIAM P. WALLACE, Manager. J. A. SNYDER, Chief Inspector.
ST. LOUIS, MO., 319 North Fourth Street	CHAS. D. ASHCROFT, Manager. EUGENE WEBB, Chief Inspector.
SAN FRANCISCO, Cal., 114 Sansome Street	C. B. PADDOCK, Manager. L. E. GRUNDELL, Chief Inspector.
SEATTLE, Wash., Arctic Building	E. G. WATSON, Manager. WILLIAM J. SMITH, Chief Inspector.
TORONTO, Ont., Canada, Federal Building	H. N. ROBERTS, President The Boiler In- spection and Insurance Company of Canada.

JUL 16 1900
OF PITTSBURGH

18,000,000 *Inspections*

In its three generations of service to American power plants, The Hartford Steam Boiler Inspection and Insurance Company has made more than 18,000,000 inspections, thereby accumulating a fund of knowledge about power plant operation and the prevention of accidents, which is of inestimable value to every policyholder - - - - -

The Locomotive

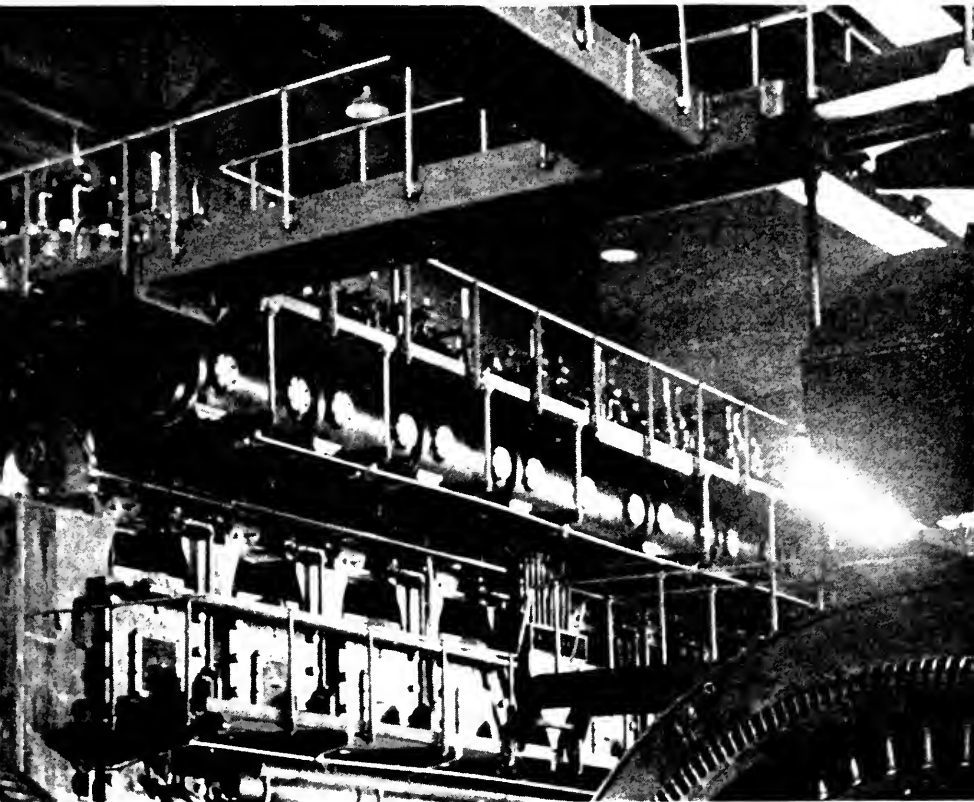
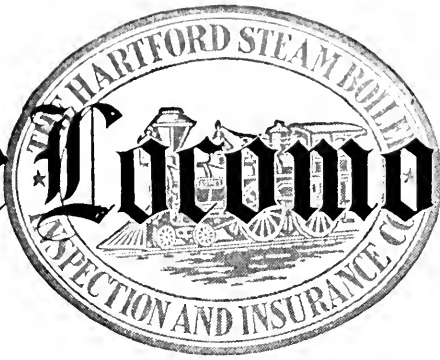

Quarterly Magazine Devoted to Power Plant Protection
Please Show to Your Engineer



Corrosion of Lead Covered Cables

By J. B. SWERING, *Chief Engineer, Electrical Division*

UNTIL recent years it was generally believed that lead sheaths on wires and cables afforded the maximum protection against moisture under all conditions and thus insured safe operation of such types of cables. However, of late, considerable study has been given to the subject of corrosion of the lead sheath due to the presence of either acids or alkalis—an entirely different action from electrolysis, and one not having any relationship to the cable troubles directly resulting from corona effect.

During the past year corrosion has resulted in failures of lead covered cables, the replacement of which usually involved an expensive repair. The nature of these failures is illustrated by the cases described below.

When a hydro-electric plant was built, no expense was spared to provide the best types of equipment to keep down operating failures. The design engineers found it was necessary to run two sets of cable ducts upward from the 7500 v bus structure to the transformer vaults. These fibre ducts were each 5" in diameter and 45' long, about half of which length was located in the main concrete fill of the dam. There were three separate ducts per phase spaced about 18 inches apart. The original specification called for 1½ million circular mil cable with 1" hemp core, approximately ½" cambric insulation and the whole covered with a double layer of weatherproof braid. However, before this cable was installed the engineers realized that in time there would probably be some seepage into the ducts in spite of all the precautions taken to make them waterproof. Therefore, the cables were returned to the manufacturer's plant where they were covered with a lead sheath. The finished cable was about 3" in diameter, but as there were no sharp bends in the duct run, these cables were easily pulled in from the top of the ducts. The duct drainage was good.

After a few months of service a small seepage was noted from nearly all of the ducts, but during six years the amount was very small and usually dried up on coming in contact with the air at the duct ends. A lime deposit gave evidence of seepage both inside and outside the ducts. However, it was thought that the damp condition was well guarded against through the lead covering on the cables. During a night shift in July, 1936, the operator noted an unusual odor and quickly located its source at the lower end of one cable. The portion of the lead sheath protruding about one foot beyond the end of the duct was

extremely hot. After the cable was de-energized, it was noted that the lead sheath was corroded on the underside, back into the duct.

When the defective cable had been pulled and laid out on the floor, it was found that the lead was corroded through for about two-thirds of the length of the cable and could be stripped off without cutting. This condition is shown in Figure 1. There was no point on the cable



Figure 1—Cable attacked by corrosive caustics in seepage water.

indicating that injury had taken place during installation or afterward, except possibly at the lower end, which had rested on the edge of the duct. Apparently that was the point where current leakage had taken place and resulted in local heating.

Chemical analysis of the seepage water showed total alkalinity of 1264 parts per million consisting mainly of sodium hydroxide and some calcium hydroxide, both of which are active in corroding lead.

The chemist's report covering the test of the material found on the lead sheath and the seepage water analysis follows:

"The three samples submitted to us have been examined and analyzed. They consist of a piece of lead badly corroded and partly covered with products of corrosion, a sample of white residue, and a bottle of liquid.

"The composition of the material on the lead pipe is practically the same as the white residue below except that it contains a small amount of red lead oxide next to the metallic lead.

"The composition of the white residue is as follows:

Calcium carbonate (CaCO_3)	88.80%
Basic lead carbonate $2\text{PbCO}_3 \cdot \text{Pb}(\text{OH})_2$	8.40%
Magnesium carbonate (MgCO_3)60%
Undetermined	2.20%

"The composition of the solution in the bottle is as follows:

Sodium hydroxide (NaOH)914 gms. per liter
Sodium plumbite (Na_2PbO_2)621 gms. per liter
Calcium hydroxide $\text{Ca}(\text{OH})_2$716 gms. per liter
Magnesium hydroxide $\text{Mg}(\text{OH})_2$..	Trace

"It will be noted that the liquid sample is quite caustic, which accounts for its action on metallic lead."

After this investigation there arose the problem of supplying a suitable cable for the location, and all the data was given to several different cable manufacturers. Two of the manufacturers designed special cables with a rubber insulation and mechanical protection.

The cable which was selected to replace the damaged lead-covered cable was one with the copper strands properly tinned, these strands, of course, being spirally wound. Over the stranded copper was placed a 12/64" layer of rubber composition. This rubber composition was then wrapped with a layer of cambric tape over which was wound a copper shielding tape which could be grounded. A 7/64" outside jacket of 60 per cent tellurium non-hygroscopic compounded rubber furnished protection against moisture, mechanical injury and practically all chemicals.

It has been known for a considerable time that if lead covered cables are installed in concrete-embedded ducts, lead corrosion takes place, providing the concrete has not been given a sufficient length of time to cure properly. After the concrete has been cured thoroughly and if no moisture is allowed to enter the ducts, satisfactory operation of the cable is usually obtained.

A somewhat different source of corrosion in the vicinity of the above plant was experienced by the power and telephone companies which found it necessary to remove many lead covered cables which were buried in the earth. Some of these were placed above ground to get away from the corrosive effect prevalent in the soil in this area.

The telephone company also had trouble where the cables were installed in creosoted redwood ducts. It seems that the creosote gradually worked out of the wood, and weak wood acids then attacked the lead. The condition was apparently overcome by pumping oil into the ducts, which forced out the water and sealed the acids in the wood.

In another part of the country, in a manufacturing plant, two lead sheath cables are installed between the power company's distribution circuit and the plant's bank of transformers, which is located indoors. The two cables at this location, one ordinarily a "spare," are 3-conductor, 13,200 v, insulated with oil impregnated paper, lead covered, and each is about 100 ft long. The power company's distribution system is

operated without a ground connection, and the first intimation of trouble with these cables came when the power company advised the manufacturer that the telephone company had reported line interference, caused by a ground on the power system which had been traced to one of the manufacturer's service cables. The first cable under suspicion was discontinued from service, and the potheads were removed from both ends. Insulation resistance values indicated that two phases of this three-phase cable were in satisfactory condition with respect to insulation resistance, while the third was grounded.

In installing these cables, the lead sheath had been belled out and properly secured to the clamping ring on the potheads at each end. When the cables were pulled through the conduits, the potheads were secured to the ends of the iron conduits so that the cable sheaths were grounded at both ends. The potheads at the outdoor end are located 17 feet above the ground on a wooden pole. The cables pass down through the conduits and underground at a depth of about 5 feet and then turn vertically to the room in which the transformer bank is located.

When the grounded cable was pulled from the conduit, two defective spots were noted on the lead sheath. At one of these spots the insulation was completely burned through and the copper conductor was slightly burned, showing that arcing had taken place, although an actual power failure had not occurred. However, the area around the hole, instead of being rounded and melted, as would be the case if only arcing had taken place, was found to be pitted. The other affected spot on the lead sheath was also pitted and it was at first thought that a complete insulation failure to ground had occurred due to lightning and that, subsequently, electrolysis or corrosion had caused the pitting around the hole.

There was also the possibility that an acid condition of the soil had attacked and damaged the iron conduit and permitted the lead sheath to be attacked, but both conduits were examined over their entire lengths and no defects were noted. At the time the conduits were exposed, both were thoroughly cleaned and painted and the damaged cable was replaced by new.

On an inspection of the "spare" cable an insulation resistance of only 700,000 ohms to ground was obtained on one of the conductors. Tests were then made at short intervals for the following two months and the insulation resistance subsequently dropped to a value of 40,000 ohms. The owner then removed the pothead from each end of this cable in order to determine definitely whether the cable itself was at fault. This was found to be the case and the cable was pulled from the conduit.

Three affected areas were located on the lead sheath. These were similar in character to the two spots described in connection with the

other cable that failed. This second cable was then cut into several lengths and insulation resistance tests made of the several sections, values of 100 megohms being obtained on all sections except one, which indicated 40,000 ohms to ground with respect to one conductor.

The point of low insulation resistance was located approximately 4 feet from the base of the pole and beyond the point where the conduit turned in the direction of the transformer room. The other two defective areas on the sheath were further along toward the transformer room, being 10 feet and 12 feet respectively, from the base of the pole. It was quite apparent that no serious arcing had taken place and from this it was concluded that the lead sheath had deteriorated from some external cause over the six-year period that it had been installed, and that the failure of the sheath permitted moisture to enter the insulation, resulting in the low insulation resistance value that led to the investigation.

Following a study of the problem by all concerned and an examination of the affected cable by the manufacturer, the following facts were determined.

1. The cable failed due to moisture entering the insulation through a hole in the lead sheath.
2. The cable itself was normal, showed good impregnation and no signs of poor material, poor workmanship, or over-loading.
3. There appeared to be two possible causes for the hole in the sheath, (1) corrosion and (2) mechanical damage during installation. It is almost certain that both conditions were contributory.

The sample containing the failure appeared to have been badly kinked during installation. This seems evident since the corrosion was present even at the bottom of the lead wrinkle, an indication that it had been there for some time. The sample containing the hole in the lead also showed signs of heavy corrosion, which smoothed out the wrinkle formed when the cable was installed. Samples of the impregnated paper tape, taken immediately under the hole in the sheath, showed high moisture content which decreased rapidly on tapes further into the belt insulation. Apparently, moisture was slowly working into the cable and an actual power failure would have resulted soon. The products of corrosion were analyzed and found to consist mostly of lead oxides, both the yellow and red being present.

Perhaps many have been inclined to believe that properly installed lead covered cables, except for the possibility of electrical breakdown of insulation between phases or to ground, are a "lifetime" installation requiring very little care or inspection. However, the failures illustrated

in connection with these two dissimilar applications, in widely separated sections of the country and under totally different conditions, will serve as a warning that such is not the case and indicate that accident prevention work may be done by as complete visual inspection as circumstances permit, together with due consideration of the application itself, followed by periodic insulation resistance tests.

A continued decrease in the insulation resistance values is a warning that failure may be expected, either because of deterioration of the insulation itself or because of some condition of the lead sheath brought about by causes of the kind described. Hence, it must be realized that regular and thorough inspections of cable runs, both in service and out of service, constitute good accident prevention practice and will, in many instances, indicate the danger of impending failure and afford the opportunity of making corrections before an actual breakdown results.

50 Accidents per Day; \$4,000,000 Loss per Year

WITH the 1937-1938 heating boiler season in full swing, there is asked the perennial question on the part of many owners of heating boilers and hot water supply boilers: "Is such equipment subject to accidents?"

The answer to the question is merely the furnishing of proof in a multitude of forms. The newspapers carry articles periodically dealing with such accidents when lives are lost, persons are injured or property damage is spectacular. What the newspapers do not record are the thousands of accidents which keep steam fitters and plumbers busy in the heating boiler season, but which are not considered important enough to grace the news columns.

Exactly how many accidents of this sort are there? How many explosions caused by the pressure of steam or water? How many cracking accidents? How many fuel explosions? There are no comprehensive statistics on this subject, but there are facts compiled by insurance companies from which an estimate can be made. In 1936 insurance companies paid several hundred thousand dollars for approximately 1800 accidents to insured heating and hot water supply boilers. These accidents were to equipment safeguarded by pressure relief valves and various automatic safety devices. Furthermore, the equipment involved in these accidents was inspected. Had it not been for these precautions the accidents would have been more severe and more frequent. Those familiar with the subject are agreed that for the country as a whole the total of accidents reached an estimated minimum of 18,000 for 1936, or

approximately 50 accidents a day. Using the insurance company average loss per heating boiler accident as a guide, these 18,000 failures cost more than \$4,000,000.

Easily predominant among heating boiler accidents are the non-spectacular failures involving the cracking of cast iron sections. Accidents of this type often come from over-heating because of low water, and the prevention of such accidents is primarily the safeguarding of the water supply.

The causes of low water are legion. A few accidents from last season's grist will serve to illustrate their variety. At a lodge home the

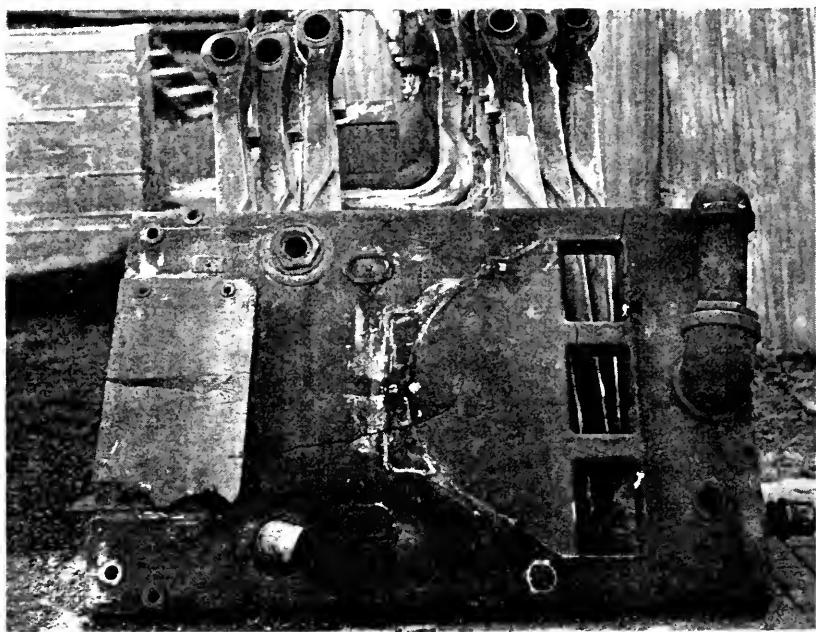

Figure 1. Cracks in a cast iron section—never a spectacular accident but the most frequent of all failures of heating boilers.

improper manipulation of valves brought about low water and the cracking of nine sections. To have such an accident occur in severe weather, as was the case, must have brought a considerable hardship to the elderly people who resided in the institution. . . . In a municipal building a stopped-up gauge glass misled the operator and a \$570 loss resulted. . . . Obstruction of return lines figured in several accidents as did the failure of return pumps. In one case leakage from the roof caused a short circuit in the pump motor, the accident illustrating how

remote from the heating system itself the cause of the accidents may be. . . . Low water fuel cut-offs have failed with costly results.

Explosions of cast iron steam heating boilers occurred principally in uninsured installations. A typical case is illustrated in Figure. 2. The residence, in which this boiler was located, suffered extensive damage and a woman occupant narrowly escaped injury. . . . In a church in a Mid-West town such an explosion severely injured the custodian and caused damage estimated at \$8,000 to the edifice, stained glass windows, organ and furnishings.

Steel boilers also sustained accidents. The rear of a Western store and apartment building was blown out when a small steel heating boiler exploded because of over-pressure. While the debris did not permit an accurate determination of the cause, the accident was obviously the result of an inoperative safety valve, coupled with a burner which did not shut off as it should as the temperature and pressure increased. . . . Several failures of small welded boilers occurred when minor welded parts opened up to permit loss of water and subsequent over-heating. Obviously, even such welding failures as the pulling out of a stay or the loosening of a header may bring about more serious failure. . . . In one case over-heating of a welded single-flue boiler caused the collapse of the furnace, this accident being the result of deposits within the boiler.



Figure 2. Partial damage following a cast iron boiler explosion.

Hot water heating boiler explosions, of which there were several, occurred when over-pressure developed without proper relief. In any closed heater, whether containing water for heating or for domestic supply, the application of heat will raise both temperature and pressure and a serious explosion can occur if safety or regulating devices do not function and the vessel fails. The amount of energy released is illustrated by an accident in South Carolina in which a 40 lb piece of metal from an exploding boiler went upward, cleared immediately adjacent

buildings and crashed through the marquee of a store 150 feet distant. (See Figure 3). The accident occurred during the Christmas season and a Salvation Army worker at her kettle sustained injuries when the chunk of iron pierced the heavy canopy over the store entrance.

Among the violent accidents to uninsured equipment the most frequent are to hot water supply boilers which have, in addition to the hazards of steam and hot water heating boilers, the additional hazard brought about by deposits of scale and sediment from the raw water which is circulated through them. Fresh cold water, when it is heated,

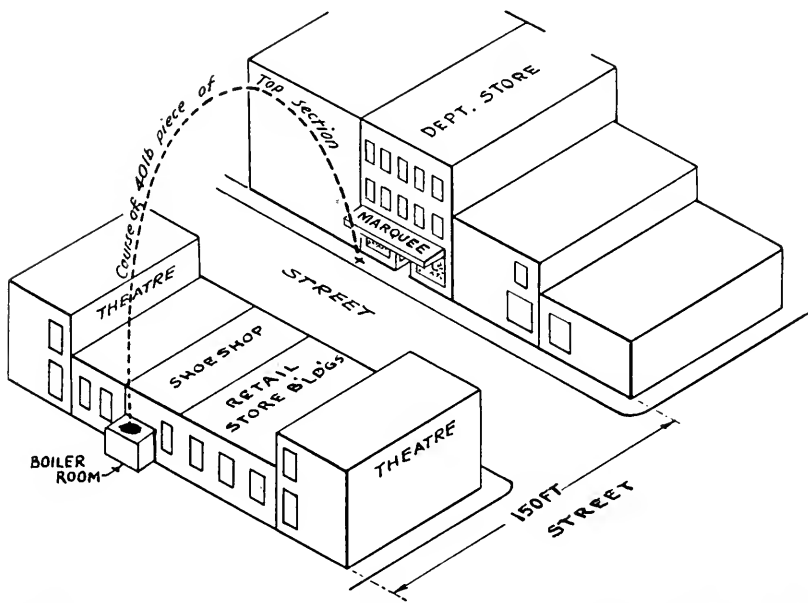

Figure 3. Course of travel of the top of a hot water heating boiler that exploded because of over-pressure.

gives up deposits, and unless these are removed periodically, over-heating may result, or they may cause corrosion at places where the circulation in the boiler is retarded for any reason. However, even without sediment, such boilers cannot withstand the terrific pressures generated if the system becomes closed, either because of the blocking of outlets or the faulty handling of valves. In New Jersey a mother and her 7-year-old boy were killed when it was attempted to start a pot stove with all valves closed. . . . A similar accident in Cleveland wrecked a barber shop. . . . At a New England parochial school the sisters escaped the consequences of an explosion in their living quarters only because

they were at lunch in another building. The explosion damaged rooms on three floors. In this case a non-operative relief valve and a firing up of the boiler at a time when no water was being drawn were blamed for the accident. . . . In another explosion, in a Maryland inn, patrons were knocked from their seats while they were at lunch, and two women were reported by newspapers to have suffered minor injuries. . . . In a New York City apartment a hot water supply boiler exploded so violently that efforts to ascertain the cause of the failure from evidence in the debris were unsuccessful. Lack of relief valves, stopped up pipes or several other conditions might have led to the over-pressure. Two men were injured and 40 families inconvenienced. . . . Another New York city explosion of a hot water heater in a hotel demolished the vessel, and a piece of flying debris struck a nearby cast iron heating boiler, cracking a section. By promptly pulling the fire the rest of the boiler was saved from over-heating. A hot water tank, however, was damaged beyond further use. Following his investigation, an inspector reported that the 3-months-old hot water supply boiler had exploded because it had no relief valve.

On reviewing this account of heating and hot water supply boiler losses in the United States, a few precautions appear in order. Most of the accidents to such equipment could have been prevented by the following simple rules:

1. Keep the boiler room clean and well lighted.
2. Install proper relief and control devices.
3. Understand the operation of heating and hot water supply units.
4. Use ordinary care in checking up on the operation of the boiler.
5. Do not entrust the servicing of the boiler to incompetent persons.
6. Secure periodic inspections by experts. If the boiler is insured, it is the practice of the insurance company to make such periodic inspections.

Riveted Patches

In THE LOCOMOTIVE for July, 1937, Page 202, is a table of riveted patch seam efficiencies for single-riveted seams. In this table the efficiency for a plate thickness of $\frac{1}{2}$ " should have read 55.5 instead of 52.5, for $2\frac{1}{32}$ " 46.7 instead of 51.4, and for $1\frac{1}{16}$ " 50 instead of 51.4.

Modern civilization in America rests upon a base of steel, in the form of countless articles in every day use, estimated at 954,000,000 tons, or nearly 17,000 lbs. for every man, woman and child in the country. This estimate is based on calculations of steel consumption and production from 1865 through 1935.

American Timely Topics.

Turbo-Generator Rotor Breaks in Half

THE breaking in half of the rotor of a 3600 rpm, 1500 kva generator driven by a reaction type turbine at a Southern plant gives evidence that the generator end of turbines is not exempt from "explosions." When this accident occurred, one man, in attempting to

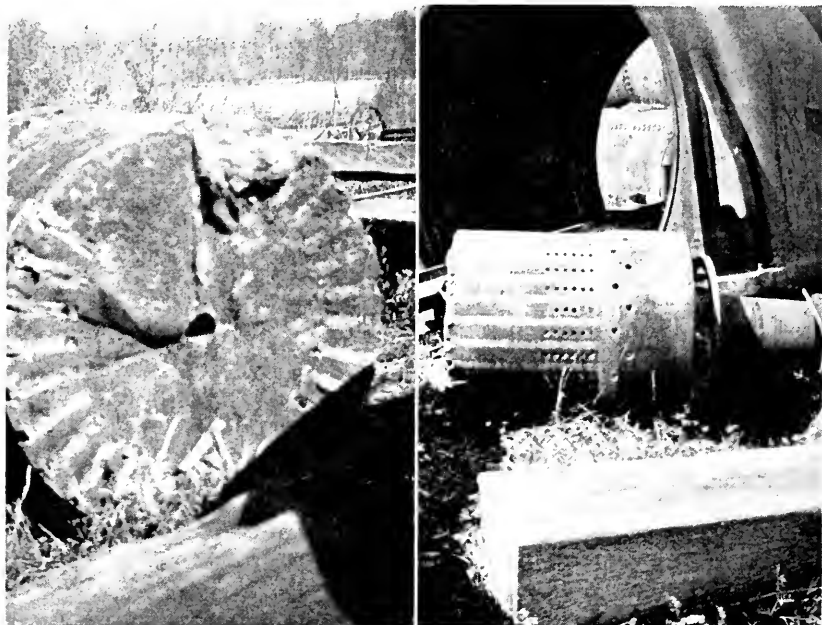

Generator rotor which exploded.

avoid injury, jumped from a window and broke his ankle, and another received minor injuries because of flying metal. A turbine erector, who tried to knock out the emergency trip by hand, reported that he found it was already out. Damage was estimated at \$20,000.

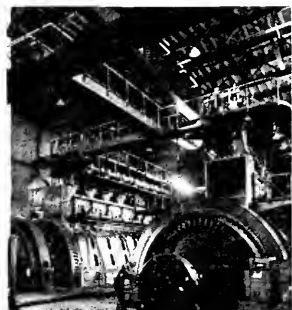

THE COVER

An inspector checking the exciter for a large Diesel-driven generator. As the photograph indicates, a large Diesel engine is an imposing piece of machinery which represents a large investment. Thorough inspections of both the engine and driven machine or machines help to prevent accidents to the equipment and prolong its useful life.

HARTFORD STEAM BOILER IN THE DESERT

Two Diesel Engines Break Down at Remote Mine in Nevada; Repairs Involve Unusual Difficulties.

H. S. B. File E-74-- contains approximately 25 typewritten pages which outline in business-like fashion the details with respect to the breakdown of two Diesel engines.

This file, as in scores of similar accident cases, tells the pertinent facts—that there was an accident, that repairs were made, and that the engine is running satisfactorily again. The engineers involved handled



The Nevada desert near the mine.

the case as a matter of routine, but it is a good example of coordination in the completion of a prompt repair in spite of obstacles.

In the desert in southwestern Nevada, about the halfway mark of the long diagonal that is the state's southern boundary, is a shaft mine located perhaps a mile above sea level. Its output is gold ore from which a concentrate is made. Temperatures at the mine exceed 100°F. in summer and in winter touch 15° below zero. The nearest telephone is 30 miles away. Water must be pumped 10 miles. A desert road bridges the 14 miles from the last graveled highway.

For 16 hours a day, and in peak periods continuously, the sound of Diesel engine exhaust is heard across the desert, two 200 hp engines being used alternately for a week each to drive generators.

Early in August of last year the oil in the No. 1 engine began sludging so seriously that the machine was shut down, and mine operations were continued using power from the second engine. Two cylinder heads were found cracked, the cracks extending from the fuel valve opening across the inlet and exhaust valve seats.

Late in August oil sludging was noticed in the No. 2 engine and on September 1 this condition became so bad that the engine would not carry its load. On examination this engine was found to have four cylinder heads cracked in much the same way as those on the No. 1 engine.

The mine's engine room crew then spent some 36 hours in removing the two remaining sound heads from Engine No. 2, installed them in Engine No. 1, and the mine resumed its operations.

At 3 P. M., September 4, Hartford Steam Boiler received word of the breakdown of the two engines, and as there was Use and Occupancy insurance effective eighth midnight (liability begins the eighth midnight after the notice of accident is received), the quickest possible repair was desired.

The inspection department responsible for these engines and for expediting the repair is directed from San Francisco. All that was known at this office on the afternoon of Friday, September 4, was that there had been accidents to the two Diesel engines, but the exact nature and extent of the damage was to be learned only at the mine some 550 miles (highway mileage) distant.

The field inspector nearest to the mine, was at Hanford, King's County, California, about 150 miles by "bee-line" across Death Valley and several ranges of mountains. By automobile it was more than three times as far, some of the way over desert and mountain trails (See the accompanying relief map). The inspector completed several important calls, leaving Hanford Sunday, September 6. He reached the mine at 11 A. M. Labor Day. Ascertaining the nature and extent of the difficulty and with a carefully checked list of needed parts, he drove back 30 miles to a telephone, called his chief and returned to the mine.

Meanwhile the Chief Inspector at San Francisco had been in touch with the Diesel manufacturer and was advised that a machinists' strike was in progress and the plant closed. Two cylinder heads of the proper size and type were in stock, and the manufacturer was asked to hold them. When the field inspector was heard from, however, he did not



Hartford Steam Boiler in the far west sometimes finds the longest way around is the shortest way to its destination. To avoid climbing as much as possible with the heavy cylinder heads, the longer route by way of Reno was taken from San Francisco. The inspector from Hanford drove 528 miles to get around the Sierra Nevada Range.

request two heads, but six, together with complete sets of piston rings for both engines, necessary gaskets, etc.—and a manufacturer's erector.

Tuesday morning, September 8, the engine manufacturer's plant was visited. There the news was brighter, for the plant had a stock engine of the same size that could be "robbed" of the needed parts. Disassembling took until 4 P. M.

It was first planned to transport the parts by truck, but it was decided, in view of the distance, bad roads part of the way and the need for speed, that two lighter and faster passenger cars would be better. By 5 P. M. three cylinder heads were loaded into a coupe, and three more with other parts into a large sedan. The cars were in charge of two members of the San Francisco office inspection department staff, who were accompanied by an engine erector.

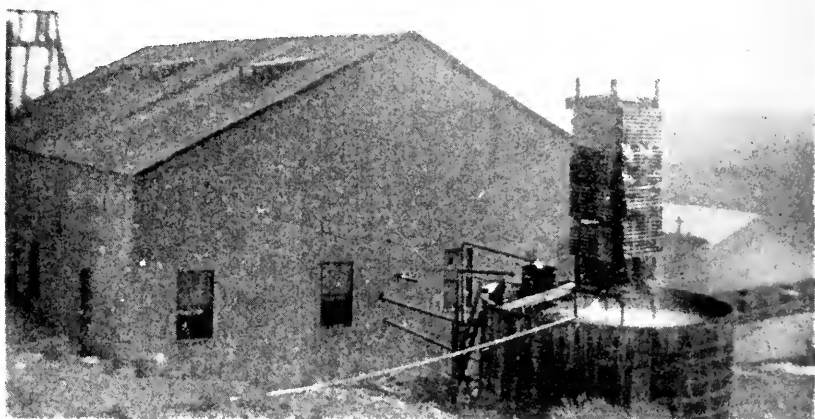

One of the mine buildings and the circulating water cooling tower. Water is carefully conserved. Even water for shower baths is saved and used in process work.

They reached Reno, Nevada, at 2 A. M., September 9, and arrived at the plant at 11 A. M.—a total distance of 541 miles. The heads were unloaded and the three Company engineers and the erector, helped by the plant crew, immediately went to work on the idle engine.

Reassembly was completed at 10:30 P. M., September 12, the No. 2 engine taking over the regular load the next morning. The Assured's operators were left to dismantle and completely overhaul the No. 1 engine.

Several factors contributed to the breakdowns. Chief among them was the fact that the engines were not adequately after-cooled following each shutdown. The installation of a gasoline engine and a circulating pump, previously recommended but not installed before the accident, proved a successful remedy.

They were trying an Irishman, charged with a petty offense in an Oklahoma town, when the judge asked: "Have you anyone in court who will vouch for your good character?"

"Yis, your honor," quickly responded the Celt, "there's the sheriff there."

Whereupon the sheriff evinced signs of great amazement.

"Why, your honor," declared he, "I don't even know the man."

"Observe that I've lived in the county for over twelve years an' the sheriff doesn't even know me yit! Ain't that character fer ye?"—*Kreolite News*.

34 Boiler and Pressure Vessel Accidents—34 Dead

BOILER and pressure vessel accidents in recent months have taken a disastrous toll of human life and have destroyed thousands of dollars worth of property, despite the constantly increasing insistence on safety measures by many individual operators, by the insurance companies, by state and municipal authorities and by the National Safety Council.

Since January there have come to the Company's attention 34 accidents in the United States involving loss of life or injury to persons.



Figure 1. Result of a lap seam failure early in June.

Almost all of these accidents were to uninsured boilers and pressure vessels. Many of the explosions might have been prevented by means of periodic inspections.

In the 34 cases there were 34 deaths and injury to 105 persons. Four other accidents in Mexico, China, Chile and Quebec accounted for 94 deaths and 30 injured, the worst cases being a steam launch explosion in Hongkong harbor that killed 70 and maimed 18, and an explosion at a Mexican hacienda which killed 18.

Accounts of these accidents rarely give the exact cause of the failure, but, whenever investigations have been made, the part that carelessness,

neglect and ignorance play is evident. It might be said that all pressure vessel accidents occur from an "excess" of pressure, because a pressure of even a few pounds is too high if the boiler plate is corroded to paper thinness or is cracked and without inherent strength.

An inspector discussing one of the accidents reported that a fire tube boiler had exploded and traveled 600 feet, the blast scattering tubes over



Figure 2. Aftermath of corrosion around the crown bolts of a locomotive type boiler.

40 acres. The cause he traced to an old lap seam crack. Two mills were destroyed either by the explosion itself or subsequent fire, and a town is likely to lose a leading industry as a result. The boiler was not insured.

In another case there was such grooving around the crown bolts in a locomotive type boiler that most of them had held by only two threads and some of them by only one.

In a third investigation it was found that the safety valve had not blown for three years on the boiler which failed and it was not known whether the pressure gage had ever been tested. . . . A poorly



Figure 3. Extreme corrosion of boiler plate, the cause of an explosion that badly wrecked a mill and damaged property of four other owners.

welded patch was blamed for another accident. . . . In a fifth case corrosion from an original thickness of $\frac{1}{2}$ " to $\frac{1}{16}$ ", as shown in Figure 3, brought about a disastrous explosion.

New Chief Inspector at Pittsburgh

Of particular interest to policyholders and friends of the Company in Western Pennsylvania and West Virginia is the appointment on September 15, 1937, of Mr. Wilbur Carl Nicol to the position of Chief Inspector in the Pittsburgh Department. Mr. Nicol succeeds Mr. J. A. Snyder, who is retiring after nearly 20 years as Chief Inspector, and a quarter century of meritorious service in the Pittsburgh territory.

Mr. Nicol joined the Company as an inspector in the Pittsburgh territory on March 25, 1922, and served there until August 10, 1930, when he was transferred to the Chicago Department as Directing Inspector. He was stationed at Chicago from 1930 until his recent promotion.

Born March 6, 1895, at Woodland, Manitoba, Canada, Mr. Nicol attended Brandon Collegiate Institute at Brandon, Manitoba. In 1916 and 1917 he studied at the Bliss Electrical School in Washington and in the latter year entered the United States Army as a Master Engineer.

Through his work both within the Company and prior to his joining it, the new Pittsburgh Chief Inspector brings to his responsibilities a wealth of experience in many phases of the Company's engineering and inspection activity.



W. C. NICOL

"What's the charge for this battery?"

"Three amperes."

"Well, how much is that in American money?"—*Union Electric Magazine.*

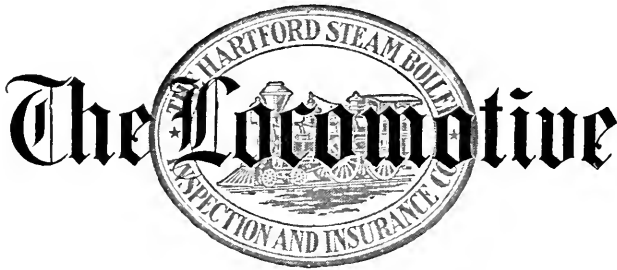

A QUARTERLY MAGAZINE
DEVOTED TO POWER PLANT PROTECTION

Published continuously since 1867

SIDNEY B. COATES, *Editor*

Copyright 1937 by The Hartford Steam Boiler Inspection and Insurance Company

HARTFORD, CONN., October, 1937

Single copies may be obtained free by calling at any of the Company's offices.

Subscription price 50 cents per year when mailed from this office.

Bound volumes one dollar each.

Reprinting matter from this paper is permitted if credited to

THE LOCOMOTIVE of THE HARTFORD STEAM BOILER INSPECTION AND INSURANCE CO.

Connecting Rod Failures

MORE steam engine breakdowns are caused by connecting rod failures than by the breakage of any other reciprocating part except the crosshead. This is to be expected because of the complicated combination of stresses which are imposed on the connecting rod and which constantly change in amount and direction.

If a rod is sound, the probability of its breaking is remote. However, a number of failures have occurred when the rod has been weakened by a forging flaw or when a welded repair has been attempted. In fact, so much trouble has been experienced following the repair of broken or cracked rods by forge welding or electric fusion welding that such repairs are not recommended. Three cases which illustrate characteristic failures at forging flaws or welds are described in subsequent paragraphs.

At a paper mill a steam engine connecting rod, 8' 6" in length, had broken about 40" from the crosshead end and had been repaired by forge welding. Less than a year later the rod broke at the weld, which had not been properly made. A crack apparently had extended from

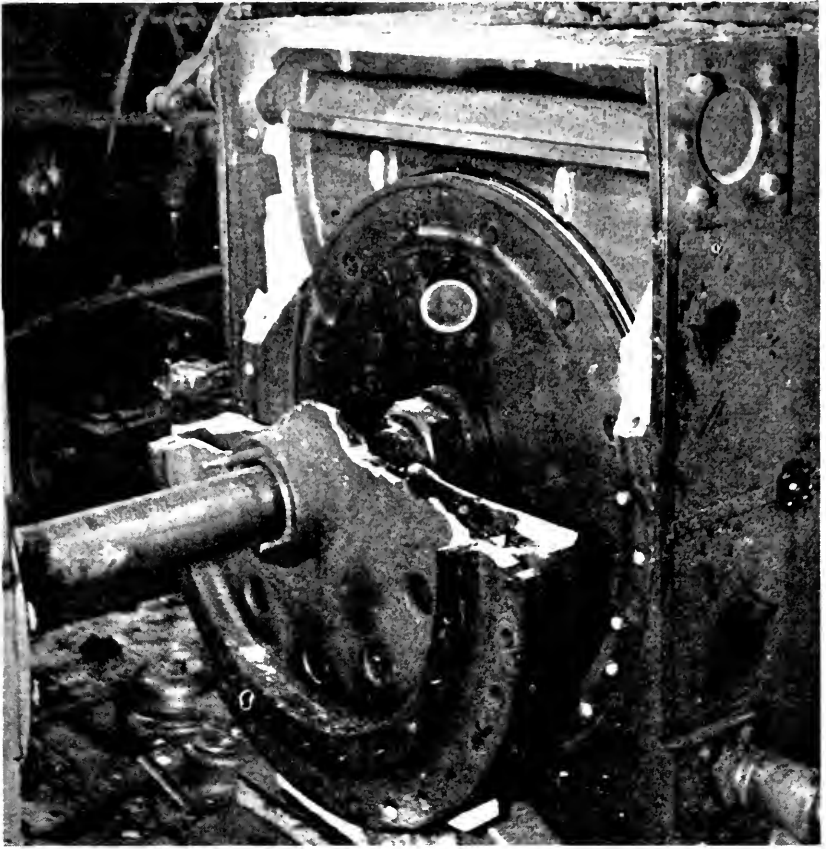

Figure 1—Cylinder wrecked because of connecting rod failure. The damage is typical of accidents from this cause.

the center of the rod outward, until it so weakened the part that it broke. This accident caused damage to the engine in an amount of nearly \$5,000. The location of the crack was such that it could not have been discovered by any practicable means.

In another case at a Mid-Western laundry a crack was located in a Corliss engine connecting rod near the crosshead. The crack was cut out and the removed metal was replaced by fusion welding. After about four months of use, the rod broke at the weld, either because of the failure of an imperfect weld or the development of another crack adjacent to the weld. Considerable damage to the cylinder head and valve chests resulted.

A third case was the failure at a forging flaw in a large cross-

compound steam engine at a flour mill. The connecting rod on the low pressure side broke near the crosshead, the fracture evidently having come about because of slag inclusion, approximately $8\frac{1}{2}$ " in length, along the center axis of the rod. The loss, in excess of \$4,000, included damage to the crosshead, cylinder, piston, piston rod and other parts on the low pressure side. A new rod was obtained.

While difficulties such as those described above do cause the main shanks of connecting rods to fail from time to time, these accidents are not as frequent as breakage of the rod-ends. The design of connecting rod-end which is now recognized as the best and simplest is the solid type shown in Figure 2 and adopted by most steam engine manufacturers. Obviously, this design cannot be used on center crank engines. The design of rod for such engines is that shown in Figure 3 with an open end and a strap, or else the so-called marine-end type, commonly found in internal combustion engines.

The net section through the wedge-bolt holes at "A" (Figure 2) is usually the weakest part of the rod in tension, but as a rule cracks do not develop at this point, but rather in or near the corners at "B" or at the middle of the end members, "C."

The stresses in connecting rod-ends are complex; in addition to the straight tension stress there is an indirect stress due to bending action. This is sometimes referred to as "whipping." It strongly concentrates the stress at the corners of the eye at "B." This is an important feature to be considered in the design, and the bending stress referred to is usually the limiting factor on the safe speed of a reciprocating engine.

With the design of rod-end having a strap, the section of metal at which the bending stresses take place is the end section through the bolt holes at "D" (Figure 3). Because this also happens to be the weakest section of the strap in straight tension, it is obvious that cracks are most likely to form in it. With this design of rod-end, therefore, the limitation of speed is of greater importance than is the case with the solid rod-end.

Cracks in the end members "C" are, as a rule, caused by sudden obstructions such as water in the cylinder. Weakness in these members usually occurs because the designer apparently assumed that the load was uniformly distributed over the entire length of the "beam." Actually, in view of the fact that the wedge may be considerably shorter than member "C," it is safer to regard the "beam" as having fixed ends and its load applied in the middle. In rods which are properly designed, "C" is made very heavy.

A steel mill recently was the scene of a serious accident because of a break at "B" at the crosshead end of the connecting rod of a large twin-tandem-compound steam engine. The left side of the engine was almost completely wrecked, as is indicated by Figures 1 and 4—an end of a low pressure cylinder and the connecting rod, respectively. The rod is an open-hearth steel forging with solid ends, is 15' 8" in length and weighs 4,900 lb. The low pressure cylinder is 56" in

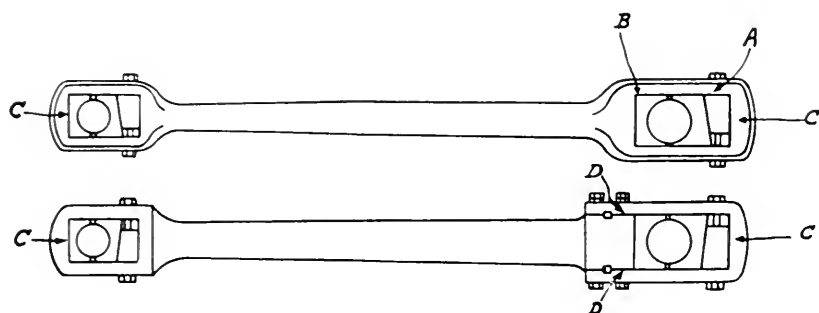

Figure 2 (above)—Solid-end type of connecting rod. Figure 3 (below)—Open-end type of connecting rod for center crank engines.

diameter, and the over-all length of the engine about 35'. Besides the destruction of the rod and low pressure cylinder, the accident involved the pushing of the high pressure cylinder about 12" off its base, and the breaking of an 8" steam line in two places. Fortunately, extensive personal injury from escaping steam was averted because the jar on the piping tripped the quick closing valve in the steam line. Just when the shock, which originally started the crack at "B," occurred, is not known, for such cracks start so minutely and develop so slowly that their presence, even by special tests, is not determinable until they are some months old. When the metal became severed at "B," a fresh break occurred at "C" and the engine went to pieces.

The loss from this accident, which was covered by Hartford Steam Boiler, amounted to about \$17,000. Even with the fullest co-operation on the part of the assured and parts manufacturers, and with 24-hour service, the repair took nearly six weeks.

In another case at a grain elevator, the misalignment of reciprocating parts imposed such stresses at "C" that a piece broke out at the crosshead end of the rod-eye of a tandem-compound Corliss engine. The crosshead was forced toward the forward end of the guide frame, the result being the knocking out or cracking of heads in both

cylinders and the cracking of the piston in the low pressure cylinder. Damage to the engine exceeded \$4,000.

A small flaw on the inside of the connecting rod eye brought about the breaking of the rod and extensive damage to the head of the high pressure cylinder and other parts of a cross-compound steam engine at an Eastern plant. When the eye of the rod failed, the piston was carried to the forward end of the cylinder and broke all the stud bolts, thereby forcing off the cylinder head.

Sometimes, as the result of an accident to some other part of the engine, a connecting rod will become bent. When this occurs, there is

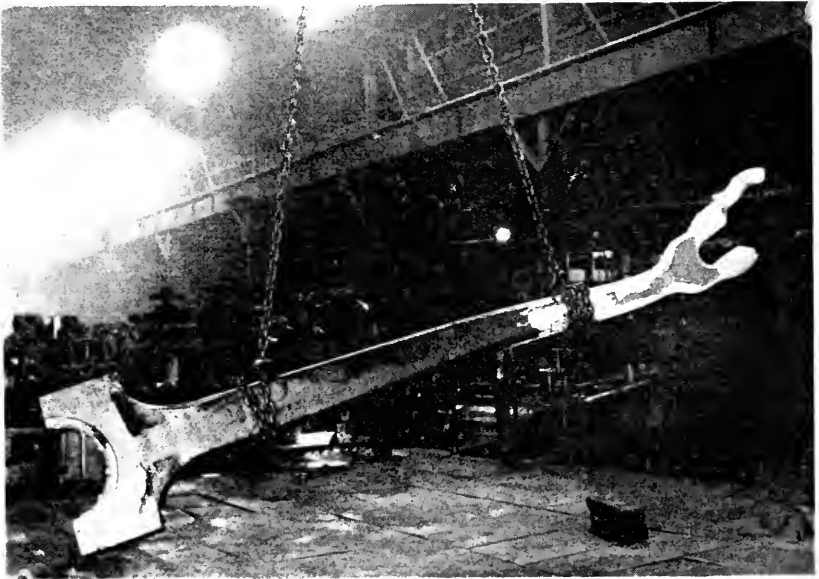

Figure 4—Typical break of the rod-end in a large Corliss engine.

always a temptation to straighten it. However, in the event of serious distortion, subsequent straightening may set up unusual stresses, if not actually cause minute cracks, so that competent engineers should be called in to study the location and extent of the distortion and to recommend whether to repair or replace the rod.

In some engine installations the breaking of wedge-bolts is a chronic trouble. When this occurs, the wedge may drop, causing excessive clearance in the crank bearing or crosshead bearing which may be sufficient to destroy the piston clearance so that serious damage to the engine may result. With the application shown in Figure 2, it will be

seen that breakage of the wedge bolt will cause a tightening of the wedge, while with the application shown in Figure 3, such a mishap is almost sure to cause serious damage because of the excessive clearance resulting when the wedge drops.

The general requirements of good construction of wedge bolts can be summed up as follows:

The threads in the wedge should be a perfect fit with the bolt and the threaded hole through the wedge should be in perfect parallelism to the vertical part of the wedge. This parallelism should be tested with the wedge in place but with the brasses removed. The holes through the connecting rod members should be from 1/16" to 1/8" larger than the diameter of the bolt. Finally, the surface of the rod-ends under the head of the wedge bolt should be properly spot-faced so that the bolt heads can bear squarely on the rod surface. Any serious deviation from these basic principles will cause chronic breaking of wedge bolts. Best results are obtained with wedge-bolts made of a good grade of wrought iron rather than steel.

The breakage of bolts or wedges is often as dangerous as the breakage of the connecting rod itself, since it destroys the close adjustment of the reciprocating parts and may lead to a serious accident. In the operation of reciprocating machines a maximum of safety may be obtained only by replacing defective parts, and by keeping sound parts in proper adjustment.

Paragraphs of Progress

300 SQ FT 12 FT HIGH

The first industrial installation of a new boiler-turbine-generator unit has been made at Northville, Michigan. In only 300 sq ft of floor space is an oil-fired forced circulation boiler, producing 10,000 lb per hour of 1200 lb, 950°F. steam; the necessary auxiliaries; a 750 kw condensing extraction turbine-generator, and controls. The unit requires a height to the top of the boiler of 12 feet, and the condenser and condenser pumps are located below the turbine, but above the shop floor level. Operating at 10,000 rpm, the turbine drives a 3,600 rpm generator through a single reduction gear. The blower, feedwater pump, fuel and lubricating oil pumps are driven by a single stage high pressure turbine, the speed of which is variable

downward from 13,500 rpm depending on the steam output of the boiler. Completely automatic control is a salient feature.

NOW 2,500 LB PER SQ IN.

Steam at 2,500 lb pressure and 940°F. is to operate a 22,500 kw—2,400 lb turbine-generator which will exhaust into a new 40,000 kw—400 lb turbine generator. This equipment is to be erected at Mishawaka, Indiana. *Electrical World* reports the outlay for the boiler and turbines at \$4,000,000.

DOUBLE-SHELL TURBINE

A 40,000 kw, 3,600 rpm, superposed turbine-generator unit, operating at 1250 lb per sq in. pressure and 925°F. initial temperature is nearing completion at Logan, W. Va. The generator is hydro-

gen cooled. This turbine offers as an advancement in design what has been called a double-shell construction. In effect there is one casing inside the other with a high pressure steam cushion between the inner and the outer shell, both of which carry a part of the internal pressure. Advantages claimed are less internal strains during the heating period, less possibility of flange leakage, faster and more symmetrical heating, simpler castings and thinner shell walls.

128°F. BELOW ZERO

In a recent issue of *Power* is described an achievement in the production of cold. The specifications called

for 4,000 Btu per hour of refrigeration at a temperature of -128°F . Ethane (C_2H_6) was selected as the refrigerant. The condensing was accomplished by means of another refrigerating system with propane (C_3H_8) as the refrigerant. All ethane-containing equipment was installed in a cold room, the condensing being done with a standard 2-ton enclosed-crankcase ammonia compressor. Difficulties included detailed protection against the explosive characteristics of ethane, the selection of a suitable lubricant (light transformer oil with a small amount of kerosene added proved satisfactory), and automatic control. The system is operated 6 to 8 weeks, 24 hours a day, without shutdown.

Japs From the Old Chief's Hammer



THE Old Chief and Tom Preble had been to the safety deposit vault of a bank near the office. There, they had paused to examine the huge vault door with its complicated mechanism, and were discussing it as they returned to the office.

"A big door like that must be as much of an advertisement as it is a protection," Preble remarked.

"Yes," answered the older man, "it does look foolproof, and I have confidence enough in the bank to believe that it is, but those big doors, with their timing devices, may be liabilities sometimes."

"How's that, Chief?"

"Well . . ." chuckled the older man, "you've heard the story about the vice president who was entrusted with the care of the vault in a small bank. He had a poor memory, so he wrote the combination of the vault on a piece of paper. One night he inadvertently locked the piece of paper in the vault.

"In the morning he went to open the vault, remembered he had locked up the paper, and was stumped. He fiddled with the dial, but he couldn't get the proper sequence. Customers started coming into the

bank and the vice president became more and more perturbed. Finally, one of the tellers mentioned the name of a first class locksmith.

"The man was telephoned and asked to hurry. He did. After some fifteen minutes of work he had opened the door, told the vice president how to go about having the combination changed, and left.

"He sent a bill for \$100, and the vice president protested, sending back the bill, commenting on its size, and asking for an itemized statement.

"The locksmith sent an itemized statement as follows:

'Opening vault—one-half hour	\$ 5.00
Knowing how	95.00
	<hr/>
Total	\$100.00'

Preble laughed.

"Tom," continued the Chief, "did it ever occur to you that sometimes we have jobs like that locksmith?"

"What do you mean?" asked Preble.

"Let me tell you about Inspector Mike Sinton, . . . yes, and about Inspector Mason, too."

Preble knew a story was on the way, in fact, two stories. "What did they do, Chief?" he asked.

The older man continued, "Inspector Sinton was down in the mountains, conducting a survey of electrical equipment at one of the mines. When he arrived early in the afternoon, the superintendent was waiting, and after a short talk they set out to see the several locations in the superintendent's charge. They worked all afternoon examining various electrical equipment, discussing operating practice, maintenance, and many other things. All afternoon the superintendent carried a roll of blue prints under his arm, but he didn't refer to them. At about 6 o'clock the superintendent suggested that they return to the office and then go to dinner.

"Sinton, however, was curious about those blue prints, so he asked, 'What are the prints; something that you want me to see?'

"'Nothing important,' was the answer. 'We've had a little trouble up at one of the automatic substations. A rotary converter won't cut in as it should. I was going to ask you about it, but the time is getting on.'

"'Do you want me to look at the station?' asked Sinton.

"'That's pretty much to ask, as it's getting late and we will have to go up there beyond the tippie,' . . . and he pointed to a small building perched high above on the mountain.

"'Let's go,' said Sinton; 'after all, that's what I came down here for—to see what you had. If I can help you, I will.'

"At the substation, Sinton looked things over in a general way.

"'Here are the plans,' said the superintendent. 'Don't you want to see them?' and he laid them out on the floor. 'How long will it take to fix it, do you think?' he asked.

"Sinton's reply was, 'Perhaps four hours to find the trouble and five minutes to remedy it. That's control.'

"'Let's see the equipment work,' Sinton said, 'and save the blue prints until later.'

"The superintendent pressed the starting button and certain relays were seen to function, but the converter didn't start.

"'Once more,' said Sinton.

"Again the relays began operating and then stalled.

"'Hello,' remarked Sinton, 'this relay doesn't seem to function. Let's make it work.'

"The next time the control was energized, he pushed down with a pencil on the brushes of the inoperative relay; the solenoid coil functioned and the converter went on the line.

"'Well, I'll be . . .' remarked the superintendent.

"'A bit of luck,' was Sinton's answer. 'I wonder whether we can do it again.' The sequence was repeated.

"'There's probably something wrong with the pilot brushes,' said Mike. 'Do you have any spares?'

"To make a long story shorter, Sinton's experience, not with vault doors but with control, had made short work of a problem, which, it turned out, had been bothering the mine's maintenance crew for several days.

"As they returned to a late dinner, Sinton commented about as follows to the mine executive, 'Your men would have found the trouble soon. We were lucky, and besides sometimes it's easier to find trouble when you haven't seen the control before.'

"What Sinton didn't say was that he ate, slept and lived control."

Preble interrupted, "Is Mike Sinton always that quick in finding trouble?"

"Not by a long shot," replied the Chief: "I've known him to work for hours on a control difficulty, but he'd never give up."

"What about the other story, Chief, about Inspector Mason?"

"Tim Mason? Sure. That case was an elevator job. One of our agents called us about 4:30 one afternoon . . . said one of his clients, the owner of a big office building, was having trouble with an elevator, and would we help. It seems that at every attempt to start it the fuses would blow.

"Tim was in the office, so I sent him down—just a block away. The building superintendent was waiting and took Inspector Mason to the control room. There he saw four service men, who for seven hours had been working on the difficulty, tracing circuit after circuit. He knew two of them by name, but the building superintendent got in the first words.

" 'All right, boys,' he said. 'Here's an insurance company expert to see what he can do.'

"Tim is a diplomat of a sort. He was mad as could be, for he knew that the word 'expert' would make those tired men see red.

" 'I didn't know what to say,' Tim told me, 'so I just laughed . . . and told them that I couldn't be an expert, because an expert is said to be an ordinary man away from home, and my office was just around the corner.'

"Tim said they still 'felt' huffy, so he added, 'It's getting late, men, and I am sure you have found the trouble, but are too tired to recognize it. Men as good as you' (and they were good men as we've found out on many an occasion) 'don't work all day without getting somewhere. Let's rest our backs and talk this over a bit.'

"With that, to everybody's surprise, Tim sat down on the floor and proceeded to light his pipe. Four weary men, a bit puzzled, joined him, and the building superintendent stood leaning against a support near the control panel, glowering at Tim.

"Guided by Tim's questions they talked about the setup. After about 15 minutes Tim said, 'I knew you wouldn't make me do a lot of work over again. You've tested all the circuits and it seems to me that they are all functioning normally except one,' and he pointed to a corner of the switchboard. 'I knew you must have solved the difficulty. You know as well as I do that the trouble's got to be there.'

"Almost before he finished speaking the building superintendent said, 'I see it.'

"Two contactors or 'clappers' as they are sometimes referred to had worn and wobbled until they had touched and fused. This caused a short circuit and was the reason for the difficulty.

" 'Well, you old so-and-so,' said one of the service men, 'I guess we'll have to swallow that expert stuff.'

" 'Don't talk that way,' said Tim. 'You'd have found the trouble in another 5 minutes.' "

"It seems to me," remarked Preble, "that Mason's expertness was a matter of tact more than anything else."

The Old Chief didn't reply for a moment and then remarked in his quiet voice, "Yes, 'tact' perhaps. I like the word 'friendliness' better . . . and Tim does know control."

The Hartford Steam Boiler Inspection and Insurance Company

OF HARTFORD, CONN.

December 31, 1936

Capital Stock, \$3,000,000.00

ASSETS

Cash on hand and in banks	\$904,668.68
Premiums in course of collection (since October 1, 1936)	1,000,760.69
Interest accrued on mortgage loans	4,169.65
Interest accrued on bonds	88,854.77
Loaned on mortgages	290,275.00
Home Office real estate and Philadelphia branch office	642,331.05
Other real estate	332,274.83
Bonds on an amortized basis	\$8,970,348.42
Stocks at market value	7,154,705.00
	<hr/>
	16,125,053.42
Other admitted assets	6,903.34
	<hr/>
<i>Total</i>	\$19,395,291.43

LIABILITIES

Premium reserve	\$6,765,042.57
Losses in process of adjustment	463,395.19
Commissions and brokerage	200,152.14
Difference between market and book values of stock	507,096.59
Other liabilities (taxes incurred, etc.)	504,352.01
	<hr/>
<i>Liabilities other than capital and surplus</i>	\$8,440,038.50
Capital stock	\$3,000,000.00
Surplus over all liabilities	7,955,252.93
	<hr/>
<i>Surplus to Policyholders</i>	10,955,252.93
	<hr/>
<i>Total</i>	\$19,395,291.43

WILLIAM R. C. CORSON, President and Treasurer

BOARD OF DIRECTORS

LUCIUS F. ROBINSON, Attorney, Hartford, Conn.	HON. JOHN H. TRUMBULL, President The Trumbull Electric Mfg. Co., Plainville, Conn.
JOHN O. ENDERS, Chairman Executive Committee Hartford National Bank & Trust Co., Hartford, Conn.	CURTISS C. GARDINER, Vice President The Hartford Steam Boiler Inspection and Insurance Company, 90 John Street, New York.
MORGAN B. BRAINARD, President Aetna Life Insurance Company, Hartford, Conn.	JAMES L. THOMSON, Chairman Finance Committee Hartford Fire Insurance Company, Hartford, Conn.
CHARLES P. COOLEY, Chairman Board of Trustees Society for Savings, Hartford, Conn.	PHILIP B. GALE, Chairman Board of Directors Standard Screw Co., Hartford, Conn.
JOSEPH R. ENSIGN, President The Ensign-Bickford Co., Simsbury, Conn.	JOHN J. GRAHAM, Vice President The Hartford Steam Boiler Inspection and Insurance Co., Hartford, Conn.
WM. R. C. CORSON, President The Hartford Steam Boiler Inspection and Insurance Co., Hartford, Conn.	AUSTIN DUNHAM BARNEY, Vice President The Hartford Electric Light Co., Hartford, Conn.
SAMUEL M. STONE, President Colt's Patent Fire Arms Mfg. Co., Hartford, Conn.	JOHN R. COOK, President Arrow-Hart & Hege- man Electric Co., Hartford, Conn.
SAMUEL FERGUSON, Chairman Board of Directors The Hartford Electric Light Co., Hartford, Conn.	

Incorporated 1866



Charter Perpetual

Department

Representatives

ATLANTA, Ga., Citizens & So. Nat. Bk. Bldg.	W. M. FRANCIS, Manager. C. R. SUMMERS, Chief Inspector.
BALTIMORE, Md., 704-9 Garrett Building	D. W. LITTLE, Manager. R. P. GUY, Chief Inspector.
BOSTON, Mass., 87 Kilby Street	THOMAS F. RICE, Manager W. A. BAYLISS, Chief Inspector.
BRIDGEPORT, Conn., City Savings Bank Building	W. G. LINEBURGH & SON, General Agents. A. E. BONNET, Chief Inspector.
CHICAGO, Ill., 175 West Jackson Boulevard	P. M. MURRAY, Manager. C. W. ZIMMER, Chief Inspector.
CINCINNATI, Ohio, 1904-12 Carew Tower	JAMES P. KERRIGAN, Manager. W. E. GLENNON, Chief Inspector.
CLEVELAND, Ohio, 1040 Leader Building	ARTHUR F. GRAHAM, Manager. JOHN L. SCOTT, Chief Inspector.
DENVER, Colo., Gas & Electric Building	J. H. CHESNUTT, Manager. JESSE L. FRY, Chief Inspector.
DETROIT, Mich., National Bank Building	L. L. COATES, Manager. THOMAS P. HETU, Chief Inspector.
HARTFORD, Conn., 56 Prospect Street	F. H. KENYON, Manager. A. E. BONNET, Chief Inspector.
NEW ORLEANS, La., 333 St. Charles Street	R. T. BURWELL, Manager. P. E. TERROY, Chief Inspector.
NEW YORK, N. Y., 90 John Street	C. C. GARDINER, Vice President. J. F. HUNT, Chief Inspector.
PHILADELPHIA, Pa., 429 Walnut Street	A. S. WICKHAM, Manager. S. B. ADAMS, Chief Inspector.
PITTSBURGH, Pa., Arrott Building	WILLIAM P. WALLACE, Manager. W. C. NICOL, Chief Inspector.
ST. LOUIS, Mo., 319 North Fourth Street	CHAS. D. ASHCROFT, Manager. EUGENE WEBB, Chief Inspector.
SAN FRANCISCO, Cal., 114 Sansome Street	C. B. PADDOCK, Manager. L. E. GRUNDALL, Chief Inspector.
SEATTLE, Wash., Arctic Building	E. G. WATSON, Manager. WILLIAM J. SMITH, Chief Inspector.
TORONTO, Ont., Canada, Federal Building	H. N. ROBERTS, President The Boiler In- spection and Insurance Company of Canada.

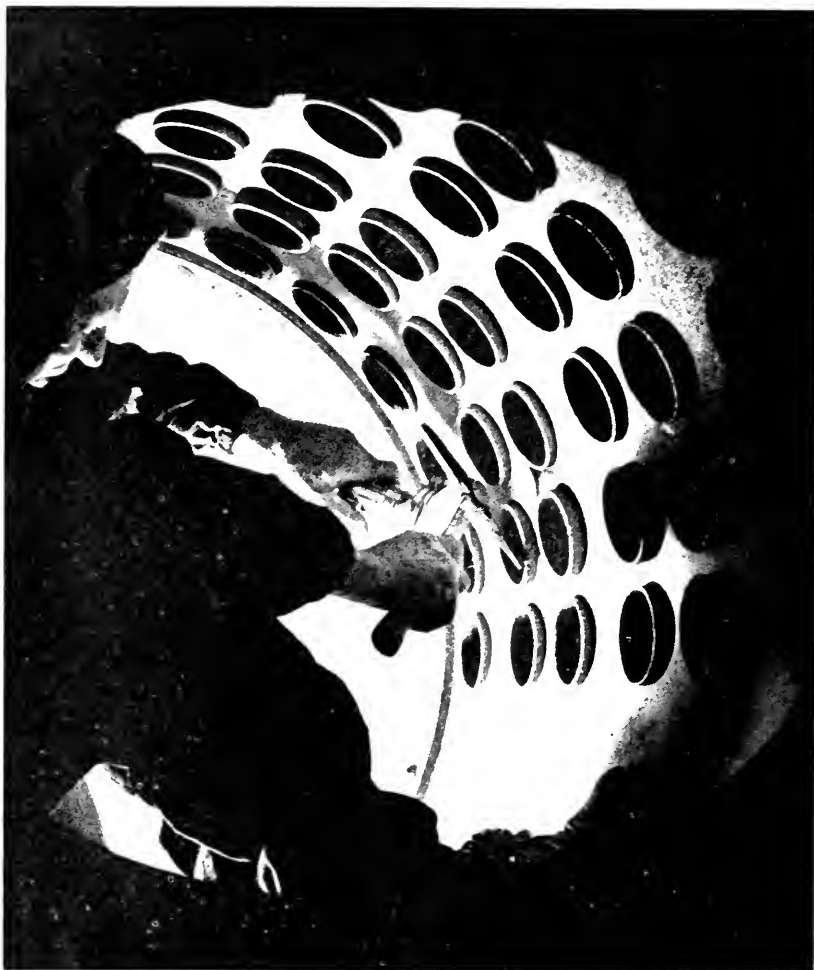

THIS HEALTHY BOILER anticipates a ripe old age. Hartford Steam Boiler inspected it during construction . . . placed on it the famous Hartford "Stamp of Approval" . . . sponsored its baptism by fire . . . now inspects to prolong its life-span of safe, useful operation.







CARNEGIE LIBRARY OF PITTSBURGH



3 1812 04248 1383