

FINANCING, CONSTRUCTING AND MAINTAINING.

— 124636

FORMING ONE OF THE TWELVE VOLUMES OF THE REVISED AND
ENLARGED EDITION OF

THE SCIENCE OF RAILWAYS.

BY

MARSHALL M. ^{Director} KIRKMAN.

FINANCING, CONSTRUCTING AND MAINTAINING

TREATS OF CAPITALIZATION, LOCATION, BUILDING AND MAINTAINING
THE ORGANIZATION AND PROPERTY OF RAILROADS AND THE ECO-
NOMIC QUESTIONS SURROUNDING THESE SUBJECTS; THE
MAGNITUDE OF THE INTERESTS INVOLVED, THEIR
INTRICACY AND VAST IMPORTANCE, AND THE
INFLUENCES, PURPOSES, PRINCIPLES
AND METHODS THAT GOVERN.

VOLUME III.

NEW YORK AND CHICAGO:
THE WORLD RAILWAY PUBLISHING COMPANY.

1903.

COPYRIGHT BY
THE WORLD RAILWAY PUBLISHING COMPANY
1894, 1895, 1896, 1898, 1899, 1900, 1902, 1903.
Also entered at Stationer's Hall, London, England
All rights reserved.

THE HENNERBERRY COMPANY
PRINTERS...BINDERS...CHICAGO

TABLE OF CONTENTS.

BOOK I.—FINANCING.

	PAGE
CHAPTER I. What constitutes money and the effect of a debased currency upon railways and other property. Its baleful effect upon those who work for wages, . . .	7
CHAPTER II. Basis and method of capitalizing railroads,	28
CHAPTER III. Capitalization and management. Methods pursued by different governments,	41
CHAPTER IV. Influences favorable and otherwise on the capitalization of railroads,	53
CHAPTER V. Something about the character of different kinds of securities,	59
CHAPTER VI. So-called "watered stock,"	72
CHAPTER VII. Railway capital—investors must not buy without scrutinizing, nor hold without guarding, . .	79
CHAPTER VIII. Different kinds of shares; returns thereon; transfer books, etc.; capital stock and shareholders, .	85
CHAPTER IX. Details of railway bonds, leases, etc., . . .	92
CHAPTER X. Particulars of sinking funds,	101

BOOK II. CONSTRUCTING AND MAINTAINING.

CHAPTER I. Railway evolution,	109
CHAPTER II. Railway construction,	123
CHAPTER III. Methods of construction,	137
CHAPTER IV. Particulars of construction—cost, details thereof, etc.,	152
CHAPTER V. Elements of construction,	167
CHAPTER VI. Track. Its construction and evolution, . .	174

172/035
4-29-25
A. A. P.

172/035

	Page
CHAPTER VII. Construction, maintenance and care of the roadway and track,	206
CHAPTER VIII. Maintenance of track,	272
CHAPTER IX. Track details—snow and ice, rails, joints, spikes, splice bars, plates, alignment, premiums and other matters,	301
CHAPTER X. Use of wood by railways—its preservatives and substitutes—metal ties, etc.,	348
CHAPTER XI. Maintenance and operation—what cost is dependent upon,	383
CHAPTER XII. Maintenance—fixed operating expenses,	413
CHAPTER XIII. Maintenance—cost of operating affected by facilities,	427
CHAPTER XIV. Maintenance—proper basis of railway taxation,	433
CHAPTER XV. Maintenance—things that enter into the maintenance of a railroad,	458
 APPENDIXES:	
Appendix A. Methods of capitalization in Great Britain,	487
Appendix B. Relation the various items of track labor bear to each other,	491
Appendix C. Relation various classes of maintenance bear to total cost of maintenance,	492
Appendix D. Percentage of the total cost of operating due to maintenance of organization and the prevention of the destruction of the property from natural causes,	493
Appendix E. Gauges of railroads that are or have been in use in different countries,	494
Appendix F. Quantity of material required to lay one mile of railroad track on the basis named,	495
INDEX,	496

BOOK I.

FINANCING.

NOTE.—The subjects of which this volume treats are inseparably connected with others relating to the operation of railroads, but only the more salient features are discussed specifically here. They will be found referred to again and again throughout the work in connection with other subjects. Indeed, the student who would understand any particular phase of railway operations must study the subject of railways in all its parts. He may never, indeed, be able to compass an exhaustive knowledge of every department, but his information will be sufficient to afford the side light which an understanding of any particular department requires.



CHAPTER I.

WHAT CONSTITUTES MONEY, AND THE EFFECT OF A DEBASED CURRENCY UPON RAILWAYS AND OTHER PROPERTY—ITS BALEFUL EFFECT UPON THOSE WHO WORK FOR WAGES.

The economic conditions which a government countenances or enforces are all-important to railroads. This is particularly true of matters affecting credits. The financial standing of a nation, the character of its people and their disposition to conform to common usage in matters of business, are vital matters. The building of railroads and their successful operation are facilitated or embarrassed, according to the wisdom and patriotism of those who manage the finances of a nation. Thus the citizens of those countries so fortunate as to be blessed with a stable government and a sound currency obtain the capital they need on the most favorable terms. Those so unhappy as to have a weak government or a debased or fluctuating currency, on the other hand, are universally shunned by those who have money to lend. And by money is meant that which the great commercial nations concur in designating as such. At this time gold only is thus recognized. At one period in the history of men, cattle constituted the circulating medium;

the cow was the unit of value. Men did not then speak of dollars or pounds, but of cows. Afterward sheep constituted the circulating medium, then horses, mules, the skins of animals, and so on. As men progressed in wealth and intelligence and became more settled in their mode of life, copper, bronze, iron, tin and lead, and finally, silver and gold, were used for money. The change finally to gold was based on commercial reasons, and in this connection it cannot be too strongly impressed on men's minds, that what shall constitute money (the circulating medium of the world) is never a matter of sentiment or tradition, but of present utility. We may just as properly mourn over the abandonment of the cow as the unit of value as to mourn over the loss of silver or any other medium of circulation.

What shall constitute money is not determined by the interests or prejudices of a particular individual or country. Gold is the standard at the present time because it, more nearly than any other thing, answers the requirements of money as regards present quantity, yearly supply, bulk, quality of metal, stability of value, desirability as property, and cost of production.

Money is property in the same sense that a horse or a piece of land is property, and must be intrinsically valuable in itself and, moreover, a thing generally desired. Superabundance or violent fluctuations attending the production or use of a thing render it unfit for money. It was never designed to be used to pay debts; making it a legal

tender was an afterthought—a business device. Its being such does not add to its value. If made a legal tender for more than it is worth as property, it is made a device to rob one man for the benefit of another and, like all the devices of rogues, loses its efficacy as soon as known, reacting finally and disastrously upon those who seek to profit by the deceit.

It is a universal law, based on supply and demand, that the purchasing power of money decreases if the quantity in circulation is increased disproportionately to the needs of the world. Reversely, its purchasing power is increased if the relative quantity is not kept up.

It costs less to mine gold now than formerly. Production has also increased greater, relatively, than the needs of the community. In consequence it will not buy to-day as much as formerly, as is evinced in the rise of wages and the decrease in the rate of interest.

What constitutes money varies with the changed conditions of men. Arrow heads and beads answer the requirements of savages, and for them constitute the highest possible form of money. But as savages emerge from barbarism something else must be substituted. In this way from time immemorial that which constitutes money has been changing as circumstances and the needs of men have changed.

The word money is said to owe its origin to the fact that the first Roman coins were struck in the temple of the goddess Juno Moneta. The

greatest delusions in regard to what constitutes money occur in times of business depression, when men lose heart; when employment is difficult to get, and wages are low and trade dull. Then there spring up in every direction men who demand that the government shall bring back the prosperity of the past by creating money, forgetful that such prosperity is as unreal as a meal made upon the shadows or odors of real food.

Money originally passed between man and man by weight. Coinage (authoritatively stamping the value of the coin on its face) was a later device, designed to facilitate easy and rapid interchange. But this device has, from the start, been more or less used as a means of defrauding the community by putting less metal into the coin than the actual value of the bullion it contains.

There is no doubt that if metals passed by weight, many of the misapprehensions which arise from time to time as to what constitutes money would not occur. If, to illustrate, we passed from hand to hand the number of ounces of silver which, as bullion, can be bought for a dollar in gold, men would be cured of the delusion that the government stamp makes it worth a given sum, rather than the amount of metal it contains. The stamp adds nothing. It is merely a certification. If the bullion in the token is not worth what the coin is stamped, the public (if the government's credit warrants) may accept it tem-

porarily for what it claims to represent, in the belief that the government will ultimately make it good.

From time immemorial men have also con-founded printed slips of paper (bills) with money. They have accepted the statement of governments or bankers in lieu of the fact. They have forgotten that paper tokens are of value only so long as they are backed up by real money.

In connection with money and its uses, there will always be more or less incoherent talk about bimetallism. Men are voluble, and speak without investigation or reflection. Bimetallism means the free coinage and circulation, simultaneously, of two kinds of metal. Such a thing is clearly impossible, either by international agreement or otherwise.*

Without free coinage and free circulation and interchange, bimetallism is a misnomer, and it has been clearly established that coins of different metals will not circulate side by side. This fundamental law has never varied in a single instance during the thousand and odd years its operations have been watched. Its workings are based on natural causes, and are inevitable and final. They are thus stated by Sir Thomas Gresham, Chief of the British Mint in the

*Bimetallism is defined as "The legal obligation of a national mint to coin both gold and silver at a fixed ratio between the two metals, coupled with a law giving debtors the power, unless prevented by special contract, to satisfy their creditors by payment in either of the metals thus coined."—*American Encyclopedic Dictionary*.

seventeenth century: "When two sorts of coin are current in the same nation, of like denomination, but not intrinsically (that is to say, when they have not the same value relatively in the market), that which has the least value will be current; the other will be hoarded, melted down or exported." Thus, we will say, if silver might be coined in unlimited quantities (i. e., if free coinage existed), on the basis of sixteen ounces of silver to one ounce of gold, while thirty-two ounces of silver could be bought for one ounce of gold, it would follow that gold would disappear and silver alone become the circulating medium. No one would pay out a dollar in gold when he could take it and buy silver bullion out of which the government would coin for him, without charge, two silver dollars, each of which was a legal tender. The ratio of silver to gold has constantly varied in the experience of the world. At the dawn of history silver was more highly esteemed than gold. It is said to have been the case in Arabia; also in primitive Germany. Strabo speaks of gold as being worth twice as much as silver. It is said that silver and gold were of equal value in Japan in the sixteenth century. In the time of Herodotus (400 B. C.) gold was worth thirteen times the value of silver in Greece. The ratio was variable among the Romans—from ten to one to twelve to one. It is said to have been nine to one in England in the time of Richard Cœur de Leon. In Spain in the thirteenth century, it was seven and a-half to

one; afterward, at the close of this century, it was changed to ten and three-quarters to one; later on, Portugal being for the moment the governing force in such matters, the ratio was sixteen to one. From this it will be seen that the value of silver has constantly varied, and on the whole greatly decreased. Similar fluctuations in the price of cows foretold in early days their downfall as money. The great and rapid decline in the value of silver is due to several causes, which will tend to still further cheapen it. Among these causes may be mentioned (and I name them in the order of their importance), the superabundant supply of the metal, the ease and cheapness with which it may be mined with the aid of improved machinery, the fact that the supply of gold has been so increased as to meet the wants of commerce, and, finally, its demonetization by all great nations.

However carefully the ratio between gold and silver may be fixed (where free coinage exists), it cannot be maintained except for the moment. The supply of the two metals by the mines will never continue for any length of time to be relatively the same. Nor will the demand for them be the same, either for money or for use in connection with the fine arts. Because of this the ratio will constantly be disturbed, and as soon as this occurs the metal which has suffered the greater depreciation will be used, and the other hoarded or exported. Bimetallism, so called, is possible only where the less valuable coin,

relatively, is supported by the other and redeemed in it.*

It is probable that silver will always be used more or less by every nation. But, because of its greater stability, uniformity of production and value, gold has become the basis of circulation of every wisely governed country. It will cease to be so when the conditions which brought it about no longer exist. I speak merely of the present. That is always sufficient. Nor is it material to anyone to inquire why gold became the accepted medium of circulation. The fact is enough. Economists and metallographists may trace the causes and derive pleasure therefrom, but for others the question is too subtle. For such the verdict of the commercial and financial world (all important in such matters) is sufficient and may be accepted unhesitatingly. But sophists will question this and seek to lead astray the ignorant and unthinking, on the plea that there are exceptions to the rule; that while gold may be highly adapted to the selfish interests of a rich nation, it may bear very heavily on a poor country. There is no truth whatever in such statements. A currency good for the rich is doubly good for the poor. Fortune is assured

* It was made possible in the United States, first, because the coinage of the baser metal, silver, was restricted; second, by the government's acceptance of silver in payment of all debts due it, and third, by its agreement to maintain the parity and purchasing power of the two metals, so far as coined. These conditions were necessary, as the silver coins were not made specifically redeemable in gold.

to the rich under all conditions, but it is impossible to the poor except under the most favorable circumstances, among which is a stable currency.

A country which uses paper or other medium of circulation not redeemable at sight in the recognized money of the world, is discredited, not by foreigners alone, but by its own people.* Men will not invest money in a community so debauched. It is for this reason that the capitalists of the world, including those of the United States, avoid investments in discredited countries, although their natural advantages may be equal to the best portions of the world. Venezuela may, for illustration, be cited as an instance in point. Thus, its people had to pay ten and twelve per cent. interest in gold (for the small credit they were able to obtain), while British Guiana, an adjoining country not so rich in natural resources, was able to secure all it needed at four per cent. The same misfortune which befell Venezuela before it adopted the gold standard would befall England, the United States, Germany or any other country that should disregard the edict of the commercial and financial world in such a matter.

When investments are made by foreign capital in a country financially discredited, burdensome

* It is as if a merchant, when called upon to pay his debts, should offer sheep pelts at a dollar apiece, in lieu of money, when everybody knew they might be bought in the market for fifty cents.

guarantees are exacted. Moreover, the rate of interest must be sufficient to enable the investor to convert the return he receives into gold and still have a margin of profit to cover the wide fluctuations which always attend the use of a debased currency.

The fluctuations of silver, no longer generally recognized as money by the world, illustrate this last. Thus three hundred and seventy-one and one-quarter grains of this metal in 1885 were worth about one hundred cents in gold; in 1897 they were only worth forty-eight cents. But silver is only one of many forms of a fluctuating and, therefore, a debased currency. I remember in 1860 the circulating medium of the United States consisted of paper issued by private banks, based on securities such as town bonds, lands, stocks and such other collaterals as the state officials could be induced to accept as a basis of circulation. The bills, not being redeemable in gold, were quoted just as stocks and bonds are now, and carriers were compelled to notify their agents daily, sometimes several times a day, the price at which they should receive bills of the different banks, in payment for tickets, freights and so on; thus the Southern Bank of Tennessee would be accepted to-day at sixty cents, and to-morrow at fifty cents, and so on. Twenty years afterward I found in the vaults of a railroad company a package two feet square, tied with rope, which was at first thought to contain old papers and accounts, but upon investigation

was found to consist of one, two, three, five, ten and twenty dollar bills of the banks in question (some two hundred thousand dollars in all) which had remained in the possession of the transportation company when the final collapse came. All this stuff was at one time thought to be real (instead of play) money.

The issuance of paper promises—bills—so-called money—“stuff”—based on the faith of a nation or other intangible substance, ever has many advocates in countries and communities more or less in debt. In the United States such money is known as “fiat” money. It is no more money, however, than a snow-flake or other intangible or worthless substance is money. To write on a piece of paper “This is a dollar” does not make it so. Money is a real thing; a concrete substance; property; something substantial, permanent and that does not fluctuate. Something that mankind treasures as having intrinsic worth the world over. There is a belief more or less general in such communities as I refer to, that governments may make money just as mills make paper. However, it cannot be too often reiterated that no token can be called money which is not redeemable in what the world designates as money. To-day this is gold.

Another form of so-called money is based on the belief that a government or its citizens may take a certain amount of metal (to be bought in the market for a certain sum) and after running it through the mint stamp it for a larger sum.

Phantom tokens of this kind pass at par only so long as the government supports them, dollar for dollar, in real money. The practice referred to, however, of buying bullion at one price and, after coining it, issuing it at another, was indulged in by the United States for several years, until it had piled up in its vaults some four hundred and sixty millions of so-called dollars. The people, because of the high credit of the government, believed these silver tokens would be maintained on a gold basis. They, therefore, accepted them at their purported value. Except for this belief (which would, of course, have been dispelled had free coinage been permitted), the purchasing power of the silver tokens would only have been that of silver bullion.*

A remarkable idiosyncrasy, oftentimes observable in those who advocate a debased form of currency, is a belief that the more there is of such money the more valuable it will become. This notwithstanding the experience of mankind proves the reverse to be the case. It is a delusion and, like all delusions, it is idle to combat it. Experience is lost upon those who give it expression.

*I cannot refrain from saying here, in this connection, that whatever the financial and commercial world shall fix upon as the circulating medium, whether it be gold or something else, all other forms of currency must be made redeemable therein, whether they take the shape of paper or other device. If this fact is always borne in mind and insisted upon, men and women can never go astray in their conclusions as to what constitutes money.

The United States has in its short history sounded all the depths and shoals of financial delusion. Its experience affords illustrations of every form of financial heresy which has afflicted men since they emerged from savagery. Those who are inclined to experiment in such matters, or to accept their unaided judgment in preference to the experience of mankind, cannot do better than study the financial methods of the United States. The subject is rendered doubly interesting by the fact that mankind are not yet through experimenting.

A currency not redeemable at sight in real money occasions labor peculiar hardships, for, while wages are fixed at long intervals, the fluctuations of such a currency are of hourly occurrence. Thus the rate of wages agreed upon between employer and employe to-day may lose (indeed is quite likely to lose) a part of its purchasing power before the question can be taken up again. Moreover, in fixing wages employers ever contemplate a rise in the value of such a circulating medium. It is a risk they must provide for. If, therefore, its value decreases rather than increases, their profit is further augmented. Such are the vicissitudes of a debased currency. But no matter whether its value goes up or down, the employer is bound to insure himself against loss. He would be unwise not to do so.

A discredited nation pays enormous usury for its folly. Benumbed by its isolation and disgrace,

it quickly becomes an outcast. The busy world avoids it, as men avoid a hospital in which lepers lie. No wise man will associate with a dishonored person. It is the same with nations. That which operates to injure a man, operates similarly with communities. A country which does a thing the world designates as foolish or dishonest, courts the fate of the fool or rogue. It is avoided, and although its citizens may cry to passers-by, "We have something which it is very much to your advantage to invest in," they are ignored and their plea disregarded. For it is the experience of mankind that he who deals with a fool or rogue is an ass who endangers his capital and risks his good name. No inducement of gain is sufficient to overcome the general distrust. Such a country is shunned, and wisely, just as rogues are shunned.

A district like Turkestan which was at one period separated from the world by impassable barriers, may, so long as thus separated, adopt any kind of currency it pleases. It has no commerce. But the moment it buys and sells in other countries it must adopt their form of money or suffer the disadvantages that follow. A country having relations with the outside world must adopt the circulating medium of the world.

The discredit which attaches to a country afflicted with a fluctuating currency reacts especially and disastrously, as I have pointed out, on those of its people who work for wages. Both the area of their usefulness and the value of their

services are reduced. This, because great business activity can only be secured when every advantage is present, such as a strong government, the confidence of the financial world (at home and abroad), abundance of capital and low rates of interest. These are fundamental.

Nor do wages increase as the value (purchasing power) of the circulating medium decreases. Directly the reverse. In 1885 the Mexican silver dollar was at par with gold. In 1897 it was only worth about forty-eight cents in gold. Yet the wages paid the laborer were not increased; directly the contrary. But everything that was imported which the laborer used (or once used) doubled in price.

A nation which adopts a debased currency multiplies the hardships of its citizens indefinitely. Thus, the withdrawal of capital, local and foreign, which the loss of confidence that follows involves, causes industries of all kinds to shrink, prevents the introduction of new enterprises and destroys others which, except for this, would be carried on successfully. The result is a corresponding falling off in the demand for labor. This throws many out of employment, and the sharp competition that follows for the work which is left ends in lessening the compensation of those who find something to do.

Where a fluctuating currency exists, capital, in order to insure itself against the risk it runs, exacts usurious returns, and in estimating its risks a wide margin is taken. It demands in

every case special guaranties and exacting concessions, if the prospect of enormous gain is not apparent. Enterprise in every direction is burdened. The risks investors are willing to take in more favored countries the borrower, under such circumstances, must assume. The lender must be assured that the tokens he is to receive will net such a sum that, when converted into gold, will pay double, perhaps treble, what he would ask if the currency of the country conformed to that of the commercial nations of the world. That is what loose methods of business and loss of credit cost a community.

And further, it may be said, to illustrate this thought, railway employes who receive their wages in gold (or its equivalent) could not expect a like amount—in value—in silver, in the event free coinage of the latter were permitted on a basis disproportionate to gold, so long as the latter is the recognized money of the world. No. A man who got forty dollars a month might for a time not have his wages decreased, further than that the forty dollars would be depreciated dollars instead of good dollars. But this could not be if his wages were to procure for himself or his family what they bought before in gold. But pleas of this kind would avail him nothing. To enable railroad companies to keep up the wages of their employes to the gold standard, they would have to increase correspondingly their business or rates. Thus, if in a change from gold to silver, the latter were worth relatively

only half its face in gold, either the business or the rates would have to be doubled. But is it likely a community would permit an increase of rates? Even if it did, the shrinkage in the business of the country which would follow loss of credit in the financial world would so lessen the revenues of railroads as to render it utterly impossible for them to keep up the wages of employes to the former gold standard. This would be equally true of employers in other branches of trade.

In nearly every country it is the margin afforded by foreign capital which supplies the means for extending old improvements and developing new ones. Without such capital, the enterprises they foster would not exist, and to the extent that this was so, the construction of railroads, and the opening of manufactories, mines and other sources of industry would languish. And if it should occur that, through unwise legislation or otherwise, the credit of the United States (or indeed of any stable country) should be impaired, the truth of what I say would quickly make itself apparent in the general falling off in business which would ensue. This shrinkage would throw many out of employment, and in the struggle of the idle to secure work they would, as already intimated, be led through their necessities to underbid those who had employment. Thus wages would be pulled down again and again in the struggle, until they barely sufficed to enable men to live.

While this would be true in regard to wages, it would not be the same in the case of food and clothing. The market of the world fixes the price of bread products as it does of wool and cotton. If the price of wheat were fifty cents a bushel in gold, it would be twice that in silver, on the basis of the value of silver in 1897. So that the workman who got his flour for two dollars and a half in gold would have to pay five dollars for it in silver. The price would advance in the same way for woolen and cotton garments. Thus, while he received in silver only what he might have received, under a stable government, in gold, his necessities would cost him twice as much. This is what cheap or plentiful money, so-called, means to those who work for wages. The picture is the experience of men, the fate which overtakes the poor in every country where a debased currency is permitted.

They are grievously misled who believe that a country can ever be benefited by adopting an unstable currency. Those who owe money on farms, homesteads, and other property, not easily and quickly convertible, like wheat, would under such circumstances, instead of finding relief, be glad, in the majority of cases, to let the lender take the property for the amount of his debt. For with departing prosperity would vanish the resources with which the debtor expected to pay. With shrinkage of business and consequent loss of prosperity, the value of farms, homesteads, and all other property of that nature, would

shrink correspondingly. There would be no surplus or speculative capital, and in consequence, demand would fall off so that a property or business which might be worth two thousand dollars when the credit of a country stood high, might not be worth half that sum in debased money, in a discredited country. Under such conditions, a farmer or land owner who might receive twice as much for his produce in debased money as he would in gold, and might use such money to pay his debts and thereby greatly facilitate such payment, would lose in the end, because everything he had which did not have a world-wide market, like wheat, would be cut in two again and again in value, as the credit of his country sank lower and lower in the estimation of the honest people of the world.

It is unavoidable that enormous losses should ever attend a change from a stable to an unstable currency. They will be caused by a variety of reasons. But immediately and directly by the disappearance of real money, by loss of credit at home and abroad, by the withdrawal of local and foreign capital which will follow, by readjustment of values on extreme lines; and finally in new countries, like the United States, by a cessation of emigration, for men will not emigrate to a country which is financially dishonored. Notwithstanding the experience of mankind, however, in this respect, there are, in every country, more or less sincere but misinformed people who believe that in some way they will be benefited by a

debased currency; that money will be easier under such circumstances. It is enough to say that in such a country there is little call for money of any kind. But to those who believe that borrowers will be benefited by such a state of affairs, it is enough to point out that when money may be freely borrowed in London and Amsterdam at three per cent. on approved securities, from twenty to twenty-five per cent. is asked by the same men for loans placed in discredited countries. In other words, while capitalists gladly lend their money at three per cent. (or current rates), to those worthy of trust, they charge discredited people from twenty to twenty-five per cent. And furthermore, it is only in exceptional cases, and under peculiar and harassing guaranties, be it remembered, that the latter can obtain money at all. Where others have but to ask, they must implore, supplicate, pawn all they have.

A debased currency is the most destructive device ever invented by man to oppress those who borrow, as well as those who work for wages. And as all the nations of the world but two or three are borrowers, and all mankind, save a favored few, are workers, the measure of hardship such a condition of affairs entails, words cannot depict nor imagination paint. And in the case of railroads (the index of every kind of prosperity in our day), nothing more effective, it may be said, could be invented for lowering the social status of employes, or be more effective in preventing the building of new lines, or the improvement

or extension of old ones, than a debased currency. Let us hope that the unhappy conditions I have pointed out may never arise in the United States, nor indeed in any country where this will be read, but however that may be, their discussion forms a fit corollary of the subject of Railway Finance

CHAPTER II.

BASIS AND METHOD OF CAPITALIZING RAILROADS.

The risks that attend the investment of capital in new railroads or the improvement of old ones, where the return is doubtful, enforce abnormal rates of interest. The discount suffered will depend on the plentifulness of money and the probable productiveness of the property, the latter being underestimated rather than overestimated. When money is scarce or the security doubtful, the rate of interest will be high and the price the securities will bring will be low.

The influences that affect the capitalization of railways are very imperfectly understood, and the methods that it is necessary to follow in order to secure the money needed in the construction of these enterprises have been severely and unjustly criticised. This criticism, however, is not confined to any particular country. It is the common theme of idealists and ignorant men everywhere. The practical realities of life never conform to the illusions of such people. They approach a business proposition in the spirit that a child does the construction of a blockhouse, or a mathematician anticipates the solution of a problem wherein the processes are preconceived

and the result certain. The necessities of business and the compromises of conflicting interests they know nothing about, and do not therefore regard. Different circumstances and surroundings are as if they were not; and the peculiarities of men and the requirements of capital cut no figure in their child world. It is their happy fortune to be always superior to facts. They live in a world quite apart, where men are not led to achieve results because of a love of money, but are animated by a lofty public spirit; a world wherein mankind labor for the public good while their children starve. This class comprises a very large number. It looks upon itself as the public guardian. To it the acquisition of wealth in railroads is, as a rule, treated as a misfortune, not a thing in which the people share. It speaks of railway corporations indifferently as extortionists, and of railway managers as robbers. It does not recognize that owners have either wisdom or honesty, and is generally a warm advocate of public interference and supervision.

Generally speaking, the capitalization of railways represents their cost; neither more nor less. It includes commissions paid, interest during the period of construction, and discount suffered on the securities sold. If the credit of a company is such as to enable it to sell its securities at a premium, the amount realized goes to reduce capital.

Cost per mile varies greatly upon different roads. The extent of a property, it is apparent, depends on the traffic to be handled. Cost is

especially affected by alignment, grades, labor, equipment, and right of way. Many items are affected by the nearness or remoteness of markets. How far, if at all, a company may issue shares (to its owners) at par to cover construction work, when such shares command a premium, is a subject about which men differ. In some cases the practice is forbidden by law.

The increase of capital per mile of road since the inauguration of railways has been much greater in England than elsewhere. This is due partly to outlays for facilities at terminals, and partly to investments in collateral enterprises. The comparatively small increase in the United States is owing, in a measure, to the fact that much of the construction work has been paid for out of earnings not yet capitalized; in other words, profits instead of being divided in full among owners, in the shape of dividends, have been used to make improvements.

The basis of capitalization of railways is cost. If America has departed from this rule, it has been on the safe side; on the side of reduced capitalization. Of this there can be no doubt, theories and general impressions to the contrary notwithstanding.

In reference to the methods of raising money for the construction of railway properties, they vary greatly. Railways are, however, coming more and more to be built under the supervision of companies already established. These latter are in such cases guarantors. In many instances

they issue their own securities, hypothecating those of the new enterprises. Thus the latter receive the benefit of the credit of the established company.

The importance to be attached to estimates of the cost of railroads to be built, and their probable productiveness afterward, depend upon the character and experience of the men making them. It is not an unusual thing for cost to double or treble the estimates. Investors should, therefore, scrutinize the character and practical knowledge of men back of every railway enterprise.

To be of value, estimates of cost must be made by capable engineers. Abundance of time must be taken. Men of different experience are required to forecast the future of properties. Both may be done with reasonable accuracy, but the many instances in which estimates of cost and forecasts of business have proven delusive should teach those having money to invest in enterprises of this character to exercise care.

The value of the securities of prospective railways, unless guaranteed by a stable concern, is always more or less a question of doubt. Such properties are largely speculative, and like all speculative enterprises must be liberally discounted. They do not come within the domain of those who cannot risk the loss of a part or the whole of their capital. They afford a field only for capitalists who are able to assume such risks. The risk in the United States may be seen in the

number and character of railroads which have passed through the hands of receivers. The promoters who, by specious arguments and false representations, have induced the people of Europe to invest in worthless railway securities in the United States, can hardly be counted. The result has been highly disastrous to the credit of the country and a great injustice to the people who have placed confidence in their statements.

During the early history of railroads little was written about them by practical railroad men. Theorists occupied the field. A few phases of railway operation, such as pools and accidents, they grasped. However, they have never been content to confine themselves to subjects they understand. They believe themselves to be cosmopolitan—each has his theme; each his particular subject. He sees in it, however, the all in all of railway life. One finds it in heightened facilities; another in the abolition of class privileges; another in better protection of life; another in lower charges; another in more stable tariffs; another in the abolition of all traffic distinctions; another in the abolishment of passes; another in government supervision; another in government ownership; another in the enforcement of agreements between railroad companies; another in restricted railway construction; another in prevention of fictitious capital; another in securing more adequate returns and accounts; another in better management; another in prevention of speculative tendencies on the part of

owners; another in greater interest in the welfare of railway employes; another in curbing the prejudices and passions of the people; another in preventing hasty and inconsiderate legislation. The subject is an endless one. Each writer pursues his theme with fervor amidst the acclaim of friends and ignorant lookers-on. All these writers are, in the main, honest; all are fully assured of the efficacy of their panacea; each believes it to be the one thing necessary. In the generality of cases the views they express are empirical. They take no account of natural progress and evolution, or the practical habits and needs of men.

Every evil in railway administration contains within itself its own cure. When the cure is thus effected, it is equitable and lasting. Railway critics will not, however, await this slow and beneficent process.

The capitalization of railway property has always been a favorite theme with writers and speakers. It has not been necessary for them to know anything definitely about the subject. They have had simply to cry injustice, fraud, wrong.

Notwithstanding this and the current belief of many, capitalization of railway property in America and elsewhere is based on equitable grounds. The exceptions are few and unworthy of notice. But the methods of owners in regard to capitalization are not uniform, any more than they are uniform in other things. Thus, the

owners of railroads differ widely in regard to the disposition they make of surplus revenue. In Europe it has been the rule to divide it among the proprietors to the last farthing, every cent spent for construction being capitalized. In the United States it has been a very general custom of railway companies to put a portion of their net earnings into needed additions and improvements. In some cases this is capitalized afterward, but more often not. Such use of a company's surplus is, however, always in the nature of a loan. In making it, the owners clearly do not relinquish the right to capitalize it whenever their interests will be benefited thereby. Loose and ignorant writers sweepingly designate increases of capital of this kind as watered stock. This is wrong from every point of view, but its immediate effect is to injure the owners of railways in the minds of the public. They are blamed for benefits conferred on the community. This suggests the need, in the United States, of a self-respecting class which will frown down unwarranted criticism of railroad corporations with the same spirit that they would condemn efforts to destroy the credit of merchants, manufacturers and banks. The result is equally bad.

The era of railway construction has been one of change; of financial evolution; of periods of great prosperity, followed by distressing reverses. It is the same with these properties as with other great interests. Whenever more money is put

into them than the community can spare, or it is unwisely placed, reaction follows, as in the case of overinvestment or unproductive outlay elsewhere.

The cost of railway construction in the United States for the twenty-five years from 1870 to 1895, about equals the savings of the people from reduced rates during that period. The added facilities were constructed out of profits saved to the community. "Had the actual quantity of merchandise moved by the railroads in the year 1880 been subjected to the average rate per ton per mile which was charged from 1866 to 1869, inclusive, the difference would have amounted to at least five hundred millions of dollars, and perhaps eight hundred millions of dollars, more than the actual charge of 1880."*

Political economists are not agreed as to the ratio the capital of a railway should bear to gross earnings. It has been stated that it should not exceed ten times the yearly receipts.† Estimates of this kind are unprofitable. The cost of operating, quite as much as earnings, determines the

* Edward Atkinson, "The Distribution of Products." The reduction in rates in New York for 1883, as compared with the rates of 1870, amounted to \$74,549,000, and in Ohio to \$89,400,000. It is estimated that the reduction of rates (i. e., the amount saved to the people) in the year 1883 for the country at large amounted to \$400,000,000. M. M. K.

† "It has been held by high financial authorities that, in order to be a commercial success, a railway should not cost more than ten times the amount of its yearly traffic; or in other words, the annual traffic should be 10 per cent. of its capital cost."—J. S. Jeans, "*Railway Problems*," page 25.

percentage of profit. So long as it costs in one case fifty per cent. of gross earnings, and in another seventy per cent., to operate a property, it is apparent that no uniform standard of capitalization based on gross earnings is possible. On the other hand, it is a safe statement to make to say that a property should not be capitalized beyond a moderate return on its business. Cost should be restricted as much as possible consistently with the object the property is intended to serve.

The excessive cost of operating the English roads consequent upon their prodigal outlay for safety appliances is said to seriously cripple England's internal industries, rates being so high in many cases as to prevent competition with more favored localities. It has been claimed that the low rates of American railways will ultimately drive the interior manufacturers of England out of the market if their carriers do not find a way to reduce rates.

America is indebted for her low rates to free railway construction and active competition. England has not been subjected to the stimulating effect of the former.

The elaborate safety devices of English roads have added much both to cost of construction and working. The hypothetical safeguards there thrown around life have grievously burdened the country at large; they have made the cost of food and clothing dear in order that the careless members of the community may not be run over.

They have denied the poor many necessities and comforts of life in order that the absent minded, the tramp and the drunkard might be safe. This is an extreme way to state the case, but it is true.

It is fashionable to claim that every safety device introduced is a gain—a step forward. This is a superficial way of viewing it. Practically every safety device which adds to the cost of doing business (over and above what the device saves) is a perpetual tax on the community, like money sunk in any other enterprise which does not yield a return. It is in matters of this kind that the practical common sense of business men is a safer guide than the theories of the engineer or publicist. The business man provides only when the urgency is great; when the time is ripe. Others provide wherever necessary to theoretical perfection. In the case of the engineer, perfection is a part of his education and necessary to substantiate his skill and reputation. He is a magnificent idealist. Nor do governments or communities stop to think of such outlays. They simply see that a safeguard is missing. The hardships that injudicious expenditures of money in its attainment will entail, the industries it will prevent, the heightened cost of food and clothes it will precipitate, they do not for a moment consider.

The disposition to sink money in romantic efforts to save life in connection with railroads, which are not deemed necessary in connection

with our common highways, has always struck me as the acme of folly. Thus the block system has been made compulsory in many countries. It pleases the idealist but strikes more practical men with a chill, because it greatly increases cost and thereby decreases facilities. It absorbs money needed for more necessary things. Instead of making the roads that are little used conform to the block system, a reduction in speed of trains should have been prescribed and other devices of a simple and practical nature introduced, but uniformity would not have been attained and the dramatic effect governments seek would have been lost.

The safety appliances of railroads resolve themselves, like everything else, into a purely practical question, a question of ways and means. Governments will not, however, view the subject in this way. To them a thousand people starving in silence is not so distressing as the dramatic death of a single man at some railway crossing. The subject should be stripped of sentiment.

The limit of expenditure for safety appliances cannot be fixed, but must be determined for each property apart. It should go as far as circumstances warrant and no further. In making such expenditures it should be remembered that every dollar saved to the owners of railroads in this direction is a dollar laid away to be used to build and operate railroads and factories, and to the extent this is so employment is given those who

must work; those who must provide bread and clothing for dependent wives and children.

Many countries have sought systematically to direct and control capitalization. Thus, England sought through the law to compel two-thirds of the money to be raised by the sale of stock. Only one-third could be raised by bonds or debentures. In the United States, on the other hand, greater discretion has been permitted the projectors of railroads. Differences in practice do not imply wrong or improper methods. It has been necessitated in this case by different conditions. In one case the investment has been practically secure; in the other speculative; in one country money has been plentiful, in the other scarce.

Differences in method of capitalization in England and America are accentuated by differences in cost. The greater cost in the former country is occasioned largely by the high price paid for right of way and the ideal thoroughness with which work is done before roads are thrown open for business.

Government aid has been a factor in railway construction on the continent. In Great Britain, however, the government has never in a single instance guaranteed the debt of a railroad. The wealth, courage and commercial enterprise of the people have rendered such a course unnecessary. Guarantees have, however, been freely made in the British colonies. In new countries the aid extended to railroad companies commonly takes

the form of concessions of land and local assistance. This is the form it has taken in the United States, except in the case of the Pacific roads, which the government, for political reasons, aided by guaranties.

CHAPTER III.

CAPITALIZATION AND MANAGEMENT; METHODS PURSUED BY DIFFERENT GOVERNMENTS.

Wide fluctuations in the dividends of railroads suggest widely different causes to investors and others. In the case of corporations paying small dividends, or paying no dividends at all, the inquiry suggests itself: Were the roads needed; will they ultimately be productive; were they wisely located; were they properly constructed; are they efficiently managed; are they permitted to base their rates on economic laws (on what traffic will bear), or are they oppressed in this respect by the government?

The productiveness (net revenue) of railway property varies greatly in different sections of the same country. Thus the average for the northwestern portion of the United States was for a long time scarcely one-third what it was in the Eastern states, and the agrarian spirit that characterized the section in question seemed likely to still further increase the disparity. Happily, conditions have changed until the capital stock of the roads located in the section referred to stands as high as any in the world.

Under normal conditions railway returns should grow steadily better, because the property should

grow stronger with the development of the country it does so much to build up. Wherever this improvement is lacking, it indicates want of commercial enterprise, or thrift.

The English companies very generally paid dividends from the start. No American company did this, and only the higher classes made adequate return on a part of their cost. The wide fluctuations in the securities of the railroads of the United States caused them at one period to be generally distrusted. Their shares were little esteemed by investors. Mortgage bonds were the favorite form of investment. In England, on the other hand, capital shares were always from the first the popular form of investment. However, with the growing cost of their railroads and increased capitalization, debenture stock (which partakes of the nature of a mortgage) is becoming a favorite form of investment.

The growth of railway mileage and productivity has been greater in the United States than in any other country. This result has been achieved without injury to anyone. Improved methods of business have kept pace with increased needs, while decrease in rates has been steady and marked. This decrease is fully eighty per cent. of the original charge. Reductions have been made in other countries, but only to a very limited extent compared with those of America. How much further it will be possible to reduce rates in America, it is impossible to tell. Much will depend upon the law-making

power and the spirit in which the laws are enforced. Both must conform to the laws of trade and commercial needs.

The ability of a railroad company to capitalize its property on favorable terms depends, as I have intimated elsewhere, upon the plentifulness of money and confidence in the ability of the property to earn a return on the investment. The last, it is manifest, depends upon the productiveness of the country, its friendliness, the economy and skill used in construction and, finally, the experience and fidelity of managers. This last may be said to be assured.

There is no difference, so far as the injury the public sustains, between improvident management of private owners and that of the government. Railroads that cannot pay a return on the capital invested should not be built. The injury that a community suffers from the construction of unproductive roads, or those improperly managed, cannot be measured in dollars and cents.

Every dollar lost or wasted in railway construction or administration impoverishes the community to that extent. If roads do not earn what they might be made to earn, the loss falls on the owners and thus on the community. Railways that cannot earn a return on their capital are like unprofitable manufactories, a curse to a country.

In the United States and England, where commercial needs have been left free to govern the construction of railroads, only such properties

as are needed should have been built and, consequently, only productive properties (present or prospective) should exist. That the contrary is true is due to excessive enterprise and speculation.

Wherever a line is located on other than business grounds, whether to conserve military or other ends, its maintenance becomes a perpetual tax on the community, just as much as the army or navy of a country is a tax.

Nowhere do railroads cost so much per mile as in England. Correspondingly, however, their traffic is larger. The English roads are effectively and honestly constructed and ably and efficiently managed. The return on the capital invested is generally satisfactory. The expense of operating English roads is more per train mile than on the continent, and less than in the United States. The average load is, however, much less than in the United States. On the basis of cost per ton or per passenger per mile—the only true basis—the expense of maintenance and working is much greater in Great Britain than in America. The relative cost, progressively, per unit of increase of net revenue is also much greater in England than in the United States. In the United States four millions were found sufficient to increase net earnings seventy-two millions; in England ten millions were needed to increase net earnings six millions.*

* For particulars in regard to details of capitalization of English railroads and other matters incident thereto, see Appendix A.

The difference in cost of railways per mile in the United States as compared with those of Europe, although very large, is not so great as appears from the accounts. The disparity is due in part, as I have noticed elsewhere, to the fact that a great deal of construction work in the United States has been paid for out of net earnings. But after allowing for this, the cost of right of way and station and yard facilities in the United States has been very much less per mile of road or unit of service than in any other country with which its railway system may properly be compared. The low cost of American roads is, however, in the main due to the fact that the owners of railroads were not held to any hard and fast rule by government officials, but were left free to build according to their judgment of what was best. The country thus got the benefit of their prudent and economical methods. Government interference in the United States has come too late to make her railroads costly, but not too late, if ill advised, to make their operations wasteful and injurious to the country.

The policy that different governments first adopted in regard to railways, they have generally followed. In some countries ownership by the government was contemplated at the start and the anticipation has borne fruit. Authorizations of railroads have not been the same from year to year, but have been modified as experience or interest suggested. Thus, rights freely accorded early railroads have been grudgingly

granted or wholly denied later applicants. But no great hardship has followed.

In the United States, railroads are chartered by the various states, sometimes under general laws, sometimes under special acts. The railroads, while amenable to the police regulations of every township through which they pass, are governed by the regulations of the state. Each state has the right to determine the method of capitalization within its boundaries and fix the amount of taxes. The general government has jurisdiction only over interstate traffic. Both the general government and the various state governments have commissioners to look after their interests, respectively. Their action, however, is subject to revision by the courts.

In France the railway system is owned partly by the state and partly by private companies. Government interference, however, is active. It was the original intention that all railways accorded guaranties and immunities by the government should become the property of the state at the expiration of a certain period. In 1883, however, because of the financial troubles of the government, and the strong competition of private companies, the government found it necessary to relinquish its right to purchase. In regard to auxiliary railroads constructed after that date, it has been provided that the constructing company shall bear a part of the burden and the government a part. The builder shall, however, provide all the money in the first instance, the state agreeing to

make annual payments to it on account of interest thereon, and for the further purpose of creating a sinking fund to extinguish the principal by the time the concessions terminate, at which period the road will become the property of the state. The French government designates the territory each railroad shall occupy, and protects it therein. The lines thus have a local monopoly. The bulk of the French lines is owned and operated by private companies, occupying distinct territories. The price paid for the intervention of the French government is greater, in many instances, than would be allowed if the value of independent management of railways was better understood or more fully permitted. Thus, the government requires the free transportation of its mails and a very low rate for its military and civil servants, and, in addition to other enactments, levies a duty or income tax amounting to ten per cent. on certain classes of earnings,

Governmental interference in France is not such as to suggest imitation elsewhere. It has greatly lessened individual interest, and, through its cumbersome exactions, has materially modified railway enterprise. The French system is said to be extravagant and top-heavy. The government, in its zeal to protect everybody, has carried its interference beyond the bounds of conservative action. The supervisory power of the French government is both costly and annoying. Intended originally to protect the people, it has ended by becoming a burden. But this is

(up to this time) the effect of government management everywhere and under all circumstances. It is not confined to France. Government interference in the case of railroads is more injurious than in other cases, because of the complex character of these properties and their intimate influence on all the affairs of life. No matter how admirable government management may be, it cannot be so wise, so attentive, so alert to the needs of trade as the situation requires. It is not adaptive, and is, moreover, expensive, slow and cumbersome.*

The debenture or bond system of capitalization is more favorably viewed by the French people than any other. Stocks, unless guaranteed, are too uncertain for these thrifty and cautious people. They require definite guaranties; a specific agreement as to the extent of the return and date of payment. The French are greatly to be admired. No people are so apprehensive of commercial results as they, so quick to take advantage of them, or so careful in preserving the fruits of their industry, frugality and foresight.

Germany exercises a supervision over its railroads such as we might expect from a military government. It requires to be consulted in advance in regard to the route roads propose to traverse, the nature of their construction and equipment, capitalization, sinking funds and

*I refer here only incidentally to government control of railroads. The subject is discussed more fully in another book, "Economic Theory of Rates."

working arrangements. The state has from the start extended more or less aid to railroads, reserving the right to purchase at pleasure, subject to certain conditions as regards time and price. The German government enters with military precision and autocratic power into every detail of railway operation. It scrutinizes with particularity all construction work; fitness, adequacy and handling of equipment; administration of property; expense of operating; details of receipts, and finally, the inspection of trains, stations and other property. Its admirable bureaucratic system, the result of many years of patient and systematic work under a stable government, in a measure redeems its operations from the cruel hardships that generally characterize government management. But notwithstanding this its railroads would be operated with much greater efficiency if they were in the hands of private citizens.

In Austria the bulk of the railway securities are guaranteed by the government, and the properties, save their equipment, revert to it at the expiration of ninety years. The Austria-Hungarian government, like that of Germany, has a highly creditable civil service, and performs what it undertakes with more than average efficiency. It is not able, however, to supply the place of private talent, experience and interest. It strives to throw around railway construction and management every needed safeguard. But like the emanations of other governments under similar

circumstances, its regulations are more specious than real. Thus, one of them provides that in the event the profits of a railroad exceed fifteen per cent., the government shall have the right to reduce them to that figure!*

In Belgium the government has interested itself directly and actively in the operation of railroads from the start. It first took upon itself to provide the land they needed. Afterward, its intervention extended to the work of construction and management. It practically owns all the railroads in the kingdom. In some cases they are leased to private parties; in others they are managed directly by the state.

The Italian railroads were built partly by the government and partly by private parties. State guarantees were, however, important. The government exercises a strict supervision over affairs. The railroad system is vested in two great companies having leases for sixty years, with the right to relinquish to the government at the end of twenty or forty years. Rental to be paid the government is based on a reciprocal division of receipts.

In Holland the railways were constructed by the government with public moneys. The working of the roads is, however, intrusted to private parties, the state participating in the revenues on an agreed scale.

* This is one of the reservations governments make that seem so sagacious, but that are really unnecessary, unbusiness-like and absurd.

The number of railways built and managed by private corporations in Russia is greater, relatively, it is said, than in any other country on the continent of Europe; but private management, it is thought, will not continue permanently, the nature of the country and the military exigencies of the government rendering final possession of the railroads by the government almost a certainty. However, the power of the Czar is such as to give him control tantamount to that of individual ownership. The bulk of the railroads in Russia have been fostered by governmental aid, conditioned upon the lines reverting to the state under certain conditions.

Such is, briefly, a history of the development and capitalization of the railroads of some of the great countries of the world. In comparing the methods that have attended the inception, growth and administration of railroads, the superior wisdom and sagacity of the government of Great Britain is apparent. It has believed from the start that the greatest good was to be attained by encouraging individuals to take the initiative, and by granting them sole power and responsibility of management. It has not reserved to itself powers that could by any possibility embarrass owners or cripple the capacity of properties. Its intervention has never extended further than to prevent two roads being built where one only was needed. Wisdom such as it has displayed is rare in the history of mankind, but such as we might expect from a nation of business

men who, by conservatism, energy and wise administration of affairs, have made that country the greatest the world has ever known. The business men of America are not less wise, not less conservative, not less energetic than their English cousins. The action of the two governments has from the start been based on purely commercial grounds. It has been such as the greatness of the occasion and the exigencies of railway property required. It may well find favor and imitation in other less worldly wise countries.

CHAPTER IV.

INFLUENCES FAVORABLE AND OTHERWISE ON THE CAPITALIZATION OF RAILROADS.

In capitalizing railways, care ought always to be exercised, so far as it is practicable, not to issue a form of security which may at some future time make those holding it antagonistic to the permanent interests of the property. That will prevent a conservative course being followed. That may have the effect to trench on necessary reserves, or suggest reckless financiering in other directions. Circumstances, however, sometimes compel such a course; the financial situation of a property may be such as to prevent consideration of future contingencies. The vicissitudes of business afford many illustrations of this kind, in private life as well as in corporate experience. While they are to be deplored, they cannot be remedied nor their consequences avoided. Business men live in a practical world, and provide as best they may for its wants as they occur, leaving it to their successors to do the same. However, an emergency that compels a disregard of the future in corporate existence must be real and pressing; nothing else can excuse it. Such an occasion may justify the issue of an income

bond or a stock upon which no dividend can be paid until a certain return has been made on a prior security. But such a thing is sure, sooner or later, to create antagonisms between holders. When this occurs, the scales of justice cannot be evenly balanced nor properties impartially administered. Whenever it is in the power of a particular class of holders to take advantage of another class of holders, we may be certain that they will do so. Such struggles, however, teach men wisdom, self-reliance, foresight and prudence, and are not, therefore, unmixed evils.

The holders of different kinds of railway securities largely represent different classes of people. Those whose fortunes require a definite and sure income are conservative and invest only in securities of a high class. Many business men and capitalists are attracted only by securities of this kind. Those not so conservative, or to whom present income is not a matter of especial concern, take into account the future possibilities of a property. The speculative classes invest in anything they think they may make money out of. They are like the fireflies that glimmer in the dusk of a summer's evening, now here, now there, but affording neither light to guide nor fire to warm.

Under normal conditions the price of railway securities is based on present returns, conditioned on future probabilities. Capital is extremely sensitive to extraneous influences, such as unfriendly

legislation, or possible reverses of business. Every influence of this kind is carefully weighed by prudent investors and fully discounted in advance. Many securities do not, unfortunately, command a price proportionate to their value, because of not being fully known to those who have money to invest in enterprises of this character. On the other hand, many securities command a much greater price than their relative worth justifies, because of being well known and generally traded in.

The holders of railway securities are highly apprehensive. In nothing is their business-like character so quickly and unmistakably evinced as in its condemnation of attempts to bolster up the price of securities by such fictitious aids as the payment of unearned dividends or a division of profits required to be reinvested in the property. Such action always results eventually in weakening securities. Thus it frequently happens that a dividend will depreciate a stock to a much greater extent than the amount divided. So well is this understood in the United States that conservative men who manage railways will not declare a dividend for a sum greater than the actual financial affairs of the company warrant, erring, if they err at all, on the safe side.

In the inception of railways in America it was designed that they should be constructed wholly with the proceeds of capital stock. But the discretion such form of security afforded those charged with management (as to time and amount of

return to be rendered holders) did not satisfy investors. Not that managers were generally unfaithful, but that results did not realize the expectations of owners, and they did not have the control over their property they desired. Hence, while capital stock was not wholly abandoned, mortgage bonds and other forms of security, definite as regards returns, took its place. The wisdom of this course cannot be doubted.

The construction of a railway is attended by an almost infinite variety of influences, as regards available means and probable productiveness of the property. Upon these the amount and nature of its capitalization directly depend. The securities issued, whatever their amount or form, represent the property. They are the axis about which everything revolves; the center of expectation and desire; the tangible evidence of ownership, of accumulated wealth, of hope of income or gain. Their fluctuations in the market are consequently marked by gladness or sorrow, comfort or deprivation, abundance or want of holders.

The uniformity of relation that net income bears to capital over the world is an evidence of the wisdom of the capitalistic class. It proves that, notwithstanding the vagaries of governments and peoples, the expectations of capital in all stable countries have been fulfilled.

Because of unavoidable limitations, investments in railways cannot exceed, if they equal, rates of interest in other directions. But they should not fall far below, and when they do, it

indicates abnormal conditions which should be remedied.

The greatest possible differences exist as to the relation earnings and expenses of railroads bear to each other. The relation, whatever it may be, is generally construed as indicating the relative value of properties, or the wisdom and economy exercised in working them. It varies, however, very much from year to year.

Railways generally may be depended upon to show the best results whose organization is the best. Wisdom in organizing precedes skill and fidelity in managing. Only the securities of such companies afford safe investments; only such should be traded in. Others may be stable for a time, but are unsafe.

Men differ greatly in opinion in regard to methods of management. From the results achieved, many believe the administration of railroads in the United States to be the best in the world; that no others equal it in ability to achieve great ends with so little friction or at so small a cost. Moreover, it grows each day more effective, each day better, each day more accountable.

Corporations managed by private owners are the most effective, and the most useful to the community. The percentage of expenses to earnings in the case of private ownership is considerably less under like conditions than state management. It has been demonstrated, over and over again, that government control is more expensive than

that of private management, but in considering the difference in cost it should be remembered that the loss to the community is only represented, in part, by the difference in expense of working under government management as compared with private ownership. Waste in expenses represents high rates. Economical management, low rates. Under one many industries are impossible that may be carried on profitably under the other. Extravagance in the management of railways ever means more to the public than the difference in the amount of the expense account.

Of the factors that affect the productiveness of capital invested in railways, cost of maintaining and operating are ever quite as important as gross revenue. The cost of operating is being decreased year by year, as we become more experienced and possess better appliances, but the cost of maintenance is not so sensibly affected by these influences.

CHAPTER V.

SOMETHING ABOUT THE CHARACTER OF DIFFERENT KINDS OF SECURITIES.

The capitalization of railways takes on that form which best conserves the interests of the property. Instances where this is not so are exceptions, exceptions to be guarded against, no doubt, but not to be made the occasion of embarrassing railroads generally.

Methods of capitalizing railways are few and simple, and such as investors understand. Men will not place funds in ventures difficult to comprehend or that they are unused to.

If the law takes cognizance at all of methods of capitalizing railways, it should prevent stocks or bonds being issued except for *bona fide* consideration, for new property or improvements. However, as a matter of fact, the intervention of the law-making power is not necessary, except to legalize what is done. Buyer and seller may be safely left to adjust details and arrange prices. Private citizens are able here, as elsewhere, to guard their own interests. Methods and forms arranged by individuals familiar with such matters, and personally concerned, will always be better than those of a perfunctory nature arranged by public officials to fit every occasion.

It is a purely practical question, to be settled between practical and self-adaptive people.

While wrongs have, no doubt attended the capitalization of particular railroads, personal surveillance and self-interest are more powerful to control and keep such matters in check than any other influences. The state has not suffered because of laxity in this respect. On the contrary, enormous advantages have accrued to it from the successful launching of railways, through individual enterprise, impossible under more complex forms.

Men who invest money look carefully to the security they get, and may be depended upon to hold in restraint those with whom they deal. If they fail to do so, the experience they gain through their losses is money well invested. Men are thus taught. On the other hand, governmental interference fosters ignorance and builds up a dependent instead of a self-reliant people.

In all matters of a commercial nature man's covetousness will crop out—will lead him to do things he ought not to do and omit to do things he ought to do. It has been so from the beginning and will be to the end. Acquisitiveness is the instinct of trade, and we make a mistake in attaching importance to many of the practices it gives rise to. Railway owners have been singled out for especial animadversion in this respect, while kindred practices on the part of merchants, ~~ma~~ manufacturers, bankers and others have passed

unnoticed. Those who own and operate railroads compare favorably with men engaged in other commercial pursuits. Their weaknesses are not on the whole prejudicial to public good; their lapses from virtue not more frequent than those of editors and farmers. When these lapses occur, it is wrong to attribute to them the importance of conditions. They should be treated, if criminal, as we treat criminal acts in other walks of life. But the whole railroad community should not be bound over to keep the peace because of them.

An extreme instance of deliberate wrong-doing is the case of those who build railroads without reference to their need or earnings power, with a view to making money out of their construction, capitalization or sale. Such transactions may properly be prevented by law, if it can be done without creating in the minds of the people a further desire to interfere through the legislature. A law requiring the projectors of railroads to secure the approval in advance of an impartial governmental board of experts would be a good thing, if we could be sure it would be honestly and wisely administered.

Concentrating the savings of many in the ownership of railways has been followed by similar concentration elsewhere. The tendency of the times is steadily in the direction of the consolidation of analogous interests, either in corporations or so-called trusts. We may inveigh against this tendency, but uselessly, because it

is responsive to the needs of mankind; is the outgrowth of competition—of the necessity there is to reduce expenses in order to afford owners of capital a margin of profit.

It is said that the capital invested in railroads represents in the neighborhood of a tenth of the wealth of the world and a third of its invested capital. Its relation to other industries is more likely to increase in magnitude than diminish with time. If wisely governed, its growth will be rapid; if unwisely governed, its growth will be slow. Each day adds to our experience and fits us better to cope with the subject. We notice this growing power in the disposition and ability of owners to manage great properties where they formerly found it difficult to manage small ones; in the growing tendency to consolidate scattering lines into great systems.

Within certain bounds concentration is a convenience to the public and a profit to owners. But it must be attended by enlarged and adaptive methods of administration. When a property passes beyond the immediate eye of its manager, when he can no longer watch each man and see what he is doing from hour to hour, responsible, co-operative governmental methods must be instituted. The trouble is that those affected by the change frequently do not know anything about responsible methods of government, or, if they do, will not conform thereto. Such cases call for quick and energetic action wherever it is expected properties will prove productive.

The benefits of consolidated properties have been added to by the practices of railroads of sending traffic through over connecting lines without rebilling or changing cars. Such arrangements have, so far as the public is concerned, the advantages of a continuous line. They add to the convenience, comfort and profit of the people, and stimulate their patriotism and broaden their understanding by leading them to undertake distant ventures they would not otherwise attempt.

In the construction, capitalization and operation of railroads, it is inevitable that unfair advantage should sometimes be taken of owners by their representatives. Such occurrences are, however, a mere incident of the situation, neither frequent nor important. I do not make them a feature of my writings, because such evils are unavoidable and carry within themselves the seeds of correction. The owners of railroads may be safely trusted to apply necessary remedies. It is idle to inveigh against such practices or formulate speculative remedies. They can only be reached effectively by the owner. His self-interest will prompt action and quicken his intelligence.

The securities of railroads may be safely left to the corporation that sells and to those who buy. Public solicitude here, as elsewhere, is not only injurious, but futile. If men are beguiled into unprofitable trades it teaches them wisdom; and wisdom thus acquired is a part of our

commercial greatness. Experience cannot be obtained in any less practical way. Governments cannot teach it, nor can laws render its possession unnecessary in life. The struggle between those who have something to sell and those who wish to buy is incessant. Injustice is oftentimes done, but it cannot be prevented by statutes or police regulations, and good eventually flows from it.

In the purchase of railway securities investors do not always get the security they think they do. Thus, a mortgage should be for a part only of the cost. Those who make loans on real estate only advance a portion of the value. The mortgage bonds of railways should be similarly supported. There would then be fewer roads in the hands of receivers, fewer disappointed bondholders. The precaution is a reasonable one.

When properties are built wholly with the proceeds of bonds, such securities are not as good as capital stock would be under similar circumstances. Such ventures lack financial elasticity. They cannot adjust themselves to the vicissitudes of business, and because of this are likely at any time to occasion a crisis highly detrimental to owners. Reasonable safety requires that only a portion of the cost of a property should be covered by bonds, or that such securities should be guaranteed by more stable properties. When thus supported, they offer greater attractions than capital stock, and may, therefore, as a rule, be sold to better advantage than stock

The English generally divide their capital account as between bonds (debentures) and preferred and common stock. The value of this division, and the relation each sustains to the other so as to secure advantageous results (especially in the case of established properties), is thus portrayed by an English writer on the subject.* “The smaller the percentage of bonds the greater the likelihood of some dividend being paid on the shares. Thus the proportion of capital upon which no dividend is paid is twice as great in the United States as in the United Kingdom. A large percentage of bonds has another very important consequence, namely, that it renders the line more susceptible of becoming bankrupt or falling into a receiver’s hands, or being wound up, as the case may be. A loss of earnings which in the case of a line with twenty-five per cent. of bonds would only involve a diminution of the dividend, might in the case of a line with fifty per cent. of bonds involve the appointment of a receiver. Now the defaults which have occurred on American lines have been one of the causes of the prevalent distrust of American railway securities. Thus a practical means of improving the credit of American railways would be by raising further capital, when required, by the issue of shares instead of bonds. The difference between English and American railways is marked. In the United Kingdom rather more than half the share capital consists

* Charles Eason, Jr., M. A.

of guaranteed and preference shares; while in the United States only about thirteen per cent. of the stock is preferred. . . The English companies consider it more beneficial to raise capital by the creation of preferred stock. A too large creation of preferential stock has disadvantages. It renders the ordinary stock more exposed to variations of dividend and the company more liable to the discredit of not paying full dividend on preference shares, and also impairs the control of the line by the ordinary shareholders, who are most interested in its successful management. It is not clear to me why the American lines have created so little preferred stock; for example, the Pennsylvania railway company has no preferred stock. Now, this company would find the same advantages from raising capital by means of preferred stock as are obtained by, say, the London and North-Western. The advantages are (1) as against the issue of bonds it has the advantage of giving additional security to the payment of interest upon existing mortgages, and (2) as against ordinary stock, it has the advantage of not tending to reduce the dividend upon the ordinary stock, which a creation of ordinary stock would have unless the capital expended yielded the full rate of dividend already being paid upon the ordinary shares. Thus, suppose five million dollars of capital to be required, the net revenue yielded will in no way be affected by the mode in which the money is raised, whether, let us say, by bonds at three and a half per cent.,

or preferred stock at four per cent., or ordinary stock on which a seven per cent. dividend is being paid. Let us suppose that the expenditure yields a net revenue of one hundred and fifty thousand dollars. In case one the debenture interest is increased by one hundred and seventy-five thousand dollars, there is twenty-five thousand dollars less for division among preferred and ordinary shareholders, and the margin of earnings over interest is diminished to this extent. In case two, the preferred stock requires an additional two hundred thousand dollars per annum. Thus the sum available for ordinary shareholders is diminished by fifty thousand dollars; but on the other hand the margin of earnings over interest is increased by one hundred and fifty thousand dollars. In case three, the margin over earnings is increased as in case two, but the net revenue is deficient by two hundred thousand dollars of the sum required to pay seven per cent. dividend upon ordinary stock, and the dividend must therefore be diminished. The course to be adopted in any particular case must depend upon the proportions of the capital already existing and the dividends that are being paid. Taking the case of the Pennsylvania railway, a preference stock would be the best, for the proportion of bonds is large enough, and as it is not likely that the new capital will earn eight per cent. the creation of preference stock would tend to maintain the dividend. It is an obvious objection that a new stock might be less marketable on account

of its novelty, custom having a great deal of influence in such matters; but the essential soundness of the policy would soon be perceived by investors. It is a *sine qua non* of a sound issue of preference stock that a dividend should have been, for some time, steadily paid upon ordinary stock, otherwise the *preference* is one in name only. Fluctuations in receipts render the value of stocks uncertain, and thus fit them for being the subjects of speculation. It is the small proportion of stocks to bonds which enables a small combination of capitalists, or even a single capitalist, to control entire railways and to manipulate them at pleasure. The only practical way to mitigate such power is by operating upon the causes which form its basis. It is important to observe how the various circumstances combine to facilitate the acquisition of properties under the circumstances mentioned. First the earnings power of railways is liable to great variations; second, this renders manipulation of the traffic and earnings difficult to detect; third, the small percentage of share capital renders the dividends very sensitive to variations in earnings; and, fourth, this causes a large proportion of lines to pay no dividends or very small dividends; fifth, the value of the shares being depreciated, and standing very much below par, only a small amount relatively is necessary to purchase a majority of the stock, and thus obtain control of a line; sixth, the non-existence of any large quantity of preference stock further facilitates such

operations. Voting power attaches to preference stock, but not to bonds. Hence, a large quantity of preference stock would make it more difficult to get a preponderance of voting power."

The matter-of-fact way in which railways were built and capitalized in the United States is characteristic of business men. The scant means at hand to build with, the high rate of interest that prevailed, and the risk that attended such ventures, occupied the people much more than questions of future administration. Construction and capitalization were such as the resources of a versatile people, hardly pressed, suggested. The American method of capitalization was good for America. It resulted in the rapid development of the country and its unexampled growth in wealth. If it had not been generally fair and equitable, this would not have been the case.

The peculiar situation in the United States, coupled with the extreme conservatism of those who own our railroads, first suggested the reservation of a part of the net earnings for use in improving the property. Many institutions have thus been saved from discredit that would otherwise have met with disaster. It is a simple, homely means, and such as only practical business men could be induced to adopt. Referring to it, Mr. Eason says: "What are the advantages of carrying forward these balances, and how are they employed? They are required to give additional security to the bondholders, and are rendered necessary by the excessive proportion

of interest bearing capital, and consequent interest charges. They are employed as capital, but as they do not bear interest, whatever they yield goes to increase the surplus for interest and dividend. The effect is shown in the maintenance of the earning power of a line and in its power to maintain it in the face of competition of other companies. The value put upon the permanent way in the company's balance sheet is merely nominal. The true measure of value is net revenue that a company can earn. In deciding upon the appropriation of net revenue and the method of providing the capital for further expenditure, whether on lines open for traffic, making new lines, or investments in securities of other lines, the important point for consideration is what will be the effect upon the net revenue. If the additional expenditure will yield net revenue sufficient to pay the interest upon the sum expended, there is no reason why it should not be provided for by the issue of an additional capital. If it is provided for out of income, the additional net revenue would become available for payment of dividend upon the existing stock, and the rate of dividend would increase. But it may happen that competition may so reduce rates that the earning power of the capital may diminish, so that the yield on total expenditure may not be increased. In this case, if the expenditure had been provided for by creation of fresh capital, the dividend must diminish, but if provided for out of income the rate of dividend may be

maintained. . . . It may be that the capital expended has added to the earning power of the line, but the net revenue may remain stationary in consequence of a decline in rates, and it may well be that it was recognition of the liability to a loss of profit from this cause which leads a company to devote surplus income to permanent expenditure. The company adopting such a policy has a clear advantage over a rival company which has no surplus income, and has to obtain the funds for construction by the creation of additional capital. This latter company may be gradually driven into default by competition with a strong company adopting another policy."

It is to meet the eventualities of the future that provident owners of railroads are led to invest a part of present income in strengthening their properties. The wisdom of their course has been proven too many times to need demonstration now.

CHAPTER VI.

SO-CALLED "WATERED" STOCK.

Most of the literature in regard to railroads emanates from men unfamiliar with their affairs. It is as a rule severely critical. Men who have filled prominent railroad offices without being railroad men have also favored us. Their views are optimistic and afford food for demagogues only. Railway men have little leisure to devote to abstract thought. Moreover, the labor of correcting the misrepresentations of the class referred to is too Herculean a task to be undertaken lightly. Time alone is equal to this.

What is needed in discussing railway questions of public concern, is common honesty based on experience and knowledge of economic laws. Faithful portrayal is impossible otherwise.

The belief, more or less general, that the stocks of American railroads are generally watered is due to lack of information. The subject has been much harped upon and is a fad. As a pleasantry it is well enough, but seriously it is wrong, because not true. The securities of American railroads are, as a rule, *bona fide*. Many properties are not fully capitalized. The small average cost per mile is sufficient to prove this. But it is

probable that the charge will continue to be made so long as railroads are run and people may attract attention by misrepresenting them. The theme is an endless one for those who seek to catch the public ear through its passions and prejudices. Millions to them are as soap bubbles, and particular instances of wrong have the force of universal custom. If an individual railroad man sins, they fasten his crime, like a blanket, on the whole human race. It straightway becomes a rallying cry and a means of spreading distrust. Actual instances of wrong-doing are few in number and unimportant. However, they are made the subject of general accusations, and in that form serve to create dissatisfaction between carrier and patron, and employer and employe.

Warfare on property takes on many aspects. It is never open and manly; always insidious and covert, always cowardly. Whatever its aspect, its purpose is bad, its aim the aggrandizement of the improvident at the expense of the industrious and saving. It cannot be restricted to railway property. If encouraged, it will ultimately extend to manufactures, newspapers, banks, farms and other industries. It is anarchy. As we sow, so shall we reap.

The issuance of railway stocks and bonds in England is jealously guarded by the state. While great laxity in this respect has existed in the United States, the forbearance has as a rule been fully respected. Good business usage has

governed in this matter, as it must and does in all things where men deal on equal terms with each other.

The capital stock of American railways does not bear the authoritative stamp of the government. This has undoubtedly had its influence in determining owners to use their surplus income in many cases to improve and strengthen their property. It has made them conservative, as responsibility always does. They have sought to make assurance doubly sure. Undoubtedly cases of wrong-doing have occurred and will continue to occur in railway practices, including those of capitalizing these properties. They cannot be prevented. The parties in fault are eventually the greatest sufferers. Sins of this kind react on properties just as sins react on men. Atonement must always be made in the flesh.

Many makeshifts are necessary in connection with railway development in a new country that are unknown in older and wealthier communities. Thus, bonuses are offered and discounts suffered that are unnecessary in the latter case. But no honest man thinks of repudiating a note because he has to sell it at a discount. In old and established communities, when money is not forthcoming it is evidence that the field is not ripe for its use. It is different in new countries. It must be sought.

Those who study the methods of a railway company become admirers of its adaptability and skill. Thus, the practice of established railway

corporations of buying up the stock of other and weaker companies, and issuing their own in lieu thereof (depositing the stock of the purchased company as collateral), while much criticised, is business-like, and has been found eminently useful. It is also a common practice for a company, in extending its lines, to organize a new company, the stock and bonds of the parent company being issued in lieu of those of the new company, the latter being deposited with a trustee. The securities of the older corporation, being known, can be sold to much better advantage than the new. Now, while the stock and bonds are technically duplicated, they are not so represented in the market. No one is injured, while everyone is benefited. I cite this particular practice of railroads, which has been somewhat severely criticised, as an illustration of many others that are assailed without reason.

In some instances so-called watered stock represents the premium paid for the risk involved. To illustrate, we will suppose that money in British Columbia is worth four per cent. per month; in London it is worth four per cent. per annum. Why the difference? Because money is scarce in British Columbia, and the risk is greater, or not so well known. But the transactions that occur in British Columbia are just as equitable as in London, and must be respected the same. And so it is when railroad stocks are sold at a discount, or, indeed, given as a bonus to purchasers to induce them to buy bonds. The

obligation is as *bona fide* as if a premium had been received. To the failure on the part of American railroad companies to capitalize construction expenditures as they arise is due in some part the misunderstanding that exists in regard to our so-called watered stock. The misunderstanding is also due in some part to imperfect bookkeeping. In other countries the issue of stocks and bonds is co-existent with the improvement. Both can be seen at a glance, and no one dreams of denying owners this right, or of referring to the securities as fictitious.

While we are accustomed to look upon railroads in use as finished, they are, as a matter of fact, ever in a state of growth. Sometimes the transformation is so rapid and of such great magnitude as to attract attention. Such outlays, it may be, are singled out by the railroad company and embraced in its returns under the head of construction, and capitalized. This, in a general way, is supposed to be the extent of a railway company's rights in this direction. As a matter of fact, however, the great bulk of the additions to a property are made up of myriads of petty improvements, so small as to escape the attention of everyone but the accountant. The use of two nails where only one was originally charged to construction is an improvement, and affords the basis of further capitalization; but petty items of this nature have been entirely overlooked, being embraced bodily in the operating expense account.

No railway is so perfectly constructed in the first instance that it is not improved by the adding of new ballast; by adjustment of grade; by widening of cuts and ditches; by better alignment; by improved bridges and culverts; by greater weight and better quality of rail; by added office, station and yard facilities; by new machine shops; by filling up of grounds; by accumulation of personal property, and, generally, by the substitution of appliances of modern construction for those of an old pattern. Thus properties grow. This growth, however, may not be noted in the returns, the whole being charged up as an operating expense. In such case the owners of the property have advanced the money needed to make the improvements, and in doing so have lessened the return available for dividends on their capital by just so much. It is in the nature of a loan. Manifestly it is their right and privilege, at their pleasure, to require a return of the amount thus loaned.

In those cases where the capital of a railroad has been watered, the conservative instincts of subsequent owners generally lead them to make good the amount; to supplement it with expenditures for construction out of net earnings. The cases are extremely rare where a return is earned on watered values. Such securities are generally worthless so far as income is concerned and are so esteemed. They have no effect on rates whatever. The competition of markets, not the actual or assumed cost of a property, determines these.*

* See "Economic Theory of Rates."

The bonuses which must be paid for railroads and other improvements in a new and stable country cease when the risks, real or imaginary, that attend such ventures become known. These embarrassments are not known in wealthy countries or in the case of established and productive properties.

When net earnings are used for construction purposes, not only is the owner entitled to representation therefor, but also to interest thereon, as in the case of the original investment. He should be free to capitalize the outlay at his pleasure; whenever, in fact, his interests will be best conserved thereby. It is purely a practical question, and he should be allowed to meet it in his own time and way. We have no more right to deprive him of this privilege than we have to rob him of his watch. So acute, however, has been the feeling on the subject that the most absurd laws have been passed in the United States regulating such matters. Thus, one state forbids railroad companies issuing capital stock to cover disbursements for construction, but allows them to issue bonds therefor. This utter inability of the state to deal with an economic question is on a par with the whole batch of laws.

CHAPTER VII.

RAILWAY CAPITAL—INVESTORS MUST NOT BUY WITHOUT SCRUTINIZING, NOR HOLD WITHOUT GUARDING.

Property owners are the same the world over. They have not changed since men emerged from savagery. Their persistent, aggressive effort to achieve fortune is commendable. What one possesses others strive to duplicate. This is called enterprise. Acquisitiveness is the animating cause of commercial activity. Possession of wealth the goal of mankind. If these truths were more generally kept in mind, careless and improvident men would be more wary in making investments, and more painstaking in looking after investments already made.

Those who have money to invest in railroad securities should not buy without investigating, nor hold without guarding. Men who own valuable horses do not leave them unguarded. Investors in corporations will be wise if they exercise similar foresight. It is only common business prudence.

As long as men buy securities without intelligent investigation, so long will they be disappointed in their investments. I do not say that securities selling below par or at merely normal

figures may not be valuable. They may be more desirable than those selling at a premium. It is in judicious selections from such securities that great fortunes are often built up. But wise men will not touch a security without careful investigation. Those who do are reckless gamblers and unworthy of sympathy if their ventures turn out unfortunately.

Those who have money to invest will also be wise in avoiding a country which does not accord corporate capital the same impartial treatment as other property. A country animated by such a spirit is as unsafe as a powder magazine in which children play.

In making investments in railways the property into which it is proposed to buy should be scanned with reference to its particular merits and demerits. It must be considered generally and specifically: the country it supplies, its revenues, character and amplitude of its construction, nature and extent of its bonds, stocks, leases, floating debt, contracts, agreements, and so on. The character of the management, its adequacy, fitness and trustworthiness, are also all important. A railway with an inadequate or defective government is as untrustworthy as a corrupt or weak civil government. All these details must be carefully looked after by investors in every country.

Investors resident in new countries are more apt to neglect necessary precautions than in older communities. They lack the wisdom that

comes only with experience. In England shareholders in corporations consider it a duty to be present at meetings, and their sharp criticism is heard in every assembly of this kind. In America the owner of railroad stock rarely, if ever, goes to a meeting of shareholders unless he has sufficient holdings to control the board or is a director. To do so is thought intrusive. This feeling is assiduously cultivated by his more robust, aggressive and powerful brothers who have control. The stockholder's absence is grateful, his presence irritating. This is natural. Criticism is always offensive. However, stockholders should not be deterred from doing their duty. No one should ever give a proxy if he can be present personally. It is common sense, simply business prudence not to do so. The practice should not be waived in the case of railways any more than in the case of manufactories, breweries and banks. It is a duty property holders owe to themselves and to the community at large.

While men should not buy railway securities without investigation, they should not sell without reason. Mere rumor should not disturb them. Stocks and bonds are ever the subjects of manipulation. The effort to induce holders to sell, when they ought to hold, never for a moment ceases. Representations conform to these ends and markets are manipulated accordingly. Speculative classes are kept alive by the dupes who believe these misrepresentations.

Much good advice has been given the English, Dutch and Germans in reference to their investments in other countries, especially America. I do not remember, however, to have noticed any reference to a safeguard of the utmost importance to them, namely, proper representation on the ground. The losses foreigners have suffered in America have not been the result so much of dishonesty or trickery on the part of local owners and managers, as of the gross stupidity of those who represent foreign holders. These representatives are generally of the same nationality as their principals, and, as a rule, know nothing about American methods or men, and are not in sympathy with its people. The honorable exceptions to this rule only make it the more noticeable.

As a rule the men sent to represent foreign capital know little about the business they are hired to look after, and their avenues of information are neither influential nor trustworthy; certainly not such as to secure the objects they have in view. Foreigners investing in America or in any country will find it to their interest to select local agents from among reputable, practical business men, and in general those who do not solicit such trusts. Selection should be made if practicable of men already employed in similar work. In order to find fit agents, foreign investors must visit the country and select their representatives from among those who possess the confidence of the business world. Such men do

not go abroad to solicit trusts. Nor are they to be found in the lobbies of hotels. The same rule must be observed that is followed in selecting a cashier or superintendent. If investors will do this they will not have to complain of being over-reached by local owners and managers.

The men that English, German and Dutch investors have sent abroad as agents have not, generally speaking, been such as to justify a reputation for shrewdness or business knowledge. Investments will not be wisely placed nor securely held until they change their methods in this respect.

In many cases the representatives of foreign holders in America have been the unconscious dupes of those who are not trusted by their own neighbors; foreigners in control of stable companies in America have not too often been able to maintain them; when they have controlled weak companies they have lacked the skill to strengthen them. In the majority of cases their purchases have been such as attract the credulous and unwary; of those who look for exorbitant returns; of those who seek a royal road to wealth; those who do not observe the common precautions of business men.

But if those who represent foreign investors in other countries lack ability, experience, adaptability, and oftentimes common honesty, how shall we characterize many Americans who visit Europe to negotiate loans? They are rarely representative and are not trusted by their own

countrymen. Birds of passage, their migratory errands too often indicate a lack of capital at home that does not exist. While many trustworthy men go upon such errands, many of them are unworthy to be trusted. They sin doubly, first in inducing people to invest, and afterward in representing them. They first fleece the foreigner by misrepresentations and rob him afterward as agents. What are we to think of the acumen of men who have been so systematically imposed upon as the English, Hollanders and Germans have in this respect?

Generally speaking, foreigners will exercise a wise discretion if they decline to buy into enterprises to such an extent as to give the properties the reputation of being controlled by them. Such reputation may prove hurtful. The more unobtrusively foreign investments are made and held, the more likely they are to be satisfactory and the less likely they are to occasion owners anxiety. Not that there is necessarily any enmity toward foreigners, but patriotic prejudices run high among every people, and wise men do not run counter thereto in business matters if they can avoid it.

CHAPTER VIII.

DIFFERENT KINDS OF SHARES; RETURNS THEREON; TRANSFER BOOKS, ETC.—CAPITAL STOCK AND SHAREHOLDERS.

As I have pointed out, the practice in England in capitalizing railway property is to sell capital stock (shares) to such an extent as to constitute a substantial investment, and a material security to the holders of debentures. It will be a good rule to follow in America hereafter, in the inauguration of new companies not backed by old and well established corporations. The practice in the beginning was to pay a nominal sum on the stock, and issue bonds to cover the balance. The custom was a necessity, and, under the circumstances, perfectly proper. I have no criticism to make. Other countries cannot go far wrong under similar circumstances if they follow the practices of America. Its railroads have been admirably managed from the first. A very clever Englishman* has written a book of advice and warning to his countrymen who have investments in America. He might have claimed for it a wider field. It is in the main good. But there is no cut and dried formula that can be followed in capitalizing a property or in making invest-

* John Swann, M. A.

ments in it afterward. I have referred to this phase of the subject very fully in another chapter.

The total cost of a company's property, including the supplies and working fund required in its operation, is the proper basis of its capitalization. In the United States this is represented largely by mortgage bonds and what is called capital stock. The latter should more properly be called shares capital. The term capital stock in the sense we use it is misleading, because applied to a security that represents only a fraction of the cost.

In England they speak of the capital stock of railways. Never of cost. The former at one time implied the latter.

Every company should be privileged to cause the cost of its property to be represented either with interest bearing bonds or shares,* any excess of cost over such issues to stand upon the books until such time as the proprietors see proper to give it representation; it is a part of the capital as much as the first dollar paid toward the venture.

Whatever a company earns over its operating expenses, taxes, rentals, interest, and other accounts chargeable against income, belongs to the owners of its shares, to be equitably apportioned among them. It is called a dividend. This division is in many cases delayed. In some instances it is never made, but withheld for use

* The English speak of the obligations of governments as stocks; the securities of railroads as shares.

in improving the property. However, it is in the nature of a loan, and should not be covered up in the accounts nor lost sight of. It is an obligation due to the shareholder, the same as a note of hand, payable when the exigencies of business will permit.

A majority of the shares of the capital stock of a property (or a majority of those voting, according to the by-laws of the company) elect its directors. These control its operations for the period of time for which they are elected. In the event of foreclosure and sale of a property, the shareholders (who are the company) possess the right of redemption, but in the event this right is not exercised, their shares may become invalid.

The par value of a share of capital stock in an American railroad is usually one hundred dollars. In some cases the shares are fifty dollars each. Frequently two kinds of shares (preferred and common) are issued. Their printed form is substantially alike.* They have, however, different

* Form of certificate of capital stock:

No. 980.		PREFERRED.	100 Shares.
	Capital Stock.	Shares \$100 each.	
MINNEAPOLIS & SOUTH PACIFIC RAILROAD CO.			
STATE OF MINNESOTA.			

THIS CERTIFIES that JOHN DOE is the owner of ONE HUNDRED Shares of the Preferred Capital Stock of the Minneapolis & South Pacific Railroad Company, transferable on the books of the Company on surrender of this certificate.

WITNESS the signature of the President and Secretary.

Dated April 19, 1880.

HUGH GRAY, Secretary.

C. G. PHILLIPS, President.

The certificates for common shares are similar to the above, except that the word Common is substituted for Preferred.

rights. The higher grade is called preferred stock or preference shares, the subordinate grade, common or ordinary stock. The rights these shares severally enjoy, and the maximum amount of each that may be issued, are set forth in the articles of incorporation, and this limit cannot be exceeded without formal consent of the parties in interest.

Many companies have more than two classes of shares.* The relation they sustain to each other is determined by the circumstances that necessitated the diversity of interest. When a company in poor credit is compelled to raise money, the best terms it can get are accepted; sometimes mortgage bonds are thus created; sometimes new shares are issued (at a great discount, perhaps), which shares, by consent of the holders of existing securities, frequently take precedence of prior issues. There is no fixed value. It is in such ways that different classes of shares and bonds come into existence. The rights enjoyed by holders of preferred and common shares, on different roads, are rarely the same.†

* The Grand Trunk Railway Company, of Canada, has five, viz.: Ordinary Stock; Guaranteed Four Per Cent.; First Preference; Second Preference; and Third Preference. It has, besides, various kinds of bonds.

† The Chicago, Milwaukee & St. Paul Company's preferred shareholders are entitled to an annual dividend of seven per cent. before a dividend can be paid on the common shares. The preferred shares of the Lake Shore & Michigan Southern Railway (which amount to only \$533,500) are entitled to an annual dividend of ten per cent. on their par value before the ordinary shares can receive any return. No dividend can be paid on the

When there are two classes of stock, the preference usually extends no further than a division of net earnings. Thus while the holders of preferred stock may be entitled to a certain return before inferior shares can receive anything, still, in the event the property is sold, the surplus, after satisfying the mortgage and other debts, is divided equally among all classes of shareholders. In some instances, however, the rights of the preferred holders extend to a division of the property.

Dividends are declared by the board of directors. The meeting at which a dividend is declared must be legally convened and must in all respects conform to the statutes and the company's by-laws. The amount of the contemplated dividend being fixed by the board, it declares how it shall be paid (whether in cash, in shares or in bonds) and when. It also fixes the date when the books in which transfers of stock are recorded shall be closed and when they shall be reopened.

Dividends are paid to the order of the persons who appear upon the stock ledger as owners at the time the books are closed.

A period averaging from ten to thirty days usually elapses, between the declaration of a dividend and the closing of the books. The reason is that there are many shares passing from hand to hand (as they are bought and sold) that have not

common shares of the North-Western road during any year, out of the receipts of such year, until seven per cent. has been divided among the holders of preferred shares. Other differences, still more marked, might be cited.

been transferred on the books. When a certificate is sold by the original holder the power of attorney on the back is signed, in blank, by him.* This enables the holder, whoever he may be, to take it to the office of the registrar at any time he pleases and have it transferred. But shares frequently change hands many times without transfer of ownership appearing on the books.

When a dividend is declared, every person who owns a certificate registered in the name of some one else usually (but not necessarily) has it transferred. It is in order to facilitate these transfers that a period of time is allowed between the declaration of a dividend and the closing of the books. While the books are closed details regarding payment, such as the drawing of checks, etc., are performed.

Corporations are required by law to give notice of the payment of dividends; also of meetings of stockholders. They are not allowed to close their stock books without giving public notice in advance, specifying the date the books are to be closed, when they will be reopened, and the reason

* Form of Transfer and power of attorney printed on back of certificate of stock:

For value received.....do hereby sell, transfer and assign to.....
 the within mentioned Shares of Stock, and do hereby constitute and appoint
as.....Attorney, irrevocably, to transfer said stock on
 the books of the within named Company, and to make and execute all neces-
 sary acts of assignment and transfer required by the regulations and by-laws
 of said Company either in person or by such other Attorney or Attorneys as
may appoint or substitute for that purpose.

Witness.....hand and seal this.....day of18....
 Signed and Delivered in the presence of

(*Thos. Robinson.*)

JAMES JONES.

why they are closed. A period of from thirty to forty days generally elapses between the closing and reopening of the books for a meeting of stockholders. The stock books are closed preparatory to such meeting in order that a correct list of those legally entitled to vote may be made. Holders of stock are entitled to one vote for each share standing in their names when the books are closed. During the time the stock books are closed no transfer of shares can be made thereon.

CHAPTER IX.

DETAILS OF RAILWAY BONDS, LEASES, ETC.

Bonds issued in the United States for the purpose of providing the means to build and equip railroads are called the Funded Debt. They are an absolute lien, and, in the event the interest or principal is not paid as agreed, the property may be foreclosed and sold to the highest bidder. Bonds are commonly signed by the president and secretary and countersigned by the trustee. The latter is the contingent agent of the holder.

Bonds vary in amount from one hundred to one hundred thousand dollars, according to the needs of the occasion.

When there is more than one mortgage upon a property, the relation of the mortgages to each other is commonly indicated by their designation, as first, second, third and so on. It frequently occurs that a mortgage will be a first lien upon one piece of road and occupy a secondary place elsewhere. Each bond recites upon its face the property it covers and the rights its holders possess.

Owners are called bondholders. Sometimes a company sells its bonds directly to investors, but more frequently through brokers. In the latter

case a commission is paid. Bonds run for various periods from one year upwards.

To enable bondholders the better to protect their interests they are sometimes allowed to vote at meetings the same as stockholders. Such a course insures a very conservative management, as it is the interest of bondholders to divide as little of the surplus as possible among stockholders, and expend as much as possible in improving and building up the property, every dollar thus expended adding so much to the security of the bondholder.

The necessities of a company are sometimes such as to compel it to mortgage its income in advance; i. e., the balance that will be left after meeting existing obligations. Such securities are called Income Bonds. Specific articles of property, such as a building, bridge, engine, car or piece of machinery, are also sometimes separately mortgaged. Mortgages of this character, as well as those based on income, generally run only for a short period.

The extent to which a road may with propriety be bonded depends, of course, upon its net receipts. Great conservatism is, so far as possible, exercised. The multitude of properties that have passed into hands of receivers represent risks more or less well understood from the start.

There are oftentimes many distinct mortgages upon a piece of property. A fifth mortgage does not seem to be a very valuable security, yet it

may be preferable to a first mortgage in another case. Its obligations may be promptly met, and it may command a premium in the market, while a first mortgage in another case is discredited. The mortgages on a property usually represent its different stages of progress, and are, as a rule, evidences of prosperity rather than the contrary.

The objection to a mortgage on a railway is its lack of flexibility. It makes no distinction between a property of no present or prospective value and one requiring only time to build it up. Many of the mortgages that have been foreclosed and the properties sold at a sacrifice, would have been paid in full, with interest, if the owners had been compelled to wait. For this reason a mortgage is too exacting. Instead of protecting its holders it may be made the means, under false representations, perhaps, of frightening them into sacrificing their investment.

Every mortgage provides for one or more trustees, whose duty it is, if the interest and principal are not paid when due, or within a specified time thereafter, to advertise and sell the property, if called upon by the holders of the bonds. The manner and form of action are prescribed. The minimum amount of bonds required to compel action upon the part of the trustee is also indicated. This amount is commonly made so small as to protect all the holders. In the event of default the trustee may, of his own volition in many cases, go ahead and

foreclose without being called upon by holders. He is supposed to act always in their interests.

Mortgages take precedence according to their dates. Thus, the foreclosure of a third mortgage does not affect those of a prior date. But the foreclosure of a first mortgage invalidates all others. If, however, there remains any surplus over and above the amount required to satisfy such mortgage, it must be divided among the holders of the next succeeding mortgage, and so on until it is exhausted. In the event of the foreclosure of a first mortgage, or of any mortgage, the holders of the next succeeding mortgage usually redeem the property if its worth justifies such a course, so as to save their interest in the property. In the event the requirements of an inferior mortgage are not satisfied, the holders of such mortgage have, in some cases, the right to compel the holders of prior mortgages to become parties to foreclosure proceedings; thus forcing the holders of such prior bonds to accept payment for the same in advance of the time originally specified.

Debenture stock is a favorite form of security in Great Britain. It has a fixed rate of interest and is a positive lien upon the property, but there is no trustee, no definite form of procedure involving the whole issue in case of default. A holder can, if his interest is not paid, levy upon the company's property wherever found and place his name upon it, and hold it until his claim is satisfied. Co-operation with other holders is not

obligatory, and the sale of the property proceeds no farther than is necessary to reimburse the disaffected holder.

In some portions of the United States mortgages must be recorded upon the books of the recorder of deeds or other designated officer for each county in which the property is located. In other cases it is only necessary to record the mortgage at the state capital. An unrecorded mortgage has no value as against a recorded mortgage or the judgment of a court.

Attached to every mortgage bond issued by railroad companies are diminutive notes of hand called coupons of the general form indicated below.* Each installment of interest, whether payable annually, semi-annually, or quarterly, is represented by one of these coupons. Thus the number of coupons attached is sometimes very great. The coupon when due is in the nature of a sight draft (payable to bearer) on the company issuing it.

Every bond specifies on its face where the interest and principal are payable and the form of payment.

* On the first day of January, A. D.

THE MINNEAPOLIS & SOUTH PACIFIC RAILWAY COMPANY

Will pay to the bearer hereof **THIRTY-FIVE DOLLARS, IN GOLD COIN,**
 at its office or agency, in the city of New York, or, at its
 option, **SEVEN POUNDS STERLING,** at the office or
 agency of the **BANK OF MONTREAL,** in the city of
 London, England, being **SIX months' interest** due on
 that day on its (\$1000) **First Mortgage Gold Bond, No.**
236. Dated JUNE 21st, 1879.

\$35

£7

L. C. JONES,

SECRETARY.

Registered bonds are different from coupon bonds. Both the principal and interest are payable to order and can only be collected by the person in whose name they are registered upon the books of the corporation. This name is inserted in the body of the instrument. No coupons are attached to a registered bond. When interest matures it is forwarded to the address of the person in whose name the bond is registered. The expense and annoyance of transferring registered bonds when they change hands detract from their market value. They are never issued except upon request.

The bonds of railroad companies and those of the government are much alike in form. The manner of paying interest is also much the same.

The interest on different kinds of bonds does not fall due at the same time. The convenience of a company is followed in fixing the date for paying interest. In some cases interest is paid quarterly. The general rule, however, is to pay it semi-annually.

Interest on bonds constitutes a separate item in the income (profit and loss) account.* It is called, with rentals and guaranteed dividends, a fixed charge.

Such are the details connected with mortgage bonds. When properties are leased, the amount paid as rental takes the place of interest on bonds

* The returns of the United States government contemplate that the amount shall be entered on the books of a company each month as it accrues.

in the returns of the lessee. In some cases, however, the interest on the funded debt of the property leased is assumed by the lessee, in which case it may thus appear in the returns in lieu of rental as part or full payment of rental.

The same diversity that is noticeable in other operations of railways characterizes their leases. A description of them is impracticable. Their scope and purpose find expression in the provisions that hedge them about. The consideration is never the same in any two cases, because the circumstances under which properties are leased are never the same. The manner of paying rentals also varies. Sometimes a fixed sum is paid, but more frequently the amount is dependent upon the earnings of the property or on the number of passengers or tons of freight transported. Sometimes it is based on the earnings per train mile. Whatever it may be, it is clearly defined in the instrument, which also fixes the manner, time and place of payment. As the value of a railroad is dependent upon the fidelity and skill exercised in its operation and maintenance, the obligation of the lessee to manage so as to secure the best results is usually set forth in the instrument at great length.* Arbitrators are, as a rule, provided for

*I find the following in reference to this phase of the subject in an old lease: "And the lessee agrees that at all times during the existence of this agreement he will faithfully maintain and efficiently operate said railroad, and keep the same in good repair and condition, with appurtenances and incidents . . . furnish and supply at all times a sufficient and ample amount of motive power, and passenger and freight and other

in every lease (in the event differences should arise), the manner of their appointment and the rules governing their action being carefully prescribed. The lessee usually obligates himself to pay the taxes on the property leased and make full returns of its affairs to the lessor, the latter reserving the right to examine the books and accounts of the lessee at pleasure. It is the duty of the lessor, as a rule, to keep up the legal organization of the property.* He is also required to

cars, to do advantageously and in a proper manner all the freight and passenger business which may be offered or procured for said road, and which may be secured to the said line . . . and will in all ways furnish all needful and proper facilities for the increasing business of said line, and the growing demands of the country by its increasing production, or by the extension of said railroad communication; and will further adopt such judicious and efficient measures as may tend to make the said line a main and prosperous line; the lessee further agrees that during the term hereby granted, he will operate, maintain, and keep in repair the said demised premises, pay all taxes assessed upon it, and indemnify and save harmless the said lessor against and from all costs, expenses and damages growing out of the maintaining, repairing, operating and using the said road."

* "And the lessors hereby covenant and agree that they will, during the term in which the provisions of this indenture shall be in force, preserve and continue the legal organization of said leased road; will hold meetings, keep records, pass votes, and appoint officers, so far as necessary to enable the lessees to carry into full force and effect the objects of this instrument; and that they will give such further assurances as may be necessary therefor, and that they will at any and all times hereafter, when thereunto requested by the lessees, use their corporate powers, and do and perform in their own corporate name, any and all acts and things that may be necessary fully to protect said lessees in the full enjoyment of all the rights and privileges herein granted."—*Extract from old lease.*

maintain the lessee in peaceable possession and pay all liens or incumbrances on the property not otherwise provided for.* In addition to the practice of leasing of railroads as a whole, many leases are made to cover particular objects, such as the use of tracks, terminals, buildings and docks. In this way two or more companies frequently use properties in common.

*“And the lessors further covenant and agree, that they will at all times protect the lessees in the quiet possession and enjoyment of the premises and rights hereby granted, or intended so to do, on said line of —— miles, and will assume and pay all liens and incumbrances at any time found to exist thereon, with all costs, damages, and legal charges by reason th of.”—*Old lease.*

CHAPTER X.

PARTICULARS OF SINKING FUNDS.

Mankind has only a vague idea of what constitutes a sinking fund. Many who are otherwise attentive to what transpires about them refuse to consider the term at all when they meet it in print, but dodge it as they would a weak spot in the ice. They look upon it as an enigma of finance that only a few favored mortals may understand. Webster, defining the verb "sink," says, "To cause to sink; to put under water; to immerse in water, as to sink a ship; to depress; to make by digging or delving, as to sink a pit or well." This explanation, though lucid, affords no clue to the term used in the vernacular of corporations.

A sinking fund is something set apart for a particular purpose. It does not necessarily consist of money. We will suppose that a railroad company has certain bonds that will become due at a specified time in the future. To insure the payment of these bonds, a fixed sum is laid aside annually, or semi-annually. The amount thus husbanded can be used for no other purpose whatsoever. It is called a sinking fund.

The custodian of the fund is the trustee. Sometimes there are two or more of these officers.* In many cases a trust company acts. The last named practice is growing more and more in favor, and offers many advantages over old practices.

The value of a security is dependent somewhat, as may readily be supposed, upon the character of the trustee for its sinking fund. His discretion is oftentimes large, and he may rigidly enforce the provisions of the instrument or he may evade them. No penalty usually attaches to him for neglect. In the case, however, of trust companies, they are held to a more rigid responsibility than individuals and their duties are better defined.

The holders of a security for which a sinking fund is provided may call upon the trustee to ascertain if the requirements of the trust are complied with, but this is rarely, if ever, done. People who think about such things at all take it for granted that the trustee is performing his duty, and so let the matter drop.

Another phase of the subject suggests itself. If a sinking fund is payable in cash, as it is in many cases, what is to prevent the trustee, if a private person, from appropriating the amount to his own use? He rarely, if ever, gives a bond.

* Provision is usually made in the instrument creating a sinking fund, for the appointment of new trustees in the event those specifically named die or cease to act.

Frequently no provision is made in a mortgage for a sinking fund. In many cases the creation of a sinking fund is esteemed imperative by investors. The object sought is, of course, to strengthen the security; to insure the fulfillment of all the obligations of the mortgage, including the payment of interest and principal when due. The company issuing the mortgage binds itself to place a specified sum at fixed periods in the hands of the trustee of the fund. Sometimes these payments are in cash, sometimes in bonds of the issue for which the fund is created, sometimes in other securities. Provision is also made in regard to investing the accretions of the fund, i. e., the interest and premiums that accrue on the amount in the hands of the trustee.

In case uncanceled bonds are deposited with the trustee, the provisions of the fund require that the interest on such bonds shall be collected and added to the fund. Whatever sum the trustee may have on hand when the bonds mature he uses in payment of the mortgage.

To prevent improper use of bonds thus deposited, the fact that they are held in trust should be plainly stamped upon their face.

Sinking funds should only be paid in cash when bonds for which the fund is created cannot be purchased and used in lieu thereof.

In some cases it is provided that in the event sufficient bonds cannot be purchased at a specified price in the market to satisfy a sinking fund, the trustee may draw by lot the number of bonds

required, the holders of such bonds being compelled to deliver the same at a stipulated rate. This plan is a very good one, but is objectionable to the holders of bonds, as it makes the duration of their investment uncertain. Such provision is, therefore, held in the place of a stable security to be undesirable.

Of the various forms of sinking funds, that which requires the keeping alive of the bonds in the hands of the trustee, and the collection of the interest thereon and its re-investment by the trustee, affords the greatest security.

But whatever method may be adopted, it is necessary that the trustee should give guarantees for the faithful performance of his duty. Trust companies afford this in their subscribed capital and in the character of their officers and stockholders.

In reference to the treatment of sinking funds in the accounts, they are in the nature of unrepresented capital. A sinking fund takes the place of obligations that at one time represented cost. It has, therefore, the same rights as the original investment; the right to be represented by bonds or shares. It is not chargeable against income account any more than any other capital expenditure. The reason why we so often find it included in the income account is because of the conservatism of proprietors. It is another way they have of strengthening their properties. It is similar in effect to making improvements with net earnings. While the practice appears to

trench on the rights of stockholders, it is not to be hastily condemned. The fact that it is done by sagacious and practical business men is, in itself, sufficient evidence that it is proper.



BOOK II.

CONSTRUCTING AND MAINTAINING RAILROADS.

This book, like the series of which it is a part, treats of a subject inseparably interwoven with others relating to the operation of railroads; and as I have constantly pointed out, the student who would understand any particular phase of railway operations must study the subject as a whole. He may not, indeed, thus compass fully a technical knowledge of every department, but his information will be sufficiently specific to afford the basis which such an understanding requires.

SUPPLEMENTARY BOOK TREATING OF THE CONSTRUCTION AND MAIN- TENANCE OF RAILWAYS.

In connection with the matter herein embraced in Book 2 of this volume, the reader's attention is respectfully called to a *new treatise* relating to the Construction and Maintenance of railroads, issued in the latter part of 1900, and intended by the Publishers hereof as a *Supplement* to the "Science of Railways." It is profusely illustrated and is thought by many to take up the subject of Construction and Maintenance in a more orderly and scientific manner than the Treatises herein. At any rate it will be of great interest to those who are concerned in such matters as affording a wider field of knowledge and greater discretion (in judging) wherever they find it necessary or useful to consult books of reference. Students and others who are studying the operation of railroads as a Science, will welcome the added light however faint or imperfect it may be.

Oct., 1900.

M. M. K.

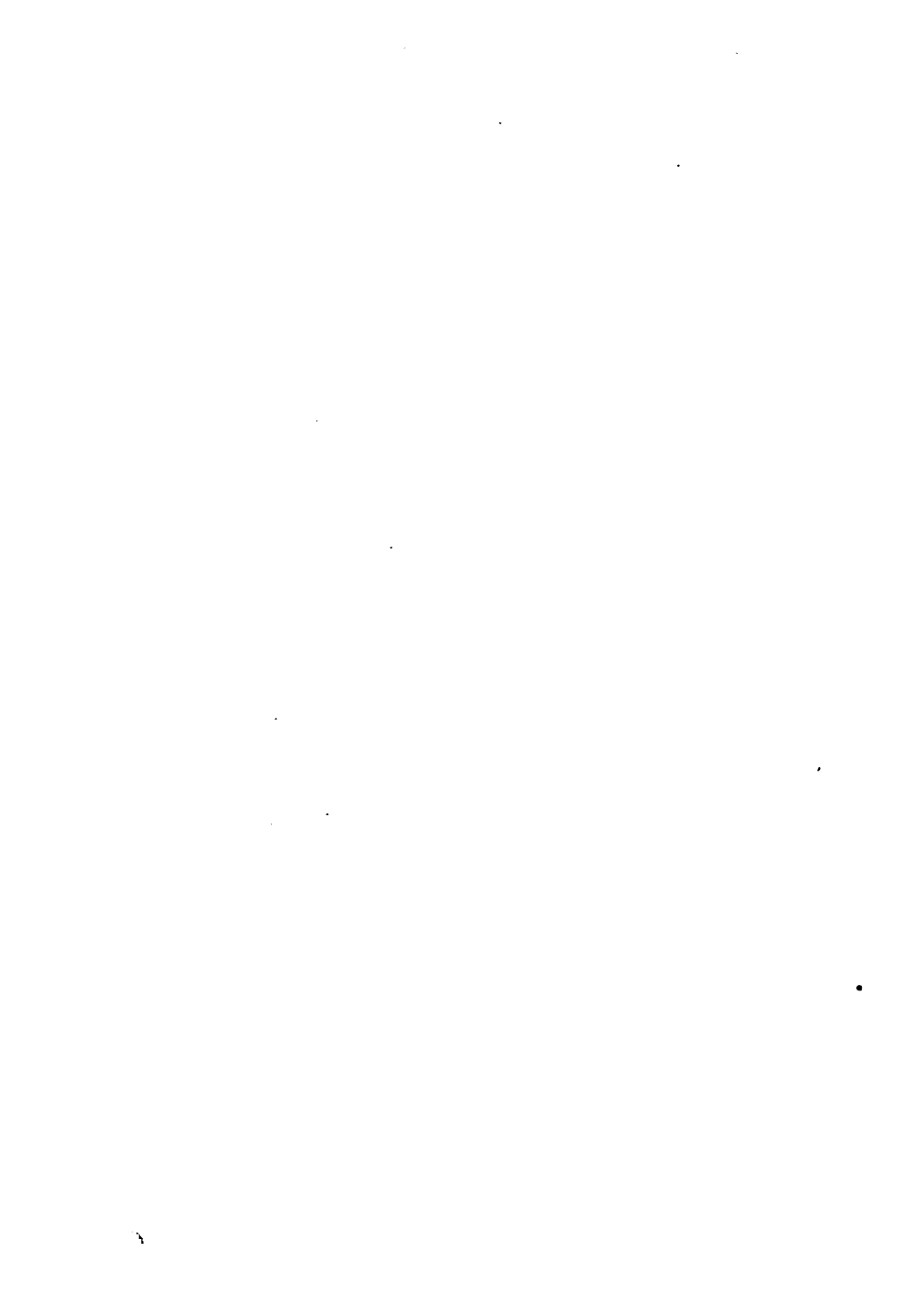

CHAPTER I.

RAILWAY EVOLUTION.

In depicting railways, an account of the conditions which lead up to them is interesting, not only in itself, but as affording a better understanding of the subject. It is that which suggested incorporating the volume on the Evolution of Transportation as a part of this work. The origin and growth of property go hand in hand with the birth and development of man. When we describe the condition of one we describe the condition of the other. The two are coexistent. Thus the business principles which we observe to-day were in the main established by the ancients, who were commercially inclined as we are, many hundreds of years ago. In the same way they originated in the main our utensils and methods. We have simply developed their primary thoughts.

In legal phraseology there are three kinds of property—real, personal and mixed. Railway property partakes of all these characteristics. The privileges it enjoys are such as are accorded it under the limited knowledge we have of its uses and needs. Its rights are exceptional because of its special duties and responsibilities. Its

limitations are such as attach to common carriers. It represents a new departure in industrial effort; a progressive step greatly stimulative of man's efforts. In other respects it presents no distinguishing features. It furnishes, however, another instance, if one were wanting, of the sympathetic tie that connects man's intellectual growth with that which he so greatly prizes, namely, material wealth.

The primary purpose of the permanent way of a railroad was to furnish a surface that should be at once hard, smooth and unchanging for wheels to run upon.

Railways had their origin in Great Britain in the tramways laid in the mining districts for conveying coal to the sea from the mines near Newcastle-on-Tyne during the seventeenth century. The rails were formed of scantlings of oak, straight and parallel to each other, connected by cross timbers also of oak and pinned together with oak treenails; on these, carts made with four rollers fitting the rails traveled, the carriage being so easy that one horse is said to have been able to draw four or five chaldrons of coal. The benefits derived from this manner of transporting coal suggested to the thinking man the employment of similar means for facilitating the conveyance of passengers and general merchandise.

A road graveled between the rails was at first provided as a foothold for the horses which drew the cars. The wheels were kept on the rails by

guides, attached either to the wheels or to the rails. As stated, the earliest railroads were constructed wholly of wood.

In comparing the first railroads with the common turnpike road, an early writer says: "A saving is made of seven-eighths of the power, one horse on a railroad producing as much effect as eight horses on a turnpike road. In the effect produced by a given power the railroad is about a mean between the turnpike road and a canal, when the rate is about three miles an hour; but when greater speed is desirable the railroad may equal the canal in effect and even surpass it."

There were, at first, three varieties of iron railroads—the edge rail, the tram road, and the single rail. In the edge railway the rails were laid with the edge upward, the carriages being kept on them by a flange, or projecting edge, attached to the wheels instead of to the rails. The rails were at first about three feet long, and four or five inches deep in the middle. The strength was equalized by curving the outline of the rail on the under side. The tram roads had flat rails, usually made of cast iron, having an elevated edge or flange on one side to guide the wheels which ran upon them. They, being weaker than the edge rails, were frequently strengthened with ribs on the under side. Ordinary wheel carriages could be used on the tram rails, but unless the wheels were smooth they were injurious to the track. One railroad which used the single rail is thus described: "The rail is about three feet

above the surface of the ground, and is supported by pillars placed at distances of about nine feet from each other. The carriage consists of two receptacles or boxes, suspended one on each side of the rail by an iron frame and having two wheels placed one before the other. The rims of the wheels are concave and fit the convex surface of the rail, and the center of gravity of the carriage, whether loaded or empty, is so far below the upper edge of the rail that the receptacles hang in equilibrium and will bear a considerable inequality of load without inconvenience, owing to the change of fulcrum allowed by the breadth of the rail, which is about four inches. The alleged advantages of the single rail are, that it is more free from lateral friction than the other kinds of railway, and that being higher from the ground it is less liable to be covered with dust and gravel, and, lastly, that it is more economical, the construction of one rail being less expensive than of two."

The introduction of railways means much more in the way of convenience and celerity of transportation to those countries having poor highways than to those more favored in this respect. Again, countries not traversed by canals and navigable rivers, open the year through, or lying far from the sea, are more benefited by railways than others. Intercommunication is expensive and

tedious without railways; their presence renders it expeditious and comparatively cheap.

The railway may be said to be a leveler in this respect, that it places all countries on a comparative equality. For heavy classes of freight, water carriage is cheaper than that by land, but railways render transportation more certain and expeditious than any other form of carriage. Transportation over them may be calculated to a moment. As regards passenger traffic, railways have no proper substitute. From these conclusions, it is apparent that where a traffic is sufficient to warrant the construction of a railway, no other form of land carriage can compete with it.*

In constructing a railroad, the policy of incurring the extra cost involved in cutting down grades to the minimum, running tunnels, building

* This may be illustrated very simply by the comparative resistance in pounds per ton hauled on highways and railways. Thus, the resistance in pounds per ton on level highways, constructed of different materials, is stated, approximately: for stone tramway, twenty pounds per ton; for paved roads, thirty-three pounds per ton; for macadamized roads, forty-four to sixty-seven pounds per ton; for gravel, one hundred and fifty pounds per ton; for soft, sandy and gravelly ground, two hundred and ten pounds per ton. On the other hand, the resistance on a straight and level railroad, for trains of ordinary weight and description, such as are in general use, is, for a train having a velocity of ten miles per hour, equal to about eight and one-half pounds per ton; for trains of fifteen miles, about nine and one-fourth pounds per ton; for trains of twenty miles, about ten and one-fourth pounds; for thirty miles, thirteen and one-fourth pounds; for forty miles, seventeen and one-fourth pounds; for fifty miles, twenty-two and one-half pounds.

viaducts, and kindred outlays, is governed, not by sentiment or theories regarding what is perfect, but by the saving effected. Will the gain exceed the interest on the extra outlay and the added cost of operating and maintaining? And by gain is meant the increased haul possible and the saving, if any, in cost of working. However, lack of means, quite irrespective of these considerations, oftentimes determines the character of a road. This is so in all new countries; oftentimes in old ones. Steep gradients and sharp curves do not now operate against the working of railways to the extent they did at one time. This is because of changes in locomotives and cars. In Europe, in early days, a curve of less than a mile radius was deemed impracticable, except where trains moved at a low rate of speed. Now, through their adoption of the bogie truck, so long ignored, their lines may be very sharply curved without serious detriment to the speed of trains or the cost of maintenance.

The character of railway construction is governed by the business to be done, as regards kind and quantity of traffic. If wholly or largely freight, trains may be run slowly; if the passenger business forms an element, the rate of speed must be such as to attract and keep business. Thus, if speed is high, the gradients must, per consequence, be moderate. In old countries the nature of a traffic may be determined in advance. In new countries it can only be surmised, consequently it often falls out that a road must

be practically rebuilt when the nature of its traffic has been developed.

Those who constructed and operated railways in America in early days were much embarrassed because of a lack of means. As an instance of this, an old chronicle tells how men were "sometimes put on the tender with a saw horse to saw and cut the wood to make steam for the trip, because there was no supply on hand, and no money and no credit to buy any." A story is also told of an official who surrendered his gold watch as security for a train seized for debt while en route. In the beginning, railway companies experienced great difficulty in securing reliable locomotive enginemen, and few of the machinists who understood the business cared to enter the service. Some companies found experienced blacksmiths the best source of supply; others took young men who had been trained as farmers. The engineman in those days was expected to make the light repairs that his engine required, as well as operate the machine. In case of derailment he more often than otherwise had to set matters right without aid from a wrecking train. The employes of the stage companies suffered more than any other class from loss of employment when railways were introduced. Many of them went into the service of the latter. They were employed as conductors, station agents, baggagemasters, firemen, etc. Their previous

occupation and training had made them robust and in a measure fitted them for their new work.

In some localities, when railways were first constructed it was thought they should be operated like a chartered turnpike; the company would lay the rails and the public drive their carriages over them, the proprietors having the right to charge toll from the individual owners of the vehicles. It was soon discovered, however, that a railroad could not be operated to the best advantage in this way and so the idea was, little by little, abandoned. However, on one line known as the Portage road, before locomotives were used, individuals and firms furnished their own drivers, horses and cars. The cars were small and had four wheels and a capacity of about seven thousand pounds. Four cars usually constituted a train. The drivers were rough, stubborn fellows whom the officers of the road had neither power to discharge nor discipline. At points where there was only a single track between sidings, a center post was set up half way between the two turnouts. When two drivers met on the single track the one who had passed the center post had the right of way, while the other was compelled to go back to the turnout he had left. Because of this, it was the practice for drivers to go very slowly when leaving a turnout, but when approaching the center post to drive faster and faster in order to get beyond it if possible, and thus compel any cars which they might meet to go back. This resulted in

frequent accidents and occasional loss of life caused by cars being driven together, as the road, in many cases, was so crooked that a driver could see but a short distance ahead. These and other attendant difficulties led to the abandonment of the practice of operating roads in the manner indicated.

The introduction of railways in England was at first strongly opposed in Parliament, as well as elsewhere. Newspapers spoke disparagingly of them, and many pamphlets were written on the subject. The evils which it was supposed they would occasion were vividly portrayed. It was insisted upon that the air would be so poisoned from the locomotive that birds would be killed as they flew overhead. The noise and confusion, it was also maintained, would prevent cows grazing and hens from laying; houses adjoining the line of railway would be burned by sparks from the engine; the atmosphere would be clouded with smoke; horses would become extinct; oats and hay would be rendered unsalable; the boilers of the machines would burst and passengers be blown to atoms; and, finally, traveling by the public highway would be rendered dangerous, and country inns ruined. A consoling feature, however, was the belief that the weight of the locomotive would prevent its moving, and the railways, therefore, if made, could never be worked by steam power.

Many quaint experiences attended the early operation of railroads. Thus, among others, the

means of warning passengers against standing on the platforms of the cars were more or less characteristic. On the car doors of one railroad was painted a representation of a newly-made grave, with a tombstone bearing the inscription: "Sacred to the memory of the man who stood on the platform when the train was in motion." Upon another line, the watch furnished the conductor was required to be suspended by a chain around his neck and carried in a fob outside of his coat. The engineer was similarly enjoined. At the end of the trip it was required that the watches should be returned to headquarters to be examined and regulated. Conductors were required to compare their time with that at the stations as they advanced, and notify agents of any errors.

The early methods of railways were the outgrowth of the ingenuity of those in charge, and differed according to the financial ability of the companies and the skill of those in charge. In no case, however, did anyone foresee the part which railroads were destined to play in the affairs of the world. In some instances, the carriage of passengers was alone anticipated; in others, freight. But in no case was it supposed that the interchange of traffic between the cities and towns of a country was in the end to be handled wholly by railway companies, and that stage coaches, freight vans, canals and other means of conveyance were to be banished except for local purposes. Nothing of this kind was anticipated, and as railroads came to be



more and more operated, it was found that provision had not been made for many exigencies that arose.

It is probable that the makeshifts of American builders and managers in early days exceeded all others. This because of lack of capital, and misapprehension as to the traffic railroads would be called upon to handle. At first, baggage, express and mail matter were all put into one car in charge of the baggageman. Before express companies were organized, the engineer or conductor oftentimes carried the money buyers wished to send to their agents on the line, and it was no unusual thing to find the tool box of the engineer filled with packages of money, which he distributed, as called for, at the little stopping places along the line, where grain, live stock or other produce was being bought. All trains hauled passenger and freight cars in common, the former being attached to the rear end of the train. This was a slow and uncomfortable way of traveling, as long stops had to be made at stations, and the bumping and jolting of the train was uncomfortable and sometimes startling to the passengers. At the worst, however, it was not so great as the bumping and jolting of the old-fashioned stage coach. There was, therefore, little fault found. In early practice no night trains were run, and trains stopped whenever and wherever people desired to get on or off. Nor were the companies averse to loading freight at country road crossings. Every accommodation, indeed,

that could be asked, was offered patrons, and no trouble was thought too great to secure business. Wood was the fuel commonly used on locomotives and for heating cars in America. Later on great difficulty was found in burning coal, though it proved very simple in the end. At first, the most good-natured engineers were put on the coal-burning locomotives, as their patience was constantly and greatly tried. Solid metal rails were the exception and not the rule. The ordinary roadbed was a strap of iron bolted to a long, square piece of timber, which, in its turn, was laid across ties, or, if not laid on ties, was at least held uniformly by cross-bars. The cars were lighted with tallow candles.

The locomotive was not at first accepted as being the best means of moving trains. On the London and Blackwall line stationary engines were used. A wire rope thus propelled was attached to the car, a rope being provided for each direction. The electric telegraph was used in connection with the device to enable the engineer at the terminus to know when to wind up or let go the wire. The train outward bound consisted of seven carriages. The two first vehicles went through to the end of the line, the others were dropped off at different stations. On the return trip the carriages were attached to the rope at a fixed hour, arriving at the end of the line at intervals. In Ireland atmospheric engines worked some of the railways. A speed of thirty miles and, later on, seventy miles an hour was

thus attained. A pneumatic locomotive was constructed in one instance to be driven by compressed air stored in reservoirs at a pressure of two thousand pounds to the square inch. It was at first the impression among railway engineers that the locomotive could not ascend a grade, and that the roadbed must, therefore, be level.

In early days passengers as well as trainmen were very careless while riding on the trains. This occasioned many accidents. People thoughtlessly jumped off the cars when in motion, men fell out of the windows while pushing and jostling each other, and as riding on top of the cars was not absolutely prohibited, passengers were frequently injured by falling therefrom or by coming in contact with overhead bridges. Instances were also frequent where the cars were set on fire by careless passengers overturning the lamps or igniting the furnishings of the vehicle while lighting their pipes.

Among the conceptions of early railroad experiences, it was suggested that a feather bed be suspended between the cars as a buffer. Another suggestion was that the engine should be a mile or so in advance of the train, connected to it by a strong rope, so as to avoid danger from explosion. In those cases where the engine could not start its load, horses were hitched in front oftentimes to aid in pulling both engine and train. Turntables were also so short that it was necessary to disconnect the tender from the locomotive.

Such were some of the incidents of early railway practice. They are interesting as illustrative of primitive conditions and instructive as foreshadowing the advances that railway men of the present day labor unceasingly to bring about. While our methods seem to be nearly perfect, it is probable they will be looked upon fifty years hence as merely preparatory. Such will surely be the case if we strive intelligently to better them.

CHAPTER II.

RAILWAY CONSTRUCTION.

That form of railway construction is most to be commended which best answers the commercial wants of a community and restricts cost to the narrowest practicable limit. Anything beyond this is a perpetual burden.

It is the dream of idealists that particular kinds of engines or cars should be used; that cars should be lighted or heated in a particular way; that tracks should be straight or level; that bridges and buildings should be of stone or iron; that ballast should consist of a particular kind of material; that rails should be heavy; that ties should conform to a particular pattern; that crossings should be above or below grade; that trains should run fast; that artistic features of construction or landscape gardening should receive greater attention and so on. All these are purely practical questions, however. Sentiment has no proper place in the economy of railway construction or management, any more than it has in developing or operating a farm. They are matters of business merely; of good judgment and common sense; of freedom from bias; of making outlay conform to income.

That the disposition will grow to add costly items of luxury to railroads without reference to their revenue producing qualities, there can be no doubt. Estheticism, sentimentalism and idealism will contribute to bring about such a result, but let us put it off as long as possible. It is not in the interest of the people nor of the railroad companies.

Railroads should be constructed and operated solely with a view to handling traffic. Ideal questions should not be considered. At least not now. Questions of need and practical utility should alone receive attention. In any event, the outlay of railroads should harmonize with their income, the same as with individuals. An extravagance not in accord therewith is paid for with multiplied usury. Luxuries accompany a plethoric purse, not an empty one. In the case of railroads, extravagance in this direction is generally the outgrowth of excessive competition, and may not, therefore, be avoided at will.

The wise location, economical construction and efficient management of railroads are all-important.

Railway economy acts and reacts on the commerce of a nation. Railways, if managed efficiently and economically, stimulate the commercial growth of a people; if mismanaged, retard it.

The impossibility of telling in advance of building a road exactly what is needed is apparent. It is especially difficult in a new or undeveloped country. The most glaring contrasts

everywhere present themselves. Thus, India, with a population equal to twenty thousand people per mile of railroad, transports less freight per mile than Canada with a population not nearly so great. This discrepancy is due to the fact that the latter is the home of a young, virile, growing, commercial people, while the former is not.

The trading capacity of a people is evinced in the use it makes of its railroads. George Stephenson, speaking of England, said that "the making of the railroads would be the making of the country." The truth of this has been evinced in every land where the industrial thrift of a people has warranted the construction of a railway system.

George Stephenson, while he did not invent the first successful locomotive, is, nevertheless, quite generally accredited with being the father of this machine and, therefore, of the railway system. He did much to perfect the locomotive. As I have had occasion to remark elsewhere, his prominence in connection with the opening of the Liverpool & Manchester railway, where for the first time the attention of the world was generally drawn to the railroad question, concentrated attention upon him, so that it was believed, though erroneously, that he invented the locomotive and operated the first successful one. The idea of the locomotive originated with Trevithick, as I have also pointed out, in 1803, but it was not a financial success. Afterward, John Blenkinsop accomplished what Trevithick had been unable to do. Blenkinsop had constructed two locomotives

which answered every requirement, so far as the action of steam and economy of operation were concerned, before Stephenson manufactured his first machine.

The locomotive followed naturally the invention of a suitable roadbed, as the wagon and carriage followed a suitable highway. The railway track, as referred to elsewhere, was first utilized in connection with the handling of coal. The bulk of the latter, and the necessity for cheapening its price, made some simple appliance for transporting it a matter of the greatest possible importance to the people of Great Britain. Horses were at first used, then steam. The cost of transportation over these tramways, or primitive railroads, is said to have been about ten per cent. of that over the common turnpike.

The evolution of the rail, with its support and fastenings, is both curious and instructive. Illustrations tell the story better than words. These will be found elsewhere. They afford a connected study of the various forms of rails that have been used, the different kinds of stone, wood and metal supports that have been tried, and the splices, chairs and fastening that have been invented and used from time to time.

No single item of construction equals in importance the track rail. It is fundamental and has been the subject of study and experiment by chemists, manufacturers and railway managers and operatives since railroads were first opened and, while the texture and pattern have

been greatly improved, they are not yet satisfactory, and it is unlikely that they ever will be. Men are too exacting, too progressive for that. No particular form of rail has been adopted that is everywhere recognized as superior to all others.

Uniform patterns for different uses are, when practicable, of the greatest importance in railway economy. They cheapen manufacture because they lessen the machinery of manufacturers and render it unnecessary to keep a great variety (and stock) of material on hand. Once a uniform pattern has been agreed upon, the manufacturer can carry it in stock the same as other standard material. It furthermore assists those in making selections who know little about such matters.

Rails differ widely in form, texture and weight. The strain they are subjected to is constantly changing. Each year the tendency is to increase the load. The speed of trains also grows greater. There must be harmony throughout. A rail that will answer for light use will not, as is well known, do for great weight or high speed.

The adoption of standard rails, while having advantages, would also have disadvantages. Unless engineers and others fitted for the work should continue their experiments and studies afterward with fidelity and zeal, there would be great danger that progress would be stayed. But if inquiry and experiment could continue unabated, the danger that always attends the

adoption of standard forms might be measurably avoided.

Railway development is influenced by the demand that exists for its product and the treatment such properties receive from the public. Unfriendliness on the part of a people affects unfavorably the construction of new lines. Railways are the natural adjuncts of civilization, and their growth is assured wherever protection is accorded them; wherever they are allowed free scope to prosecute their business within necessary and proper limits. Refusal or neglect to do this will prevent their construction, except in those cases where prospective gain outweighs possible risks.

Railways, like other industries, adjust themselves naturally to the countries they serve; to the instincts and habits of a people. Their construction depends upon the demand there is for them, the plentifulness of money, the rate at which it can be obtained and the protection accorded such interests.

Where wealth is plentiful and a people is accustomed to stable, permanent structures, the physical construction of railroads usually conforms thereto. In new and poor countries, makeshifts are the rule. Here the ingenuity and the genius of man is taxed to the utmost to lessen cost, to avoid expense; to be economical oftentimes where his inclinations lead him to be profuse. The railway development of the United States demonstrates the truth of this.

Every invention that lessens cost is a gain to a community, as it fosters development by releasing just so much capital for use elsewhere. In railway construction it permits the building of roads otherwise impossible.

It is noticeable of railways in different countries that the particular patterns or devices they first take on cling to them very tenaciously afterward.

The form of equipment adopted in Great Britain shaped the gradients, curves, bridges and tunnels of its railroads. They cannot now be changed in many important particulars. In the United States, where money was scarce and credit poor, it was necessary to adopt something less costly. The effect was to depart from the English method of construction in order to simplify and cheapen. Our railroads were made to conform to resources, and are different from those of Europe in alignment and grades, in the protection afforded at stations and crossings, in bridges, culverts and tunnels, and, finally, in the roadbed itself. While Europe built its permanent structures of stone, America built of wood. Here piling took the place of great embankments, and trestles, of arched masonry. While cheaper in the first instance, the cost of maintaining was greater. However, such practices nurtured economical habits and the exercise of prudent foresight. Expensive roads were not built where cheap ones were sufficient. The roads that were cheaply built were improved out of the earnings of the property or

by increased capitalization, as circumstances rendered desirable. In this way great properties in the United States have been built up. Canada, Mexico and South America are, in many respects, following a similar policy.

Particulars of railway construction cannot be described. They are not precisely alike in any two countries. The devices of one differ from those of another. Thus the wooden bridge, so familiar at one time to Americans, has never been known in Europe.

The word "permanent," while much used in railway nomenclature, has no proper place; change is the rule. It was suggested in the first instance by the solid wall, coped with smooth cut stone, used to support the rail, in place of the cross-tie that we use to-day. It was called the permanent way. It was as nearly permanent as anything could be. But it lacked elasticity, and so was abandoned.

Preliminary construction work, coupled with the investigations that precede the building of a railroad, is both interesting and instructive. An excursion is first made over the proposed line by a competent person or committee, and the topography of the country noted. Necessary inquiries are also made and statistics collected. The route having been determined upon, it is methodically surveyed. Afterward the plans and maps are passed upon, and such alterations made as circumstances suggest. Sometimes repeated surveys are made. When the route is finally

determined upon, the right of way, depot grounds, and other like facilities are obtained. The importance of a proper location is supreme. Upon it depends cost of construction, the load that may be hauled, the business that may be secured, and the expense of maintenance and operation.

After a line is agreed upon, the next thing in order is to prepare specifications of cost for use of engineers, contractors and others. In many cases the owner himself builds the road, especially in the case of extensions of old lines. But in every instance the duty of supervising the work falls to the engineer. It is his office to stake out the proposed line, make estimates of work done as it progresses and arrange for payments. This is his natural field, and in it he is supreme. His duties are at once laborious and of the highest responsibility. They involve close application, long hours of work, exposure, and the hardships that progress through a country, oftentimes destitute of comforts and conveniences, entails.*

The exact location of a railway, and the wise and economical expenditure of the money used in its construction, depend largely upon the engineer. The growth of his office in America has been great and marked. In no other branch of the service was there less conception originally of just needs. Its management was at first too often extravagant, ill-advised and self-sufficient.

*The duties and peculiarities of the civil engineer are referred to more fully in the book "Railway Organization."

This condition of affairs did not long continue. From being an abstractionist, or a creature of formulas merely, the engineer has added to his acquirements adaptability, practical knowledge, financial skill, business training. The status of the engineer in the early history of railroads was, moreover, much misunderstood. He was supposed to be wise above his fellows. The contrary was the case. It followed in America that responsibility for location and, largely, of method, was early taken out of his hands by men who studied the means as well as the ends to be achieved. But as he has grown in worldly wisdom and commercial sense, work has been given back to him and he has gradually taken his natural and proper place. "In its earliest development, engineering was hardly more than an art, a trade acquired by example and experience progressing slowly by small degrees from precedent. . . . The dominant spirit to-day is scientific; the application of principles without much regard to precedent. Only conclusions derived by logical methods from exact data and applied to conditions which have been fully valued inspire respect. Experience is also demanded, that experience in the application of forces and materials which gives practical skill and confidence, but not in the nature of that precedent, which is too often a handicap under different conditions. The profession is losing its transient character. Tenure of position is more secure and work on many lines is done throughout wide sections by

engineers from a central office or headquarters. The engineer is assuming more the position of counselor, is more the executive factor in the conduct of large operations, is retained more as an adviser on the staff of industrial enterprises. All this gives stability, material rewards and independence; gives the engineer a fixed abiding place and makes him a factor in the community in which he lives; enables him to develop the social qualities he needs and leads to that pre-eminence enjoyed by our profession in older lands."*

In locating railways, the nearer level they are, or can be made, the cheaper, relatively, it is to operate them; the greater the load they can haul and the greater their ability to stand the strain of competition. This last every company, to a greater or less extent, sustains. If rightly anticipated, it may be met with less embarrassment. Every obstacle that will impede traffic or the continued and rapid movement of trains is, so far as practicable, to be avoided. The speed of trains, directness of route, the load that may be hauled, and cost of maintaining and operating, are ever determining factors. These the engineer keeps constantly in mind.

Under all well established and stable governments, save ours, no railroad is allowed to be built to compete with others; that does not answer an actual need; that does not open up a new field; that will not presumably have sufficient

* L. E. Cooley, C. E.

income to pay cost of maintenance, operation and fixed charges. The exception is the case of roads built to meet military or political aims. In America, however, from the start railway construction was free. Whoever could raise the means might build.*

In our age the location of railways determines the center of communities, just as the highways of the past did. An animated contest was waged by railways with the water courses of the world from the start. At first it was for supremacy; afterward for revenue; later, so far as rivers and canals were concerned, it was a fight on the part of the latter for existence.

The construction and operation of railways have invited speculation, and been the occasion of many financial crises. Such evils, however, carry their own cure. Legislation can do nothing. The very uncertainty in regard to the business of a new railroad invites speculation. Within certain limits it is not harmful. Except for this speculative spirit no great enterprise, attended with uncertainty, could be carried out. We owe the early development of railroads to men who are willing to take certain risks because of the prospect of large gains. "Speculation is a necessity of modern life. Modern business involves large risks. . . . It rests with individuals to learn the lessons of each crisis, and protect themselves as best they can from a recurrence of the

* This phase of the subject is referred to in the book "*Economic Theory of Rates.*"

same evils. . . . A new permanent investment is almost necessarily speculative."*

Each year that a railroad exists it becomes more and more a permanent geographical feature. In time it will become like a navigable river or inland sea, which supplies a particular territory or affords intercommunication between far distant places. It can rarely, if ever, be considered distinctively a local enterprise, but whatever complexion it may take on, the property interests of those who own it can never be safely disregarded by the government. The original interests which fostered its inception and growth must also be remembered.

The political importance of railways cannot be estimated. In the easy intercommunication they afford between widely separated peoples, all previous ideas of local environment or national exclusiveness vanish. Their effect on exchanges and the habits of mankind is marked and progressive. Their tendency is to foster great enterprises, to swell the volume of business, to increase the importance of trade, to obliterate political lines and create new social conditions. The means of intercommunication they afford and the common markets they create will tend to make the commercial world a unit.

In the inception of railways expectation ran high as to the probable speed trains would attain. These expectations have not been fully realized. On the other hand rates are lower than it was

* Arthur T. Hadley on "Railroad Transportation."

supposed they could be. Growth of traffic has contributed to this. Rates depend much upon the amount of business; a maximum traffic makes possible a low rate.

Favorable rates are also in a measure dependent upon cheap appliances and good management.

Under the stimulus of railway life the impossible has become possible. Isolated and struggling villages, otherwise unimportant, have become great cities, and primitive continents, in a decade, became settled and civilized.

In the location of railroads in Great Britain and America their military value has been little regarded. This feature has, however, been a determining factor in many cases on the continent of Europe. In all countries railways will hereafter afford the lines upon which the battles of the future will be fought.

In the early history of railroads, especially in the United States, legislation concerned itself wholly with fostering their growth. Afterward it turned its attention to their control, to an attempt to regulate their business, to prescribe their methods, to say what they should do and what they should not do. Wherever these efforts did not conform to economic laws they were hurtful, both to the owners of railroads and the people. Mistakes in this direction are exceedingly difficult of correction and greatly retard the material interests and happiness of a country.

CHAPTER III.

METHODS OF CONSTRUCTION.

The term construction has a well understood meaning in railway parlance. It embraces the original or first cost of a property, including all disbursements, expenses, costs, commissions, salaries and debts incurred in connection therewith or incident thereto. It also includes all interest that accrues while the property is in course of construction and before it has been opened for business; all disbursements and losses suffered in the sale or disposal of bonds, shares, securities or assets, the proceeds of which are used for construction; also all expenditures on account of rights, franchises and appurtenances. These constitute the first cost of the property—its construction expenditures in fact.* Many of the differences noticeable in railway construction are inherent; others, again, are of method merely. The loam ballast, for instance, used largely upon the upland roads of Colorado, will not do at all in

* Construction accounts and classification are treated of in the book "Disbursements of Railways." Construction is also referred to more or less extensively in connection with "Maintenance." The two subjects are so inseparably intertwined that a description of the maintenance of railroads incidentally involves a description of many important features of construction.

India, where rains are heavy and prolonged. Such differences are inherent. On the other hand, the use of wood or metal are largely differences of method or expediency, although it is true that the rapid destruction of wood in hot, humid climates renders the use of something less destructible highly desirable.* The practice of one engineer to lay rails with broken joints and to anathematize all who do differently is an instance of method; method wrongly directed, it might be. Again, one engineer will advocate supported joints for rails, while another will not; both may be right. On one railroad fish plates forty-six inches long will be used; on another eighteen inches is esteemed sufficient. Both practices may be right, taking into account road-bed, speed and weight of trains, shape of rail, plate and so on.

Variations in construction that are not necessary entail added cost and should be avoided. They usually arise from lack of experience and study. They are oftentimes the result of prejudice or indisposition to learn. Ignorance is always arrogant, supercilious and self-sufficient. I remember once spending three months writing rules and regulations governing a particular phase of railway business. Afterward an officer of a neighboring road adopted the method they contemplated, but said he had not adopted the

* It is noticeable in railway operations that the wooden tie each year costs more and more. Limitation of supply occasioned by the destruction of forests accounts in part for this.

rules and regulations, indeed had not read them, because he wished to adopt something original. This spirit too often animates corporate officers. It is the result of arbitrary exercise of power without financial risk, of overweening egotism, or jealousy and narrow mindedness. As the railway service fills up with men of education, they will esteem their own wisdom less and will avail themselves of the knowledge of others more. That is where educated men have the advantage of the uneducated. It is, in the main, useless to attempt to teach an ignorant man, as he is superior to books and cannot appreciate how superficial his knowledge is, or how much we may be benefited by study and comparison. He is all-sufficient.

Uniformity in railway construction and method, while desirable, cannot be enforced arbitrarily. That would stifle interest, put a stop to invention and retard advancement. That is the objection to standard forms and methods of all kinds. Wherever introduced they must be attended by continued inquiries and experiments and systematic provision must be made therefor. Unless such a course is followed, interest will die out and, with it, further advancement.

In constructing a road much depends upon the topography and business of the proposed line, and much upon the financial ability of the company. Necessary things are oftentimes long delayed for lack of funds. After the opening of a line further work is undertaken only after searching

inquiry. When passed upon by local officials, it is referred to the board of management for authorization, unless the expenditure is an unimportant one.

The circumstances attending the expenditure of money for new construction work are substantially the same in different countries, except that the scrutiny of the directory will be more minute in some instances than in others. English directors are noticeably alert in this respect, and require to be kept advised of everything. Englishmen possess an especial aptitude for working in committees. Their political wisdom and adaptability is evinced in a marked manner in the government of private corporations. Their practices in regard to improvements and additions to railways are thus described by one skilled in such matters:* “Recommendations for increased accommodation at stations and depots undergo a very searching examination before any effect is given to them. We will suppose, for example, that a goods [freight] agent conceives it to be necessary for an additional siding to be laid at a station. He makes a report to that effect to the manager of the district; the latter inquires into the facts on the spot, and, if he concurs with the necessity, reports his recommendation to the general manager. The latter consults, in the first instance, the chief goods manager or the superintendent of the line, as the case may be, and, if his report be favorable, authorizes the engineer to

* Colonel George Findlay.

prepare a plan and estimate. The plan, when ready, is subjected to the criticism of the district officer, the chief officer, and of the general manager, and if all are satisfied the directors are next asked to authorize the necessary outlay. But even this is not all, for, finally, the plan has to be signed by the chairman of the company before the engineer commences operations, and that gentleman, who keeps a watchful guard over the company's purse strings, has to be convinced that the expenditure is not only desirable, but actually unavoidable, before his signature is obtained." This is substantially the practice of railway corporations everywhere. Improvements are not undertaken except after careful inquiry.

The managers of American properties have no superiors in the world in constructing and operating railroads. America differs from Great Britain in many ways. The roads of the latter are, however, uniformly well built and efficiently managed. So far as faithfulness in the discharge of trusts reposed is concerned, it is probable the owners of English railroads had less cause to complain of their agents in the early history of these enterprises, than owners in other countries where business methods were not so well systematized, and fiduciary responsibility not so well enforced. Cases are very rare in England where the servants of railroads laid themselves open to the suspicion of having taken advantage of their position to enrich themselves at the expense of their employers.

Rates are dependent on cost to the extent that, if not remunerative, no more roads are built. A remunerative railroad means multiplied construction; an unremunerative railroad means comparative cessation of work.

In respect to low capitalization America has the advantage of Europe: first cost was less, while subsequent charges to construction have been more discriminative. The owners of European railroads generally charged every improvement to construction, capitalizing the amount from year to year. America, on the other hand, has used a portion of its surplus to improve and strengthen its properties, charging the amount to operating. Abroad, the surplus has been divided as dividends, resulting in the fact that capital account has increased until many railroads are unable to make an adequate return thereon, while the resources of others have been greatly strained. Under the American system of constructing parallel railroads not needed, competition, in many cases, prevented maintenance of rates or the payment of dividends, to the great injury of the community. The monopoly the railroads of other countries possessed enabled them to pay interest on cost from the start. They may be able to continue this; it is to be hoped they will. The situation is, however, such as to excite apprehension in the minds of many familiar with the subject. "On a survey of the whole matter, there would appear to be too much reason to believe that the financial position and prospects of English

railways are going from bad to worse. Our railway boards have not as yet adequately realized this great fact, and have consequently done little or nothing to stem the tide of insolvency that threatens to overtake them.”*

In the building of railways America had the advantage over Europe in this, that she was not wedded to any particular kind of work, and had no theoretical standard to attain. Her aim was to make cost conform to means in hand. The result is a comparatively cheap railway system. In order to accomplish this, however, owners found it necessary to avail themselves of cheap appliances, wooden bridges, wooden culverts, wooden piling, trestles, cheap buildings, light rails, scant ballast, and so on. This necessitated slow trains, but trains quite on a par with their earnings ability. The engineers of Europe could not, if they would, have constructed such a railroad. It was too flimsy, too repugnant to ideas acquired by hundreds of years of stable construction work.

Nevertheless, the American system is the proper one, where doubt exists as to the productiveness of a property. First cost should be adapted to possible income, and improvements made afterward as events justify.

Another means of lessening outlay was the construction of narrow gauge roads. Whether this device was, on the whole, a good one or not, is doubtful. In many cases it was not. Where

* J. S. Jeans.

there is a prospect of through business requiring a standard road, a narrow gauge will, in many instances, prove an expensive device.

Whenever practicable, railways should be completed before being opened, and it goes without saying that they should be built to accommodate the work they are expected to do, the speed trains are expected to make, the loads they are expected to haul. The extra expense that attends the wear and tear of track and machinery on a poorly constructed road required to run fast or heavy trains is out of all proportion to the saving in interest on the added cost needed to put it in proper condition in the first place.

In new countries men are satisfied to get through to-day safely. To-morrow is left to take care of itself. It is necessary oftentimes to disregard permanent interests to save present outlay. Thus, temporary structures are built and rebuilt over and over again at an expense so near what it would cost to construct first class edifices in the first place, that inability to build durably at the start is paid for many times over, with usurious interest. Such makeshifts are not necessary in old countries; practices there tend to the other extreme; to wasteful extravagance too often.

In constructing a railroad there is no fixed ratio of cost to gross earnings which it is safe to follow, even if we could tell in advance what a road would earn. It has been stated as a safe guide, however, by those who profess to be versed

in such matters, that cost should be limited to ten times the annual earning power of a property, and that equipment outlay should be limited to the amount of the annual gross receipts.

The conditions that attend traffic in the United Kingdom are directly the reverse of those in the United States in many respects; thus, the speed of its freight trains is great, while the paying load is small. In America the speed is moderate, while the paying load is great.*

The cost of maintaining an English railroad is, in some particulars, much less than an American road. This is because it is better built. The English companies pay lower wages than American, but the number of employes per unit of traffic handled is greater.

Economy in railway construction and operation has been greatly facilitated in America by the use of what is called the bogie truck. This device adjusts itself easily and naturally to the track, rendering shorter curves possible and producing much less friction than the rigid wheel base formerly in general use abroad.

The cost of operating English railways is increased by the exclusiveness of passengers. Also by the retail business they carry on; the small

* "The average English freight car carries a load of about eight tons, and weighs five tons, being 1.6 to 1; the American box freight car carries fifty thousand pounds and weighs twenty-three thousand pounds, being 2.13 to 1."—*Edward Bates Dorsey*. The tendency in America is all in the direction of a heavier load; of cars that will hold more and tracks that will sustain greater weight and speed.

carrying capacity of their cars, and the practice of allowing shippers to partially load vehicles, is a burden that American companies are happily exempt from.

The wide differences that exist in cost of operating railways in different countries will, in many respects, grow less and less marked as they are able to adopt the best appliances of each other. But no two systems will ever be exactly alike. Differences in construction and environment will prevent this. But so far as inherent differences will permit, the good points of each system will be finally adopted by all. Business men are not tenacious of their methods when the effect is to deprive them of income. The difficulty in the way will not, however, be with the business man, the owner, but with his agents. The latter will be more or less stubborn, more or less firm in the belief that their systems are the best, more or less intent upon devising something Original.

It is a necessity that rates should be low in America in order to move traffic over the vast distances to be traversed. This has been realized from the start and has resulted in lessening cost of operating and in adding in every way to the carrying (earning) capacity of railroads. The result is that cost of operating in America, taking everything into consideration, is very low. Carriers have met falling rates by increased loads and better appliances. The limit of low rates, however, is determinable. Beyond that point further reductions involve the bankruptcy of

railroad companies and the demoralization of the business of a country generally.

While competition increases expenses in some directions and lessens earnings in particular instances, it is not without advantages. To its stimulating effect we owe all the substantial advances that have been made since railways were first opened. Had there been no competition, had not men been incited to invent and adopt better appliances to secure the favor of the public and lessen cost, there can be no doubt but that we should be using substantially the same appliances that were adopted in the first instance. Men progress, not because they love to progress, but because of strife and friction; because of rivalry; of a desire to secure advantages, to distance neighbors; to acquire and retain property.

Comparison of the equipment of England with that of America is interesting: "Stephenson and his colleagues mounted the old stage coach body on car wheels, which became the type of passenger cars; the coal wagons that were then in use in the collieries were put on the railroad, and became the type of freight cars; and before the conservative English character thought that they ought to be improved, and should be changed, the trunk lines had been built, adapted to this narrow and low type of rolling stock. To have made it wider and higher later would have required the removing and reconstruction of the masonry platforms, the raising and widening of bridges and tunnels—in fact, almost a reconstruction of the road. This

will prevent the use of high and wide cars. It is not fair to blame the modern English engineer for continuing the use of this description of cars, which he cannot change at any justifiable expense. . . . The English railroads have cost per mile more than three times as much as the American. . . . One of the principal items of the greater cost is the necessity of having much straighter alignment or easier curves, so that it can be safely operated by the rigid and long wheel base rolling stock in use there.* The Baltimore & Ohio Railroad is a sample of what can be done with the American rolling stock. This road is built through a very difficult and rugged country, which compelled a very poor alignment, with nearly one-half of the entire length in curvature, which curves run up to six hundred feet *radii*, and long grades running up to one hundred and twenty feet per mile. The country affords no natural advantages whatever. Yet, with all these drawbacks, this road does a very large and profitable business and operates its passenger trains safely at very high speed. All this is done on a road that could not be operated with rolling stock built on the English system. The

* It has been estimated that the long, rigid wheel base of the English equipment makes the cost of maintenance of way, locomotive power and repairs and renewals of cars double what it is on American roads for like service. There is, however, a marked tendency to adopt more facile methods in Great Britain. The railway managers of that country are not less alert than those of other lands to improve their methods, so that the conditions referred to are likely to be overcome in the near future. M. M. K.

extra cost of enlarging these curves to adapt them to English rolling stock would be so great as to be commercially impracticable. It is not difficult to appreciate the great difference in cost of construction, in an extremely rough country, of a railroad with curves six hundred feet, or twenty-six hundred and forty feet *radii*. Unquestionably the American system of construction is the best for new countries, or where cheapness of construction is desirable. The American rolling stock, with the bogie truck, will run safely and rapidly over roads of inferior construction, or sharp curves that would be impossible for rolling stock constructed on the English type of long and rigid wheel base. The American type is especially adapted for military purposes. . . . Through an ordinary rough country, a railroad to be operated with the American type of rolling stock could be constructed in one-fourth of the time and for one-fourth of the money that one suitable for the English rolling stock could be built.”*

America, in the construction of her railways, was happily free from many prejudices and habits that operated to the disadvantage of older countries. Its railways were made to conform to practical needs. If a road was not expected to do a large business, its cost was made to conform thereto. If it was not expected to require more than one train a day, it was built to accommodate one train. This adjustment of outlay to

* Edward Bates Dorsey.

income, however, has been seriously threatened in some instances. Thus, local authorities have assumed, though not generally, to fix arbitrarily the number of trains that shall be run; to make a political tribunal, in fact, the judge of the commercial situation; actual needs, paying loads, profits, precedent, all counted for nothing. Capitalists might not, if this spirit prevailed, hope to build railroads based on traffic, but rather on the peculiarities, passions and ambitions of politicians and parties. However, they need not make investments under such circumstances, and that the action I have referred to tended to keep them from making investments in the localities mentioned there can be no doubt. But where this spirit does not prevail, capital will seek investment in railways so far as traffic needs warrant and money can be profitably placed. Supply and demand will go hand in hand.

The intensely practical spirit of railway management in America is generally remarked by foreigners. Expenditures are made to conform to income. There is no straining after theoretical objects in any direction; estheticism is allowed to lie on the shelf; trains are run to accommodate traffic and conform to its profitableness. In older countries railway operation has had to conform more or less to firmly fixed habits and preconceived ideas of what was needed. Thus, in constructing railways very little distinction has been made between productive and nonproductive property. Everything must be stable and of

the first class. W. H. Booth, referring to this aspect of the case, says that unless it be in lighter rails, there is, in England, practically no difference observable in nature of construction between a short branch line, on which a small train runs to and fro three or four times daily, and the main line carrying numerous fast expresses. There are the same substantial bridges over and under mere country cart tracks, and the usual culverts, fences and station buildings. Expensive brick freight sheds are found at many stations where the traffic is almost *nil*. These cannot possibly be paid for by the volume of traffic they serve and must go very far to eat up the returns from the larger towns. Extravagances like these are the penalties men pay in business affairs for permitting prejudices or preconceived notions to govern practical needs.

CHAPTER IV.

PARTICULARS OF CONSTRUCTION, COST, DETAILS THEREOF, ETC.

The cost of constructing railways has been lessened by the cheapening of appliances and the introduction of better methods and implements. To enumerate these would involve a history of railway evolution, because every article has been changed, bettered and cheapened. The result of changes has been to lessen cost, save work, expedite business and to render it generally more satisfactory.

Every device that the ingenuity of man could suggest has been brought into requisition to lessen cost of constructing and operating. Mankind have ever been in accord in devising ways to reduce the number of men engaged in building railroads, and in substituting therefor mechanical devices. But such has not been the case everywhere. Men may be cheaper than machines or horses. This is the case in India in many localities. There, myriads of men, women and children take the place of steam dredges, shovels and other devices for preparing the roadbed. The work is carried on by hand, a common hoe and wicker basket being used. The natives work in families, the head of the family digging the earth

and filling the basket, while the wife and children carry it away. Two or three thousand people may thus be engaged on a mile of track. Labor is plentiful and cheap and progress rapid, unless food fails or an epidemic breaks out. The latter not infrequently happens on account of the lax habits of the natives. The embankments of the Indian railways are allowed to settle during the rainy season before use; they sink one to two inches per foot, according to the quality of soil. Wooden bridges and cast-iron girders are never used. The bridges are built with stone or brick abutments and wrought-iron girders. The waterway allowed is very large, because heavy rainfalls and floods are frequent at certain seasons, when little streams become wide rivers in a few hours. Stone ballast is generally used. Sandstone, slate and other soft ballast becomes useless within a few years, but burnt clay has been used successfully. Steel rails are generally laid, the best roads using thirty-foot rails of the double-headed type; the weight varies from seventy-two to eighty-two pounds a yard. Steel or iron ties are very generally used, as wood is scarce and high priced. No oak is used for this purpose; the best wood is a native timber called *sal*, but it is scarce. Creosoted fir from Norway has been successfully used, but as the price continually advances recourse is being had more and more to metal ties. Especial care has to be taken to provide for the expansion and contraction of the rails in track, owing to extreme changes

of temperature, and devices for rail joints are adapted to this end. Suspended joints opposite each other are the rule.

The money to build railroads seldom comes from the localities where the properties are situated. Local interests, however, gather the rich fruits that follow the construction of a railroad. They feel the stimulus of increased population, of new industries, of general appreciation of values, including land. They are the principal beneficiaries. And this without any risk or the expenditure of a cent.*

As the capital of railroads is raised outside of the immediate community where they are located, it follows that it adds so much to the wealth of the community in which it is disbursed. This accession of wealth, with the new enterprises that follow in its train, including increase of population and general enhancement of values, the community receives in consideration of certain rights, of no particular value to it, which it gives or sells

* In reference to the enhancement of values consequent upon the introduction of railways in Great Britain, Sir Rowland Hill says (Royal Com. p. cviii.): "The possessors of land and other fixed property in all districts traversed by railways have been enriched by the increased value of their possessions, to the extent, probably, in many instances of four fold." While the increase in the British Isles may not have exceeded Sir Rowland's estimates, it falls much below the appreciation realized by property owners in America; this difference, it is hardly necessary, perhaps, to state, is occasioned by the greater extent of country, its comparative newness, and the meager facilities it enjoyed for intercommunication previous to the introduction of railways.

in exchange. The most important of these is the right of eminent domain. This right is made much of by railway critics and superficial writers on railway subjects. It is not a gift. Those who exercise it pay for everything they get. Nor is it an exclusive privilege, where railway construction is free. Moreover, its exercise by railroads is much more valuable to the community than to those upon whom it is conferred. It is like widening or deepening the channel of a river before unnavigable, or opening a passage through a mountain previously impassable. Its exercise creates new sources of supply, new markets, new lines of travel, new means of intercourse, new sources of wealth. Those who provide the capital for constructing the railroad by which these results are brought about derive no other benefit, as a rule, than a reasonable (oftentimes meager) return on their investment. Their gain is slight indeed compared to that the community at large receives.

While the first cost of a road is in the nature of new capital brought into a community, the expense of operating, taxes, improvements and additions also adds annually a large sum. Practically nothing is taken away. What is not disbursed for expenses is reinvested. Thus a community is benefited in every way.

These simple and suggestive facts occur forcibly to those who study the railway subject in the light of condemnation which so often assails these properties. However apparent they may

be to students, they do not receive from a large class of the community the consideration they merit.

In considering the disbursements of railroads, those relating to the cost of the property are naturally the first to receive attention. The expenditures on this account embrace several distinct objects, all subservient, however, to the main purpose. Let us consider them in their order; and first we may note the cost of the charter or permit to build, the outlay for legal advice, notarial expenses, the company's seal and other items of a like character. These disbursements vary greatly with different companies. In some of the states of the Union it is required that a company shall procure a charter from the legislature. This charter is the substance or embodiment of a law specifying the duties and prerogatives of the company and the territory it may occupy. This is the manner of procedure followed in the United Kingdom. There the authorization of Parliament must be secured in every case. It is, as a rule, both expensive and tedious. In some of the states of the Union railways are built under a general statute. There is no limit to the number that may be organized in such cases. It only requires a permit involving the expenditure of a few dollars. The cost is much greater for a charter than a permit. Where a special charter is required, the expense varies in proportion to the necessity for the proposed road, the fidelity and skill with which the matter is pressed upon

the legislature, and finally the industry, intelligence and good intention of the latter body. A law must be drafted in any event, and men skilled in the arts of legislative practice employed to press it. It requires time and more or less outlay.

When railroads are organized under a general law, the process is comparatively simple. The incorporators must perfect arrangements in conformity therewith and file the papers required. In return it receives a permit to build. A certain percentage of the capital stock is usually required to be paid up before a railroad company can go ahead to construct.

After the procurement of a charter or permit, the amount necessary to be disbursed to perfect the organization is very small. However, it forms a part of the cost of the property and is placed to its debit with other items of greater consequence.

Preparatory to the location of a line, one or more preliminary surveys are made, as I have pointed out elsewhere. It is sometimes necessary to explore several routes before it is possible to decide intelligently which has the greater advantages or, perhaps, which is the least objectionable. This labor requires time and skill and frequently involves the expenditure of a large sum of money. Under the most favorable circumstances the work of locating a property, if conducted intelligently and with a view to ultimate outlay and income, requires the exercise of patience and good judgment. Not only must the

engineer prepare a general description, or profile, of the different routes, but must determine the approximate cost of the various structures, embankments, cuts, tunnels, bridges and culverts; the amount and quality of the earth that must be moved, and the distance it must be moved; the cost of track and other supplies, including ballast; and, finally, the maximum load that may be hauled in either direction over the whole line and over its different sections. In connection with the cost of each route surveyed, traffic advantages have also to be carefully studied.

Expenditures for surveys involve disbursements for implements, wages of men, clerical and supervisory force at headquarters, and the incidental expenses of the men in the field. The outlay belongs to the engineering department.

While the surveying parties are still engaged, or preliminary thereto, the capital outlay incident to the construction of the proposed road must be considered by its projectors. There are two ways of raising money, namely, by the sale of mortgage bonds and capital stock.* Both are usually employed in America, but not in equal degrees. Expenditures incident to the preparation of mortgage bonds and shares capital and the placing of the same on the market, vary greatly. Among them may be embraced printing, engraving, registering, commissions, exchange, and expenses connected with the sale

* These methods are frequently supplemented by a large floating debt before the road is opened.

and delivery of the securities. The discount suffered in the sale of securities forms, in many cases, a very large item in the construction account. It is chargeable to cost of property.

Ability to dispose of the securities of a corporation upon favorable terms depends upon the probable value of the proposed road, familiarity with the subject by capitalists, the condition of the money market, and the character of the men in charge. Political considerations also enter into the subject. A community known to be dishonest in paying its debts, or in not paying them, cannot borrow as cheaply as honest people.

An important item, chargeable to construction, is interest on capital while the road is being built. It varies greatly, but is considerable in every instance.

Up to this point, it is apparent, nothing of a tangible value has been secured, although the disbursements have been large and continuous. We now come to the outlay for real estate, for roadway, station houses, supply depots, shops, yards, sidings, docks and offices. In the procurement of its realty a company requires agents possessing especial aptitude and men withal of approved integrity and discretion, as the successful and honorable fulfillment of their duties requires patience, tact, skill and fidelity.

Except in isolated cases it is the experience of every company that the price put upon the land which it buys or condemns is excessive. The price is based upon neighborly accommodation,

interest and thrift; rarely, if ever, upon *bona fide* sales to private parties.*

Railways never strive to acquire land at less than its value. All their efforts are directed to escaping the payment of grossly fictitious sums. The expense of procuring the realty a company requires, aside from the cost of the realty itself, varies greatly. In new or sparsely settled districts the number of transactions is comparatively small, and the general desire of the community to have the roads constructed renders the holders of land tractable. Where the population is dense, the outlay to which a company is put for land and the expenses of juries, commissions,

* This is the case in every country where railways are built except where the appraisement is made by disinterested and capable officers of the government. The disposition to exaggerate the value of property required by railway companies has been the subject of frequent complaint in Great Britain. Sir Rowland Hill, in a report made by him, says: "In the purchase of land for railway purposes the amount actually paid is, as already stated, often several times the antecedent value." Mr. A. Sinclair, C. E., in his interesting notes on British railways says, in reference to the excessive demands made upon the English companies for the land they require and for land damages: "In the cost of British railways, right of way has proved an expensive item. As the land is mostly divided up into large estates, a company negotiating for right of way has not a multitude of property holders to contend with. But if the land owners are few, they are perfect Trojans to fight for compensation. There is a curious laxity of principle among a great many people in their dealings with railway corporations. Noblemen who are popularly credited with the possession of sentiments as elevated as their titles, clergymen with reputation spotless as their neckties, have been known to swear that a railway going through their grounds would inflict an amount of damage exceeding the market value of their whole estates."

arbitrators, experts, witnesses, and other court costs, is a severe tax on the wealthiest corporation.

To avoid imposition as far as possible, railway companies do not, when they can avoid it, definitely locate their lines until the realty they require has been contracted for. Those who procure the right of way must be allowed wide discretion to enable them to secure the most advantageous terms possible. It will be the policy of these agents, as it is of the company employing them, to represent that the location of the line is dependent (as it should be) upon the facilities afforded, and the amount the company is required to pay for right of way, depot grounds and yards; also upon the general friendliness and fairness of the people. Under a method so discreet, property owners will perceive that the benefits they hope to derive from the contemplated enterprise will not be realized if they are unreasonable in their demands. Public sympathy and interest will also be excited, and thus the more rapacious of the community will be held in check. Disbursements for notaries, registers, attorneys, clerks, abstracts, deeds, and kindred items connected with the procurement of land, swell the cost of a company's property. Aside from these are the salaries and expenses of the agents engaged. This outlay may be determined approximately in advance, but it will vary with different localities, periods and circumstances.

Matters relating to the lands of a company are rarely, if ever, fully closed at the time of the opening of its line. Years sometimes elapse before court proceedings and private negotiations are brought to a close, and requisite deeds passed. Whenever a company finds it impossible to come to an amicable arrangement with the owners of property, proceedings of condemnation are instituted and the work of building pushed on, leaving the matter of compensation to be determined afterward by the courts or boards of arbitration.

Disbursements for construction increase in volume as work progresses. At first small and infrequent, they grow in number and magnitude with the lapse of time, just as a storm oftentimes progresses from a few preparatory drops to a blinding tempest. With the active inauguration of the work of construction, those who provide the capital must meet the cost of grading and ditching; perfecting the roadbed; building bridges; constructing culverts; boring tunnels; excavating cuts; raising embankments; clearing away obstructing objects; constructing dikes; laying ties and rails, and, finally, ballasting and surfacing. Concurrent with these expenditures, or following them, the work of constructing fences, telegraph lines, depots, warehouses, platforms, sidings, engine houses, workshops and machinery and supply depots progresses with more or less activity. Finally, the vast panorama is closed for the time being by the purchase of necessary

furniture and fixtures for offices and buildings, and the procurement of needed equipment and supplies.

All the expenditures enumerated, or incident to them, form a part of the cost of a property, and appear in the returns as construction. In some cases the road is built directly by the company, but more often by contractors. At one time it was the custom to let railway work in small contracts, but this has given place more or less to the practice of letting the work to one contractor of large experience and means. It is thought the work is thus simplified, cheapened and expedited.

The cost of railroads per mile varies greatly in different localities and under different circumstances, as I have had frequent occasion to explain. It is affected by climate, the character of the soil, the cost of labor and supplies, nature of the traffic to be provided for, profile of country and kindred causes.*

The great cost of many European railroads is occasioned by the outlay they were subjected to

* Great expenditures are frequently necessary after the completion of a road. This feature is illustrated in the report of S. S. Montague, chief engineer of the Central Pacific Railroad: "Changes are taking place in the regimen of many of the streams crossed by your lines, notably the Yuba River at Marysville. The channel of this stream has been filled to a depth of twenty or more feet in many places, and at the point of crossing by the railroad it has shifted its position several hundred feet since the construction of the bridge, the main channel being now near the northern or Marysville bank. Two additional spans were constructed last year to provide for this channel, and it is probable that a further extension will be required."

for right of way and station and shop grounds. They found the land occupied, and the great bulk of it highly improved. In new countries vast tracts were still but sparsely inhabited when railroads were first introduced, while prices in the most densely settled localities were comparatively low. European roads were moreover constructed in a more permanent manner and with greater reference to the possible wants of the future than the financial condition or judgment of owners warranted elsewhere. Difference in cost is further heightened by differences in book-keeping. In one instance everything is scrupulously charged to construction and capitalization, while in the other a large part is charged to operating expenses. The extent of the latter practice has been very great. I cannot better describe it than by quoting what the railroad commissioners of Connecticut have said in regard to the additions and improvements made by the railroads of that state, the money being taken from current earnings. "A comparison of the present with the former condition of the railroads of the state enables us to realize the extent and importance of the improvements being made from year to year. Take, for instance, the size, appearance, cost and convenience of the station buildings in most of the important business centers as compared with those which preceded them. The old structures still remaining in various parts of the state emphasize this contrast. Still more striking is the contrast between the

strong, permanent stone and iron bridges which now span most of our large waterways, and the wooden structures which were displaced by them. Even the long pieces of pile bridging, which must necessarily remain for a long time to come, are gradually being floored and guarded in such a manner as to increase their strength and safety in case of derailment. Heavier steel rails than those formerly used are being laid upon those doing the largest amount of business. The amount of stone ballast is yearly increasing. In no one particular is the progress being made so apparent as in the character of the passenger equipment now being brought into use upon our important roads. This is made forcibly evident when it becomes necessary, on some special occasion, to bring out and use the equipment which was in use many years ago. The amount expended by the various companies during the past year for repairs of roadbed, track, bridges, buildings and for new equipment, indicates that substantial progress has been made in each of these departments. The increased weight of the locomotives and other equipment used and the increased tonnage of freight cars require a more solid roadbed, heavier rails and bridges of larger safe carrying capacity than were formerly needed, and the companies are realizing and meeting these requirements."*

What was done in Connecticut has been done in every state of the Union.

* Report, 1888.

The total disbursements of a railroad for construction purposes can never be accurately determined. Upon the books of no company, probably, is cost fully set forth. There are difficulties of accounting that prevent it, even in those cases where there is a desire to ascertain and make known the amount. Figures, therefore, that profess to give these facts are incomplete.

In every expenditure a railway company makes for construction purposes, no matter how charged on the books, no matter whether capitalized or not, the community is interested. All classes are favorably affected by it, from the man who digs coal to the dealer in pins; from the common laborer to the banker; from the manufacturer of scientific instruments to the farmer who plows his ground or tends his flock; and, as a railroad is never completed, the community's interest in its disbursements for construction never ceases; it is always growing. New wants are constantly suggested by the needs of business and the discovery of cheaper and better appliances. These involve further outlay, and will do so as long as men continue to invent or railroads continue to grow.*

*In this connection I beg to refer the reader to the book "Disbursements of Railways," forming a part of this series. It treats of a subject that affects construction, and several of its chapters are devoted wholly to construction work.

CHAPTER V.

ELEMENTS OF CONSTRUCTION.

Cost of construction is dependent, as I have already pointed out with more or less particularity, upon the character of the road, the nature of the country, the season of the year, the distance from source of supplies, the kind of material used, the amount and kind of business to be accommodated, the relative cost of labor, the ability and experience of the engineer and, finally, the skill and fidelity exercised in procuring the real and personal property.

A road built during a period of inflated prices will cost, it is apparent, a greater sum than one constructed at a more opportune time. Certain portions of the year are also more propitious for work of this character than others. Moreover, the work done then is more satisfactory and the cost of operating afterward, less. Circumstances concerning the soil and profile of a country govern cost. A road that may be built for a few thousand dollars per mile on the sandy plains of western Nebraska would cost many times the sum in the Sierra Madre Mountains. Character also governs. A broad gauge road is not only more costly than a narrow gauge line, but its machinery and equipment are, correspondingly,

more expensive. A road constructed to accommodate a large traffic has more elaborate and expensive facilities than a property built to accommodate a light business. The traffic that must be hauled to market over heavy grades requires larger and more costly engines than a line where there are no grades. The cost of constructing the road proper is also much greater. Roads are oftentimes built to handle a particular kind of business. Its nature may be discerned in the character of the equipment and the nature of the facilities provided.

The appliances of railroads are unique and exhaustive. Equipment must be adapted to traffic. The supply from which to choose is large and varied. The measure of profit a company reaps is ever largely dependent upon the adaptability of its equipment. If the load is light, a light locomotive is employed. It costs less in the first instance, consumes less fuel and lubricants, is less destructive to the track, and less expensive to keep in order than a heavy machine. If the load is great, the locomotive must correspond to the need. The roadbed, superstructure and rails of a line doing a small business may also be much lighter, and, therefore, cheaper than where the traffic is large.

Facilities are never the same in kind, quantity or cost. Thus, a company handling ores uses different cars from one handling merchandise. The necessities of a passenger road are different from those of a freight road. Upon such a line

expenditure for freight will be comparatively light, while the outlay for passengers will be relatively great. Upon another line these peculiarities will be reversed. The products of a country and the character of its people fix the status of a property. "A densely populated district, occupied by a manufacturing or a mining population, has far different wants from those of an agricultural population. The mountain districts of Scotland or the sparsely inhabited portions of Ireland could be supplied with railway communication suited to their wants by means of a very different mode of construction from that necessary for South Staffordshire or the metropolis."*

Many lines are constructed wholly with a view to through business. Local wants receive little or no consideration. Again, the traffic may be wholly local. If the traffic of a line is of a varied character, it is discernible in the arrangement of station and yard facilities, in the character of the cars and the adaptability of locomotives.

A glance is sufficient to distinguish a prosperous company from a poor one. It appears, first, in the nature of the construction work, and afterward in its condition. One will be well kept, the other will be lean; one will be vigorous and animated, the other feeble and lacking in purpose. The roadbed of one will be generous in proportion and of durable character, the rails will be heavy and well preserved, the cross ties broad and well together, the bridges admirably proportioned and

* Royal Commission on Railways, Report, p. xliii.

of durable material, the culverts constructed of stone or iron and ample to meet the contingencies of tempest and flood, the buildings will be large and well arranged, and the equipment extensive and well adapted for the work. The other will be pinched and circumscribed, with a contracted roadbed, more or less overgrown with weeds, with light rails, ties wide apart, buildings mean in appearance, and fences, bridges and culverts needing repair. The equipment of a company, more than anything else, perhaps, indicates want of care and renewals. If an unproductive line does not present the outward appearance I have indicated, it is because the owner pays more than his share of the losses its operation entails. This is frequently the case, especially where it forms a part of a lucrative property.

Many short roads are required to be built from year to year to accommodate local wants. They constitute a class. Their wants are few and the accommodations should be limited and simple. They ought, however, to be built of durable material, according to approved plans, by men versed in such matters. Otherwise the work is not likely to be such as to facilitate economical operations afterward. However, this applies to all railroads.

The opportunity for making money through construction contracts and otherwise suggested the building of lines, in many instances, that otherwise would not have been thought of. The community was, at one time, much harassed by

enterprises of this character in the United States, and investors suffered great hardships therefrom. Neighboring enterprises were also crippled, for the moment, by their introduction. The construction of these speculative enterprises occasioned temporary activity, *quasi* prosperity, in the community, followed by corresponding depression. A railroad that is not needed absorbs the resources of a country without rendering a return, and until the amount has been restored by savings, stringency and attendant hardship ensue. A country is never the richer for railroads that parallel existing lines. This incidental benefit, however, is derived: It intensifies competition; stimulates men to do their best; to invent new and better appliances; to be more attentive, more circumspect, more anxious to please their customers; to do more and better work than they otherwise would. These benefits, in a slight way, compensate for the ills entailed.

A railroad built by speculators is not usually well constructed. Little attention is paid to the needs of the traffic it is to accommodate. It is built to sell, and the slight interest of its projectors in its future leads them to do many things they would not under different circumstances. The securities of such properties are generally placed in the hands of agents and brokers to dispose of, at figures that would destroy their credit if known. Inferior material is used and the work slighted wherever possible. Large profits are

also made in the construction of these speculative properties by collusion with those who furnish construction supplies. The equipment furnished is, as a rule, superabundant and poor. The full extent of the profligacy of the builders is never apparent, however, until after the property is completed and the cost of operating it compared, year by year, with gross receipts and the expenses of neighboring lines. Then defects are realized, and the full amount of the wrong becomes apparent. At one time, in the heyday of railway enthusiasm, the construction of speculative railroads was a common thing. With lapse of time, and greater knowledge, however, they have been rendered less frequent because of inability to dispose of their securities. The lesson was a severe one to the community, but will not, on the whole, prove unprofitable.

The intelligence and experience of agents are evinced in the purchase of the real estate and other property corporations require from time to time. Generally speaking, it is of a suitable character and bought at the lowest figure. When not, the fault does not necessarily imply action purposely inimical to the owners. It may arise from lack of experience, or too much haste. As a rule, the agents of railroad corporations are men of keen appreciation and good judgment, acting only after mature reflection, and then wisely and well. Nor can they be accused of being too sanguine or too precipitate. They fear the accusation of extravagance too

much for that. They are extremely cautious, and, because of this, opportunity is sometimes allowed to pass before action is taken. More frequently than otherwise, however, in such cases the owners and not the agents are to blame. Timidity or ignorance oftentimes leads the former to place undue restrictions on their representatives. The productiveness of properties is in this way oftentimes seriously crippled. In many cases lack of money or credit render it impossible to do necessary work. In such cases there is nothing to do but to wait.

Leaving out of consideration the exceptional cases, the amount of a company's outlay for construction is governed by just needs and the character, extent and profitableness of the business to be accommodated. If for any reason property is acquired in excess of just wants, such disposition is made of it as the case permits.

CHAPTER VI.

TRACK—ITS CONSTRUCTION AND EVOLUTION.

The cuts contained in this book are designed to illustrate the evolution of track appliances. They depict the successes and failures of inventors, and to those who would understand the subject thoroughly, details in regard to the latter are almost as necessary as particulars in regard to the former.

If we know that a thing has been tried unsuccessfully, we are saved making experiments on our own account. It is this phase of the subject that makes the failures of life valuable. The illustrations portray the growth of the track of railways. Many of the physical affairs of a railroad cannot be successfully understood from a printed account. We must have the thing illustrated in order to understand it. Thus equipped we may in a short time acquire information that could not be gleaned in practical railway life in many years. However, in order to make the information their own, the students must study it not idly and disconnectedly, but consecutively and laboriously, as men study at our universities.

The track and, more particularly, the rail, next to the motive power, represent the central idea

of a railroad. Progress here keeps pace with improvements in other branches of the service. A full description of the devices of the track that have been introduced, some of which have been abandoned while others have remained to be perfected, would fill a volume. Such of them as I have thought necessary to a clear elucidation of the subject, I embrace in the accompanying illustrations. Each one speaks for itself. From these pictures the reader may, without weariness, trace the steps by which the track of a railroad has reached its present high standard. I am indebted for many of my illustrations of early appliances to the courtesy of officials connected with the United States National Museum, and wish here to thank them for their kindness.

When in the beginning men began to use vehicles, it quickly became apparent that a load could be hauled with greater ease on a road with a hard surface than on one that was poor and yielding. This brought about improvements. Similarly, when the needs of carriage became great, as they did in the eighteenth century, in connection with the hauling of coal from the mines, something better than a common highway was called for. The slabs or strips of comparatively smooth stone, as devised and used originally by the Romans, were not found to be good enough. The result was the invention of a perfectly smooth track, made of wooden rails or

stringers laid parallel with each other, the whole held in place by cross ties or other devices. Afterward these rails were covered with sheets of iron in order to make them more durable. This was called the "strap" rail.

Rails were first cast; afterward, early in the nineteenth century, they were rolled. In 1767 the first iron rail was cast at Colebrookdale, England. This was a great stride forward. It was three feet long, four inches wide at the top, and three inches high. This progressive step prepared the way for the locomotive when it should be evolved. However, the rail thus cast proved to be too light, but the difficulty was overcome by making the carts or wagons smaller and coupling a number of them together instead of having one big vehicle. Thus the train came into being. Shortly afterward it was found possible to cast a rail six feet long; in 1815 it had grown to fifteen feet; still later to thirty feet.

The modern form of "T" rail, with its supporting base, was, it is said, devised by Robert L. Stevens, of the Camden & Amboy Railroad, in 1830. The especial value of his rail consisted in the fact that it rendered the use of cheap wooden ties practicable. It also obviated the necessity of the expensive chair and other devices then in use. Inability to pay for these appliances in America necessitated adopting something whereby the expense might be avoided. However, notwithstanding its wide base, the rail is found to cut more or less into the tie. With the

constantly increasing weight of equipment and load this defect is accentuated. One of the means of overcoming it is the use of a "chair," or metal plate, placed between the rail and its support. Another, the use of a metal tie.

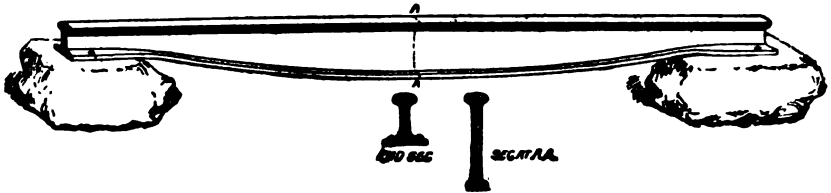

Jessop's Cast-Iron Fish-bellied Rail, A. D. 1789.—[NOTE: The attention of the reader is particularly called to the fact that in the accompanying illustrations not only the form of the rail is shown, but also the fastenings, splice bars, chairs, ties and other details of interest connected with the track.]

In 1789 William Jessop first introduced a rail with a smooth, level top, substituting a wheel with a flange for the old-fashioned form. This simple, yet ingenious, device at once revolutionized previous practices. Before, a flange or something of the kind had formed a part of the rail in order to keep the wheel on the track. This not only added to the cost of the rail, but rendered it less strong and more easily worn out. The flanged wheel cleared the sky. In 1797 Jessop also contributed to the development of railroads by inventing the iron chair, which he



The First Rail Chair. Newcastle-on-Tyne, A. D. 1797.

inserted between the rail and the tie. Rails at this time were very light, and the load and speed were made to correspond. In 1825 the rail used weighed twenty-eight pounds per yard. In 1830 it had been increased to thirty-five pounds; shortly afterward to fifty pounds, then to sixty-five pounds and so on according to the need.*

Up to the time the locomotive was rendered practicable, railroads were used mainly for hauling coal and were called tramways. The invention of the iron rail was what suggested the name of railway. Wrought-iron rails were not

*In illustration of this, the standard of the Eastern Railway of France we are told was, in 1897, eighty-eight pounds. The rails rested on strips of tarred felt placed on the ties. The rails on the Belgian state railways were spliced with two angle bars twenty-eight and three-fourths inches long, each weighing forty-seven pounds. Metal tie plates were used on every tie on tangents and curves, except the joint ties on which rested the broad flanges of the splice bars. Maintenance on similar lines with heavy and fast traffic is said to have cost about three hundred and fifty dollars per mile per year for labor. The track must approximately be renewed once in fifteen years, costing on an average nine hundred and seventy dollars per mile for material. The standard track of the East Indian Railway at the time mentioned above was laid with eighty-five pound bull-head rails, spliced by twenty-two inch bars and four bolts. The ties were of creosoted pine or sal. The approximate cost of maintenance of way is said to have been six hundred and twenty-five dollars per mile per year. The Great Indian Peninsular Railway was laid with double-headed rails (laid in chairs on teak and creosoted pine ties) weighing sixty-nine and eighty-six pounds per yard. The ties were ten by five inches, ten feet long, their life varying from twelve to fifteen years. One-third of the track of the Great Northern Railway of Ireland was laid with eighty-five pound bull-head rails and two-thirds with eighty-pound T or flange rails. The ties were creosoted, and would last from twelve to eighteen years.

manufactured until about 1805. They were two feet long, but never came into general use. At first the cross tie was used only at the ends of the rails. There the two were fastened together, as the illustrations suggest.*

In many cases ties were not used at all, but stationary blocks or piling instead. The usual way was to support the rail midway with stone blocks.

All things being new, every kind of experiment was tried. Among other things, the need of elasticity in a track was not

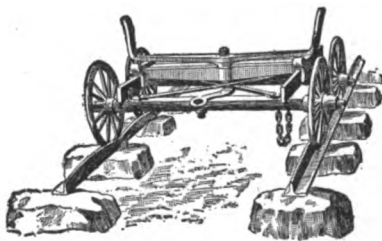

A Railway of A. D. 1800.

known, and hence great pains were oftentimes taken to lay the rails on the solid rock or on a concrete base. It was, however, soon discovered that such lack of elasticity quickly destroyed the superstructure as well as the locomotives and cars. Something else had therefore, to be tried. The stone blocks used to support the rails were found to be nearly as bad as the solid base. Relief was not found until the ballasted wooden tie was adopted. These experiments, with many others of a similar nature, went hand in hand

* While the cross tie is generally used by railroads throughout the world, the Great Western Railway of England uses a longitudinal support for its rails. Such support was quite common in the early days of railroading, but has, as a rule, been abandoned.

with the continued betterment of the rail that occurred previous to the introduction of the locomotive, the moderate speed attained on the tramways had not rendered the solid roadbed particularly objectionable, and so its destructive features were not noticed.

In the beginning, when attention was called to the wooden tie it was lightly regarded as not being sufficiently durable. However, its great availability was quickly discovered and henceforward it was fully utilized. The English, with

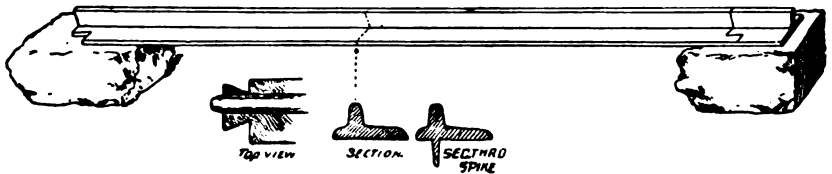

LeCann's Tram Rail, requiring neither bolts nor spikes. Wales, A. D. 1801.

the provident habits peculiar to them, quickly discovered that by the process of creosoting, the durability of the tie or stringer could be greatly prolonged.

At first it was deemed necessary to strengthen the rail between the supports upon which it rested. Thus the top and bottom of the rail were not parallel. The object sought was attained, so far as possible, in various ways, but the fish-bellied form of rail, shown elsewhere, was thought to accomplish the purpose more effectively than any other. Afterward, however, upon careful experiments being made, it was found that a rail

with a straight top and bottom (the lines running parallel with each other), supported by cross ties, was better than any other form. This was about the time the Liverpool & Manchester Railway was opened, in 1830.

No rigid connection between the ends of the rails laid in a track was made until 1847. Prior to that time they were placed one against the other in a chair, especially designed for the purpose, called a joint chair. The ends of the rails were not held securely in this chair, but could slide past each other and were quickly ruined by



Wyatt's Hexagonal Rail, North Wales, A. D. 1802.

the wheels jolting over the uneven surface. In 1847 fish plates for uniting the ends of the rails were introduced, and the device has since been generally adopted. By this means the rails are firmly held together, affording an even surface at the top. The fish plate, a strip of iron about an inch thick, was placed on either side of, but not touching, the web of the rail, the edges of the plate being made to perfectly fit the sloping sides of the head and foot of the rail. The fish plate is held in place by bolts, called fish bolts, which pass through the rail and the two fish plates (one on either side of the rails), drawing

the plates together and tightening their edges against the rail. The rail was further strengthened at the fish joint by the cross ties being laid nearer each other there than in other portions of the track. The efficiency of the fish joint depends upon the plates being kept securely in their place. They require to be frequently looked after and the bolts screwed up, as they are liable to work loose with the jar of the trains passing over them. Various styles of fish plates and fastenings have been introduced, the object being to find some way for holding the bolt and nut firm after being screwed into place, so they cannot work loose.

The custom prevails of imbedding the ties in ballast, so as to deaden noise and lessen the jar and vibration, and for other good reasons. It is recommended as a practice in England to raise the ballast to the level of the top of the rail in switching yards as a protection to switchmen in going in and out between the cars.

The ballast of a railroad necessarily conforms to the material which the company is able to secure for this purpose. Because of this, and because of lack of unanimity as to what is best, the kind of ballast used and the method of applying it upon different roads vary. Speed of trains and the traffic of a road are important factors in determining the kind of ballast and the quantity required. However, cheap and inadequate material is often used because of the inability of a company to pay for anything better.

The manner of applying ballast, while more generally understood than formerly, is still more or less a question of experiment and personal opinion. Thus, the ballast of the Lancashire & Yorkshire Railway is composed of a bottom course of stone pitching nine inches deep, three inches of ashes and a top ballast of cinders. On the Eastern Railway of France it is of broken stone, gravel and furnace slag. On the Great Northern Railway of Ireland the ties are laid in six inches of broken stone ballast above a six-inch paved or telford foundation. The ballast of the Belgian

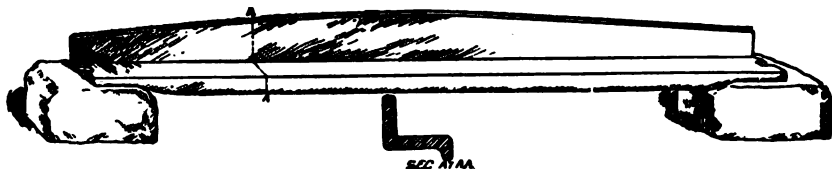

Tram Rail, Surrey Railway, A. D. 1808.

state railways is of broken stone—basalt, porphyry and sandstone. The standard ballast of the Pennsylvania Railroad consists of stone ten inches deep under the center of the cross tie. The stone is broken to a size not larger than a cube that will pass through a two and one-half inch ring, and is cleaned from dust by passing over a screen. The smaller stones are used for dressing and surfacing.* Gravel is the standard ballast of the Chicago & North-Western Railway, twelve inches deep beneath the ties. The center of the roadbed

* See diagrams of Pennsylvania track herein

between the ties is filled in even with the top of the ties. Stone ballast is also used, the stone being broken to a size that will pass through a three-inch ring.*

Shingle from the ocean beach is sometimes used on coast lines and forms an excellent ballast when free from shells, which latter, when they become crushed, make dirt.

The railways of the United States differ from those of European countries in this, that the latter were built for an existing population. Their con-

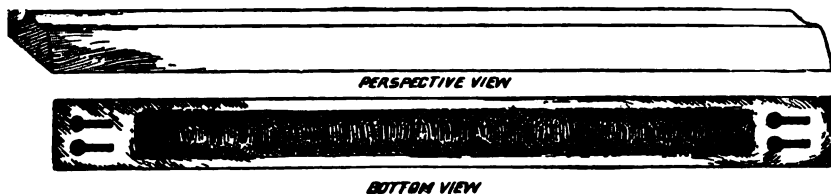

Woodhouse's patent Concave Rail for wagons, A. D. 1803.

struction was, therefore, in a measure, adapted to known traffic. In the United States they were generally built in advance of the population. They were, consequently, of lighter construction. Moreover, money with which to build was scarce, and the anticipated revenues did not warrant great outlay in construction. As business increased, improvements have been made.

Various conditions enter into the relation between track and traffic. Safety and economy are important factors. A light track which

* See diagram of Chicago & North-Western track herein.

would answer every purpose on a level and straight line of road may be dangerous and expensive on steep grades and sharp curves. The speed of trains and the frequency with which they are run must be considered in connection with the strength of a track. The question of maintenance also enters into the subject. New and heavy rails put into service on a poor roadway, with insufficient ballast, loose spikes and worn or decayed ties, could not be expected to make a good track, nor to last. The whole structure should correspond with the uses to which it is to be put. The track of a railway should not be allowed to deteriorate beyond a certain point; otherwise, the expense of maintenance and renewals is very heavy and frequently results, practically, in a reconstruction of the track.

A noticeable feature of American railways, in contradistinction to those of other countries, is the enormous traffic hauled in great trains by heavy engines over a light track. It is claimed by authorities on the subject that railway engineers have been less energetic in asserting the needs of the track than the master car builders and superintendents of motive power have been in asserting the needs of equipment; in other words, the track of American railways has not been kept up to so high a standard, relatively, as the rolling stock. The engineer, it is asserted, is not fully in touch with the equipment and operating departments. If loads are increased and more powerful engines used, the track should be

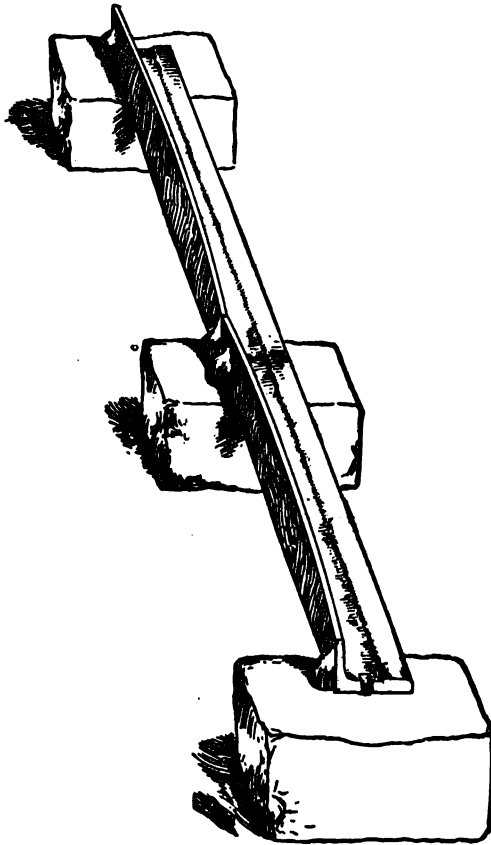

Tram Rail with stone supports, upon which Trevithick's first locomotive ran

kept in harmony with these conditions. The following, it has been stated, are among the important points to be considered in improving the track to conform to the requirements of traffic :

Weight, age, character of wear, quality and price of rails.

Kind of joints, their condition, life of angle bars, size of bolts, and amount of maintenance work expended.

Expenses for maintenance and renewals of rail fastenings.

Kind, price and life of ties.

Number of switches and frogs in use, amount of reduction possible without affecting the movement of trains, and their relation to the wheels.

Quality and quantity of ballast, efficiency of drainage, and cost of replacing gravel with stone ballast.

Cost of intelligent and efficient foremen and section men.

Cost of changing lines (when necessary) to obviate the necessity of curves and grades, proper arrangement of yards, and proper equipment of track with automatic signals.

Weight of locomotives, number in use, frequency of runs, wheel base, and condition of tires.

Weight and capacity of cars, and condition of wheels.

Number of cars per train, average load each way, number of trains, speed and weight.

In passing around a curved track, the centrifugal force of the train has a tendency to make the flanges of the wheels on the outside of the

curve press against the rail with a force dependent on the weight of the load, the size of the curve and the speed of the train. This is counteracted by elevating the outer rail above the inner one, the amount of such elevation being determined by a consideration of the maximum speed at which trains will travel round the curve.

In the early history of railways in America the construction of tunnels was little understood, and because of this the work was improperly performed, resulting in great waste of resources and

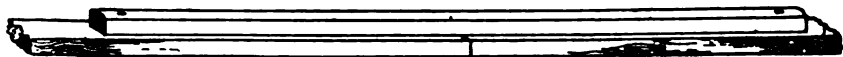

Carlisle's Wrought (rolled) Iron Rail, A. D. 1811.

embarrassment in the operation of the roads. However, with experience and acquired knowledge, the difficulties of the situation have become familiar to us and so have been overcome. An engineer of experience, in speaking of the construction of tunnels, points out the desirability of their being straight whenever possible, in order to afford the engineer a view of the entire length when his train enters a tunnel. Provision is also to be made for ventilation. This is sometimes accomplished by means of a fan operated by a stationary engine in a shaft in the center of the tunnel. If a double track is laid, ventilation may be aided by constructing a middle partition

(or brattice) lengthwise of the tunnel between the tracks, so the currents of air created by trains passing through in opposite directions will not become mixed. If the tunnel is not too long, the currents thus raised will be strong enough to move the air throughout its entire length unless they are impeded by conflicting currents. When such a partition is built, the tunnel must be wider than would otherwise be necessary, as the space between the two tracks should be at least eight feet in width. In making a tunnel through the

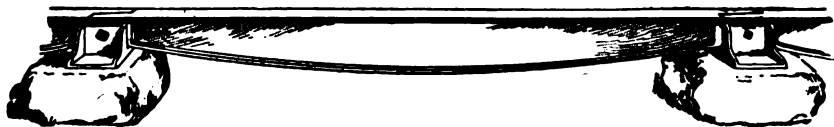

Losh & Stephenson's Edge Rail, Stockton & Darlington Railroad, A. D. 1816.

side of a hill where the pressure on the two sides is not equal, special care should be exercised lest the sides of the tunnel be damaged by the unequal pressure and the hillside rendered unstable. Recesses should be made in the sides of tunnels, into which trackmen may retire while trains are passing, and in which they may place their tools.*

The term "permanent way" represents the materials used in constructing the road on which vehicles are to run, as distinguished from those used by contractors temporarily in constructing a line for conveying material from place to place, making embankments, etc. By permanent way

* Mr. John Wolfe Barry.

is meant ballast, ties, rails, chairs, fastenings, fish plates, switches, crossings, etc.; in fact, the whole structure complete.

The track formed of two rails laid parallel to each other, upon which locomotives and cars run, is technically known as the "line of way." The distance between the two rails is called the "gauge of the line."

The gauge generally accepted and known as the standard is four feet eight and one-half inches.

An interesting feature in connection with the development of the track has been the question as to what was the best gauge to adopt as the

Birkenshaw's Wrought-Iron Rail, A. D. 1820.

standard. When the nomadic tribes of primitive days used their vehicles for habitations, the width between the wheels was much broader than now. Their purposes were facilitated by a broad gauge. However, when wagons were built for use simply as vehicles, the gauge was reduced until about what it is to-day. Utility decided what was best. When railway vehicles were introduced, lack of practical information, coupled with the disposition of man to experiment, led to the adoption of many different gauges. The variations in the United States, it is probable, exceeded those of any other country. Our lines were more scattered.

The advocates of the broad gauge, notably led by the Great Western Company of England, believed they had discovered what was best. On the other hand, gauges even narrower than what is now recognized as the standard (four feet eight and one-half inches) had many advocates. The very narrow gauge roads, however, were more often necessitated by a slender purse than a belief that they were the best. Hence it has followed naturally that, as their owners have acquired capital, the gauge has been changed to conform to the standard.

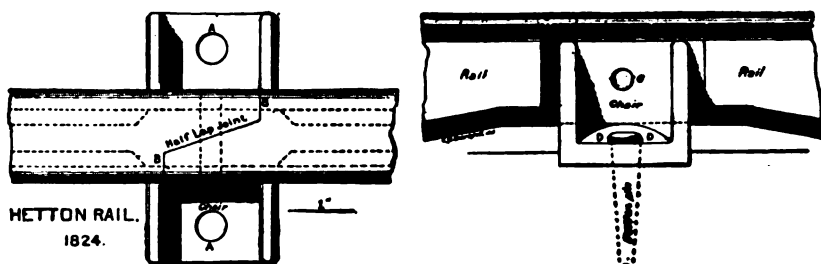

The widest gauge ever used was that adopted by Brunel for the Great Western of England—seven feet. He claimed it was the safest, steadiest and most comfortable and, moreover, that better time could be made on such a track. His claims were proven not to be well founded, while his gauge necessitated a much greater outlay than the other, as the engines and cars had to be larger and stronger and the track much heavier than a more moderate gauge. A gauge of ten inches is

said to be the narrowest ever devised. Such a road was built by a railway contractor named Mansfield for his own use in 1874.

The battle of the gauges was among the first and most bitter of the railway contests. It occurred in England. The contest ended in the first instance by the adoption nominally of two standards, viz.: seven feet and four feet eight and one-half inches, respectively. The latter is now

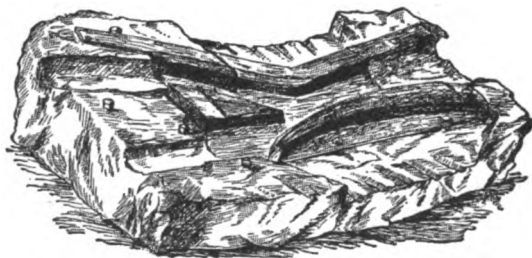

An early Frog pattern.

the standard, the former having become obsolete with its final abandonment by the Great Western Railway in 1892. The necessity of traffic, however, resulted at an early day in laying a third (standard) rail in many instances on the broad gauge lines. In India the government adopted a gauge of five feet six inches, impelled to such conclusion, it is said, by considerations of the advantage such a gauge afforded for the convenient arrangement of the machinery of the locomotive.

On the continent of Europe, where the government has exercised more or less supervision from the start, uniformity has been required in gauges. If the roads were broad gauge, the dimensions conformed to that style, and if narrow, then to that pattern. So there have, practically, been but two gauges. In this respect government supervision has been beneficial.

The adoption of a gauge of four feet eight and one-half inches in the first place (prior to the intro-

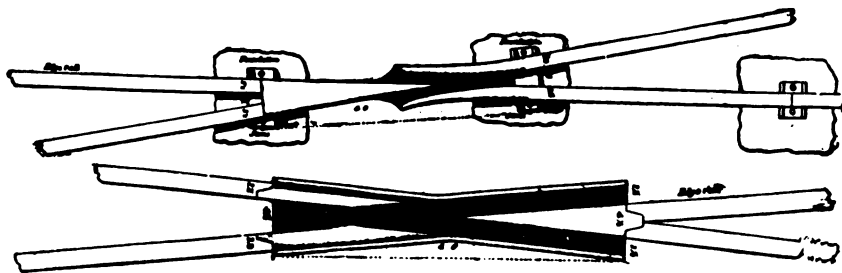

Frogs, Colliery Railroads of England, A. D. 1825.

duction of the locomotive), was accidental rather than calculated. It, however, led to its use by other tramways modeled upon it. When the locomotive was introduced, this gauge, more generally in use than any other, was accepted for that reason, and, as neighboring lines were constructed, the convenience growing out of uniformity led to its recommendation by George Stephenson.

The first railroad or wooden way having a four foot eight and one-half inch gauge was built, in

1630, in Newcastle-on-Tyne. Originally the gauge was measured, not from the inside, but from the outside of the rails. In this way the first railroad had a gauge of five feet, but after subtracting the width of the two rails the inside measurement was found to be four feet eight and one-half inches. This gauge is compulsory in England, Belgium, France, Italy and Germany. It is also in use on the greater part of the mileage of Europe. Spain, however, has a

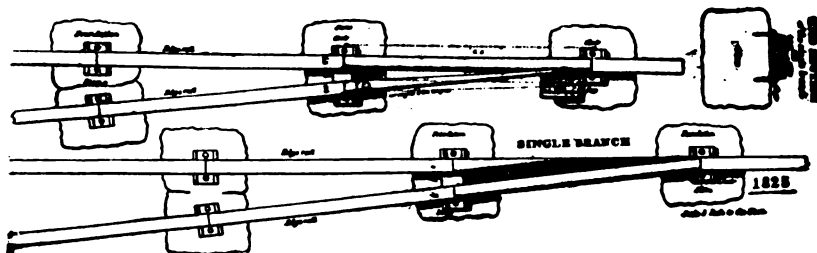

Switches in Colliery Railroads, England, A. D. 1828.

gauge of five feet six inches, while Russia has one of five feet. In the United States, while narrow gauge railroads are sometimes constructed, for financial or other reasons, there is practically a standard gauge throughout. In Ireland the gauge was settled by Parliament, in 1846, at five feet three inches.

In the operation of connecting lines, where the gauges are different, it is the practice, in some instances, to lift the train bodily from the trucks of one gauge to those of another. In such

cases, of course, the cars are fitted with suitable machinery.

In the appendix attached to this volume will be found a table, more or less complete, showing the gauges of railways in use, at one time or another, in different countries of the world.*

It is important that every portion of the permanent way should be sufficiently strong to bear the weight of the heaviest load to be transported over the line, as the strain to which a line is subjected is determined by the greatest load carried on any one pair of wheels.

The heaviest load carried is on the driving wheels of the locomotive. The power of the engine, as applied to the hauling of a train, is through the adhesion due to the insistent weight of the drivers upon the rails. This weight is very destructive to the permanent way, and efforts have been made to distribute it by adding more driving wheels, coupled together, without losing any portion of the tractive force of the locomotive. It is claimed, however, that an engine with one pair of drivers travels easier and with less friction than a coupled engine. When means are devised for applying the tractive force of the locomotive through the various wheels of the vehicles in the train, the strain on the permanent way will be materially lessened and the expense of operating greatly reduced.

In constructing a railway capable of carrying heavy loads, the following general principles are

* Appendix E.

laid down by those versed in such matters: The surface of the ties resting on the ballast should be large enough to keep them from settling under the pressure brought upon them; the bearing surface of the rails or chairs (if the latter are used) should be sufficient to prevent their crushing or settling into the ties; the rail should be of sufficient strength not to deviate either sideways or vertically, except within the proper limits of its elasticity; the two rails constituting a track should be kept from spreading apart by secure fastenings; the ends of the rails should be con-

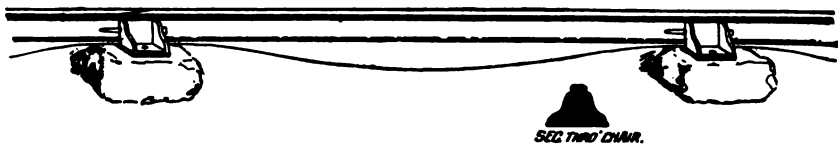

George Stephenson's Fish-Belly Rail, Manchester & Liverpool Railway,
A. D. 1829.

nected in such a way that the joints will, as nearly as possible, be as strong as the rest of the line; the rails should be made of material that will resist intense strain, great pressure and the wear and tear caused by the sliding of wheels; the whole track structure must possess a certain degree of elasticity when trains pass over it.

In laying rails the expansion and contraction of the metal, caused by changes in temperature, must be taken into consideration and allowance made therefor by having the holes in the rails larger than the bolts to be used, or of a different shape.

The rails (or chairs, in case the latter are used) are fastened to the ties by spikes, treenails, wood screws, or fang bolts. A spike is a cylindrical iron bar with a head, and is driven into a hole in the tie which has been bored a little smaller than the spike in order that the latter may be held more firmly. The shrinking of the timber, however, is liable to loosen the spikes in a short time. The spikes should exactly fit the holes in the chairs.

Treenails are wooden spikes which have been compressed by machinery and all moisture driven out of them before being used in the track.

When placed in the track they are held firmly in their place by absorbing moisture and swelling. Treenails afford a good fastening while in perfect condition, but the liability of their becoming inefficient because of decay had led to the general use of iron spikes in connection with them.

In some cases a combination of spike and treenail has been employed, the treenail consisting of a hollow cylinder of compressed wood into which an iron spike is driven after the treenail has been inserted into the tie.

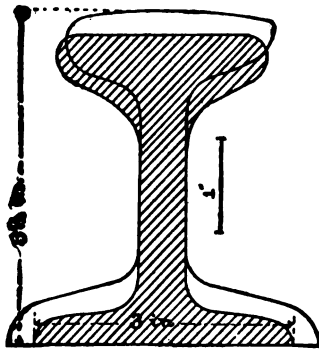

Rail designed by Robert L. Stevens, A. D. 1830; adopted by American railroads. Shaded section shows rail as originally designed, 1830. Section not shaded shows rail as rolled, 1831. This rail was fastened to stone blocks with hook headed spikes; at the joints were iron tongues fastened to the stem of the rail, put on hot.

Rectangular spikes, sometimes called "dog spikes," having a projecting head which extends about half an inch over the upper surface of the foot of the rail, are a common means of fastening the flat bottomed rail to the tie.

Fang bolts are said to be the most satisfactory fastenings employed in England. The bolts are long enough to pass through the ties and have a screw on the end which fits a large flat nut. A fang or short spike is on each corner of the nut. These fangs imbed themselves into the under side of the tie and prevent the nut from turning, the bolt being screwed into the nut by turning the head. The rail, or chair, is firmly drawn down on to the tie and elasticity of the wood tightly holds the bolt. A disadvantage in connection with the use of the fang bolt is that it becomes set by rusting and cannot be turned around. The latter is frequently necessary, especially in hot climates where the ties become shrunken by the hot sun.

Another English device for fastening rails is known as the wedge spike. The spike is split at the bottom for receiving a wedge, which expands the two halves of the spike and makes it assume a dovetail shape. A hole is bored through the tie and an iron plate used to hold up the wedge while the split spike is driven on to the latter. The spike cannot be removed from the tie until the wedge has been withdrawn, this being done by a lever made for that purpose.

The accompanying illustrations of the rail show, incidentally, the evolution of its accessories. Thus, at first the rail was laid directly on a block of stone, to which it was attached. Later on we notice, in England, the introduction of a support or chair; then came the splice bars, with bolts, wedges and other devices, such as the particular form required. One improvement followed close upon another. The era was one of invention. Man's ingenuity was stimulated to

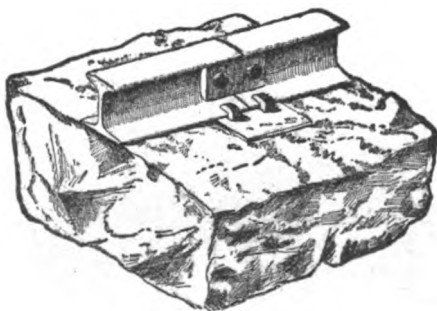

Stone Block, Rail and Joint Tongue laid on Camden & Amboy Railroad,
A. D. 1831.

the utmost. In this way the appliances of the first-class track of to-day were evolved. Each year adds something new and better, but substantially the first twenty years of active railway operation saw the track fairly perfected. Differences have existed and do exist, and always will exist, it is probable, as to what particular or technical form a device shall take. It may be a form which is the best in one instance may not be in another. In some cases, ignorance and

prejudice undoubtedly intervene. Thus, while the splice bar is everywhere recognized as indispensable, the particular manner of applying it differs. How far these differences are necessitated by different conditions is a question which I shall not pretend to answer here. The use of different patterns involves, it is apparent, loss (temporary at least) to the companies that do not select the best. Nevertheless, railroads are, on the whole, benefited by the experiments they involve, because out of them is finally ascertained what is best. These experiments are not at an end, in regard to any particular device connected with the track, but will continue to animate those interested in railroads as long as they are operated.

The double headed rail was designed for reversing when the top became worn, instead of replacing it with a new rail. When this form of rail is used, a chair is necessary to keep the rail from cutting into the tie, and also to protect the lower part of the rail from becoming worn. It is held in place in the chair by a wooden block.

The bridge rail was intended for use with the longitudinal tie. It has in some instances, however, been laid on cross ties, although not perfectly adapted to this use.

The flat-bottomed rail (called the "Vignoles" rail in Europe, the "Stevens" rail in America), does not require the use of a chair, except, possibly, at switches, as it is wide enough at the bottom to resist the pressure of the wheels upon

it. It is the common form in use on American railways.

The upper surface of a rail should correspond as nearly as possible to the shape of the tread of the wheels which are to pass over it, in order to afford the wheels the largest possible amount of supporting surface. Rails are worn much more rapidly by the sliding of wheels upon them than by their rolling over them.

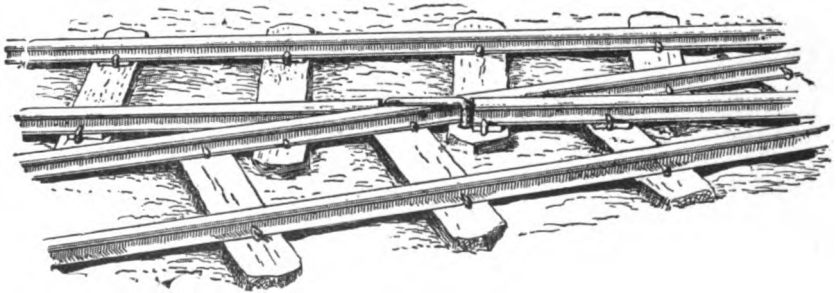

Staple iron used as a makeshift for a Frog, Camden & Amboy Railroad, A. D. 1831.

A noticeable thing in connection with railroads, and one that has excited as much attention as the form of the rail, is the support or tie on which the rail rests. Longitudinal ties, or sleepers, as they are called, are in some cases used in England. These pieces of timber (about twelve inches by six inches) give the rails continuous support by lying under and parallel to them. The timbers are connected by cross bars notched into them and fastened with iron bolts. When soft wood is used, a thin strip of hard wood is laid between

the rail and the tie so the grain of the wood is at right angles to the rail. Longitudinal sleepers permit the use of lighter rails than when cross ties are laid. They are also safer in the event the trucks of railway vehicles leave the rails, as they afford a comparatively smooth surface for the wheels to run on, while in the case of cross ties the wheels bump from one tie to another in a manner which is disastrous to the couplings, springs and other portions of the train. The advantages in favor of longitudinal over cross ties, however, are offset by numerous disadvantages. Thus, the timber required for the former must be larger and, therefore, more expensive. When a longitudinal tie becomes defective it can be removed and replaced only by taking up the rail and, as a result, stopping traffic for the time required for this work, while if a cross tie is unfit for further service it may be replaced without disturbing the rail or any other tie and without sensible interruption to traffic.

While engineers have, in the main, been restricted to a wood tie, they have not been satisfied with it. It decays too quickly. This discontent early found expression in the invention of metal ties of different forms. Many of these I illustrate herein. This form of tie is perfectly practicable, and in many cases, more economical to use, it is probable, than any other; but until railway managers become entirely familiar with its merits, it will receive only cursory notice. Up to this time, the first outlay

it necessitates has been thought to be too great for many companies.

The so-called metal pot tie is sometimes used on European railways. It is made of cast or wrought iron, dome-shaped. The chair is a part of the tie and the rail is fastened to the chair with a key. In laying this form of tie, the ballast

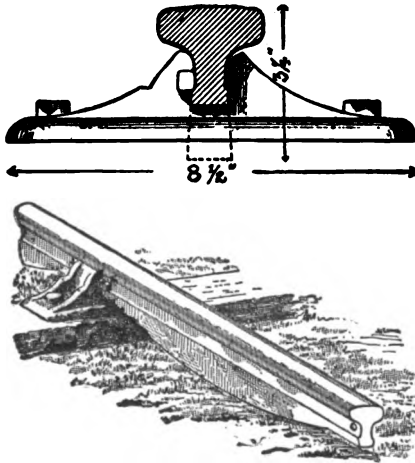

English Fish-belly Rail, New Jersey Railroad, A. D. 1882.

is made into little piles or heaps where the ties are to be put in the track. The bowl of the tie is placed over the pile and packed by forcing fine ballast through the holes in the upper part of the bowl. The rails are kept parallel by tie rods extending crosswise, which are attached to the pot ties.

The forms of metal ties invented are exceedingly varied and will repay the most careful investigation. Experiments in this direction are, however, not at an end, any more than they are in connection with other features of the track. Indeed, the rail itself, upon which so much thought and experimental action have been devoted, and which is apparently so perfect, will take on still other and better forms as use demonstrates its present imperfections. It is notice-

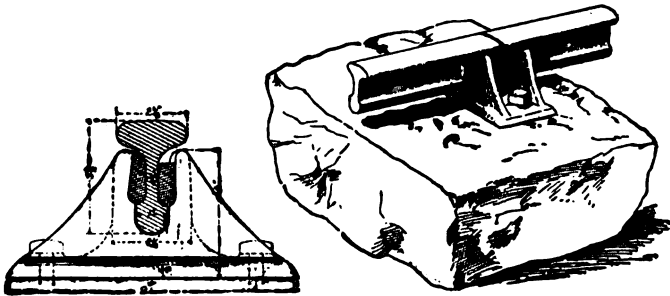

Joint Chair and Wedge, Old Portage Railroad, A. D. 1832.

able, however, that very early in the operation of railroads the rail began to shape itself on present lines, and this not without due thought and experiment, for it is hardly possible to conceive of a shape the rail has not assumed under the deft hands of different engineers and manufacturers. Nothing in connection with the evolution of railroads is more interesting than this feature of their development, but while almost every conceivable form has been made and tried, it is

noticeable that only those have survived which conform generally to the present pattern, and as I have copiously illustrated this I shall not attempt to describe it further here. And so in regard to some other features of the track: they can be better understood by carefully studying the cuts illustrating them than by the most lucid explanations. I, therefore, refer the reader, for further and more technical information in regard to the track and its evolution, to these illustrations.

CHAPTER VII.

CONSTRUCTION, MAINTENANCE AND CARE OF THE ROADWAY AND TRACK.

[NOTE—An effective and thorough system of track accounts is necessary to a proper understanding of track maintenance and its due and economical enforcement. Such a system will be found in the book "Disbursements of Railways."]

As this is the salient feature of a railway, it naturally excites greater interest and speculation among managers than any other part of the property. Upon it our lives and the safety of our property depend. Other structures connected with a railway are the work of architects, machinists, plumbers, carpenters with their accessories; we use the same agents in building and repairing our houses, and consequently possess more or less knowledge of their methods. The track of a railway, on the other hand, is a thing apart, something special and unknown.

A good track is commonly an indication of a solvent company, a wise manager, a skillful staff and careful and trustworthy employes. Much might be written about it of a theoretical nature. The subject is such as to excite the imagination. I shall, however, lay before my readers only that which is of practical use. I have given the subject much thought, but feel I

cannot say anything so pertinent as those practically familiar with the subject. I beg the reader's indulgence, therefore, if I avail myself largely of what has been written by those wise in such matters.*

Let us take up the subject at the point where the roadbed is ready for laying the ties and rails. We will assume that the contractors have finished the work of grading; that the culverts and bridges have been constructed; that the ties have been bought and are piled at convenient places along the road; that the surfaces of the ties have so far as possible been prepared ready for the rail, and that they have been seasoned for at least one year; that the timber for switches is conveniently placed and similarly seasoned, and that the rails and splices are ready for delivery as required.† At this point there will, it is probable, be several places at which it may be possible to commence laying track. The first thing to be done is to organize one or more gangs



Rolled Rail, Old
Portage Railroad
of Pennsylvania,
A. D. 1833.

* The authorities I particularly refer to are Mr. Andrew Morrison and Mr. H. W. Reed. The free use that I make of the genius and experience of others in this respect involves, as the reader will notice, more or less repetition. It will be, however, more apparent than real. In any event, the sidelight thrown upon the subject will be found to warrant it. This is true, not only here, but elsewhere throughout the work in connection with the subject about which I write.

M. M. K.

† See Appendix F for approximate quantities of material required to lay one mile of track on the basis named therein.

of tracklayers; also a construction train for each gang, and surfacers for each gang. It will usually be necessary to prepare the roadbed for the track before putting these gangs to work. This preparatory work is commonly known as—

TRIMMING.—This is work which contractors are very likely to do imperfectly or neglect entirely. Thus a most important part of their work is left for the track department to do, if a company is desirous of having a good track so as to save expense in later years. The roadbed in cuts should be prepared with great care, especially

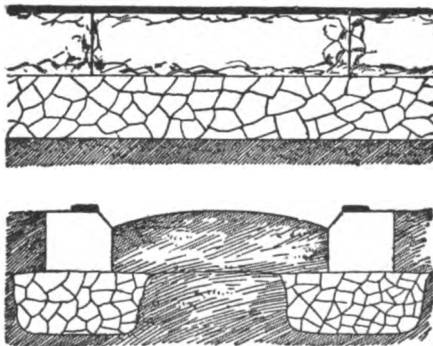

Stone Stringer and Strap Rail, Baltimore & Ohio Railroad, A. D., 1823. This was a favorite American device.

in regard to drainage. The center of the bed should be eight inches higher than the ditches for single track, and eleven inches higher for double track. The roadbed for double track should have its summit of drainage at the center of each track. This provides efficient drainage between these points, but not for the space between the track centers. This is why longitudinal drains with cross branches to the ditches are often necessary to drain the inner two halves of the track. The roadbed for double track should slope from the summit of drainage, at the rate of one-half inch to the foot, until it

reaches the extreme outer ends of the ties, from which it should slope to form the ditch, six inches below this point; the bottom of the ditch should be six and a half or seven feet distant from the near rail of each track. Single track should be in proportion. All holes should be filled solid, uniform with the surface of the bed. When this is completed gangs can be put to work.

CONSTRUCTION TRAIN.—The number of construction trainmen and foremen will depend upon circumstances. It is their duty to load and unload material. Work can be economized by using as few engines as possible. One engine can be made to do the work of two by placing the cars for loading and unloading material while it attends to other work. If, however, the haul is too great to admit of this, an extra engine is necessary.

TRACK LAYING.—A track laying gang should consist of as many men as can be worked conveniently. Small gangs can be worked more economically than large ones. The best men should be kept at the front. If one man in each sub-gang is paid five or ten cents a day more than the others, he will encourage his fellows to greater exertion than a foreman can. The foreman of a track laying gang should be smart and ingenious. The following is about the force required to lay the track of a new road under normal conditions: nine men to load construction material on the truck, eight men to unload the truck, one man with a horse to haul material, four men to lay out rope for lining and spacing ties, six men to put on splices, and a proper number of spikers. A track laying gang will lay on an average one mile in two days. Sometimes less, sometimes more. Portable turntables are used for the convenience of loaders and unloaders. When a truck is unloaded, and the horse has hauled back the empty truck, the driver will put the turntable on the track and haul the empty truck off on two cross ties; he will then hitch on to the loaded truck and haul ahead to be in turn unloaded; the loaders will then run the returned empty truck back to its position for reloading. Should the unloaders have their truck unloaded before the driver

arrives with the next load, they will put the turntable on the track and run it off when the next loaded truck is hauled to position. Should the driver reach the unloaders before their truck is empty, it will be his duty to place the turntable. The object to be kept in view is the keeping of unloaders constantly supplied with material. An ordinary truck load is six rails and sufficient cross ties to lay that number of rails, with a supply of splices, bolts, nut locks and spikes. It is better and cheaper to lay ties complete than to lay them for joints and quarters only, allowing the intermediate ties to be unloaded afterward and pulled beneath the rails. It requires the track to be raised in order to accomplish this, and it is injurious to the rails and roadbed to run a train on such a track. As fast as the

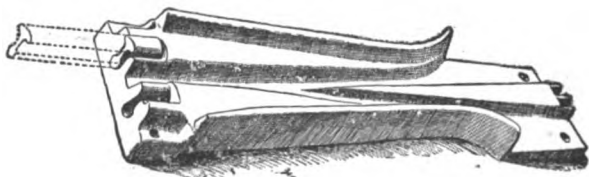

Frog, Old Portage Railroad, A. D. 1835.

ties are laid sufficient for each half rail length, the rail is laid down, partly spliced and spiked and the truck then moved ahead. The splicers and spikers do the principal part of their work behind the truck. The spacers will locate the places for the joint ties, using a pole of the proper length, and laying the rails with broken joint. On curves, the rope is first laid in position the same distance from engineers' stakes as on tangents; then put to curve by measuring off the middle and intermediate ordinates from the straight line first given by the rope. The rope is placed on the proper side for lining ties, namely, on tangents of double track, the right-hand side in the direction the trains run; and on the inner side of curves. The splicers will space the rails by tightening up the rear bolt, and then inserting

the round end of their wrench in the forward hole of the splice and rail, which will give sufficient leverage to move the rail. They should be provided with a suitable rail spacer. When they have adjusted the joint and bolted it up, the spiking may be done.

GAUGING AND SPIKING.—Joints and centers should be gauged and spiked first, so as to bring the rails to their proper position on the ties. This facilitates intermediate spiking. Each tie should be gauged as it is spiked. Curves of three degrees and over should have their gauge widened, so that the longest rigid wheel based engine can pass around the curve without crowding or spreading the track; this will vary from one-eighth of an inch on a three-degree curve to one and one-fourth inches on a twenty-degree curve. The widening of the gauge should begin back on the tangent and be full gauge at the beginning of the curve and continue all the way around to the beginning of the tangent, being then run off on the tangent as before. Slot holes in flanges of splices should be spiked to prevent creeping of track. All spikes should be driven plumb and snug to the rail; they should not be struck laterally, as they are thereby bent and consequently fit improperly against the rail. Striking the rail should be prohibited; it is the result of carelessness and is injurious to the rail. A fracture on the base of a rail, caused by striking, is liable to result in a broken rail. This is due to the fact that in the manufacture of rails the base cools faster than the head, and as the head contracts in cooling the base is forced to form the outer ring of a circle; to overcome this tendency it is curved in the opposite direction when red hot—hence the strain on the base when cooled.

LAYING TIES.—Those who unload the ties should select those for joints. These should be as near a ten-inch face as possible, and not over that width. No intermediate tie should have a face of less than seven inches. Ties should be spaced with a maximum distance of fourteen inches and a minimum distance of twelve inches between them. The butt end of the tie should be placed on the inside of curves.

SPECIFICATIONS FOR CROSS TIES.—Hewed ties require to be adzed level for the rails, and scribed for the outer side of rail bases. This facilitates track laying. The end which is to be placed on the lining side of the track should be indicated by adzing off a small corner, care being taken to select



Cross Tie, split quarter log.

the butt end of the ties for the lining of curves and to pile them separately. Ties should be of young and thrifty timber (usually the second growth) which possesses the greatest toughness and elasticity. Trees should be felled during the winter months, when the sap is down. Ties thus made are less liable to immediate attacks of fungi. The bark should be removed from all such trees to facilitate the seasoning of the wood and prevent the bad effect of bark upon ties when in the track.

TIES FOR TRACK.—Ties for main track curves should be of the highest grade. Those for tangents may be of the second order. No tie with a face less than seven inches, or more than ten, should be used in the main track. Ties should be of a uniform thickness of seven inches. They should approximate in length double the gauge, so that the rail may be equally distant from the end and center of the tie. This will, in a measure, obviate the track becoming center bound, and secure greater bearing surface on the roadbed. Ties should be spaced so that the maximum distance from face to face will be fourteen and the minimum twelve inches. The object sought is to distribute the weight of trains uniformly on the roadbed. Ties which are furthest apart have the greatest weight to sustain, and will be the first to show a weak point in the surface. Second-class or "cull" ties may be used in sidings and yard tracks. Hard wood should be used on curves. Soft wood may be used on tangents. Ties when received

should be piled so as to allow free circulation of air around each tie and shed as much water as possible. Two old ties should be used as a foundation for each pile. Ties that meet the requirements of main track use are white or rock oak, chestnut and yellow pine. The oak ties should be used exclusively on curves and the others on tangents only. It is better, however, to use oak in tangents, instead of soft wood ties, as the spike has greater adhesion in an oak tie. Chestnut or yellow pine ties are altogether too soft to use on curves.

THE PLATES.—By using tie plates on chestnut and yellow pine ties, they can be made to take the place of oak ties on curves. The

plates must be of sufficient strength to overcome the turning up tendency they possess. They increase the lateral resistance of the spike. It is a question whether it

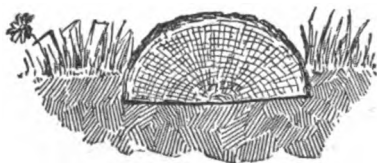

Cross Tie, split half log.

will pay to use tie plates on tangents, as the tendency of the rails to cut into the ties is slight in comparison with that on curves. As soon as a low place is found on a curve, it should be tamped to surface; such places on tangents may usually remain till it is convenient to repair them. Tie plates used on tangents are liable to rattle and are in the way when blocking or shimming is to be done. Track on tangents is apt to heave more than on curves, because the latter are dug out and usually well drained and ballasted, whereas on tangents this work is not so necessary for safe and fast running.

DAMAGE TO CROSS TIES BY SPIKING.—Experiments show that driving the spike, without previously boring for the same, lessens the adhesion of the spike and injures the wood. When a spike is so driven in an oak tie, the woody fibers are driven downward with the spike, extending around the same for about half an inch, and inclining, on an average, at an angle of about forty-five degrees. By removing the spike and splitting

the tie through the spike hole, it will be found that the fibers have sprung back until the hole is nearly half closed; they will also be found to be perfectly pliable,

having lost almost all power of adhesion; they are thus in good condition to receive moisture, which engenders decay. To obviate this, a hole, one-sixteenth of an inch less in diameter than the thickness of the spike, should be bored the full depth that the spike will be driven in the wood.

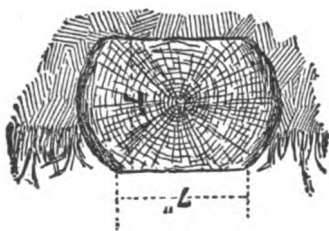

Cross Tie, whole log, hewn both sides.

This prevents injury to

the fibers and increases adhesion, which latter is the principal point gained by boring holes. A spike with a diamond point will give better satisfaction than the ordinary chisel pointed spike. The ordinary spike, on account of its sharp edges, has a tendency to drift from the direction of the hole. The diamond pointed spike will go straight home. The spike should have a short point commencing half an inch from the end and tapering uniformly on its four sides. The holes should be made in ties before they are put in track.

INSPECTING RAILS.—Rails should be inspected with a view to their composition, length, flaws, line and surface. Each end of the rail should be filed underneath the head and top base to remove projecting sharp edges caused by sawing, so as to allow the splices to fit snugly.

CURVING RAILS.—Rails for curves of over five degrees should be curved with a rail bender, but an allowance of curvature equal to that due to a curve of five degrees should be made to allow the lining of track to spring the rails that amount. This amount of spring in the rails is not injurious and will take out kinks made in curving. A kinked rail in a curve soon forces the track into the natural position of the rail, resulting in a bad riding track and continual expense, as rails frequently

require to be removed from this cause. The rail bender, while the best means of curving rails, is imperfect, because the curving is a series of small bends, while it should be a perfect curve. The simplest manner of testing the curving of rails is to stretch a string from one end to the other of the rail and mark the rail off into quarters; from the string to the rail at the center mark will be the middle ordinate and at the quarter marks the intermediate ordinates, these ordinates being calculated according to the degree of curve.*

SPLICES.—Splices should be carefully inspected as to quality of material and make, care being taken to reject all that are bent or twisted in any manner. Only straight splices should be used. A splice bent laterally will prevent the track from lining, and bent vertically will prevent the joint from surfacing and be liable to break. Turned up corners on the ends of splice bearings should be filed level with the surface.

SUPPORTED AND SUSPENDED JOINTS.—This subject, for obvious reasons, cannot be given here the consideration it deserves. The miter jointed rail, where used, has gone far to settle the controversy. The square jointed rail leaves more or less of an opening for wheels to fall into. In time this depression becomes greater by the rail ends flattening and the joints becoming low, so that the break in the line of rail offers an opportunity for each wheel to strike a blow proportionate to the opening weight exerted and speed of travel. The miter jointed rail practically overcomes this blow. With its use the splice acts as its name suggests and makes the joint as strong as the unbroken part of the rail, while furnishing slot holes to enable the track to be spiked without injuring the base of the rail by punching slot holes. The splice should have sufficient bolts to overcome the tendency of rails to pass each other and form a lip. It is claimed by

* One of the simplest methods of calculating the middle ordinate is to square half the length of the rail and divide the result by twice the radius of the curve, thus: Mid. ord. $\frac{Ch^2}{2R}$
The intermediate ordinate is three-fourths of the middle ordinate.

some that the supported splice joint has all these requirements and, in preference to the suspended joint, allows of an additional tie under the rail ends or center of splice, thereby securing the aid of this tie to act in resistance to the rail's running, as well as furnishing greater bearing surface at this weak point of the rail. But there are objections to these points, namely, the punching of slot holes so near the center of the splice renders the splice liable to break at its weakest point, and, in the case of square cut rails, the placing of a tie underneath the rail ends prevents, to a certain extent, the free, elastic action of the splice, thereby increasing the blow and weight to be sustained at that point. Further, this center tie cannot remain at good surface, as it receives the blows exerted by the wheels directly and must necessarily soon get low. When the tie recedes below the surface, it ceases to be a support and acts as a suspended joint. The same is true of the miter jointed rail, though to a less extent.

RAISING TRACK.—The gang for surfacing will vary in number according to the kind of ballast used. Track should be raised in grade in two lifts. In surfacing track, both rails should be raised and tamped at the same time to obviate unevenness.

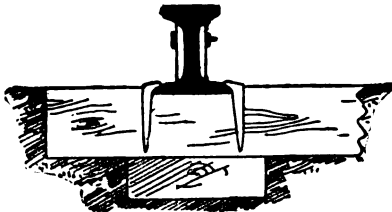
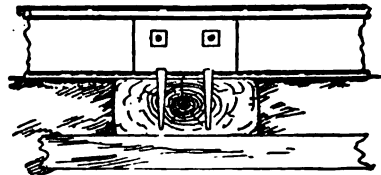

Standard Track of Camden & Amboy Railroad,
A. D. 1837.

TAMPING TRACK WITH BARS.—This work should be done several days after surfacing, so as to allow the track to be partially consolidated. When square cut rails are used, the inside and outside of the joint ties should be well

tamped and surfaced slightly high; the outside of the intermediate ties should be well tamped and the inside lightly a distance of twelve inches from the rail. Ballast should be simply packed around the center of ties so as to prevent the track becoming center bound.

CENTER BOUND TRACK.—This is due to settling of the ends of ties caused by their elasticity and the unevenly distributed weight passing over them; this weight is more on the ends of the ties than the centers. The track thus becomes more solid at the center than at the ends. Center bound track shows itself by the oozing of mud or water from the ends of the ties in wet weather and the rising of dust in dry weather. Sometimes a track becomes so center bound that the ends of the ties will depress from two to three inches. This is a drag on motive power, destructive to machinery and expensive in every way. Each depression forms a grade to be overcome. Time spent in repairing such a track is useless. It must be raised from its old bed.

LINING TRACK.—This is very important. All curves should have spiral ends to allow trains to enter and leave them gradually, and also allow a proper elevation, since the elevation should increase with the spiral. Curves on new roads should be laid with spiral ends, because it entails great expense to relieve an old track in this manner, requiring the purchase of additional right of way, perfecting cuts and fills and the building of new bridges, etc. The great defect of the trackman in correcting engineer's stakes by throwing in the points of curves is, that while he lightens the curve points he increases the curvature further in on the curve, thereby transferring the swing of the cars toward the center of the curve; but as the greatest centrifugal force to overcome is at the point of curve, he has removed the objectionable lining to a point requiring less lateral resistance, which is, however, a move in the right direction. A good practice in correcting engineer's stakes when dealing with old track, or even new track, is to examine the nearer obstructions along the inside of the curve and determine how far it can be thrown toward

its center without interference with such obstructions; then set stakes—or measure the required distance from the engineer's stakes (if such have been given)—the distance it can be moved; throw the track to these stakes all around the curve, except the last hundred feet or so (according to the distance thrown), and line with the eye the ends of the curve so as to run out on the tangent about the same distance from the point of curve as the point first started to line from is ahead of the original point of curve. This is simply throwing the curve points out instead of in, thereby lightening instead of increasing them. The lining up of a curve should be done by sighting on the outer rail; better work can be done by bending down to bring the eye near to the rail than by standing. This is more necessary on curves than on tangents, because it is necessary to be nearer the bars on the former than on the latter. Curves on old tracks should be lined with a sixty-two feet line, first obtaining the average ordinate by trying each joint around the curve, then going around again and taking out all its irregularities; this is the only true and easy manner of testing curves, as the eye is deceiving in lining as well as in leveling. A sixty-two feet line should be used, because with a curve of that length each inch of the middle ordinate represents that number of degrees of the curve. Stakes should be set for all tangents, as it is impossible to get them correct otherwise.

ELEVATION OF CURVES.—The outer rail of curves should be elevated according to the degree of curve and the speed of traffic, taking the slow trains, however, also into consideration, as well as the grade of track, as grade and curvature usually determine speed. The outer rail at point of curves should have the full elevation carried back on the tangents at about the rate of fifty feet per degree of curve (if the tangent is sufficiently long for the purpose), and should decrease at this rate for curves beyond six degrees. It often occurs that the engineer has left tangents of one hundred or one hundred and fifty feet between the points of curves as a matter

of economy in construction, and as for a length of a passenger car at least the track should be level between the two elevations of outer rails, the trackman discovers that he will require to make the elevation very suddenly, and can only give half the required elevation at the point of curve instead of full—shortening the run off on the tangent in consequence. Should such a case occur on double track, the elevation on the run off end should be reduced considerably further back on the curve, thereby terminating its elevation nearer to its point; this will allow more room for the elevation to enter the next curve on the run on end, which is vastly more important. Should the two

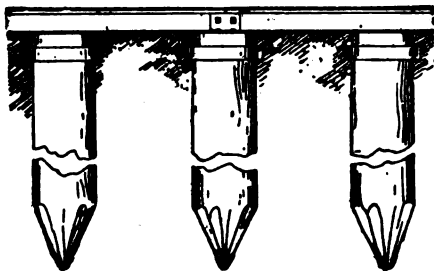

Track of Camden & Amboy Railroad. Rails laid on piling through marshes, A. D. 1837.

curves be in the same direction, it is good practice to carry a certain amount of the elevation throughout the entire tangent intervening, as in such case it will not be necessary to leave any level space on the same for the cars to partially gain their equilibrium. No fixed proportion for the elevation of curves can be given, as the lighter curves require much more elevation per degree of curvature than the heavier curves without detriment to slow trains. The elevation for light curves can be calculated so that the fast trains will have their centrifugal force equalized, but nothing more. The elevation on heavy curves should be such that the outer rail will not require bracing to prevent its spreading; the inner

rail, in lieu thereof, should be braced to prevent its spreading and turning. There should, however, be a brace put on the outer rail opposite the inside braces to prevent the tie pulling through, as the spike will be insufficient to prevent it from doing so. A good manner of determining the proper elevation for fast trains, and what will be safe for slow trains, is when the passenger car will ride perfectly level; should the outer side ride above this level, the elevation is too great; if below this level, it is too small.

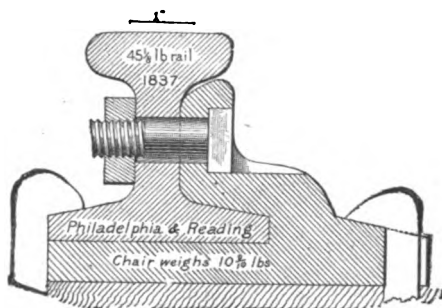

Stevens' Rail supported by Cast-Iron Chair, A. D. 1837.

BROKEN VS. EVEN JOINTS.—Broken joints are the custom upon some of our best roads having tracks ballasted with broken stone, gravel, slag and anthracite engine cinder. Even joints are the custom on some roads where the different kinds of material the road passes through govern the kind and quantity of ballast. Hence roads having poor ballast are laid with the joints even, and those having good ballast are laid with the joints broken. It is self-evident that the softer the ballast the quicker the joints will become depressed, and the opposite is true the harder the material. We might, therefore, assume that low joints are in proportion to the quality of the ballast, other things being equal. When a wagon crosses a ditch at right angles, so that each pair of wheels will descend at the same

time, the jar is lighter than if the wagon crosses so that one wheel descends before the other. As a wagon goes along an ordinary road with slight depressions, the jars are so slight that they are, practically, of no consequence. This is true of rolling stock on the track. Broken joints are less likely to depress, since the ballast is superior, the depressions not being of such consequence as to require special adjustment, whereas the opposite is true of even joints. Even joints would answer the same purpose on good ballast, if it were possible to lay them perfectly even, which it is not. Again, on curves it is out of the question to have even joints, as the outer rail is continually falling behind the inner rail. Therefore, since even jointed rails are practically impossible, it is preferable to have the joints in one rail come as nearly opposite the center of the other as possible.

BALLAST.—Ballast usually consists of broken stone, slag, gravel or anthracite engine cinder. Each has its peculiar qualities. The extremes are broken stone and cinder; the mean, slag and gravel.

Broken stone is superior to any other ballast for cleanness, durability and absence from dust; for drainage and distributing the weight over the entire roadbed; also for use on grades to prevent the track from creeping. It should be placed twelve inches deep below the bottom of the ties and well filled in between them. It is, however, the most expensive ballast to prepare and also to deal with in the track. Section men will perform twice as much work in cinder ballast as in stone. With stone ballast it is difficult to obtain a good surface. It is not the best preventive of track heaving from frost. Where the roadbed is of a muddy nature the soil will ooze up through the stone, unless the ballast is deepened to prevent it. It is also destructive to soft wood ties, their lower corners being rounded by the sharp edges of the stone when tamping, and the tie greatly damaged by the stones cutting into the wood.

Slag is a good ballast. When the rougher slag is selected for ballasting underneath the ties, and the finer

from that point up to the surface, it may be said to possess all the good qualities of broken stone and cinder, excepting the lasting qualities of the former.

Gravel is a good ballast. It should be carefully selected and the larger stones removed. It should be clean and clear of loam. It may be classed as a fourth class ballast. It has good drainage qualities and prevents the heaving of the track from frost, though to a less extent than slag or cinder. An objection to gravel ballast is the roundness of the stones composing it, which is the opposite of what stone for ballast should be. It is, therefore, of little value for holding track on grades. It also shakes from the ties from vibration caused by traffic and is, therefore, of little value for distributing weight.

Anthracite cinder is the best ballast to prevent heaving. It can be worked more cheaply than any other and the finest surface and line can be obtained with it; it, consequently, makes the easiest and smoothest riding track. It is more elastic than any other ballast, and, when new, adheres well to the ties. It must, however, be renewed from time to time, as it works fine and makes dust. This feature obliterates its fine qualities. However, it may be remedied by having it watered when first laid, after which it will give little trouble.

STREET CROSSINGS.—One of the best methods of preparing a street crossing is to place a guard rail on the inside of each rail, so that their two bases will butt against each other. The guard rail should be one-fourth of an inch lower than the main rail. The ends of the guard rails on each side of the crossing should have a sharp curve toward the center of the track, so that the end of the guard rail will be about four inches from the main track rail, having the outer corner of head chamfered at each end. Previous to placing the guard rails, a piece of oak that will fit underneath the railheads and base should be so placed between their webs. This strip of wood overcomes the objectionable feature to such guards, namely, the catching of

horses' toe calks under the rail heads. The space between the two guard rails should be filled with three and one-half inch white oak plank spiked to the ties. If the track rails are four and three-fourths inches high, the plank should have one-inch oak undershoring extending the full width and length of the tie so planked, a twelve-inch plank being used on the outside of each main rail, up to which it is paved between tracks. On crossings of little traffic, guard rails may be omitted, having in place of them a plank beveled so as to lap over the rail base and up to the web, to prevent dust, dirt and snow

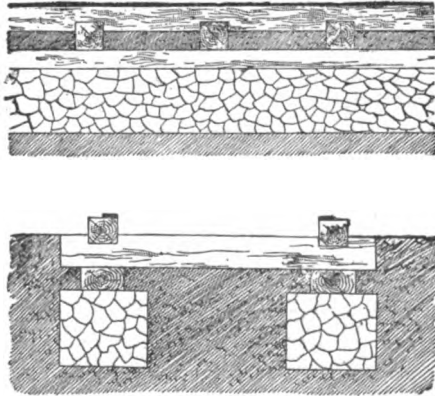

Wooden Stringer and Strap Rail, Albany & Schenectady Railroad, A. D. 1837. A strap rail was used on many of the first railroads in America, particularly in the Central and Western States.

from working underneath and heaving it up. The plank should be beveled on the upper surface sufficient to clear the wheel flanges, the upper edge of the bevel being distant from the gauge line of the rail two and one-half inches.

GUARD RAILS FOR BRIDGES.—Bridges should be provided with guard rails. Old rails as near the height of the main rails as possible should be used; these rails

should be placed as near the main rails as the splices will allow, and on the approach end of the bridge should be carried parallel for at least thirty feet, where they should converge to the center of the track so as to line into the old point of a frog; at the point where they diverge from the running rail rerailing castings should be placed. Three or four braces should be placed on the inside of each guard rail between the castings and the frog point; these guard rails should be

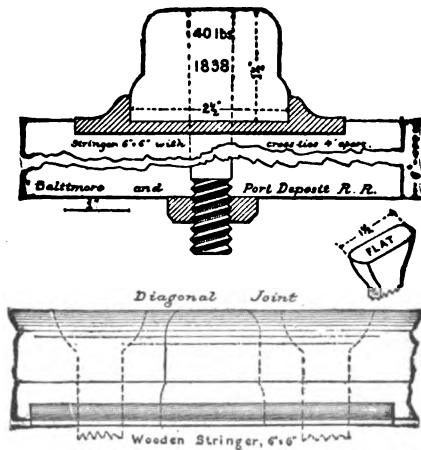

Thick Rectangular Rail, A. D. 1838.

spiked on each tie, and as a foot guard for the frog point, a piece of twelve-inch plank (oak) three and one-half inches thick, cut to fit the frog point from where the rails are twelve inches wide up snugly into the sharp point, should be placed and spiked to the ties, finishing the twelve-inch end by leveling. The run-off end of the bridge for double track need not have a rerailing apparatus, but the guard rails should be continued about thirty feet beyond the bridge, where they may terminate in a slight curve distant from the main rail about six inches.

CATTLE GUARDS.—Such guards should be placed at all farm and public road crossings where there is no protection by gates or otherwise; to prevent cattle running along the track, a fence should be built from the right of way fence on both sides of the opening to as near the rail as practicable. There are various forms of cattle guards. One plan in particular commends itself, being effective and cheap. It is a space of not less than six feet stretching the entire width of the track parallel to the road, laid with two and one-half by four inch oak pieces laid across the ties parallel to the rails, cut to a sharp edge on the upper face, spaced with two-inch spacing blocks, and spiked down to the ties. The most effective plan, however, is to build a pit the entire width of the road about six feet wide, and of sufficient depth to enable a cow to drop entirely clear of the trains. This, however, is too expensive, requiring the building of retaining walls and bridged for the rails only. This style of a cattle guard is perfectly effective.

SLOPES AND DRAINAGE.—Cuts should be sloped to an inclination arrived at after careful examination of the material composing them. In ordinary earth cuts a slope of one and one-half to one will be sufficient, while it may be necessary to give some cuts a slope that an engineer would not approve. In all cases they should have slopes that will obviate land slides.

FILLS.—Fills made of rock and good sharp material will give little or no trouble, but those made in a careless manner will be a source of continual expense. Engineers should prohibit the use of material that will slide at a slope of more than one and one-half to one, unless it be along the tail of fills, where the weight is comparatively slight. To prevent fills and cuts from sliding, in slight cases, willow cuttings, or shrubbery of a rooty and spreading nature may be planted. In severe cases, broken stone or slag dumped down the face, so that it will be about one foot deep at the top and two or three feet at the bottom (or of a greater thickness, if necessary), will prevent sliding.

ROCK CUTS.—Rock cuts should be examined, and all loose material removed. Trees that might fall on the track should be cut down.

SLOPE DRAINAGE.—Earth cuts should have a berme ditch on both sides (except side hill cuts, where one on the upper side is sufficient) to intercept surface water. The ditches should be of sufficient width and depth to accommodate the maximum drainage. At the tail of the cut they should diverge sufficiently from the track, so that the water will flow off. Ditches should be run parallel to the track in all cuts, and wherever the adjoining ground is higher than the roadbed, the bottom of the ditch should be, for single track, eight inches, and for double track eleven inches, lower than the center of the roadbed, and seven feet from the near rail.

SPRINGS ON SLOPES.—Cuts showing springs of water should be provided with a system of surface drainage. A good plan is to dig ditches straight or diagonally down the slope, intercepting all such places; the nature of the material will determine the depth and distance apart. These ditches should be filled with stone of a size sufficiently large to allow the water to pass through their interstices. Should the flow of water be too copious for such a drain, a pipe or ordinary square built drain will answer the purpose.

SODDING AND SOWING GRASS SEED ON EMBANKMENTS AND CUTS.—Earth cuts and embankments should either be sodded from the sod saved by stripping the surface, or by sowing grass seed and white clover. Should they not slide before a sod has been formed, this will be sufficient to prevent slipping.

TUNNEL DRAINAGE.—Good drainage in a tunnel is necessary to secure safety to traffic, and enable the trackman to do his duty. Tunnels have proportionately more water to be drained off than other parts of the track, owing to the surface water permeating to them; moreover, the strata being interfered with in the building of a tunnel, it receives the drainage for a greater or less extent of country. The roadbed of a tunnel for double track should have a uniform grade from the

sides to the center, with a fall of six inches, emptying into a drain at its center running the length of the tunnel and emptying into the ditches at each end; this drain should be eighteen inches wide and twelve inches deep, with a covering stone to allow the tracks to be filled up between. Where the bed is other than rock, this ditch should be made by laying a bed stone wide enough for a stone on each side to rest upon it, these forming the sides of the drain; the covering stone should rest upon the side stones. Where the bed is rock, the drain should be excavated as near the required form as possible, and where it is too wide side stones

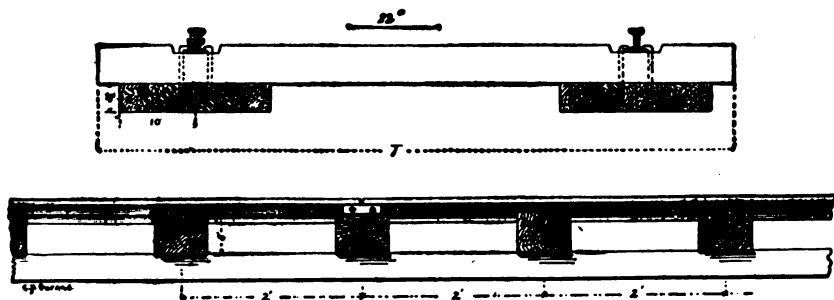

Stevens Rail, Vicksburg & Jackson Railroad, A. D. 1841.

should be used to support the covering stone. All large holes should be filled and carefully packed to a uniform surface, so as to assist the flow of water to the drain and prevent its accumulation in pools. The grade of the track in long tunnels usually has its summit in the center, so as to drain toward both ends. Broken stone is the best ballast for use in tunnels, the larger sized stone being put below the ties, and the finer from thence up to the surface. If the bed is poor, an inverted arch should be built as a bed, both for advantage of drainage and to support the side walls and arch.

SWITCHES.—The split switch has long been in use and is the favorite for all purposes. It is the cheapest (in

the long run) yet invented. The split switch should be planed to the lightest possible angle, without having the rail too long; the best length and angle being twenty-one feet long with a spread of six inches at the heel, which is just enough to clear the base of the splice from lapping on to the base of the stock or main rail. The split or point rails should be planed straight on both sides (except for special use) and chamfered three feet back from the point. All split switches should be fitted with adjustable rods. The best form of side plates are made of one-inch cast steel. The objection to wrought-iron plates is their bending and the imperfect manner in which the projections for the point rails to slide on keep the main rails in position. The point rails should crown one-fourth of an inch above the main rails, which gives a good shoulder in securing the main rails and especially when lining up the track at the time the switch is being put in.

SWITCH SILLS.—Sills for switches should be of good, sound white oak, seven by ten inches, well seasoned. They should be prepared in sets by cutting the line side square and the turnout side to the required bevel. The most convenient manner to cut sets of switch timber is to prepare a board one inch by ten inches, planed and sufficiently long to mark the longest sill thereon. The length and bevel of each sill should be marked by a scribe line on this board laid off from the square or line end, having a line indicating the outer base of rail on the line end, for guidance when putting them in the track; on the turnout end of the board the number of each sill should be marked for its corresponding line. These numbers should be marked on the end of each sill and lettered, thus, R-10 or L-10, indicating the number of the frog the set is for and whether it is a right or left turnout.

FROGS.—As the stub switch is to the split switch, so is the cast-iron frog to the rigid rail frog, and the rigid rail frog to the spring rail frog. Spring rail frogs have been long tested, and have stood the test, except at places where trains run at great speed. The damage to

the spring rail frog by fast running is either in the breaking of the spring or spring rail, or damage to the wheels of rolling stock. But this has been overcome by the use of heavier rails. While the cost of a spring rail frog is but slightly more than of a rigid frog, it lasts three times as long. Rigid frogs should not be longer than will allow of splices being put on without cutting the base; in no case should they be shorter than six feet, as a short frog has a tendency to tilt whenever the wheels strike either end, thus depressing the sills. The distance from the toe to the point and point to the heel should be even feet. This will enable trackmen to remember the different parts of the frogs more readily and prevent mistakes. The distance from the toe to point of spring rail frogs should not be less than seven feet, and the distance from the point to the heel the same as that of rigid frogs; this will save cutting when there is occasion to replace one by the other. It has been found satisfactory to rivet (not bolt) rigid and spring rail frogs to a plate; it increases their bearing surface on the sills and more securely fastens their parts together. The plate is somewhat expensive at the beginning, but it can be used over and over again.

TURNOUT.—The simplest form of a switch on straight line or curves is a turnout. To locate a turnout on a straight line, the heel of the frog should be placed at a joint if possible, so as to save a cut and allow the guard rail to be placed clear of a joint on the opposite rail; this obviates the use of a fish plate. The distance from point to heel of frog should next be laid off, marking the point on the outside of the head of the rail, and the lead should be laid off to the point of switch from the last named point, marking it in like manner. When splices are two feet long and the switch twenty-one feet, and bend in turnout rail two feet ahead of switch point, then the joint of the bent rail can be seven feet ahead of the last named point, while the joint on main line side can be three feet ahead of same point, thus allowing them to break joints by four feet at point and six feet at heel of switch on main track; this clears all joints so that

there will be no two butting against each other, and no necessity of cutting the splice base or using fish plates. If, however, thirty-inch splices are used, the only way to clear joints will be to put joint of bent rail five instead of seven feet from point of switch, the main rail joint remaining the same. After the rails are cut for the main track side opposite to which the frog is located, they should be put in first, the switch timber being next put in and spiked to the side already put in, spacing them properly for all joints as they should appear when the switch is completed. When putting in the sills, however, it is necessary to place the switch plate on each as far as these plates extend underneath the switch, spiking them on the above named side, but only as much on the opposite side (as well as for the remainder of the sills) as will be necessary to hold the rails safely in position. When all the rails to complete the main track are ready, the frog should be put in place, then the switch laid and rails bent to place. Next the track should be spiked throughout, spiking the turnout rail not any further ahead than its bend, which should be done to gauge. Next the main track should be lined up; that done, the bent rail should be spread at heel of switch the calculated distance, and lined perfectly straight between the end and bend already spiked. The switch plates should be tapped up snugly against the rail and spiked. This will allow the split rail to fit properly to the bent rail, and line nicely for the main track. Since the split rail, while being made and after the base is planed, will curve more or less in consequence and will require to be straightened, the back of the split rail should be planed perfectly straight, so that when put in place in track and thrown over against the straight part of the spiked bent rail, it will straighten up in its proper position. The bend in the turnout rail should be according to the angle of the split rail. In order to secure a true bend that will guard the point to its fullest extent, the rail, after being marked where the bend is to be put, should be heated enough to boil a spittle; then, with a rail bender, it should be given the calculated bend. A

line should then be stretched between these two points on the gauge line, and the calculated distance measured to this line from the line so stretched. If this rail is bent properly, there will be no trouble in securing a good and easy working switch. The turnout lead is next to be put in. If the difference in length of curve lead over that of the straight lead is not known, the switch

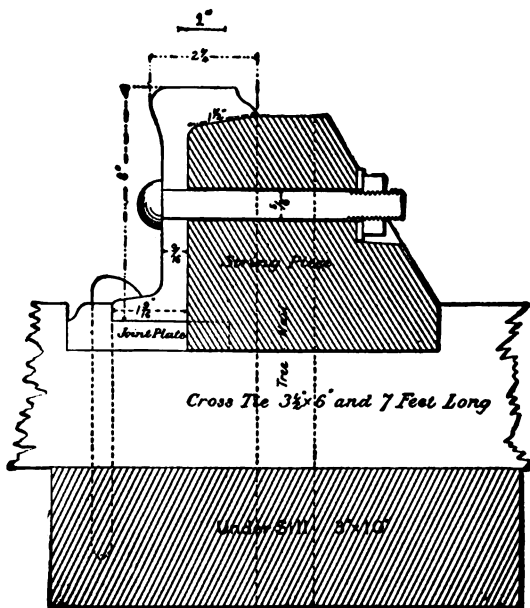

Latrobe's Compound Rail, wood and iron. Baltimore & Ohio Railroad, A. D. 1841.

should be squared and rails measured and cut accordingly. These rails are next to be curved to calculated ordinates, allowing for the equivalent of five degrees of curvature to be put in by lining; the splices must also be slightly bent as the degree of curve requires. The lead should be calculated so as to enable the frog and

switch to be placed naturally, i. e., straight as they are built, except for special cases, and should not be distorted in the track to a curve. A frog distorted will not remain in any such forced condition, and will thus spoil the lead. Should the turnout side be curved to suit the turnout lead, it necessitates the use of right and left hand frogs. This is objectionable. They should only be used for special cases when it is desirable to lighten curves to the minimum. Engines cannot pass through curved frogs unless the throat is made wider to prevent the rigid wheels binding; and the wider the throat the less the point is protected and the quicker it will wear down. In lining up the turnout curve, a line should be stretched from the heel of the switch (the latter being thrown over to position) to the end of curve at frog tangent; this distance should be divided into quarters and the curve tacked at these points according to calculated ordinates. It is necessary in spiking the frog to see that the frog as well as heel of switch is spiked at proper spread, otherwise these ordinates will be of no consequence. The curve should then be lined between these points and spiked down.

FROG GUARD RAILS.—Guard rails may be made of slightly lower rails than those of the track (never higher), and should be of steel in preference to iron, as the latter wears more rapidly, consequently widening the opening of flangeway. Guard rails should be made of old rails removed from curves where the rails have never been changed to the lower side or turned, their original height being nearly retained. Each guard rail should be cut in two and bent to a uniform curve throughout, so that the maximum opening at the ends will be three and one-half inches and the minimum opening at the center one and seven-eighths inches, thus allowing the wheels to be drawn to the guard point with the least possible jar. When curving these rails the unworn side should be kept to the outer side; the base of the outer side should be planed so as to clear the spikes, the ends having the rail heads chamfered on each side. In making guard rails care must be taken to have them perfectly level.

They should be placed in the track so as to extend over one more sill ahead of the frog point than behind it, letting each end lie uniform relative to the sills; this will bring their centers opposite a point between the throat and point of frog. Each guard rail on a curved track should be supported by not less than four braces, and on straight track by not less than two. As the gauge of the track is widened the guard rail must be set correspondingly wide from the track rail.

THREE-WAY SPLIT SWITCH.—A three-way switch is simply two turnouts beginning at the same point, or with the point of one switch far enough behind the other to allow it sufficient room to work between the main turnout rail of the first switch. These turnouts can be arranged one on each side of the main track, or both on the same

side, according to the frog used, so that the curve of the second turnout may not be too heavy. When one switch is behind the other, it is necessary to make oblong holes in the web of the turnout rail of the first switch, through which the rods of

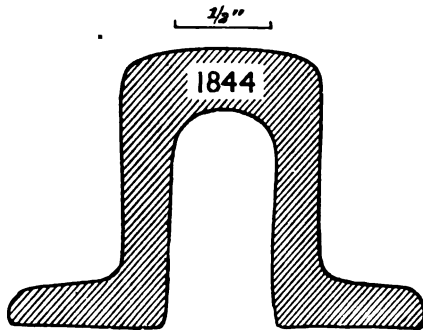

First Rail rolled in America, Baltimore & Ohio Railroad.

the second switch work. Usually the first or second rods are all that require to be dealt with in this manner, the remainder being bent down at right angles close to the split rail, low enough to pass under the turnout rail of the first switch. All crotch frogs should be "specials," built to the proper angle and curved to the same curve as that of the turnouts. A three-way switch consisting of one turnout to the left and the other to the right will require two bent rails opposite each other; if both turnout to the same side, one bent rail is all that is required,

but it must be bent to a much greater angle. The main line frogs can be either opposite each other or one ahead of the other. The crotch frog, if not built on a plate, should be supported by not less than four braces so as to secure its position. So should all such heavy angled frogs.

CROSS-OVERS ON STRAIGHT LINES.—A cross-over is a turnout in two adjoining tracks, located so that one will connect with the other by a straight line between frogs, or curved, as the case may be; the latter, however, is only done where room is deficient. The explanation given to the turnout is applicable to this, but care must be exercised in setting the frogs; they must be carefully spread to the calculated angles or distance apart, and the tracks lined to their true centers before spiking down, otherwise it will be impossible to secure a line between them.

TURNOUTS AND CROSS-OVERS ON CURVES.—The same leads as are required for straight lines will practically suit on curves, the only difference in their construction being more or less angle in the bent rail, and making the turnout curve longer or shorter than the main line curve, according as the turnout is on the inside or outside of a curve—being less when on the outside and greater when on the inside. Leads with a heavy curve should have their gauge widened, as provided for curves on ordinary track, and when so widened the guard rails must be placed correspondingly wide. Guard rails on turnout side should have six braces to the rail, and on main track four.

DOUBLE CROSS-OVERS.—A double cross-over is a cross-over passing directly through another. It is a convenient system of switching, and greatly economizes space. It is more expensive than two single cross-overs, though it requires less timber. It requires a set of crossing frogs; the two center frogs being double, and the extreme frogs either double or single. If the parallel tracks are less than eleven feet on centers, the two frogs in the main track on one side and the nearest center crossing frog on same side require to be built in one, and

should be on one plate; the two remaining corner or extreme frogs should be built single. No special rules can be given for putting in this system beyond those heretofore described.

CROSSINGS.—A crossing is where one track passes directly through another without switches. All the frogs may be double, or the center frogs double and the extreme single. Should the crossing be on straight lines, it is more economical to make all frogs double and reversible, so that they may be changed, as the wear is greater on one side than on the other. If, however, the crossing is curved, this is impossible; but the center frogs may be made double, though not reversible, and the extreme frogs single. It is not absolutely safe to use double crossing frogs on a less angle than fifteen degrees, as they then cease to be self-guarding, especially so on curves. Instead of using double frogs for center frogs, it is much better to use a system of movable points admitting of any angle being used. The frogs for a crossing should be built very carefully, and it is impossible to secure a good line and gauge unless they are strictly true.

• **SLIP SWITCHES.**—Slip or diamond switches have become much admired in this country for their compactness, and because they embrace nearly all other kinds of switches in the space required for one of them. What is known as the number seven frog is the angle usually adopted, so that the center double crossing frogs may be as near an angle that will be self-guarding as the degrees of curvature on the turnout sides will permit. A single slip switch is a crossing with a turnout on one side only; a double slip is a crossing with a turnout on both sides. The rods of the switches are depressed near the split rail so as to pass under the other switch and crossing rails. If the points are opposite each other, the distance between the diamond or crossing rails at the point of switches should not be less than twelve inches, so as to allow sufficient working room for the points; if not opposite each other, one point may be placed nearer to the frog and the other further from it. It is important

with crossing frogs of all kinds that they be built true, otherwise it is utterly impossible to put them in correctly, and they invite disaster. The construction of this system is similar to the turnout, so far as the bent rails and side plates are concerned, only the joints should be brought nearer to the switch points (in using number seven frog), so as to save a cut on the outer or turnout rails. It is customary, however, to build these split switches for a number seven frog, especially, so that they can be built on a curve; when such is the case, there should be no bend in the rails referred to, but they should be curved to correspond with the switch rail, the curve starting sufficiently far ahead of the point to allow the turnout and crossing track to gauge.

MOVABLE POINTS IN LIEU OF CROSSING FROGS.—To enable slip switches to be used on curves and to light angled frogs, it is necessary to use a system of movable points, or split switches, in lieu of the center double crossing frogs. The outer rails at the crossing points should be bent to the crossing angle at that point, and the points of the movable switches placed so that they will come six inches or more from each other at the crossing point, their heels being connected with the diamond or crossing rails. These points work on plates extending under the turnout rails and offset for the movable points, as is customary in ordinary switches, so as to raise the split rail above the main rail. This system of movable points is more economical than the double crossing frogs, as they will last as long as the main rails, whereas the frogs would require to be removed every two years or more, according to the traffic. In addition to this matter of economy, they are absolutely safe when properly attended to. It is quite common on examining number seven crossing frogs to find marks squarely on their points made by the flange of wheels on imperfect axles; as the angle decreases in crossing frogs, the danger is proportionately increased. The above system is very desirable for yard purposes, where space must be economized. It gives access to tracks in four different ways. When put in correctly,

so that all its parts fit snugly, it will stay in better line than any other system of switches. This is due to its numerous combinations of rails and frogs so constructed that each part braces another. The plates for these switches, except for the movable points, can be made the same as the cast-iron plates used in the ordinary switches or turnouts.

SWITCHES ON OUTSIDE OF CURVES.—All facing point split switches on outside of curves in main track should be "special," having the point rail on that side at least two feet longer than the inside point rail, so as to admit of a guard rail being placed opposite to prevent the wear of this rail. There is more or less of an angle at the point of all split switches, due to the fact that it is wholly impracticable to plane them to the theoretical point of curve—the consequence being the dropping of wheels into this angle, creating a great lateral strain and consequent wear on the split rail point; but by placing the guard rail as above, it will be sufficiently long to guide the wheels clear of this angle.

DERAILING SWITCH.—Each side track leading to or from the main track, on which cars are allowed to stand, should be provided with a safety throw off or derailing switch (except where grades make this unnecessary). It should be placed not nearer to the main track switch than the point at which the siding becomes parallel, and arranged so as to throw the cars off the side track and prevent them from entering upon the main track. This switch may be either a point rail of an old split switch, or one especially constructed for the

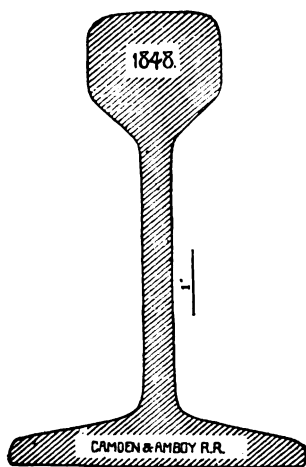

92-pound Rail, 7 inches high.

purpose. It should be put in similarly to a turnout rail of an ordinary split switch, having side plates and bent rail; the bent rail should be carried straight along the point rail as far as the rail head planing extends, whence it should diverge from the track so that its end will spread at least five inches from the gauge line of the near track rail, so as to clear the wheel treads. This switch can either be operated by a stand connected therewith for that purpose, or connected with the main track switch. In either case it should be provided with a lock and kept locked when cars are on the track.

CLEARANCE POSTS.—All tracks leading to or from the main track should have a distance, clearance or tail post set in the ground between these tracks immediately beyond the safety switch, and not nearer to the main track switch than eleven feet on centers. These posts are usually made of chestnut, four by four inches by four feet, planed square and rounded on top, the lower half being placed in the ground; they are painted white and tops black.



T Rail, A. D. 1850.

MAINTENANCE OF TRACK.

A railroad is not a permanent piece of work. As soon as traffic commences repairs are necessary. To provide for this necessity section gangs are organized, and a certain amount of track, termed a "section," allotted to each. A section of double track should be about four miles long, and of single track about six miles long. On roads having a large traffic, each section gang should consist of a foreman and one and one-half men per mile of double track, with an additional allowance of one man for every two miles of sidings. On single track each gang should consist of a foreman and one man per mile of track, with an additional allowance of one man for every two miles of sidings. Taking these proportions as

a basis, sections may be varied in length as locality and circumstances make necessary. Generally speaking no section should be so reduced in length that its proportionate allowance of force would be less than six men and a foreman. Watchmen should be counted extra. All extra work should be calculated to be done by a special gang and ballast train; or extra men should be allowed section foremen. Each section should have a tool house large enough to accommodate a hand car and a full complement of tools.

SPRING REPAIRS.—When the snow has disappeared and the frost is going out of the ground, the track should be cleared of rubbish and dirt accumulated during the winter; then should begin the work of reducing and removing the blocking as the track settles. As soon as this work is done, spring work will have fairly begun. Ditches should then be opened, low joints raised, and the track lined.

RENEWING TIES—OLD TRACK.—The foreman should test and mark each tie that needs to be removed. He will thus know the number of ties required, and where they should be unloaded. The foreman, when ready to renew faulty ties, will divide his gang into sub-gangs of three men. Before taking out a tie, the spikes should be started far enough to allow a spike to be placed between the rail and tie, when, by raising the rail with a bar, the old tie can be readily removed, and the new one put in without raising the adjoining ties from their beds. This avoids the likelihood of ballast getting under adjoining ties. Previous to removing the old tie, the ballast should be dug out on either side, making it lower on one side than the tie bed; the tie should then be pulled on one side into the ditch thus made, where it can readily be pulled out. The new tie is next pulled into the same ditch, lifted up to the rail and drawn to its place. If it is too thick to go in on the old bed without raising track too high, the bed should be lowered accordingly. The old bed should be disturbed as little as possible. It is customary with most section foremen to allow their men to lower the old bed, and

as this cannot be done with exactness, the result is that the new tie will be from one to three inches too low; this necessitates tamping from time to time in order to make its bed as solid as that of the old tie. Every ten years at least a track should be raised from one to three inches above the old bed, to prevent its becoming center bound; all low spots should be raised, however, when ties are renewed. Old ties taken from track should be piled on the last day of each week, so as to give the track a neat and tidy appearance; this allows them to dry either for use as cribbing, firewood, or burning on the ground. Ties should be adzed level to secure the better fitting of the rails and wheels. Rails will not

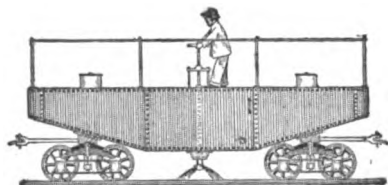

Track (Dust) Sprinkler, A. D. 1851.

turn on tangents, nor on the outside of curves, if properly elevated. To overcome the turning of rails on the inside of curves, rail braces should be used; they will also prevent the spreading of the track. In order to perform the latter office properly, a brace should be placed on the outer rail opposite each brace on the inner, otherwise the spike will bend over and the tie pull through. Ties should be renewed for the season by the end of September; from that time till winter the track should be surfaced and trimmed, and the ditches put in good condition for the winter.

GRASS AND WEEDS.—Grass, weeds and brush on the right of way should be cut sufficiently often to prevent the weeds running to seed. Generally, one cut in the first week in August will be sufficient. Brush cut at this time is not likely to sprout again. Brush and weeds should be gathered into piles and burned.

CHANGING RAILS.—On roads having heavy traffic, it is customary to change rails on Sundays, preparing the track on week days. On roads with light traffic, rails can be changed at any time. One side of the track should be changed at a time.

PREPARING TRACK MATERIAL FOR SUNDAY WORK.—Rails and splices generally require to be filed on the ends to a uniform surface, so as to remove projections; this work is therefore included in preparing the track, though properly speaking it should be done at the mill. The following is the organization of men for such work, namely: The first thing to be done is to put four men on the car of splices, two on each end, to file and inspect the splices, each man having a small bench to lay the splice on to facilitate the filing; after they are filed they should be thrown on a car, laying them at right angles to each other the full length of the splice; this will facilitate their being counted. When the men have sufficient room on the car they are filing on, they should pile the splices behind them in like manner. Rails, splices, bolts, nut locks and plugs should be distributed at the same time as the rails. It is necessary, however, to have half of the cars which are loaded with rails turned on a turntable or Y block to admit of their being unloaded, with the brand on the outside of the rails as they will be put in the track.

UNLOADING RAILS.—Care should be exercised in unloading rails. Rails, on gondola cars especially, should be let down to the ground on skids, and each skid should be provided with a pulley on the upper end, placed below its surface; a rope with a hook sufficiently large to receive a rail should be used through this pulley for lowering the rails to the ground; each skid should be provided at its lower end with a round iron projection, around which the rope is turned for the purpose of controlling the rails while being lowered. Two men on the ground, operating the ropes raise the hooks to the upper end of the skids, when one foreman and twelve men (handling seventy-six pound rails) will place the rail in

the hooks and lower the first named two men, in

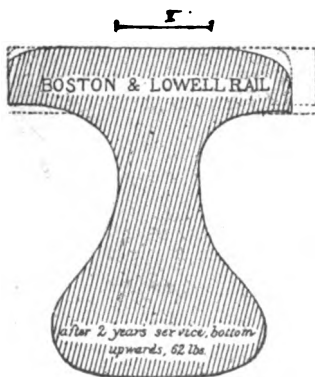

Pear-headed Rail, A. D. 1853.

same to the ground. The rails, will lift the skids as the car is moved ahead. On another car are the rails for the other side of the track, the men being similarly organized. Unloading a rail on each side prevents moving the train so often and obviates the men passing from one car to another. Time may be saved by unloading two rails from each car before moving the train ahead, unloading the next two rails one rail length ahead of the last two. Two men on the

splice car will distribute the splices, bolts and nut locks, and two men with a basket will distribute the plugs from the supply car.

FILING RAILS, ETC.—As soon as the rails are unloaded, men should be set at work to file the ends of the rails underneath the heads and upper side of the base. After the rails are unloaded, the men should be organized as follows, namely: One foreman and eight men with tongs should string the rails along the outer edge of the ties; one man with an adze should level any projecting ends of same, and one man should tack-spike all unspliced ends of each four rails. For six-bolted splices, six men should bolt the rails and lay the splices, bolts and nut locks at each unspliced end. Four men should remove all the bolts that can be removed with safety from the rails in the track; these men should also put the nut locks, or washers and nuts, on each bolt as it is removed. Four men should pull the spikes that can be pulled with safety, those remaining being left slightly started. On tangents, four spikes to each rail are sufficient to leave unpulled, leaving one of these

spikes at each joint; on curves, six spikes to the rail should be left, and one in the slot hole. These spikes should be pulled on the inside when the same sized rails are to be used, and when of different base, the inside of one rail and outside of the other should be pulled, which will admit of their being laid retaining the same gauge. When pulling spikes on curves, they should be pulled on the side having the ties cut down the least, which will more readily admit of ties being adzed. Four men should be at work score-ading each tie on the side from which the spikes are removed, keeping well on the outside of the spikes. As each sub-gang finishes its work, it should clear the ballast between the ties and underneath the rails; the other foreman should look after the sub-gangs, except rail stringers. Two boys should be engaged in carrying water for the men. In all, forty men will prepare in the above manner one mile of track per day. On double track, one track should be used to distribute from, allowing schedule trains to pass on the other, flagging all other trains and allowing them to pass as they arrive.*

JOINTING RAILS.—As it is impossible to change rails and have them joint on the old ties, it is necessary that these ties be changed to admit of the slot holes being spiked, and thus prevent the rails from running.

* **GANG FOR CHANGING RAILS ON SUNDAY.**—The same gang of men that prepared the track at the rate of one mile per day will change the rails at the same rate, organized as follows, namely:

Men removing bolts	4
Men throwing out rails	2
Men adzing ties	13
Men spiking rails, joint slot holes, quarters and centers	4
Foremen	2
Men pulling spikes	4
Men plugging spike holes	2
Man guiding and testing adzing with single-headed spotting boards with face one-half inch broad	1
Water boys	2

As adzing is more or less on account of ties being cut into, these men will require to be increased or diminished accordingly. The remainder of the spiking can be done by this gang the next day, as well as tamping up all ties that are loose or low, especially the joint ties. They should also go over all bolts with wrenches and tighten them up.

MOVING OLD TRACK.—Improvements of line, especially double tracking, when the old line is being improved at the same time, render it necessary to either take up and relay the old track or move it over to the new line. When the change of line is within twenty feet throw, it is cheaper to move the track than to take it up and relay. This work, like changing rails, is usually done on Sundays. It is, however, possible to be done in the week, if there is an occasional half hour or so between trains. It requires skill and scientific ability.

PROPER CARE OF ENGINEERS' STAKES.—Grade stakes set by engineers for top of rail for new line should be set so as to be clear of the track when it is being moved to place. If, however, the same grade is to be retained, the foreman in charge should put two intelligent men to transferring the level of the lower rail, using a long straight edge and track level for this purpose. The engineers' center line stakes are liable to be in different positions relative to the old track to be moved, necessitating the latter passing over these

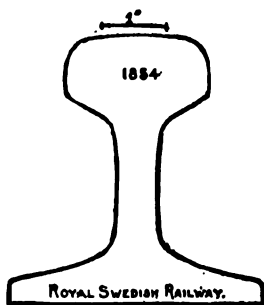

stakes in many cases. In order to obviate as much as possible the liability of their being moved, they should be driven sufficiently low to clear the bottom of the rail. Another manner of dealing with these stakes is to pull the spikes out of each tie surrounding the same, so as to allow of the track being moved and leave those ties untouched. This, however, entails considerable expense. Another manner of dealing with these stakes is to transfer them so as to be entirely clear of the track when moving. Too great care cannot be taken with these stakes, in order to facilitate the lining and surfacing of the track so changed.

PREPARING TRACK FOR SUNDAY WORK.—The bed for the track on a new line should be ballasted and leveled off

on tangents, and elevated on curves so that the bed will be within two inches of the bottom of the ties. It is necessary to prepare this bed with more than ordinary care, so that when the track is moved over to its new position trains can be allowed to pass without the necessity of holding them until the track is tamped. All trains, however, should run slowly over this track. When old track is to be thrown entirely clear of the old bed, it is not necessary to dig it out between the ties, but only to loosen it up with a pick, so as to make it easier

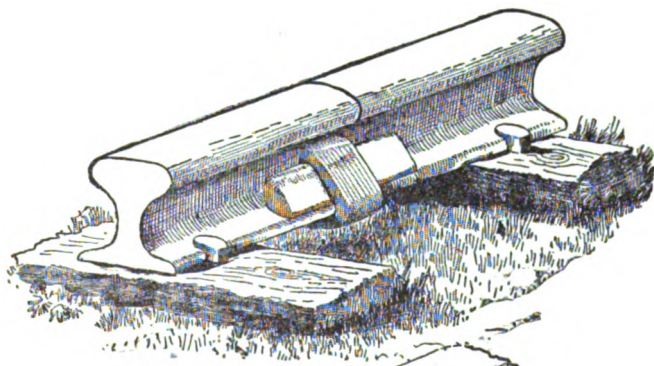

Ring, Joint and Wedge, West Jersey Railroad.

to throw. This loosening might be omitted, but in that case it would take half as many more men to pull the track out of the old bed. If old track is to be thrown less than the length of a tie, the part occupying the old bed should be dug out slightly below the bed of the ties, and the remainder loosened with a pick. This being done, the track is ready to be thrown.

MOVING THE TRACK ON SUNDAY.—It is necessary that good judgment be used in determining what amount of track can be moved to allow necessary trains to pass without being held, and also to determine the proper place to cut the track so as to prevent the necessity of

pulling it longitudinally more than one foot each way. The men may be divided into sub-gangs of not more than thirty men with two foremen each, and a certain piece of track allotted to them. This number of men will admit of being divided, using one gang behind the other in throwing the track, or have one surfacing while the other is finishing the lining and surfacing later. When throwing the track it should not be moved more than twelve inches at any time; this saves the rails and splices and prevents twisting the ties. Rail cuts, to allow for expansion or contraction, should be at the center of curves, or at as many more places as the degree of the curve and distance to be thrown render necessary. Not less than six men should be placed at each cut, so as to employ three in cutting rails and three drilling; they should first remove the splices from two joints, one on each rail, and pull the spikes on the sides opposite to which the track is thrown, so that the ties will be taken along as the track is moved. In order to pass trains after curves have been moved, the line should be changed on the tangents by reversed curve. When the track is in place, two men in each gang with sledge hammers should be put at work tapping the ties to proper space and square to the rail. Track in cinder may be tamped only with shovels and tamped with bars later after it has consolidated.

TO MOVE TRACK DURING THE WEEK.—After the track is prepared, it is necessary to know how much shorter or longer it will be when moved. This can be ascertained by setting temporary stakes. They should be placed on the line of rail where its position will be when changed, measuring along this new line to the similar rail of the old track, after which this latter rail should be measured between the same points; thus the difference between them is obtained. This can only be done correctly by using a steel tape. When moving track during warm weather, the track to be changed should be first examined, and for every tight or close joint one-eighth inch allowed for expansion; the sum of these allowances must be taken into con-

sideration in ascertaining the difference between the two rails. The rails should then be cut and drilled ready for use. When the time selected to make the change arrives, and the last schedule train has passed, gangs should begin to throw the track, always throwing toward the point or points cut loose. As soon as the throwing of the track is started, the rails at these points are replaced by those already cut. When the track is finally thrown to position, the ends can be spliced and bolted.

WINTER REPAIRS, GENERAL ROUTINE.—The principal work during winter is blocking track, clearing snow and ice, and keeping ditches open. Where track heaves badly, the rails should be marked on the web, and in the spring such places should be dug out and ballasted with clean, sharp material. No digging out of such places should be done during winter, other than lowering ties to overcome too high blocking, as it is too expensive.

BLOCKING OR SHIMMING.—Generally, the maximum blocking should not exceed two inches. On curves, the blocking should be spiked to the tie, and holes bored for spikes. Good and cheap blocking can be had from car shops, where oak offals can be had of any thickness. These offals should be from four to six inches in width. Extreme blocking on tangents may be four inches thick; the rail block should be braced by fitting one end into a notch in the tie and the other underneath the head of the rail; the block should be spiked to the tie at the notched end, and should incline at an angle of forty-five degrees. Another manner of dealing with extreme blocking of from four to six inches high, is to have the blocking in two pieces, the first being two feet long, the width of the tie, and securely spiked thereto, while a second block of the same size is laid on top of the first and spiked

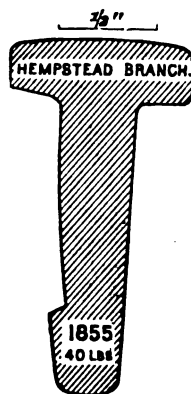

T Rail, Long Island Railroad.

through holes bored for the purpose. The rails should be track-spiked through half-inch holes bored in the blocking. When blocking more than one inch thick is used on curves, the safest and cheapest method (and the least injurious to ties, especially when the track is braced) is to spring the ties from their bed and drive a wedge-shaped block of wood underneath until the rail rises to surface. During snow storms, sufficient force must be kept on hand to keep switches, crossings, station platforms and flangeway of track open for traffic.

TRACKWALKERS OR WATCHMEN.—The number required depends on location. The least should be one by day and one by night. It is the duty of these watchmen to clean, light, put up and take down switch lamps; to tighten bolts and remove obstructions from drainage. When more than one trackwalker is employed, each should be allotted a certain distance, commonly called a "beat;" this beat he should patrol ahead of schedule trains as nearly as possible. A shanty, with a stove, should be provided for each beat, in which watchmen can take shelter.

INSPECTION OF ROAD.—The roadmaster should ride over the track and examine it from the rear end of trains as often as possible. He should do this at least twice a week. He should note all irregularities in the track, marking off on previous notes what has already been attended to and making any additional notes concerning the work. He should keep informed of the work each gang is doing and as to the number of men at work. His orders to foremen should be given verbally; by so doing the work will be executed with less trouble and



Pear-headed Rail.

at less expense. He should make frequent visits to the foremen and walk over their sections with them; these opportunities should be improved to draw section

foremen's attention to the items of work requiring to be done—explaining, advising and encouraging them. Section foremen should walk their track as often as possible—at least once a week. Trackwalkers should report all defects or obstructions of the track to the foreman; should any such be found likely to interfere with traffic, approaching trains must be flagged until the track-walker has an opportunity of being relieved or of sending word to the foreman; the foreman should, in turn, notify the roadmaster and ask for such assistance as may be necessary, if it requires more force than his own to remedy the defect or remove the obstruction.

PREMIUM SYSTEM.—Nothing is more encouraging or stimulating to men engaged in any work than the fact of having an object in view. The payment of premiums is a recompense in acknowledgment of superior ability; it creates a stimulus to thrift and energy that cannot be aroused in any other manner, and, at the same time, it does not injure the feelings or lessen the ambition of those less successful. The mere intrinsic value of the premium offered is not the sole encouragement given; the contest for pre-eminence is a valuable aid in the attainment of what is desired.

MANAGEMENT.—The contemplation of the vast expenses incurred in the maintenance of way, and the necessity for rigid economies in the face of an equal necessity for perfect conditions, illustrate the importance of a wise and progressive management. This can only result from careful training and judicious selection of the men who manage these expenses, either as a whole or in part. Therefore, to obtain competent men is a first requisite of any well conducted railroad. How to obtain such men is governed largely by local considerations, but some system of training and examination must be instituted for men who are to fill the responsible positions.

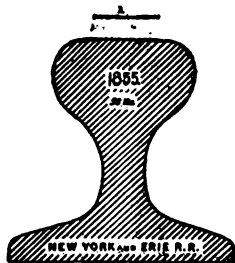

Pear-headed Rail.

In the roadway department there is especial need for a thorough system of accountability, which can only be exacted by superior governing intelligence, and must be executed by well drilled subordinate



Pear-headed Rail.

talent. Railroading has advanced from the experimental or theoretical stage to the plane of practical business. The roadmaster, or engineer of maintenance of way, should know just how much labor and material are required under certain conditions to maintain and equip every element of his roadway, and knowing this, he should possess accurate standards of efficiency and economy, and every man who fails to work to these standards should be dropped as incompetent.

ROADBED.—The roadbed is the foundation upon which is built the superstructure or track. If the foundation is defective, its imperfections will develop a rough and dangerous track. The material of the roadbed is of first consideration. It should be the best soil or earth obtainable in the locality—soil that will hold its position, become compact, resist the action of storms and possess needed elasticity. Logs in a roadbed are pernicious, as they decay and allow of sudden and dangerous pitfalls; large rocks or boulders are also objectionable, as they allow an uneven and rigid bearing and permit the too free percolation of water, that, in time of heavy rains, may develop a washout; clay and sand, in about equal quantities, generally give about the most satisfactory results. The size and shape of the roadbed will be determined by the importance of the road and the character of the material; as a rule, it should never be narrower at the top than six feet added to the gauge of track, and generally eight feet should be added to the

gauge of track for single track roads. The slope of embankments should be at an angle of one and one-half feet horizontally to one foot vertically, and a space of at least three feet of the natural earth should be left between the base of embankment and the inside edge of side ditches. This space is called the berme, which should be kept intact.

DRAINAGE of the roadbed is the process of preventing its saturation and erosion by water. Thorough drainage is necessary. Ordinary drainage is provided by a system of side ditches, surface ditches, ballast and the improvement of natural waterways. Extraordinary drainage, by special methods to suit particular obstacles to be overcome. Side ditches should be straight, with a uniform gradient toward their outlet. It is not customary nor expedient to make side ditches of sufficient capacity to provide for the largest recorded rainfall, as, in such cases, ordinary prudence would dictate the suspension of traffic and the construction of such ditches would entail useless expense upon the road; but it is essential that side ditches should be so made as to provide for carrying off, with greatest directness and rapidity, all the water falling within forty feet of the rail; beyond that limit surface ditches should be provided. In alignment, side ditches should conform generally to the alignment of the road and should not be deviated around stumps, boulders, etc., as such obstructions decrease the efficiency of the ditches and detract from the good appearance of the road; therefore such obstacles should be removed and ditches made straight, except where they emerge from a cut and join the ditches along the embankment, when they should be connected by a ditch of gentle curvature, and, at such connecting ditches, the earth removed in their construction should form a dam on



Pear-headed Rail.

the side toward the roadbed, to prevent the water from the cut overflowing the ditch and damaging the embankment. Side ditches along embankments should be made of a cross section; the bottom of ditch should be made to slope away from the road, as any wash will then occur on the side of the ditch where the water is deepest and away from the road.

Ditches should be maintained to a depth of at least two feet below the level of the bottom of cross ties, as an earth roadbed will absorb water to the height of two feet by capillary attraction; they should gradually increase in size toward their outlet. Surface ditches should be constructed on all slopes that tend toward the roadbed in cuts; they should be made of the same general cross section as the side ditches along embankments, except that the earth should be thrown on the side of the ditch toward the roadbed. This affords ready access for the water coming from the slope, and prevents overflowing on the side of the road. The size of surface ditches should be sufficient to carry off the rainfall from the slope on which they are dug; they should be straight, free from obstructions, and increase in size toward their outlet, which should be directed into the nearest natural waterway. On new roads the track forces should watch

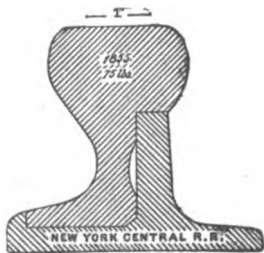

Compound Rail.

the drainage system with special vigilance during storms, as some weakness is almost sure to exist which will develop at such times. If the quick construction of a ditch is necessary, it should be started at the lower end, as it will thus drain itself as it is made. Where a roadbed is in a saturated condition, the constant passage of trains will cause the track to sink in the

wet earth, and "churn," resulting in a rough riding track. To prevent this and also the "heaving" of track by frost in winter, a layer of porous material called "ballast" is introduced between the ties and roadbed

proper; thus the weight of passing trains is distributed uniformly over the entire surface of the yielding roadbed, producing a uniform surface under all circumstances. Stone broken uniformly into cubes of about one and one-half inches on the side, clean gravel, furnace slag, clay burned with coal into hard lumps from one inch to two inches in diameter, and coarse sand, are valuable for ballast in the order named. The last, however, is exceedingly dusty, and is of too unstable a character to make good ballast. Broken stone has the advantage of freedom from dust, dirt, weeds and grass. Broken stone and gravel also wear much better than furnace slag or burnt clay. To insure a good track, ballast should be uniformly placed for a depth of at least one foot below the ties. Probably the ideal ballast is a layer of broken stone from eight inches to one foot thick on the roadbed, and a layer of from four to six inches of gravel above the broken stone and immediately under the ties. This insures perfect drainage, and renders the track easy to keep in surface. The top of the roadbed, under the ballast, should slope both ways from the center, so that water filtering through the ballast may pass off immediately into the side ditches. Where ballast cannot be obtained except at such an expense as to be prohibitory, it is important to secure perfect drainage in other ways. In such cases the top of the roadbed should slope both ways from the center of track to the bottom of the ends of cross ties, to afford an opportunity for rain water to run off rapidly into the side ditches. This is, however, only a partial remedy, as the roadbed will ultimately become saturated with continuous drains. The surface of such track should never be broken during rainy weather, as the looser the earth the more rapidly it absorbs the water. After continuous rains, the earth of a roadbed frequently becomes

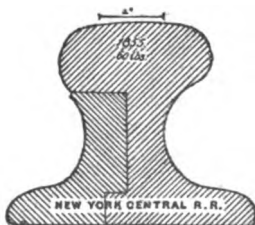

Compound Rail.

so thoroughly saturated with water as to render it unfit for tamping under the churned ties: in such cases it is necessary, in the absence of ballast and dry earth, to use some other coarse material as a temporary substitute until dry weather; ordinary grass sods, long coarse grass, or even brush, particularly pine, may be tamped under the ties; this will sustain the track at soft spots in a passable condition for a considerable length of time.

The next element of ordinary drainage is the improvement of natural waterways; they constitute the main arteries of a drainage system. The small natural streams should be examined for a considerable distance above and below a road, and all obstructions that tend to affect the natural flow of water should, if practicable, be removed; old timber from bridges, logs and other debris should never be allowed to obstruct them.

In reference to extraordinary drainage, the protection of slopes and banks is an important feature. Generally some short, creeping, long-rooted variety of grass will be ample protection for slopes and banks, both from the effects of rainfall and of flowing water. It frequently becomes necessary, however, to furnish additional protection at abutments and along embankments where

there is a swift running stream. Rock revetments or "riprap" can be employed to good advantage in such places, or a wooden revetment or walling made of old bridge timber is a good substitute.

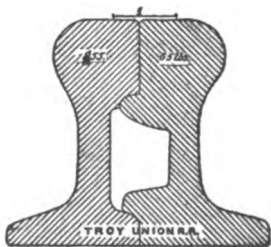

Compound Rail.

This walling should project into the trestle opening at least six feet, so that the current passing around the corner of the revetment walling will form an eddy sufficiently far from the abutment not to undermine it. In severe storms, where revetments have not been built or have been washed out from any cause, a good temporary substitute for the protection of the

bank is found in tree tops or large bushes, placed so that the bushy ends of limbs will spread over the side of bank as deep in the water as possible, the butt ends being laid in a direction up stream against the top of bank, and held in that position by timbers or earth piled on them. Springs occurring in cuts can generally be sufficiently drained by means of porous drain tile run at right angles to the line of track, about two feet below the ties, the ends opening into the side ditches. Sometimes, however, it is necessary to excavate an opening in the roadbed for several feet below the ties out to the side ditches, filling the bottom with coarse rock and the top with sand or gravel.

TRACK.—The prevailing material for cross ties is timber. The qualities required of timber for cross ties are durability, to resist decay; hardness, to resist wear; toughness, to resist breaking; and elasticity, to save the rail and rolling stock and to hold spikes in position.

The size of cross ties will be regulated largely by the timber supply on different roads. Where suitable timber can be obtained in abundance, a cross tie seven inches thick, ten inches wide and nine feet long is probably the best, though on many roads it becomes necessary as a measure of economy to use ties from six to eight inches wide and eight to eight and a half feet long. But whatever the size, the total bearing in a given distance is the important feature; the thickness of the tie should be fixed at not less than seven inches; the length not less than eight feet, and from that to nine and a half feet, bearing in mind that with the increased length should come increased thickness, and the width from seven to ten inches. The distance apart of ties in the track should be regulated according to

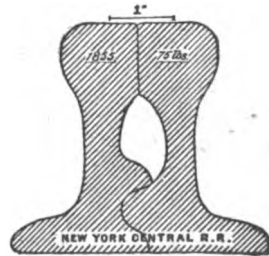

Compound Rail

their width, so as to maintain a uniform bearing surface. The usual limits of this bearing surface require that ties shall not be placed farther apart than one and one-half times their width, nor nearer than a space equal their width, for if they are closer there will not be sufficient room between the ties for proper tamping. Above all things, the size of ties and the distance between them must be uniform to insure good track.

FENCES.—The best material for a cheap fence is wire, and barbed wire is the most effective. Wire is practically indestructible, is cheap in first cost, requires the minimum number of posts, and is more rapidly put up than any other kind of fence. A top rail or board should be added as a brace for the posts and as a protection to stock that cannot see the wires. A flat wire ribbon with projecting points is used, as stock can see it better.

CATTLE GUARDS are the means of continuing fences across railroad tracks without interfering with the passage of trains. They form a very considerable portion of the expenses of a road, and therefore it is desirable to obtain a device as simple as possible, and yet it must effectually exclude all stock from the enclosure. A framed pit sufficiently wide for the connecting fences to afford proper clearance for the cars, and with stringers for the rails to rest on, was, until recent years, the form in most general use. The danger of stringers spreading and the disastrous effect of a derailment at these pits led to the addition of ties and guard timbers; these additions permitted a much shallower pit. As cattle, sheep and goats learned to walk these ties or guard timbers, it became necessary to have them chamfered.

Many other forms of stock guards, principally surface guards intended to do away with the pit entirely, have been suggested and patented.

ROAD CROSSINGS.—The intersection of a highway with a railroad at an elevation common to both is called a road crossing. At such points it is essential to provide

an easy and safe means of passage for vehicles over the track. Grade road crossings in cuts and on or near curves should be avoided whenever possible. At road crossings the grade of highways immediately approaching the track should not exceed one foot in ten. Public road crossings should be sufficiently wide for two teams to pass easily abreast, and in cities the width should be regulated to suit local requirements. Eight feet is sufficiently wide for private crossings, and twelve to eighteen feet for public roads; this width should be carried out to the limits of the right of way, if on banks, by a "ramp" of the same width as crossing; culvert pipe should be used under the "ramp" to prevent obstruction of drainage.

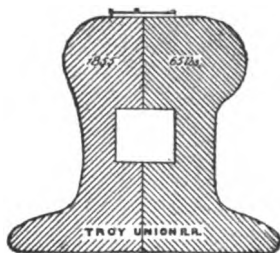

Compound Rail.

TOOLS.—The character of a workman may be determined by his tools. If found in proper order and ready for any emergency, he may be classed as a first class foreman. Good tools are necessary for good work. Foremen should be provided with suitable boxes and racks for their tools and should not allow them to become mixed.*

* The following list of tools is suggested as an outfit for a section gang:

Adze	1	Lanterns, red.....	2
Auger, 1½-inch.....	1	Lanterns, white.....	2
Axes, club.....	2	Level, track.....	1
Axe, hand.....	1	Line, ditch, 100 feet long.....	1
Bars, to three laborers.....	2	Lock, with five feet of trace chain..	1
Cans, oil.....	2	Mauls, spike.....	3
Car, lever.....	1	Picks, tamping, to three laborers..	2
Car, pole.....	1	Saw, cross-cut.....	1
Chisel, 1½ inch.....	1	Shovels, for each laborer.....	1
Chisels, track.....	4	Signals, danger.....	2
Drill, track, with six bits.....	1	Spike puller.....	1
File, 8-inch M. S.....	1	Square.....	1
Gauge, track.....	1	Torpedoes.....	12
Grindstone.....	1	Wire, telegraph, feet.....	30
Hooks, bush, to each man.....	1	Wrench, screw, 14-inch.....	1
Jacks, track.....	2	Wrenches, track, for each laborer..	1
Keg, water.....	1		

For each five sections, one rail bender and one rail straightener.

There should be a systematic inspection of tools by the roadmaster. Every foreman should be required to have his full number of tools in efficient condition at all times. Spirit levels should be tested and adjusted at each inspection. Every division of road should be provided with a hand derrick car, and a box car with wire ropes, blocks and falls, levers, jacks and blocking, and on every road where the traffic is of much importance there should be a steam derrick of at least thirty tons' capacity, and a car fitted up for the accommodation of a considerable wrecking crew.

Steam ditchers and ballast unloaders are also an essential part of the equipment of any first-class road, for they perform the services of very large forces of men at much less cost, and are ready for immediate service when it is frequently impossible to secure a sufficient amount of labor at the time required.

ORGANIZATION.—There are two distinct features to be considered in the organization of the roadway department. The first is



Box Rail.

the execution of that which is to be done; the next, the inspection of that which has been done. Under some circumstances, the duties of execution and inspection are combined in one individual; in the broadest sense, however, there should be no community of in-

terests between the inspector and the man who is directly responsible for the work. The man who executes or directs the execution of work is naturally inclined to magnify its excellence and excuse its imperfections, but he who views it with the practiced eye of a critic, whose judgment is not tempered with self-interest, will give an estimate of certain and just value.

Road inspection will therefore be considered under a separate heading, as a distinct system instituted to meet the increasing exaction of modern railroading.

In the organization of the roadway service there should be no division of authority or responsibility; all orders should proceed from a responsible head, and all reports should ultimately reach his office and be consolidated by him for the information of superior officers. This head is variously termed the roadmaster, superintendent of roadway, engineer, etc. Under this officer come the supervisors, division roadmasters, or assistant engineers, as the case may be; also timber inspectors, pump inspectors, and frequently bridge and building inspectors; then come the gang foremen, etc., who in turn employ their own laborers. Under such an organization, with a proper system of rules and accounts, a road may be extended to almost unlimited proportions by a simple addition to the number of divisions and subdivisions, and an enlargement of the central office. A division roadmaster or supervisor is rarely capable of supervising more than one hundred miles of single track or fifty miles of double track road. On our more important lines, a section of single track should not exceed six miles, and sectionhouses should be placed as near a telegraph office or station as possible.

The foreman should have the care of track and property of the company on his section, and should be held accountable for their proper care and maintenance.

As far as possible the roadmaster should lay out the work for his foremen. Foremen should be shown the value of thorough system, of planning the week's work ahead so as to economize time and to accomplish a little more

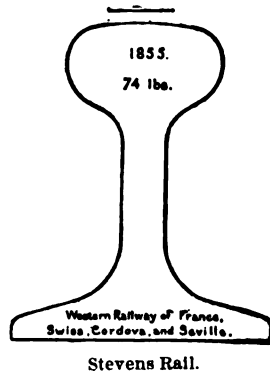

than the proper week's allowance. For this reason it is very essential for the roadmaster to establish the proper allowance of labor, and to issue a little in advance of requirements the necessary material. Foremen should not be permitted to work portions of a day at points widely separated, as the loss of time in going from one place to another will easily consume a large percentage of the day's time. The regular inspection, which foremen should be required to make at least twice a week over every part of their sections, should be made in such a manner that they will use as little time away from their regular work as possible.

The following rules for the guidance of employes in the roadway department are in the main generally appropriate.*

GENERAL RULES.—Each employe whose duties require it must have the book of rules with him while on duty.

Any employe who does not clearly understand the rules must ask an explanation of his superior officer.

Employes must report violations of rules by other employes which endanger life or property, or which prevent them from discharging their own duty.

Employes while on duty must refrain from profane or violent language, personal altercation, and from using intoxicating drinks.

Each employe is hereby warned that while on the tracks or grounds of the company, or in working with or being in any manner on or with its cars, engines, machinery or tools, he must examine, for his own safety, the condition of all machinery, tools, tracks, cars, engines, or whatever he may undertake to work on or with, before he makes use of or exposes himself on or with the same, so as to ascertain, so far as he reasonably can, their condition and soundness; and he is required promptly to report to his superior officer any defect in any track, machinery, tools or property of said company affecting the safety of anyone in operating upon or with the same.

* I copy them substantially as I find them.

Supervisors, inspectors, foremen and conductors must keep a daily record of their occupation, showing in detail the work done, material used, and the time of each person employed under their immediate supervision.

Red must not be worn in a conspicuous manner.

Supervisors, conductors, section foremen and foremen of all other gangs, during work hours, must not leave their respective division, train, section or gang, without written permission from the roadmaster.

In case of accident to train or road, the highest officer in the roadway department, or the oldest foreman in continuous service present at the time, will have charge of the work until relieved by someone higher in authority.

Supervisors must pass over their divisions on trains, and foremen over their sections on hand cars, during stormy weather, and must know that all is safe before allowing trains to pass. Conductors must keep in telegraphic communication with the roadmaster and the master of trains during the continuance of storms, and be prepared to move on shortest notice.

Hand cars must not be towed at the rear of trains, and must not be on the track after dark, nor in foggy weather, unless protected by proper signals in front and rear.

Standard plans and specifications for the construction and location of all structures will be furnished, and officers and foremen must inform themselves of such standards and work entirely in conformity with them.

Trains must be expected at all times.

Foremen and officers must provide themselves with reliable watches before entering upon their duties, and

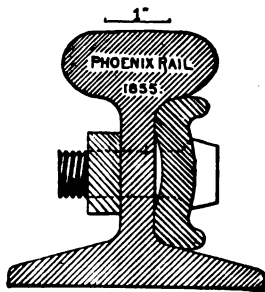

Single Splice Bar.

see that they are always in order and conform to standard time.

When watchmen are left with danger signals, they must be supplied with tools and required to work.

When dangerous places are found, or while work is being done that renders the road unsafe for the passage of trains, the person in charge must attend to the placing and maintaining of danger signals on the engineer's side of track in both directions. In no case must they be nearer than fifteen telegraph poles, and on a continuous down grade in the direction of the work the signal must be placed at least twenty telegraph poles from the work. When such points come on a curve, the signal must be placed at the further end of the curve. If either signal cannot be clearly seen from the work and from an approaching train, a watchman must be left with it.

Whenever signals of the roadway department are disregarded, immediate report must be made to the roadmaster.

Slow boards must be posted at a distance of ten telegraph poles on each side of the place where the speed is to be reduced.

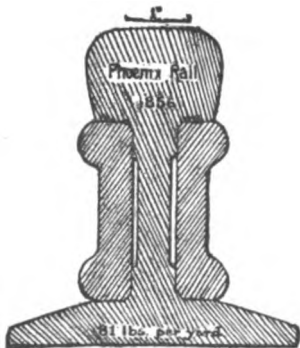

Double Splice Bar.

When two or more hand cars may be following each other over the road, they must maintain an interval of at least two telegraph poles apart.

SUPERVISORS OR ASSISTANT ROADMASTERS: Must test track levels once a week, and see that they are used in surfacing track; must see that foremen are supplied with the full number of tools required, and that they are in proper order; must carry with them on their

hand car a standard track gauge, an axe, six torpedoes, a red and white lantern, and a red flag; must examine switches, frogs and turntables once a week, and see that

they are in proper order; must see that turntables and car guards are provided with proper means to securely lock them; must see that their foremen are provided with the proper forms for making reports, and with copies of all rules and schedules; must pass over their respective divisions at least once a week on a hand car, once a week on an engine, and as often as possible on the rear of a train; must see that signs are placed where required, and are kept in proper order; must see that fences are kept in proper order.

Reports of the resignation, discharge, removal, suspension, transfer, death, injury, sickness, or marriage of any foreman must be sent at once to the roadmaster.

FOREMEN: Must be familiar with the regular code of signals and the proper position and use of torpedoes; must work when their entire attention is not required in directing their men; must report promptly in detail to the supervisor any accidents to persons or trains; must notice the signals carried by passing engines; must examine every switch, frog and guard rail on their respective sections at least three times every week, and keep them in good order.

Trackmen must see that the nuts and bolts in the track are kept tight.

Road crossings must be kept in good order.

Foremen must watch the telegraph lines, especially after storms, unite the wires when broken, and keep poles free from grass. They must promptly report to the roadmaster any derangement of wires they cannot repair.

Old ties must be piled, on the day after they are taken out, not less than thirty feet from the rail, piles to be not less than one telegraph pole apart. Old timber that is unserviceable must be burned.

All rails or scraps of metal must be neatly piled at mile posts, stations or section houses, not less than six feet from the rail. Serviceable material must be kept separate.

Foremen must see that scattered wood or trash around wood racks, station grounds or water stations is properly piled up or burned.

Foremen must repair promptly any break in fences, and report the facts to the supervisor.

Bushes and weeds within the limits of the right of way must be cut.

Foremen, when working on track, must see that earth is not piled up in such a way as to touch any part of a train.

The track must never be raised off the roadbed where drainage is complete; the low places should only be brought to a surface with the high places.

The track must be raised level with track jacks. Ties must be uniformly spaced and tamped.*



Barlow's "Saddle Back" Rail; laid without supports.

Spikes must be driven perpendicularly—outside spikes three inches from the edge of tie nearest, and inside spikes three inches from the opposite edge of tie, except at joint. Ties must be placed square across the track.

- * The following rules will be observed in laying new rails:
- a. Defective ties must be removed where rail is laid, and ties properly spaced and lined.
 - b. Track must be put to true gauge, level, line and surface.
 - c. Shims of proper size for the degree of temperature must be used.
 - d. Spikes must be placed in the slots of angle plates.
 - e. The full number of bolts must always be used. Nuts must be screwed up tight.

The track must be kept in proper gauge, and on curves of five degrees and upwards, guard rail braces must be placed on outside of both rails at intervals of six feet.

The ends of ties put in must be lined on the side of track on which the mile posts are located.

Ditches must be kept free from obstructions.

When a foreman takes charge of a gang, he must receipt for all company property delivered to him by his predecessor.

Foremen will be held accountable for the proper care of the company's property on their sections.

Hand cars and tools must be properly secured when not in use.

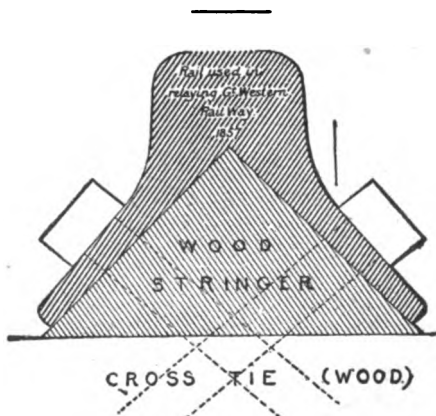

Triangular Stringer capped with iron.

Details concerning the track are infinite. In another volume* will be found particular instructions relating to the duties of trackmen in connection with the operation of trains. In addition to such rules, and supplementary to those already given, the following suggest themselves:

* Train Service.

Laborers will be arranged in gangs of such number and force as the roadmaster may direct; to each gang there must be a foreman, who must work constantly with his gang, and will be held responsible for the faithful and efficient execution of the work under his care.*

The safety of life and property requires that section-men should be especially vigilant in foggy weather and during and after storms.†

They must see that all obstructions upon the track, or likely to fall thereon so as to endanger the safety of trains, are promptly removed.

In no case, except in the most absolute necessity, is a rail to be displaced or any other work to be performed by which an obstruction may be made to the passage of trains during a fog or snow storm; the times for effecting repairs which involve the stopping of trains must, as far as practicable, be so selected as to interfere as little as possible with the passage of traffic.‡

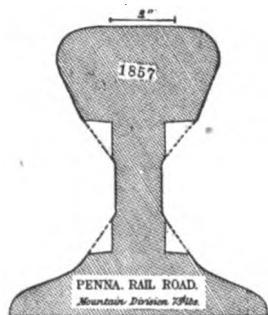

73-pound Rail, under head planed for splice.

Gravel or ballast unloaded along the line must be promptly spread upon the track, so as not to endanger

* "In each gang of platelayers, or men repairing the permanent way, there shall be a foreman or ganger."—*English Standard*.

† "They must see that after all heavy winds, rains and other storms, and during the same, the men are out on the road ready to render such assistance as may be required, and to give proper warning to the trains, and to repair such damages and remove such obstructions as are necessary. In foggy weather, when a train cannot be seen at three hundred yards, all the foremen and laborers must leave their ordinary work, and the foreman must range them along his portion of the line, over which they must walk up and down, driving such spikes and keys, or doing such other work as needs attention, and be ready to give notice of danger to the signalmen or the trains."—1854.

‡ "In all cases, before taking out a rail, the platelayer must have at the spot a perfect rail in readiness to replace it."—*English Standard*.

the safety of trains.* In lifting the permanent way, no lift must be greater than three inches at once, and then it must be effected in a length of at least twenty yards, in such a manner as not to occasion any sudden change of gradient. Both rails must be raised equally and at the same time, and the ascent must be made in the direction in which the trains run.†

Trackmen must keep the fences in good order at crossings and at each side of the track; they must see that all breaks are repaired without delay;‡ that cattle guards are kept in repair; that all gates that are found open are closed, and that all bars found down are put in proper condition.||

When watchmen are employed, they must walk over the track and carefully inspect the same at intervals between the passage of trains.§ It is the duty of watch-

* "No ballast must be thrown up to a higher level between the rails than three inches, and it must be thrown as much as possible on the outside of each line, and between the two lines, and be replaced as soon as possible. The rails must be kept clear of gravel, ballast or any other material."—*English Standard*.

† English Standard.

‡ "Surely, it is far better to stop a hand car and repair a fence than to subject a company to damages for killing stock, with the additional expense, occasionally, of a wrecked train. In a word, men, when passing over a road with a hand car, should be prompt to remedy every defect they discover. It should be a rule never to postpone any work of repairs that can be done on the instant."—*The Roadmasters' Assistant*, page 118.

|| "Gangers must close and fasten all gates they find open, and report the circumstances, in order that the persons who are required to keep such gates closed and fastened may be charged with the proper penalties. The gangers must take care to maintain proper scotches on all sidings requiring them."—*English Standard*.

§ "Whenever any person has occasion to walk on the railway he must not walk on either line of rails, but on the right-hand side of the line, off the ballast, clear of passing engines or trains."—*Great Northern Railway of England*. "Gangers must order off the railway all persons trespassing within the fences, and must do their best to obtain the trespasser's name and address. If any trespasser persists in remaining, they must take him to the nearest station and give him in charge of the stationmaster or police there; or (if any police constable be

men (and switchmen and agents as well) to signal trains that disregard the regulations prescribing the time and distance that must elapse between trains that are following each other.*

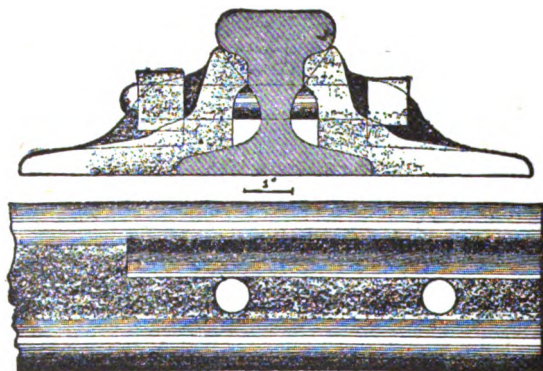

Erie Rill with ends stamped for Adams' Cast-Iron Bracket Splice, A.D. 1857.

Foremen are required, in the event of storms or floods, to examine carefully the action of the water

nearer than the nearest station) gangers must give the trespasser in charge of such constable, and report at once having done so to the nearest station."—*Great Western Railway of England*.

* "The foreman and other men of the squads must look at every passing train, and if they see a train running on the same track, within ten minutes of another train, or anything wrong, they must signal the engineman with a red signal, and they must report to the trackmaster when an engineman does not obey the signals."—1854. "Where the line is not worked under the block telegraph regulations, if a passenger train approach within ten minutes of a goods, cattle, mineral or ballast train, or light engine, the men repairing the line must give the engine driver of such passenger train a signal to go slowly."—*English Standard*.

through the culverts and bridges on their length of line; and should they see any cause to apprehend danger to the works, they must immediately exhibit the proper signals for the trains to proceed cautiously, or to stop, as necessity may require, and inform the inspector thereof; and, until the inspector arrives, they must take all the precautionary measures necessary for securing the stability of the line.*

They must see that water courses under the bridges and culverts are not allowed to become clogged or obstructed. †

In wet weather, and during and after snow storms, they must use every effort to prevent delay or accident to trains. ‡

Track foremen must carefully walk over and inspect every portion of the section under their charge at least once each day.§

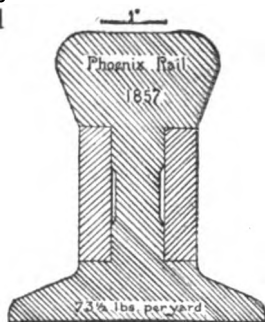

Double Splice Bar.

* Great Western Railway of England.

† "They will be particular not to allow standing water upon any part of their line, but keep the ditches open and free at all times, and keep floodwood away from the culverts, bridges and water courses."—1853.

‡ "Their whole time will be devoted to their duties in the service of the company, and generally their services are more urgently required in bad, inclement weather than at any other time. In winter it is as much their duty to keep the track clear from snow and ice, as far as it is possible, as to keep it in repair. At this season every possible effort should be made to keep the road open and insure the regularity of trains."—1853.

§ "Each ganger must walk over his length of the line every morning and evening on week days (except where the engineers consider once each day sufficient, and have laid down such instructions in writing) and where passenger trains are run, once on Sundays, and tighten up all keys and other fastenings that may be loose; and he must examine the line, level and gauge of the road, and the state of the joints, marking, and if necessary repairing, such as are defective."—*Great Western Railway of England.*

Each foreman must, when going over his length of line to examine the keys and fastenings of the rails, have with him a keying hammer and spanners or nut keys, and be prepared promptly to supply keys, nuts, packings, fastenings, or other parts of the permanent way that may be required.*

No wagon or other vehicle employed in the permanent way department must be left in any siding without the wheels nearest to the entrance into the main line being properly blocked and secured.†

Old and unused material of every kind upon the line of the road, or at stations or shops, must be carefully collected and preserved.‡

All luggage, goods or articles found on the line must immediately be taken to the nearest station, and a report made containing the best information that can be obtained respecting the train from which they may have fallen.§

Trackmen working in a tunnel, when trains are approaching in both directions, must, if unable to reach any recess between the two lines of rails, or between the line and the side of the tunnel, until the trains have passed. The width of the space depends on the construction of the tunnel, with which every man must make himself acquainted in order that he may select the place which affords the greatest safety.||

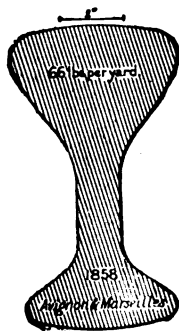

Bull-Headed Rail.

* Great Western Railway of England.

† English Standard.

‡ "They will protect the materials or property of the company (whether new or old) upon their line from depredation, loss or injury, and keep it properly and neatly piled up, ready for use or removal."—1853.

§ English Standard. "Anything which may have been lost from a passing train, such as a casting, nut, screw or bolt, or any piece of machinery, piece of freight, baggage, or other matter, they will pick up and carry to a regular station and deliver to the station agent."—*Old Rule*.

|| English Road.

Trackmen must desist from work upon a train approaching, and must not cross over to the other lines, but move to the side of the road, clear of all the lines, to secure themselves from the risk of accident by trains running in opposite directions.

In the event of any fire taking place upon or near the line, employes must take immediate measures for putting it out.*

Bridges and culverts should be carefully inspected after the passage of each train; but where this is impossible they must be examined daily, or oftener, if sectionmen have occasion to pass over them. All defects should be promptly remedied, and in the event sparks, burning waste, fuel or fire of any kind is observed, it should be put out.†

Before removing any traveling crane, the person in charge of it must see that the jib is properly lowered and secured, and so fixed that it will pass under the gauge, and, when it has to be removed by train, it must, when practicable, be so placed that the jib will point toward the rear of the train.

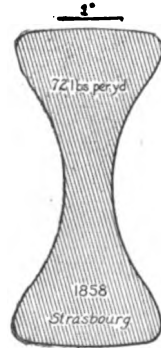

Bull-Headed Rail.

* "Careless firemen frequently throw overboard handfuls of dirty waste, which at any time may be ignited by a spark from a passing locomotive. Fire may be carried thence into the dry grass by the roadside, afterward into the fence, and so on to haystacks, buildings, woodpiles, etc."—*The Roadmasters' Assistant*, page 116.

† "When a gang of trackmen engaged at work discover smoke on a line, they should at once attend to it. It should be a rule at all times never to neglect the least indication that a fire has caught on the line. On more than one occasion expensive bridges have been destroyed owing to a neglect to stop the hand car and remove a live coal of fire dropped by a locomotive, or to put out a fire caused by a spark from a smokestack lodging in a decayed spot of timber. Some of the worst wrecks on record have been taken out of culverts where a stringer has been nearly burned through."—*Ibid*, pages 116-117.

CHAPTER VIII.

MAINTENANCE OF TRACK.

In the maintenance of railways the track is the source of the greatest single expense. This we may divide under several heads.*

These relations will, of course, vary in different localities, according to natural advantages, such as nature of soil, climate, proximity to sources of supply, etc.

And, first, in regard to rails. Natural deterioration of this kind of material arises from rust. Other classes of material suffer from more acute causes. But in the case of iron, oxidation is the great enemy to contend with. Deterioration from this cause is much greater, in some localities, than in others. The damage, for instance, is greater near salt water than elsewhere.† Ability of rails to resist the effects of climatic influences depends upon location. We have,

* These heads and the relation they severally bear to each other may be stated, approximately, as follows:

	PER CENT.
New Rails (less value of old).....	16.13
Handling Rails (i. e., laying the new and taking up the old).....	2.84
Ties	13.97
Handling Ties.....	5.18
Miscellaneous (general) Repairs, Roadway and Track.....	62.88
	<hr/>
	100.00

† It is also great in tunnels. The durability of ties is also less in tunnels than elsewhere.

unfortunately, no accurate data as to percentage of deterioration from climatic causes. It is a question about which metallurgists have collected little definite information. Steel is less able to resist rust than iron.

The deterioration of metal from oxidation is not uniform, but proceeds with increased momentum as the cause of decay deepens and spreads, each new inroad affording an additional storehouse in which the destructive elements multiply and extend themselves. The increase in the destructive power of rust may be likened unto the cumulative malignancy of a cancer. As it grows wider and deeper it destroys the fiber and absorbs the tissues of the body, increasing in intensity with what it feeds upon, until the object attacked is no longer able to withstand the slightest strain.

Oxidation is obviated by the exclusion of dampness. This would not be necessary if the article could be preserved free from abrasion or contact with surrounding objects; for while dampness is the propelling or primary cause of rust, it is not operative except in case of abrasion of the metal, or its contact with some particle of matter. Either of these precipitates vapor by rendering condensation of moisture possible, thus inducing oxidation. Wherever there is a scratch upon a

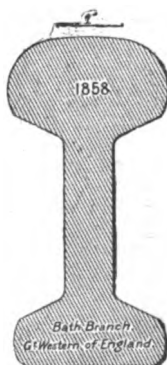

Bull-Headed Rail.

piece of metal, or wherever a particle of dust (however invisible to the naked eye) adheres to it, there moisture collects, evaporation ensues and rust is engendered. An abrasion, or particle, affords a vantage ground for the retention of moisture. From this vapor arises, precipitating the conditions described. It is believed that rails in actual use suffer less from rust than those not

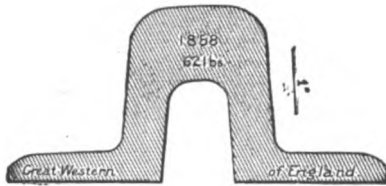

"Box Rail."

in use. The friction of the wheel polishes the surface of the rail, while the vibration of passing trains prevents the retention of moisture. Professor Carhart, in answering a question in regard to

the destructive tendency of rust and the length of time a rail will resist its effects, says: "It is well known that a polished iron or steel surface does not rust so soon as a rough surface when exposed to the same conditions. Rough lines and sharp points appear to serve as nuclei, about which water condenses. Moist air when expanded suddenly precipitates its vapor as a cloud, if dust is present to furnish centers of condensation. Frost crystals form first along scratches on glass. So moisture appears to condense more quickly and freely on a rough surface of iron than on a clean polished one. Rusting takes place only in the

presence of moisture. A clean plate in dry air never rusts. Mixtures of explosive gases do not explode when the electric spark passes, unless vapor of water is present. When a metal surface is once covered with

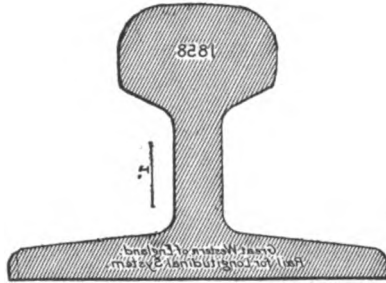

Stevens Rail, Great Western Railway of England (Longitudinal System), A. D. 1858.

rust, the rusting proceeds much more rapidly than at first, because the rust is hygroscopic; moisture is taken up and conducted inward toward the metal; hydratic oxides of iron are thus formed, and fresh metal underneath is attacked because of the presence of moisture or of the hydratic oxides on the outside. A coat of iron rust hastens the rusting process except when the metal is coated with the black oxide of iron. It can then be exposed to any weather without rusting. But the black oxide is formed only at a high temperature. The scales that fall from the rails as they come from the rolls are largely black oxide of iron."

In a climate such as we are treating of, it is probable that fifty years of exposure would render a rail unsafe for use. If this is so, the deterioration from natural causes is two per cent. annually. With a moderate traffic the average period of usefulness of a Bessemer steel rail is

fourteen and six-tenths years. It is probable (for the reasons we have already specified) that a rail will last longer under mild usage than if not used at all, provided its strength is commensurate with the load.

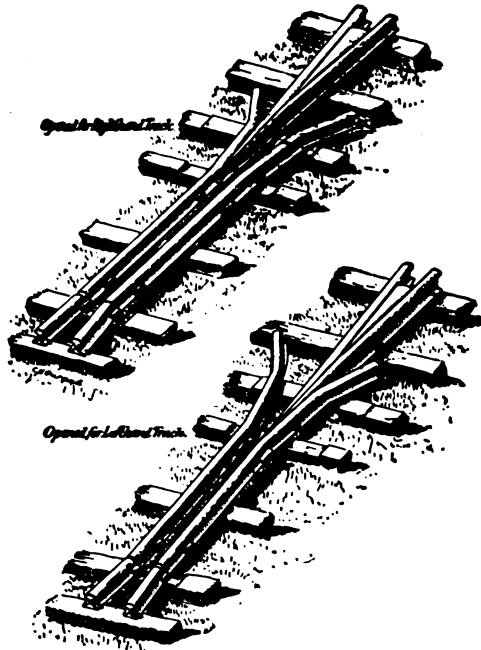

Wood's Rail Frog, New Jersey, A. D. 1859.

Under ordinary usage, the rapid deterioration of rails is occasioned by the speed of trains. Speed not only intensifies the friction, but increases the weight through its centrifugal force.

Inquiries in regard to the percentage of decay of rails from natural causes elicit extraordinary differences of opinion. They serve to show how little attention the subject has received from practical men. In some cases deterioration is ascribed wholly to traffic. The highest rate ascribed by anyone to climatic causes was fifty per cent. In considering the deterioration of rails from natural causes, the damage would not, as already stated, be the same relatively for railroads doing a great business that it would in the case of those doing a small business. When a rail is worn out quickly, relative deterioration from rust is not nearly so great, though it is undoubtedly weakened from this cause, especially where defects of any kind exist as receptacles for moisture. Herein, undoubtedly, lies the secret of the sudden and inexplicable collapse of rails that, according to the law of averages, should last many years.

Just what the difference of deterioration from climatic causes between a rail in use and a rail not in use is, is not known. In answer to inquiries on this subject one writer says: "I do not know how long rails would be effective for fast running trains if laid down and not used, but will allow a hundred years; a track that is used would last about ten years." Another writer says: "The expense of maintaining rails is almost exclusively dependent on the traffic. If entirely idle, the loss by rust would be considerable in rails by weakening the fiber of the

metal, and causing rapid wear and breakage when again brought in use. Under ordinary conditions ninety-five per cent. is due to traffic." Another writer says: "There would be a slow destruction of rails from rust, which might take off three or four per cent. of the expense chargeable to traffic." Another writer says: "If no trains were run there would be no wear of rails, except such as might be incident to the action of the elements. A rail laid in track twenty-four

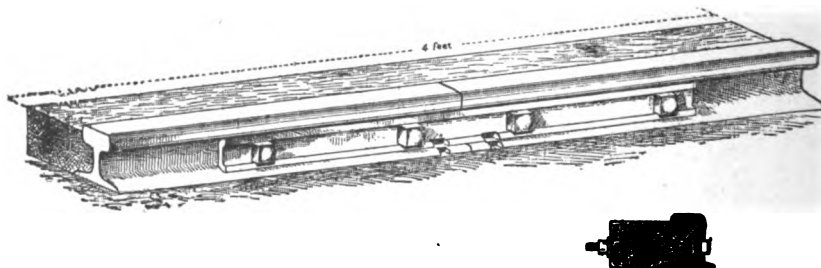

Wooden Joint Block, New Jersey Railroad, A. D. 1860.

years would deteriorate from rust to such an extent as to necessitate renewal in order to put the track in first-class condition." An authority upon the subject says: "The average life of sixty-four rails we are studying, on the supposition that they are worn out when they have lost eight pounds per yard, and that the yearly tonnage is eight million tons, is thirteen years. If we are able to obtain steel rails as good in quality as thirty-two slower wearing rails we have under test, the average life would be almost twenty

years." The roadmasters, in their meeting of 1884, state that "The average life of a steel rail may be taken at nine years." The source of information is not stated, but the duration of the rail, it will be noticed, is very much less than is generally given and is too small except for roads doing an unusually heavy business.

From numerous inquiries extending over a large area of country, and addressed to practical men actively engaged in the care and maintenance of track, I find that they estimate the average deterioration of rails from natural causes in the lake region of the

United States at about seven and a half per cent.; at interior points less, not exceeding two per cent. One piece of rail that has been in use thirty years was submitted to an expert in such matters.* He says: "The roughness of the surface indicates that some inroads have been

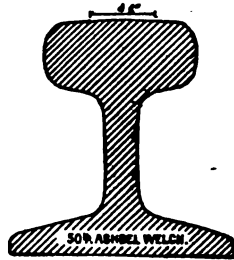

A. D. 1866.

made upon its integrity. The fracture recently made reveals a highly fibrous texture of the iron. I do not detect much evidence of granular or crystalline structure. The iron left, therefore, is in good physical, or perhaps molecular, condition to do service." The metals used by a railway outside of its track suffer from the same general causes as iron and steel rails.

* Professor Carhart.

Next in order, in connection with the fixed expenses of maintaining the track of a railroad, we may consider the question of ties. The cost of this item is great and exceptional. No class of material used by railroads suffers so greatly from the action of the elements. No matter how favorably placed, as regards quality of ballast, deterioration is noticeable and rapid. The kind of wood and how seasoned influence perceptibly its duration and usefulness. Quality and arrangement of ballast have much to do with the preservation of the tie from decay. But ballast is intended to serve several other necessary purposes besides acting as a filter to protect the tie from dampness. It serves to increase the bearing surface of the tie, strengthen the roadbed, increase the elasticity of the latter and render it more uniform.

Broken stone and slag are the kinds of material most useful for preventing the decay of ties.

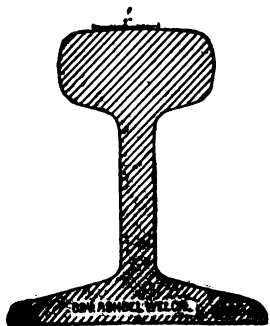

A. D. 1866.

Next in order are cinders, gravel and sand. The expense of handling ties (i. e., replacing) is much greater where slag or broken stone is used, on account of the difficulty of removal, including labor of readjustment. This disadvantage is, however, more than compensated by the great advantages of such mate-

rial. Where soil or clay is used, the interior of the tie oftentimes rots before it is injured by the weight of the traffic. Where the business of a line is heavy, ties receive material harm from respiking and resetting of rails, and if of inferior wood are frequently cut down and split by the rail. Ties, if properly ballasted, receive little detriment from the wear and tear of light traffic, except upon curves.

The natural duration of a tie is dependent upon the kind of wood of which it is made, how it is seasoned, nature of climate, and quality of the ballast in which it is laid. All these must be considered in arriving at a result. The most serviceable tie that we have for all conditions of use is white oak. It is able to sustain a great load, and affords very satisfactory resistance to the elements.

Results of inquiries made of practical men in reference to the duration and value of ties, while exceedingly interesting, are not altogether satisfactory, for the reason that the premises upon which they base their conclusions are nowhere the same. This difficulty, however, besets the student at every turn in attempting to arrive at general conclusions from isolated instances. One writer

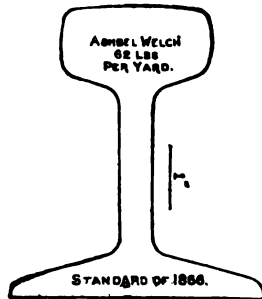

A. D. 1866.

says: "A tie will last about seven years. Without traffic, it would probably last ten years. Cedar ties would not last as long with traffic as oak, but without traffic, would last longer. The life of a hemlock tie would not be as long with or without traffic." Another writer says: "Thirty per cent. should be charged to traffic account for damage by rails cutting into the tie and injury arising from driving and pulling of spikes, rendered necessary in changing rails and regauging the track." The greatest ignorance exists here, as elsewhere, among so-called experts. Thus, one writer says: "A tie will last just as long in a track that is operated as it will in a track that is not operated." Another writer of unusual intelligence says: "Natural decay of ties ballasted with the best material, such as broken stone, gravel or cinders, would be much less than where poor ballast was used. I should think twenty-five per cent. less, as a tie would lie perfectly undisturbed and dry, and would not be cut into by the rail. In poor ballast, such as soil and clay, the middle of the tie would decay before its surface was damaged."

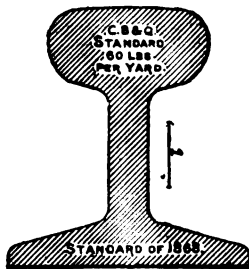

A. D. 1868.

The relative deterioration of ties from natural causes and from wear and tear is dependent upon so many contingencies that estimates for particular properties would not apply generally. However, it is probable that

the expense of maintenance for ties in a temperate climate cannot be far from seventy per cent., leaving thirty per cent. as chargeable to wear and tear of traffic. The greatest difference of opinion exists among practical men as to the damage arising from decay and wear and tear, respectively, one writer insisting that no portion of cost of maintenance should be charged to traffic, while another not only insists that the tie is injured by the weight of passing trains and changing of spikes, but that the movement of passing trains loosens the soil enveloping the tie, thus greatly hastening its decay.

I have not attempted in the foregoing to discuss the question of railway ties except in its simpler aspects. The various questions as to the best and most economical tie are referred to elsewhere herein. The subject grows each year more and more important to railways and to the public. The great cost of wood ties, the destruction of timber their use engenders, the ever increasing difficulty of procuring those of a suitable nature, render it more and more important each year that their durability should be increased or that a substitute should be found to take their place. To those who are interested in the subject—and all who are interested in economic subjects are thus interested—I beg to refer to what is said elsewhere in regard to the timber supply and its preservation, the qualities of wood best adapted for ties, how the duration of wood ties may be prolonged by preservative processes,

and the experiments that have been made with metal ties.

The cost of repairs and renewals of roadway and track, outside of the cost of rails and ties,

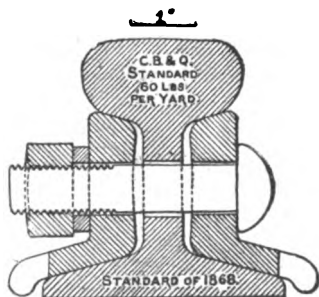

A. D. 1868.

is made up largely of labor. In the appendix hereto will be found a table of expenses, classified under appropriate headings.* This classification was the result of many years of carefully collated statistics upon many hundred miles of railways, cov-

ering many millions of dollars. It is, so far as it goes, conclusive for the great lake region of America.

The general repairs of roadway and track embrace all classes of material used in connection with the track, save rails and ties, including ballast, and the tools and supplies of trackmen. The

* Appendix B. While the matter is, perhaps, not strictly germane, it is proper to refer the reader here to the classification of track material and labor embraced in the book "Disbursements of Railways." The track accounts of railways are the most difficult of all to keep, because of the limited facilities possessed by those who have charge of such work. Detailed information in reference to track expenditures is, upon many roads, very meager. Yet an effective system of track accounts is necessary to economical and effective management. It plays a most important and necessary part. I do not pretend to say that the system of accounts referred to is the best; it is, however, simple, economical, easily kept, and affords a graphic account of the divisions of track expenses.

material embraced under this head is quite as quickly and vitally affected by wear and tear as rails or ties. Bolts, spikes, splicebars and nuts receive marked and rapid deterioration from both climate and traffic, while the tools used by trackmen (and they comprise a considerable list) are quickly consumed. The account known as general repairs of roadway and track embraces

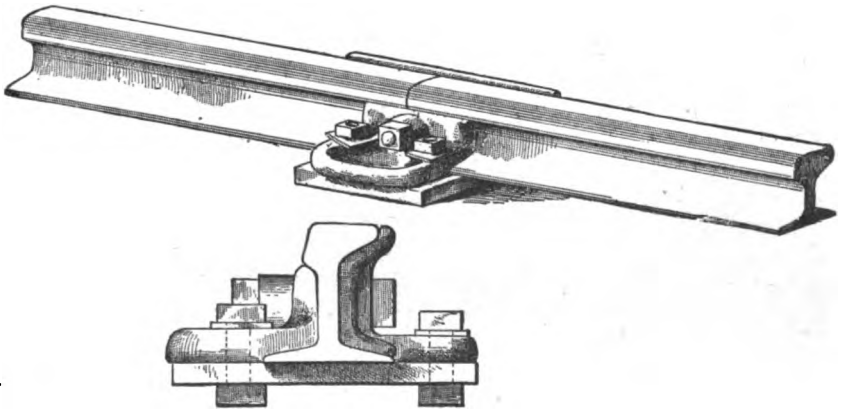

Joint Fixture used on Western railroads, A. D. 1860.

various classes of material, and includes cost of surfacing track, ditching, drainage, freshet repairs, track watchmen, clearing track of snow, and removing weeds, brush and grass.

An examination of the different expenses of roadway and track elicits the fact that a large proportion of them is directly chargeable to traffic. The expense is increased, moreover, by

the fact that the traffic of a line greatly interferes with repairs and renewals. The necessity of the work being carried on without reference to weather or the accommodation of business adds greatly to cost. The added expense on this account is much greater than those not familiar with the work would suppose. Safety regards neither convenience nor economy. An occasion arises and it must be met, no matter how great the waste involved. The significance of this is startling, even to railway men. Work is carried on upon the track in every instance at a disadvantage, and in many cases involves large expense over what would be necessary if it could be pursued with reference to the economical use of labor and material.

The most surprising diversity of opinion exists I find, among trackmen as to the proportion that

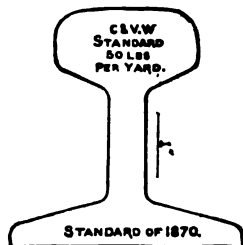

A. D. 1870.

is chargeable to fixed expenses of maintenance of roadway and track. This is due in part to the peculiar circumstances that attend such expenditures. It arises also from differences in conditions and cost in different localities. The superintendent or roadmaster whose

track is well ballasted with broken stone or slag, if asked as to the cost of its maintenance, or the relative wear and tear of ties, or the duration of the ballast, will return an answer entirely

different from that of the official whose road is ballasted with sand or common soil. The effect of this local coloring must be kept in mind in any attempt to arrive at general conclusions about railroads. People speak of things, not as they are commonly, but as they see them from day to day. No one is superior to influences of this nature, and but few, even among the most thoughtful, rise wholly above them.

As already stated, the relation of fixed expenses for maintenance to traffic expenses is governed largely by the amount of business. Wear and tear increases with use, but expenses arising from decay are not materially heightened on this account, except in the case of rolling stock. I do not wish to be understood as saying that while wear and tear increase with business, the cost of repairing increases in a like ratio. On the contrary, it is relatively cheaper to maintain a track with the maximum amount of business than with the minimum amount, for the reason that it permits concentration of work within narrower limits.

In the operation of properties, deterioration is oftentimes due largely to traffic; in other cases, almost wholly to natural causes. The intervening gradations are infinite in detail and complexity. In classifying expenses for

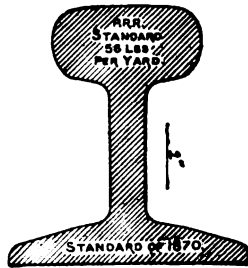

A. D. 1870.

ditching, freshet repairs, and removing snow, weeds, brush and grass, however, we are not beset by any difficulties. The movement of traffic has nothing to do with the filling up of ditches or the growth of vegetation. The movement of trains does not materially affect the cost of ditching or removing snow, weeds, brush and grass. In some cases it increases the cost, in other cases the work is assisted thereby. However, the cost of repairing damages by freshets is greatly increased by movement of trains, because of the urgency of the work and the inconvenience attending it. The expense of keeping a track free from snow and ice under normal conditions is lessened by the movement of trains. Except for such fortuitous help, cuts

would in many cases soon fill up with snow, which, through the alternation of heat and cold, would turn to ice, rendering removal both expensive and tedious. The movement of trains, with slight assistance from trackmen, as a rule, keeps these cuts open. The movement of trains from day to day also lessens the expense of keeping a track free from weeds, brush and grass; except

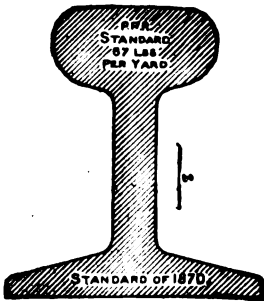

A. D. 1870.

for the continual passage of trains and track

forces, these obstructions would quickly block the road.*

Another important item of track expense is the cost of watchmen. This is, however, wholly chargeable to traffic, for, while they perform an important and necessary duty, they would not be necessary except for the passage of trains.

In the inquiries I have had occasion to make in regard to expenses connected with the maintenance of track, the marked intelligence of those in charge of work of this kind, and the purely speculative knowledge they have evinced in connection with it, have been apparent. Thus, in connection with the expenses connected with snow, one writer says: "To keep an idle road in condition so that business might be done at any time, would require that a snowplow should be used. The clearing off of snow also causes the track to heave, and makes shimming necessary." Another writer says: "A road would not be in first-class shape (if temporarily closed to business), buried under six feet of snow, and yet the snow could not be kept off at ordinary expense unless there was a regular train service." Another



Plain Splice Bar.

* I remember going over a piece of road in the eastern part of Dakota in 1874 that had been abandoned for some time. The train consisted of an engine and two cars, and three days were

roadmaster says: "Climatic cause is the largest source of expense, as we should have to keep the track free from snow by special means in the absence of regular trains."

While there is no great divergence of opinion in regard to the deterioration of roadway and track, there is the greatest diversity of opinion among practical men as to the proportion chargeable to climatic causes and traffic, respectively. With more reflection, they will be able to harmonize their differences. Men experience difficulty in forming an opinion as to the relation natural expenses bear to traffic expenses, because of the fact that the whole is primarily due to traffic. Every expense must, of course, be borne by the revenue of a property, but that fact does not make the ascertainment of the source of the expense any less interesting or less valuable to its possessor. The confounding of forms with principles, however, always occasions more or less confusion in

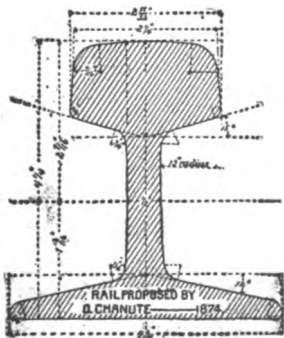

required to travel eighty miles. The weeds and grass were from six inches to six feet in height. Everywhere the roadbed was tunneled with the burrows of jack rabbits and squirrels. The weeds and grass rendered the track so slippery that it was necessary for laborers to place sand and gravel on the rails as we proceeded. Water was procured with the aid of syphons from ponds along the road, and the trestles and bridges swayed

the minds of inquirers and renders them liable to decide questions according to preconceived notions. It is in consequence of this that in many instances those especially familiar with the operations of track ascribe an undue proportion of expense to traffic. In attempting to arrive at the truth, the testimony of extremists of this kind, it is apparent, must be eliminated. After doing this, I find that the differences of opinion among practical men are not great. According to their estimates fifty-seven per cent. of the expenses of roadway and track, excluding rails and ties, is considered to be due in a temperate climate to climatic causes, and forty-three per cent. to traffic. If a railroad were, therefore, to cease to do business, it would reduce its expenses for miscellaneous track material and tools and track labor forty-three per cent., unless the suspension were permanent, or likely to extend over a period of a year or more. Fifty-seven per cent. would be required to maintain the track in a condition to resume business at any time. The result arrived at would be more trustworthy if we knew the expense for track tools separately from miscellaneous track material, but with this knowledge we would still be

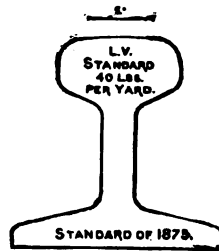

under the weight of the train like trees in a tempest. When eventually this particular piece of track was opened for business, it was found necessary to rebuild it entirely, although the abandonment had only extended over a period of five years.

unable to determine what proportion of deterioration of tools was due to natural and traffic expenses, respectively.

One obstacle in the way of a separation of natural and traffic expenses is the difficulty of determining the proportion of the expense of ballasting, surfacing, tamping, etc., due to the weight and movement of trains apart from the damage occasioned by natural causes.

Next in order comes the cost of maintenance of bridges, culverts and cattle guards. In connection with these, it is apparent that expenditure is largely dependent on the nature of the structure and the quality of material used. Manifestly a wooden bridge will decay much more rapidly than one of stone or steel. A large per-

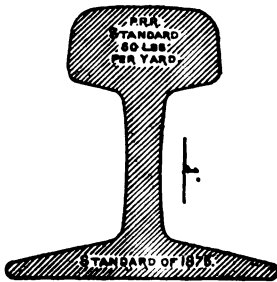

centage of the expense of renewing wooden bridges is due to climatic causes. Decay is accelerated by the opening of the fissures in the material and the straining of the fiber of the wood caused by the weight of passing trains. To this extent damage is

chargeable to traffic. Repairs and renewals occasioned by the wear and tear of traffic are, generally speaking, proportionate to the business done. This truth finds illustration in the experience of every bridge builder. He quickly discovers that expenses for repairs where traffic is

great are much larger than where traffic is small. This is so marked as to be a constant subject of notice. Where business is small great economy is possible, permitting the use of bridges that would not answer at all where traffic was great.

The duration of an iron or steel bridge cannot be determined in advance, as the extent to which the strain upon the metal will affect its fiber and weaken its strength cannot be estimated. The accidents arising from the breaking down of iron and steel bridges, apparently stable, make it apparent, however, that the material of which they are composed suffers deterioration from the start. The damage that arises from use, whatever it may be, is, of course, chargeable to traffic.

The relation that the track and the bridges and culverts of a line bear to each other, and the difference in degree to which they respond to the action of frost and kindred causes, render their adjustment a source of constant expense and anxiety. Not only is alignment different, but they do not settle or rise uniformly. The jar and weight of trains affect bridges and culverts so perceptibly as to continually require their readjustment. The expense of preventing

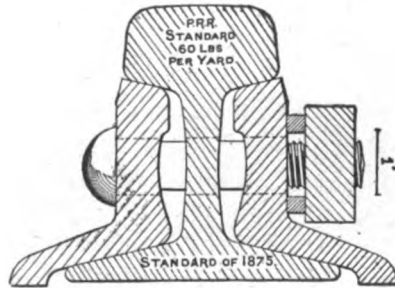

Angle Splice Bar.

the channel under or above these structures from becoming obstructed and damaged by freshets also constitutes a fixed charge for maintenance. Experts place the duration of wooden bridges, under a light traffic, at, approximately, eleven years. The life of an iron or steel structure is much longer. The expense of protecting iron and steel structures is said to be much greater than for wooden bridges.

In the case of a stone-arched culvert, the material of which is of durable quality, properly laid, and of sufficient strength, expense from natural decay is merely nominal. The expense for repairs and renewals of bridges and culverts arising from natural causes depends upon the climate, the nature of the structure, the care expended upon it, and the volume of traffic; taking the railway system in its entirety, it is probable that the annual expense occasioned by natural causes is in the neighborhood of seventy-five per cent.

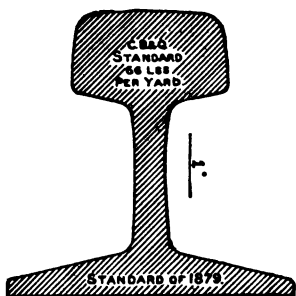

My investigation in regard to these structures has extended over many miles of road. There is little difference of opinion as to the relative expense for maintenance from natural causes and traffic. The percentage I give is that of experts. However, whatever the percentage of expense due to climatic influences is, it will

grow less relatively in every instance with increase of traffic and improvement in quality of structure. Some of the communications I have received on this subject are exceedingly interesting. Thus, one writer says: "A bridge will lie still all summer, but as soon as winter sets in it is all out of shape. It heaves by frost up and down and sideways and out of line, causing it to be cut down, shimmed and respiked. Wooden bridges are very short lived, their life being ten or twelve years. Traffic affects them a little by shaking." Another writer says: "The relative expense depends upon whether the bridges are built of iron or wood; whether heavy or light structures, if of wood. If light, they will deteriorate more rapidly under moving trains because the timber will spring, disturbing the fiber and opening the grain for the admission of water, thereby causing decay." Another writer says: "I notice that the cost is much greater upon some lines than upon others. It is partly attributable to the difference in traffic. The bridges that we use where the traffic is light and that we derive good service from would not answer at all where the business was great."

Of the multitudinous details incident to the construction and maintenance of railroads, no phase of the subject interests the inquirer more than that connected with bridges. The feat of carrying a track safely and economically across the streams, canons and valleys that beset its course is ever a matter of interest. The maintenance of

a bridge does not involve special knowledge, but its construction and development have elicited the thought and life labor of many eminent men. Yet, it is probable that in this field, as in others, the great advances made are only precursors of others yet to come.

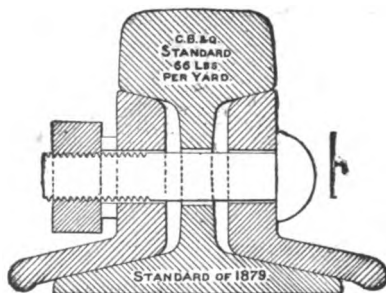

Angle Splice Bar.

The technicalities of structures and their maintenance do not properly find a place in a book of this kind. They are to be sought in the works of engineers. Many volumes have been written on the subject. But while I cannot take it up in detail, I may be pardoned if I quote here what an eminent engineer* has said in regard to the development of the art of bridge construction and the experiences of American railroads in this direction. It falls into line directly with our subject. He says: "In the early history of railways in Europe, substantial viaducts of brick and stone masonry were generally built; and in

* John Bogart.

this country there are notable instances of such constructions. In this country the wooden bridge has been an important—in fact, an essential—element in the successful building of our railways.

Timber is also used extensively in railroad construction in the form of trestles.

. . . The fundamental idea of a bridge is a simple beam of wood. If metal is substituted, it is still a beam with all superfluous parts cut away. The result is what is



called an I beam. When greater loads have to be carried, the I beam is enlarged and built up of metal plates riveted together, and thus becomes a plate girder. These are used for all short railway spans. For greater spans the truss must be employed. . . . Except under special circumstances of location or length of span, the truss bridge is a more economical and suitable structure for railway traffic than a suspension bridge. The advance from the wood truss to the modern steel structure has been through a number of stages. Excellent bridges were built in combinations of wood and iron. Then came the use of cast iron for those portions of the truss subject only to compressive strains, wrought iron being used for all members liable to tension. Many bridges of notable spans were built in this way. The form of this combination truss varied with

the designs of different engineers, and the spans extended to over three hundred feet. The substitution of wrought for cast iron followed. The latest step has been made in the use of steel, at first for special members of a truss and latterly for the whole structure. The art of railway bridge building has thus, in a comparatively few years, passed through its ages of wood, and then of iron, and now rests in the application of steel in all its parts."

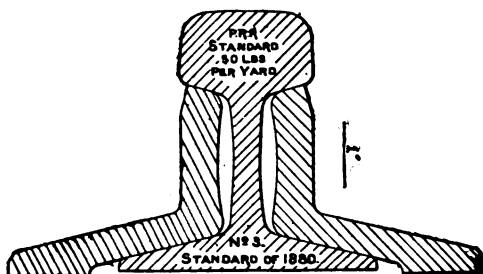

Angle Splice Bar

In connection with the maintenance of bridges and culverts, the necessity of preventing their injury or destruction by floods is an incident of our subject. The expense is a natural one, but none the less real. It frequently happens in practical experience that because of lack of skill upon the part of the engineer, or on account of undue economy, sufficient space is not left underneath the bridge or culvert to carry off the water. In such cases the proper way is to enlarge the channel; but as the necessity for this will not in

every case be apparent, or perhaps practicable, the course left for those in charge to pursue is to see that the watercourse is kept free from obstruction underneath the structure, also above it, so as to prevent the accumulation of rubbish which, by collecting, will choke up the stream, and thus undermine or carry away the structure.

Expenses attending the care and maintenance of buildings are analogous, in many respects, to those connected with bridges and culverts. However, these expenses are not uniform upon different railroads, or even upon the same lines. They are like those of other structures. The wear and tear of machinery, furniture, implements and fixtures used in and about buildings, is almost wholly chargeable to traffic. The platforms, doors and windows of warehouses and depots are also greatly injured from this cause. Imperceptible wear and tear, and attendant accidents and mishaps of business, occasion more or less damage to every building, as may be readily supposed, but its extent is not uniform.

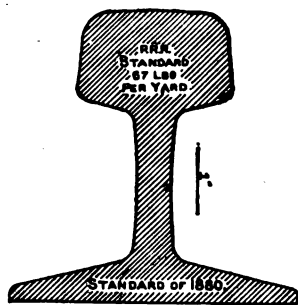

The nature of a structure has much to do with its ability to resist deterioration from natural causes; but, while brick and stone buildings require, relatively, little or no attention, the doors,

windows, roofs, floors and other appurtenances of such structures require constant attention, and the cost of maintenance is not materially different from that of other buildings. In addition to the wear and tear from traffic are the losses from fires chargeable to the same cause. Outlay rendered necessary by traffic will depend upon its nature and extent. The ability of a structure to resist deterioration is largely dependent upon climate, material used in construction, and the care with which the structure is built; but differences are not so great that we cannot determine, with reasonable accuracy, the proportion chargeable to natural causes.

The cost of maintenance of fences, road crossings and signs is variable. The damage arising

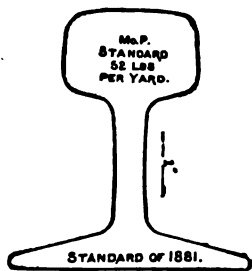

from fires ignited by passing trains and injuries to crossings are about the only expenses connected with this account chargeable to traffic. It is apparent, however, that the damage occasioned by fires will be extremely variable. Where fences are built of wire or formed of hedges,

the expense is merely nominal. In the case of wooden fences, it is fully twenty-five per cent. As, however, the use of wood is giving place to other material, this estimate possesses no practical value.

CHAPTER IX.

TRACK DETAILS—SNOW AND ICE, RAILS, JOINTS, SPIKES, SPLICE BARS, PLATES, ALIGNMENT, PREMIUMS AND OTHER MATTERS.

The maintenance of a railway involves many things beside keeping up the property. A proper organization must be maintained. Its supervision must be looked after, and its legal rights maintained. The efforts of those who would destroy its usefulness or profitableness, whether knowingly or ignorantly, must be warded off. The property must be kept open for business. Nothing must be allowed to interfere with the regular routine of work, neither the march of contending armies, the difficulty of getting supplies, nor the complications of labor.

It is the duty of managers to look after the property as a whole. However, these phases of railway maintenance are discussed elsewhere. It is designed here to treat more particularly of the physical property of railways. Its maintenance involves a constant struggle with the elements; the frosts of winter, the floods of spring, the storms of summer. Each part of a property has its peculiar risks, breakage, decay, fire, heat, frost, flood, drought, neglect, lack of proper

understanding, social disorder and so on. Each must be looked after, must be especially considered. It is impossible to describe the vicissitudes of railway property particularly. The most that can be done is to take up those that appeal to us as matters of importance.

The keeping up of a railroad implies its being kept open. This is not the least of the difficul-

ties that beset managers. In the tropics excessive growth of vegetation has to be overcome. In the north frosts and snow beset the property. Many northern companies have great difficulty in keeping their roads free from snow during many weeks and months of the year. At one time it was not an

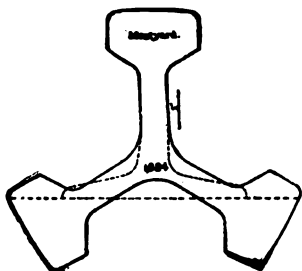

Bethlehem Iron Company's Rail,
"Meat Yard" Pattern, 1884.

unusual thing for a road to be closed for many weeks each year because of the impossibility of keeping it free from snow and ice. The difficulty has now been much simplified owing to the use of more effective snowplows, and the construction of snow sheds and fences better adapted to their purpose. The protection of railroads from snow has received much attention from trackmen, and I am mainly indebted to them for the information I have on the subject.

With a sharp and high wind snow accumulates with astonishing rapidity wherever obstruction

is met with. Under other circumstances it does not drift badly. Protection of the track depends much upon the temperature and the direction and velocity of the wind. In locating snow fences they should be placed at right angles with prevailing winds. Trees afford valuable protection where snow sheds are impossible. Of these, willows and similar growths that may be planted compactly are the best. They must, however, be located at a distance from the track.

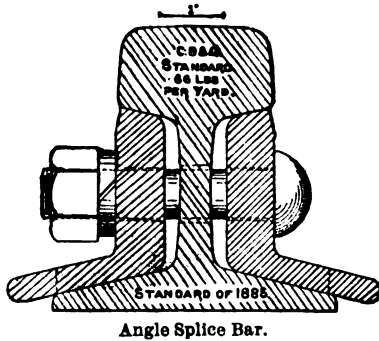
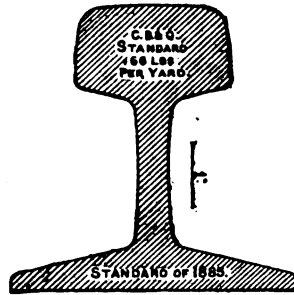

Where it is necessary to depend upon fences, as many should be erected as necessary, the first one being placed one hundred feet from the track, the next two hundred, and so on. It would be well if each fence were supplemented

by a portable fence; when the snow has drifted to the top of the permanent fence, the portable structure should be erected thereon, and so raised higher and higher as the snow accumulates.

In constructing a road in an open country it is, of course, desirable to avoid cuts as much as possible. When it is necessary to depress the track, the ground on either side should, if possible, be cut away at least seventy feet, sloping gradually to a foot below the rail. A fence should be eight feet high and so strongly constructed as to with-

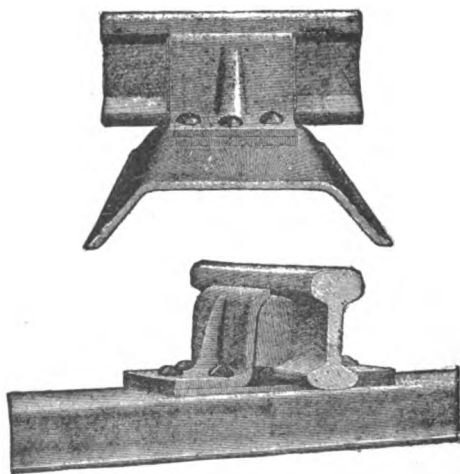

Steel Tie, London & Northwestern Railway, A. D. 1885.

stand the most violent storm. The higher it is the better. With these precautions a company, with the aid of snowplows, will be able to keep its track open under the most trying circumstances. In a mountainous country only snow sheds will answer. Their nature will depend upon the country. On some roads they will have to be built so as to protect the track from avalanches.

They must be strong and so placed as to carry the snow forward and over the track without impediment. In the majority of instances, however, simple snow sheds are all that is needed. The question of the protection of a railroad from snow, it will thus be seen, is a great one. Its complete elucidation will be a work of time and experience.

In maintaining the property of railways, naturally the greatest importance attaches to the track. This is the artery of life, the vital thread. If not effectively maintained, risk and disaster follow as certainly as a weak truss or other defect in a bridge precipitates disaster. Not all railways are maintained at the same standard, nor, of course, do different railways involve similar expenditures for maintenance. The routine that is observed upon different roads is substantially the same.

Smoothness and stability of track and freedom from accident are never the result of chance, but of far-seeing care and sagacity; of constant inspection and tests. It is not necessary to wait until a structure breaks down to demonstrate its weakness. The mishap may be averted by timely action. Herein lies the secret of the security of railway travel. If the same care and in-

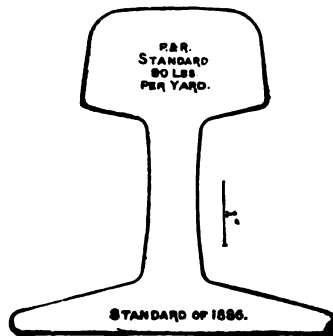

telligence were exercised in the maintenance of the highways of the world that railways observe, their cost would not be one-third what it is to-day, while they would be an ever-increasing source of profit and pleasure to mankind.

Speaking of track work, an authority on such matters* says that the province of labor is to make the track stable, and to securely fasten and unite its parts so as to prevent independent motion. Elasticity of bearing does not imply loose and shifting parts. Flexibility of material must not be confounded with yielding and inadequate support. The impact due to low joints, bad surface, poor line and defective gauge greatly augments the destructive effects of increased wheel pressure, and the deterioration of track is much accelerated when deprived of proper care.

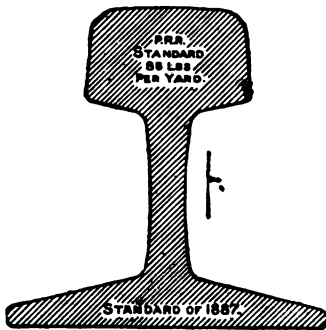

In nothing do trackmen need to be more fully drilled than in the matter of thorough and conscientious track work, more particularly in tamping so that the track may stand the service to which it is subjected. Thorough track work

implies tight joints, the use of track level, true gauge, and conscientious tamping and attention to minor details. As early in the year as settled

* Mr. Benj. Reece.

weather will permit, every section gang should be increased to its maximum strength, so that the work of renewals may be completed in time.

Every detail connected with the maintenance of a property would be interesting if it could be so generalized as to come within our comprehension. This is not possible, however. The details connected with the maintenance of machinery and equipment are things that only machinists can fully comprehend. To others the subject is more or less confusing, but they know that renewals must be made promptly and effectively as they are about a house, otherwise

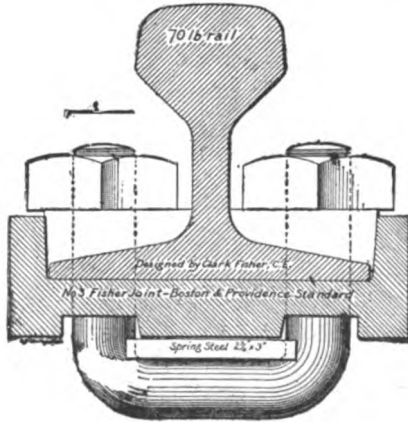

A. D. 1888.

the damage is multiplied indefinitely. The same is true of buildings, fences and other paraphernalia. It is true of the track, except that here the routine is more generally comprehended. An English writer thus describes the maintenance of the track on an English road.* It is not noticeably different from our methods. "In England

* Colonel Geo. Findlay.

three men with a foreman form a gang. This gang has charge of the inspection and maintenance of about two miles of double line of railway. An average of one man to each mile of single line. The exact number depends upon the extent of traffic and consequent wear and tear;

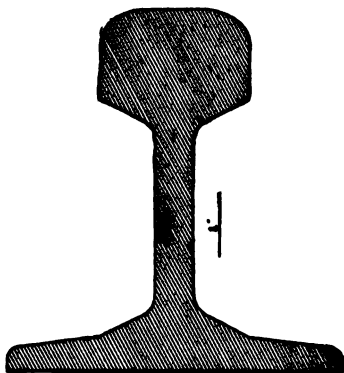

Stevens Rail, Chemin de fer du Nord.
France, A. D. 1838.

also the number of junctions and sidings which have to be maintained.* Every ten or twenty gangs are under the direct supervision of an officer known as an inspector. Every seven or eight inspectors are under the control of a chief inspector, who has also under him traveling gangs of ballasting men and

relayers, who are employed in renewing the permanent way and carrying out alterations and additions. Each division of road has also a full complement of artificers, joiners, masons, bricklayers, painters and blacksmiths, with their fore-

*The length of track allotted different gangs in the United States depends upon the character of the track and the amount of traffic passing over it; also somewhat upon the capacity of the foreman. Four miles is about the maximum, except in the case of single track. A section must not be so long that those in charge cannot inspect it at frequent intervals; cannot quickly reach any point in the event of disaster. M. M. K.

men and inspectors, whose duty it is to repair the bridges, tunnels, stations and buildings of the company. All these men, with their chiefs and inspectors, are under the direction of a civil engineer of experience, who has a staff of surveyors, draughtsmen and clerks, located at the most important center of traffic on his division. The duties of the track force comprise the daily inspection of every portion of the section of line under its charge, and the repairs of the permanent way, fences, drains and roads. Track foremen are required to report anything they may observe to be amiss with telegraph wires, signals or passing trains. This duty is especially imperative during storms, fogs or heavy falls of snow. It is made their duty to furnish inspectors with a statement of materials needed, used and on hand. Each official throughout the corps is, in his order, responsible for the work of men under him. The stability of the permanent way and works of a railway is frequently threatened. Ceaseless vigilance has, consequently, to be exercised." The efficiency of the track force on the roads of Great Britain has long been remarked by the railway men of other countries.

On some French railroads a novel system of maintenance is adopted, which is claimed to

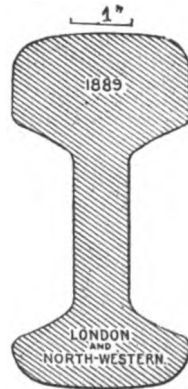

Bull-headed Rail.

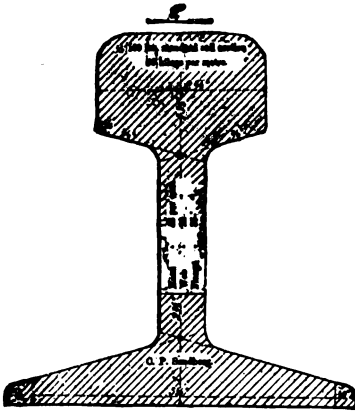

Standard rail of Belgian government,
A. D. 1889.

lessen cost. Instead of making repairs daily, as the necessity develops, the whole road is periodically gone over and repaired. At such times the ballast is readjusted (new ballast being applied if necessary), ties are tamped, the track cleared of weeds, the rail fastenings cleaned and inspected, chairs examined, the gauge tested and corrected, rails adjusted, and other defects remedied. The intervals between these periodical overhauls vary according to the traffic; thus, main lines, over which, say, more than forty trains pass daily, will be gone over once each year; track over which twenty, and not more than forty, trains run daily will be overhauled every two years, and so on. It is not asserted by those who practice this system that other repairs beside these periodical overhauls are not required, but it is claimed that under this plan occasional repairs are reduced to the minimum.

In the maintenance of the track of a railway, the foremen in charge of gangs of men are greatly trusted, because of their experience and reliability. They are not, however, as a rule,

men of high education. They are practical men, who have entered the service as laborers. The time will come, however, it is probable, when superior officials, including civil engineers, will climb to preferment through positions of this kind. There is no doubt that a civil engineer's efficiency would be greatly enhanced if he had the practical knowledge of track matters that is acquired by the use of the pick and shovel and the actual management of a gang of men. Men may have experience in railway matters and yet

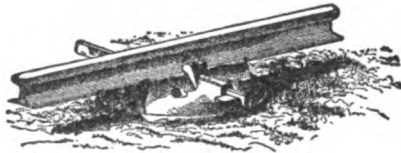

Metal "Pot" Tie, Midland Railway of India,
A. D. 1889.

not be so valuable as those without it, because of lack of knowledge and intelligence, but experience adds to the value of every man's usefulness. A civil engineer in charge of roadway and track, who has come to his position through the various grades of the service, has a better grasp of affairs than one who has not. He is without prejudice and has an enlightened understanding of the possibilities of every position under him. This knowledge cannot be acquired in all its fullness except by experience. Not only would the capability of the civil engineer be increased by his

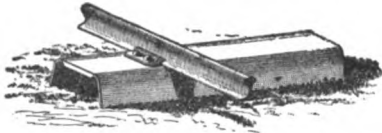

Metal track, Queensland, A. D. 1889.

filling the various positions under him, but the efficiency of other officers, from the track foremen up,

would be greatly heightened thereby. If there is any value in education and practical knowledge, it would in this way be secured for the lowest offices in the service as well as the highest.

In the things that go to make up the physical structure of railroads in Great Britain and America* there has been a tendency, from the start, to conform to particular patterns. This tendency has, on the whole, been a healthy one, because based on discussion and experiment. There has been no compulsion about it. Selection has been based on the survival of the fittest. Inherent differences in properties have ever been recognized, and attempts have not been made to harmo-

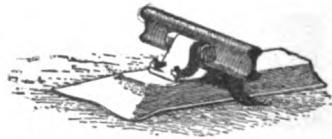

Metal track, Midland Railway, A. D. 1889.

nize elements naturally antagonistic. Unification, so far as it has extended, has been predicated upon these conditions. The theories of doctrinaires have nowhere found expression.

* I beg the reader to understand that wherever, throughout this work, I refer to America, I mean the United States and Canada. Most of the Mexican railroads are constructed and operated the same as those of the United States and Canada.

The standard articles used by railroads embrace things that are alike, such as the flange and form of wheel, the tread, the interposition of springs and equalizing bars to relieve the blow, the gauge of tires, driving wheel centers, couplers, gauge of wheels, journals, axles and other items connected with the running gear of locomotives and cars.

After patterns have been formally agreed upon, however, they continue to be the subject of ani-

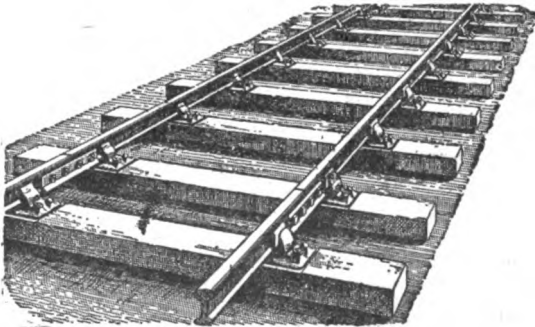

Section of English Permanent Way.

mated discussion by railway officers and others, so that the service does not remain stationary or deteriorate from lack of continual interest and attention, as it would if devices were introduced and enforced by arbitrary means. The work, it is understood, is only just begun. It is probable that a standard rail section for different kinds and weights of metal will, sooner or later, be adopted. Interest in the matter spreads continually. It is of the greatest possible importance

in the maintenance of railroads, as the rail forms a preponderating item in the permanent way. And in regard to the permanent way, it is the key of the railway situation and dominates all other interests. The subject is most interesting and practically inexhaustible.

The permanent way of a road, as referred to in a previous chapter, consists of the rails, their sup-



Metal track, London & Northwestern,
A. D. 1889.

ports and fastenings, and attendant switches and frogs; the alignment of tangents and curves; the superstructure of stone, gravel

and dirt, and the bridges and culverts. This mass must be so constructed and blended that trains may pass over it safely and smoothly with the minimum wear and tear to both equipment and permanent way.

An interesting writer,* speaking of American railways, says in regard to permanent way matters:

“Rails should be curved before laying on any curve that exceeds two degrees; they should be curved with

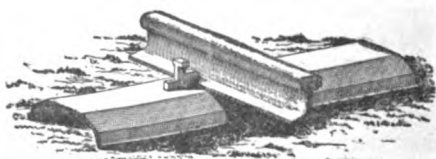

Metal track, Elferfeld Railway, Germany,
A. D. 1889.

* Wm. F. Ellis.

some form of machine which will not produce sudden concussion on the rail. Angle bar joints should not be over twenty-four inches long, of such weight and shape as not to break, and to give proper support. The ties should not be less than eight feet long, seven inches thick, with face at least seven inches, using at least twenty-eight hundred to the mile. The split switch with the automatic stand, with a flexible tie or switch rod, should be used not only on the main track but on inside track switches where there is any amount of switching done, and at side track switches where a derailment from an open non-safety automatic switch would stop the traffic on the main track. I would also recommend a guard rail to be used at the points of all split switches where same are not trailing switches. A spring rail frog should be used in all cases except where there is nearly the same wear on each

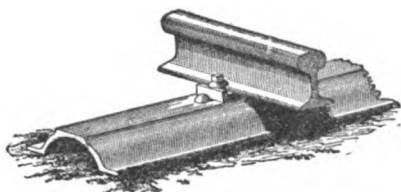

Metal track, Great Central Railway of Belgium,
A. D. 1889.

wing of the frog, and at yards where the rigid rail frog is used. The best form of guard rails at frogs is the following: Length, twelve to fifteen feet, curved a true curve, with a radius of one hundred and fifty or a hundred and seventy-five feet; center of guard rail set six inches ahead of point of the frog, securely spiked and

fastened with three braces, one opposite the point of the frog and one on either side. This would be a correct guard rail for rigid rail frogs, but for a spring rail frog the guard rail would have to be parallel to the main rail, with a flangeway of one and three-quarter inches for at least nine feet of its length at center of same and well braced its entire length. Alignment of tangents once in ten years, and especially of the curves once in five years, should be corrected by transit. Elevation should be such as the speed of trains and traffic demand. Ballast should be

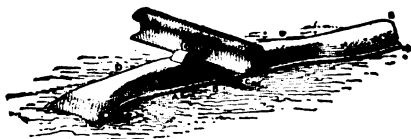

Metal track, Holland "Post" Tie, A. D. 1890.

of broken stone when circumstances permit, or good gravel with proper drainage to same, and at least once in five years in the surfacing of the track, slight raising of the same, where possible to be done. All highway crossings should be carefully cleaned out each year and renewed with fresh ballast. Culverts should be of stone and covered with ballast if possible. Where arches of stone, through cost or location, cannot be used, iron bridges should be. They should be constructed with a view to carry with safety not only the weight of the present rolling stock, but

a proportional increase in the same as the last ten years' progress has indicated what it may be, and with these

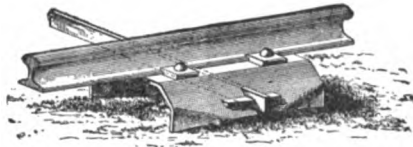

Metal track, Egyptian Agricultural Railway, A. D. 1889.

bridges a floor and guard rail should be used, in which the ties should be ten feet long, eight by eight inches square, eight inches apart, secured in place by timber six by six inches square, gained on to each tie near the outer end and bolted firmly, an iron guard of railroad iron on the inside of the track rails and eight inches from them, and approaching the center of the track at about thirty feet from the ends of the bridge and connected together by the old point of a frog; the long bridge ties for the distance of about thirty feet should be put in on the ground at each end of the bridge, and the outside guard rail should be extended on same, spreading at the ends about three feet outside of the main track rail. To this I would add the use

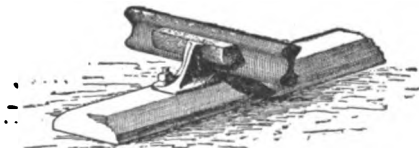

Metal track, Vautherin system, France, A. D. 1889.

of a rerailing device. The metal used in a track should be such as the speed of trains and ton-

nage require. Material should be renewed at the proper time, and when renewed, maintained."

While cross ties are very generally used as the support for rails, the use of longitudinal bearings is more or less practiced, especially in Germany and Austria. They have, however, never been generally popular because of peculiar defects and greater cost. But the increase in weight of locomotives and cars, and the possibility that such increase will go on indefinitely, indicate a possible necessity for further strengthening the track. Exactly how this will be done cannot be foretold. It has been suggested that the use of longitudinal supports for the rails in connection with the cross tie would meet the situation. The requisites of such a longitudinal system are thus described by Thomas C. Clark, M. Am. Soc. C. E. "First. The

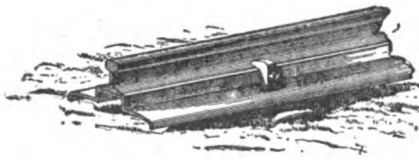

Haarman longitudinal metal track, Rhine Railway,
A. D. 1889.

longitudinal bearer under the rail must be stiff enough to transmit the load to such a distance, on each side of the wheel, as will limit the pressure to not much over two tons per square foot of bearing surface, without requiring excessive width. Experience has shown that a greater pressure than two tons per square foot will sink ties too deep into the gravel or broken stone. Second. The next thing is to attach the rails and bearers together by a form of fastening strong enough to resist all strains and shocks and yet allow of freedom of the rail to expand and

contract independently of its bearer. It must also be held to its bearer so that creeping of the rail on the bearer may be prevented, and that without any notching or cutting of the rail that will impair its strength. The rails must break joints with the bearers. The fastenings must be so made that the rails can be quickly removed

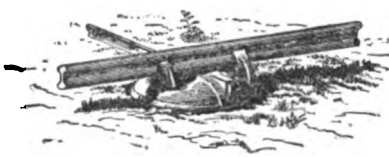

Metal track, Central Railway, Argentine Republic, A. D. 1889.

and replaced by new ones without disturbing the bearers. The fastenings must be able to hold for a time a broken rail so that it will safely

pass the trains, and no system but the longitudinal can do this. Third. The bearers and rails should be united firmly together by light metallic gauge ties, placed near enough to properly preserve the accuracy of the gauge. Fourth. The bearers and gauge ties should be of such shapes as can easily be tamped with gravel or broken stone, as will stay in place vertically, laterally and longitudinally, and will allow of drainage to pass between them. Fifth. The system should be so planned that no difficulty of construction can occur at curves, either in alignment or elevation

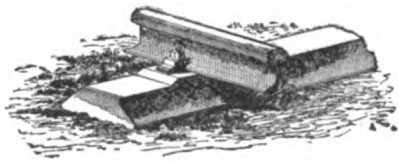

Metal track, Bilbao and Las Arenas, Spain, A. D. 1889.

of outer rail. Also it should be so made as to easily join to the ordinary form of T rail at turn-outs and switches. Sixth. Besides the obvious advantages which such a construction gives, there are two others: The upper rail can be made of a harder and better worked steel, while the bearer can be made of a softer and tougher quality of metal. Probably basic steel would do for this.

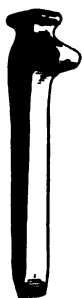

Owing to the rails being supported under their entire length by continuous bearers they can be made of less depth and sectional area in their flanges than at present. The metal so saved can be put into the head of the rail, where it is most needed. It is believed that rails can be designed for a longitudinal system with heads three inches wide, and instead of weighing one hundred and

Track Spike. ten pounds to the yard, they need not weigh over seventy pounds to the yard. This saving of metal can be applied to reducing the cost of the whole system. The wear being confined to the upper rail, the amount of metal which goes into the scrap heap is the least possible."

The free use of metals in connection with railways has now become so general that the causes that precipitate deterioration in that direction have assumed an importance unknown in earlier days.

The wear of metals is understood to be the tearing off of minute particles of the substance

by friction. Chemists have formulated no theory in regard to the matter. Wear is influenced by the particular conditions under which it takes place, such as lubrication, speed, temperature, pressure, rolling, friction, etc. Railways have been handicapped in their experiments, and the conclusions drawn the future will quite likely upset. It is believed, however, by experts in such matters that metal having fine granular structure (provided its tensile strength and elongation are equal to those of a coarser description) will wear less than the other, for the reason that the particle of metal torn off is smaller and, therefore, less destructive. This conclusion, however, is disputed. Actual tests, meager as they are, it is claimed, show that metal which may be extended (elongated) most without breaking will wear best. Thus rails of mild steel, if properly made, are thought to be less liable to

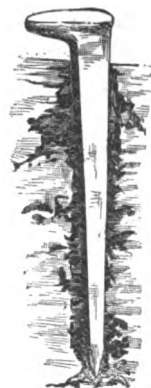

Action of Spike
on Tie.



Action of Rail on Tie.

fracture, crushing and disintegration than harder rails. The fact has been disputed, but preponderance of evidence seems to be in favor of the conclusion. The same is claimed to be true of the wear of the tires of driving wheels. When tires taken from wheels of the same locomotive have come into the shops

for returning it has been noticed that more metal had to be removed from the soft than from the hard tires, thus proving that the wear of the latter was greater. It is also claimed that experiments conducted in alloys used as bearings show that wear is greater with metals which are brittle than with those which are more pliable. The reason for this is thought to lie in the fact that in metals of higher temper the rupture of small particles, because of their brittleness, occurs more easily than in more ductile metals. The more brittle a metal the larger its granular structure.

It is the conclusion of many versed in such matters that the greater the elongation of a metal, while still retaining its tensile strength, the less the wear; that high tensile strength, with great elongation and fine structure, give the best results in actual service. On the other hand, tests made on a state railroad of The Netherlands seem to disprove them in some respects. These tests demonstrate that a soft rail wears much more rapidly than a hard one. In making the tests a number of experimental rails were placed in both single and double tracks. The point selected was on a level and straight track sufficiently distant from a station to avoid the use and effect of brakes. The rails were carefully selected, weighed and measured. Their tensile strength varied from sixty-seven thousand to one hundred thousand pounds per square inch. At first, effort was made to ascertain wear by means of measurement with a micrometer. These meas-

urements were not satisfactory, inasmuch as the least inclination of the rail removed the point of wear to one side of the center. The instrument would not, because of this, record the actual wear. A number of the rails were then taken up, and, after being carefully cleaned of dirt and rust with a steel brush, were weighed. The difference between the first and second weighing gave the wear due to the passage of trains and to rust. The conclusions drawn from the data thus obtained showed that the wear of the soft rails had been about twenty-seven per cent. more than that of the hard rails, or inversely to the tensile strength of the rails. From these practical tests it would seem that the harder the rail the better the wear; but as the wear of the rails in question was due somewhat to rust, it is claimed that definite conclusions cannot be drawn therefrom.

Each year witnesses some improvement in the track of railways; in a decrease in derailment of trains from an unstable roadbed; from the spreading of the track; from broken rails and defective switches. These improvements are the result of

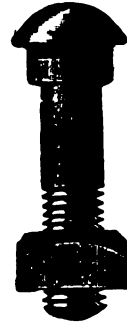

Track Bolt.

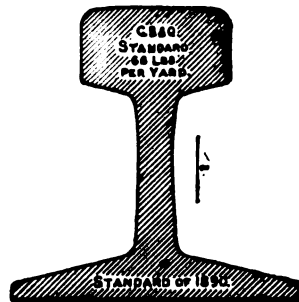

experience and added ability on the part of those in charge.

In the maintenance of the permanent structures of a company the payment of premiums for manifest excellence has found strenuous advocates. They claim it is especially efficacious in securing a good roadbed and in maintaining and improving the track and yards. Awards are made under different systems by different companies. One company's schedule of premiums is given below.* Its effect in securing greater interest and intelligence, it is claimed, has been marked. In its practical operation the recipients of a premium are not allowed to compete for lower premiums. The inspections upon which the premiums are based are made yearly. The men for whom the rewards are instituted themselves make the inspections, each for the other. The premiums are awarded under the supervision of the employing company. The system has been found to stimulate the ambition of men and to increase and broaden their understanding. It intensifies their desire to learn instead of relying wholly upon themselves.

*\$100 to the roadmaster having the best yard on his division. \$100 each to the roadmasters having the best roadmaster's division on each superintendent's division of 100 miles. \$75 to the section foreman having the best section of two and a half miles on his division. \$60 to each section foreman having the best section on his superintendent's division, including yards. \$50 to the section foreman having the best section on each roadmaster's division. \$100 to the roadmaster having the best line and surface for the whole length of road. \$50 to the second best *ditto*.

The question of paying premiums for superior service is taken up in another volume.* The subject is an interesting one and wherever properly regulated will be found beneficial, its advocates believe. Men are differently constituted. Some are more conscientious than others. But the interest of all will be stimulated by prospective re-

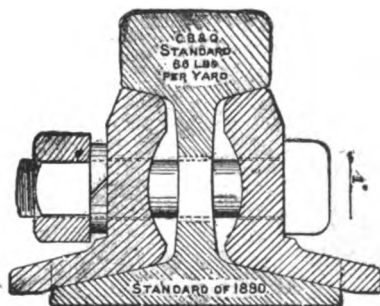

wards. If this is true of a conscientious man, how much more true it is of those differently constituted, who need the spur of incentive. There can be no doubt that the zeal of everyone who labors for another will be heightened by the hope of special reward for faithful and intelligent service. Wherever the practice has been properly tried it has been found beneficial, especially in regard to the track and train service, its advocates claim.

The maintenance of a railroad means, among other things, freedom from risk, from accident, from delay, from unnecessary expense, the adoption of due safeguards. One of the greatest sources of anxiety to railroad managers is the care of bridges and culverts, their protection from fires, from the undermining effects of water

* "Train Service."

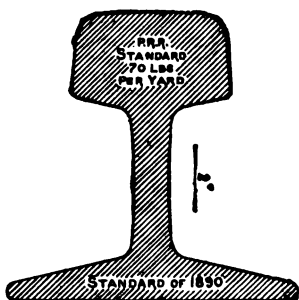

and frost, from the floods of summer and the ice of winter. The struggle is a never ending one. Each month takes on some new phase. Every structure has its peculiar features. In addition to the dangers that menace bridges and culverts from the streams

they cross, their immediate stability is threatened by the trains that pass over them. The risk here is a double one—that of destruction of both the bridge and the train, with attendant loss of life.

The prevention of this double calamity, it is apparent at a glance, is one of importance. Yet the risk is not so great or imminent as to make the question a vital one. Acci-

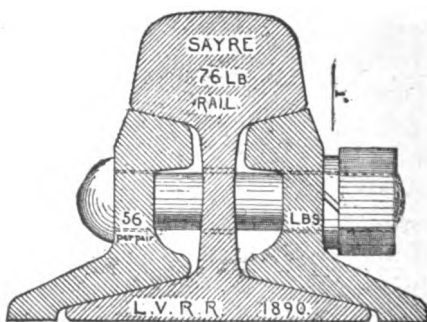

dents are only occasional and do not, therefore, impress themselves upon the managers or the public. Nevertheless, as railway practice grows older and men have more time to think and carriers have greater means and leisure to accomplish results, they will interest themselves more and more in precautionary measures. The

devices adopted will be manifold. A writer* discussing the subject of bridge (track) protection, says: "The device must be so arranged that it cannot in any way cause the derailment of a car. It should, therefore, leave abundant room for the passage of wheels, making allowances for the condition of wheels and tires that are badly worn, as well as those that are new. Account must also be taken of the use of cars from other roads. It must not touch the weak points of a derailed car, and must be so arranged as to come in contact with the running gear only. It must direct the wheels of a derailed car back upon the track without violent shocks, either in a horizontal or vertical direction, and must bring them back before they reach the bridge. It must keep on the track during the passage over the structure cars which may have been derailed from any defect. It must be constructed of durable materials, and in such a way that it will not fail when needed. It must have no very heavy pieces, so that its putting in place, repair, etc., can be easily done by an ordinary track gang. It must permit the tamping of ties. It must be cheap to make, to put in place, to keep in order and to renew. In other words, it must be easy to handle, and of small cost."

The track of a railway must be sufficient to support the weight and rush of traffic, however great. That it should be well moored and have a strong wall and tenacious fiber goes without

* J. W. Post.

saying. The moorings of a track are its ballast, including the fastenings that hold the rail to the tie.* The devices used for track fastenings have been improved in many respects, nevertheless no device has yet been found that will hold the rail securely to the tie. It may be too much to expect this. The strain is too great. However, if it can be attained it will reduce the wear and

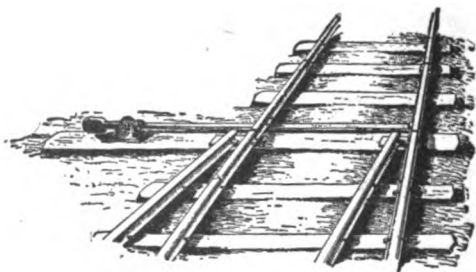

Old-fashioned Switch, with "ball" counter weight.

tear of the tie, add smoothness to the roadbed and lessen depreciation of track and equipment.

The instrument that fastens the rail to the tie has two great purposes to serve; first, to prevent the rail from spreading, and, second, to resist the effort to lift it vertically from its socket. The

* "Where there is not sufficient ballast to give elasticity to the track, the rail wears out twice as fast as on level ground or an embankment. A large stone or piece of rock under a tie will soon show itself by the rail wearing out over it. Clamp a pair of angle plates to the center of a rail where there is no joint and in six months the rail will be worn down in a rut directly over the plates, showing clearly that any extra resistance produces extra wear."—*James Churchward, C. E.*

lateral pressure of a train passing over a track would cause the rails to spread apart unless the fastenings prevented it. Again, the effect of the passing train is to depress the rail, and with it the tie. The reaction of the rail and the tie is not coincident. The rail springs back first. The result is to throw the weight of the tie and the surrounding ballast with the added strain on the head of the spike. This explains why, in examining a track, but few spikes are found to press firmly against the rail. Because of this the rail is allowed greater or less freedom of motion in every direction. Among other evils engendered by this is the accumulation of sand and dirt between the rail and the tie, precipitating the destruction of the latter. The difficulties of the situation are aggravated in winter.



Track Level.

Thus, when the ground is frozen it is impossible for the spike to lift the mass in which the tie is imbedded. It consequently gives way.

It is possible that a practicable fastening that will hold the rail and tie together, making them one, will be discovered. The value of such a device cannot be overestimated. The common spike, driven perpendicularly into the tie, is the chief fastening used in America, as it has been from the first. While far from perfect, from a theoretical point of view, it nevertheless gives fairly good satisfaction. However, a committee of experts having the matter under consideration condemned it as not the best possible design to

resist the vertical pull of the rail, due to the theory of wave motion, or elasticity, under the moving train. How much this strain amounted to they were unable to tell, but believed the weight of the train able to resist the reaction. They thought the danger sufficiently great on bridges to recommend an interlocking bolt as a precautionary measure. What is needed is a

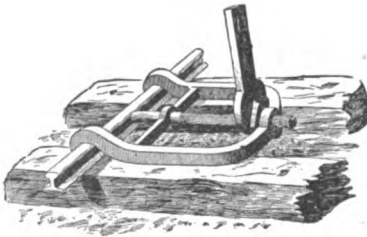

Track Drill.

spike made of steel, that shall be driven vertically on each side of the rail, thus securely interlocking the latter; that will resist lateral pressure, or any sudden derangement of

the machinery, whereby extraordinary outward strain is thrown on the rail; that has a strong head; that can be used over and over again; that will cut and compress the fiber of the wood, and not break or mash it; that holds tenaciously to the wood, and is thus prevented from being loosened or withdrawn; a spike that will hold the tie and the rail securely together.

Referring to the track spike, a writer says: "A spike possesses adhesive resistance on account of the friction between the sides of the spike and the wood into which it is driven; this friction depends upon the amount of compressive stress exerted by the wood against the spike, and the friction will be greater or less according to the

character of the surfaces in contact. In driving a spike the wood is compressed laterally. The resilience or tendency to spring back again gives the pressure against



Track Gauge.

the sides of the spike. The greater the compression of the wood the greater will be the compressive stress until the wood splits; the limit of adhesive resistance is therefore that which is due to a compression of the fibers which splits the wood. Care must be taken, however, in driving the spike that the fibers are not too abruptly displaced. With spikes of large cross section dimensions there is a tendency to carry along some of the fibers in front of the blunt point, and leave cavities next the body of the spike instead of solid wood in close contact.”*

No matter how well a track is ballasted, it will not remain in good surface unless the rails are held securely to the ties. Moreover, a “rail being free allows sand and dirt to accumulate between itself and the tie, so that the movement of the rail from passing trains becomes a gigantic rasp to cut the tie. When it has once commenced to cut, the rate of disintegration is vastly

*James E. Howard. Mr. Howard thinks that if it is required to materially increase the adhesive qualities of the spike, experiments should be made in the direction of larger spikes with bored holes to receive them.

increased. The wood underneath and around the edges of the rail is mashed so that it holds water; incipient rot is the immediate result. To make a tie last its natural life, the first cutting must be prevented."* It is a question whether so much shimming or blocking in winter would be

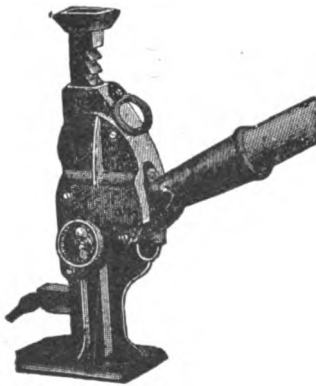

Track Jack.

required if rails were perfectly fastened, because the tie being securely fastened to the rail would bring it up to its own level and prevent its freezing down in the track. The friction of the tie meantime against the ballast, caused by its moving up and down as trains pass, would detach particles of ballast, thus tamping

it to a fair surface. "Accidents frequently arise from the rail cutting away the tie underneath the outside flange, causing the rail to roll completely over. This trouble arises from the fact that the inside flange of the rail is not securely held down. Many European roads guard against this by canting their rails inward."*

Upon many roads the rail is laid directly on the tie and spiked thereto. The placing of a plate or chair on the tie for the rail to rest on is

* James Churchward, C. E.

advocated. It prevents the rail from cutting the tie, gives it steadiness, and compensates for a narrow rail base. "Ties are made more durable by this plate and can be kept in service until rendered useless by decay. The cheapest kinds of wood will wear, except for decay, as long as the most expensive. Wearing away of the tie by the rail is the direct result of the creeping and oscillating movement of the rails caused by the impact of the weight passing over them. There are also indirect causes which contribute largely towards the wear, such as sand or grit between the rail and tie; also water under the base of the rail injected into the tie by the pressure of passing trains, making the wood soft and spongy where it should be hardest. The plate overcomes these difficulties. Being fastened to the tie, it receives the wear arising from any movement and friction of the rail, and thus a combination is obtained which furnishes the wearing qualities of an iron or steel tie at a reasonable cost. These plates render possible the use of soft wood for ties—cedar, for instance, which makes only a poor tie without the use of a plate or chair; it is very light and soft and is soon ground away under the attrition of the rails which imbed



Track Saw.

themselves in the timber, weakening the tie, which quickly breaks under the line of the rail. Wear plates prevent this, and thus a cheap tie is rendered as effective as a white oak tie costing much more. The value of the rail plate is becoming more marked daily from the increased weight that passes over the track. The portions of the tie where the strain comes, where the spike more or less injures the fiber and where the crushing by the wheels is most destructive, these plates perfectly protect from the weather. Under the plate there is no tendency to rot, even when the sun and rain have damaged other portions. Moreover, the weight is better distributed over the surface of the tie, and, as the area under pressure is thus considerably larger, the pressure per square inch on the timber is reduced.”*

Durability of rails and ties is directly dependent upon a proper alignment of the track and upon the preservation of an even and firm surface to the rail, especially at the point of juncture. Trackmen claim that a proper maintenance of the joint (junction of the rails) is of supreme importance. It is ever an object of solicitude to them. If the joint is inadequately supported, the rail head will be quickly battered. The seriousness of this, as regards the effect on equipment and roadway, does not need elaboration. Trackmen are practically a unit in claiming that the joint should be afforded such support as will

*James Churchward, C. E.

prevent its sinking with the weight of passing trains. This requires, if the joint is not supported by a tie, constant readjustment of the support afforded by the angle bar to meet the ever increasing weight of trains. Upon some well managed roads the joint is not thus placed, but is supported only by a splice bar—a bar fitting to the rail on each side, lapping at the point of junction and securely bolted to the rail. Each method has its advocates. The form of the rail and the pattern of the splice bar are factors to be considered in judging the merits of the support to be afforded the joint. Mr. Churchward, whom I have already quoted, says: “Present joints are a failure. The principal way of fastening the ends of the rails is by means of splice bars in some form or other. This is the correct way; they form a bridge or support to uphold the ends of the rails, and, bearing against the head of the rail as well as the flange, keep the rails, where they join, in line and continuity. The objections to any fastening that does not bear against the heads of the rails as well as the base are—on curves, as the heads of the rails are in no wise held in continuity, it is a question whether with a heavy engine swerving against a light rail, the engine would not bend the loaded rail slightly over, presenting the face of the receiving rail for the flanges of the wheels to strike, thus causing derailment; and another question is whether the web or base of the rail would not break also, the leverage on it being greatly enhanced. The

present angle or splice bars are of all shapes and sizes. They wear and crush down underneath the ends of the rails; a cavity thus forms in their center. The fault is not with the plates, but with the rails. The bearing surface under-

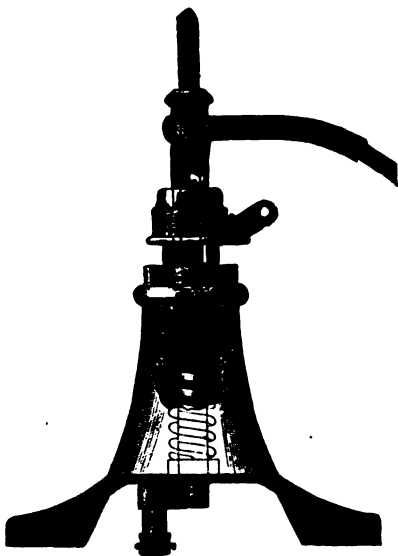

Automatic Safety Switch Stand.

neath the head of the rail for the splice bar (in the present shaped rails) is only about half an inch—often less. This half-inch bearing or face has to sustain the blow and weight of great engines ever increasing in weight. It is impossible for this face to withstand the blow it receives. Down it goes, forming first a loose, then a low,

joint. It is impossible to make a suspended joint satisfactory with the present shaped rails and the ordinary shaped splice bars. The only thing that can be done is to make the joint on a tie with the plate underneath the ends of the rails, to help the splice bars withstand the blow and weight of the load. If a suspended joint is used—i. e., where the ends of the rails connect between two ties—it is absolutely necessary to have a base or auxiliary plate. Initial wear under the rail must be prevented, as tightening of bolts after they have once started cannot make the joint solid again. Each succeeding blow from the wheels, from its lengthened drop, falls heavier than the previous one, making the cavity deeper between the end of the rail and upper bearing of the splice bar. The lower bearing of the angle plate on the flange of the rail never shows the same wear as the head, simply because the lower bearings are wide enough to withstand the blow. We therefore come to the conclusion that it is not practicable to form a perfect joint with angle or splice bars without the aid of an auxiliary base plate. It is yet to be demonstrated which is the best form of plate. It must not be too heavy, otherwise it will present an extra resistance to the wheels, the effect of which will be as damaging as low joints.* If a four-bolted

* "What is absolutely required for a perfect joint is a set of plates whose elastic limit shall be at least equal to the same length or span of the rail. These plates should have a bearing under the head or base of the rail sufficiently large to prevent

angle plate is examined, it will be found that the wear commences about the second bolt, and increases past the first, obtaining its maximum directly underneath the end of the rail. Many of our roads are increasing their angle plates to nearly double the old length to prevent the crushing over and in front of the first bolt. What is required is sufficient bearing and strength, not extra length. A splice should never be over twenty inches, and eighteen would be better; but it must have the necessary bearings to withstand crushing, and an elastic limit equal to the

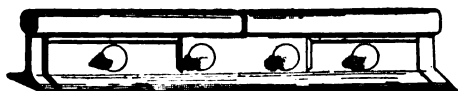

Reinforced Rail Joint.

same length of rail. The objection to long joints is, they commence to strengthen what is not weak, and, stopping the elastic wave of the rail, they cause the wheels to jump and ricochet over the joint, thereby turning the even, gliding movement of the wheels into a direct hammering blow on the weakest part of the construction—the joint. A false mechanical function has been placed on the plates now in use. They are crushing down under the weight of the maximum load; this bearing to be always kept solid by a sufficiently strong automatic power—a power that will force the plates to this solid bearing as the scale wears off and retain them there under the maximum load, so that the joint has never any movement independent of the rail.”—*James Churchward, C. E.*

slotted or punched to receive the spikes to prevent the rail from creeping. Originally they were only intended to keep the ends of the rails up and in line. This is enough. They are now clamped to the rail and spiked to the tie in such a position that with every passing wheel the rails and plates are antagonized and all repose destroyed. The spiked angle plate resists creeping; with every passing wheel the rails are pushed forward and again brought back with the plates. Every movement involves friction between the two surfaces. Metal is displaced by each operation. If the loss is infinitesimal, multiply the atoms by the wheels passing over the joint and it will be plainly seen why the joint is so quickly ruined. How is creeping to be stopped? By putting a separate fastening on the receiving tie, so that the rail is fastened to this tie. There are three or four forms of these fastenings — simple effective and cheap. One cannot find on any road with heavy traffic a joint that is perfect at the end of two or three years' wear. They are all



Tendency which the motion of the wheel has to crush the rails at their joint.

more or less worn and low. Every one of these joints is below the center of the rail, and goes lower every day. No angle plate has yet been constructed that has an equal perpendicular strength as the same length of span in the rail; consequently, when the weight of a passing load

comes on the ends of the rails, it bends the plates down and in a short time forms a permanent set in them. Many roads, appreciating this fact, are placing the ends on a tie, to give additional support to the plates. It is but a short time before the ends of the rails, bending the plates, start to dent the wooden tie underneath, so that the evil of a low joint is only partially obviated by placing the joint on a tie. When the tie has been

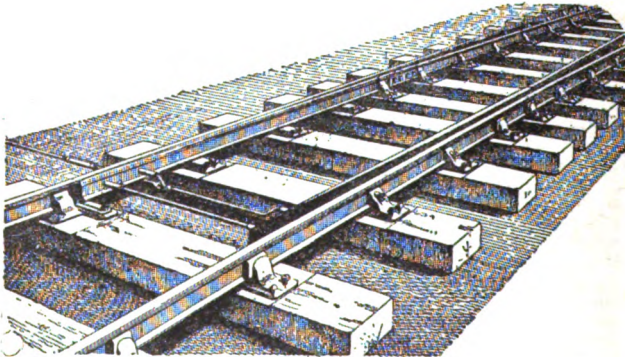

The Split Switch.

dented down, and the loaded rail can sink below the receiving rail, it strikes the latter with a heavy blow in taking it, which batters and burrs out the end, and finally ruins the joint. The tie plate referred to elsewhere prevents this, because the loaded rail cannot crush the tie, consequently the loaded rail is always kept up on a level with the receiving rail. This does away with the blow before mentioned, and extends the life of a joint in a very marked degree."

The effect of depression in the joint of the rail or elsewhere is felt outside of the increased wear and tear involved on roadway and machinery. It involves loss of power and a constant lifting of the vehicle from the declivities or sinkage in the track into which it falls. This loss is proportionate to the number and depth of the depressions and the velocity of the moving vehicle. Moreover, a weak spot in a rail involves an undue strain on the rail opposite caused by the increased weight it must bear.

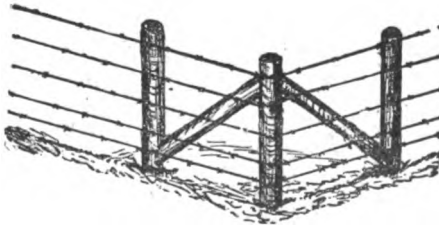

Barbed Wire Fence.

Track fastenings must adjust themselves to the form of rail in vogue. The patterns that answer with one form will not answer with another. Thus, the device used with the form of rail in the United States would be entirely out of place in India, where a different pattern is used.

Upon bridges and curves the spike is frequently supplemented by a bolt. The precaution is a wise one. In early use, rail joints were supported by a piece of metal called a "chair." The device was far from satisfactory. It was replaced by the splice bar. The latter added greatly to

the agreeableness of travel and measurably reduced the wear and tear of track and machinery.

The details connected with the care and maintenance of track are so infinite that I cannot hope to deal here with anything except vital things. These have been, perhaps, amply noticed. Yet I cannot close what I have to say on track joints without quoting what a very interesting and intelligent writer* has to say on the

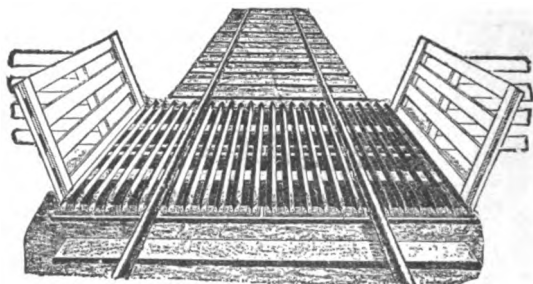

American Cattle Guard.

subject. He says: "First. The splice bar must hold the two ends of the rail at the same level; not allowing the slightest depression in one end without an equal depression in the other. Second. The strength to resist a vertical stress or shock downwards at the joint should be fully twenty-five per cent. greater than the strength of the rail to resist a similar stress or shock at any point in its length. Third. When the joint contrivance is tightened securely in all its parts,

* F. A. Delano.

in a condition to meet the above requirements, the expansion and contraction of the rails should be absolutely unhindered; otherwise, the rails will be bent while expanding, and the track, in extreme cases, be buckled or spread. Fourth. At the same time the rails must be held so firmly that, with good ties and ballast, the creeping or running of the track will be effectually prevented. Fifth. The joint device should not require a form of rail which is uneconomical in the disposition of metal, or which, for any reason,

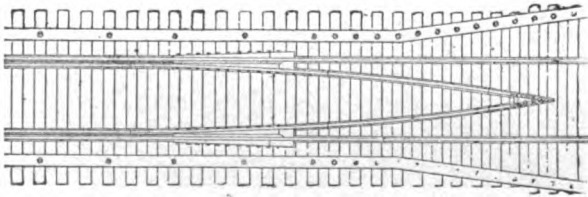

Bridge Guard, intended to prevent trains from being precipitated into the stream beneath or over the embankments on either side.

is not as well suited as another form. In addition to the foregoing there is also that very important consideration, the ease of manipulation, as governing the convenience and rapidity of laying track. Thus, if a joint is cumbersome, in many parts, and slow to lay track with, such disadvantages should be taken into account in figuring the first cost of the joints. Passing briefly over this list of requirements in order, let us consider the good points and the bad of the common types of joints now on the market. A. The

fish plate and angle bar type meet the first requirement very well while they are new and the bolts are tight; but if, for any cause, the bolts get loose or broken, the two rail ends are not held at the same height, or if the joint is neglected the bar is nicked or bent and loses at once its principal value, no matter how much attention it has afterward. *B.* All fish plates and most angle bars are sadly deficient in strength, making the strength at the joint only partly as strong as the body of the rail, whereas it should be twenty-five per cent. stronger than the body of the rail. With rail sections having wide, thin heads, which are now being so widely adopted in this country, it is possible to make the angle bar far stronger than it has been possible to do with rails having deep and narrow heads; but after all the strength of the angle bar is only effective when the bolts hold it tight in its position. *C.* Every roadmaster knows that fish plates and angle bars, when tightly bolted up, do not meet the third requirement, and it is well known that if the track bolts are too tight in summer the angle bars clutch the rail with so much fierceness that the track is liable to be kinked or buckled sooner than let the rails take up the full space which has been left for expansion. Knowing that this is the case with angle bars twenty-six inches long with four bolts, it seems to me poor wisdom to make the bar forty-four to forty-eight inches long with six bolts. Indeed, it seems to me that this question of expansion and con-

traction in rails is too little regarded in the consideration of rail joints, and many of the patented devices which aim at curing the faults in the angle bar type of joint tumble into the fault of making no provision for the unhindered expansion and contraction. *D.* One much heard of and advertised device, while containing many good features, allowing free expansion and contraction, places no limit on the distance apart that the rails might be. In this respect the angle bar is good and prevents creeping, especially if anchored to three ties. Some of the patent devices attempt to hold the rail from creeping by notching it in the flange, which is, of course, a

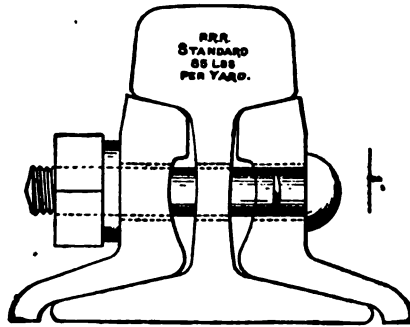

bad practice, as it makes the rail very liable to break through the notch. *E.* Angle bar and fish plate joints are at fault in respect to the fifth requirement inasmuch as such a type of joint requires flat finishing angles (the more nearly horizontal the better), small internal fillets, so as to reduce the area of support as little as possible, and small corner fillets, to increase this area of support as much as possible. To make a rail for the angle bar involves a sacrifice

unquestionably, and while I am not prepared to say that the sacrifice is not worth making, I do think it is one which should be admitted, and its value in money, as nearly as it can be estimated, added to the cost of the joint when considering it in comparison with other devices.

F. Lastly, to take up the question of the ease of manipulation, etc., probably nothing will ever be made which surpasses the angle bar or fish-plate joint for convenience in rapid laying, and undoubtedly the extra time and labor incident to laying rail with other devices should be charged as part of the first cost of the joint." Mr. Delano thinks that the perfect rail joint has yet to be

devised. "A good track joint depends a great deal on the man who lays the steel and the man who takes care of it. Rails which are laid one-quarter of an inch apart in mid-summer when they should be close together can-

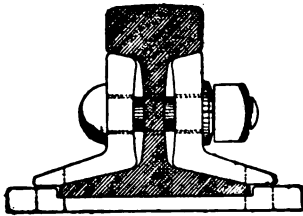

Chicago & North-Western Railway
Standard 60-lb. Rail, A. D. 1897.

not give the best results, no matter how good the subsequent maintenance may be. However, irrespective of the care which joints may get, they have a tendency to get low. Firstly, because there is a blow at the opening between the rails to cause this, and secondly, because the rolling of the wheels tends to lengthen the head, while the base remains the same, thus

arching the rail to the detriment of the joint. The first difficulty cannot be wholly avoided, but possibly the second might be partly overcome by making the rails a little low in the center. I do not mean by this that the rail should show this hollow when in the track, but simply that when on supports fifteen feet apart, and seven and one-half feet from each end, the rail should be hollowed enough to be one-quarter to one-half an inch lower at the center than at the ends." It is thought possible that rails will ultimately be welded together in the track by electricity, thus making them continuous. If necessary to repair any defect, the same power will be used to sever the rail and reattach its ends afterward.

CHAPTER X.

USE OF WOOD BY RAILWAYS—ITS PRESERVATIVES AND SUBSTITUTES, METAL TIES, ETC.

The kind of material used by railways depends very much on circumstances. Where wood is the most economical, it is used. Where it is not, iron and steel will take its place in the construction of cars, buildings and other structures. The practices of one country are not followed by other countries any further than economy dictates. It is this that makes comparisons difficult.

In their early experience American railways were constant and large consumers of timber, but with improved processes, for making iron and steel, these latter have more and more taken its place. Coal for fuel has very generally become a substitute for wood. These changes are fortunate, as no country could long withstand so great a drain on its forestry. We have seen many illustrations of this. Lands once possessing great agricultural resources, and the centers of a vast population, are to-day barren and desolate because of it. This is so of Palestine and many parts of Northern Africa and Central Asia. Uniformity of rainfall and an equable climate depend upon a moist atmosphere. This

in turn depends upon the verdure of a country, except in the immediate vicinity of large bodies of water.

In North and South America and in Africa, systematic effort has not been made to preserve the forests, nor economize in the use of wood. Preservatives of wood are also largely disregarded. The subject invites atten-

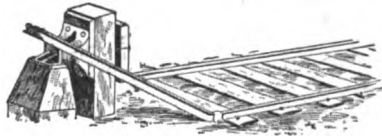

Bumping Post.

tion and interest. Economy in the use of wood is the first thing to be considered in seeking to remedy the evil. This is to be attained by the substitution of other material whenever possible, and by increasing the durability of such timber as is used.

Much thought has been given the subject of the preservation of wood against the vicissitudes of weather, the *teredo*, and other destructive agents. But preservatives will not be used, however much we may deplore the fact, except when it is clearly for the selfish interests of the consumer to do so. Moreover, effort will not be put forth to preserve wood, because of supposed extra cost, in many cases when it would clearly be economy to do so. Practical men who use wood must study the subject. Those interested in forestry have done so, and the measures of economy they suggest cover not only preservatives, but more careful use of wood.

The kinds of wood used vary, of course, with every country. The different kinds of wood used in the United States for ties approximate the following proportions: Oak, sixty-two per cent.; chestnut, five per cent.; pine, seventeen per cent.; cedar (red, white and California), seven per cent.; hemlock and tamarack, three per cent.; cypress, two per cent.; redwood, three per cent.; other kinds, one per cent.



Truss Bridge.

The number of ties per mile of track averages two thousand seven hundred. The average duration of a tie when no preservative is used is in the neighborhood of eight years. The reader can estimate for himself the number of ties required annually; the mass is enormous, and the inroad it makes upon the forests alarming in the extreme. Those, therefore, who have suggestions to make as to how the life of a tie may be prolonged, we listen to gratefully. Mr. B. E. Fernow, of the Forestry Division of the United States Department of Agriculture, gives these directions: "Use only the most durable timbers; give proper attention to the cutting and piling of ties before they are used; pay attention to the drainage and

ballast material of the roadbed; replace ties in the roadbed which have rotted from the attack of a specific fungus by ties of a kind not liable to attack by the same fungus, so as to avoid its spread; bore spike holes and fill the old ones when respiking, and use more permanent rail fastenings; use tie plates in order to reduce flange cutting; use preserving processes to lengthen the life of the timber; cut ties at the right season of the year; increase weight of rail; maintain careful drainage; and, finally, exercise care in laying ties."

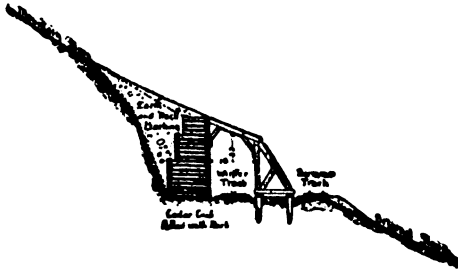

Snow Shed in the Sierra Nevadas.

Numerous methods are advocated for the preservation of wood. Creosote, chloride of zinc and sulphate of copper are the preservatives generally used. In Europe creosoting is practiced more than any other method. Ties thus treated are stated to have an average life of about twenty-five years. Experience proves that a tie prepared in a particular manner, while satisfactory in one locality, oftentimes fails in another

locality. Different kinds of wood also require different kinds of treatment.* Creosoting will not be as beneficial in America as in Europe, unless we make use of tie plates. Creosoting softens the fiber of wood, and ties thus treated are quickly injured by the increased cutting of the rail flange when plates are not used. Some method, therefore, which will harden the wood while preventing disintegration is necessary where the tie plate is not used. Metallic salts have been found to give good results in this direction.

The devices which railways profitably use to prolong the life of a tie are supplemented by them, in other directions, with good results. Thus, at one time fences in the United States were constructed wholly of wood. To-day wire with, in many instances, metal posts, has taken its place. Hedges have also been introduced in some districts, but, unfortunately, our climate is not favorable to this form of fence. In England, on the other hand, hedges are common and, happily, answer the double purpose of beautifying the landscape and lessening the outlay of the railroad company.

* Wood preservatives do not act alike in all countries. Thus in India, owing to sudden changes in temperature and other climatic influences, creosoting does not preserve wood. The timber under the rail decays so that the duration of ties does not exceed ten years, except in the case of certain kinds of wood indigenous to that country. The difficulty of preserving wood in India has led to the extensive introduction of metal ties. These latter are destined to grow steadily in popularity.

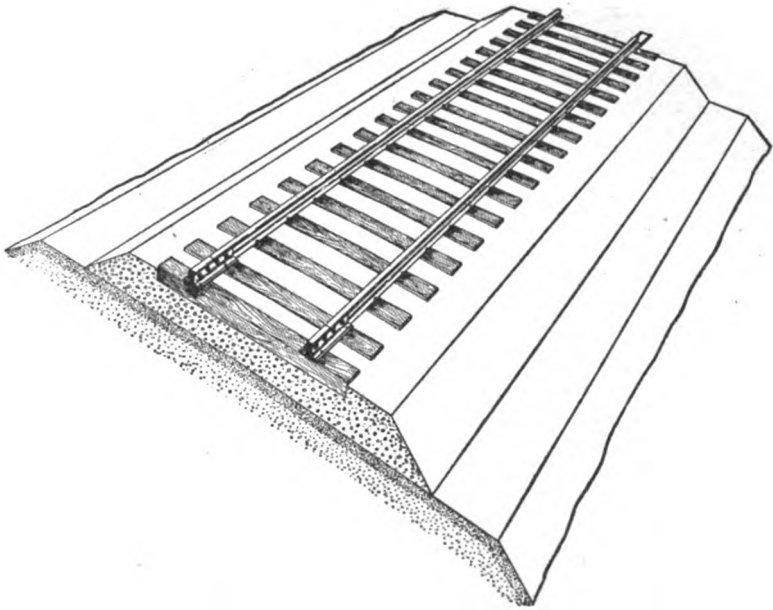

Section of the Chicago & North-Western Railway gravel ballast. This company also uses stone ballast, as will be seen by the description below. The standard of this company is as follows:

Thickness of tie, six inches; surface bearing face, if sawed, eight inches; if hewed, six inches; length, eight feet; distance between ties, twenty-one inches from center to center; kind of wood, oak.

The roadbed is finished off for a width of ten feet on each side of the center line one and one-half feet below the grade line, and sloped uniformly each way from the center line at the rate of five-tenths of a foot in ten feet. Gravel ballast is one foot in depth from the bottom of the tie to the roadbed, filled in between the ties even with the top of the tie at the center of the track, and sloping uniformly from the center of the track to a point one and one-half feet outside of the end of the tie, at which point it is two inches below the level of the base of the rail. From this point to the surface of the roadbed the slope is at the rate of one and one-half to one. When broken stone is used, the size is such as will pass through a three-inch ring. The ballast is one foot in depth from the bottom of the tie to the roadbed, filled in between the ties even with the top of the tie for its full length to a point one and one-half feet outside of the end of the tie, from which point the surface of the roadbed is sloped at the rate of one to one.

In the use of wood for telegraph poles little foresight has been practiced in America. Underground lines were not popular, and but little effort was made to introduce tubular poles. The postal authorities, who have charge of the telegraph in Great Britain, recommend that the wires be placed underground, and it is probable that this will be done, in the main, throughout the island.

In America, bridges of steel, iron and stone are replacing those of wood. However, wood will be used, more or less, so long as it is cheap. In the

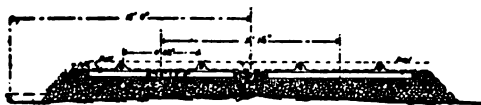

Section of double track, New South Wales. Top ballast broken blue stone 2½-inch gauge; bottom ballast broken stone, 4-inch gauge, hand packed.

construction of buildings, steel, brick and stone are being more and more generally used. A large amount of wood is used in the construction of the rolling stock of railways. The tendency, however, is to substitute metal therefor.

Such are, briefly, the ways in which wood is used and the means whereby its durability is prolonged and its consumption reduced. The subject is one that invites the attention of the owners and managers of railroads, and the public generally.

The following description, by an English engineer, of the creosoting process, as practiced in the

United Kingdom, is interesting and instructive: "Creosoting has both a chemical and a mechanical aspect. Chemically, it may be looked upon as a process which renders wood fiber distasteful to fungoid growth or boring worms and insects, the material being fatal to such types of vitality. Mechanically, certain forms of creosote act like so much wax or paint, filling up the pores of the wood and thereby preventing the access of water or air. Clearly, the mechanical effect can only endure while the creosote continues in the pores. When the mechanical process has been only half carried out, the wood is protected upon its exterior surface and to a depth inward of half an inch and upward, according to the extent to which the process has been carried. The process of creosoting is one requiring care in the selection of a chemically proper creosote and in the mechanical process by which such creosote is put into the timber. . . . Timber can only be said to be properly treated when it is penetrated by the creosote to its very center. Where complete saturation has not been effected, it is only a matter of time for cracks to develop and fungi to grow upon the untreated portions thus exposed."*

* In France we are told ties as delivered are piled and seasoned in the open air. They are then adzed and bored by a special machine, loaded on trucks and run into a drying oven, where they remain twenty-four hours or more. After drying at a temperature of about 176 degrees Fahr., they are run into a metal cylinder six feet three inches in diameter and thirty-six feet long, which is hermetically closed. The air is then

Mr. H. W. Reed, in an interesting treatise on the maintenance of timber, thus discourses on



Pennsylvania Railroad.

wood preservatives: "The destruction of timber by decay is ascribed by Liebig to 'eremacausis or a slow combustion' by

oxidation. Pasteur and Tyndall attribute it to the action of living germs in the atmosphere. The latter, in a series of experiments, found that on placing putrescible materials in a tube and excluding the air, which is laden with clouds of living germs or agents of decomposition, putrefaction ceased indefinitely or until the material was again exposed to the atmosphere. This is the generally accepted theory, and conforms very nearly to the results of modern observation. It has been determined by repeated experiments that a thorough preservative of timber must

exhausted and a partial vacuum is maintained for about half an hour. Communication is then opened with reservoirs of dead oil, which is allowed to flow in at a temperature of 176 degrees Fahr., under pressure. When the oil ceases to flow under moderate pressure, it is forced in by a pump up to a pressure of eighty-three pounds per square inch, and this pressure is maintained for an hour or an hour and a quarter. Communication with the oil reservoirs is then opened again and the excess of oil not absorbed by the timber flows back into the reservoir. The cylinders hold one hundred and sixty-eight ties each. The quantity of oil absorbed is measured by determining the difference in volume of the oil before and after operation. The wood used is principally oak and beech. The oak ties absorb from 2.4 to 2.7 quarts per cubic foot; beech ties from 8.7 to 10 quarts per cubic foot. The whole operation takes about four hours.

possess chemical antiseptics for the coagulation of albumen, and power as an insecticide, and also the mechanical property of excluding the atmosphere by filling the pores and surrounding the fibers with a substance impenetrable by the atmosphere. The atmospheric germ theory seems to find additional support in the fact that timber constantly under water does not decay. Wood which is constantly dry decays slowly, due probably to the coagulation of the albumen. Timber thoroughly seasoned by heat decays less rapidly than if treated by any other mechanical means, because of the more thorough coagulation of



Pennsylvania Railroad.

the albumen. Timber subject to alternate dryness and moisture decays most rapidly, owing, doubtless, to the repeated softening of the albuminous substances of the timber, which renders it more certain of attacks by atmospheric germs. There are four conditions under which timber is used which require different properties in the preservatives employed. They are: First. Submersion in water and subjection in sea water to attack of the *Teredo Navalis* and other sea worms. Second. Exposure to alternate moisture and dryness. Third. Exposure to the atmosphere only. Fourth. Subjection to transverse strains. Of the many preservative agents employed, those

of value may be resolved into two classes, viz.: *A.* Those derived from the distillation, at high temperature, of vegetable tars, albuminous and oily substances. *B.* Those having a mineral acid as a base. Under the first head we have creosote as the only known preservative capable of resisting for an indefinite time the attacks of the *Teredo*, destruction by atmospheric germs, and leaving the structure of the timber in its normal condition. Creosoting is the only process known that meets all the requirements of a wood preservative,

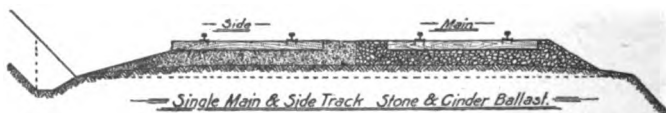

Pennsylvania Railroad.

only one element, its expense, mitigating against it.* The value of creosote is attributed by an eminent English authority, Samuel S. Boulton, to the presence of acridine ("an intensely acrid and pungent substance" and "one of the alkaloïds or bases" of creosote oil), and naphthaline, a substance less volatile than the tar acids; the latter is recognized in the thick, yellow appearance given to the outside of creosoted timber,

* Wood creosote oil is much cheaper than the creosote made from dead oil of coal tar. If it should prove equally effective, or measurably so, the cost of creosoting will be materially reduced, and thus the chief objection to its general use will be removed. It is claimed that wood creosote oil is more soluble than the dead oil. If this is so, its use would be restricted in damp districts.

which afterward becomes darker by exposure to the atmosphere. These, Mr. Boulton, as well as other English scientists, agree are more powerful as permanent preservatives than the tar acids, which are more active at first in coagulating the albumen, but exceedingly unstable, passing away in a comparatively short time. Acridine and naphthaline remain permanently, closing the approaches, both chemically and mechanically, against the attacks of atmospheric germs. These substances are among the residual products, after distillation, of coal tar at a temperature exceeding four hundred and fifty degrees Fahrenheit. Under the second head we have "kyanizing," "burnettizing," and the "boucherie" process. The foregoing are the oldest methods and have shown the best results. Creosoting consists of the treatment of timber with dead oil or tar; kyanizing, with bichloride of mercury (corrosive sublimate); burnettizing, with chloride of zinc; and the boucherie process with sulphate of copper.* Creosoting deals with the outer sur-

* The burnettizing process has been employed with very economical results by the Southern Pacific Railway, in treating pine and fir ties. The great distances between the points for delivery of ties and the points for their use, and the expense of maintaining a sufficient number of stationary plants, led to the adoption by that company of a portable wood preserving plant. It has been found to work very satisfactorily, and with great saving of expense. In December, 1889, some burnettized ties were laid in the San Joaquin Valley, Cal., near Turlock station, in a roadbed of sandy loam, under sixty-pound rails. In March, 1894, after three years and four months of service, slight decay was shown on the under side. Ties of similar timber, untreated,

face of the tie, charging the wood cells nearest the surface, varying from one-fourth to one-half inch in depth, according to the density of the wood, the bulk of the oil penetrating the ends of the ties, which prevents the further passage of water or air beyond the outer cells. It is also insoluble in water. The weak point of the creosote system for ties is, that this outer coating is broken by spiking, by rails cutting in, and by picks when drawing them into place in the track,

were laid at the same time, adjoining the burnettized ties, and of them the white and red fir were completely decayed and removed from the track after three years and nine months' service; 90 per cent. of the yellow pine untreated ties was removed from the track after three years and nine months of service; 90 per cent. of the sugar pine was removed as dangerous after three years and four months. Of 2,000 burnettized ties laid on the C. R. I. & P. R. R., near Chicago, in 1866 (pine, tamarack and cedar, and the greater part hemlock), 75 per cent. remained in the track after sixteen years of heavy traffic, and in such good condition that they would do service for two or three years longer. Mr. L. L. Buck reports that in 1882 he examined a lot of burnettized maple, beech and hemlock ties laid in 1866-68, and although they had been in the ground sixteen years they were in such good condition that he expressed the opinion that they would probably last seven or eight years longer, especially the hemlock. In November, 1889, a small number of burnettized ties were put in a gravelly clay roadbed near Tucson, Ariz., and after four years and eleven months of service found to be perfectly sound. At the same time and place untreated ties were laid adjoining the burnettized ties. Of these, the Truckee white fir had decayed to a depth of one-quarter inch on the under side; Truckee yellow pine to a depth of from one to three inches; Shasta white fir and white yellow pine from one to four inches; Truckee red fir to a depth of one-half inch; Shasta red fir, from one to two inches; Shasta sugar pine, one and one-half to two and one-half inches; and tamarack and sugar pine, from one and one-half to three inches.

so that the moisture has a free passage to the heart of the tie. Kyanizing, burnettizing and the boucherie processes consist in the use of mineral salts, which, being soluble in moisture or water, are practically useless for treating ties, unless the roadbed is ballasted with good,



Pennsylvania Railroad.

clean material and properly drained. The track must also be in a favored location, where it will not be liable to be flooded.* The boucherie process is also practically useless on account of the chemical action of the preservative on iron; because of this, ties require to be coated with coal

* To overcome the liability of the chloride of zinc used in burnettizing to be washed out, several processes have been introduced, the best known of which is the Wellhouse or zinc-tannin process, in which the chloride of zinc is mixed with a small percentage of glue, and then subjected to pressure; the solution is then drawn off and a tannin solution added. The glue combines with the tannin and forms a leathery waterproof substance which closes the outer pores of the wood, thus excluding the moisture and retaining the zinc. An especially valuable feature of this process is that it makes available timber which would otherwise be useless. Works for treating ties by the zinc-tannin process have lately been constructed by the Atchison, Topeka & Santa Fe Railroad at Las Vegas, N. M., and by the Union Pacific at Laramie, Wyo. On the Atchison, Topeka & Santa Fe it was estimated that ties costing 35 cents could be treated by the zinc-tannin process for 18 cents per tie, increasing their life to twelve or fourteen years. During the month of June, 1894, the cost was reduced to 10 cents per tie.

tar where the rails rest, and the spikes must be galvanized.* Kyanizing, burnettizing and the boucherie processes harden the fiber of the wood, offering greater resistance to the cutting of the tie by the rail; for this reason better results are obtained from the treatment of soft wood than oak ties, the fiber of the oak being too dense to readily admit the antiseptic. These preservatives will, however, penetrate the wood more thoroughly than creosote. In treating ties, bet-



Section of roadbed, Chicago & North-Western
Railway.

ter results are obtained if, before creosoting, the ties are adzed and the spike holes bored,

so as to allow those parts to be treated that are otherwise soonest liable to ferment and decay. Treated ties should be laid in the track with tie plates to prevent the rails cutting in and through the crust of the ties. A tie that costs ninety-five

* In Europe the boucherie process is said to have increased the life of pine ties from seven to fourteen years, and there is one respect in which this process is superior to treatment by chloride of zinc. It is much easier to control the strength of the solution and to determine by chemical analysis the actual quantity of the antiseptic contained in the timber after treatment. This is very important when the work is done by contract, as it affords less opportunity for misrepresentation. On account of the chemical action which takes place when the solution is brought in contact, in course of manufacture, with iron, the boilers, pumps, pipes, tools, etc., must be of copper, which materially increases the cost of the plant. In France, the cost of treating ties by this process on the Paris, Lyons & Mediterranean Railway is 11.4 cents per tie, while the cost of creosoting is 22.4 cents for beech or pine ties.

cents in the track and that will last without creosoting ten years will, when creosoted, last twenty years and cost one dollar and fifty cents in the track. The saving effected will equal seventeen dollars and sixty cents per mile per year. A tie that costs seventy-three cents in the track and that will last without creosoting six years will, when creosoted, last eighteen years and cost one dollar and eighteen cents. The saving effected will equal forty-eight dollars and forty cents per mile per year. These figures will, of course, vary on different roads according to the cost of ties, labor and creosote, but they are sufficient to illustrate the substantial value of creosoting under the conditions named."

At the creosoting works at Houston, Tex., the average amount of oil absorbed is one and one-quarter gallons per cubic foot, and the average cost twelve dollars and fifty cents to fourteen dollars and fifty cents per one thousand feet, B. M. It is claimed that the ties are not softened by the process, provided they are allowed to stand about six weeks after treatment before they are used. In 1876 four thousand creosoted

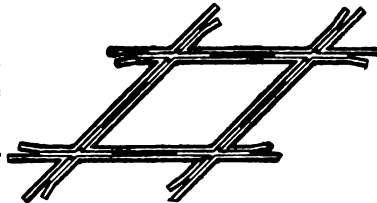

Forty-five Degree crossing.

Virginia pine ties were laid on the main track of the Central Railroad of New Jersey, near Bound Brook station, and in 1894 the superintendent of

the company reported that one thousand were still in use and in good condition. The contract for treating these ties called for twelve pounds of dead oil per cubic foot of timber. The creosoting process is very generally used in France and England. In the former country beech ties treated in this way are claimed to have an average life of twenty-seven years, and in the latter creosoted ties have been found perfectly sound after having been in the ground twenty-two years. In 1876 the Paris, Lyons & Mediterranean Railway, which had formerly used sulphate of copper for treating ties, substituted the creosote process for beech and oak ties. The average life of these ties when taken out of the track, up to 1883, had been nine and eight-tenths years. From this time their life gradually increased until in 1893 it had reached thirteen and four-tenths years. The cost of the ties which have been treated on this road has increased twenty per cent.; their life has been increased thirty-seven per cent.; an increase of life of sixty-five per cent. is reported on the Eastern System; an increase of life from thirteen and seven-tenths years to twenty-four years is expected as a result of the change from sulphate of copper to creosote treatment on the Paris, Lyons & Mediterranean Railway. A process is proposed by Mr. James T. Card, president of the Chicago Wood Preserving Works at Chicago, by which timber is to be impregnated with chloride of zinc, and after the moisture is partially removed from the wood dead

oil is to be injected through the outer portions of it. In Mr. Card's opinion this will give us all the benefits derived from the oil where the timber comes in contact with the ground, and insure the thorough treatment of the wood by the chloride of zinc, which will be protected by the oil surrounding it, thus preventing its being washed out or chemically changed. This seems rational, but so far as we know has not been sufficiently tested to determine its value.

Processes for preserving wood are, under the most favorable circumstances, unsatisfactory. This is especially so in regard to ties. Because of this, substitutes for wood are sought. Attention is turned to steel and iron. For many years their use was merely experimental. Much misapprehension existed which greater familiarity clears away. In India and in several European countries metal ties are used almost entirely. Careful and painstaking experiments not only demonstrate their practicability, but their superiority to wooden ties. Considering the relative durability of wooden and metal ties, and the expense attending the changing of ties in a track, metal will be found the cheaper, except in localities where suitable wood is plentiful and cheap. A metal tie, if properly laid, is more safe than one of wood because of its greater strength and durability. It affords an elastic and smooth track, at once noiseless and durable.*

* The use of steel ties is strongly advocated for tropical countries, where the use of timber is open to many objections. In the

The metal tie has advanced beyond the experimental stage. Among its advantages are reduction in cost of maintenance, less renewals (and avoidance of the danger and expense thereof) and greater safety because of greater stability. The



Turn-out Frog.

metal tie is the coming tie. It must be of sufficient weight to make a firm track, yet easy of manufacture and of reasonable cost; it must be convenient to handle and simple in construction; it must be of a pattern adapted to the particular locality in which it is used; it must be so made that it can be removed from or replaced in the track without interfering with traffic. It is desirable that it should be adopted for use in conjunction with wooden ties, so that the change from wood to iron may be made. The fastenings must be simple and effective.

A trouble experienced in the use of metal ties arises from the wear of the holes for fastenings.

official report on the projected Mombasa-Victoria Lake Railway, for opening up communication with the interior of Africa, it is recommended that general use be made of steel ties rather than creosoted fir or pingado wood, for the reason that a permanent way of this construction is practically indestructible by the natives with such few mechanical appliances as are to be met with in East Africa. Besides, the custom of firing the grass at certain periods of the year, and the temptation to use the timber sleepers for fuel or hunting purposes, would expose a line laid with timber ties to many risks. Moreover, white ants are numerous in the country and exceedingly destructive to wood. Finally, the steel tie has no tendency to float and be carried away by flood water, which is the case with timber.

Time will overcome this. The average duration of the metal tie depends upon several causes. It exceeds, however, many times that of the wood tie. Moreover, at the expiration of its usefulness it has a value, the same as old rails. The wooden tie when no longer fit for use is practically without value.

At first metal ties were made of iron; later mild steel took its place. Tensile strength depends upon the shape of the tie. No particular pattern has been universally recognized as the best. Metal ties are not easily broken, even

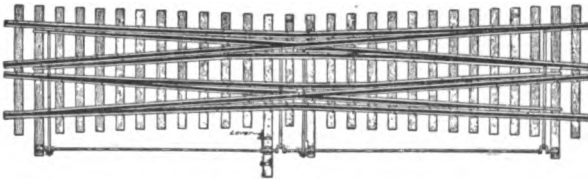

Movable Frog, Slip Switch.

when subjected to the shock of derailment. Danger of fracture, for a long time anticipated, has proven a groundless fear.

In the construction of a metal tie it is usual to make it of uniform thickness throughout its length. A more economical distribution of the metal is, however, thought possible. In order to reduce the weight of the tie to the minimum, the tendency is to decrease its dimensions. This must not, however, be carried too far, since it is evident that vibration and attendant noise will be less with a heavy than with a light tie. The

weight of the tie must be such as to secure stability, lest disproportionate increase of expense for maintenance and wear and tear of machinery be incurred. Moreover, if too light it cannot withstand the concussions to which it is subjected, without breakage or distortion. When a track is subjected to extraordinarily heavy traffic the weight must be proportionate. Experience shows that in ordinary gravel or dirt ballast there is very little corrosion. It occurs, however, with slag or cinder ballast, and in tunnels and damp places.* To prevent corrosion, ties have been painted with a composition of oil and tar; generally, however, they are used as they come from the mill.

Much difficulty has been found in fastening the rail to the tie so as to hold the former securely



Pipe Culvert.

and prevent noise and wear and tear.

The fewer parts a track has, the more desirable, and the

less the friction and expense for construction and maintenance. It is important, therefore, that whatever fastening is used it should not be complicated. It must be simple, easily understood and handled and such as to effectively hold the rail firm. In order to deaden the noise, heavy paper soaked in tar, also asbestos sheets and tarred canvas, have been placed between the rail

*This is owing to the effect upon the ties of the acids in the ballast and smoke.

and the tie. Such devices are, however, unnecessary, if the fastenings are properly secured. These should be made tight and kept so.

The first cost of the metal tie greatly exceeds that of the wooden tie. This disparity will be less and less with time. The saving effected is in greater durability and avoidance of renewals. The cost of laying a metal tie is greater than that of wood, owing to difficulty of handling and the complications of the fastenings. This is more than offset, however, by the saving in renewals and maintenance and the value of the tie when no longer fit for use in the track. A metal track after it has become firmly settled is more stable than wood. Where metal is used it is more or less the practice to use wooden ties at switches and frogs. There is, however, no good reason for this. Metal, if laid with proper fastenings and well surfaced, is preferable here as elsewhere. In connection with the use of metal ties, wooden blocks have been placed under the rails to give increased elasticity to the track. It is unnecessary, however. If properly constructed, the metal tie is elastic without extraneous aid.

Each year the discovery of a practicable substitute for wood in railway construction and maintenance grows more and more imperative. Each year timber becomes more rare and costly. Each

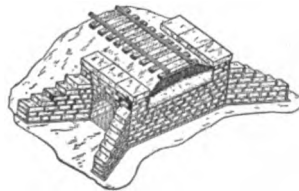

Stone Arch Culvert.

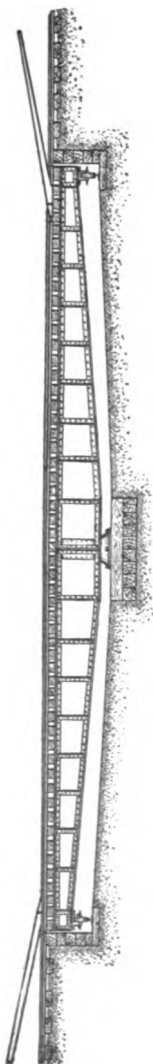

Sixty-foot Turntable.

year the climatic changes its destruction involves also grow more and more imminent. Anything, therefore, that promises relief is worthy of regard. In this connection the investigations of Mr. B. E. Fernow, of the department of forestry, in reference to wood preservatives and the substitution therefor of metal are interesting. I cannot do better in closing what I have to say on the subject than by availing myself of his researches. He aptly points out that not only the different species of wood in practical use show varying durability, that is, resistance to decay, but the same species exhibits variation according to the locality where it is grown and the part of the tree from which the wood is taken, and even its age seems to influence durability. Young wood, he observes, is more susceptible of decay than old wood; sap wood is less durable than the heart. The idea that young wood is more durable because it is young, which seems to prevail among railway managers, must, he says, be considered erroneous. On the contrary, young wood, which contains

a large amount of albuminates, the food of fungi, is more apt to decay, other things being equal, than the wood of older timber. Sound, mature, well grown trees yield more durable timber than either young or very old trees. Rapid growth, exhibited in broad annual rings and due to favorable soil and light conditions, yields the most durable timber in hard woods, and only as far as the growth in the virgin forest has been slow ought there to be a difference in favor of second growth timber. In conifers, however, slow growth with narrow rings, which contain more of the dense summer wood in a given space, yields the better timber. In piling ties he recommends that they should be placed in squares, with not over fifty ties in a pile, in such a manner that one tier shall contain six to nine ties, separated from each other by a space equal to about the width of the tie; the next tier to consist of one tie placed crosswise at each end of the first tier. The bottom tie should consist of two ties, or better, poles, to raise the pile from the ground. The piles should be five feet apart. The piling ground should be somewhere in the woods, or at least away from the sun, wind or rain, so as to secure a slow and uniform seasoning. If dried too rapidly, the wood warps and splits, the cracks collect water, and the timber is then easily attacked and destroyed by rot. He points out that the best method of obtaining proper seasoning, in a shorter time, without costly apparatus, is to immerse the prepared timber in water from one to three weeks,

in order to dissolve and leach out the fermentable matter nearest the surface. This is best done in running water—if such is not at hand, a tank may be substituted, the water of which needs, however, frequent change. Timber so treated, like raft timber, will season more quickly and is known to be more durable. The application of boiling water or steam is advantageous in leaching out the sap. Referring to the decay of railway ties, he ascribes the lack of durability to two causes, namely, a mechanical one, the breaking of

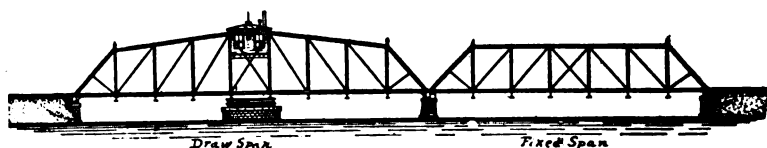

Steel Truss Bridge.

the wood fiber by the flange of the rail and by the spikes, and a chemical or physiological one, the rot or decay which is due to fungus growth. These causes work either in combination or, more rarely, independently. The cutting of the wood may be prevented by the use of tie plates. The damage caused by the spikes may be lessened as pointed out elsewhere. In reference to drainage he suggests that rock ballast is best drained and hence the best record comes from such roadbeds; gravel is next best and clay or loam the worst. On the other hand, where soft wood ties, like chestnut, are used, the hard rock ballast, while

unfavorable to decay, reduces their life by pounding and cutting. Sand ballast seems to vary considerably; a sharp, coarse silicious (not calcareous) sand with good under drainage should be next to gravel, while some reports give a heavy black soil and loam as better than sand. The reason why sand, although offering good drainage, is favorable to decay, may be sought in its great capacity for heat, which induces fermentation. Referring to wood preservatives, Mr. Fernow says in France wooden ties are universally subjected to

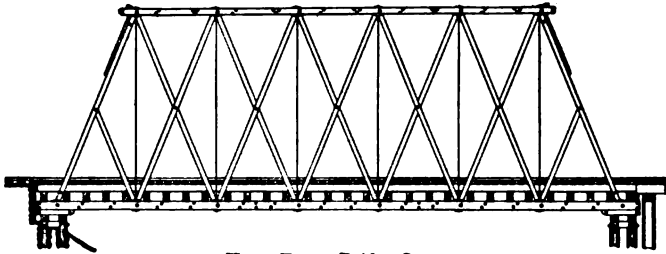

Howe Truss Bridge Span.

preservatives; that similar practices are quite general in England and throughout Europe, caused by the scarcity of wood and its great cost. He ascribes lack of interest in the subject in the United States to ignorance, to unwise economy, to cheapness of wooden ties, and to the fact that the flange cutting of the rail is even more destructive than decay. He recommends the use of tie plates in order to prevent this. The cutting of the tie not only disturbs the poise of the track, but serves as a cup in which to collect dampness,

as I have pointed out in preceding chapters, thereby superinducing decay. There are many different patterns for these plates. A rail chair is used in England. A hard wood plate let into the tie is also in use. A plate of felt a quarter of an inch thick placed between the rail and the tie has been used satisfactorily in France. Lead sunk into the wood has also been used as a plate. Where plates are used there is practically no wear to the tie. Their effect is to secure a more even distribution of rail pressure over a greater area of the tie; retardation of the mechanical destruction of the tie by cutting; avoidance of danger of tilting of rails; prevention of the lateral bending of spikes or screws, thus loosening the rail; increased resistance of screws and spikes against lateral motion or the spreading of the rails. The pattern of plate must be such as to secure these results most effectively. The use of tie plates with preserving processes makes a wooden tie almost as satisfactory as a metal one as far as durability and safety are concerned. They also greatly extend the durability of ties of soft wood. Mr. Fernow does not indorse any particular preserving process. He thinks, however, that if what is known as vulcanizing (i. e., subjecting unseasoned wood to a hot, dry air under great pressure) accomplishes what is claimed for it, it promises exceedingly favorable results. The cost of this process is said to not exceed three cents per tie. Its advantages are that unseasoned timber is preferably used; that

the fiber of the wood is not weakened by the process; that the timber may be worked after treatment without exposing any untreated parts, as the wood seems to be permeated through and through; that the timber is unaffected by atmospheric changes, being thoroughly seasoned by the process. Mr. Fernow, concurring with practical railway men in such matters, points out that the

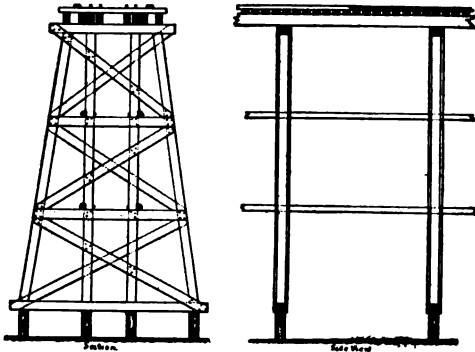

Frame Bent Trestle Bridge.

first cost of material is frequently not the most important factor; that it is oftentimes overshadowed by the question of maintenance and renewal; by perfection of roadway and appliances and the safety and comfort of travelers. He therefore recommends the use of preservatives where wood is employed and the adoption of such other devices as are calculated to lessen the consumption of timber.

Metal ties are being introduced in England, and experiments have been made with them by all the principal roads. These experiments are generally satisfactory and promise important results. The railways of France have not officially adopted the metal tie, but are experimenting with a view to its adaptability and the discovery of a suitable pattern. M. Vautherin, a French engineer, has designed what is considered to be, all in all, a desirable form. The use of preservatives in France, it should be remarked in passing, has made substitutes for timber less necessary than they otherwise would be. France

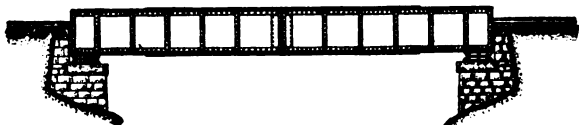

Through Plate Girder Bridge.

finds that when a metal tie is used, tie plates are not necessary. French railways use the suspended joint, spliced by fish plates and four bolts. On the outside the ballast is brought up even with the rail head; on the inside, even with the bottom of the rail. No breakage has occurred in their experience in connection with the use of metal ties, nor have difficulties arisen with the fastenings. The use of these ties is thought to lessen cost of maintenance and to increase the smoothness and safety of the track. Atmospheric agencies do not appear to affect the ties which are laid without

any coating or other preparatory measures. When laid in tunnels or low places, however, or in ballast containing sulphurous material, it is noticed that they corrode more or less.

In Holland the railroads are, in the main, using metal ties, and have been doing so for several years, notwithstanding the cheapness of suitable wood. Great intelligence seems to have been observed in that country in connection with the use of metal ties, and results have been satisfactory from every point of view. Of one hundred and twenty-four thousand metal ties laid during a period of sixteen years not one had to be removed. Ties, after being in use for twenty-five years with a service of sixteen trains per day, have been found to be substantially as good as new. The metal track is found to be safe, elastic and agreeable.

In Belgium the metal tie was originally introduced through pressure brought to bear by labor agitators and unions, and was not properly considered before its adoption. Because of this, its use was not generally satisfactory. Later experiments, however, have induced the government to take up the subject again more deliberately.

The use of metal ties in Germany evinces their popularity. It is found there, as elsewhere, that great improvements can be made in the original devices. The early forms introduced were too weak. Longitudinal ties are quite extensively used in that country, but are being abandoned

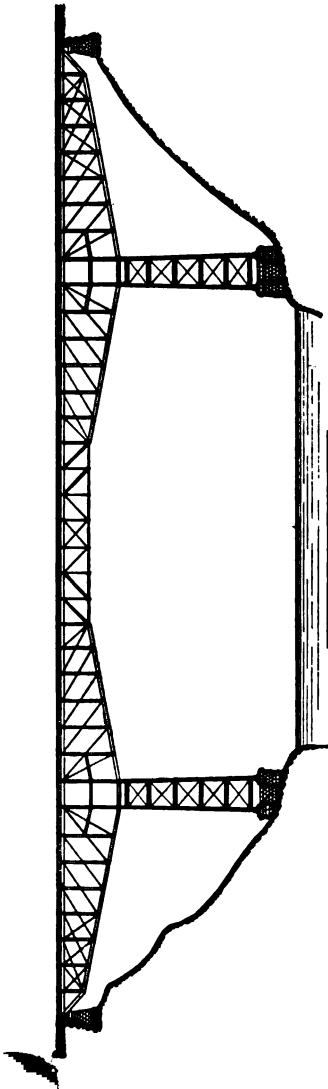

Cantilever Bridge.

because of added cost of maintenance and the difficulty of properly draining the track.

The minimum durability of metal ties is placed at forty years; it may be extended to seventy. Information on the subject, however, is exceedingly meager. Mistaken economy and a desire to encourage forest industries have retarded the introduction of metal ties in Germany. Wood used for ties is very generally subjected to preservative processes. Tie plates are also generally used.

Austria and Hungary, among the more favored countries as regards abundant, suitable and cheap timber, while making careful experiments with metal ties, have not fully adopted them. They are, however, used upon many roads and are laid in both longitudinal and

cross sections. Metal tie plates are very generally employed when wooden ties are used. They are not, however, used on every tie, except at sharp curves. The spike passes through the plate and holds both the rail and the plate.

Metal ties are used in Switzerland and highly esteemed. They are used mainly on lines having the heaviest traffic.

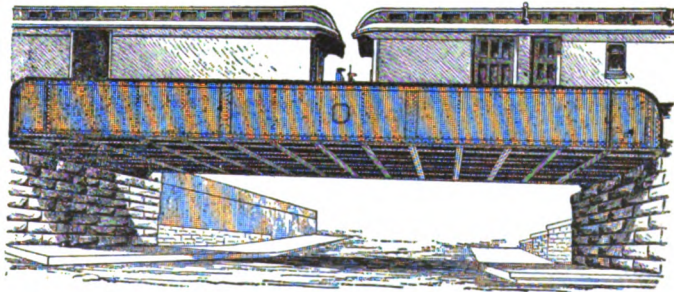

American Plate Girder Overhead Bridge. (Side view.)

The growing scarcity of wood in Spain, Portugal and Italy, and the probability of still greater scarcity in the future, have induced those interested in such matters to give attention to suggested substitutes therefor, and, while no concerted attempt has been made to introduce metal ties, careful experiment is being made with them. There is no prejudice against them, and the investigations, so far as they have been carried on, are satisfactory. But so long as the first cost of wood is less than metal, it finds favor even when

the ultimate cost (taking into account maintenance and renewals) is greater. However, this is the case to a greater or less extent in every other country.

In conclusion, it may be said that in every country experiments more or less careful and full are being made with metal ties. Out of these will grow practical forms and efficient methods.

The use of the metal tie under different conditions has conclusively demonstrated its practicability as a substitute for wood. Its advantages are economy, efficiency and safety. The experimental stage has been passed, as shown by the extent to which it is used and its steadily increasing introduction. It remains for us to profit by this experience, making use of the improvements and modifications suggested by actual practice. The main advantages presented by a good system of metal track are reduced expenses for maintenance and renewals, owing to the solid construction and the greater durability of the parts; a better class of track, owing to improved fastenings, etc., and the fact that the roadbed is not torn up (as with wooden ties) for frequent renewals, so that it gives the best road with the least amount of work for maintenance, and finally increased safety for traffic, owing to the superiority of the fastenings over those used with wooden ties.

The conclusion of men who have given the subject most study is that if in comparing the cost of different systems of track account is

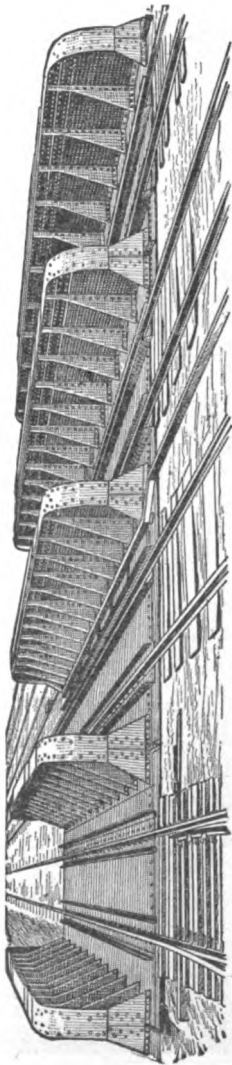

American Plate Girder Overhead Bridge. (Front View.)

taken of every expense, namely, first cost, transportation, handling, laying, maintaining, renewing, interest, and the value of the old material, there are few railroads where the exclusive use of wood for ties is the cheapest. Those who possess skill and experience in such matters sum up the result of their observations in regard to the requirements of a successful metal tie as follows, namely: It must be heavy enough to hold the rails down well and make a firm track; light enough to be of reasonable cost; must have metal enough to stand wear and tear and give ample strength; must be easy of manufacture, and require a minimum of shop work; must not be liable to lateral motion in the ballast; must be easy to lay, remove, or ballast. The fastenings must be simple and efficient, with as few parts as possible, and capable of adjustment for

widening the gauge at curves, etc.; the price must be such as to enable an actual ultimate economy to be shown; the quality of metal must be such as to sustain shocks without injury; and, finally, it must have sufficient elasticity to give an easy riding track.

The value and character of the metal tie have been discussed frequently and exhaustively at the various congresses of railways held in Europe. The conclusions are that, while metal ties present many favorable and advantageous points, the experience with them has not been sufficient to justify any final decision in their favor against wooden ties. It is recommended that each management should select two trial sections, laying one with metal ties and the other with wooden ties, both sections to have as nearly as possible the same conditions of grade, alignment, road-bed, ballast and traffic; that the trials should last long enough to enable definite conclusions to be arrived at; that the special points to be considered should be: first cost; cost of maintenance; cost of renewals; approximate life of ties; effect on the rails; best types or forms of ties, and general cost, taking renewals into account.

CHAPTER XI.

MAINTENANCE AND OPERATION—WHAT COST IS DEPENDENT UPON.

[NOTE.—For a full understanding of the maintenance and operation of railways, a knowledge of accounting in connection therewith is desirable. The reader will find this important branch of the subject in the book "Disbursements of Railways."]

The tendency of railway operations from the start has been to lessen cost and reduce rates.

The expense of maintaining a railroad is dependent upon cost of material and labor, condition of the property, amount and kind of traffic, nature of the climate, character of bridges, culverts, buildings and platforms, nature and adequacy of ballast and drainage, and finally the weight and texture of the rail. These comprise the principal items.

Cost of conducting traffic depends upon the grade and alignment of road, quantity and nature of the traffic, adequacy of the company's facilities, cost of labor, character of the latter, etc.

The maximum price is paid for labor in America; the minimum price in India.

The rapid development of railways in America is attributable to the intelligence and economy exercised in their construction and operation, and

to the fortitude of railway owners and the skill and boundless ambition of railway managers.

A railway, like the human body, is constantly undergoing change, yet so gradually as not to be noticeable. Not only does everything wear out, but many things are put away while yet stable to give place to something better. Thus diminutive engines have been supplanted. This last change necessitated a better roadbed, heavier rails, better fastenings and stronger bridges and culverts.

Track scales that answered every requirement in the early history of carriers have long since been replaced by others capable of accommodating greater loads and longer vehicles.

Necessity has been the mother of invention. To need a thing has been to induce its invention and introduction. This is seen in the truss bridge, the swivel truck by which railway vehicles adjust themselves readily to the track, the equalizing beams of locomotives, by which their adhesion is increased and their hauling capacity multiplied, and so on, and in an incomprehensible number of ways, improvements in railway appliances are not confined to any particular department of the service. They cover every field, from the tie used to the form of check with which dividends are paid. They are seen in the substitution of steel for iron; of the fish bar for the old-fashioned chair; of sixty-ton locomotives for those that weighed six; in improved forms of axles, springs, splices, spikes, signals, the tread flange and center

of wheels, and other appliances. Each in its way tended to render transportation quicker, safer and cheaper, and therefore more generally used.

To know the cost of maintaining a particular property as compared with another property, is not to possess anything of value, unless we have accompanying details. Greater outlay one year may be offset by lowered expenses the succeeding year. Differences are also occasioned by varying cost of material. Use occasions wear and tear; hence a property that is used much wears out more quickly than one that is not. To compare the cost of maintenance of two or more roads intelligently, we must know how far the differences are inherent and how far the result of management or traffic.

The cost of maintaining railways is relatively less each year. This is due to the better establishment of the roadbed, cheaper material,* higher skilled labor and kindred causes.

Effectiveness requires that ultimate perfection should be the aim of railway management. Long delays may intervene, and many makeshifts based on the character of the business and the income of the property adopted, but the building up of the property to a perfect standard should be and is the aim. It involves systematic organization; a machine capable of intelligent and consecutive

*In Great Britain there was a decrease of fifty-four per cent. in the cost of material per mile of road in 1885 as compared with 1876, and this notwithstanding the increased mileage of trains.

action. Nothing creditable or permanent can be attained in any other way. Work without system involves the affairs of a railroad in the same confusion that similar work involves other industries. It is not an unusual thing in the history of a railway to see the greatest perfection attained in one branch of the service while everything else will be comparatively crude.

This fact, while illustrating capacities, shows how distinct the different departments of a railroad are from each other, while acting in unison for the attainment of a common end. Men are not alike blessed with wisdom, experience or capability. The ignorant, the dull, the obstinate and the vicious, while not numerous in railway life, still abound. They are stumbling blocks and retard the efforts of their more amiable brothers.

In the progress of work on a railway much depends on the general manager; but capability here cannot supply the place of mediocrity, indifference or worthlessness elsewhere. To overcome the inertia, there must be active co-operation throughout every part of a property, and its supervision must be wise, intelligent, faithful and constant. In no other way can a systematic organization be built up or maintained or the best results achieved.

Unfortunately we have no means of fitting men for railway business as we have for making lawyers and doctors. Railway men are educated in the business after they enter the service. This involves long apprenticeship, capable instruction

and competent instructors. Over every department of railway service there must extend the active supervision of a single man, supplemented by capable assistants. In this way only can efficiency be secured. An organization thus effected must supplement its labors by exhibits of results, so that comparisons may be made. Without these comparisons it will oftentimes be impossible to distinguish between capable, industrious and economical men and those of a contrary character.

In railway operations, prevention is a guiding factor. To stop the leak in the roof promptly, to strengthen the crumbling wall without delay, is to prevent disintegration, very likely accident. This applies to the track, equipment, buildings, bridges, fences and other structures of railways as much as it does to the houses of citizens. Not only is the destruction of property prevented by such measures, but cost of maintenance is reduced. Moreover, if action is not prompt, those intrusted with the work become disheartened by the great expense and the immensity of the field.

The question of railway maintenance is by no means simple. Its proper understanding involves a knowledge of every detail of railway construction and operation; acquaintance with the topography of the country, its climate, population, financial resources and distance from the base of supply. We must also be familiar with methods of taxation, the personnel of the force, extent and nature of the company's appliances,

and the amount and kind of its traffic. These are fundamental. Maintenance means something more than preservation of the track, bridges, buildings and other structures. It also means the building up and maintaining of a competent and trustworthy organization and the proper grouping of forces, without which a property is cumbersome and unwieldy.

Features incidental to railway maintenance are the differences, inherent and otherwise, in railway construction, and the consequent differences in cost of operating and maintaining that follow. They form a part of the question, and therefore engage the attention of those concerned. Their comprehension is, moreover, necessary to a proper comparison of results. Because of this let us glance, for a moment, at some of the differences between railroads.

The disbursements of a railroad are influenced, favorably or otherwise, by the peculiarities of the country through which it passes, and until these are determined we cannot estimate the cost of maintaining or operating. The circumstances surrounding the cost of constructing a road first, and operating and maintaining it afterward, change with every succeeding mile. The distinction is more marked in some cases than in others, but it exists everywhere and at all times. In one case it will be the difference between a road located upon the summit of a mountain and another located in a valley, or between one that surmounts a steep and dangerous ascent and one constructed

upon a perfectly level plain. In another case it will depend on the elasticity of the roadbed, the sufficiency of the drainage, the quantity and quality of the ballast, or the manner in which the latter is applied. Instances of difference have no limit. However small, they affect the cost of maintaining and working.

The differences in cost will vary from a few cents per mile to hundreds of dollars. The extent of the difference can only be anticipated by a careful survey of the property. In some cases it will be so marked as to make itself perceptible to the dullest comprehension; in others it will be discernible only to experts in such matters.

A road with costly bridges, high embankments, precipitous grades, sharp curves and extended tunnels will, it is manifest, cost more to maintain and operate than a line devoid of these costly features.

In considering relative cost, as affected by the peculiarities of a country, I can only notice the more important differences. Generally, it may be stated as true that a road traversing a level country, adapted to grazing or agriculture, is more cheaply worked than a line differently located. Its drainage may be difficult, and a supply of ballast not easily obtainable, except at considerable expense, but such objections are felt more or less on all roads. They are more than offset by the obstacles to be surmounted on a line located in a hilly country. Moreover, a company whose property is favorably located, as



regards grades and alignment, can haul the maximum load. It has been demonstrated that upon a line favorably located a locomotive can perform three times the service possible upon a line unfavorably situated in this respect. Moreover, wear and tear of equipment is less. Accidents are also diminished. The expense of keeping the road in good condition is much lighter. Many other differences might be cited.

On the other hand, the drainage of a road which winds around the edge of a mountain range is more easily provided for than on one traversing an alluvial plain.

The first presents highly favorable circumstances for economical and effective drainage, the latter rarely does. To a superficial observer, the difference in cost of operation and maintenance between a track susceptible of perfect drainage and one that is not is never rightly estimated. Imperfect drainage, besides being an evil in itself, implies collateral evils. The roadbed is hard to maintain, ties rapidly decay, rails speedily become unfit for use. A large force, relatively, must also be kept constantly employed, while frequent renewals of the track itself are required. Cost is multiplied in many directions.

For these reasons engineers are careful to make provision for good drainage, whenever possible. In many instances, however, the nature of the soil or the character of the country render it impossible. In such cases the burden on the carrier becomes a permanent one.

No other phase of railway operations possesses such a variety of aspects as the question of drainage. None requires greater knowledge and skill. It is not only essential that the person in charge possesses the practical qualities of an engineer, which enable him to utilize to the utmost the topographical features of the country, but he must understand the action of water upon different kinds of soil; must be able to distinguish between that kind of soil which will absorb water without especial detriment to the roadbed and that which must be quickly relieved of the burden. He must also understand the law of capillary attraction and take necessary measures to remove the track beyond the reach of its influence.

Questions of temperature are prime factors. In a cold region the cost of generating steam is greater than in a milder climate. The load hauled is also less, while broken and defective rails and damaged machinery and appliances multiply in number indefinitely. Absence of elasticity in a frozen roadbed increases wear and tear of equipment and hastens the destruction of track. To these must be added the cost of keeping the track free from snow and ice in a cold climate. The disbursements on this latter account appear in cost of snowplows, supplies, wages, use of locomotives and cars, added cost of fences and snowsheds, and, finally, in delay of business. Upon many lines located within the snow belt the expense of keeping the track free from snow and ice forms a considerable propor-

tion of the total cost. From this and kindred expenses, lines further south are happily free. On the other hand, however, the latter have their own disadvantages, such as rapid deterioration from insects and climatic causes.

Differences in cost of fencing also affect maintenance and operations. Upon some roads no fences are practically required in America; upon others their erection and maintenance are difficult and expensive. A company contiguous to supplies is put to less expense for fence material than a line located at a distance. Moreover, the laws defining a legal fence are not the same in every state. Relative cost is thus further complicated.

Cost of maintaining and operating is vitally affected by the number and character of the grades. Every foot of ascent entails extra expense. A line that requires a heavy engine to move a minimum load cannot be worked as cheaply as a line more favorably located. Cost varies upon railroads according to the nature of the country, the judgment exercised in locating the line and the money expended in overcoming construction obstacles. Experts do not agree as to the ratio of expense each foot of elevation occasions, but it is relatively much greater when the rise is abrupt than when gradual. Thus, cost of a maximum grade of one hundred feet to the mile is more than where the grade is fifty feet. Nor is the collateral outlay which gradients entail relatively the same. Differences in cost of maintaining track are particularly noticeable. Cost

of fuel, lubricants and wear and tear of machinery are also heightened.

The curvature of a track, hardly less than its grades, affects the cost of maintaining and working, though the fact is not so generally recognized.

Another important feature is alignment. Defective alignment adds to the cost of property in the first place and the expense of maintaining and working it afterward. The inconvenience continues without sensible diminution until the mistake is remedied, but as defective alignment oftentimes involves questions of management and policy as well as cost of correction, it follows that such defects are generally of much longer standing than they would be if they came within the duty of the practical men who look after the track. An acute defect these latter may remedy, but errors in alignment affecting considerable sections of a line they may not notice, or if they do, are oftentimes unable to demonstrate the practicability of their views.

Many other differences affect cost. Thus a company that is compelled, either by the nature of its traffic or the peculiarities of its line, to sever and reunite its trains at intervals is put to greater expense for maintenance and operation than one that does not. This expense will vary according to the length of the haul, the amount and character of the load and the particulars of a local nature that affect the transfer. Such expenses represent in a measure, it may be said, the difference between cost of handling through and local

business. However, many terminal expenses involved by the latter are wanting.

Relative cost is affected by density of population, more especially the frequency with which towns, villages and cities occur. It is also influenced by the number and character of the tunnels, viaducts and road crossings. Every tunnel, viaduct and road crossing increases cost in the same sense that a line dotted with signals and crowded with watchmen cannot be worked as cheaply as a road running through a country where these precautions are unnecessary.

Anything that interferes with the free movement of trains, or that increases or diminishes the speed best suited to the load hauled, adds to cost. Thus the amount of fuel required by a locomotive to start its load is relatively much greater than the amount required to keep it in motion once it is started. Experts have estimated the loss of power occasioned by stopping a train traveling at the rate of twenty-five miles an hour as sufficient to carry it a mile forward on its journey. Consumption of fuel, it is also to be remembered, is only lessened, not avoided, while a locomotive is thus idle. Further than this, the wages of employes experience no abatement, while the extra cost of wear and tear of road and equipment, incident to the interruption, are considerable in every case. Finally, it may be said that anything which retards the business of a railroad, increases its cost or multiplies the restrictions under which its trains are operated, adds to the cost of doing

business and lessens by just so much the facilities of the public. The interests of the public, not less than owners, require that railroads should be harassed by as few restrictions as possible.

Particulars of construction act and react on the operating expenses of railroads. Cost is never the same relatively upon any two lines.

The same influences that contribute to swell the first cost of a road serve in the majority of cases to increase its operating expenses afterward.

In investigating the subject of railway economy, each enterprise must be judged according to its environment. In no other way can its status be accurately ascertained.

The causes which produce differences in the cost of operating properties are so numerous and so complex that I can only notice the more important. This partial analysis will be useful, not for the information of experts, but for those whose facilities for observing the multitudinous details of railway operation are limited.

The influences that occasion differences in cost of operating open up incidentally the whole vista of railway administration. I shall consider but one phase here and only the more salient features of this.

And first, in regard to supplies. To ascertain the cost of these, including fuel, the expense of handling and the cost of transportation must be added to first cost.

The first cost of fuel is very small in many cases, but the expense of hauling and the absence of economical facilities for unloading from the cars, and afterward placing it upon the tenders, makes the final cost very great, much greater even than is discernible from the accounts. The expense is aggravated in the case of many companies by their having no return load for their cars. Much of the cost of fuel appears in the returns under foreign headings and thus remains unknown. In portraying the expenses of a railroad we cannot, if we would, group in the accounts or elsewhere, under one head, all the expenses incident to a particular article of material.

To the first cost we must add the shrinkage, and in the case of fuel and oils this is very great. The cost of substituting new material for old, in the case of repairs and renewals, must also be remembered. With many classes of material the cost of substitution equals or exceeds the first cost. It is considerable under the most favorable circumstances. The disbursements, for instance, that attend the substitution of new track material for old material of the same kind are very great. This is noticeably so with rails and ties. It is measurably the same with machinery and fixtures that appertain to bridges, buildings and other structures.

To ascertain the cost of any kind of material we must consider it relatively. Thus, in weighing the value of a particular quality of fuel we

must consider its heating capacity and effect upon the locomotive. These, therefore, and not the price asked for the coal by the dealer, finally determine the cost of the article.

To purchase an article without considering the collateral effect is, in many cases, to occasion a loss out of all proportion to the main transaction.

Ability to pay for material promptly affects sensibly the price for which it can be bought.

Interest on money invested in supplies also forms a part of cost.

The time expended upon an article, and the accounting it involves, must be considered; nor must the cost of storage and the outlay for insurance be overlooked.

Thus, a multiplicity of things are to be considered before the final cost of an article can be known.

Roads operated in the immediate vicinity of markets buy more cheaply than lines located at a distance. Their presence exercises a favorable influence on the dealer. They are, moreover, able to keep better posted in reference to the market.

A company that concentrates its purchases can buy upon more advantageous terms than one that intrusts its purchases to a number of persons or to officers not skilled in the way of buying cheaply.*

* No one ever connected with a railway company in a responsible position, it may be said in this connection, can have failed to be impressed by the great importance which the responsible managers of railroads attach to the organization and

The necessities of a company, real or imaginary, sometimes induce it to purchase supplies of inferior quality. When this is so the loss occasioned thereby can only be traced indirectly, as in the case of fuel, already referred to. At different periods in the history of railroads the rails were, in many cases, of inferior quality. Times were not propitious, business was unprofitable and the companies were poor. The desire to buy at a low figure, therefore, was strong. This was particularly true of the intermediate period between the use of iron and Bessemer steel. Manufacturers had, to a certain extent, lost the art of making the former cheaply and well and were not yet able to produce the latter at a rate the railroads were able to pay. The effect of the use of poor rails at this time was quickly discernible.* It was seen in many ways outside of the cost of keeping the track in repair. It was perceptible in the disbursements for injuries; in the fees of coroners and surgeons; in the account for losses and damages to property; in expenditures for legal services, nurses and medicines; in repairing broken down bridges and culverts; in renewals

performance of the duties connected with the purchase of supplies; to the limiting of the purchases to as few officials as possible, and to the placing in such positions only men experienced in the wants of railroads and in the knack of buying cheaply; men withal accustomed to the discharge of acts of trust and of long tried and approved integrity.

*The length of time a rail will last is dependent (even upon a line having light traffic) upon its quality, the care with which it is laid, the number and quality of the ties and the character of the roadbed.

of equipment, machinery and tools; in outlay for labor of various kinds; in fuel used, and, finally, in diminished receipts.

Many companies were slow in discovering the loss occasioned by the use of poor rails, and not a few were dilatory in effecting a remedy after the discovery. Why? Because it requires a knowledge of railways that every proprietor does not possess, to enable him to appreciate the fact that unless he maintains a good roadbed and track favorable results will not long attend the operations of his property.

The smoothness and elasticity of a track affect directly the cost of keeping the rolling stock in condition, so that the cost of a poor track is quite as apparent in expenditures for keeping the equipment in serviceable order as in the disbursements for the track itself.

Only an experienced and sagacious manager can withstand the seductive glamour of an article of prime necessity offered at a low rate. The fact that its ultimate cost, if of poor quality, will be out of all proportion to the temporary saving is lost sight of. The immediate reduction in the cost of operating and the glory of effecting the reduction is too great for a weak man to withstand. This would not be the case to the extent it is if so great a proportion of the loss suffered in consequence of the purchase of inferior material were not covered up under foreign headings and remained, therefore, unsuspected. The track of a railway is the largest single expense, and it

is in connection with this that the greatest, and in many instances the most unadvised, efforts at economy are attempted. The harm that ensues is apparent in collateral expenses, but it is impossible to determine the amount of these even approximately. Actual outlay for track involves the cost of transporting the new material and the removal of the old, the cost of loading and unloading, the expense of handling, the withdrawal of the old material and the insertion of the new in the track; the value of the new supplies, less the amount received for the old; the material destroyed and injured in making renewals; the wear and tear of tools; in the delay of business, and the increased wear and tear arising from imperfect alignment of track which the changes temporarily occasion. These are the principal items. Their cost to a company cannot, in every case, be ascertained, but whatever the amount may be it is aggravated by the use of poor rails, whether inadvertently or otherwise. It is only by keeping such facts in mind that we can appreciate the importance to a company of purchasing good material. Only a wealthy company, it is apparent, can do otherwise without endangering its safety.

What I have said in relation to inferior rails applies also to inferior ties. A poor rail may be sold, but a tie is practically worthless when no longer fit for use in the track.* Besides the fact

* Huntington, in his unique treatise on railroad track, however, points out, though in a somewhat forced way, some of the

that a worn-out tie possesses no value, its removal is difficult. The alignment of the track is also seriously disturbed.*

The expenses attending a poor bridge are relatively greater than those of a poor rail or tie. The cost of removing such a structure may, indeed, exceed the original outlay. Leaving out of consideration, however, the cost of maintenance of cheap bridges, the incidental outlay they involve for persons killed or injured, property destroyed or damaged and the injury suffered by equipment (to say nothing of loss of revenue a company suffers by the distrust engendered in the mind of the community) is out of all proportion to the saving effected by the erection of an unsafe structure of this kind.

In reference to structures of a temporary character, such as depots, platforms, roundhouses, workshops and water stations, that we find

uses to which old and worn-out ties may be put, namely: "To patch temporarily broken fences; to make footings for washing embankments; for temporary platforms for piling rails; fuel for drying sand at sand stations; fuel for sectionmen. Sawing up old ties for wood is also profitable to a company in many localities." They may also be used by a company for starting fires and other purposes.

* Ties manufactured from what we call soft woods are not only not able to withstand the wear and tear of a heavy business, but they decay much more quickly than oak and other hard wood ties. The cost, however, of transporting the latter and inserting them in the track is not greater than for the former; it is, therefore, manifestly for the interest of every company to use the latter when the difference in the purchase price is not greater than the subsequent difference in the length of time the ties will last.

clustered about many new enterprises, the incidental loss to the company erecting them in many cases far exceeds the cost of a first-class edifice. It follows, therefore, that the erection of such structures is inexcusable, except in those instances (not so frequent as supposed) where the necessities of a company render it unavoidable.

The injury to rolling stock and machinery by the use of inferior lubricants aptly illustrates the folly of buying material of inferior quality. The difference in first cost is oftentimes so marked, however, as to secure the purchase of the latter article. When this is so the charge upon the books for lubricants appears as a reduction of outlay and is quite likely to excite the admiration of directors and owners. The actual cost is never known, but comparisons will exhibit increased consumption. The destruction engendered will appear in the returns under other headings, which seemingly have no connection with it. The extra outlay will be seen in disbursements for repairs and renewals of equipment, for new axles, brasses and other parts of machinery, and in all the accounts incident to the working of trains, such as repairs of equipment, disbursements for people killed and injured, losses, damages, and services of lawyers and doctors. The increased cost may be traced step by step through all the labyrinths of the service, in the stoppage of trains, in the diminished usefulness of the plant, and in the myriad of expenses incident to the detention of

business. Every conceivable expense follows in the train of hot journal boxes, broken axles, torn up tracks, derailed trains and kindred mishaps that ever attend the use of poor lubricants.

In connection with the cost of wheels, axles, frames, springs, bolts, nuts and kindred appliances, we find, as in the case of oils, that the relative cost of a good and a bad article is not alone manifest in the first price. The cost of the poor article will further appear in added disbursements for people killed and injured, losses and damages and all the multitudinous expenditures that attend accidents to trains.

Other interests, foreign to the immediate purpose, attend the use of supplies. It frequently occurs that the purchase of material is made to facilitate the securing of business or the placating of someone. When this is so, the price represents the value of the article and the benefit derived from its purchase. Many other things, such as a desire to foster local interests, affect the source from which supplies are drawn, inducing the purchaser, it may be, to pay a rate above the market price. In such cases, of course, the indirect gain is expected to offset the direct loss. Practices of this kind are of frequent occurrence. Generally, however, it may be said that the emergency that warrants going out of the general market to purchase presupposes an extreme case, and one, therefore, not to be considered as a factor in a general review of the procurement of railway material.

The interests of a railroad are identical with those of the country in which it operates. It endeavors, consequently, in every way to advance the affairs of its co-laborers—the local producer and consumer. But this assistance, however valuable and real, never appears under specific headings on the books of the railroad. When aid is extended, as I have shown in the purchase of supplies, the added cost cannot be fixed, under any head, in the accounts. Separation, therefore, is not attempted; the total price paid for the material is charged to operating expenses, although a portion might, with more propriety, be charged to traffic. Particular operating accounts are thus burdened with disbursements foreign to their purpose.

Before attempting to fix the cost of operating a company's property, it is apparent from the foregoing, we must know the circumstances attending its purchase and use of materials, including prime cost, indirect cost, distance supplies are hauled, cost of hauling, service of equipment, expense of substitution, storage, shrinkage, interest, insurance, etc.

The difference between affairs as they exist and as they are supposed to exist in the purchase and use of supplies, illustrates very fairly the difference between practice and theory in railway operations. To the amateur the railway problem is like a shallow cistern that may be dipped dry with a drinking cup, but to the practical worker and thinker it represents, in its economy, the problems of a mighty sea.

Management of railroads requires that those who direct affairs shall be men trained in the discharge of business, fitted to govern, whose judgment has been trained by years of observation, practical work and restraint. Men self-controlled and self-contained, forcible, luminous in their conception of great problems, and yet capable of employing simple and economical expedients. They must possess, in fact, the business ability of the trader with the executive force of the general and statesman. They must be educated in minor offices. No railway can afford to educate an officer in the position of an officer; it is at once too expensive and too demoralizing.

The cost of working a property is greatly affected by the quality of the traffic and the length of haul. This is, perhaps, more particularly the case with freight than passenger business, for the reason that the former entails current expenses unknown to the latter.

The expenses of railway companies now entailed for loading, unloading and storing freight are, in many respects, foreign to the original intent and purpose of common carriers, and, in many instances, not necessarily a part of their office.

In some countries, notably in Great Britain, railway companies contract with teaming companies or employ carts of their own to haul

merchandise to and from stations. Much of the freight, however, is loaded by the shipper directly upon the cars.* The freight rate charged by English companies does not uniformly include either the cost of loading, unloading or covering the goods. When such services are performed by the railway it makes a special charge therefor. It also makes an additional charge, in many cases, for cost of building and working side tracks. In America, on the other hand, it is usual for the railroad companies to load and unload freight, and while they do not generally attend to the collection or delivery of freight at terminal points, they nevertheless place it in a secure warehouse, which they generally own and control.†

No direct charge is made in America for loading or unloading, no matter what the length of haul. Nor is anything exacted specifically for the use of a company's warehouses, except in those cases where goods remain for an unreasonable length of time. A charge for demurrage is made in the case of cars that are not unloaded

* The box or inclosed freight car so universally in use in America is little known upon English lines, the flat or open car being used by them, merchandise loaded upon it being covered, when necessary, with a tarpaulin. This vehicle is much lighter than the box car; indeed, it is much shorter and lighter than our flat or open car.

† The exception to this rule is in the case of express companies, who conduct what in England is denominated "the parcels traffic;" these companies not only collect much of the freight transported by them, but deliver it (in large towns) to the consignee, the charge for this service (within certain limits) being embraced in the general rate.

within a specified time, if it is the duty of the consignee to unload the freight.

No charge is made by American companies for the use of side tracks.

In England a special charge is made when traffic is hauled but a short distance. Thus, the rate for six miles, or any fraction thereof, may be the same as for twelve miles. This is in addition to the supplementary charge for loading, unloading, etc. Our custom with respect to this class of business is doubtless in practice not materially different, but the basis for the charge is not so well understood. The omission operates in favor of the shipper.*

The practices in this country in connection with loading, unloading and care of freight have assumed the habit of a fixed custom, though the duty does not properly fall within the province of a carrier. This is demonstrated, if demonstration were necessary, by the discrimination which companies make against particular classes of freight, a discrimination the public acquiesces in. It is, perhaps, true that the labor can be performed by the railway to better advantage and at less expense than by its patron, but this does

* In reference to the manner of settlement between the different lines for through traffic, or that which passes over several lines of railway, it is said to be the custom in England to deduct from the gross amount charged for performing the service a specified sum for terminal expenses, varying in amount as between London and provincial towns; this sum is apportioned between the companies receiving and delivering the traffic, after which the balance is divided upon the basis agreed upon, whatever it may be.

not alter the fact. It was at one time supposed that the community would provide cars required to do business, and would attend personally to the loading and unloading of freight, while the railway company would provide the track, and in some cases the motive power.

It is the office of a carrier to transport the freight that is offered, not necessarily to load and unload it; that is the business of the owner. However, it is my purpose in this connection to notice the custom, not to suggest its change or modification.

Practices are not uniform as to the articles which owners must load or unload, but vary according to real or supposed necessities of business. Usually, however, our carriers discriminate only against coarse articles of freight, such as are bulky and not easily damaged, such as coal, grain, lumber, ores, pig iron and similar articles.

From the foregoing it is apparent that a company's outlay for station labor, warehouse and yard room is largely dependent upon the character of its business. If made up of freight which the carrier undertakes to handle, the terminal charges will be much greater than in other cases.

These charges are incidental in character and contemplate an outlay for grounds, tracks, warehouses, platforms, yards, elevators, depots and other machinery necessary to the economical and expeditious discharge of business. They vary so

greatly that before attempting to compute the expense of conducting a traffic their cost must be carefully ascertained.

Terminal facilities, moreover, that cost but little at one point may involve enormous outlay at another. Thus, depot grounds and yard room that can be provided for a few dollars in an interior town, cost millions of dollars in a great city. The interest upon the capital invested in these facilities, whatever it may be, becomes a fixed charge upon the property and must not be overlooked in determining the cost of doing business.

In reference to cost of handling different kinds of traffic, the greatest difference exists, but the extent of this difference is little appreciated. Thus, the expense for station labor in connection with the movement of fifty thousand cars of coal, earning perhaps a million of dollars, will hardly be more than that for handling a few crocks of butter or the worn-out effects of an itinerant preacher. Differences of this character continually occur in the operations of railroads and will ever confound those who seek to make a law or institute a practice that place them upon a common level. As soon might we prescribe a given quantity of food, drink, air or clothes for men, without reference to their appetite, health, labor or size. Terminal expenses, permanent and otherwise, are not governed by the revenue derived from a business, but are the same in all cases, whether the traffic is desirable or otherwise.

Nor are terminal expenses affected by the length of the haul. Thus, it costs as much to handle a consignment of merchandise destined to a neighboring town as to a point a thousand miles away; the number of laborers is the same, the clerical force the same, the facilities the same, the risk of accident and theft the same.

The through traffic of railroads may be said to represent the long haul in contradistinction to local business, which represents the short haul, and while the terminal expenses are the same in either case, local traffic necessitates frequent stoppage of trains, with all the expenses incident thereto. They form a sensible burden, never to be lightly considered or overlooked in estimating the difficulties and expenses of operating.

Within certain bounds the profitableness of a business is dependent upon the length of haul. It is an aphorism in railway management that the equipment of a company earns money only when in motion. Anything, therefore, which retards that motion, acts to the disadvantage of a carrier.

To continue: the station facilities necessary to accommodate the suburban travel of a metropolitan road must be quite as elaborate as for a more profitable business—for long haul traffic, for instance. The expense that attends it is much greater than for ordinary traffic, because it is fixed in cities or their immediate neighborhood, where values have reached the highest point. This business, instead of paying a higher

rate than traffic requiring less costly accommodations, is awarded a less rate. This difference is oftentimes more than is justified by the quantity handled. A low rate is given from a desire to stimulate traffic. It represents also the difference between wholesale and retail business. Suburban residents represent an average haul each day equal to so many trains (a fixed quantity), while isolated passengers, gathered at widely separated points, represent the retail element of trade.

While it is true that terminal expenses incident to traffic must be considered in fixing the rate, it is also true that no recognized or uniform practice can be observed. The judgment of the compiler of the tariff, based on the peculiarities of the business, must determine the rate for the time being. A more formal basis is not practicable.

Few companies could provide the terminal facilities they do if their trade were wholly local. The profits they derive from through business enable them, for the moment, to carry the burden of the less profitable traffic.

It is a generally accepted belief that the local business of a road is the more remunerative, for the reason that it is not subjected to the disturbing influences which surround through traffic. This was the case at one time, but long ago ceased to be so. Multiplicity of roads paralleling and intersecting each other oftentimes compels them to compete for local business quite as much as for through traffic.

The cost of soliciting business is to some extent a terminal expense. It varies greatly upon different lines. The expense of one line for advertising and soliciting agents, for illustration, will be treble that of another. This difference may be occasioned by the disadvantages of the company's line or the special character of the business.

It will be seen from the foregoing brief and imperfect consideration of the subject that special items of cost connected with the handling of traffic cannot be overlooked in studying the disbursements of railways. This fact should be remembered by legislators and others in attempting to enforce uniform rates and conditions. Each company must be considered apart and the conditions attending its traffic duly and exhaustively studied.

CHAPTER XII.

MAINTENANCE—FIXED OPERATING EXPENSES.

Expenditures do not grow relatively with a traffic. The outlay upon a heavily worked line is not proportionately as great as upon a line less busy. One of the reasons is that a large proportion of the disbursements of a company comes under what are called fixed expenses. Many expenses of this character are not affected at all, or only remotely, by an increase or decrease in business. However, these expenses are never the same relatively upon different roads.*

The fixed expenses of a railroad may be termed the minimum cost of operating. After they are provided for, every dollar of income a property can be made to earn without increasing such expenses, represents, obviously, a decided gain. This is well understood and represents a principle

* The term fixed expenses or charges is used in a double sense in railway nomenclature; first, it applies generally to the operating expenses, interest and rentals of railroad companies, and, second, to those expenses connected with the immediate working of the property that are not affected at all, or only lightly, by the amount of its traffic, such as superintendence, salaries of station agents, flagmen at crossings, bridge tenders, etc. The last named should be called "fixed operating expenses" or "fixed expenses," while the former should be called "fixed charges."

that lies at the foundation of the practice of granting a relatively low rate when the traffic is unusual in quantity or can be handled without adding relatively to cost.

A brief summary of fixed expenditures may be properly given here; and, first, I may mention those relating to organization. This must be maintained with little, if any, reference to the amount or profitableness of the business done. All of a company's affairs are dependent upon the preservation, unimpaired, of its legal status. This obligation is imperative, and while the disbursements on this account may be small compared with many others, they are, nevertheless, considerable.

Many expenses intervene, without much, if any, reference to the amount of traffic. Thus the mail must be carried and delivered punctually, no matter how small it may be; the convenience of the public must also be provided for at stations and elsewhere, and the number of specified trains (which the custom of the country or the charter of the company compels it to operate) must be run each day. In matters such as these the discretion of the management is very limited indeed.

The outlay incident to the movement of trains is the same for wages of men engaged, whether the cars are loaded to repletion or travel comparatively empty. This is also true, relatively, of other train expenses, such as fuel, oil, lights, attendance, wear and tear, etc. Someone, also,

must be on hand at stations to open the company's waiting rooms, see that they are kept clean and comfortable, preserve order 'in and about the buildings, keep the platforms and track unobstructed, ticket such passengers as present themselves, receive and discharge goods, and answer questions asked by patrons.

The wages paid the incumbents of these offices must moreover be such as to secure faithful men, competent to perform the maximum amount of service required. And so it is with the organization of the force as a whole—with general and local officers, superior and petty heads, including foremen and others. Each must, in his place, be competent to perform, at a moment's notice, the greatest amount of service that the necessities of the company require. An exigency arises and passes in railway life like the flight of an express train. There is no time for consultation, no time to study text-books, no time to examine rules and regulations, or to write to superior officers for instructions; the company at such times must have someone on the spot competent to act. Such necessities must be provided for without reference to the general run of business, and in so far as this is so, they constitute a fixed expense.

An agency that may, at any moment, be called upon to handle a hundred carloads of freight cannot be intrusted to the care of a person who could perhaps manipulate half that number with facility, but would break down under greater responsibility. The agent must, in his turn, select

subordinate servants with a view to like contingencies. What is true in this respect of the agent and his assistants applies with equal force to conductors of trains, foremen of shops, track bosses and superintendents of bridges. It applies, with redoubled force, to managers. The exigencies of railway service require men of special training, of peculiar qualifications, of minute practical knowledge. There are no exceptions to this rule in any department or branch of the service. Supervisory officials, especially those in immediate charge of the property, must be as well skilled as the directing manager. They must possess general knowledge, as well as particular acquaintance with the immediate position they hold. This involves intimate acquaintance with the property as a whole—its defects, resources and peculiarities. This presupposes long association, years of observation and thought. Attainment is impossible otherwise. Without prolonged association the knowledge officials bring to the discharge of their duties is incomplete, oftentimes impracticable.

The personnel of a railroad organization may not, therefore, be changed hastily or unadvisedly without detriment, for the property is the creature of the operative and its value dependent upon his capacity and fidelity. He must ever be considered in forming an estimate of its present or prospective value.

In every department of railway service we discover carefully selected men of capacity and

resources, the superiors of their fellows, singled out with reference to present and prospective emergencies. From the character of these men we may judge intelligently of the discernment and trustworthiness of the managers.

The importance of the duties (present and prospective) performed by various classes of officials is apparent in the compensation allotted them. The official in charge of a pass high up on a mountain side, or having the care of a difficult morass or hazardous piece of track, no matter where it may be located, is paid a higher rate of wages than his neighbor, whose skill and responsibility are less. Selections in every case are based on fitness. A track foreman who might be trusted in the absence of danger could not be depended upon to act with intelligence and precision in case of a wreck or the washing away of a roadbed. A bridge superintendent who understands how to keep in repair the property intrusted to his charge under ordinary circumstances, might be exceedingly awkward if called upon at a moment's notice to construct an entire structure. In the same way a conductor who might know how and when to start or stop a train, how tickets should be collected or cars received into or detached from a train, would not, perhaps, know what to do in case his train was thrown from the track or lost its rights. All these things are thought of and anticipated.

In the selection of men to fill petty offices of responsibility, as well as those of greater degree.

every varying circumstance must be carefully considered by the appointing power. Selection or continuance in the service require, frequently, extra wages. Thus extra wages are paid sometimes to meet exigencies that never arise. These we may term constructive expenditures. They are much the same upon all lines, without reference to the business done.

The cost of caring for a property is not affected by what it earns to so great an extent as is generally supposed. A competent and trustworthy manager must in any event be employed to look after its affairs. The amount paid him is dictated by the extent of the property and the ability and faithfulness of the man. This is true to a certain extent of all the officers of a company. The salaries of minor officials are more dependent upon the business done. This is also true of subordinate servants, but a large proportion constitutes a fixed expense, not dependent, except remotely, upon the amount or profitableness of the business.

At the headquarters of every company an expensive force must be maintained. It is made up of assistants, and is the subsidiary brain of the enterprise, without which the organization would fall to pieces of its own weight. It consists of skilled men. They carry on the general business of the company as between the corporation and the public; also as between the former and employes on the line of the road. They are, as a rule, discreet and able men, well disciplined

in their offices, and commanding the respect of the public and the obedience of the employes of the company on the line. The number and salaries of these assistants are not materially influenced by the fluctuations of trade, except when it extends over a considerable period of time. They may be said to be fixed in the offices they occupy. Increase or decrease of traffic does not affect them. The explanation of this is found in the difficulty of filling their places. The knowledge they possess is the result of laborious training and years of familiarity with their particular duties. Except when business is depressed for a very considerable period, it is inexpedient as well as expensive for a company to make any change or reduction in its general office force. A reduction of wages is practicable, but not a reduction in number.

The traffic of a company may be paralyzed by a great storm, or its business disturbed by the failure of a crop or through the diversion of trade, without lessening its fixed expenses.

Up to a certain point, addition to traffic is not followed by corresponding increase in either the number or wages of employes. There is no increase in the number or pay of watchmen at crossings and bridges, track patrol, or persons in charge of tunnels or bridges. No increase in the number of agents at stations, of the principal ticket sellers, of the men employed in connection with the customary trains, of foremen and their assistants, busied in keeping the track in order,

or of the force at shops and roundhouses and depots of supply.

When, however, traffic increases beyond a certain point, expenditures for wages will increase beyond what the profitableness of the added traffic warrants. This increase will continue until the traffic again reaches a point where the maximum amount of labor is exacted.

Within certain limits, the elasticity of every organization enables it to accommodate an increase of business without addition to its number, just as a considerable increase is possible in the number of guests at a hotel without any addition to the number of attendants. Let us suppose the maximum of this increase to be fifty guests. This number may be added without increased cost for service to the proprietor, but at this point the addition of a guest will necessitate the employment of an additional clerk, another waiter, an assistant porter, and so on through the list of attendants. This outlay is, of course, out of all proportion to the added income and has, therefore, the effect of increasing the relative cost of operating the house. It is, however, unavoidable, and so it is in the working of railroads. We will suppose a passenger train is added to the list of those already operated by a company. Only a small percentage of the patrons of this new train is made up of new passengers. The traffic of the line simply readjusts itself to the increased facilities. The convenience which the new train offers

the public will add a few passengers, but there is no marked addition to the business, and until there is an increase commensurate with the added facilities the company is a loser, for the reason that under the new order of things its train service is performing only the minimum labor of which it is capable, while before it performed the maximum amount. The same rule applies to freight trains and is noticeable in all departments of the service. At a certain time in the growth of a traffic, it thus appears, the outlay is much greater than the income. Subsequent growth of business may warrant the increase, or it may not. In determining such questions (and they are of continual occurrence in the operations of a railroad) the judgment of the officer upon whom the responsibility rests is sometimes colored and confused, so that intelligent action is not to be expected in every case. So far as the writer's observation extends, the only means of testing the possibilities of a company's traffic is to add new trains.

There is this to be remembered in connection with additions made to the number of employes of a well appointed railway company (in contradistinction to a new enterprise), its well disciplined organization enables it to utilize the cheapest quality of labor of the kind it needs. This is impossible in the other case. The first only requires an increase of mechanical force, not of constructive ability. The effect of such additions is, of course, to reduce the average cost of doing

business; a consummation every manager labors unceasingly to bring about.

The effect I have pointed out of determinate expenses or cost as it is influenced by labor of a certain character is quite as marked in other departments of the service. Thus, disbursements for interest on bonds are not affected even remotely by fluctuations of business. This is equally true in many instances of taxes, assessments being based on the supposed value of the property rather than upon its revenue producing qualities.

Many of the guaranties also which business compels a company to enter into are not affected one way or another by earnings.

The amount paid for rent of buildings and grounds is only nominally affected by the increase or decrease of earnings. Any permanent decline of business in the end necessitates a readjustment of contracts and leases, but as agreements connected with buildings and grounds are usually entered into for a series of years, the expenses they entail cannot be hastily diminished.

Also the cost to a company of keeping its fences, gates and crossings in order is not increased or diminished, perceptibly, by the business it does. The amount disbursed for these purposes is dependent upon other causes, over which a company has very little control.

The expense of maintaining the permanent structures of a company depends quite as much upon natural influences as upon the business

done. Under the most favorable circumstances bridges and culverts will crumble, buildings will fall to the ground, fences, gates and crossings will succumb to climatic and other influences, embankments and cuts will be rendered unsafe, ditches will fill up, the roadbed will require ballast and careful attention, and ties will decay and the rails become unfit for use. All these things will occur, whether business be light or heavy, if a constant stream of money is not poured out day by day.

The expenses of a company also depend largely upon the nature of renewals. These, it is apparent, will be influenced by the length of time the property has been in operation and the thoroughness with which it was originally constructed.

At first, cost of maintenance will be very light upon a well constructed road, but with the lapse of time it will steadily increase, the maximum being reached at the point at which the average durability of such property is reached. This period will vary in different sections and under different circumstances, according to climate, nature of material used and amount of business done. Under ordinary circumstances, the average should not be reached under ten years, or whatever time may represent the average durability of rails, ties, spikes, equipment, platforms, fences, buildings, bridges, culverts and similar property.

Generally, it may be said that the amount of business determines the duration of equipment, while weight and speed measurably determine the duration of rails.

Turning to another feature of the case (the machinery of railroads), the difference between the wear and tear of that used and unused is not nearly so great as it would seem at first glance. The cost of preserving unemployed machinery in good order is not noticeably less, as every manufacturer is aware, than the cost of keeping it in order when employed.

The subtle influences of idleness are as destructive to man's work in this case as idleness is to man himself. The machinery he constructs with such infinite care and labor requires constant attention, otherwise it quickly becomes worthless.

The amount of fuel necessary to haul the minimum load of a train is a fixed charge. The fuel consumed by a locomotive hauling thirty cars is not relatively as great as when hauling one-third that number, yet the appurtenances necessary to the successful operation of the train are practically the same; the lubricants used upon the locomotive are substantially the same; the lights and furniture are the same; the conflagrations which the locomotive causes are the same; the accidents are the same; the number of incautious people killed or injured is the same; the number of cattle run over and crushed is the same; the number of switches to be turned at meeting points is the same; the wages of the train force

are the same; the telegraphic orders that pass back and forth between different train officials are the same; all the varied expenses connected with the use of water are practically the same.

As I have stated, the cost of keeping up the organization of a company is not noticeably different, whether the business is large or small, productive or otherwise. The expenses which the laws require must be met without reference to receipts; bulletins must be posted as the law prescribes; tariffs must be promulgated, agreements made, notices of elections posted, trustees remunerated, traveling expenses met, complicated and expensive returns rendered, lawyers employed, and insurance duly looked after.

These expenses are in the main inherent and in no wise dependent upon the productiveness of business. When, therefore, we see a partially loaded train winding its way across the country, or remark a yard filled with idle equipment, we must not conclude that the owner has reduced his expenses to conform to the business he is transacting, or that it is possible for him to do so. On the contrary, we may truthfully believe that many of his expenses have not been lessened at all. And we may remember another fact, namely, that the owners are never disregarding of the circumstance that profits arise out of the business that is carried on after the fixed expenses have been met, and hence in fostering business they need no spur. To them, therefore,

may safely be left the development of the business of their lines. Out of it grows their profit; without it their roads are worthless. No one is so much interested as they, no one so wise in the solution of vexed questions.

CHAPTER XIII.

MAINTENANCE—COST OF OPERATING AFFECTED BY FACILITIES.

The cost of operating a road is affected favorably or otherwise according as its facilities are ample or not.

To enable a company to secure the most favorable results possible it must be able to carry forward its repairs and renewals at the most opportune season of the year and have appliances fitted to their economical and rapid performance. It must be in good condition financially and possess machinery fitted to its wants and adequate to carry on its work.

Many of the differences noticeable in the cost of working railway properties are attributable to differences in facilities.

A company that is not provided with adequate equipment for doing its business suffers many expenses that would under other circumstances be avoided. In addition to this loss, the traffic that it cannot for the moment accommodate will, when it can, seek other channels, and thus its revenue will be lost. Moreover, current expenses will be increased in many cases, while loss of business will swell the percentage of operating expenses to revenue.

A superabundant equipment, on the other hand, is unprofitable to its owner. Its possession involves loss of interest on cost and the expense of keeping it in order. In addition to this, the effort to find employment for it is quite likely to lead its owners into excesses, of one kind or another, but mainly in the direction of unnecessary rate cutting and other foolish competitive efforts.

The disposition of railway companies to encroach upon each other, coupled with a belief inherent in the breasts of many of those who serve them that they can create business, has been the cause of many of the disasters that have wrecked railway properties.

What I have said in reference to the necessity of restricting the machinery and rolling stock of a company within necessary bounds, applies equally to its property as a whole. While a property must be maintained at a point commensurate with the needs of business, it must stop there. Contingent wants that may never occur should not be anticipated, but left to be met when the exigency arises.

While owners thus restrict themselves they will remember that prosperity cannot be attained or maintained without adequate facilities. When needs are inadequately provided, revenue that should accrue for extending and strengthening the property is lost. A company thus unhappily situated cannot compete successfully with an alert rival. It is avoided by many who would, under other circumstances, give it support, while

its expenses are swollen unnecessarily by its improvidence.

Railway managers, it may be said, understand the importance of keeping a property in good condition. The difficulty is, and always will be, to make the owners equally alive to the fact. Absorbed in the prospect of a dividend, secure in the belief that the management will provide the necessary ways and means for meeting renewals and improvements, they lack apprehension and interest. They do not refuse to make provision for the company's wants, they simply ignore the matter. To meet together from time to time and authorize an expected dividend, is too often the consummation of earthly responsibility on their part. They listen with approval to the remarks of the chairman, congratulate the manager upon his energy and efficiency, and disperse, leaving him to get along as best he can. Thus, his wishes are disregarded and the strength of the property wasted. The truthfulness of this is apparent in many ways and it is needless to say that the losses resulting are always disproportionate to the saving effected.

Innumerable instances might be cited, if necessary, to illustrate the necessity of a company supplying itself with needed appliances. Thus, a company that does not possess adequate tracks, convenient sidings or sufficient yard room cannot handle its traffic with the celerity and economy it could if it possessed such facilities. Again, the company that is able to make its track

repairs and renewals at the period of the year most advantageous for such work will be able, manifestly, to do so more economically than its less fortunate neighbor. It is essential, above all things, to the prosperity of a company, that it should be able to make its repairs and renewals as occasions for them arise. An unsafe bridge, an insecure culvert, or a defective axle or wheel may involve the destruction of a train which, with collateral losses, will amount to thousands of dollars. And it must be remembered that the losses that result to a company from accidents of this kind can never be known, for the reason that they entail loss of public confidence in the methods of a company. Thus, to the known loss there must be added indirect loss occasioned by diversion of traffic.

It is in details of operation that losses accruing from improvident management are most marked. Thus, a battered rail in the track of a busy line will so rack the equipment passing over it that the cost of repairs will many times outweigh the value of a new rail. The same is true of a line imperfectly ballasted, or one where the alignment is wrong.

The cost of keeping locomotives and machinery in good condition is very much dependent upon the carefulness with which they are kept cleaned and housed when not in use. The rolling stock that is kept well painted and in good repair is not so expensive to maintain as the equipment that is neglected and, while present outlay for repairs,

cleaning, housing and painting may be a burden, it will result in more satisfactory returns to owners than a contrary course.

What I have said in reference to machinery and rolling stock applies to every branch of the service. Thus, the increased disbursements to meet interest on money expended for overhead bridges or viaducts at busy points is, in many cases, more than counterbalanced by freedom from accidents and saving in wages and other expenses.

The wisdom of providing needed appliances for conducting business is perceptible, everywhere, in reduced expenses. Thus, the introduction of a new piece of machinery, a copying press, a patent ink, a new blank or other contrivance intended to simplify or cheapen, frequently renders a reduction of the force possible, or prevents an increase otherwise unavoidable. Innumerable illustrations of this nature might be cited.

The usefulness and perpetuity of a plant is indefinitely heightened and prolonged by its maintenance at a high state of efficiency. This is particularly the case with machinery and equipment, as I have noticed. Such property should be maintained at the maximum state of efficiency. The life of a car, locomotive or stationary engine may be greatly prolonged by prompt repair of the various parts as rendered necessary, while neglect will hasten the general breaking up. The necessity of maintaining property is well understood by managers; but they are often

overruled in the matter, not being allowed the funds necessary to carry on needed repairs. There can be no doubt of the shortsightedness of such a policy, and a company thus administered is an unsafe enterprise to invest in.

CHAPTER XIV.

MAINTENANCE—PROPER BASIS OF RAILWAY TAXATION.

Questions attending the taxation of railway property are most perplexing. It is hard to conceive of a basis that will not, under conditions likely to occur, work hardship to either the state or the carrier. If the tax is based upon realty, the difficulty of determining the value thereof is apparent. If based upon gross earnings, the temptation of the state to abuse the opportunity is a constant menace.

In fixing the tax, it is apparent a different basis should be found from that in force in the case of private property, for the reason that railroads are surrounded by restrictions (not known in other cases) which greatly retard their earnings capacity. These, it is manifest, must be carefully considered. Many methods of taxation are in force. Differences are as prevalent here as in other matters affecting the operation of railways. A description, however, of the systems of taxation of a few representative governments will be interesting.

The Belgian system suggests itself first. It is on the whole very satisfactory. Taxes are levied on the basis of net earnings. If there are no net earnings, there is no tax. In other words,

if the owners of a property do not receive anything for its use, they are not asked to supplement their loss by other losses. Taxes upon real or personal property are unknown. A small tax on the capital stock owned by Belgian citizens is exacted, but the law does not require holders to register their shares. The tax, therefore, can be, and is, evaded. Indeed, the evasion is designed, the purpose being to make net income the basis.

In Great Britain the general tax on railway property is based, like that in Belgium, on net earnings. Following the custom, however, enforced prior to the introduction of railroads, a tax of five per cent. is levied on gross passenger earnings. Fares that do not exceed a penny per mile (instituted to benefit the poorer classes) are, however, exempt. No direct tax is levied on freight, express, mail or miscellaneous earnings, as such. Taxes are based on net annual profits. Thus, except in the case of the tax on a portion of the passenger traffic, nothing is exacted in the event there is no surplus over and above operating expenses. It must be remembered, however, in connection with the English method of taxation, that the practice of mortgaging railroads is not practiced there to the extent it is in the United States. Money raised to build railroads is represented by capital stock, and the government tax takes precedence of any dividend on such stock. It is, in a general way, the same as levying a tax in the United States on earnings

before deducting the amount paid as interest on bonds or for dividends. A committee of our state commissioners, appointed several years ago to examine the question of taxation, commended the English system, but, in the recommendations they make I am unable to find that they conform to its provisions.

During the civil war in America a tax was levied on gross earnings, but it was added to the tariff rate by the carrier, so that he acted simply as the agent of the government in collecting the tax from the people. A tax of three per cent. (afterward increased to five) was levied on mortgage interest and dividends. It was deductible by the payer.* A stamp tax on the bank checks of railroads was also levied. All these taxes were considered to be of an extraordinary nature consequent upon the expenses of the war, and were, one and all, permitted to lapse with the occasion that gave them birth.

Taxes levied by different states of the Union are not the same. Frequently, different methods are pursued by the same state. The basis will be different, and the method of assessment and levy different. Each pursues a system, partly its own, partly borrowed. The annoyance these differences occasion are aggravated by the fact that the lines that separate the states have no com-

* The tax was usually deducted by the companies from the amount holders would otherwise have been entitled to receive. In some cases, however, the amount of the tax was paid by the company.

mercial significance. Moreover, the differences are oftentimes discriminative in their nature to the extent of two or three per cent. of gross earnings.* This is a very serious matter in the case of competitive companies. To those familiar with the subject it requires no difficult stretch of the imagination to picture, under such a state of affairs, a line so taxed as to afford another company, not so heavily handicapped, a margin on its business equivalent to a fair profit on its investment, or sufficient, if divided among its patrons, to afford inducements to shippers that the first named company could not meet without putting an undue strain upon its resources. This is discrimination in its most objectionable form. When a state discriminates, as it does sometimes, between railways within its own borders, the same results are produced, the difference in the tax affording the favored line a margin it may use to ruin its adversary.

A description of the different methods of taxation in the United States would fill a volume. For purposes of illustration a few representative states may be given. In Wisconsin, taxes are based on gross earnings. The tax is levied by the state and is payable yearly in two equal installments, six months apart, in the year following that for which the tax is levied. Towns and

* Thus, in Michigan, in 1897, the tax was two and one-half per cent. on roads earning less than \$2,000 per mile, with an increased percentage on earnings in excess of \$2,000 per mile; while in Wisconsin, across the border, the tax was four per cent. on all roads earning over \$3,000 per mile.

cities are only permitted to levy a tax for the improvement of streets within their borders occupied by railroads. The Wisconsin tax is based upon the annual gross earnings per mile of road. When the earnings exceed, we will say, three thousand dollars per mile, a tax of four per cent. of the gross earnings is levied; if earnings are over one thousand five hundred dollars per mile and under three thousand dollars per mile, the tax is two per cent. of gross earnings; if gross earnings are under one thousand five hundred dollars per mile, the tax is five dollars per mile of road.*

The advantage afforded the second and third class roads, while it may be proper in the main, is capable of being used to the serious detriment of other lines. It is not difficult to picture a road of the second or third class that is earning more on its capital than those having a higher revenue per mile. Of course, the presumption is that the lower grade roads are only able to pay a small tax, but this presumption is not tenable in every case, and when not true to the extent of the favor extended, the discrimination may be used to

* According to this, the tax on a mile of road earning \$5,000 is \$200; on a mile of road earning \$1,500 it is \$5; and on a mile of road earning \$500 it is also \$5. The decrease of percentage in favor of the road earning \$1,500 per mile as compared with a road earning \$5,000 per mile is $3\frac{2}{3}$ or $91\frac{2}{3}\%$ per cent. of the tax levied on the latter. On the other hand, the road earning \$1,500 per mile has an advantage over the road earning \$500 per mile of two-thirds of one per cent., the tax being the same on both roads. On a road earning less than \$500 per mile the discrepancy would be relatively greater.

reduce rates to the serious detriment of roads of a higher class. It is apparent that a road that pays only five dollars per mile annual tax is in a condition to do business on more favorable terms than one paying two hundred dollars or more, and may use the advantage thus afforded by the state to undermine other properties.

The Michigan tax, based on the law of 1897, is two and one-half per cent. on gross earnings up to two thousand dollars per mile; three and one fourth per cent. on the second two thousand dollars of earnings per mile; four per cent. on the next two thousand dollars; four and one-half per cent. on the fourth two thousand dollars, and five per cent. on all earnings in excess of eight thousand dollars per mile. Taxes are levied for the calendar year and are payable before July 1st of the succeeding year. Michigan also levies a tax of two and one-half per cent. on such receipts of corporations (not operating a railroad in Michigan and paying the specific tax above mentioned) as may be received by such corporations from passengers carried in said state in palace or sleeping cars, or cars for which an extra price is paid; also on gross receipts derived from the leasing or hiring of cars by fast freight and other lines. Railroads incorporated before 1850 are subject to an annual tax of three-fourths of one per cent. on their capital stock and loans used in construction. Lands owned by a company in Michigan, but not required in connection with the operation and

maintenance of its road, are treated in all respects as if owned by private individuals.

In Minnesota, taxes are based on gross earnings, but practices are not uniform. Railroad companies organized under special charters may pay, in lieu of all other taxes, one per cent. of their gross earnings for the first three years, two per cent. for the next seven years and three per cent. thereafter, or they may accept the provisions of the general law applicable to all property.

Iowa fixes the valuation of railroad property by a state board, consisting of the governor, secretary of state, auditor and treasurer. The assessment is also made by this board. The tax is fixed arbitrarily at a certain amount per mile of road. The amount is apportioned by the board to the various taxing districts through which the line runs, upon the basis of the relation that the mileage of the road in such districts bears to the total mileage. Under this method the real or relative value of the property in the various taxing districts, it will be seen, does not affect the amount allowed them, the basis being the number of miles of main track. The tax thus assessed is paid to the local authorities along the line and includes real and personal property of every description. It does not, however, prevent taxation for special improvements by cities and towns.*

* In Iowa, the holder of the securities of a railroad company located within the state is taxed on such securities the same as on other personal property, although the railroad has already been taxed on its full value.

Illinois has a more complicated system of taxation than any noticed. Taxes are based on the value of the property. The assessment is made partly by a state board of equalization and partly by local authorities. Taxes are paid to the treasurers of the various counties through which the road runs. The value of the property in the various taxing districts (coming within the cognizance of the state board) is certified to such board by the local authorities. The state board then fixes the value upon which the assessment shall be made. A railroad in Illinois is understood to include the right of way, tracks and other improvements thereon. The value of the rolling stock is determined by the state board and apportioned to the local taxing districts on the basis that the mileage in such districts bears to the total mileage. Real and personal property not included in the assessment referred to, such as wharves, shop grounds, supply depots, storage houses and the contents thereof, including furniture, tools, machinery and fuel, are assessed by the local authorities. Moreover, if the funded debt of a company and the market value of its shares exceed the value of the real and personal property ascertained in the manner described, the company may be taxed for such excess.

Such are some of the methods of taxation pursued in America. I refer to the subject again further on. There is nothing fixed about these methods and they may be changed at any meeting of a state legislature. The manner in which the

states apply the tax is never, so far as I know, the same in any two cases. Systems differ in detail and oftentimes in principle. None of them is satisfactory, and it is probable that a perfectly satisfactory system cannot be attained. To be just it must take cognizance of each company and must be equitable in its application. This is hardly to be expected—at least for the present. We should not, however, the less strive for its attainment. In this connection it is noticeable that the more enlightened of the officials of our state governments appreciate the serious objections that exist to the systems of taxation they enforce. This feeling found expression at one period in the appointment of a board of state railroad commissioners to examine into the subject. It finally recommended a tax on gross earnings, supplemented by a tax on realty. “The conclusion at which your committee arrived was that all the requisites of a sound system were found in taxes on real property and on gross receipts, and in no others—in fact, that when these were properly imposed, no other taxes would or could be necessary, as nothing would escape untaxed. Under this system the real estate of the railroad corporations, held for corporate use outside of their right of way, would be locally assessed, exactly in the same way as the real estate of private persons or of other corporations adjoining it was assessed. There would be no distinction made in regard to it. It is the ordinary tax on real property. Beyond that a certain fixed percentage, established

by law and of general application, should be assessed on the entire gross earnings of the corporations, and this should be in lieu of all forms of taxation on what is known as personal property. Under this system the rolling stock of the corporation would not be assessable; nor its securities, whether stock or bonds, either indirectly through the corporation or directly in the hands of those owning them. The entire burden, be the same more or less, would be imposed in one lump on the corporation and levied directly. It does not need to be pointed out that this system is perfectly simple; that under it taxation is fixed by a general law and not by local valuations; that it is thoroughly proportionate, inasmuch as the amount levied depends on the volume of gross receipts; finally, it can be ascertained by anyone, and can by no possibility be evaded."

Let us examine the method they suggest, and, as they have themselves pointed out its merits, we may confine our examination to its objectionable features. And first it is apparent that the property, outside the right of way, would be doubly taxed, for the reason that earnings are based on total cost. A tax levied on earnings covers every species of property so far as such property is necessary or contributes in any way to earnings. The objection to this basis is it supposes that property outside the right of way does not contribute to the earnings power of a road. Might we not with equal reason say that the brain is not a part of man, that he is made up

wholly of legs and arms? A system, moreover, which permits a company to be taxed by the state authorities and also by the various districts through which it runs, independently of each other, invites in its operation measures of the most oppressive character.

The rate of taxation proposed is also variable. If earnings exceed a certain amount per mile, then a particular rate is to be enforced. If the earnings do not exceed this amount, then a different rate is charged. The distinctions contemplated are objectionable for the reasons I have already pointed out.

The operation of a tax based on gross receipts without reference to the cost of a property or the expense of operating is objectionable, as its effect is to confiscate net revenue in many cases. A tax on gross earnings does not recognize the equities of business—the difference between a profitable and an unprofitable business. If the capital invested in different roads or different parts of a road were the same, the cost of maintenance the same, the amount of business the same, the expense of operating the same, and if there were a sufficient margin of profit after deducting expenses of maintenance and operating, a tax on gross earnings would not be objectionable; but, unfortunately, these conditions do not exist in a single instance. Cost is never the same for different roads, and for the same road one portion will cost more than another. The expensive part, however, is as necessary to the

system as the other. Thus, while gross earnings amounting to one thousand five hundred dollars per mile may afford a fair margin of profit on a cheap line, earnings amounting to ten thousand dollars per mile might be insufficient on a more costly line. A tax on gross earnings does not recognize the distinction between widely different classes of property, and in so far as it fails to do this is objectionable.

Discrimination between railroads through the levying of a different tax on their gross earnings is in the nature of a subsidy granted to one and denied to another. This subsidy is allowed without reference to relative net receipts, and is, therefore, nothing more nor less than a fund which the receiving company may retain or use in the procurement of business to the serious detriment of its rivals.*

A tax based on gross earnings is objectionable under the most favorable circumstances. The directness and simplicity of the assessment and levy invite aggressiveness and injustice upon the part of legislators and others. Its processes are too easy.

If taxation were a blessing to be encouraged, then the case would be different. Unfortunately, it is the reverse of this, and one of the chief concerns of men in America is to restrict by every means the amount of the annual tax levy. Under the system of assessing gross earnings

* In Wisconsin this rebate, as I have shown, exceeds three per cent. in some cases.

legislators, ambitious of cheap renown, see in the addition of a slight per cent. to the tax on railroads an easy way to relieve their constituents without loss of local popularity, and thus an injustice brought about by the weaknesses of a legislator is forever fastened upon the carrying interest. Or, in the absence of individual action, the burdens of the community are placed upon the railroads simply because they represent a small and unpopular minority, the process for fixing the burden upon them being simple and certain.* A tax on gross earnings is objectionable on other accounts. If the business of a company were unprofitable, the greater the amount of its business the greater the burden it would have to bear. We can easily conceive of a case where a company might have large gross earnings but no net revenue at all. The burden of a tax under such circumstances would greatly accelerate its road to ruin. When the business of a railroad is barely profitable, a tax based on gross earnings is in the nature of a prohibitory enactment. Such a tax takes no account of the cost of properties nor their real earnings. There

* "In certain states railroads are apparently looked upon as a species of windfall from which everything that can be exacted in the way of taxation is so much pure gain."—*Report of Committee of State Railroad Commissioners on Taxation; Proceedings of the National Convention of Railroad Commissioners*. This disposition would only be aggravated, we may believe, by simplifying the processes by which the railroad companies may be harassed. Our efforts, therefore, should be directed to rendering it difficult, if not impossible, for the ignorant and vicious to make a football of railway interests.

are other objectionable features I cannot stop to notice. Wherever taxes are based on gross earnings, the amount of the tax should be added specifically to the tariff rate in billing the freight or ticketing the passenger. In no other way can the baneful effects likely to follow such a system be obviated.

Taxes based on capital stock or bonded debt are also objectionable. While apparently fair in many ways, they are like taxes on gross earnings, fallacious and unjust. However, as such method has few advocates, I do not esteem it necessary to enter into a discussion of the subject here.

Taxation based on real and personal property, the assessment being made by persons on the ground and familiar with local values, is the least objectionable of the methods that have been tried in America. Such a tax does not invite class legislation to the extent that a tax on gross earnings does. Valuations are measurably real, because based on the condition of the property in the various taxing districts. The tax on gross earnings is based, in many instances, upon merely nominal values. The realty tax is at least *bona fide*, and permits, moreover, the exercise of judgment and an equitable conscience. The objections to it are that assessments are not always made by competent persons. The justness of such an objection cannot be disputed, but it applies to our whole system of taxation.

An objection to the realty tax is that it fails to take cognizance of the profitableness of a

company's property, the tax oftentimes being the same whether the enterprise is productive or not. This objection is fatal. So long as the state claims the right to fix the rates railroads shall charge, or otherwise restricts their operation, it is bound to ascertain the effect of its action before determining the responsibility of the carrier as a tax payer. If the state exercises the right to circumscribe the earnings of a property, it must circumscribe in like manner the taxes it imposes. The duties of sovereignty are not simply coercive; they are protective as well. When a government by its action reduces the income of a property, the amount of that reduction is in the nature of a tax, and the effect must be considered before proceeding to impose an additional burden. The essence of railway property, as of all other commercial enterprises, is its net earnings. For this railroads are built, and for this they are operated. They are, however, the slaves of the state and require, therefore, exceptional consideration at its hands. If the state restricts their earnings, it must not impose burdens inconsistent therewith. This does not need argument. And herein lies the objection to any method of taxation of railway property not based on net earnings. If a state restricts railways in their operations, the amount a property yields its owners must be the gauge of the latter's responsibility. The systems of taxation that our states enforce do not, unfortunately, make this just distinction. Whatever surplus remains, if any, after paying expenses, is

properly subject to taxation. In all matters relating to the worth of railroads, estimates are predicated upon net earnings, for the reason that railroad property, outside its uses for railroad purposes, has no value to its owners. If a railway earns nothing, then the public which has enjoyed its benefits without rewarding its owners should not make further claim upon it;* if net earnings have been meager, the tax gatherers' portion should also be meager; if net receipts have been fair, then the tax should correspond; if the earnings have been bountiful, then the tax should be bountiful. Herein I conceive to lie the true principles of taxing railroad property. Under so beneficent a system the community of interest, as between the state and its servant, would be complete. Under it the state would be concerned in fostering railroad interests rather than in harassing them. This direct and personal concern upon the part of the state our system lacks. It levies taxes without reference to the ability of a company to pay, after having fixed, without reference to the subject of taxation,

* It may be said, perhaps, that this rule, if applied to railroads, should also be applied to individual cases. Under exactly similar circumstances, yes; not otherwise. Many of the industries of our citizens are especially protected by a tariff designed largely for that purpose, and in those cases where protection is not extended the individual is left free to derive from his business, trade or calling such profit as his experience, foresight and capital render possible. The railroad companies, on the other hand, as already stated, are hampered by special laws, and in many cases their income expressly limited by legislative enactment.

the rate of compensation to be charged for doing business. During the time railways are being constructed, and before they are opened for business, the application of the method adopted for taxing private parties is right and proper. Whatever the method of taxing railroads may be, whether based on property, shares, bonds, gross receipts or net earnings, the tax, when levied, should be final and in lieu of all other assessments.

Very little has been written in regard to methods of railway taxation. Sources of information in this direction are, consequently, meager. Mr. C. C. Harvey, who has given the subject much thought, in an article on railway taxation has this to say: "In Ohio the county auditors constitute a board of appraisers and assessors and report annually to the Auditor of State, for the use of the State Board of Equalization of Railroad Property, the amount assessed against each railroad, specifying the total sum and the amount distributed to each county, city, incorporated town, township and village. In addition to the tax paid thereon, there is a privilege tax of one dollar per mile charged by the state for each mile of main track and siding. In Kentucky the railroad commissioners (three in number) constitute the board of assessors and equalization, the valuation found by them being used for state purposes and also for each city, town, county and tax district. In Tennessee three railroad assessors appointed by the governor assess the distributable property, i. e., the

roadbed, rolling stock and personal property having no actual *situs*, every two years for state and municipal taxation, deducting from the valuation one thousand dollars before apportioning the amount per mile to each county, town and district. All other property, real, personal and mixed, including depot buildings, yards, etc., is assessed by county assessors and by the assessors of municipal corporations, who, however, submit the returns to the state railroad assessors. The governor, secretary of state and treasurer of state constitute a board of examiners upon the valuations found upon the distributable property, and their action thereon is final. It is provided that the assessors, in making their valuations of distributable property, shall have in view and look to the capital stock, property and franchises of each company, as well as the gross receipts, the individual stock of each shareholder, and the schedules filed. The local property (depots, shops, yards, material, etc.,) is assessed like other taxable property by county and municipal assessors upon the basis of the marketable value of the property. The assessment can be reviewed at the instance of either party before an equalization board and the assessments altered as the facts may warrant. In Georgia the comptroller general passes upon the returns made by the railroad companies, and, if dissatisfied with the same, reports to the governor, who shall then appoint three competent and disinterested persons to examine and assess the property. If the railroad

company is dissatisfied, the state permits the question to be decided by arbitrators, one to be chosen by the state and one by the railroad company. The law provides that the property shall be valued, as far as may be practicable, to be taxed as other property of the people of the state. In Alabama the governor, secretary of state, treasurer and auditor of state constitute a board of assessment, and the valuation found by them must be taken by the county assessors. Real estate, fixtures, etc., are, however, assessed as other property owned by private citizens. The law provides that the valuation of railroad property shall be made upon the same principle as the valuation of other species of property, namely, what it would sell for under the conditions under which that character of property is most usually sold. In addition to the ordinary tax, a privilege tax of one-tenth of one per cent. is charged by the state. In Mississippi, the auditor of public accounts, treasurer and secretary of state form the board of assessors, the valuations found by them per mile being valuations to be used for state and county purposes and incorporated towns; but the local property of any railroad in any city or incorporated town may be taxed to the extent allowed by law upon a valuation made upon the same basis as the property of individuals. In lieu of this plan as to state and county taxes, a privilege tax ranging up to one hundred and twenty-five dollars per mile of main track is fixed, two-thirds of the amount being

placed by the state to the credit of the counties, and in some cases cities and towns are allowed to impose a privilege tax equal to one-half that levied by the state in lieu of the *ad valorem* tax. In Louisiana, the police jury of each parish is required to elect one of their number, or some other property taxpayer of the parish, to act as a board of assessors on the assessment of railroads passing through the parish; the assessment, which shall be uniform, found by them, is reported to the assessors of the different parishes, and is to be final unless changed by suit for reduction, said suit to be filed and conducted in the parish in which the president of the board may live. It will be observed that in Mississippi the railways may pay a privilege tax per mile of main track in lieu of the state and county taxes. This system of so-called "privilege" tax is in vogue in other states. Maryland, Dakota and Vermont tax gross earnings. The valuation per mile of road placed upon railroad property for taxation purposes differs very materially in different states; for example, the assessed value per mile of road in Kentucky and Tennessee is about double the assessed value in Ohio. In like manner the percentage that taxes bear to gross earnings varies very much in different states and for different railways. As to the basis upon which railways should be taxed, there seems to be no good reason why the rules governing the assessment of other than railway property should not apply also to railways; the valuation

of the distributable property per mile of road, however, should be uniform in each state, as the intrinsic value of the railway depends upon its integral feature, and it is impossible to correctly assess the road separately by tax districts; it should be valued as a whole and not as a collection of separate properties. The claim that because railways are so-called monopolies they should be subjected to great burdens is not founded upon justice. Railways are subjected to governmental regulations of no ordinary nature. Many states reduce railway rates, and, by various regulations, by demands for alleged improvements to rolling stock and for special accommodations, greatly increase the operating expenses. They reduce the resources of the railway companies, and should not, consequently, burden them with excessive taxes. The question is frequently asked, How is the taxable value of a railroad to be ascertained? I am of the opinion that net revenue (the difference between gross earnings and operating expenses) should be the chief factor to determine the value. Gross earnings may be large, but the value of the property will mainly depend upon the net earnings, which will be all that can be relied upon to compensate the owners for the money invested. Capital looks for a return upon its outlay and will not, under ordinary circumstances, invest in property that will not pay a dividend upon the investment, and however large an amount a road may have cost, or however great its earnings, the property

cannot be expected to bring in the open market more than it can reasonably be expected to pay a dividend upon. The character also of the road-bed and the condition of the track will be reflected, in the course of a few years, in the net revenue of the company. Poor rails and unballasted track will entail heavy working expenses for maintenance of way and for repairs to rolling stock and probably for wrecks that might otherwise be avoided. Except as a going concern a railroad is worth very little; the cost of grading, bridging, tunneling, cross-ties, ballasting, etc., would be absolutely lost, and but a small amount obtained from the right of way, station grounds, buildings, shops, machinery, rails and the other essentials of a railroad if the road should cease to be operated. It is worthy of remark that in England, the Southwark & Deptford Tramway Company successfully appealed against an assessment for taxation, and, by proving that from various circumstances and the low fares at which they were obliged to run, their expenses were greater than their receipts, and that if the tramways were in the market to let, no tenant could be found to rent, the company practically obtained exemption from assessment. There are so many circumstances affecting the net earnings of a railroad—the actual competition of to-day, the possible competition of to-morrow, reductions of rates, poor harvests, dullness of business, labor strikes, increased demands necessitating heavy operating expenses

or perhaps capital outlay, accidents that the most careful management cannot guard against—that a liberal rate should be allowed by which to estimate the par value of the property. Probably ten per cent. would be necessary as a basis for par value, to place railroads upon an equality with other property. Upon this basis a road earning one thousand dollars per mile net would be valued at ten thousand dollars per mile, and a road earning three thousand dollars per mile net would be valued at thirty thousand dollars per mile, this valuation to be subject to such reductions as might be customary on other classes of property in the state. The annual accounts required by the state are so complete that an accurate knowledge of the results of the yearly operations can be obtained therefrom. Assessors have more reliable means at their disposal by which to make a fair valuation of railway property than for any other species of property; they have the sworn statements of the railroad companies and can refer to the annual reports made to the stockholders, to the annual reports made to the state, and in many cases to reports made to commissioners. Unfortunately, there is an increasing tendency to heavily tax corporations. The taxes paid by them are generally of large amounts and are easily collected with small cost, whereas the sums paid by individuals are comparatively small. The heavier the taxes on corporations, the lighter the burden on individuals, and the individuals are voters. A

serious objection to taxing railroads by special laws, by a gross revenue tax or by a privilege tax per mile of road, is that the tendency induces legislators, perhaps unconsciously, to unduly increase the burdens on railroads; and, consequently, to decrease the burdens on individuals; in other words, to discriminate against one class of property. As an instance, the Mississippi code of 1880 fixed the privilege tax per mile on certain railroads at eighty dollars per mile, seventy dollars per mile and sixty dollars per mile, respectively. In 1884 these taxes were increased, the eighty dollars and seventy dollars per mile tax to one hundred dollars per mile, and the sixty dollars per mile tax to eighty dollars per mile. Two years later (in 1886) there was a further addition, the taxes on all railroads being increased twenty-five per cent. over the amount fixed in 1884. In 1888 another increase was made, by amendment, to some local statute, which, however, was not signed by the proper authorities and did not, therefore, become a law. The increase actually made, however, between the years 1880 and 1886, amounted to over fifty-six per cent. on the eighty dollars tax, to over seventy-eight per cent. on the seventy dollars tax, and to nearly sixty-seven per cent. on the sixty dollars tax, while reference to Poor's manual shows that very little improvement, if any, took place in the net or gross earnings of the companies in question during that time. For other classes of property the increase in taxation was comparatively

light. The objections to a tax on gross earnings, beside that of principle, are that it operates against those roads which, for various causes beyond control, are worked at a higher cost per cent. of gross earnings than other roads (possibly their competitors) within the state; and also that it is unfair to those companies that do business at low rates, as the relative profit on low rates is less than on high rates." It is noticeable that where the tax is fixed by the state, and is based on mileage of road or gross earnings, the tendency is to keep increasing it without much, if any, reference to the income owners derive from their property. Such action cannot be too severely condemned by the public. It is nothing more nor less than confiscation.

CHAPTER XV.

MAINTENANCE—THINGS THAT ENTER INTO THE MAINTENANCE OF A RAILROAD.

Railway maintenance presents itself under various aspects, such as the preservation of the material property, the maintenance of the rights of railways under their charters or acts of incorporation, the building up of the esprit de corps of the forces (a matter of vital importance to the public, the owner and the employe), the education of officers and employes in the things that pertain to railway operations, and so on.

All these phases of the subject receive more or less attention throughout these volumes. They are a part of the science of railways and not the less important because not forming a part of the daily thoughts of officers and employes.

The particular phase of railway maintenance which I wish to consider in this chapter relates mainly to the effect of certain influences.

I have mentioned in another place the possibility that through the unwise exactions of labor it may some time be found necessary to close up a railway, or group of railways, for a longer or shorter period, because of the impossibility of procuring men to operate them. Such a contingency does not seem likely, nor did it seem likely

a few years ago, when a great system, extending over several states, was suddenly paralyzed for a similar reason. Yet the event actually occurred. Moreover, the circumstances were such as to suggest the possibility of its recurrence. Let us suppose that for some reason every railroad man, or the great bulk of them, struck, as they did in the particular section I have referred to. In such event, the operation of railroads would be impossible. No other course would be left to owners but to shut up their property.

Where labor has the disposition to organize and act in concert over a great extent of country, everything is possible. The nineteenth century is peculiarly the age of possibilities of this nature. Centralization is its watchword. We observe it in the growth of corporations, manufactories and other enterprises. It was the concentration of capital, perhaps, that suggested the centralization of labor—the delegating to an agent the right to arbitrarily control the many. The co-operative organization of labor, however, is more extended than that of capital. The latter is necessarily restricted and isolated in its efforts. Labor groups great masses of men employed far apart over wide areas of country. If these organizations are not wisely governed, they will ultimately involve a corresponding centralization of capital. Certainly they will render the continuance of business under existing conditions impossible. Not only will the railway system be broken up, but all other

industrial interests will be disturbed, and in many cases destroyed.

In the event railways were closed under circumstances such as I have named, the duration of the suspension would depend very largely on the disposition and ability of the people to protect those who sought to reopen them. Meanwhile the calamities that would grow out of the upheaval would require many years to heal.

What conditions would attend a general cessation of railway operations? Could the owners of railroads permit their property to lie idle? Do railroad companies possess the passive element that is so great a source of strength to capital invested in other enterprises? It is here that a secret of the power of capital lies. Its growth, beneficent influence and perpetuity depend upon the possession of this source of strength. When no longer able to exercise this negative force, it will cease to exist.

What is the effect of idleness upon railroad property? Wherein does it deteriorate? What is the extent of the deterioration? What outlay does the maintenance of a railway involve? Should owners suffer a great loss in the effort to maintain the rights of their property, or should they effect an immediate settlement with disaffected employes, on the best terms possible? It is upon such questions that the contingency of a railway company closing its affairs for six months, or a year, or two years, may hinge, and upon the wisdom and courage governing those

making the decision, the future of mankind may depend.

Let us suppose that a railway company decides, in view of the fact that it can no longer operate its property in harmony with what it considers to be its interest and the interest of the public, to close its business until such time as its just rights are accorded.

What would be the expense of maintaining its property under such conditions? The question is an interesting one and suggests careful inquiry.

In the event of the suspension of a railway, what would be the effect upon the property? What would be the minimum amount it would be necessary to expend to preserve it from serious deterioration? These questions cannot be definitely answered. Having no income, cost, it is manifest, would have to be raised by assessments if no reserves were laid by to meet such contingencies. But in regard to reserves: Is it not incumbent upon every company to possess, according to its ability, a reserve fund of this nature? Is it not a part of the machinery of maintenance? The fund need not be unproductive. Judiciously placed, it will be a source of income as well as strength. Its effect, moreover, will be evinced in the market value of a company's securities. It will be in the nature of a guaranty, enabling its possessor to meet every call upon him. With such a fund taxes could be paid, sinking funds met, interest on mortgages satisfied, and the expense of maintenance

provided for a period proportionate to the extent of the fund, without reference to current receipts.

It may be assumed, I think, in the event a company found it necessary to suspend business, that the great bulk of its bondholders would waive interest payments for awhile. The reserve fund would provide for the balance. The amount of the fund should depend upon the amount of taxes, interest, tolls, sinking funds and expense of maintenance. Expenditures for the last named purpose are imperative. They must be met as they accrue, otherwise the owner suffers enormous usury for neglect to preserve his property. Would the cost of maintenance be so great as to prevent the proprietor meeting it? I think not, if he possessed a moderate reserve fund.

Stripped of all glamour, railway property differs very little from other property used in manufacturing, except that it is scattered over a wide territory. In the case of private manufacturers, their property lies within a narrow limit and when not in use the gates are shut and the public excluded, so that, no matter how great its value, its guardianship is compassed within the care of a watchman. He not only serves to protect the property, but helps to prevent its deterioration. Unfortunately, this simple disposition is impossible in the case of railroad property. Widely scattered, it is everywhere exposed. Its greatest security lies in the difficulty of destroying or removing it. This renders it possible for

the police force of a country to look after its protection (if it is so inclined) without material outlay. This feature would be of especial value to a company compelled to stop business. Only that portion of its property endangered by fire would require especial guardianship. Even here the risk would be slight. Moreover, in considering the safety of railroad property under conditions such as I have named, we must remember that the state must aid the proprietor, he being a taxpayer. In the event it does not, it must reimburse him for any damage he suffers. Losses, therefore, that arise from the acts of mobs or lawless combinations must be reimbursed and thus will not fall upon the proprietors of railroads, except in so far as they are taxed with others. The exercise of reasonable precautions in the preservation of the property of a railroad is, however, under all circumstances a duty. This duty railway companies have never disregarded. So that, in the event they closed their properties, they would still continue to exercise general and constant watchfulness. The expense of this would be chargeable to maintenance. Would the duty require special watchmen, or would the force required to keep up the organization be sufficient? I think the latter. In determining, therefore, the force necessary to maintain a property, we also cover its protecting force, except in isolated cases.

The maintenance of the property of a railroad involves many things not capable of demonstra-

tion in advance; contingencies that we cannot foresee nor estimate, because dependent upon circumstances and the peculiar features of a property.

In considering the cost of maintaining a road, the cost of maintenance of organization must not be overlooked. This latter, however, in the case of a property closed to business, would depend upon whether the cessation was for a long or short period. If the former, the cost would not be nearly so great as if the stoppage were for a short period. If the cessation were likely to extend over a long period, the traffic organization, or that portion of the force connected with or growing out of the conduct of business, could be wholly dispensed with, or so greatly reduced as to be no longer distinguishable as an organization. If, however, the stoppage were only for a short or indefinite period, it would be necessary to preserve at least the nucleus of an organization, such portion of the force as would render the resumption of business practicable without great delay.*

If the stoppage were likely to continue over a long period, many expenses that under other circumstances would be necessary, might be avoided. Thus the cost of keeping up the road at a point that would permit the daily movement

* Unless, indeed, it was assumed that the whole force might be brought together again at will, in which event the whole traffic force might be dispensed with. This is what would probably be done.

of trains at ordinary rates of speed would not be required. It would not be necessary to repair from day to day the inroads of storms or the damages caused by frost, and expenses attending the use of bridges, culverts, buildings and machinery might be wholly avoided, or it would be necessary at best to give them only cursory attention. Effort would be directed merely to preserving the property from permanent injury. Thus maintained, considerable time would be required to place it in shape for resuming active operations when the embargo was lifted. Buildings would have to be put in order, tracks repaired, bridges and culverts looked after, and a thousand things attended to before general resumption would be possible. The delay would be unavoidable, as the resources of the strongest company would not warrant it in keeping up its property at the maximum point of efficiency throughout an indefinite period. In attempting, therefore, to determine the cost of maintaining a property without reference to traffic, all the conditions must be known. If resumption of business were likely to occur within a reasonable time, the expense of maintenance would not be much less than during active operations.

The disintegration of property from natural causes is very nearly the same, whether used or not. If cessation of business were likely to extend over an indefinite period, the advisability of reducing expenses would be so great that we

may be sure every outlay would be cut down to the lowest possible figure.*

The maintenance of a property covers many great expenses arising from natural causes. Little has been done to determine the amount of these expenses aside from traffic. Few things are less understood. Every expense being primarily due to traffic, no attempt has been made to effect a separation. Business being the incentive to construct a railway, the whole cost of operating is properly chargeable thereto. Thus, rates must conform to cost, or if they fall short bankruptcy follows. Many expenses do not depend except primarily on traffic, but in attempting to separate the cost of maintenance arising from natural causes from that due to traffic, I do not wish to be understood that such expenditures are distinct from traffic or that traffic has no obligation to bear the burden.

Any attempt to separate the fixed expenses of maintenance from those occasioned by traffic must be largely speculative, but a separation, however imperfect, cannot but possess great interest to those who own and operate railways. It enables them to view many questions from a higher standpoint than they otherwise would, and proves valuable in directing inquiry into other

*It is possible, in the event a railroad company found it impossible to operate its property, that the wisest course to pursue would be to dismiss the whole force. Such a course, it is probable, would be thought the safer one to pursue and the one most likely to bring about a quick and satisfactory settlement.

and collateral subjects. Knowledge is not of so much value for a specific thing as for its contingent revelations and the thoughts it suggests. And so it will prove here. Even the most imperfect statement of the expenses of maintenance of railways affords suggestions in other directions to those who do not regard the information in itself of value. Thus, while a manager may not care what relation fixed expenses of maintenance bear to total expenses, yet the information is valuable to him in other directions or in special instances. Take the case of track rails for illustration. Experts with whom I have communicated as to the relative deterioration of rails from climate and traffic, have stated that a rail would remain fit for use forever, if trains were not run over it. Others put the deterioration from climatic causes at two per cent. ; others again at five per cent., and so on. As a matter of fact, the deterioration of rails from climatic causes, while not great, is marked and cumulative. Deterioration of other material is much greater. However, I cannot enter here into a scientific discussion of the effect of climatic influences upon material. I am not competent to do so. I merely cite the case of rails to illustrate the lack of information on the subject by those whose duties lie wholly in this particular department.

The natural decay of railway property is, in many cases, much greater than the damage occasioned by use. Where the business is great the

relation of fixed expense of maintenance to traffic is, of course, less.

Whatever a property suffers from natural decay is a fixed expense. Cost of organization is also, to a certain extent, a fixed charge. It is, however, never the same. It is much less, relatively, for a company actively engaged than when the contrary is the case, for the reason that in the former instance a proportion of the cost is merged in current business. Thus, a superintendent will not only maintain the property, but also superintend its business. In either case he is essential, and while he must possess greater diversity of knowledge to enable him to attend to both these duties than to either singly, yet the increased cost is not great.

The number of skilled laborers required in the operations of railroads is much greater than is supposed. They form, to a certain extent, part of the organization, but embrace many men not usually classed under this head. Everyone understands that an engineer must be technically qualified; the value of skill upon the part of the fireman is also understood. The necessity of technical knowledge on the part of machinists is equally well known; but minor officials, clerks and foremen must also possess technical skill of a high order, coupled with a practical knowledge of the property and its business. This is not so well known. No class of labor possesses so much technical knowledge as the clerical force of a railroad, and by clerical force I mean the body of

employes concerned in the movement of traffic, including those connected with accounts and finances. They are the fingers of the organization, and, in a great sense, its intellectual force. The affairs of a railroad are so great, and extend over so wide a range of thought, that managers can do little more than use the information the clerical force collects. This force, however, in the event of the stoppage of business on a railroad, would have nothing to do, and, therefore, would be dispensed with. But only those who have watched the growth of a railroad, and the patience required to build up an efficient force, can estimate the loss its abandonment would finally entail. However, necessity does not recognize distinctions of this kind. If, therefore, through upheavals of labor or other disorders, a railway were compelled to suspend business indefinitely, it would come out of the struggle stripped of its organization in this respect. No attempt, therefore, need be made here to determine the fixed expenses for such railroads on this account.

A fixed expense of Organization (or Management) under normal conditions is the pay of officers and employes necessary to the conduct of traffic. This force embraces the management, heads of departments and chiefs of bureaus and their immediate assistants. Those, in fact, possessing a knowledge of the departments and versed in the company's affairs. Such a force cannot be secured at will, and business cannot be

carried on without it. It grows with the corporation, and should become more efficient every year. The necessary force of a road also embraces the agents at stations, and if business is great, their immediate assistants; those, in fact, who possess high technical knowledge. They constitute a fixed charge. Those engaged in mechanical or simple work about the offices, warehouses and other buildings do not, as they may be replaced at will.

The cost of watching a property is not a fixed expense, or at least is only partially so, as this duty may be performed by employes who form a part of the fixed cost. The nucleus of a train force is a fixed expense of maintenance. In the case of conductors and baggagemen it embraces, let us say, ten per cent. of the force. The skill of this body constitutes the nucleus of a complete organization. In the same way ten per cent. of the engineers and firemen may be denominated as fixed. Such a train force would prove ample to guard the rolling stock and machinery and maintain it in a high state of efficiency.

The technical force retained by a company (under the conditions I have named) may be further utilized in the physical maintenance of the property, and thus serve a double purpose. Employes occupied in soliciting business do not constitute a fixed expense. Similarly, operating expenses covering personal injuries, contingent expenses, stationery, printing, supplies, advertising and lubricants belong to traffic, or

if any portion is a fixed expense it is nominal only.

The forces of a railroad that constitute a fixed charge will find, in the main, active employment, even if the property is closed. However, it does not necessarily follow that there would be no reduction in the wages of this force. On the contrary, it is probable that a very large reduction would be made. The necessity of such a course and its justness would be apparent, and would be cheerfully acquiesced in. The amount of this reduction would, it is probable, approximate fifty per cent. That it would involve hardship, goes without saying, but as this hardship would extend to the owners of the property as well, it would be borne cheerfully. If the suspension were likely to be of long continuance, the reduction would be even greater. However, fifty per cent. may, I think, be estimated as the average. In reference to the force it would be necessary to discharge (in the event of suspension), it is probable the majority of the men would await re-employment. This would certainly be the case if the stoppage were not likely to be of long duration, or if the circumstances attending dismissal did not involve personal animosities. It would be apparent to men thus situated that their interests would be more likely to be conserved by awaiting re-employment than by seeking engagement elsewhere. It might be necessary in some cases (as it would indeed be both politic and wise wherever possible), to allow this wait-

ing force a small sum monthly. Such a course would be eminently humane, if the resources of a company permitted. I assume, of course, in suggesting this gratuity, that harmony of relationship exists between employer and employe.

The best of feeling should ever be maintained between railroad companies and their employes. It is possible, indeed probable, that the latter may have more or less grievances, real and imagined, but that these grievances are such as to justify indifference or disloyalty is impossible. Nor can they be so great as not to be more likely to be amicably arranged by conciliatory measures than by strikes or other violent means. The interest of the proprietor in those who operate his property is too intimate, too vital, to permit him to disregard their welfare or to refuse to remedy just causes of complaint.

And above all, employes should not, in enumerating their own grievances, forget those of the employer. No intelligent person who has observed the operation of corporations carried on by hired agents but must have noticed innumerable instances of neglect on the part of such agents, of manifest inefficiency, gross wastefulness, inattention to duty, idleness, and other evidences of disregard of the interests of the owner. Every such instance is a legitimate and proper subject of complaint on his part, and while he may seek to prevent such acts, still his efforts in this direction, no matter how watchfully or intelligently directed, can never be wholly successful.

Employes, therefore, while enumerating their grievances, should not be unmindful of those of their employer.

In the case of a railroad, the identity of the proprietor is so covered up in the multiplicity of owners, in the rules and regulations of the service, and in the acts of managers and others, that we cannot wonder the employe sometimes forgets there is an owner—a man like himself; and in doing so fails to recognize his rights and forgets his own duties and responsibilities. If the owner possessed greater personality, were present on the ground, were a person to whom the employe could listen and might appeal, he would appreciate his existence more vividly. In considering, therefore, the relations which exist between capital and labor in connection with railroads, the first thing for the employe to do is to dismiss his prejudices; to remember that if he has grievances, so also has the owner, and that, as a rule, the grievances of the latter are more real than those of the employe. No railway employe, not blinded by passion, but knows that he is, as a rule, fairly treated.

The grievances of employes are often more imaginary than real, and when real come, not from the owner, as a rule, but from those he is compelled to trust. The remedy does not, therefore, lie in indiscriminate attacks upon property, but in an appeal to owners.

Too great care cannot be exercised by employes of corporations not to confound the owner with

the manager. The owner will never, it is safe to say, willfully or persistently disregard the welfare of his employes. Their interests are so inalienably connected with his, that to treat them unfairly would be suicidal. This truth is not always remembered by employes. No one who is dependent upon the good will and fidelity of others for the maintenance of his interests, like the owners of railroads are, can afford to permit them to remain in ignorance of his good intentions. On the contrary, his duty and interest alike demand that he should cultivate such relations with them as may, at all times, assure them of his friendly interest in their welfare.

Men who intrust the management of their property to others must do so unqualifiedly, but such delegation of power should never extend to the relinquishment of the right and duty of looking after the welfare of their employes. A proprietor will ever consult his welfare by such manifestation of interest in his servants, and any neglect to fulfill this cardinal duty of ownership will redound to his injury. By many owners manifestation of such interest is thought to be subversive of discipline. The answer to this is that when an owner cannot come in contact with his employes without jeopardizing discipline, it ought not to require an outbreak of his servants, or the destruction of his property, to convince him that there is a defect somewhere in the method of administering his property. Discipline that is dependent upon terrorism, upon ostracis-

ing (or sequestrating) the employe, upon separating him from the acquaintance or sympathy of the owner, is a gross perversion of responsible methods of government, and wherever practiced may be accepted as evidence of a disregard of the rights of owners. If the history of corporations in the United States teaches one fact more clearly than another, it is that the owners of corporate property must personally interest themselves in the affairs of their employes, lest their personality be forgotten and their property lost.

Ownership of property presupposes the duty of guardianship, including a paternal interest in the operative, and its preservation to the owner will ever depend upon the general and wise exercise of his duty in this regard.

Continuing our examination of the cost of maintaining a railroad. This cost is much increased by the interference offered by traffic. Thus, repairs of track are retarded by the passing of trains and the diverting influences that attend their movement. Necessary repairs to equipment and machinery are oftentimes delayed because of the pressing need for their use in handling traffic. Many other instances might be cited if necessary.

Insurance of property is a fixed expense, except in so far as it covers current traffic. Practices in regard to insurance are not uniform. In some cases it is the policy to insure everything. Other companies restrict their insurance to particular instances of special importance.

Others, again, do not insure at all. I do not know that the circumstances likely to attend a cessation of business would be such as to require that a company's policy in this respect, whatever it might be, should be changed. Risk from the movement of trains and the conduct of business generally would, it is apparent, be much less than under normal conditions, while damages arising from the acts of mobs would have to be made good by the government. No two companies view the question of insurance from the same standpoint, and no estimate can, therefore, be made as to the extent of a company's expenditures in this connection. After considerable observation of the effect of insurance and non-insurance, I should not think a company justified in expending a large amount in this direction unless its surplus were abundant and well assured. The magnitude of its interests renders it quite proper for it to assume risks of this nature. The cost of insuring the property of a company may be reduced to the minimum, in the event of stoppage of business from a strike or otherwise. Whatever is paid in this direction constitutes a fixed charge.

Considered from the standpoint of organization and proprietorship, the taxes of a property constitute a fixed expense without reference to the basis upon which they are predicated. In this last respect the widest differences exist. In some cases taxes are based on real and personal property. In others upon earnings. The amount and

value of outstanding capital is sometimes the factor. When the tax is based on property, the levy would be the same if the road were not operated, though it is possible a reduction might be made under such circumstances. Certainly it should be, as it is manifest that property of this kind which is earning nothing is, constructively at least, worth nothing and ought not to be taxed except upon a nominal basis. Practically, however, only a small reduction would probably be made. When taxes are based on earnings, it is manifest that a cessation of business would mean cessation of taxes, unless the stoppage were so prolonged as to suggest some other basis. In any event, however, the extent of a company's obligations for taxes, whatever they may be, become, in the case of an idle property, a fixed charge.

It is impossible to determine accurately what proportion of the cost of maintaining railway property arises from climatic causes. Two methods suggest themselves by which to estimate the amount. The first is by a survey of the property in which every feature shall be ascertained. This method is the best when practicable. But, unfortunately, it is not generally practicable. The second that suggest itself is the relation which cost of maintenance bears to the total cost of operating. It is only approximate and not reliable for our purpose.

Different properties are affected by different climatic influences. Thus, the railways of the North and the South have dissimilar conditions to

meet. Those of each section necessitate peculiar outlays. Thus, deterioration of wood in the South is much more rapid than in the North, but, on the other hand, Northern roads suffer greatly from frost and the abrupt changes peculiar to a cold country. The conditions most favorable to the preservation of material are a mild, dry climate, but it is probable the roads of the South have, on the whole, advantages over those of other localities in the cheapness with which they operate and maintain their properties.

More than anything else, fixed expense of maintenance is dependent upon quality of material, the measure of intelligence evinced in locating and constructing a line, and finally the skill exercised in protecting the property. The nature of the structure is important; stone is more durable than wood; brick more lasting than grout. But the duration of the structure is largely dependent upon the care with which it is constructed and looked after. This rule applies to the roadbed and its ballast as fully as to buildings and other structures.

The cost of keeping rolling stock in repair is greatly increased by deterioration from natural causes. This deterioration is greater when the plant is actively employed than if carefully housed, as much of it would be if not in use. The facilities of railroads every day become more ample, but they do not as yet generally contemplate placing passenger and freight cars under cover when not in use. This adds greatly to the cost

of their maintenance. Referring to the cost of preserving equipment, an interesting writer on the subject says: "A locomotive taken into the shop and covered with tallow would be ready for service with very slight repair to the stack and other parts. The atmosphere would have a greater effect upon freight cars, and it would be necessary to paint them at periods (probably of considerable length), even if not in use, as they would suffer from dry rot and other causes. With regard to passenger cars on the same basis, the percentage would not be so great as freight cars, as the material and finish are better, but they would require a coat of varnish, at long intervals, to preserve the outside paint."

The wear and tear of equipment from traffic is, of course, proportionate to its use, but cost will ever depend largely upon the intelligence and promptness with which repairs are made. If locomotives are not properly painted, cleaned and housed; if passenger cars are not kept cleaned, painted and varnished; if freight cars are not kept painted and repaired as needed; if machinery is not carefully looked after, the deterioration will be rapid and marked. The telegraphic plant of a company, including lines, furniture, tools, machinery, batteries, instruments and other appurtenances, suffers constant deterioration from natural causes, and although lines are much better constructed than formerly, the deterioration has only been lessened, not obviated.

It is apparent from the foregoing that differences exist, and ever will exist, as to the outlay of railroads, that arise from natural causes. Accurate data, therefore, in regard to a particular road will not be conclusive in regard to others. It will, however, afford an approximate estimate in many cases, for however greatly railways differ from each other in particular things, they are generally uniform. If, therefore, data were obtainable for several railroads, this average would afford a glimpse, at least (but not more), of railways similarly situated. I have this data for a period of twenty years, for railways thirty-five hundred miles long, located in a temperate climate, subject to such extremes of heat and cold as are to be found in the great lake region of the United States. Conditions here, as regards wages and cost of material, are those of American railways generally. The results are embodied in the appendix hereto.* They show the relation that particular items of maintenance bear to the total cost of maintenance. Also the proportion that cost of maintenance bears to other expenses. They also show cost arising from climatic causes, and the expense of maintaining a nucleus of organization. I have not attempted to give the aggregate cost in dollars and cents, but to show the relation which cost bears to the current cost of operating, so that the reader has only to ascertain what each operating expense

* Appendices C and D.

amounts to upon a road to ascertain approximately what the fixed expense is.

The maintenance of a railway involves, as I have pointed out, innumerable things. Some I have specified; others only hinted at. It involves, directly and indirectly, the books, blanks, forms and stationery of a company; its furniture, fixtures and appliances; a proper system of accounts; the telegraph; responsible methods of handling money; the purchase, inspection, care and use of material; the proper employment of labor; the government of the corporation; the handling of traffic; the issuance of tariffs and classifications; the movement of trains; above all, the maintenance of the track. I have said much about the latter. The theme is an important one. That of equipment and machinery is nearly, if not quite, as great. This subject, however, I refer to in the book devoted to Equipment, and so shall not discuss it here further than to point out that cost is dependent here, as elsewhere, upon the care and foresight exercised. Paint, and its accessory, varnish, I may say in a word, are important agents in this connection. Material of this nature must be of the best quality, though the difference in cost between good and bad material will constantly tempt the purchaser to buy the latter. In the preparation of paints, ingredients require to be carefully weighed and measured. The material must also be pure and finely ground. The colors used require to be harmonious and permanent. Work

of this nature cannot be hurried. Thus, varnish must be thoroughly dry and hard before being exposed to the weather, and in order to secure this ample covered space, well lighted, ventilated and heated, is required. If conditions necessitate it, artificial means of drying must be resorted to. In order to secure the best results, the varnish, after it is applied, should be well rubbed in, so as to close the pores. In England, where much attention has been given the subject, a coat of raw linseed oil, from which all the fatty material has been extracted, is applied to the varnish. In cleaning, care must be taken to avoid harmful or destructive methods, such as the use of very hot water or chemicals, otherwise the varnish on a car may be quickly ruined after the vehicle leaves the shop. In painting, questions of color are not, as would seem at first glance, entirely matters of taste. Advocates of light colors claim that the varnish holds better in such cases, that it is easier to clean, wears better, and does not absorb the heat as much as dark colored paint. On the other hand, dark colors show the dirt less and require less material.

In concluding, I repeat what I have so frequently had occasion to call attention to, namely, that cost of maintaining railroads (and operating them as well) is dependent upon the nature, location and business of properties, the thoroughness with which they are built and the effectiveness and foresight exercised in keeping them in order.

I have not attempted to elaborate the subject unduly, but to point out its more salient features and the line of inquiry to be considered. I have sought also, indirectly, to make clear to those who impose obligations upon railroads the necessity of their discriminating; of tempering the wind to the shorn lamb; of remembering that while the enforcement of arbitrary enactments without reference to local conditions will simplify official labors, the result will be disastrous to the properties concerned. The business of a railroad, like every other business, is a matter of detail and must be so considered. It is just as proper to make hats of a uniform size for all men as to prescribe fixed conditions for railroads. As well might the expenses of the government be collected by a uniform charge per head on men, women and children, without reference to their ability to pay, as to seek to make one railroad the measure of other railroads.

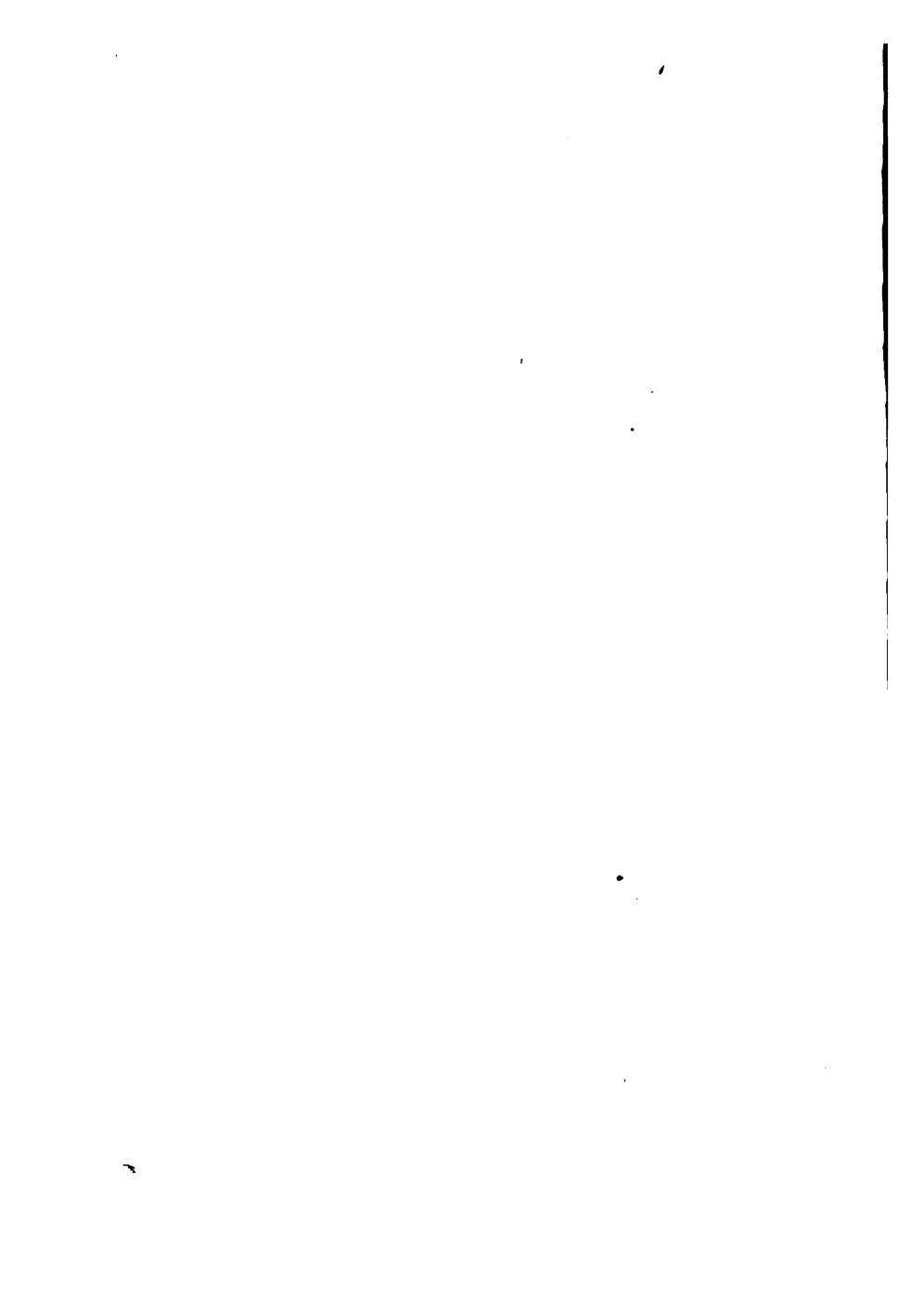

APPENDIXES.



APPENDIX A.

METHODS OF CAPITALIZATION IN GREAT BRITAIN.

The capital of the railroads of Great Britain is generally represented by capital stock (called share capital), debentures and debenture stock. The distinction between debentures and debenture stock is this: the former mature at a given date; the latter is perpetual. In the early years debentures were generally used, but of late they have been very largely superseded by debenture stock.

Dividends may be declared at pleasure up to the maximum sum fixed by the government on capital shares. They may be paid at any time, or may be wholly omitted if the interests of the company require. It is a matter within the discretion of the directors. In regard to debentures, interest is payable at a particular time, the same as on a mortgage bond.

The share capital is generally of two kinds—preferred and ordinary, the former being entitled to a dividend before any allotment can be made to the latter. In some cases the ordinary stock is of two classes, namely, preferred ordinary and deferred ordinary, the relation of these two in respect to dividends being the same as above stated in respect to preferred and ordinary stock. Often there are found special stocks which are known by various names and on which there is a guaranteed dividend.

In order that a company may issue debentures or debenture stock the assent of the government must first be obtained. Debentures are generally issued to the extent of one-third of the authorized share capital, but before

the same can be issued at least fifty per cent. of the share capital must be paid up. Railway companies are, however, allowed to issue debentures and debenture stock in excess of the amount of one-third of the share capital as above referred to, to enable them to secure funds to make additions to their plants by the introduction of such improvements as interlocking, the block system, continuous train brakes and other betterments chargeable against capital account, provided, however, that such additions are first approved by the Board of Trade. In each case specific authorization must be given by the Board of Trade for the issuing of such debentures or debenture stock.

The money realized from the issue of share capital and debentures is usually received by a company through its bank. In the case of share capital, certificates of deposit are issued by the bank to the investor for the various installments paid by him, which receipts are exchangeable for share certificates, a separate certificate being given for the nominal value of each share. When the shares have been fully paid up, the certificates are convertible into stock, a certificate being given for the total number of shares each investor may have, or for such fractions thereof as he may desire.

Money realized from the issue of share capital and debentures and debenture stock is applicable only for construction and work authorized by the act of incorporation.

Interest warrants, or coupons, covering the entire length of time the debentures run, are issued with them. These warrants are payable semi-annually. Debentures are often so drawn that they can be extended beyond the time they first fall due.

In reference to details of accounting, the warrants for interest on debenture stock are made from the stock ledger, the amount being first summarized in a record kept for this purpose, on the dates on which the interest is payable. Warrants for the payment of dividends on the share capital are likewise made from the stock ledgers. The transfer books, or ledgers, for both these

classes of stock are closed for a certain period preceding the date on which interest or dividends are payable. Transfers made in such stocks during the period the books are closed are made after they are reopened. The warrants for the interest on debenture stock and for dividends on share capital are posted directly to the credit of holders of the stock.

The records connected with the capital of the railroads of Great Britain, while not complicated, are more or less extensive. They give a clear history of each transaction, and a complete statement of the status of the various classes of capital at all times. Thus, the name, address and description of each holder, amount of same, number and date of certificates, date when interest or dividends are payable, when paid, in what manner, and so on.

The principal records kept by the companies in connection with their various classes of capital may be briefly summarized as follows:

Debenture Sealing Book.—Record of money received by the company, and the debentures to be issued therefor.

Register of Debentures.—Record of the number, date and amount of the debenture, and the name and address of holder; also particulars of any transfers.

Record of Debentures Transferred.—Record of name and address of party from whom and to whom transferred; also date and number of debenture. This register is written up from the debenture sealing book and the record of debentures transferred.

Record of Debenture Interest Coupons.—Record of interest falling due on various dates on each debenture and the number and amount of each installment.

Record of Debentures Falling Due.—Record of debentures falling due, number of debenture, date of same, date of maturity and amount; also through what bank paid and when, or if not paid, disposition made, i. e., whether renewed or converted into debenture stock.

The following books give the same information concerning debenture stock that similar records do for

debentures, viz., debenture stock sealing book; register of debenture stock certificates; record of debenture stock transferred.

Debenture Stock Ledger—Record of name and address of owner and amount of stock. Entries in this record are posted from the register of debenture stock and the transfer record.

Debenture Stock Address Book—This is an index and trial balance for the debenture stock ledger. It gives the name, address, description and amount of stock of each holder, and the folio of the ledger on which the account is to be found.

Debenture Stock Interest Register—This record gives the name of each holder of debenture stock, address, amount of stock, period for which interest is payable, rate, amount of interest, deduction for income tax, net amount payable, number of warrant issued and the name of the bank it is paid through. It is written up when the interest is due, directly from the stock ledger, the latter being closed for a number of days to facilitate this.

The records of share capital are practically the same as those for debenture stock. Separate records are kept for each of the various classes of stock. One "Address book," however, answers for all stocks, the name and address being entered in the middle of the page, on the left hand of which are separate columns for the folios of the respective ledgers, and on the right hand columns for the amount of holdings of the various classes of stock. In connection with the issuing of new shares, an Allotment book is kept showing the number and par value of the new shares allotted to each holder. This book also shows what portion, if any, of the allotment is renounced by the holder and what portion taken and the payments made therefor. In connection with it is kept a share register showing the amount of payments made by each holder and the number of such shares transferred, if any, before the same were converted into stock.

APPENDIX B.

RELATION THE VARIOUS ITEMS OF TRACK LABOR BEAR TO EACH OTHER.

Labor, handling rails.....	3.68 per cent.
Labor, handling ties.....	9.56 "
Labor, ballasting.....	12.31 "
Labor, ditching.....	4.78 "
Labor, freshet repairs.....	.92 "
Labor, watching track.....	1.25 "
Labor, clearing track of snow and ice.....	6.62 "
Labor, clearing track of weeds and grass.....	7.35 "
Labor, general repairs to track (including cutting rails).....	53.53 "
	100.00

RELATION THAT VARIOUS ITEMS OF TRACK EXPENSES BEAR TO TOTAL TRACK EXPENSES.

Labor, handling rails.....	2.23 per cent.
Labor, handling ties.....	5.79 "
Labor, ballasting.....	7.35 "
Labor, ditching.....	2.89 "
Labor, freshet repairs.....	.45 "
Labor, watching track.....	.67 "
Labor, clearing track of snow and ice.....	4.01 "
Labor, clearing track of weeds and grass.....	4.45 "
Labor, general repairs of track (including cutting of rails).....	32.52 "
Rails, ties, miscellaneous track material and tools.....	39.64 "
	100.00

APPENDIX C.

RELATION VARIOUS CLASSES OF MAINTENANCE BEAR TO TOTAL COST OF MAINTENANCE.

Maintenance of track.....	44.25	per cent.
Maintenance of bridges and culverts.....	6.68	"
Maintenance of buildings.....	6.98	"
Maintenance of fences, gates and crossings...	2.46	"
Maintenance of equipment.....	39.63	"
	<hr/>	
	100.00	

PROPORTION THAT THE COST OF MAINTAINING THE PROPERTY OF A ROAD BEARS TO ALL OTHER OPER- ATING EXPENSES.

Maintenance of property	38.62	per cent.
Other operating expenses.....	61.38	"
	<hr/>	
	100.00	

APPENDIX D.

PERCENTAGE OF THE TOTAL COST OF OPERATING DUE TO
MAINTENANCE OF ORGANIZATION AND THE PREVENTION
OF THE DESTRUCTION OF THE PROPERTY FROM NATURAL
CAUSES.

NAME OF ACCOUNT.	PERCENTAGE OF THE TOTAL OPERATING EXPENSE THAT COMES UNDER THE HEAD OF FIXED CHARGES.
Renewal of rails.....	2
Renewal of ties.....	70
Repairs of roadway and track....	57
Repairs of bridges, culverts and cattle guards.....	75
Repairs of buildings.....	70
Repairs of fences, road crossings and signs.....	95
Repairs of locomotives.....	8.5
Repairs of passenger cars.....	9
Repairs of freight cars.....	10
Telegraph expenses (mainte- nance).....	10
Agents.....	50
Clerks.....	25
Train force.....	12.5
Salaries general officers and their chief assistants.....	50
Law expenses.....	50
Oil, waste and tallow.....	1
Stationery and printing.....	1
Contingencies (and miscella- neous).....	1
Insurance.....	10
FIXED CHARGES OTHER THAN OPERATING.	
Taxes.....	100
Interest on funded debt.....	
Sinking fund requirements.....	100
Leases, contracts and agreements.	100

In the case of a }
railroad not in operation }
the expense would be..... }
5 1/2 }
6 1/2 }
9 }

In making these es- }
timates the wages of }
the force retained are }
reduced fifty per cent. }

Except where taxes }
are based on earnings, }
or special reductions }
can be secured. }

APPENDIX E.

GAUGES OF RAILROADS THAT ARE OR HAVE BEEN IN USE IN DIFFERENT COUNTRIES.

	GAUGE.		GAUGE.		GAUGE.		GAUGE.	
	Ft.	In.	Ft.	In.	Ft.	In.	Ft.	In.
Australia.....								
New South Wales.....	4	8½						
Victoria.....	5	3						
South Australia.....	5	3						
Queensland.....	3	6						
Austria.....	4	8½						
Argentine Republic.....	1 Me tre		5	6				
Belgium.....	4	8½						
Brazil.....	1 Me tre		3	6	4	0		
.....	4	3						
.....	5	6	4	8½	5	3		
British India.....	1 Me tre		5	6				
Canada.....	*4	8½	*5	6	*3	6	*3	0
Cape Colonies.....	3	6						
Ceylon.....	5	6						
Chili.....	5	6						
Denmark.....	4	8½						
Egypt.....	3	6	4	8½				
France.....	4	8½						
Great Britain.....	†4	8½	†7	0	*3	0	*3	6
.....	*5	0	*5	2	*5	3	*5	6
.....	*6	2						
Holland.....	4	8½						
Hungary.....	4	8½						
Ireland.....	5	3						
Italy.....	4	8½						
Japan.....	3	6						
Mexico.....	*3	0	*4	8½				
New Zealand.....	5	3						
North Germany.....	4	8½						
Norway.....	3	6	4	8½				
Nova Scotia.....	4	8½	5	6				
Panama.....	*5	0						
Peru.....	4	8½						
Portugal.....	5	6						
Russia.....	5	0						
Spain.....	5	6						
Sweden.....	4	8½						
Switzerland.....	4	8½						
Tasmania.....	3	6						
Turkey.....	4	8½						
.....	*2	0	*5	9				
.....	†3	0	†4	8½	*4	9	*4	8½
United States.....	4	10	*5	0	5	6	†5	3
.....	*6	0	8	0	*3	1½	*3	6
Uruguay Republic.....	4	8½						

* Gauges in use at present time, January, 1897.

† Standard Narrow.

‡ Standard Broad.

§ Standard of Ireland.

¶ Mount Washington.

‡ Sterling Mountain.

APPENDIX F.

QUANTITY OF MATERIAL REQUIRED TO LAY ONE MILE OF
RAILROAD TRACK ON THE BASIS NAMED.

DESCRIPTION.	WEIGHT PER YARD.	TONS.	NUMBER.	SIZE.
Rails	65 lbs.	102,144	352	30 feet in length.
	72 "	113,160	352	30 " " "
	80 "	125,160	352	30 " " "
	85 "	133,176	352	30 " " "
	90 "	141,180	352	30 " " "
Ties			3,017	{ 6 inches thick, by 8 inches wide, by 8 feet long, laid at a distance of 21 inches from center to center of each tie.
Spikes			12,068	{ 5½ inches long and ¾ inch thick, measured under head.
Base Plates			352	
Angle Bars			704	
Bolts			1,408	
Nut Locks			1,408	
Tie Plates			6,034	{ Number required provided a plate is put on each end of every tie. They are seldom used continuously, however, but, as a rule, only on bridges, trestles and curves.

Ballast to the depth of 12 inches under the ties, with a surface of 10 feet, requires 3,060 cubic yards for one mile of track.

INDEX.

This volume is carefully Indexed, but for the convenience of the reader and to render the book easier to handle, the Index is included (with a full Index of the whole work) in volume Twelve under the title "GENERAL INDEX." This "GENERAL INDEX" is also, in a measure, an Encyclopedia of Railway Knowledge.

In all previous editions of the work each volume contained an Index, but as this was already embraced in the Twelfth Volume, it has been determined to change it in this edition (as indicated above) thus reducing the bulk of each volume, and making it more convenient for the reader to handle.

THE SCIENCE OF RAILWAYS

By MARSHALL M. KIRKMAN.

"THE SCIENCE OF RAILWAYS" DESCRIBES THE METHODS AND PRINCIPLES CONNECTED WITH THE ORGANIZATION, LOCATION, CAPITALIZATION, CONSTRUCTION, MAINTENANCE, OPERATION AND ADMINISTRATION OF RAILROADS.

IN TWELVE VOLUMES, COMPRISING BOOKS ON

Railway Equipment.	Fiscal Affairs; Collection of Revenue.
Railway Organization.	Fiscal Duties of Agents and Conductors.
Financing, Constructing and Maintaining.	Principles Governing Collection of Revenue.
Train Service.	General Fiscal Affairs.
Passenger, Baggage, Express and Mail Service.	General Fiscal Affairs and Statistics.
Freight Business and Affairs.	Payment of Employes of Railroads.
Disbursements of Railways.	Treasurer's Office.
Economical Purchase, Care and Use of Material.	The Relief Department of Railroads.
Fiscal Affairs; Expenditures.	Origin and Evolution of Transportation.
Economic Theory of Rates; Private versus Government Control of Railroads.	Engineers' and Firemen's Manual—General Index.

"Officers and employes of railway companies and the students of this form of transportation owe you much. . . ." MARVIN HUGHART, President Chicago and North-Western Railway.

"To railroad men, whose duties so frequently run in a groove, they afford most useful information that could not otherwise be obtained, and they suggest improved methods that must be highly beneficial to railway management."—C. C. HARVEY, President New Orleans and North-Eastern Railroad.

"The Science of Railways' shows a work of labor and thought. The subject is treated as none but a practical railroad man could treat it. The illustrations showing the modes of transportation from the primitive days to the present time are necessarily quaint and instructive. His delineations of character required to make a good and efficient railway officer are clear and pointed. His reference to the construction of railways, operation, maintenance of roadway and rolling stock are discussed with a clear head and hold the reader's attention. It is a work that should be in the hands of every railroad man, young and old. There is something in every volume interesting, and it is well adapted to the wants of young and ambitious railroad men, and it should be in the hands of those employes whose aim is advancement."—JOHN M. TOUCHY, General Manager New York Central and Hudson River Railroad Company.

"A curriculum eminently adapted for the employe in any sphere of labor. It is of inestimable value as a book of reference."—ROBERT DUDGON, Superintendent Minnesota Transfer Railway Company.

"I hope your work may be spread wide amongst railroad men as well as investors."—J. L. TEN HAVE, Frzn. Capitalist, Amsterdam, Holland.

"Written with a grace and facility of diction which fairly entitle them to be received as literature of the first class."—*Noah's Sunday Times*.

"The author's long experience, his great opportunities for acquiring accurate knowledge, his careful and thorough study of railway administration, make his books authoritative, studious, thoughtful and enlightened."—*Chicago Evening Journal*.

PUBLISHED BY
THE WORLD RAILWAY PUBLISHING COMPANY,
CHICAGO, ILL.

**PARTICULARS IN REGARD TO THE SALE, DELIVERY,
PAYMENT, ETC., OF THE**

“SCIENCE OF RAILWAYS.”

The work may be paid for in monthly installments. In such cases the books will be delivered as fast as paid for.

In all cases, however, the publishers reserve the right to deliver the books in advance of payment if they so elect.

Payments may be made according to the following plans, as may be agreed upon, viz:

1. In one payment.
2. By remitting draft or postoffice order to the publishers (or such person or persons as they may direct), for the amount of the installments.
3. In the case of those in the service of corporations, orders on the proper officer thereof will be accepted when the publishers are able to arrange with the company to collect the same.

Only those who are duly authorized in writing can collect money on account of the work.

The Publishing Company has had this edition electrotyped. Those who wish all the books delivered at one time may, therefore, expect to receive them without sensible delay. Those who wish them in single volumes from month to month may also confidently anticipate delivery at the time specified.

The work is sold only by subscription.

**The World Railway Publishing Company,
79 Dearborn St., Chicago, Ill.**

