

**MHI
Copy 3**

**ARMY FM 21-10
AIR FORCE AFM 161-10**

FIELD HYGIENE AND SANITATION

**DEPARTMENTS OF THE ARMY AND THE AIR FORCE
JULY 1970**

TAGO 20008A

FIELD MANUAL
No. 21-10
AIR FORCE MANUAL
No. 161-10

DEPARTMENTS OF THE ARMY
AND THE AIR FORCE
WASHINGTON, D.C., 24 July 1970

FIELD HYGIENE AND SANITATION

	Paragraph	Page
CHAPTER 1. INTRODUCTION		
SECTION I. General	1-4	3
SECTION II. Responsibilities in Field Hygiene and Sanitation	5-9	3-5
CHAPTER 2. COMMUNICABLE DISEASES		
SECTION I. General	10-12	6
SECTION II. Essentials in Disease Transmission	13-16	6, 7
SECTION III. Communicable Disease Control Measures	17-21	8
SECTION IV. Communicable Diseases of Military Importance	22-25	9-12
CHAPTER 3. PERSONAL HYGIENE		
SECTION I. General	26-28	14
SECTION II. Measures To Protect and Improve Health	29-41	15-18
SECTION III. Improvised Hygienic Devices	42-45	19, 20
CHAPTER 4. FIELD WATER SUPPLY		
SECTION I. General	46-48	22
SECTION II. Procurement and Protection of Treated Water From Engineer Water Points	49, 50	23
SECTION III. Procurement and Treatment of Water From Other Sources	51-54	25-28
CHAPTER 5. FOOD SANITATION		
SECTION I. General	55, 56	29
SECTION II. Protection, Inspection, and Storage of Food	57-59	29, 30
SECTION III. Preparation and Serving of Food	60-62	30, 31
SECTION IV. Cleaning of Kitchen Facilities	63-66	32, 33
SECTION V. Methods for Heating Water	67, 68	33
SECTION VI. Improvised Messkit Washing Containers	69, 70	36
CHAPTER 6. WASTE DISPOSAL		
SECTION I. General	71-73	37
SECTION II. Human Wastes	74-77	37-41
SECTION III. Wash, Bath, and Liquid Kitchen Wastes	78-82	43-45
SECTION IV. Garbage and Rubbish	83, 84	46, 47
CHAPTER 7. MOSQUITO-BORNE DISEASES AND THEIR CONTROL		
SECTION I. General	85, 86	48
SECTION II. Characteristics of Mosquitoes	87, 88	49
SECTION III. Mosquito Control Measures	89-92	50-54
CHAPTER 8. LOUSE-BORNE DISEASES AND THEIR CONTROL		
SECTION I. General	93-95	55
SECTION II. Characteristics of Lice	96, 97	55
SECTION III. Louse Control Measures	98-102	56-58

*This manual supersedes FM 21-10/AFM 160-46 6 May 1957.

	Paragraph	Page
CHAPTER 9. FLY-BORNE DISEASES AND THEIR CONTROL		
SECTION I.	General -----	103-105 59
	II. Characteristics of Flies -----	106, 107 59
	III. Fly Control Measures -----	108-112 60
CHAPTER 10. FLEA-BORNE DISEASES AND THEIR CONTROL		
SECTION I.	General -----	113-115 61
	II. Characteristics of Fleas -----	116, 117 61
	III. Flea Control Methods -----	118-121 61, 62
CHAPTER 11. TICK- AND MITE-BORNE DISEASE AND THEIR CONTROL		
SECTION I.	General -----	122, 123 63
	II. Ticks -----	124-127 63, 64
	III. Mites -----	128-130 64, 65
CHAPTER 12. MISCELLANEOUS INSECTS AND INSECT-BORNE DISEASES AND THEIR CONTROL		
	13. VENOMOUS ANIMALS AND THEIR CONTROL	
SECTION I.	Spiders -----	140-143 70, 71
	II. Scorpions -----	144-146 70
	III. Snakes -----	147-150 72
CHAPTER 14. RODENT-BORNE DISEASES AND THEIR CONTROL		
SECTION I.	General -----	151-153 73
	II. Characteristics of Rodents -----	154, 155 74
	III. Rodent Control Methods -----	156-159 74, 75
CHAPTER 15. LEECHES AND THEIR CONTROL		
	16. MISCELLANEOUS DISEASES AND THEIR CONTROL -----	163-168 77, 78
	17. HEALTH PROBLEMS RELATED TO EXTREME TEMPERATURES	
SECTION I.	General -----	169, 170 80
	II. Hot Temperature -----	171-178 80-84
	III. Cold Temperature -----	179-183 84, 85
APPENDIX A.	REFERENCES -----	87
INDEX	-----	88

CHAPTER 1

INTRODUCTION

Section I. GENERAL

1. Purpose and Scope

This manual provides information and instruction in the use of established, practical measures designed to preserve health and prevent disease in the Army and Air Force. It explains the fundamentals of sanitation and their application under field conditions. It points out the responsibilities of command and of the individual soldier for knowing and observing the rules of sanitation and hygiene, especially as they apply to living conditions and to circumstances peculiar to the military service. This manual is to be used in conjunction with other manuals listed in appendix A. The material contained in this manual is applicable to both nuclear and nonnuclear warfare except as otherwise noted. The hygiene and sanitation provisions of STANAG No. 2002 and of CENTO STANAG and SEASTAG No. 2122 have been implemented in this manual except that the hygiene implications of bacteriological warfare in No. 2122 are covered in principle, not as a separate topic.

2. Maintenance of Manual

Users of this manual are encouraged to submit recommended changes or comments to improve the manual. Comments should be keyed to the specific page, paragraph, and line of the text in which the change is recommended. Reasons will be provided for each comment to insure understanding and complete evaluation. Comments should be pre-

pared using DA Form 2028 (Recommended Changes to Publications) and forwarded direct to Commandant, ATTN: MEDEW-ZNT, U.S. Army Medical Field Service School, Brooke Army Medical Center, Fort Sam Houston, Texas 78234.

3. Definitions

a. Hygiene is the self-employment of practices which will keep one healthy. Among these practices are proper eating and body cleanliness.

b. Sanitation is the effective use of measures which will create and maintain healthful environmental conditions. Among these measures are the safeguarding of food and water and the control of disease-carrying insects and animals.

4. Importance of Field Hygiene and Sanitation

In the Armed Forces, manpower is the most valuable asset. Everything possible must be done to conserve this asset. In recent wars more deaths have resulted from enemy actions than from disease, but disease still causes the greatest loss of manpower through disability and time lost from duty. Success in battle—the ultimate objective of any military force—demands that troops be maintained in a constant state of combat readiness. Field hygiene and sanitation contribute to this effort by employing all of the measures designed to protect and improve the health of Army and Air Force personnel.

Section II. RESPONSIBILITIES IN FIELD HYGIENE AND SANITATION

5. Command

a. The commanding officer of a military organization is responsible for the health of his command. In the fulfillment of this responsibility, he is assisted by a staff of trained specialists. Using the technical advice and guidance of these individuals, he issues orders and enforces measures which will most effectively maintain sanitation and practices conducive to the health and well-

being of his troops. The maintenance of their health and, consequently, their fighting efficiency is one of his greatest responsibilities.

b. The commander's chief advisor in maintaining the health of his troops is the unit surgeon. The surgeon is responsible to him for providing effective medical services, including treatment of disease and injury; devising, recommending, and supervising activities and training directed to-

ward disease prevention, personal hygiene, and first aid; furnishing technical advice and supervision in connection with the health aspects of camp sites, water supply, food and its preparation, waste disposal, bathing facilities, housing, clothing, and insect and animal control. While it is the commander's direct responsibility to enforce the practices of field hygiene and sanitation, it is the surgeon's responsibility to advise what should be done. Only in matters involving technical knowledge does the surgeon specify how it should be done. The commander may authorize the surgeon to give orders in his (the commander's) name for immediate correction of defects in sanitation. Even then, full responsibility remains with the commander.

c. To provide for the accomplishment of the many time-consuming duties essential to the establishment and maintenance of a healthful field environment for the troops, the Army commander appoints a field sanitation team and makes arrangements for the team members to receive the training which they need to accomplish these duties effectively (AR 40-5). The duties entail performing, instructing, supervising, assisting, inspecting, and reporting, as applicable, to insure that appropriate field sanitation facilities are established and maintained, that effective sanitation and control measures are applied, and that effective sanitation and protective methods are practiced by the troops. In the Air Force, these duties are performed by the Preventive Medicine Team under the direction of the military public health officer.

6. Medical Departments

The Army and Air Force medical departments have the mission of conserving the fighting strength by providing a complete health service. Certain medical department personnel serve under the surgeon as technical advisors in disease prevention, hygiene, sanitation, and nutrition. They include the preventive medicine officer, the veterinary officer, the bioenvironmental engineer, the sanitary engineer, the entomologist, and members of preventive medicine units. In each command to which dental personnel are assigned, a preventive dentistry officer is also designated. Any or all of these specialists and others may be assigned to and utilized in large commands. When so assigned—

a. The preventive medicine officer recommends to the surgeon and the commander a preventive medicine program which will meet the particular needs of the command. He supervises the commander's preventive medicine program which en-

compasses communicable disease control, personal hygiene, environmental sanitation, and nutrition.

b. The bioenvironmental engineer, the sanitary engineer, and the entomologist serve as assistants and technical advisers to the preventive medicine officer and the surgeon regarding problems of environmental engineering and the control of disease-carrying insects and rodents.

c. The veterinary officer serves as an assistant and technical adviser to the surgeon and is responsible for the inspection of foods of animal and nonanimal origins, sanitary inspection of civilian food establishments, zoonoses control, and veterinary care and treatment of Government-owned animals and authorized privately owned pets.

d. Preventive medicine units—comprised of preventive medicine officers, entomologists, bioenvironmental engineers, sanitary engineers, veterinarians, laboratory specialists, and preventive medicine specialists—supervise and assist in the execution of measures of disease control within the command as directed by the surgeon.

e. Dental personnel assist the commander in maintaining the oral health of his troops by providing dental treatment with emphasis on prevention.

7. Army Corps of Engineers/Air Force Civil Engineers

The Army Corps of Engineers/Air Force Civil Engineers are responsible for the design, construction, and operation of many facilities and services necessary for the maintenance of health. They plan, construct, and maintain buildings, grounds, water treatment plants, and waste disposal facilities at semipermanent, as well as permanent, installations. In the field they establish and operate water points. Although insect and rodent control for Army units in the field is ordinarily a unit responsibility with support furnished by the Army Medical Department, it may be assigned in certain areas to the Corps of Engineers. In the Air Force, the base civil engineer plans, initiates, and supervises the execution of pest control measures. The Air Force Medical Department advises as to safe use of pesticides and investigates the identity, source and prevalence of insects and other pests affecting the health, comfort, and efficiency of personnel.

8. Combat Service Support Units

Combat service support units are responsible for food supply and service, clothing stock and issue, laundry and dry cleaning facilities, field shower

units, and self-service supply centers. They provide for the repair of clothing, footwear, and tentage. Supplies and materials required for personal hygiene, insect and rodent control, and sanitation are provided under the combat service support system.

9. The Individual

The promotion of the health of the service is the

responsibility of every individual member. One person's ignorance of or indifference to the practices of military sanitation can counteract much of the combined effort of the many services working for his welfare. For his own sake, as well as for the sake of his buddies, it is imperative that every individual know and observe the rules of hygiene and sanitation and adhere to the principles of good health and good living.

CHAPTER 2

COMMUNICABLE DISEASES

Section I. GENERAL

10. Meaning of Term Communicable Diseases

Communicable diseases are those illnesses which can be transmitted from person to person or from animal to person. The term *communicable diseases* includes infectious diseases which result from close or direct contact with infected persons; from exposure to the breath, cough, or bodily discharge of such persons; or from the bites of animals. Communicable diseases may also be transmitted by food, water, milk, air, insects, and rodents.

11. Types of Organisms Which Cause Communicable Diseases

Organisms which cause communicable diseases have been classified as viruses, rickettsiae, protozoa, bacteria, yeasts, molds, and worms. Most of them are too small to be seen except by means of a microscope. Some of them can survive for only a few minutes outside the human body; whereas others can survive for years in man's general environment: air, water, and earth. When these living, infectious organisms enter the human body and begin to multiply or reproduce, they cause communicable diseases.

12. Classification of Communicable Diseases

Communicable diseases may be classified into five groups: respiratory, intestinal, insect-borne, ve-

neral, and miscellaneous. The diseases in each group differ from those in the other groups by the manner in which they are spread, the area of the body which they affect, and the type of control needed to prevent their spreading.

a. Respiratory Diseases. These diseases are usually transmitted from person to person by discharges from the nose, mouth, throat, or lungs of an infected person. Examples: common cold, influenza, pneumonia, streptococcal sore throat, and tuberculosis.

b. Intestinal Diseases. These diseases are usually transmitted by food or water which has become contaminated with feces or urine from an infected human or animal. Examples: typhoid and paratyphoid fevers, dysentery, and cholera.

c. Insect-Borne Diseases. These diseases are transmitted from person to person or from animal to person by insects. Examples: malaria, typhus, and yellow fever.

d. Venereal Diseases. These diseases are transmitted from person to person by sexual intercourse. Examples: syphilis, gonorrhea, and chancroid.

e. Miscellaneous Diseases. This group includes those communicable diseases which do not fall into any of the above groups. Examples: tetanus (lock-jaw); rabies (hydrophobia), and dermatophytosis (athlete's foot).

Section II. ESSENTIALS IN DISEASE TRANSMISSION

13. General

Each case of communicable disease is the result of an orderly progression of a series of events. This series of events may be described as a three-link chain, each link representing a factor essential to the transmission of disease. These links are (a) the source of the disease (reservoir), (b) the means by which the disease may be transmitted (vehicle), and (c) a susceptible person (fig 1). If any one of the links in the chain is broken, disease cannot occur (fig 2).

14. Sources of Disease (Reservoirs)

The source of disease may be a case, a carrier, or an animal.

a. Case. A person who is actually ill with a disease is called a case. A case is a common source of infection.

b. Carrier. A person who harbors disease organisms but who is not ill is called a carrier. This person can spread the germs in the same manner as the case. Actually, he is more dangerous be-

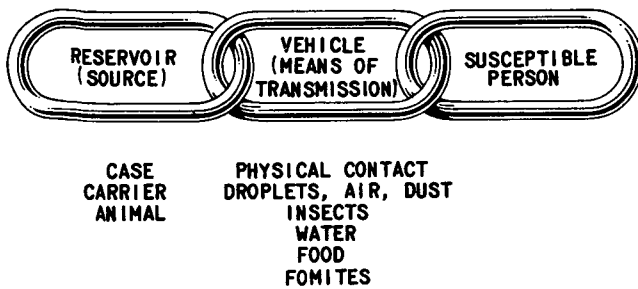

Figure 1. The chain of disease transmission.

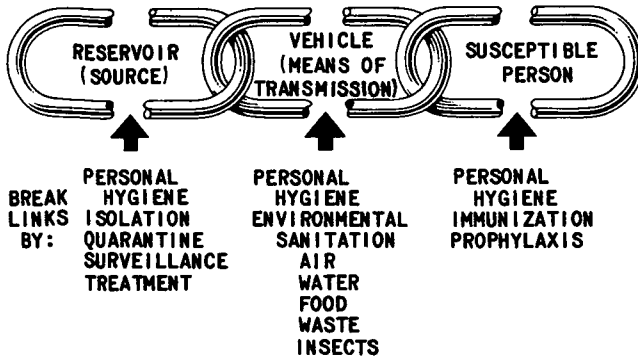

Figure 2. Break in the chain of disease transmission.

cause he may not know that he is harboring the infectious germs.

c. Animal. An animal can actually be ill with disease or it can harbor the organism, spreading it to humans in either instance. The term *animal* means any member of the animal kingdom, thus including insects as well as mammals.

15. Means of Disease Transmission (Vehicles)

a. Physical Contact. Certain diseases are spread by physical contact with an infected person. Examples: syphilis, gonorrhoea, and scabies.

b. Droplets, Air, and Dust. Droplets are vehicles by which a disease may be transmitted from an infected person to susceptible persons. When an infected person coughs, sneezes, or even talks, he spreads droplets containing disease germs. If other persons are close to the infected person, they may inhale some of these droplets. Furthermore, some germs expelled from the respiratory tract are extremely small and light in weight and may remain suspended in the air for hours or may be resuspended in dust. Inhalation of these germs by susceptible persons may also result in disease. Many of the respiratory diseases are transmitted in these ways.

c. Insects. Flies, fleas, mosquitoes, ticks, mites, and lice are among the insects (properly called arthropods) which spread disease from person to person or from animal to person. Insects are involved in both the direct and the indirect transmission of disease. A mosquito, for example, can pick up disease germs when it bites a person sick with a disease such as malaria. Later, when the mosquito bites another person, it injects the disease germs. The mosquito, is, therefore, the vehicle by which the disease is transmitted from one person directly to another person. The fly, on the other hand, transmits disease germs indirectly. It can pick up disease germs on its body when it comes in contact with filth and may deposit these germs on food. If a person eats this food, he may become ill.

d. Water and Food. Certain disease germs are transmitted through the consumption of foods such as raw fish and improperly cooked meat and poultry. However, most of the diseases which are transmitted by food and water are the result of contamination of the food or water with feces, urine, or other infectious material from a person or animal. If water or food so contaminated is not properly treated, the germs therein may infect the consumer. Outbreaks of Disease will occur when personal hygiene and proper sanitation practices applicable to food handling, water purification, water disposal, and the control of flies and other vermin are not properly observed and enforced. Among the diseases usually transmitted by contaminated food or water are typhoid fever, infectious hepatitis, cholera, dysentery, and food poisoning.

e. Fomites. Articles contaminated with disease germs from an infected person may become vehicles of disease transmission if a susceptible person uses them. Examples of fomites are contaminated clothing, bed linen, and eating utensils.

16. Susceptible Person

A susceptible or nonimmune person is one who has little resistance against a particular organism and who, if exposed to this organism, is likely to contract disease. By contrast, an immune person is one who has a high degree of resistance to the organism and who, when exposed, does not develop the disease. Immunity to many diseases is relative and can be overcome by sufficient exposure to the diseases.

Section III. COMMUNICABLE DISEASE CONTROL MEASURES

17. General

The Army and Air Force are vitally concerned with keeping the individual mentally and physically healthy. The individual's commanding officer and medical officer use every available means to make certain that he is given the best health protection available. In this effort all three factors involved in the transmission of communicable diseases are taken into consideration, namely: the source of disease, the means of transmission, and the susceptible person (para 13).

18. Control of the Disease Source (Reservoir)

The control measures for sick individuals (cases), carriers, and animal reservoirs include personal hygiene, isolation, quarantine, medical surveillance, and treatment.

a. Personal Hygiene. The spread of germs from infected individuals can be prevented or greatly reduced by carefully observing good personal hygiene and healthful practices (chap 3).

b. Isolation. This is a procedure whereby infected individuals, cases or carriers, are separated from other persons. This separation may be accomplished by having the infected individuals admitted to the isolation ward in a hospital. Clothing, linens, and other articles used by infected individuals must be disinfected and then washed or cleaned by the appropriate method to prevent the disease spreading to others.

c. Quarantine. This is the restriction of freedom of movement of those individuals who may have been in contact with cases and who may develop and/or further spread the disease.

d. Medical Surveillance. This measure may be carried out in two ways—

(1) When cases or suspects of certain communicable diseases occur in a command, all possible contacts may be inspected daily during the incubation period of the disease to detect any new cases promptly.

(2) In the presence of a threatened epidemic, examinations of all troops may be ordered at stated intervals for the purpose of detecting early cases.

e. Treatment. All cases of disease are treated as soon as the occurrence is known, thus destroying the germs and preventing further spread.

19. Control of the Means of Transmission (Vehicles)

The control of the means or the vehicles by which

diseases are transmitted requires that the following measures of environmental sanitation be practiced as rigidly as possible:

- a.* Good personal hygiene by each individual.
- b.* Avoidance of overcrowding and close physical contact.
- c.* Proper ventilation of living quarters.
- d.* Water purification.
- e.* Careful selection and preparation of food.
- f.* Maintenance of high standards of mess sanitation.
- g.* Proper disposal of waste.
- h.* Proper control of disease-carrying insects and animals.

20. Protection of the Susceptible Person

The protection of the susceptible person requires the use of all measures necessary to improve general health. It is a well-known fact that the individual who has good mental and physical health has good resistance to disease. Other protective measures include—

a. Personal Hygiene. The practice of good person hygiene will assist in preventing disease agents from entering the body (chap 3).

b. Immunization. This is an excellent control for those diseases for which immunizations are available (para 21). Immunizations, however, are rarely 100 percent effective in preventing a disease and should be used in conjunction with other control measures.

c. Prophylaxis. This refers to a direct measure used to prevent or to help prevent a disease. Examples of prophylactic measures are the cleansing of the contaminated parts of the body after intercourse to help prevent venereal diseases and the giving of medications to prevent such diseases as streptococcal sore throat and malaria. Medications are to be used only upon the advice of competent medical authority.

21. Immunity From Disease

a. General. Immunity may be defined as the ability of a person to resist the invasion of disease germs. Most persons are born with a high level of immunity which is derived from their mothers; but this immunity is lost within a few months after birth. The immunity which adults possess is usually acquired after birth in one of the following ways:

(1) *Natural immunity.* A person may acquire immunity to certain diseases by becoming infected with the germs which cause the diseases. The infection may cause a typical case, or it may be so mild that the disease is not recognized. In either instance the body may build up enough resistance to protect the person from contracting the disease a second time. This protection, however, develops only with certain infections such as measles, mumps, diphtheria, and chickenpox. There are some diseases against which the body is unable to produce an effective or lasting immunity. A person may, therefore, contract them many times. Examples are gonorrhea and the common cold.

(2) *Artificial immunity.* In the case of some infections which result in naturally acquired immunity, it is possible to stimulate this immunity by injecting a vaccine (weakened or killed organisms or their products) into the person's body. This process is called vaccination or immunization. Usually, in order to provide a protecting level of immunity, it is necessary to give several doses of the vaccine at successive intervals of a few weeks or a few months. This is called initial series. Thereafter, because the immunity is gradually lost, it is necessary to give "booster" doses at periodic intervals in order to restore an adequate level of resistance. At the present time effective artificial immunizations are available for a limited number of diseases: smallpox, typhoid, tetanus,

diphtheria, cholera, epidemic typhus, plague, yellow fever, measles, poliomyelitis, and several others. Artificial immunization against a specific disease, however, does not provide absolute protection against the disease. Consequently, a person must not become lax in the practice of protective measures such as personal hygiene and sanitation because he has been immunized.

b. Immunization Program and Record. As protection against certain diseases the Army and Air Force require that all personnel receive immunizations.

(1) All military personnel are immunized against some of the common diseases encountered within the continental United States and in most oversea areas. After the initial immunization series, booster doses are given from time to time to insure the maintenance of a protective degree of immunity. Special immunizations also may be given to personnel, depending upon the circumstances. For specific immunization requirements, reference is made to AR 40-562/AFR 161-3.

(2) The customary body site for immunization injections is the outer surface of the upper arm. It is not unusual for the surrounding area to become red, swollen, and painful.

(3) All immunizations are recorded on the individual's immunization record which becomes a part of his permanent health record.

Section IV. COMMUNICABLE DISEASES OF MILITARY IMPORTANCE

22. Diseases Spread by the Respiratory Route

Respiratory infections account for the highest incidence of disease in the Army. They occur throughout the year but are most common during winter and spring. While all troops are affected, the highest rates of infection occur among basic trainees and unseasoned troops. The principal diseases spread among civilian populations by the respiratory route are chickenpox, common cold, bronchitis, laryngitis, tonsillitis, diphtheria, measles, German measles, influenza, meningitis, mumps, pneumonia, scarlet fever, streptococcal sore throat, and tuberculosis.

a. Methods of Transmission. Disease spread by the respiratory route are transmitted by secretions from the respiratory tract, particularly through close association with an infected person. The disease-producing organisms leave the body of the case or the carrier (para 14) in small droplets of moisture during coughing, sneezing, or talking. These droplets may be inhaled directly by other persons. Some of the smaller droplets lose

their moisture by evaporation and become solid masses of dried germs. Being very light, these germ particles float in the air from long periods of time. If they are inhaled by a susceptible individual, they can cause disease. Harmful organisms from the mouth or nose may also contaminate the hands, food, eating and drinking utensils, and towels from which they may be carried to the mouths of others.

b. Control Measures. The principal difficulty in the prevention and control of diseases spread by the respiratory route lies in the fact that most individuals are susceptible to them. Another difficulty is that an infected person is usually transmitting the disease to others before he experiences any symptoms or realizes that he is infectious. There are numerous measures used to control or reduce these diseases. When used intelligently, they are very effective. The most important measures are described as follows:

(1) *Personal hygiene.* Each soldier is responsible for protecting his health as well as the health of his fellow soldiers by practicing good personal

hygiene. He must wash his hands frequently with soap and water to remove germs. When coughing or sneezing, he must cover his nose and mouth with a handkerchief. He must not use the drinking cups, canteens, towels, or any personal belongings of others. He must avoid close contact with those persons who have colds in the new, fresh, or acute stage.

(2) *Immunization.* This is an excellent preventive measure for those diseases for which immunizations are available (para 21).

(3) *Avoidance of overcrowding.* It is a well known fact that overcrowding is an important factor in the spread of respiratory infections. However, overcrowding is more likely to occur in barracks during basic combat training than in the field. During basic combat training each man is to have 72 square feet of floor space in the barracks, exclusive of stairs, halls, and latrines. The recommended space for all other troops is also 72 square feet, but this may not always be possible. The minimum is not to be less than 55 square feet except for temporary peak-load periods during which a minimum of 40 square feet per man is permissible. As the space per person is reduced, however, the incidence of respiratory diseases can be expected to increase. In the Air Force, barrack space allocations are made in accordance with AFR 161-6. Applicable for the Air Force only, a minimum of 72 square feet of floor space is recommended for each individual in open bay barracks, and a minimum of 62 square feet per occupant in dormitories housing not more than four men per room.

(a) If beds are less than 5 feet apart, individuals should sleep head-to-foot. The purpose of this arrangement is to put as much distance as possible between the respiratory tracts of persons sleeping in adjacent bunks.

(b) When respiratory diseases are present and crowding cannot be avoided, the individual cubicle system should be used. The most effective cubicle system is one which completely separates each bunk from the one on each side by a partition which extends from the floor to the ceiling; however this may not be practical in all cases. The following method may also be used in making cubicles: Attach a pole to the head of each bed. To each of these poles, attach one end of a shelter half, blanket, or sheet; secure the other end to the foot of the bed; tuck the portion which is not needed smoothly under the mattress (fig. 3).

(4) *Ventilation.* Good ventilation, either by natural or mechanical means, has a double objective—health and comfort. Proper ventilation will dilute the number of bacteria in the atmosphere, thereby reducing the number that may be inhaled.

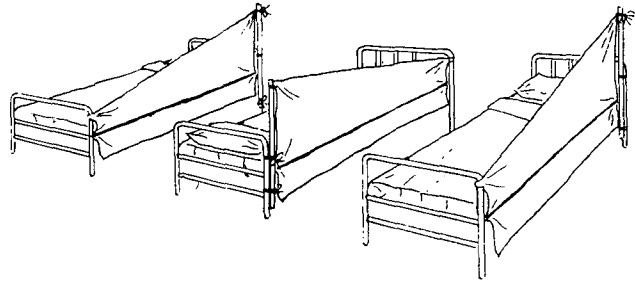

Figure 3. Construction of cubicles.

(5) *Dust control.* Dust particles carry germs. Germs from the nose and throat cling to the dust particles and may reach a susceptible person by the airborne route unless proper dust control measures are carried out. The raising of dust can be greatly decreased by forbidding dry sweeping. Water, wet sawdust, or sweeping compound should be used. Mopping can be substituted for sweeping. Oiling of unfinished wood floors is an excellent means of dust control.

(6) *Kitchen sanitation.* Dishes, cooking utensils, and kitchen equipment must be cleaned and disinfected after each meal. Food handlers must be strictly supervised and thoroughly trained in sanitary food handling practices (chap 5). Since they can infect others through the food they prepare or serve, their personal hygiene is especially important. Furthermore, each morning or at the beginning of each work shift, all food handlers must be inspected for illnesses by the supervisor. Individuals who are ill are sent to a medical facility and are returned to food handling duties when they are no longer infectious.

(7) *Prophylaxis.* As a prophylactic measure, certain drugs may be given to every member of the command for the purpose of combating such epidemic diseases as streptococcal sore throat.

(8) *Isolation of cases.* Unless the medical officer advises otherwise, all known cases should be hospitalized or otherwise separated from healthy persons (para 18b).

(9) *Quarantine and surveillance of contacts.* These measures are carried out as described in paragraph 18c and d.

23. Intestinal Diseases

Intestinal diseases usually are caused by the contamination of food and water with germs from human feces or urine. For this reason they are sometimes called "filth diseases." Such contamination of food and water results chiefly from poor hygiene and poor sanitation, both of which can be controlled by good, common-sense practices of cleanliness. Persons who keep their hands and bodies clean and who consume only food and water

that have been properly prepared and treated seldom develop these diseases. The problem of intestinal diseases exists in most parts of the world and requires constant vigilance, especially in areas where native sanitation is primitive. These diseases may affect large number of troops at the same time and cause a serious loss of fighting strength. Even with the relatively good sanitation maintained in the American Army camps of World War II, records show a total of nearly 1,000,000 hospital admissions for filth-borne diseases during that period. Moreover in 1958 when the U.S. Forces entered Lebanon at the request of the host government, the incidence of the diarrheal and dysenteric diseases exceeded 3,000 cases per 1,000 troops exposed on an annual basis. Units were at times noneffective due to the prevalence of the filth-borne diseases. Troops sometimes used the terms "GI's," "cramps," or "diarrhea" to describe their intestinal illnesses. The medical service, however, uses more specific terms. Intestinal diseases of the greatest military importance are typhoid fever, paratyphoid fever, amebic dysentery, bacillary dysentery, cholera, infectious hepatitis, and bacterial food poisoning.

a. Methods of Transmission. The most common means of transmission of intestinal diseases are often referred to as the 5 F's: feces, fingers, flies, food, and fluids. The principal source of the organism which cause intestinal diseases is the feces of man: however these organisms may be present in such foods as beef, pork, fish, poultry, and eggs which have been improperly prepared. Food may also be contaminated with these organisms by rodents. The organisms may be transmitted in any of the following ways:

(1) Food may be contaminated by infected food handlers who are careless or dirty in their personal habits or by the houseflies which carry germs directly from the latrine to the mess hall and the kitchen. Also, germs may be carried directly to the mouth by feces-contaminated fingers.

(2) Carcasses of beef, pork, poultry, and fish may be contaminated with germs from the intestines of these animals by improper or careless dressing procedures. Eggs can become fecally contaminated by the fowl on the nest. Inadequate or improper cooking of these foods permits the germs to survive and infect the consumer. Any source of foods of animal origin which has not been inspected and approved should be considered a potential health hazard.

(3) Natural sources of water, such as lakes and streams, are often polluted by drainage from latrines and sewers. Springs and wells may be similarly contaminated. In the field any careless disposal of human waste is a source of danger.

Such waste material may drain into a nearby water source or furnish a breeding place for flies.

(4) Rodents frequently urinate or defecate on foods to which they have access and in this way contaminate the foods with disease organisms.

b. Control Measures (fig 4). The most effective measures for preventing intestinal diseases are those which control the reservoir of the diseases and the vehicles by which they are transmitted; however all possible measures must be utilized.

(1) All sources of foods must be inspected and approved; and must be carefully selected, inspected, and protected at all times.

(2) Food handlers must be carefully selected, properly trained, strictly supervised, and inspected daily to insure sanitation in the handling, preparing, cooking, and storing of foods.

(3) Personal hygiene, particularly washing the hands after each visit to the latrine and before eating or otherwise handling food, must be practiced by everyone.

(4) Unapproved water sources must be avoided. All water is to be considered contaminated and unsafe to drink unless it has been properly treated and approved for drinking purposes.

(5) All human and other wastes must be disposed of properly.

(6) Insects and rodents must be effectively controlled to prevent contamination of food and eating utensils.

(7) Immunizations must be maintained in a current status.

c. Report and Investigation of Outbreak. Cases of intestinal disease should be reported to the unit surgeon as soon as detected so that he may take the necessary steps to investigate the cause of the outbreak.

24. Insect-Borne Diseases

The term *insects* as used in this manual refers to mosquitoes, flies, fleas, lice, ticks, mites, chiggers, spiders, and scorpions which are properly called arthropods. Insects affect the health of human beings (1) by transmitting disease agents, (2) by injecting venoms, (3) by invading living tissue, and (4) by annoyance. The principal insect-borne diseases include some of the most common and most serious epidemics of mankind, such as malaria, plague, yellow fever, and the typhus fevers. They are most common in the tropics but may occur in most parts of the world. Uncontrolled, they can cripple large military forces and have often done so. The principal insect-borne diseases and the insects which transmit them are listed as follows:

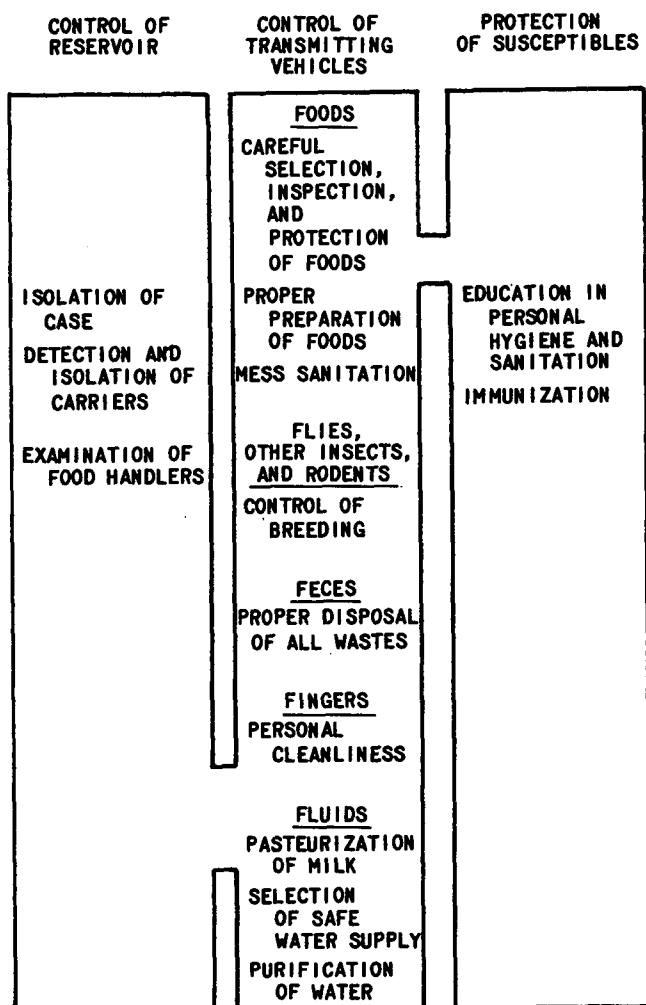

Figure 4. Factors in the control of intestinal diseases.

Disease	Insect
Dengue fever	Mosquito
Encephalitis (sleeping sickness)	Mosquito
Filariasis (elephantiasis)	Mosquito
Malaria	Mosquito
Yellow fever	Mosquito
Typhus fever (epidemic)	Body louse
Rocky Mountain spotted fever	Tick
Scrub typhus	Larval mite (chigger)
Bubonic plague	Flea
Typhus fever (murine)	Flea
Leishmaniasis	Sand fly (<i>Phlebotomus</i>)
Sand fly fever or <i>Phlebotomus</i> fever	Sand fly (<i>Phlebotomus</i>)
Onchocerciasis	Black fly (buffalo gnat)
Chagas' disease	Conenosed bug (kissing bug)

a. *Methods of Transmission.* Disease agents are transmitted by insects in two general ways: The first—called mechanical transmission—is one in which the disease organisms are picked up on the body or the legs of the insect vector and are then deposited on food, drink, or open sores. An example of this method is the transfer of typhoid or

dysentery organisms from fecal matter. The second—called biological transmission—is one in which the insect becomes infected with an organism by biting a diseased human or animal; the organism which develops in the body of the insect vector later is transmitted to a susceptible individual by a bite, as in the case of malaria, or less commonly by contamination of chafed skin with the body juices or feces of the vector, as in the case of louse-borne typhus. Certain species of bees, wasps, scorpions, and spiders inject poisons which can produce symptoms of varying severity. When gnats, mosquitoes, flies, ants, and other pests become sufficiently numerous, they can affect the health of man by their continuous annoyance.

b. *Control Measures.* Control measures are directed primarily toward the sources of infection (human beings and animals) and toward the transmitting insects. The sources of infection are controlled through personal hygiene, surveillance, isolation, quarantine, and treatment. The transmitting insects are controlled through the practice of field sanitation, individual protective measures, and chemical measures. All of these insect control measures are discussed in detail in subsequent chapters of this manual.

Note. In order to protect the environment from adverse effects of persistent pesticides or those for which hazard may exist through normal use, there will be restrictions on the use and availability of such items in CONUS and in oversea areas for other than emergency situations. Before any pesticide is used in control programs, the Medical Department should be consulted for appropriate guidance.

25. Veneral Diseases

Historically, veneral diseases have been a problem of both civilian and military communities. They are of concern to the military because of the soldier, removed from his home environment, may travel to areas where promiscuity is common and veneral diseases are prevalent. Although with modern treatment these diseases are no longer such important causes of time lost, they may be serious to the individual who is affected. There are five commonly recognized types of veneral diseases, each of which is caused by a different germ. An individual may contract more than one of these diseases as the result of a single exposure. Of the five types of veneral diseases listed below, the first three are the most common.

- Gonorrhea (clap, dose, gleet, strain)
- Syphilis (pox, bad-blood, lues)
- Chancroid (soft chancre, bubo)
- Lymphogranuloma venereum (tropical bubo)
- Granuloma inguinale (tropical sore)

a. Methods of Transmission. Venereal diseases are almost always acquired by sexual contact with an infected individual. The lesions (sores) are usually on the genitals, and direct contact with the lesion or with material from the lesion is the usual method of transmission. In rare cases when an infected person has a lesion about the mouth, syphilis may be transmitted by kissing.

b. Control Program. A venereal disease control program must be broad in scope. Its effectiveness depends on intelligent cooperation among many individuals. In the venereal disease control program of the Army, particular emphasis is placed as follows:

(1) *Responsibilities.* The unit commander is responsible for initiating and maintaining a venereal disease control program within his command. His staff officers provide him with information and advice as to suitable control measures. The real responsibility or prevention, however, rests with the individual, since these diseases are transmitted by sexual contact. Each soldier is personally responsible for the development and maintenance of his character, his self-respect, his personal hygiene, and his health.

(2) *Character guidance.* The Army's character guidance program and the Air Force's moral leadership program are aids to the commander in promoting and maintaining a healthy mental and moral attitude among the personnel under his command. The programs are designed to encourage the individual to develop moral responsibility and self-discipline. It pertains to all of the soldier's interests and activities.

(3) *Reduction of sources.* Venereal diseases that occur among military personnel are for the most part contracted from promiscuous women in the civilian population. In order to control the sources of infection, the Army and the Air Force must work closely with the civilian agencies concerned. The following methods can be used to reduce the sources of infection:

(a) *Contact tracing.* After a case of venereal disease is diagnosed or detected, all sources of sexual contact should be examined and, if found infected, placed under treatment. In this manner the reservoir of infection can be reduced. The individual who has contracted venereal disease is expected to supply information about the sex partner involved. This confidential information is for the use of health authorities only and will not be

disclosed; furthermore no disciplinary action will result.

(b) *Use of "off limits" restrictions.* In order to decrease the possibility of contact, known houses of prostitution and establishments where "pickups" loiter must be placed "off limits" to military personnel (AR 190-90/AFR 125-43).

(c) *Repression of prostitution.* Prostitution is not tolerated by the Army nor the Air Force. The unit commander is responsible for securing full compliance with the spirit as well as with the letter of regulations covering the repression of prostitution (AR 190-90/AFR 125-43).

(4) *Continence.* The most effective way of guarding against contracting venereal disease is to abstain from promiscuous sexual relations. Promiscuity increases the chances of developing venereal disease. The belief held by some people that sexual intercourse is necessary to maintain health is false.

(5) *Education in sex hygiene.* All soldiers and Airmen are instructed in matters of sex hygiene and the nature of venereal disease. Facts should be presented honestly and clearly.

(6) *Prophylaxis.* Individuals who expose themselves to the risk of venereal infection should employ as a measure of protection the materials and facilities recommended by the medical service. Good protection is afforded by mechanical prophylaxis (condoms, rubbers) if used properly. These are not items of issue but may be purchased in Army/Air Force exchanges. The degree of protection may be increased by thorough washing of the genitals with soap and water as soon as feasible after exposure.

c. Treatment. Most cases of venereal disease can now be cured if proper treatment is started early. Any sore on the genitals or any discharge from the penis may be a venereal disease; therefore any such symptoms should be reported to the medical officer immediately. One should not seek outside help, consult quacks, or try home or drugstore remedies. Avoidance of the medical officer in such cases is the surest way to complications and disaster. Contracting VD is not cause for disciplinary action; however a soldier who suspects or knows that he has venereal disease but fails to report for proper medical treatment or one who violates "off limits" orders by entering a house of prostitution is subject to disciplinary action.

CHAPTER 3

PERSONAL HYGIENE

Section I. GENERAL

26. Meaning of the Term Personal Hygiene

Personal hygiene is the practice of health rules by the individual to safeguard his own health and the health of others. Personal hygiene is often thought of as being the same as personal cleanliness. Yet, while cleanliness of the body is important, it is but one of the many essentials of healthful living.

27. Importance of Personal Hygiene to Health

An efficient military unit is a carefully planned, well-organized, well-trained fighting team. It is a team that carries no substitutes. When any team member is absent or sick, teamwork suffers. Carelessness of one member of the unit in regard to his personal hygiene may lead to disease which may incapacitate the entire unit. Personal hygiene contributes to health in several ways—

a. It protects the individual against disease germs that are present in the environment.

b. It protects the unit by reducing the spread of disease germs.

c. It promotes health—a state of maximum physical and mental well-being above and beyond the mere absence of disease.

d. It improves morale.

28. Responsibilities in Maintaining Personal Hygiene

a. The Individual. A person's fulfillment of the obligation of honorable military service involves doing the best job possible in any given assignment. This demands, among other things, that the individual maintain his health and physical fitness at the highest level and that he do everything possible to protect and promote the health of the other members of his organization. This calls for a clear understanding and continual application of personal hygiene measures. This also requires that

he seek needed medical care without delay in order to avert more serious illness, hasten recovery, and prevent the spread of disease. The Army and Air Force provide for its members a medical service of the highest possible caliber; therefore the individual has no reason for delaying needed medical care, for resorting to self-treatment, or for seeking treatment from unauthorized sources. All such actions could prove dangerous.

b. Commander. The unit commander is responsible for—

(1) Providing and maintaining facilities, equipment, and supplies necessary for the personal hygiene of his command.

(2) Insuring that the members of his command are instructed in the essentials of personal hygiene.

(3) Insuring the practice of personal hygiene measures. He must obtain the cooperation of each individual in maintaining good health and physical fitness for the job.

c. Medical Officer. The unit surgeon is the technical advisor on hygiene and sanitation. As such, he or his assistants—

(1) Conduct instruction in personal hygiene.

(2) Carry out inspections and observations of personnel and facilities.

(3) Recommend correction of any defects.

(4) Provide medical treatment.

d. Dental Officer. The senior dental officer is the technical advisor to the commander regarding the oral fitness of his troops. To prevent oral disease and injury, the preventive dentistry officer and other dental personnel—

(1) Conduct instruction and educational programs in good oral hygiene and emphasize the need for regular dental attention.

(2) Perform preventive measures and treatments.

Section II. MEASURES TO PROTECT AND IMPROVE HEALTH

29. General

The measures which the individual may apply personally to prevent disease and to promote health and physical fitness are discussed in detail in paragraphs 30 through 41 under the following headings:

- a. Personal cleanliness.
- b. Care of the mouth and teeth.
- c. Care of the feet.
- d. Food and drink.
- e. Exercise.
- f. Rest and recreation.
- g. Protection against the elements.
- h. Protection against disease-carrying insects.
- i. Avoidance of the sources of disease.
- j. Special protective measures.
- k. Cultivation of a healthy mind.
- l. Rules for avoiding illness in the field.

30. Personal Cleanliness

Even before it was known how the germs of disease were spread, civilized people gave attention to personal cleanliness because of a desire to please themselves as well as to be attractive to others. Now it is known that there are also sound medical reasons for keeping the body clean. Dirt, filth, and invisible disease germs are inseparable. Keeping the body and clothing clean is a simple, effective means of reducing the number of disease germs which could invade the body.

a. *The Skin.* The body should be washed frequently from head to foot with soap and water. If no tub or shower is available and one cannot be improvised (para 45), the body should be cleaned with a cloth and soapy water, paying particular attention to the body creases (armpits, groin, and crotch), the face, the ears, the hands, the feet, and under the foreskin. Infections, cuts, and burns should have prompt treatment at a medical facility. Some of the more common and troublesome diseases of the skin are discussed in chapter 16.

b. *The Hair.* The hair should be kept neatly combed and trimmed, preferably two inches or less in length. At least once a week the hair and scalp should be shampooed with soap and water. The soldier/Airman should be clean shaven. He may wear a neatly trimmed, conventionally shaped mustache. Combs, brushes, and razors should not be shared with other persons.

c. *Hands.* Fingernails should be kept closely trimmed and clean. The hands should be washed (with soap and warm water, if available) after any dirty work, after each visit to the latrine, and before touching food or food utensils. Effective hand-washing devices can be improvised as discussed in paragraph 43. The habits of nose-picking, nail-biting, and unnecessary scratching will cause contamination of the hands and of the things later touched by the hands. These habits, which are unpleasant to see and unhealthy for the individual, should be controlled. Coughs and sneezes should be smothered in a tissue or handkerchief or at least directed away from other persons. Fingers and other contaminated objects should be kept out of the mouth.

d. *Clothing and Bedding.* Clothing easily becomes contaminated with any disease germs that may be present in the stool, in the urine, or in secretions of the nose and throat. Underclothing, if possible, should be changed daily. Outer clothing should be washed or cleaned when it becomes soiled. Shaking of clothing followed by a 2-hour airing and sunning will greatly reduce the number of disease germs on it. The shaking should always be done out of doors. At least once a week the bedsheets should be changed; and the blankets, pillows, and mattresses should be aired and sunned.

31. Care of the Mouth and the Teeth

a. *Fundamentals of Oral Hygiene.* Regular and proper cleansing of the mouth and the teeth prevent tooth decay and gum disease, both of which can cause the individual severe pain and loss of teeth. The most healthful oral hygiene, which should be practiced whenever possible, is to cleanse the mouth and teeth thoroughly and correctly after each meal with a toothbrush and fluoride dentifrice and to remove food debris which has accumulated between the teeth with dental floss, stimulents, or toothpicks. When the situation makes this impractical, the soldier should thoroughly cleanse his mouth and teeth at least once each day, using improvised devices if necessary. If a dentifrice is not available, the toothbrush should be used without one. In the absence of a toothbrush, twigs cut from a tree and frayed on the ends to resemble toothbrush bristles can be used. Twigs can also be cut in the form of toothpicks for use in removing material caught between the teeth. If necessary, pieces of clean cloth can be used to wipe away food debris which has collected on the teeth. Rubbing the gum tissues vigorously

with a clean finger will stimulate them to better health.

b. Care of Dentures and Bridges. It must be recognized that replacements for lost natural teeth in the form of dental prosthetic appliances are only substitutes. In no instance should it be assumed that a replacement is equal or superior to natural teeth. The degree of successful usage that can be expected of these replacements depends to a great extent upon the care and maintenance given them by the wearer. Cleansing of removable and fixed dental appliances is of greatest importance and should be accomplished with as much care as the cleansing of natural teeth. Distorted or damaged dentures can be harmful to mouth tissues and should be repaired, adjusted, or replaced by a dental officer. The tissue under the dentures also requires attention. It should be brushed regularly for proper stimulation. Furthermore, the dentures should be removed at night or for a 3- or 4-hour period during the day.

c. Tooth Restorations. Silver fillings, gold inlays, gold or porcelain crowns, and other types of restorations are also substitutes for lost tooth structure and have varying degrees of functional limitations. The use of good judgment regarding these limitations will be the determining factor in the overall functional effectiveness of the teeth and the health of the mouth. Damaged or lost fillings should be replaced. Good oral hygiene also depends upon the periodic examination and care of the teeth and the mouth by a dental officer.

32. Care of the Feet

Battles and wars are still being fought by the foot soldier. Proper care of the feet is essential to the maintenance of physical fitness. Serious foot trouble usually can be prevented by observance of the following simple rules:

a. Foot Hygiene. The feet should be washed daily and dried thoroughly, especially between the toes. Persons whose feet perspire freely should apply foot powder lightly and evenly twice a day.

b. Properly Fitted Shoes. In the field only footgear issued by the combat service support units should be worn. Expert fitting at the time of issue is absolutely essential. There should be no binding or pressure spots; neither should the footgear be so large that it will permit the foot to slide forward and backward when walking.

c. Clean, Properly Fitted Socks. Socks should be changed and washed daily. They should be large enough to allow the toes to move freely but not so loose that they wrinkle. Woolen socks should be at

least one size larger than cotton socks to allow for shrinkage. Socks with holes or poorly darned socks may cause blisters. Different types of socks are provided for various footgear; their proper uses should be learned at the time they are issued.

d. Common Foot Troubles. Blisters, corns, bunions, ingrown toenails, and fungus infections are the most common causes of foot trouble.

(1) Blisters can usually be prevented by wearing properly fitted shoes and socks. Shoes should be broken in slowly and socks should be clean and hole-free. If a blister does develop, it should be treated as prescribed in FM 21-11/AFP 50-55.

(2) Ingrown toenails develop when nails are improperly cut. A person should trim his toenails straight across rather than following the contour of his toes. If tenderness develops in the nailbed or along the edge of the nail, he should report to the medical officer.

(3) Athlete's foot (dermatophytosis) is the most common infection of the feet. It can usually be prevented by proper care of the feet (*a* above) and by taking certain precautions (para 166).

e. Immersion Foot. Immersion or constant wetness of the feet for a period exceeding 48 hours usually results in immersion foot and disability even though the exposure has been to warm water. In this condition the soles of the feet become wrinkled and white, and standing or walking becomes extremely painful. The feet return to normal in about 24 hours if exposure is terminated. This condition can be prevented by avoiding prolonged immersion of the feet and by drying the feet during rest periods.

f. Special Care of the Feet on Foot Marches (FM 21-18). The foot march is the severest test of fitness of the feet. Unless special attention is given to the feet of marching troops, serious casualties from foot troubles will result.

(1) *Prior to the march.* Well in advance of the march unit officers should insure that all men are equipped with the proper type of correctly fitted broken-in footgear; with the necessary number of correctly fitted, clean socks which are free of holes or bunched darns; and with an adequate supply of foot powder. A person must never attempt to break in a new pair of shoes or boots on a long march. Any blisters, pressure spots, and infections should be treated and properly protected before the march starts.

(2) *On the march.* The feet should be kept as dry as possible. If socks become damp from perspiration or wet from weather or surface water, they should be changed for dry ones at the first

opportunity. If necessary, socks may be dried by putting them under the shirt around the waist. Tender pressure spots should be relieved promptly by adjusting gear or applying adhesive tape. Once or twice daily during the march, the feet should be dusted lightly with foot powder.

(3) *At rest periods.* The feet should be inspected from time to time and preventive measures applied before serious trouble develops. Persistent complaints should be brought to the attention of the medical aidman or other medical personnel. If possible, the feet should be washed during the noon break. It is helpful to elevate the feet while resting. This reduces congestion and swelling. The unit commander should also make periodic checks for foot complaints and insure that corrective measures are applied.

(4) *In bivouac.* All used socks should be washed thoroughly with soap and water, stretched to facilitate drying, and hung in the sun or in an air current. Woolen socks should be washed in cool water to lessen shrinkage.

33. Food and Drink

For proper development, strength, and survival, the human body requires the following variety of food substances: proteins for developing muscle, fats and carbohydrates for energy, minerals for blood and bone, certain essential vitamins, and water. The Army/Air Force ration contains these essential food substances in adequate amounts and proper balance. They are adjusted to meet the special requirements of climate and activity. A normal, healthy appetite usually will insure the intake of adequate amounts of all essential substances. Only occasionally is it necessary to provide supplements, such as salt in hot climates or vitamin tablets for special nutrition. The common beverages (soft drinks, tea, and coffee) contribute little to the diet nutritionally, but they do no harm if taken in moderation. Alcohol, if taken in more than small quantities, impairs judgment and slows the reflexes, contributes to overweight, and may be habit-forming. The nutritional beverages are milk and fruit juices.

34. Exercise

Regular exercising of muscles and joints is necessary in maintaining physical stamina and good health. Military duties usually impose a considerable amount and variety of physical activity. Training schedules ordinarily include periods of supervised physical training. When such physical training is not included in the individuals schedule, he should participate voluntarily in some form of exercise or sports. Both the supervised and volun-

tary exercises should be appropriate for the age and physical condition of the individual. Exercises should be stopped before extreme fatigue or exhaustion occurs.

35. Rest and Recreation

Our bodies require regular periods of rest to restore physical and mental vigor. Seven or eight hours of unbroken sleep each night is desirable. The individual, however, must learn to make himself comfortable and to obtain rest under conditions less than ideal. He must learn to use the shelter half, the blanket, and the sleeping bag as substitutes for the barracks and the bed. In the course of his daily schedule he should use his rest periods to obtain a change either from physical exertion to complete rest or from mental activity to physical activity as the case may be. Part of his off-duty time should be devoted to pleasant recreation such as social and religious activities, avocations, hobbies, and sports.

36. Protection Against the Elements

In both training and combat the soldier/airman is often exposed to the full forces of the elements: heat, cold, rain, mud, and wind in situations which make it impossible for him to give the normal thought and care to his comfort. For his protection against these forces of nature, he is provided with the best equipment available. If he is to survive the hardships of training and combat, he must learn to use this equipment properly. Among the important adverse effects of the elements are frostbite, trench foot, heat exhaustion, heatstroke, and sunburn. These conditions and their prevention are described in detail in chapter 17.

37. Protection Against Disease-Carrying Insects

Cleanliness of the body and clothing is the first line of defense against body parasites. In certain situations special measures must be used to control body lice, mosquitoes, fleas, and other insects. These measures are discussed in detail in subsequent chapters.

38. Avoidance of the Sources of Disease

Through the application of a variety of measures, the Army/Air Force attempts to make the individual's surroundings as healthful as possible. These measures include the provisions for water and food which are free of disease germs and poisons and for facilities which are adequate for the proper disposal of body wastes. They also include the elimination of insects and rodents. Further-

more, certain special procedures such as drug prophylaxis, immunization, and the detection and treatment of cases of communicable disease are applied. Ultimately, however, the health of the troops depends upon the consistent, intelligent application of the rules of healthful living by each and every member of the unit. The soldier/airman must avoid food and drink which may possibly be contaminated; he must protect himself against insects; and he must not expose himself unnecessarily to the germs of venereal disease, dysentery, malaria, and a host of other infectious diseases. He must definitely avoid close association with natives in areas where sanitation and hygiene are still in a primitive state.

39. Special Protective Measures

In each geographical area, climate, and living situation, special health hazards exist. As the need arises, the troops are given instruction in the nature of these dangers and in ways of guarding against them. Among the special measures for individual protection are the use of bednets, the wearing of proper clothing, the safeguards against frostbite, the addition of salt to the diet, and the use of individual water purification tablets. These measures are discussed in detail in subsequent chapters of this manual. The effectiveness of these and other protective measures depends upon the consistency and appropriateness with which they are used by each individual in the unit.

40. Cultivation of a Healthy Mind

The health of the body is interrelated to the health of the mind. Mental disorders may be just as disabling as are physical diseases. The soldier/airman who is incapacitated by combat fatigue is just as much a casualty as is the individual with malaria. Both mental health and physical health make up the total health of the individual. A sense of well-being, the absence of overpowering fears and anxieties, and a wholesome attitude toward life are essentials of total health. By following the suggestions given below, an individual can do much to cultivate and improve mental health and prevent the occurrence of a mental disorder:

a. Friendliness. The soldier/airman should seek friendship among the members of his organization, learn to enjoy the companionship of others, and participate wholeheartedly in group activities. Active participation prevents concentration on personal, depressing problems and feelings.

b. Tolerance. The soldier/airman should apply the Golden Rule. The military is composed of individuals of various ages, races, and religious be-

liefs. The right of each individual to his own beliefs and habits should be respected.

c. Combating of Worry. Worry has been defined as many useless thoughts whirling around a hub of indecision. Although worry cannot be shut off like a faucet, positive action can be taken to combat it. Troubles should be faced boldly; they may be put into words and shared with one's associates. Unit officers, chaplains, and medical officers are interested in the physical and mental welfare of each person in their units and should be consulted by those persons whose worries threaten their health.

d. Combating of Fear. Fear is a normal reaction. It serves the important purpose of preparing the body for defensive action. Fear is destructive only when it is allowed to get out of control. Some of the sensations of overpowering fear are trembling, jumpiness, pounding heart, sick stomach, sweating, and momentary "freezing." The best antidote for fear is action. The individual should concentrate on the job to be done and act in accordance with his orders and training. By doing so, he will find that fear loses its paralyzing powers.

41. Rules for Avoiding Illness in the Field

Under field conditions the dangers of disease are multiplied. Some simple "do's" and "don'ts" which will help to keep the soldier/airman healthy are as follows:

a. Don't consume foods and beverages from unauthorized sources. They are very likely to contain disease germs or poisons. When away from approved water sources, treat your water supply properly (para 51 through 54).

b. Don't soil the ground with urine or feces. Use the latrine. When no latrine is available, dig a "cat hole" and cover your waste.

c. Keep your fingers and contaminated objects out of your mouth. Wash your hands following any contamination, before eating or preparing food, and before using your fingers in the care of your mouth and teeth (para 31).

d. Be sure that after each meal your mess kit, knife, fork, and spoon are well cleansed and disinfected in boiling water or in a chlorine-water solution (para 66).

e. Cleanse the mouth and teeth thoroughly at least once each day. By carrying a toothbrush and toothpicks with you and using them correctly to remove accumulated food debris, you can pre-

vent most dental diseases associated with long periods of field duty. Remember, it is not absolutely necessary to have a dentifrice to brush your teeth. If necessary, use improvised devices as discussed in paragraph 31.

f. Avoid the bites of insects by keeping your body clean; wearing proper, protective clothing; and using an insect bar (bed net), insecticides, and repellents as instructed in subsequent chapters.

g. Avoid getting wet or chilled unnecessarily. When you get wet, change to dry clothing at the first opportunity. Whenever possible, wear clothing suitable for the temperature, weather conditions, and type of activity.

h. Don't share with others such personal items as canteens, pipes, mouth organs, towels, toothbrushes, handkerchiefs, and shaving items.

i. Don't take a laxative for pain in the stomach. Instead, see a medical officer.

j. Don't throw food scraps, cans, and refuse about the camp area. Such accumulations serve as breeding place for disease-carrying insects and rodents.

k. Avoid contacts with sources of disease. This applies particularly to natives and animals in areas where sanitation is poor and disease is prevalent.

l. Avoid intercourse with prostitutes and promiscuous women. They are usually infected with venereal disease. There is no such thing as a "clean" prostitute.

m. Whenever possible, get 7 or 8 hours of sleep each night.

n. Engage regularly in some form of physical exercise or sport, preferably out of doors.

o. Use a portion of off-duty time for wholesome recreation and self-improvement: sports, hobbies, studies, and religious activities.

Section III. IMPROVISED HYGIENIC DEVICES

42. General

In the field the devices necessary for maintaining personal hygiene must be improvised. Some of the devices which have been tried and used successfully in the field are described in this section. Potable water will be used for washing hands.

43. Hand-Washing Devices

Hand-washing devices which are easy to operate must be provided at appropriate places in the bivouac area: outside the latrine enclosures, near the mess area, and at other locations as needed. A soakage pit (para 79) must be provided under each device to prevent water from collecting. The water containers for these devices must be checked periodically to insure that they are kept filled. Two effective hand-washing devices are illustrated below—

a. Suspended 5-Gallon Water Cans. Two salvaged 5-gallon water cans, one filled with soapy water and one filled with clear water, are suspended from an improvised frame as illustrated in figure 5. A hole is punched in the cap of each can to allow the water to run out when the cans are tipped.

b. Mounted No. 10 Can. A No. 10 can in which four small holes have been punched is attached to an improvised stand as illustrated in figure 6. A 5-gallon can of water, a dipper made for a small can, and a bar of soap are provided. A small can

or a split can with the edges turned down may be used as a soap dish. The water is dipped from the 5-gallon can and poured into the No. 10 can. The streams of water from the No. 10 can makes it possible for a person to wash both hands at the same time. Minimal amounts of water are required for this washing device. When this device is not in use, the can of water should be covered to prevent mosquito breeding.

44. Shaving and Washing Device

A device suitable for shaving and washing pur-

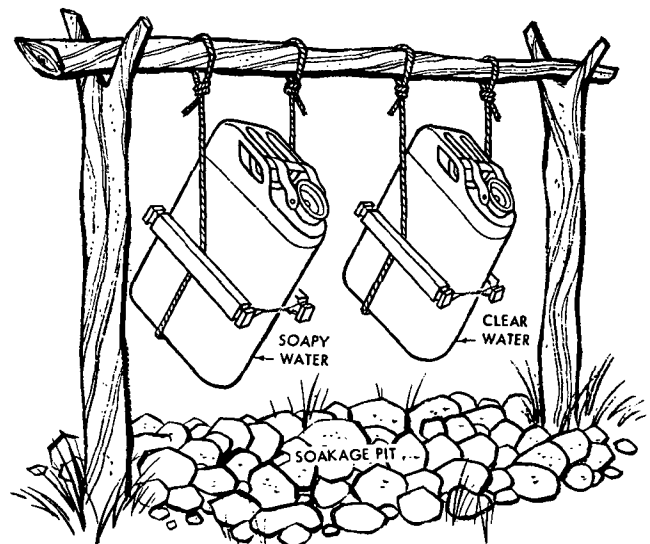

Figure 5. Hand-washing device—suspended 5-gallon water cans.

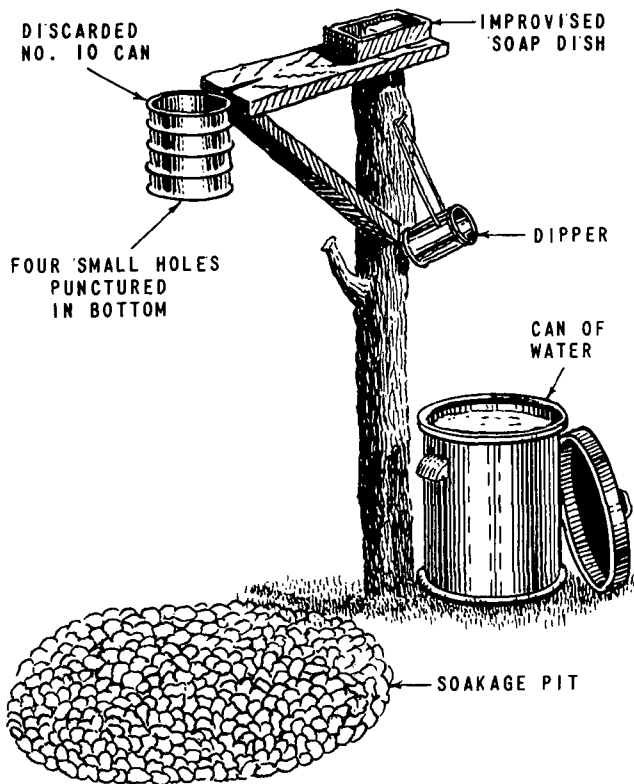

Figure 6. Hand-washing device—mounted No. 10 can.

poses is a rack built in a way which will secure steel helmets in an upsidedown position and mirrors at an appropriate height as illustrated in figure 7. The water supply can be provided in a 5-gallon can placed at one end of the rack. At the other end of the rack a grease trap and a soakage pit (para 79 and 81) can be built for the sanitary disposal of the waste water.

45. Shower Devices

Whenever possible, shower devices should be provided in the field. They are important in maintaining not only the personal hygiene of the troops but also their morale. In some climates heat from the sun will take the chill from shower water. Furthermore, painting the containers black or some other dark, dull color increases the absorption of heat from the sun. When the climate is such that a device is needed to heat the water, it may be improvised as discussed in *c* below. The shower devices illustrated below are a few of the improvised devices which have proved to be effective in the field. Each shower device should have a soakage pit built underneath it and wood duckboards positioned over the pit.

a. Mounted Inverted Drum Shower. A 55-gallon drum is converted into a suitable water container by removing the bottom and fitting the bunghole on the top with a control valve for the water out-

let. This drum is then placed upside down on an overhead platform, and a perforated tin can is fastened over the water outlet (fig 8).

b. Mounted Tilt Drum Shower. This device is built by mounting a 55-gallon drum on an over-

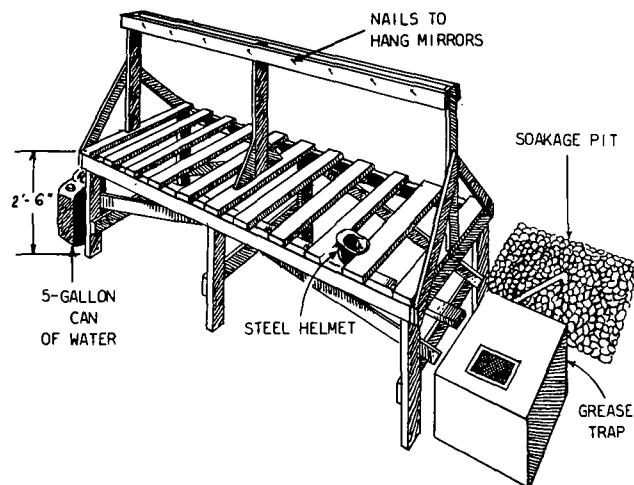

Figure 7. Shaving and washing device.

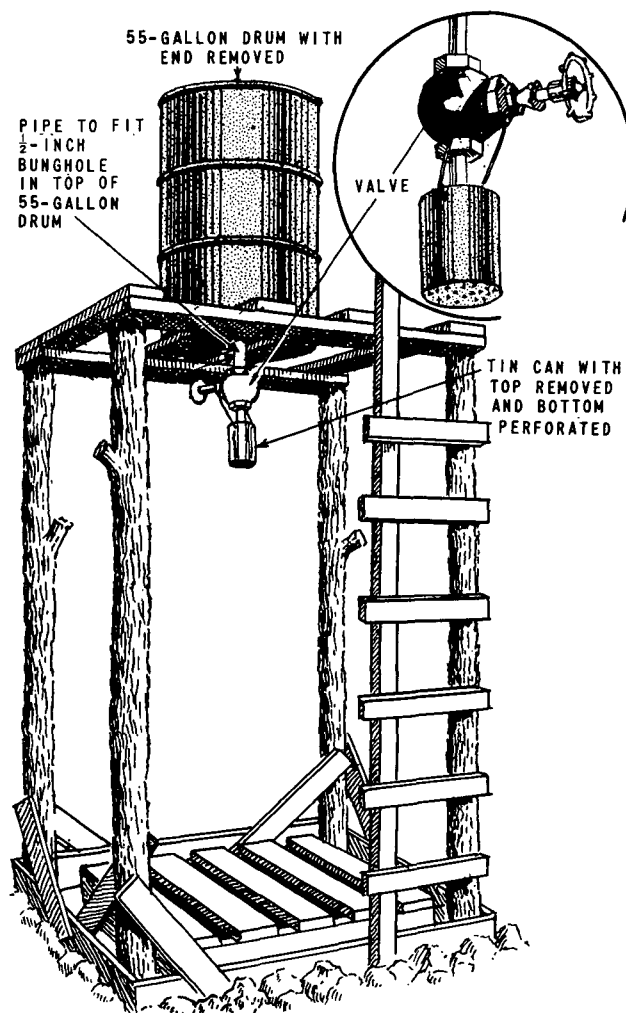

Figure 8. Mounted inverted drum shower.

head frame in a way which permits it to tilt when a rope attached to the top of the drum is pulled (fig 9). A safety strap fastened to the frame controls the extent to which the drum can be tilted downward. The bunghole portion of the top of the drum is removed, leaving about two-thirds of the top in place. Holes are punched in the upper part of the drum on the side opposite the open top; the tilt rope is attached to the top above these holes. A round rod is inserted crosswise through the drum and halfway between the top and bottom. The rod must project sufficiently on each side of the drum to remain securely in the notches which are cut into the overhead frame.

c. Shower With Water Heating Device. When a water heating device is required, two 55-gallon drums are mounted on an overhead platform as described in *a* above. An oil-water flash burner is improvised as described in paragraph 68*b*, and a 15-gallon drum of water is placed on the burner (fig 10). This burner drum is then connected to one of the overhead drums by means of two rubber tubings or metal pipes. One pipe is inserted into the overhead drum at approximately one-half

its depth; whereas the other pipe is inserted near the bottom. The other end of the pipe which has been connected near the bottom of the overhead drum should be inserted into the 15-gallon drum to a point 2 or 3 inches from the bottom as shown in figure 10. As the water in the burner drum becomes hot, it rises up the higher pipe into the overhead drum. This water is replaced in the burner drum immediately by an equal amount of water leaving the overhead drum through the lower pipe.

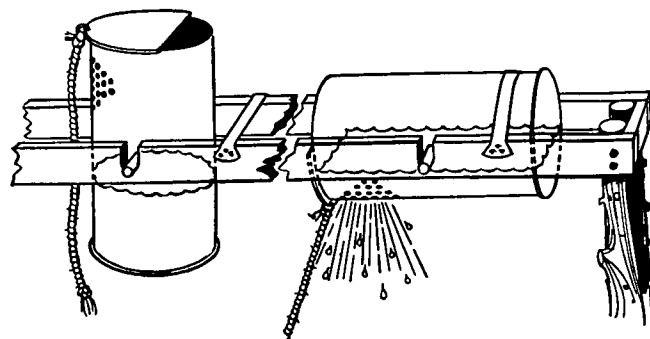

Figure 9. Mounted tilt drum shower.

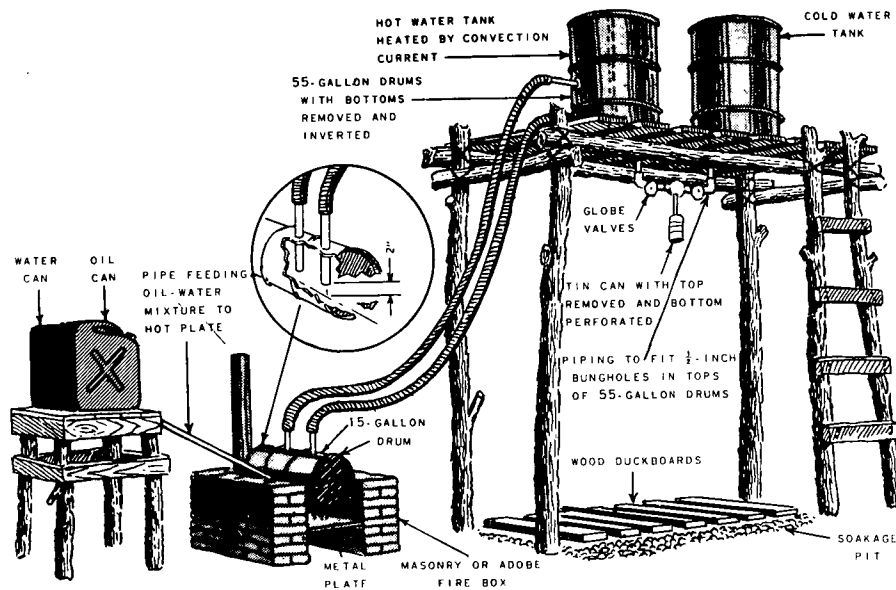

Figure 10. Shower water heated with an oil-water flash burner.

CHAPTER 4

FIELD WATER SUPPLY

Section I. GENERAL

46. Importance of Water

Safe water in sufficient amounts is essential to an army. Water which is not properly treated can spread diseases such as typhoid and paratyphoid fevers, bacillary dysentery, cholera, leptospirosis, and common diarrhea (fig 11). In certain areas, water may also transmit infectious hepatitis, schistosomiasis, and amebic dysentery. The latter diseases are caused by organisms which are highly resistant to the water disinfection methods normally used.

47. Terms Used in Relation to Water

a. Potable Water—Water which is safe for human consumption. Potable water is free from disease-causing organisms and excessive amounts of mineral and organic matter, toxic chemicals, and radioactivity.

b. Contaminated Water—Water which is unfit for human consumption even though it may be palatable (*c* below). Contaminated water contains disease-producing organisms and/or excessive amounts of mineral and organic matter, toxic chemicals, or radioactivity.

c. Palatable Water—Water which is pleasing to the taste but which may be unsafe (contaminated).

d. Brackish Water—Highly mineralized water that contains dissolved solids in excess of 500 ppm (*k* below). Both alkalinity and salinity range from very high to very low. Brackish water is found in many regions throughout the world but most fre-

quently in arid or semiarid climates as ground water and along sea coasts.

e. Water Treatment—Removal of undesirable constituents in water through such means as coagulation, sedimentation, filtration, and/or disinfection.

f. Disinfection—Treatment with a chemical or by boiling to destroy disease-producing organisms.

g. Chlorination—Disinfection of water by the addition of a chlorine compound such as calcium hypochlorite.

h. Chlorine Dosage—The amount of chlorine added to a given quantity of water.

i. Chlorine Demand—The amount of the chlorine dosage which reacts with and is consumed by organic material, bacteria, and other materials in the water.

j. Chlorine Residual—The amount of the chlorine dosage remaining after the demand has been satisfied. *Dosage minus demand equals residual.*

k. Parts Per Million (ppm)—A unit of measurement for expressing the number of units of a substance in one million units of water by weight.

48. Responsibilities for the Production of Potable Water

a. Commander. The unit commander is responsible for the adequacy and safety of the water used by his troops. He must enforce the rules of water discipline (*d* below) and insure that each individual thoroughly understands the danger of drinking contaminated water. When treated water is not obtainable, the commander must insure that proper water treatment methods are used in his unit. The unit field sanitation team assists the commander in carrying out these responsibilities.

b. Army Corps of Engineers/Air Force Civil Engineers. Personnel of the Army Corps of Engineers/Air Force Civil Engineers are responsible for obtaining and treating water. This responsibility includes the construction, operation, and main-

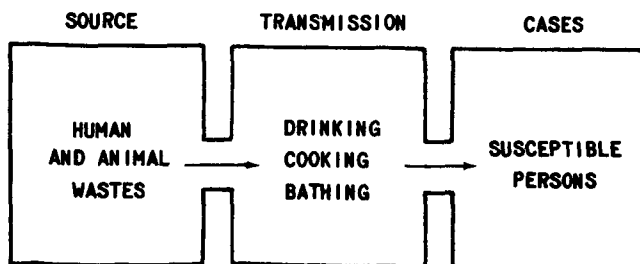

Figure 11. Spread of water-borne diseases.

tenance of all facilities for collection, treatment, and distribution of water. In the field, engineer troops will not usually deliver water to units but will establish and operate water points where water is treated and stored. Sometimes engineer troops transport water to centralized distribution points, known as dry points, for convenient pickup by unit personnel. The usual practice, however, is to provide delivery facilities at the water points. In order to provide large quantities of water for troops in the field, engineer troops use equipment developed especially for this purpose, such as mobile water purification units and distillation units. They use other special equipment in removing chemical, biological, and radiological contaminants. The water treatment process usually consists of coagulation, sedimentation, filtration, and disinfection.

c. Army/Air Force Medical Department. Medical Department personnel recommend standards for water quality, conduct bacteriological and

chemical examinations of water, and advise commanders and engineers as to the methods of purification which should be used to produce potable water. The selection of water points and water treatment methods may be based upon data provided by the Medical Department as well as the reconnaissance performed by engineer troops. Medical Department personnel also inspect water supply systems and water points and, after appropriate laboratory and field examination, approve or disapprove water for consumption.

d. Individuals. Whether in the field or in garrison, each soldier/airman is responsible for observing the rules of water discipline. These rules are (a) to drink potable water only, (b) to prevent waste of potable water, and (c) to protect water sources by good sanitary practices. It is emphasized that water discipline does not imply doing without water. It means to use water wisely and not waste it.

Section II. PROCUREMENT AND PROTECTION OF TREATED WATER FROM ENGINEER WATER POINTS

49. Quantity of Water Required

The quantity of water required for troops varies with the season of the year, the geographical area, and the tactical situation. Dehydration may be a problem in both extremely hot and cold climates. In extremely hot climates large quantities of potable water are required to replace body fluid losses. In extremely cold climates body fluid losses are not as great as in hot climates; however consideration must be given to requirements for potable water in the reconstitution of dehydrated foods. Additional amounts of water are also required for maintenance of personal hygiene in both hot and cold climates. A guide for planning to meet the water requirements in a temperate zone is 5 gallons per man per day for drinking and cooking. When showering facilities are to be made available, the amount required will be at least 15 gallons per man per day. Further discussion of water requirements is contained in paragraph 175 and in TM 5-700/AFM 86-3 and TBMED 175/AFP 160-1.

50. Treated Water from Engineer Water Points

a. Procurement of Treated Water. Unit personnel obtain water which has been treated by the engineers to make it potable from the designated water points, using tank trucks, water trailers, or water cans. The unit must insure that this treated

water does not become recontaminated while hauling it to the unit area. The following precautions must be taken:

(1) Water trailers, tank trucks, and water cans must be clean upon arrival at a water point. To the maximum extent possible, they should be used for hauling potable water only. When they are used to haul nonpotable water, they must be so marked. If they are to be used thereafter for hauling potable water, they must be cleaned and then disinfected with a 100 ppm chlorine solution. New trailers, tank trucks, and water cans should also be disinfected prior to initial use. The disinfecting solution can be prepared by adding one ampule of calcium hypochlorite to 1 gallon of water. For trailers and tank trucks, it will be more convenient to obtain calcium hypochlorite in the bulk form (3½-pound can), and use 2 ounces or 5 level messkit spoonfuls per 100 gallons of water.

(2) The interior surfaces of trailers, tanks, and cans must be properly maintained. They should be inspected periodically for rust and chips in interior enamel, tightness of seals and seams, and cleanliness.

b. Use and Care of Water Purification Bags. In the unit area, water purification bags are ordinarily used to store and dispense the treated water to troops. Water is transferred from the water tank or trailer into these bags, which are 36-gallon canvas containers issued to units on the basis of 1

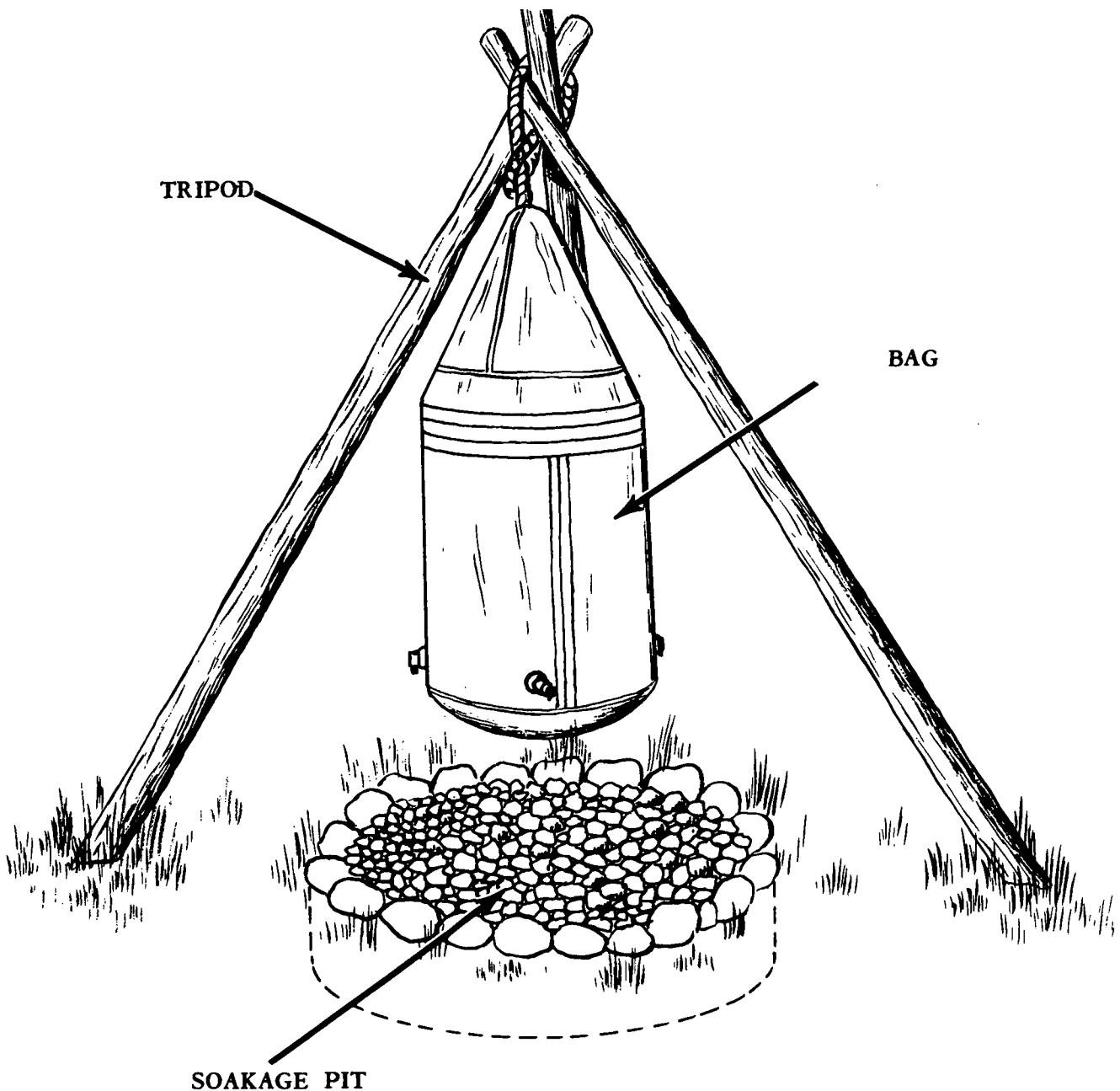

Figure 12. Water purification bag setup.

bag per 100 men. The porous canvas of which these bags are made permits seepage of water and cooling by evaporation. The bags are set up as illustrated in figure 12 before they are filled with water. The weight of the water in these bags may cause the supporting ropes to stretch, thus causing a gap between the cover and the bag. Should this occur, the ropes should be adjusted so that the cover will again fit snugly around the upper part of the bag and thus prevent contamination of the water by dust and insects. The bags should be inspected frequently for cleanliness. If they are dirty, they should be scrubbed, treated with a

strong solution of chlorine (1 ampule of calcium hypochlorite to 1 gallon water), and rinsed several times with potable water.

c. Emergency Water Containers. In cases of extreme emergency, gasoline cans may be safely cleaned for holding potable water by steaming or using detergent and water. The newest, cleanest cans with a bright interior should be selected. The procedure for cleaning the cans is as follows:

- (1) Drain the can thoroughly for 10 to 15 minutes.
- (2) Fill the can half full of water and add 1 ounce of powdered detergent; then close the can

and shake it for 5 minutes before discarding this wash water.

(3) Rinse the can with water three or four times; then fill it to overflowing and discard this water.

(4) Fill the can with water and add the contents of five calcium hypochlorite ampules; then close the can and shake it to mix the calcium hypochlorite with the water.

(5) Let the can stand for 1 hour before

emptying it for use in the storage of drinking water.

d. Maintenance of the Required Chlorine Residual. Tests to determine the chlorine residual of treated water must be made periodically (para 53b(5)). If the residual is below the level prescribed by command regulations, the contents of calcium hypochlorite ampules must be added until the prescribed residual is reached (para 53b(2)).

Section III. PROCUREMENT AND TREATMENT OF WATER FROM OTHER SOURCES

51. General

Isolated units may not be able to obtain water from engineer water points. In this case they must obtain and treat their own water.

52. Selection of Water Source

The possible sources of water are a public water supply system, surface water (lakes, rivers, streams, and ponds), ground water (wells and springs), rain collected from roofs or other catchment surfaces, ice or snow, and distilled sea water. The source that appears to be the cleanest should be selected. Water taken from any of these sources, except a public water supply system approved by the Army/Air Force Medical Department, must be properly treated before use, as all of them are presumed to be contaminated.

a. Surface Water Source. Although surface water is ordinarily more contaminated than other water sources, it is commonly selected for use in the field because it is generally more accessible in the quantity required. Water should be drawn as distant from known sources of contamination as possible. When a stream is used, the intake should be located upstream from any source of contamination. In lakes and ponds, it is generally desirable to locate the intake as far from the shore as practicable, as the amount of contamination usually decreases with the increase in distance from the shore. When surface water is used, care should be taken to avoid getting mud from the bottom or picking up floating sticks, leaves, or other debris. Muddy or cloudy water should be settled before it is used. Water from muddy streams can be improved in quality by digging a hole on the bank and permitting water to seep slowly into it through the bank. Another method is to dig a shallow trench so that water can flow into it from the stream and stand quietly. After the dirt has settled, the clean water may be taken and disinfected by methods described in paragraph 53.

b. Ground Water Source. Ground water is

usually less contaminated than surface water and is, therefore, a more desirable water source. The use of ground water by combat units, however, is usually limited unless existing wells are available. A ground water source is not selected unless it is so located that sources of contamination, such as pit latrines, will not drain into it. A ground water source should be at least 100 feet from all possible sources of contamination, and surface drainage should be away from it. A well that is selected as a water source should have a casing or lining, an impervious platform or apron, a cover, and a device for drawing water from it in a sanitary manner. Details for the construction and protection of wells and springs are contained in TM 5-297/AFM 85-23 and TM 5-700/AFM 86-3.

c. Other Water Sources. Rain, melted snow, or melted ice may be used in special instances where neither surface nor ground water is available. Water from any of these sources must be disinfected before drinking. Sea water cannot be used for human consumption until the salt has been removed by distillation or other demineralizing processes performed by engineer personnel.

53. Unit Treatment of Water

a. Knapsack Filter Unit. This hand- or foot-operated water purification unit (fig 13) is designed for use by small groups of men. It is capable of treating water at the rate of one-fourth gallon per minute. Two filter pads used simultaneously can clarify approximately 5 gallons of muddy water before becoming plugged and replaced. The filter pads are capable of removing amoebic cysts from water, but smaller bacteria and viruses will pass through the filter pads. The filtered water must, therefore, be disinfected to make it safe for drinking. The filtering process greatly improves the taste of the water. The unit weighs 7 pounds and comes with extra filtering pads and a knapsack (carrying case).

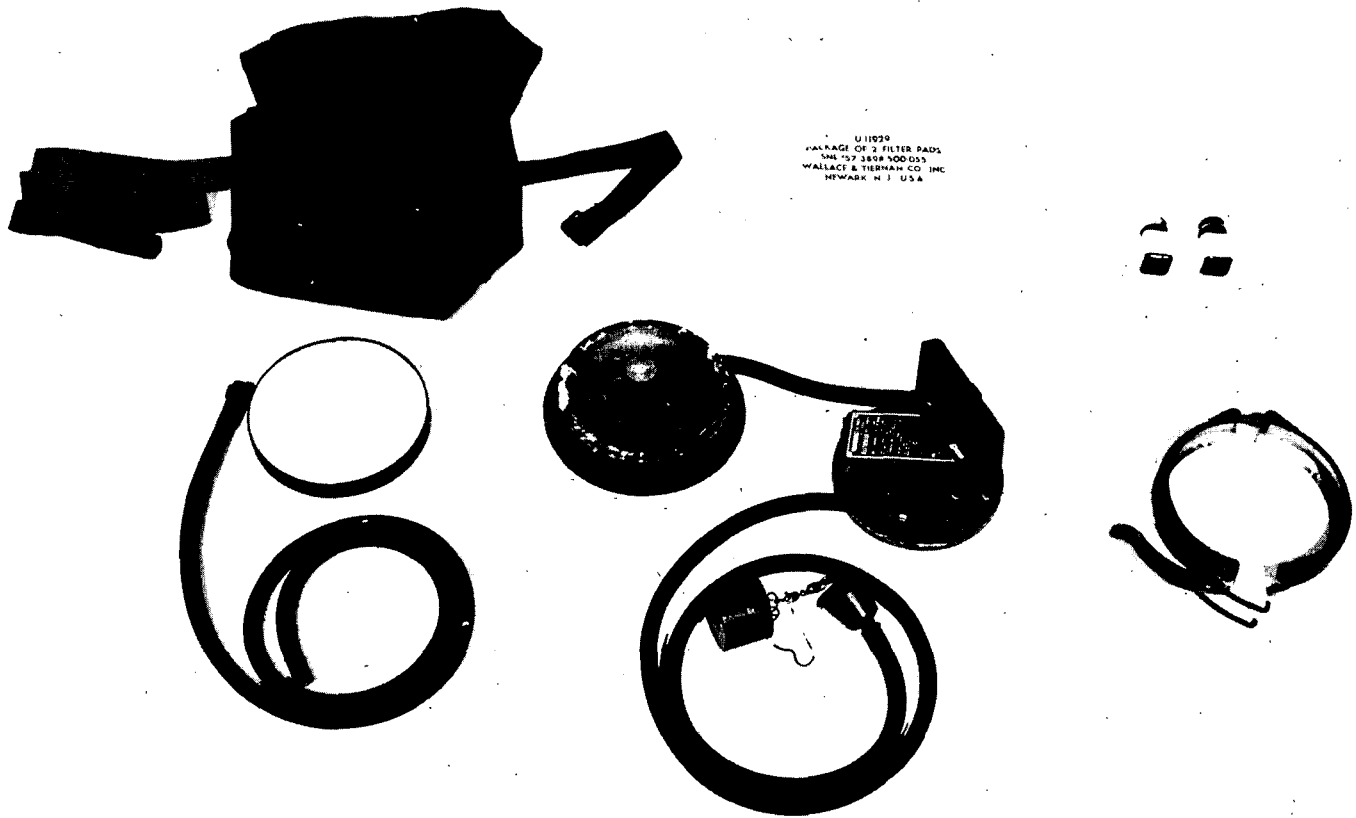

Figure 13. Water purification filter unit (knapsack type).

b. Chlorination.

(1) *General.* In the treatment of field water supplies at unit level and by the individuals, complete reliance is placed on the disinfection process. The disinfectant most often used in purifying water for drinking and other domestic purposes is chlorine. The compound normally used to chlorinate water in the field is calcium hypochlorite, which is supplied in bulk containers and in glass ampules that hold 0.5 grams. It is added to the water in the amount (dosage) necessary to destroy the disease-producing organisms (chlorine demand) with some remaining to indicate that the demand has been satisfied and to serve as a continuing disinfectant (chlorine residual).

(2) *Chlorination requirements.* Sufficient chlorine must be added to water to produce a required chlorine residual after a 30-minute contact period. A 5 ppm residual is the standard requirement for field water supplies. Higher or lower concentrations, however, may be prescribed by the command surgeon on the basis of his knowledge of local diseases and environmental conditions.

(3) *Chlorination kit.* This chlorination kit (fig 14) is available to all units for use in chlorinating water and testing it for the proper chlorine residual. The kit contains calcium hypochlorite ampules (0.5 gram) for disinfecting water together with three plastic tubes and three vials of

orthotolidine tablets for use in determining the chlorine residual ((5) below). The vials of orthotolidine tablets are packed inside the plastic tubes. Each of the plastic tubes has a band of a different shade of yellow around it; the lightest shade of yellow indicates 1 ppm; the medium shade, 5 ppm; and the darkest shade, 10 ppm. These figures are printed on the tubes.

(4) *Disinfection procedure.*

(a) Water is disinfected at the unit level by using the water purification bag (fig 12) or other suitable container and ampules of calcium hypochlorite which are provided in the chlorination kit (fig 14). The procedure for the chlorination of water in the water purification bag is as follows:

1. Clean the purification bag and hang it by the supporting ropes as illustrated in figure 12. The supports must be sturdy, as the bag filled with water weighs approximately 300 pounds.

2. Fill the bag with water to the 36-gallon marks which is 4 inches from the top of the bag. If possible, use settled, clear water.

3. Put the contents of at least three calcium hypochlorite ampules into a canteen cup; add a small amount of water from the water purification bag and stir with a small stick until a thick mixture results; then fill the cup one-half full of water and stir again.

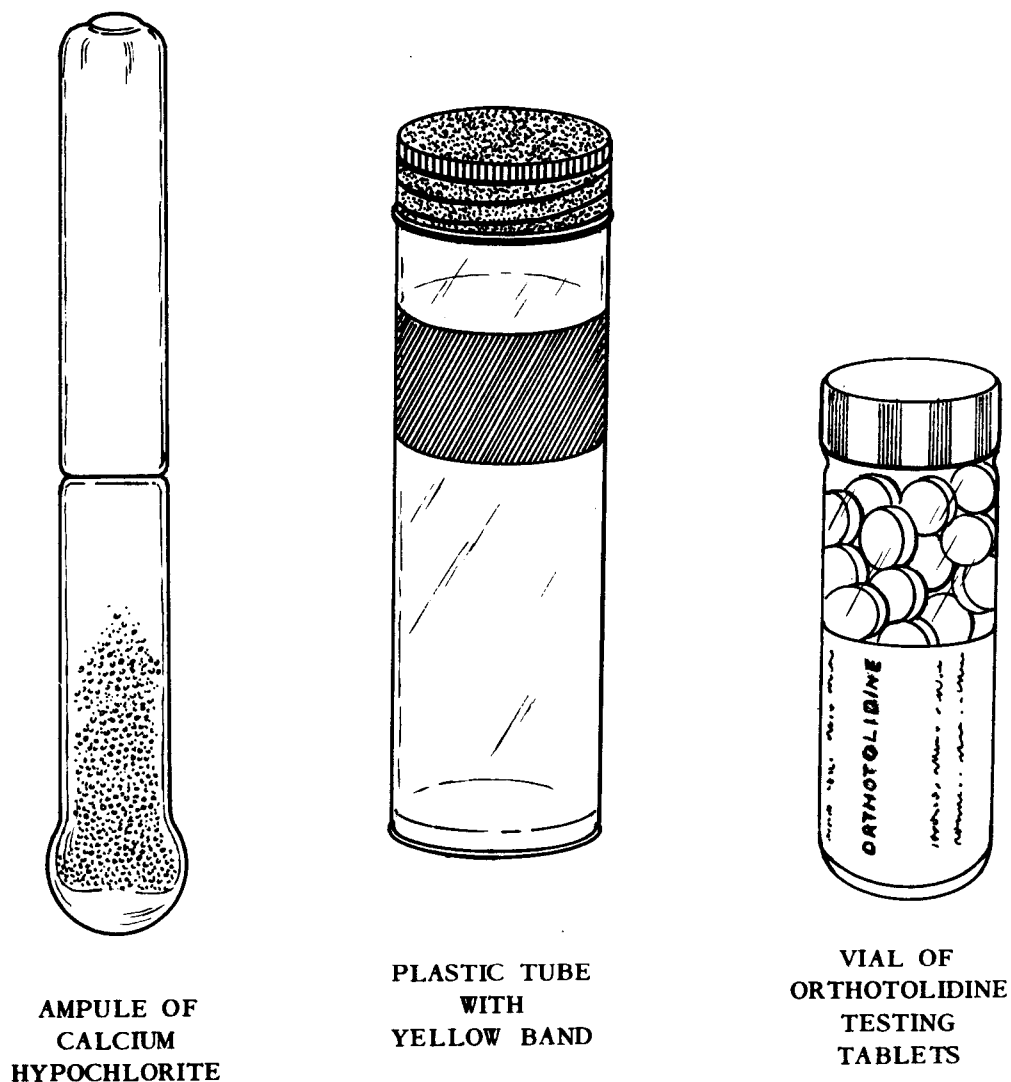

Figure 14. Items in chlorination kit.

4. Empty the prepared solution slowly into the purification bag, stirring the water with a clean stick.

5. Cover the bag and flush the faucets by running a small quantity of the water through each of them.

6. After the disinfecting solution has been mixed with the water for 10 minutes, flush the faucets again; then collect a sample of water from one of the faucets in the 5 ppm plastic tube for testing ((5) below).

7. If the test shows a chlorine residual less than 5 ppm, add the contents of an additional calcium hypochlorite ampule and after 10 minutes repeat the test.

8. If the test shows the chlorine residual to be at least 5 ppm, wait an additional 20 minutes, since a total disinfection time of 30 minutes is required. Check the residual again before drink-

ing the water. If the chlorine residual is less than 5 ppm, repeat 6 and 7 above.

(b) The same general procedures described in (a) above can be used to treat water in containers other than the water purification bag, but a different amount of calcium hypochlorite must be used. For a 5-gallon can of water, one-half of the contents of one calcium hypochlorite ampule should be used initially as explained in (a)3 above; then if necessary additional small amounts should be added ((a)7 and 8 above). For a 55-gallon drum of water, four or five ampules should be used initially; and for a 400-gallon trailer of water, 30 ampules should be used initially. Water in larger containers is not easily chlorinated by use of ampules; the use of bulk calcium hypochlorite is described in TM 5-700/AFM 86-3.

(5) *Chlorine residual testing procedure.* The chlorine residual of water is determined by use of

the plastic tubes and the orthotolidine tablets provided in the chlorination kit (fig 14). The procedure is described as follows:

(a) Select the appropriate plastic tube from the three tubes provided in the kit. The appropriate tube is the one on which is printed the number of ppm chlorine residual required within the command.

(b) Flush the faucets of the water purification bag and fill the plastic tube to a point just below the yellow band.

(c) Take one orthotolidine tablet from the vial in the kit and add it to the tube of water.

(d) Place the cap on the tube of water and shake the tube until the orthotolidine tablet is thoroughly dissolved.

(e) Compare the yellow shade of the water with the yellow shade of the band on the tube. If the color of the water is the same shade or darker than the band, the chlorine residual is equal to or greater than that printed on the tube. If a lighter color or no color is formed, the water does not have a sufficient chlorine residual; therefore additional chlorination and testing are required.

54. Individual Water Treatment

a. General. When safe water is not available, each soldier must produce his own potable water by using his canteen and iodine purification tablets or the calcium hypochlorite supplied in ampules (para 53b(3)).

b. Use of Iodine Tablets to Purify Water in a Canteen.

(1) Before iodine tablets are used, they should first be checked for physical change, as they lose their disinfecting ability in time. Tablets which are not steel gray in color, which are stuck together, or which are crumbled should not be used.

(2) The following procedure is used in treating water in a canteen with iodine tablets.

(a) Fill the canteen with the cleanest, clearest water available.

(b) Add one iodine tablet to a one-quart canteen of clear water; add two tablets if the

water is cloudy. Double these amounts for a two-quart canteen.

(c) Place the cap on the canteen loosely; wait 5 minutes; then shake the canteen well, allowing leakage to rinse the threads around the neck of the canteen.

(d) Tighten the cap and wait an additional 20 minutes before using the water for any purpose.

c. Use of Calcium Hypochlorite to Purify Water in a Canteen. The following procedure is used to purify water in a one-quart canteen with calcium hypochlorite ampules:

(1) Fill the canteen with the cleanest, clearest water available, leaving an air space of an inch or more below the neck of the canteen.

(2) Fill a canteen cup half full of water and add the calcium hypochlorite from one ampule, stirring with a clean stick until this powder is dissolved.

(3) Fill the cap of a plastic canteen half full of the solution in the cup and add it to the water in the canteen, then place the cap on the canteen and shake it thoroughly.

Note. If an aluminum one-quart canteen is being used, add at least three capfuls of the calcium hypochlorite solution to the canteen, as this cap is much smaller than the one on the plastic canteen.

(4) Loosen the cap slightly and invert the canteen, letting the treated water leak onto the threads around the neck of the canteen.

(5) Tighten the cap on the canteen and wait at least 30 minutes before using the water for any purpose.

d. Boiling of Water. This method is used when disinfecting compounds are not available. It is a good method for killing disease-producing organisms; however it has several disadvantages: (1) Fuel is needed; (2) it takes a long time for the water to boil and then cool; (3) there is no residual protection against recontamination. Water must be held at a rolling boil for at least 15 seconds to make it safe for drinking. If there is evidence that a 15-second boiling period will not make it safe, the command surgeon will prescribe the longer period required.

CHAPTER 5

FOOD SANITATION

Section I. GENERAL

55. Importance of Food Sanitation

Even the most appetizing food can cause illness if it has become contaminated with disease germs through improper handling. Outbreaks of food poisoning, dysentery, infectious hepatitis, and typhoid fever may result from unsanitary practices in kitchens and dining areas. Therefore, persons who handle food must always maintain the highest standards of personal hygiene and sanitation. Air Force, see AFM 161-6.

56. Responsibilities

a. Commander. The commander is responsible not only for the proper feeding of the personnel in his command but also for the enforcement of the sanitary regulations and procedures which govern the handling and serving of food. The commander also insures that all food service personnel have

been properly trained and appoints a mess officer to supervise dining facility operations and food service sanitation within his command. The mess officer may be assisted by members of the field sanitation team (para 5c).

b. Combat Service Support Units. The combat service support units are responsible for procuring, storing, and issuing wholesome food according to the master menu; and recommending food preparation and serving methods.

c. Army/Air Force Medical Department. The Medical Department is responsible for prescribing the basic diet for the Army/Air Force in terms of nutritional value; for establishing food sanitation standards; for conducting sanitary inspections of all foods at their sources, during shipment, and in storage; and for making sanitary inspections of mess facilities and operations.

Section II. PROTECTION, INSPECTION, AND STORAGE OF FOOD

57. Protection of Food Items During Transportation

The vehicles used for transporting food items to the unit should be clean; equipped with duckboards or dunnage; and covered to protect them from the sun, dust, insects, rodents, and other causes of contamination or growth of disease germs. They should not be used for transporting garbage, trash, petroleum products, or other materials from which food could become contaminated. Clean tarpaulins, bags, or containers of some type should be used to prevent food items, including ice, from coming in direct contact with the transporting vehicle. When it becomes necessary to transport bulk quantities of meat and dairy products over considerable distance, refrigerated vehicles should be used. Perishable foods such as meats, dairy products, fresh vegetables, and bread should be issued daily, preferably in the morning.

58. Inspection of Food Items Upon Receipt

a. General. Food items are inspected several times by personnel of the Medical Department prior to the time that they are issued to a unit; however, they must be inspected again upon receipt in a unit mess by the mess officer or his designated representative. Any food item suspected of being unfit for human consumption must pass the approval of an officer of the medical department, such as the surgeon or the veterinary officer, before it can be used. Locally produced food products, including ice and beverages, will not be procured without prior approval of the surgeon. Guidelines for the inspection and storage of subsistence supplies is discussed in detail in TM 10-210/AFM 161-6.

b. Inspection of Canned Foods. All types of canned foods should be examined carefully for faulty containers. Spoilage of food within a can is usually indicated by some deformity or abnormal-

ity in the can itself. Normal cans have sunken ends. Defective cans, which are easy to detect, may be classified into the three types listed below. All three of these types should be discarded unless they pass inspection by a qualified person of the Medical Department.

(1) *Leaker*. This can has a defect which allows air to enter it or the contents to leak out.

(2) *Springer*. This can has one end bulged.

(3) *Sweller*. This can bulges at the sides and the ends.

59. Refrigeration

a. Mechanical Refrigerators.

(1) *Operating temperature*. The temperature of freezers or freezing compartments of refrigerators in which frozen foods are stored must be maintained at 10° F or lower. Ice cream should be stored at 0° F or below. The temperature of the refrigerators in which unfrozen perishable foods are stored should be maintained at 45° F or below. Air Force, see AFM 161-6.

(2) *Cooling efficiency*. The cooling efficiency of a refrigerator is increased by placing the food items so that the cold air from the cooling unit can

circulate freely between them, by defrosting the refrigerator regularly, and by keeping the refrigerator door closed to the maximum extent possible.

b. *Iceboxes or Ice Chests*. Iceboxes or ice chests are used when mechanical refrigerator is not available. The drains from these boxes or chests must not be connected directly to the sewers, as sewage could back up into them. Ordinarily, it is difficult to maintain a temperature below 45° F in an icebox; however, every effort should be made to keep the temperature below 50° F. For sanitation requirements of ice used in the operation of iceboxes or ice chests, reference is made to *c* below.

c. *Requirements for Sanitation of Ice*. Ice must be made from only potable water; freezing the water does not purify it. Ice used by the Army/Air Force must be made only in facilities approved by the Medical Department. Furthermore, ice must be protected from disease-producing organisms, debris, and trash. Washing the exterior of ice which has become contaminated from improper handling or storage does not make it sanitary. Since ice is porous, disease-producing organisms can penetrate the ice cake.

Section III. PREPARATION AND SERVING OF FOOD

60. General

While it is desirable to make food as attractive as possible, it is more important to insure sanitary methods in the preparation and serving of the food. One of the prime responsibilities of a dining facility supervisor is to train food handlers to use sanitary methods in the handling of food. Conveniently located, well-kept handwashing facilities for all food service personnel are an absolute necessity in every kitchen. Washing the hands after going to the latrine must become an unailing practice. No one should be permitted to leave the mess area and return without washing his hands properly under the observation of supervisory personnel.

61. Food Handlers

Military food handlers are classified as permanent and temporary. Under certain conditions the employment of civilian food handlers is authorized.

a. *Permanent*. This class of food handlers includes cooks, bakers, nonrotating kitchen police, food service supervisors, food and food sanitation inspectors, and others assigned permanently to food-handling work. Prior to their assignment, they are given a preemployment physical examination by a medical officer. Those who have com-

municable diseases or who are known to be carriers of such diseases are not assigned as food handlers. Even more important than this initial screening is the supervisor's daily on-the-job check of food-handling personnel for signs of illness or infection. This inspection should be thorough enough to make certain that food handlers have no obvious signs of illness or infection; that their hands, fingernails, and clothing are clean; and that they have no boils, rashes, or other skin and wound infections. Food handlers should be instructed to report sore throats, colds, coughs, diarrhea, vomiting, and other symptoms of infection and disease. Questionable cases must be referred to the unit surgeon without delay.

b. *Temporary*. This class includes rotating kitchen police. It is usually impossible to keep such transient personnel under sufficiently close and constant surveillance to be certain that they are free from all infectious conditions. However, the dining facility supervisor should examine them for obvious infectious conditions prior to their beginning work each day and refer those who are ill to the unit surgeon. Temporary food handlers should not be assigned duties which require them to come into contact with prepared foods, except as specifically authorized by the unit surgeon.

c. Civilian. In parts of the world where sanitation is primitive and where intestinal and other communicable diseases are prevalent, natives should not be employed in army/air force kitchens to handle food without the specific approval of the surgeon. Where the employment of civilians as food handlers is approved, they should be given the same type of pre-employment examination required for army/air force personnel and whatever immunizations are prescribed by the surgeon. Thorough instruction in sanitary methods and constant supervision over their work practices are even more necessary than for military personnel. Civilian food handlers should be provided adequate sanitary facilities, including showers, hand-washing devices, and latrines.

62. Sanitary Preparation and Serving of Food Items

a. Raw Fruit and Vegetables. Fruits and vegetables which are to be eaten raw must be washed thoroughly in potable water before serving. This applies especially to fruits and vegetables contaminated with insecticides or through handling in market places and to leafy and root vegetables such as lettuce, celery, cabbage, carrots, radishes, and fresh onions, as they are usually contaminated with germs from the soil. Furthermore, in some areas of the world human waste is used as a fertilizer. If it becomes necessary to serve produce grown in such areas, it must first be washed in potable water and thoroughly disinfected by one of the following methods:

(1) Chemical disinfection of produce may be accomplished as follows:

(a) Dispose of any fruit or vegetable which is damaged and any outer leaves which are bruised or torn. Do not cut or peel fruits and vegetables before disinfecting them.

(b) Wash the produce thoroughly in a solution prepared by dissolving one package of Disinfectant, Food Service (FSN 6840-270-8172) in 20 gallons of warm potable water (100° F).

(c) Remove the produce from the wash solution and immerse it in another solution prepared by dissolving one package of Disinfectant, Food Service (FSN 6840-270-8172) in 20 gallons of warm potable water (100° F). Leave the produce in this solution for 30 minutes and stir it occasionally to insure that the surfaces are kept thoroughly wet.

(d) Remove the produce from the solution and rinse it thoroughly in potable water.

(e) Dispose of the food service disinfectant solutions, as they are not to be used more than once. Fresh solutions must be prepared for each

batch of produce, immersed in a 20-gallon solution.

(2) Produce may be disinfected by dipping it in boiling water for 15 seconds. Placing the produce in net bags will make dipping and draining quick and easy. Since the boiling water must come in contact with all parts of the produce, each batch to be dipped should be small and loosely arranged. Leafy vegetables should be treated by chemical disinfection ((1) above) whenever possible, as boiling water will cause wilting of the outer leaves.

b. Milk. All fresh milk used by the Army/Air Force must be pasteurized. It must be procured only from dairies approved by the Medical Department. Milk is ideal culture medium (food) for germs. When the temperature of milk is above 45° F, germs will grow and multiply rapidly. It is therefore necessary to observe the strictest sanitary control in the handling of milk. Milk for beverage purposes should be served in the original two-quart or smaller containers as received from the distributor or from a bulk container through an approved dispenser. All unused milk left either in the opened original container or in an individual's drinking receptacle must be disposed of as food waste.

c. Hash, Chopped Meats, Cream Mixtures, and Salads.

(1) *Preparation.* Hash and chopped meats are ideal for the growth of germs. Cream mixtures for pastry fillings, puddings, sauces, and salads containing egg, milk, mayonnaise, or salad dressing are also excellent culture media for germs. Since these foods require considerable handling in their preparation, the chances for contamination are greatly increased. Food service personnel who prepare these foods should take special care to cleanse their hands with soap and warm water immediately before they handle the ingredients. Whenever possible, touching the food with the hands should be avoided. Suitable utensils such as spoons, forks, tongs, and knives should be used to avoid direct contact with the hands. Items which readily support bacterial growth, such as locally prepared sauces, mayonnaise, salad dressings, ham salad, chicken salad, cream filling, cream sauces, custards, and hash (corned-beef excepted) will in no instance be prepared more than 3 hours before serving and always as near serving time as possible. Such foods must not be held over from one meal to another. The ingredients of sandwiches made for box lunches will not contain sauces, mayonnaise, salad dressing, ground meat, or chopped eggs. Processed meats such as Bo-

logna, liver sausage and spiced meats are acceptable.

(2) *Temperature control.* At normal room temperature the bacteria which cause food poisoning multiply rapidly. If it is not possible to prepare foods which readily support bacterial growth just before serving time, its temperature should be controlled. Food which is to be served cold should be promptly cooled to a temperature of less than 45° F. This food will cool faster if it is placed in shallow pans. Food which is to be served hot should be kept at a temperature of more than 140° F.

d. Cooked Food Items.

(1) *General.* The best safeguards against getting sick from food are thorough cooking and immediate serving. With the exception of those foods which contain chemical poisons or the very common staphylococcus toxin, food can usually be made safe to eat by thorough cooking. It is necessary, however that all parts of the food be heated close to boiling temperature.

(2) *Cooking time and temperature for meat products.* The cooking time and temperature for meat products must be such to insure that the center of the meat is adequately cooked. For beef, this can be achieved by roasting it at an oven temperature of 325° F until the thermometer which has been inserted into the thickest part of the meat registers 140° F (rare), 160° F (medium), or 170° F (well done). Pork must be roasted at an oven temperature of 350° F until the thermometer which has been inserted into the thickest part of

the meat registers 185° F. The longer cooking time for pork is necessary because of the danger of trichinosis, a disease caused by tiny parasitic worms. If meat juices and drippings are saved, they should be refrigerated and then used as soon as possible. Seafood and fowl must also be thoroughly cooked.

(3) *Fowl and meat dressings.* Dressing should not be allowed to stand at room temperature. It should be prepared just before it is to be cooked and handled as little as possible. Dressing is easily contaminated in preparation. It is recommended that dressing be cooked in shallow pans separately from the carcass. Unless the dressing is to be eaten within 3 hours after it is cooked, it should be refrigerated.

e. Acid Foods. Acid food and beverage such as a citrus fruit drink must never be stored or served in galvanized iron cans because they are capable of dissolving the zinc which will produce a chemical poisoning.

f. Leftovers. Meals should be planned so that there will be a minimum of leftover food. In the absence of mechanical refrigeration, food left from a meal should not be held until the next meal. Even with mechanical refrigeration, foods of the type described in *c* above should never be held from one meal to the next. Other foods must be refrigerated immediately and not held for more than 24 hours. The only exception to this policy is nonperishable food such as fresh fruit and vegetables and other foods not requiring refrigeration and not subjected to contamination.

Section IV. CLEANING OF KITCHEN FACILITIES

63. General

No one wants to eat from a dirty messkit. Food particles which are allowed to remain on mess utensils or anywhere in the mess may serve as breeding places for germs. This is the reason for stressing the importance of thorough cleaning of mess facilities and utensils.

64. Cleaning of Mess Facilities

Floors, tables, ranges, and refrigerators must be kept clean. Covered cans must be placed at convenient places in the kitchen to collect wastes. If the kitchen is in a tent, the ground and surrounding area must be well policed.

a. Ranges. Ranges should be cleaned after each meal; otherwise dirt and grease will accumulate and be baked onto the metal.

b. Refrigerators. Refrigerators should be cleaned frequently with soap and hot water.

c. Tables. All tables in the kitchen and the dining area should be scrubbed after use. Furthermore, tables should have solid tops without cracks or crevices in which food particles can lodge. If material for solid tops is not available, the tops should be made of smooth boards.

65. Cleaning of Cooking, Serving, and Eating Utensils

The two procedures which may be used by kitchen personnel in cleaning the cooking, serving, and eating utensils are outlined below. For individual cleaning of messkits, see paragraph 66.

a. Procedure To Be Used When Hot Water Is Available.

(1) Scrape utensils free of food particles.

(2) Wash utensils in warm water containing soap or detergent.

(3) Rinse utensils in hot clear water.

(4) Disinfect utensils by immersing them in clear water of 180° F for 30 seconds. If a thermometer is not available to determine the temperature of the water, heat the water to the boiling point.

(5) Allow the utensils to air-dry in a place where they are protected against dust, splash, and other sources of contamination.

b. Procedure To Be Used When Hot Water Is Not Available.

(1) Scrape utensils free of food particles.

(2) Wash utensils in water containing soap or detergent.

(3) Rinse utensils with potable water.

(4) Disinfect utensils by immersing them in a chlorine-water solution for not less than 30 seconds. This solution is prepared by using Disinfectant, Food Service (FSN 6840-270-8172) as specified on its container. If this disinfectant is not available, an emergency solution can be prepared by mixing at least one level messkit spoonful of calcium hypochlorite (water disinfecting powder) to each 10 gallons of water. If liquid chlorine bleach is available, it may be used. About one-third canteen cup of 5 percent chlorine bleach to each 10 gallons of water will provide the same disinfecting strength. Fresh chlorine-water solutions must be made for rinsing and disinfecting utensils for each 100 persons.

(5) Allow the utensils to air-dry in a place where they are protected against dust, splash, and other sources of contamination.

66. Individual Cleaning of Messkit

In the field each individual ordinarily cares for his own messkit. Proper washing is important; otherwise food particles will remain and become breeding places for disease germs.

a. Equipment Required. Three corrugated cans or other similar containers (para 69), placed in a row, are required for washing messkits. Enough water is placed in each can to allow at least one quart of water per man, or one wash line of three cans is provided for every 80 men. Large messes may require several washing lines. The first can contains hot water (150° F) with soap or detergent; the second and third cans contain clear water which is kept boiling throughout the washing period. A long-handled washbrush and a garbage can or pit are also needed. For discussion of devices which may be used to heat the water, reference is made to paragraphs 67 and 68. If a water heating device is not available or cannot be improvised, the procedure for using a Disinfectant, Food Service solution should be followed (para 65b).

b. Procedure for Cleaning Messkit.

(1) Scrape the food particles from the messkit into a garbage can or pit.

(2) Wash the kit in the first container of hot soapy water, using a long-handled brush.

(3) Rinse the kit in the second can of boiling clear water by dipping it up and down several times.

(4) Disinfect the kit by immersing it in the third container of boiling clear water for several seconds.

(5) Shake the kit to remove the excess water and allow it to dry in the air; then close the kit to keep out dust and vermin.

c. Rewashing of Messkit Prior to Use. If a messkit becomes soiled or contaminated between meals, it should be rewashed prior to use as described in b(2) through (5) above.

When desirable to preheat utensils prior to the meal, a corrugated can with clear boiling water may be placed near the start of the serving line. It is important that such water be maintained at a rolling boil throughout the meal service period.

Section V. METHODS FOR HEATING WATER

67. Immersion Heater

The immersion heater, which is the standard field-type water heater, is issued to all units organized under tables of organization and equipment. This heater, which consists of a doughnut-shaped combustion chamber and a stack assembly welded together, is fired by gasoline. It is placed directly in the water which is to be heated, thus displacing approximately 12 gallons of water. The operating

instructions are inscribed on a metal plate located on the hinged hood which covers the top of the burner compartment.

Precaution: Do not operate this heater within a building, tent, or other inclosed place unless exhaust fumes are piped outside.

68. Improvised Water Heaters

a. Operation Hazards. Whenever improvised gas-

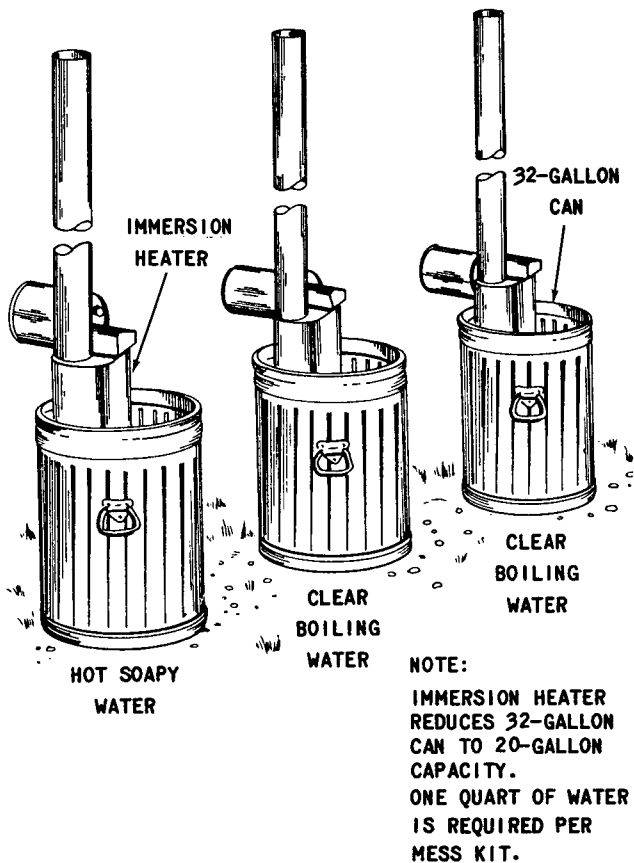

Figure 15. Immersion heaters for messkit washing setup.

oline or oil heaters are used, the potential dangers are carbon monoxide poisoning, lead poisoning, and explosions; therefore only experienced personnel should be permitted to operate them.

(1) Carbon monoxide is a colorless, odorless gas which is given off by the burner when combustion is incomplete. This hazard may be eliminated by proper operation of the equipment and adequate ventilation.

(2) Lead poisoning may result from the use of a leaded fuel, such as ethyl gasoline. The inhaling of vapors given off by the burner is particularly dangerous. Adequate ventilation, therefore, is absolutely necessary.

(3) Serious explosion may result from an improperly constructed or operated burner. If the flame of a burner goes out and the fuel is not burned off, turned off, or relighted immediately, a dangerous concentration of gas may build up. If this gas is ignited, an explosion may result. This danger is not as great with the oil-water flash burner (*b* below) as it is with the vapor burner (*c* below). The automatic relighting device described in *c* below will lessen the possibility of such an explosion. Also the possibility of an explosion in a fuel tank can be considerably decreased by not al-

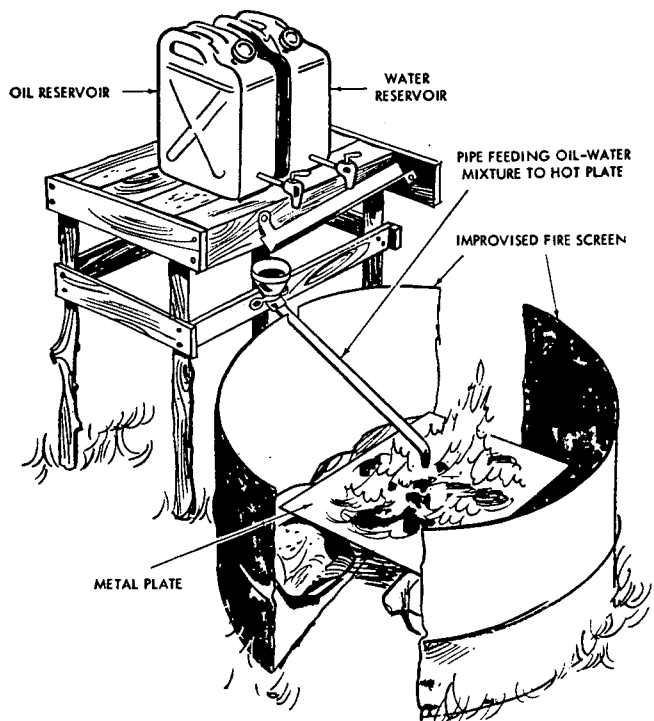

Figure 16. Oil-water flash burner for messkit washing setup.

lowing the fuel to fall below the half-full mark. A visible float-level indicator should be used.

b. Oil-Water Flash Burner (fig. 16).

(1) The oil-water flash burner uses diesel or motor oil as fuel. In cold climates it may be necessary to thin these oils with gasoline or kerosene to obtain a good flow. If waste motor oil is to be used as fuel, it must first be strained through a screen or a cloth to remove sludge and lumps.

(2) One oil-water flash burner is required for each large can of water to be heated. This burner consists of containers for the oil and the water, a feed pipe, a metal burner plate, shields, and a grate (fig 16). The containers are equipped with valves, taps, plugs, or siphons for controlling the rate of fuel and water flow. The shields, which prevent strong drafts or rain from cooling the plate, may be made from sheet metal or oil drums; or a simple protecting wall of stones or earth may be built to protect the plate. The grate, which is placed over the burner to support the water can, may be made from scrap rods or pipes.

(3) This burner operates as the oil and water combination, generally about 4 parts of oil to 1 part of water, drips slowly onto the metal plate which has been preheated to the flash point of the oil. The flash point is the temperature at which liquid fuel bursts into flame. The water in small amounts increases the efficiency of this burner, as it becomes steam when it hits the heated plate.

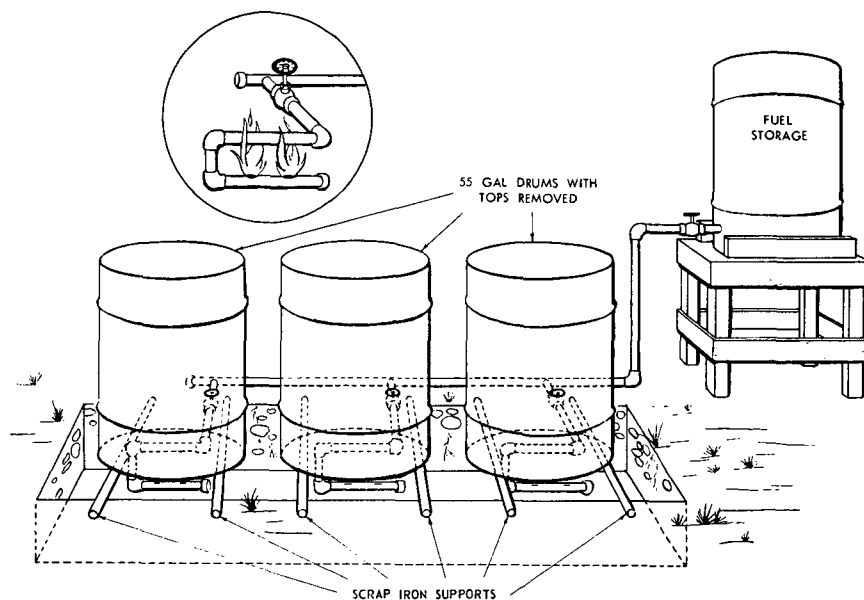

Figure 17. Vapor burner for messkit washing setup.

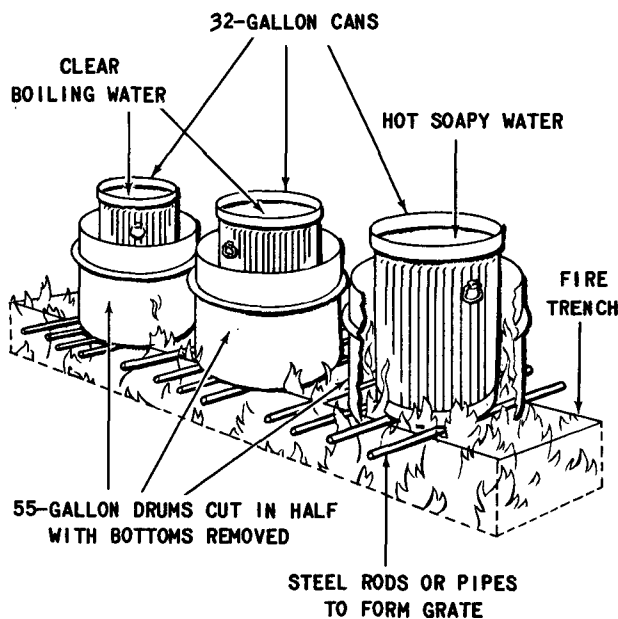

Figure 18. Fire trench and cans for messkit washing setup.

This steam aids burning by shattering the oil into very small droplets which burn more readily than large drops. The burner plate is preheated by burning waste material under it. A hotter flame may be obtained by adjusting the oil and water outlets. Very little smoke or odor is produced when the burner is operating properly.

c. Vapor Burner (fig 17).

(1) The vapor burner uses liquids such as diesel oil, kerosene, or gasoline, or a combination of these. As with the oil-water flash burner, it may be necessary in cold climates to thin the oil with gasoline before use. For the construction of this

burner it is necessary to have several sections of pipe, a valve, pipe fittings, and a fuel reservoir (fig 17). The operation of the vapor burner depends upon vaporization of the fuel by preheating before burning.

(2) The pipe is assembled in such a manner that it is doubled under itself. The best-size pipe to use is either one-half or three-quarters of an inch in diameter. Very small holes (1/16-inch or less) are drilled in the top of the lower pipe at points where the water containers will be placed. The end of the pipe is capped so that fuel can escape only from the drilled holes. Burnings of the fuel which escapes from the holes in the lower pipe heats the fuel in the upper pipe, causing the fuel to vaporize into gas. This gas produces pressure in the lower pipe and forces the fuel out through the small holes as a spray, thus making a better flame. For best operation, the pipes should be placed in a fire trench. The trench should be about 1 foot wide and 15 inches deep. Iron wire should be coiled around the lower pipe near the holes and around the upper pipe just above the holes to serve as an automatic relighting device. These wires become red hot after the burner has been in operation for a few minutes. Should one flame go out, the heat from the wires would relight the fuel, thus preventing an accumulation of gas in the trench and a possible explosion (α(3) above).

(3) Before lighting the burner, the valve which controls the flow of fuel is opened to allow a small amount of fuel to run out through the holes in the lower pipe. This fuel is then ignited, thus heating the upper pipe and starting the fuel-heat-gas pressure cycle described above. A properly op-

erated burner will produce a blue flame. A yellow flame, which indicates incomplete burning, is caused by too much fuel escaping from the holes. This may be corrected by closing the valve slightly, thus reducing the amount of fuel going to the burner, or by decreasing the size of the holes in the pipe. If the flame is blue but tends to blow itself out, not enough fuel is getting through the holes. The condition may be corrected by opening the valve slightly, thus allowing more fuel to go to the burner, or by enlarging the holes in the pipe.

d. Fire Trench (fig 18).

(1) When solid fuels are available, a fire trench is one method used for heating. The trench should be about 1 foot wide and 1 foot deep. Its length will depend on the number of water cans to

be heated. For three cans an 8-foot trench is usually sufficient. The cans, supported by steel rods or pipes, are placed over the trench; and the fire is built in the trench. Oil drums cut into halves with the ends removed may be placed around the water containers to increase heating efficiency.

(2) Except as a temporary measure, the fire trench is not considered a practical method for heating water. It requires a large amount of solid fuel, such as coal or wood, which ordinarily is not plentiful in the field. Unless wind shields are used around the corrugated cans, heating water to the boiling point becomes very difficult. Furthermore, the external heat from the open flame quickly burns out the cans. It also makes standing close enough to wash mess kits uncomfortable and possibly hazardous.

Section VI. IMPROVISED MESSKIT WASHING CONTAINERS

69. Drums

(fig. 19)

When corrugated cans are not available, messkit washing containers may be made from metal drums and used with any of the heating devices described in paragraphs 67 and 68. The drums may be used with or without modification in size. In the modification of drums, they should be cut into two-thirds and one-third portions. The two-thirds portions are used as washing containers; the one-third portions are used as needed for supports or shields as illustrated in figure 16. Although drums are ordinarily cut crosswise, they may be cut lengthwise (fig 19). The two-thirds portions of drums cut lengthwise are placed directly on a trench.

70. Drainage Device

a. As an aid in draining washing containers (para 69), a pipe coupling can be welded into the bottom of each of the three containers; then all three containers can be connected with pipes to one central outlet pipe. This central outlet pipe should be positioned so that the water will pass through a grease trap (para 81) into a soakage pit (para 79).

b. Plugs or pipes may be screwed into the pipe couplings inside the washing containers to secure the water until drainage is desired. If a pipe is used, it must be cut long enough to extend above the water level.

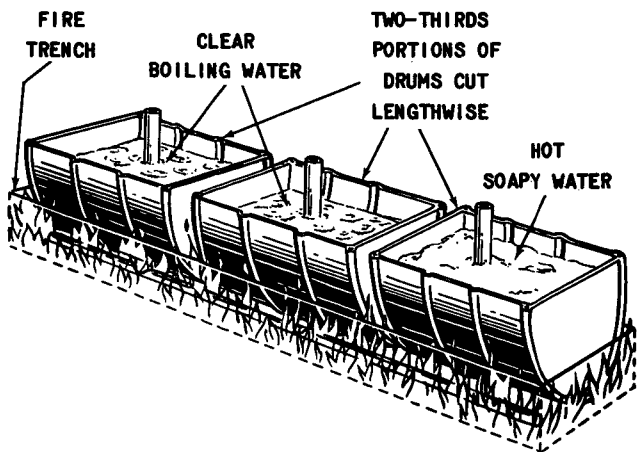

Figure 19. Fire trench and drums for messkit washing setup.

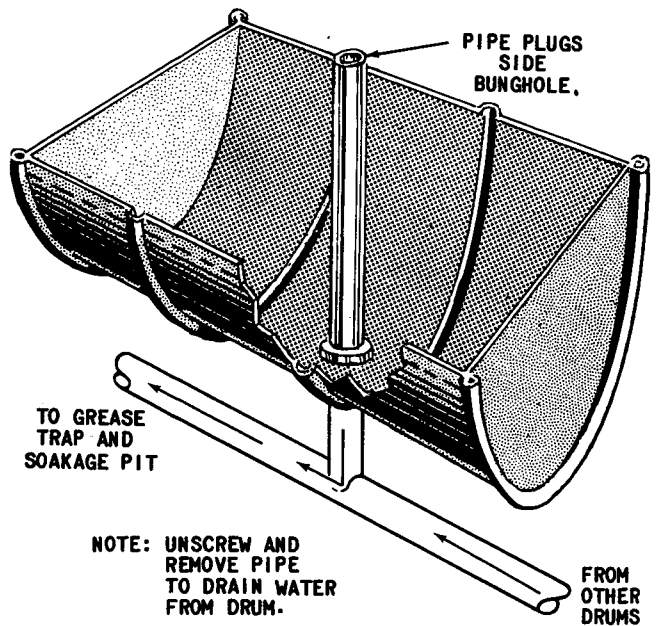

Figure 20. Drainage for messkit washing setup.

CHAPTER 6

WASTE DISPOSAL

Section I. GENERAL

71. General

a. The term *wastes* includes all types of refuse resulting from the living activities of humans or animals. In this chapter the following types of wastes are discussed:

- (1) Human wastes (feces and urine).
- (2) Liquid wastes (wash, bath, and liquid kitchen wastes).
- (3) Garbage.
- (4) Rubbish.

b. The methods which should be used for the disposal of wastes depend upon the military situation and the unit location. Burial and burning are the methods most commonly used in the field.

72. Medical Importance of Waste Disposal

Large quantities of all types of wastes, liquid and solid, are generated each day under field conditions. These materials must be removed promptly and thoroughly; otherwise the camp or bivouac will quickly become an ideal breeding area for

flies, rats, and other vermin. Filth-borne diseases such as dysentery (amebic and bacillary), typhoid, paratyphoid, cholera, and plague could become prevalent.

73. Responsibilities

a. *Commander*. The unit commander is responsible for the disposal of wastes generated within his unit area. When waste disposal facilities are not provided, he must arrange for their construction and operation. He should employ his field sanitation team (para 5c) to supervise the construction and operation of these facilities.

b. *Army/Air Force Medical Department*. The medical department inspects waste disposal facilities and operations and recommends such changes as will aid in protecting the health and welfare of the troops.

c. *Combat Service Support Units*. The combat service support units store and issue certain items that are necessary for the proper disposal of wastes.

Section II. HUMAN WASTES

74. Disposal of Human Wastes

a. The devices for disposing of human wastes in the field vary with the situations—

(1) When troops are on the march, each person uses a “cat-hole” latrine during short halts. It is dug approximately 1 foot deep and is completely covered and packed down after use.

(2) In temporary bivouac of 1 to 3 days the straddle trench is most likely to be used unless more permanent facilities are provided for the unit.

(3) In temporary camps deep pit latrines and urine soakage pits are usually constructed. Until such time as the construction of deep pit latrines can be completed, straddle trench latrines are used. Where the construction of deep pit latrines is not practicable, other types of latrines discussed

in this chapter are used. Whatever latrine device is used, the unit is responsible for its construction, maintenance, and closure.

b. The devices most generally used for disposal of human wastes in the field are—

- (1) Straddle trench latrines.
- (2) Deep pit latrines.
- (3) Burn-out latrines.
- (4) Mound latrines.
- (5) Bored hole latrines.
- (6) Pail latrines.
- (7) Urine soakage pits.

75. Rules Common to the Construction, Maintenance, and Closing of Latrines

a. In determining the type of latrines to be con-

structed, consider the length of stay, the water level, and the soil conditions. To protect water from contamination, do not extend the depth of a latrine pit or trench below the underground water level.

b. In determining the location within the camp area for construction of latrines, consider, first, the protection of food and water from contamination and, secondly, the accessibility to the users.

(1) To protect food and water from contamination, select a location which is at least 100 yards from the unit mess and 100 feet from the nearest water source and which drains away from all water sources.

(2) Choose a location which is accessible to the users but reasonably near the end of the unit area.

c. Construct the latrines as explained in paragraph 76.

d. After the latrines have been completed, construct the necessary protective and hygiene devices.

(1) Place canvas or brush screens around the latrines or tents over them. In a cold climate the shelters should be heated, if possible.

(2) To prevent surface water from flowing into the shelters, dig drainage ditches around them.

(3) In each latrine shelter, provide toilet paper on suitable holders with tin cans for covering the toilet paper to keep it from getting wet during bad weather.

(4) Install a simple, easily operated hand-washing device just outside each latrine shelter (para 43). These devices should be kept filled with water at all times so that each individual can wash his hands after he uses the latrine.

(5) At night, if the military situation permits, keep the latrines lighted; otherwise extend cords from trees or stakes to the latrines to serve as guides.

e. Police the latrines properly and maintain a good fly-control program in the entire camp area to prevent fly breeding and to reduce odors.

(1) Keep the lids to the latrine seats closed and all cracks sealed.

(2) Scrub the latrine seats and boxes with soap and water daily.

(3) Spray the inside of the shelters with a residual insecticide twice weekly. If a fly problem exists, also spray the pit contents and the interior of the boxes twice weekly with a residual insecticide. Using lime in the pits or burning out the pit contents, except in burn-out latrines (para 76c), is

not effective for fly or odor control; these methods are not, therefore, recommended.

f. At such time as a latrine pit becomes filled with wastes to a point 1 foot from the surface or it is to be abandoned, remove the latrine box and close it as follows:

(1) Using an approved residual insecticide, spray the pit contents, the side walls, and the ground surface extending 2 feet from the side walls.

(2) Fill the pit to the ground level with successive 3-inch layers of earth, packing each layer down before adding the next one; then mound the pit over with at least 1 foot of dirt and spray it again with insecticide. This prevents any fly pupa, which may hatch in the closed latrine, from getting out.

(3) Place a rectangular sign on top of the mound. The sign must indicate the type of pit and the date closed as well as the unit designation in non-operational areas.

76. Latrine Facilities

For rules common to the construction, maintenance, and closing of latrine facilities, reference is made to paragraph 75.

a. *Straddle Trench Latrine* (fig 21). A straddle trench is dug 1 foot wide, 2½ feet deep, and 4 feet long. This will accommodate two men at the same time. The number of trenches provided should be sufficient to serve at least 8 percent of the unit strength at one time. Thus for a unit of 100 men, at least 16 feet of trench or four-foot trenches are needed. The trenches should be at least 2 feet apart. There are no seats in this type of latrine, but boards may be placed along both sides of the trenches to provide better footing. Some of the earth removed is piled at the end of each trench, and a shovel or paddle provided so that each man can promptly cover his excreta and the toilet paper which he uses.

b. *Deep Pit Latrine* (fig 22).

(1) A deep pit latrine is a deep pit with a latrine box placed over it. The standard latrine box has four seats. It is 8 feet long and 2½ feet wide at the base. A unit of 100 men requires two 4-seat latrine boxes or 16 feet of latrine space. The holes should be covered with flyproof, self-closing lids. Any cracks should be flyproofed by nailing strips of wood or tin over them. A metal deflector should be placed inside the front of the box to prevent urine from soaking into the wood. The deflector may be made from flattened cans.

(2) The pit is dug 2 feet wide and 7½ feet long. This allows 3 inches of earth surface on each

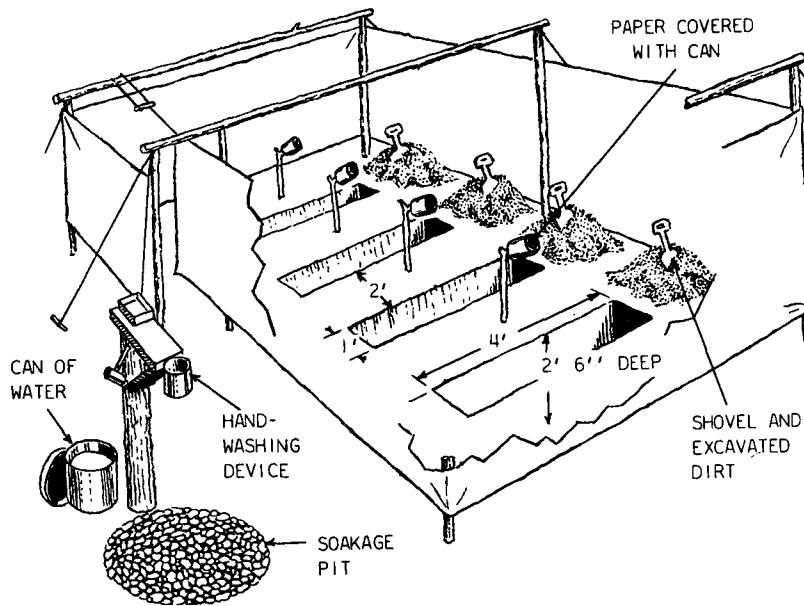

Figure 21. Straddle trench latrine with hand-washing device.

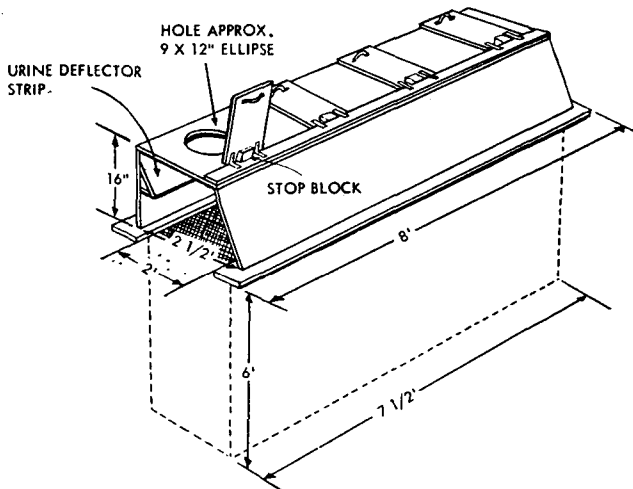

Figure 22. Deep pit latrine.

side of the pit to support the latrine box. The depth of the pit depends upon the estimated length of time the latrine is to be used. As a guide, a depth of 1 foot is allowed for each week of estimated use, plus 1 foot of depth for dirt cover when it is to be closed. It is not generally desirable to dig the pit more than 6 feet deep because of the danger of the walls caving in. Rock or a high ground water level may also limit the depth of the pit. In some soils, supports of planking or other material may be necessary to prevent the walls from caving in. Earth should be packed tightly around the bottom edges of the box so as to seal any openings through which flies could gain entrance.

(3) It is sometimes desirable to install a vent stack in the more permanent pit latrines to release the moisture laden gases of decomposition, thus preventing condensate from forming on in-

side of the self-closing lids which may come in contact with an individual's back. The vent stack should extend from the upper part of the pit to approximately 6 feet above the ground level. The outside opening of the vent stack must be screened.

c. *Burn-out Latrine* (fig 23). The burn-out latrine may be provided when the soil conditions (hard, frozen, rocky) make digging a deep pit latrine difficult. It is also particularly suitable to jungle areas with high water tables. The burn-out latrine should not be used when air pollution regulations prohibit open fires. For a unit of 100 men, at least 8 latrines are needed.

(1) A 55-gallon drum is placed into the ground, leaving enough of the drum above the ground for a comfortable sitting height. Furthermore, the drum may be cut in half, thus making two latrines of less capacity. A wooden seat with a flyproof, self-closing lid is placed on top of the drum. Personnel are encouraged to urinate in a urine disposal facility rather than the burn-out latrine, as more fuel is required to burn out one containing liquid.

(2) The latrine is burned out daily by adding sufficient fuel to incinerate the fecal matter. Highly volatile fuel such as gasoline or JP4 should not be used because of its explosive nature. A mixture of 1 quart of gasoline to 5 quarts of diesel oil is effective, but still it must be used with caution. If the drum must be moved to another site before it is burned out, handles should be welded to the sides of the drum to make it possible for two men to carry the drum with ease. Furthermore, it is convenient to have two sets of drums, one set for

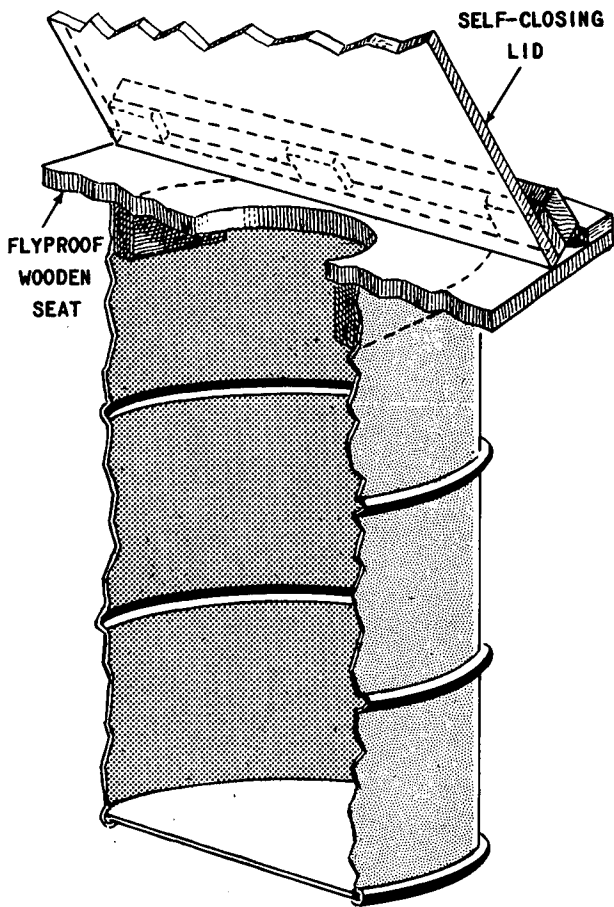

Figure 23. Burn-out latrine.

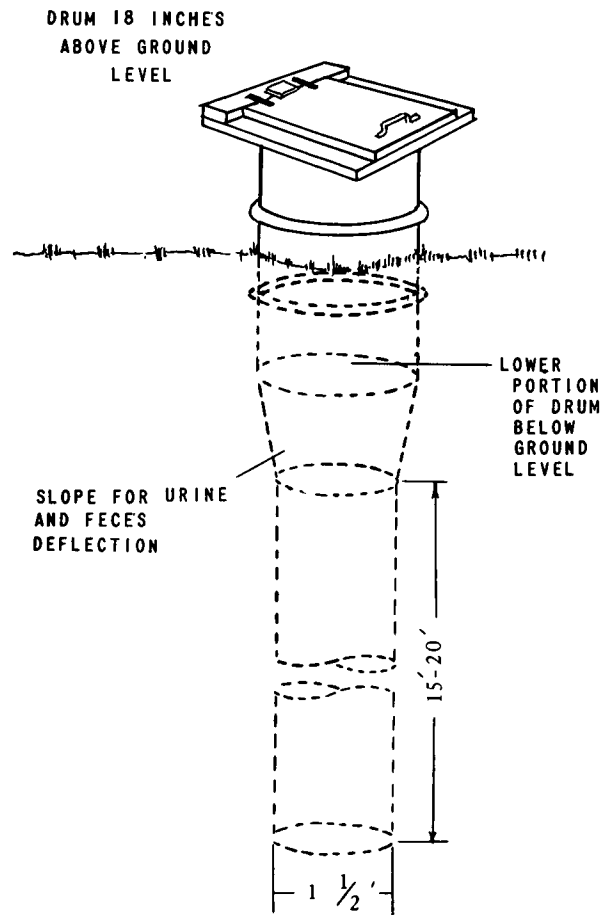

Figure 25. Bored hole latrine.

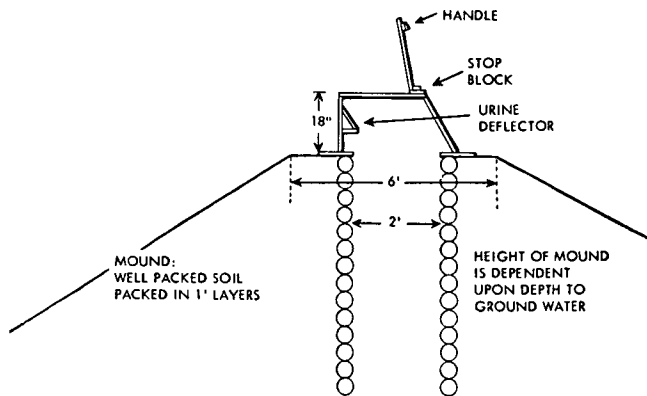

Figure 24. Mound latrine.

use while the other set is being burned clean. If the contents are not rendered dry and odorless by one burning, they should be burned again. Any remaining dry ash should be buried.

d. *Mound Latrine* (fig 24). The mound latrine may be indicated when a high ground water level or a rock formation near the ground surface prevents the digging of a deep pit. A dirt mound makes it possible to build a deep pit and still not have it extend into the ground water or rock.

(1) A mound of earth with a top at least 6

feet wide and 12 feet long is formed so that a four-seat, flyproof latrine box (b above) may be placed on top of it. The mound is made high enough to meet the pit's requirements for depth, allowing 1 foot from the base of the pit to the water or the rock level. Before the mound is built, the area where it is to be placed should be broken up or plowed in order to aid seepage of liquids from the pit. The mound is formed in approximately 1-foot layers. The surface of each layer is roughened before the next is added. When the desired mound height has been reached, the pit is dug into the mound. It may be necessary to brace the walls with wood, sandbags, or other suitable material to prevent cave-ins. The exact size of the base of the mound depends upon the type of soil; it should be made large enough to avoid a steep slope. It may be necessary to provide steps up the slope.

(2) An alternate method for constructing the mound latrine is to build the pit first on top of the ground, using lumber, logs, corrugated sheet metal, or other available material. The dirt is then piled around the pit and up to its brim, thus creating the mound.

e. *Bored Hole Latrine* (fig 25). The bored hole latrine is satisfactory for a small unit; however the necessary mechanical equipment for boring the hole must be available. A hole about 18 inches in diameter and 15 to 20 feet deep is bored into the ground. The hole is then covered by a one-seat latrine box. If such a box is not available, a metal drum which has both ends removed is sunk into the ground over the hole, leaving about 18 inches of the drum above the ground surface. A flyproof, self-closing lid is then fitted securely on the top of the drum. Bored hole latrines should be constructed on basis of eight per 100 men.

f. *Pail Latrine* (fig 26). A pail latrine may be built when conditions (populated areas, rocky soil, marshes) are such that a latrine of other types cannot be constructed. A standard type latrine box (b above) may be converted for use as a pail latrine by placing a hinged door on the rear of the box, adding a floor, and placing a pail under each seat. If the box is located in a building, it should, if possible, be fitted into an opening made in the outer wall so that the rear of the box can be opened from outside the building (fig 26). The seats and rear door should be self-closing, and the entire box should be made flyproof. The floor of the box should be made of an impervious material (concrete, if possible) and should slope enough toward the rear to facilitate rapid drainage of water used in cleaning the box. A urinal may also be installed in the latrine enclosure with a drainpipe leading to a pail outside. This pail also should be

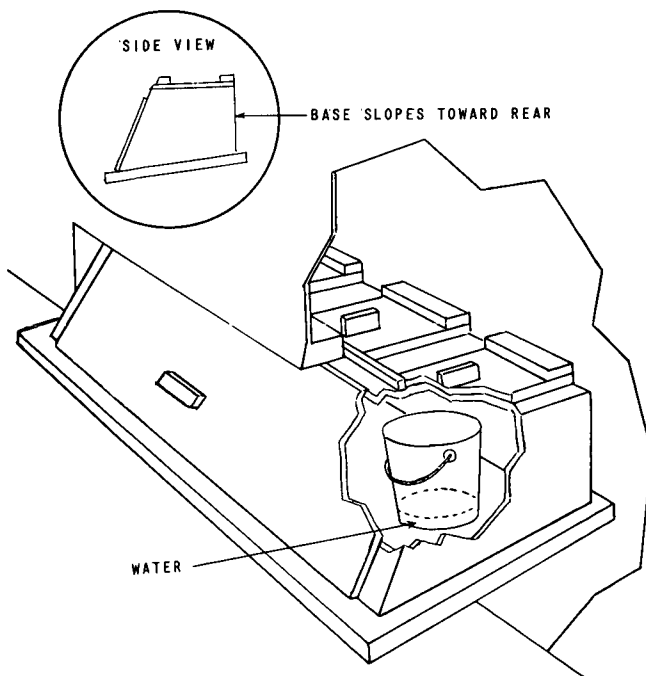

Figure 26. Pail latrine in building.

enclosed in a flyproof box. The waste in pails may be disposed of by burning (c(2) above) or by hauling to a suitable area and burying. The emptying and hauling of containers of waste must be closely supervised to prevent careless spillage. The use of plastic bag liners for pails reduces the risk of accidental spillage. The filled bags are tied at the top; then they are disposed of by burning or burial.

77. Urine Disposal Facilities (figs 27, 28, and 29)

a. Urine disposal facilities should be provided to accommodate at least 5 percent of the command at one time. This means that five urinal pipes ((1) below) are needed for a unit of 100 men. When trough urinals ((2) below) are used, 10 feet of length should be allowed for 100 men. When urinoils ((3) below) are provided, one is required per 100 men. Urinals should be drained either into a soakage pit or into a standard deep pit latrine if the urinals are constructed in conjunction with it. The urine may be drained into a deep pit latrine through a pipe, a hose, or a screened trough. If a soakage pit is to be used, it should be dug 4 feet square and 4 feet deep and filled with rocks, bricks, broken bottles, or similar rubble. It should then be covered with tar paper, boards, or other suitable material and a layer of earth. If the urine disposal facility is located some distance from the sleeping area, another urinal should be provided at a convenient location for use at night.

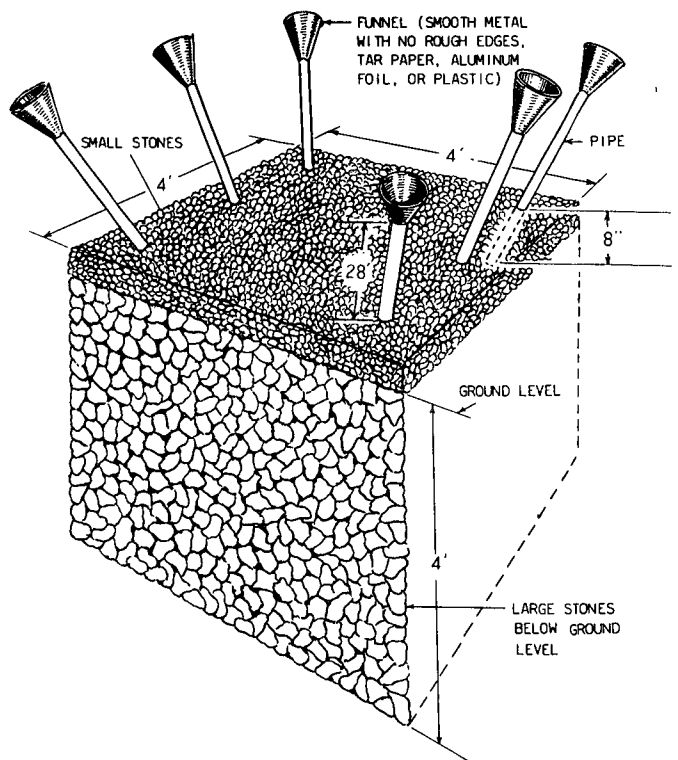

Figure 27. Urinal pipes and soakage pit.

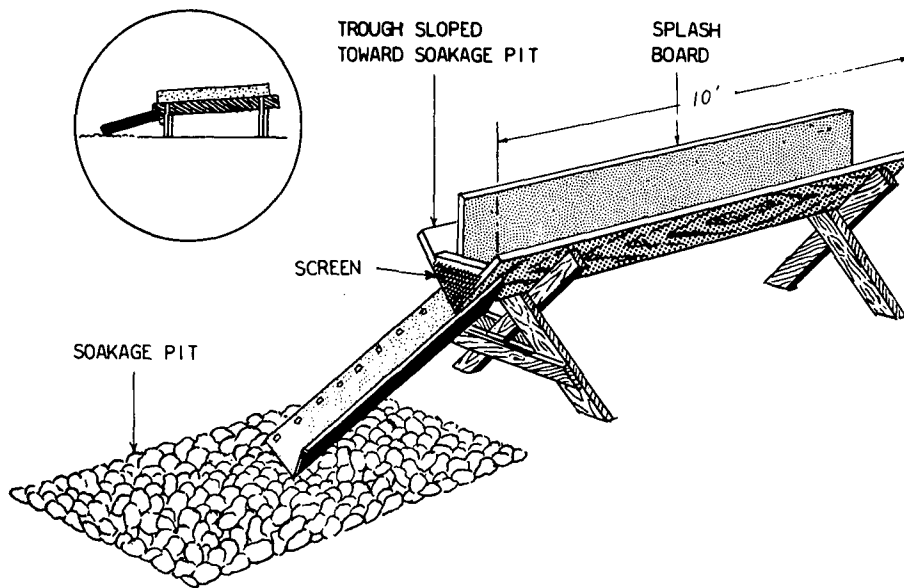
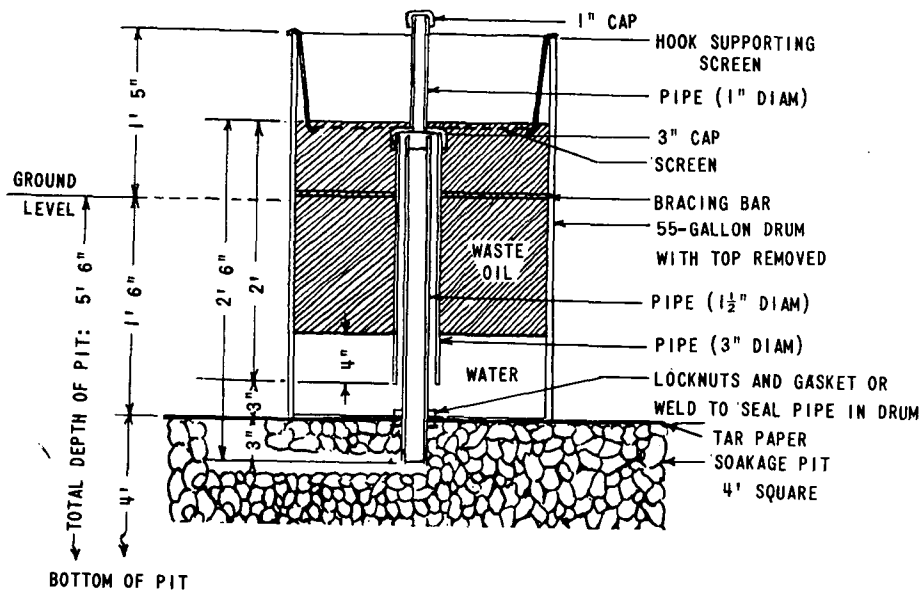

Figure 28. Urinal trough and soakage pit.



①
Figure 29. Urinoil.

(1) Urinal pipes (fig. 27) should be at least 1 inch in diameter and approximately 36 inches long. They are placed at each corner of the soakage pit and, if needed, on two sides halfway between the corners. The pipes are inserted to a point 8 inches below the surface of the pit with the remaining 28 inches slanted outward above the surface. A funnel made of tar paper, sheet metal which has no rough edges, aluminum foil, plastic,

or similar material is placed in the top of each pipe.

(2) A urinal trough about 10 feet long (fig 28) should be provided when material for its construction is more readily available than pipes. This trough is made of sheet metal or wood with eight V- or U-shaped ends. If the trough is made of wood, it is lined with heavy tar paper or metal.

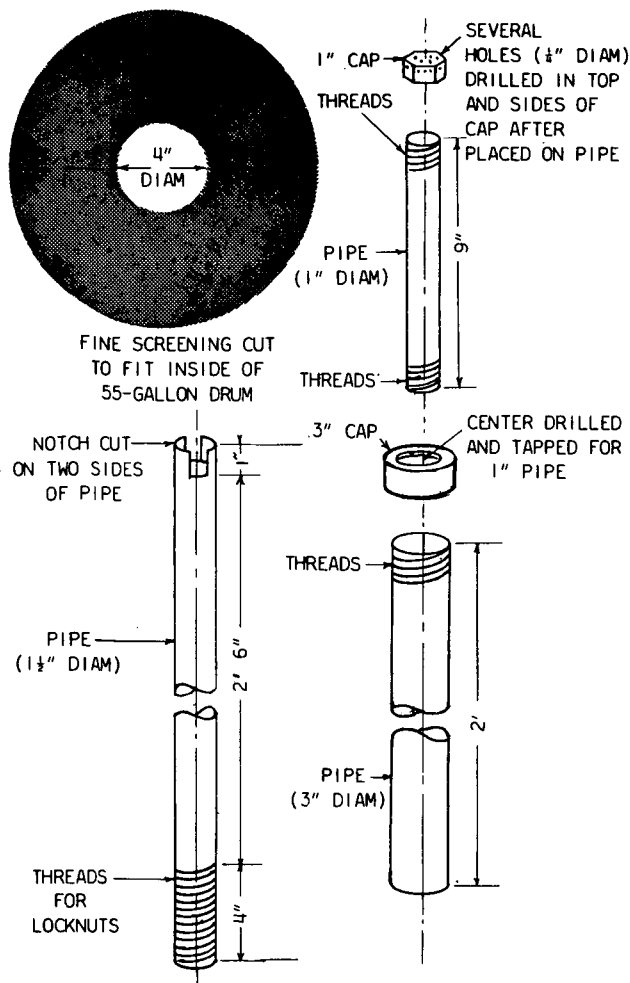

② Preparation of material
Figure 29—Continued.

A splash board is inserted down the middle of the trough. The legs which are to support the trough are cut slightly shorter on one end. At this lower end a shallow trough or a pipe is attached to carry the urine from the urinal trough to the soakage pit or deep pit latrine.

(3) In areas where the ground water level is not too high, that is more than 3 feet below the surface, the urinoil (fig 29) is an acceptable substitute for other types of urine disposal facilities. The urinoil is a 55-gallon drum designed to receive and trap urine and to dispose of it into a soakage pit as illustrated in ①, figure 29. Urine voided through the screen onto the surface of the oil immediately sinks through the oil to the bottom of the drum. As urine is added, the level rises within the 3-inch diameter pipe and overflows into the 1 1/2-inch diameter pipe through the notches cut in the top of this pipe. The oil acts as an effective seal against odors and against the entrance of flies. The screen on top of the oil is lifted by supporting hooks and cleaned of debris as necessary.

b. In order for a urine soakage pit to function properly, the troops must not urinate on the surface of the pit. The funnels or trough must be cleaned daily with soap and water and the funnels replaced as necessary. Oil and grease must never be poured into the pit, as they may clog it. When a urine soakage pit is to be abandoned or it becomes clogged, it should first be sprayed with a residual insecticide; then it must be mounded over with a 1-foot covering of compacted earth and marked as explained in paragraph 75f(3).

Section III. WASH, BATH, AND LIQUID KITCHEN WASTES

78. General

In the field, wash, bath, and liquid kitchen wastes are disposed of in the soil usually by means of either soakage pits or soakage trenches. In order for the soil to absorb these liquids, the grease and soap, as well as any solid particles, must first be removed from them. For this reason a grease trap is made a part of each soakage pit or trench to be used for the disposal of wash and liquid kitchen wastes. In places where heavy clay soil prevents the use of soakage pits or trenches, evaporation beds may be used if the climate is hot and dry.

79. Soakage Pits

In a temporary camp, a soakage pit 4 feet square and 4 feet deep normally will be adequate to dispose of liquid kitchen waste for 200 persons. If the troops are to remain in the camp for 2 weeks, two pits should be constructed for disposal of liquid

kitchen waste; each pit should be used on alternate days, thus lessening the possibility of clogging. Each device provided for washing and bathing must also have a soakage pit under it. These soakage pits are constructed in the same way as a urinal soakage pit (para 77a) except that the urinal pipes are omitted. A grease trap (para 81) is provided for each pit, except those under showers. The area under field showers, as well as under drinking devices, should be excavated a few inches and then filled with small, smooth stones to keep the water from standing. Should a soakage pit become clogged, it is closed; and a new one is constructed. A soakage pit is closed by covering it with 1 foot of compacted earth and marked as explained in paragraph 75f(3).

80. Soakage Trenches

If the ground water level or a rock formation exists close to the surface, soakage trenches instead

of pits should be used. A soakage trench consists of a pit, 2 feet square and 1 foot deep, with a trench extending outward from each of its sides for a distance of 6 or more feet (fig 30). The trenches are 1 foot wide and vary in depth from 1 foot at the central pit to 1½ feet at the outer ends. The pit and trenches are filled with the same material used in a soakage pit (para 79). Two such units should be built to dispose of liquid kitchen waste for every 200 persons, and each unit should be used on alternate days. One unit should be built for each washing device provided. A grease trap (para 81) is provided for each soakage trench. A soakage trench is closed by covering it with 1 foot of compacted earth and marked as explained in paragraph 75f(3).

81. Grease Traps

a. Baffle Grease Trap.

(1) A baffle grease trap may be made from a drum (fig 31) or from a water-tight box (fig 32). The drum or box is divided vertically into an entrance chamber and an exit chamber by attaching a wooden baffle. The baffle should be placed so that the entrance chamber will be approximately twice the size of the exit chamber. The baffle should hang to a point within 1 inch of the bottom. A strainer which may be made from a small perforated box filled with straw, hay, or burlap is inserted into the lid above the entrance chamber. A pipe is inserted into the exit chamber about 3 to 6 inches below the top as an outlet to the soakage pit. This baffle grease trap is usually placed on the ground at the side of the soakage pit with the outlet pipe extending 1 foot beneath the surface at the center of the pit. If a grease trap is not water-tight, it must be placed partially under the ground.

(2) Before the grease trap is used, the chambers are filled with cool water. The waste liquid is poured through the strainer which retains any solids. As the warm liquid strikes the cool water, the

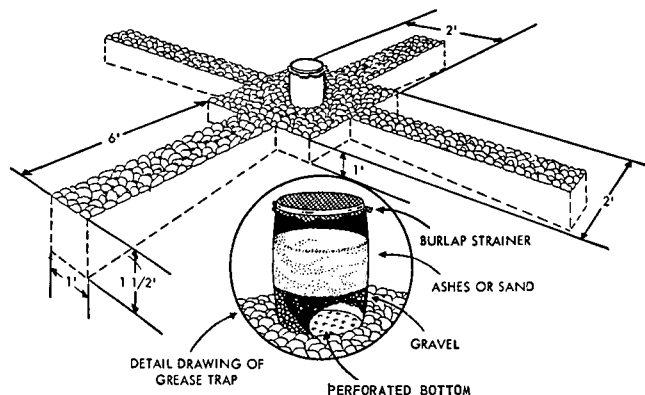

Figure 30. Soakage trench with barrel filter grease trap.

grease rises to the surface of the entrance chamber; and the liquid runs under the baffle, filling the exit chamber. When the liquid reaches the outlet pipe near the top of the exit chamber, it runs through this pipe into the soakage pit. Unless the grease trap is of sufficient capacity, the warm greasy liquid poured into the trap will heat the cool water in the trap, thus allowing the grease to remain uncongealed and to pass through the trap. The efficiency of this grease trap can be increased by constructing it with multiple baffles. Also, a series of traps may be used.

(3) The baffle grease trap must be properly maintained to prevent clogging of the soakage pit. The grease retained in the trap should be skimmed from the surface of the water daily or as often as required and either buried or burned. The entire trap should be emptied and thoroughly scrubbed with hot, soapy water as often as necessary.

b. Barrel Filter Grease Trap.

(1) The barrel filter grease trap may be made from a 30- to 50-gallon barrel or drum which has the top removed and a number of large holes bored into the bottom (fig 30). Eight inches of gravel or small stones are placed in the bottom and covered with 12 to 18 inches of ashes or sand. A piece of burlap is fastened to the top of the barrel to serve as a coarse filter. The trap may be placed directly on the soakage pit, or it may be placed on a platform with a trough leading to the pit.

(2) Every 2 days the grease trap should be emptied, washed, and refilled as described in (1) above. The material removed should be buried. The burlap filter should be either washed or replaced every day.

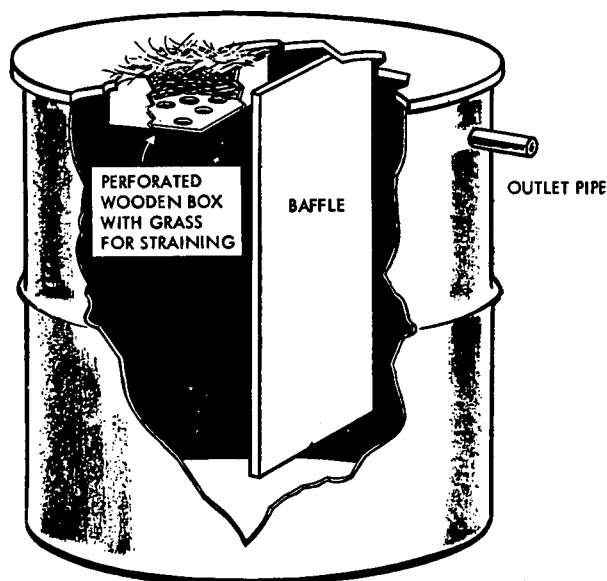

Figure 31. Baffle grease trap (drum type).

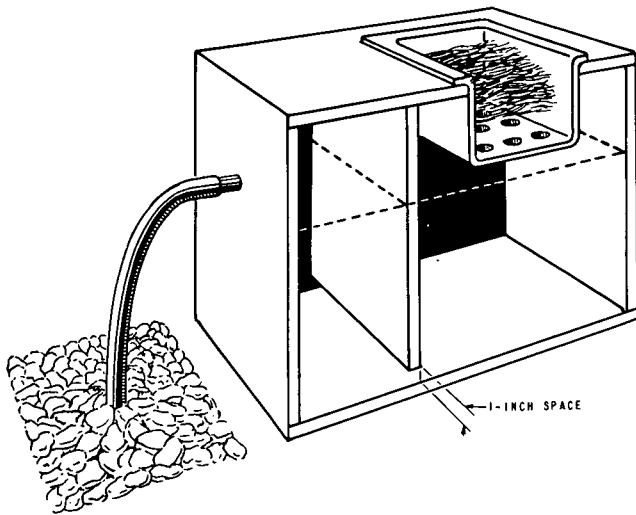

Figure 32. Baffle grease trap (box type).

(3) A pail strainer may be used instead of the burlap filter. It is made by boring holes in the bottom of an old metal pail or can and filling it with grass or straw. This strainer will remove coarse particles of food and a small part of the grease. It is placed on top of the barrel grease trap.

82. Evaporation Beds

In places where clay soil prevents the use of standard soakage pits, evaporation beds (fig 33) may be used if the climate is hot and dry.

a. Sufficient beds, 8 by 10 feet, are constructed

to allow 3 square feet of surface area per person per day for kitchen waste and 2 square feet per person per day for wash and bath wastes. The beds are spaced so that the wastes can be distributed to any one of the beds. In the construction of a bed, the top soil is first scraped to the edges, thus forming a small dike around it; then the earth within the bed is spaded to a depth of 10 to 15 inches and raked into a series of rows, making the ridges approximately 6 inches above the depressions. These rows may be formed either lengthwise or crosswise as deemed desirable for best distribution of water.

b. In operation, one bed is flooded during the day with liquid waste to the top of the ridges, which is equivalent to an average depth of 3 inches over the bed; then the liquid waste is allowed to evaporate and percolate. After 3 or 4 days this bed is usually sufficiently dry for respading and re-forming. The other beds are flooded on successive days, and the same sequence of events is followed.

c. Careful attention must be given to proper rotation, maintenance, and dosage of evaporation beds. It is also essential that the kitchen waste be run through an efficient grease trap (para 81) before it is allowed to enter the evaporation beds. If these beds are used properly, they create no insect hazard and only a slight odor. Other modifications of waste disposal methods are possible and should be used when they are more adaptable to the particular situation.

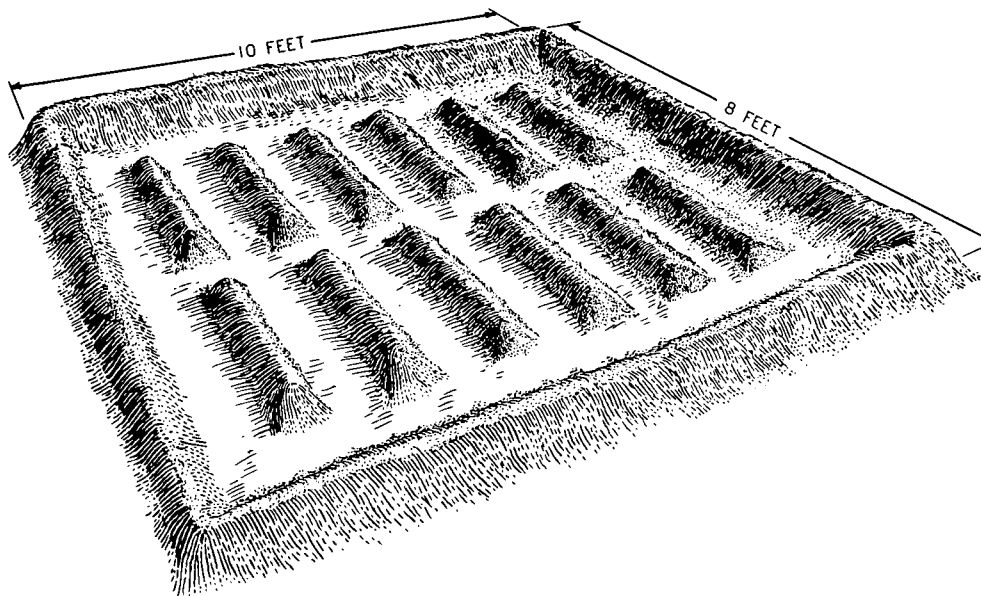

Figure 33. Evaporation bed.

Section IV. GARBAGE AND RUBBISH

83. Garbage Disposal

Garbage is the solid or semisolid waste resulting from the preparation, cooking, and serving of food. It does not include rubbish which is discussed in paragraph 84. Garbage is disposed of by burial or incineration.

a. Burial. When troops are on the march, in bivouac, or in camps for less than 1-week duration, garbage is disposed of by burial in pits or trenches. These pits or trenches should not be over 30 yards from the mess area. Garbage must not, however, be buried closer than 100 feet to any source of water used for cooking or drinking.

(1) Pits are preferred for burying garbage during overnight halts. A pit 4 feet square and 4 feet deep is suitable for 1 day for a unit of 100 men. At the end of the day or at such time as the pit is filled to 1 foot below the ground surface, it should be sprayed with insecticide; then it must be filled with earth, mounded over with an additional foot of compacted earth, and marked as explained in paragraph 75f(3).

(2) The continuous trench is more adaptable to stays of 2 days or more. The trench is first dug about 2 feet wide, 3 to 4 feet deep, and long enough to accommodate the garbage for the first day. As in the pit method the trench is filled to not more than 1 foot from the top. The trench is extended as required, and the excavated dirt is used to cover and mound the garbage already deposited. This procedure is repeated daily or as often as

garbage is dumped. It is a very efficient field expedient for disposing of garbage.

b. Incineration.

(1) In temporary camps of over 1 week, the garbage is often burned in open incinerators. Excellent types of open incinerators may be constructed from materials which are readily available in any camp area. Since incinerators will not handle wet garbage, it is necessary to separate the liquid from the solid portion. This is done by straining the garbage with a coarse strainer such as an old bucket, salvaged can, or 55-gallon drum in which holes have been punched in the bottom. The solids remaining in the strainer are incinerated, and the liquids are poured through a grease trap (para 81) into a soakage pit or trench (para 79 and 80). Field incinerators should be located at least 50 yards downwind from the camp to prevent their being an odor nuisance.

(2) The inclined plane incinerator (fig 34) will dispose of the garbage of an entire battalion, evacuation hospital, or other unit of similar size. Its effectiveness in combustion and the fact that it is somewhat protected from rain or wind make it an excellent improvised device. Time and skill, however, are required in building it. A sheet metal plane is inserted through telescoped 55-gallon drums from which the ends have been removed. The metal plane should extend approximately 2 feet beyond the upper end of the telescoped drums to serve as a loading or stoking platform. The telescoped drums are positioned on an in-

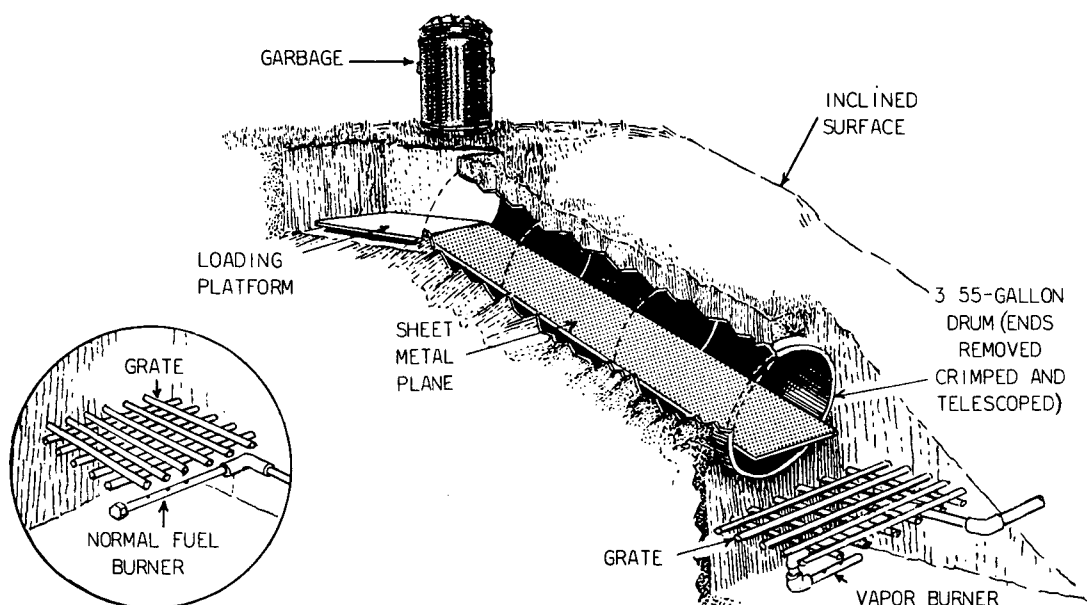

Figure 34. Inclined plane incinerator.

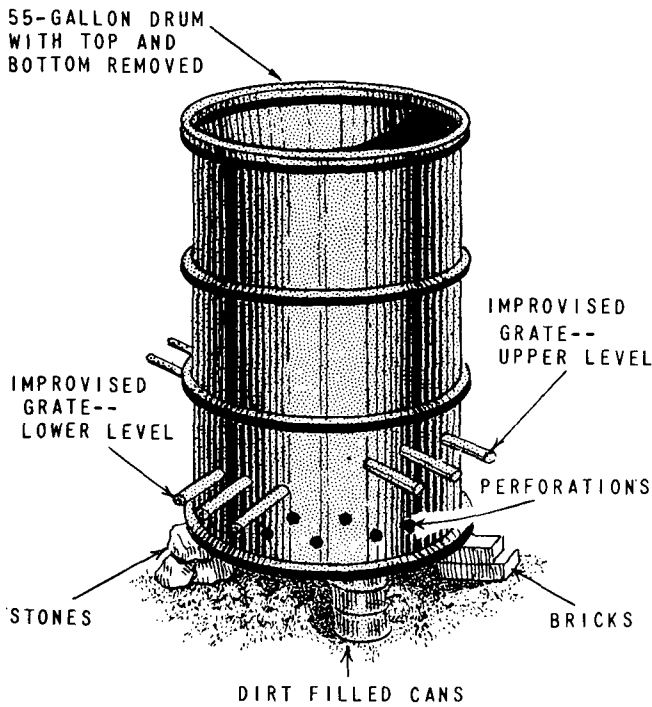

Figure 35. Barrel incinerator.

clined surface. A grate is placed at the lower end of the telescoped drums, and a wood or fuel oil fire is provided under the grate. After the incinerator becomes hot, drained garbage is placed on the stoking platform. As the garbage becomes dry, it is pushed through the telescoped drums in small amounts to burn. Final burning takes place on the grate. If time does not permit the construction of

the inclined plane incinerator as illustrated in figure 34, it may be simplified as follows: Dig a fire pit at the bottom of an incline, line it with rocks, and place a grate over it. Place three telescoped drums in a shallow trench up the incline, letting the lower end of the telescoped drums extend somewhat over the fire pit so the flame will be drawn up the drums. The sheet metal plane, if available, should be used, as it permits more thorough drying of the garbage.

84. Rubbish Disposal

a. In temporary camps or on bivouac, all rubbish usually is buried in pits or in trenches with the garbage (para 83a). If this is done, care should be taken to flatten the tin cans and break down the boxes before they are added to the rubbish. In camps where the length of stay is over 1 week, the combustible rubbish is usually burned in a barrel incinerator (b below); and the noncombustible rubbish is either buried or hauled to a suitable disposal site. Should the unit be located near an ocean or on an island, rubbish, as well as garbage, may be disposed of by having it hauled out to sea and dumped.

b. A barrel incinerator (fig 35) is made from a 55-gallon drum by cutting out both ends, punching many holes near the bottom, and inserting grates inside the barrel several inches above the holes. The barrel is supported several inches above the ground on stones, bricks, or dirt filled cans, thus allowing space to build a fire under the barrel. The rubbish is put into the barrel on the top grate.

CHAPTER 7

MOSQUITO-BORNE DISEASES AND THEIR CONTROL

Section I. GENERAL

85. General

Mosquitoes are found all over the world. In the tropics and subtropics they breed throughout the year; even in the subarctic regions they appear in tremendous numbers during the brief summer season. Most of the disease-carrying mosquitoes are found in the milder climates and in the tropics. Different types of mosquitoes transmit different types of diseases. The three most common types of mosquitoes which transmit disease are *Anopheles*, *Aedes*, and *Culex*. Each of these types consists of many species. For a schematic view of the important parts of a mosquito, see figure 36.

86. Mosquito-Borne Diseases

There are many diseases transmitted by mosquitoes. Some of the more important ones are malaria, yellow fever, dengue fever, encephalitis, and filariasis. Of these diseases, malaria is the greatest threat to military operations. It is important to know that anti-mosquito measures are the major weapons against this group of diseases. Also available are excellent drugs for the suppression and cure of malaria and an excellent vaccine for the prevention of yellow fever.

a. Malaria. Although the occurrence of malaria is rare in the United States, it occurs very commonly in most tropical, subtropical, and semi-tropical areas of the world. Malaria is caused by a microscopic parasite carried by the *Anopheles* mosquito. This parasite destroys the blood cells and causes chills, fever, weakness, and anemia. Unless the disease is treated promptly and properly, it may cause death from damage to the brain. The only sure way of preventing malaria is to avoid the bites of infected mosquitoes. When complete mosquito control (para 90) is difficult or even impossible, such as during periods of active combat, the prevention of malaria is dependent upon the application of individual protective measures (para 91) and the use of antimalarial drugs as prescribed.

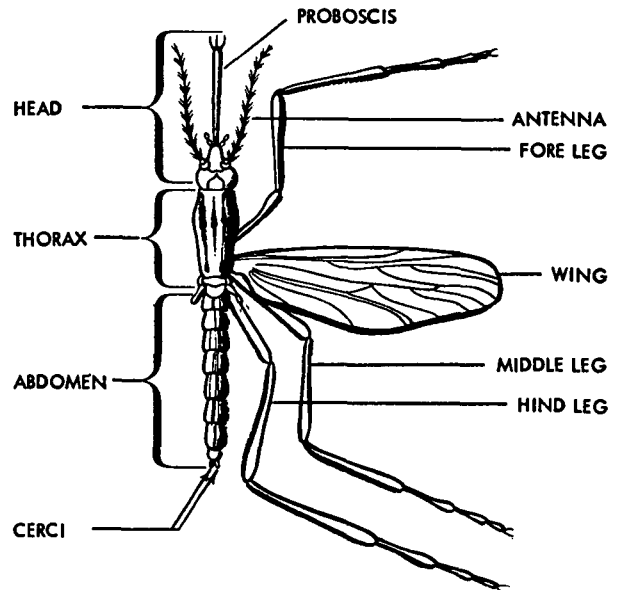

Figure 36. The adult mosquito.

b. Yellow Fever. Yellow fever is a viral disease now confined to tropical Africa and tropical Americas. The virus is transmitted by the *Aedes aegypti* mosquito. In the jungles of the tropics, it is transmitted by the *Haemagogus* mosquito. Yellow fever is characterized by fever, headache, backache, jaundice, and internal bleeding. The most important preventive measures include the administration of a highly effective vaccine and the application of individual protective measures (para 91).

c. Dengue Fever. The term *dengue* refers to a group of viral diseases which are widespread throughout the tropical areas of the world. These diseases, which are of great military significance, are transmitted by *Aedes* mosquitoes. Often the only symptom is a mild fever, but there may also be severe muscular pain. No vaccine is available for these diseases. The best means for avoiding dengue fever is the prevention of mosquito bites by using individual protective measures (para 91).

d. Encephalitis (Sleeping Sickness). There are

many forms of encephalitis throughout the world. Often these diseases are named after the geographical area in which they are first identified. They are viral diseases which usually affect the central nervous system (brain and spinal column). The viruses are transmitted to man by *Aedes* and *Culex* mosquitoes. Some of the viruses are thought to be transmitted from birds to man by the mosquitoes. No vaccines are available; thus individual protective measures (para 91) are essential in the prevention of this group of diseases. These mosquito-borne types of sleeping sickness are not to be

confused with African or American trypanosomiasis which is also known as sleeping sickness.

e. *Filariasis (Elephantiasis)*. This disease occurs in the Pacific and Far East areas. It is caused by a tiny worm which is injected into man by the bite of an infected *Aedes*, *Culex*, or *Anopheles* mosquito. If only a few of these parasites are in the body, they will do no harm and will eventually die. Natives who develop ugly, swollen limbs from this disease are those who have been reinfected with the parasite continually over a period of many years. Avoiding mosquito bites is the best preventive measure (para 91).

Section II. CHARACTERISTICS OF MOSQUITOES

87. Life Cycle

Mosquitoes go through four stages during their life cycle: egg, larva, pupa, and adult (fig 37). The time required for mosquitoes to complete their life cycle varies greatly, depending upon their species and the weather conditions. Most species of medical importance require approximately 1 to 3 weeks to complete the cycle from the egg to the adult. Adult mosquitoes may live from 2 weeks to several months, depending upon their species. The larval and pupal stages of all mosquitoes are passed in water where the larvae, sometimes called wigglers, can be easily detected. In their adult or flying stage, certain mosquitoes such as *Anopheles*—vectors of malaria—can fly at least one mile; *Aedes aegypti*—vectors of yellow fever—can travel a few hundred yards; other species have been known to travel 100 miles or more when the wind is favorable. Male mosquitoes do not suck blood and are, therefore, harmless; the females are bloodsuckers and are the transmitters of disease. A person is not always aware that mosqui-

toes are biting him until later when the sites of the bites began to itch.

88. Characteristics of Anopheles, Aedes, and Culex Mosquitoes

a. *General*. Mosquitoes will breed in practically any collection of water which stands longer than 5 to 7 days. Those breeding in and around human dwelling places are called domestic mosquitoes. Different kinds of mosquitoes vary in their choice or breeding places. Some like sunlit places; whereas others prefer the shade. Some prefer fresh water to stagnant water; others prefer the brackish water of salt marshes. Common breeding sites are ponds, pools, slow-moving streams, inland swamps and bogs, salt marches, ditches, tree holes, rock holes, and man-made containers of water. Man-made containers of water are wells, cisterns, rain barrels, roof gutters, road gutters,

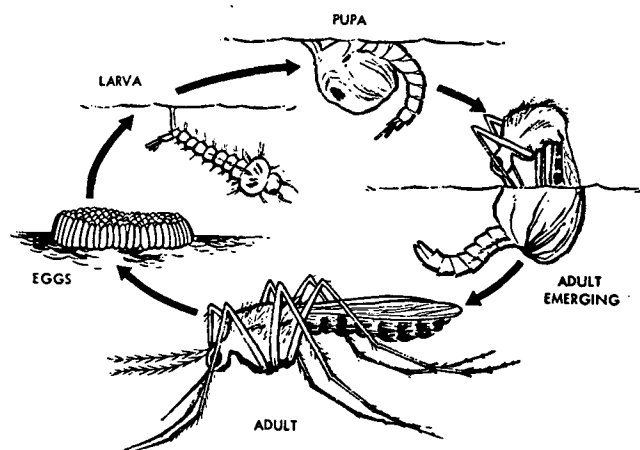

Figure 37. Life cycle of the mosquito.

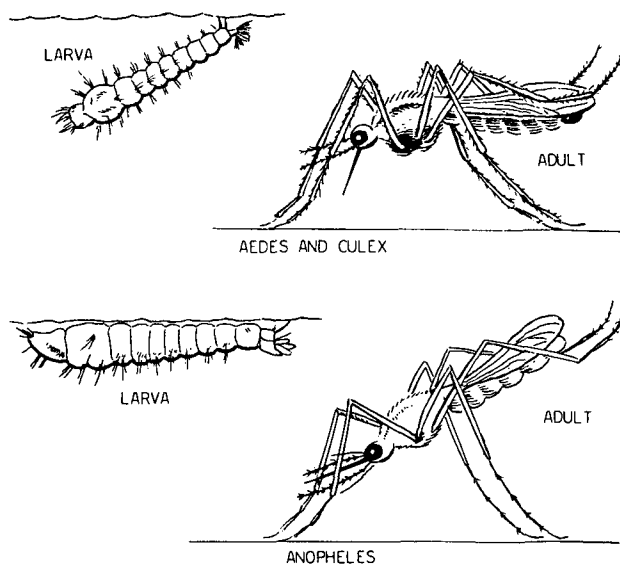

Figure 38. Typical positions of mosquitoes in their larval and adult stages.

cans, buckets, drains, cesspools, septic tanks, pit latrines, excavation sites, road holes, bomb craters, and old tires.

b. Anopheles. *Anopheles* mosquitoes bite primarily during the period from dusk to dawn. They may bite during the daylight hours in an area which is heavily shaded or in a room which is dark. Normally, most species will breed in any collection of water; some species breed only in tree holes. The larvae lie parallel to the surface of the water (fig 38). The adults usually rest and feed with the body at an angle of 45° to the surface (fig. 38).

c. Aedes. *Aedes* mosquitoes bite in daylight. They breed in fresh, stagnant, or brackish water. *Aedes aegypti*, one of the most important disease

transmitter, breed almost entirely in old tires, tin cans, flower vases, and other similar man-made containers. While the larvae, which are equipped with an air tube or siphon, are breathing, they hang at an angle to the surface of the water (fig 38). The adult rest and feed with their body parallel to the surface.

d. Culex. *Culex* mosquitoes, depending upon the species, may bite anytime of the day or night. They are commonly found in fresh or stagnant water in and about buildings, as well as in swamps, ditches, street gutters, cesspools, and other places which hold water. The common house mosquitoes found in the United States are members of this group. The larvae hang at an angle in the water, and the adults rest and feed parallel to the surface as do *Aedes* (fig 38).

Section III. MOSQUITO CONTROL MEASURES

89. Responsibilities

a. Commander. The unit commander is responsible for mosquito control in his unit area (AR 40-5/AFR 161-1). He should employ his field sanitation team (para 5c) to accomplish unit control measures (para 90) and to supervise the application of protective measures which must be performed by the individual soldier (para 91).

b. Army/Air Force Medical Department. The medical department conducts surveys to determine control requirements, advises the commander of effective control measures for a particular area or situation, and prescribes the antimalarial drug program. This department also assists in the training of the unit field sanitation team appointed by the commander and supervises or conducts, as required, control operations beyond the capabilities of the field sanitation team.

90. Unit Mosquito Control Measures

a. Selection of Bivouac Site. A bivouac site is selected according to well-defined military and sanitary rules. The ideal location of a bivouac site is on high, well-drained ground at least 1 mile from breeding sites of mosquitoes as well as flies and 1 mile from the habitation of natives, who are often heavily infected with mosquito-borne diseases. It is not always possible, however, to bivouac in the ideal location. A unit commander may be confronted, therefore, with the necessity for mosquito control in the vicinity of his camp site. The area for which the unit is responsible for mosquito control generally includes the camp site and 100 yards beyond the perimeter of this

site. If only minor mosquito-breeding sites exist, the area may be extended farther.

b. Control of Breeding Sites. Since all mosquitoes require water for breeding, the control of water sites is the most effective means of eliminating mosquitoes. The field sanitation team of the unit accomplishes this by (1) insuring the proper disposal of discarded containers and the elimination of any holes, ruts, or other low areas in which water can collect and stand and (2) applying an insecticide to the water holes which cannot be eliminated at sufficient intervals to kill the mosquito larvae (see note, para 24b). Insecticides for the control of larvae may be applied in various formulations. Only a small quantity of the actual chemical ingredient is necessary to attain control. For the explanation of insecticides, reference is made to *c*(2) below. Any large bodies of standing water in which mosquitoes are breeding should be reported so that such control measures as ditching, draining, and filling may be accomplished by units with the required capabilities.

c. Control of Adult Mosquitoes.

(1) *General.* Adult mosquitoes, as well as other insects, are controlled by clearing away such mosquito resting places as tall grass, bushes, and vines; by space spraying with an insecticide; and by applying a residual insecticide to quarters or shelters, mess areas, and latrines ((2) below). Adult mosquitoes are further controlled by the application of individual protective measures prescribed to protect troops against mosquito bites (para 91). The troops must be taught the proper application of the protective measures which they are to use individually.

(2) *Insecticides.* DDT spray, diazinon, and pyrethrum are effective against adult mosquitoes when used properly. DDT and diazinon are residual-type insecticides. A residual insecticide is one that is applied to surfaces from which insects may later get a toxic dose. A residual spray may remain toxic to certain insects for a few days to several months after application. DDT has the longest residual effect against mosquitoes and should be used until a qualified representative of the Army/Air Force Medical Department determines it to be noneffective. A residual spray is applied to the interior surfaces of walls and ceilings where mosquitoes usually rest when not feeding. Under certain conditions a residual spray is applied to shrubbery and other vegetation outside to form a protective barrier or zone between the breeding areas and human habitations. Pyrethrum, issued in a 12-ounce aerosol dispenser, is to be applied into the air of inclosed spaces to kill insects in flight. Its effectiveness lasts from a few minutes to several hours after application.

(a) *DDT insecticide, residual-type spray.* This residual-type insecticide contains 5 percent DDT and requires no dilution. It is the preferred formulation issued to units for use by the field sanitation teams. This spray is flammable and should not, therefore, be used where open flames are present. DDT insecticide is applied to the interior surfaces at the rate of 1 gallon per 1,000 square feet of surface. The number of seasonal treatments required varies with geographical locations and abundance of adult mosquitoes. Some facilities may have to be treated every 2 months; whereas for others one annual application may be sufficient. To establish an effective schedule, the unit commander should consult a qualified representative of the Army medical department.

Precautions: DDT insecticide may be poisonous if it is absorbed through the skin in sufficient amounts. Not only are the chemicals poisonous but the solvent, such as kerosene or fuel oil, mixed with the chemicals makes them more hazardous for humans. The human skin repels water but absorbs oil; the insecticide is, therefore, absorbed with the oil. When a person is using this insecticide, he should wear clothing which extends over his arms and legs and rubberized gloves. Should the skin become contaminated with DDT insecticide, it should be washed with soap and water. When spraying DDT in closed spaces, he should also wear a respirator or gas mask. Food, utensils, and table tops should be covered before spraying; and fires should be extinguished. Only trained personnel should apply DDT.

(b) *Diazinon insecticide, residual-type spray.* This insecticide contains 0.5 percent diazinon. It is effective for the control of DDT-resistant mosquitoes as well as DDT-resistant flies, fleas, mites, ticks, cockroaches, and bedbugs. It should be used against mosquitoes only when they cannot be controlled with DDT. Diazinon has relatively long residual action. It can be used as an exterior residual spray for the control of adult mosquitoes by applying it at the rate of 1 gallon per 1,000 square feet of surface area to be treated.

Precautions: When a person uses diazinon insecticide, he should take the same precautions as he would in using DDT ((a) above).

(c) *Pyrethrum insecticide.* This insecticide is supplied in a low-pressure, 12-ounce dispenser referred to as an aerosol bomb (fig 39). It is used to kill flying insets in tents, foxholes, bomb shelters, barracks, and other quarters or shelters. This aerosol bomb is not to be used as a residual spray. Its toxic action is immediate but of only temporary duration. Seven seconds of spraying per 1,000 cubic feet or roughly 22 seconds for a squad tent are sufficient. The dispenser should be carried quickly to all the corners while the insecticide is escaping. Aerosol bombs may be supplied to men in combat areas along with their food, ammunition, and first-aid items. It should be used to spray their shelter tents and dugouts at dusk and at other times when mosquitoes bite to keep out these insects as well as to kill them. The aerosol bomb should also be used after entering the insect bar at night (para 91d). A few seconds of spraying are enough for an ordinary tent, dugout, or insect bar.

(3) *Mosquito-proofing.*

(a) Mosquito-proofing is another means of protecting troops against adult mosquitoes. A screened billet is a highly desirable protective measure, but it cannot always be provided in the field. To certain units in specific areas, insect-proof liners (FM 21-15) are authorized for use in tents.

(b) Any facility in which troops gather should be mosquito-proofed. The windows and outside doors should be covered with 18-mesh screening. The doors should open outward and close au-

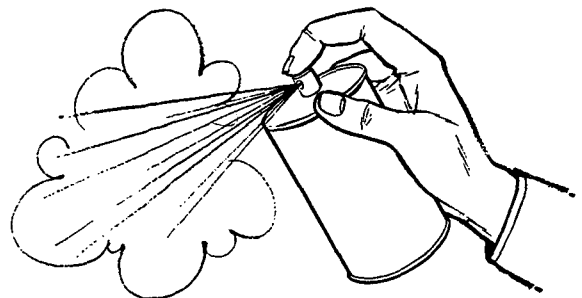

Figure 39. Insecticide dispenser (aerosol bomb).

tomatically. They should be of sturdy construction so that they will not warp or sag and should be reinforced with cross-strips of wood or metal at the hand and foot levels. Strips of wood or metal should also be used to block any spaces between the frame and the door where mosquitoes might enter. In highly malarious areas, entrances should have a vestibule with double screen doors at least 6 feet apart. Both doors should open outward. All cracks, knotholes, and spaces in flooring, walls, or corner joints should be closed with pieces of tin cans, shingles, or a mastic made by boiling shredded paper and flour into a doughy mass and adding sand as well as cement, if available. Torn screening must be repaired promptly. The unit field sanitation team should be given the duties of making regular inspections and necessary minor repairs and of promptly reporting major repair requirements.

d. Equipment for Application of Insecticides. The items of equipment issued to units for control of mosquito larvae and adult mosquitoes are discussed as follows:

(1) *Two-gallon hand pressure sprayer* (fig 40). The 2-gallon hand pressure sprayer is used for most mosquito control operations. Various makes of this sprayer are available. The instructional manual furnished with each sprayer must be retained and followed in regard to its operation and maintenance. Regardless of the make of sprayer used, it should be flushed with kerosene or fuel oil and wiped off at the end of each day's operation to prevent the insecticide from crystalizing. The crystals will corrode the metal, jam the valves, deteriorate the gaskets, and cause malfunction of the nozzles. A box should be constructed for protection of the sprayer during storage and transport.

(2) *One- and three-quart hand pressure sprayers* (fig 41). These small sprayers are used principally for spraying small areas for mosquitoes as well as flies, cockroaches, and ants. They operate best when they are filled to only three-quarters of their capacity. At the end of the day's use, the sprayers should be flushed with kerosene or fuel oil, wiped off, and hung in a position which will allow them to drain.

(3) *Hand duster* (fig 42). This plunger-type hand duster is for use in the application of dusts for the control of mosquito larvae as well as lice, fleas, ants, and other insects. It operates best when the dust cylinder is filled to only three-quarters of its capacity. The only maintenance required is a drop of oil applied occasionally to the pump cylinder.



Figure 40. Two-gallon hand pressure sprayer.

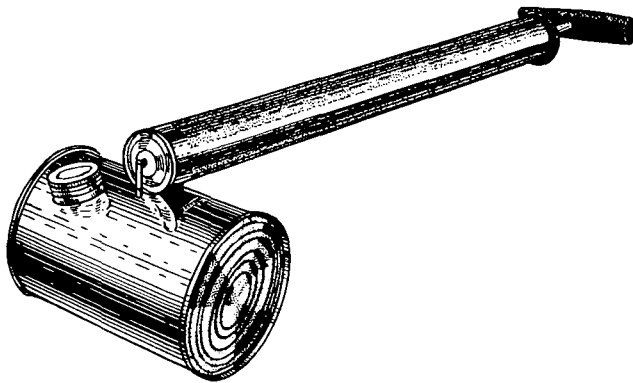

Figure 41. One-quart hand pressure sprayer.

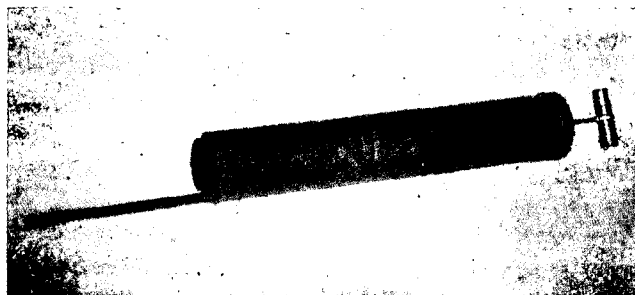

Figure 42. Hand duster.

91. Individual Protective Measures

Individual protective measures are those which must be used by each soldier/airman. Often, they are the only preventive measures available to troops in the field. Since these measures are essential for the effective prevention and control of malaria, they are frequently called "malaria discipline" even though they are also necessary for the prevention and control of most other insect-borne diseases. The closer an individual gets to combat, the more important it is that he know how to apply individual protective measures and how to take care of his protective equipment. Instruction given in training periods should be repeated when necessary and applied on field maneuvers. Commanders must strictly enforce individual measures for insect and malaria control. A man in a foxhole or on the frontline can protect himself reasonably well if he knows how to avoid infection and realizes the importance of doing so.

a. Clothing. The combat uniform worn loosely with the pants tucked into the boots without blousing rubbers and with the sleeves down and buttoned provides a large measure of protection to the soldier. A mosquito can bite through most clothing only when it is worn tightly against the skin. Wearing the uniform in this way also makes it more difficult for mites and ticks to get under the clothing. It may be necessary to wear headnets and gloves. Headnets afford excellent protection for the face and neck and are particularly useful in areas where mosquitoes and biting flies are abundant as they are in the arctic during the summer. The wearing of shorts as an outer garment during the hours from dusk to dawn should be prohibited; furthermore no person should be allowed outdoors without a shirt during this period. This type of control can be effected only by strict discipline and frequent inspection.

b. Insect Repellent for Clothing. The uniform impregnated with a chemical clothing repellent provides additional protection against mosquitoes. The instructions provided on the repellent container should be followed in impregnating clothing.

c. Insect Repellent for Personal Application (DEET). This insect repellent is available in a 2-ounce plastic bottle and in a 6-ounce pressurized dispenser. Insect repellent must not be sprayed into the face but applied to the hands and then rubbed on the face. With DEET on the exposed skin and with the uniform impregnated and worn correctly (*a* and *b* above), good protection is provided against disease-carrying mosquitoes and other insects for 2 to 4 hours, provided the repel-

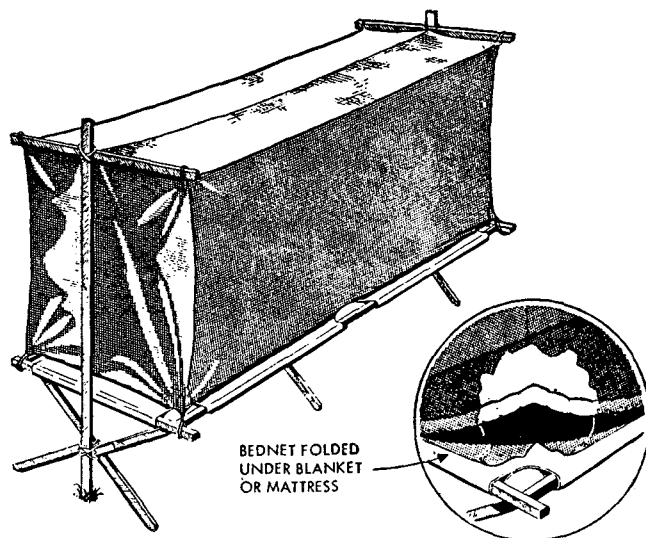

Figure 48. Insect bar on the folding cot.

lent is not washed off or diluted with perspiration. More frequent applications may be necessary for soldiers engaged in strenuous activity. In an emergency DEET applied from the pressurized dispenser also serves effectively as a supplementary repellent for clothing (*b* above). The DEET should be applied around the clothing openings such as the collar, waist, sleeve cuffs, and boot tops and to other parts which fit over the body snugly such as over the shoulder blades and buttocks.

d. Insect Bar (fig 43). The insect bar (bednet) is a necessity even though the billet is screened. This device is composed of two T-bars and a net. One T-bar is attached to each end of the bed or is stuck into the ground at the head and the feet when a bed is not available. The net is suspended from, not draped over, the T-bars and tucked under the mattress securely except for an entrance port. The net is then inspected for holes and repaired as needed. After crawling through the entrance port, the occupant tucks the remainder of the net under the mattress. He must take care not to come in contact with the net, as insects can bite through it. The importance of the insect bar cannot be overemphasized; it should always be carried as personal equipment by all troops entering a malarious area, even in forward combat areas. There are places in the tropics where 20 percent of the troops have become ill with malaria as the result of being exposed to mosquitoes for one night without the protective of insect bars.

e. Insecticide Dispenser (Aerosol Bomb). Use of the aerosol bomb (para 90c(2)(c)) is the last line of defense. After getting inside an insect bar, the occupant releases the insecticide from the dispenser for approximately 5 seconds, thus killing

any insects which may be trapped inside the insect bar.

92. Area Protective Measures

Area insect control is performed under the supervision of preventive medicine units. These units

are capable of performing and supervising control operations over large areas against insect- and rodent-borne diseases. Requests for assistance from a preventive medicine unit should be made through channels to the Army/Air Force area commander.

CHAPTER 8

LOUSE-BORNE DISEASES AND THEIR CONTROL

Section I. GENERAL

93. General

Human lice are found all over the world. They thrive during famines and wars and among people suffering economic hardships. Whenever large groups of people are deprived of homes, clothing, and bathing facilities, lice usually appear. They are particularly associated with cold weather. Although lice are present in the higher altitudes of the tropics, they are found more commonly in temperate and subarctic areas where people wear heavy clothing in several layers. Diseases transmitted by lice have always been a threat to fighting forces. Wars have been lost as a result of the casualties caused by a louse-borne disease.

94. Louse-Borne Diseases

The louse-borne diseases are typhus fever (epidemic), relapsing fever, and trench fever. Of these, epidemic typhus is the most important. Trench fever was very common among European

armies during World War I but has greatly declined in incidence since then. Relapsing fever is usually present wherever epidemic typhus occurs; cases occurred among American troops both in World War II and in Korea. All of these diseases, which are spread from man to man by lice, occur in epidemics. Since they are serious infections, they are a special threat to armies. A good vaccine against typhus fever is available, but as yet none is available for relapsing fever or trench fever.

95. Method of Disease Transmission

Disease is seldom transmitted by the actual bite of the louse. The germs contained in the gut of the louse are passed out with the droppings of the louse when it feeds. Louse bites itch and cause scratching during which the germ-laden feces are rubbed into the tiny skin abrasions. Scratching also may crush the louse and rub the germs it contains into the wound. This is true especially in the case of relapsing fever.

Section II. CHARACTERISTICS OF LICE

96. Life Cycle

All lice have three stages of development during their life cycle. These are the egg, the nymph, and the adult (fig 44).

97. Characteristics of the Body, Head, and Crab Lice

a. General. The three species of lice which are of medical importance are the body louse, the head louse, and the crab louse (fig 45). They live on human blood. If they are unable to feed, they will die in a relatively short time. In the higher temperatures, lice require more food and die even more quickly if they are deprived of it. Lice are spread by contact with infested persons or with things onto which adult lice or eggs have dropped, such as straw, debris, blankets, clothing, or latrine seats.

b. Body Lice. Body lice are the vectors of epi-

demical typhus. Except when these lice are feeding on a person's body, they remain in his clothing. Adult females begin to lay eggs 4 days after matu-

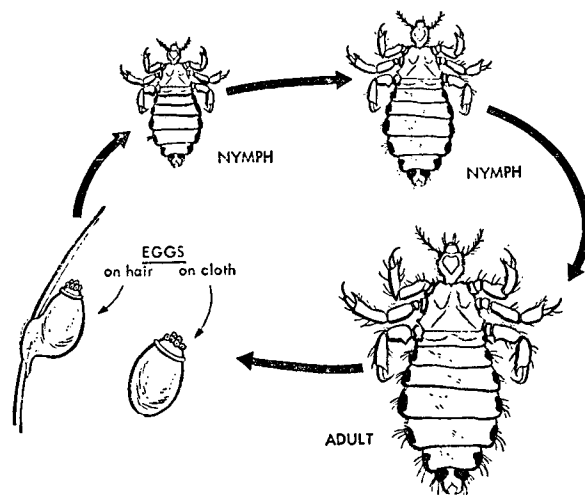

Figure 44. Life cycle of the louse.

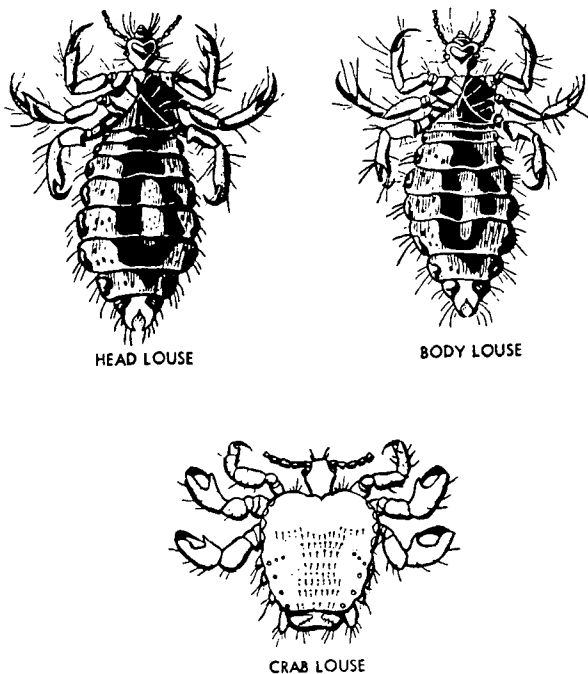

Figure 45. Human lice of medical importance.

rity at the rate of five to 10 eggs a day. Under favorable conditions they will continue the laying process for 30 days. They attach their eggs to the fibers of clothing, especially along the seams, and occasionally to body hairs. The eggs are white,

Section III. LOUSE CONTROL MEASURES

98. Preventive Measures and Inspections

In every military campaign, provisions to combat lice, especially body lice, must be made in advance. Head and crab lice present individual problems, but from the standpoint of disease they are of no great importance. When troops are located in areas where the civilian population is lousy, they should use louse powder on their clothes routinely (para 101a) as a preventive measure. They should also be warned to stay away from the natives. In spite of precautionary measures the troops may become infested, particularly if bathing facilities and changes of clothing are not available. Under such conditions frequent inspections must be made. Lice are not easy to find and may become quite numerous before they are noticed. Whenever a person's skin shows evidence of itching or of insect bites, he should carefully examine his clothing for lice, especially at the seams where eggs and young lice are most likely to be found. When one infested person is found, all other personnel in that particular unit should also be examined.

99. Criteria for Selecting Delousing Procedures

If 5 percent or more of the troops are found to be

oval, and approximately the size of the period at the end of a sentence; they have a lid-shaped structure on one end. At temperatures of 86° to 90° F, eggs will hatch into nymphs in about 8 days; but at lower temperatures the hatching process may take 2 weeks or more. Nymphs are similar to the adult, except that they are much smaller (pinhead size). Unless nymphs obtains a meal of blood within 24 to 48 hours after hatching, they will die. The nymphal stage lasts about 9 days, after which the lice are mature adults.

c. Head Lice. Head lice, which are closely related to body lice, are considered to be of lesser importance in the transmission of disease. They prefer the hairy parts of the body, particularly the head, where they attach their eggs to hairs. Their life cycle, size, and structure are similar to those of body lice.

d. Crab Lice. Crab lice are probably of no importance in the transmission of disease but are annoying pests. They are recognized by their crab-like appearance. They infest the armpits, beard, eyebrows, eyelashes, and particularly the pubic regions. Female crab lice lay about 20 to 50 eggs which they attach to the body hairs. The incubation period requires from 7 to 10 days. It takes about 15 days for nymphs to reach the adult stage.

infested upon inspection of a unit, the entire unit should be dusted, using mass delousing procedures. In this case assistance should be requested through command channels from a preventive medicine unit. If less than 5 percent of the troops are lousy, the infested individuals and the remaining troops in the unit should be required to dust themselves (para 101). Weekly inspections should be made by the medical officer to determine the effectiveness of the operation.

100. Insecticides for Louse Prevention and Delousing

DDT has been the basic louse powder since it was made available during World War II. In 1951 the strain of lice in Korea was found to be resistant to DDT, hence a substitute powder, lindane, was made available. Louse powders are effective against all three forms of lice.

a. DDT Insecticide Dust (10 Percent DDT), 2-Ounce Can. This powder contains 10 percent DDT and 90 percent talc. It is issued for individual louse control in 2-ounce cans.

b. DDT Insecticide Dust (10 Percent DDT), 25-

Pound Pail. This powder has the same ingredients as *a* above. It is packed in 25-pound pails and is used for the unit delousing of personnel (para 101c) as well as for the control of mosquito larvae, fleas, and ants.

c. Lindane Insecticide Powder (1 Percent Lindane), 2-Ounce Can. This material contains 1 percent lindane and 99 percent talc. It is effective against lice, fleas, and bedbugs. The amount used per person should be limited to not more than 2 ounces per week.

d. Malathion Insecticide Powder (1 Percent Malathion), 2-Ounce Can. Lice may become resistant to DDT and lindane and not be killed by these insecticides. In this case and upon approval of higher headquarters, the use of 1 percent malathion louse powder may be authorized.

101. Delousing Procedures for Troops

a. Individual Louse Control Procedure for Clothing. Using a 2-ounce sifter can of insecticide powder (para 100a or c), an individual can treat his own clothing for delousing or louse-prevention purposes. If possible, the individual should take a bath before putting on the treated clothing. The clothing should be dusted as follows:

(1) Apply the powder inside of the hat.

(2) Spread the coat, with sleeves turned inside out, on a table so that all of the inside can be seen; then powder the inside, taking special care to apply the powder along the shoulder, armpit, and arm seams.

(3) Turn the trousers inside out and lay them with the seat uppermost on top of the coat; then powder all seams, particularly at the crotch and down both legs.

(4) Next, spread and powder the shirt in the same way as the coat ((2) above).

(5) Turn the underwear inside out and powder it thoroughly, again giving special attention to the seams.

(6) Fold the entire pile of clothing together and pound it several times to fluff the powder.

(7) Before putting on each change of clean clothing, repeat the procedure. The shoes are not ordinarily powdered.

b. Individual Control Procedure for Head and Crab Lice.

(1) Using the 2-ounce sifter can of insecticide powder (para 100a or c), dust the head and hairy portions of the body.

(2) Do not bathe or wash the hair for 24 hours, thus giving the insecticide time to kill the lice.

(3) One week from the initial application, apply the insecticide powder again to kill lice which may have hatched in the meantime and withhold bath and shampoo for 24 hours.

(4) At the end of 10 days, examine the head and hairy parts of the body closely to be sure that no living lice are present. If the hair is cut short, lice can be seen more easily; short hair is also easier to powder effectively. Shorn hair should be collected and burned.

c. Unit Delousing Procedure.

(1) For unit delousing, insecticide powder (para 100b) is applied with a hand duster (fig 42). Approximately 2 ounces of insecticide powder will be required for each person to be dusted. The field sanitation team should supervise the delousing procedure.

(2) The powder compartment of the hand duster is filled about three-fourth full of louse powder. Before beginning the dusting process, the operator should test the delivery of the powder in the open and adjust the flow as necessary to get a heavy cloud of powder from the outlet tube.

(3) The dusting is done without having the troops remove their clothing and in such a manner that the inside of garments next to the body, as well as the body itself, is covered with powder. An operator doing this work for the first time should check the results by examining the skin and garments of the first few men dusted. If the dusting process is done properly, powder should cover the underwear entirely and should be visible on the body hairs of the chest, back, armpits, crotch, and thighs. Since body lice are most often found in the seams of clothing, particular attention must be

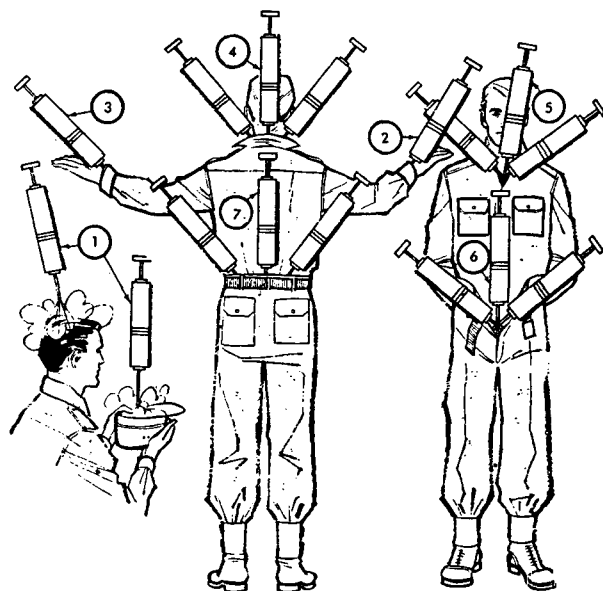

Figure 46. Delousing procedure.

given to the neck, armpits, waist, shirttail, and crotch of clothing. The men loosen their collars, ties, and belts and then stand or sit as instructed with their hats in their hands. The procedure described below and illustrated in figure 46 should be followed. The operator may remain in one position and have the subject turn as required, or the operator may move around the subject. At least two full, even strokes of the plunger are required each time the hand duster is pointed in a different direction.

(a) First dust the subject's head, having him rub the powder into his hair until it is whitened; then dust his hat.

(b) Have the subject stretch his right arm out to the side at shoulder height, insert the nozzle of the duster into the sleeve next to the skin, and direct the flow of powder toward the armpit. Hold the trigger on the duster down until powder is seen coming from the loosened neck of the shirt. The subject's face should be turned away from the side being dusted.

(c) Repeat the same operation ((b) above) in the left sleeve at this time or after (d) or (e) below.

(d) Insert the nozzle inside the shirt collar at back next to the skin; blow powder toward right side, waistline, and left side. Be sure that some powder is dusted on the collar where lice are likely to hide. This can be done most effectively with the operator's standing in front of the subject and the subject's resting his chin on his chest.

(e) Insert the nozzle inside the shirt collar at the front next to the skin; blow powder toward right armpit, waistline, and left armpit. The subject should lean forward with his head tipped backward.

(f) With the subject standing, insert the nozzle inside the top of his loosened drawers at front next to the skin; blow powder toward right side and leg, toward crotch, and toward left side and leg.

(g) Insert the nozzle inside the top of the

loosened drawers at the back next to the skin; blow powder toward right side and leg, toward buttocks, and toward left side and leg.

(4) For female personnel the same general procedure described above should be followed provided women operators are available. Otherwise, liberal application of the powder next to the skin at the neck and into the sleeves next to the skin may be sufficient.

102. Delousing of Extra Clothing and Bedding

Although 99 percent of all lice are found on a person's body or on the clothes he is wearing, extra clothing and bedding may be infested and cause reinfestations.

a. When delousing extra clothing and bedding with a hand duster (fig 42), place the delivery tube between the layers of clothing in order to speed the job and avoid wasting powder. If mattress covers are not in use, place a blanket over the mattress and apply the powder between the two items, taking care to reach the sides and seams. Blankets are deloused by spreading one on top of another and dusting between every two of them or by folding each blanket once and dusting between the two layers. The folded blanket may be placed on a flat surface, hung over a line, or held by two other persons. When the whole job is finished, each pile of blankets should be pounded several times in order to spread the powder and work it into the seams and patches.

b. When a hand duster is not available, apply the powder with a sifter can (para 101a). As each blanket is spread, the powder is shaken onto it. The surface of one blanket will then spread the powder onto the undersurface of the next. After a number of blankets have been dusted, pound or fluff them lightly to distribute powder evenly. Canvas packs, duffle bags, boxes, footlockers, and similar items may also need dusting.

CHAPTER 9

FLY-BORNE DISEASES AND THEIR CONTROL

Section I. GENERAL

103. General

Houseflies are found all over the world, but they are most abundant in warm climates. Houseflies, which comprise the majority of all flies found in messes, are the most important of the nonbiting species in the transmission of diseases.

104. Fly-Borne Diseases

The medical history of past wars indicates that the health of troops has been seriously affected by

flies. They carry the germs which cause dysentery and may carry those which cause cholera, typhoid, and other diseases. In the tropics various skin and eye diseases may be spread by flies.

105. Method of Disease Transmission

Flies transmit disease organism on the tiny hairs of their bodies and feet and in their feces and vomitus. They may bring the disease germs directly from manure, garbage, and human feces to food and water.

Section II. CHARACTERISTICS OF FLIES

106. Life Cycle

The common housefly goes through four stages during its life cycle: egg, larva, pupa, adult (fig 47). The female fly lays eggs in clusters in waste such as manure, garbage, and rotting fruit or vegetables. About 36 hours later, the larvae hatch from the eggs and feed on the waste. From 5 to 8 days later, the larvae crawl to drier areas and pupate. The adults emerge 4 to 7 days later. The female usually starts laying eggs about 2 days after her emergence. Under favorable conditions, the cycle from egg to eggs averages 15 days. Adult flies live about 30 days during the summer.

107. Characteristics

Flies have mouthparts which allow them only to sponge up their food. To dissolve solid food, they vomit some of their stomach contents onto the food and then sponge it up. By this method flies sample all manner of filth and waste matter and may easily swallow disease germs or pick them up on their feet and bodies. Knowledge of the following characteristics and habits of houseflies will serve as a useful guide to effective fly control.

a. Houseflies breed in manure, human waste, and decaying vegetable or other organic matter.

b. Temperatures most favorable for breeding are 80° to 90° F.

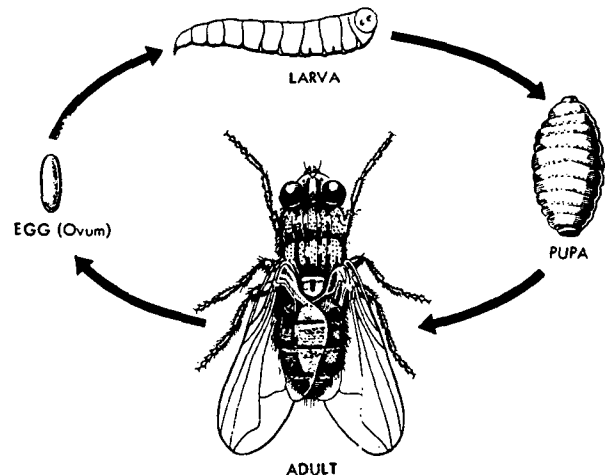

Figure 47. Life cycle of common housefly.

c. For growth, larvae or maggots require suitable food, moisture, and warmth.

d. Larvae move from the breeding material to a dried place to pupate.

e. Adult flies are attracted by food odors.

f. Flies tend to rest on vertical surfaces and hanging objects.

g. In the temperate areas of the world, flies are most abundant in late summer and early fall.

h. In warm climates, flies breed throughout the year.

Section III. FLY CONTROL MEASURES

108. General

Flies may be controlled through proper sanitation, thus eliminating their breeding places; by the screening of living quarters; and by the use of chemicals to kill both adults and larvae. The elimination of breeding through proper sanitation is the most effective fly control measure.

109. Control of Breeding Places

Elimination of breeding places of flies requires that all human waste, animal manure, and garbage be covered, disposed of, or treated promptly and effectively. For discussion of effective waste disposal procedures, see chapter 6.

110. Protection of Food Against Infestation

All food-handling places should be properly screened to protect food against infestation by flies. The screens should be constructed of 18-mesh wire to bar mosquitoes as well as the flies. Food-handling places should also be equipped with self-closing doors which fit snugly and open outward.

111. Chemical Control

While the use of chemicals is an important aid to fly control, it should never be adopted as a substitute for sanitation. In places where sanitation is difficult, chemicals may be used to control fly breeding or to prevent new adults from leaving their breeding places (See Note, para 24b). Two types of insecticide spray are used for fly control.

a. Space Spray. Pyrethrum insecticide which is supplied in low-pressure, 12-ounce dispenser (fig 39) may be used to kill flies quickly. When correctly applied, it is very effective. The windows and doors should be closed before the insecticide is sprayed and should remain closed for 30 to 60 minutes. In dining facilities application at the rate of 7 seconds per 1,000 cubic feet should be made

one-half to one hour before serving a meal. Since this spray does not have sufficient strength to deposit an effective residue of toxic materials, it should never be applied to surfaces as a residual spray.

b. Residual Spray. Diazinon insecticide, 0.5 percent diazinon liquid emulsion, may be used as a residual spray for the control of adult flies. Residual sprays are effective for long periods of time. Ordinarily, flies must be exposed to this residue for one-half to 4-hours before they die. The spray should be applied to areas where flies usually rest, such as ceilings, corners, table legs, and fixtures inside billets and messes and to outside doors, screens, and porches. Since fly larvae are usually below the surface of breeding media, it is difficult to reach them with chemicals. The most effective way to control fly larvae is to destroy or remove the material in which they are breeding.

c. Fly Baits. Where houseflies have developed resistance to pyrethrum and diazinon insecticides, effective control can be obtained by using a bait containing an organic phosphorous insecticide such as malathion. Since some of the organic phosphorous insecticides are highly toxic to humans, only approved formulations may be used. The bait, which usually consists of cornmeal or sugar and malathion, is prepared by trained personnel and furnished to the unit. It is to be sprinkled at the rate of one ounce per 300 square feet at locations where flies congregate.

112. Swatting

Swatting is an excellent method of destroying flies which have entered a screened facility. If the shades are drawn on most of the windows, flies will congregate near the light of the unshaded windows where they can be swatted quickly. No dining facility or kitchen should be without several conveniently placed fly swatters.

CHAPTER 10

FLEA-BORNE DISEASES AND THEIR CONTROL

Section I. GENERAL

113. General

Fleas are medically important because they produce irritating bites and transmit diseases to man. The fleas which attack man live chiefly on cats, dogs, and rodents. When man lives and works in close association with these animals, conditions are ideal for the occurrence of flea-borne diseases. Although fleas have certain host preferences, they will transfer to and feed on different animals, including man.

114. Flea-Borne Diseases

Rodent fleas are responsible for the transmission of plague and typhus fever (murine). Various rodents, principally rats and ground squirrels, are sources of infection from which fleas pick up the disease germs and transmit them to man. When

the normal rodent hosts are unavailable, rodent fleas will readily attack man. Other fleas (chigoe or jigger fleas) attack the bare feet, usually between the toes and on the soles of the feet, where they cause painful swelling and inflammation.

115. Methods of Disease Transmission

Fleas become infected with plague germs when they feed on a rodent that has plague. Plague is then transmitted to man through the bite of the infected flea. Man can also become infected with plague when he breathes the plague germs coughed out of the lungs of a person who has pneumonic plague. Typhus fever (murine) is transmitted when flea feces or crushed fleas are scratched into the skin. This may happen when a person scratches a flea bite.

Section II. CHARACTERISTICS OF FLEAS

116. Life Cycle

Fleas go through four stages of development: egg, larva, pupa, and adult (fig 48). The completion of this life cycle from egg to adult may take several weeks to many months, depending upon the environmental conditions.

117. Characteristics

The female flea lays her eggs in nests of rodents or in places where dogs and cats sleep. The small, white, oval eggs hatch into larvae which are worm-like. Larvae feed on the fecal material of

adult fleas and other organic material in the nest or bed of the host animal. Upon reaching maturity, each larva spins a silken cocoon to shelter it while changing into the pupal or resting stage. The cocoons can also be found in the nest or bed of the animal host. The adult fleas later emerge from the cocoons. The adults are wingless, and their bodies are flat on the sides. They have strong, spiny legs which enable them to move rapidly among the hairs of the host and to jump several inches. Both male and female fleas have piercing-sucking mouthparts used for sucking blood from the host.

Section III. FLEA CONTROL METHODS

118. General

Fleas are controlled by applying insecticides to the animal hosts and to the infested areas. Insecticide powder is applied to animals. Powder or liquid insecticide may be applied to the infested areas; however powder is preferred for treating rodent

burrows, as it can be distributed more thoroughly than a spray (see Note, para 24b).

119. Dusting of Animal Hosts

Except for cats, rabbits, and other animals which clean themselves by licking, lindane powder is the insecticide ordinarily used to control fleas on ani-

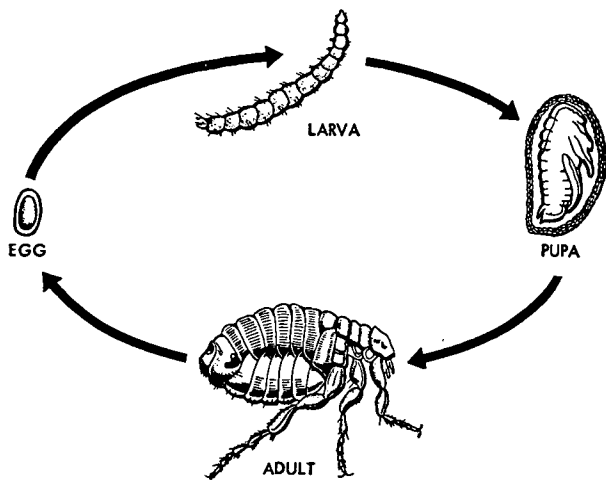

Figure 48. Life cycle of the flea.

mals. Animals which lick themselves should be dusted with pyrethrum powder. Merely dusting the animals, however, will not control the fleas, as flea eggs and larvae are in the debris about the areas where the animals rest. Unless these areas are properly treated, reinfestation will take place.

120. Treatment of Infested Areas

a. In the treatment of areas infested with fleas and flea larvae, such as rodent nests, burrows, and runways and places where other animals rest, DDT insecticide dust (10 percent DDT) is effective. It should be applied with the hand duster illustrated in figure 42. Should a plague epidemic

occur, the dusting operations to kill the fleas must always be accomplished before the rat-poisoning operations (para 156-159) are started; otherwise the fleas will leave the dead rodents and attack man.

b. When rats or other flea-infested animals enter buildings, the fleas may leave the host and infect the cracks and crevices in the floors. These fleas may deposit eggs which hatch into larvae which continue to live and develop in the cracks and crevices of the floor. Good cleaning practices will do much to eliminate or prevent such infestations. If necessary, DDT insecticide dust or spray should be applied.

121. Individual Protective Measures

Individual protective measures should be used in flea-infested areas. This is especially important for those persons who perform flea and rodent control work where plague and typhus fever (murine) are present. Clothing, particularly the trouser legs, should be impregnated with insect repellent. If insect repellent is not available, DDT dust should be applied to the boots, socks, and lower parts of the trouser legs. Insect repellent (DEET) should also be applied to the hands and other exposed portions of the body. The sleeves should be kept rolled down, and the trouser legs should be kept tucked into the boots. For further discussion of individual protective measures, reference is made to paragraph 130c.

CHAPTER 11

TICK- AND MITE-BORNE DISEASES AND THEIR CONTROL

Section I. GENERAL

122. General

Ticks and mites are commonly called insects. Technically, however, they belong to the class *Arachnida*; whereas true insects belong to the class *Insecta*.

123. Body Structure of Ticks and Mites

Ticks and mites differ from insects in the following ways:

<i>Arachnida</i> (fig 49) (Ticks, Mites, and Related Forms)	<i>Insecta</i> (fig 36) (Mosquitoes, Flies, and Fleas)
Antennae (feelers) are absent.	Antennae (feelers) are present.
The adult has eight legs.	The adult has six legs.
The body is divided into two main regions.	The body is divided into three main regions.

Section II. TICKS

124. General

Ticks occur throughout the world but are less common in the arctic and subarctic zones. They are divided into two groups: the hard ticks and the soft ticks. The hard tick has a hard shield on its back, and its mouthparts can be seen from above (fig 49). The soft tick does not have a hard shield on its back, and its mouthparts cannot be seen from above (fig 50). It often has a leatherlike appearance.

also pass the germs of several diseases to their offspring through their eggs, so that future generations of ticks are already infected when they hatch from the eggs.

125. Tick-Borne Diseases and Methods of Transmission

a. Hard ticks are known to carry and transmit several diseases such as Rocky Mountain spotted fever and other typhus-like fevers, tularemia (rabbit fever), Q fever, and certain viral diseases. Some kinds of hard ticks can cause tick paralysis. This condition results after a female hard tick has remained attached to the base of a person's neck or the back of his head for several days. This is most likely to occur when the tick attaches near the hairlines or in the hair, thus making detection of it difficult. When tick bites are numerous, the skin may become badly inflamed and infected. Several species of soft ticks transmit relapsing fever.

b. The tick becomes infected with the disease organism when it feeds on an infected animal. It can then transmit this disease to man if it feeds on him later. Both the hard and the soft ticks can

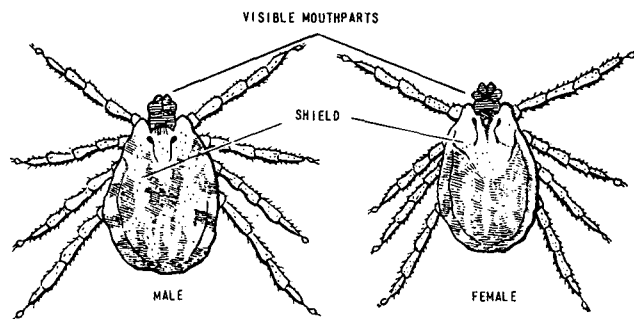

Figure 49. The adult hard ticks.

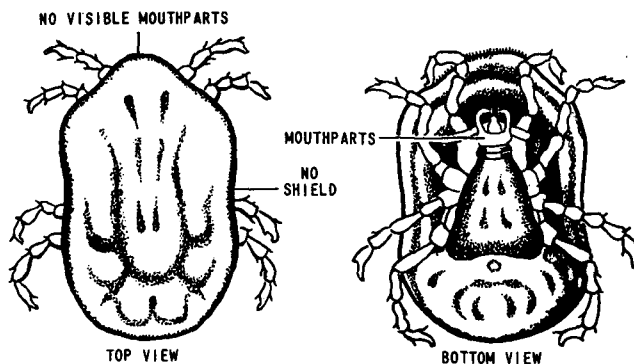

Figure 50. The adult soft tick.

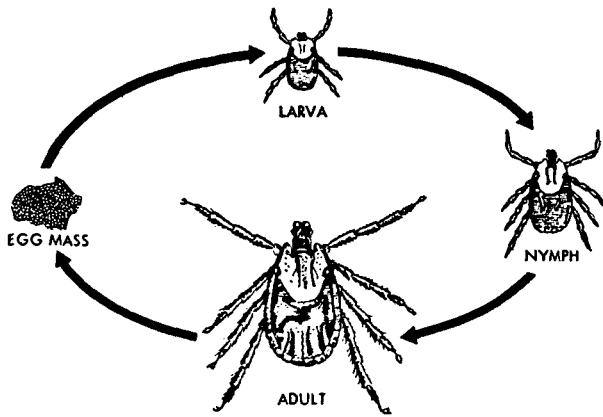

Figure 51. Life cycle of the tick (six-legged larva).

126. Characteristics of Ticks

a. The life cycle of the tick consists of four stages: egg, larva, nymph, and adult (fig 51). The completion of this life cycle may take 6 weeks to several years.

b. After a female tick feeds on blood, she lays from 100 to 10,000 eggs in masses; then she dies. After incubation, the eggs hatch into six-legged larvae. Hard tick larvae and some soft tick larvae often climb upon grass and vegetation and then wait for a suitable host. Should a person or animal brush by this vegetation, the larvae will quickly attach to the person's clothing or the animal's fur and then take a blood meal. After feeding, the larvae of most kinds of ticks drop off the host and then molt, thus becoming nymphs. The nymphs have eight legs as do the adults. The nymphs seek man or animal, take a blood meal, drop to the ground, and then develop into adults. During the life cycle some ticks require only one host; whereas others need two or three hosts for development. Soft ticks that transmit relapsing fever usually remain hidden in rodent nests or in cracks and crevices of buildings during the day and feed on blood of man or animal at night.

128. General

Mites are found throughout most of the world in practically all climates. Many mites feed on plants but some feed on man and animal. Mites lay eggs which hatch into six-legged larval mites. Certain mites feed on man and animal only in this larval stage; these are commonly called chiggers. Larval mites develop into nymphs; and these, in turn, develop into adult mites (fig 52). Both the nymphs and adults have eight legs.

127. Tick Control Methods

a. *Environmental Control.* Controlling vast areas of tick-infested land is a major operation accomplished by either a preventive medicine unit or other trained personnel. A certain degree of control can be accomplished by clearing away brush and vegetation and keeping animals out of the area. Ticks in buildings can be controlled by spraying or dusting such insecticides as malathion, chlordane, or lindane on walls and in cracks and corners (See note, para 24b). These insecticides may also be used to spray or dust the vegetation and the ground in tick-infested areas. Effective control of ticks is greatly dependent upon knowledge of the species present.

b. *Individual Protective Measures.* Impregnating clothing with an insecticide clothing repellent gives excellent protection against ticks. Insect repellent (DEET) applied to the exposed skin (para 91c) provides additional protection. Proper wearing of the uniform will also reduce tick bites. The bottoms of trousers should be tucked inside the boots without blousing rubbers. Blousing rubbers make it possible for ticks as well as mites to slip between the top of the boots and the treated cloth unharmed.

c. *Removal of Ticks.* It may require some time for ticks to infect a person after they attach to his body. Persons in tick-infested areas should examine themselves and each other at least every 2 hours for the presence of ticks. This will often prevent the transmission of disease. In the removal of an imbedded tick, care must be taken not to crush it or to leave its mouthparts imbedded in the skin. A tick can be removed most effectively by using small forceps to grasp it as close to its mouthpart as possible and then carefully pulling it off. The tick should not be grasped by its abdomen, since disease germs may be injected into the person due to pressure in this area. After a tick is removed, it should be killed with alcohol or heat; then the bite should be treated with a suitable antiseptic.

Section III. MITES

129. Medical Importance of Mites

The scabies itch mite (fig 52) burrows and lives in the skin of man, causing a condition called scabies or the seven year itch. This condition is not fatal but may cause much discomfort due to intense itching, especially at night. Scabies is often found among people who do not or cannot practice good personal hygiene. Scabies mites are transferred from person to person by intimate personal contact. The use or wearing of infested clothes,

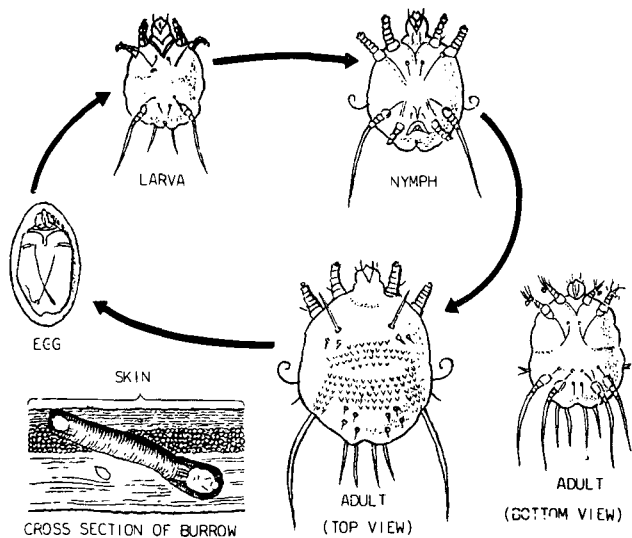

Figure 52. Life cycle of scabies mite and cross section of a typical itch mite burrow.

bedding, or towels may also be a method of transmission. Bites from chigger mites (fig 53) and some rodent mites may also cause severe itching. Infection may result from scratching these bites. In Southeast Asia some kinds of chiggers transmit a dangerous disease called scrub typhus. These chiggers get the disease from small mammals; the disease agent may be passed from an infected mite to her off-spring. Chiggers often occur in tall grass or in scrub vegetation, appearing after land has been cleared and abandoned. When man enters these mite-infested areas, he may be attacked by chiggers. Certain rodent mites are involved in the transmission of rickettsialpox—a rare, nonfatal disease occurring primarily in large cities in the United States and Russia. Korean hemorrhagic fever may also be transmitted to man by biting mites.

130. Mite Control Methods

a. Scabies itch mites are killed by applying a 0.5 to 1 percent lindane ointment to affected parts of the skin. Washing the skin thoroughly with soap and water before applying the ointment will aid in its effectiveness. This should be applied twice a day until all the mites are killed. Disinfection of clothing and bedding with methyl bromide or heat destroys scabies itch mites. Ordinary laundering and cleaning are likewise effective.

b. Area control of larval mites (chiggers) is

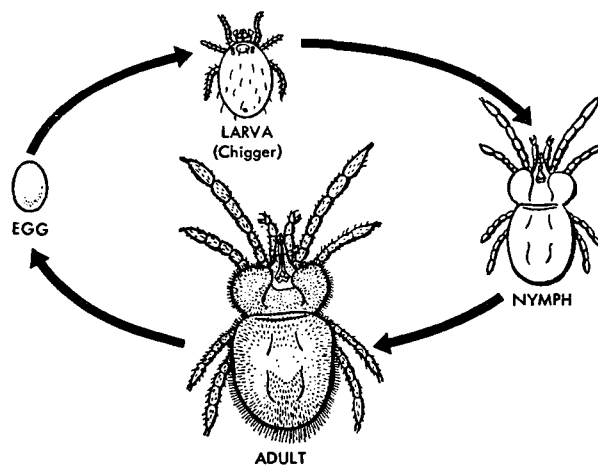

Figure 53. Life cycle of the mite (six-legged larva of chigger).

often difficult or impractical. However, in permanent or semi-permanent camps located in scrub typhus areas, it is desirable to remove all surrounding growth with bulldozers, to burn the collected debris, and to place tents 2 or 3 feet off the ground. Application of insecticide to the ground in the camp area and in training areas will aid in mite control. Insecticides such as chlordane, lindane, and dieldrin are effective. Control of rodents (para 156–158) is also helpful in reducing the number of chiggers. Mite-infested areas should, if possible, be avoided.

c. If mite-infested areas cannot be avoided, the troops should apply individual protective measures as follows:

(1) All personnel operating in chigger-borne disease areas should wear clothing which has been impregnated with the prescribed insect repellent. All clothing except the underwear and the socks should be treated. Furthermore, blankets and sleeping bag covers should be treated whenever bivouac in mite-infested areas is planned. The impregnation instructions printed on the container should be followed.

(2) The uniform should be worn with the trouser legs tucked into the boots without blousing rubbers and with the sleeves and collar buttoned.

(3) The standard insecticide repellent (DEET) should be applied to the exposed skin and to all openings of the uniform, including the collar, shirt front, waist band, sleeve cuffs, and boot tops (para 91c).

CHAPTER 12

MISCELLANEOUS INSECTS AND INSECT-BORNE DISEASES AND THEIR CONTROL

131. General

Many insects not involved in disease transmission are medically important because of their sting, such as bees and wasps, or because of their presence in large numbers, such as nonbiting ants and midges. This chapter, however, deals with such selected insects as bedbugs and cockroaches which may not be involved in disease transmission but which cause concern by their presence. It also deals with certain other insects which are proven vectors of disease such as sand flies.

132. Bedbugs

a. General. Bedbugs survive wherever they can live in close association with man. As yet it has not been proved that bedbugs transmit any disease. In some persons their bites produce marked swellings and considerable irritation; whereas in other persons such bites do not cause the slightest inconvenience.

b. Life Cycle. Bedbugs pass through three stages in their development: eggs, nymph, and adult (fig 54). The nymphs and adults are blood-suckers.

(1) *Eggs.* The female deposits eggs in batches of 10 to 50 in crevices of mattresses, bedframes, and bedsprings and in cracks of floors and walls. One female may lay as many as 500 eggs. The eggs are yellowish white and visible to the naked eye. The egg stage lasts from 7 to 30 days, depending upon the temperature.

(2) *Nymphs.* The nymphs look very much like the adults, except that they are smaller. The nymphal stage may last from 40 days to many months. The nymphs molt five times before reaching maturity with an average period of 8 days between moltings. Ordinarily, they take but one meal between moltings.

(3) *Adults.* The adults are a dark brown before feeding and a reddish brown after feeding. Their flat bodies permit them to crawl into narrow cracks and crevices. A nasty, pungent odor is noticeable where bedbugs are abundant. Adults may live up to 4 months without food. Under ordinary

room temperature, normally fed bedbugs may live as long as a year. A temperature of 100° F will kill them.

c. Habits. Bedbugs feed at night and hide during the day in cracks and crevices. Often they can be found in the seams of mattresses or in bed-springs. Being very active at night, bedbugs will travel considerable distances to attack a sleeping person. At the slightest disturbance they will retreat to the nearest hiding place.

d. Control Methods. Bedbugs are easily controlled with chemicals (see note, para 24b). Both the DDT and the diazinon residual insecticides (para 90c(2)(a) and (b)) are very effective. The insecticide is applied to walls, cracks, and crevices on the inside of buildings to a height of 5 to 6 feet. Bedframes are sprayed, particularly the undersides, joints, and cracks where bedbugs are likely to hide. Mattresses are sprayed on both sides and on the edges with an extra amount applied to tufts and crevices. For big jobs a three-man team is needed: one man should do the spraying; and the other two should turn, remove, and replace the mattresses. If no equipment for spraying is available, the solution may be applied with a paint brush; only a slight moistening of the surface is necessary. During the application of the insecticide, there should be no smoking and no fire in the building; thereafter the building should be aired

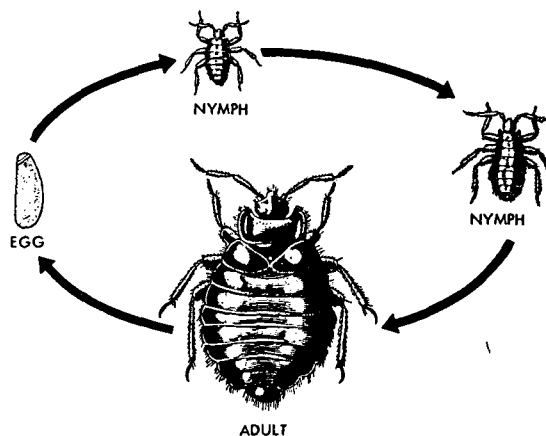

Figure 54. Life cycle of the bedbug

for about 4 hours. The personnel doing the work should take the precautions described in paragraph 90c(2) (a) and (b). Provided the insecticide is applied properly, it will kill practically all of the bedbugs within the first 24 hours.

133. Cockroaches and Ants

a. General. It has not been proved that cockroaches and ants transmit diseases, but they may transport disease organisms on their bodies and feet and thereby contaminate food as they crawl over it. There are three stages in the life cycle of cockroaches: egg, nymph, and adult (fig 55); whereas ants have four stages: egg, larva, pupa, and adult.

b. Control Methods.

(1) The first step in cockroach and ant control in messes and quarters is sanitation. Stored food should be kept in insect-proof containers. Garbage and food scraps should be removed and disposed of by burial or incineration (para 83).

(2) Diazinon insecticide is used to control roaches (see note, para 24b). It should be applied with a brush underneath cabinet drawers, around baseboards, and in cracks and crevices where roaches usually rest. Insecticide powder may be used to treat electrical switch boxes.

(3) Chlordane is used to control ants (see note, para 24b). It should be applied to ant nests, door and window sills, foundations, and other places where ants crawl. Buildings that have a solid foundation can be treated by applying chlordane around the entire base at the ground level.

134. Stable Flies

a. General. The stable fly (fig 56), which is also called a biting housefly and a dog fly, looks some-

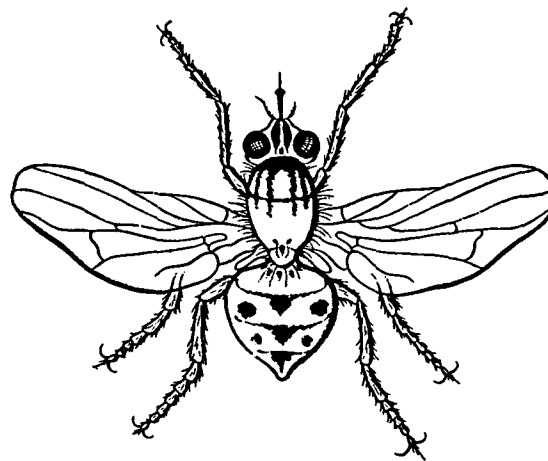

Figure 56. The common stable fly.

what like a housefly; but it has piercing mouthparts and is a severe biter of man and animal. Like the housefly, it has four stages of development in its life cycle. Along coastal areas the stable fly breeds in the sea grass washed onto sheltered beaches and is often a very serious pest. Inland, it breeds in barnyard manures which contain large quantities of decaying hay, in waste feed, under piled hay or peanut litter left in the fields, and in other vegetable wastes.

b. Control Methods. Stable flies are best controlled by treating their breeding places with diazinon insecticide (see note, para 24b). Spreading manure and litter before it becomes infested and in such a way that it dries quickly will also prevent fly-breeding. Residual spray of 0.5 percent diazinon emulsion on the exterior and interior walls and screens will control adult stable flies. Insect repellants (para 91b and c) provide effective protection for man, as well as animals, against the bites of stable flies.

135. Eye Gnats

a. General. Gnats are small flies which will crawl about the nose, mouth, and eyes, thus annoying both man and livestock. Gnats feed readily on serum exuding from wounds or lacerated skin tissue and may be responsible for spreading serious eye infections. They have a wide distribution and are most common in the milder climates.

b. Control Methods. Insect repellent (DEET) affords individuals protection against eye gnats. Area control of these gnats is very difficult and generally requires the services of a preventive medicine unit. Requests for such services as fogging the area by use of special power equipment may be made through channels to the Army/Air Force area commander (see note, para 24b).

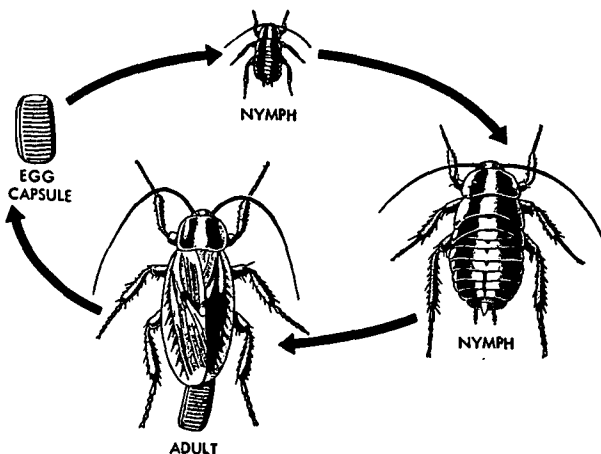

Figure 55. Life cycle of the cockroach.

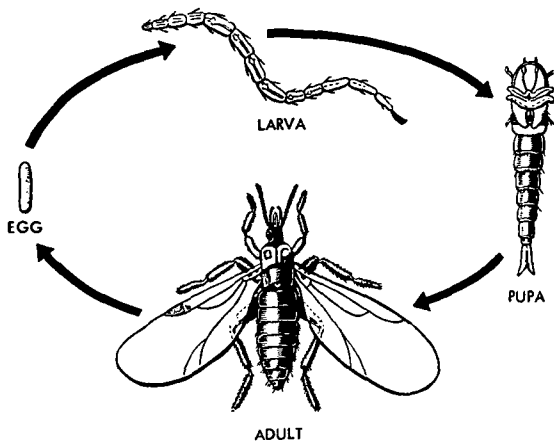

Figure 57. Life cycle of the biting midge (punkie).

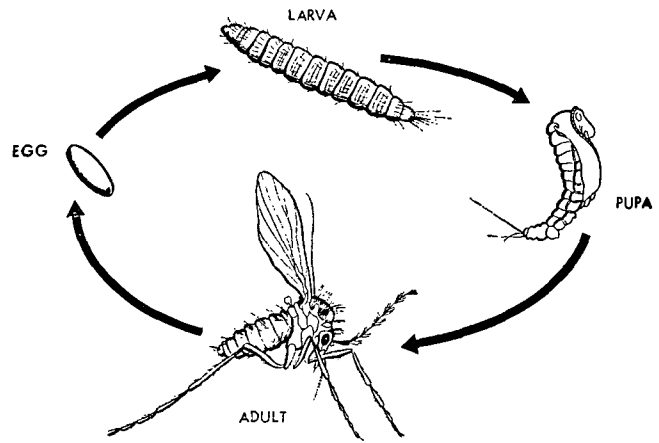

Figure 58. Life cycle of the sand fly.

136. Biting Midges (Punkies)

a. General. Small, biting midges (fig 57), which are 1 to 3 millimeters in length, are extremely annoying and can pass through the mesh of ordinary window screens. They are commonly found in the tropics and subtropics and in the arctic during the short summer months. Some species breed in salt marshes where the larvae feed upon dead crabs and small fish left in wet soil. Other species breed in rot-holes of trees, and the larvae feed upon decaying insects usually present in these locations. When the adults emerge, they are attracted to light and will feed upon warm-blooded animals.

b. Control Methods. Punkies are so small that only fine mesh (0.0334-inch) screens or nets will keep them out. In areas where such insects are found, fine mesh nets are usually furnished by combat service support units. Ordinary screening can be made midge-proof by painting it frequently with diazinon insecticide. Insecticides and repellents used for mosquitoes (para 90 and 91) are also effective for punkies (see note, para 24b).

137. Sand Flies

a. General. Sand flies are hairy gnats. They resemble small mosquitoes; but their short, hopping flights are unlike those of mosquitoes. Sand flies are uncommon in most parts of the United States but are common in South America, Africa, Asia, and many other warm parts of the world.

b. Life Cycle. Sand flies pass through the stages of egg, larva, pupa, and adult in their life cycle (fig 58). They breed in dark places, caves, crevices, stone embankments, crumbling ruins, earth fissures, and stony rubble. Although the larvae require damp breeding media, too much moisture will kill them.

c. Medical Importance. Sand flies transmit sand fly fever, a disease present in the coastal regions of the Mediterranean, South China, India, and Ceylon. They may also transmit a form of Oriental sore as well as serious diseases known as kala-azar and Oroya fever. The bites of sand flies are painful and may result in marked irritation.

d. Habits. Sand flies are active at night, in the evening, and at dawn; they usually avoid wind, sun, and full daylight but are attracted to artificial light. They travel in short, hopping flights from their breeding areas. Most sand flies have a flight range of about 50 yards, but in Africa some of them fly several hundred yards. Sand flies seldom travel above the first floor of a building. They attack man at the wrist, ankles, or any exposed part of the body and will readily bite through thin socks.

e. Control Methods. Sand flies are very sensitive to residual insecticides (see note, para 24b). In areas where there has been extensive residual spraying against mosquitoes for the control of malaria, sand flies will have been eliminated. Their habit of frequenting only the lower floor of buildings can sometimes be used to advantage by moving personnel to upper floor levels. Insect repellents also give protection against attacks by these pests.

(1) *Insecticides.* Diazinon insecticide is effective against sand flies. This residual-type insecticide should be applied to the screens, inside of buildings, and inside of sleeping quarters. Sand flies inside of sleeping quarters may also be controlled by the use of a space spray (90c(2)(c)). If possible, the area within a radius of 50 to 100 yards should be cleared and sprayed with a residual spray.

(2) *Insect bars.* In heavily infested areas,

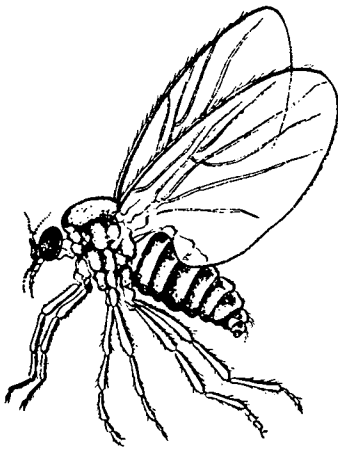

Figure 59. The adult black fly.

Insect bars (para 91d) with nets of fine mesh (0.0334-inch) may have to be used.

(3) *Repellent.* The regular use of an insect repellent (para 91c) has proved to be an effective means of preventing sand fly fever. Insect repellent (DEET) should be applied after sundown to the exposed parts of the body. One application should be made at sundown and another upon retiring. Each application will afford protection against sand flies for 4 to 6 hours.

(4) *Protective clothing.* Long sleeves and long trousers will give some protection, especially after sundown.

138. Black Flies

a. General. Black flies (fig 59), which are also called buffalo gnats, are 1 to 5 millimeters in length. They are particularly abundant in the north temperate and subarctic zones and often appear in great swarms during the late spring and early summer in hilly sections where swiftly flowing streams provide well-aerated water for larval development.

b. Life Cycle. Black flies pass through the stages of egg, larva, pupa, and adult in their life cycle. The female adult deposits her eggs near plants, logs, or rocks at the water line of swift flowing streams. The larvae hatch 5 to 30 days later and attach to underwater rocks and logs by use of their suckers. From 20 to 60 days after hatching, the larvae pupate in bullet-shaped cocoons. Adults emerge 2 to 20 days after pupation. The female adults may seek blood several miles from the streams.

c. Medical Importance. After some time the bite of a black fly becomes very painful and irritating.

The extreme pain, intense itching, and the resultant local swelling with occasional severe complications indicate the presence of an active venom. The most important disease transmitted by black flies is onchocerciasis often called river blindness. Animals often die from the bites of these flies.

c. Control Methods (see note, para 24b).

(1) *Control of breeding sites.* The control of black flies is aimed at the control of breeding sites. DDT insecticide is very effective against the larvae in streams. By use of the hand pressure sprayer (fig 40), the DDT residual insecticide (para 90c(2)(a)) should be applied to a stream at points about one mile apart. Overwintering larvae are more difficult to kill than summer larvae. The spraying should be accomplished after the ice melts in the spring and before the larvae start to pupate. Additional applications may be required later in the season. Spraying operations which are beyond the unit's capabilities should be reported so that they can be accomplished by units with the required capabilities.

(2) *Control of adult black flies.* Although black flies are larger than sand flies (para 137), they are small enough to enter ordinary 18-mesh screen. Painting the screens with a residual insecticide usually keeps out black flies. All of the insecticides used to control mosquitoes (para 90c(2)) will also control black flies. Applications of insect repellent (DEET) to the exposed skin (para 91c) will repel black flies for several hours.

139. Kissing Bugs

a. Medical Importance. Kissing bugs transmit the causative germ of Chagas' disease which has a high mortality rate in Central and South America, especially in Brazil and Argentina. These bugs transmit germs between such animals as armadillos, opossums, house mice, rats, cats, dogs, and squirrels and from such animals to man.

b. Habits. Kissing bugs commonly infest houses, hiding in crevices of sites which are dark, obscure, and near sources of blood. Cracked walls of inhabited adobe huts provide choice aggregation sites for these insects. Domestic types are usually more active at night.

c. Control Methods. Spraying of sleeping quarters with DDT insecticide (para 90c(2)(a)) as well as chlordane is effective against infestation (See note, para 24b). Removing litter used by bugs and rodents for harborage is also a helpful control method.

CHAPTER 13

VENOMOUS ANIMALS AND THEIR CONTROL

Section I. SPIDERS

140. General

Very few spiders are capable of inflicting bites which are fatal to man. Tarantula spiders are commonly thought to attack man readily; however, most tarantulas are nonaggressive unless teased considerably. The bites of tarantula spiders are not known to be harmful to man. Several species of spiders do inflict painful bites. The two spiders of greatest importance to the soldier are the black widow spider and the brown recluse spider. The black widow spider is also called the hourglass spider and the shoebutton spider.

141. Characteristics of Black Widow and Brown Recluse Spiders

a. The black widow spider (fig 60) is found in practically all parts of the Western Hemisphere. Closely related forms of this spider are found in Europe, Africa, Indonesia, Australia, and Oceania. The brown recluse spider (fig 61) is found in at least 13 southern and central states of the U.S.A. Two other closely related species of the brown recluse spider are found in South America. Not any

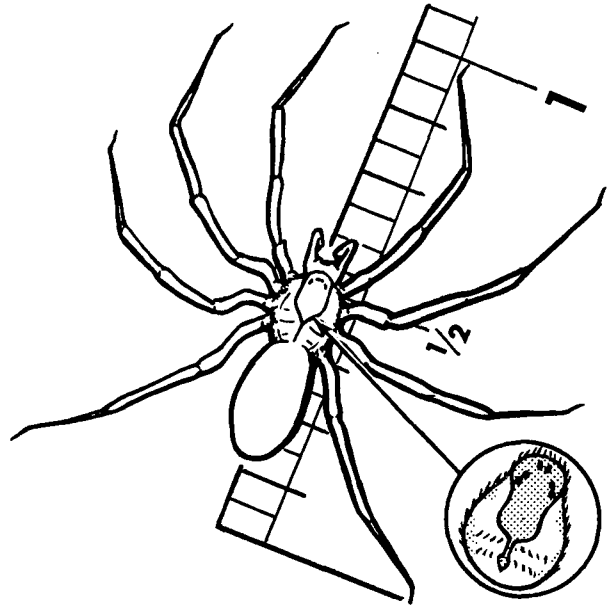

Figure 61. The brown recluse spider.

of these spiders are found on the Southeast Asia mainland.

b. The black widow spider (fig 60) is easily identified by its jetblack color and the reddish hourglass-shaped figure found on the underside of its abdomen. The recluse spider (fig 61) is about $\frac{3}{8}$ -inch long and is differentiated from other brown spiders by a dark brown area on its back. This dark brown area is shaped like a violin. The black widow spider is found in grass, shrubs, rock piles, latrines, and similar locations. The brown recluse spider is found primarily in grass and weed shelters, around rocky bluffs, and in rock piles; it sometimes seeks refuge in blankets, bedrolls, shoes, clothing, or wadded up paper. Both the black widow spider and the brown recluse spider prefer to remain hidden and are generally considered to be nonaggressive. When they are molested, however, they will readily bite.

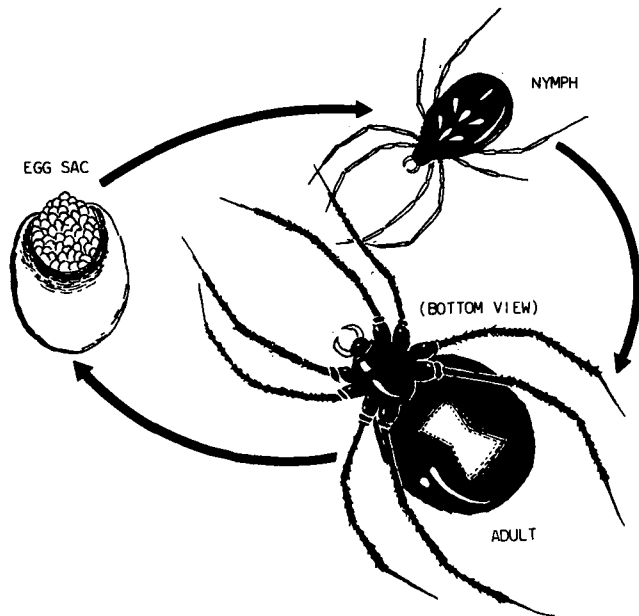

Figure 60. Life cycle of the black widow spider.

142. Control Measures

Whenever a black widow spider or a brown recluse spider is discovered, the spider and its web

should be destroyed with a long tool or stick. The egg sac which may be present in the web should not be overlooked. Special care must be taken when removing this egg sac because the female, when guarding her eggs, is inclined to attack. As a rule, DDT residual insecticide (para 90c(2)(a)) as well as a spray of lindane, chlordane, or dieldrin will give satisfactory control (see note, para 24b).

143. Medical Importance of Venoms of Black Widow and Brown Recluse Spiders

The venom injected by the black widow spider affects the nervous system of the body, especially the nerves of the abdominal muscles. Ordinarily, the bite is not felt immediately; but two tiny red

spots usually appear. A few minutes later severe pain is felt at the location of the bite; this pain may last as long as two days before it subsides. The muscles of the abdomen frequently become stiff and boardlike and there is severe abdominal pain. The venom injected by the brown recluse spider generally causes a gangrenous slough at the site of the bite and occasionally a severe systemic reaction. Although pain may occur 2 to 8 hours after the time of biting, only a mild stinging sensation is felt initially. Death seldom results from the bite of a black widow or a brown recluse if proper treatment is administered in time. The victim of a spider bite should be kept as quiet as possible, provided first aid as prescribed in FM 21-11/AFP 50-55, and treated by a medical officer without delay.

Section II. SCORPIONS

144. Characteristics of Scorpions

Scorpions are easily recognized by their crablike appearance and long, segmented tail which ends in a sharp spine or stinger (fig 62). Scorpions are found most commonly in warm climates. They prefer damp locations and are particularly active during the night. In the daytime they prefer to remain hidden under the bark of logs and under rocks, woodpiles, floors of outbuildings, debris, sand, or loose dirt. Their diet consists of insects and spiders which they grasp with their pincers and kill with their stinger. Dampness and a supply of food seem to attract them to certain areas. Some buildings may become infested, while adjacent ones remain free. Many a soldier has been stung on the toe as he puts on his shoes in the morning.

145. Control Measures

At the present time there is no insecticide which is highly effective in controlling scorpions. DDT residual insecticide (para 90c(2)(a)) is partially effective for several months when used in places where scorpions hide on the inside of buildings, (see note, para 24b). If this spray is used to keep scorpions from entering a building, it must be applied around the entire building, forming a band from the ground to the window sills. Particular care must be taken to saturate all cracks and crevices in the walls and window sills. Keeping house-

hold insects, which scorpions eat as food, to the minimum will cause scorpions to leave in search of food elsewhere.

146. Medical Importance of Scorpion Venom

Scorpions are able to inflict painful stings. In most areas of the world scorpions are not highly dangerous; however in the Middle East, South America, Mexico, and some parts of North Africa, certain types are deadly. In these areas deaths from scorpion stings are reported almost every year. All but a few of the scorpions found in the United States are capable of causing only painful stings. If a person is stung by a scorpion on the face, neck, or genital organs, he should be treated immediately by a medical officer. For an ordinary scorpion sting, first aid should be given as prescribed in FM 21-11/AFP 50-55.

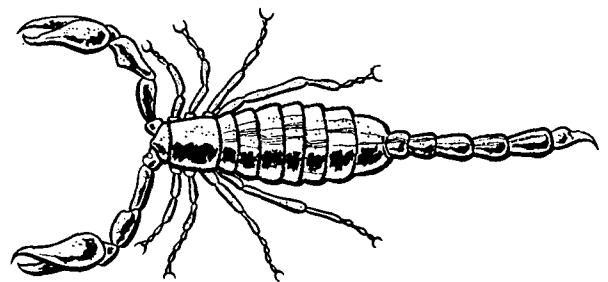

Figure 62. A typical scorpion.

Section III. SNAKES

147. General

a. Except for a few species of snakes in South-east Asia and Africa, snakes tend to be shy or passive by nature. Usually, they will avoid contact with human beings unless they are injured, trapped, or somehow disturbed. The harmless species are often more prone to attack than the poisonous ones. Both the poisonous and nonpoisonous snakes usually show more aggressiveness during their breeding season.

b. All species of snakes can swim; many can remain under water for long periods without drowning. A bite sustained in water is just as dangerous as one sustained on dry land.

148. Characteristics of Poisonous and Nonpoisonous Snakes

It is of obvious importance to know whether or not a snake is poisonous. Poisonous snakes have fangs and two rows of teeth. Nonpoisonous snakes have four to six rows of teeth without fangs. The snakes known as pit vipers have between their nostrils and eyes a sensory organ which is capable of detecting small amounts of radiant heat. All pit vipers are poisonous. The bite of a nonpoisonous snake is also a threat to the victim, as it may become infected and result in marked local tissue destruction.

149. Preventive Measures

The following measures should be taken to avoid being bitten by a snake:

a. If the military situation permits, avoid walking about in an area during the period from twilight to complete daylight, as many snakes are more active during this period.

b. Avoid swimming in areas where snakes abound, as all of them are good swimmers.

c. Keep your hands off rock ledges where snakes are likely to be sunning.

d. Always look an area over before sitting down, particularly if it is in deep grass among rocks.

e. Avoid camping near piles of brush, rocks, or other debris.

f. Never sleep on the ground if this can be avoided.

g. Never step over a large rock without first

checking what is on the other side. If you wish to look under the rock, turn it toward you so that it will shield you should a snake be lying beneath it.

h. Avoid walking close to rock walls or ledges where unseen snakes may be hiding.

i. Determine in advance, if possible, what species of snakes are likely to be found in an area which you are about to enter.

j. Never hike alone in a snake infested area if this can be avoided. It is important to have at least one companion to perform lifesaving first aid measures and to kill the snake, if possible. Providing medical personnel with the snake which bit the person may make immediate identification of the snake possible and thus facilitates treatment.

k. Handle freshly killed venomous snakes only with a long tool or stick, as snakes can inflict fatal bites by reflex action even after death.

150. Medical Importance of Snake Venoms

a. Snake venoms contain substances which are toxic to many cells and tissues of the body; but most venoms are primarily neurotoxic (poisonous to the nervous system), hemotoxic (poisonous to the circulatory system), or a combination of the two. A venom which is chiefly neurotoxic may also cause impairment of the circulation as a result of its effect on the heart as well as a severe headache, dizziness, blurred vision or blindness, hearing difficulty, mental derangement, fever or chills, and vomiting. A hemotoxic venom usually causes tissue swelling and pain at the site of the bite; this is not characteristic of a neurotoxic venom. A hemotoxic venom may also cause blood to escape from blood vessels, from major internal organs, and from the site of the bite.

b. The severity of the symptoms depends on the amount of venom injected by the snake and whether it was injected directly into a blood vessel or into muscle or fatty tissue. Most venoms also contain an enzyme which causes them to spread more rapidly within the body. If a person is bitten by a snake, he should be kept as quiet as possible and be given first aid immediately as prescribed in FM 21-11/AFP 50-55; then as quickly as possible he should be provided treatment by a medical officer. If the snake has been killed, it should be made available for identification, thus facilitating treatment.

CHAPTER 14

RODENT-BORNE DISEASES AND THEIR CONTROL

Section I. GENERAL

151. General

The term *rodent* means any one of several animals including rats, mice, squirrels, marmots, gophers, beavers, porcupines, rabbits, and ground hogs. Rodents discussed here, however, are limited to the domestic rats. The Norway and roof rats (fig 63) are two of the most common domestic rats.

152. Economic Importance

Rats contaminate and destroy food supplies, damage buildings, and cause fires by gnawing the insulation of electric wires and conduits. Based on the estimates that there are as many rats in the United States as there are people and that each rat contaminates, consumes, or otherwise destroys at least three dollars' worth of food per year, the annual cost of supporting the rat population of the United States approximates \$600,000,000.00. This does not include the cost of hospitalization, of medical care, and of productive time lost as the result of rat-borne diseases.

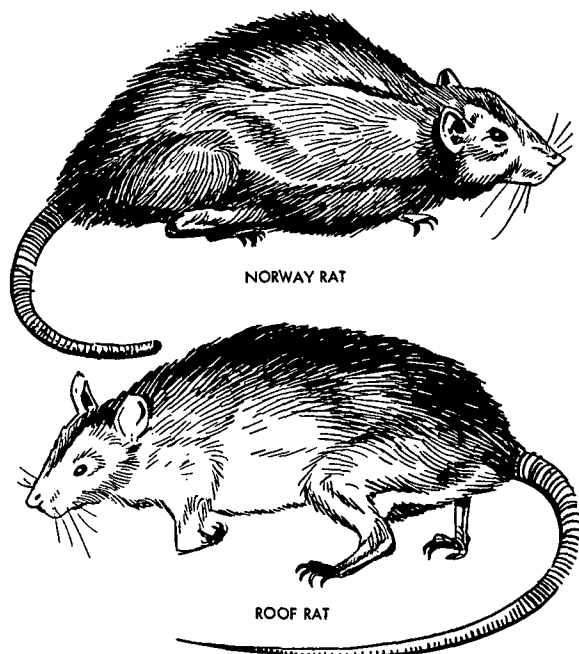

Figure 63. Two common domestic rodents.

153. Rodent-Borne Diseases and Methods of Transmission

Rodents are carriers of several human diseases. Most of these diseases are transmitted through an insect vector, but with few exceptions they can also be transmitted by direct contact.

a. Plague. Plague ranks first in importance among rodent-borne diseases. It is found worldwide. Primarily a disease of rats and of other wild rodents, plague may be transmitted to man by the bite or the feces of a flea which has previously fed on an infected rodent. Control of plague is accomplished through the control of rodent fleas with the use of various insecticides as discussed in chapter 10.

b. Endemic Typhus. Endemic or murine typhus is transmitted to man by the feces of rat fleas (chap 10). It is occasionally seen in the southern and southeastern parts of the United States but is also found in many other parts of the world. This disease is usually milder than the epidemic typhus transmitted from man to man by the body louse (chap 8).

c. Leptospirosis. Leptospirosis is caused by contact with urine or the feces of an infected rat or other animal. It is widely distributed throughout the world and may be contracted through the skin or mucous membrane by coming in contact with water contaminated with infected urine or feces or by the consumption of food which has been contaminated by rats. Hogs, dogs, and cattle also have been known to spread the germs which cause this disease.

d. Rocky Mountain Spotted Fever. Rodents and other animals are the natural reservoirs of this disease. It is transmitted to man by infected ticks (chap 11).

e. Scrub Typhus. Also called tsutsugamushi fever or Japanese river fever, this disease is transmitted by a larval mite (chap 11) which is normally parasitic on rodents.

f. Tularemia. This is a serious disease which may be contracted from the handling of infected

rabbits or other rodents or from the bite of ticks (chap 11) or deer flies. It is widely distributed throughout the United States and has also been reported in Russia, Japan, Central Europe, Scandinavia, and Canada.

g. Salmonellosis. This is one form of food poisoning. Although the major sources of such poisoning are food handlers and poultry products, the germs may come from infected rats and mice. The germs may be transmitted to man by food which has been contaminated with rat feces and urine.

Section II. CHARACTERISTICS OF RODENTS

154. General Characteristics of Rodents

Rodents are nocturnal. Ordinarily, they do not move about during the day, as they prefer the cover of darkness to forage for food and water. They move in narrow runs along buildings, walls, pipes, and overhead beams. Rodents gnaw through materials to obtain food and harborage. Wood is not a barrier, as they have very sharp teeth which cut through it quickly. They are spoilers. For example, they will take one bite from many potatoes instead of eating one, sample every bag of flour, and eat from every piece of meat, thus contaminating all of them. These pests damage far more food than they eat.

Section III. RODENT CONTROL METHODS

156. Environmental Control

The most effective rodent control is to prevent the infestation of rodents by making food and places for harborage inaccessible and by surveying the area regularly for signs of rodents. The commander should utilize the field sanitation team (para 5c) to maintain environmental control of rodents.

a. Food and harborage can be made inaccessible by ratproofing all buildings as well as the food storage areas inside buildings (TM 5-632/AFM 85-7). Mess personnel should be required to store open packages of food in tightly covered metal containers. Furthermore, soldiers should be required to store any personal food in tightly covered containers such as cake tins. All garbage and rubbish, which are food and harborage for rodents, must be disposed of promptly and properly (para 83 and 84).

b. Surveys for signs of rodents should be made by the field sanitation team regularly in order to detect the presence of rodents early. All soldiers

h. Trichinosis. This is a disease of rats and pigs. Man becomes infected through the consumption of infected pork which has not been cooked sufficiently. Pigs contract the disease by eating infected pork scraps in garbage and sometimes by eating infected rodent carcasses.

i. Rat-Bite Fever. The germs which cause this disease are transmitted through the bite of a rodent. This disease is uncommon in the North and South Americas and in most European countries but occurs somewhat frequently in other parts of the world.

155. Specific Characteristics of Norway and Roof Rats

a. Norway Rats. These rats prefer to live on the lower floor and in the basement of buildings or in sewers. They burrow into the ground, using the tunnel as a harborage or as an entrance to a building. They nest between walls or floors and in piles of rubbish or wood.

b. Roof Rat. The roof rats are not the burrowing type but are excellent climbers. They prefer to live above the ground, normally inhabiting the upper stories of buildings.

should be oriented to report observations of rodent signs. The following signs indicate not only the presence of rodents but also the type of rodents, the approximate number, and their location.

(1) *Sounds.* Rodents can be heard scurrying about at night or during the day when the part of the building which they inhabit is dark. Overhead scurrying noises are a reasonably sure sign of roof rats.

(2) *Burrows in the ground.* Burrows may be found inside a building with dirt floors, outside with the tunnel leading inside a building, around rubbish or wood piles, and around stacks of supplies stored outside. The presence of burrows is a sign of Norway rats.

(3) *Holes gnawed into food containers, through walls, et cetera.* Rats gnaw holes to gain entrance for food and harborage.

(4) *Smudges along beams, pipes, or floors close to walls.* Like most animals, rats create paths or runs in which they travel. A run has a smudgy, greasy appearance.

(5) *Droppings.* Rats drop pelletlike excreta

along the runs or on the floor under the runs. This sign is very helpful in determining the extent to which rodents have infested the area.

(6) *Tracks.* Rat tracks are visible in dirt and insecticide dust.

(7) *Dead rodents.* In the absence of chemical and mechanical control measures, dead rodents may indicate the presence of plague. For disposal of rodents, see paragraph 159.

157. Mechanical Control

Mechanical control which is achieved through the use of traps is the method of choice in any area where food is handled or stored because of the hazards created in using a poisonous chemical around food. A large number of traps should be used, as a 10-percent catch is considered good. Various types of mechanical traps are available. The type used most frequently is the snap trap which kills the rodent. The following procedure should be used in preparation and placement of the traps.

a. Bait the traps with the food which has attracted the particular rodents present in the area. For baits to be effective, they must contain food which attracts the rodents. Rodents ordinarily prefer foods that are prominent in the diet of people around whom they live. Good baits are oily foods such as bacon and peanut butter; cereals such as oatmeal and cream of wheat; fresh fruits and vegetables such as apples, bananas, lettuce, and carrots. Citrus fruits and acid vegetables such as tomatoes do not make good bait.

b. Place the traps along the runs created by the rodents or at the entrance of the burrows and harborages. Position the traps so that the rodents can approach them from both directions.

c. Sprinkle a light dusting of 2 percent diazinon powder around each trap for the purpose of killing the parasites (insects which feed on rodents) as they leave the dead rodent. Otherwise, the parasites, which transmit diseases, will leave the dead rodent and find a new host, which may be a soldier.

158. Chemical Control

a. Chemical control which is achieved through the use of poisonous bait stations may be the method of choice except in the areas where food is handled or stored. Unit personnel, including the field sanitation team, must never use poisonous

bait in food areas. If this becomes necessary, the work will be performed by personnel who have had specialized training.

b. Only one ready-to-use poisonous bait is available to the unit. Several doses and 8 or 9 days are required for this bait to kill a rodent. For this reason an adequate supply of bait must be kept out so the rodents will return until they get the amount required to kill them. If the rodents do not like this bait, the preventive medicine officer must be notified. The following procedure should be used in the preparation and placement of poisonous bait stations.

(1) Obtain the necessary number of rodent bait containers of the disposable type. If these containers are not available, make bait boxes. The most effective bait box is made by nailing together four boards which are 5 inches wide and 18 inches long, thus forming a rectangular structure with the ends open. The rodent bait containers or boxes make the poison accessible to rodents but unaccessible to most other domestic animals.

(2) Place 4 to 8 ounces of bait inside each container.

(3) Position the bait stations along the runs or at the entrance of burrows and harborages with both ends accessible to the rodents.

(4) Sprinkle a light dusting of 2% diazinon powder around each bait station so that the rodent will get the insecticide on its fur. The insecticide will kill the disease-transmitting parasites on the rodent and in the nest to which the rodent returns.

159. Disposal of Dead Rodents

All traps and bait stations must be checked early each morning for dead rodents. The following self-protective measures are essential in disposing of the dead rodents.

a. Apply insect repellent (DEET) to the hands, sleeves, and front of clothing in order to repel any parasites which may attempt to leave the rodents as they are removed from the traps or stations. Do not assume that all parasites have already left the rodents or have been killed in the insecticide dust (para 157c and 158b(4)).

b. Using long-handled tongs or a shovel, pick up the rodents and place them in a plastic bag or a metal container which has a tightly fitted lid.

c. Burn or bury the dead rodents, depending upon the local situation.

CHAPTER 15

LEECHES AND THEIR CONTROL

160. General

Blood-sucking leeches (fig 64) are annoying pests of man in many portions of East and Southeast Asia. Although their bites are usually painless, they cause blood loss; and the lesions produced by their bites may ooze blood for some time after the leeches have dropped off or have been removed from the skin. These sores, like any abrasions in jungle areas, may become infected.

161. Types of Medically Important Leeches

There are three main types of medically important leeches in the Pacific area. They are described as follows:

a. Common Water Leeches (Buffalo Leeches). These leeches are often brightly colored and may attain a length of 8 or more inches. They are found in swamps, rice fields, ditches, and slow-moving streams.

b. Nasal Leeches. These stream-dwelling leeches will enter the nostrils or mouth of any animal or man who goes into leech infested water or drinks it. They may remain for weeks in the nasal passages and cause considerable distress. When they enter the nostrils, they are usually less than an inch in length but may grow within the nasal passage to a length of 6 or 7 inches.

c. Land Leeches. These tiny pests, which are seldom more than 2 inches in length, are numerous along game trails and in wet vegetation in many areas. Some species may climb bushes and tall grass and quickly attach to the skin or clothing as a person brushes against them. They will enter a very small opening in the clothing in order to get to the skin. Except for a few species including the bush climbing leeches, their bites are entirely painless during the actual feeding. Later, intense itching may occur; and the bites may become infected.

162. Protective Measures

Repellents used on the clothing and the skin offer

the only practical protection against leeches. A repellent especially for leeches is available as a special item of issue to units in areas where leeches are a serious problem. Otherwise, the clothing and skin repellents discussed in paragraph 91b and c should be used. Since the skin repellent (DEET) is highly soluble in water, it must be reapplied if the wearer is caught in heavy rain or if he must wade, crawl, or swim in leech-infested water.

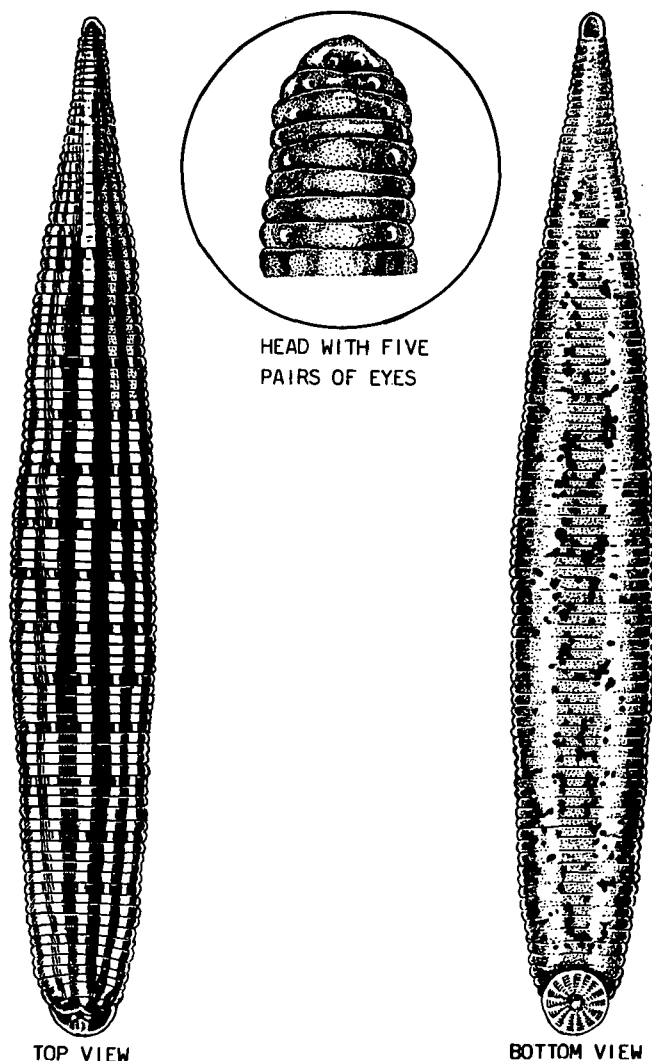

Figure 64. Typical water leech.

CHAPTER 16

MISCELLANEOUS DISEASES AND THEIR CONTROL

163. General

The communicable diseases discussed in this chapter are transmitted by means somewhat different from those previously discussed and are, therefore, placed in a group termed "miscellaneous diseases."

164. Tetanus

a. General. Tetanus (lockjaw) is a rare but highly fatal disease which results from the introduction of tetanus germs into the body through a wound or burn. A deep puncture wound is usually the most dangerous because the germs are carried deep into the tissues; but tetanus may follow even the most trivial wound or burn. Normally, tetanus germs live in the intestinal tracts of man and animal. These germs are very resistant to heat, drying, and chemical agents. They will live for long periods of time after they have left the intestinal tract and are frequently found in soil which has been contaminated by feces. Because of the common occurrence of these germs in soil, any wound contaminated with dirt can be serious.

b. Control Measures. The best method of control is active immunization. Upon entering the service, all military personnel are given a series of three tetanus toxoid injections. These immunizations make the individual resistant to tetanus for a period of time. Since this immunity is gradually lost, it is necessary that a "booster dose" of tetanus toxoid be given every 6 years. A "booster dose" must also be given promptly after the incurrence of a wound or severe burn. As a result of the Army's/Air Force's immunization program, cases of tetanus among military personnel are extremely rare.

165. Rabies

a. General. Rabies (hydrophobia) is a disease of animals which may be transmitted to human beings. It occurs in many wild and domestic animals. Of the domestic animals, the occurrence is most common in dogs. The organism causing the disease is present in the rabid animal's saliva and usually gains entrance into the body through a

bite by the animal. The disease attacks the nervous system; once the signs and symptoms of the disease have developed, it is always fatal. Every animal bite should be reported because the animal may have rabies and the disease may develop in the individual bitten unless proper treatment is promptly received.

b. Control Measures. Control of rabies is based upon prevention of the disease in animals, prompt treatment of bites, and vaccination of persons who have been bitten.

(1) Dogs and other warm-blooded pets should be given rabies immunization periodically as recommended by the veterinary officer, and the date of the vaccination should be marked on the dog's tag or collar. Dogs exposed or suspected of having been exposed to the infection should be held in quarantine for a time period recommended by the veterinary officer. Any animal which is suspected of being rabid or which has died of unknown causes should be turned over to the veterinary officer for disposition. Stray animals should not be permitted in a military camp nor on a military reservation but should be impounded and, if unclaimed, disposed of in a humane manner.

(2) Any person who has been bitten by an animal should report immediately to a medical facility for treatment of the wound and for determination as to whether a course of rabies vaccination is needed. If possible, the wound should be washed with soap and water prior to leaving for the medical facility. If avoidable, the animal should not be killed. It should be captured and turned over to the veterinary officer for quarantine and observation. If the animal must be killed, extreme care should be taken to see that the head is not damaged. The animal's head should be promptly sent to the nearest medical laboratory to be tested for rabies.

166. Dermatophytosis

a. General. The term *dermatophytosis* includes skin diseases, such as ringworm and athlete's foot, caused by fungi (microscopic molds) which attack the outer layer of the skin. They may also involve the scalp and nails. The organisms grow best

under conditions of warmth and moisture; thus dermatophytosis is more common in the summer. It frequently occurs in the moist, sweaty parts of the body and is more likely to be a serious problem in tropical or subtropical regions. Diseases of this type are spread by direct skin-to-skin contact of the bare skin with contaminated articles of clothing, shoes, towels, floors, and the like. Skin which has been subjected to prolonged effects of perspiration and poor hygiene may have an appearance similar to that of a fungus infection.

(1) *Ringworm*. Since the tendency of many of the fungus infections is to form rings by spreading at the edges while the center heals, the common name for these infections is "ringworm." The principal forms are ringworm of the scalp, beard, body, crotch, and feet. Often there is considerable itching. Ringworm of the crotch, commonly known as "jock-strap itch," is very troublesome in warm climates.

(2) *Fungal infection of the feet*. A fungal infection of the feet is commonly called "athlete's foot." It is the most common skin disease and usually occurs as an inflammation of the skin between the toes and on the soles of the feet. It may appear as a thickening and scaling of the skin, as raw inflamed areas, as cracked skin, or as blisters. Usually, there is considerable itching. Additional infection with other organisms may occur, adding to the inflammation and disability. Athlete's foot tends to flare up when the feet perspire. If neglected, complete cures are difficult to obtain.

b. Control Measures. The control measures for all forms of dermatophytosis are directed toward preventing contact with infected persons and articles contaminated by infected persons and toward improving personal hygiene. Special control measures for preventing fungus infections of the feet are delineated as follows:

(1) *Care of feet*. Proper care of the feet, especially keeping them clean and dry, is particularly important in the prevention and control of athlete's foot. Feet should be washed daily and dried thoroughly, especially between the toes. Persons whose feet perspire freely should apply foot powder lightly and evenly twice a day.

(2) *Treatment of fungus infections of the feet*. Active cases of fungus infection should receive prompt and thorough treatment under the supervision of a medical officer. If the disease is prevalent, the feet of all troops should be inspected at prescribed intervals in order to detect cases early and to insure prompt treatment.

(3) *Disinfection of floors and equipment*. Bathroom floors and equipment such as mats,

benches, and chairs should be scrubbed as often as feasible, preferably each day, with soap and water; flushed with water; and dried out. To aid in preventing athlete's foot, floors should be disinfected with 50 ppm chlorine solution at least once each week and more often if necessary. In warm weather, screened windows should be kept open to permit the direct rays of the sun to shine on the floor. Duckboards, if used in shower baths, should be removable so that they can be scrubbed thoroughly and exposed to sunlight for several hours each day. Two sets of duckboards should be available so they can be alternated daily. Towels, gymnastic suits, and similar articles should not be used by a second person until they have been thoroughly disinfected. Articles which do not become damaged by boiling may be sterilized in this way.

167. Scabies

a. General. Scabies (the itch) is a contagious skin infestation caused by a tiny mite. The mite burrows into the skin, causing a rash which occurs in patches and itches. The itching becomes more severe at night. Parts of the body which are most frequently involved are the wrists, webs of the fingers, lower abdomen, genitals, and buttocks. The itch mite is usually transmitted by direct contact; however it may be transmitted indirectly by underclothing, bedding, and towels which have been used by an infected person.

b. Control Measures. Cleanliness of the body, underclothing, and bedding is the most important preventive measure. A person who suspects that he has scabies should report to a medical officer for immediate treatment. All persons who have been in daily intimate contact with a case should be examined carefully. For further discussion of control measures, see paragraph 130.

168. Plant Dermatitis

a. General. In some persons the sap or juice of certain plants will cause skin eruptions. The most common of such plants are poison ivy, poison oak, and poison sumac. Although most skin eruptions result from direct contact with the plant, a person can get the eruption from contact with clothing or objects which have been in contact with the plant. Cases have even resulted from contact with smoke from fires containing these plants. The skin eruption, accompanied by severe burning and itching, may occur within a few hours to several days after exposure, usually on the hands, forearms, and face. Redness and swelling appear first and blisters later. The blisters break after 2 to 4 days, leaving a raw surface. This surface then becomes crusted and usually heals within 2 weeks.

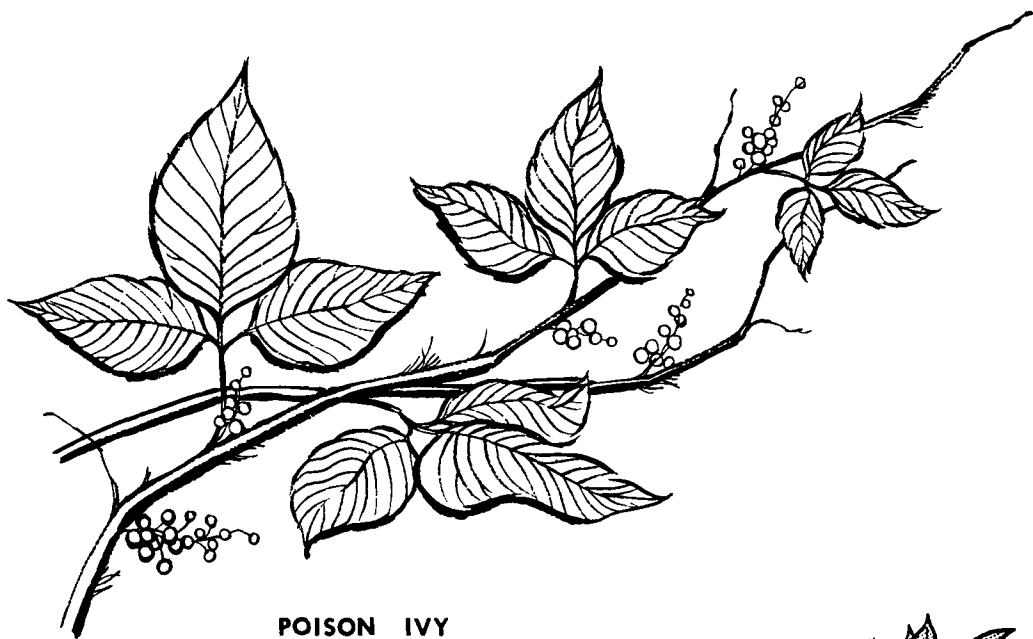

POISON IVY



POISON OAK

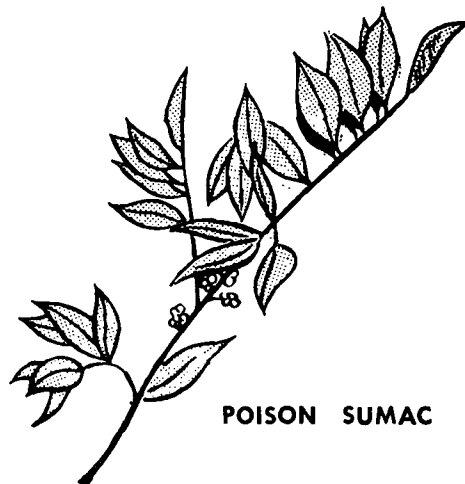

POISON SUMAC

Figure 65. Poison ivy, oak, and sumac.

b. Identification of Poisonous Plants (fig 65). Every person should learn to identify poison ivy, oak, and sumac. Poison ivy is a creeping vine with leaves growing in clusters of three. Two of the three leaves are opposite each other, and one is at the end of the stem. The leaves of some poison ivy are toothed on the sides. This plant has white waxy berries which may remain after the leaves have fallen. Poison oak, which is especially plentiful in the Western United States, is a shrub or small tree. The leaves also grown in clusters of three but are usually more distinctly toothed than those of poison ivy. It has berries similar to poison ivy. Poison sumac is a shrub or small tree which grows in swampy places. Its leaves have from 7 to 13 leaflets which are in pairs with a single leaflet at the end of the stem.

c. Control Measures. An area where poison ivy, poison oak, or poison sumac grows should not be selected as a camp site. Persons working in areas where these plants are found should wear gloves. Outer clothing and gloves should be changed upon leaving the area, and contaminated tools should be kept apart from others. If vegetation is to be burned, it should be piled a distance from the camp site and on the leeward side so that the wind will carry the smoke away from the camp site. Immediately after any exposure to these plants, all body parts which have been exposed must be washed several times in succession with a strong soap solution or alcohol. A fresh solution must be used for each wash. Contaminated clothing and tools should be washed with soap and hot water. If eruptions appear, a medical officer should be consulted.

CHAPTER 17

HEALTH PROBLEMS RELATED TO EXTREME TEMPERATURES

Section I. GENERAL

169. General

The average American soldier performs most effectively in climates similar to the one to which he has become accustomed in the United States. To be able to perform effectively in other climates, especially those with extreme temperatures, he must first become acclimatized to them. A gradual acclimatization comes about as the body makes natural adjustments to the changes. This acclimatization period is hastened and facilitated by participation in special training and in limited exercise activities which are increased daily until the body has made adequate adjustments.

170. Responsibilities

When troops must live and perform in the pres-

ence of extreme temperatures, the commissioned and noncommissioned officers assume additional responsibilities for the health and safety of these troops. They must plan and conduct whatever training and exercise activities are necessary to bring about proper acclimatization. They must insure that each soldier understands the prevailing hazardous conditions and the appropriate precautions which should be taken to prevent or overcome the problems that could endanger his health and life. Furthermore, they must insure that each soldier is able to recognize the early signs and symptoms of conditions caused by heat stress and by freezing temperatures (para 177 and 183) and to apply emergency first aid measures (FM 21-11/AFP 50-55).

Section II. HOT TEMPERATURE

171. General

Even though a person is in good physical condition, he must go through a period of acclimatization before he can safely do heavy work in the presence of a hot temperature. After becoming acclimatized to heat, he remains acclimatized for a week or two after he leaves the hot environment. Then, if he is not re-exposed to high temperature, the acclimatization will gradually be lost. For general information, see TB Med 175/AFP 160-1.

172. Body's Response to Heat

a. The body's response to the heat depends not only upon the air temperature but also upon the amount of air movement, the relative humidity (amount of moisture in the air), and the amount of radiant heat from the sun and surroundings. The combined effects of these environmental elements, to which persons are exposed, are discussed in paragraph 173.

b. The type and amount of clothing and equipment which a soldier wears and the manner in which they are worn also have a marked influence on the heat load imposed on the body. Clothing protects the body from radiant heat of the sun or

hot objects; but excessive or tightly fitting clothing, web equipment, and packs reduce the ventilation which normally helps to cool the body. During halts, rest stops, and other periods when such items are not required, they should be removed to permit greater cooling.

c. Other conditions which may increase heat stress and heat injury include infections, fever, recent illness or injury, overweight, previous heat injury, dehydration, exertion, fatigue, heavy meals, and alcohol. For example, feverish reactions from immunizations may increase heat stress. Immunizations should, therefore, be scheduled so that recovery will be complete before exposure to heat stress. Persons who appear to be ill or who complain of illness should be provided immediate medical care.

173. Wet Bulb Globe Temperature (WBGT) Index

(TB Med 175/AFP 160-1)

a. The wet bulb globe temperature index is a single numeral by which the air temperature, air movement, relative humidity, and radiant heat can be expressed as favorable or unfavorable for cer-

tain types of activities. This index of environmental factors is obtained by: (1) measuring the air temperature, the air movement and relative humidity, and the radiant heat; (2) multiplying the air temperature reading by 0.1, the air movement and relative humidity reading by 0.7, and the radiant heat reading by 0.2; and then adding the three resulting numerals. For example, if the air temperature is 90° F, the air movement and relative humidity reading is 80° F, and the radiant heat reading is 100° F, the WBGT index would be 85, which is calculated as follows:

$$\begin{aligned} 90^{\circ}\text{F} \times 0.1 &= 9.0 \\ 80^{\circ}\text{F} \times 0.7 &= 56.0 \\ 100^{\circ}\text{F} \times 0.2 &= 20.0 \\ \hline \text{WBGT Index} &= 85.0 \end{aligned}$$

b. The environmental factors are measured with the following devices (fig 66) set up in the area where exposure is to take place:

(1) Air temperature is measured with a dry-

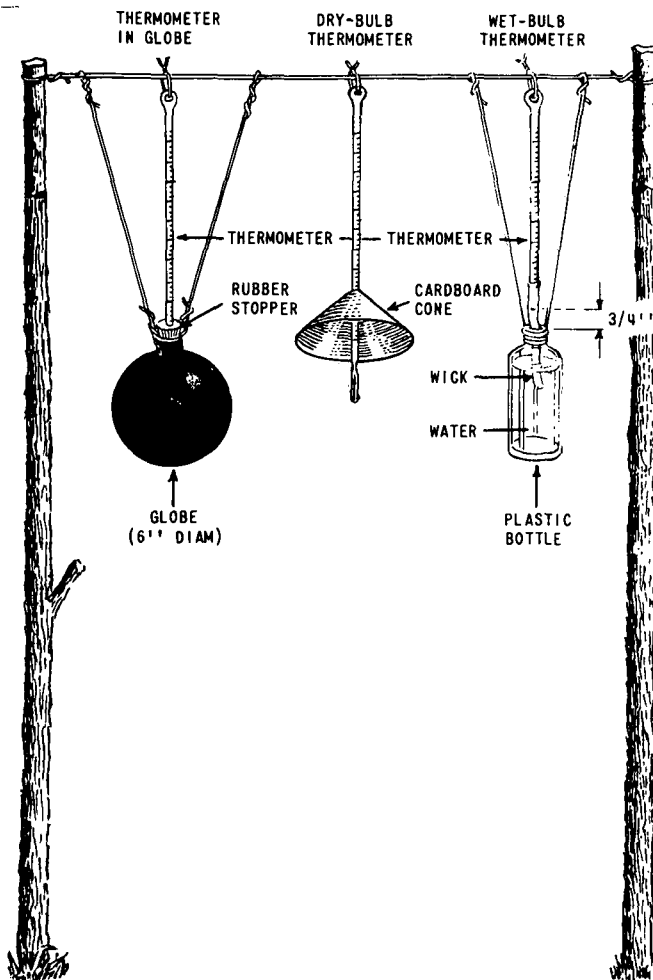

Figure 66. Equipment for measuring the air temperature, the air movement and relative humidity, and the radiant heat.

bulb thermometer shielded from the direct rays of the sun.

(2) Air movement and relative humidity are measured with a wet-bulb thermometer. A wet-bulb thermometer is regular thermometer which has a mercury bulb covered by a wet wick. The mouth of the water bottle in which the wick is placed should be about three-fourths of an inch below the tip of the thermometer bulb. The higher the relative humidity and the slower the air movement, the closer the wet-bulb reading will be to the dry-bulb reading.

(3) Radiant heat is measured with a thermometer inserted into the center of a hollow, flat black, 6-inch copper globe exposed to the full effects of the sun and wind.

c. The following WBGT indexes should be used as guides in directing acclimatization processes and the regular activities of troops. They are not to be confused with comfort guides. With a WBGT index over 80, the commander should use discretion in having unacclimatized troops do heavy work or exercises. With an index over 85, he should avoid having unacclimatized troops do strenuous activities. With an index over 90, he should halt all strenuous outdoor activities provided the military situation permits. If the devices for measuring all of the environmental factors (b above) cannot be constructed, the commander should use table 1 as a guide for achieving acclimatization.

174. Acclimatization to Heat

The major portion of acclimatization to heat takes place automatically during a period from 5 to 7 days provided the workload is increased gradually, the exposure time to heat is increased gradually, and the troops get plenty of rest between the activity periods and at night and consume adequate water, salt, and food. Full acclimatization to the heat (the ability to perform a maximum amount of strenuous work) will be reached most quickly if moderate work is begun at the time of first exposure to the heat and is increased progressively within the limits of the individual's tolerance. During the first 2 or 3 days the work periods should be scheduled during the coolest hours of the morning and of the afternoon with intervening rest periods. These work periods should be gradually extended into the hot part of the day. A guide for increasing the length of the work period is shown in table 1; however local conditions may make modification necessary. Commissioned and noncommissioned officers who know the work capacities of their men can determine the degree of their acclimatization and whether or not it is

safe for them to continue a given activity. The acclimatized man is alert, energetic, and free of abnormal symptoms. In contrast, the unacclimatized man who is working too hard in the heat becomes dull and apathetic, performs his work poorly, and may show symptoms of heat exhaustion (para 177a). For acclimatization of troops at high altitudes, see FM 31-72.

Table 1. Guide for Increasing Length of Work Periods

Moderate Conditions:

Desert: Air temperature below 105° F
Tropical: Air temperature below 85° F

	Hours of Work	
	Morn- ing	After- noon
First day -----	1	1
Second day -----	1½	1½
Third day -----	2	2
Fourth day -----	3	3
Fifth day -----	Regular duty	

Severe Conditions:

Desert: Air temperature show 105° F
Tropical: Air temperature above 85° F

	Hours of Work	
	Morn- ing	After- noon
First day -----	1	1
Second day -----	1½	1½
Third day -----	2	2
Fourth day -----	2½	2½
Fifth day -----	3	3
Sixth day -----	Regular duty	

175. Water Requirements

(TB Med 175/AFP 160-1)

a. Water requirements of the human body vary with the environmental condition (para 172) and the amount of exercise. At high temperatures a person who is resting may lose as much as a pint of water per hour by sweating. If he is working, his water loss and water requirement will increase in proportion to the amount of work being done. The supply of water must, therefore, be sufficient to provide for the heaviest type of work which the troops may be doing. Troops engaged in heavy work in extreme heat may require 4½ gallons or more of drinking water per man during a 24-hour period. A water requirement guide to be used for planning purposes only is shown in table 2. Water requirements should be increased above the levels shown in this guide when troops are performing heavy labor in temperatures of 90° F or greater with high humidity or in temperatures of 110° F or greater with low humidity. Unit commanders must provide optimum amounts of water at all times for drinking purposes. Troops should be encouraged to drink more water and to drink it more

frequently than is necessary to quench sensations of thirst, especially during periods of acclimatization.

Table 2. Guide for Determining Average Drinking Water Requirements

Activities		Quarts of water per man per day	
Types	Examples	Moderate*	Severe**
Light	Desk work; guard; KP duty.	6	10
Moderate	Route march on level ground; tank operation.	7	11
Heavy	Forced marching; stevedoring; entrenching.	9	13

*Desert: Air temperature below 105° F.
*Tropical: Air temperature below 85° F.
**Desert: Air temperature above 105° F.
**Tropical: Air temperature above 85° F.

b. Intake of water below the amount needed for proper cooling will result in rapid loss of efficiency, reduction in the ability to work, and deterioration of morale. If water loss without replacement continues for hours, heat exhaustion may result. In heat exhaustion the body temperature may or may not rise. There is no advantage in the use of thirst quenchers such as chewing gum or fruit drops. For a given amount of work under high temperature conditions, water consumption is substantially the same whether water is taken only at mealtimes or whenever one is thirsty. Those who delay drinking until mealtime may experience considerable discomfort without any apparent advantage in water economy. The greatest benefit will be obtained and the maximum efficiency will result if water is taken at short rather than at long intervals. Drinking in small amounts when thirsty is the best practice, thus preventing discomfort which may result from drinking large quantities of water at one time. When the water supply is limited, unit commanders should conserve it by having their troops do the required heavy work and strenuous marching during the coolest periods of the day or at night, if possible, when heat stress and water requirements will be less. Up to 40 percent of the daily fluid requirement may be saved by this method. The human body cannot be trained to function with less than the minimum amount of water it requires for cooling, waste elimination, and metabolism; any attempt to train the body to do so can be harmful.

176. Salt Requirements

(TB Med 175/AFP 160-1)

a. When water is lost through perspiration, vital body salt is also lost. An ordinary diet contains enough salt to make up for this loss when a

person's water intake is less than 1 gallon a day. If the daily water intake is increased to 1½ gallons, it is still possible to take in an adequate amount of salt through the diet by adding extra salt to prepared food. The amount of salt which a person can spread over his food in three meals without spoiling the taste of it is approximately one-half teaspoonful. Even though a full diet is eaten, the salt lost through perspiration may be so great that the salt stores of the body will have to be replenished. This can be done by adding salt to the drinking water or by taking salt tablets; however if there is a shortage of water, extra salt should not be taken.

b. Coated salt tablets which are made to dissolve slowly in the intestines are available. These tablets will prevent the nausea and sick feeling sometimes felt after taking the plain salt tablets. They should be taken while drinking water or eating and should be swallowed whole. When there is much sweating, two tablets should be taken for every quart of water consumed.

c. Some people prefer to take their extra salt in the form of lightly salted water. This is an excellent method. The amount of table salt used for different water containers is as follows:

(1) One pound of table salt to a tank (100 gallons) of water.

(2) Three-tenths pound of table salt to a purification bag (36 gallons) of water.

(3) One-fourth teaspoonful of table salt to a canteen (quart) of water.

(4) Two 10-grain plain salt tablets dissolved in a canteen (quart) of water.

177. Special Condition Caused by Extreme Heat

a. *Heat Exhaustion.* This condition is caused by excessive loss of water and salt from the body. At air temperatures above 95° F the only means by which the body is cooled and heat exhaustion is prevented is through the evaporation of sweat. In the jungle where the humidity is high, for example, sweat does not completely evaporate but runs off the skin; therefore cooling is less efficient and water losses may be greater. The symptoms of heat exhaustion are headache, excessive sweating, weakness, dizziness, and muscle cramps. Also, the skin is pale, cold, moist, and clammy. Heat exhaustion may come on gradually or it may happen suddenly. Few deaths occur from heat exhaustion; however a severe case which goes untreated can be fatal. A victim of heat exhaustion should be placed in a cool, shady spot immediately and given first

aid as prescribed in FM 21-11/AFP 50-55 and TB Med 175/AFP 160-1. He should then be taken to the nearest medical treatment facility.

b. *Heatstroke.* Prolonged exposure to high temperature may cause heatstroke, which is sometimes referred to as "sunstroke." Heatstroke is a medical emergency and calls for prompt emergency treatment. Heatstroke is more likely to strike a person who is not acclimatized to heat. Furthermore, an individual who has heatstroke is more subject to attacks in the future with lessening degrees of response to treatment. The first sign of heatstroke may be stoppage of sweating which causes the skin to feel hot and dry. Collapse and unconsciousness may come suddenly or may be preceded by headache, dizziness, fast pulse, nausea, vomiting, and mental confusion. It is necessary to work fast to save life, as the heat regulators of the body have been damaged and the temperature may rise to as high as 108° F. A victim of a heatstroke should be placed in a cool, shady spot immediately and given first aid as prescribed in FM 21-11/AFP 50-55 and TB Med 175/AFP 160-1. As soon as possible the patient should be taken to a medical treatment facility, continuing the first aid en route.

c. *Heat Cramps.* Heat cramps are painful spasms of the muscles, usually those of the legs, arm, and abdomen. They may be either mild or severe. Cramps are due directly to loss of salt from the body and are relieved when this loss is replaced. The proper first aid is prescribed in FM 21-11/AFP 50-55 and TB Med 175/AFP 160-1. A victim with severe heat cramps may have to be sent to a medical treatment facility.

d. *Sunburn.*

(1) Overexposure of uncovered skin surfaces to sunlight causes sunburn. Sunburn is characterized by painful reddened skin. More severe exposure can result in blistering of the skin. Severe skin burns may result from relatively short periods of outdoor exposure on cloudy as well as on clear days. Sunburn can be prevented by the use of clothing and by gradually increasing the time of successive exposures.

(2) A suntan should be acquired gradually, preferably in the early morning or late afternoon and without exposing too much of the body at one time. A good method is to start with a 5-minute exposure and to increase the exposure gradually at the rate of 5 minutes each day. Even after a good tan has been acquired, excessive sunbathing in tropical or desert areas is never wise. Persons with freckles or auburn hair should be particu-

larly careful, as they are especially susceptible to sunburns. Considerable protection from sunburn is received from the use of the sunburn ointment available for issue to units in the field; however it does not fully protect the skin against the harmful effects of the sun.

e. Prickly Heat. Prickly heat is an irritating inflammation of the skin associated with excessive sweating. It usually starts around the waist and in the armpits with numerous tiny blisters which itch intensely. As a result of the prickly heat, the skin may become infected, causing troublesome sores. Clean, loose, dry clothing helps to prevent prickly heat. Gradual suntanning (*d*(2) above) seems to help increase resistance to prickly heat. After bathing, a person should dry his skin thoroughly. Too frequent bathing seems to make

prickly heat worse, as the natural protective oils of the skin are removed by soap. Severe cases of prickly heat should be referred to the medical officer for treatment.

178. Fungus Infections

Chronic, disabling fungus infections of the skin are more common in hot climates than in cool ones. Excessive sweating causes softening of the skin and makes moist areas such as the groin, crotch, armpits, and feet ideally suited for the growth of the tiny plantlike germs which cause these conditions. Fungus infections are much easier to prevent than to cure. Following the rules of personal hygiene (chap 3) and taking simple precautions (para 166) are the best means of preventing such infections.

Section III. COLD TEMPERATURE

179. General

Although the cold temperature in the arctic and other parts of the world presents problems, life in these regions need not be unpleasant and unhealthful. Troops can learn to maintain health.

a. Living conditions in the inhabited areas of the arctic are crowded. Special precautions must, therefore, be taken to prevent the spread of respiratory, intestinal, and skin diseases. Especially important are the practice of personal hygiene (chap 3), adequate ventilation (para 183*e*), and proper waste disposal (chap 6).

b. In some parts of the arctic during the summer, mosquitoes and flies are extremely numerous; therefore the use of nets, gloves, insect repellents, and smudges are needed to prevent annoyance and suffering. The arctic mosquito is a vicious biter; however, it does not transmit malaria or yellow fever. The term *flies* as used here does not refer to the common types, such as houseflies, or bluebottle flies, but rather to the biting and blood-sucking varieties, such as midges, black flies, deer flies, horse flies, and moose flies. Hordes of several species of flies may attack an unprotected individual at one time.

180. Diet

Cold temperature alone imposes no need for food intake to be increased; however operations in cold weather may require extra energy because of the increased physical exertion necessary. The diet provided for troops contains sufficient calories to meet this energy requirement. Troops should be encouraged to eat all their food. Should a person

eat game, either for the sake of survival or for pleasure, it must be thoroughly cooked, since in certain areas of the north some game species, especially bear, are infected with small parasitic worms called *Trichinae*. If the meat is undercooked, these worms can cause a serious infection known as trichinosis. Furthermore, the liver of a polar bear or of a bearded seal should never be eaten, as it contains a high concentration of vitamin A, thus making it very harmful to man.

181. Clothing

Clothing for cold weather is designed to afford protection, insulation, and ventilation: protection by covering as large an area of the body as possible; insulation by trapping air which has been warmed by the body and holding it near the skin to prevent loss of heat from the body; ventilation by allowing a two-way exchange of air through the various layers of clothing. This exchange of air prevents overheating and excessive perspiring and at the same time protects against chilling of the body surface. Perspiration, grease, and dirt must not be allowed to remain on clothing, as they decrease its insulating qualities, thus preventing it from retaining heat. The amount of clothing and the way in which it is worn should leave the body slightly cool rather than hot. Also, clothing should be loose enough to allow movement and exercise of the hands, feet, and other parts of the body and thereby maintain proper circulation. Each individual must insure that his clothing is clean and dry and that he is wearing it in loose layers. For further discussion of clothing for cold weather, reference is made to FM 31-70.

182. Adverse Effects of Alcohol

Alcohol is ineffective in combating the cold. In cold weather the human body shrinks the small blood vessels which lie just beneath the skin over the whole body surface, thereby reducing the flow of warm blood to the surface from which heat may be lost by radiation to the surrounding air. When alcohol is taken, one of its effects is to cause expansion of these small vessels. While this gives a temporary feeling of warmth, body heat will be rapidly lost from the large radiating area of the flushed skin. The loss of heat from the core of the body causes a great deal of extra work for the body's heat-producing mechanisms, and they may be unable to withstand this extra demand. When a person's body heat is low, he is truly cold; and his hands, feet, or any exposed part is more likely to be injured by the cold. Another harmful result of the alcoholic drink is the false sense of security it gives. The drinker may have such a sense of well-being that he will neglect to take sensible precautions and fail to recognize the early warning signs of trouble. Furthermore, when the body heat has been lowered and an injury occurs, shock may develop more rapidly.

183. Special Conditions Which Occur in Cold Weather

It is advisable that troops in cold weather be paired as "buddies," each having the responsibilities for reminding the other one to take warming exercises at frequent intervals and for watching him for signs of frostbite and other conditions. Conditions especially to be guarded against are trench foot, immersion foot, frostbite, snow blindness, and carbon monoxide poisoning.

a. Trench Foot.

(1) Trench foot is an injury which results from fairly long exposures of the feet to continued wet conditions, generally at temperatures from approximately freezing to 50° F. Although these conditions may prevail in the arctic during certain seasons, they are found more often in temperate climates during the spring, fall, or winter. Rain, sleet, or the thawing of snow or frozen soil may make the ground so wet that the troops' boots and socks become wet or damp. If men are inactive, as they are in fox holes, the combination of wet feet, cold weather, and little movement causes changes in the circulation of the blood in the feet. Foot injuries caused by these changes may be very serious; they can lead to the loss of toes or parts of the feet.

(2) Fortunately, trench foot can be prevented by taking care of the feet. The feet should be kept

dry and warm. Good circulation should be maintained by exercising the feet and legs. A person can always move his toes and ankles within his shoes. When socks get wet, they should be changed for a dry pair. Before the boots are put back on, the feet should be massaged and rubbed until warm, thus increasing the flow of blood. Socks may be dried under field conditions by putting them under the shirt where the body heat will help to evaporate the moisture. Alternating two pairs of socks in this way is a great aid in keeping the feet dry. Feet can be kept dry while standing in fox holes by bailing out any water therein or by putting stones, pieces of logs, branches, or brush on the bottom so that the feet are above the water or mud. A drainage sump can be dug to one side of the hole or standing steps can be made.

b. Immersion Foot. Immersion foot is similar to trench foot (*a* above) except in the manner in which it is caused. It results from immersion of the feet in water which is below 50° F for a prolonged period, usually in excess of 12 hours. Other portions of the body may be similarly affected. For discussion of immersion foot in warm weather, see paragraph 32*e*.

c. Frostbite.

(1) Frostbite is the injury of tissue from exposure to intense cold. The body parts most easily frostbitten are the cheeks, nose, ears, chin, forehead, wrists, hands, and feet. Frostbitten skin is whitish, stiff, and numb rather than painful. Frostbite can be prevented by wearing the proper amount of warm, loose, dry clothing (para 181) and by exercising the entire body and massaging the face, hands, and feet periodically to promote good circulation. Troops traveling in cold weather by vehicle, particularly in the rear of trucks, should be allowed to dismount and exercise periodically to restore circulation. Proper footgear and handgear are especially important. Should any part of the clothing become wet, it should be dried or changed at once. Furthermore, it is important not to become overheated and perspire, as the perspiration and damp clothing cause the body heat to escape and allow the body to cool too rapidly. This can be avoided by removing the proper layers of clothing before exercising. Should frostbite occur, appropriate actions must be taken immediately as described in FM 21-11/AFP 50-55 and 161-1-11. Care should also be taken to avoid touching cold metal such as the messkit or canteen with the bare hands or lips, as they may freeze to it. Should this occur, the metal should be warmed to release the skin and prevent tearing it.

(2) The condition sometimes referred to as

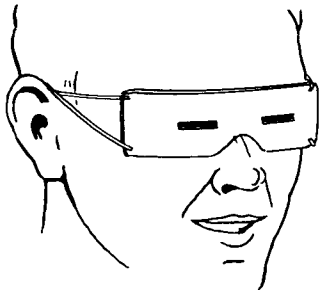

Figure 67. Improvised sunglasses.

frozen or frosted lungs does not exist. Even though a person exercises hard at 50° F below zero, no damage is done to his lungs despite the discomfort which he may feel. Mild inflammation of the upper airway, such as sore throat or hoarseness, may result; but even this is rare.

d. Snow Blindness. Snow blindness is the effect which glare from an iceland or snowfield has on the eyes. This condition can occur even in cloudy weather. In fact, it occurs more often in hazy, cloudy weather than when the sun is shining. The early stages of snow blindness can be recognized by the scratchy feeling in the eyes when the eyelids are closed. Snow blindness can be prevented by wearing sunglasses at all times when in areas where there is unbroken ice or snow. Should the sunglasses be lost, an emergency pair may be made from a thin piece of wood or cardboard which is the width of the face by cutting slits into it and attaching strings to hold it over the eyes (fig 67). Sometimes blackening the eyelids and face around the eyes will absorb some of the harmful rays. Should a person develop a severe case of snow blindness, his eyes should be protected as described in FM 21-11/AFP 50-55; then he should be taken to a medical facility at once. The same condition that causes snow blindness can cause snowburn of skin, lips, and eyelids. If a snowburn is neglected, the result is a painful reddened skin similar to a sunburn.

e. Carbon Monoxide (CO) Poisoning.

(1) Carbon monoxide poisoning can be severe, prolonged, and sometimes fatal. It results from inhaling carbon monoxide which is a colorless, tasteless, and practically odorless gas produced by the incomplete combustion of coal, oil, and other fuels used in such equipment as motor

vehicles, field ranges, and lighting and heating devices. This carbon monoxide destroys the ability of the red blood cells to carry the needed oxygen to the body tissues. Carbon monoxide poisoning is usually the result of faulty equipment, improper use of equipment, or inadequate ventilation.

(2) The symptoms of carbon monoxide poisoning come on rapidly and in quick succession. Dizziness, headache, noises in the ears, and throbbing in the temples are quickly followed by a feeling of sleepiness and weakness. Vomiting and convulsions may occur, followed by unconsciousness and death. The skin and lips are often bright red. The individual who is becoming poisoned may realize what is taking place, but he may not have enough strength left to get into the fresh air. Under circumstances in which there is muscular exertion or where there are extremes of temperature or humidity, the effects of the poisoning act more rapidly.

(3) The following measures are essential in the prevention of carbon monoxide poisoning:

(a) Insure that equipment is in proper working condition, especially the exhaust.

(b) Insure adequate ventilation of sleeping areas in which fuel-burning equipment is being used. In cold climates, regardless of the severity of the weather, make sure there is adequate ventilation before going to sleep.

(c) Insure adequate ventilation in the cab of a vehicle when the motor is running. Never run the engine of a vehicle inside a closed garage. Prolonged standing of a vehicle with the motor running increases the danger of carbon monoxide poisoning.

(d) Any time the presence of carbon monoxide is even remotely suspected, immediately shut off all mechanisms that could be a possible cause and seek open air and help. This should be done in a calm, deliberate manner and with the least possible exertion. Hysteria or rushing about may cause the expenditure of just enough extra energy to block accomplishment.

(4) A person who is overcome with carbon monoxide should be moved into fresh air immediately and given first aid in accordance with FM 21-11/AFP 50-55. He should then be taken to a medical treatment facility.

APPENDIX A

REFERENCES

Army:

AR 40-5	Medical Service—Preventive Medicine
AR 40-562	Immunization Requirements and Procedures
AR 190-90	Suppression of Prostitution
FM 21-11	First Aid for Soldiers
FM 21-15	Care and Use of Individual Clothing and Equipment
FM 21-18	Foot Marches
FM 31-70	Basic Cold Weather Manual
FM 31-72	Mountain Operations
TM 5-297	Well Drilling Operations
TM 5-632	Military Entomology Operational Handbook
TM 5-700	Field Water Supply
TM 10-210	Inspection and Storage of Subsistence Supplies

Air Force:

AFR 85-23	Well Drilling Operations
AFR 125-43	Suppression of Prostitution Near Air Force Bases
AFR 161-1	Control of Vector-Borne Diseases
AFR 161-6	Control of Communicable Diseases in Man.
AFR 161-13	Immunization Requirements & Procedures
AFM 64-4	Handbook of Protective Equipment
AFM 85-7	Military Entomology Operational Handbook
AFM 86-3	Planning and Design—Theater of Operations Air Bases
AFM 161-6	Medical Aspects of Food Service (Food Poisoning and Food Inspection)
AFP 50-55	GMT—First Aid
AFP 160-1	The Etiology, Prevention, Diagnosis and Treatment of Adverse Effects of Heat
AFP 161-1-11	Cold Injury

INDEX

	Paragraph	Page
Acclimatization	171-174	80, 81
Aerosol bomb	90c(2)(c), 91e	51, 53
Air:		
Movement	172-173	80
Temperature	172-173	80
Alcohol	33, 182	17
Animal	14c	7
Ants:		
Control of	90d(3), 100b, 133b	52, 56, 67
Life cycle of	133a	67
Medical importance of	133a	67
Area protective measures	92, 130, 135b	54, 65, 67
Arthropods	15c	7
Bar, insect	91d, e; 136e(2)	53; 67
Bathhouse, care of	166b	78
Bedbugs:		
Control of	90c(2)(b), 132d	51, 66
Habits of	132c	66
Life cycle of	132b	66
Medical importance of	132a	66
Bednets (<i>See</i> Bars, insect.)		
Biting midges	91a, 136, 179b	53, 67, 84
Black flies:		
Control of	138c	69
Life cycle of	138b	69
Medical importance	138c	69
Black widow spider:		
Characteristics of	141	70
Control of	142	70
Medical importance of	143	71
Boiling water	53d, 62a(2)	28, 31
Brown recluse spider:		
Characteristics of	141	70
Control of	142	70
Medical importance of	143	71
Burners (<i>See</i> Devices, hygiene and sanitation.)		
Calcium hypochlorite	50a(1), b, c(4); 53b(1); 54c	23, 25; 26; 28
Canned foods	58b	29
Carbon monoxide (CO) poisoning	183e	86
Carrier	14b	6
Case	14a	6
Chlorination	47g	22
Chlorine:		
Compound	53b(1)	22, 26
Demand	47i, 53b	22, 26
Dosage	47h, 53b	22, 25, 26
Residual	47j, 50d, 53b	23, 25
Solution	50a(1), c(4)	
Cleanliness, personal	30	15

	Paragraph	Page
Clothing, wearing of -----	91a, 121, 127b, 130c, 137e(4), 168c, 172b, 177d, 179b, 181, 183c(1)	53, 62, 64, 65, 69, 79, 80, 83, 84, 85
Cockroaches:		
Control of -----	90c(2)(b), 133b	51, 67
Life cycle of -----	133a	67
Medical importance of -----	133a	67
Control of diseases (<i>See</i> Diseases.)		
Creamed mixtures -----	62c	31
Cubicles for sleeping -----	22b(3)(b)	10
Delousing procedure:		
Clothing and bedding, for -----	102	58
Troops, for -----	101	57
Dentures and bridges, care of -----	31b	16
Devices, hygiene and sanitation:		
Bag, water purification -----	50b	23
Burner:		
Oil-water flash -----	68b	34
Vapor -----	68c	35
Grease trap:		
Baffle -----	81a	44
Barrel filter -----	81b	44
Hand-washing -----	43, 44, 75d(4)	19, 38
Heater, immersion -----	69	36
Incinerator:		
Barrel -----	84	47
Inclined plane -----	83b(2)	46
Latrine:		
Bored hole -----	76e	41
Burn-out -----	76c	39
Cat-hole -----	74a(1)	37
Deep pit -----	76b	38
Mound -----	76d	40
Pail -----	76f	41
Straddle trench -----	76a	38
Messkit washing -----	69-70	36
Pit:		
Burial -----	83a	46
Soakage -----	77-79	41-43
Shaving and washing -----	44	19
Shower -----	45	20
Trench:		
Burial -----	83a	46
Fire -----	68d	36
Soakage -----	78, 80	43
Urinal:		
Pipes -----	77a(1), b	42, 43
Trough -----	77a(2), b	42, 43
Urinoil -----	77a(3), b	43
Diet, cold temperature -----	180	84
Diseases, communicable:		
Athlete's foot -----	166a(2)	78
Chagas' disease -----	139a	69
Cholera -----	46, 104	22, 59
Defined -----	10	6
Dengue fever -----	86c	48
Dermatophytosis -----	12e, 166	6, 77
Diarrhea -----	46	22
Dysentery -----	46, 55	22, 29
Encephalitis (sleeping sickness) -----	86d	48
Endemic typhus -----	153b	73
Eye, of -----	104	59

	Paragraph	Page
Diseases, communicable—Continued		
Filariasis (elephantiasis)	86e	49
Flea-borne	114	61
Fly-borne	104	59
Food poisoning	55	29
Hepatitis, infectious	46, 55	22, 29
Insect-borne	12c, 24	6, 11
Intestinal	12b, 15d, 23, 104	6, 7, 10, 59
Japanese river fever (<i>See</i> Scrub typhus.)		
Kala-azar	137c	67
Korean hemorrhagic fever	129	64
Leptospirosis	46, 153c	22, 73
Lockjaw (<i>See</i> Tetanus.)		
Louse-borne	94	55
Malaria	86a	48
Mite-borne	129	64
Mosquito-borne	86	48
Onchocerciasis	138c	69
Oroya fever	137c	67
Plague	114, 153a	61, 73
Q fever	125	63
Rabies (hydrophobia)	12e, 165	6, 77
Rat-Bite fever	153i	74
Relapsing fever	94, 125	55, 63
Respiratory	12a, 22	6, 9
Rickettsialpox	129	64
Ringworm	166a(1)	78
River blindness (<i>See</i> Onchocerciasis.)		
Rocky Mountain spotted fever	125, 153d	63, 73
Rodent-borne	153	73
Salmonellosis	153g	74
Sand fly fever	137c	67
Scabies	129, 167	64, 78
Schistosomiasis	46	22
Scrub typhus	129, 153e	64, 73
Skin, of	104, 166	59, 77
Tetanus (lockjaw)	12e, 164	6, 77
Tick-borne	125	63
Tick paralysis	125	63
Trench fever	94	55
Trichinosis	153h, 180	74, 84
Tsutsugamushi fever (<i>See</i> Scrub typhus.)		
Tularemia (rabbit fever)	125, 153f	63, 73
Typhoid	46, 55, 104	22, 29, 59
Typhus fever:		
Epidemic	94	55
Murine	114	61
Typhus-like fevers	125	63
Venereal	25	12
Viral	125	63
Water-borne	46	22
Yellow fever	86b	48
Disinfection solution	62a(1) (c), 65b(4)	31, 33
Dispenser for:		
Insecticide	90c(2) (c), 91e, 100-102, 111, 120	51, 53, 56-58, 60, 62
Insect repellent	91c	53
Dressings, fowl and meat	62d(3)	32
Drink	33, 62e	17, 32
Droplets	15b, 22a	7, 9
Dust	15b, 22b(5)	7, 10
Duster, hand	90d(3), 101c, 120	52, 57, 62
Evaporation beds	78, 82	43, 45
Exercise	34, 169-170, 183c	17, 30, 85

	Paragraph	Page
Feet, care of -----	32, 166b(1), 183a(2), c(1)	16, 78, 85
Filter unit, water purification -----	53a	25
Fleas:		
Characteristics of -----	117	61
Control of -----	90c(2)(b), d(3); 100b; 118-121	51, 52; 56; 61, 62
Diseases transmitted by -----	15c, 114-115, 153a	7, 61, 73
Life cycle of -----	116	61
Flies (<i>See also</i> Black, Stable, and Sand flies.):		
Characteristics of -----	107	59
Control of -----	75e, 77b, 90c(2)(b), 108-112	38, 43, 51, 60
Diseases transmitted by -----	15c, 23a	7, 11
Life cycle of -----	106	59
Fomites -----	15e	7
Food:		
Handlers -----	61	30
Importance of -----	33	17
Inspection -----	58	29
Preparation -----	60-62, 180	30, 31, 84
Protection -----	57, 75, 156a	29, 37, 74
Refrigeration -----	59	30
Sanitation -----	55-70	29-36
Serving -----	60-62	30-32
Storage -----	59	30
Foot marches -----	32f	16
Frostbite -----	183c	85
Fruit -----	62a, e	31, 32
Fungous infections -----	178	84
Garbage disposal -----	83, 156a	46, 74
Gnats, eye -----	135	67
Grease traps (<i>See</i> Devices, hygiene and sanitation.)		
Hand-washing device (<i>See</i> Devices, hygiene and sanitation.)		
Heat:		
Cramps -----	177c	83
Exhaustion -----	175b, 177	82, 83
Injury -----	172c	80
Prickly -----	177e	84
Radiant -----	172-173	80
Stress -----	172c	80
Heatstroke -----	177b	83
Humidity, relative -----	172-173	80
Hygienic devices, improvised -----	42-45	19-20
Ice -----	57, 59c	29, 30
Iceboxes -----	59b	30
Illness, prevention of -----	17-21, 22b, 23b, 24b, 25b, 36-41	8, 9, 11, 12, 13, 17-19
Immersion:		
Foot -----	32e, 183b	16, 85
Heater (<i>See</i> Devices, hygiene and sanitation.)		
Immunity -----	21	8
Immunization -----	20b, 21a-b, 22b(2), 164b, 165b, 172c	8, 9, 10, 77, 80
Incinerators (<i>See</i> Devices, hygiene and sanitation.)		
Insect-borne diseases -----	24	11
Insecticide:		
Dispenser -----	90c(2)(c), 91e, 101-102, 111a, 120	51, 53, 57-58, 60, 62
Equipment -----	90d	52

	Paragraph	Page
Insecticides -----	90 <i>b</i> , <i>c</i> (2); 100; 111; 118-121; 127; 130; 132 <i>d</i> ; 133 <i>b</i> ; 134 <i>b</i> ; 137 <i>e</i> (1); 138 <i>c</i> ; 139 <i>c</i> ; 142; 145; 153 <i>a</i> ; 158 <i>b</i> (4)	50, 51; 56; 60; 61-62 64; 65; 66; 67; 67; 69 69; 70; 71 73, 75
Insects -----	15 <i>c</i>	7
Investigation of disease outbreak -----	23 <i>c</i>	11
Iodine purification tablets -----	54	28
Isolation -----	18 <i>b</i> , 22 <i>b</i> (8)	8, 10
Ivy, poison -----	168	78
Kissing bugs:		
Control of -----	139 <i>c</i>	69
Habits of -----	139 <i>b</i>	69
Medical importance of -----	139 <i>a</i>	69
Kit:		
Chlorination -----	53 <i>b</i> (8)	26
Mess -----	66	33
Knapsack filter unit -----	53 <i>a</i>	25
Latrines (<i>See also</i> Devices, hygiene and sanitation.)		
Closing of -----	75 <i>f</i>	38
Construction and maintenance of -----	75, 76	37, 38
Leeches:		
Medical importance of -----	161	76
Protective measures for -----	162	76
Leftover food -----	62 <i>f</i>	32
Lice:		
Characteristics of -----	97	55
Control of -----	90 <i>d</i> (3), 98-102	52, 56-58
Diseases transmitted by -----	15 <i>c</i> , 94-95	7, 55
Life cycle of -----	96	55
Maintenance of manual -----	1	3
Malaria discipline -----	91	53
Meat products -----	62 <i>c</i> , <i>d</i>	31, 32
Mental disorders, prevention of -----	40	18
Mess:		
Devices for washing -----	69-70	36
Facilities, cleaning of -----	64	32
Kit, cleaning of -----	66	33
Sanitation -----	22 <i>b</i> (6), 23, 83	10, 46
Utensils, cleaning of -----	65	32
Midges (<i>See</i> Biting midges.)		
Milk -----	62 <i>b</i>	31
Mites:		
Characteristics of -----	128	64
Control of -----	90 <i>c</i> (2)(<i>b</i>), 91 <i>a</i> , 127 <i>b</i> , 130	51, 53, 64, 65
Diseases transmitted by -----	15 <i>c</i> , 129, 153 <i>e</i> , 167	7, 64, 73, 78
Life cycle of -----	128	64
Mosquitoes:		
Characteristics of -----	88, 179 <i>b</i>	49, 84
Control of -----	90-92, 100 <i>b</i>	50-54, 56
Diseases transmitted by -----	15 <i>c</i> , 86	7, 48
Life cycle of -----	87	49
Types of -----	85	48
Oak, poison -----	168	78
Organisms, communicable disease -----	11	6
Overcrowding, avoidance of -----	22 <i>b</i> (3)	10

	Paragraph	Page
Parts per million (ppm) -----	47 <i>k</i>	22
Personal hygiene -----	3 <i>a</i> ; 18 <i>a</i> ; 20 <i>a</i> ; 22 <i>b</i> (1), (6); 23; 26-45; 60; 129; 166 <i>b</i> ; 167 <i>b</i>	3; 8; 9, 10; 14-20; 2-4; 78
Pits (<i>See</i> Devices, hygiene and sanitation.)		
Poisoning:		
Carbon monoxide (CO) -----	183 <i>e</i>	86
Plants -----	186 <i>b</i>	86
Prophylaxis -----	20 <i>c</i> , 22 <i>b</i> (7)	8, 10
Punkies (<i>See</i> Biting midges.)		
Purpose of manual -----	1	3
Quarantine -----	18 <i>c</i>	8
Rats (<i>See</i> Rodents.)		
Recreation -----	35	17
References -----	app	87
Refrigeration of food -----	59	30
Repellent, insect -----	91, 121, 127 <i>b</i> , 130 <i>c</i> , 134 <i>b</i> , 135 <i>b</i> , 137 <i>e</i> (3), 138 <i>c</i> (2), 159 <i>a</i> , 162, 179 <i>b</i>	53, 62, 64, 65, 67, 69, 75, 76, 84
Report of disease outbreak -----	23 <i>c</i>	11
Responsibilities:		
Army Medical Department -----	6, 48 <i>c</i> , 52, 56 <i>c</i> , 59 <i>c</i> , 61, 62 <i>b</i> , 73 <i>b</i> , 89 <i>b</i> , 90 <i>c</i> (2) (a)	4, 23, 25 29, 30, 31, 37, 50
Combat service support units -----	8, 56 <i>b</i> , 73 <i>c</i> , 136 <i>b</i>	51 4, 29, 27, 67
Commander -----	5, 28 <i>a</i> , 48 <i>a</i> 56 <i>a</i> , 73 <i>a</i> , 74 <i>a</i> , 89, 170, 173 <i>c</i> , 175	3, 14, 22 29, 27, 50, 80, 81, 82
Dental personnel -----	6 <i>e</i> , 28 <i>d</i>	4, 14
Engineers, corps of -----	7, 48 <i>b</i> , 52 <i>c</i>	4, 22, 25
Entomologist -----	6 <i>b</i>	4
Field sanitation team -----	5 <i>c</i> ; 24 <i>b</i> ; 56; 73 <i>a</i> ; 89 <i>a-b</i> ; 90 <i>b-c</i> (2) (a), (3) (b); 156; 158 <i>a</i>	4; 11; 29; 37; 50; 51; 74; 75
Individual -----	9, 22 <i>b</i> (1), 28 <i>a</i> , 48 <i>d</i> , 54, 66, 74 <i>a</i> , 91, 99, 121, 127 <i>b</i> , 130 <i>c</i> 156 <i>a</i> , 170, 181, 183	5, 9, 14, 23, 28, 33, 37, 53, 56, 62, 64, 65, 74, 80, 84, 85
Mess officer -----	56 <i>a</i> , 58 <i>a</i> , 60	29, 30
Preventive medicine:		
Officer -----	69 <i>a</i> , 158 <i>b</i>	36, 75
Units -----	6 <i>d</i> , 92, 99, 127, 135 <i>b</i>	4, 54, 56, 64, 67
Sanitary engineer -----	6 <i>b</i>	4
Surgeon, command -----	5 <i>b</i> ; 6; 28 <i>c</i> ; 53 <i>b</i> (2), <i>d</i> ; 58; 61; 99	3; 4; 14; 26; 29; 30; 56
Veterinary officer -----	6 <i>c</i> , 58, 165 <i>b</i>	4, 29, 77
Rest -----	35	17
Rodents:		
Characteristics of -----	154-155	74
Control of -----	92, 156-157	54, 74-75
Diseases transmitted by -----	153	73
Disposal of -----	159	75
Economic importance of -----	152	73
Signs of -----	156 <i>b</i>	74
Rubbish disposal -----	84, 156 <i>a</i>	47, 74

	Paragraph	Page
Salads	62c	31
Salt requirements	176	82
Sand flies:		
Control of	137e	67
Habits of	137d	67
Life cycle of	137b	67
Medical importance of	137c	67
Sanitation:		
Defined	3b	3
Food, of	57-62	29-31
Mess, of	63-70	32-36
Scope of manual	1	3
Scorpions:		
Characteristics of	144	71
Control of	145	71
Medical importance of	146	71
Screening	90c(3), 110	51, 60
Shaving and washing device (<i>See</i> Devices, hygiene and sanitation.)		
Shoes, properly fitted	32b	16
Shower (<i>See</i> Devices, hygiene and sanitation.)		
Skin conditions, prevention of	166b, 167b, 168c	78, 79
Snakes:		
Characteristics of	148	72
Medical importance of	150	72
Prevention of bites from	149	72
Snow blindness	183d	86
Snowburn	183d	86
Socks, properly fitted	32c	16
Sources of disease (reservoir)	13, 14	166
Spiders	140-143	70-71
Sprayer, hand pressure:		
One-quart	90d(2)	52
Three-quart	90d(2)	52
Two-gallon	90d(1)	52
Stable flies:		
Control of	134b	67
Life cycle of	134a	67
Medical importance of	134a	67
Sumac, poison	168	78
Sunburn	177d	83
Sunglasses, improvised	183d	86
Sunstroke (<i>See</i> Heatstroke.)		
Surveillance, medical	18d	8
Susceptible person	13, 16, 20, 22a	6, 7, 8, 9
Teeth and mouth, care of	31	15
Temperatures:		
Cold	179-183	84-86
Hot	171-178	80-84
Tent liners	90c(3)(a)	51
Thermometer:		
Dry-bulb	173b(1)	81
Globe, in	173b(3)	81
Wet-bulb	173b(2)	81
Ticks:		
Characteristics of	126b	64
Control of	90c(2)(b), 91a, 127	51, 53, 64
Diseases transmitted by	15c; 125; 153d, f	7; 63; 73
Life cycle of	126a	64
Removal of	127c	64
Transmission of disease (vehicle) (<i>See also</i> Diseases.)	13, 15	6, 7

	Paragraph	Page
Treatment of:		
Fruit, raw -----	62	31
Vegetables, raw -----	62	31
Water -----	47e, 53-54	22, 25-28
Trenches (<i>See</i> Devices, hygiene and sanitation.)		
Trench foot -----	183a	85
Urine disposal (<i>See</i> Devices, hygiene and sanitation.)		
Vaccination -----	21a(2), 94	9, 55
Vegetables, raw -----	62a	31
Venomous animals -----	140-150	70-72
Ventilation -----	22b(4), 183e(3)	10, 86
Waste disposal -----	71-84	37-47
Water:		
Bag, purification -----	50b	23
Boiling -----	53d, 62a(2)	28, 31
Brackish -----	47d	22
Canteen, treated in -----	54	28
Chlorination -----	53b	26
Containers, emergency -----	50c	24
Contaminated -----	47b	22
Disinfection -----	47f; 50a(1), c(4); 53b; 54	22; 23, 25; 26; 28
Filter unit, purification -----	53a	25
Heating devices -----	67-68	33
Palatable -----	47c	22
Potable -----	47a	22
Procurement from:		
Engineer water points -----	50	23
Other sources -----	52	25
Protection -----	50b-d, 75	23-25, 37
Quantity -----	49	23
Requirements -----	175	82
Sources -----	52	25
Supply, field -----	46-54	22-28
Testing -----	53b(5)	27
Trailer and tank truck -----	50a	23
Treatment -----	47e, 53-54	22, 25-28
Wet bulb globe temperature (WBGT) index -----	173	80

By Order of the Secretaries of the Army and the Air Force:

W. C. WESTMORELAND,
General, United States Army,
Chief of Staff

Official:

KENNETH G. WICKHAM,
Major General, United States Army,
The Adjutant General.

JOHN D. RYAN, *General, USAF*
Chief of Staff

Official:

JOHN F. RASH, *Colonel, USAF*
Director of Administration

Distribution:

Army:

To be distributed in accordance with DA Form 12-11 requirements for the individual soldier.

Air Force:

F