

# Scientific American.

THE ADVOCATE OF INDUSTRY, AND JOURNAL OF SCIENTIFIC, MECHANICAL AND OTHER IMPROVEMENTS.

VOLUME VII.]

NEW-YORK, MAY 22, 1852.

[NUMBER 36.

THE Scientific American,

CIRCULATION 16,000.

PUBLISHED WEEKLY

At 128 Fulton street, N. Y., (Sun Buildings),  
BY MUNN & COMPANY.

Hatchkiss & Co., Boston.  
Dexter & Bro., New York City.  
Stokes & Bro., Philadelphia.  
Jno. Thomson, Cincinnati, O.  
Cooke & LeCount, San Francisco, Cal.  
Courtenay & Wienges, Charleston, S. C.  
John Carruthers, Savannah, Ga.  
M. Boullemet, Mobile, Ala.  
Sidney Smith, St. Louis, Mo.  
Barlow & Co., London.  
M. M. Gardissal & Co., Paris.  
Responsible Agents may also be found in all the principal cities and towns in the United States.  
Terms—\$2 a year—\$1 in advance and the remainder in 6 months.

## RAIL-ROAD NEWS.

### Indiana and Ohio Central Railroad.

Among the roads which will meet with an early completion is the Indiana and Ohio Railroad. This important link commences at Crestline, 78 miles southwest from Cleveland, and runs to Fort Wayne, Ind., a distance of 131 miles. The amount of stock taken to January, 1852, is \$711,000—being about one-half the entire cost of the road, independent of the right of way, which will no doubt be negotiated upon favorable terms. The region through which this road passes, though comparatively new, is increasing in population and wealth in a greater ratio than any other part of Ohio, and Allen County, Ind., has increased in population nearly 200 per cent., within the last ten years.

### Dangers of Railroads.

Many accidents happen through carelessness of thoughtful forecast. On Thursday the 6th inst., four young ladies were killed on the Watertown and Rome Railroad, this State, while amusing themselves on a hand-car. They thought all the trains for the day had passed, and while they were on the track a freight train suddenly came upon them; they then became paralyzed, and before they could jump off, were mangled in a fearful manner. This accident, we trust, will be a warning to others. When will the time come for our Railroads to be enclosed?

A locomotive engine factory is about to be established at Montreal, C. E. A company from Dundee, Scotland (Kimmond & Co.), is the firm. They must build upon the principle of American locomotives, not those of England and Scotland, to be successful. Wood will be used for fuel, and the roads are different, so that the same locomotives we use in the States, and best suited for the railroads in Canada.

The citizens of Albany propose to erect a manufactory for building locomotives. It would be a very excellent place indeed for such a purpose.

### Traffic of the Wheeling Bridge.

The passage of horses and cattle over the Wheeling Bridge during the last winter, has been immense. Since the 1st of December the number has probably been not less than 70,000, about double the number passed during the same months last year. Were the bridge not there, this immense amount of western product could not, for a large part of the time, have passed the river at all, but must have remained at the West.

### Honor to Agassiz.

The Paris correspondent of the Boston Atlas states that the Academy of Sciences, of France, at their last session, unanimously voted to give the Cuvier prize to Prof. Agassiz for his "Recherches sur les Poissons Fossiles." This is the first time the prize has been given.

## SLATER'S HEATING AND FIRE-PROOF BOILER FRONT.

Figure 1.

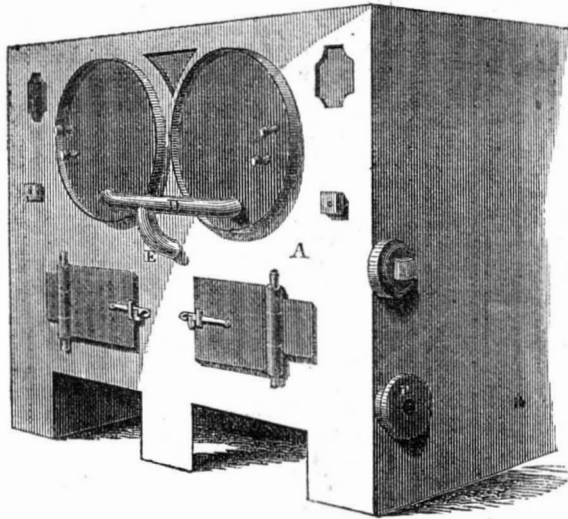
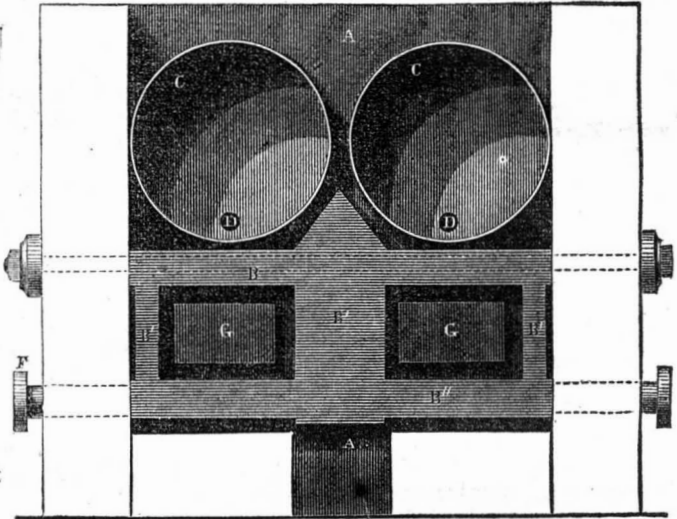

Figure 2.



The accompanying engravings are views of improvements on Steam Boilers, by James Slater, of Macon, Ga., who has taken measures to secure a patent for the same. Fig. 1 is a perspective of the outside front of the boilers and furnaces. Fig. 2 is an inside or back view of the boiler front and furnaces. The same letters refer to like parts.

A is the front plates or casing, through which passes strong screw-bolts on each side, to the back and side plates. Surrounding the furnace doors, B B' B'', and B'', fig. 2, indicate water chambers. The water is fed to the boilers, C C', from the chambers by the pipe, E, and branch-pipes, D, fig. 1. The water is fed into the chambers, B' B', by the pipe, F, which has a flange for coupling with another pipe. On the other side of the front is a pipe

similar to F, which is used for a blow-off; G G are the furnace doors. It will be observed that the water is fed in through the chambers forming part of the fronts of the furnaces, and, in passing to the boiler, it (the water) absorbs a great deal of heat from surrounding the furnace door sides, bottom, and top, and it passes into the boiler at a considerable high temperature. This preserves the fire box of common furnaces, while, at the same time, it economizes fuel by enlarging the heating surface in a very simple manner, without taking up any more space. According to the way in which the water is thus fed into the boiler or boilers, the sedimentary must all—or nearly all—be deposited in the lower feed chambers or passages, B B', before it enters the boiler. The blow-off being placed so low, therefore, the

hole of such matters can be blown out by opening the cock. The boiler or boilers will thus be kept free from incrustations and sedimentary matters. The transverse and longitudinal screw bolts passing through the water spaces keep the plates firm and secure. This boiler front can be cast all in one piece, or in sections with the water passages, or it can be made of good plate-iron. The figures, with this explanation, will enable any mechanic, or reader of the Scientific American, to understand the improvements claimed by the inventor. The boilers are the same as those in common use. The water chambers and the mode of keeping sediment out of the boilers, are the peculiar features of the improvement. More information may be obtained by letter addressed to Mr. Slater.

## TAFT'S FRICTIONAL COUPLING.—Fig. 1.

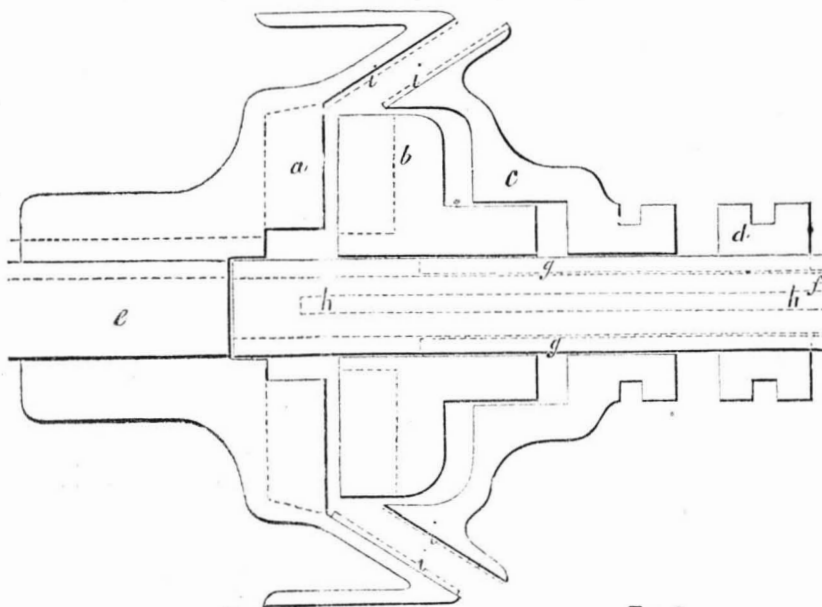
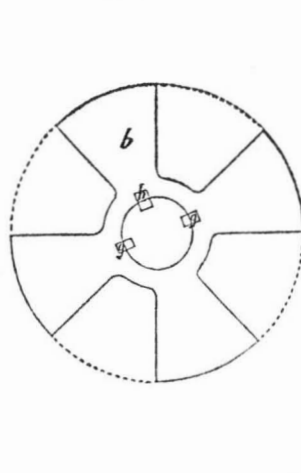
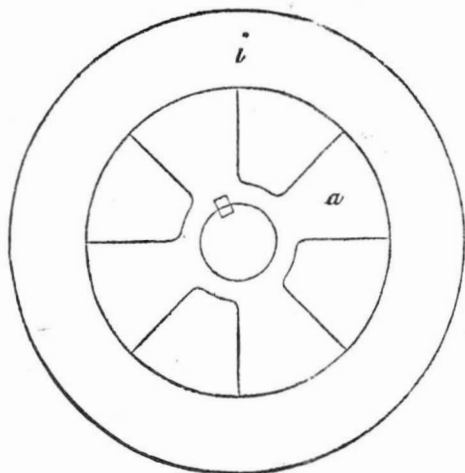

FIG. 2.

FIG. 3.



The accompanying engravings are views of improvements on Shaft Coupling, by George Taft, of Worcester, Mass. Fig. 1 is a longitudinal section, and figs. 2 and 3 are transverse sections; the same letters refer to like parts on all the figures. a is a coupling, made fast to the driving-shaft, e and b is its tallow, which slides upon the shaft, f, and is connected to the collar, d, by the rods, g g, which move freely in groves in the shaft, f; c is a friction coupling, having its face, i, covered with leather, to work with the face, i, of the coupling, a; h h is a spline to convey motion from couplings b and c to shaft f.

All consumers of power have long felt the necessity of some device that would enable them to bring to rest, and start again, sectional parts of a main line of shafting, without stopping the engine. Such an improvement becomes peculiarly necessary in large establishments, where power is hired out to different tenants, and where the end of the line is remote from the engine. There have been some ingenious frictional devices proposed to accomplish this desirable result, which, however, have failed in practical use; the sudden throwing on or off of working belts, causing a momentary slip of the frictional contact. To combine all the good qualities of the frictional yielding clutch, with the rigid security of the lock coupling, has been the object of Mr. Taft's efforts. The section of shaft at rest is gradually brought up to the velocity of the moving sections, by frictional contact of a divided pulley, one half of which is keyed to the one section of shafting, and the other moving on a spline on the other section. When both shafts are revolving with equal velocity, their unity of motion is secured against all accident by a rigid locking of the two sections, which relieves the frictional surfaces from strain. The value of devices of this kind depends on the simplicity and permanency of their combinations, and we think

that an examination of the diagram sections accompanying this will satisfy every mechanic that both of these requirements are met.

More information about it may be obtained by letter addressed to Mr. Taft.

## MISCELLANEOUS.

### California a Hundred and Fifty Years Ago.

About the year 1701, a missionary named Francis Maria Pocolo, published a description of California, from which we extract the following scientific statements:

The climate is very healthy. Along the coast the heat is great, and it seldom rains; but the air of the inland is more temperate. In April, May, and June there falls with the dew a sort of manna, which congeals on the leaves of reeds—sweet as sugar, though not so white. The country abounds in large plains, pleasant valleys, and excellent pastures; the rivers contain plenty of fish, especially xicames and crawfish. On the mountains are mescales all the year round, besides figs of different colors, pistachios (*Pistacia vera*), and palo santo. The natives feed on fourteen sorts of grains, and make bread of the yuca; skirrets (*sium sisarum*), a species of red strawberry and mammoth citrons and watermelons also abound. The land is so good, most plants bear three times a year. The animals are numerous: among them we found two sorts of deer that we knew nothing of: one is as large as a calf, having the head of a stag, the horns of a ram, the hoof of an ox, and a speckled tail; the other resemble sheep, but have more wool. As for fowls, there are in California all that there are in Mexico and New Spain. The sea affords plenty of good fish—pilchards, anchovies, and tunnies, which last are caught with the hands. The shores are covered with heaps of shells. Salt is procured from pits; it is as bright as crystal, and so hard it is necessary to break it with hammers. The coasts are famous for the pearl fishery. I doubt not but there are mines to be found in several places, if they were sought for: since the country is under the same degree as the provinces of Cinalao and Sonora. Yet the Californians, amidst this plenty and riches of their country, content themselves with what is only necessary for life. The inland parts of this region, towards the north, are very populous. The common employment of men and women is spinning; they make their thread of long plants, or else of a cotton-like substance found in the shells of some sorts of fruit. They have a great deal of liveliness, and are naturally addicted to raillery, but we found no form of government or religion.

### Honey Trees in California.

As California has been established a land flowing with gold, it will soon come to be the definition of a land flowing with honey. One of the papers in Stockton states that in the region round, there is to be found an abundance of saccharine matter of delicious flavor. It is to be found on different descriptions of trees, and in different forms. On the leaves of the willows which grow upon the banks, it is found in a candied form, on the upper surface, early in the month of July. The Indians gather the sugar, and at their encampment, enjoy the luxury of chewing the leaves. On the leaves of the white oak, also, there is a clear deposit of honey, which is as transparent and fine as the article is ever seen, but it is of thicker consistency. Here, also, it collects on the upper foilage until the latter is borne down, when the saccharine matter drops in masses or lumps. Its flavor is exceedingly pleasant. On the ascent of the Sierra Nevada there is a species of pine, much resembling the white pine of the Atlantic States, except that the leaves turn down. This tree grows to an enormous size—270 feet in height, and 30 feet in diameter at the base; and sometimes the trunk runs up 180 feet, almost without a limb or crook. The resinous matter which exudes from the bark has a rich saccharine flavor. The Indians eat it in large quantities.

### Camphene Lamps.

At a meeting of the American Academy of Arts and Sciences, at Boston, on Thursday the 6th inst., Prof. Hosford exhibited the tin

camphene vessel whose explosion at Salem caused the death of a female in the room where it took place. The stopper of the vessel was still in its place, from which it had not been driven by the explosion. Prof. H. submitted a satisfactory explanation of the manner in which the explosion was probably occasioned. He also exhibited the fragments of a glass camphene lamp which had exploded, seemingly without contact with the flame, in the hand of a lady at Hamilton. It is evident from these and other instances of the kind, that the use of highly inflammable burning fluids is attended with considerable danger, in cases where no apparent contact with fire takes place.

### Cultivating Potatoes.

"All experience shows that flowers of the potato are produced at the expense of that organizable matter which gives its value to the tuber, and which is diminished in quantity as in proportion to the number of flowers that have been fed; for flowers must exist and feed on something, and that something is what would, if not removed by the flowers, descend beneath the ground, and collect itself in the tubers. The mere production of flowers is a loss; but the mischief is infinitely increased if the flowers are succeeded, as they almost always are, by the berries."

Mr. Editor—the above I have seen in a number of papers, and as some excellent things have been published in the Sci. Am., on potatoes, I must say so far as opportunities of observation have been presented to me while travelling in various countries, the above is not correct. In England and Ireland the potatoes always flower and produce "plumbs" as they are termed which somewhat resemble yellow tomatoes. And I must say that no finer potatoes are produced in any other countries whatever than in these. I have seen a field of 100 acres of potatoes in blossom at once, and a more beautiful sight cannot possibly be imagined. I suppose that climates have a different effect upon potatoes in respect to their flowers. Our potatoes never produce plumbs like those in England. It would be a new idea to introduce into agriculture, viz., "the mischief of potatoes flowering." R.

### The Great Britain Screw Steamship Again.

This noble vessel, the largest steamship afloat, arrived at this port on last Friday, at noon. She left Liverpool on the 1st, at 9 A. M., thus making the passage in 13 days and 3 hours, having beaten the Washington, a paddle-wheel steamer, two days. It is now five years since she visited our shores before, since which time she has occupied public attention, perhaps, more than any other vessel ever built. Her beaching in Dundrum Bay; the skill called out to extricate her from the perilous position in which she was placed, and her long, long inglorious repose in dock, are things with which all are familiar. She is built of iron no wooden vessel would have undergone what she has. She has been completely refitted and renovated. Her tonnage is 3,500 tons.

She has ten keelsons of three feet in depth, running the entire length, strengthened by transverse floors every three feet,—the whole being covered by a wrought iron platform. Her frame, for the space occupied by the engine and boilers, and for ten feet beyond at each end, is of double angle irons only eighteen inches apart. Three double lines of angle iron stringers run under each dock, and the stern and bow are both still further strengthened by a series of deep shelves of wrought-iron, while to the latter there are heavy breast-hooks in addition. The decks are supported throughout by strong wrought-iron stanchions, based on the lines of keelsons, and carried thence continuously to the upper deck. The space occupied by the machinery is fastened in the strongest way by seven wrought-iron box beams and six iron-plated beams, secured in each case to a large surface of the ship's frame. The engine-bearers are of the height of the platform, weigh many tons, and, together with the gearing and thrust beams, are of wrought-iron, of hitherto unparalleled strength. Five water-tight bulkheads divide the ship: three through her entire height to the main deck—one being placed at either end of the engines and boiler space, so as entirely to inclose them, while two are carried

up as high as her lower deck. The coal bunkers are entirely of iron, on each side of the machinery, and on the forward platform. The engines are a beautiful pair of oscillators, by John Penn & Son, of London, with 82-inch cylinders and 6 feet stroke. The principle of the geared engine has been adopted, in order that full advantage might be taken of the comparatively fine pitch of the screw, which has been fixed at 19 feet, its diameter being 15 feet 6 inches. The diameter of the driving wheel is 14 feet, and of the pinion, 4 feet 8 inches, the entire breadth of both being 4 feet; and the jarring, usual in wheel gearing, is prevented by its division into four parts placed slightly in advance of each other. The boilers, six in number, with two funnels, are also made by Messrs. Penn & Son. They are tubular, and are so arranged that they can be used collectively or separately, as occasion may require. There are eight pumps placed in different parts of the ship, independent of the bilge pumps, in connection with the engine. In addition to the Great Britain being of iron, with an iron deck over her boilers and engines, every arrangement has been made to guard against the possibility of fire. There is nothing but iron near the funnels, which have two outside iron castings. The galleys are placed upon iron decks, on stands of the same metal, with a free circulation of air beneath. A pipe from the boiler will enable a jet of steam to be directed, in a moment's notice, to all parts in the immediate neighborhood. A hose, attached to the fire engine, will reach from one end of the ship to the other, and fire annihilators will be kept ready in different parts. Ten life boats are carried—eight on davits, which will require only one person to lower them; and are so hung as to render it impossible for them to reach the water except on an even keel, while an arrangement will be made enabling the two on deck to be lowered with great ease and rapidity. Second to no other steamship of her class, the Great Britain spreads on her four masts nearly 13,000 yards of canvas, and fairly competes with any sailing vessel in the world.

We are glad to see the Great Britain on her legs again. She will test the value of oscillating engines, and give us some more data on the economy and utility of the screw.—Her steam arrangements to prevent fires are good. All steamships should adopt the same plan. May she long be a regular sailer on our seas.

### Compliment to Mr. Squier.

At the last meeting of the French Geographical Society, where the annual prizes were rewarded to those, who in the judgment of the society had made the most important discoveries during the past year, one of the distinctions of this kind was bestowed upon E. G. Squier, late U. S. Charge to Nicaragua in reward of his archaeological discoveries, particularly those made in the last named country.

### Astronomical.

Lieutenant Maury states officially, that the Asteroid discovered by Gasparis on the 17th of March last, was observed at the National Observatory at Washington, by Mr. James Ferguson, with the filar micrometer of the large Equatorial, on the 6th, and again the 7th instant.

This Asteroid has the appearance of a star of the 10-11 magnitude, and makes the 16th in the group between Mars and Jupiter.

The longest known current of modern lava on the earth is in Iceland, extending 60 miles; while from the foot of the largest volcanic cone on the southern limb of the moon diverging streams of lava flow to the distance of 600 miles.

An animal performs the greatest quantity of work in the least time, when it moves with one-third of the utmost speed with which it is capable of moving, and is loaded with four-ninths of the greatest load which it is capable of putting in motion.

Proportions of the earth's equatorial and polar diameter:—according to Bernoulli and Maupertius, 129 to 128; Bouguer, 179 to 178; Newton, 230 to 220; La Place, 334 to 333; Huygens, 578 to 577.

### Handling Red-hot Metal.

M. Boutigny, the celebrated Frenchman, recently astonished the members of the Royal Institution in Albemarle street, London, by delivering a lecture, with experiments, on the spheroidal condition of liquids when brought into sudden contact with heated surfaces. M. Boutigny commenced by heating a metal plate red-hot, and dropping upon it a small quantity of water. The liquid, instead of coming into contact, as might have been imagined, with the heated metal, and expanding into vapor, remained at an appreciable distance, and continued at a temperature far short of boiling. On removing the flame from the metal plate, and consequently diminishing the amount of heat, the water came into contact with the metal, burst violently into steam, and escaped. M. Boutigny now, instead of using the metal plate, took a silver bottle, which may be considered the representative of a steam-engine boiler. This bottle he made glowing hot, and pouring water into it, corked the bottle securely, and removed the lamp. For a few seconds the apparatus remained tranquil; but no sooner had a sufficient amount of heat escaped to permit of contact with the water, than the latter violently expanded, and forced out the cork with a loud explosion. M. Boutigny remarked, that artificers well knew the difficulty of tempering highly heated steel, and explained the difficulty by reference to the spheroidal condition of water, into which it is plunged. M. Boutigny concluded a series of well-devised and demonstrative experiments by dipping his hands, only moistened by the tongue, into molten lead. Molten iron, he told his audience, would have been quite as innocent, the only danger being lest the hand be plunged into the metal just as it is solidifying, when a permanent fixation of a most destructive kind would result.

### Cure for Cancer.

A Mr. Benson, of Franklin county, Tenn., has been cured of a cancer by the following means:—He procured a peck of cleaned oak bark, by first cutting off the rough outside, and put it into a vessel containing about two gallons of water, which he boiled over a slow fire until the ooze became quite strong, when he strained it through a cloth to remove all the particles of the bark, then he again put it into a clean vessel and simmered it over a slow fire, till it came to the consistency of molasses, when it is fit for use. It is then spread upon a piece of silk or other soft rag, and applied to the diseased part. He used about two plasters each week, until the cancer was removed and the wound healed. He says it is not painful, but believes it an infallible remedy.

[The above we copy from an exchange. We neither endorse nor discredit it, for cancer is a disease which baffles our greatest doctors' skill. The asserted remedy can easily be tried; it is merely a strong astringent, and experiment alone can discover the remedy if there be one.]

### Bushy Tomatoes.

Those who love good tomatoes will take pains to cultivate them so as to insure them as near as may be in their full perfection.—There is no other fruit that delights more in air and sunshine than the tomato. They should have, therefore, abundance of room, and the vines be sustained from falling to the earth. Stout brush firmly set around the plants, answer the purpose better than any other method. The branches have room to extend themselves as they like, while the limbs of the brush keep them in their positions. By this method the fruit is more fully exposed to the genial influences of the air and sunshine; whereby it attains a more delicious flavor, larger size, and comes quicker to maturity.

### Collins' Line of Steamers.

It is expected by all the friends of this line that the bill appropriating \$33,000 per trip, will pass the Senate and House of Representatives. Many of the Senators have opposed it conscientiously, but we incline to the opinion that the measure of relief is necessary, honorable, and of paramount importance to our country.

\*The quantity of land in the northern hemisphere is to that in the southern as 16 to 5



**Engineers' Institute of New York City.**

TO THE ENGINEERING PROFESSION AND THE PUBLIC,

Many inquiries and much misrepresentation being made as to the objects of this Association, it has been deemed advisable, in justice to its members, and others interested in the success of institutions of a kindred nature, to set them forth fully and explicitly, by an Address drawn up by a special committee, and approved of by its members at a regularly organized meeting.

The Engineers' Institute, in its membership, comprises engineers, draughtsmen, machinists, pattern-makers, and apprentices in the above-named branches, being organized on the 25th of October, 1849, by the election of Alfred Stillman, Esq., as its first President, whose melancholy death has deprived us of a warm and valued friend, and an active, energetic supporter of its objects.

Any Association that has for its object the advancement of human happiness by the diffusion of useful knowledge, tends to ameliorate the condition of mankind, and to lessen the ills and miseries incident to the trials and struggles of life: as such, we conceive it to be worthy of approbation, and entitled to the warmest support and admiration of all capable of appreciating the benefits which mankind at large reap by the increased intelligence of the artisan, to whom it is indebted, in a great measure, for its numberless enjoyments and luxuries; and as it has been from the artisan class, more especially from our profession, that the great and wonderful inventions and improvements in arts and manufactures have sprung, so it is reasonable to expect that this is the source from whence such improvements will continue to flow; and it may safely be affirmed that he who is most intelligent will be foremost in bringing to light and reducing to practice some great discovery, which shall cause his name to be handed down to future generations, adding another bright page in his country's history of her mechanical skill, and the capability of her artisans to compete successfully with the world at large.

To encourage and aid the mechanic in his studies, to make him acquainted with the theory as well as the practice of his profession—to instil into his mind a taste for all that is useful and instructing—to impress upon him the necessity of acquiring knowledge,—to enable him to keep pace with the improvements of the age, and to elevate him by these means above the low level in which he has too often been held, and enable him by intelligence, industry, and perseverance to assume a position in society to which, by the possession of these, he is entitled to, and will assuredly attain,—these, and these only, are the objects of the Engineers' Institute.

The reports and misrepresentations made by malicious and reckless persons, to employers and others, that its object is that of combining to obtain a high rate of wages, foment strikes, and otherwise to work against their interests—we unequivocally and emphatically deny; as also the truth of the reports which have been so industriously circulated by the same class of persons, that another object of our Association is that of driving from the profession, and depriving of a living, those of our brethren who have not served a time to the mechanical part of the business, and are employed as engineers on board our steamboats, and in establishments where steam power is used. It is true, the conditions of membership is confined to those only who, in the general acceptance of the term, are practical men; but it does not follow, nor is it the case, that this Institute, as a body, have, in any manner or shape, from the date of its organization to the present time, sought to interfere with, or injure, those belonging to this class. We therefore desire it to be distinctly understood by employers, steamship and steamboat owners, and the class of engineers referred to, that this Institute has not sought, nor is it the object of its organization, to injure, directly or indirectly, present or prospective, the interests or rights of any one. The sayings and doings of other than members, and even some one or more of them, acting individually, the Institute, as a body, cannot, nor would it be just that it should, be chargeable with, any more than society at large can be for the acts of any one or more of its members; we desire only, by its existence, to afford knowledge and in-

struction to those desiring to avail themselves of it, and by so doing, confer a benefit on others as well as ourselves.

The means provided to carry out the objects of this Institute, consist of a Library and Reading Room, which is open every evening throughout the week, with weekly meetings on Thursday evenings for the transaction of business; also classes for mathematics and drawing. One of the most important and interesting features of the weekly meetings consists in descriptions of and debates on all the prominent inventions of the day, as well as on subjects connected with or bearing on the principles and practice of our profession. The nature of these discussions will be seen from the following subjects now pending:—"Safety Valves—their construction and application;" "Ericsson's Caloric Engine;" "Will a Condensing Engine work without a foot valve; if so, what construction of air pump is required?" By these means an unlimited amount of theoretical and practical information is diffused among its members. The classes in mathematics and drawing are a valuable auxiliary to the acquisition of knowledge imparted by these discussions, independent of which it affords the means to many, particularly apprentices and young men, of employing, to great advantage, their leisure hours, in supplying that void in their education, which, in many cases, the necessity of having to earn a livelihood for themselves, and support widowed mothers, sisters, and brothers, early in life, has imposed.

To carry out the above objects efficiently, we should possess a good library, as also be well supplied with the current scientific and mechanical publications of the day, issued here and in Europe, likewise commodious reading and class rooms, but we are sorry to say that one room has to answer all these purposes; and our income being very limited—that only arising from members' dues, which are very small, it is scarcely sufficient to pay rent, light, fuel, and other incidental expenses—we have therefore been unable to appropriate any funds toward our library, which is extremely small, almost deficient of standard scientific and mechanical works, which are very expensive; and even the little we do possess consists of works given or loaned to it by its members, and a few from others, whilst we are entirely without the many scientific publications that are constantly to be found on the tables of other institutions.

In view of these facts, and the incalculable good that this Institute is capable of doing, if its objects are efficiently carried out, which can only be done by aids afforded us by the philanthropist, and liberal-minded of our profession who possess more of this world's goods than ourselves.

We are therefore induced earnestly to appeal to employers, and all others disposed to afford encouragement and assistance to our enterprise, to aid us by donations in money, books, or otherwise, and those disposed to aid us by the loan of books, drawings, models, instruments, &c., may rest assured that the same will be thankfully received and religiously taken care of.

Having taken the preliminary steps to become incorporated, and a Board of Trustees appointed, is a guaranty to all who may respond to our appeal, that the same will be honestly and faithfully administered, to forward and carry out the objects for which this Institute is founded; and all communications addressed to W. H. Lindsay, Corresponding Secretary, Engineers' Institute, 151 Bowery, corner of Broome street, will receive prompt attention.

In conclusion, we trust that all other considerations aside, national pride will not allow us to appeal in vain to those who have the heart and means to aid and sustain our mechanics in the proud position they have already achieved in the struggle going on between them and those of other nations, for supremacy, by placing us on a par with them in the facilities of acquiring knowledge. Our rivals, we are well aware, have not appealed in vain to their countrymen for aid—and they have responded nobly and with a will, for which we honor them. We have had to contend with them, unaided, against the experience and the advantages so liberally furnished by those who feel their country's honor is at stake, and in maintaining the unequal contest

have been dependent solely on our own energy, perseverance, and talents. So far we have reason to be proud in saying that the national honor has not suffered in the struggle at the hands of her engineers; and, without egotism, we may also be permitted to say, that, thus far, we are the victors, whether we shall retain it depends, in a measure, no less on our countrymen, in aiding and sustaining us, than on ourselves. But, aid or no aid, we shall still manfully and honorably contest the superiority,—without aid, impregnable in the indomitable will, perseverance, and self-reliance, with which we shall continue to contest it; and with aid, confident in the belief that the same advantages, a clear field, and no favor, the Engineers of the United States will not only maintain the laurels they have already contributed to entwine around their country's name, but, at no distant day, achieve triumphs which, whilst shedding a brilliant lustre on the national escutcheon, bespeaking the intelligence and skill of her artisans, will aid in drawing more closely together the great family of Nations, and contribute, in no small degree, to place her permanently at their head in arts, science, and manufactures.

WILLIAM B. LINDSAY,  
GEORGE P. CLARKE,  
JOHN B. MOORE, } Committee.

**Coffee, its Properties, &c.**

In the two last numbers of the "New Jersey Medical Reporter," there is a very interesting article on Coffee, "its medicinal, disinfecting, and dietetic properties," by J. Paul, M. D., of Trenton. We will pass over its history, as that has been presented to our readers before, but there are some new points respecting its use, which we have seen in no other work, and since 150,000,000 lbs. of coffee are consumed in these United States every year, no person can be neutral in respect to any thing which may be said about this plant.

As an antifebrifuge, it has long had a high character when drunk early in the morning. It is used for this purpose to prevent fevers, by those living in marshy situations in a tropical climate; and in Batavia it is used for quinine. "It has been recommended to relieve obstinate spasmodic asthma, by taking one ounce of a strong infusion without milk or sugar, the same to be repeated, fresh made, every half hour." The doctor who recommended this, we must say, was not afraid to prescribe any thing. "In headache, from weakness of stomach, contracted by sedentary habits, close attention, or accidental drunkenness, if coffee can be drunk within an hour after dinner, it is said to be of singular use." This may be true, but it would not be wise to use a too strong infusion. Mr. Hannon speaks in high terms of the use of caffeine for those who are depressed in spirits. In diarrhoea and infantile cholera, Dr. Pickford, speaks highly of its valuable effects. He gives one half to two scruples of coffee, in two ounces of water, adding one ounce of syrup and giving a table-spoonful every hour. In bilious diarrhoea, it should be given in small doses, as in large doses it has a purgative effect. For whooping-cough, Dr. Jules Guyot recommends its use: it is given hot, well sugared, about four times every day. He states that he has cured sixty cases with it, and the most obstinate yielded in four days. The "Southern Medical and Surgical Journal," for 1835, states that coffee should not be used by nursing mothers, as it has a tendency to lessen milk secretions, while tea has a contrary effect. We must say, however, that our knowledge of coffee, as a medicine, is but limited, and while it may affect a person favorably in one case, it might affect another person unfavorably.—There is a great tendency to run certain medicines above the standard value, such as cod-liver oil and quinine, and it may be coffee.

As a disinfectant, coffee has been highly lauded; in the "Medical Gazette," for 1849, a writer asserts it possesses the property of rendering animal and vegetable effluvia not only innocuous, but actually destroying them; it overpowered the smell of musk and castor, also the effluvia of decaying meat and sulphuretted hydrogen. The way to use it is to take hot rotted coffee into the places where the effluvia is given off.

For diet, Dr. Jackson states that all aliment adapted to healthy nutrition must be a protein

compound—a combination of carbon, hydrogen, oxygen and nitrogen, (C.40. H.30. O.12. N.8), substances mostly containing nitrogen are supposed by some chemists to be nutritious (the Grahamite theory), but this is an error. The alkaloid of coffee is caffeine, a nitrogenized body, which cannot be ranked as a food. Coffee, however, according to Payer's Analysis, is an alimentary substance, but it cannot rank high as a food, nor can its use, as a chief material of diet, be justified. Dr. Bocker asserts it acts on the nervous system in a peculiar manner, and Dr. Jackson ascertained this by experiments on himself;—large doses produced a diminished appetite, slow digestion, and an uneasiness of breathing similar to asthma. The blood in the veins had a darker tint and the globules did not redden easily by contact with air. Dr. Jackson therefore considers coffee a false aliment, which diminishes the healthy decomposing action of the organs, but it may be employed as a medicine in diseases where metamorphosis is too active, but not in inflammatory cases. Coffee has the property of exciting the nervous system, and may be looked upon as an incentive by rich and a consolation to the poor. It appeases hunger and renders an indifferent meal apparently substantial to the poor, while it excites the rich by its action on the nervous system. Tea and coffee exert the same nervous excitement, for in constitution they are nearly alike, but coffee has the advantage as a nutrient. When fatigued, and weary with travelling, or watching by a sick bed, a cup of tea or coffee exerts a beneficial and enlivening influence. Dr. Jackson, says, that coffee should not be used for food, except in a strong extract, and the cup only half filled with this, the other half being good milk, and the whole well sweetened with sugar. This he calls "a good alimentary drink." The use of large doses of weak tea and coffee, so common at every meal in our country, he deprecates as destructive to the appetite, by rendering more nutritious food unpalatable, thereby tending to impoverish the blood. "The limited and moderate use of coffee, taken conjointly with more nutritious food, is not to be forbidden," says Dr. Paul, "but its immoderate use, to the exclusion of other proper nourishment, is positively injurious." He believes that coffee is injurious to children and to persons of a highly nervous temperament. They should partake of a simple and wholesome aliment that does not stimulate the appetite with a false satisfaction. People whose lives are devoted to severe physical labor should also be careful in the use of coffee,—they should use it but seldom, and never without plenty of milk and sugar; and when they drink it, the evening meal should rather be chosen, when they are fatigued and depressed, than the breakfast, which is the one, by unaccountable custom, at which coffee is now generally taken.

**The Sand in Egypt.**

The sand has played a preservative part in Egypt, and has saved for future investigators much that would otherwise have disappeared. Miss Martineau says, in her "Eastern Life."—"If I were to have the choice of a fairy gift, it should be like none of the many things I fixed upon in my childhood, in readiness for such occasions. It would be for a great winnowing fan, such as would, without injury to human eyes and lungs, blow away the sand which buries the monuments of Egypt. What a scene would be laid open to them! One statue and sarcophagus, brought from Memphis, was buried 130 feet below the mound surface. Who knows but that the greater part of old Memphis, and of other glorious cities, lies almost unharmed under the sand! Who can say what armies of sphinxes, what sentinels of colossi, might start up on the banks of the river, or come forth from the hill sides of the interior, when the cloud of sand have been wafted away?" All will be discovered in good time; we are not yet ready for it; it is desirable we should be farther advanced in our power of interpretation before the sand be wholly blown away. But, in truth, it will need a high wind to do it, begin when it may.

Copper wire, the thirteenth of an inch, will sustain 302 lbs.; lead, 28 lbs.; tin, 34.7 lbs.; zinc, 110 lbs.; silver, 137 lbs.; gold, 150 lbs.

## NEW INVENTIONS.

## Improvement in Time Pieces.

Silas B. Terry, of Terryville, Plymouth, Conn., has invented new and useful improvements in Time-pieces, for which he has taken measures to secure a patent. The improvement is more particularly applicable to "Marine Clocks," but is also applicable to all sorts of "time-pieces." It consists in substituting for the spindle of the balance, a straight, thin, flat spring of steel, or other suitable metal, secured at its ends, so that they cannot turn or otherwise move from their position. The balance is fastened to this spring at about the middle of its length; the said spring must be of sufficient length to allow of its twisting by the vibration of the balance. The object of thus hanging the balance is to avoid the friction of the pivots of the ordinary balance, which soon chafe by use, and require to be often lubricated. The improvement also dispenses with the common hair-spring. Another part of the improvement consists in making what is termed the "fork" or "crutch wire," which transmits the motion from the verge to the balance, very flat or thin, or forming it with a joint, so as to be capable of bending or turning with ease in a direction at right angles to the motion of the pallets of the verge, at the part where it is fastened to the verge, or verge-arbor, from which it extends in line with the axis of the balance, and in fitting its point into a collet attached to the balance, whereby, as it gives motion to the balance, it will move in the same direction, and obviate the excessive friction produced by the common lever, whose motion is at right angles to the arbor of the balance.

## Improvement in Threshing Machines.

James Robinson of West Hebron, Washington Co., N. Y., has taken measures to secure a patent for an improvement in machines for threshing grain. The object of the improvements are mainly to combine the threshing apparatus in such a manner, with a wagon, that the grain can be threshed on the field while the wagon is moving, without taking it into the barn and housing it. Of course, in carrying out this idea, there must be other peculiar improvements in the arrangement of the machinery, to carry it out so as to render it useful, profitable, and practicable.

## Improvements in Pianofortes.

R. E. Letton, of Quincy, Adams Co., Illinois, has taken measures to secure a patent for improvements in Upright Pianofortes. The invention consists in the construction of the frame and the arrangement of the sounding board, metallic plate, and bridges, and also in the action or striking parts. The base or longer strings are placed in a different plane with and oblique to the shorter one, which are vertical.

## Dairyman's Assistant.

Miss Lettie A. Smith, of Pineville, Bucks Co., Pa., has taken measures to secure a patent for a good improvement on a new machine for working butter. For large dairies, one man or a dairymaid will be able, by this improved machine, to work as much butter in the same time as five persons by the plans in common use, and do it with more ease. It is a most commendable improvement, and deserves the praise and consideration of our whole agricultural people.

## Improvement in Paper Making.

Milner Gibson, M. P., in a recent speech made in the House of Commons, on the subject of taxing paper, stated that he had found by experiment that paper can be manufactured in a fit state for the printer, with a beautiful smooth surface, that could be printed upon without drying, and that printing could be carried to a more advanced state—both letter press and engraving—than can now be attained by drying paper and re-wetting it for printing.

## Hydrogen Gas for Singeing Cloth.

In Bradford, England, hydrogen gas, made from water by White's process, has been employed by a Mr. Sister for singeing cloth. This, we believe, is a good improvement, as this gas gives out great heat, and the expense of decomposing carbonic gas, to mix with it,

is dispensed with. Some of our cloth manufacturers and bleachers might do worse than try this process.

## Improvements in Ventilation.

In Vol. 6 of the Scientific American, we published a description of Ruttan's System of Ventilation; it was illustrated with eight engravings, on pages 299 and 317, said volume. It has been very difficult to get his system in-

duced into our part of the country; there is a spirit of conservatism, even to indifferent and useless things, which seems to stand in the way of many good inventions. One man has had the spirit and enterprise to try it; he is John L. Shorey, Principal of the Howard School, Lynn, Mass. A spontaneous certificate from him is now before us; he speaks of it exultingly, and says, "it has given him a new lease of life."

## GUTHRIE'S WATER INDICATOR FOR BOILERS.

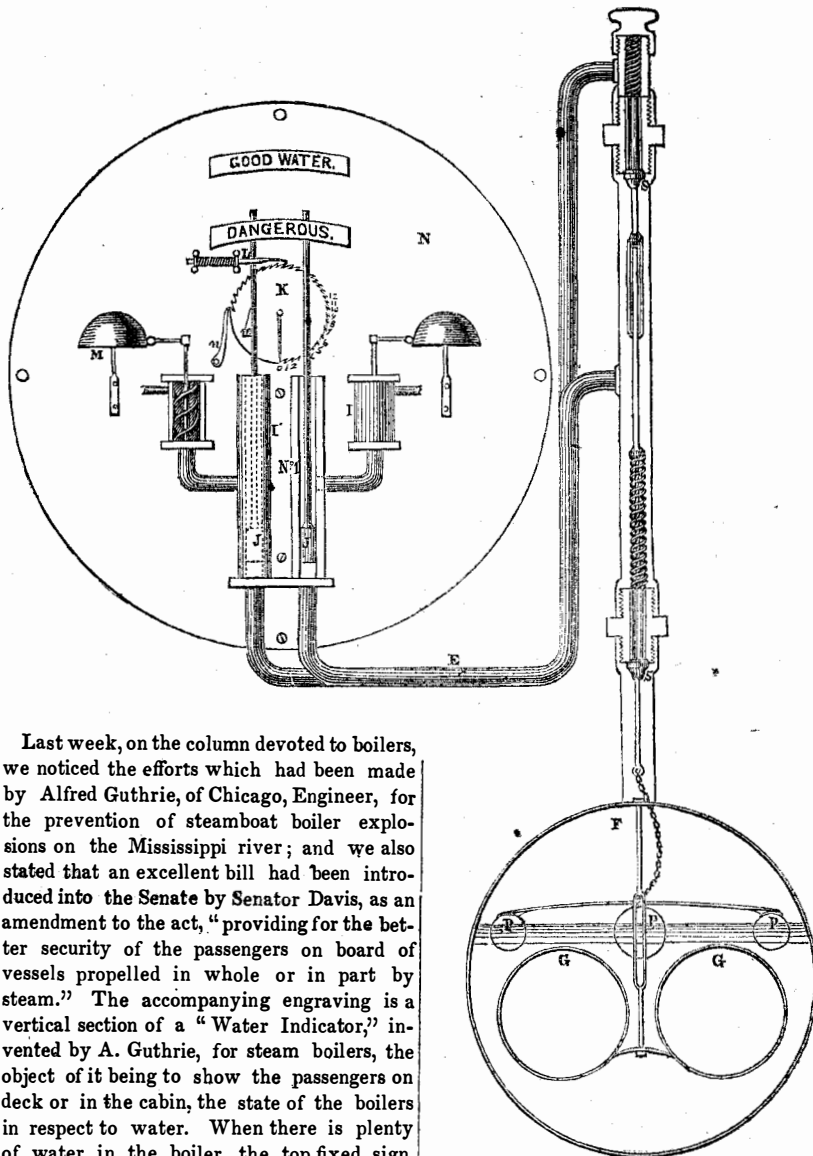

Last week, on the column devoted to boilers, we noticed the efforts which had been made by Alfred Guthrie, of Chicago, Engineer, for the prevention of steamboat boiler explosions on the Mississippi river; and we also stated that an excellent bill had been introduced into the Senate by Senator Davis, as an amendment to the act, "providing for the better security of the passengers on board of vessels propelled in whole or in part by steam." The accompanying engraving is a vertical section of a "Water Indicator," invented by A. Guthrie, for steam boilers, the object of it being to show the passengers on deck or in the cabin, the state of the boilers in respect to water. When there is plenty of water in the boiler, the top fixed sign, "Good Water" alone is exhibited, when the water falls too low, the card "Dangerous" is pushed up and covers the other, so as to let all know, when there is danger from low water. It is well known that a defective supply of water has been the cause of most explosions, for a defective supply of water leads to the overheating of flues, and as a result they are made soft and weak, and then when fresh water is suddenly ejected on the red hot plates, a sudden increase of steam to a very great pressure is generally the result. This forces the boiler to pieces like gunpowder, for water has nearly the same expansive power when combined with a certain amount of caloric, (steam is the product of water, and caloric or heat.)

In the annexed figure, F is the boiler of a steamboat; G G are the flues; P P P are three floats bound together and separated by a stretcher. These floats are attached by a chain to valves, S S, which on being drawn open by the floats as they descend with the water, admit steam through the pipes, E, to the miniature engine or cylinders, I I, which have pistons, J J, in them, the one set of which raises the card "Dangerous," and the other strikes the bell, M, to give warning both by sound and sight. The pistons, J J, No. 1, are also intended to raise a card above the one "Dangerous," with the words "Water getting low" on it. It will be observed that the small cylinders to strike the bells, have screw pistons, which receive a rotary motion so as to turn round and operate the hammers; K is an index for registering the number of times there has been "Dangerous" or low water in one trip; L is a pall to turn the register; n is a spring to hold the index; m is a cam for throwing back the pall, L; N is the plate of

the indicator, which is secured in a suitable conspicuous place, but kept from being touched by any person on the steamboat. Mr. Guthrie states in his pamphlet that he does not suppose any law can be so framed or administered that evasions and abuses will not creep in, he therefore invented this water indicator, and he has also a steam indicator operated by the pressure of steam, raising a piston which lifts weights, acting thus by expansive pressure, precisely as this water indicator does by gravity. In all parts they are nearly alike. These are for the passengers, their safeguards which warn them of danger. This indicator is to be locked up against all interference of any person but the government inspectors, who are intended to be located on various points on the Mississippi and Western waters. These inspectors are to have the same charge of the indicators that proper persons now have of the keys of the mails. The plan of operations sketched out by the inventor is as follows:—

We will suppose a steamboat at St. Louis, ready to depart for New Orleans. The inspector is notified of the fact, repairs on board, and makes a proper inspection of the boilers, engines, and machinery, and finds they bear the relative proportions, with the proper pumping apparatus, free and unobstructed passages, and all in good order. But he finds the boilers are old and somewhat worn; or perhaps, in the hydrostatic pressure, he finds indications that it will not be safe to run these boilers under a higher pressure than, say fifty-five pounds to the square inch. He then says to the engineer, you may run with this pressure and no more. You may also run, when the water is full, three inches above the flues and no lower. He then repairs to the

cabin, and there adjusts the indicators to the prescribed limits, (which can be done in a moment), locks up the indicators and retains the keys. Between the two indicators he places his permit, and the boat is allowed to depart. We will now suppose that the boat has proceeded on her voyage as far as Memphis, and during this time the engineer has had "dangerous steam" or dangerous water, and none of the passengers are disposed to prosecute him for the penalty in the bond; it will be the duty of the local inspector there to repair immediately on board and unlock the indicators, where he will find a secret register giving the exact number of times that dangerous steam or water has occurred, and exactly to what extent, since the departure from St. Louis; and if he should consider it unsafe to allow the engineer to continue in charge, he substitutes another in his stead.

The steamboat men of St. Louis have held a public meeting, at which they suggested the necessary measures to prevent a recurrence of the terrible steamboat disasters on the Western waters; expressing their candid anxiety for the adoption of restrictive and cogent laws for the better protection of life and property, only asking that they may not be subject to useless and uncalled-for expenditures and restrictions; all of which we agree with, but then the question will arise, "what are useless and uncalled-for expenditures?"—There is a necessity for the most strict and thorough reform, and that promptly. We hope Congress will act on Senator Davis' Bill at an early date.

## Nystrom's Calculating Machine.

It may be remembered by our constant readers that, on page 273 of our last volume, there was presented an engraving and description of "Nystrom's Calculating Machine," which is the neatest and most compact of all the calculating machines that have come under our observation. Since that time Mr. Nystrom has made some important improvements, by the addition of two more scales—one on the outside and one on the inside of the "Calculator's" disc. The new inner scale is laid out in points and fractions thereof, by the compass, which correspond with angles, distances, and differences in latitude, longitude, &c., on the outer scales spoken of, so that navigators will be enabled to make quick and correct calculations without reference to any tables.

The new outer scale, which has been added, is divided into degrees and parts of the same, and is for adding and subtracting degrees and minutes, and to turn degrees and minutes into time, &c. Were the engraving before us, we could present the method of solving many problems by it in a simple and expert manner, but without this it would only confuse this notice of the said machine, to present figures of reference. We allude to this machine at present for two reasons; one is, an improvement has been added to it; another is, that we have examined the new machine, and we like it. A calculator is only a disc, not quite 9 inches in diameter, and with two arms placed upon it. The most intricate questions in arithmetic and higher branches of mathematics, can be resolved in a very short period. For calculating angles it is an invaluable instrument, and is therefore of great benefit to engineers, navigators, surveyors and draughtsmen. The Calculator is made of brass, and is silvered. The prices, we believe, are \$10, \$15, and \$20, and can be obtained of the inventor and patentee, J. W. Nystrom, No. 31 Union street, Philadelphia. There are two pamphlets of instructions accompanying the machine, these have to be studied attentively for some time until a perfect acquaintance with working the machine is obtained, after which it will be esteemed a constant friend.

## Locks.

Hobb's American Bank Lock has been opened by an ingenious mechanic, on the Surry side of the river, in two hours.

[The above is from the English correspondence of the Quebec Mercury. We have seen no such notice in any of our numerous English exchanges. We question its correctness.

According to Hawksbee, water is condensable by cold one 28th part of the whole from 130° above freezing point.



Scientific American

NEW-YORK, MAY 22, 1852.

Discovery of Etherization.

It is well known that application was made to the present Congress, by Drs. Morton and Jackson, of Boston, to get remuneration for the application of etherization in the U. S. Hospitals. It was said that the Committee having the matter in hand, had agreed to grant \$100,000 to Dr. Morton, whose claims were disputed by Dr. Jackson. In commenting upon this question, on page 221, we said, "if Dr. Wells were living, he perhaps could establish his claim against both of these gentlemen." A pamphlet is now before us by J. Wales, of Hartford, Conn., which, in our opinion, clearly demonstrates who was the discoverer of etherization, and who was the first person that applied it successfully in surgical operations;—that person was Dr. Wells. Before the latter part of 1844, the fact was not known that, by the inhalation of a gaseous substance, the body could be rendered insensible to pain during surgical operations, without injury to the patient. "No one," says the pamphlet, "before that time, had ascertained the fact by actual experiment;" It is true Sir Humphrey Davy made the first suggestion, and so far as that goes, his claims are entitled to some prominence. He says, "nitrous oxide, in its extensive operation, appears capable of destroying physical pain; it may probably be used with advantage during surgical operations, in which no great effusion of blood takes place." We have no record of any experiment made by him for this purpose, therefore his conjecture must be estimated according to its worth, and we must say that is not little; it exhibits that far-reaching sagacity for which he was celebrated.

In the autumn of 1844, Dr. Horace Wells, of Hartford, Conn., directed his attention to this subject, and having procured some nitrous oxide (laughing gas) he resolved to make the first experiment on himself, by having a tooth extracted. This was done, and Dr. John Riggs made the experiment at Dr. Wells' request. This was about the first of November, 1844. Dr. Riggs testifies that he along, with Dr. Wells, encouraged by this experiment, administered the gas to various individuals in the presence of several gentlemen and extracted teeth from those who were placed under its influence. At this time Dr. Wells knew the properties of sulphuric ether, but he believed the nitrous oxide gas to be more safe. The testimony of the persons upon whom these experiments were made in 1844, has been given. Dr. E. E. Marcy, formerly of Hartford, now of this city (New York), was present at one of the experiments, and the fact of rendering the body, for a limited time, insensible to pain while undergoing a surgical operation, by the inhalation of a gas, was then entirely new to him. He suggested to Dr. Wells the employment of rectified sulphuric ether, as he knew it produced the same effects as the nitrous oxide gas. He prepared some sulphuric ether, and in a few days afterwards he administered it to a young man, who was rendered insensible, and a tumor was cut from his head. This demonstrated to him and Dr. Wells the anæsthetic properties of ether vapor. It is also stated that Dr. Wells visited Boston, and communicated these facts to Drs. Jackson and Morton,—and the former, and other medical gentlemen in Boston, only ridiculed him for his pains. The fact of gas being used to render persons insensible to pain during surgical operations, was also announced in June, 1845, in the "Boston Medical and Surgical Journal."

It was not until the 27th of October, 1846, that Drs. Jackson and Morton—the latter a pupil of Dr. Wells—applied for and obtained a patent for the use of ether, or the vapor thereof, in surgical operations. This was about two years after the first experiments of Dr. Wells. Taking all these facts into consideration, it appears to us that the claims to priority of discovery and application belong to Dr. Wells. Congress, therefore, instead of granting \$100,000 to either of these gentlemen, should first investigate the claims of Dr. Wells. It is the duty of our government to

render "honor to whom honor is due, and tribute to whom tribute is due."

Fires and Falling Walls.

On Thursday last week (13th inst.), a fire broke out at 11½ A. M., in the rear of French's Hotel, this city, and the whole of that part of the premises was destroyed. The building was a very high one, and it was difficult for the firemen to do rapid execution, as none of the ladders could reach the top story. The body of a man was found burned to a crisp among the ruins. Part of one wall fell and wounded a fireman severely. If the whole hotel had been burned, and the walls tumbled down, they would no doubt have crushed Tammany Hall on one side, and the buildings on Frankfort street on the other. Owing to the very high price of lots in the city, it is customary to erect very high buildings, in order to economize money upwards, because so much has to be expended in purchasing the few miserable feet of ground on which a building is erected—owing to America being so very small, and ground so scarce, we suppose. There should be a new law passed forbidding the erection of stone or brick buildings over a certain height according to a sure thickness of the walls. Thus for a six story building—specifying the height in feet, the outside walls should be no less than two feet thick and a four story building no less than twenty inches, and so on. The outside walls of some buildings in our city are mere shells, and the front walls of all brick buildings are now built for show, without respect to their strength, for no headers and binders are employed in the front rows of brick. The walls of these buildings are dependent on the joists and floors for support; therefore, when a fire takes place, and the floors are burned, the walls come crushing down to the great danger of life and adjacent houses. It is time that some reform was effected in respect to the security of the walls of houses in this city.

New War Steamers.

On the 11th inst., Senator Stockton addressed the Senate at length on the resolution authorizing the building of a war steamer for harbor defence, in pursuance of a law authorizing a contract for that purpose with Robert L. Stevens. He said he desired to impress upon the Senate the necessity of providing a harbor defence, and to have justice done to one of his constituents who had been ungenerously treated by the former Secretary of the Navy. "It was his opinion that the present state of affairs in Europe rendered war probable, and in that event there was danger of us being brought into it. The harbor of New York is not now any better than it was during the war of 1812, and fleets now approached the United States uninterrupted by winds or tides. With a speed of 20 miles per hour, a steamer could pass beyond the range of a fort in five minutes. To obviate the attack of a foreign fleet, it was necessary that there should be a construction for harbor defence, combining the qualities of stone with the power of motion. This vessel being shot and bomb proof, could do more to resist the progress of hostile fleets than 20 forts. Mr. Stevens, the author of the design, is an accomplished and experienced gentleman, who is willing to hazard his character and reputation on the success of the undertaking." Thus, and a great deal more, Senator Stockton spoke in reference to a steam floating battery.

A petition has also been presented to Congress by a person professing to be acquainted with steam navigation, who believes that he can construct an ocean craft which can neither be burnt nor sunk, (even if stove against icebergs or rocks), nor blown up by its boilers, and which will average, in a voyage across the Atlantic, fifteen miles an hour, and he will undertake to build the vessel providing the Government will remunerate him in case of success. He asks Congress to place in the Deficiency Bill a provision giving him and his associates, or their legal representatives, the sum of one million of dollars upon condition of his producing such a vessel within five years from the passage of the act, to be adjudged and reported on by a committee of five disinterested persons to be appointed by the President, on whose decision the Se-

cretary of the Navy is to pay the money. The plan is, that the vessel is not to be less than four thousand tons, forty rods long, and six wide; to draw only from five to six feet of water when laden. She is to have two sets of boilers and engines, and four pairs of water wheels; is to be of iron entirely, with zinc finishing; the keelsons, ribs, &c., are of plate iron, corrugated where proper, and made air-tight, forming air chambers. The floors or decks will be double, having sectional air chambers throughout, as will also the portions of the ship, including those forming the state rooms, cabins, &c., thereby rendering it impossible for her to sink. She is also to be subdivided by water-tight partitions. Although five years are asked, the memorialist says he can accomplish the work in two; and although the condition of speed is fixed at the moderate rate of fifteen miles an hour, he has no doubt of accomplishing an average of from twenty to twenty-five miles per hour, besides having her shot-proof.

Here, then, are two Richmonds in the field. The latter proposition, we believe, is the best. Mr. Stevens will no doubt accomplish anything he undertakes in the steamboat line, but a harbor floating fort would be a most useless appendage. Let us have a good steam fleet; let our sea defence be upon the mountain wave. In an emergency, sand bank barricades can be thrown up for the defence of our harbors, and these, with heavy guns and brave hearts, need fear no foreign floating batteries.

Patent Self-Raising Flour.

We see it stated in many papers that Hecker & Brothers, of Croton Mills, this city, manufacture and sell flour ready for the market, called "Patent Self-Raising Flour." We are not aware of any patent ever having been issued for the said flour, and we presume the public have given it the name of patent, not the manufacturers. It is not very safe to use word "patent" on an article, if it has not been patented. That such flour as "self-raising flour" is made by Hecker & Bro., is true, but it is not the flour itself which has the quality of raising, as it is termed, when kneaded only with cold water, but it must be some admixture which causes effervescence. As this kind of flour is coming into somewhat extensive use, it is right the public should know what the effervescing materials are which are mixed with the flour. Tartaric acid and saleratus may be the ingredients, which are very excellent and safe, but if alum be used, a trick common among English millers, we deprecate its general use. Any person can mix their own flour, with but little trouble, so as to make the dough ferment, but there are so many who dislike even this little trouble, that the new fermenting flour will become quite a favorite; and, we must say, if the fermenting ingredients are healthful, we hail its introduction; if not, we deprecate its use.

Academy of Natural Sciences of Philadelphia.

This respected and time-honored Institution has published a pamphlet, containing a condensed notice of its origin, progress, and present condition, which was the subject of a paper read before the society during the past winter, by Dr. Ruschenberger, U. S. Navy. From small things it has attained to a most dignified and respectable position. It contains Wilson's unrivalled collections of birds, and in time it may rival the British Museum. It was founded in 1812, with seven members, and since that time, has had, and now has, some of the most eminent men in our country for members, such as Say, Wm. McClure, Drs. Morton, Hare, and others. The object of this Association is the cultivation of the "Natural Sciences," and we cannot help quoting the following extract to show their importance:—"To ascertain, and understand the laws of God, exhibited in the living organization, which exists on its surface; to bring to light whatever may lie hidden in the obscure recesses of nature; to expose truth stripped of the distorting disguises in which ignorance and superstition combine to hide her charms from the gaze of mankind, are among the objects of the natural sciences. Such objects are not and cannot be inconsistent with the duties or the feelings of a true Christian.—The study of natural history has a happy influence in the cultivation of the intellect,—while it tends to tranquilize and strengthen

the mind, and to release it from the thralldom of superstition and credulity, it refines the taste and teaches man to appreciate justly the beauties and wisdom of nature. It enables us to derive from objects that everywhere present themselves in our rural walks, not only amusement and instruction, but the highest incitements to piety and virtue." This is indeed true; a naturalist cannot be an atheist, for all he sees and all he learns is absolute truth.

Naval Dry Docks of the United States.

This is the title of a book—that is a book—by Charles B. Stuart, Engineer in Chief of the United States Navy. This work is now before us, and we must pay it the compliment of being far and away the most beautiful work on engineering ever published in our country, and perhaps any other,—at least without some government support. As a private undertaking it is an extraordinary one. It will stand a monument of the author's taste, skill great acquirements, and spirit, for centuries, Gen. Stuart deserves the gratitude (for he has extorted praises of every one who has seen his work) of his countrymen for the splendid manner in which he has treated his subject, and commemorated those great national works, "The Dry Docks of the United States." It is his intention to bring out a second number of the series, on the "Naval and Mail Steamers of the United States," to be followed by a third on the "Railways of the United States."

As a work for its own intrinsic merit, we hope it will have a most extensive sale, and we also bespeak for it the attention of our countrymen, in order that it may be followed by the two other volumes spoken of, for such subjects are in the hands of the very person who can do them justice.

In this work we have an historical description, embracing the fullest details, of the Granite Dry Dock at the Brooklyn Navy Yard, the Floating Sectional Dry Dock, Philadelphia, and the Floating Balance Dry Dock, Portsmouth, together with the mode of constructing and working the dry docks at the principal naval stations of the United States. The statistics of these great public works, in addition to the engineering descriptions, are given at length, comprising a statement of the materials and their cost, the contract prices of the various kinds of machinery, the expenditures for labor, the names of the contractors, and a great amount of valuable information on every point relating to the construction of the docks. The volume is splendidly illustrated by twenty-four engravings on steel.

This valuable work is gracefully and appropriately dedicated to the President of the United States, Millard Fillmore. It should find a place on the shelves of every public library in the Union, and the private library of no American will be complete without it. It is for sale at C. B. Norton's Irving House.

Another Telegraph Case.

On the 10th inst. Judge Kane refused to grant an injunction on behalf of the proprietors of the Morse Telegraph Patent, to restrain the Ohio Telegraph Company, and the Pittsburg and Louisville Company from using said patent. The complainants stated that they were entitled to one-quarter of the stock, and one quarter of the dividends in the above line, under what is generally known as the O'Reilly contract, which had been withheld by defendants. This was denied by defendants who charged vexatious suits, and fraudulent proceedings on the part of the plaintiffs for the purpose of breaking down the O'Reilly Line, &c.

Iodine

This substance, which a few years since was thought to be confined to a few marine plants, has been gradually traced through the mineral, vegetable, and animal kingdoms, and its general diffusion throughout nature is rendered exceedingly probable. At the Paris Academy of Sciences, M. Chatin recently read a paper in continuation of his researches on the presence of iodine in the air, the water, the soils, and products of the Alps of France.

The Managers of the Maryland Institute have adopted suitable measures of respect to the memory of the late Prof. R. Johnson.

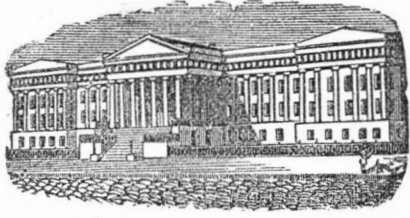

Reported Officially for the Scientific American

### LIST OF PATENT CLAIMS

Issued from the United States Patent Office  
FOR THE WEEK ENDING MAY 11, 1852.

**BLIND AND SHUTTER FASTENER**—By Saml. Barker, of New York City: I claim the method of securing or fastening window shutters, by having the upper portion of the pintle of the hinge of a square or other many-sided form, and the upper portion of the socket of a corresponding shape, a space being being between the socket and pintle to receive the cap, which corresponds, in shape, to the upper portion of the pintle and socket, and fits on the pintle and in the socket, securing, or fastening the shutter, as specified.

**PORTABLE COT BEDSTEDS**—By Wm. C. Betts, of New York City: I claim, first, the elevation in the side rails, as a substitute for the pillow, as described.

Second, I also claim the dovetails as used for attaching and detaching the legs to and from the side rails, that is to say, the dovetails entering the mortises from opposite ends of the cot frame, so that they cannot readily loosen by use.

Third, I also claim the arrangement of the right and left hand screws which unite the opposite legs at their crossings, in such a manner that the screws shall tend to tighten the joint, as the legs separate from each other, or loosen the same as they approximate.

Fourth, I claim the combination of the tense bars, having right and left screws, with the side rails of a cot bed, for the purpose of keeping the sacking bottom tense.

**RAILROAD CAR SEATS**—By A. B. Buell, of Westmoreland, N. Y.: I claim constructing the backs of railroad car seats, with outer sliding backs fitting in slides, and held by springs, for the purpose of elevation above the ordinary back, or depression below it, as set forth.

**MEAT CUTTERS**—By Wm. Burns, of Rome, O.: I do not claim as new any of these parts, separately considered, or irrespective of the manner or arrangement in which I propose, in combination, to apply them for the purposes, and to produce the advantages specified. But I claim arranging, in separate concaves, maintaining vertical positions, and uniting with each other, two cylinders, the one above the other, the upper one operating to partially mince the meat and deliver it upon the lower cylinder, revolving at a greater speed, for reducing it to the required fineness, as described.

**MEASURING FAUCETS**—Jacob R. Byler and Geo. W. Sosenich of Beartown, Pa.: We claim so constructing a faucet for measuring and drawing molasses, honey, oil, tar, or other liquids, as that they shall always stand charged with a measured quantity of the liquid, which may be forced out of the faucet instantaneously, however thick or sluggish it may be, when the same is accomplished by means substantially as described.

**BRUSHES**—By A. R. Davis, of East Cambridge, Mass.: I claim the described improvement in filling the holes of a brush block with bristles, the same consisting in the employment of a frame to contain said bristles in mass, and hold them in the brush blocks, and in the direction of their respective holes in the block, in combination with giving to such block and frame, such movements, rappings, jarrings, or blows, as to cause the bristles, by the force of gravity, or concussion, to pass into and fill the holes in the block, as stated.

**COOKING BOILERS**—By L. S. De Bibory, of Baltimore, Md.: I claim the application of the small cap to the cooking pot, as described.

**APPARATUS FOR SOLDERING IN A VACUUM**—By J. B. & J. R. Horne, of Xenia, O.: We claim the application to the purpose of soldering in vacuum, of a hollow bent tube for the reception of a heater, the said tube being closed at the lower end, and provided with a screw thread at its upper end, fitting tightly, within a screw-neck or collar, upon the glass receiver of an ordinary air pump, or other suitable instrument for producing a vacuum, the bent form of the tube bringing it to bear, during its rotation, upon the perimeter of the circular disc which closes the aperture.

**BLOCKS FOR PRINTING OIL CLOTHS**—By James Jenkins of Elizabethtown, N. J.: I claim the movable gauge, in combination with the adjustable point, or its equivalent, to compensate for the contraction and expansion of the pattern block, in the manner and for the purpose substantially as described.

**PLATFORM SCALES**—By Robt. Newell, of Lebanon, Ind.: I claim the rod I, and the rod and socket and sector, or their equivalents, in combination with the revolving head and face (or graduated plate) and hand or index, to show at once, and in any required direction, the weight of the article weighed.

**LEAD-PIPE MACHINERY**—By Benj. Tatham, of New York City: I am aware that the invention of this machinery describes the core as being forced to the centre of the die, and retained there by the pressure of the issuing pipe; therefore I do not claim, broadly, having the core so that it shall not be affected by the vibrations of the ram.

What I claim is connecting the core with the ram, by means of a universal joint, or its equivalent, substantially as specified, so that the core shall be retracted with the ram, in combination with the cylinder and die, of a machine for making pipe by pressure from lead or other soft metal, run into the cylinder, and on to the said core, in the molten state, substantially as specified, whereby the core is retracted with the ram and held in position, while the charge is poured in, and during the operation of forming the pipe, the vibrations of the ram do not practically affect the central position of the core in the dies, as specified.

**TABLES**—By T. H. Taylor, of Fayetteville, N. Y.: I claim, first, the employment of files, levers, or their equivalents, in combination with the spiral springs, or their equivalents, the whole being constructed, arranged, and operated in the manner set forth.

Second, the employment, in the manner substantially as described, of the levers, or their equivalents, in combination with the files, for the purpose of lowering the table leaves when desired.

[See engravings on page 164, present volume.]

**GOLD BEATING MACHINERY**—By Wm. Vine, of Hartford, Ct.: I claim the double action adjustable, differential cams, or their equivalent, combined with the sliding rod and pivoted cylinder, in connection with other parts of gold beating machinery, substantially in the manner and for the purpose as set forth and described.

**MASH TUNS**—By Robt. Wicks & James Faulkner, Jr., of Williamsburgh, N. Y.: We claim the completely enveloping the mash tun with water, or sufficiently so to produce the desired rapidity, in cooling the mash.

**IMPLEMENT FOR CUTTING BUTTER FROM FIRKINS**—By Nathl. Woodbury, of Salem, Mass.: I claim the knife, operated by means of the levers, or their equivalents, in combination with the piston, and the box, the knife, levers and piston being constructed, arranged and operated in the manner and for the purpose substantially as described.

#### RE-ISSUE.

**APPARATUS FOR PARTI-COLORING YARN**—By A. Smith, of West Farms, N. Y. Patented originally June 18, 1850: I claim the method, substantially as specified, of parti-coloring yarns that have been reeled, by direct and free immersion, by means of frames carrying the reeled frames and combined with the vat containing the dyeing liquor, by means of machinery adapted to let down and draw up the said frame, and measure the extent of immersion, substantially as set forth.

I also claim connecting one or both of the reels, in each frame, by means of slides, to admit of removing the reel from contact with the yarns, whilst in the process of dyeing, substantially as specified.

#### DESIGNS.

**COOKING STOVES**—By Apollon Richmond, of Providence, R. I., (assignor to A. C. Barstow & Co.)

**COOKING STOVE**—By Hosea H. Huntley, (assignor to David T. Woodrow), of Cincinnati, O.

[In the above brief list of patents, granted last week, we feel a pride in stating that six out of the number were secured through this office.]

#### The Omnibus.

The omnibus is the perfection of clumsiness in every way; and considering all things, it is amazing that so little has been done to relieve it of its lumbering weight and remedy its petty conveniences. Its errors may be thus enumerated:—1st. It is double the weight it need be. 2nd. The "vis-a-vis" fashion of seating passengers wastes room. 3rd. It chokes by confined air in winter, and in summer it affords the worst circulation of air, with the best system of passive martyrdom. 4th. The unseparated seats fosters rudeness. 5th. The huge wheels and general contour are of a barbarous age.

This is a catalogue of points to spur inventors. Now, as we dislike carping, and have charged faults, we will suggest some remedies.

The Irish outside "Jaunting Car," that is, (or was in use in Dublin some years ago), presents to our mind the basis of a sound conception of the perfection of a street carriage for this climate. The axle is short, the wheels are low and play beneath the elevated seats, which place the passengers "dos-a-dos" facing the side walks. The step which forms the foot rest is on a level with the curbstone, and extends, of course, along the whole length of the car on each side; there is no top. In this climate covering from the sunshine is necessary as well as from rain during six months of the year; but then light and picturesque awnings would entirely answer this purpose, with such extra provision as may be suggested in case of rain. Why shall we for ever drag about so stupid an over-weight, and so suffocating a dish cover, to serve us only on occasions when rain falls? Each seat can readily be made separate in this way, and kept closed by a light sheet-iron ornamented apron, to be opened by a spring from the coachman's box, and this movement might be used with a neat machine to register the number of passengers which daily may ride in the said carriage. The nuisance of a bundle or basket would, in this way, be confined to its owner. Gentleman and ladies of the heavy weights would have the pleasure of tight lacing themselves, instead of squeezing their neighbors; in short, a new omnibus, constructed after some of these suggestions, would be like universal suffrage and vote by ballot in England. We need say no more; the hints given are surely enough for any man, and for you, Messrs. Yankee Inventors, it will surely be an easy matter to place the clumsy omnibus "hors de combat," and construct a tasty, convenient, and good new public street carriage, and about a patent, you need have no fears of that.

ANTHEAX.

Philadelphia.

#### Surface Coal.

A great coal mine has been discovered in Kentucky, seven miles back of Cloverpark. The coal is found on surface veins. The district of land was first sold for \$5 per acre, some years since, and it was subsequently

purchased by a speculator for the sum of \$10,000. He has since sold out to the present owners for the handsome sum of \$100,000. The mines have been worked but very little, and are almost inexhaustible. The coal burns like gas, and imparts great heat, and is accompanied by no dirt whatever. It will as readily ignite as a candle, and the steamboat men use it instead of pine wood for torches.

#### Something New and Important, if True.

We extract the following from a letter from Baltimore to the Washington Telegraph:—

A young man named Force has been residing partly in this city and partly in Washington for some months past. He is originally from St. Louis, but more recently from Texas. I learn, upon what may be deemed good authority, that he is about to become distinguished as a mechanical genius. He is said to have invented and patented a new motive power, which bids fair to supersede both steam and water. It is stated that a model of the machine is already in existence, and that it has been patented with an injunction of secrecy for a certain time. So cautious has he been to avoid infringement, that he had one part of the machinery necessary to the completion of the engine made in New Orleans, another part in Baltimore, another part in Philadelphia, and another in New York. The separate parts thus constructed were, in due time, collected in Baltimore, and put together by the inventor himself in a room into which no person has been permitted to enter.

It is asserted that the machine worked to the full satisfaction, and beyond the expectations of those most deeply interested in it. I have had an introduction to, and some conversation with, the inventor. The only idea I could glean in regard to his invention was, that it brought the atmosphere into use as a powerful motive agent, amounting almost to independent self-action. It is asserted—and the truth of the assertion, of course, will be established or falsified when the invention is made public—that this new momentum can be increased as to propel the largest ocean steamers, or brought down and suited to the delicate movement of a watch. Nothing will be found to bear the slightest comparison to it in point of utility and completeness as a motive power.

The inventor is quite a young man, with good common sense and much shrewdness, though of moderate education. It is his purpose, I am further informed, to proceed to Europe and obtain patents there; and that he does not design having the patent or principle of his invention made public here until time has been allowed to secure it from piracy in other countries. Some three or four distinguished gentlemen—men of wealth and influence—are peculiarly interested with him in the patent. One or more of them design accompanying him to Europe. They set sail probably in June next, and perhaps a month or six weeks subsequent to their sailing the patent or model will be exhibited in the United States. I can only say if the invention proves to be what is claimed for it, the world, up to this age has never seen its equal. We shall await patiently the wonderful development; and in due time award the distinguished author full credit.

[The above we copy from the United States Gazette, which sensibly does not endorse anything about this wonderful invention. It will turn out like a great number of other blowing inventions which, within two years, have been heralded with loud trumpet-tongue.—About the patenting of it, nobody believes that who has any acquaintance with these things. The idea of bringing "the atmosphere" into use as a powerful motive agent, amounting almost to independent self-action" is very good but nothing new. A self regulating wind-mill, for example, is a powerful machine according to its size and the velocity of the wind. Air engines are nothing new, the hot air engine of Ericsson is not new in principle, for Stirling patented one in 1840, and has had it in operation for a number of years, and in 1846, in a paper read before the London Institution of Civil Engineers, he claimed to have saved two-thirds of the fuel usually expended on steam engines, by using the heated air over and over again, by using two vessels,

one at a high and the other at a low temperature, as described on pages 134 and 142, Vol. 3, Scientific American.

We cannot say, with the concluding words of the foregoing extract that "we will await patiently the wonderful development, and award the distinguished author due credit." We have no patience with such trumpeting, and we notice it to prevent, if possible, Hilleotype and Remington Bridge excitements.

#### Vegetable Origin of Coal.

Geologists are now, from recent discoveries and observation, in a tolerably safe position to prove not only the vegetable origin of coal, but of the comparative geological period at which the several deposits were formed. The theory of the vegetable origin of coal is founded, first, on the regular mineralogical gradation, traceable from bog, wood, or peat, through lignite and common bituminous coal to anthracite, on evidence showing that dead vegetable matter, under proper conditions, undergoes consecutive chemical changes, which convert it successively into these several descriptions of coal, and on the constant presence of vegetable remains in rocks of the carboniferous period, and the vegetable structure of the coal itself. In peat there is the organic structure as perfect as in living wood; in lignite the woody fibre is still marked, but less obvious, while bituminous coal obeys the law of true rock or mineral cleavage, in which no vestige of vegetation is visible to the naked eye; but let a thin slice be placed under the microscope, and the most beautiful vegetable structure is apparent. Trees have been found in tertiary beds, having one portion in the state of bog-wood, and another in that of true coal; and in the north of England the compressed stems of trees, of enormous length, are exposed in all positions; gigantic reed-like forms, in a crushed state, are profusely imbedded in the solid rocks; ferns, with their delicate nerves most beautifully preserved, are to be seen in countless numbers, while here and there may be observed the under part of gigantic roots, their branches radiating to a distance of 60 feet from the parent stem, and their surfaces thickly studded with long fibres, shooting in all directions through the now consolidated mud. With respect to the periods of coal deposit, they are now generally considered to have been widely various—that of Oporto is supposed to have been formed at the commencement of the Silurian division of the primary period—that of Great Britain at its close. The coal of Virginia, U. S., belongs to the middle division of the secondary period, while those of Piedmont, Tuscany, and other parts of the south of Europe, are undoubtedly a deposit of the tertiary age.

[The above is from a correspondent of the London Mining and Railroad Journal, and it enunciates what nobody contradicts, respecting the materials of which coal is composed, or rather was composed; but, then, is it not a more difficult affair to account for these vegetables. It may as justly be said, freestone is of vegetable origin, if we take the appearance of certain stones for proof positive of its primary state. We have seen, and so have thousands of others, "stone trees," with their branches and bark as perfect as when they stood erect and braved the driving storm.—There are many peat bogs in England which have been formed since the Romans were in that country; some of them are very deep, and produce hard black peat. These can easily be converted into coal by heat and compression. In some parts of our country we have coal near the surface of the ground, and there are some kinds apparently half coal and half peat. With respect to certain periods and formations of those periods, it is very unsatisfactory, excepting for classification. We have certain formations in different parts of the world, but these formations are but simple facts which have to be accounted for yet themselves.

Philostratus relates that the knights of Lybia, at a certain time, fought upon elephants, some of which had a tower engraven on their teeth; and when they were separated by the night, such as had the tower were beaten, and fled to Mount Atlas; and that Juba, King of Lybia, 400 years after, took one of them, which had this ensign so lively engraven as if it had been done lately.



TO CORRESPONDENTS.

S. S. B., of N. Y.—We are not acquainted with any person who enamels wrought-iron in this city.

E. H. B., of Ill.—You will see, by our article on Boilers, that the subject is now before Congress; all the information on explosions, necessary for correct action, has been collected.

E. D. D., of N. S.—Yours has been received: steam has been employed for extinguishing fires for a long time; it is a pity that it is not more extensively employed.

S. D., of Conn.—Your plan for conveying packages, etc., through exhausted air-tight tubes, was proposed twenty-five years ago, and we have a book in which the plan is described.

W. B., of N. Y.—The kind of faucet which you illustrated by diagram had its day before you were born, and was discarded.

C. P. W., of Ga.—The articles referred to are continued in various numbers throughout the volume, and we could not go to the trouble of selecting them for you. Your subscription expires at No. 37. You can order volume 6, and have it complete, if you choose.

G. W., of O.—See reply to G. G. H., of Pa., in our last number. The same plan for a churn dasher we have now in our office; it is not patentable.

C. B. B., of Ill.—There are patents on implements for raking grain, by using them in connection with a reaping machine. McCormick has a patent on the seat as arranged in his Harvesting Machine. Your plan for propelling canal boats is believed to be new. A model would be required if you should make an application for a patent.

W. B. H., of N. Y.—There have been several patents taken out already on invalid bedsteads, and it is a matter of some doubt whether your plan is patentable; still it may be. We will examine a model of your invention if you will send one, and advise you further on its receipt.

R. M. W., of Va.—We have never seen the engine alluded to, but if it be one of Hoe's make, and is of the capacity you mention, and is in good condition, it must be astonishingly cheap for that price.

H. W. S., of Ind.—S. C. Hills, No. 12 Platt st, this city, will furnish you with a sash and blind machine if you correspond with him on the subject.

B. C. C., of Ill.—The model of your bridge has just come to hand, and we shall take up your case for execution in about 10 days.

J. T. C., of Ohio.—We do not see anything new in your rotary engine on which we could base a claim for a patent.

N. N., of N. O.—There is no doubt but that your revolving sails for ships is new, as you have them applied, but we question the plan being practicable.

T. J. K., of Va.—We do not know what you refer to; however, the best thing you can do is to address other parties.

E. S. Z., of Md.—You are mistaken; we never publish engravings as advertisements, and your press does not embrace sufficient novelty to be of interest to our readers; besides, the engraving is too poorly executed for our purpose, even if it did illustrate an important invention.

I. S., of S. C.—We have entered Mr. Judges for 6 months, from No. 27, according to your request.

P. F. H., of N. Y.—Certainly, you have the same right to manufacture and sell as if the patent were issued.

J. A., of S. C.—We know of no patent on any apparatus of the kind.

H. B. M., of N. H.—The amount you sent was correct: the paper will be duly sent.

J. Y. B., of La.—As compensation for your services, we have entered your brother's name as subscriber, for six months, as you suggested. We are obliged to you for your repeated favors.

S. N., of O.—Hatching chickens by artificial heat is not much practiced at the present day; it was never a very successful method, although much in vogue a few years ago for amusement and exhibitions.

W. A. E., of N. C.—See page 242, Vol. 7, Sci. Am., for a machine of the description you need; the price we do not know; address the inventor.

C. C. J., of Ala.—We have examined both of your inventions, and perceive no novelty in either, of a patentable character. Both of your plans have been tried, but long since discarded.

O. J. H., of N. Y.—Your drawing is too imperfect for us to understand; send us a model.

G. G. S., of Mass.—You cannot have been a careful reader of the Sci. Am., or you must have observed our remarks, from time to time, on Electro Magnetism as a motive power.

J. G., of Albany, N. Y.—We are much obliged to you for the pamphlet.

H. P., of Mo.—Mr. Guthrie has investigated the causes of explosions very satisfactorily. We wish you could get his pamphlet.

H. K. A., of S. C.—We know not the price of either of the stone dressing machines, but presume the owners of each, would be happy to hear from you.

A. M. G., of S. C.—Since forwarding your caveat on the 15th we have received a check from your bankers for \$40; your model has also come to hand.

G. B., of Ind.—The "London Repertory of Inventions" published Ericsson's plans for an Atmospheric Engine as long ago as 1833, and still was not the first to communicate upon that subject; Sterling's invention dates as far back as 1826.

R. K., of N. Y.—The best way to bring your invention into public notice is to get engravings of it published in our columns.

Money received on account of Patent Office business or the week ending May 15:

G. B. P., of Pa., \$20; V. E. R., of Ill., \$5; H. B., of N. Y., \$60; D. C. T., of N. Y., \$30; J. G., of Mass., \$10; R. R. F. & Son, of N. Y., \$50; J. L., of N. Y., \$40; E. H., Jr., of Mass., \$12.

Specifications and drawings belonging to parties with the following initials have been forwarded to the Patent Office during the week ending May 15:

E. D., of N. Y.; V. E. R., of Ill.; A. J., of N. Y.; E. H., Jr., of Mass.; J. L., of N. Y.

An Important Paragraph.

Whenever our friends order numbers they have missed—we always send them if we have them on hand. We make this statement to save time and trouble, to which we are subjected in replying when the numbers called for cannot be supplied.

The Post Office Laws do not allow publishers to enclose receipts; when the paper comes regular subscribers may consider their money as received.

Subscribers ordering books or pamphlets are particularly requested to remit sufficient to pay postage.

Back Numbers and Volumes.

In reply to many interrogatories as to what back numbers and volumes of the Scientific American can be furnished, we make the following statement:

Of Volumes 1, 2 and 3—none.

Of Volume 4, about 20 Nos.; price 50 cts.

Of Volume 5, all but 4 numbers, price, in sheets, \$1.

Of Volume 6, all; price in sheets, \$2; bound, \$2.75

Of Vol. 7, all back numbers at subscription price.

Patent Claims.

Persons desiring the claims of any invention which has been patented within fourteen years, can obtain a copy by addressing a letter to this office;—stating the name of the patentee, and enclosing one dollar as fee for copying.

Patent Laws, and Guide to Inventors.

We publish, and have for sale, the Patent Laws of the United States. The pamphlet contains not only the laws but all information touching the rules and regulation of the Patent Office. Price 121-2 cts. per copy.

ADVERTISEMENTS.

Terms of Advertising.

Table with 3 columns: Lines, Price per line, Total price. 4 lines for each insertion - 50 cts. 8 lines - \$1.00. 12 lines - \$1.50. 16 lines - \$2.00.

Advertisements exceeding 16 lines cannot be admitted; neither can engravings be inserted in the advertising columns at any price.

All advertisements must be paid for before inserting.

American and Foreign Patent Agency

IMPORTANT TO INVENTORS.—The undersigned having for several years been extensively engaged in procuring Letters Patent for new mechanical and chemical inventions, offer their services to inventors upon the most reasonable terms. All business entrusted to their charge is strictly confidential. Private consultations are held with inventors at their office from 9 A. M., until 4 P. M. Inventors, however, need not incur the expense of attending in person, as the preliminaries can all be arranged by letter. Models can be sent with safety by express or any other convenient medium. They should not be over 1 foot square in size, if possible. Having Agents located in the chief cities of Europe, our facilities for obtaining Foreign Patents are unequalled. This branch of our business receives the special attention of one of the members of the firm, who is prepared to advise with inventors and manufacturers at all times, relating to Foreign Patent. MUNN & CO., Scientific American Office, 123 Fulton street, New York.

TO CONTRACTORS AND ENGINEERS.—A situation is wanted by a Civil and Mechanical Engineer—a good calculator and accurate draughtsman. Address G. D. H., 31 Jay st., N. Y. 1\*

TELESCOPE AND POLARISCOPE.—For sale, a five feet reflector, 5 inch aperture; 6 eye-pieces, and dioptric micrometer, mounted with equatorial movement, convenient for the use of a school. A fine Polariscope, with reducing microscope, 30 crystals, all in complete order, with mahogany box, at very low prices, by G. D. HISCOX, 31 Jay street, N. Y. 1\*

SHERRY & BYRAM'S AMERICAN CLOCKS (unequaled Time-keepers).—The following extract of a letter from the Rector of an Episcopal church in this State, advises us of an accuracy of time-keeping which, it is believed, has never been equalled by any turret clock in this country or Europe. Messrs. S. & B. having just made arrangements with the Common Council of this city to put up one of their clocks in the City Hall, our citizens may soon expect reliable time: April 22, 1852. It is now about six months since the clock was set going with Bliss & Creighton's time (chronometer makers, New York), and yesterday I went to the city and compared it with theirs myself, and I could see no variation. I can conceive of no time keeper that could do any better. Sherry & Byram, Sag Harbor, L. I. 36 2\*

STEAM ENGINES AND TOOLS.—One Horizontal Steam Engine, of superior workmanship, 12 inch cylinder, 3 feet stroke; heavy bed frame of 4,600 lbs., the whole well finished. One Steam Engine, as above, 10 inch cylinder, 3 feet stroke. A sample of the above engines may be seen at work in Mr. Bogardus's, corner Duane and Centre sts., N. Y.; also at Messrs Platt & Bros., Maiden Lane. Two 6 1-2 Planing Machines, of the most improved English pattern, strong and heavy. Six 2 feet 4 in. Planing Machines, will plane 12 inches wide, work with quick motion, well adapted to locomotive tools and engine work. Also a variety of Lathes, Boiler Punches, Presses, and other tools, for sale by the Matteawan Machine Co., Dutchess Co., N. Y., 1 mile from the H. R. Depot, at Fishkill. A. L. ACKERMAN, Agent. 36 3\*

NOTICE TO IRON FOUNDERS.—The advertiser wishes the situation of "Charge of a Foundry," having had long experience at it, and several years' experience in charge of a machine shop doing new work and repairs. For reference, address A. T. Pierce, Esq., Providence, R. I., post-paid. 36 4\*

DEPPER'S IMPROVED KNITTING MACHINES.—The subscriber is prepared to furnish, at short notice, power stocking looms of every size and gauge for making ladies' hose, men's half hose, shirts, and drawers, stocking net (for lining all kinds of rubber goods), or any other kinds of goods made on stocking looms; samples of goods sent to order, and looms warranted to make goods equal to sample. For further information address JOHN PEP- PER, Portsmouth, N. H. 34 4\*

IRON FOUNDERS MATERIALS.—viz.: good American Pig Iron—grey, mottled and white; No. 1 Scotch Pig Iron, of favorite brands. Pulverized Sea Coal, Anthracite Charcoal, Soapstone, and Black Lead Facings. English and Scotch patent Fire Bricks—plain, arch, and circular, for cupolas. Fire Sand and Fire Clay. Iron and brass moulding sand; Core sand and flour; always on hand and for sale by G. O. ROBERTSON, 135 Water street (corner of Pine), N. Y. 33 6\*

LATHES FOR BROOM HANDLES, Etc.—We continue to sell Alcott's Concentric Lathe, which is adapted to turning Windsor Chair Legs, Pillars, Rods and Rounds; Hoe Handles, Fork Handles and Broom Handles.

This Lathe is capable of turning under two inches diameter, with only the trouble of changing the dies and pattern to the size required. It will turn smooth over swells or depressions of 3-4 to the inch and work as smoothly as on a straight line—and does excellent work. Sold without frames for the low price of \$25—boxed and shipped with directions for setting up. Address (post-paid) MUNN & CO. At this Office.

DRAUGHT BOARDS, PATENT—23 by 29 inches, with scales and Paper Fastener combined, for Engineers, Architects, Surveyors, Designers, etc. \$10, with T. Rule. Sent by Express, Direct (post-paid) to H. W. CHAMBERLIN, Pittsfield, Mass. 34 2w\*

REGULATORS FOR STEAM ENGINES.—The subscribers having purchased of L. B. Pitcher the exclusive right to make, vend, and use his PATENT HYDRAULIC REGULATOR, are now prepared to attach the same to any Steam Engine or Water Wheel now in use, and warrant them to give a regular and steady motion to the Engine or Wheel; and in any case where they do not work as recommended, will replace the old Regulator at their own expense. Engines making fifty revolutions per minute, can be held, regardless of the kind of work to be performed, so as not to vary more than one half revolution per minute; the more sudden the change of work or steam, the quicker the Regulator moves the valve—a loss or gain of half a revolution will open or close the steam valve from one extreme to the other. THURSTON, GREENE & CO., 34 3\* Providence, R. I.

1852 TO 1856.—WOODWORTH'S PATENT Planing, Tonguing, Grooving, Rabeting, and Moulding Machines.—Ninety-nine hundredths of all the planed lumber used in our large cities and towns continues to be dressed with Woodworth's Patent Machines. Price from \$150 to \$700. For rights in the unoccupied towns and counties of New York and Northern Pennsylvania, apply to JOHN GIBSON, Planing Mills, Albany, N. Y. 26tf

JOHN W. GRIFFITHS—Ship Builder and Marine Architect, 658 Fourth st., N. Y., furnishes models and draughts of all description of vessels, with the computation of stability, capacity, displacement, and necessary amount of impulsion. Propelling power located and proportionally adapted to the form of the vessel, whether sailing or steaming. Mr. G. also superintends the construction of vessels, and may be consulted upon all subjects pertaining to the various departments of the science or practice of ship building. Draughts forwarded by letter to all parts of the world, and to any desired scale; all letters must be post-paid. 27 13\*

LEONARD'S MACHINERY DEPOT, 109 Pearl-st. and 60 Beaver, N. Y.—Leather Banding Manufactory, N. Y.—Machinists' Tools, a large assortment from the "Lowell Machine Shop," and other celebrated makers. Also a general supply of mechanics' and manufacturers' articles, and a superior quality of oak-tanned Leather Belting. P. A. LEONARD. 27tf

A. B. ELY, Counsellor at Law, 46 Washington st., Boston, will give particular attention to Patent Cases. Refers to Munn & Co., Scientific American. 13tf

CLOCKS FOR CHURCHES, PUBLIC BUILDINGS, RAILROAD STATIONS, &c., and REGULATORS FOR JEWELLERS.—The undersigned having succeeded in counteracting entirely the influence of the changes of the temperature upon the pendulum, and introduced other important improvements in the construction of clocks, are prepared to furnish an article, superior to any made in the United States, (the highest grade warranted to vary less than two minutes in twelve months). Glass dials for illumination furnished. Address SHERRY & BYRAM, Oakland Works, Sag Harbor, Long Island, N. Y.

"At the Oakland Works of Sherry & Byram there are made some of the finest clocks in the world."—Scientific American. "Mr. Byram is a rare mechanical genius." [Jour. of Commerce. 26tf

TRACY & FALES, RAILROAD CAR MANUFACTORY.—Grove Works, Hartford, Conn. Passenger, freight, and all other descriptions of railroad cars and locomotive tenders made to order promptly. 26tf

POST'S PATENT SLIDING DOOR FRONTS.—For stores and Public Buildings; a new, cheap, and simple fixture for securing store fronts, which renders them fire and burglar proof, has been invented and patented by the subscriber, who is now prepared to sell rights. Messrs. Quarterman and Son, 114 John st., N. Y., are general agents. Address, (post-paid) Wm. POST, Architect, Flushing, L. I. 25tf

TO BUILDERS AND WORKERS in Wood.—We are selling a very simple durable, and effective Mortising Machine for \$20, boxed ready for shipment. We have sold a large number within the last year, and they have given satisfaction. We furnish three chisels and a lever to operate them. Address MUNN & CO.

PAINTS, &c. &c.—American Atomic Drier, Graining Colors, Anti-friction Paste, Gold Size, Zinc Drier, and Stove Polish. QUARTERMAN & SON, 114 John st., 25tf Painters and Chemists.

BEARDSLEE'S PATENT PLANING MACHINE, for Planing, Tonguing and Grooving Boards and Plank.—This recently patented machine is now in successful operation at the Machine shop and Foundry of Messrs. F. & T. Townsend, Albany N. Y.; where it can be seen. It produces work superior to any mode of planing before known. The number of plank or boards fed into it is the only limit to the amount it will plane. For rights to this machine apply to the patentee at the abovenamed foundry—or at his residence No. 704 Broadway; Albany. GEO. W. BEARDSLEE. 23tf

MACHINERY.—S. C. HILLS, No. 12 Platt-st. N. Y. dealer in Steam Engines, Boilers, Iron Planers, Lathes, Universal Chucks, Drills; Kase's, Von Schmidt's and other Pumps; Johnson's Shingle Machines; Woodworth's, Daniel's and Law's Planing machines; Dick's Presses, Punches and Shears; Mortising and Tenoning machines; Belting; machinery oil, Beal's patent Cob and Corn mills; Burr mill and Grindstones; Lead and Iron Pipe &c. Letters to be noticed must be post-paid. 26 tf

WOOD'S IMPROVED SHINGLE MACHINE.—Patented January 8th 1850, is without doubt the most valuable improvement ever made in this branch of labor-saving machinery. It has been thoroughly tested upon all kinds of timber and so great was the favor with which this machine was held at the last Fair of the American Institute that an unbought premium was awarded to it in preference to any other on exhibition. Persons wishing for rights can address (post-paid) JAMES D. JOHNSON, Bridgeport, Ct.; or WM. WOOD, Westport, Ct.; All letters will be promptly attended to. 22tf

THE EXCELSIOR Sand and Emery Papers. Are offered as new and superior articles, being manufactured by an improved process; the paper is made from the best Manila hemp, and consequently is very strong and lasting; the grit is of the sharpest and most enduring kind, and is firmly attached to the paper with a remarkable evenness of surface; their freedom from ridges, stripes, and other imperfections, recommend them to the notice of consumers. These papers have been used by many of our first mechanics, and are pronounced superior to all others. Every sheet is stamped WM. B. PARSONS, and warranted. Samples furnished at the office, No. 234 Pearl street, New York. WM. B. PARSONS, 14 6m\*

P. W. GATES'S PATENT DIES FOR CUTTING SCREWS.—Patented May 8th, 1847.—This Die cuts Screws of any size, V or square thread, by once passing over the Iron. Also, Lead Screws for Lathes, Hoisting Screws, &c. All orders for Dies and Taps, with or without machines, will meet with prompt attention by addressing P. W. Gates, or Gates & McKnight, Chicago; Marshall, Bement & Colby, Philadelphia; Woodburn, Light & Co., Worcester, Mass. References.—All the principal machine shops in New York, Philadelphia, and Boston. 13 6m\*

CHARLES F. MANN, FULTON IRON WORKS, Troy, N. Y.—The subscriber builds Steam Engines and Boilers of various patterns and sizes, from the horse power upward; also, his Portable Steam Engine and Boiler combined, occupying little space, economical in fuel, safe, and easily managed; Double Action Lift and Force Pumps; Fixtures and Apparatus for Steam or Water; Tools for Machine Shops; Shafting and Pulleys for Factories. Brass Castings and Machinery made to order at short notice. Steam engines furnished cheaper than can be had elsewhere, of the same quality. 30tf

N. G. NORCROSS'S ROTARY PLANING MACHINE UNEQUALLED.—This machine took the first medals awarded to Rotary Planers at the Fair in Boston and at the American Institute, in the Fall of 1850. The Circuit Court, in the Eastern Circuit, held at Boston on the 24th Feb., before his honor Judge Sprague, decided, after a long and tedious litigation of two years, that the Norcross Machine does not infringe the Woodworth Patent; this was on a motion for a permanent injunction, which was refused without ordering a jury trial. Rights to use this patent are for sale by N. G. NORCROSS, Lowell, Mass. 29 8\*

IMPORTANT TO IRON FOUNDRIES.—The Galvanic Alloy Manufacturing Co., Nos. 401, 403, and 405 Cherry st., N. Y., will furnish the Aerostatic Fan Blower at \$55, and with patent fitting at \$65; that produce sufficient blast for the longest cupola, melting 3 and 4 tons of iron per hour; taking less than one half the power of those now in use, that cost from \$80 to \$100. The wings, being only about an inch in width (planned upon entirely new and mathematical principles), produce double the blast with half the power of other blowers. Warranted in all cases, or they may be returned and the money refunded. 29tf.

MANUFACTURE OF PATENT WIRE Ropes and Cables.—for inclined planes, suspension bridges, standing rigging, mines, cranes, derrick, tilters &c.; by JOHN A. ROEBLING; Civil Engineer—Trenton N. J. 47 1y\*

BALLOONS.—From 1 to 1000 lbs. ascending power, made to order and warranted perfect. Also for sale, Wise's History and Practice of Aeronautics. No library is complete without this work: "It is the best book ever published on this subject."—Scientific Am. Octavo, over 300 pages; 13 plates; price \$2, delivered postage free to any part of the U. S. All letters (post-paid) addressed Lancaster, Pa., promptly attended to. JOHN WISE, Aeronaut. 32 5\*

LOGAN VAIL & CO., No. 9 Gold street, New York, agents for George Vail & Co., Speedwell Iron Works, have constantly on hand Saw Mill and Grist Mill Irons, Press Screws, Bogardus' Horse-Powers, and will take orders of Machinery of any kind, of iron and brass; Portable Saw-mills and Steam Engines, Saw Gummers of approved and cheap kind, &c. Gearing, Shafting, large and small, cast or of wrought iron. 11 1y

NEW HAVEN MANUFACTURING COMPANY, Tool Builders, New Haven, Conn., (successors to Scranton & Parshley) have now on hand \$25,000 worth of Machinist's Tools, consisting of power planers, to plane from 5 to 12 feet; slide lathes from 6 to 18 feet long; 3 size hand lathes, with or without shears; counter shafts, to fit all sizes and kinds of universal chuck gear cutting engines; drill presses, index plates, bolt cutters, and 3 size slide rests. The Co. are also manufacturing steam engines. All of the above tools are of the best quality, and are for sale at 25 per cent. less than any other tools in the market. Cuts and list of prices can be had by addressing as above, post-paid. Warehouse No. 12 Platt st., New York, S. C. HILLS, Agent N. H. Man's Co. 25tf

## SCIENTIFIC MUSEUM.

For the Scientific American.  
Agricultural Science.

**MOISTURE OF THE SOIL—WATERING.**—As stated in our notice of "Lindley's Horticulture," the following is condensed from the said work:

Water is one of the most important elements in the food of plants; they will not live in a soil which, without being chemically dry, contains so little moisture as to appear dry; on the other hand an excessive quantity of moisture, is in many cases equally prejudicial. In winter, in northern climates, and during the dry season in the tropics, plants do not require so much moisture. This does not apply to aquatic and marshy plants. When plants are in a state of growth, and as soon as young leaves sprout forth, perspiration commences, and a powerful absorption of moisture must take place at the roots, and the younger the leaves, the more rapid their perspiratory action. As a general rule, the ground should be abundantly supplied with moisture when the plants first begin to grow. To keep plants tender—such as lettuce and spinach for table use—they should have a plentiful supply of moisture.

Market gardeners deluge their strawberries with moisture while the fruit is swelling; this increases the size of the fruit, but detracts from its flavor. When succulent fruit is ripening, the supply of water should be diminished,—this happens in nature all over the world. Fruits are impaired by growing on a wet soil—the plum and grape often burst in wet seasons. Melons require a great supply of moisture, but every plant has its own peculiar wants, and it does not do to make some plants grow in a wet soil, for instead of flowers and leaves, they only produce a superabundance of leaves and ill-formed shoots. It is an excellent plan to drain gardens and orchards. Glazed flower-pots are unfit for most plants; they prevent evaporation, and are not so good as the common unglazed ones. Painted wooden boxes for flowers are, for the same reason, to be avoided. Covering the soil in summer in our country, by what is called *mulching*, is excellent; this consists in covering the surface of the ground, around plants or trees, with some good non-conducting substance. Some gardeners use spent tan bark, others barn-yard litter, straw, &c. This maintains a uniform temperature and moisture for the roots. Mulching is excellent for delicate fruit-bearing trees and obviates the necessity of artificial watering. It is injurious to water plants artificially in the hot sunshine. They should be watered early in the morning, or, after sundown, and the watering pot should be raised high to allow the water to mingle with the air before it falls on the plants. Rain or soft water, is the kind to use. It is a bad plan to deluge plants by slashing pailsfull of water on or around them. By pouring water daily around plants and newly transplanted trees, if the soil is stiff, is a very injudicious practice. The ground by this system soon becomes very hard, and this prevents access of air to the roots. While planting a tree late in spring, the hole should be abundantly watered before the upper layer is laid on. Although moisture is essentially necessary to the growth of plants, artificial watering should be performed with great care. Dry air, acting upon a vegetable tissue of delicate surface, causes mildew, which is prevented in annuals by an abundant watering. The mildew which attacks the young fruit of the foreign grape when reared here in the open air, is very troublesome. This is prevented by dusting the flowers of sulphur over the bunches; but the best way to prevent this mildew in these vines, is to lay down half the young shoots of the vine annually, thus forming new plants, as the old ones shrivel and mildew in three or four years. The ravages of insects, on spinach, the onion, and the pea, are often prevented by an abundant artificial watering.

## Powerful Antidote.

M. Mentere relates, in the Gazette Medical, some of the experiments which he witnessed while travelling with M. Orfila, the famous poison chemist. During their visit to the Museum of Natural History at Prague, they

were introduced to Dr. Ellenberger, who exhibited his experiments with antidotes for mineral poisons, particularly strychnine and morphine. After relating the various trials he made on himself, he proposed to perform an immediate experiment. He sent to the apothecary for 30 grains of acetate of morphine, which Orfila pronounced pure. He, (Dr. Ellenberger) put it on his tongue and swallowed it to the alarm of all present.—One minute after, he swallowed a white powder, and the poison produced no effect. He had often performed like experiments with strychnine, but recently in performing one he lost his life. The secret of his antidote has not been revealed. It probably has died with him. We hope it may be found in his papers. Some other person will no doubt re-discover it, or something as good, since it is known that such a thing had an existence.

On Boilers.—No. 24.  
Fig. 49

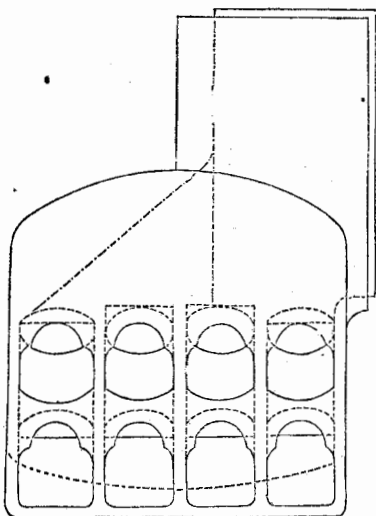

**MARINE BOILERS**—B. H. Bartol, Engineer, has a work on the "Marine Boilers of the United States." It is not a treatise on Boilers, for the author has not entered into explanations, nor does he discuss principles or practices in relation to the construction, draught, and working of the boilers; but he presents correct drawings to scale, and gives the dimensions of machinery, fuel consumed, &c., of 64 American steamers, and the data he thus furnishes for the engineer is exceedingly useful. A great amount of heating surface, combined with strength, has been the grand desideratum in steam boilers. These qualities are carried out in the best manner in locomotive boilers, by the employment of a great number of tubes surrounded with water, the heated products passing through the interior. In some cases, like Dimpfel's boiler, the water passes through the interior. These are called tubular boilers. Tubular boilers, although employed a number of years ago, on steamboats, were objected to by many, as being difficult to clean out, and because salt and limous incrustations were formed so rapidly in the

Fig. 50.

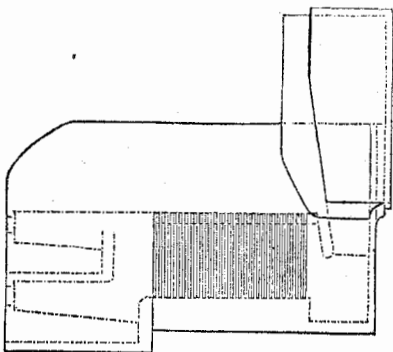

boilers of sea steamers. In 1842, however, we find that steamboat boilers, with tubes of three inches diameter, were common on the Clyde; but, judging from the opinion of the Editor of the "Glasgow Mechanics' Magazine," expressed ten years ago, they found no favor with him, as they did not with many other engineers in England. The principle of employing a very great number of tubes, for the boilers of ocean steamers, has been more fully carried out in our American steamships than in any of those yet built in Europe. How much economical advantage is possessed by them (the profit and loss) we have not sufficient data to form an opinion. Figs. 49. and 50 are a longitudinal and a

transverse section of the Atlantic. This steamship has four iron boilers, back to back, which are distinguished for their great amount of fire surface. The whole amount of fire surface is 19,044 square feet, tube surface 13,560 square feet; grate 572 square feet. The ratio of fire surface to the cubic foot of cylinder, is 21½ to 1, and of grate surface 33½ to 1. In the Franklin, the ratio of fire surface to the cubic foot of cylinder, is 11 3-10 square feet to 1, and of grate surface 28 4-10 to 1—a very great difference certainly. The consumption of bituminous coal per hour in the Atlantic is set down at 5,880 lbs., in the Franklin 6,160 lbs. The water evaporated by 1 lb. of coal, in the Atlantic, is 7½ lbs.; in the Franklin 5 lbs. The ratio of heating and grate surface to the size of the cylinder, is, by this comparison, a correct rule to guide us in forming a correct judgment of the economy of fuel by different boilers. The equilibrium point of economy, taking all things into consideration, is not known, but this will be determined before many years pass away. The tubes of the Atlantic's boilers are only two inches outside diameter.

## A Singular Case.

A singular case of mesmerism, or something else, has occurred in this town within a few days. Anna Norwood, aged about 17 years, daughter of Mr. Jonathan Norwood, of Montague, was engaged doing housework in this town. On the evening of the 20th ult. she was present where several gentlemen and ladies were engaged in trying to have communications with the "spirits," by "rappings and tipplings." During the evening she was thrown, as was supposed, into a mesmeric state, out of which she was partially brought sometime in the course of the night. The next forenoon she did some baking and other housework, but about noon went into a supposed mesmeric state again, in which she has remained to the present time. On Friday, the 23rd, she was taken home to her father's, in Montague City, and one of the persons who was with her at the time of her going into the mesmeric state, sent for, but he had but little influence over her. During the whole time she has been subject to the most distressing convulsions, it taking from two to six men to keep her on the bed. When not in convulsions she would frequently carry on a conversation with the persons present, always calling them by the names of those persons who were present when she went into the mesmeric state, and talking upon subjects connected with them.—Shelies with her eyes closed, and has the appearance of a person mesmerised. On Tuesday her mother went into a similar state, being mesmerised, as is stated, by her daughter, while attending upon her. Mr. and Mrs. Cheney, of Athol, who are considered among the best of the "spiritual mediums," were sent for on Wednesday, and although the daughter could not be brought out of the state, she was evidently benefitted, and her convulsions have been less frequent since. Several physicians have visited her, but cannot help her, and consider it the most singular case they have ever seen.—[Greenfield (Mass.) Gaz.]

[Here is a poor girl of a nervous temperament, and who should be in charge of an able physician, rendered helpless, at least for the time being, by the orgies of a set of dementarians.]

## Chloroform.

The London Lancet says there are two modes of administering chloroform; one consists in using a small quantity of it, to be inhaled in a very short time, with hardly any admixture of atmospheric air. Patients are in this manner quickly rendered insensible. The method is dangerous; and though but comparatively few accidents have occurred, the latter have struck such terror into the practitioners and members of the community that this mode should never be followed. Chloroform should first be inhaled with a large quantity of atmospheric air; respiration should be allowed to go on regularly and normally, the chloroform is then gradually inhaled in a more concentrated form, and left off as soon as any unpleasant symptoms occur. Eight or ten minutes, and from three to five drachms are thus employed in obtaining anæsthesia; but this loss of time and chloroform is made up in the absence of danger.

Operations of the most delicate kind can thus be carried on for a whole hour; much as three ounces or more of chloroform are consumed, and no accident occurs.

## LITERARY NOTICES.

**LINDLEY'S HORTICULTURE**—By John Wiley, of 18 Park Place, this city, has just issued the second American Edition of "Lindley's Horticulture," to which has been added Notes by A. J. Downing, a name familiar to all our horticulturists. Lindley enters into the theory of the action of plants, their growth, production, &c. He presents a great mass of information respecting the heat necessary for vegetation, also the moisture, and the best modes of treating all vegetables scientifically. We find the "Notes" of Mr. Downing to be exceedingly valuable, as the method of gardening in England and America must be different, owing to the great difference in climate; this is clearly pointed out and explained, when necessary, in the "Notes." The watering of plants is treated in a very satisfactory manner; as this is a subject of interest to every family which has a patch of ground for a garden, we present the substance of this chapter on another column.

**ASSAYER'S GUIDE**—This is a neat and excellent little volume, published by H. C. Baird, Philadelphia, and edited by Oscar M. Lieber, late Geologist of the State of Mississippi. It contains directions to Assayers, Miners, Smelters, for the tests and assays, by heat and by the wet process, of the ores of all the principle metals, and of gold and silver coins and alloys. It is a capital work, exceedingly practical and valuable. The author of it is perfectly at home, with this subject, and treats it in a plain and distinct style. It is for sale by John S. Taylor, 143 Nassau street, this city, who is also agent for the sale of the other excellent works published by Mr. Baird.

**THE CAVALIERS OF ENGLAND; or the Times of the Revolution of 1642 and 1688;** by Wm. Henry Herbert, pp. 428; J. S. Redfield, publisher, Clinton Hall, N. Y. This volume contains four legends of love and chivalry, viz., "The Brother in Arms, or the Three Noblest Victims for Opinions' Sake," "The Rival Sisters, or Inglesborough Hall," "Jasper St. Aubyn, or the Course of Passion," and "Venon in the Vale, or the Price of Blood." These legends are full of stirring interest, and are fit subjects for a neat book, issued in Redfield's uniform excellent style.

**BRONCHITIS AND KINDRED DISEASES**—By W. W. Hall, Md.—An interesting and valuable work to those afflicted with bronchitis or consumption in its incipient stages, has just been issued from the well-known publishing house of S. P. Redfield, Clinton Hall. We are convinced, from a perusal of this book, that, if it is as extensively circulated and read, as it should be, and its precepts followed, many valuable lives may be saved, annually, by means of its publication.

**WALL STREET JOURNAL**—This is the title of one of our favorite papers which we take home with us to peruse at our leisure. The "Wall Street Journal" is of the financial order, and its editorials are short, pithy, and convey, as far as we have acquaintance in such matters, correct impressions. In each number is chronicled the state of the Stock Market—the state and prospect of trade, a record of the real estate sales, etc. etc. Published weekly by Robinson & Co., 15 Merchants' Exchange. Price \$2 per annum.

**AMERICAN UNION**—A new volume of this interesting literary paper was commenced on the 1st instant, thus affording an excellent opportunity for new subscribers to forward on their names and receive its weekly visits. The "Union" stands very high in a literary point of view, and we can heartily recommend it to those who may desire a good family paper. Published by R. B. Fitts & Co. Price \$2 per annum: Boston, Mass.

## INVENTORS

### Mechanics and Manufacturers

Will find the SCIENTIFIC AMERICAN a journal exactly suited to their wants. It is issued regularly every week in FORM SUITABLE FOR BINDING. Each number contains an Official List of PATENT CLAIMS, notices of New Inventions, Chemical and Mechanical; Reviews, proceedings of Scientific Societies; articles upon Engineering, Mining, Architecture, Internal Improvements, Patents, and Patent Laws; Practical Essays upon all subjects connected with the Arts and Sciences. Each Volume covers 416 pages of clearly printed matter, interspersed with from Four to Six Hundred Engravings, and Specifications of Patents. It is the REPERTORY OF AMERICAN INVENTION, and is widely complimented at home and abroad for the soundness of its views. If success is any criterion of its character, the publishers have the satisfaction of believing it the first among the many Scientific Journals in the world.

Postmasters, being authorized agents for the Scientific American, will very generally attend to forwarding letters covering remittances.

MUNN & CO.,  
Publishers of the Scientific American,  
128 Fulton street, New York.

## INDUCEMENTS FOR CLUBBING.

Any person who will send us four subscribers for six months, at our regular rates, shall be entitled to one copy for the same length of time; or we will furnish—

Ten Copies for Six Months for	\$ 8
Ten Copies for Twelve Months,	15
Fifteen Copies for Twelve Months,	22
Twenty Copies for Twelve Months,	28

Southern and Western Money taken at par for subscriptions, or Post Office Stamps taken at their full value.

N. B.—The public are particularly warned against paying money to Travelling Agents, as none are accredited from this office. The only safe way to obtain a paper is to remit to the publishers.