

Scientific American

A WEEKLY JOURNAL OF PRACTICAL INFORMATION, ART, SCIENCE, MECHANICS, CHEMISTRY, AND MANUFACTURES.

Vol. XV.—No. 25.
[NEW SERIES.]

NEW YORK, DECEMBER 15, 1866.

{ \$3 per Annum,
[IN ADVANCE.] }

Improved Apparatus for Well Boring and Hoisting.

The discovery of the commercial value of mineral oil has greatly stimulated the efforts of inventors to improve upon the crude attempts first made to reach the buried treasures of the earth; yet the old walking beam and samson post are still adhered to, probably because of their simplicity and cheapness. The object of the apparatus herewith illustrated is to provide an improved device for boring wells. It is also adapted for pumping and hoisting purposes. Its operation is easily understood, as the parts are simple in character and few.

A level platform, A, circular in form, and either a disk or a rim, is laid upon the ground, and the platform, B, revolves upon it by means of trucks or rollers. At the center of this platform is a well-hole, and rising from its side is the upright, C. Under the platform, B, is a fixed gear wheel in which the wheel, D, meshes. The platform being rotated, by horse or any other power, its revolution gives motion to the wheel, D. On the same shaft with this gear is a double lever, having circumferential slots in either arm, at equal distances from the center. In front of this is a similar lever or double arm, E, having pins in its rear face which play in the segmental slots, and by which the arm, E, is carried around with the shaft of D. In this arm is a longitudinal slot, in which moves loosely a box to which the connecting rod, F, is pivoted, which is secured at the other end to a box which slides up and down in a corresponding slot in the upright, C.

As the shaft, D, rotates the arm, E, is carried around, and soon after the box carrying the connecting rod has passed the lower center it slides to the upper end of the arm, allowing the drill, F, to fall, when the continued revolution of the shaft again raises it, to fall again at the next half revolution. By this means there are two full strokes given to each one revolution of the wheel, D. The drill may be attached to the upper block directly, or after the hole has progressed, to the knob, G, on the box by a rope passing over the pulley at the top of the uprights. The rope passes around the shaft, D, thence on the drum or winch, H, to be let out as demanded by the progress of the work. The sand-pump is always suspended ready for use from the hinged pulley block, I, by a rope winding on the barrel of the winch, J. The drill can easily be removed by the winch, H, and the sand-pump lowered into the well without the trouble of disconnecting the drill,

For pumping purposes this machine appears to be equally efficient. It can be worked very rapidly by having a large wheel under the platform, B, even when the horse or other motive power is traveling slowly. The rotation of the platform insures a gradual rotation of the drill, so that at every stroke it presents its cutting edge at a different angle, and the hole is always bored perfectly round.

A patent was issued March 6, 1866, to W. C.

nishes the data on which his statements are founded, and the Worcester and Western railways, between Boston and Albany, are those to which his remarks are specially applied.

Quoting from the report of the English Board of Trade for the year 1863, the average expenditure per train, taking all the railroads in the United Kingdom, is placed at 2s. 7d., or 63 cents per mile. Of this sum the cost of maintaining the way and works, the locomotive power, and the repairs and renewals of cars, amounts to 1s. 2½d., or 29 cents; the remaining items include the Government tax, compensation for personal injury, legal expenses, and other expenditures which must be paid whether the trains run or not.

In regard to the traction of a locomotive, 1,000 passengers, or 300 tons of freight, are considered as a fair maximum load on the majority of the English railways. When the track is laid, and the road is fully equipped, the results of full trains at the present prices would be, on the roads under discussion, 10,000 tons on the five daily freight trains at \$7, and 6,000 passengers, in six trains, at \$6 each, giving a total of \$106,000; but, by the estimate given above, the actual cost is only \$124 for each train, yet, to cover all expenditures, call it \$159. Then 27 passengers pay the total cost, and 973 are carried free. For freight alone, 23 tons defray the whole expense, and 177 go free.

A prevalent opinion is that the charges on a railroad must be proportioned to the cost of construction. Now it is found that the English railways on which the greatest amount of capital per mile has been expended, are those on which the fares are the lowest. The Charing Cross Railway cost a million and a-half sterling, or \$7,500,000 in gold, per mile, yet passengers are carried at a lower rate than on some roads constructed at a hundredth

part of that cost. When the actual fares exceed the expense incurred in the conveyance, it becomes a mere question of numbers as to what fares best pay. English experience also proves that any decrease in price of transportation is immediately followed by a nearly corresponding increase in business.

The effect of reducing fares, on dividends, is seen in the contest between the Edinburgh and Glasgow, and the Caledonian railways, connecting these two cities, which, with their immediate vicinities, have a population of 600,000 inhabitants. During the contest the fares were reduced to one-eighth of the ordinary charges; the loss in dividends, resulting,

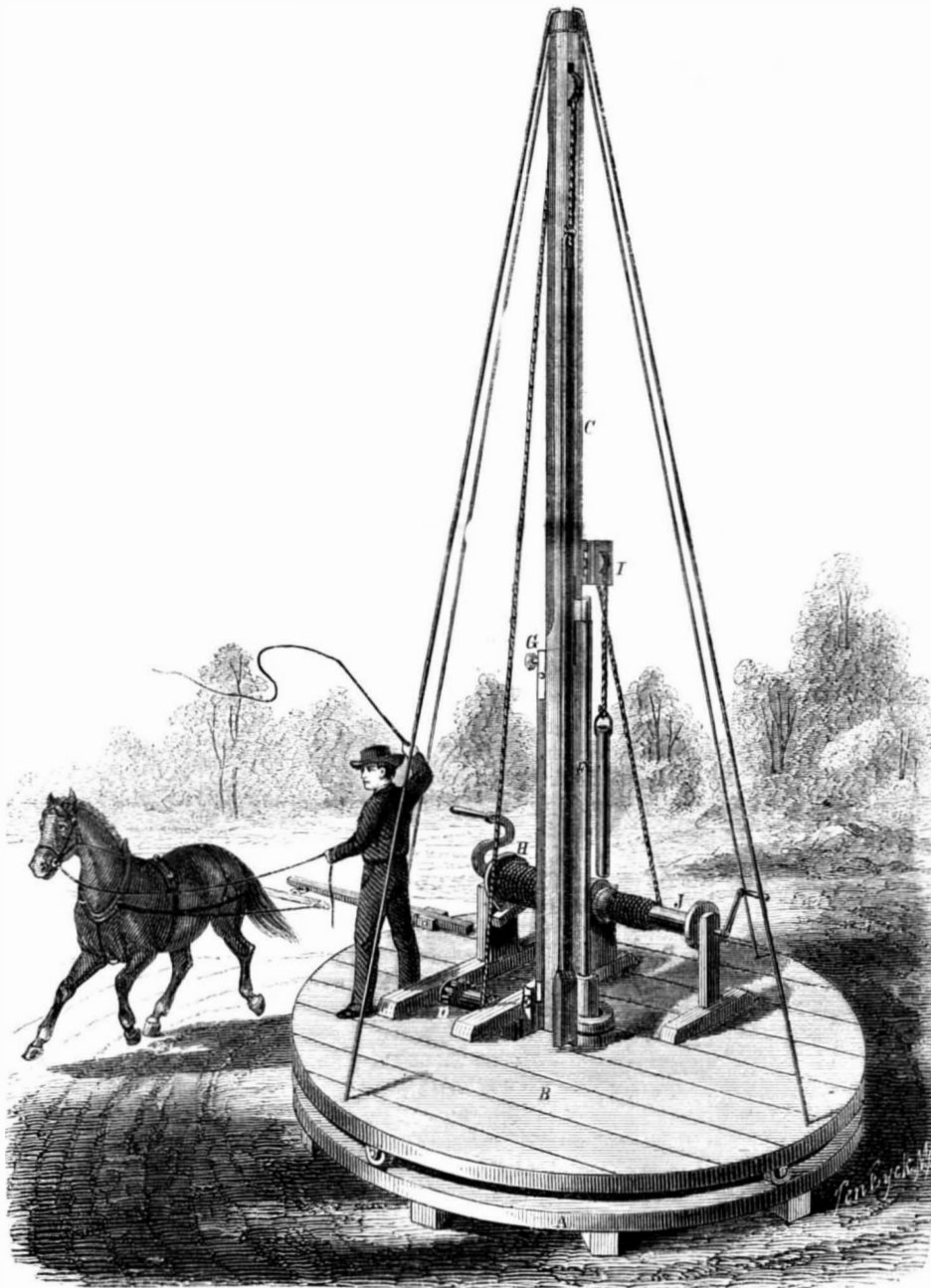

MCGILL & GIBSON'S DRILLING, PUMPING, AND HOISTING MACHINE.

McGill and A. J. Gibson, of Cincinnati, Ohio. For further information address A. V. Stewart, No. 14 Public Landing, Cincinnati, Ohio, or W. C. McGill, No. 277 Walnut street, same city.

REDUCTION OF RAILWAY CHARGES.

Hon. Josiah Quincy delivered, last week, an address before the Boston Board of Trade warmly advocating the possession by the several States of all the important railway lines, believing that thereby the charges for passage and transportation of freight would be reduced to correspond with the mere cost of operation. The experience of English roads fur-

amounted in the one company to one, and in the other to less than one-half, per cent per annum.

Should the Worcester and Western roads lower their charges, not to one-eighth, but to one-sixth, with a similar increase of business, the difference to the shareholders would consist in receiving nine instead of ten per cent, annually, on their investments, a loss of \$100,000 to the roads and a gain of millions to the community.

According to General Stark, freight is now carried by the tun on some of our Western roads for one cent per mile. At this rate a tun could be taken from Albany to Boston for two dollars, the cars in both cases returning empty. As a tun is equivalent to two passengers, they could be taken between the two cities for one dollar each.

However great may be the benefits accruing to the people from the low-fare system, they are unattainable under the present mode of management. The plan proposed for securing these advantages is the purchase of the roads referred to, for an equitable price, payment to be made by the issue of bonds for fifty years at five per cent; the grant of a permanent lease to the city of Boston—the city paying the interest on the loans—to keep the road and stock in repair, and to use the surplus after making all the facilities required by the enlargement of business.

Referring to a movement of like character in England, the address closed with expressing the desire that Massachusetts should inaugurate the movement whose universal adoption is merely a question of time.

INTERESTING OFFICIAL STATISTICS.

The departmental reports are rather barren of instruction appropriate to our pages. We collect a few items:

POSTAL MONEY ORDERS.

The money-order offices have been doubled in number (760 against 347 last year) and the business has been more than tripled. The number of orders issued has been nearly a quarter of a million (243,609), and the amount of money transmitted nearly four millions of dollars (\$3,977,250 28), in sums averaging \$16 32. The commissions paid on these orders amounted in round numbers to \$35,000, and the expenses to \$28,000; profits \$7,000. The system has now paid an excess of \$90 over all its expenses from the start.

SOUTHERN RAILROADS.

The domestic mail-service has been extended 38,581 miles; chiefly in the lately insurgent states. Nine tenths of the railroads in the South are now in operation, consisting of ninety roads with an aggregate length of 8,170 miles; leaving 14 roads, with a length of 696 miles, idle.

ACTIVE FOREIGN CORRESPONDENCE.

The foreign postage collected has been nearly half a million dollars greater than last year. Over nine millions of letters have been exchanged with foreign countries, about an equal number passing each way. The increase in the European correspondence over that of 1865, is remarkable, amounting to 1,851,330 letters. Over four millions of newspapers were exchanged with foreign countries, and more than two-thirds of these went from the United States: increase, only about 30,000.

CONSUMPTION OF POSTAGE STAMPS.

Twenty tuns, or, by superficial measurement, forty-eight and a half square miles, of postage stamps, have been used during the year: enough to roof a large township, with all its houses, barns, churches, gardens, forests and farms; or, if you choose to make a ribbon of them, enough to reach nearly from the equator to either pole, or twice the length of the Mississippi river. So that if everybody would be obliging enough to use the government stamp on the envelope itself, the mere omission of these little extra bits of paper would lighten the mail-bags by more than forty thousand pounds, and save in paper fifteen or twenty thousand dollars. The Postmaster General does not impart this information in so many words, but he assures us that nearly 350 millions of stamps have been sold in the year past, beside nearly forty millions of stamped envelopes;

and a simple calculation reduces the story to the more tangible form we have given it.

THE NAVY.

Material and occasion for numerous suggestions of great interest might be found in the present state of naval affairs; but Secretary Welles is popularly supposed to be a man not easily roused, and his report is hardly of a rousing character. There is nothing new in the references made to our successful ocean monitors, or in the suggestions advanced on the subject. A great increase of ship-houses, building shops, dry docks and building materials, at the navy yards, the renovation of the yards at Norfolk and Pensacola, and the settlement of a fresh-water station for iron bottoms, are strongly urged. There is nothing worth mentioning about harbor defenses. The universal deterioration and decrease of seamen is referred to, and an improvement in their condition, which is indispensable to induce men in these days to seek the dangerous calling of sailors, is recommended in general terms. Economical management of the liberal war appropriations to the Navy Department has enabled it to complete all the vessels and engines contracted for before the close of the war, leaving a residue of about fifty millions which can be relinquished to the Treasury. The navy does not appear to be improving its present leisure by any service of a scientific character.

COAST DEFENSES.

As everybody knows, the entrances of the New York and other harbors are being lined with tremendous weights of metal, in batteries of enormous length, of fifteen and twenty-inch guns. Surveys of the lakes are energetically prosecuted.

SMALL-ARMS.

A plan for converting Springfield muskets into breech-loaders more efficient than the Prussian needle gun, and at a comparatively small cost; also models of new breech-loaders for the various arms of the service, have been decided on by the special Board of officers appointed for that purpose, whose lengthened experiments have often been publicly referred to. The manufacture and alteration are already vigorously going forward, but the Secretary does not deign to throw any light upon what he is doing. Nobody out of the department seems to know what improvements have been adopted.

FEVERISH PRICES AND ENFEEBLED GROWTH.

The Treasury report imputes to a redundant currency and a fallacious inflation of values, a decline in American enterprise, on sea and land, exhibited in the slow construction of needed dwellings and manufactories, in the abandonment or inactivity of most of our ship yards, and in a decrease of our tonnage clearances in foreign trade from upward of six millions in 1860 to less than three and a half millions in 1866, while the foreign tonnage cleared from our ports increased from two and a half to four and a half millions. The Secretary, that is, does not see in the stifling of our ocean enterprise by British Confederate privateers during the war, adequate cause for its continued torpor after two years of peace.

GOLD PRODUCT.

The value of gold assessed for Internal Revenue the past year has been \$81,389,541. Of this amount, \$70,032,805 were assessed on the Pacific side; twenty-five per cent of the whole product being estimated as having escaped assessment. Adding this, and allowing about half the gold assessed in the East to be foreign, the total domestic production is estimated at \$93,219,374; an increase of \$19,675,015, in comparison with 1865.

NATIONAL BANKING SYSTEM.

Only eleven banking institutions have been converted into national banks, in the year ending Oct. 1, 1866. Fifty-one new national banks have been organized. Sixteen are closing or closed, and 1,647 are in active operation. Aggregate capital paid in, about 418 millions of dollars; bonds to secure circulation, about 330 millions; circulation not quite 300 millions, being an increase of about 100 millions, reduced to about fifty millions by State circulation retired by converted banks. Total resources \$1,525,493,960; liabilities for circulation and deposits \$1,024,274,386; leaving a surplus of \$501,221,574 for capital and earning.

NEW YORK THE METROPOLIS.

Every national bank in the United States is obliged by the necessities of business, to keep an account in New York; and about 1,000 of them voluntarily redeem in New York, of all the seventeen cities from which they are allowed by law to choose. The necessary principle of requiring all national banks to receive each other's notes at par, while it would be manifestly unsound policy to compel private creditors to receive them as legal tender, throws great risk and periodical embarrassment upon the banks at the centers of trade where circulation accumulates, and furnishes an unanswerable reason, in the opinion of the Controller of the Currency, for requiring all national banks to redeem at one or another of the great centers—in New York, Boston, Philadelphia, or better still, in New York alone.

PUBLIC LANDS.

The whole public domain now contains nearly 1,500 millions of acres, of which only about one-third have been surveyed. Upward of four and a half millions have been disposed of in the year, of which only about 388,000 acres were sold, while nearly two millions of acres were taken up by settlers under the homestead act, nearly a million and a quarter of swamp lands were conceded to the States (making over 43 millions in all), and the rest were absorbed by railroads, military warrants and agricultural colleges. Measures are recommended for promoting the planting and growth of timber on the public domain.

PATENTS.

There were 14,039 applications for patents in 1866; about 3,000 more than in any previous year. Of these, 10,130 were granted, of which 8,716 have been issued.

PENSIONS.

It is a singular fact that although but one Revolutionary pensioner—Samuel Downing, of Edinburg, Saratoga county, N. Y.—now survives, there are no less than 931 widows of Revolutionary soldiers still on the pension rolls. The greater longevity of women will not account for this enormous discrepancy, and the fact that pensioners and annuitants live long, seems equally in favor of both sexes. Of course, the widows of those killed in battle swelled the proportion of female pensioners very largely, but this could not have multiplied it 900 times, hardly 10 times. Probably, in consideration that "none but the brave deserve the fair" (not to speak of the pensions) the surviving heroes were generally and even repeatedly blessed with youthful and blooming brides. There are now, in round numbers, 45,000 invalids, and 70,000 widows and relatives on the rolls, at an annual cost of eleven and a-half millions of dollars.

A New Caustic.

Perhaps we should rather have headed this item "an old bleacher," instead of a new caustic. A Mr. Augustus Barnes proposes to take out a patent for removing spots, moles, naevi, and other diseased conditions of the skin, by the action of sunlight concentrated through a lens. Dr. P. W. Ellsworth, of Hartford, in the *Medical and Surgical Reporter*, vouches for the removal of a naevus covering four or five square inches of the face, of a deep cherry red color, approaching purple, and covered with knobs of condensed tissue an eighth of an inch high. After two applications, every knob had disappeared, the skin had gained a natural color, and, as a deformity, the naevus was practically cured. Mr. Barnes professes also to have removed small tumors, to have produced a true and healthy skin on the surface affected by ichthyosis, and to have high expectations in regard to lupus and incipient cancer. The prospects of the colored race also open a boundless field for speculation under the power of Mr. Barnes's magic lens.

BREAD, beer and buttermilk (and the same is partially true of butter), directly after being made, make a rapid exchange of carbon for oxygen, with a proportional improvement in wholesomeness. Bread, when thus ripened, is computed to contain twenty per cent, more of nutriment than when hot from the oven. The change in both taste and texture is very marked. It is important to have all

these articles ripen in a pure, clear atmosphere, as they absorb very freely the ill savors and unwholesome ingredients of the air around them.

[From our Foreign Correspondent.]

ROLLING STOCK OF ENGLISH RAILWAYS.

LONDON, Nov. 15, 1866.

Having, in my last letter, noticed the principal features of English railways in respect to "works of line" and permanent way, I now proceed to give some description of the rolling stock. Owing to the excellence of the permanent way, some arrangements, which on our roads are necessities, have not been as generally introduced in English locomotives; and while with us makers have settled on one or two types of engine exclusively, the variety of arrangement here is much greater. There are many lines, however, which of late have adopted several American ideas, such as the Bissell truck, the equalizing bar between coupled drivers, and placing the steam chest on the top of outside cylinders; and it is probable that the use of most of these will ere long become general. The English locomotive, however, though unfit for American roads, is nevertheless, for the roads on which it has to run, an excellent machine, and presents some points which we would do well to copy. For good engines the type most generally adopted is six coupled driving wheels, about five feet diameter, without other wheels. For an engine of twenty-seven tons' weight, the amount on each pair of wheels would be about nine tons on the forward pair, eleven and a half on the center or driving axle, and six and a half tons on the after pair. Such an engine would have cylinders eighteen inches diameter by twenty-four-inch stroke, with a thousand square feet of heating surface in the boiler, and carry one hundred and twenty lbs. steam. For passenger engines there is greater variety. The majority have inside cylinders, though a respectable proportion have outside. A favorite plan has been to give but a single pair of driving wheels, of from six feet six inches to seven feet six inches diameter, with one pair of leading and one pair of trailing wheels, of three feet six inches diameter; cylinders sixteen inches or seventeen inches diameter by twenty-four-inch stroke. The driving wheels in these carry eleven or twelve tons, but, as we should suppose, they are often deficient in adhesion. Four coupled wheels are now more in favor, either with a single pair of leading wheels, or with a four-wheel bogie. The largest diameter of coupled wheels is seven feet. There is hardly any arrangement of wheels that may not be found in quite general use, two pair of driving wheels alone, four drivers, and a pair of trailing wheels, four drivers and two pair of leading wheels, or a single pair of driving wheels and a bogie, but the first mentioned forms are perhaps the most usual. The boilers are made of seven-sixteenths-inch plates in the shell, five-eighths or three-fourths for the forward tube sheet, and copper fire-boxes half inch thick, except the tube sheet, which is three-fourths inch thick reduced to five-eighths inch below the tubes. The water spaces around the fire-box are two and a half inches to three inches wide. The circular seams of boilers, as a general thing, are single riveted, while the longitudinal ones are double riveted, three-fourths inch being the usual diameter for the rivets. As this plan is not generally followed with us, it is worth while to call attention to the reason why it is done here, and why it certainly is the right way to build boilers. The strain on any joint or section of a boiler is proportioned to the area acted upon by the steam divided by the amount of length of section of metal to resist the pressure. Now the pressure tending to tear asunder the circular seams is due to the area of the ends of the boiler, and is resisted by a length of section equal to the circumference. The pressure tending to rupture the longitudinal seams is due to the diameter of the boiler multiplied by any unit of length, and the resisting section of metal is twice that unit of length or the amount on each side of the barrel in that length. Now as the area of the end is equal to half the circumference multiplied by half the diameter, the strain on the circular seams, which is as this amount divided by the circumference, will be as the diameter divided by four, while on the longitudinal seams it is as the diameter divided by two, or twice as great per unit

of length. If, in addition to this, we consider that the area of the heads taken up by the tubes, on which there can be no pressure, is very great beside the proportion of the strain that they themselves bear, we see that the circular seams always have a great excess of strength over the longitudinal ones, and hence the propriety of double riveting the latter. Angle iron is used in the construction of boilers to a larger extent than we should think advisable, though the best builders only use it for fastening the forward tube sheet to the shell.

The tubes are always of brass, and are set with steel ferrules at one or both ends. Steel is coming largely into use for boilers, on account of its great strength and the facility with which it can be flanged to any desired form. It may reasonably be expected, also, that the reduction of the thickness of the plates, consequent on the substitution of steel for iron, will remove a difficulty which is always found with English locomotive boilers, but which is unknown in America, viz., the grooving of the plates just at the end of the lap of the circular joints in the submerged part of the joint. This has always been a most serious trouble, since the plates are reduced to an unsafe thickness just at this part long before the remainder of the boiler is at all impaired by use. This cannot be due to bad calking, for it occurs in places where no calking is done. It is attributed by some to the strain caused by expansion, tending to buckle the plates, especially where, as in some cases, no expansion joint on the frame is provided; and if this be the cause it would no doubt be less serious with comparatively flexible thin plates than with the thicker ones. The adaptation of the fire-boxes to the burning of bituminous coal is generally very simple and quite effectual. On the London and South-western perhaps the most complete combustion of the gases is obtained by the use of large quantities of fire brick in the form of tubes, arches, and gratings, to insure the requisite heat for ignition after the air for combustion has been admitted; but as this system is very heavy, and not readily applied to existing boilers, it has not come into as general use as other less expensive and scarcely less perfect means. The most usual plan is to have an arch of fire brick projecting from just below the tubes, about half way across the fire-box, and under this air is admitted through two openings in the front of the fire-box seven inches square, provided with dampers by which the quantity can be regulated. Or the air may be introduced at the door, and thrown down toward the arch by a deflector of old sheet iron, in either case the air being obliged to mingle with the gas and ignite before entering the tubes. Sometimes the deflector is used without the fire-brick arch, and in some cases there is no fire door at all, though, unless the firing be constant, this must, I should think, admit too much air. In all arrangements an ample supply of air is provided, and some means for preventing it from entering the tubes without having combined with the gas. As this is a matter which greatly affects the coal bill of a railway, it is well worth the careful attention of those in charge of such matters with us. The fire door is now always made sliding, and consists merely of two plates, connected by links in such a way that they open and shut together by a simple push with the foot on a suitable lever. Beside being much handier and more out of the way, they have the advantage of not being blown open in case of the failure of a tube. The usual size of blast pipe is four and a half inches or five inches, always single. English engineers deem it very important that the boiler should be subjected to no strain other than that arising from the pressure of the steam. Accordingly the cylinders are fastened to the frame alone, and all the working strains are sustained by the framing, the boiler being simply carried on it. The frames consist of deep plates, one inch thick, running the length of the engine, with jaws forged on, wide enough to receive the axle boxes, and in some cases made deep enough at the forward end to completely encircle the steam chest of an outside cylinder (which is at the side of the cylinder, and projects inward through the frame) and allow of a goodly number of bolts being put through the frame and casting. This form of frame is, no doubt, very rigid and good.

With inside cylinders the two steam chests are turned toward each other and bolted together, the cylinders being bolted to the two frames by flanges on their opposite sides. This is an exceedingly inconvenient arrangement for taking care of the valve seats, as there is but a narrow space for getting at them to scrape them if necessary, yet there is but one line, the London and South-western, that has adopted our plan of using a rock shaft, and placing the valve chest where it is accessible. In regard to valve motion there is much greater variety than with us, for while we have generally agreed upon the shifting link of the curved slotted form, with knuckle joints for the eccentric rods behind, here there is not only a division between the shifting and stationary links, but in regard to form and positions of the centers there is every possible variety. In addition to these there is a form of link which has been largely adopted of late, from the cheapness with which it can be made, which is a combination of the two systems, the link being straight, and therefore easy to fit up, and is suspended from a weigh shaft which also carries at its opposite extremity the valve-rod link, so that when one is raised the other is lowered, and both move in the operation of reversing. This gives as good a distribution of the steam as the other forms, and in addition to its simplicity has the advantage of dispensing with the counterbalance, as the link and valve rod link counterbalance each other.

The reciprocating parts are now mostly made of Bessemer metal, to insure strength with lightness. The pistons are made in a much simpler manner than ours, and are equally good as regards tightness and smoothness of the cylinder. They are generally packed on Ramsbottom's patent, in which the piston is a light solid disk, with a flange to give width of bearing on the cylinder. In this flange are turned three square grooves five-sixteenths inch wide, and into these are spring rings of square steel wire of that size, cut carefully to exactly the proper length, so that the ends shall just come together when in working condition, having first been bent to the proper curve so that they shall be pressed out by their own elasticity to a steam-tight bearing. Nothing could be simpler or more efficient than this for a piston packing.

All locomotive wheels are of wrought iron, generally with steel tires. As already stated, the size of both driving and carrying wheels is larger than with us, and the same applies to the carriage wheels also, which gives an advantage in regard to ease of traction, at least where the roads are good enough, as they are here, to admit of them without danger of riding the rails. SLADE.

Patentees in France.

Commissioner General Beckwith, in a letter to the Secretary of State, says he addressed an inquiry to the Imperial Commission, some time since, concerning the legal right of foreigners holding French patents for their inventions, to exhibit and afterward sell the foreign-made products thus patented in France, without forfeiture of the French patent. The Imperial Commission referred the inquiry to the Minister of Commerce, and were informed that, in the opinion of the government, such exhibitions and sale, if duly authorized by the Minister of Commerce, would not operate a forfeiture of patent; but that the decision of questions touching such forfeiture belonged to the courts of law.

Just so, Mr. Beckwith. The reply of the Minister of Commerce decides nothing. That functionary refers the matter to the courts, where it properly belongs. He has no more power to upset the patent laws of France than Secretary Browning has to declare void the patent laws of the United States. The French law will invalidate a patent if the article is made abroad and sold there. To remedy this evil requires new legislation and not the *ipse dixit* of a Cabinet Minister, who is merely an executive officer.

TUNNEL UNDER THE ENGLISH CHANNEL.—Surveys are going forward in the bed of the English channel for the projected tunnel from Dover to Calais. The engineers have a steam tug especially fitted out with scientific apparatus and employed in this survey.

THE GREAT WATER TUNNEL UNDER LAKE MICHIGAN.

Our exchanges bring us, this week, accounts of the virtual completion of a work of American engineering, which, for boldness of conception, unerring skill, and uninterrupted success, deserves to be classed with the proudest achievements of the old world, or of any age.

The greatest produce market in the world, and the most energetic and enterprising city on even the American continent, Chicago has grown up in thirty-six years from a lair of wild beasts to a great metropolis, under some of the grossest natural disadvantages that ever taxed the resolution of any similar community. Its water supply—always miserable, since the drainage of a city begun to be mingled with the lake from which it was drawn—has been all this time growing execrable, until hardly fit to be tasted by man or beast. There the crystal waters of Lake Michigan, among the purest in the world, spread out before the tantalized citizen in all their beauty, beyond his reach, poisoned far along the shore by a ceaseless drench of abominations

from the sewers of the city. It was impossible to conduct water from any point remote enough to be assured against this contamination; and in fact, the shore water from whatever point must always continue subject to every variation of impurity from attrition with the banks and from the deposits washed down by streams and rains. The pure and undisturbed depths of the mid-lake were the only source from which a supply of clean water could be obtained. It was resolved to reach those depths by a tunnel under the bed of the lake, tapping its bottom at a distance of two miles from the shore. Surveys of the lake-bed, by means of an auger inclosed in a tube, revealed the favorable circumstance of a continuous underlying stratum of hard blue clay. The contract for the bold undertaking was awarded in October, 1863, to James Gowan and James J. Dall, of Harrisburgh, Pa., at the sum of \$315,139. They have already expended more than double this amount, mainly in consequence of the enhanced prices of labor and materials; and it is expected that, with all changes, improvements and finishing touches, the waterworks will not be completed for less than \$1,000,000. The contractors have as yet received no relief; but their splendid success warrants the expectation that the city of Chicago will not suffer them to go either unrepaid or unrewarded.

Work was begun at both extremities—the shore end and the lake end—of the tunnel. At the latter point the great engineering difficulty and triumph occurred. The violent storms on the lake, it was thought by eminent engineers, would make it impossible to fix a permanent structure in the waters. A huge wooden crib, or coffer dam, was built, like a ship, on the shore, launched, and towed to its location. It was 40 feet deep, five-sided, 290 feet in circumference, and over 90 feet in diameter. Its angles were armored with iron two and a half inches thick. It had three distinct walls or shells, one within another, each constructed of twelve-inch square timber, caulked water-tight like a ship, and all three braced and girded together in every direction, with irons and timbers, to the utmost possible pitch of mechanical strength. The central area, or well, inclosed by the inner wall, was only twenty-five feet in diameter; leaving spaces about fifteen feet wide between the shells. Within these spaces were constructed fifteen caulked and water-tight compartments, which were filled with clean rubble stone, after the crib was placed in position. By this means the crib was sunk to the bottom, where it was firmly moored by cables reaching in every direction to huge screws forced ten feet into the bed of the lake. The water in which it was sunk was 35 feet deep, leaving five feet of the structure above the surface. This was in June, 1865. The crib had cost \$100,000;

consuming 618,625 feet of timber, 65 tons of iron, and 400 bales of oakum.

The next business was to sink a water-tight shaft within the well of the crib, and into the bottom of the lake to a depth of some thirty feet further; making 66 feet in all below the surface of the water. Seven great iron cylinders were cast, each about 9 feet long, nine feet in diameter, 2½ inches thick, and weighing 30,000 pounds. One of these cylinders having been suspended in the well, another was placed upon it, the two were firmly bolted together with a water-tight joint, lowered, a third cylinder bolted to the second in the same manner, and so on until the shaft, a solid iron tube 64 feet deep, rested on the bottom, and forced its way by its own weight through the softer deposits into the hard blue clay

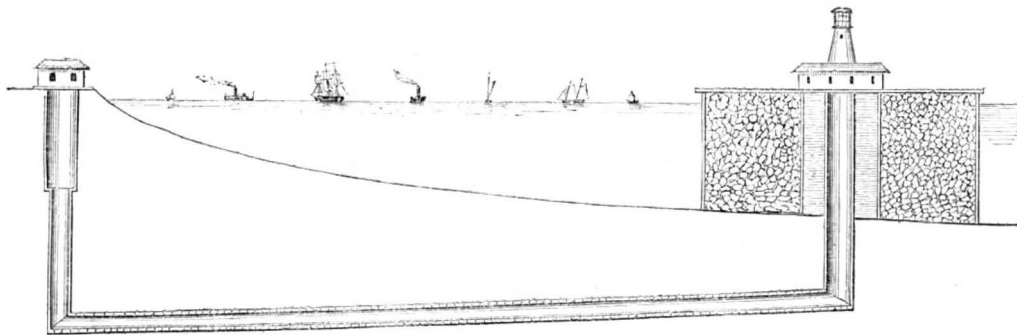

CHICAGO WATER-WORKS TUNNEL.

beneath. The water was now pumped out, the top of the shaft was closed as nearly as possible air tight, and a powerful air-pump, driven by steam, commenced to exhaust the air also. As fast as a vacuum could be created, the atmospheric pressure, added to its own weight of over one hundred tons, forced the huge shaft downward into the bed of the lake with inconceivable force. Thus a depth was reached and secured, at which it became perfectly safe to carry forward the excavation, and complete the shaft to the level at which the tunnel was to begin. The loose rubble stone is finally to be taken out of the water-tight compartments, one at a time, and they will be re-filled with piers of solid masonry, laid in hydraulic cement, and united above the surface in some manner, so as to present an immovable front on all sides against the force of storms. A light-house is to surmount the whole.

The process of constructing the rest of the tunnel was simple, though interesting. Three sections of great cast-iron tubing, like that used in the lake shaft, were let into the earth by simply excavating beneath them, and letting them sink as the earth was removed. Having thus worked through the sands, and into the blue clay, the shaft was now narrowed to eight feet, and completed and walled in the ordinary manner to a total depth of 77 feet. This shaft was sunk four feet further below the surface of the lake than the lake shaft; causing a descent of two feet to the mile in the tunnel, to facilitate emptying it when required.

Both shafts having been completed, the excavation of the tunnel was commenced from both ends. On the 16th ult. the opposite gangs of workmen were within two feet of each other; and on the following day, the Board of Public Works formally broke through this last natural obstruction to the passage of the pure waters of the mid-lake into the city of Chicago. The accuracy with which the two lines of excavation met was an admirable engineering success. The center lines coincided within nine and a-half inches, and the floors joined with a difference of only one inch. The tunnel is nearly a true cylinder, of five feet diameter in the clear, but worked two inches higher, vertically, on account of the keystone of the arch. It is lined with the best of brick and cement, 8 inches thick, laid lengthwise, in two shells, with toothing joints. The lining of the shore shaft consists of twelve inches of the same masonry, in three shells. About 4,000,000 of bricks were used.

Ground was first broken on the 17th of March, 1864; and the work has been continued with but slight interruption, night and day, and at all seasons. A narrow railway was laid from the foot of each shaft, as the work progressed, with turn-out

chambers for the passage of meeting trains; and small cars, drawn by mules, conveyed the excavated earth to the hoisting apparatus, and brought back at every trip a load of brick and cement. The men worked in gangs of five, at the excavation; the foremost running a drift in the center of the tunnel, about two and a half feet wide, the second breaking down the sides of the drift, the third trimming up the work to proper shape and size, and the last two loading the earth into the cars. The bricklayers followed closely, only a few feet behind the miners. About a hundred and twenty-five men were employed in this work, in three relays, working eight hours each; the only cessation being from 12 o'clock Saturday night, to 12 o'clock Sunday night. A current of fresh air was constantly forced through the tunnel by machinery. It is remarkable that no accident from earth, gas, or water, occurred in the whole course of the work, sufficient to interrupt its progress.

Water is to be let into the lake shaft by three gates, on different sides, and at different heights. The lowest is five feet from the bottom of the lake; the next ten feet, and the highest fifteen feet.

Flumes through the surrounding masonry, also closed by gates and gratings at their outward ends, will conduct the water to the shaft gates. All the gates can, of course, be opened and closed at pleasure. Chicago will boast—with how much reason unprejudiced water-drinkers must judge—of all other cities on the continent, the best supply of the best water, at a trifling cost for both construction and maintenance—if the work holds as good as it promises to—in comparison with some of her eastern sisters.

Galileo's Instruments.

About a year since, M. Boquillon, formerly librarian of the *Conservatoire des Arts et Metiers*, of Paris, and who enjoyed a high reputation as an expert in connection with scientific questions before the French law courts, went to Italy commissioned to search the public libraries, museums, and private collections of that country, for all the documents throwing any light upon the labors of the great astronomer and natural philosopher, Galileo. It is said that the many works and dissertations published respecting the life and experiments of the illustrious Tuscan abound in grave errors, and that M. Boquillon has been fortunate to find authentic materials for correcting these errors. With the assistance of M. Mateucci, formerly Minister of Instruction in Italy, and M. Donati, the astronomer, M. Boquillon has had access to all the manuscripts of Galileo, and has been enabled to read, study, and compare them at his ease, and is now in a position to publish a complete work upon the subject. Some of the documents which will be embodied in this work are said never to have been made known to the scientific world. The museum called *La Specola*, in Florence, possesses a most precious and interesting collection of scientific relics, namely, the instruments which served for the experiments of Galileo and for those of the *Academy del Cimento*; they are preserved in that portion of the museum which is known as the Tribune of Galileo. The greater portion of these instruments are composed of extremely thin transparent glass, and they are said to be perfect marvels of the glass-blower's art. The whole of these have been carefully photographed, under the direction of M. Boquillon, by two of the ablest photographers of Italy, and it is said that these interesting reproductions of the instruments, which served for the famous experiments of Pisa, will be shown at the Exhibition in Paris next year. It is hardly possible to imagine a more attractive series of pictures than these will present to the scientific world.

A NOVEL and commendable feature of a recent fair in Canada consisted of two essays by young ladies on the qualifications of a farmer's wife.

English Hop Culture.

The culture of hops is becoming profitable and extensive in this country, in consequence of the great influx of beer-drinkers from abroad, and the growing fashion of beer-drinking among Americans. A few notes on the English hop plantations may therefore be of interest and use; conceding the disputed point, that beer is an addition to the sources of human welfare.

The hop culture in England is so extensive, particularly in the counties of Kent and Sussex, that the picking season draws throngs of laborers by railway and otherwise, from the great cities and all parts of the country, and keeps them profitably employed from three to six weeks. "Hop gathering," as most of our readers interested in the fine arts will remember, has been made the subject of a very pleasing picture by a modern English artist. The motley multitude of men, women and children, employed in hop gathering—encamped together as they are for weeks in the open fields, by night and day, in wild but crowded liberty—must open a yawning door for missionary work. Whether the long, promiscuous encampment be on the whole more demoralizing than the pure influences of nature are salutary, to these poor creatures, may be matter of doubt.

The heavily laden poles are first hauled out of their earthen sockets and placed in piles, by a class of hands employed for that purpose, and using a lifter with iron teeth, acting as a lever. The pickers throw the hops into canvas sheets, loosely hung within frames like a light bedstead. The measurers pass around and empty these receptacles as often as they are filled, leaving each picker checks indicating the number of bushels, according to which they are paid.

From the field, the hops go to the "oast house," or drying house. The word is of doubtful etymology: Webster only suggests a conjectural analogy to the latin *ustus*—burned. The oast house is a circular building from eight to eighteen feet in diameter, or very commonly a cluster of four such buildings, meeting in one at the center; each having a spiral roof, with an opening at the top covered with a revolving cowl, to secure a strong and uninterrupted outward draft. The first floor is occupied by fires, placed about the center, of charcoal and Welsh coal, causing little smoke. Roll sulphur is added at intervals, to give the hops the pale yellow tinge so much sought after. The second floor is made of horsehair to afford free and uniform passage to the heat and sulphurous fumes of the fires beneath, supported on a light framework of wood. Upon this horsehair floor the hops are emptied as they are brought from the plantation; spread, stirred and turned, from eight to eleven hours, until thoroughly dried by the heat; and afterward transferred to a cooling room. When cooled, they are compressed into bags, and branded for market.

MELLON'S IMPROVED LOCOMOTIVE TIRE.

The unavoidable working loose of the tires on locomotive driving wheels is a large annual bill of expense to all railroad companies. Usually dependence has been placed mainly on the adhesion of the tire to the wheel by shrinkage, with other mechanical devices. In time the tire becomes expanded by the continual pressure, combined with rolling, to which it is subjected, aided perhaps by the percussion incident to a defective permanent way, and the tire is loosened, endangering not only the locomotive, but the train with its passengers. Then comes the annoyance of removing and reheat- ing the tire, "shimming up," and sometimes returning the surface. The inventor of the improvement under consideration attempts to remove these objections and obviate these difficulties. He does not hope to prevent the gradual stretching of the tire from use, but to prevent it when loose from moving from its seat, endangering life and property.

Figs. 1 and 2 in the engraving represent the improved method of forming and attaching the tire. Fig. 3 is a section of an ordinary tire worn and stretched by use. Fig. 1 shows a wheel and improved tire section, the wheel having on its inner edge a rim against which the edge of the tire sets firmly. It will be seen that the flange, A, on th

periphery of the wheel prevents the tire, should it become loose, from slipping off at the inner side of the wheel, and the flange, B, of the tire prevents it from slipping off on the outer side.

The same result will be attained by having the inner surface of the tire at its outer edge provided with a flange, as at C, Fig. 2. It will be noticed that the inner edge of the tire, where it comes in contact with the wheel, is rounded, as at D, to prevent it from indenting or sinking into the substance of the wheel and rendering the removal of the tire difficult. In Fig. 3 is seen the result of the

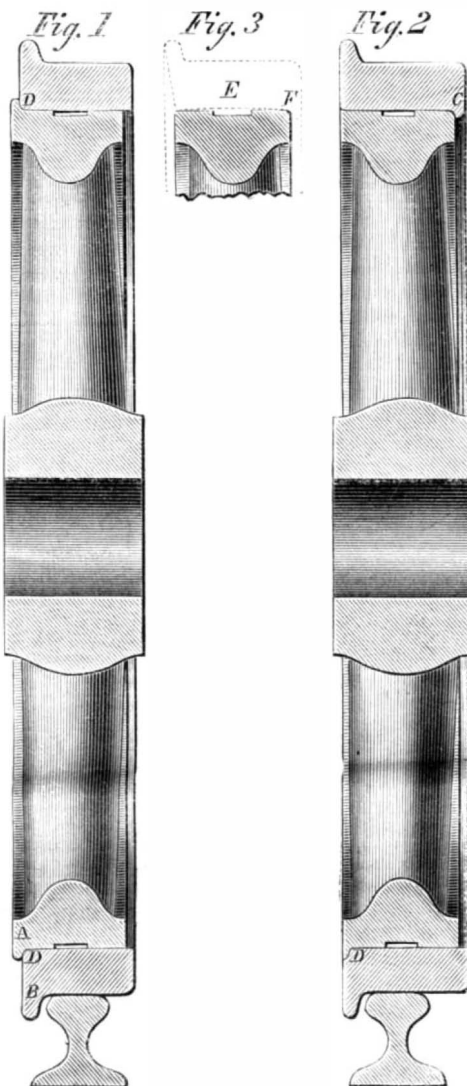

spreading of the tires ordinarily used. The center of the tire is concave, as at E, while the edge, at F, has spread over the edge of the wheel. Frequently this overlapping compels the cutting of the tire in order to effect its removal. No bolts, rivets, nor keys are required to secure this improved tire. If it becomes loose while on the road, it will be safe until the terminus or shop is reached, as it cannot fly off, when it can be readily removed and replaced by another.

Patented through the Scientific American Patent Agency, Oct. 2, 1866, by Edward Mellon, of Scranton, Pa., to whom those interested should apply for additional information.

THE Commissioner of the General Land Office, at Washington, has received rich specimens of argen- tiferous galena from newly discovered veins in Colorado, within five miles of one of the finest coal veins in the territory. The discovery (says the *Intelligencer*) is important, as it indicates a continuation of the precious metallic veins in a north-easterly direction nearly if not quite to the plains, and in close proximity to the coal.

"THEIR Academy of Natural Sciences (says the *Enquirer*) has been for fifty years a pride to Phila- delphians. No other city on the continent possesses so fine a collection." The specimens collected are said to be worth half a million of dollars. The Building Fund Committee are now making a final appeal for subscriptions to secure a fire-proof build- ing worthy of the institution.



The Crank and Piston in Setting Valves.

MESSRS. EDITORS:—I trust you will excuse me if I respond to some editorial remarks appended to the letter of a correspondent in your issue of Nov. 24. In the communication referred to there is a diagram of the crank of a steam engine, giving the relative positions of crank and piston at various points of the stroke. Concerning the best method of finding this, much correspondence has been published in the SCIENTIFIC AMERICAN. In the remarks I criticize it is said, "the importance of a correct knowledge of the relative positions of the crank and piston will be conceded by those who have to set the valves of steam engines." I do not think this will be con- ceded, Messrs. Editors, for the following reasons:—

The crank has nothing whatever to do with set- ting the valves.

Any valve set with the crank as a guide is more apt to be wrong than right, for the reason that the relative distance moved over by the crank and pis- ton vary with different points of the stroke, vary with different strokes, and with different lengths of connecting rod.

All valves that cut off steam at a given point of the stroke should have that given point measured from the end of the slide, not on the crank. The large number of badly-set valves you speak of is ac- counted for by guessing at the position of the crank and piston, or by measuring on the crank, which amount to the same thing.

Further, the expansion of bed plates and spring- ing of valve and eccentric rods, always derange the lead, even when it is measured on the slide. It is much more liable to be deranged when measured on the crank, for the reason that the point of no motion on the slide, at or near which lead is given, cannot be found on the crank without much trouble, for when the piston is on the dead center the crank has freedom to move through a considerable arc, enough to disturb the lead very much.

It is not of any importance to know the relative position of the crank and piston in setting valves, but I do not see any harm in persons amusing themselves by making diagrams of it. The practice is akin to the problem of the celebrated ten-foot pole in the forty-acre lot, which casts a shadow at sunrise so many feet long; how long will it be at some other time?

It may be asserted, without fear of contradiction, that if we take care of the piston, the crank will take care of itself, for we measure divisions in the cylinder by the space occupied and traveled through by it, not by the movement of the crank.

EGBERT P. WATSON.

New York City, Dec. 21, 1866.

[We publish the above communication for the purpose of drawing attention to some erroneous opinions in it, which we believe are shared by a number of mechanics. The ordinary steam engine not only is a medium for transmitting the power of steam by the reciprocating movements of the piston, but is also a medium for converting those movements into a rotary motion by means of a crank with its connections. The movement of the piston is not often exactly coincident with that of the crank, varying, as our correspondent truly says, "with different points of the stroke, with different strokes, and with different lengths of connecting rod." It will be evident to any one who will sit down and analyze the diagram accompanying the article to our comments on which Mr. Watson takes exception, that the "crank has something to do with setting the valves," and that it is of some importance to "know the relative position of the crank and pis- ton in setting valves." One of the uses of the in- dicator is to ascertain the difference between the action of the steam at either end of the cylinder and that at the other. We have seen diagrams taken by the indicator, from an engine built by a manufac- turer whose name on an engine is a guarantee al- most of perfection, which showed a difference amounting to one-eighth of the power exerted on the piston. Yet the valves were set, as our corre-

spondent advises, without regard to the position of the crank. The valves in this case had probably been shifted after being set by the manufacturer.

We have neither time nor space to enter into any lengthy explanation in regard to this matter, as it can be readily understood by an examination of a diagram similar to that published in our issue of the 24th ult.—Eds.

Water Spouts.

MESSRS. EDITORS:—In No. 22 of your journal I read with interest a very able article entitled "Water Spouts in the Mountains," signed "D. C."

I propose to relate the appearance of something similar to what "D. C." describes as a "Water Spout in the Mountains," that I witnessed thirteen years ago. The place of its occurrence was upon Long Mountain, in New Milford, Conn. I do not know its exact elevation, but will call it nearly one thousand feet above the level of the sea.

It was on the 8th of August, 1853, the morning of which broke forth with unwonted splendor, though very hot. Before 10 o'clock, A. M., the wind had veered to every point of the compass, and had been especially partial to the N. W., W. and S. E., making several calls in rapid succession.

We had kept a close watch upon the high clouds which had been forming for the space of an hour, as it seemed, from every place in the horizon. They had a singular aspect and were incessantly rolling, tumbling and whirling, and then vanishing.

These clouds had almost wholly disappeared by noon, and it bade fair for good weather, but while at dinner some one observed "There's a shower in the west," and, looking, I beheld a large black cloud directly in the west looming up at a fearful rate, and in nearly half an hour from the first discovery of the cloud, a medium thunder shower was upon us. The cloud had not quite reached the zenith, barely obscuring the sun, when it commenced to rain. It was apparently a mile wide at its base, and gradually widened to its summit, which covered about 45°—a huge black, inverted trapezoid, every portion of which was trying to gain the peak. It was a grand and sublime sight.

The rest of the sky was clear for a time, when behold, two more black pillars arose simultaneously, the one in the north-west, while the other was directly opposite in the south-east.

These appeared in great haste, and spread in every direction rapidly. The electric fluid was constantly in motion from the first appearance of each cloud, and increased with the clouds, until it was but a constant blaze and roar, ten times more frightful than any battle scene that I ever witnessed, though I have shared the success and failure of many of the hottest contests of the late war.

I was out in the heaviest part of the storm; the sensation produced is difficult to describe; but there was an absence of pure air that made it almost impossible for one to breathe. The hail, rain, thunder and lightning seemed commingled, and descended apparently perpendicularly.

The storm was of about three hours' duration, and, as I ascertained, was principally terrific within a circle of one mile radius. Deep gulches had been washed in the mountain sides, huge boulders had been displaced, weighing many tons, and in some instances carried to a considerable distance, large trees were uprooted, and the Housatonic Railroad Company lost four large culverts in as many miles. The exact amount of hail and rain that fell will probably never be known; but a neighbor of mine had set an empty flour barrel in the open air, near to which there was no other object, and, at the close of the storm it was full, and of course had been running over. It is evident that not less than thirty inches of water and ice fell upon the level during that shower.

D. B. D.

Gaylorsville, Conn.

EXTENSION NOTICES.

William Smith, of New York City, having petitioned for the extension of a patent granted to him the 5th day of April, 1853, for an improvement in weaving corded fabrics, for seven years from the expiration of said patent, which takes place on the 5th day of April, 1867, it is ordered that the said petition be heard at the Patent Office on Monday, the 18th day of March next.

RECEIPTS.—When money is paid at the office for subscriptions, a receipt for it will always be given; but when subscribers remit their money by mail, they may consider the arrival of the first paper a *bona-fide* acknowledgment of the receipt of their funds.

NEW PUBLICATIONS.

POCKET-BOOK OF USEFUL FORMULÆ AND MEMORANDA FOR CIVIL AND MECHANICAL ENGINEERS. By Guilford L. Molesworth. Henry Carey Baird, 406 Walnut street, Philadelphia.

The title of this handy manual is sufficiently suggestive without more than an allusion to its contents, which comprise the data and formulæ which lie at the basis of engineering practice. Not pretending to the character of a treatise, which would be impossible in a volume so small, it gives facts, suggestions, hints, rules, and tables, serving not only as a convenient pocket reference for the thorough mechanic, but as a guide for ordinary workmen. Bound in flexible covers of Turkey morocco. For sale by D. Van Nostrand, 192 Broadway, New York.

THE FOREST-TREE CULTURIST. A Treatise on the Cultivation of American Forest Trees, with Notes of the Most Valuable Foreign Species. By Andrew S. Fuller, of the Horticulturist. Geo. E. & F. W. Woodward, 37 Park Row, New York.

A timely and appropriate volume which, it is to be hoped, will in some measure, aid in arresting the wholesale and indiscriminate destruction of our forests. The author gives many useful directions in relation to the propagation and care of trees, which are as applicable to fruit as to shade trees. Apart from its value as a manual, it is a very entertaining volume.

MODERN PRACTICE OF AMERICAN MACHINISTS. By Egbert P. Watson, late of the Scientific American. H. C. Baird, 406 Walnut street, Philadelphia.

For apprentices and even for those further advanced, this book will be found invaluable. It teems with useful hints, excellent suggestions, and practical advice drawn mainly from personal experience. It is remarkably free from unexplained technicalities and algebraic formulæ, and is written in a plain, practical, and unassuming manner. The text is profusely illustrated with explanatory engravings, and although much of the matter treats on processes familiar to the experienced mechanic, he will find improved methods described which he could not otherwise learn except by personal communication with others.

IMPROVED PRACTICAL SYSTEM OF EDUCATING THE HORSE. By A. H. Rockwell, Harpersville, Broome county, N. Y.

Some of our readers have doubtless seen the author of this treatise driving his educated horses without reins. The manual contains full instructions as to the methods used in attaining that result, with information on the management of horses in general, and the correction of bad and vicious habits. It is illustrated with explanatory cuts. Price \$5, to be obtained only of the author.

REPORT OF THE SMITHSONIAN INSTITUTION for 1865. We have received the annual report of the above institution for 1865. In addition to the reports of the Secretaries, and a review of the condition of the institution, there are a number of exceedingly interesting papers on popular as well as scientific subjects.

ORIGIN OF THE STARS, and Causes of their Motion and Light. By Jacob Ennis. D. Appleton & Co., Broadway.

We have read this work attentively and with great interest. The points it discusses are of importance to all having any fondness for astronomical studies, while, simply as a work abounding in curious facts, its contents must prove attractive and beneficial to the general reader. The author shows that the earth is a true fixed star, once shining by its own independent light. In the first part of the book he thoroughly investigates the chemical theory of stellar light and heat. In the second part he advances the hypothesis, which he founds on facts, that the conversion or conservation of the atomic force of repulsion, which once held the solar system in a nebulous condition, is the force which prolongs the heat and light of the sun. The origin of the stars is treated of in the third part, while the fourth part shows Gravity to be the force which originally gave motion to the heavenly bodies.

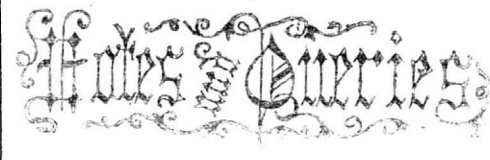

SPECIAL NOTE.—This column is designed for the general interest and instruction of our readers, not for gratuitous replies to questions of a purely business or personal nature. We will publish such inquiries, however, when paid for as advertisements at 50 cents a line, under the head of "Business and Personal Queries."

H. L. W., of Mass.—The foaming of boilers is the sudden rising of the water into the steam space in the form of spray or foam. It is seen exemplified, in a manner, by plunging a piece of hot metal into a vessel containing soapsuds. Its causes are not entirely understood. The presence of oil or grease in a tubular boiler, generally will cause it to foam, while in a flue boiler, with great water surface, its effect is directly the opposite. Soap will often cause boilers to foam and foaming is produced from many causes, some of which as yet seem to be unexplained. When a boiler foams it is known by the sudden rise of the water to the steam gage cock, and, as in priming, water frequently passes into the cylinder. The best remedy we know is careful, regular firing and frequent pumping. . . . We have known the water from a woolen mill where soap, soda, and acids were used, to be employed for steam boilers without injury. Acidulated water will oxidize the boiler, and the alkali and grease in soap may cause it to foam; but one may neutralize the other when mixed in proper proportions. We recommend in all cases the purest water for boilers.

W. M., of Ind.—If your specific for preventing the foaming of boilers will do what you affirm it is a valuable discovery.

W. F. D. of Conn., leads water from a spring over a very uneven surface, through galvanized iron pipe 25 rods long. The head of water, or the difference in height of the surface of the spring and the delivery end of the pipe, is 25 feet. He is much disappointed in the quantity of water which flows through the pipe, and desires to know if he will get more by setting vertically near the spring an iron pipe 20 feet long and 20 inches in diameter, the upper end being level with the surface of the spring, and his inch conducting pipe being connected with the lower end. We answer: the pipe delivers slowly or the flow of water is retarded by friction of the water on the inner surface of the pipe. The 20-inch pipe at the spring will not help the matter at all. It will not increase the head of water, and it is that only which constitutes the moving force. Perhaps the head might be increased by banking or curbing up the spring.

E., of Conn.—The only reason we can give for your grate bars sinking, is that the bars are too near the crown sheets. You do not give the distance, but undoubtedly it is too small. Your grate to a boiler 48 inches diameter should not be less than 14 inches from the crown sheets. Look to your bridge walls also and see if the throats are not too small. Write particulars and we will answer by mail.

J. E. E., of N. J.—The date of the introduction of circular saws has never been ascertained. They have been used for cutting teeth of watch and clock wheels since the time of Dr. Hook, about the year 1700. Such saws were in use for sawing timber, it is certain, about the year 1750, but the exact date when, or by whom, they were first employed, is not recorded.

F. D., of N. Y., says that there are a number of new burning fluids which are claimed to be non-explosive. He desires us to tell him the composition of these, and to explain why they are non-explosive. F. D. should indicate more particularly the fluids to which he refers. The danger of explosion from burning fluids arises from its volatility, and we know of no way of destroying that property. The construction and use of the lamp has much to do with the question of explosion.

F. G., of Mich.—There are pretty formidable difficulties in the way of heating cars by steam or water. But the advantages of a successful plan would be so great, that the subject is a very promising one for inventors. The present plan of heating surely needs reform. For some thoughts on the subject see page 297.

C. R., of N. Y.—We recommend for your purpose a gold lacquer composed as follows:—Seedlac, 3 oz.; turmeric, 1 oz.; dragon's blood, ¼ oz.; alcohol, 1 pint. Dissolve by digestion and filter for use. . . . A good way of platinizing the silver plate of the battery, is to connect the plate with a piece of zinc; place the zinc in a porous cup of acidulated water; now set the cup in the platinizing solution, and at the same time immerse the plate in the same.

G. R. asks:—Why do the lightest cutters on a planing cylinder do the most cutting when they are set out the same distance the heavy cutters are, and why do they get dull and worn out the soonest? Perhaps some of our readers will answer this question.

Business and Personal.

[The charge of insertion under this heading is 50 cts. a line.]

P. D. Frey, Chambersburg, Pa., requests information as to the best sizing for putting gold leaf upon glass; also the best manner of furnishing the gold.

Case, Thomas & Co., Waterbury, Vt., request information about coppering iron.

John S. Taxis, Hagerstown, Md., would like to be informed how to unite leather and rubber so as to make a strong and water-proof union.

Joseph H. Bancroft, 121 Hanover street, Boston, Mass., wishes to know where he can procure the safest, cheapest and most economical portable steam heater for a dwelling house of 15 rooms, price, etc.

Dr. J. B. Williams, Pittsburgh, Pa., wishes to know who has the patent for the U. S. of Rouson's patent silicious concrete stone.

J. T. M. Barnes, Baltimore, Md., desires to procure machine for making paper bags. Give full particulars as to sizes, cost, etc.

W. R. Tuttle, Knoxville, Tenn., wants a machine for breaking up stone for macadamizing roads; also the best brick machine.

W. McGuire, Edgefield Junction, Tenn., wants the best machine for making staves 60x40x5 1-inch thick. Also a cross-cut wood-awing machine, also circular saw, also bucket and tub machine. We can furnish Vols. 14 and 15 only bound, \$3 75 per vol.

F. M. Patterson, Seymour, Ind., wants a small turning lathe, for wood.

J. W. Sever, Fredericksburg, Va., desires to obtain a good and reliable water meter.

P. Fagercrans, Princeton, Ill., would like to communicate with makers of belfry and tower clocks.

J. R. Carpenter, Salem, N. J., desires the address of Wm. H. Pinner, patentee of rendering pans.

S. Hewes, Boston, Mass., desires to know which of the various electro-magnetic machines for medical use yields the strongest electric current.

J. B. Whitehouse, Florence, Mass., wishes to know where he can purchase an instrument to ascertain the power of any machine, cost, etc.

Jro. H. Calkin, Troy, Pa., wishes to communicate with parties who manufacture small brass tubes; also with parties who would manufacture his patent oiler.

G. Watson, Lowell, Mass., desires information concerning the manufacture of Russia sheet iron.

Saenger, Henricks & Wells, Joliet, Ill., desire to communicate with parties who make nitro-glycerin.

James Foley, St. Joseph, Mo., wishes to communicate with the patentees of the screen used on well pipes, when the pipes are driven.

Ed. H. Bell, Autestown, Blair County, Pa., asks where Sopher's Registering Callipers can be obtained.

James Ross, New Orleans, La., wishes to know where he can order lenses in the rough. He proposes to finish them himself.

J. A. McNeil, Grand Rapids, Mich., wishes for information concerning the manufacture of articles from shells. What is the process in working up the shell of the "pearl oyster," for instance? Also the address of parties who are manufacturing articles from the shell of the pearl. Also the process of eating off the epidermis with acid?

Messrs. Editors:—Can you inform me where to buy the best molding machine. If manufacturers only knew how many business men search and read the SCIENTIFIC, they would advertise their place of business in your paper. Will you be so kind as to inform me the correct way of balancing pulleys, heads, etc. P. C.

NEW INVENTIONS.

The following are some of the most prominent of the patents issued this week, with the names of the patentees:—

METHOD OF PREPARING PEAT, COAL DUST, AND OTHER SUBSTANCES FOR FUEL.—LOUIS S. ROBBINS, New York City.—This invention consists in drying and preparing peat, coal dust, and other substances, either separately or in combination, so that the material employed shall be economically and uniformly mixed and combined during the process of drying, and at the same time furnishing to the material employed highly concentrated and adhesive substances.

MACHINE FOR SCOURING LEATHER.—FRANKLIN DAVIS, Lawrence, Kansas.—This invention consists in constructing a machine by which the tedious and expensive process of scouring leather shall be accomplished by the use of power, either water, steam, or horse power, in a much more rapid, cheap and perfect manner than it has been done hitherto.

ROCK MOTION FOR HAND PRESS.—CHARLES WELLS, Cincinnati, Ohio.—This invention has for its object to gain power at the ends of the rack, where inertia and momentum are to be overcome in starting and stopping the rack.

SALT BLOCK.—NEWELL BARNARD and JOSEPH G. SPILLER, Saginaw City, Mich.—This invention has for its object to furnish an improvement to the salt block known as Chapin's Patent Salt Block.

MANUFACTURE OF SPRINGS.—J. F. DUBBER, Brooklyn, N. Y.—This invention consists in the use of a former of suitable shape for the purpose of drawing the temper of a spring after the same has been hardened, in such a manner that the said spring can be brought to the desired power or shape while being tempered, and the tedious operation of setting the spring after the temper has been drawn is avoided.

FILING SAW TEETH.—M. M. PETTES, Oxford, Mass.—This invention relates to an implement for the filing of saw teeth, and the invention consists in so arranging or hanging a guide for the file used upon a yoke or frame of suitable shape to be fitted over the saw-blade and moved along upon the same, as to be susceptible of such adjustments with regard to its length as may be necessary to produce the desired form, shape, size, or style of teeth to the saw.

CAST-IRON ARCHES FOR BRIDGES, TUNNELS, ETC.—GEORGE T. LAPE, Summit, N. Y.—This invention relates to an improvement in cast-iron arches for building bridges, aqueducts, roofs, trusses, and vaults for subterranean railroad tunnels and other similar purposes, and consists in making a cast-iron voussoir or section of an arch of such conformation that one voussoir shall constitute a unit of the whole structure.

WATER ELEVATOR.—ISAAC A. PINNELL, Galva, Ill.—This invention consists in providing machinery to elevate water from common wells in such a manner that one or more buckets may be used at the same time.

RAILROAD CAR BRAKE.—SAMUEL H. TIMMONS, Lafayette, Ind.—This invention relates to a brake for railroad cars by which all the brakes of a train or series of cars may be simultaneously applied, and by a very simple means connected with the ordinary brakes in use.

PRINTER'S GALLEY.—ALEXANDER T. DE PUY (assignor in full to R. HOE & Co.), New York City.—The object of this invention is to attach the metallic strips or lining which protects the wooden side and end ledges or sides, forming the frame of a printer's galley, to said wooden side and end ledges in such a manner that they may be firmly secured without the means of screws, nails, or any other third material.

SPINNING MACHINE.—WILLIAM and JOSEPH LEACH, Stewartsville, Ind.—The object of this invention is to produce a machine which will take the place of the old-fashioned hand wheel, while it will not be expensive and cumbersome, like the jack.

LOOM.—JOHN WHITEHEAD, Oskaloosa, Iowa.—This invention consists in providing or constructing plates and attaching them to the lathe of a loom so that they may be adjusted in such a manner as to give a light or hard blow, as may be desired.

HOE.—A. C. KASSON, Milwaukee, Wis.—This invention consists in a hoe so constructed that the edge of the blade from the center to each outer corner describes an obtuse angle and the two sides of the blade from the center outward are bent toward each other and toward the handle.

FIRE-ARM.—GRANVILLE HENRY, Nazareth, Pa.—This invention consists in so constructing or forming the frame of a rifle or other fire-arm that the whole stock to be secured to it can be made in one piece, whereby the weight of the stock or but of the fire-arm is greatly decreased and at the same time its strength increased, and at less expense than by the ordinary construction of the frame and stock of a fire-arm.

OIL CAN AND LAMP.—ELIAS ASHROFT, South Boston, Mass.—This invention consists in constructing an oil can with two spouts or nozzles, the one for pouring out the oil and the other for the insertion of a wick which can be lighted for the purpose of showing clearly where the oil is to be poured, the flame being near the end of the oil spout.

SCAFFOLD BRACKET.—HIRAM BECKWITH, Grass Lake, Mich.—The object of this invention is to prevent the occurrence of the accidents which so often happen to those engaged in erecting buildings in consequence of the insecure scaffolds upon which they stand.

GRAPE-VINE PROTECTOR.—JOHN WALTER, Princeton, Ill.—This invention relates to an apparatus which is designed to protect grape vines and other plants of similar nature from the injurious effects of the mildew in summer and from the frost in winter.

REVOLVING FLUE CLEANER.—G. E. BINGHAM, Milwaukee, Wis.—This invention has for its object to furnish an improved machine for cleaning lime scale, etc., from boiler flues.

CHUCK FOR POLISHING BUTTONS.—EDWIN RUSSELL, Naugatuck, Conn.—The object of this invention is to provide a chuck for holding buttons, such, for instance, as are made of vegetable ivory, so as to enable the workmen to polish them in a lathe, rotary motion being given to them by means of the chuck, and the body having the polishing surface being held against them.

CHURN.—ANDREW J. VANATTA, Vanatta, Ohio.—This invention consists in so constructing and combining a spur wheel and pinion as to give to the dasher of a churn both a rotary and vertical motion for the purpose of breaking the rotary current of the cream made by the rotary dashers, and at the same time agitate the inert cream around the center of the churn, by giving independent motions both to the rotary and vertical-moving dashers.

PENDULUM FOR CLOCKS.—W. D. WHALEN, Northville, Mich.—This invention consists of an improvement in the manner of constructing and attaching pendulums to clocks, by which many of the inconveniences and irregularities of the time-keepers now in use are obviated.

CARRIAGE BRAKE.—JOHN J. LOOK, Farmington, Me.—This invention relates to a brake which may be applied to wagons and carriages, and which is so constructed and applied that it acts automatically.

GAS RETORT.—G. W. HARRIS, Elizabeth, N. J.—This invention consists in a retort made of clay or other suitable material, and provided with return passages, either built into it after it is made or formed in its bottom while it is manufactured, in such a manner that steam passed through said passages will be superheated and distributed through the incandescent coal placed in the retort; it consists also in a superheater, made of fire clay or other suitable material, to be used in combination with the retort, in such a manner that the steam is superheated before it enters the retort and prevented from cooling the same, and furthermore, the effect of the steam on the incandescent coal in the retort is increased.

BOOK-MARK HOLDER.—PHILIP TOMPERT, Jr., Louisville, Ky.—This invention consists in a metallic clasp, consisting of a bent strip of metal having slots or perforations made in its head portion, through which slots tapes or ribbons are passed, which, when the two legs of the device are clasped over a number of leaves of the book, can be thrown down between the leaves to keep a place of reference in a book.

HEATING STOVE.—LEWIS BRIDGE, York, Pa.—This invention relates to an improvement in parlor fireside stoves, adapted to either wood or coal, and is designed to utilize the heat by the more complete radiation into the apartment, or its diversion to an upper chamber through a flue attached to the stove.

CARRIER OR CLUTCH FOR LATHES.—RICHARD ALLEN, Jersey City, N. J.—This invention relates to a clutch for lathes of that class of clutches which are employed for the turning of bolts more particularly, and the invention consists in so constructing the said clutches that bolts of various sizes, whether with or without heads, may be properly held and secured within them.

HORSE RAKE.—FRANCIS M. SMITH and EDWIN BRAMFIELD, Albion, N. Y.—This invention consists in constructing the head of a horse rake in sections, which are united by means of suitable joints, so that the head of the rake, while it is at work, will readily accommodate itself to the unevenness of the surface of the ground.

STEAM VALVE.—W. B. ROBINSON, Detroit, Mich.—This invention consists in a counterbalance placed between two valves, in combination with the exhaust passages in the valves, in such a manner that the exhaust steam is passed in a direct course through the valve, counterbalance, and steam chest cover, and furthermore, the cost of the valve and of the engines is reduced, and steam is economized by shortening the posts in the cylinder to the thickness of said cylinder or of the valve seat.

BROOM.—HENRY H. B. VINCENT, Oshkosh, Wis.—This invention consists in a broom head formed with downwardly-projecting side and edge arms, and in the combination of a sliding band and binding bars with each other and with the arms of the broom head.

CAR COUPLING.—CLEMENS WEAVER, Easton, Pa.—This is a device for coupling railroad cars, and consists of hooks suspended to the draw bar of the cars, which are adjusted by raising and lowering with side levers, so that they can act as self-coupling devices, and may be readily disconnected.

SURFACE-SIZING FIBROUS MATERIALS.—WILLIAM FUZZARD, Chelsea, Mass.—This invention relates to machinery for applying a glazing or size to fibrous substances, such as cotton wadding, etc.

LANTERN.—JOHN BELLERJEU, Philadelphia, Pa.—The object of this invention is so to construct a lantern that the globe is well secured to the cap and base of the lantern without the use of cement, so that all the parts may be easily taken apart, at will.

FORMING CLOSE JOINTS.—THOMAS HANDY, Decatur, Ill.—This invention relates to a machine for grinding the edges of metal plates so that the same may be placed closely in contact and perfect joints formed. It is more especially designed for grinding the edges of the moldboards and shares of plows, but it may be advantageously used for other purposes.

LATHE.—LUTHER R. FAUGHT, Philadelphia, Pa.—This invention has for its object to furnish an improved means for tightening the spindle in lathe stocks.

SPADE HANDLE.—CHARLES DIMMICK, Brockport, N. Y.—This invention has for its object to form a spade or shovel handle from one piece of wood.

FRUIT HARVESTER.—ROBERTS & HARTZELL, Addison, Pa.—This invention has for its object to furnish an improved instrument by means of which apples, pears, peaches, and other fruit may be gathered from the tree rapidly, conveniently, and without bruising the fruit.

COTTON PICKER.—JOHN S. PAGE, Memphis, Tenn.—This invention relates to a device for separating dirt and foreign substances from cotton, and is more especially designed for separating such substances from long-staple cotton without cutting or breaking it. The invention consists of a series of revolving toothed or armed cylinders placed within a case or box, the bottom of which is provided with a series of perforated concaves, one underneath each cylinder. The cotton is fed into one end of the case or box, and the toothed or armed cylinders are rotated all in the same direction, and the cotton, by the action of the teeth or arms, passed or fed through the case or box, the fabric during this operation being drawn out and straightened and the dirt and foreign substances detached, dropping by their own gravity through the perforated concaves.

TWINE AND SMALL CORDAGE.—GEORGE A. TAYLOR, LESTER CRANDALL, HORACE L. CRANDALL, and JONATHAN LARKIN, Hopkinton, R. I.—This invention relates to mechanism for manufacturing twine and small cordage, and has for its object the twisting of a plurality of cords or lines simultaneously, or at one operation, with one attendant or operator only, and the latter allowed full control over each line or cord during the process of twisting.

DAMPER FOR STOVE PIPES.—CHARLES R. EVERSON, Palmyra, N. Y.—This invention relates to a damper for stove pipes, and it consists in providing a circular plate, hung on journals or pivots similar to the ordinary damper, with a valve, and also with a curved or semicircular perforated plate, all arranged in such a manner that when the damper is closed sufficient draft will be allowed to carry off the smoke, gas, etc., which would otherwise escape into the room, and when the damper is open the products of combustion be deflected to the side of the pipe, in order that the heat may be radiated therefrom.

PLANE.—JOHN SAWYER, Moravia, N. Y.—This invention has for its object to furnish an improved apparatus by means of which the ends of moldings may be cut at any desired bevel, so as to make a close joint.

BRIDGE.—O. G. LEOPOLD, Cincinnati, Ohio.—The construction of this bridge is based upon the theory of the neutral line or point of gravity of the cross section of a loaded beam, supported at its ends, and its parts are made double T-shaped in their cross section, as being the strongest, with reference to the amount of metal expended.

FENCE.—EDWARD C. GORDON, Sevastopol, Ind.—This invention consists principally in the combination of wire guys, keys, wedges, and anchoring blocks with each other, and with the fence panels.

BAG HOLDER.—J. V. HENRY MOTT, Gunderland N. Y.—This invention relates to a device for holding the mouth of a bag open while being filled, whereby it can be filled with readiness and dispatch.

OIL WELLS.—THOMAS M. FOSTER, Union Mills, Pa.—This invention relates particularly to the sucker rods, so called, used in oil wells, and its object is to preserve the tubing and economize expense.

BRIDLE.—A. H. ROCKWELL, Harpersville, N. Y.—The object which this invention is designed to secure is to provide a means by which a horse that is in any way vicious or inclined to be unruly, or to kick while being curried, or when in harness, or when being led out of his stall, or at any other time, can be brought to a complete state of control or subjugation, and in such a manner as not to produce the least injury to the mouth of the horse.

SAFETY LINE OR REIN FOR HARNESS.—A. H. ROCKWELL, Harpersville, N. Y.—The object of this invention is to prevent, both kicking and biting in double or single harness; in the latter case it being especially desirable, as it then acts as a preventive against the kicking of the horse when at a rest or stop.

THE MARKETS.

The state of business is generally dull. Prices of most of the commodities of merchandise are unsettled, but show a general decline. The money market shows the same deranged condition. Capitalists seem waiting for some expression by Congress, indicating the course to be pursued in regard to the contraction or expansion of currency, and previous to its reception, trade generally is likely to rule very quiet. The exports of gold from this city during the past week amount to \$781,865, giving a total since January 1st, of \$38,243,524, against \$27,356,302, for the same time last year. In the grain market, the limited arrivals, and news of failure of crops in Europe, it was generally supposed, would tend to raise prices, but, on the other hand, we have to record a steady decline. The demand for home consumption is well supplied, there is no competition among buyers, and prices have fallen to effect sales.

The cotton business, early in the past week, was quite active, chiefly for exports, but on receipt of less favorable European news, a decline in gold, and an easier money market, prices fell, and closed heavy, with considerable abatement in the demand. The complete block of the coal trade, is of the highest importance. At the last semi-monthly auction sales of Scranton coal, a heavy decline was shown from previous prices, ranging from 45 cents to \$1.40 per ton. This ruinous state of affairs, owing to a glut in market, can be traced to the backwardness of the severe winter season, and the long continuance of a remarkably mild temperature. Prices paid at this sale are less than the actual cost of transportation to market, leaving nothing to pay for the mining. Work will necessarily stop at the mines, as has already been the case with the collieries of the Schuylkill. The effect of this will soon show itself in diminished arrivals, the demand will steadily increase, and prices will advance as rapidly as has been the case in the late fall.

Improved Portable Sawing Machine.

Many attempts have been made to bring the saw-mill to the timber, instead of taking the timber to the mill. They have not been uniformly successful. For the purposes of fuel, where the wood was not cut by the circular saw, the old-fashioned and laborious method of the "buck saw" and horse has been employed. This work is excellent exercise for dyspeptics, but preferable as an amusement or medicine rather than as a steady occupation.

In the accompanying engraving is an illustration of a very simple and, to some extent, a self-operating machine which is intended to be used in cutting up fallen timber, logs, and "fire-wood." It is applied to the cutting of stock for wheel hubs and bolts for shingles as well. It can be worked by hand or horse-power, as may be desired, and according to the size and capacity of the machine.

The machine being conveniently placed, the power is applied in any manner desired to the shaft, A, and by the lever, B, the clutch, C, is engaged with the shaft, D, when motion is given to the shaft at the log end of the frame, acting as a windlass, and by means of the rope and hook, E, bringing the log or block into position to be sawed. The clutch is then disconnected with the motive power, which is diverted to the driving of the saw, F. This is simply a straight saw blade, connected to the sliding bar, G, which is guided in a direct forward and backward movement by slides on the pivoted bar, H, and attached to the crank on the balance wheel, I, by a pitman or connecting rod. The bar, H, is secured to a box, J, which moves up or down in the curved frame, which is a segment of the circle of which the pivoted bar, H, is the radius. This frame is fastened to the sill of the machine and at the top is connected with the uprights, K, which carry a sliding weight, which guides the saw, and, at the same time, keeps it in contact with the log. By the crank, L, the box, J, is raised, through the intervention of a strap and roller. It retains the box and saw in an elevated position, when a log is being loaded, by a spring and ratchet. The lever, M, disengages the spring while the sawing is being performed.

By this machine it is claimed that, with the power of two horses, from forty to fifty cords of stove wood can be sawed in ten hours. It is so simple that it is not liable to get out of order, and necessary repairs could be made by any ordinary mechanic. It is easily managed by even unskillful hands.

A patent was granted through the Scientific American Patent Agency, July 5, 1864. For further information, and for district and State rights to vend and manufacture, address either W. M. Salmon, Westville, Laporte Co., Ind., or Joseph Salmon, agent and manufacturer, Monmouth, Warren Co., Ill.

Photographs on Porcelain.

Mr. J. M. Herron, of this city, has so perfected the art of photographing on porcelain that the art of miniature painting on ivory, of which this takes the place, may be considered obsolete.

A recent visit to Mr. Herron's gallery, 227 Sixth Avenue, corner of Fifteenth street, suggested that many persons who are at their wit's end to know what to get their friends for the approaching holidays, might invest a small sum in a picture of themselves on porcelain, which would be as acceptable a present, in many cases, as could be given. We get nothing for this suggestion, nor do we charge our readers for the hint, but any who wish for fault-

less pictures of themselves or friends are recommended to examine Mr. Herron's specimens of the several different kinds of photographs which he executes.

CHAMPLIN'S PATENT ICE-CREAM FREEZER.

Ice cream is a modern luxury, but its palatableness and cooling properties, in the heat of summer, have so recommended it that its manufacture has become quite an important business. It is made in immense quantities for hotels and eating-houses, and a cream-freezer has become a part of household furnishing.

the gears, are in opposite directions, thus greatly aiding in the comminution of the particles and facilitating their congelation. The peculiar form of the dasher, also, assists in this "fining" and in the rapidity of the freezing process. The upright arms of the dasher are of longitudinal concave form, as at D, and midway on the dasher is a transverse concave arm, E, which lifts and mixes the cream. By these means twice the amount of energy is exerted in throwing the particles together as in ordinary freezers, where only the can or the dasher revolves, and the tendency in this is to throw the cream against

the sides of the can in immediate contact with the freezing mixture.

By these appliances the inventor claims to freeze quicker and beat finer than with any other freezer in use. They are made in sizes varying from six quarts, for a family, to fifteen gallons, for large hotels, and are driven either by hand or power. The stand sustaining the gearing is pivoted so that it can be tipped back and swung to one side to enable the operator to remove the can without trouble. When designed to operate, a clutch, F, engages with the can cover to rotate the cream vessel, while the dasher is turned by a shaft passing through the clutch.

It was patented through the Scientific American Patent office, June, 26, 1866. For further information address, J. R. Champlin & Co., Laconia, N. H.

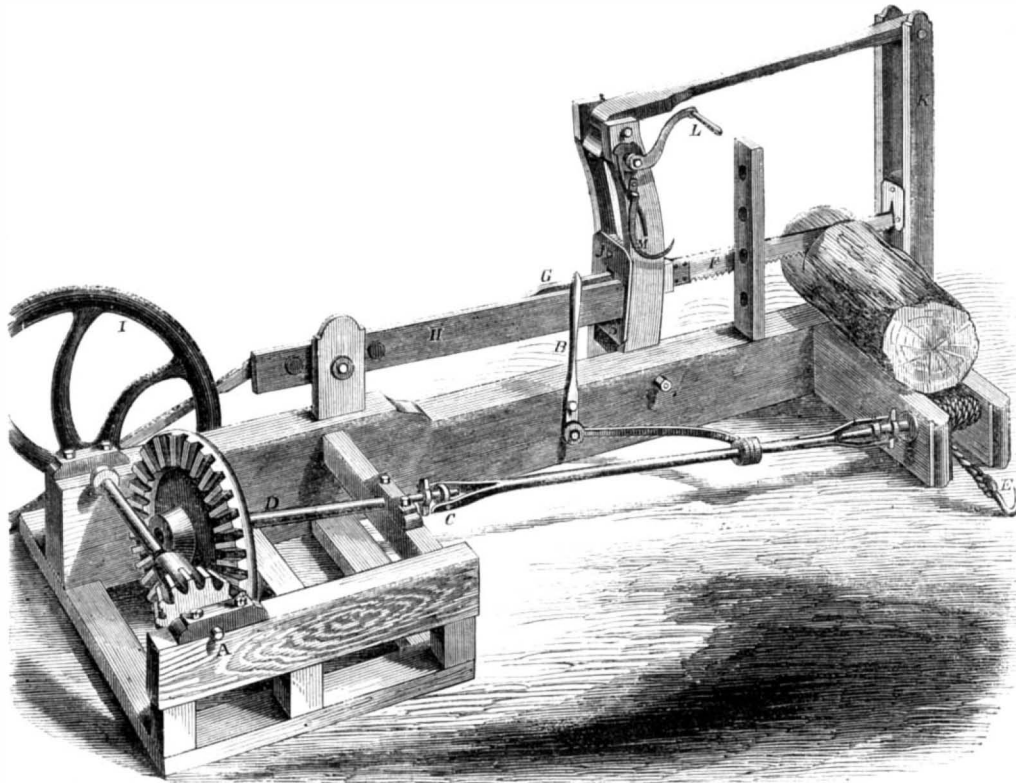
**SALMON'S WOOD-SAWING MACHINE.**

The engraving herewith presented shows one on a new plan, which is claimed to be superior to any other in use.

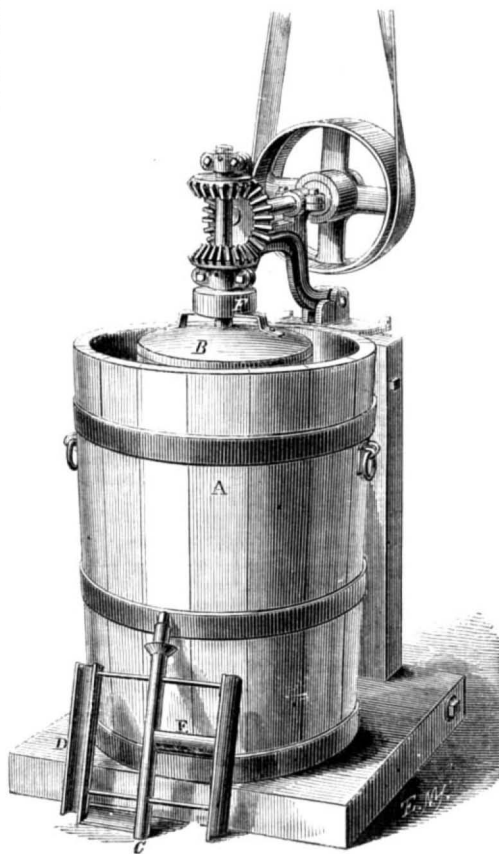

A, in the engraving, represents the ice receptacle and B the cream can. By means of the combination of beveled gears motion is imparted, not only to the dasher, shown at C, but to the cream vessel. The two rotations, as may be seen by the combination of

TORPEDO POWDER.—A new explosive mixture called *Poudre Fontaine*, used in the torpedoes which were tried against the hull of the *Vauban*, has been employed in blowing up the old quays of one of the basins at Toulon. A mine charged with five kilogrammes of the powder exploded with such effect that a charge of 100 kilogrammes of the ordinary gunpowder would have caused less destruction. The charge was purposely a small one, and the engineers congratulated themselves on having commenced so cautiously. A singular result of the explosion was the killing a quantity of fish. The workmen picked up 70 lbs. or 80 lbs. weight, which floated on the surface of the water. The same phenomenon had been remarked from the action of the torpedoes.

THE *London Mechanics' Magazine* has an article on what it terms vegetable leather, manufactured on a large scale by the firm of Spill & Co., Stepney Green. Its composition is rather vaguely referred to, as containing caoutchouc and naphtha; but from the remark that any desired thickness may be given it "by additional backings of linea, etc., cemented with the caoutchouc," one is led to infer that it is a modification of what is known as india-rubber cloth. The qualities attributed to it, however, go much beyond those of our American article. It is said to be of great strength in comparison with leather, and to be even better adapted to sewing; to be valuable for all kinds of harness, and an article of the most durable beauty, far superior to any leather, for book-binding.

A REGULAR running drill has been introduced into the British army. For the first two weeks of practice the daily run is not to exceed 300 yards, for the second two weeks, 600 yards, and for the third two weeks, 900. After that 1,000 yards are to be run, with and without arms, etc., on alternate days.

THE difference in expansibility between steel at its maximum and at its minimum of hardness, is calculated as 84 to 62.

THE
Scientific American

MUNN & COMPANY, Editors and Proprietors.

PUBLISHED WEEKLY AT
NO. 37 PARK ROW (PARK BUILDING), NEW YORK.

O. D. MUNN, S. H. WALES, A. E. BEACH.

VOL. XV., No. 25 [NEW SERIES.] *Twenty-first Year.*

NEW YORK, SATURDAY, DEC. 15, 1866.

Contents :

(Illustrated articles are marked with an asterisk.)

*Improved Apparatus for Well Boring and Hoisting..... 401	New Inventions..... 407
Reduction of Railway Fares..... 401	Markets..... 407
Interesting Official Statistics of Rolling Stock of English Railway..... 402	*Improved Portable Sawing Machine..... 408
Patentees in France..... 403	Photographs on Porcelain..... 408
*The Great Water Tunnel Under Lake Michigan..... 404	*Champlin's Patent Ice-Cream Freezer..... 408
Galileo's Instruments..... 404	The New Volume for 1867..... 409
English Hop Culture..... 405	No. 1 Advertisers..... 409
*Mellon's Improved Locomotive Tire..... 405	The Dangers in Storing Petroleum..... 409
The Crank and Piston in Setting Valves..... 405	Parrott Gun Case Decided..... 410
Water Spouts..... 406	Patent Claims, 410, 411, 412, 413, 414, 415
Extension Notices..... 406	Advertisements..... 415, 416, 417
New Publications..... 406	*Improved Device for Steering Children's Sleds..... 418
Notes and Queries..... 406	*Improved Driving Reins and Check..... 418
Business and Personal..... 406	

THE NEW VOLUME FOR 1867.

We intend to make the forthcoming Volume of the SCIENTIFIC AMERICAN worth to every subscriber tenfold more than the cost of subscription. Our energies will be taxed to the utmost to supply our readers with the most valuable information to be obtained in all the practical arts and sciences. The amount of reading matter will be more than double that of any similar paper in this country, and nearly equal to the largest in Great Britain. We have an active and intelligent correspondent now in Europe, who is engaged to furnish a letter once a fortnight, not simply made up of the odds and ends of newspaper clippings, but to present and discuss in a practical manner, the systems of mechanical Engineering and manufacturing industry as now practiced in Europe.

With the opening of the Great Exhibition of Industry of all Nations in Paris, next year, our correspondent will be in attendance, and will furnish a series of valuable letters descriptive of the wonders which will there be gathered from all parts of the world.

In addition to this, one of the principal Editors of the SCIENTIFIC AMERICAN will also be at the Exhibition in an official capacity, and will give personal attention to the interests of our journal while he remains abroad.

Our Engraving department will receive special attention, and we expect to add to it new and attractive features.

Our subscription list ought to be doubled. This can be done by a very simple sum in multiplication, "twice two are four." If each of our subscribers would get one additional name, the problem would be wrought out at once and very much to our satisfaction.

NO. 1 ADVERTISERS.

Parties who intend to advertise on the outside page of the first number of the new volume, should send their advertisements without delay. We cannot receive them after the 20th inst. The terms are seventy-five cents per line for each insertion. To enable advertisers to calculate how much they must remit, we will state that, independent of the head line, about seven words will make a line of agate type. It will be safe to estimate but four words for the head line.

Engravings will be inserted with advertisements

at \$1 a line for the back page and 75 cents a line on the inside. The rates for ordinary advertisements in the inside, 40 cents a line.

REALITY VERSUS SHAM.

"Whatever is worth doing is worth doing well." This is a truism that cannot be gainsayed. The mechanic who acts according to its spirit and who practices its wisdom will have a fame worthy of his profession and will deserve corresponding success. No sham or half-finished jobs should ever go out of a shop, or from the hands of a workman. While he may achieve a reputation for a hundred well-finished jobs, the one hundred-and-first may ruin him because it is shammed. Those whose custom is really worth anything are men who want a good, rather than a cheap article. The best is the cheapest. An ephemeral success can possibly be attained by making and vending imitations and shams, but for a permanent business something valuable must be offered for the *quid pro quo*. "The burned child dreads the fire," and the cheated customer comes not again, but, on the contrary, is solicitous and careful to spread the benefit of the warning he has received.

If a mechanic desires the confidence of his employers, if a manufacturer values the respect of his customers; if a merchant wishes the continuance of his trade, he must "deal justly." We know of some who are so conscientious that they will not accept a job, nor assume a contract which debars them from fidelity to the principle of honor—which requires them to lower their status as workmen—for a present pecuniary benefit, however promising. There is more than worldly wisdom in this—more than the low motive of gain—it is an honorable spirit, which is the life of labor and the blood of true workmanship.

It is shameful to see the "tricks of trade" to which some resort. They are willing to ruin their reputation for a present benefit. If competition has compelled them to assume the responsibility of a contract, rather than lose the job they begin to contrive how they can ostensibly fulfill that contract while they really do not. They will put in poor material, or, if this is not possible, will turn out poor work. They may get their price, but it is not seldom that it is the price of blood as well as of reputation. Sham-built boilers, half finished machinery, insufficient material, coarse workmanship, and hurried manipulation are to be seen on all hands. The producers of such shams can at best but have a brief business existence. They are soon "known and read of all men." Cast iron is well in its way, so is the same material made malleable, but one will not long pass for steel, nor the other for wrought iron. Green timber may be best for some purposes, but it cannot equal for others seasoned stock. The mechanic and the manufacturer should be actuated by some other motive in addition to that of making money fast. Their own reputation and the credit of their craft should exert an influence.

Judging from many of our productions, one would suppose that the eye was the only organ to which our mechanics appealed in their work. If the iron work of a machine looks bright, or shines with deceptive paint, japan, and varnish, it can pass muster. "Deep scratches and high finish" is the machinist's designation for such work. There is too much of this style sent from manufactories all over the country. The forger ignores a "cold-shut" or an imperfect weld. He finishes his work by cold hammering, destroying the fiber of the iron, but giving it a fair surface. The machinist hides his faulty lathe work with the polish of emery and the abrasion of the file. The carpenter is satisfied with imperfect materials, unseasoned or water soaked, put together with glue, or cut nails, enough merely to keep the fabric in place until he can turn his back upon it. The cabinet-maker shams with his veneering, well enough in its place and properly applied to properly prepared stock, but worse than the plain and cheaper wood when not judiciously used. The builder puts up veneered houses, representing structures of solid stone by thin veneers of marble and even of cheap sandstone. These veneers he sets on edge and anchors by thin straps of iron to

the true wall of brick, certain in case of a fire to drop on the heads of hard-working firemen. The mason puts sand in the place of lime because cheaper. Such work is valuable only for temporary purposes. Such buildings frequently do not outlive those who erected them.

The cant question "what is the price of putty?" has a deeper meaning than appears on its surface. Putty "covers a multitude of sins." The wood-worker shares its benefits with the worker in metals. It is used to fill holes made by the carelessness of the workmen, or belonging to the imperfect quality of the material. It smooths otherwise rough and unfinished surfaces, and is a humbug generally.

If the mechanic desires to give the future historian material which will be creditable to his craft and country; if he cares for personal reputation and consequent advantage; if he has regard to the welfare of his kind—he ought to leaven his work with professional honor and be sure that his productions cannot rise up in judgment against him.

THE DANGERS IN STORING PETROLEUM.

Shortly after the destructive fire at the Erie Railway Docks, in Jersey City, caused by the ignition of stored petroleum, we drew attention to the fact that in its crude state that substance is highly inflammable and explosive, and suggested what we then considered a remedy. Subsequent events and investigations have assured us that our opinion was well founded.

On the night of the 30th ult., another large fire occurred from the same cause; happily this time without loss of life, but still attended with the destruction of not less than \$100,000 worth of property. The building in which the oil was stored at this last fire was deemed fire-proof, but it was as completely demolished by the intensity of the heat as a wooden building would have been by a fire from any other cause. Water will not extinguish burning petroleum. It serves only to spread its ravages by bearing on its surface the blazing mass. Depriving the fuel of all air, by smothering, seems to be the only known method of checking an oil fire. The most, therefore, that can be done in case of such a fire is to confine its ravages and allow it to burn itself out.

The ready inflammability of petroleum and its liability to explosion are not necessary qualities of the substance. They come from an ingredient the absence of which would really increase its value for all purposes to which it is now applied. Petroleum is a composition chemically blending substances varying in character, from solid paraffine to a highly volatile gas. In this latter, or in the volatile liquids from which it is evoked, lies the danger of fire and explosion. We are not prepared to say that these lighter oils, or the gases, are capable of spontaneous ignition or explosion; in fact, we are not aware that in the case of any one of the petroleum fires that have occurred such a hypothesis is necessary to account for their origin. But it is certain that petroleum at ordinary temperatures generates and throws off a gas as inflammable and dangerous as that used for illuminating purposes. This gas impregnates the air to a considerable distance, especially when the quantity of oil is large. It may be likened to a cloud overhanging and extending beyond the reservoir or vessels that contain the oil. It penetrates the fibers of wood, so that ordinary barrels do not prevent its escape. Here, then, is a source of very great danger. How shall it be removed?

That it can be removed is easily demonstrated. Indeed, one of the largest oil refineries in this vicinity distills no petroleum from which these volatile elements have not been removed at the place of production. This is easily accomplished. Only a very low heat is required for vaporizing these volatile constituents, which can be obtained from a coil of steam pipe placed in a suitable vessel. The product, after being condensed, can be placed in metallic airtight receptacles and transported or stored without great danger. The oil for distillation into illuminating fluid or for lubricating purposes, would not at all be injured by this preparatory distillation. It has been stated that some unprincipled refiners mix a portion of the inflammable fluids with their illuminating oils; but whether this is so or not, it is certain that in nearly all of the qualities of crude

oil, except perhaps the heavy lubricating petroleum, these dangerous elements are present, in some oils reaching at least 20 per cent.

Some legislation appears to be necessary in regard to this matter for the proper protection of persons and property. We hope the attention of our legislators will speedily be directed to this subject, which must be conceded to be one of the first importance.

PARROTT GUN CASE DECIDED.

U. S. CIRCUIT COURT, SOUTHERN DISTRICT—BEFORE JUDGE NELSON.

The bill is filed by Treadwell against Parrott, maker of the well known Parrott gun, founded on Letters Patent granted Dec. 11, 1855, and reissued Feb. 4, 1862, for improvement in the manufacture of cannon, to restrain him from infringement. The invention claims, first, casting a cannon the walls of which are encased with wrought-iron rings, smaller than the part which they are to surround but enlarged by expansion, and by contraction bringing the particles of said body nearer together. Second, in securing the hoops, a female screw is cut on the inside to fit threads cut on the body of the gun, and are finished to 1-1000th part of the interior diameters less than the male screw to be encircled. The Barlow Law, to which the inventor refers as having furnished him with the principles leading to this invention, showed that "hollow cylinders of the same material, do not increase in strength in the ratio of increased thickness, but the power of resistance diminishes after considerable thickness is obtained." To obviate the elements of weakness, caused as above, and to obtain the strength of wrought instead of cast iron, the plan of construction before described is resorted to, and by this means a gun is made nearly four times stronger than a cast iron gun of the same weight.

The only material and difficult question is, whether or not the patentee is the original and first inventor of the improvement. After an attentive examination, and our best consideration, the conclusion seems clear that he is not.

A combined cast-iron gun and wrought-iron envelope was constructed by Thiery, a French officer, as early as 1834. It is seen from his description, that the hooping of cast-iron guns by wrought-iron bands, much after the manner of the patentee, was then known to add to the power of resistance; that this was increased by the contraction of heated bands; and the difference in diameter was governed by the law of expansion of wrought iron.

In 1843, the Frith gun was patented in England, having a cast-iron barrel, that part most acted upon by the explosion being strengthened by strong wrought iron or steel bands, driven on while hot, so that the contraction thereof in cooling would produce firm adhesion. The question might here arise, whether the information in the description would enable an intelligent mechanic to make the proper difference between the interior diameter of the hoop and the exterior diameter of the gun's body. We are assured that any one having any knowledge in relation to this subject, is qualified to carry into effect in a scientific way the purpose and object of the patentee. This is also affirmed in detail by all the defendant's experts whose attention was called to the subject. The state of the art was familiar to Chambers in 1849, for by his own statements he determined the difference in diameter of the wrought-iron hoops used in his wrought-iron guns of that date, on the principle of the law of expansion of wrought iron. Another point should be noticed. The thickness of the walls of the Frith gun nearly correspond with the thickness of complainant's, and the same is true as to thickness of the hoops. Whether or not this inventor has a knowledge of Barlow's Law, cannot affect the question.

The point of superiority of finish of the defendant's cannon over the old Frith guns is not entitled to consideration. It is owing to the mechanic and not the inventor. Upon the whole, without pursuing the case further, we are compelled to the conclusion: That in view of the state of the art at the time, the improvement in the construction of cast-iron guns with wrought-iron hoops, claimed by the complainant, will be found in a description of the Frith patent, and upon this ground a decree must be entered for the defendant, dismissing the bill.



ISSUED FROM THE U. S. PATENT OFFICE

FOR THE WEEK ENDING DEC. 4, 1866.

Reported Officially for the Scientific American.

pamphlets containing the Patent Laws and full particulars of the mode of applying for Letters Patent, specifying size of model required, and much other information useful to inventors, may be had gratis by addressing MUNN & Co., Publishers of the SCIENTIFIC AMERICAN, New York.

60,112.—RAILROAD RAILS.—Joseph Adams, Fairhaven, Vt.

I claim a railroad rail made in two parts, A A', with their top surfaces so shaped as to form a central longitudinal groove, c, and having said top surfaces highest at the points where the wheels will bear directly over the center of the neck of each half rail, the whole being arranged and constructed substantially in the manner and for the purpose set forth.

60,113.—LATHE CLUTCH.—Richard Allen, Jersey City, N. J.

I claim the carrier clutch, constructed and operating substantially as described.

60,114.—DRILLING MACHINE.—M. M. Ammitown, Boston, Mass.

First, I claim the combination of the collar, E, provided with the projection, e, and the grooved arm, F, substantially as a id for the purpose specified.

Second, I also claim the combination of the slotted standard, B, and screw, D, with the collar, E, arm, F, and plate, C, as and for the purpose specified.

Third, I claim the grooved arm or holder, F, as and for the purpose specified.

60,115.—EMBOSSING MACHINE.—James C. Arms, Northampton, Mass.

First, I claim the embossing machine, constructed and arranged to operate as and for the purpose substantially as set forth.

Second, The heater, D, provided with the removable embossing plate, n, as shown and described.

60,116.—CHUCK.—T. G. Arnold, New York City.

I claim the arrangement of the expanding jaws, E, pivoted to the solid head piece, B, constructed and operating substantially as herein before set forth and for the purposes described.

60,117.—LUBRICATING OIL CAN AND LAMP.—Elias Ashcroft, South Boston, Mass. Antedated Nov. 29, 1866.

I claim the combination of the tube, D, tube, C, plate, B, and can, A, constructed and arranged in the manner and for the purpose herein specified.

60,118.—COOKING STOVE.—Frederick M. Baker, South Reading, Mass. Antedated Nov. 22, 1866.

I claim the combination as well as the arrangement of the flues, m and n, the dampers, D1 D2 and D3, and openings, a2 b2, with the auxiliary oven, G, its flue, F, and the main oven, and its flues, B B1 B2, and C, the whole being substantially as hereinbefore specified.

60,119.—PROCESS FOR MANUFACTURE OF GLASS.—Hayden M. Baker, Rochester, N. Y., assignor to himself and Robert J. Lester.

I claim the application to manufacture of the processes herein described, for the production of "best flint glass" from a mixture of nitrate of potash, nitrate of lead, and silicic acid at elevated temperatures, and the recovery of the nitric acid employed by displacement and distillation in the manner herein described and set forth, or any other process substantially the same, and which produces the same intended effects or results.

69,120.—APPARATUS FOR THE MANUFACTURE OF SALT BLOCK.—Newell Barnard and J. G. Spiller, Saginaw City, Mich.

First, I claim admitting the brine at the forward end, or hottest part of the block, D, substantially as described and for the purpose set forth.

Second, Drawing off the bitter water at the rear end of the block, D, substantially as described and for the purpose set forth.

Third, The combination with the lower vat, c, with the block, D, and with the drying rack, B, of the trough, A, substantially as described and for the purpose set forth.

60,121.—BAG HOLDER.—Chas. J. Barney, Edgerton, Mass.

I claim the frame, A, provided with a platform, B, having an opening, C, made in it to receive the flange or lower part of the hinge hopper, D, and used in combination with a removable platform, E, substantially as and for the purpose specified.

60,122.—SCAFFOLD BRACKET.—Hiram Beckwith, Grass Lake, Mich.

I claim the tie, B, the rail, C, and the brace, D, when constructed and combined substantially as herein shown and described, for the purposes set forth.

60,123.—LANTERN.—John Bellerjeau, Philadelphia, Pa.

I claim the two-part guard, D D, and confining ring, f, when used in combination with projections, h, studs, i, or their equivalent, so as to constitute a means of connecting the cap and base of the lantern, substantially as described.

60,124.—STEAM-GENERATOR HEATERS.—Thomas E. Belton, Buffalo, N. Y.

I claim the heater, F, provided with flues, g, g, and central discharge ports, O O, arranged in combination with a boiler and furnace, so as to operate substantially as set forth.

I also claim the mud shields, H H, provided with perforations, 11, in combination with the pipes, J, for discharging the mud and other sediment, substantially in the manner specified.

I also claim the directing and distributing plate, m, arranged and operated as described.

I also claim, in combination with the heater, F, constructed as described, and leg, c, of the boiler, when the same extends below the level of said heater, the pipe, q, arranged and operating substantially in the manner and for the purpose herein set forth.

60,125.—GRATE BAR FOR FURNACE.—Charles C. Bemis, San Francisco, Cal.

I claim a furnace grate with bridges or barrier plates, b c d e f, placed beneath the said grate at intervals, and increasing in depth to near the flue, the whole arranged and constructed substantially as described and for the purpose set forth.

60,126.—COMMUNICATING MOTION.—William Bicknell, Hartford, Maine.

I claim the new method of transmitting motion, consisting of the arrangement upon fly wheel, A, of cog or friction wheel, c, so constructed that a plane passing through the axis of either of them shall preserve the same angle with the horizon, throughout the revolution of wheel, A, said wheel, c, driving wheel, c', substantially as described.

60,127.—FENCE.—Benjamin Billings, Lyons, Iowa. I claim the arrangement of the post, A, picket, B, cap, D, when constructed, arranged and operating substantially as and for the purpose set forth.

60,128.—REVOLVING FLUE CLEANER.—G. E. Bingham, Milwaukee, Wis.

I claim the revolving flue cleaner formed by the combination and arrangement of the heads, E, wooden bars, F and A, binding bands, Band C, binding rods, G, and shaft, I, substantially as herein described and for the purposes set forth.

60,129.—SOLAR CAMERA.—J. B. Blair, Philadelphia, Pa.

I claim the application of an adjustable piece, E, to the use and purpose substantially as set forth.

60,130.—WICK INSERTER FOR LAMPS.—William Y. A. Boardman, New Haven, Conn.

I claim the herein-described instrument for inserting wicks in lamp tubes as a new article of manufacture.

60,131.—ELASTIC STRAP FOR GARMENTS.—Jno. W. Boughton, Chicago, Ill.

I claim an elastic strap, A, having an attaching plate or its equivalent at each end for application to the garment, substantially as herein shown and described.

60,132.—HEATING STOVE.—Lewis Bridge, York, Pa.

I claim the arrangement of a parlor fireplace heating stove, with a vertical cold air space, D, around the back of the fire chamber, A, in combination with the surrounding hood, h, h, for utilizing the heat radiated from the rear of the stove, and conducting it into the room, or to an upper chamber when desired, constructed and operating substantially as and for the purposes herein described.

60,133.—APPARATUS FOR DETACHING BOATS.—S. Brown and Leon Level, New York City.

We claim the standard, C, the bent lever, a, and the shackle hook, b, constructed, combined and operating as a detaching hook, substantially as herein shown and described, for launching boats and for other purposes.

60,134.—FURNACE FOR DESULPHURIZING COAL.—Wm. Bruckner, San Francisco, Cal.

I claim the internal screw ribs or rifes arranged spirally in opposite directions, so as to convey the ore alternately from one end of the cylinder, and heat it uniformly.

60,135.—BUCKLE.—Angeline Button, Administratrix of Charles A. Button, deceased, Pontiac, Mich.

I claim the combination of the clasp, C, and body, or rim, A, constructed and connected substantially as and for the purpose herein specified.

60,136.—INSTRUMENT FOR DESTROYING EMBRYO CATERPILLARS.—Aaron Casebeer, Sipesville, Pa.

I claim a knife which is composed of two blades, C C, united to a contracted shank, b, to be used substantially as described.

60,137.—CAR REPLACER.—George Chambers, Ithaca, N. Y.

I claim, first, the truss, trunnion or tool, A, made with two surfaces, one for replacing a wheel from the inside, and the other from the outside of the track, and the duplicating the same in one instrument or trunnion, so as to fit any emergency and either direction of motion of the displaced wheel or wheels, as described.

Second, I claim on either a single or double inclined plane, with a surface or surfaces suited to replacing a wheel off of the track, the placing or combining therewith an adjustable piece or part which, while it aids in replacing a wheel off on the inside of the track, is also useful in carrying the flange over the rail when the wheel is off on the outside of the track, as described, and all equivalents thereunto.

60,138.—CHUCK.—John C. Chapman, Cambridgeport, Mass., assignor to himself and David W. Weston, Boston.

I claim the beveled keys, A, a, and the prevention pins, c, c, c, in combination with the collars, B, B, operating substantially as above described.

I claim the beveled key, A, and the prevention pins, c, c, in combination with the removable bushing, E, operating substantially as above described.

60,139.—LANTERN.—Richard Chester, Chicago, Ill.

I claim the combination and arrangement with a lantern and its globe, of the globe support, d, perforated jackets, c, c', and diaphragm, e, arranged and operating as and for the purposes specified.

60,140.—LANTERN.—Richard Chester, Chicago, Ill. I claim, first, The arrangement of the perforations in the center of the bottom, E, and the perforated inclosure, F, arranged beneath the platform, C, for the lamp, as and for the purposes described.

Second, The horizontal tubes, H, provided with perforated cups and extending within the lantern top as shown, in combination with the diaphragm, G, having openings at the corners of the range of said tubes, as herein specified and set forth.

60,141.—TOY BUILDING BLOCKS.—George H. Chinnock, New York City.

I claim the building blocks of the form of the half of a cube, having five sides, in combination with letters or numerals on their surfaces, which are whole in themselves or bisected diagonally, substantially as shown and described for the purposes specified.

60,142.—MANUFACTURE OF PARIS WHITE AND WHITING.—William W. Chipman (assignor to the Chipman Mining Company), New York City. Antedated November 22, 1866.

I claim the manufacture as herein described of Paris white and whiting from the earthy material known as marl.

60,143.—ANIMAL TRAP.—Greville E. Clarke, Racine, Wis.

I claim, first, The combination of the pivoted platform, E, and the arm, F, arranged and operating substantially as and for the purposes set forth.

Second, In combination with said platform, E, and arm, F, the ratchet wheel, G, provided with a finger, I, operating substantially as specified.

Third, In combination with said ratchet wheel, G, I claim the arrangement of the spring, s, to hold the wheel from moving back while the arm, F, recedes, in the manner described.

Fourth, The combination of the spur wheel, G, provided with the pin, l, and the lever, H, arranged and operating substantially in the manner and for the purposes described.

60,144.—VISE.—Emmett Coon, Kalamazoo, Mich.

I claim, first, The adjustable dies, F, F, with cavities, b b, and keys, c, c, as and for the purpose set forth.

Second, The adjustable die, F1, and die, F2, made with the bevel n, horn, d, and keys, c, c, when used in combination with a vise.

60,145.—CENTRIFUGAL PUMP.—E. Hall Covel, New York City.

I claim, in pumps, the combination of a water wheel and screw elevator, when arranged substantially as and for the purpose described.

I also claim an angular or irregularly-shaped chamber, in combination with a pump cylinder, in which water or other fluid is elevated by a spiral of vertical motion, substantially as described for the purpose specified.

60,146.—FORCE PUMP.—W. G. Crutchfield (assignor to himself and James O. Atlick), Dayton, Ohio.

I claim the arrangement with the stem, A, of a force pump, of the pipe, C, with its cock and cup, substantially as and for the purpose specified.

60,147.—SEEDING MACHINE.—H. D. Dann, Waupun, Wis.

I claim, First, The seeding cylinders, consisting of the parts, B and C, constructed and arranged to operate in combination, as herein described. Second, Attaching the parts, B, permanently to the axle, O, and the parts, C, to the rod, a, for the purpose of adjusting the size of the cells, as set forth. Third, The plates, E, provided with the opening, I, and the slides, m, attached to the bar, b, arranged to operate in combination therewith, as shown and described.

60,148.—METHOD OF TREATING THREAD OR YARN PREVIOUS TO WEAVING.—John Davis, Manchester, England.

I claim caps or bobbins of yarn or thread saturated with a solution containing tanning matter, for the purpose specified.

60,149.—MACHINE FOR SCOURING LEATHER.—Franklin Davis, Lawrence, Kansas.

I claim the cylinder, B, and the apron, C, constructed, arranged and operating substantially as described, in combination with the frame, A, and the water reservoir, D, for the purposes set forth.

60,150.—SADIRON HEATERS.—Joseph S. Dennis, Chicago, Ill.

I claim the chambers, D and E, with the inlet and exit tubes, connecting pipes or jets, b, and orifices, a, constructed and operating substantially as herein described.

60,151.—PRINTER'S GALLEY.—Alexander T. De Puy (assignor to R. Hoe & Company), New York City.

I claim the combination of the metal lining with the frame of a printing galley, in the manner substantially as herein shown and described.

60,152.—SPADE HANDLE.—Charles Dimmick, Brockport, N. Y.

I claim making a spade, or rather handle, from a straight piece of wood, formed and bent round in the manner substantially as herein shown and described and for the purposes set forth.

60,153.—DETACHABLE FLANGES FOR PRIVY BOWLS.—Robert Diven, Brooklyn, N. Y.

I claim the water-closet hopper, constructed with a detached flange, B, substantially as herein set forth for the purpose specified, as a new article of manufacture.

60,154.—ORE CRUSHER.—M. B. Dodge, New York City.

I claim the application of soft wrought-iron faces to the jaws of a quartz crusher, substantially as and for the purpose specified.

60,155.—TURNING LATHES.—Reuben W. Drew, Lowell, Mass.

I claim making the front box or bearing, B, tapering, in the manner as and for the purpose set forth.

60,156.—SASH HOLDER AND FASTENER.—E. F. Driggs, Brooklyn, N. Y.

I claim, in combination with a window sash, A, a ratchet, C, provided with teeth as described, and a spring dog or pawl, D, provided with a thumb piece, E, the whole constructed and operating substantially as described and specified.

60,157.—MANUFACTURE OF SPRINGS.—J. F. Dubber, Brooklyn, N. Y.

I claim tempering steel springs and adjusting their shape by means of the former herein described, and in the manner set forth.

60,158.—APPARATUS FOR TESTING SPIRITS AND PREVENTING FRAUDS ON THE REVENUE.—John C. Dunlevy, Dayton, Ohio.

I claim the testing apparatus herein described, composed of the vessel, C, with the parts, f and g, or their equivalents, in combination with the pipe, A, and the stop cocks, D and E, all substantially as and for the purpose set forth and described.

60,159.—HORSE POWER.—George Eichenseer, Waterloo, Ill.

I claim, First, The arrangement of the shaft, B, for horizontal adjustment, thereby tightening the driving belt, H, substantially as set forth. Second, The flexible joints of the parts, C and D, as set forth. Third, The arrangement of the drum, E, in sections, e, and their combination with each other and with the arms, D, as set forth. Fourth, The arrangement of the supporting casters, F, and their combination with the segments, e, as set forth. Fifth, The castor shafts as a guide for the belt, H, after it has slipped, substantially as set forth.

60,160.—STOVE-PIPE DAMPER.—Charles R. Everson, Palmyra, N. Y.

I claim the combination of the arched plate, E*, perforated at d, with the annular plate, B, valve, C, loop, D, and shaft, E, all constructed and arranged as and for the purposes specified.

60,161.—WAGON HAY RACK.—Francis M. Everingham, Lafayette, N. Y.

I claim the lever, A, the drum, B, the flanges, C, the ratchet, D, the catches, E, the winch, F, and the rope, G, when the same are constructed and operated substantially in the manner and for the purpose described.

60,162.—BURGLAR ALARM.—Willard Farnham, Jancsville, Wis.

I claim the combination and arrangement of the wedge, A, base, B, B, and spurs, a, substantially as and for the purpose set forth.

60,163.—TURNING LATHE.—Luther R. Faught, Philadelphia, Pa.

I claim an improved binder for lathe spindles, formed by combining the nut, E, and sleeve, D, constructed and arranged as herein described, with each other, and with the spindle, C, and stock, A, substantially as described and for the purpose set forth.

60,164.—ROTARY CULTIVATOR.—James C. Fitzgerald, Willet, N. Y.

I claim the arrangement of the spirally and inclined armed pulverizer, H, resting in the eccentric bearings, k, when said parts are combined with a vertically adjustable frame, G, suspended from the main frame and concentric with the axle, as set forth.

60,165.—OIL WELLS.—Thomas M. Foster, Union Mills, Pa.

I claim the sleeve, B, sections, A, A, couplings, a, a, connecting piece, D, and ferrule, E, combined and operating substantially as described as and for the purpose specified.

60,166.—DISTILLING AND REFINING OIL, WINE, AND OTHER LIQUIDS.—Andre Foubert, New York City.

First, I claim the column, c, containing the perforated diaphragms, d, d, in combination with the worm or condenser, g, and pipe, m, passing back to the column, c, as and for the purposes set forth. Second, I claim the flanges or divisions upon the perforated diaphragm to cause the liquid to circulate from the cup, i, to the pipe, e, in the manner specified.

60,167.—MACHINE FOR SIZING FIBROUS MATERIAL.—William Fuzzard, Chelsea, Mass.

I claim the combination of the distributing roller, E, and the heated cylinder, C, arranged relatively with each other to operate substantially in the manner as and for the purpose set forth.

60,168.—HARNESS SADDLE.—John Fye, Hamilton, Ohio.

I claim the combination of the detachable bisected bases with dovetailed rebates therein, with the turret feet, m, m, and saddle-tree, when constructed and secured together in the manner and for the purpose specified.

60,169.—CENTERING AND SQUARING DEVICE.—Charles G. Gardiner, Springfield, Ohio.

I claim, First, The chuck, C, provided with the conical sectional rings or wedge, a, and nut, o, for centering and holding the drill, e, as shown and described. Second, The sectional rings, n, and cap, D, in combination with the chuck, C, and spindle, F, arranged and operating as shown and described.

60,170.—COTTON PLANTER.—William L. Gebby, New Richmond, Ohio.

I claim, First, The wheel, H, droppers, b, b, springs, d, d, inclined planes, I and I, and apron, 12, constructed and operating substantially as and for the purposes set forth. Second, The seed box, F, constructed substantially as described.

60,171.—GATE.—Riley James Gilbert, Hanover, Wis.

I claim, First, The carrying beams, B and C, when constructed, arranged and used with or without the side cap, r, substantially as and for the purpose set forth. Second, The combination and arrangement of the handles, N, levers, L, swinging fulcrums, M, carrying beams, B and C, connecting rods, A, parts, F, E, B, and cross beam, F, substantially as and for the purpose set forth.

60,172.—PLOW.—Carlos Glidden, Milwaukee, Wis.

I claim coating or covering with porcelain or silicious enamels, substantially as herein set forth, such portion of the metal surface of plows and other ground-working or cultivating and planting implements as come in contact with the earth.

60,173.—MACHINE FOR ORNAMENTS MOLDINGS.—Gottlieb F. Goetze, New York City.

I claim the arrangement of the pattern wheel, D, roller, F, springs, J, and adjustable plate, E, carriage, G, slide, H, screws, n and o, and clamp, p, combined and operating in the manner and for the purpose herein specified.

60,174.—FENCE.—E. C. Gordon, Sevastopol, Ind.

I claim the combination of the wire guys, D, keys, C, wedges, F, and anchoring blocks, E, with each other and with the panel A, of the fence, when said guys, keys, wedges and blocks are constructed and arranged substantially as herein described and for the purposes set forth.

60,175.—BRICK MACHINE.—G. Gracze, Hamilton, Ohio.

First, I claim the arrangement of the frame, L, and knife, L', in relation to the molds, G, when carried upon an endless apron, H, substantially as set forth. Second, The combination of an endless apron, H, having cleats, I, with the revolving arms, J, when constructed and arranged substantially as and for the purpose set forth.

60,176.—MACHINE FOR PICKING MILLSTONES.—J. H. Gray, Boston, Mass.

I claim a machine for the purpose specified, so arranged and organized that while the pick is guided and controlled as to the direction of its movement, each blow is effected and its force controlled by the operative, substantially as described.

60,177.—MODE OF TREATING HEMP, FLAX, ETC.—Thomas Gray, Union Road, Wandsworth, Eng.

I claim as my invention the new and useful and improved method of treating flax, hemp, grasses, and other like fibrous substances, for manufacturing and useful purposes, in removing the bark or skin and resinous or gummy mucilage and the woody fibers of flax and other like plants while in a wet state, and in neutralizing the alkaline matter left in the fiber previous to bleaching in the manner hereinbefore set forth, and in bleaching the same with a combination of bleaching liquor and alkaline saponified fat or oil, or with an alkaline solution, without the fat or oil, so that the fibers after the process of bleaching is completed are rendered stronger than they were in their natural or original state, and I also claim by my invention the permeating the fiber with saponified fat or oil, as herein set forth.

60,178.—PIPE COUPLING.—Alfred Gwynne, New York City.

First, I claim the method of securing or fastening together the ends of water and other pipes, by means of the screws, 1 1 1, or their equivalents, arranged and operating substantially as and for the purposes set forth. Second, In combination with such method of fastening the ends of such pipes, the use of an elastic ring packing, substantially as and for the purposes set forth.

60,179.—METHOD OF IMPARTING AGE TO WINES.—Francois Haecck, Brussels, Belgium.

First, I claim the treatment, substantially as herein described, of wines, spirits, and other distilled liquors, by subjecting them to heat or heat and agitation combined, when the same is effected in a close vessel, or effected in a close vessel or chamber, D, gradually heated in the manner described, or in any other equivalent way, and the condensed vapors collected at or near the top of the wine chamber and run off therefrom, essentially as and for the purposes set forth.

60,180.—MACHINE FOR CUTTING SICKLE SECTIONS.—Samuel C. Hall, White Water, Wis.

First, I claim an improved machine which is adapted for sustaining sickle sections beneath a reciprocating chisel, in such position that the chisel will form serrations, or teeth, upon the beveled edges of said sections, constructed substantially as described.

60,181.—DEVICE FOR GRINDING METAL PLATES.—Thomas Handy, Decatur, Ill.

First, I claim the combination of the carriage, E, carriage, G, ways, D, screws, F, clamp, H, and bars, e, f, arranged and operating in the manner and for the purpose herein specified.

60,182.—SKATE FASTENER.—Theodore Harcourt, Indianapolis, Ind.

First, I claim the heel plate, C, with the grooved ends, C C, section, I, made to the rings, E, E, of the instep strap, A, as represented in the accompanying drawings.

60,183.—GAS RETORT.—George W. Harris, Elizabeth, N. J.

I claim the combination of the fire-clay retort, A, and superheater, B, when arranged as herein specified, to inject the superheated steam at the bottom of the bed of incandescent coal.

60,184.—BALANCE WEIGHT.—Sandy Harris (assignor to C. Thornton Murphy), Philadelphia, Pa.

I claim combining the lever weights with the scale beam in the manner described.

60,185.—MACHINE FOR GATHERING AND LOADING FLAX, ETC.—G. W. Hatch, Parkman, Ohio.

First, I claim the lag, g, hinged to the roller, N, in combination with the elevator, I, and roller, M, for the purpose and in the manner set forth.

60,186.—SURFACE AND DEPTH GAGE.—R. Hathaway, Chicopee, Mass.

I claim the holder, A, or its equivalent, in combination with the gage rod, B, hung in one end of a spindle, G, and set screw, F, and thumb nut, J, respectively, for the said gage rod, B, and spindle, G, when combined and arranged together substantially as and for the purpose described.

60,187.—COTTON TIE.—John W. Heddenberg, Chicago, Ill.

I claim a cotton tie, with one or more keys, C, so made and arranged as to require a lateral movement to clasp and to unclasp it, constructed and operated in the manner herein described.

60,188.—FITTING LOCK PLATE TO STOCK OF FIRE-ARMS.—Granville Henry, Nazareth, Pa.

I claim the stock, D, made in one piece, and cut out at G, in combination with the frame, C, having a shoulder, E, substantially as and for the purpose described.

60,189.—SEEDING MACHINE.—Frank A. Hill, Marysville, Cal.

I claim the agitators, D, D, in combination with the beveled gearing, B and C, and connecting rods, E, E; substantially as described and for the purpose set forth.

60,190.—APPARATUS FOR PRESERVING MILK.—Noah P. Holmes, Indianapolis, Ind.

I claim, in combination with the external and internal chambers, 6 and 8, the use of horizontal partitions for the subdividing the preserving chamber into compartments for various uses, the entire apparatus being constructed substantially in the manner and for the purpose set forth.

60,191.—SAFE.—Edwin B. Horn, Boston, Mass.

First, I claim, as an article of manufacture, a safe made substantially as described. Second, I claim the holes or perforations in the space between the inner and outer safe, so as to afford an outlet for explosive material, substantially as described and for the purpose set forth.

60,192.—STEAM-ENGINE GOVERNOR.—Reuben K. Huntoon, Boston, Mass.

I claim the combination of the bearing, C, its passage, c, and stop cock, d, with the shaft, B, the propeller, D, and the cistern or vessel, A, arranged as and for the purpose set forth.

60,193.—SEAL FASTENER.—Ralph S. Jennings, New York City.

I claim the implement, as a new article of manufacture, for sealing metallic seal envelopes, which is constructed with a spreading portion, c, and a closing or riveting portion, d, substantially as described.

60,194.—FASTENING FOR BUTTONS.—John M. Johnson, New York City.

I claim a button whose collet is provided with a slot to admit the head of a shank, said collet having upon its inner side and at an angle to the slot a depression on one side and a hole on the other, or a hole upon each, in combination with a spear or T-shaped shank or stud, whose transverse end or ends are provided with a spur at right angles thereto, with or without a spring, J, substantially in the manner and for the purpose described.

60,195.—HOE.—A. C. Kasson, Milwaukee, Wis., assignor to himself and Nelson C. Gridley.

I claim a hoe made substantially as herein shown and described, that is to say, construct the edge proper at an angle, and setting the blade at such angle relatively with the handle that the two opposite sides of the hoe will operate upon the earth, substantially as and for the purpose specified.

60,196.—BALING PRESS.—Wendell R. King, Chicago, Ill.

I claim the combination of the gearing, J F and G I, with the screw, C, and boxes, A, when constructed and operating substantially as described.

60,197.—COMB.—Edward H. Knight, Washington, D. C., assignor to Ignatius Rice, New York City.

I claim, First, The combination with a comb of a strip of metal imbedded or inserted in the back of the comb, substantially as hereinabove set forth.

Second, The combination with a strip of metal, A, and the back of a comb, of the bands or hooks, D, substantially as and to the effect set forth.

Third, Returning the strip of metal, A, over the ends of the comb, substantially as herein above set forth.

60,198.—BOOT AND SHOE IRONS.—John Knox, Auburn, N. Y.

I claim, First, Adjusting the space between the back and front guards, substantially in the manner and for the purpose set forth.

Second, The combination of the short back guard and long front guard with the long back guard and short front guard, substantially in the manner and for the purpose above specified.

Third, In fore-part irons holding the front guards in their place by means of a screw operated through the handle, as above set forth.

199.—CAST-IRON ARCH FOR BRIDGES, VAULTS, ETC.—George T. Lape, Summit, N. Y.

I claim a cast-iron voussoir for the construction of arches and vaults for bridges, subterranean railroads, and similar purposes, formed of a top plate, a, a rib or stem, b, and abutting ends, c, c, and fastened with bolts, e, substantially as herein described.

60,200.—HAND SEED PLANTER.—John H. Latimer, Crystal Lake, Ill.

I claim a seed planter provided with one or two chambers, B, C, and a chamber, L, provided with a hinged bottom, G, and a spring, S, or its equivalent, arranged with a slide, D, provided with one or more seed cavities, m, c operating substantially in the manner and for the purposes specified.

Second, In combination with the above, I claim the arrangement of the gages, d, f, and the point, e, as and for the purposes specified.

Third, I claim providing the chamber, L, with the hinged bottom, G, and a spring, S, substantially as and for the purposes set forth.

60,201.—SUBSTITUTE FOR YEAST FOR BAKING PURPOSES.—John E. Lauer, New York City.

First, I claim the preparation of muriate of phosphate of lime herein described.

Second, The mixture of the above-described preparation of muriate of phosphate of lime with an alkaline carbonate, as a substitute for yeast in raising bread.

60,202.—HAND SPINNING MACHINE.—Wm. Leach and Joseph Leach, Stewartsville, Ind.

First, We claim as an improvement in a hand spinning machine, the arrangement of two sets of twistlers to each thread, each twistler having three or more grooves for the purpose of varying the amount of twist to suit different kinds of wool, and the same being placed immediately behind the front and middle rollers, so as to retain the twist close up to said rollers, in the manner and for the purpose specified.

Second, We also claim raising and lowering the spools, J, by means of the platform, K, the connecting rods, P and M, and the levers, O, L, and the rock shaft, H, substantially as described.

60,203.—COOLING GLASS PRESS.—Henry J. Leasure and James S. Gill, Wheeling, W. Virginia.

We claim cooling the plunger of a glass press with water or other liquid or atmospheric air, substantially as herein shown and described.

60,204.—COFFEE POT.—James H. Lee, Charlestown, Mass. Antedated Nov. 23, 1866.

I claim the combination and arrangement of the tubes, B and H, the boiler, A, the coffee pot, D, and the vessel, F.

I also claim the combination and arrangement of the tubes, B, H and E, the boiler, A, the coffee pot, D, and the vessel, F.

I also claim the combination of the safety bell cover, G, and its spring, m, the cover, C, the coffee holder, F, the pipes, H E B, or their equivalents, the coffee pot, D, and the boiler, A.

I also claim the combination of the arrangement of the seat, b, one or more openings, d, the flexible cap or washer, a, and the screws, f, g, in the coffee pot, D, in boiler, A, and the tube, B, applied to such boiler and opening into it, as specified.

60,205.—BRIDGE.—O. G. Leopold, Cincinnati, Ohio.

First, I claim the general arrangement and combination of wrought angle iron and plate in a bridge, so as to present in the cross section the girders and all other essential parts of the bridge, the double T form, substantially as described.

Second, The arrangement and adaptation of the bar, D, to the central rib, a3, in such a manner that the platform or roadway of the bridge shall be located at or near the line of stability or neutral line of the girder, substantially as described.

Third, And in combination with the above I claim the lateral bracing for the support of the roadway, substantially as described.

Fourth, Making, in the combination of the double T of the bridge girder, the upper stringer or heel of the same of either a flat bar or a hollow tube of any form, substantially as described.

Fifth, Making the sills or cross ties of the roadway or hollow wooden beams instead of solid timber, and covering the same with metal plate, substantially as described.

60,206.—CORE BOX PLANE.—Elisha W. Lewis, Philadelphia, Pa.

I claim, in combination with the stock, A, the rotative tool holder, E, carrying a transversely-adjustable cutter, F, to which a circular feed motion is given by means of the worm, I, and worm wheel, H, or in any other equivalent manner.

60,207.—COUNTERSINK BIT.—Henry C. Lewis, Essex, Conn.

I claim a countersink bit constructed in the manner herein described, and so as to operate as and for the purpose specified.

60,208.—GRAIN BINDER.—Sylvanus D. Locke, Janesville, Wis.

First, I claim the combination of a revolving twisting or tying device, and a reciprocating toothed rack with a vibrating driving worm, substantially as set forth.

Second, The combination of a reciprocating toothed rack and a vibrating driving worm, substantially as set forth.

Third, The combination of a revolving twisting or tying device with a scroll spring in such a manner that the former is returned to its original position by the latter, substantially as set forth.

Fourth, The combination of a reciprocating toothed rack with a scroll spring, in such a manner that each is alternately operated by the other, substantially as set forth.

Fifth, The combination of a revolving twisting or tying device and a scroll spring with a reciprocating cutting device, substantially as set forth.

60,209.—WAGON BRAKE.—John J. Look, Farmington, Maine.

I claim the pole, C, provided with the tapering enlargement, e, as described, in combination with the slotted hounds, D, brake bar, E, lateral braces, F, F, and axle, A, when the parts are so arranged that by a lateral movement of the pole one of the shoes only is brought to bear on its corresponding wheel, substantially in the manner and for the purpose set forth.

60,210.—WINDOW-BLIND FASTENING.—J. Luther and A. Marsh, Worcester, Mass.

First, We claim the peculiar formation of spring, C, as shown and for the purpose stated.

Second, Making a blind fastening of two pieces, a spring, and main or bed piece, when the latter is constructed as described, so that it will receive and arrest the blind when opening or closing the same without injury to the spring.

Third, The combination with the main or bed piece, A, and spring, C, as shown and described, when by the screw serves to hold the spring in place, and also answers as a fastening to the blind.

60,211.—MACHINE FOR SHEARING TWISTED STRANDS OF WOOL, ETC.—Edward T. C. Sutton, Philadelphia, Pa.

I claim knives operating substantially as described in combination with the devices herein set forth, or their equivalents, for so guiding and turning twisted strands of fibrous material, that the same may be sheared by the said knives.

60,212.—APPARATUS FOR COOLING AND DISINFECTING.—Sebeus C. Maine, Boston, Mass. Antedated Nov. 23, 1866.

I claim the employment of cloth or equivalent porous material for receiving and carrying the disinfecting and cooling liquid through or in contact with a current of air produced by a fan H, or equivalent device, substantially as described.

60,213.—SPRING FOR HAT BRIMS.—George Mallory, Bridgeport, Conn.

I claim a hat, the brim of which is distended by a covered spring, having inclosed within its covering a cord or an equivalent thereof, substantially as herein set forth.

60,214.—EXPANDING CYLINDER.—Philo Molby, Kent, Ohio.

First, I claim the grooved center, H, in combination with the cylinder, A, and nuts, M, substantially as and for the purpose set forth.

Second, The cylinder, A, and sockets, B, in combination with the arms, C, and bars, D, substantially as and for the purpose described.

Third, The grooved centers, H, and slides, F, in combination with the screws, E, sockets, B, and arms, C, substantially as and for the purpose specified.

Fourth, The gib, N, and centers, H, in combination with the set screws, O, and cylinder, A, as and for the purpose set forth.

60,215.—LAMP BURNER.—J. J. Marcy (assignor to Edward Miller), West Meriden, Conn.

First, I claim the combination of the tube, A, and the case, D, when the said case, D, is enlarged at its mouth, and the said outer case, D, constructed with perforation, d, met its base, substantially as and for the purpose specified.

Second, The combination of the wick tube, A, and case, D, perforated near its mouth, and above the wick tube, substantially as and for the purpose specified.

60,216.—CARPET STRETCHER.—James Martindale, Newcastle, Ind.

I claim a carpet stretcher made with a roller covered with indiarubber, the roller with a roughened surface, the pressure of which is regulated at pleasure by means of the brake, B, substantially as set forth.

60,217.—BUTTON.—Paul Francois Mauvas, New York City.

First, I claim the combination with a button shank provided at or near its end with one or more laterally projecting teeth or studs, of a metal or other plate or equivalent device slotted and perforated as herein described, so that it may be adjusted to or removed from said shank, as and for the purpose set forth.

Second, I claim the combination with a button provided with a tubular shank and locking mechanism as described, of the fastening or buttoning device herein described, the same consisting of a plate provided with a shank secured to the cloth or other material in the manner above indicated, and with a stem grooved or flanged at its upper end so as to engage with the locking mechanism of the button, substantially as herein shown and set forth.

60,218.—CORN PLANTER.—Thomas B. McCaughey, Newark, Del.

I claim the slide or part, D, of the corn planter provided with an oblique opening, F, with a recess, e, above it for the purpose of stirring or agitating the seed and insuring the filling of F, as set forth, in combination with the attachment of the said slide to the part, A, by means of the band, E, and the motions of said slide are limited by the stops, b and c, as described.

60,219.—FURNACE.—James T. McDougall, San Francisco, Cal.

First, I claim a smelting hearth of peculiar construction, A, B, the sloping portion, A, inclining toward C, its lower portion forming the dam wall or ridge, B, running across the hearth of the furnace from side to side, substantially as described and for the purposes set forth.

Second, I claim the half-oval-shaped refining hearth, C, conforming in shape to the smelting hearth where they join, the sole of which has a slight inclination from the flue, D, toward B, where it has a lower level than the smelting hearth, A, for the purposes specified and set forth.

Third, The combination of the feeding trough: fuels and ores to the furnace by the use of the hoppers, V V, and grooved bars or rods, W W, substantially as described.

Fourth, I claim the device for feeding the fuel to the furnace and depriving it of its moisture by the use of the cylinder, N, and conducting pipe, C (or their equivalents), as herein specified and shown.

Fifth, The arrangement of the door hearths, H H, for discharging the metal and slag, substantially as described.

Sixth, The manner of binding the said furnace with bands of iron secured to the casing of the furnace and keyed below it, when arranged substantially as described and for the purpose set forth.

Seventh, The cone rollers, R R R, and convex rolls, S S S, with chimney shaft, L, and lever sockets, d, d.

Lastly, I claim the within-described improvements, whether employed singly or in combination, in smelting furnaces, substantially as and for the purposes herein specified.

60,220.—FIREPLACE.—William T. McMillen, Cincinnati, Ohio.

I claim the combination of the deflectors, K K, with the chamber, C, pipes, F F, conduits, D E, and flue, H, all constructed and arranged as and for the purpose set forth.

60,221.—BROOM HEAD.—Charles Messenger, Chicago, Ill.

I claim the socket, A, nut, E, and handle, A', perforated plate, C, arranged in combination with the hooks, b, and case, D, for the purpose and in the manner as specified.

60,222.—STEAM-ENGINE CONDENSER.—J. M. Miller, New York City.

First, I claim the combination of apparatus for transferring the water of condensation to the boiler, the boiler being heated by passing it through the case containing the condenser, said apparatus consisting of the vacuum pump case, e, and pump, n, that forces the water from the case, e, into the boiler, substantially as and for the purposes set forth.

I also claim arranging the coils of pipe, h, within the case, e above the base plate, f, and in combination with the chambers, a, a, specified.

I also claim the conjoint arrangement of pipes, h, and pipes, k, substantially as herein described.

I also claim the combination of the chambers, a, b, case, e, vacuum and feed pumps, l and n, arranged and combined substantially as and for the purposes herein made known.

60,223.—FAUCET.—Oscar F. Morrill, Chelsea, Mass. Antedated Nov. 21, 1866.

I claim, in combination with the metal valve, e, the metal diaphragm packing, h, extending over the faucet chamber and held down by the screw cap, g, substantially as described.

Also, in combination with the diaphragm, h, and valve, e, the spring lifter, b, operating to raise the valve from its seat as the follower is unscrewed, said spring being provided with legs or projections which serve to keep the valve in central position with respect to its seat, substantially as described.

Also, the relative arrangement of the valve, e, diaphragm, h, spring, l, shoe, o, and follower, i, to effect the raising of the valve from its seat and its closing thereupon, substantially as set forth.

60,224.—HYDRO-CARBON HEATING APPARATUS.—Oscar F. Morrill, Chelsea, Mass.

I claim giving to the metallic casing, d, surrounding and protecting the filling, c, the peculiar form shown, for the purpose of obtaining the current of air from which to dissipate the heat received in the chimney.

Also, connecting the metallic covering, d, by the filling, c, with the outer wick tube, when the spaces, i and 2, intervene, so as to cut off metallic connection, substantially as and for the purpose specified.

Also, connecting the tube, f, with the inner wick tube, b, by filling in such a manner as to cut off metallic connection by the spaces, 3 and 4, substantially as described and for the purpose set forth.

And regulating irregularities of the length of the flame from the wick, by contracting the flue opening on one side and contracting it on the other, substantially as and for the purpose specified.

60,225.—PRUNING KNIVES.—L. B. Morris, Hopkinsville, Ky.

I claim a knife having its blade provided with the notches or recesses, l and d, and a handle having the projections, i and n, arranged to fit therein, as shown and described.

60,226.—BLACKING BRUSH.—Charles Mulchahey, Springfield, Mass. Antedated November 25, 1866.

First, I claim attaching to the top of an ordinary polishing brush for boots, shoes, etc., a blacking box fitted in a case, B, formed to receive it.

Second, Attaching to this box, or to the case which is formed to receive it, the said blacking brush, c, by means of a rim or cover, arranged as shown and described.

60,227.—CAR SPRING.—David Myers, Chicago, Ill. Antedated September 24, 1866.

I claim the jointed hangers, F G, when operated by springs, substantially as and for the purposes herein specified and shown.

60,228.—CAR BRAKE.—David Myers, Chicago, Ill.

First, I claim the combination of the cam wheel, C, shaft, in chain, D, and spring or springs, E, arranged and operating substantially as and for the purposes specified and shown.

Second, I claim, in combination with cam wheel, C, and shaft, m, the box, M, and shive, h, arranged substantially in the manner and for the purposes set forth.

Third, I claim, in combination with cam wheel, C, provided with a recess, c, the bar, B, and elbow lever, A, arranged and operating as described and for the purposes specified.

Fourth, I claim providing the ratchet wheel, H, with the smooth periphery or flange, N, when arranged in combination with the projection, u, upon the point, t, of the pawl, P, and operating substantially as described.

Fifth, I claim the arrangement of the arm, R, provided with a shoulder, as described, with the elbow lever, A, and pawl, P, operating substantially in the manner and for the purposes specified.

Sixth, I claim, in combination with said bar, B, t, e arrangement of the movable elastic support or spring, S, operating substantially as and for the purposes herein shown and described.

60,229.—FURNACE FOR STEAM BOILER.—John F. Myers, Kokomo, Ind.

First, I claim a furnace for a steam boiler, when constructed with a door or valve, B, for closing the throat of the furnace, and with doors through the exterior walls of the furnace for the admission of cold air to the surface of the boiler and flues, substantially in the manner and for the purpose set forth.

Second, A door or valve, B, as described, I claim the pipes, G, and valves, I, arranged to operate substantially as and for the purpose set forth.

60,230.—HYDRANT.—Walter P. Newhall (assignor to himself and Harriet A. Davison), New York City.

First, I claim a hydrant in which two or more exterior basins, at different altitudes, are connected by pipes within the casing, substantially as described.

Second, Combining a fire hydrant with the said hydrant, substantially as described.

Third, Keeping the water in a live condition beneath the fireing valve, D, or cut off, by means of the auxiliary ejection pipe, F, or its equivalent, substantially as described.

60,231.—BRICK MACHINE.—A. N. Newton, Richmond, Ind.

First, I claim, in a machine for making brick, a reciprocating lubricated plunger acting in combination with an exterior reciprocating cutter, substantially in the manner and for the purpose set forth.

Second, In combination with the plunger, L, and cutter, m, I claim the endless apron, C, stationary when the cutters are acting on the clay, and moving forward when the cutters are raised, substantially as set forth.

Third, I claim the actuating mechanism of the cutters, m, in combination with the same, when so arranged, that the pressure shall be applied to the cutters by a spring which will yield to the resistance of solid substances, substantially as set forth.

Fourth, I claim the roller, E, when used in combination with the endless apron, C, and so geared that it shall revolve only with the forward motion of the same, substantially as and for the purpose set forth.

Fifth, I claim the reciprocating roller, F, when operated substantially in the manner and for the purpose set forth.

Sixth, In combination with the rod, l, and plunger, L, I claim the actuating cam, G3, when constructed substantially as and for the purpose set forth.

Seventh, The oscillating screw, O, when constructed and operated as and for the purpose set forth.

Eighth, I claim the vertical endless aprons, C, running lengthwise with the side of the hopper, when used in combination with the endless apron, C, and roller, E, substantially as and for the purpose set forth.

60,232.—MECHANICAL MOVEMENT FOR OPERATING CHURNS, ETC.—John P. Nichols, New Richmond, Ohio.

I claim the arrangement and combination of the pallet levers, F F', levers, H H', and their connections, G G' S and T, with the ratchet wheel, D, and the dasher of a churn, operating substantially as and for the purpose specified.

60,233.—BAG HOLDER.—J. V. Henry Nott, Guildersland, N. Y.

I claim the frame, D, consisting of two bent or curved spring arms, F, each having an outward-projecting lip or flange, in combination with the post or standard, B, when arranged together so as to operate substantially in the manner described and for the purpose specified.

60,234.—EXPRESS WAGON.—W. D. Osborn, Boston, Mass.

I claim a wagon made with the rear part of its body offset and depending downward below the bottom of the front part thereof, when combined with a bent hinder axle placed directly under the rear part of the body, and when the sides and front end of the

body rise above the bottom of that part, all substantially as and for the purpose specified.

Also, the construction with such a wagon body and bent hind axle, located as described, of springs, e, and bifurcated perch, c, as specified.

60,235.—COTTON PICKER.—John G. Page, Memphis, Tenn.

I claim a series of toothed or armed cylinders, B B' B'' B''' placed within a case or box, A, provided with a bottom composed of a series of perforated concaves, C, the cylinders gradually increasing in size from the face to the discharge of the case or box, and their speed of rotation increasing about in proportion to the increase of their dimensions, substantially as and for the purpose set forth.

60,236.—SPRING FOR HAT BRIM.—Samuel Peck, New Haven, Conn.

I claim forming springs for hat brims, so as to droop at the front and rear, by curving the wire, substantially as herein set forth.

60,237.—MACHINE FOR FILING SAW TEETH.—M. M. Pettes, Oxford, Mass.

I claim, First, So hanging the guide, A, or its equivalent, to and upon any frame or holder suitable for being secured upon a saw blade, and the said guide can be adjusted to various angles with regard to the length of the blade, substantially as herein described and for the purpose specified.

Second, So hanging the guide, A, or its equivalent, to and upon any frame or holder suitable for being secured upon a saw blade, that the said guide can be adjusted in position to vary the pitch of the teeth of the saw blade, substantially as described.

Third, So hanging the guide, A, or its equivalent, to and upon a y frame or holder suitable for being secured upon a saw blade that it can be adjusted both to various positions or angles with regard to the length of the blade, and also to accommodate it to various pitches of the teeth of the saw, substantially as and for the purpose described.

Fourth, So hanging the frame, E, or its equivalent, to which a guide, A, or its equivalent, is secured in any proper manner to a yoke or other frame suitable for being sawed upon a saw blade, so that it can be either raised or lowered, or so set as to more or less incline the said guide, A, or both, substantially as herein described and for the purposes specified.

Fifth, The guide, A, frame, E, with circular bar, G, and yoke, S, when arranged, combined and connected together so as to be susceptible of each and all the several adjustments hereinabove described, and substantially as and for the purposes specified.

Sixth, In combination with the above, I claim the spring pawl, Y, when arranged upon the yoke frame, S, or its equivalent, so as to operate substantially as and for the purpose described.

60,238.—LATHIE DOG.—William Pimlott, Syracuse, N. Y.

I claim the bar, B, the screw, C, the nut of the jaws, D, the jaws, E, E', the set nuts, F, F', when the same are constructed and operated substantially in the manner and for the purpose described.

60,239.—WATER ELEVATOR.—Isaac A. Pinnell, Galva, Ill.

I claim, First, The bar, P, provided at the ends with slotted arms that engage the shafts of the drums, E E', for the purposes and substantially as described.

Second, The bar, P, provided with slotted arms, Q, Q, in combination with the lever, N, substantially as and for the purposes herein described.

Third, In combination with the bar, P, and lever, N, the drums, E E', with the gear wheels, F F', and the ratchet wheels, D D', for the purposes and substantially as described.

Fourth, The wheel, B, provided with a rat-hat upon its periphery and one upon the inside of the rim, in combination with the drums, E E', lever, N, and bar, P, substantially as herein set forth.

60,240.—CHURN.—A. J. Pope, Strongsville, Ohio.

I claim the standard, C, pendulum, D, and handle, E, in combination with the arms, F, dasher, H, and beater, G, constructed and operated as and for the purpose set forth.

60,241.—SEWING MACHINE.—T. K. Reed, East Bridgewater, Mass.

I claim combining with the reciprocating shuttle and shuttle race of a sewing machine, a device or mechanism operated by the movement of the shuttle to regulate or change the tension of the shuttle thread, substantially as set forth.

60,242.—MODE OF DEFECCATING CANE JUICE.—Lawrence Reid, New York City, and David Lyman, Middlefield, Conn., Administrator of the Estate of Edward H. Swift, deceased, assignors to Phineas L. Robinson and Joseph H. Parsons. Antedated Nov. 29, 1866.

We claim the mode herein described of defecating cane juice with superphosphate of lime and slaked lime introducing some of the superphosphate in advance of the lime as herein specified, with or without the final use of the prepared slightly alkaline phosphate of lime described to correct acidity and promote the crystallization of the sugar.

We also claim, in the defecation of cane juice, the alternate use of superphosphate of lime and slaked lime in small proportions, and in two or more successive increments, as described by us above.

We also claim the combination with the superphosphate of lime in the above described process of one or more of the other defecating agents set forth in patents issued to us of even date herewith.

60,243.—MODE OF DEFECCATING CANE JUICE.—Lawrence Reid, New York City, and David Lyman, Middlefield, Conn., Administrator of the Estate of Edward H. Swift, deceased, assignors to Phineas L. Robinson and Joseph H. Parsons. Antedated Nov. 29, 1866.

We claim the mode herein described of defecating cane juice with acid and slaked lime, introducing some of the acid in advance of the lime, as herein specified.

60,244.—METHOD OF DEFECCATING CANE JUICE.—Lawrence Reid, New York City, and David Lyman, Middlefield, Conn., Administrator of the Estate of Edward H. Swift, deceased, assignors to Phineas L. Robinson and Joseph H. Parsons. Antedated Nov. 29, 1866.

We claim defecating cane juice with lime and a liquid impregnated with carbonic acid gas, in the manner above specified.

We also claim defecating cane juice by slaked lime and the supercarbonate of lime or magnesia with carbonic acid gas, applied as above described.

We also claim the combination in the above described process of one or more of the other defecating agents set forth in patents issued to us of even date herewith, with a liquid containing carbonic acid gas, with or without the supercarbonates of lime and magnesia, applied as herein specified.

60,245.—METHOD OF DEFECCATING CANE JUICE.—Lawrence Reid, New York City, and David Lyman, Middlefield, Conn., Administrator of the Estate of Edward H. Swift, deceased, assignors to Phineas L. Robinson and Joseph H. Parsons. Antedated Nov. 29, 1866.

We claim the within-described chemical compound adapted for use in the defecation of sugar cane juice, substantially as and for the purpose herein set forth.

60,246.—METHOD OF DEFECCATING CANE JUICE.—Lawrence Reid, New York City, and David Lyman, Middlefield, Conn., Administrator of the Estate of Edward H. Swift, deceased, as-

signors to Phineas L. Robinson and Joseph H. Parsons. Antedated Nov. 29, 1866.

We claim in the defecation of sugar cane juice, the use of the compound of alcohol and sulphurous acid, prepared by impregnating alcohol with sulphurous acid gas, in the manner and for the purpose herein set forth.

60,247.—BATTLE WAR CHESS.—Charles Richardson, Richmond, Va.

I claim the board herein described and illustrated, in combination with movable figures representing cavalry, artillery, infantry, a supply train and a citadel, or base of supplies, substantially as shown and described and for the purpose set forth.

60,248.—SUBSTANCE FOR FUEL.—Louis S. Robbins, New York City.

I claim saturating peat, coal dust, or other substances, either separately or in combination, with hot oleaginous vapors, substantially as herein described.

I also claim the drying and saturating the peat, coal dust or other substances either separately or in combination at one and the same operation, substantially as described.

I also claim the method herein described of drying the peat, coal dust, or other substances by the use of heated air, substantially as herein described.

60,249.—FRUIT GATHERER.—C. R. Roberts and J. S. Hartzell, Addison, Pa.

We claim an improved fruit harvester formed by the combination of the movable jaw, F, lever, G, cords, H and K, receiving sack, J, stationary jaw, E, ring, A, shank, B, and socket, C, when said parts are constructed and arranged substantially as herein shown and described.

60,250.—POLE FOR HORSE RAILWAY CAR.—Daniel S. Robinson, Boston, Mass.

I claim combining with the pole, a, coupling plate or bar, b, and brace rod or bar, c, the means or mechanism for adjusting the position of this brace bar relatively to the pole, substantially as set forth.

60,251.—LUBRICATOR.—T. R. Robinson and R. E. Jones, Providence, R. I.

We claim a lubricating bolster having chamber, A, cap, C, with or without central perforation, E, and absorbent, B, substantially as described for the purpose set forth.

60,252.—SLIDE VALVE.—W. B. Robinson, Detroit, Mich.

I claim the combination of the counter balance, E, having suitable packing rings, and the bridge, D, with its passage, b, and valve, C, C', arranged with the valve chest, A, and cylinder, B, provided with post, a, a, and operating substantially as described for the purpose specified.

60,253.—SAFETY LINE FOR HARNESS.—A. H. Rockwell, Harpersville, N. Y.

I claim the overdraw strap, D, secured to the rings, G, sliding loosely on the joint bit, the check straps, C, secured to the end rings of the same bit, operating together in combination with the rein, B, in the manner as and for the purpose specified.

60,254.—BRIDLE.—A. H. Rockwell, Harpersville, N. Y.

I claim the combination of the double-ring bit, H, head stall, A, and strap, K, when all connected together and applied to a horse or other animal, substantially as and for the purpose specified.

60,255.—TRAVELING BAG.—E. A. G. Roulstone, Roxbury, Mass.

I claim the combination and arrangement of the inner and outer plates, a, i, making up one half of the frame, when so constructed and applied to the body, a, inserted between them, that from one or both of them a lip is turned down which shall protect or cover the edge of the body without either lip passing around or inclosing the edge, the plates and body being secured together substantially as shown and described.

I also claim the corner stay piece when constructed and applied substantially as described.

Also, the construction of the bearings, f, with a screw thread extending only partly through the bearing so as to secure and protect the hinge rod, substantially as described.

Also, so applying the lock to the frame that its bolt works in a slot in the frame, substantially as shown and described.

Also, in a bag made up of two parts, a, a, applied to frame, c, d, forming the bag body from one piece, substantially as set forth.

60,256.—TRAVELING BAG.—E. A. G. Roulstone, Roxbury, Mass.

I claim the arrangement and manner of connecting together the body, the frame, and the frame cover, substantially as shown and described.

I also claim combining with the frame and its covering and the body, the welt, f, secured to the frame covering and body, substantially as set forth.

60,257.—LOCK.—E. A. G. Roulstone, Roxbury, Mass.

I claim the bolt, e, constructed to operate in connection with a locking mechanism, substantially as set forth.

60,253.—CHUCK FOR HOLDING BUTTONS.—Edwin Russell, Naugatuck, Conn.

I claim the chuck, A, made substantially as above described, with an elastic center, B, as set forth.

60,259.—MACHINE FOR TURNING SHAFTING.—Robt. Safely, Cohoes, N. Y.

First, I claim an improved machine which is adapted for turning and finishing shafts, when they are supported in an upright position, said machine being constructed and operating substantially as herein specified.

Second, The combination of the horizontal chuck support, E, and sliding shaft holder, C, with devices for feeding, turning, and finishing shafts, that are arranged in an upright or vertical position, substantially as described.

60,260.—MACHINE FOR STRAIGHTENING SHAFTING.—Robert Safely, Cohoes, N. Y.

First, I claim the combination of a reciprocating slide, D, which is vertically adjustable with the bed plate, A, for the purpose of straightening rods or shafts, substantially as described.

Second, Supporting the ends of the slide, D, by means of guides, E, E, having adjusting screws, g, and steadying screws, h, h, applied to them, substantially as and for the purposes described.

60,261.—DRILL FOR WELLS.—Henry W. Safford, Philadelphia, Pa.

I claim providing the stem or shank, a3, of the drill, A, B, or other boring or cutting tool used in making deep wells, with a fixed projecting shoulder or supplementary boss, b1, between the upper boss, a2, and the cutting end, a4, substantially as and for the purpose described.

60,262.—SHEEP CHAIR.—Cyrus W. Saladee and Jesse R. Moore, Newark, Ohio.

I claim the combination of box, A, and bench, S, as described, and pin, E, in combination with box, A, constructed and operating as specified and for the purposes set forth.

60,263.—LAMP BURNER.—John F. Sanford, Keokuk, Iowa.

First, I claim the application of a wick spur stem, d, to adjustable bearings, in such a manner that this stem, with its spur, can be removed from the burner at pleasure, substantially as described.

Second, Constructing the body of the burner of two sections, A, B, in combination with the wick spurs, which are so applied that they can be detached from their bearings, c1, c2, at pleasure, substantially as described.

60,261.—COMPOSITION OF MATTER FOR POLISHING METALS.—A. M. Sawyer, Athol, Mass.

First, I claim the polishing compound of emery and soft vulcanized rubber malle, substantially as described.

Second, The forming of the surfaces of polishing or scouring devices by means of a thin layer of the polishing compound before described, united to a backing of soft vulcanized rubber, substantially as described.

60,265.—MITER PLANE.—John Sawyer, Moravia, N. Y.

I claim the grooved and slotted plate, B, and pivoted guide bars, C, when used in combination with the plane, A, having its iron, a1, a2, inclined in opposite directions, substantially as described and for the purpose specified.

60,266.—TOOL REST FOR LATHES.—James Service, Greenville, Conn.

I claim the combination of the screw, D, and pinion and spur wheels, B E, with the clathe tool rest, arranged and operating substantially in the manner and for the purpose herein described.

60,267.—WINDOW FASTENER.—Warren Shailer, Deep River, Conn.

I claim the window fastener substantially as herein described and represented by Figs. 3, 4, and 5.

60,268.—EXCAVATOR.—Benjamin Slusser, Sidney, Ohio.

First, I claim the combination of the spool, L, chain, M, wheel, N, pinion, O, and crank, P, when used to regulate the height of the shovel, A, adjustably sustained by the front axle, substantially as and for the purpose set forth.

Second, In combination with the driver's seat, Q, I claim the cord, L', and rope, G', or their equivalents, for opening and closing the driver's seat, the hinged doors, F', in the bottom of the box, E, substantially as set forth.

Third, The doors, F', latches, H, and inclined faces, H', in combination, when constructed and arranged substantially as set forth.

Fourth, In combination with the doors, F, I claim the latch, I, lever, I', arm, I'', and bar, K, substantially as set forth.

60,269.—FRICTION PULLEY.—Charles B. Smith (assignor to Wright and Smith), Newark, N. J.

I claim the combination of levers, E' and E'', block, B, sliding block, J, wedge, H, or its equivalent, bolt, F, and set screws, F' and F'', for the purpose set forth.

60,270.—HORSE RAKE.—Francis M. Smith and Edwin Brumfield, Albion, N. Y.

We claim the combination of the jointed latches, C, straps, N N, pendants, I, spring braces, J, flanged plate, K, jointed head, B, and foot, L, arranged and operating substantially as described and for the purpose specified.

60,271.—HAY RACK FOR WAGONS.—George T. Smith, Plainfield, Ill.

First, I claim the combination and arrangement of the hooks, 1, and eye or eye bolt, 2, with the cross pieces, B, and bed pieces, A, substantially as and for the purposes described.

Second, The combination and arrangement of the hooks, 3, and eyes, 7, with the beams, C, and bed pieces, A, substantially as and for the purposes set forth.

Third, The combination and arrangement of the hooks, 6, the straps, 5, bolts, 4, with the beams, C, and raves, D, and E, when constructed and operating substantially as and for the purpose described.

60,272.—MACHINE FOR CUTTING BUNGS.—John E. Smith, Buffalo, N. Y. Antedated Nov. 16, 1866.

I claim the ring, J, and nut, K, in combination with the groove, T, and the flange or ring, L, when constructed as and for the purposes described.

60,273.—POTATO DIGGER.—John P. Smith, Hudson, N. Y. Antedated Nov. 23, 1866.

First, I claim the inclined digging screen, A, furnished with shares, G, and combined with the shaking screen, L, substantially as herein set forth for the purpose specified.

Second, The pitman, B, cranked lever, P, and sliding bar, N, arranged in relation with each other and with the shaking screen, L, driving wheel or wheels, H, and digging screen, A, substantially as herein set forth for the purpose specified.

Third, The sled, C, J, arranged in rear of the digging screen, A, and underneath the shaking screen, L, substantially as herein set forth for the purpose specified.

Fourth, The arrangement with reference to the digging screen, A, of the arched braces, D, beam, E, transverse bar, F, and wheels, H, substantially as herein set forth for the purpose specified.

60,274.—MACHINE FOR FELTING HAT BODIES.—Philip W. Somers, Danbury, Conn.

I claim, in combination with the endless moving platform of grooved bars or slats, the stationary, yielding, adjustable lower bed concave and upper bed, the whole constructed and arranged to yield and be adjusted substantially as described.

In combination with the lower bed and endless moving bed, the sliding bed with its two inclined concaves, one of them forming, in connection with an endless platform, an adjustable throat, and the other being a receiving table to receive the rolls thrown out of the machine.

The valve, located at the entrance of the throat of the machine, in combination with the endless bed, throat, and receiving table, substantially as described and for the purposes set forth.

60,275.—ROLL FOR FELTING OR SIZING HAT BODIES BY MACHINERY.—Philip W. Somers, Danbury, Conn.

I claim the new roll adopted for working hat bodies in the roll by machinery, wherein the coils or folds of the body or bodies rolled up within the covering cloth are in a reverse direction from the coils or folds of the covering cloth, substantially as and for the purposes hereinbefore set forth.

60,276.—STEERING APPARATUS.—Reuben Sparks, Buffalo, N. Y.

I claim the arrangement of the vertical shaft, B, having a pinion, D, on the lower end thereof, with the pinions, E and F, and spur wheel, G, connected with the drum, H, and chain, I, I', connecting with the drum, H, and wheel, H', substantially as described.

60,277.—MACHINE FOR ROLLING LEATHER.—Quincy Stoddard, Jackson, Mich.

I claim the combination of two pairs of plain and corrugated rollers, D D', resting in swing frames, C, C, so arranged that they may be turned to opposite positions to roll plain, found, or half round leather, as herein set forth.

I also claim forming the corrugated rollers with the independent spools, b b, operating in the manner and for the purpose specified.

60,278.—MACHINE FOR BOXING PAPER COLLARS.—Daniel Stoner and John Sigwalt, Chicago, Ill. Antedated Nov. 21, 1866.

First, We claim a cylindrical form, F G, and face plate, E, in combination with a rotating shaft, or its equivalent, for imparting a rotating motion thereto, substantially as and for the purposes described.

Second, We claim, in combination with said face plate and cylindrical form, the adjustable bar, H, operating as and for the purposes set forth.

60,279.—STEAM GENERATOR.—D. B. Tanger, Bellefontaine, Ohio.

I claim, First, The pipes, E F H, in combination with the fire box, D, and boiler, A, constructed and operating substantially as and for the purpose described.

Second, The pipes, I J K, in combination with the fire box, D, and boiler, A, constructed and operating substantially as and for the purpose set forth.

60,280.—MACHINE FOR MAKING TWINE AND SMALL CORDAGE.—George A. Taylor, Lester Crandall, Horace L. Crandall, and Jonathan Larkin, Hopkinton, R. I.

We claim the elevated way or rail, A, provided with the suspended carriage, B, having the top bar, C, attached, all arranged substantially as and for the purpose set forth.

60,281.—REFRIGERATOR.—Henry R. Taylor, Roxbury, Mass.

I claim a refrigerator provided with a drawer so arranged that when pulled out it will close the opening in which it slides and exclude the external air from the interior of the refrigerator, substantially as described.

60,282.—TOBACCO PIPE.—Ferdinand Tellmann (assignor to Ellsworth Fox and W. L. Smith), Stamford, Conn.

I claim a tobacco pipe having a nicotine chamber, C, interposed between the tobacco chamber of the pipe, and its stem, when such chamber is provided with a valve stem or plug, G, arranged so as to operate substantially as and for the purpose described.

I also claim the valve stem, G, when so constructed and arranged in combination with the aperture, A, in the bottom of the pipe bowl, as to close and clear the same as it is opened, substantially as described for the purpose specified.

60,283.—BOTTLE STOPPER.—Nathan Thompson, London, England.

I claim, First, A stopper made of hollow wood capped with metal, substantially as described.

Second, A stopper made of hollow wood capped with metal with a layer of material, substantially as specified, interposed between the wood and the metal, the complete stopper being substantially such as described.

60,284.—CAR BRAKE.—Samuel H. Timmons, Lafayette, Ind.

I claim, First, The connecting of the brakes of a train or series of cars by means of rods, N N', or their equivalents, in such a manner that by applying the brakes to the wheels of any one of the cars, the pull of the locomotive or draft will be transmitted through said connections to the several brakes, and the latter all applied, substantially as shown and described.

Second, The rods, N N', or their equivalents, when applied in such a manner as to serve the double purpose of a brake connection and a car coupling, substantially as set forth.

Third, The screws, S, and nuts, T, applied to the rods, N N', for the purpose of operating or applying power to the brakes, substantially as set forth.

60,285.—BOOK-MARK HOLDER.—Phil. Tomppert, Louisville, Ky.

I claim the ribbon-receiving slots, a, in the book marker herein described, whereby a piece of reference may be marked and opened by the ribbon, as and for the purpose specified.

60,286.—FENCE.—Simeon P. Tuttle, Decatur, Mich.

I claim the post, C, provided with the L-shaped screws or staples, D D, and cap, F, when used in combination with the fence sections, A or B, constructed as described to form a portable fence, when arranged and used as and for the purposes set forth.

60,287.—DRAG FOR VESSELS.—George L. Upton, Milbridge, Me.

I claim the combination of the shaft, A, hub, B, beveled wings, D, braces, F, slide, E, constructed substantially as and for the purpose as specified.

60,288.—TRUNK.—Samuel W. Valentine, Bristol, Conn.

I claim a trunk as made with a sealing strap, A, and loop, B, to be combined or connected by an eyelet, C, or a rivet, substantially as and for the purpose specified.

60,289.—CHURN.—Andrew J. Vanatta, Vanatta, Ohio.

I claim, First, The combination of the wheel, D, and wheel, P, with the plunger, H, and G, for the purpose of giving the beaters, N, both a vertical and rotary motion at the same time so as to break the rotary current of the cream at the sides of the churn, substantially as shown and described.

Second, I claim the dasher, N, having a bearing, Y, on the rod, M, so as to have a rotary motion, at the same time a vertical motion, substantially as shown and described.

Third, The beater, G, in combination with beater, N, substantially as and for the purpose described.

60,290.—REFINING PETROLEUM.—Henry C. Van Tine, Pittsburgh, Pa.

I claim the refining of petroleum or carbon oil without the aid of artificial heat, by means of the series of operations hereinbefore described, consisting substantially of the use of sulphuric acid, sulphate of zinc, sugar of lead, and bichromate of potash, or their equivalents, for separating the heavy carbons and impurities, the neutralizing of the acid, and washing with water, combined with the subsequent exposure of the oil thus heated in shallow pans to the action of the atmosphere, substantially in the manner and for the purposes hereinbefore described.

60,291.—BROOM HEAD.—H. H. B. Vincent, Oshkosh, Wis.

I claim the combination of the projecting sides and edge arms with the sliding band, H, and binding rods, I, substantially as and for the purpose set forth.

60,292.—LATHE CHUCK.—Louis Von Gunten, Cincinnati, Ohio.

I claim the grasping jaws, h h h, formed upon a stem, F, guided by collars, J J', and operated by a nut, E, confined within the chambered spindle, A, which is formed with scoops, a, to afford access to the milled head, e, of the nut, all constructed and combined substantially as herein described and for the purposes specified.

60,293.—WINDOW-SASH FASTENER.—Z. B. Wakeman, Rockford, Ill.

I claim the combination of the roller, lever arm, D, secured to it, fixed staple or guide, G, and stop or rest pin, K, when arranged together, as and for the purpose described.

60,294.—APPARATUS TO BE ATTACHED TO STILLTS TO PREVENT FRAUD.—W. J. Walker, Baltimore, Md.

I claim, First, The combination of a vessel or tube containing a hydrometer, or a hydrometer and thermometer, with a system of pipes and stop cocks, so as to test spirits, and pass it to its proper tank, substantially as described.

Second, The waste pipe for safety and escape of gas and air in combination with a testing apparatus, as described.

Third, The combination of stop cocks and pipes for testing and distributing the spirits, as described.

60,295.—STEERING APPARATUS.—Samuel L. Walkinslaw, Baden, Pa.

I claim the combination and arrangement of the shaft, D and g, wheels, I 3 4 and C, coupling sleeve, E, jointed lever, m, friction pulley, f, and pilot wheel, B, constructed, arranged and operating in the manner and for the purpose herein described and set forth.

60,296.—ATTACHING THILLS TO CARRIAGES.—Samuel H. Ward, Altona, Ill.

I claim, In combination with the thills, E, lugs, C, and removable bolt, F, the employment of the spring, G, provided with a lip, H, when arranged so as to secure the bolt from slipping out, and also to prevent rattling and wear of the same, as herein set forth.

60,297.—SAWING MACHINE.—A. E. and J. V. Warner, Norwalk, Ohio.

We claim, First, The special arrangement of the levers, p, p, cross piece, T, and lever, V, in combination with the racks, J, I, and saw frame, as and for the purpose set forth.

Second, We claim the guide, m, and spring, n, in combination with the slide, l, spring catch, L, and catch, P, as and for the purpose set forth.

60,298.—TOBACCO PRESS.—William T. Watson, Nottingham, Md.

I claim, First, The combination of the sills, G, sliding bars, I, and rods, U, for confining the keg in a tobacco press, substantially as described.

Second, In combination with above parts and the main frame, A, I claim the rack, B, plimons, D and D', shafts, E', and wheels, E, together with the ratchet and wheel, F F', arranged to operate substantially as set forth.

60,299.—CAR COUPLING.—Clemens Weaver, Easton, Pa.

I claim the arrangement of the loop and hook coupling bars a, a, pivoted on their under sides with the bar, G, guide, F, and when applied to railroad cars for coupling them together, substantially as herein described.

60,300.—COTTON-SEED CLEANER.—A. Wells, Morgantown, West Va.

First, I claim the reciprocating slide, C, used in connection with the inclined trough, A, substantially as and for the purpose herein specified.

Second, The arrangement of the slide, C, and board, D, as constructed on their under sides with the bar, G, guide, F, and trough, A, as and for the purpose herein specified.

Third, Providing the under side of the slide with an elastic covering for the purpose of rolling the seed between it and the bottom of the trough, as and for the purpose set forth.

60,301.—RACK MOTION FOR HAND PRESS.—Charles Wells, Cincinnati, Ohio.

I claim the rack, C, having curved ends, E E, in combination with the eccentric pinion, F, and ordinary pinion, D, of larger diameter, the whole being constructed, arranged and operated in the manner and for the purpose set forth.

60,302.—BUCKLE.—William Welsh (assignor to himself and Ora C. Colby), McHenry, Ill.

I claim the combination and arrangement of the buckle frame, A B C, with one or more tongues, E, and corresponding cross bars, b, operating substantially as and for the purposes specified.

60,303.—PENDULUM FOR CLOCKS.—W. D. Whalen, Northville, Mich.

First, I claim a horizontal pendulum vibrating in a vertical plane, and suspended and operating substantially as and for the purpose specified.

Second, I claim, in combination with the above, the adjustable balls, G, applied in the manner and for the purpose specified.

60,304.—WASHBOARD AND WRINGER.—John Wheeler, Augusta, Me.

I claim the combination of the wringer and washboard in connection with the folding frame, as and for the purposes herein named.

60,305.—HAND LOOM.—John Whitehead, Oskaloosa, Iowa.

I claim the combination of the adjustable flanged plates, b b, attached to the lay and the notched plates, c c, applied to the top of the loom forming, as herein described and for the purpose set forth.

60,306.—MODE OF TRAINING HOPS.—Levi H. Whitney, Vallejo, Cal.

First, I claim the device herein described for training grapes, hops, etc., in such manner as to retain them separate to any desirable distance from each other, and to carry them horizontally across the space to the next row opposite, substantially as described.

Second, The shackles or device herein described for securing the strings or cords, when constructed and used in the manner described.

Third, Constructing the shackles, b b b, with longer arms than those of the cords, to allow them to drop lower than the latter, to which the upper ends of the cords are attached.

Fourth, The device constructed and arranged as described, for securing the lower ends of the cords over the hills of vines, for the purpose described.

60,307.—MELTING FURNACE.—Samuel A. Whitney, Glassboro, N. J.

First, I claim a furnace composed of the lower portion, A, containing the fire places and central flue, C, and the superstructure containing the central chamber, G, and crucible chambers communicating with each other through contracted passages, all substantially as described.

Second, The combination and arrangement substantially as described of the central distributing chamber, C', passages, H h, and crucible chamber, G'.

Third, The projections arranged as a support for the crucibles, substantially as and for the purpose described.

Fourth, The dome-shaped structure, F, depressed in the middle and arranged to cover the central chamber, C', and crucible chamber, G', in the manner and for the purpose specified.

60,308.—BUTTER DISH.—William M. Whittaker (assignor to himself and B. Church), Wallingford, Conn.

I claim the combination of the pivot, d, and the ears, c and a, when constructed and arranged so as to operate substantially in the manner herein set forth.

60,309.—COMPOSITION FOR FURNITURE AND OTHER PURPOSES.—Jay J. Wiggin, Cincinnati, Ohio.

I claim the compound produced by boiling a mixture of sand, lime and clay in coal tar or pitch, in the manner and for the purpose substantially as specified.

60,310.—MOLD FOR PLASTIC MATERIAL.—Jay J. Wiggin, Cincinnati, Ohio.

I claim the within-described mold, constructed with removable partitions, in the manner and for the purpose shown and described.

60,311.—WELL AND CISTERN FILTER.—William H. Wiley, Fredonia, N. Y.

I claim a portable well and cistern filter composed of the sub-plate, E, filtering cylinder, F G, disk, d, met or fastening, j, and perforated central tube, C, combined with and attached to the pump tube, B, the whole constructed and arranged substantially as and for the purposes set forth.

I also claim the partially perforated sides, F and G, when constructed as described, in combination with the porous packing, L, base plates, D E, and tubes, C and B, arranged and operating substantially in the manner and for the purpose described.

60,312.—PESSEARY.—J. P. Willens, Baltimore, Md.

I claim the lobes, A, opening forwardly relatively to the person, and operated by a swiveled screw and stem between the arms, B, substantially as described and represented.

60,313.—MODE OF CONVEYING GRAIN.—S. W. Wood, Cornwall, N. Y.

I claim the combination of a pump, A, exhaust pipe, C, and conveying pipe, D, arranged and operating substantially as and for the purpose herein specified.

60,314.—STONE DRILL.—Thomas Woods, Jessamine County, Ky.

First, I claim the eye for the drill rope passing from the ordinary eye of the spindle in front of the bearing through the side of the spindles, and then through the pulley in the line of the radius to the groove on the circumference, as described.

Second, I claim, also, the arrangement of the ratchet wheel and pawl on the spool and spindle, in combination with the band wheel, g, on the stool, for the purpose of producing the feed motion of the drill, as herein described.

Third, I claim also the arrangement of the small pulleys on the arms of the flyers, and the pulley at the eye for the rope.

Fourth, I claim the combination of the flyers, the drill, and the other improvements, as herein described.

60,315.—SCALE PENCIL.—Benjamin Worcester, Waltham, Mass.

First, I claim the combination of a fixed and a sliding point with a pencil, substantially as and for the purposes set forth.

Second, The construction of the marking point with a thin, curved edge, and so arranged as to cover and protect the other point when not in use, substantially as and for the purposes set forth.

Third, The combination of pencil, scale, and points as an article of manufacture, substantially as and for the purposes set forth.

60,316.—APPARATUS FOR TYING AND PACKING WOOL FLEECES.—James M. Worcester, Oberlin, Ohio.

I claim the sliding heads, E, weights, J, grooved bars, D, and the adjustable levers, C, as arranged, in combination with the lever, M, and rollers, K and H, in the manner and for the purpose set forth.

60,317.—WOOD LATHES.—William H. Wussow, Aurora, Ill.

First, So constructing and arranging the cutting and guiding frame that its forward end, without the aid of extraneous devices, bears with a preponderating force down upon the work to be turned, while the rear end is caused to bear up against the pattern, substantially in the manner herein described.

Second, The construction of the cutter with two circular saws and intermediate finishing cutters, all arranged and operating substantially as described.

Third, The arrangement of the device, y y', with the longitudinally-moving frame, H, and the vertically-swinging and longitudinally-moving cutter frame, K, substantially as herein described.

60,318.—CORN HARVESTER.—Thomas Yates, Dubuque, Iowa.

First, I claim the fixed or stationary fingers, f, at the front part of the bed of a wagon, and having a reciprocating cutter, composed of a series of knives, g, working underneath it, in combination with the double draft pole, composed of two parts, b b, connected by a bow-shaped bar, e, at their front ends, substantially as described and for the purpose specified.

Second, The pivoted or turning rear axle, B', with forked bar, D, attached in connection with the catches, i i, on the bar, E, substantially as and for the purpose specified.

REISSUES.

2,405.—RAILROAD FROG.—E. G. Allen, Boston, Mass. Patented Sept. 25, 1866.

First, I claim the combination and arrangement of the plates, A and B, with their supports, H and F, with or without the elastic packing, u, connected together substantially as and for the purpose specified.

Second, In a truss railroad frog, constructed substantially as herein set forth, I claim the use of the supports, H and F, recessed to receive and hold the elastic material, u, as set forth.

Third, I claim the plate, f, at the point of the toe piece, I, fitted in the hole in plate, A, and secured to the support, H', by means of bolts, all arranged as shown and described.

2,406.—APPARATUS FOR SUPPLYING AND MEASURING SIRUPS IN SODA WATER.—Edmund Bigelow, Springfield, Mass. Patented April 6, 1858.

Reissued May 4, 1858.

I claim the employment of reservoirs in permanent cases or stands, revolving or otherwise, as herein described, with registering faucets, substantially as and for the purposes herein set forth.

I also claim a self-registering apparatus with an air-tube or vent, substantially as herein set forth, combined with a reservoir, as and for the purposes herein described.

2,407.—VALVE GEAR FOR STEAM ENGINES.—Adam S. Cameron, New York City. Patented Oct. 3, 1865.

First, I claim the valves, I I', in the heads of the main steam cylinder, A, to be operated by the direct action of the main piston, B, substantially as and for the purpose set forth.

Second, The construction of the stems of the valves, I I', at each end of the cylinder, in such a manner that said valves shall be moved, reversing the main valve before the piston reaches the end of the cylinder, so as to cushion or arrest the motion of the piston, as set forth.

Third, The valve chambers, H H', and valves, I I', in the heads of the main cylinder, A, in combination with supplementary cylinders, E E', pistons, F F', and main valve, C, constructed and operating substantially as and for the purpose described.

2,408.—CLOTHES WRINGER.—Colby Brothers & Co. (assignees to George J. Colby), Waterbury Vt. Patented Dec. 4, 1860.

First, We claim the frame, A, of a wringing machine, with elastic rollers, C J, and the springs, F, or their equivalents, so as to be self-adjusting in regard to mutual pressure of the rollers, with the use of wedges, cams, or screws, substantially as and for the purpose set forth.

Second, The construction of clothes wringers with the tongs, E E, pivoted arms, I I, and rollers, C J, or their equivalents, arranged so that the act of compressing the clothes between the rollers will cause the device to clamp itself firmly to the tub or other article, substantially as herein shown and set forth.

2,409.—FIRE ALARM.—Charles Dion, Montreal, Canada. Patented April 3, 1866.

I claim the expansion piece, A or a', and bed plate or tube, B, or other equivalents, as shown in the different modifications, in combination with the tilting lever, D, or its equivalent, and with the falling weight, F, or its equivalent, constructed and operating substantially as and for the purpose described.

2,410.—HYDRAULIC GOVERNOR.—The Gillespie Governor Company, Boston, Mass., assignees of James E. Gillespie. Patented Jan. 7, 1862.

I claim the combination with a valve or with a water gate, and for the purpose of automatically governing or controlling the position thereof, in order to regulate the flow of liquid past such valve or gate, of a pump, a cylinder, and its piston, and a notched bar, or the equivalent of these, operating substantially as described.

2,411.—ARTIFICIAL DENTURE.—Julius Guttman, Great Falls, N. H. Patented March 6, 1866.

First, I claim an artificial tooth or set of teeth provided with pins set in a zigzag line, substantially as and for the purpose set forth.

Second, Loading sections of artificial teeth previous to making them up in sets, substantially as and for the purpose described.

2,412.—LAMP BURNERS.—Edward Miller, Meriden, Conn., assignee of John J. Marcy. Patented July 21, 1863.

I claim the combination with the hinge, C, of the rigid curved rod, F, fixed to the cone, B, projecting downward through the shell, A, between the hinge and the wick tube, and provided with a bent end or equivalent stop, b, which, coming in contact with the under side of the said shell, operates by a tensional strain upon the rod, F, to limit the turning of the chimney, all as herein described.

2,413.—MACHINE FOR BORING AND DRILLING GUN-STOCKS.—The New York Engraving and Carving Company (assignees by mesne assignments of John G. Pusey), New York City. Patented February 17, 1863.

First, We claim arranging a series of tool stocks to radiate from a common center, in combination with a series of tracers, substantially as specified, whereby all the tools and tracers may be moved together in mortising, boring, or carving, but the tools not in use will, by their divergence, be out of the way, as set forth.

Second, The arrangement of the pulley, m, in the middle of the circular head, k, and of the fork, p', or its equivalent, for receiving and changing the belt, d', in the manner set forth.

Third, The parallel bars, c c', each jointed at one end by a universal joint to a fixed support, and at the other end to a movable head, in combination with a cutter and a guide or tracer, substantially as specified, whereby the said cutter and tracer may be freely moved in carving, substantially as set forth.

Fourth, The frame, u, on centers, 10, at right angles, or nearly so, to its length, and receiving the pattern and gun stock, or other article, substantially as specified, whereby the pattern and article to be acted upon can be reversed to present either side to the tool and tracer, as set forth.

Fifth, A holder fitted on centers, and carrying the pattern and gun stock or other article, and arranged substantially as specified, to swing on said centers while the tool is in cutting or cutting the curved parts, in order that said tool may act at right angles to the surface, for the purposes specified.

Sixth, Rotating the pattern and the article to be carved in parallel planes, at right angles to the axis on which they are supported, substantially as and for the purposes set forth.

DESIGNS.

- 2,514.—ORNAMENTAL PICTURE FOR ANIMAL STUDIES.—Charles A. Foster, North Providence, R. I.
- 2,515.—FLOOR OIL CLOTH.—Robert Haskin, Brooklyn, N. Y., assignor to Edward C. Sampson, New York City.
- 2,516 to 2,520.—STOVE.—William Resor, Cincinnati, Ohio. Five Patents.
- 2,521.—GROUP OF FIGURES.—John Rogers, New York City.
- 2,522.—BOTTLE.—W. H. Ware, Philadelphia, Pa.

NOTE.—In the above list of patents we recognize FIFTY-TWO whose cases were solicited through the Scientific American Patent Agency.

PATENT OFFICE.

PATENTS GRANTED FOR SEVENTEEN YEARS.

MUNN & COMPANY,

In connection with the publication of the SCIENTIFIC AMERICAN have acted as Solicitors and Attorneys for procuring "Letters Patent" for new inventions in the United States and in all foreign countries during the past twenty years. Statistics show that nearly ONE-HALF of all the applications made for patents in the United States are solicited through this office; while nearly THREE-FOURTHS of all the patents taken in foreign countries are procured through the same source. It is almost needless to add that, after so many years' experience in preparing specifications and drawings for the United States Patent Office, the proprietors of the SCIENTIFIC AMERICAN are perfectly conversant with the preparation of applications in the best manner, and the transaction of all business before the Patent Office.

Judge Mason, formerly Commissioner of Patents, says, in a letter addressed to us:—"In all your intercourse with the Office, I always observed a marked degree of promptness, skill, and fidelity to the interests of your clients."

Ex-Commissioner Holt says:—"Your business was very large, and you sustained and justly deserved the reputation of marked ability and uncompromising fidelity to the interests of your clients."

Ex-Commissioner Bishop says:—"I have ever found you faithful and devoted to the interests of your clients, as well as eminently qualified to perform the duties of Patent Attorneys."

EXAMINATIONS.—If an Inventor wishes our opinion in regard to the probable novelty of his invention, he has only to send us a pencil or pen-and-ink sketch of it, together with a description of its operation. For an Opinion, without examination at the Patent Office, we make no charge, but if a

PRELIMINARY EXAMINATION AT THE PATENT OFFICE is desired, we charge the small fee of \$5. This examination involves a personal search at the Patent Office of all models belonging to the class, and will generally determine the question of novelty in advance of an application for a patent. Up to this time we have conducted over THIRTEEN THOUSAND Preliminary Examinations, thus showing a more intimate knowledge of inventions at the Patent Office than can be possessed by any other person or firm.

If an inventor decides to apply for a patent, he should proceed at once to send us by express (charges prepaid) a model not over one foot in size, and substantially made. He should also attach his name and residence to the model.

PATENTS ARE GRANTED FOR SEVENTEEN YEARS, the following being a schedule of fees—

On filing each caveat.....	\$10
On filing each application for a Patent, except for a design.....	\$25
On issuing each original Patent.....	\$10
On appeal to Commissioner of Patents.....	\$20
On application for Reissue.....	\$30
On application for Extension of Patent.....	\$50
On granting the Extension.....	\$50
On filing a Disclaimer.....	\$10
On filing application for Design (three and a half years).....	\$10
On filing application for Design (seven years).....	\$15
On filing application for Design (fourteen years).....	\$30

In addition to which there are some small revenue-stamp taxes. Canadians have to pay \$500.

FOREIGN PATENTS.—Messrs. MUNN & CO. have had more experience than any other solicitors in this country in procuring foreign patents, and have old-established agencies in London, Paris, Brussels, Berlin, Vienna, and other large cities. Foreign business should never be entrusted to other than experienced agents.

If an inventor wishes to apply for a patent, all he has to do is to write to us freely for advice and instruction, and he will receive prompt attention. If his invention contains any patentable features, he can depend upon getting his Letters Patent. All communications considered confidential. Send models and fees addressed to

MUNN & CO.,
No. 37 Park Row, New York.

PATENT CLAIMS.—Persons desiring the claim of any invention which has been patented within thirty years, can obtain a copy by addressing a note to this office, stating the name of the patentee and date of patent, when known, and inclosing \$1 as a fee for copying. We can also furnish a sketch of any patented machine to accompany the claim, at a reasonable additional cost. Address MUNN & CO., Patent Solicitors No. 37 Park Row, New York.

RATES OF ADVERTISING:

FORTY CENTS per line for each and every insertion, payable in advance. To enable all to understand how to calculate the amount they must send when they wish advertisements published, we will explain that eight words average one line. Engravings will not be admitted into our advertising columns, except on payment of one dollar a line each insertion, and, as heretofore, the publishers reserve to themselves the right to reject any advertisement they may deem objectionable.

PLATINUM LABORATORY.—H. M. RAY—NOR.—Office, 748 Broadway, New York. 25 5*

AN EXPERIENCED MECHANICAL Draughtsman and Engineer seeks a suitable engagement. Address ENGINEER, Box 2,594, Boston, Mass. 25-3

AGENTS WANTED TO SELL RIGHTS OF A new and useful article for general use, just patented. Incentives good. For particulars address GEO. W. PARSONS, Harrisburg, Pa. 25 3*

ENGINEERING. An illustrated weekly journal, conducted by Zerah Colburn, London. Price \$10 per annum. D. VAN NOSTRAND, 25 1] 192 Broadway, sole Agent for the United States.

FREDERIC H. BETTS, ATTORNEY AND COUNSELOR. ADVOCATE IN PATENT AND COPYRIGHT CASES. 25 13] 31 and 33 Pine street, New York City.

PATENTS.—Having established Agents in Foreign Countries, we are now prepared to sell American and Foreign Patents on most satisfactory terms. Address KENYON & CO., 151 Broadway, New York. 1*

BRASS AND OTHER METAL GOODS Made and introduced to the Trade. Pressed, Stamped, and Spoon Work. Dies, Tools, etc., to order. J. H. WHITE, 25 4] 157 Chestnut street, Newark, N. J.

IMPORTANT NOTICE.—BONNER & CO., 117 Nassau street, undertake the sale of Patents of real merit. Manufacturers should examine our list of machines and articles that we have always on hand. Inventor send stamp for terms. 25 BONNER & CO.

SCIENTIFIC and Practical Mining Engineer is open for an engagement. Has devoted his time and attention particularly to Iron Smelting in all its different branches, and is an experienced Chemist and Manufacturer of Coke. Address WINTZ, Care of Kutter, Luckemeyer & Co., 61 and 63 Worth st., N. Y. 1*

NEW YORK STATE BRANCH NATIONAL INVENTORS' EXCHANGE, "208" Broadway, New York, Central office at Washington. Branch offices throughout the States. Valuable patents introduced, and patent rights bought and sold on commission. Correspondence solicited. JAMES B. COIT & CO., Directors N. Y. S. B. N. I. E. 25-1*

RARE CHANCE FOR A SMART BUSINESS man with a small capital. Wanted, a party to take an interest in and the management of Foreign Patents (secured) on a valuable invention which has been adopted by some of the largest establishments in the country, and is rapidly coming into extensive use. Address X, Box 419, Providence, R. I. 25 4*

FABRICATION OF VINEGAR. Prof. H. DUSSAUCE, Chemist, is ready to furnish the most recent European process of manufacturing vinegar by the slow and quick processes, with and without alcohol, directly from grains, potatoes, etc. Also, Processes to Manufacture Vinegar from wood, acetic acid, and methods of assaying vinegars. Address NEW Lebanon, N. Y. 1*

IMPORTANT TO IRONMASTERS.—PLAYER'S PATENT HEATING STOVES for Blast Furnaces are recommended as the best and most efficient that have hitherto been used, inasmuch as blast can be heated 1200° Fah., without the least danger of injuring the cast-iron pipes through which the blast circulates. Already, 54 stoves have been erected in the country, and are rapidly coming into use. Address JAMES HENDERSON, Agent, 218 Fulton st., N. Y. 3*

WOOD LIGHT & CO.—MANUFACTURERS of Machinists' Tools and Naysmyth Hammers, Lathes from 4 to 30 feet long, and from 15 to 100 inch swing. Planers from 24 to 60 inches wide and from 4 to 46 feet long. Upright Drills. Milling and Index Milling Machines. Profile or Edging Machines. Gun Barrel Machines. Shafting, Mill Gearing, Pulleys and Hangers, with Patent Self-oiling Boxes. Works, Junction Shop, Worcester, Mass. Warehouse at 107 Liberty street, New York. 25-1f

NEW PATENTED PLOW.—HIGHLY IMPORTANT FOR MANUFACTURERS AND CAPITALISTS.—Mr. F. Volkman, the inventor and owner of the new Patent Self-holding Plow, which was favorably noticed in the Semi-weekly Tribune, Nov. 13, Semi-weekly Times, Nov. 9, Independent, Nov. 15, American Artisan, Dec. 5, and in many other prominent papers, desires to sell State rights, or to form a partnership for the manufacture and speedy introduction of his plow. Address, F. VOLKMAN, 171 West 83th street, New York City. 1*

SEWING-MACHINE OFFICE AND REPAIR SHOP FOR SALE.—The most centrally located suite of rooms in Philadelphia—two prominent entrances, all water and gas arrangements, etc., private, fourteen large windows, high ceiling, the best display for signs, etc. Office furniture complete. A general assortment of tools for all work, and building. This is undoubtedly the best chance ever offered, especially for a General Exchange, Rental, and Repairing Office. The present Proprietor is about leaving the City. Address CHARLES PARHAM, 701 Chestnut street, Philadelphia, Pa. 1*

OUR YOUNG FOLKS. Is very highly praised by numerous State Superintendents of Schools and other distinguished Educators, for "the freshness, vigor, and variety of its pages," "its simplicity and purity of style," "its high moral tone," "pure and ennobling sentiment," "elevating and refining influences," "life-like and attractive illustrations," as "unquestionably the best juvenile magazine published in this country." Terms—\$2 00 a year; Large discount to Clubs; Single or Specimen Numbers, 20 cents.

EVERY SATURDAY! Is frequently enriched with admirable papers on Scientific subjects, so written as to fascinate while they instruct. It has already contained very interesting articles on Precious Stones, Engraving with a Sunbeam, Spiders, a toms, How Fish Hooks are made, and similar topics. Terms: Single Number, 10 cents. Yearly Subscription, \$5 00. 25 1] TICKNOR & FIELDS, Publishers, Boston.

LABORATORY OF INDUSTRIAL CHEMISTRY, Directed by Prof. H. DUSSAUCE, Chemist, United States Commissioner to the Exposition at Paris. 1*

AN ENGINEER and Chemist, familiar with managing Blast Furnaces, Foundries, and Bessemer Steel Works, desires an engagement. Address Dr. ADOLPH SCHMIDT, care Penns. Steel Co., 424 Walnut street, Philadelphia. 1*

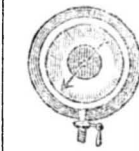

SCOTCH GLASS TUBES.

Steam Gages. Water Gages. Steam Engine Counters. Steam Engine Indicators. Pyrometers.

E. BROWN, 311 Walnut street, Philadelphia, Pa.

A LITERARY SENSATION!

THE NEW YORK WEEKLY, THE LEADING STORY AND SKETCH PAPER OF THE AGE, Is Now Publishing

A THRILLING STORY.

Half Romance and half Reality, entitled

ON THE BORDER!

From the pen of America's gifted son,

EDMUND KIRKE,

Author of "Among the Pines," "My Southern Friend," "Down in Tennessee," etc., etc., etc.

The admirers of

EDMUND KIRKE

are legion. His name is known wherever the English language is spoken, and his works have been translated in almost every known tongue. The mere announcement of his name, therefore, as a contributor to the columns of the

NEW YORK WEEKLY

ought to secure for that journal a million readers; but when we announce that in

ON THE BORDER

EDMUND KIRKE enters upon an entirely new field in the world of literature, that fact should lead everybody to look after his

LAST AND GREATEST WORK.

The Hero in

ON THE BORDER

Is

A REAL CHARACTER;

and the work loses nothing in the way of interest from the fact that he belonged to that miserable class of Southern society,

THE POOR WHITES.

Although a living, breathing reality, the hero of

ON THE BORDER

was the man who

SAVED KENTUCKY.

Words are inadequate to describe the interest which attaches to

ON THE BORDER.

The Story, as whole, is a mingling of romance and reality such as must enchain the attention of all classes, whatever their peculiar views may be. It is full of the most absorbing interest from the beginning to the end. Acts of heroism, hair-breadth escapes deeds of daring, and inimitable pen-portraits of character, follow each other so rapidly that the reader has scarcely breathing time to jump from one to the other. We read in the pages of pure romance of the exploits of Cooper's "Harvey Birch," and other fictitious characters, and are fairly carried away by them. But what must be the effect when we know that the hero of whom we are reading once had on the "dark and bloody ground" a "local habitation and a name"—that he was a real character, and that what is set down concerning him is true? Everybody must be deeply interested in this great story, and it is only necessary to say in conclusion that

ON THE BORDER,

BY EDMUND KIRKE,

will be ready in

THE NEW YORK WEEKLY,

ON THURSDAY, December 6.

THE NEW YORK WEEKLY is for sale by all News Agents throughout the United States and in the Canadas.

STREET & SMITH,

25 1]

No. 11 Frankfort street, New York.

MESSEURS LES INVENTEURS—AVIS important. Les inventeurs non familiers avec la langue Anglaise, et qui préféreraient nous communiquer leurs inventions en Français peuvent nous adresser dans leur langue natale. Envoyez nous un dessin et une description concise pour notre examen. Toutes communications seront reçues en confiance. MUNN & CO., Scientific American Office, No. 37 Park Row, New York.

CHARLES A. SEELY, CONSULTING AND ANALYTICAL CHEMIST, No. 26 Pine street, New York.

OILERS—Olmsted's Improved Spring Top. The spring cannot be set or injured by pressing upon it to expel the oil.

IMPORTANT TO CONSUMERS OF STEAM. 25 per cent of fuel is wasted by using ordinary "wet" steam.

INCORUSTATIONS in Steam Boilers prevented by Winans's anti-Incrustation Powder, 11 Wall-st., N. Y.

IMPORTANT TO MANUFACTURERS USING STEAM FOR POWER. KELLEY & LAMB'S Improved Steam Engine Governor, the only Governor that will give the same speed, with high or low pressure of steam.

JUDSON'S GOVERNORS. MALLEABLE CASTINGS. SAW GRINDERS. CARRIAGE AND MACHINE BOLTS.

BARK MILLS. HOISTING MACHINERY. SORGHUM SUGAR SEPARATORS. STEAM PIPES For Warming with "scape steam" Do. Do. For Boiling Paper Stock. IRON CASTINGS.

Address JAMES L. HAVEN & CO., Cincinnati, Ohio

IMPORTANT. MOST VALUABLE MACHINE for all kinds of irregular and straight work in wood, called the Variety Molding and Planing Machine.

TO ARCHITECTS. Plans and Specifications for new buildings for the War Department at Washington, D. C.

Agents WANTED—To Sell Hodgins's Patent Elastic Paper-Collar Fastening, illustrated in the Scientific American, Aug. 11, 1866.

MACHINISTS. Every Machinist should have a copy of MCARTHUR'S MECHANICAL SERIES, No. 2, Now Ready—setting of Slide Valve and Link Motion; price 50 cents.

FOR SALE—The Right of Henry Asbury & Co.'s Patent Screw Cutting Indicator for the entire United States.

GOULD MACHINE COMPANY, Of Newark, N. J., and 102 Liberty street, New York

PORTABLE AND STATIONARY STEAM Engines and Boilers, Circular Saw Mills, Mill Work, Cotton Gins and Cotton Gin Materials, manufactured by the ALBERTSON & DOUGLASS MACHINE CO., New London, Conn.

JENKINS'S PATENT COMPRESSION GLOBE VALVE. For Steam, Oil, Water, etc. The bottom of the Valve is provided with an improved, durable, slightly elastic, rubber disk.

ERICSSON CALORIC ENGINES OF GREATLY IMPROVED CONSTRUCTION.—Ten years of practical working by the thousands of these engines in use, have demonstrated beyond cavil their superiority.

LECTURES ON CHEMISTRY AND METALLURGY.—Tickets for Prof. SEELY'S Lectures may be procured at his office, No. 26 Pine street, or from Dr. Kingsley, Dean of the Faculty, No. 25 West 27th street.

E. C. TAINTER, OF THE LATE FIRM OF J. A. FAY & CO., having bought the Letters, Orders, and Correspondence of the late firm, respectfully solicits orders for Wood-working Machinery.

Table with 2 columns: Description of engine (One portable, Stationary Upright) and Horse-power (35, 30, 25, 18, 6, 30, 15, 12).

MOSES G. WILDER, Draftsman, Machinist, and Manufacturer of all kinds of fine Machinery, would call attention to his facilities for designing, arranging, or building first-class work.

NITRO-GLYCERIN.—Part of a quantity of the above article in quantity—say 100 lbs per day—are invited to correspond with the subscriber, who has devised a new method for its manufacture.

WANTED—Men to Sell, By Sample, Andrews's Gas Generator, price \$1. Can be attached to any lamp. Makes the best gas light in use from Carbolic Oil.

IMPORTANT TO STOVE MANUFACTURERS.—The undersigned will sell Rights to manufacture his valuable Patent Smoke Consuming Stove for Bituminous Coal.

IRON CASTINGS COPPERED.—Address S. VANDOREN, Box 58, New Brunswick, N. J.

THE Cheapest and Best Wood Mill in the world. Warranted to saw a cord of hard wood in seven minutes, with one horse.

CIRCULAR SAWS.—With EMERSON'S Patent MOVABLE TEETH. These saws cut more and better number in the same time, and with less power, than any other saw in the world.

CARTRIDGE MACHINERY FOR SALE. Complete set of Tools and Presses for the Manufacture of Metallic Cartridges, nearly new and in perfect order.

SPOKE LATHES, TENONING AND SPOKE-POLISHING MACHINES, of an approved pattern, manufactured by J. GLEASON, 1030 Germantown Avenue, Philadelphia, Pa.

PACIFIC PATENT AGENCY.—Patents Procured and Sold. Agencies for Manufacturers solicited.

PATTERN Letters & Figures (metallic) for foundrymen, machinists, pattern makers, inventor, etc., to letter patterns to cast from.

UNITED STATES CENSUS, BY TOWNS, IN Pocket form, 174 pages. Price, postpaid, 60c. Tuck \$1.

MILLED MACHINE SCREWS.—EVERY VARIETY of square or round-head milled and case hardened, set or cap screws.

FOR CUTS AND PRICES OF WOOD-WORKING MACHINERY AND MACHINISTS' TOOLS, send to us and be particular and say for what purpose tools are wanted.

MESSRS. STEPTOE, McFARLAN & CO., Gentlemen.—Inclosed you will please find check for One Thousand Dollars (\$1000), which is in full for the two Engine Lathes last shipped to us.

WE WOULD CALL ATTENTION to WALKER & SNEED'S Machines, suitable for small fans, working models, and moving articles in show windows when a reciprocating motion is required.

THE CELEBRATED "SCHENCK" WITH NEW AND IMPORTANT IMPROVEMENTS, Manufactured by the SCHENCK MACHINE CO., MATTEAVAN, NEW YORK.

MAKE SURE OF IT.—THE PHRENOLOGICAL JOURNAL for December contains fine portraits of Dore, the great French Artist, the King and Queen of Prussia, twelve distinguished American Congressmen, Miss Kate Bateman, with biographies and sketches of character.

FABRICATION OF MATCHES.—Prof H. DUSSAUCE, Chemist, is ready to furnish the most recent European processes to prepare white and amorphous phosphorus, bi-oxide of lead.

JUST PUBLISHED—THE INVENTOR'S AND MECHANIC'S GUIDE.—A new book upon Mechanics, Patents, and New Inventions. Containing the U. S. Patent Laws, Rules and Directions for doing business at the Patent Office.

TANNING, CURRYING, AND LEATHER DRESSING. New Edition Just Ready. A new and complete treatise on the Arts of Tanning, Curryng, and Leather Dressing; comprising all the discoveries made in France, Great Britain, and the United States.

Part I. CHEMISTRY OF TANNING. Sec. 1. Tan and Tannin. 2. Tanning materials. 3. Skin. Part II. TANNING. 4. Preliminary Treatment of Skins.

Part III. CURRYING. 8. General Work of the Currier. 9. Russia Leather. 10. Patent Leather. 11. Water Proof Leather. Part IV. HUNGARY LEATHER. 12. Grease and Animal Oils, etc.

Part V. GUT DRESSING. 13. Preparation of the Intestines of Cattle. Part VI. DIFFERENT KINDS OF APPARATUS USED BY LEATHER MANUFACTURERS.

The above book is known to be the best of its kind ever published in any language. In all the several branches of the important arts of which it treats, as well in regard to the various raw materials, whether hides, skins, or liquors, as to processes, old and new, general manipulation and machinery, it will be found well nigh exhaustive.

CAN I OBTAIN A PATENT?—FOR ADVICE and Instructions address MUNN & CO., 37 Park Row, New York, for TWENTY YEARS Attorneys for American and Foreign Patents.

THE HARRISON BOILER—A SAFE STEAM BOILER.—This new Steam Generator combines essential advantages in Absolute Safety from explosion, in first cost and cost of repairs, durability, economy of fuel, facility of cleaning, and transportation, not possessed by any other boiler.

It is formed of a combination of cast-iron hollow spheres—each 8 inches in external diameter, and 3/8ths of an inch thick, connected by curved necks. These spheres are held together by wrought iron bolts with caps at the ends.

It is easily transported, and may be taken apart so that no piece need weigh more than eighty pounds. In difficult places of access, the large boiler may be hoisted through an opening of four feet square.

Zur Beachtung für deutsche Erfinder. Die Unterzeichneten haben eine Anstalt, die Erfindern das Verhalten angibt, um sich ihre Patente zu sichern, heranzugeben, und betheiligen solche gratis an dieselben.

Die Patent-Gesellschaft der Vereinigten Staaten, welche den Regeln und der Geschäftsordnung der Patent-Office und Anstalten für den Erfinder, um sich Patente zu sichern, in den Vereinigten Staaten sowohl als in Europa. Ferner Auszüge aus den Patent-Gesetzen fremder Länder und darauf bezügliche Nachrichten; ebenfalls nützliche Winke für Erfinder und solche, welche Patenteiren wollen.

Preis 20 Cts., per Post 25 Cts. Munn & Co., 37 Park Row, New-York.

SHEET AND ROLL BRASS.

German Silver, Brass, and Copper Wire, etc. Especial attention to particular sizes and widths for Machinists' and Type Founders. Manufactured by the THOMAS MANUFACTURING COMPANY, Thomaston, Conn.

TO SPRING MANUFACTURERS.

Address JOHN EVANS, 31 Wooster st., New Haven Conn., for his Patent Improved Machinery for HEADING CARRIAGE SPRINGS. Shops fitted with complete sets.

JOSEPH HIRSH, Ph. Dr.

ANALYTICAL AND CONSULTING CHEMIST. Manufacture of PURE CHEMICALS. Office 33 Courtland street, New York.

THE BEST POWER HAMMER MADE IS

The Dead Stroke Hammer of Shaw & Justice. Sizes suited for manufacturing awl blades or engine shafts; consume but little space, and require but little power. Manufactured by PHILIP S. JUSTICE, 14 North 5th street, Philadelphia, and 42 Cliff-st., New York.

SHAW & JUSTICE'S POWER HAMMER IS

Moderate in Price, is driven with one-tenth the power used by other Hammers, and will not cost the one-hundredth part of what is usually spent in repairs. Its power is far in excess of any Hammer known. Manufactured by PHILIP S. JUSTICE, 14 North 5th street, Philadelphia, and 42 Cliff-st., New York.

MODELS, PATTERNS, EXPERIMENTAL

and other Machinery. Models for the Patent Office, built to order by HOLSICK MACHINE CO., Nos. 523, 530, and 532 Water street, near Jefferson. Refer to SCIENTIFIC AMERICAN Office. 1 tf

WHEELER & WILSON, 625 BROADWAY,

N. Y.—Lock-stitch Sewing Machine and Buttonhole do. 1t

TAYLOR, BROTHERS & CO.'S BEST YORK-

SHIRE IRON.—This Iron is of a Superior Quality for locomotive and gun parts, cotton and other machinery, and is capable of receiving the highest finish. A good assortment of bars in stock and for sale by JOHN B. TAYLOR, sole agent for the United States and Canada. No. 18 Battery-march-st., Boston. 13 54-R.

WROUGHT IRON WELDED TUBE OF ALL

sizes; Upright Drill Presses; Peace's Improved Gas Pipe Screwing Machines, and all other Tools used by Steam and Gas Fitters. Also, Brass Work and Fittings manufactured and for sale by CAMDEN TUBE WORKS, Second a Stevens-sts., Camden, N. J. Please send for illustrated catalogue.

STEAM BOILER EXPLOSIONS PREVENTED

by use of Ashcroft's Low Water Detector. Over 5,000 in use. Send for Circular. JOHN ASHCROFT, 50 John st., N. Y. 19 13*

FOR ENGINE BUILDERS' AND STEAM

Fitters' Brass Work, address F. LUNKENHEIMER, Cincinnati Brass Works. 8 26*

FOR WOODWORTH PATENT PLANING

AND MATCHING MACHINES, Patent Siding and Resawing Machine, address J. A. FAY & Co., Cincinnati, O. 3 1y

ATMOSPHERIC TRIP HAMMERS ARE

made by CHAS. MERRILL & SONS, 550 Grand street, New York. They will do more and better work with less power and repairs, than any other Hammer. Illustrated circulars, giving full particulars, sent on application.

J. A. FAY & CO.,

CINCINNATI, OHIO. Patentees and Manufacturers of all kinds of PATENT WOOD-WORKING MACHINERY of the latest and most approved description. Particularly designed for Navy Yards, Ship Yards, Railroad, Car and Agricultural Shops, Mills, Etc. Warranted superior to any in use. Send for Circulars. For further particulars address J. A. FAY & Co., Corner John and Front streets, Cincinnati, Ohio. Who are the only manufacturers of J. A. Fay & Co.'s Patent Wood-working Machinery in the United States. 5 1y

WATER WHEELS.—

WARREN'S AMERICAN TURBINE is acknowledged the best finished, the simplest constructed, and the greatest water-saving wheel in the market. Also, Warren's Improved Turbine Regulator is not surpassed for giving uniform speed. Address ALONZO WARREN, Agent, 31 Exchange street, Boston, Mass. 22 12*

R. BALL & CO.,

SCHOOL STREET, WORCESTER, MASS., Manufacturers of Woodworth's, Daniells', and Gray & Wood's Planers, Sash Molding, Tenoning, Mortising, Upright and Vertical Shaping, Boring Machines, Scroll Saws, and a variety of other Machines and tools for working wood. Send for our Illustrated Catalogue. 1 51*

THE DAVIS BOLT-HEADER.—THIS SIM-

ple and durable Bolt-Header has the unqualified approval of over thirty of the first mechanics of our railroad shops; also of Sellers & Co., Philadelphia; Wood, Light & Co., Worcester, and many others. Address L. E. OSBORN, New Haven, Conn. 21 9*

LENOIR PATENT GAS ENGINES—Without

Boiler, Fire, Coals, or Smoke, for hoisting, grinding, sawing, pumping, and all small industries. In use five years in Paris and in London. In operation daily at H. GAN'S Hoist Wheel establishment, No. 107 Laurens street, near Prince street, New York. Manufactured at the LENOIR GAS ENGINE WORKS, No. 435 East Tenth street, near Avenue D, New York. 15 10

COMPLETE SETS OF DRAWING INSTRU-

ments, fine finish, from \$25 per set to \$150 per set, for sale by JAMES W. QUEEN & CO., 924 CHESTNUT STREET, Philadelphia, Pa. Catalogue and Manual of 112 pages, describing all mathematical instruments, their use, and how to use them and keep them in order, sent free. 21 12*

SMITH'S PATENT FUSIBLE SAFETY

VALVE OR PLUG.—These Plugs are in extensive use in England, and are the best application of fusible alloy, for safety from accidents by low water or over pressure; are self-acting, and can not be tampered with. For sale by CHARLES W. COPELAND, No. 171 Broadway, Sole Agent for the United States. 21 8j

PATENT SHINGLE, STAVE, AND BARREL

Machinery, Comprising Shingle Mills, Heading Mills, Stave Cutters, Stave Jointers, Shingle and Heading Jointers, Heading Rounders and Planers, Equalizing and Cut-off Saws. Send for Illustrated List. FULLER & FORD, 261 6* tr-C.] 282 and 284 Madison street, Chicago, Ill.

ANDREW'S PATENT PUMPS, ENGINES

etc.—CENTRIFUGAL PUMPS, from 90 Gals. to 40,000 Gals. per minute, capacity. OSCILLATING ENGINES (Double and Single), from 2 to 250 horse-power. TUBULAR BOILERS, from 2 to 50 horse-power, consume all smoke. STEAM HOISTERS, to raise from 1/2 to 6 tons. PORTABLE ENGINES, 2 to 30 horse-power. These machines are all first-class, and are unsurpassed for compactness, simplicity, durability, and economy of working. For descriptive pamphlets and price list address the manufacturers, W. D. ANDREWS & BRO., No. 414 Water street N. Y. 3 tf

IRON PLANERS, ENGINE LATHES, DRILLS,

and other Machinists' Tools, of Superior Quality, on hand and finishing. For Sale Low. For Description and Price, address 2tf] NEW HAVEN MANUFACTURING CO., New Haven, Ct.

"POWER-LOOM WIRE CLOTHS" AND

nettings, of all widths, grades, and meshes, and of the most superior quality, made by the CLINTON WIRE CLOTH COMPANY, Clinton, Mass. 1 36*

OXY-HYDROGEN STEREOTYPES,

OXY-CALCIUM STEREOTYPES, DISSOLVING LANTERNS, MAGIC LANTERNS, Etc., Etc. A Large Assortment of American, European, and Foreign Photograph Views for the same!! A Priced and Illustrated Catalogue, containing 15 Cuts and 50 pages, will be sent free by Mail on application. WILLIAM V. McALLISTER, 728 Chestnut street, Philadelphia. 21 52*

10,000 AGENTS WANTED, IN EVERY

TOWN, COUNTY, and STATE, to sell Toplift's Patent Perpetual Lamp Wick. Needs no Trimming. Sample sent for 20c; and for 30c. State and County Rights for Sale. MURPHY & COLE, 81 Newark Avenue, Jersey City, N. J. 3 tf]

WOODWORTH PLANERS, BARLETT'S

Patent Power Mortise Machine, the best in market. Wood-working Machinery, all of the most approved styles and workmanship. No. 24 and 26 Central, corner Union street, Worcester, Mass. [17 1*] WITHERBY, RUGG & RICHARDSON.

IMPORTANT TO MANUFACTURERS AND

Inventors.—SMITH & GARVIN, No. 3 Hague street, New York, Machinists and Model Makers, are now ready to make proposals for building all kinds of Light Machinery, Manufacturers' Tools, Models, etc. Satisfactory reference given. 7 28*

BULLARD & PARSONS, HARTFORD, CONN.,

are prepared to furnish Shafting of any size and length, in large or small quantities. Our hangers are adjustable in every point, and fitted with Patent Self-oiling Boxes, guaranteed to run six months without re-oiling, and save 80 per cent. of oil. By making a speciality of shafting, we are able to furnish very superior work at reasonable rates. Heavy work built to order. 15 tf

FOR SALE—One New Boring Mill, Swing 9 ft.

2 in. Will do all work required of it for building Engines, etc. Also, very useful for Pulleys. Built from Patterns at Niles's Works, with latest improvements. Address C. KRATZ, Evansville, Ind. 19 12*

GROVER & BAKER'S HIGHEST PREMIUM

ELASTIC Stitch Sewing Machines, 455 Broadway, N. Y. 1 tf

TO ENGINE BUILDERS.—

Ross's Celebrated Patent Oil Cups for Cylinders or Engines, Brass and Iron body, Globe and Check Valves, Gage Cocks, Whistles, etc., on hand and made to order. Price list sent on application. B. E. LEHMAN, 19 tf] Lehigh Valley Brass Works, Bethlehem, Pa.

TURBINE WATER WHEELS!

REYNOLDS' PATENT SWEETS THE FIELD! New Inventions; Low Prices; Does not Clog; Has no Complications of Gates or Costly Flume Works; Compact for Shipment; Great Water Saver. THE ONLY WHEEL THAT EXCELS OVERSHOTS! Gold Medal awarded by American Institute for Superiority. Shafting and Geering furnished when required. GEORGE TALLCOT, Late TALLCOT & UNDERHILL, 15 13* E.] No. 96 Liberty street, N. Y.

STATIONARY ENGINES

Fitted with BABCOCK & WILCOX'S Improved CUT-OFF VALVE GEAR: An entirely novel arrangement guaranteed to give a more regular speed, and to consume less fuel per horse-power than any engine in use. Call or send for a circular. HOWARD ROGERS, 50 Vesey street, New York. 21 26j

PORTABLE STEAM ENGINES, COMBINING

The maximum of efficiency, durability, and economy with the minimum of weight and price. They are widely and favorably known, more than 300 being in use. All warranted satisfactory or no sale. Descriptive Circulars sent on application. Address J. C. HOADLEY & Co., Lawrence, Mass. 1 tf

FOR WHEEL, FELLY AND SPOKE MA-

chinery, Spoke Lathes, Hub Mortising and Boring Machinery, Etc., address J. A. FAY & Co., Cincinnati, Ohio. 5 tfc

MACHINERY.—S. C. HILLS, NO. 12 PLATT

street, New York, dealer in Steam Engines, Boilers, Planes; Lathes, Chucks, Drills, Pumps; Mortising, Tenoning and Sash Machines, Woodworth's and Daniells's Planers, Dick's Punches, Presses and Shears; Cob and Corn Mills; Harrison's Grist Mills, Johnson's Shingle Mills; Belting, Oil, &c. c

PRANG'S AMERICAN CHROMOS.

Your home is not complete without good pictures; pictures that cultivate the taste and elevate the soul; pictures, the pleasant collection of which will accompany the child through all his life's wanderings. Next to music, printing is good reproduction of such in chromo-print will answer your purpose. A Chromo print is the result of printing from 15 to 20 plates in oil color, one over the other, and when done skillfully, will represent the original painting in its minutest details. Our CHICKENS and DUCKINGS, after A. T. Tait, our LANDSCAPES, after A. T. Brierley, and a number of other excellent subjects, which we have the honor to bring before the public this season, may be examined in all Art and Picture Stores, and in most of the first-class bookstores throughout the land. The lively interest they create among the Art connoisseurs, and the liberal encouragement we have received by the community at large, give us the pleasant satisfaction that we have not labored in vain to reach the highest standard of European excellence. L. PRANG & CO., ART PUBLISHERS, BOSTON. 24 4t.

MASON'S PATENT FRICTION CLUTCHES,

for starting Machinery, especially Heavy Machinery, without sudden shock or jar, are manufactured by VOLNEY W. MASON, Providence, R. I. 6 20 j

WOOD & MANN STEAM ENGINE CO.'S

CELEBRATED PORTABLE STEAM ENGINES, from 4 to 35 horse-power. Also, PORTABLE SAW MILLS. We have the oldest, largest, and most complete works in the United States, devoted exclusively to the manufacture of Portable Engines and Saw Mills, which, for simplicity, compactness, power, and economy of fuel, are conceded by experts to be superior to any ever offered to the public. The great amount of boiler room, fire surface, and cylinder area, which we give to the rated horse-power, make our Engines the most powerful and cheapest in use; and they are adapted to every purpose where power is required. All sizes constantly on hand, or furnished on short notice. Descriptive circulars, with price list, sent on application. WOOD & MANN STEAM ENGINE CO., 52* Utica, N. Y. Branch office 96 Maiden Lane N. Y. City.

FOR DANIELLS'S PLANING MACHINES,

Car Mortising, Boring Machines, Car Tenoning Machines Car Planing and Bending Machines, etc., address J. A. FAY & CO., Cincinnati, Ohio. 4 1y]

BUERK'S WATCHMAN'S TIME DETECTOR.

Important for all large Corporations and Manufacturing concerns—capable of controlling with the utmost accuracy the motion of a watchman or patrolman, as the same roams between stations of his beat. Send for a Circular. P. O. Box 1057, Boston, Mass. N. B.—This detector is covered by two U. S. patents. Parties using or selling these instruments without authority from me will be dealt with according to law. 13 28*

TO BUILDERS.—

Patent Rolled Plate Glass for Skylights for sale very low by E. & H. T. ANTHONY & CO, 501 Broadway, Agents of Southbridge Glass Works. 13 13*]

GODDARD'S BURNING MACHINE WORKS

Office, No. 3 Bowling Green, New York, manufacture the Patent Steel Ring and Solid Packing BURNING MACHINES, Patent Mestizo Wool-burring Pickers, Shake Willows, Wool and Waste Dusters, Gessner's Patent Gigs, Etc. Orders respectfully solicited, and prompt attention given, by addressing C. L. GODDARD, No. 3 Bowling Green, N. Y. 1 tf

PATENTEES TAKE NOTICE.—

Having made large additions to our Works, we can add one or two machines to our list of manufactures. The machines must be strictly first-class, and well protected. BLYMYER, BATES & JAY, Manufacturers of Agricultural Machinery, Mansfield, O. 19 1t

\$200 A MONTH IS BEING MADE WITH

our IMPROVED STENCIL DIES, by Ladies and Gentlemen. Send for our free Catalogue containing Samples and Prices. Address S. M. SPENCER & CO., 21 6* tr-R.] Brattleboro, Vt.

THOMAS BARRACLOUGH & CO.,

MANCHESTER, ENGLAND, Makers and Patentees of HECKLING, SPINNING, LAYING, and other Machines, for the Manufacture of ROPE, LINES, CORD, TWINE, 19 19*] FISHING LINES, SPUN YARN, NETS, ETC.

TWENTY-FIVE PER CENT OF THE COST

of Fuel saved annually by the use of Hair and Wool Felt as applied and for sale by JOHN ASHCROFT 50 John street, New York. Send for Circular. 19 12*

PATENT POWER AND FOOT-PUNCHING

PRESSES, the best in market, manufactured by N. C. STILES & CO., West Meriden, Conn. Cutting and Stamping Dies made to order. Send for Circulars. 123 tf

STEAM ENGINES AND BOILERS.—

By making the Steam-Engine business a speciality, with exclusive and carefully prepared Patterns, and all the advantages of special Machinery and tools, and division of labor, we are producing a far more perfect, complete, and better article than can be procured elsewhere, at even much higher prices. WOODBURY, BOUTH & CO., Rochester, N. Y. 21 5*]

THE STEAM SIPHON PUMP IS THE MOST

simple, direct, and effective device for raising water by steam yet discovered. It is an independent lift and force pump, without piston, plunger, valves, or any movable part. It cannot get out of order, or freeze up, and can be used wherever there is a steam boiler, either with high or low pressure. It is an efficient fire engine, and the best bilge pump known. Address STEAM SIPHON COMPANY, 48 Devon street, New York. 22 tf

PRESSURE BLOWERS.

PRESSURE BLOWERS—FOR CUPOLA FURNACES, Forges, and all kinds of Iron Works. The blast from this blower is four times as strong as that of ordinary fan blowers, and fully equal in strength to piston blowers, when applied to furnaces for melting iron. They make no noise and possess very great durability, and are made to run more economically than any other blowing machine. Every blower warranted to give entire satisfaction. Ten sizes, the largest being sufficient to melt sixteen tons of pig iron in two hours. Price varying from \$40 to \$345. FAN BLOWERS, from No. 1 to No. 45, for Steamships, Iron Mills, Ventilation, etc., manufactured by B. F. STURTEVANT, 7 7 tf] No. 72 Sudbury street, Boston, Mass.

OIL! OIL!! OIL!!!

For Railroads, Steamers, and for machinery and Burning, PEASE'S Improved Engine Signal, and Car Oils, indorsed and recommended by the highest authority in the United States and Europe. This Oil possesses qualities vitally essential for lubricating and burning, and found in no other oil. It is offered to the public upon the most reliable, thorough, and practical test. Our most skillful engineers and machinists pronounce it superior to and cheaper than any other, and the only oil that is in all cases reliable and will not gum. The "Scientific American", after several tests, pronounces it superior to any other they have used for machinery. For sale only by the Inventor and Manufacturer, F. S. PEASE, No. 61 and 63 Main street, Buffalo, N. Y. N. B.—Reliable orders filled for all the world. 24 tf

NITRO GLYCERIN.—A CARD.—IN REPLY

to Col. Shaffner's suggestion in his favor of 20th inst. " Hoping the United States Blasting Oil Co. would not increase the price of Nitro Glycerin above \$1 75 per pound," I would say that, although possessed of a monopoly, our motto is "quick sales and small profits," and we shall at all times supply the trade at the lowest possible price, reserving only a fair manufacturing profit on the article. When it is known that more than ninety per cent. of the cost of blasting is expended in labor of drilling, and that four-fifths of this drilling can be saved by the use of Nitro Glycerin, the price, whether \$2 or \$5 per pound, is but a trifling consideration on to the contractor, miner, or quarryman, but our aim is, and always will be, to furnish it to the public at a price far below that of any kind of blasting material, to say nothing of the very many advantages arising from the use of this valuable compound. ISRAEL HALL, President U. S. Blasting Oil Co. No. 32 Pine street, New York. 24 1

Improved Device for Steering Children's Sleds.

The charm and excitement of coasting is one which will never lose its attraction to the young, and is one of the last of childhood's pleasures to fade from the memory of the man. Even the weariness attendant upon its exercise, the dangers of collisions, the sudden capsizing into the snow bank, are all elements of the youngster's enjoyment. The abrasion of boot toes worn out by steering is, perhaps, the only drawback to unmixed pleasure. The device herewith shown is intended to obviate the necessity for steering the sled at the expense of heel and toe. Its operation is easily understood. On the outside of the runner, or of the side rail, a curved lever is pivoted, as at A, the short end reaching the snow, and being shod with iron or steel, and the long end reaching to the front of the sled and guided by a clasp, B.

These levers are operated by the drawing cord, which is divided at the ends, one part attached in the usual manner to the runner and the other to the end of the lever. The relative length of these ends is so arranged that when drawing the sled the shod ends of the levers are kept free of the ground. In use the sled can be steered by pulling upon either line, or brought to a stop by holding in on both. The advantages claimed are that the dangers of collisions are lessened by the more perfect control over the course and velocity of the sled, that there is no wear of shoe leather, and that the rider can maintain an upright position. This contrivance can be easily applied to any sled used, whether frame or box.

A patent was issued through the Scientific American Patent Agency, to N. P. Lindergreen, of Boston, Mass., Aug. 21, 1866, whom address at No. 7 Commercial Wharf, Boston, for State, county, and manufacturer's rights.

Improved Driving Reins and Check.

Many humane people, and some societies for the prevention of cruelty to animals, have had their attention drawn to the barbarous use of the check-rein on man's faithful servant and favorite companion, the horse. The matter has been agitated in our newspapers, and so far as it directed attention to the evil, and thus removed the first obstacle to improvement, it was well. But some practical and feasible mode of abolishing the check-rein, or preventing its abuse, should follow. The engraving accompanying shows how this can be accomplished without injuring the appearance or style of the horse, and at the same time relieving the animal from the absolute and relentless bondage of the check-rein.

In the engraving it will be seen that the check is

but a part of the guiding reins. The loop of the reins is placed on the hook of the saddle at A, and united by a sheath just in front of the hook. The reins then divide and pass on either side of the head through the runner, B, provided with a pulley, and through an attachment to the bit at C, also provided with pulleys. From the bit the reins pass through the martingale rings at D, thence through the saddle rings, as in ordinary harnesses.

It will be seen that the elevation of the horse's head is always under the control of the driver. By



LINDERGREEN'S SLED GUIDE.

drawing on the reins the horse's head will be raised, and by slacking the reins he can lower his head even enough to drink, which will obviate the necessity of getting out of the carriage to unhook the check-rein. The pulleys give entire control over a hard-bitted horse, while at the same time the most tender-mouthed horse need not receive injury. If the horse pulls on the bit to relieve himself of the strain, the driver can give him rein, and thus at all times he is more perfectly *en rapport* with his horse than by the ordinary check and rein. The simplicity, utility, and advantages of this arrangement can be understood at a glance.

Patented through the Scientific American Patent

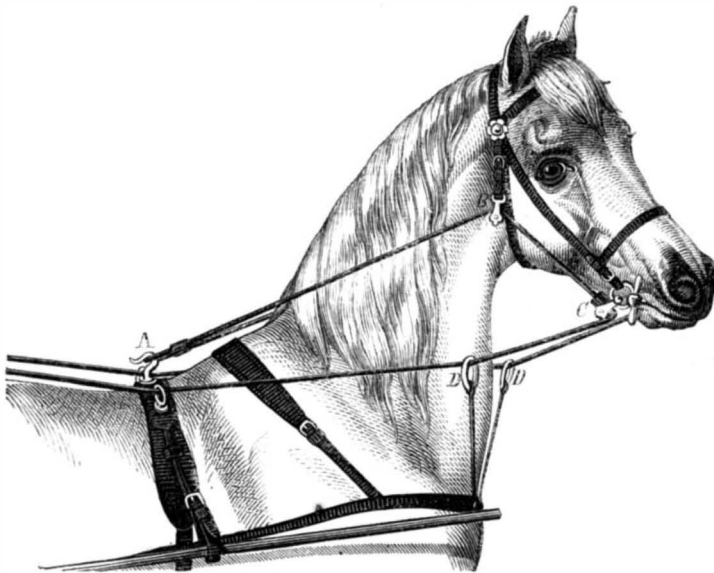

CLARK'S COMBINED CHECK AND REINS.

Agency Nov. 20th, 1866, by Rev. William Clark, of Valatie, Columbia Co., N. Y., whom address for particulars.

A CORRESPONDENT writing from Jordan, N. Y. says they make more skates up there than the establishment at Worcester, which we noticed some time ago. The Worcester concern report 25,000 pairs per annum, and they employ 35 hands. The Jordan concern reports 55,000 pairs made this year and only 23 hands. So far as heard from, Jordan is ahead.

A CORRESPONDENT at Washington questions the statement made by Capt. Norton, and published in our last number wherein he claims to be the original inventor of elongated projectiles for rifled ordnance.

PROF. DUSSAUCE of the Chemical Laboratory, New Lebanon, N. Y., has been appointed one of the Commissioners to the Paris Exhibition. We hope to have the pleasure to publish some correspondence from the Professor while he is at Paris.

THE Scientific American. TO BE ENLARGED For 1867.

This valuable journal enters upon its twenty-second year on the first of January next, at which time the Publishers have determined to considerably enlarge and otherwise improve it. The SCIENTIFIC AMERICAN is the oldest, and, by general consent, the most popular Journal of Science ever published; and, in point of circulation, it is safe to say that it exceeds the aggregate issues of all similar papers in this country and Great Britain combined.

The first number of the SCIENTIFIC AMERICAN, a folio of four pages, appeared in the summer of 1845. Soon after its appearance the form was changed to a quarto of eight pages. In 1859, encouraged by the great success which met their efforts, the Publishers determined to double its size to sixteen pages. But this enlargement has finally proved inadequate to the great demand upon its columns, and, in spite of the greatly enhanced cost of paper and all other materials, the Publishers have decided that their journal must be enlarged, *without any increase in the terms of subscription*, confident that their generous patrons will appreciate the benefits of the proposed change, and lend their influence to increase its subscription list. It has been the constant aim of the editors of this journal, who are aided by some of the best known scientific writers in the country, to discuss all subjects relating to the Industrial Arts and Sciences in a plain, practical, and attractive manner.

Having access, also, to all the principal Scientific Journals of Europe, the editors have unequalled facilities for gathering up for the benefit of their readers, a record of all the important Inventions and Discoveries of European Nations.

Avoiding all political and partisan questions, the SCIENTIFIC AMERICAN is universally recognized as the leading exponent of American Industry, in every department. All the latest and best Inventions of the day are described and illustrated by SPLENDID Engravings, prepared expressly for its columns by the first Mechanical Engravers in the country.

It would be impossible within the limits of this Prospectus, to enumerate the great variety of subjects which are discussed and illustrated. A few only can be indicated, such as Steam Engineering, Fire-arms, Mechanics' Tools, Manufacturing Machines, Farm Implements, Hydraulic Engines, Wood-working Machines, Chemical Apparatus, Household Utensils, Curious Inventions, beside all the varied articles designed to lighten the labors of man in the Shop, Factory, Warehouse, and Household.

The SCIENTIFIC AMERICAN has always been the Advocate of the Rights of American Inventors. Each number contains a weekly list of Claims of Patents, furnished expressly for it by the Patent Office. In this particular, no other journal now published can approach it, as the Publishers, Messrs. MUNN & CO., have long been recognized as the most extensive Solicitors in the world of American and Foreign Patents, their business amounting to more than one-third of all the claims presented at the Patent Office.

With such advantages and facilities, the columns of the SCIENTIFIC AMERICAN are almost exclusive in their value to all who desire to be well informed about the progress of Art, Science, Invention, and Discovery.

Patent Law Decisions, and questions arising under these laws, are fully and freely discussed by an able writer on Patent Law. Correspondents frequently write that a single recipe will repay them the whole cost of a year's subscription.

Published Weekly, two volumes each year, commencing January and July,

Per annum.....\$3 00
Six months..... 1 50
Ten copies for One Year.....25 00

Canada subscriptions, 25 cents extra. Specimen copies sent free Address

MUNN & CO., Publishers,
No. 37 Park Row, New York City.

Messrs. MUNN & CO. have had twenty years' experience in procuring Patents for New Inventions. Inventors who may have such business to transact can receive free, all needful advice how to proceed.

FROM THE STEAM PRESS OF JOHN A. GRAY & GREEN.