

Scientific American

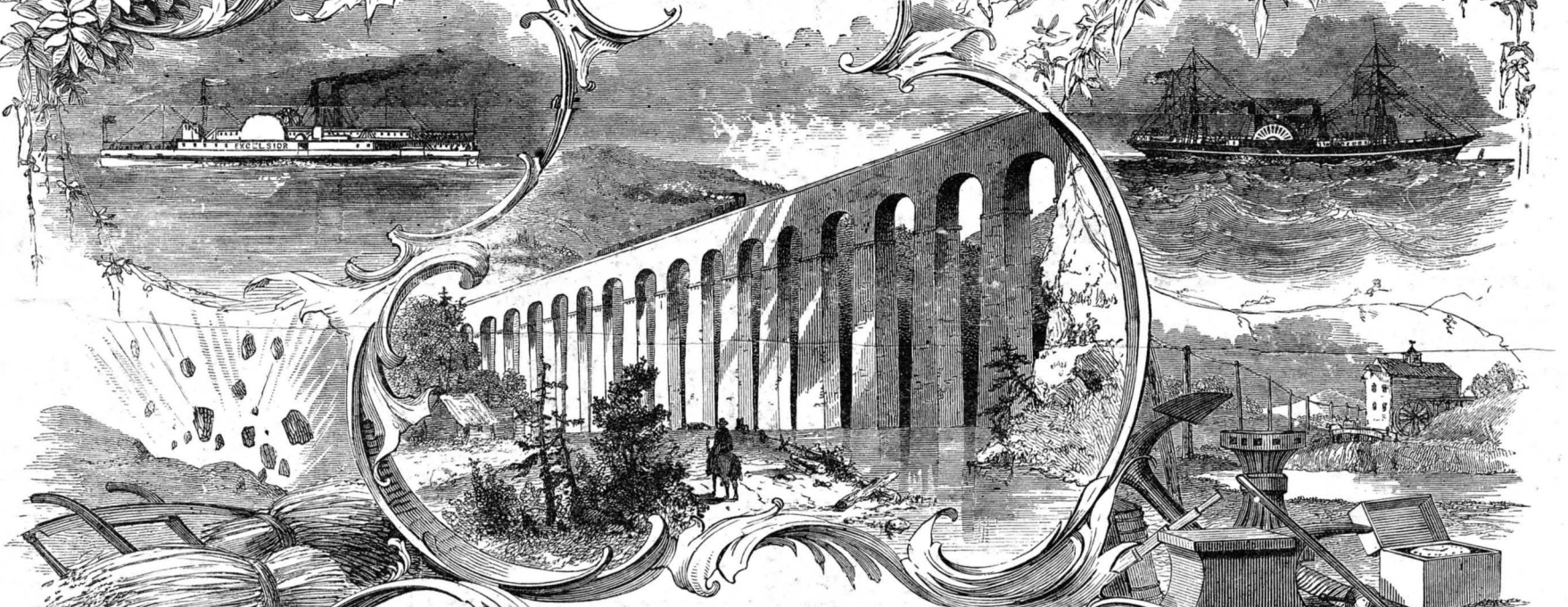

AN ILLUSTRATED
JOURNAL OF ART, SCIENCE & MECHANICS

VOL. LIV.



NEW-YORK
PUBLISHED BY MUNN & CO.

SCIENTIFIC AMERICAN

[Entered at the Post Office of New York, N. Y., as Second Class Matter.]

A WEEKLY JOURNAL OF PRACTICAL INFORMATION, ART, SCIENCE, MECHANICS, CHEMISTRY, AND MANUFACTURES.

Vol. LIV.—No. 1.
[NEW SERIES.]

NEW YORK, JANUARY 2, 1886.

[\$3.20 per Annum.
[POSTAGE PREPAID.]

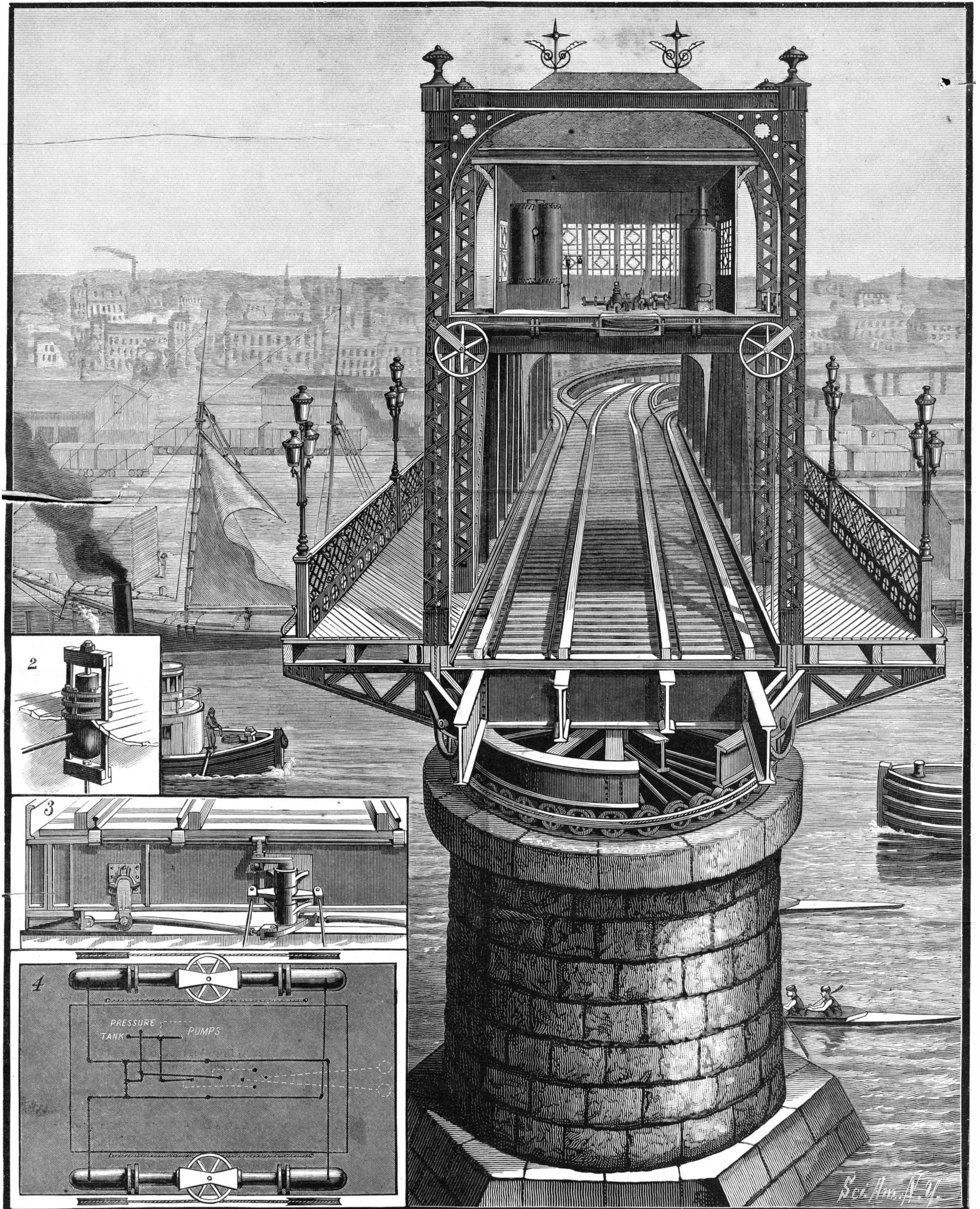

HYDRAULIC MACHINERY FOR OPERATING THE DRAWBRIDGE ACROSS THE HARLEM RIVER AT SECOND AVE. N. Y. CITY.—[See page 6.]

Scientific American.

ESTABLISHED 1845.

MUNN & CO., Editors and Proprietors. PUBLISHED WEEKLY AT No. 361 BROADWAY, NEW YORK.

O. D. MUNN.

A. E. BEACH.

TERMS FOR THE SCIENTIFIC AMERICAN.

One copy, one year, postage included.....\$3 20 One copy, six months, postage included..... 1 60

Clubs.—One extra copy of THE SCIENTIFIC AMERICAN will be supplied gratis for every club of five subscribers at \$3.20 each; additional copies at same proportionate rate. Postage prepaid. Remit by postal order. Address

MUNN & CO., 361 Broadway, corner of Franklin Street, New York.

The Scientific American Supplement

is a distinct paper from the SCIENTIFIC AMERICAN. THE SUPPLEMENT is issued weekly. Every number contains 16 octavo pages, uniform in size with SCIENTIFIC AMERICAN. Terms of subscription for SUPPLEMENT, \$5.00 a year, postage paid, to subscribers. Single copies, 10 cents. Sold by all newsdealers throughout the country.

Combined Rates.—The SCIENTIFIC AMERICAN and SUPPLEMENT will be sent for one year, postage free, on receipt of seven dollars. Both papers to one address or different addresses as desired.

The safest way to remit is by draft, postal order, or registered letter. Address MUNN & CO., 361 Broadway, corner of Franklin Street, New York.

Scientific American Export Edition.

The SCIENTIFIC AMERICAN Export Edition is a large and splendid periodical, issued once a month. Each number contains about one hundred large quarto pages, profusely illustrated, embracing: (1.) Most of the plates and pages of the four preceding weekly issues of the SCIENTIFIC AMERICAN, with its splendid engravings and valuable information; (2.) Commercial, trade, and manufacturing announcements of leading houses. Terms for Export Edition, \$5.00 a year, sent prepaid to any part of the world. Single copies, 50 cents. Manufacturers and others who desire to secure foreign trade may have large and handsomely displayed announcements published in this edition at a very moderate cost.

The SCIENTIFIC AMERICAN Export Edition has a large guaranteed circulation in all commercial places throughout the world. Address MUNN & CO., 361 Broadway, corner of Franklin Street, New York.

NEW YORK, SATURDAY, JANUARY 2, 1886.

Contents.

(Illustrated articles are marked with an asterisk.)

Table listing various articles such as 'Astronomical notes', 'Bell telephone case', 'Books and publications', 'Bridge, draw, hydraulic machinery for operating', etc., with corresponding page numbers.

TABLE OF CONTENTS OF SCIENTIFIC AMERICAN SUPPLEMENT No. 522, For the Week Ending January 2, 1886.

Price 10 cents. For sale by all newsdealers.

Table listing sections I through VII, including 'CHEMISTRY, ETC.', 'ENGINEERING, ETC.', 'TECHNOLOGY', 'DECORATIVE ART AND ARCHITECTURE', 'BIOLOGY, NATURAL HISTORY, ETC.', 'HYGIENE, MEDICINE, ETC.', and 'MISCELLANEOUS'.

IMPROVE THE CHANNELWAYS.

The gradual shoaling, or filling up, of the harbor of New York has long been a cause of anxiety to those interested in the commerce of the port. The big steamers as they pass in and out constantly find bottom where before they ran clear, and the pilots complain that, unless something is soon done, it will become a difficult feat to guide the heaviest draught ships safely in, save under phenomenal conditions of tide. A hydrographic survey of the port and its approaches has been for some time in progress, and this serves only to corroborate the assertion made by the pilots that the channels are filling up.

Last week the agents of the transatlantic steamship lines appealed to the Chamber of Commerce to have something done in the way of deepening the channels. They say:

"Builders have now to construct vessels with limited draught to suit this particular port; but even under these restrictions they at times run great danger in having to drag themselves through the sand and mud, and over exceedingly shoal places, when the least error in handling or failure in machinery might cause most disastrous results, not only to property, but to human lives. New York requires a channel having a constant depth of not less than thirty feet and a width sufficient to allow ample working room for vessels to steam full speed through it at all states of the weather and tides, day or night; otherwise, she cannot retain the prominence and business she has a right to expect."

In response to this, the Chamber passed a resolution in which it is decided to ask Congress to appropriate money for the deepening and widening of a channel which shall have a depth of thirty feet at mean low water.

It seems proper that a body containing so many public-spirited citizens and merchants identified with the commerce of the port should take steps looking to its commercial welfare, and yet it cannot be denied that such attempts often fall short of their mark, and miscarry, by reason of ill-advised recommendations on the part of those who draw up the resolutions. Only recently the work of improving Gedney's channel was stopped after \$80,000 had been thrown away, because Nature did not act in the way the directions going with the appropriations insisted it should. Congress was asked to appropriate \$200,000 for loosening the sand at the bottom of Gedney's channel, it being declared that when thus loosened Nature would do the rest by carrying it safely out to sea on the ebb tide. Congress did what was expected of it, but Nature didn't, and there remains at this moment, so far as the lead line will determine, the same quantity of material at the bottom of Gedney's channel as there was before the work was begun, and also an unexpended balance of \$120,000 in the hands of the government agents.

Apparently regardless of the result of this abortive attempt to interpret Nature's processes, the Chamber of Commerce last week pledged itself through its resolutions to "suggest" to Congress:

"That such contract have all payments conditioned upon actual accomplishment of work to the value of such payments, and the profits to be largely, if not wholly, dependent on the demonstration of the ability of such channel to maintain itself in depth and width chiefly by the operations of Nature after complete construction."

In other words, the prospective contractor must practically assent to the proposition that Nature will keep the channel clear by the process known as "scour" when he shall have once dredged it to the required depth.

It seems to be forgotten that the principal cause of the filling up of these channelways is the unlawful dumping of refuse into the waters of the harbor.

The intelligent physician always seeks to remove the cause which produced his patient's malady before seeking to give relief, and the physical hydrographer, if capable, would naturally seek to remove the causes of bar or shoal formation before beginning their forcible removal.

It was in this way Mr. Eads succeeded in removing the bars at the mouths of the Mississippi below New Orleans. The law says that the garbage scows must be dumped three leagues outside of Sandy Hook on the first of the ebb tide, and also fixes a severe penalty for throwing ashes and clinker into the bay or rivers from steam vessels. Yet it is well known by those who have looked into the matter that the scows are unloaded as soon as they are sufficiently far from land to escape detection. As a matter of fact, under conditions of wind and sea which often prevail, the loaded scows could not live at the distance to sea they are expected to go. As to the steamers, steamboats, and tugs, most of them dump wherever it is most convenient.

The writer, who assisted in a physical survey made of New York harbor by the United States Coast Survey some years since, can testify that marked material dumped in the bay and the North and East rivers found its way into the Swash, the East, Gedney's, and the main ship channel, and that dredgings in these channels disclosed the fact that they were partially filled

with ashes, clinker, and other foreign material. Stop this unlawful dumping first, and dredge out the channels afterward.

THE BELL TELEPHONE CASE.

Associated Press reports state that the Interior Department has decided to recommend that the Attorney-General authorize suit to be brought in the name of the United States to test the validity of Bell's original patent. Although the full text of the decision will not appear for some days, it is said that it will set forth, among other things, that "the specification of Bell's patent contains nothing about the capability of Bell's instrument to transmit articulate speech, but only claims for it the power to transmit 'vocal sounds;' that an instrument may transmit 'vocal sounds' without being a speaking telephone; and that, in point of fact, Bell did not invent a speaking telephone until after the issue of his patent, as appears from the record." For these reasons, it will be urged, the validity of the Bell patent is fairly questionable.

An Enormous Granite Slab.

To separate from the main ledge a slab of granite 354 feet long, 3 to 4 feet thick, and 11 feet wide, is no ordinary feat to accomplish.

But this has been done at the Flynt Granite quarry, in Monson, Mass., and by the means usual in all quarries for separating slabs or blocks from the main ledge. A row of wedges were set, several hundred in number, and the workmen beginning at one end gently and carefully tapped the wedges, moving by degrees down the line, until the other end of them was reached, when the same operation was repeated.

In this manner, by careful and patient application, aided by favorable conditions of the weather, the slab of the above phenomenal size was successfully separated from the main rock.

The value of this immense slab, if it could have been transferred safely to one of our large cities, at not too great cost, would have been several thousand dollars. And it seemed almost sacrilegious that it was necessary to cut it up into smaller blocks for transportation and finally used for ordinary building purposes.

The possibility of getting out a slab of such size without breaking it indicates that the grain of the Monson granite not only runs evenly, but that it possesses great tenacity.

Separation of Solder from Old Zinc.

According to the Revue Industrielle, a new method has been introduced by M. Piallat for dealing with the clippings, shavings, turnings, and other forms of waste zinc resulting from various manufactures. The values of these forms of old zinc are very much lower than that of new zinc, because there is always an amount of solder present which spoils the zinc for rolling and for most other direct uses, and the difference in value is so considerable that M. Piallat considered the subject of treating this zinc debris to be well worth study and experiment. It is stated that he has fully succeeded in making a very profitable success of his labors.

He places the zinc cuttings, etc., in a sort of basket, in which they can be subjected to heat and to centrifugal force at the same time. The actual basket-like container is surrounded by an outer envelope. Superheated steam or heated air can be used, and the temperature regulated as desired. Under the influence of the heat and the centrifugal action, the solder is melted, detached from the zinc, and driven to the exterior of the container, where it collects and is drawn off. The solder thus collected is remelted and cast into bars. It is stated that the value of it alone will pay all the costs of the operation. The zinc remaining after this operation is further purified by fusion. It is then very suitable for use in making small castings, and can be sold at lower price than the brands of zinc which are now specially in use for this purpose.

This branch of trade is stated to be of considerable importance, great quantities of zinc being used in Paris alone for casting figures and in clock making. M. Piallat estimates that one of his machines, working ten hours per day, can extract the solder from three tons of old zinc. This amount of purified zinc will be too great to be all disposed of for casting purposes, and so the remainder is to be rendered pure and soft enough for rolling into sheets. It is stated that M. Piallat has also found a method of purification far superior to any in ordinary use, and producing a better quality of metal than any on the market, but this method is kept secret at present.

Wash-bottle for Chemical Laboratories.

Mr. J. F. Sleeper, of Portland, Maine, writes us that the improved washing apparatus for laboratory use, which was described by Mr. H. B. Battle in our issue of November 28, was first invented by himself a number of years ago, and introduced by him in a modified form into the Government Assay Office in New York. He says it was in practical operation for a couple of years, and gave complete satisfaction.

NIGHT SKY.—DECEMBER AND JANUARY.

BY RICHARD A. PROCTOR.

The Great Bear (*Ursa Major*) is now rising well above the horizon, in the northeast, the pointers about midway between north and northeast. A line from the Pole Star to the Guardians of the Pole is now in the position of the minute hand of a clock about 28 minutes past the hour. The Dragon (*Draco*) lies due north, curving round under the Little Bear, its head close to the horizon. Low down in the northwest is a part of the Swan (*Cygnus*). Higher up we see King *Cepheus*, his wife *Cassiopeia*, and their daughter *Andromeda* (the Seated Lady and Chained Lady, respectively), with the Rescuer, *Perseus*, nearly overhead. The Winged Horse is setting, his head close by the western horizon, and near the jar of the Water Bearer (*Aquarius*).

In the southwest is the Whale, and close by the constellation *Pisces*, or the Fishes; above them the Ram (*Aries*), between which and *Andromeda* the Triangle can be seen.

In the south the River *Eridanus* makes now its best show. Its leading brilliant, *Achernar*, is, however, never seen in the United States. In the southwest the Great Dog with the splendid *Sirius* ("which brightest shines when laved of ocean's wave") shows resplendently. Above is *Orion*, now standing upright, treading on the Hare (*Lepus*) and facing the Bull (*Taurus*), now at its highest. The Dove (*Columba*) below the Hare is a modern and not very interesting constellation.

The Little Dog (*Canis Minor*) is on the east of *Orion*. In the east the Sea Serpent (*Hydra*) is rising, and due east a little higher we find *Cancer*, the Crab (note the pretty cluster called the Bee Hive—*Præsepe*); above are the Twins (*Gemini*), and above them the Charioteer (*Auriga*), with the bright *Capella*, nearly overhead.

The Lion is rising in the northwest, his heart star *Regulus* (α) being low down a little north of east.

Lastly, due north, high up, the absurd Giraffe (*Camelopardus*) stands proudly on his ridiculous head.

Prof. John C. Draper.

Dr. John C. Draper died at his residence in New York city, on Dec. 20, after three days' illness from pneumonia. He was born in Prince Edward County, Va., in 1835, and was educated at the University of the city of New York. After graduation, he spent a year abroad. He occupied positions of responsibility at different times in Bellevue Hospital, the University, and Cooper Institute. During the war, he acted as volunteer surgeon, and at the time of his death occupied the chair of physiology and natural history at New York College, and of chemistry in the medical department of the University. As an investigator and writer, Dr. Draper attained considerable distinction. He was connected for some years with *Scribner's Magazine*, and just before his death published an advanced text-book on medical physics, which promises to be of much importance.

The Prevalence of Hydrophobia.

Hydrophobia is so terrible a disease that for many years undoubted cases of the malady have been reported by the newspapers with almost the same regularity that they have chronicled murders, suicides, or other tragedies. It is therefore impossible to believe, as has been suggested, that the present unfortunate abundance of news of this character has been called forth by the widespread discussion of Pasteur's researches. The dreaded malady has made its appearance in so many and such widely separated districts that it has almost the appearance of an epidemic. In various parts of the Continent—in Russia, Austria, Switzerland, France—numerous individuals have been bitten by rabid dogs, and many of them have suffered a terrible death. Others undertook the journey to Paris, and are now under treatment,

while a few less fortunate ones left their homes only to be stricken down on the way. In England it has been particularly prevalent, and has occasioned much alarm. It is a country which is never altogether free from the disease, but during the past few weeks the outbreak has been of unusual extent. In London, which, next to Lancashire and the West Riding of Yorkshire, is pronounced by the *Lancet* to be the home of rabies, so many cases have occurred that a lively discussion, both legal and medical, has been provoked. It is complained that there is a great laxity in the laws regulating the destination of stray dogs, and an even greater carelessness in enforcing those enactments which already exist. At each epidemic there is a general outcry, but with the disappearance of the disease the cry is soon stifled, and the reappearance of the epidemic made possible. Children are particularly susceptible to attack from rabid animals. Their size and strength make the encounter very unequal. When bitten, the child is usually in much greater danger than the adult, since the bite is more apt to be on the bare skin, where no clothing can hinder the virus from coming in contact with the blood. The London outbreak has raised the

sent to Pasteur in charge of Dr. Billings, two or three other patients are now on their way to Paris for treatment. Some of these go at their own expense, while others, not able to afford such a journey, owe their opportunity to public generosity. The epidemic seems spreading in New Jersey. Each day bring news of more rabid dogs and more injured people. The list is already very large; and should only the usual 50 per cent of those bitten develop hydrophobia, the suffering and death in store will be appalling. In the West, cases in several localities have been reported. At Milwaukee, Wis., much alarm has been felt. One of the victims, a Bohemian workman, who was bitten in the latter part of November, developed premonitory symptoms of hydrophobia. As the theory had been advanced that a Turkish bath was an excellent preventive, submitted to several hours in the sweating room, and at last reports had recovered his usual health.

We have recorded his case because, being an ignorant man, and unacquainted with the symptoms of hydrophobia, his attack cannot possibly be ascribed to the effect of imagination. These details have been repeated in so many communities throughout the land that some relief action becomes imperative. It is to be hoped that the widespread alarm will be productive of such preventive measures as getting rid of all stray dogs at once, and of a thorough investigation of Pasteur's method of treatment. If his treatment prove effective, we are permitting an unnecessary sacrifice of life. If not, it is time that some other clew should be followed.

Electrical Selenium Plates.

The plates of Mr. Ch. E. Fritts, of New York, are described as consisting of a thin, homogeneous sheet of selenium, spread upon a metal plate, and covered over with a fine gold leaf.

The illumination of the gold leaf by direct sunlight increases the conductivity of the selenium plate to an enormous extent. By means of a modification of this simple apparatus, Mr. Fritts now believes that he can accomplish the conversion of the greater portion of the energy of light into electrical energy, and if so, we may, ere long, see the photo-electric plate competing with the dynamo electric machine itself. Thus, for instance, the light of the sun would be converted into electricity, and the latter again into light.

These and similar experiments in which selenium is largely employed attach considerable importance to new methods of procuring this valuable substance.

New seleniferous minerals are spoken of as existing in California and Bolivia, but the main source of this element at present is the flue dust and red acid deposits which arise from the manufacture of sulphuric acid from pyrites. The selenium originally present in the pyrites is met with in every stage of the process. All that is required is some economical method of concentrating it, and so collecting it all together.

Whales off Long Island.

The neighborhood of Easthampton, L. I., was thrown into considerable excitement on the 12th of December by the announcement that several whales had been sighted to the southwest, and about five miles out. The whalers started after their game at once, and succeeded in capturing two, a large bull and a cow. The fight lasted over an hour, and carried the hunters fifteen miles out to sea. The animals were towed back to shore, and landed on the beach at Amagansett. The bull measured fifty feet in length, and the cow seventy feet. It is estimated that they will yield from 125 to 150 barrels of oil and about 1,800 pounds of bone. The net profit will probably amount to several thousand dollars. It is seldom that the whale appears on this coast so early in the season, and the fact of the double capture has raised anticipations of a prosperous winter's work.

NIGHT SKY: DECEMBER & JANUARY.

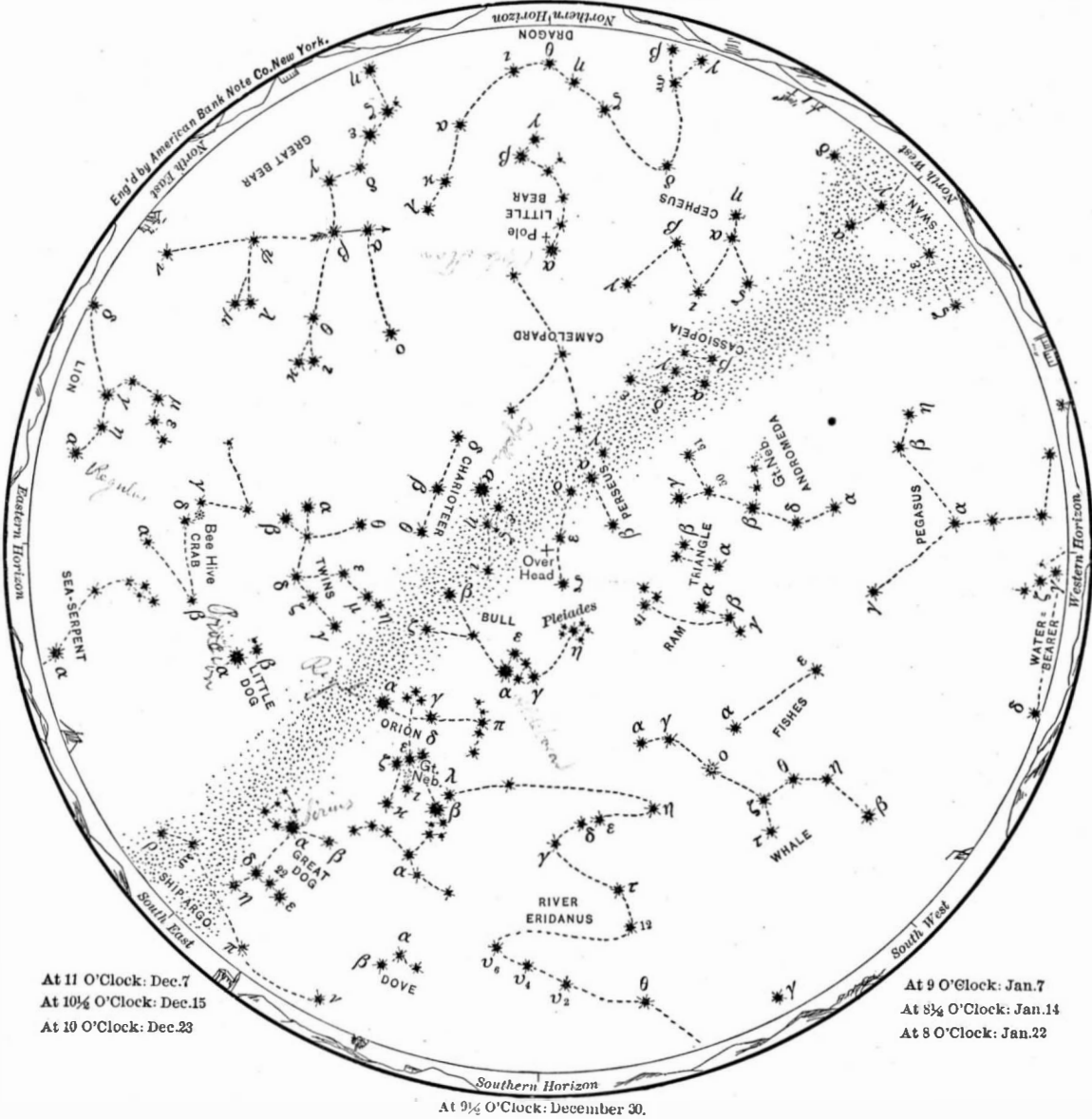

In the map, stars of the first magnitude are eight-pointed; second magnitude, six-pointed; third magnitude, five-pointed; fourth magnitude (a few), four-pointed; fifth magnitude (very few), three-pointed, counting the points only as shown in the solid outline, without the intermediate lines signifying star rays.

FIRE ESCAPE LADDER.

The rounds of the ladder are connected to opposite side ropes or chains by tying the ropes around the rounds near their ends, the rounds being reduced in diameter at these points to prevent slipping. The upper end of the ladder is supported by a metal hanger or frame, the shape of which is clearly shown

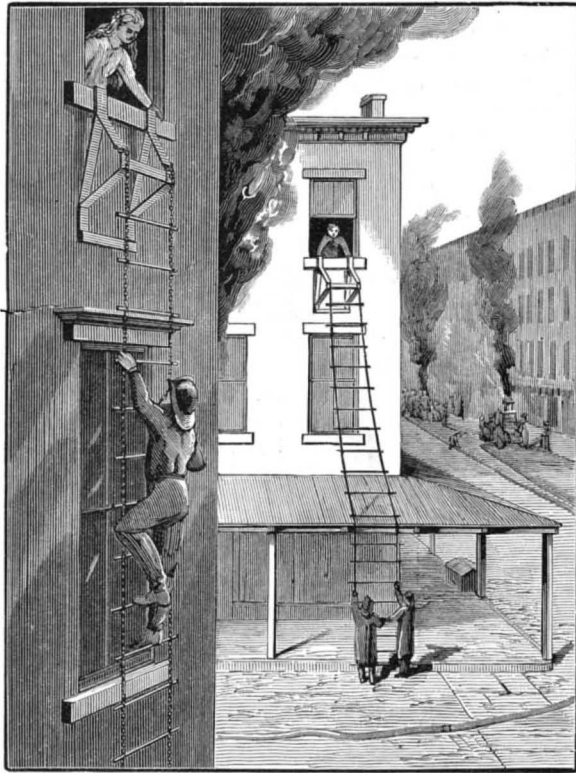
**ROSE'S FIRE ESCAPE LADDER.**

in the engraving. The upper ends of the sides of the hanger are bent to form inwardly projecting hooks, which are adapted to be caught over and behind the window sill, to give a strong support to the hanger and consequently to the ladder. It will be seen that the ladder hangs clear of the capstones and sills of the windows below the hanger. The lower round is made of such length that it may be extended across a window if it should be necessary to support the ladder from that end. The ends of this round also form handles, by which the lower end of the ladder may be drawn back from the building. It is evident that the ladder may be rolled up and stored away with the hanger; the apparatus is always ready for use, and requires but a few moments to place it in position. This invention has been patented by Mr. Alexander Rose, of Lawrence, Kansas.

IMPROVED SQUARE.

This square is for the use of carpenters and other wood workers in marking out their work in order to form perfect joints, and is particularly applicable for use in weather-boarding houses. The stock is preferably made of wood faced with metal. A wide slot is formed in the stock at right angles to the blade, so that the stock actually consists of two parallel legs. The upper end of the slot is at right angles to the face of the stock, so that, when hung upon a weather board, the face of the stock

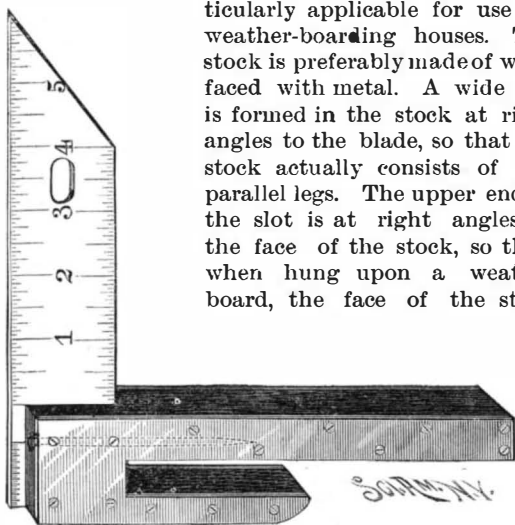
**SEARGEANT'S IMPROVED SQUARE.**

gives a line at right angles to the edge of the board. The blade is graduated as shown, and its projecting end is beveled, in order that it may be used in marking miters. By the use of this square, accurate joints may be formed at the points where the boards abut against the window casings and the corner boards, and in such cases the board is placed in the slot, the outer edge of the stock is brought in line with the casing or corner board, and the board is marked at the exact point where it is to be cut. The square may also be used for all ordinary purposes. In the blade is a hole, so that the square can be hung upon a peg or nail. This invention has been patented by Mr. William F. Seargeant, of Marshall, Missouri.

A Fall of 250 Feet without Severe Injury.

Dr. Evans relates, in the *Bristol Med. Chirurg. Journal*, the history of a girl who attempted suicide on May 8, by jumping from the Clifton Suspension Bridge. The bridge is 250 feet high, and has been a favorite place for suicides. Sixteen persons have been known to have succeeded in self-destruction by making this same leap. One other only was picked up alive, but survived only thirty minutes. Twenty days after the fall the patient was considered convalescent and able to walk without pain. There was apparently no permanent injury. As far as the writer knows, no case of survival after a fall from as great a height as 150 feet has hitherto been recorded, and considers this instance as probably unique.

FARM FENCE POST.

The central part of the post is made of an iron rod, to which the wires forming the panels of the fence are secured. A rod bent spirally in the middle of its length, to form an eye for receiving the center rod, is bent to the form clearly shown in the engraving. The extremities of the rod are bent downward, and inclined slightly inward; near the ends of this rod shoulders are formed. When the post is to be used in hard ground, the main rod is driven vertically into the earth, the eye of the brace is placed on it, and the flattened extremities are either driven into the earth or

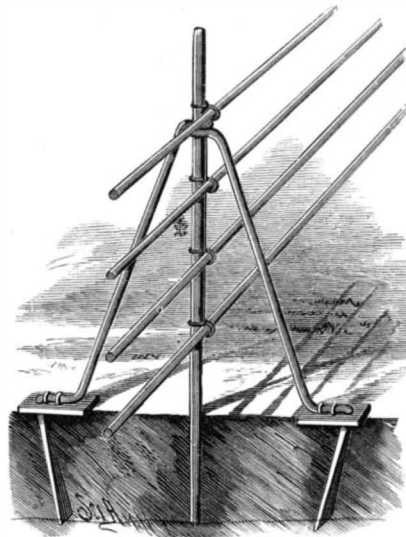
**HICKS' FARM FENCE POST.**

set in holes with the earth tamped around them. When the post is set in soft ground, bearing plates are placed under the shoulders; these plates are apertured to receive the rods, to which they are secured by staples. The posts may be made of half inch iron, and the panels of any wire of suitable size. A fence so constructed has great rigidity with but little weight, and may be quickly erected or taken down.

Further particulars may be obtained from the inventor, Mr. Samuel Hicks, of Orangeville, Ind.

A SEPARATOR TO REMOVE IMPURITIES FROM WHEAT.

In connection with an ordinary grain separator and thrasher, the invention herewith illustrated shows a novel construction and arrangement of parts to facilitate the removal of cheat and other small seeds and impurities from wheat. An opening in the bottom of the elevator trough is covered with a wire screen of such fineness of mesh as to prevent kernels of wheat from passing through, while allowing the passage of finer particles; and this screen is protected from being worn or injured by the friction of the elevator lags by wires placed on the screen longitudinally with the elevator trough, and attached at their ends to stationary parts of the trough bottom. These wires are so put in as to serve for ways on which the elevator lags slide, while the lags themselves come so close to the screen that no kernels of wheat will be left thereon. In the trough of the shoe at the lower end, shown in the engraving in a part broken away, is another fine screen for sifting out small seeds and impurities, and conducting them away into a separate discharge spout.

This invention has been patented by Mr. Andrew T. Hawley, of Alton, Ill.

THE Machine Tool Works, Fred'k B. Miles, Engineer, Philadelphia, has been united with the Industrial Works, William B. Bement & Son, Callowhill and Twenty-first Streets, Philadelphia, and the two establishments are conducted as one by William B. Bement, Clarence S. Bement, Fred'k B. Miles, and William P. Bement, under the firm name of Bement, Miles & Co.

AUTOMATIC DISCHARGER FOR EVAPORATING PANS.

A discharger for evaporating pans, recently invented by Mr. M. E. Sprague, of Plymouth, Vermont, is so constructed as to automatically open an outlet near the bottom of the pan, when the liquid being evaporated has reached the desired density. A hollow float, having a vent tube to allow for the expansion of the air, is provided with an upwardly projecting stem, which may be weighted, as shown. The stem terminates in a slotted portion, to which the free end of a curved lever is adjustably attached. At its fixed, pivoted end the lever is formed with a downwardly projecting arm, which carries a valve. This valve is adjusted to close the outlet of the evaporating pan so long as the hollow float rests upon the bottom. In

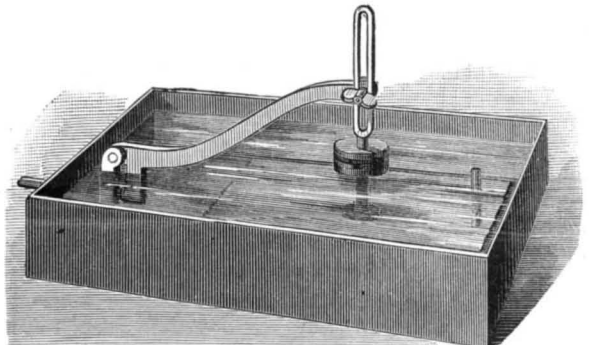
**AUTOMATIC DISCHARGER FOR EVAPORATING PANS.**

operation, the lever is so weighted that the float will not rise until the liquid has reached the proper degree of evaporation. When this point is reached, the rising of the float moves the lever upward, and consequently its downwardly extending arm and valve on the same outward, by which the outlet of the pan is uncovered, and the liquid is automatically discharged. In our illustration, the float is shown resting on the bottom of the pan, and the outlet closed. The adjustable connection between the lever and the stem of the float permits the device to be used on pans of different depths. The discharger is applicable in concentrating sirup, brine, and other liquids, and aims to secure their automatic discharge at any degree of concentration desired.

The Treatment of Obesity.

Starvation, semi-starvation, surcharging, "banting," alkalies, purgatives, Turkish baths, exercise, and the thousand and one ways of reducing corpulency to respectable dimensions, still leave a large section of our stout population in despair. M. Germain See comes to the rescue, and solves (?) the difficulty with his accustomed dash and skill. "Oh, ye massive fat ones desiring to be made lean, eat not much meat, but drink enormously of tea." That is M. See's good news put in a nutshell. That is the cry now to be heard in the Parisian wilderness of fat. Obese individuals may suffer from shortness of breath from many causes, writes M. See, and infiltration of the muscles with fat is an important one. There are many ways of reducing the fat. The first is by diet, the second

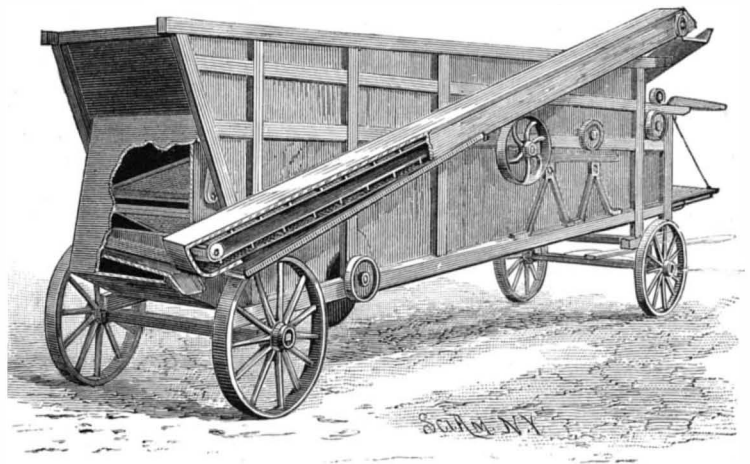
**HAWLEY'S GRAIN SEPARATOR.**

by moderating the imbibition of fluid, the third by muscular exercise; and there are also balneotherapy, or bathing, and treatment by medicaments. M. See does not approve of "banting," as it takes too long; and further, he argues that proteids, such as meat, eggs, etc., are productive of fat. Ebstein has recently advocated "banting," combined with some fatty food; but our author does not fall in with this method. Stout people do not bear bleeding well, although this was the treatment in vogue in the sixteenth and seventeenth centuries. Iodides, alkalies, and diuretics are not well borne by fat persons. Moreover, these medicines, when they reduce obesity, do so by destroying, or at least damaging, the organs on which the nutrition of the body depends.—*Lancet*.

IMPROVED MOTOR.

The motor herewith illustrated can be driven by either water, steam, compressed air, or other fluid. The disks, A B, are encircled by the shell, D, which is provided with an inlet opening, D¹, and outlet opening, D². The shaft, E, is mounted in one of the disks, and is furnished, on its outside, with a pulley; the inner end carries the wheel, F, formed with recesses, F¹, shaped as shown in the sectional elevation, Fig. 2. The rim of this wheel bears against the inner faces of the disks. In the center of the disk, B, is a pin, G, placed eccentrically as compared with the shaft, E, and having a reduced portion forming a bearing for the inner ends of the sliding arms or pistons, H, which are placed with their outer ends in the recesses in the wheel, F.

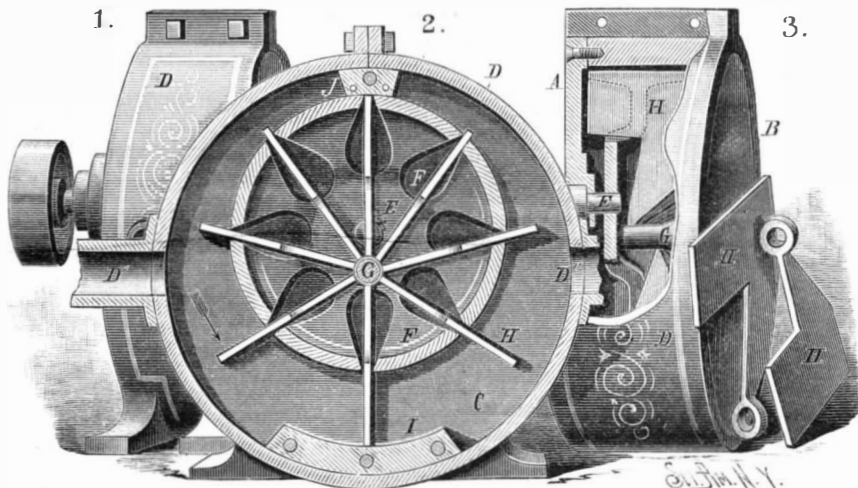

BURRY'S IMPROVED MOTOR.

The outer ends of the arms are as wide as the rim of the wheel; and as the wheel and arms are eccentric with each other, the outer ends of the arms recede or advance in the recesses when the motor is in motion. The symmetrically shaped crosspieces, I and J, in conjunction with the wheel and sliding arms, divide the space between the disks in two equal parts, one of which is in direct connection with the inlet opening, and the other with the outlet.

The fluid by which the motor is driven enters through the opening, D¹, and presses against that part of the arms projecting beyond the rim of the wheel, causing the arms and wheel to rotate in the direction of the arrow. As soon as one of the arms leaves the rear end of the crosspiece, I, the next following arm will enter on the front end of the crosspiece; the fluid will flow out through the opening, D², and will be prevented from re-entering the first half of the space by the crosspieces. The shaft, E, is rotated, and the power thus obtained can be utilized in any desirable manner by proper connections with the pulley.

This invention has been patented by Mr. John Burry, of Fort Reno, Indian Territory.

THE JARMAN ICE MACHINE.

The accompanying engraving represents the "Jarman" ice and refrigerating apparatus, manufactured by the York Manufacturing Company, of York, Pa. These machines possess many features well deserving attention, and are suitable for any place where artificial ice or artificial low temperature is desired; and they are especially adapted for use in warm climates or on ocean steamers, owing to their simplicity and small consumption of water and fuel. The manufacturers claim that this machine has fewer movable parts than any other machine in the market, thereby rendering it less liable to get out of order. It is also claimed that it only requires from one-eighth to one-tenth the quantity of chemicals to reach the same results ob-

tained by other machines; and consequently, not having the same resistance to overcome, it can be run at a very low rate of speed, which naturally reduces the wear and tear, and causes a great saving in fuel; and by a special system of piping a result nearly double is obtained in comparison with the old system in use in some other ice machines. The builders of the "Jarman" ice machine will furnish all further particulars regarding their apparatus, and may be addressed on all subjects relating to the manufacture of artificial ice.

A Remarkable Stroke of Lightning.

The Granite Falls *Journal*, Minnesota, gives an account by N. O. Carle and Christian Olson, farmers of Granite Falls, of the remarkable results of a stroke of lightning which struck the prairie about a mile and a half from Olson's house. It occurred in June last, during a heavy storm.

They say it made a hole in the ground between five and six feet across, and nearly six feet deep, and from this hole there extend six trenches two feet deep, branching off in different directions, and extending for a distance of from six to eight rods. And what was very singular, not a particle of the sod and dirt thrown from the hole and trenches was to be seen, except now

and then a large piece of sod twenty or thirty rods away. Mr. Olson says that by actual measurement the ditches plowed out by the lightning from where it struck were all of an equal distance apart; four of them were of the same length, and the other two six feet shorter. The report is said to have been as terrible as if an explosion had occurred. A lady sitting at a window in a house a mile away sensibly felt the shock; two men were sitting outside another house a mile away from the scene, and so forcibly did they feel it that they immediately jumped to their feet and went into the house without speaking. Mr. C. A. Bennett, editor of the *Journal*, writes us that he vouches for the truthfulness of the above account.

Japanese Patents.

The Japanese Assistant Secretary of State, Koerhiyo Takahaski, a dignitary whose duties are confined chiefly to the Department of Commerce and Agriculture, is now in America, and will visit Washington and the Eastern cities. His mission to this country is to study the American patent system, with a view to improving the administration of that department in his own country. Since the Japanese patent law went into effect, last July, an average of two applications a day have been filed. These have been mainly for patents for agricultural machinery.

IMPROVED GRINDING MILL.

Mr. B. J. Du Bose, of Lisbon (Goshen P. O.), Ga., has patented an improved grinding mill in which the top stone, or runner, is automatically adjusted by a novel arrangement of balances, so as to insure a uniform grinding without the constant attention of the miller.

In the class of mills to which his invention applies, the weight of the runner is upheld by the bridge tree and by the reaction of the grain being ground; but as the expansion and contraction of the runner spindle and other circumstances make the pressure borne by

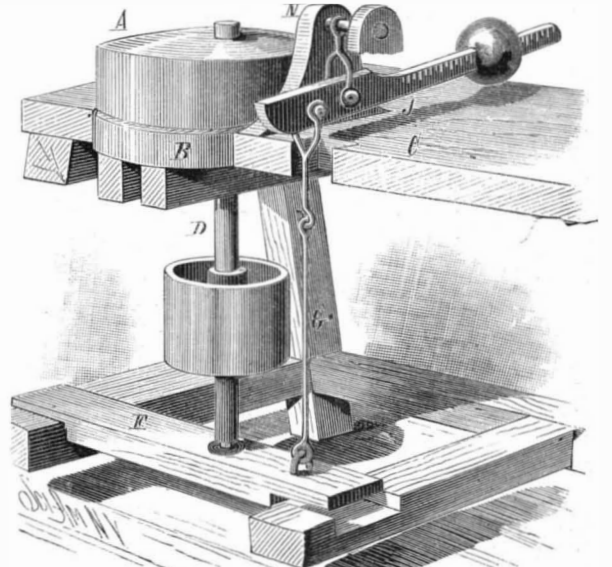

DU BOSE'S IMPROVED GRINDING MILL.

the grain far from constant, the operation of the mill requires careful attention to insure uniformity. In the improved form, the bridge tree, F, supporting the runner spindle, D, is fulcrumed at one end to the mill frame, and has its free end connected by means of the rod, G, and link to the short end of a scale beam or lever, J. A weight or counterpoise is placed on the long arm of the beam, and may be adjusted in different positions.

The distance between the pivotal point of the beam itself and that of the link supporting the bridge tree is such that the movement of the beam between its extreme positions will be comparatively slight. The length of the beam is so determined that the counterpoise, when near the outer end of the long arm, will about balance the weight of the bridge tree and runner stone.

By the arrangement of the beam directly over the free end of the bridge tree, its center of gravity being likewise its center of motion, a delicate balance is established; so that by adjusting the counterpoise nearer or further from the fulcrum of the beam, more or less of the weight of the runner becomes effective in grinding, and this may be determined independently of expansion and contraction of the runner spindle, or other accidental factors. The construction is simple and inexpensive, and allows a greater number of stones to be run with the same attendance.

Removing Silver Stains.

Dr. H. W. Vogel, in the *Photographischer Mittheilungen*, recommends, for removing silver stains from the hands, the same compound that has been used as a reducer, *i. e.*, a mixture of ferricyanide of potassium and hyposulphite of soda. A few crystals of the former substance are dissolved in a solution of hypo, or from 10 to 20 per cent of a 20 per cent solution of the ferricyanide may be added to the hypo solution, and applied to the stains. This substance is not poisonous, and does not destroy the color of articles of clothing.

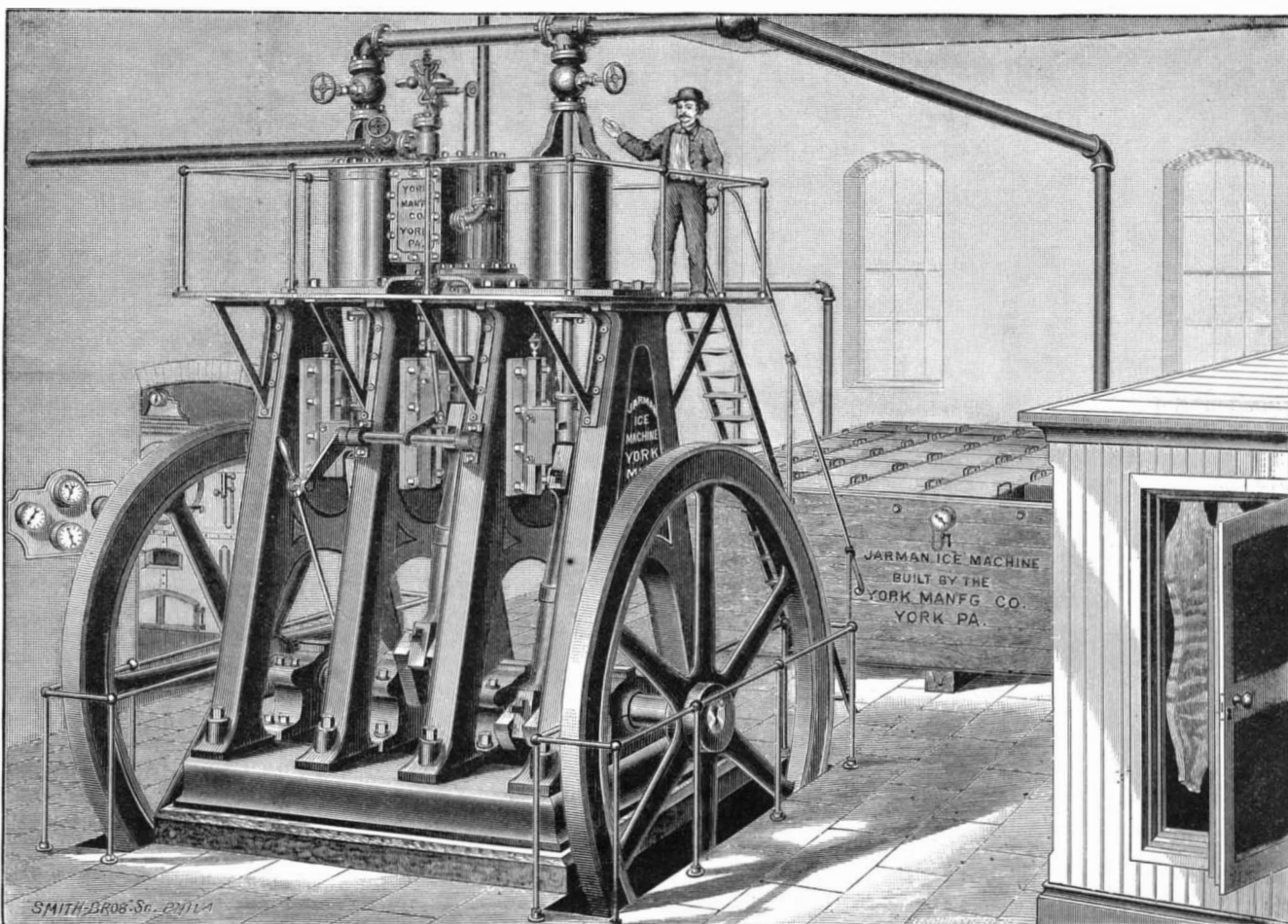

THE JARMAN ICE AND REFRIGERATING MACHINE.

HYDRAULIC MACHINERY FOR OPERATING A DRAW-BRIDGE.

As generally constructed, the mechanism by means of which a drawbridge is turned requires that a nice adjustment of the parts be always maintained, in order to insure perfect working. Those familiar with such appliances will be interested in the hydraulic machinery designed by Mr. Theodore Cooper, of this city, by which the drawbridge* across the Harlem River near Second Avenue, this city, is operated, because of its extreme simplicity and the reliability of its action under all possible conditions. While doing away with several of the expensive parts to be found in the old style of draw, it performs its duty better, and is not so much affected by ordinary wear and tear; in addition, the one part most liable to wear can be easily, quickly, and cheaply replaced when necessary. Aside from the practical bridge builder, this apparatus is also of interest to the mechanic, since it introduces a simple and ingenious method of accomplishing the rotation. To the general reader it is worthy of study, as it produces a seemingly anomalous movement of the draw, when we consider the direction in which the power is applied. The bridge moves in a direction directly opposite or against that in which the operating ropes ought (apparently) to pull it; in other words, the ropes pull in one direction, and the bridge moves in the contrary direction. This also appears the more strange as there is no connection whatever between the bridge or its machinery and the pier upon which it rests.

The bridge rests and turns upon a ring made up of 54 cast iron coned wheels, 16 inches in diameter at the base; the drum thus formed is 26 feet in diameter. The wheels are held truly radial by two guide rings, one inside and one outside of the wheels; the outer ring is grooved to receive the operating ropes. A tension rod connects the axle of each wheel with a movable center or hub (turning upon a steel shaft 6 inches in diameter), to which the guide rings are also braced by angle iron struts. The axes of the wheels are inclined upward toward the center at such an angle as to bring the upper bearing lines of the wheels in a horizontal plane. Heretofore, the axes of the wheels have been placed in a horizontal plane, thereby compelling the use of two inclined tracks for the wheels to roll between. But in this case the upper bearing plates, forming the upper circular track, are of wrought iron planed flat, while the lower track circle is made of cast iron segments, bolted together and firmly anchored to the masonry; its bearing surface is planed to conform to the inclined position of the wheels. On the upper bearing plate are springs for equalizing the load on the rollers.

The operating ropes—wire cables—are led by properly placed sheaves, as shown in the engraving, to a small room located in the center of the bridge, and the floor of which is at an elevation equal to that of the portals. There are four of these ropes, one at each corner, and the lower ends are secured to the guide ring at diametrically opposite points. These ropes act in pairs; two open the draw, and the other two close it. Those ropes at diagonal corners operate together, or in the same direction. One of these ropes, after being passed around a drum carried in a frame placed between and uniting the plungers of two hydraulic rams—as shown in the inverted plan view of the floor of the operating room, Fig. 4—is secured to the framing at a point alongside of its own ram. The rope that operates in the contrary direction is led around a drum in the same frame, and fastened alongside of the opposite ram. These two ropes are clearly shown in the large view. It will be seen that either of these ropes may be made to pull upon the guide ring, according to the direction in which the rams move. At the other side are two more rams, working together, and two ropes arranged in the same way. Each pair of rams has a stroke of 6 feet, so that the ropes and guide ring to which they are attached have a movement of 12 feet, but the bridge moves 24 feet and turns a quarter of a circle at each stroke. If the lower horizontal portion of the right hand rope shown in the large view be pulled in a direction toward the right, the bridge itself and the guide ring and rollers will move against this pull, or toward the left.

The cylinders of those rams that work together are connected with each other by pipes, as shown in Fig. 4. A small steam pump takes its supply from a tank, and pumps either to the rams or to the accumulators, which are two large wrought iron boiler shells, capable of standing a working pressure of 400 pounds to the square inch; they are simply large air chambers by which to obtain a permanent air pressure. They are so proportioned that, when filled half with water and half with air at 300 pounds pressure, the draw can be swung open and closed again without the use of the pump. The pumps are provided with small air check valves, so that the operator can supply any leakage, and on top of the accumulators is a valve by which any excess of air can be relieved. The piping is provided with the usual safety valve attached to hydraulic

machinery. A four-way valve guides the water to and from the rams. As the working rams are operating, the remaining two push the water back into the supply tank.

To provide for the case when the bridge may have a large momentum, and the operator desires to reverse or break the movement of the draw to prevent the water ram which would occur on the non-operating rams, the supply pipes are furnished with check valves, which lift and connect with the accumulators, thereby allowing the bridge to cushion on the air in the accumulators.

A small pump is introduced for the purpose of getting a plunger small enough to be worked by hand during repairs to the boiler. By the use of this pump, driven by hand, and the accumulators, which can be pumped up when the draw is not in operation, the addition of the ordinary hand gear was considered unnecessary.

The wedges are operated by two small rams—one is shown in Fig. 2, and both are shown to the right of the engine room in the main view—connected by rods with the arms of a bell crank in bearings secured to the floor beams at each end of the bridge. To the lower arms of these cranks are attached rods which move the wedges and rollers; the movement of this bell crank also locks and unlocks the bridge. In closing, the ends of the bridge swing clear of the masonry; when closed, water is admitted to the proper ram, which then turns the bell crank at each end of the bridge. The arms carrying the rollers approach the vertical position shown in Fig. 3, and each wedge moves in the same direction as its own roller, but not so fast. The ends of the bridge now rest upon the rollers, which in turn rest upon heavy iron plates on the masonry. The speed of the wedges is now increased, and they come to a bearing; the rollers move a little further, and the ends of the bridge are supported by the wedges. When the other ram works, the ends of the bridge are lifted by the rollers, the wedges are withdrawn, and the bridge is free to swing. The same hydraulic pressure, but of course controlled by an independent valve, operates these rams.

The liquid used in the rams is glycerine mixed with water in such proportion as to be unaffected by the coldest weather.

The main object of employing this form of mechanism for operating draws was the avoidance of toothed gear of any kind—a class of mechanism which usually gives a great deal of trouble on drawbridges because of the difficulty of getting a positive control of the bridge during high winds. This is caused by the necessary slackness of the gear, due to back lash, which permits the knocking of the bridge back and forth. A very small play between the teeth of the gears is sufficient to allow the ends of the bridge a considerable movement. The method above described differs from those employing gears, as there is no possibility of any of its parts binding so as to prevent the moving of the draw. An even bearing upon the rollers, if there should be a distortion of the bridge, is always obtained by the equalizing springs.

Invention of the Telephone.

To the Editor of the Scientific American:

I have read with much interest your articles on the invention of the telephone originally by Reis. I have also read the work of my friend, Professor Silvanus Thompson, on this subject, and I have discussed the matter with him. I think I am in a position to supply a small link in the chain of evidence, which, though not important, may really prove to have a good deal, and certainly is not devoid, of interest. I was a student of medicine in the University of Edinburgh from 1860 to 1865, and being much interested in physical research, I was very frequently in the shop of Messrs. Kemp & Co., which used to stand near the entrance of the old Edinburgh Infirmary. Probably many of your readers have, like myself, visited that well-known establishment, and they will remember that it consisted really of two shops—one in which chemicals were sold, and the other, which had a separate entrance from the street, yet connected with the first by a door of communication, was occupied chiefly by physical apparatus, and was not common to the ordinary customers of the shop. Mr. Kemp died somewhere about the year 1861, and the business for some time, until, I think, about the middle of 1864, was managed by an extremely intelligent assistant named Mr. Shearer, of whom for many years I have entirely lost sight. Could Mr. Shearer be discovered, I fancy that he could give some extremely interesting information about the point which I am about to indicate.

As near as I can identify the date, in December, 1862, a very simple-looking instrument was shown to a number of his customers by Mr. Shearer. That instrument is depicted accurately on page 342 of your journal (Nov. 28, 1885). It was connected in a circuit with a battery, and by means of wires to a transmitter of a rather different form from that which you figure on the same page, but precisely identical with one which is figured on page 97 of Professor Silvanus Thompson's work. Mr.

Shearer had his apparatus in action, the transmitter being arranged in the one shop, while the wires passed through to the receiver in the other. In common with many others of those who frequented the shop, I heard articulate words, which I could appreciate accurately, pass through this instrument from one shop to the other. At that time Mr. Alexander Melville Bell was a well-known teacher of elocution in Edinburgh, giving public readings, to which many of the young men of the town were strongly attracted. He was, indeed, a very well-known man in Edinburgh, and lived there with his family.

When I met Mr. Graham Bell at Plymouth, in 1877, when he first exhibited his telephone, I immediately recognized him as the son of Mr. Melville Bell. I cannot say whether he was resident in Edinburgh at the time that Shearer exhibited Reis' telephone in Kemp's shop, but I think it is very likely he was, and I feel almost certain that I have seen Mr. Melville Bell as one of the frequenters of that shop. So that it seems to me that nothing is more likely than that it was through this chain that Reis' telephone was transferred to America, and there became developed. Mr. Melville Bell was then engaged in the contrivance of a universal alphabet, upon which he has published an extremely interesting book. Reis' telephone was greatly talked about in Edinburgh at the time of its exhibition by Shearer, and I think it is extremely likely that Mr. Melville Bell would go to the shop to see it, and he might have been accompanied by his son.

LAWSON TAIT.

Birmingham, December, 1885.

[It is almost unnecessary to remind our readers that Dr. Tait is an eminent British physician, of distinguished ability, well known in this country.—EDS.]

Best Mode of Ventilation.

Speaking upon the subject of the ventilation of dwelling houses before the Toronto Sanitary Association, Mr. David Dick controverted the theory that the carbonic acid of an inhabited room can be drawn off by outlets placed at the floor level, which is the French practice. He pointed out that, in view of the principle of the diffusion of gases, it is impossible to expect that carbonic acid, although the heavier gas, will so far separate itself from the other components of the atmosphere as to be susceptible of withdrawal at a low level. According to Mr. Dick, the only factor to be regarded in ventilation is temperature. The air is cold at the floor line and warm at the ceiling; the difference in rooms artificially heated or full of people being seldom less than 20° Fah. Owing to this tendency of heated air to rise, and to be supplanted at the floor line by cold air coming in from crevices in the doors and windows, etc., Mr. Dick considers that a room cannot be properly warmed solely by the radiant heat of a fire. The heat from this source should be helped by some means for preventing the draughts of cold air on the floor.

With this view, Mr. Dick advises that rooms should be provided with many inlets for warmed fresh air at the floor line, the effect of which would be to drive up all impure air toward the hotter stratum near the ceiling. An outlet at the ceiling line would then carry off the whole of the vitiated air. As the warm air begins to rise as soon as it enters the room, the more it is subdivided into separate inlets the better, because it will ascend by the most direct line to the outlet; and therefore a number of small streams will move the general body of air in the room more effectually than one large current, which would be likely to pass through the body of air without affecting anything that did not happen to be directly in its path.

The temperature of the inflowing air should be moderate, and its velocity low. It is desirable, however, that there should be only one outlet for foul air from an apartment, because if there were more than one the draught might be unequal, and then one would pull against another, causing a flow of air down one and up the other, instead of from the proper inlets. Of course, the one outlet need not appear as such in the apartment, as its mouth may be concealed by a perforated cornice or other device.

Another Great California University.

Senator Stanford, of San Francisco, has executed a deed of trust by which lands and funds to the value of \$20,000,000 have been devoted to the establishment of a great university at Palo Alto, Cal. This is the largest gift ever received by any institution, and makes the endowment of the new university larger at the beginning than that of any of the oldest colleges in the country. For several years Senator Stanford has been laboring to devise a satisfactory plan by which his wishes would be promptly carried out in case of death, and he has now accomplished this by the appointment of a Board of Trustees. He reserves the power to revoke their acts should they not carry out the spirit of the trust, and has taken every legal precaution to prevent the interference of his heirs with the enforcement of the bequest. The new university is a princely memorial to the Senator's dead son.

* This bridge was described and illustrated in the SCIENTIFIC AMERICAN of Aug. 1, 1885.

Correspondence.

Making Water Heat Itself.

To the Editor of the Scientific American:

In the articles appearing in your columns, Nov. 7 and Dec. 12, in regard to making water heat itself by means of placing friction wheels in streams, Mr. Server and also Mr. Baker seem to overlook the prime fact that the water gives out the same amount of heat in falling through its channel that it would in falling through friction wheels—the heat given out being due to the fall of the water, not to the arrangement of appurtenances.

JAMES M. DOUGHERTY.
Dundaff, Pa., Dec. 12, 1885.

The Preservation of Stone.

To the Editor of the Scientific American:

In reply to your invitation, I would submit the results of some experiments which I have recently made. I used a heated mixture of two parts of paraffine and one part of boiled linseed oil, applying several coats successively. After the stone was thoroughly dry, I applied a mixture of two parts boiled linseed oil and one part japan, adding enough zinc to permit an even flow of the material over the surface. When this second coat was dry, the treatment was completed by a generous application of japan. I found that the oil penetrated the stone to a considerable distance. Summer would of course be the best time for treating so large a mass as the obelisk.

J. A. HACKER.
Houston, Texas, Nov. 15, 1885.

"A Gateway to Knowledge."

To the Editor of the Scientific American:

In current issue I notice the letter with above title, "from an old subscriber," and I take this opportunity to indorse its truths. As I now sit in my office, with my huge pile of the bound volumes of the SCIENTIFIC AMERICAN and SUPPLEMENT—the first dating June 2, 1849 (with some interruptions), down to the present time—I reflect that *very much* of what I know of science, of the manifold appliances of mechanics, I have gleaned from those pages. How oft, in all those past years, when in want of light on some difficult problem in the construction of machinery, I have consulted those pages, and found the solution, or have got hints that led me out! Yes, I owe very much to my great cyclopaedia of useful and practical knowledge, the SCIENTIFIC AMERICAN.

G. M. MARSHALL.
Kilbourn City, Wis., Dec. 6, 1885.

Poisonous Fish at Rotuma.

To the Editor of the Scientific American:

Rotuma, or Rotuam—for the natives have the habit of transposing the two last letters of many words—is situated about 280 miles north and west of Fiji, and, although geographically beyond the limits of the colony, it is a portion of, and belonging to it.

One of the principal articles of food has always been fish, which are abundant, and of many kinds. Since, however, the hurricane of 1884, this article of diet has materially failed the people; the fish are as plentiful, but the greater number are now poisonous. Many deaths, and much painful and long sickness, have resulted from eating fish that, until the blow, had been wholesome. The fact was first noticed on the north west side of the island, immediately after the hurricane, the fish along the other parts of the coast, and latest on the southwest end, continuing sound; but the cause, whatever it was, gradually spread, moving east-about, until on the whole coast of Rotuma the greater portion of the hitherto edible fish have become unfit for food, and dangerous to life and health.

There is a sea reef of considerable dimensions about three miles north of Rotuma; and, in the hopes that the fish here were not tainted, a fishing expedition visited the spot a short time ago, and returned with quite a number of fine fish. All who ate of the fish suffered severely, many being made seriously ill for days. For the cause of this strange freak in Rotuma fish nature, no one can account, and the natives are bewildered. Some of the few fish that yet remain safe to eat are rock seeders, some ground fish, and some eaters of their kind, but the numbers are few, and the fish small, and inferior in quality.

I returned from Rotuma a few weeks ago, and am personally cognizant of the foregoing facts. Perhaps some of your correspondents may be able to suggest a probable cause for this singular and, to the natives, serious abnormality in the usual traits of the fish at Rotuma.

ROBERT S. SWANSTON.
Fiji, October 15, 1885.

THE production of lead in Germany has doubled since 1858, in spite of a simultaneous increase in the production of Spain and in the growth of the lead yield of North America from almost nothing to 140,000 tons annually.

Astronomical Notes.

THE NOVEMBER METEORS.

There is a possibility that we may not have to wait until 1899 for a brilliant show of Leonids, or meteors of the 14th of November. Professor Kirkwood, of Bloomington, Ind., has made a discovery which, if substantiated by observation, will prove to be of great importance. It is generally accepted that the meteors of the 14th of November are caused by a swarm of meteoric particles moving in the orbit of Tempel's comet of 1866. Professor Kirkwood asserts that there are three meteor swarms traveling in the same orbit. The principal group of the three is the well known one that produced the showers of 1833 and 1866, another shower being expected in 1899. The period of this group is 33.25 years. The second group was identified in 1875 from the dates of meteoric showers given by Humboldt and Quetelet, the period being about 33.31 years. The next shower from this group will be due about the 14th of November, 1887, but the display may commence at that time in 1886.

The third group has been less thoroughly observed than either of the others. Its period is about 33.19 years, and another shower may be expected in 1912.

A comet was observed in China in 1366 that is thought to be identical with that of 1866. For 500 years the difference between the two dates is very nearly equal to 15 times 33.25 years. Professor Kirkwood suggests that the diminution of the comet of that year may have been caused by the separation from it of the first and largest of these groups.

The truth of this theory will soon be tested. If it be tenable, either next year or the year after a great meteor shower will take place, the Leonids will muster in full force, and the heavens will be aflame with falling stars. We have faith in the prophecy, but not without misgiving. Disintegrating comets and meteor swarms are curious members of the solar system. It will be long before we shall fully understand their origin, the place they hold in the economy of the universe, and their final destiny.

TOTAL ECLIPSE OF THE SUN ON THE 8TH OF SEPTEMBER.

Interesting observations have been reported from various observers in New Zealand who witnessed the recent total solar eclipse. It will be remembered that the only land over which the belt of totality passed was the portions of New Zealand bordering on Cook's Strait. Nothing new seems to have been learned during the progress of the most grand and imposing spectacle on which mortal eyes ever gaze. The observations were, however, successful and of exceeding interest. An observer in Wellington thus describes in *Nature* the wondrous vision. About fifteen or twenty seconds before totality, the whole disk of the moon suddenly became visible, the further limb of the moon being seen projected upon the white background of the corona. During totality, great masses of cloud, on the horizon, appeared lit up with sunset tints. The corona extended from the moon's limb more than two lunar diameters, the coronal light quivering in a way that reminded one of the aurora.

An observer at Nelson gives this account. As the period of totality passed, a bright point of light as from a diamond of wonderful brilliance shot forth from the upper surface of the moon. At first it seemed to be only a flame, but it speedily extended to the moon's shadow, passed downward, and totality was over.

The enthusiastic members of a party that had encamped at the foot of Otahuao, climbed to the top of the mountain, and arranged their instruments amid driving snow and hail. Just before totality the sky cleared, they were able to take several photographs successfully, and the grand phenomena attending a total solar eclipse were fairly visible.

The eclipse was observed at Blenheim on the outer edge of the belt. The totality here lasted but a few seconds; but the corona and rosy protuberances were plainly visible in all their grandeur and beauty. Several stars were seen, and the general appearance of the sky, the shadows on the hillside and on the water, was that of early dawn.

An observer at Tahoraite, 40 miles north of the center line, devoted his entire attention to the corona, and succeeded in obtaining several satisfactory sketches of its contour. He describes a dark rift in the corona reaching to the sun's disk.

Other observers noted that an immense red flame shot out suddenly close to this rift just as totality closed. Southerly squalls, hail, and snow prevented observation at several stations. All observers, however, agree in noting the sudden fall of the temperature, the numerous rosy protuberances, the beautiful sunset hues, the quivering of the corona, and the magnificence of the spectacle, which words are powerless to describe.

THE CORONA VISIBLE TO THE NAKED EYE ON HIGH MOUNTAINS.

Professor Tacchini, a great authority among scientists, gives a remarkable piece of information in a letter to *L'Astronomie*. He records that M. Favel asserts that on high mountains, when the sky is serene, the

solar corona is so apparent that it strikes all observers. The mountaineers and dwellers among the Alps agree in affirming that the phenomenon is something entirely new. Tacchini also gives an experience of his own on the subject. He made the ascent of Mt. Etna in July last. When near the volcano, at a height of over 10,000 feet, under a clear sky of a dark blue tint, he saw the sun surrounded by a white aureola, concentric with a magnificent corona of a coppery red. The corona was transformed near the horizon into an arc less defined and of much greater extent.

"The Dollar Medical Shop."

A Hartford correspondent, who signs himself "A Druggist," has entered a protest against the reference to his class in an article under the above caption, which appeared in a recent issue. He begs to remind us that the large responsibility of an apothecary, which forces him to satisfy himself that the prescribed doses are correct, that the ingredients are mixed so as to give the full effect of all, and that the mixture does not form an explosive compound, together with the time required in preparing the prescription, make it absolutely necessary that his charge shall be largely in excess of the simple cost of the unmixed drugs. These considerations we have not overlooked, and they are of sufficient weight to make a profit of two or even, in some cases, three hundred per cent quite justifiable. If the matter stopped here, reasonable people would not be disposed to complain; but when the percentage is carried beyond this, and occasionally is doubled or even trebled, there is just cause for a protest. There is another element which deserves attention in connection with this excessive charge. In almost all lines of business, competition lowers prices; but in the prescription department of most drug stores, it seems to have had the opposite effect. Fancy goods and the thousand and one ready made articles which make up the stock of a retail druggist are open to comparison, and their price is regulated accordingly; but in a prescription the ingredients are usually unknown to the purchaser, and he has therefore no standard of comparison by which to judge of their value. As the same prescription is seldom filled at two different shops, there is really no competition, for the purchaser cannot assert that one man is more excessive in his charges than another. Add to this the fact that there are probably twice as many drug stores in the country as can possibly make a comfortable living, and it cannot be denied that there is a strong temptation for the charge to be made out of all just proportion, when there is so little chance of the extortion being discovered. All druggists, to be sure, do not yield to this temptation, and our Hartford correspondent is no doubt one of the exceptions, but a sufficient number of them do, to make it very well worth the attention of the benevolent to see that the poor are supplied with medicines at a cost more nearly approximating to their real market value.

The Van Depoele Electric Railway.

The city of South Bend, Ind., has introduced an electric street railway. The system in use, the Van Depoele railway, has been in successful operation at Toronto, Canada, for the past two years, and it is expected to be introduced shortly into Minneapolis and Detroit.

The railway at South Bend is operated by an electric current transmitted by overhead wires. The current is generated by three Van Depoele dynamos, which form the stationary motive power plant, and is conducted to the motor of the street car by means of a wire extending from the overhead cable. From the motor, the current passes through one of the wheels, and by means of the track the circuit is completed. In order to make the track a perfect conductor, strips of brass are laid under the joints of the rails. As but one track is used, the cars must pass each other on switches, and an ingenious device provides for this necessity. It consists of a brass and copper frog or switch, attached to the copper wire. This hangs directly over the frog in the track. It is so arranged that the motor connecting wire passes through it on one side when going in one direction, and through on the other side when returning. The action is entirely automatic. A speed regulator is attached to each car, and operated by the driver. It consists of a small cylinder through which the current passes. A crank handle on the top of this cylinder regulates the speed, and its position in numbered notches shows at a glance the rate at which the car is traveling. The highest speed allowed by the regulator is eight miles an hour. The railway has been constructed under the personal supervision of the inventor.

A New Comet.

A cable message from Dr. Krueger, of Kiel, received recently at the Harvard College Observatory, announces the discovery of a faint comet at Paris. Its position at the time was: right ascension, 39° 8' 5"; declination north, 21° 2' 25"; daily motion in right ascension, 2' 28"; in declination south, 3'. It has since been observed at Harvard by Mr. Wendell, and its position determined on Dec. 2 to be: right ascension, 39° 8' 30"; declination north, 21° 0' 30".

VERTICAL FLOUR MILL ENGINES.

These engines were made for driving a flour mill at Wolverhampton, and the particular design shown in our engraving was, says *Engineering*, adopted to suit the peculiar circumstances of the case, no room being available for engines of the horizontal description. As will be seen, the engines are of the vertical inverted cylinder marine type. The cylinders are 18 inches diameter, with a stroke of 3 feet, and are bolted together in the middle, with the steam chests outside. The valves are of the ordinary slide description, with cut-off plates working on the backs of them, and made adjustable while in motion to suit the required grade of expansion. The crank shaft is of the double sweep marine type, with solid coupling end forged on to connect to the mill shafting, the bearings being 7 inches diameter by 11 inches long, and three in number. The engine bed and the frames on which the cylinders rest are very strong and rigid, and the cylinders are further supported at the front by two wrought iron polished pillars. An air pump is fitted to each, and worked from the main cross-heads by means of wrought iron levers, and coupling links with brass blocked ends of the marine type. The pumps are each $10\frac{1}{2}$ inches diameter, and work a stroke of 18 inches. The condenser, which is common to both pumps and placed between them on the engine bed, is of the ordinary jet description. The speed of the engines is regulated by a quick-speed governor connected to an ordinary throttle valve. These engines run at seventy revolutions per minute, and are perfectly steady and free from vibration. The whole arrangement is very neat and compact, the different parts lying well together.

Car Starters.

Mr. Augustine W. Wright, writing to the *American Railroad Journal*, says: The question of car starters is one of interest to every horse railway, for the original cost and renewal of horse flesh is no inconsiderable item of the operating expenses. I made a number of experiments to ascertain how much greater force was exerted by a team in starting a loaded street car than was required to keep the said car in motion at an average speed of six miles per hour. I selected steady teams and good drivers, and under these favorable conditions found that upon new steel rail tracks 7.1 times the power was exerted to start the car, and upon old iron rails with low joints 4.1 times the power used to maintain the speed after starting. The power required to keep the car in motion was much less upon the new steel rail tracks, and shows that the better the tracks the greater the relative loss in starting the loaded car. With a poor driver, who allows his team to start quickly, the relative loss is much greater, and no inconsiderable inconvenience is caused the unlucky passengers.

It is chiefly the wear and tear of starting the heavy load of car and passengers which give our horses such brief railway lives. If the pavement in the horse paths consists of any other than well selected cobble stones of suitable size and shape, the horses slip and frequently strain their backs—an injury from which they never recover. To guard against this slipping during unfavorable seasons of the year, their shoes are removed and calks sharpened. When our horses were traveling upon wooden blocks, at times their shoes were removed and sharpened every *third day*. This caused rapid hoof depreciation, but was the only way to keep them upon

their feet. The leverage system I believe practicable, but the machinery must be strong and light, so that the energy saved in starting may not be lost in transporting it during the time when it is not in use. It must be cheap and readily applied to existing cars without re-

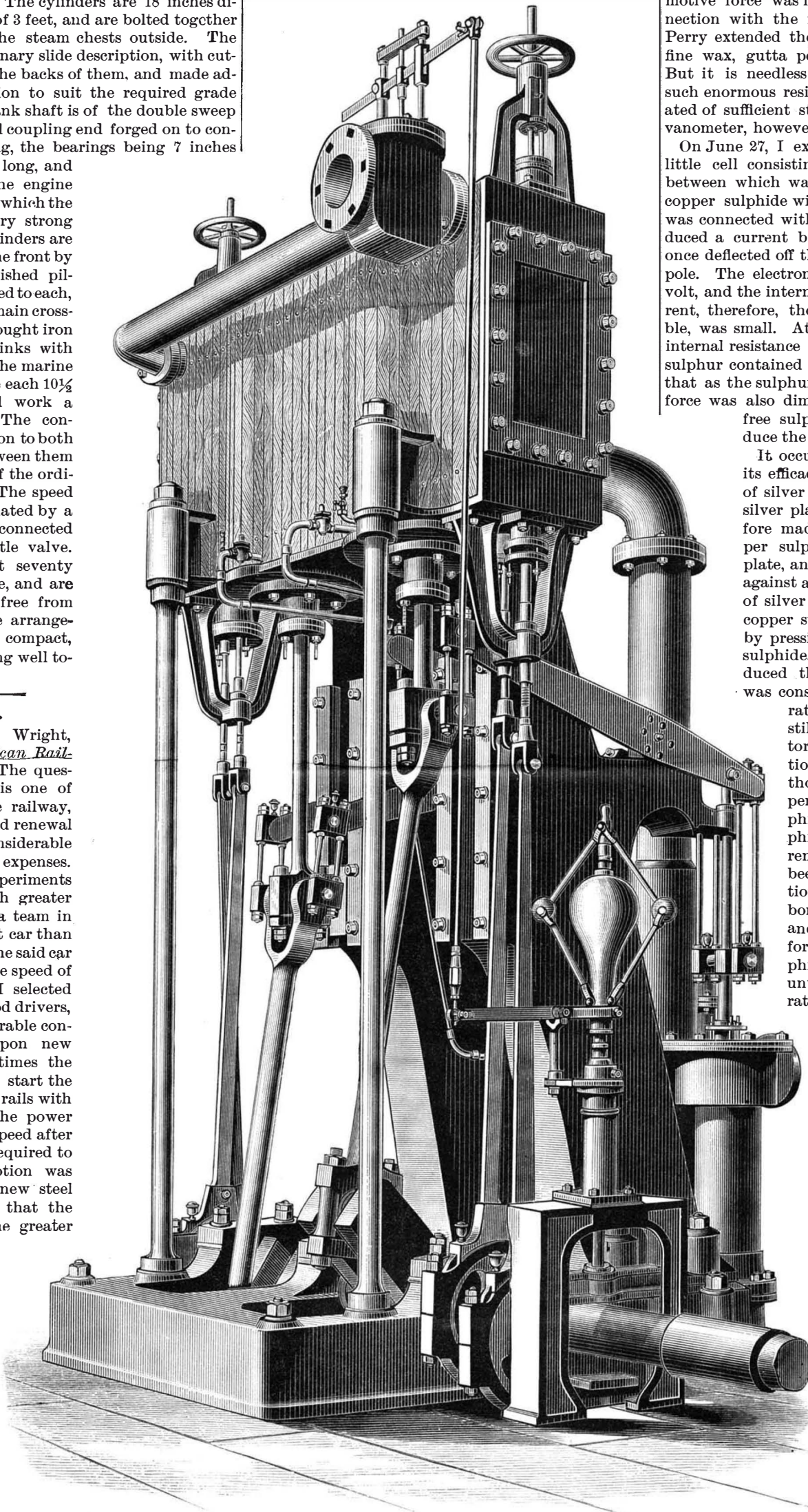

VERTICAL FLOUR MILL ENGINES.

quiring any cutting of woodwork or changes in their construction. It must be simple, with few wearing surfaces to be cut by the sharp grit arising from the street. It must be automatic, worked by the team without intervention of the driver. We all know that the driver, when out of sight, is not going to trouble himself to assist the horses. Horse railways would undoubtedly welcome such an auxiliary to their horse flesh, for it means a saving of many thousands of dollars in operating expenses.

A Voltaic Cell with a Solid Electrolyte.

I believe that there has never hitherto been made a voltaic cell with a solid electrolyte which was capable of generating the smallest sensible current—at least at ordinary temperatures. Sir William Thomson found that when warm glass was placed between plates of zinc and copper, the existence of an electromotive force was indicated by an electrometer in connection with the metals; and Professors Ayrton and Perry extended the observation to the cases of paraffine wax, gutta percha, India rubber, and shellac. But it is needless to say that with electrolytes of such enormous resistance no current could be generated of sufficient strength to be detected by any galvanometer, however delicate.

On June 27, I exhibited to the Physical Society a little cell consisting of plates of silver and copper, between which was contained a mixture of 1 part of copper sulphide with 5 of sulphur. When this cell was connected with a reflecting galvanometer, it produced a current by which the spot of light was at once deflected off the scale, copper being the positive pole. The electromotive force was found to be 0.07 volt, and the internal resistance 6,537 ohms. The current, therefore, though far more than merely sensible, was small. Attempts were made to reduce the internal resistance by diminishing the proportion of sulphur contained in the mixture, but it appeared that as the sulphur was diminished the electromotive force was also diminished, until, when there was no free sulphur at all, the cell failed to produce the smallest measurable current.

It occurred to me that the sulphur owed its efficacy to the fact that it formed a film of silver sulphide upon the surface of the silver plate by direct combination. I therefore made a cell thus: A thin layer of copper sulphide was spread upon a copper plate, and compressed into a compact mass against a surface of polished steel. A layer of silver sulphide was then spread upon the copper sulphide, and the cell was completed by pressing a silver plate upon the silver sulphide. The current which this cell produced through the shunted galvanometer was considerably stronger than that generated by the cell first described; but still the result was not quite satisfactory, and there seemed to be indications of short circuiting, which I thought might possibly be due to the penetration of particles of copper sulphide through the layer of silver sulphide. The silver plate was therefore removed from the cell, and, having been brushed over with a weak solution of sulphur in bisulphide of carbon, it was heated over a gas flame, and soon became covered with a uniform and continuous coating of sulphide. The heating was continued until all the free sulphur was evaporated. When the cell was reconstructed with this prepared plate, it produced a current of 6,800 microamperes through an external resistance of 0.2 ohm, and was able to deflect the pivoted needle of an ordinary coarse galvanometer.

The dimensions of the cell are as follows: The copper and silver plates measure $2\frac{1}{2}$ inches by 2 inches; the thickness of the two layers of sulphide (strongly compressed) is about one-twentieth inch; the E. M. F. is 0.053 volt, and the internal resistance is therefore about 7 ohms.

This cell seems to be exactly analogous in its action to a Daniell cell, in which plates of copper and zinc are immersed in solutions of copper sulphate and zinc sulphate. Silver is probably the best (or only) possible metal for the positive plate, but some other metal might perhaps be substituted for the copper with advantage.—*Shelford Bidwell, in Nature.*

Death of a Remarkable Man.

M. J. B. Bailliere, the well known publisher, medical bookseller, and founder of the firm that bears his name, died on the 8th instant, in the eighty-ninth year of his age. He was the senior of the medical publishers of Paris, and although he became blind during the latter part of his life, he was, even to within the last few days of his death, to be found at his post, which he occupied for nearly seventy years, and during which time he published some of the most important French medical works extant.

A Ship Canal from the Baltic to the Ocean.

The project of connecting the waters of the Baltic, the Elbe, and the German Ocean has been under the consideration of the Prussian Government since 1865. The scheme of a ship canal was formerly opposed by Count von Moltke, on the ground that it would be better to invest the immense amount of money required by such an enterprise in building up the Imperial Navy. Now that this work has been completed, and a powerful fleet of ironclads stands ready to plow the waters of the new canal as soon as it can be opened, the Field Marshal of the Empire has changed his views, and declared himself in favor of the work. At a recent meeting of the Bundesrath, a bill for its construction was unanimously approved. It is held by the advocates of the canal that the defense of the German coast must always remain a divided task so long as no waterway connects the Baltic with the German Ocean, and German war vessels are forced to pass from one sea to the other by a route which exposes them to the danger of falling into the enemy's hands. The estimated cost of the work is put at 156,000,000 marks, or about \$39,000,000. It will be strongly fortified, and besides its military value will be of much importance to commerce.

ELECTRICITY AT THE SALPETRIERE.

At the Salpetriere, electricity constitutes one of the chief elements in the treatment of the sick. In fact, the service of electrotherapy has existed here for a long time. Its creation, in 1877, was due to the initiative of Professor Charcot, and its organization was the work of Dr. R. Vigouroux, who has continued to direct it ever since its foundation. The patients, as their numbers are called, pass from the reception room into the room for treatment shown in the engraving. Most of them take a seat upon two rows of insulating stools, where they receive electricity from the two machines seen in the middle of the room. They are thus in the first place submitted, for a length of time varying with the case, to what is called an "electric bath." Then the operator, provided with special instruments of various forms, called "exciters," makes such an application to each person as the case requires. As soon as a patient has been thus electrified, he gives way to another. In this way the sixteen stools are constantly occupied. The number of persons electrified at each sitting is 180, on an average. Those who are not to sit upon the stools go over to the electro-therapeutic table (shown to the left), where they receive electric applications of a different kind. The total number of persons treated at each sitting may be estimated as 200.

There are two categories of patients, viz., the inmates of the Salpetriere, and those from the outside, who come solely for electrical treatment. The inmates, of both sexes, belong for the most part to Professor Charcot's wards. As for the outsiders, many of them come from afar by rail, boat, etc. Numbers of these persons have a more well-to-do appearance than the usual patients of hospitals.

The original and important element of this organization consists in the use of electric machines. These latter, which had nearly ceased being used in medicine, have been very successfully applied by Dr. Vigouroux in the simultaneous treatment of a large number of sick persons. Without them, that is to say, with the ordinary processes of electrotherapeutics, the most active physician cannot treat more than twenty patients per sitting—which is an insufficient number. The electric machine solves the problem of the extension of the benefits of electricity to an indefinite number of patients.

Dr. Vigouroux has been kind enough to inform us as to the results of this electric treatment. They are, according to him, of the most satisfactory character. We believe, with most physicians, that nervous affections are nearly the only ones amenable to electricity. This, according to Dr. Vigouroux, is too narrow a view to take of it. At the Salpetriere almost all complaints are represented in the patients who succeed each other on the stools. In Dr. Vigouroux's opinion, electricity, especially static, must be considered as a stimulant and a regulator of the general nutrition. But it is not our object to write a medical criticism; and we shall confine ourselves to the descriptive side of the subject under consideration. Those persons ignorant of medicine who accompanied us were especially struck by the indifferent attitude

of the patients sitting upon the insulating stools. One had unfolded a newspaper, another was doing crocheting, a baby was asleep upon its mother's knees, and, in curious contrast, the hair of each member of this quiet party was standing on end through the effect of the electricity. The calmness diminished slightly when the operator drew some sparks with a metallic ball; but, positively, the treatment appeared to us very mild, and was certainly borne very willingly by all these patients. Several, who were very infirm, were seated in large arm chairs or lying upon stretchers placed upon the insulating supports.

The electric machines are, as shown in the figure, inclosed in glass cases that preserve them against dust and dampness. They are of the Carre system, but arranged horizontally. Dr. Vigouroux is now having others constructed on a new plan. The manner in which they are set in motion merits special mention. A Gramme motor located in the room actuates a shaft, on which there are distinct pulleys that receive two belts for the electric machines and one for a laboratory Gramme machine. The current is furnished by a dynamo situated about 600 yards off, alongside of the large steam engine of the laundry. This transmission of power was put in by the house Breguet.

A small laboratory alongside of the room for electric treatment serves for experiments or researches.—*La Nature.*

High Speed on the Ocean.

The speed of ocean steamers has, as we know, increased very much during the last few years. It is

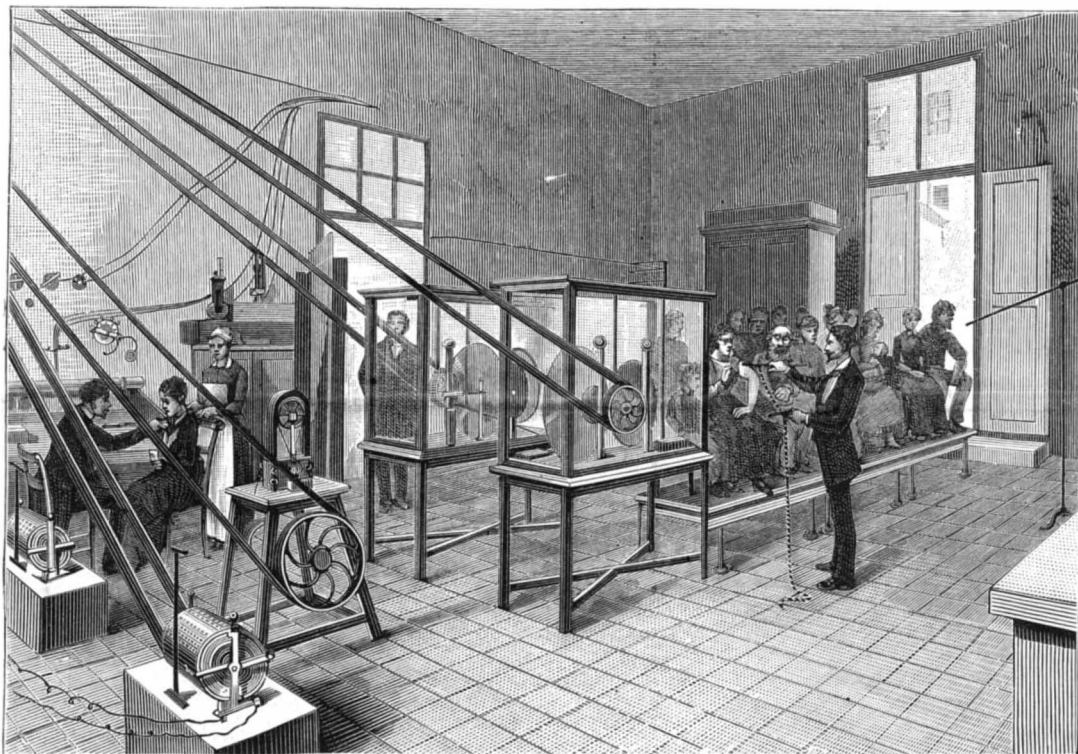

ROOM FOR ELECTRIC TREATMENT AT THE SALPETRIERE.

not so long ago that nine days was looked upon as a quick passage in a transatlantic liner, and eight days a remarkable trip. Now, anything over seven days is regarded as a slow trip; the record having been brought down to six days ten hours and ten minutes, reckoned from the moment of losing Sandy Hook lightship to the sighting of Fastnet light. Referring to this and other fast trips made by the Oregon, her designer is reported to have prophesied that the trip would eventually be reduced to six days; and this is probably the best that can be expected, even when the present type shall have been developed to its best. Others have sought for more speed by lessening the draught and increasing the beam, but have not yet found it. All seem to think that higher speed is to be found in a change of lines and distribution of weight. The theory of propulsion, however, has remained unchanged, a propeller operating in the same line as the ship's motion.

Now comes a mechanic who contents himself with the present model, but proposes to increase the speed by a radical change in the principles of propulsion. He gives his views so clearly, and brings to their support such cogent reasoning from a mechanical standpoint, that they seem worthy of serious consideration; and though perhaps failing to convince the naval architect, wedded as he is to certain mechanical theories, in which he has been trained, may at least succeed in interesting him as well as the general public, who have of late been attracted by naval designs in marine construction.

In a pamphlet before us, Capt. John Giles essays to show that a much higher rate of speed can be had by changing the position now given to the propeller at the stern of the ship, as well as its inclination or dip. He would put the propeller under the ship, and, as near as we can judge by his diagram, just forward of the mizzen-mast; giving it an inclina-

tion of 45° with the plane of the ship's motion. With a propeller thus situated, he believes he can get forty knots an hour where now only twenty are had. The theory is based upon the manner of propulsion of animals, in which, as we know, the efforts of propelling impulse all radiate at an angle from the line of motion.

He says: "The organs of propulsion obtain their impulse from the reactionary force of the water upon which they operate; and as the motion of the fish creates no current in the lines of the propulsive effort, there is no depreciation of the propelling force by the motion of the body, but the mechanical energy derived from fluid reaction is constant at all velocities. In this case the body is totally immersed in water, and the organs of propulsion are duplicated, so that the propelling forces may balance in the line of motion. How completely this principle is carried out may be seen from the flatness of the fish's head, which, if it were not balanced by the opposing mechanical force of the pectoral fins, would destroy the equilibrium of the fish's motion. In the case of birds that swim the surface or that fly in the air, and of animals that live on the land, they are all subject to the force of gravitation operating in their bodies; and though they all exhibit the same mechanical principles in their structure, yet their propelling organs are not duplicated in adverse directions, as in the fish, but the force of gravitation balances the oblique application of the animal's mechanical impulse, the two forces then uniting in the line of motion in the body. The bird which flies does not expend its force in the line of the body's motion, but upward at an angle to it, and against the weight of its body, and at such a varying angle as the

exigencies of flight and the forces resisting it require to secure a forward motion. The power of the horse is not expended in the same line as the motion of the body, but in its maximum effort of draught, in a direct line between the resting point of the hind feet and the animal's center of gravity. It is the same throughout the whole animal kingdom. Every one has doubtless experienced the force with which a fresh cherry stone can be projected by nipping it between the thumb and the finger at such an angle as to impart to it a forward impulse. This simple experiment exhibits the whole principle of animal locomotion, which in all cases is the result of coupled forces, operating at an angle to the line of the body's motion, and uniting their impulses in that line upon the center of gravity of the body. Where the body is immersed in a fluid of the same specific gravity as itself, all the propelling forces are mechanical; but where the

weight of the body operates, the mechanical force of the animal is expended against its gravity and at an angle to it."

As another instance in support of Mr. Giles' theory, the reader who can swim will remember that he goes fastest in the water when he kicks out at an angle of about 30° from the line of motion of the body, with the feet inclining downward.

But notwithstanding this and the mathematical and mechanical formulæ as to resistance of water and slip of propeller when in the usual position which Mr. Giles brings forward to sustain him, it is difficult to see how the results he confidently expects from his system are to be obtained. Looking at the diagram of the proposed ship, with its elongated overhang, it seems as if the action of the propeller, with its inclination of 45°, would result in lifting the light after-hull of the ship and in a consequent depression of her bows.

On the other hand, it is easily seen that the propeller would have a deeper average immersion, and that there would be a greater resistance of the water to the screw blades, due to the water of reaction being projected downward—an important advantage certainly.

The Fuel Used at the Mint.

Mr. D. M. Fox, Superintendent of the U.S. Mint, Philadelphia, Pa., says the fuel used exclusively in melting gold and silver is "Council Ridge" anthracite coal, carefully hand picked and screened. He adds: "After many years' experience, and many experiments with other grades of coal, we find the 'Council Ridge' anthracite to be the only fuel really suitable for the purpose, and we have discarded all others. We use the 'broken' coal size."

ENGINEERING INVENTIONS.

A boiler flue cleaner has been patented by Mr. James M. Ferguson, of New Orleans, La. The nozzle has a central aperture in its disk portion, with an inner tubular extension, around which is an annular space opening through the disk portion, and connecting with a steam chamber of the nozzle, whereby the flue cleaner is operated to remove dirt and soot and prevent the formation of scale.

A slide valve has been patented by Mr. William Mitchell, of Altoona, Pa. It has a central exhaust chamber, and the steam inlet port is formed clear through the body of the valve, the tops or outer edges of the side bars of the valve at each side of the exhaust chamber standing back of the plane of the contact faces of the chamber walls which form the valve face, so as partly to equalize the pressure at both sides of the valve and reduce its length of travel.

A revolving cylinder engine has been patented by Mr. John J. Blair, of Cincinnati, O. Combined with a fixed piston and a revolving cylinder surrounding it, with a cylindrical chamber in the piston having a sliding valve, there is a rod connected with the revolving cylinder and the sliding valve, a sleeve surrounding one end of the rod, weighted levers on the sleeve, and a plate on the ends of the rod against which the ends of the weighted levers rest.

AGRICULTURAL INVENTIONS.

A cutting apparatus for reaping and mowing machines has been patented by Mr. Elias Hazelton, of Brantford, Ont., Canada. It consists of an endless chain of knives, made by chain links, with a projecting bracket from one side adapted for the attachment of a knife, so that when the chain is run back and forth along a guide rail the edges of the oppositely moving knives cut against each other.

A seed planter has been patented by Mr. Charles C. Kierulff, of Starke, Fla. It is a light wooden box, tapering to form an edge like a spade on its lower end, with a slanting partition to guide the seed, and a vertically-sliding gate, with other novel features, the device to be operated by hand to make the holes in the ground, and mechanically drop therein cotton, corn, and similar seed.

MISCELLANEOUS INVENTIONS.

A hat and bonnet fastener has been patented by Clara Abell, of Geddes, N. Y. Combined with a hat or bonnet is an elastic band having one end secured to the hat or bonnet, and having a hair pin attached to the opposite end.

A lumber drier has been patented by Mr. Orman A. Duke, of Clanton, Ala. It is so constructed that all the hot air and gases of the furnace are utilized directly in the drying of the lumber, while the flues are so arranged that there is no danger of the lumber being fired by sparks escaping from the furnace.

A toy cap exploder has been patented by Mr. Henry M. Dixon, of New York city. Its construction is such that, in exploding a paper cap, a representation of a bird perched upon the toy will fall off as if shot, and the sparks will be prevented from flying about.

A rosin holder for violins has been patented by Mr. James W. Angus, of Macon City, Mo. It consists of a plate having lugs for holding it on the violin, with spring jaws for holding the piece of rosin, whereby the rosin will be held in such a manner as to be at all times handy and convenient.

A ring holder for displaying rings to the best advantage has been patented by Mr. Max Eising, of New York city. It is a clamp made of sheet metal, with a slotted tongue, on one end of which a bow is formed, from which a bent tongue projects through the slotted tongue, and has a curved prong on its end.

A lock has been patented by Mr. William G. Mumma, of Warrensburg, Mo. It can be made right or left handed, and the case may be so arranged that it will serve for either a mortise or rim lock, all parts being of cast iron except the springs, making a cheap lock for barns and outhouses.

A braid board has been patented by Mr. Charles E. Barnes, of Paterson, N. J. It is made of two flexible parts connected at the ends, so that the board or card of which it is made, and the braid wound thereon, may be opened out and placed upon a reel for convenience in unwinding the braid from the board.

A wheel fender for carriages has been patented by Mr. James M. Todd, of Albert Lea, Minn. It is a movable or rotatable fender for the forward wheels of vehicles, held to the carriage axle by novel means, to prevent mud and dirt taken up by the wheels from being thrown on the carriage or its occupants.

A money envelope has been patented by Mr. Patrick Scanlan, of Ida Grove, Iowa. It is of novel construction, for the use of express companies carrying valuable packages, so that after it has been sealed it will be secure against abstraction of its contents without breaking the seals or cutting or tearing it open.

A foot rest for shoeing horses has been patented by Mr. Benjamin Lear, of Woodstock, Vt. It is for supporting and holding horses' hoofs while paring, shoeing, and clinching the nails and finishing, and can be adjusted very easily to any desired height, while the horse's leg is not twisted or strained, and the hoof cannot slip.

An adjustable seat has been patented by Mr. Manoa Miles, of Russell, Kansas. Two slotted upright end pieces have a swinging seat board hung between them, with a hinged wing and a cross rod or pivots, passed through notched curved slots in the uprights, making a seat which can be easily adjusted for a lounge, invalid chair, etc.

A gas pressure regulator has been patented by Mr. Robert F. Hatfield, of New York city. It is contained in a case holding water or other liquid, and is so made as to give notice, by the flaring of the lights, when the liquid needs replenishing, and shut off the gas before the liquid becomes so low as to break the seal of the regulator.

A split gear has been patented by Mr. James Lawlor, of Fall River, Mass. Combined with a flanged hub are two or more wheel sections bolted on the flange, the sections having side recesses for receiving the flange, the wheel being readily fastened on or removed from a shaft without requiring the removal of other wheels and pulleys.

A safety stirrup has been patented by Mr. Henry Coates, of Newark, N. J. It has a pivoted guard to prevent the foot from entering too far into the stirrup, the latter being made in one piece and the entire guard in one piece, avoiding the necessity of several castings, while there is no need of a spring to hold the guard against the stirrup.

A bobbin for sewing machines has been patented by Mr. William W. Ford, of Elmira, N. Y. It has one loose head, with a spring to engage therewith and lock it closed on the barrel, to catch and hold the end of the thread on the bobbin preparatory to filling, and for afterward releasing the thread from its lock, saving time in filling, avoiding breakage, etc.

A telegraph insulator has been patented by Mr. Benjamin N. Deblieux, of Bay St. Louis, Miss. It is composed of two longitudinal sections placed together to form a joint in the middle and retaining the wire between them, with devices for holding the sections together, to support the line wire without wrapping or cutting, and altogether obviating a tie wire.

A bit fastening for bridles has been patented by Mr. Daniel Waters, of Wilkesbarre, Pa. This invention consists of a bit ring on which is formed an annular recess, with a plate to which the bit wires are fastened, the plate being placed around the annular recess formed on the bit ring, to prevent rapid wear of the bit end.

An artist's sketch book has been patented by Mr. William T. Brundage, of Brooklyn, N. Y. Combined with an artist's box are socket pieces on one end and a palette fitting in the box having at one end hook clips fitting in the sockets, to hold the palette on the end of the box, so that the holding of the palette in the same hand with the box will be facilitated.

A comb attachment for shears has been patented by Mr. Daniel M. Young, of St. Louis, Mo. The scissors blade has screw-threaded apertures near its opposite ends, through which pass thumb screws, fastening the comb through similar apertures in the back of the latter, the comb thus attached serving as a guard and to regulate the length of cutting the hair.

A vehicle axle has been patented by Mr. James I. McCalop, of Clinton, N. C. It has a cross slot in which is placed the tongue of the journal made separate from the main body of the axle, with other novel features, providing for adjusting the wheels upon the axle when worn at the hub, and at the same time maintaining them at the same distance apart.

A combined overshoe and leggin has been patented by Messrs. Henry Rudolph and Henry Schwenk, of Itco, Col. This invention covers novel details of construction and combination of parts for a shoe and leggin suitable for wear in cold mountainous districts, for warmth as well as for protection of the feet and ankles in a rough country.

An electric regulator for dampers has been patented by Mr. Wilson E. Facer, of Cleveland, O. Combined with a flue and its dampers, magnets and armatures are made to open and close a damper, a battery and thermostat having contact points for directing an electric current to automatically maintain any desired temperature for which the device may be set.

A sash frame, holder, and casing for carriages, cars, and other uses has been patented by Mr. Albert Ayers, of Rahway, N. J. The casing has a curved groove with a "throw over" in the bottom of its throw over sash groove, and the sash frame has spring friction holders, the improvement being designed to keep sashes from rubbing or rattling, and to hold them firmly in position.

A ribbon and lace exhibitor and measurer has been patented by Messrs. William B. Gleason and Milo J. Harrington, of Albion, Pa. It consists of a drum or roller having an eccentric hub, while there is a reciprocating and swinging arm operated from the hub, and a counting wheel operated from the arm, whereby ribbons and lace may be measured automatically as they are drawn from the holder.

A photographic printing frame has been patented by Mr. William H. Lewis, of New York city. It has one or more swiveling locking springs applied to its back board and ears or lip pieces applied to the frame, to engage positively with the locking ends of the springs, the ears or catches being of a novel construction, and the whole calculated to allow of the progress of the printing being watched without danger of shifting the paper.

A polishing paper has been patented by Mr. Robert J. White, of West New Brighton, N. Y. Un-sized paper is coated with a solution of rotten stone, pumice, or other polishing substance by making a solution of the latter in water of about the consistency of cream, the paper being then dried, when the polishing material is mechanically held in the interstices of and on the surface of the paper in a form convenient for use.

A portable hay and cotton press has been patented by Mr. Charles L. Barnard, of Byhalia, Miss. It is supported on wheels, so that it may be run into the field where it is to be used, and the front part of the press carries a windlass mechanism for operating the platen, the middle part being the press box proper, and the rear part being large enough to afford a space for placing hay or cotton, in which the follower reciprocates in forcing the material into the press box.

A telephone exchange forms the subject of a patent issued to Mr. William S. Ford, of Denver, Col. The invention consists of an apparatus for making connections on a switch board between a line strip and a connecting strip by means of a current acting upon the latter and another current operating electrical devices acting upon the line strip, these currents being sent to the switch board from an operator's table having upon it contact points in connection with the electrical devices at the switch board.

NEW BOOKS AND PUBLICATIONS.

CHEMICAL CONVERSION TABLES FOR USE IN THE ANALYSIS OF COMMERCIAL FERTILIZERS. By F. B. Dancy and H. B. Battle. Raleigh, N. C.: The Authors, 1885.

These tables are intended to dispense with the necessity of calculating the amount of any constituent in commercial fertilizers, from the weight of the precipitate obtained.

A GUIDE TO SANITARY HOUSE INSPECTION. By Wm. Paul Gerhard, C.E., New York: John Wiley & Sons, 1885.

It has been Mr. Gerhard's purpose, in writing this little book, to instruct the householder. The main features of sanitary house inspection are unfolded for his benefit, and are presented so briefly and so well that the scholar will find the perusal of his text-book a pleasure rather than a task. So many elements enter into the make-up of a truly healthy home that every housekeeper, no matter how thoughtful he may be, will find a guide in this matter, absolutely essential if the inspection is to be at all thorough. Ordinarily, the examination of a house for either purchase or lease is limited entirely to visible qualities, and the points which really determine its healthfulness and desirability are lost sight of. Mr. Gerhard's book goes into a brief analysis of these features, and points out to the would-be tenant the chief matters which he should investigate in choosing either a city or country home. It is not intended to be at all exhaustive, but the hints which it contains, and the special points insisted upon, are calculated to give us healthier homes, and, as a happy corollary, a stronger people.

A SKETCH OF THE GEOLOGY OF CORNWALL. By Brenton Symons. London: The Mining Journal, 1884.

Undoubtedly the most striking feature of Cornwall is its ancient mining industries, which have been in almost continuous operation since the days of adventurous Phoenicians. A Cornishman has become almost synonymous with a miner, so wide is the reputation of the country for its mining. Although so old a country, and so well explored, its geology is in some respects still quite obscure. A wide diversity of opinion exists among those naturalists who have given it careful study. In describing the geological features, therefore, Mr. Symons has put forward his own views tentatively, and avoided so far as possible adding to the causes of controversy. He gives an excellent account of the different formations and a full description of the chief mining districts into which the country is divided, with the principal minerals which are made, the object of search. Considerable attention is given to veins and their formation, since in few mining countries are the vein systems so complicated as in Cornwall, and probably in none have the theories offered in explanation been more absurd. The book is illustrated with a number of steel plates and a good geological map of the country.

Business and Personal.

The charge for insertion under this head is One Dollar a line for each insertion; about eight words to a line. Advertisements must be received at publication office as early as Thursday morning to appear in next issue.

Gold Fields

that pan out richly are not so abundant as in the early California days, but those who write to Hallett & Co., Portland, Maine, will, by return mail, receive, free, full information about work which they can do, and live at home, that will pay them from \$5 to \$25 per day, and upward. Either sex, young or old. Capital not required; you are started in business free. Those who start at once are absolutely sure of snug little fortunes.

Modern Machine Tools a specialty. Abbe Bolt Forging Machines, Power Hammers, Lathes, Planers, Drills, Shapers. Send for estimates. Forsaith M. Co., Manchester, N. H.

For Sale.—A valuable patent Coal Conveyer. Address W. S. Tomkins, Boonton, N. J.

Specialties wanted to manufacture by a well equipped machine shop. Chas. F. Hollingshead, Camden, N. J.

For Sale.—SCIENTIFIC AMERICAN, 47 volumes, unbound; January, 1882, to July, 1885. William W. Stapler, Wilmington, Del.

Woodw'g. Mch'y, Engines, and Boilers. Most complete stock in U. S. Prices to meet times. Forsaith M. Co., Manchester, N. H.

Geo. E. Lloyd & Co., Electrotype and Stereotype Machinery, Folding Machines, etc. Send for catalogue. Chicago, Ill.

Nickel Plating.—Sole manufacturers cast nickel anodes, pure nickel salts, polishing compositions, etc. \$100 "Little Wonder." A perfect Electro Plating Machine. Sole manufacturers of the new Dip Lacquer Kristaline. Complete outfit for plating, etc. Hanson, Van Winkle & Co., Newark, N. J., and 92 and 94 Liberty St., New York.

Grimshaw.—Steam Engine Catechism. A series of thoroughly Practical Questions and Answers arranged so as to give to a Young Engineer just the information required to fit him for properly running an engine. By Robert Grimshaw. 18mo, cloth, \$1.00. For sale by Munn & Co., 361 Broadway, N. Y.

The Knowles Steam Pump Works, 44 Washington St., Boston, and 93 Liberty St., New York, have just issued a new catalogue, in which are many new and improved forms of Pumping Machinery of the single and duplex, steam and power type. This catalogue will be mailed free of charge on application.

Huswell's Engineer's Pocket-Book. By Charles H. Huswell, Civil, Marine, and Mechanical Engineer. Giving Tables, Rules, and Formulas pertaining to Mechanics, Mathematics, and Physics, Architecture, Masonry, Steam Vessels, Mills, Limes, Mortars, Cements, etc. 900 pages, leather, pocket-book form, \$4.00. For sale by Munn & Co., 361 Broadway, New York.

Air Compressors, Rock Drills, J. Clayton, 43 Dey St., N. Y. Shafting, Couplings, Hangers, Pulleys, Edison Shafting Mfg. Co., 86 Goerck St., N. Y. Send for catalogue and prices.

Iron Planer, Lathe, Drill, and other machine tools of modern design. New Haven Mfg. Co., New Haven, Conn.

Wanted.—Patented articles or machinery to manufacture and introduce. Lexington Mfg. Co., Lexington, Ky. For Power & Economy, Alcott's Turbine, Mt. Holly, N. J.

Machinery for Light Manufacturing on hand and built to order. E. E. Garvin & Co., 139 Center St., N. Y.

Send for Monthly Machinery List to the George Place Machinery Company, 121 Chambers and 103 Reade Streets, New York.

Presses & Dies, Ferracute Mach. Co., Bridgeton, N. J. If an invention has not been patented in the United States for more than one year, it may still be patented in Canada. Cost for Canadian patent, \$40. Various other foreign patents may also be obtained. For instructions address Munn & Co., SCIENTIFIC AMERICAN patent agency, 361 Broadway, New York.

Curtis Damper Regulator for draught and steam pressure in boilers. Curtis Regulator Works, Boston, Mass.

Supplement Catalogue.—Persons in pursuit of information of any special engineering, mechanical, or scientific subject, can have catalogue of contents of the SCIENTIFIC AMERICAN SUPPLEMENT sent to them free. The SUPPLEMENT contains lengthy articles embracing the whole range of engineering, mechanics, and physical science. Address Munn & Co., Publishers, New York.

Guild & Garrison's Steam Pump Works, Brooklyn, N. Y. Steam Pumping Machinery of every description. Send for catalogue.

Send for catalogue of Scientific Books for sale by Munn & Co., 361 Broadway, N. Y. Free on application.

Wood Working Machinery. Full line. Williamsport Machine Co., "Limited," 110 W. 3d St., Williamsport, Pa.

"How to Keep Boilers Clean." Send your address for free 88 page book. Jas. C. Hotchkiss, 86 John St., N. Y.

Mineral Lands Prospected, Artesian Wells Bored, by Pa. Diamond Drill Co. Box 423, Pottsville, Pa. See p. 46.

Timber Gaining Machine. All kinds Wood Working Machinery. C. B. Rogers & Co., Norwich, Conn.

Bradley's improved Cushioned Helve Hammer. New design. Sizes, 25 to 500 lb. Bradley & Co., Syracuse, N. Y.

Chucks—over 100 different kinds and sizes in stock. Specials made to order. Cushman Chuck Co., Hartford, Ct.

Crescent Steel Tube Scrapers are made on scientific principles. Crescent Mfg. Co., Cleveland, Ohio.

Curtis Pressure Regulator and Steam Trap. See p. 350.

The Improved Hydraulic Jacks, Punches, and Tube Expanders. R. Dudgeon, 24 Columbia St., New York.

Hoisting Engines. D. Frisbie & Co., Philadelphia, Pa.

Tight and Slack Barrel Machinery a specialty. John Greenwood & Co., Rochester, N. Y. See illus. adv. p. 414.

Pays well on Small Investment.—Stereopticons, Magic Lanterns, and Views illustrating every subject for public exhibitions. Lanterns for colleges, Sunday schools, and home amusements. 136 page illustrated catalogue free. McAllister, Manufacturing Optician, 49 Nassau St., N. Y.

The "Improved Green Engine," Automatic Cut-off. Providence Steam Engine Co., R. I., Sole Builders.

Catechism of the Locomotive, 625 pages, 250 engravings. Most accurate, complete, and easily understood book on the Locomotive. Price \$2.50. Send for catalogue of railroad books. The Railroad Gazette, 75 B'way, N. Y.

1,000 photographs of New York houses, exteriors and interiors, doorways, vestibules, porches, oriel windows, libraries, parlors, halls, stairways, store fronts, etc., 25 cts. each (8 x 10). Send for circular. Rockwood, 17 Union Square, New York.

"Wrinkles in Electric Lighting," by V. Stephen; with illustrations. Price, \$1.00. E. & F. N. Spon, New York.

Seam and Looping Machines, patent Burr Wheels Brushing Machines. Tubbs & Humphreys, Cohoes, N. Y.

Iron and Steel Wire, Wire Rope, Wire Rope Tramways. Trenton Iron Company, Trenton, N. J.

Machinists' Pattern Letters. Pattern Letters to order. Vanderburgh, Wells & Co., 110 Fulton St., New York.

Astronomical Telescopes, from 6" to largest size. Observatory Domes, all sizes. Warner & Swasey, Cleveland, O.

Notes & Queries

HINTS TO CORRESPONDENTS.

Names and Address must accompany all letters, or no attention will be paid thereto. This is for our information, and not for publication.

References to former articles or answers should give date of paper and page or number of question. **Inquiries** not answered in reasonable time should be repeated; correspondents will bear in mind that some answers require not a little research, and, though we endeavor to reply to all, either by letter or in this department, each must take his turn.

Special Written Information on matters of personal rather than general interest, cannot be expected without remuneration.

Scientific American Supplements referred to may be had at the office. Price 10 cents each. **Minerals** sent for examination should be distinctly marked or labeled.

(1) J. A. W. writes: I want an instrument to give the per cent of sugar there is in the crude juice of the sorghum cane. A. The determinations of the specific gravity by the hydrometer are approximately correct; if these are unsatisfactory, you must use a polariscope. We should very much doubt the practicability of the other machine you mention.

(2) C. G. asks what to get to dissolve platinum. A. Platinum is soluble in aqua regia, a mixture of hydrochloric and nitric acids. It is not soluble in any single acid.

(3) F. B. P.—For how to remove marble stains, see SUPPLEMENT, No. 129. For black enamel to apply on bicycles with a brush: Dissolve in about 2 pounds of tar oil, $\frac{1}{2}$ pound of asphaltum and a like quantity of pounded resin; mix hot in an iron kettle, care being taken to prevent any contact with the flame. When cold, the varnish is ready for use.

(4) F. M. Z. asks for a formula that will make tallow soap foam well. A. See "The Method of Making Soap," in SCIENTIFIC AMERICAN SUPPLEMENT, No. 494. Numerous receipts are there given for tallow soaps that "foam well."

(5) C. A. asks: 1. How do the so-called fire eaters perform their feats, or what chemicals do they use to keep the fire from burning them? A. Dilute sulphuric acid, strong alum, and hard soap are the principal substances used. 2. What article which, when mixed with coal oil, will keep it from exploding? A. The explosive properties of coal oil cannot be removed except by so transforming it that it can no longer be used for burning purposes.

(6) F. J. E. desires information as to the value and process of manufacture of dissolved bone, a fertilizer used on wheat fields. A. Messrs. H. J. Baker and Bro., of 215 Pearl Street, New York, are the manufacturers of the fertilizer known as dissolved bone. It is excellent for wheat lands. As manufactured by a New York firm, it contains about 17 per cent of phosphoric acid, and is made by treating the bone with sulphuric acid in the proportion of 0.64 per cent of concentrated acid to each pound of bone.

(7) A. D. S.—Kerosene can be mixed with lard oil in small quantities with good effect for lamps. The kerosene should be 150° test. The quantity used must be determined by a trial as to the smoke-producing results. The browning of a gun barrel will not prevent rusting unless the barrel is oiled or varnished. Inside of barrel should also be oiled. No useful alloys of silver and steel can be made that will not rust.

(8) Student asks how he may obtain transfers or offsets from printed matter upon white paper—plate, litho, and type. A. The following process is given for the purpose of transferring engravings to paper: Place the engraving a few seconds over the vapor of iodine. Dip a slip of white paper in a weak solution of starch, and when dry in a weak solution of oil of vitriol. When again dry, lay a slip upon the engraving, and place both for a few minutes under a press. The engraving will be reproduced in all its delicacy and finish. Lithographs and printed matter cannot so be transferred with equal success.

(9) J. H. I. asks what size return tubular boiler it will take to run two engines, cylinders 2x3, revolutions 250, boiler pressure 100 pounds; and what horse power; cylinders or crank at right angles; and what size boat they would drive at about six or seven miles per hour? A. Your engines are 3 horse power, and will require a boiler of 40 square feet heating surface. With a 15 inch screw in an 18 foot boat you accomplish six to seven miles per hour.

(10) A. P. asks: What is the difference between coal oil and insurance oil? Also, what is black oil? A. By coal oil, we infer you mean the ordinary burning fluid, or kerosene. This is one of the distillates of crude petroleum, which is probably the "black oil" referred to by you. The "insurance oil" is a high grade of kerosene, having a greater density than the common article and a higher flashing point; in other words, an oil with a lesser tendency to explode than the common article.

(11) E. O. M. asks how to cut a pinion of 21 teeth on planer centers that are only divided with the numbers 16, 20, 36. A. By using the 20 index, and slotting the index catch so as to retrograde the index by one-twentieth for each tooth cut. The side of the index catch may be divided so that the length of one index notch represents 20 divisions arranged like a vernier; add one more division for the 21st tooth. Then, by drawing back the catch one division for each index division, the 20 index will produce 21 teeth. Make a trial, marking to see if the arrangement is working correctly before cutting the pinion.

(12) A. M. D.—There is no practical way of destroying the odors of melted tallow or soap boiling except by fire. You may put a close hood over the kettles, and carry the odors in a large pipe of tin or sheet iron to the boiler furnace or to the furnace that heats the kettles. Close all air inlets to the fire except from over the kettles. The only machinery for this purpose in use in this city is a sealed kettle boiled by steam, with a vent pipe extending under a fire, either under the boiler or separated. Such apparatus is used for rendering offal and dead animals for their fat.

(13) W. O. asks: 1. What is the difference between cast iron and malleable cast iron? A. Cast iron is iron that is melted and cast in moulds and used without further treatment. Malleable cast iron is iron that has been cast in moulds, and afterward annealed in annealing ovens for a considerable time to render it malleable. 2. What is meant by volts and ohms, used as terms in electricity? A. A volt is the unit of electromotive force. An ordinary or Daniell or gravity battery produces a current of about one volt. A machine which produces a current equivalent to that of one of Daniell battery will produce about one volt. The ohm is the unit of resistance. It is about equal to 350 feet of No. 9 telegraph wire. 3. What is the power of a chrome battery (bichromate of potash battery) aside of the Grenet? If they will run a 6 candle power incandescent light, how many? A. The bichromate of potash battery produces a current of about 2 volts. To run a 6 candle power of incandescent light will require about 4 to 5 cells of bichromate of potash battery. 4. I noticed, early one foggy morning, in looking at an arc light (Brush), that it had a full purple-pink cast. In looking at the same light on a clear morning through a frosted window (that was from the cold), it made the colors of a rainbow on the window. Is this spectacle natural with the light? A. The purple color of the arc lamp observed by you was probably due to the temporary elongation of the arc, the light produced by the long arc always having a violet tinge. It is not uncommon to see the colors of the spectrum in frost crystals. 5. Have you a book for sale called "Catechism of the Locomotive"? If so, what is the price? A. Yes. The price is \$2.50.

(14) D. McP. writes: There is one man maintains that it does not take any more power on the pump to test a boiler that holds 5,000 gallons of water than one that only contains 50 gallons. I say, the more water, the more power on the pump (both boilers being perfectly tight). Will you be so kind as to decide the argument? A. It takes no more pressure on the pump

to test a large boiler than it does to test a small one, but in testing the large boiler more water will be required to bring it up to the necessary pressure, and consequently more power will be consumed in testing the larger boiler.

(15) J. R.—You are making your magneto electrical machine too small to be of much service. It would not be much more expensive to make it much larger, and the labor of winding the armature would be less. Probably, with so small a machine, 6 sections, each wound with four layers of No. 32 wire, will secure the best results.

(16) C. A. B. writes: In making an electric machine, I used common green glass bottles for supports for the conductor, and the machine worked all right. I tried to better the appearance, and used flint glass rods for supports, and the machine would not work at all, under the same atmospheric conditions. I made two Leyden jars out of green glass and succeeded, and tried several out of good white glass and failed. A. The white glass contains a certain amount of lead, which renders it to some extent a conductor of electricity. The green glass which you used contained no lead and was therefore a better insulator.

(17) R. L. D. asks: 1. What size of wire and cores, and how many layers, will make the strongest electro magnet, using one cell of gravity battery in a circuit not to exceed 40 feet (besides spoils)? A. Make the cores of your magnets 2 inches long and 3/4 of an inch in diameter; wind them with ten or twelve layers of No. 24 wire. 2. Why would not vulcanite plates answer in the place of glass ones in a Wimshurst electric machine? A. Vulcanite will undoubtedly answer, but on account of the oxidation of its surface it is not so durable and reliable as glass. 3. Take a copper tube which weighs one ounce per foot and a copper wire of exactly the same weight per foot—which will have the greatest resistance to the electric current? A. There will be no difference. 4. Which would melt first under a heavy shock of lightning? A. There might be a very slight difference in favor of the tube, on account of its surface being extended, so as to radiate more heat than the wire, but we think the difference will be inappreciable.

(18) G. A. C. writes: 1. THE SCIENTIFIC AMERICAN SUPPLEMENT contains a description of an electric machine which, say, for instance, were it four times as large, would be sufficient for an arc light. Now, how can I calculate what size machine and wire to put on it if it would operate two lamps, and also how to calculate the wire for using about 30 incandescent lights at different times? A. We believe there is no rule which will enable you to calculate all of the dimensions of a dynamo electric machine so as to enable you to construct a machine to develop a given current; it is largely a matter of experiment. Much depends upon the quality of the iron used in the field magnet and in the armature, in the quality of the copper used for the conductor, and in the relative position of the various parts. 2. Why the United States incandescent machine is self-regulating? A. We believe the automatic regulation is effected by compound winding. For information on the construction of dynamos, consult Thompson's "Dynamo Electric Machines," Gordon's "Electric Illumination," and Dredge's "Electric Illumination." As you fail to give your P. O. address, we are unable to send the SUPPLEMENT desired.

(19) U. O. C.—Follow the instructions for making an induction coil given in SUPPLEMENT, No. 160, omitting the condenser, and making the iron core removable, to vary the strength of the secondary current. A short piece of iron should be left in one end of the core to operate the interrupter; or, if desirable, you may make the interrupter entirely separate from the coil, winding it with coarse wire and placing it in the battery circuit.

(20) J. C. T. asks: What kind of an instrument is used for registering the degrees of heat in a forge or furnace, and where could I obtain a good description of a simple one? A. The instrument for measuring high temperatures is called a pyrometer. You will find different forms of pyrometers described in SUPPLEMENT, Nos. 198, 33, 228, 358, 172, and 256.

(21) L. O. W. asks: 1. What must be the diameter of a lens to reflect a picture 4 inches square to a size of 8 feet at a distance of 12 feet from the screen? A. A lens of 6 inches focus and 2 inches diameter. 2. Are there two lenses used in a polyopticon, or only one? A. Two lenses are used in a polyopticon, arranged on the same principle as the magic lantern, the light being placed on the side of the lens tube, so as to illuminate the picture.

INDEX-OF INVENTIONS

For which Letters Patent of the United States were Granted December 15, 1885, AND EACH BEARING THAT DATE.

[See note at end of list about copies of these patents.]

Table listing inventions with page numbers: Air and gas engine, S. Wilcox. 332,312; Alarm. See Fire alarm. 332,473; Amalgamator, M. J. Amick. 332,527; Ash pan, Hofer & Martin. 332,274; Auger, hollow, P. Miller. 332,646; Axle box, car, M. Dougherty. 332,226; Bag. See Paper bag. 332,557; Baling press, W. W. Post. 332,291; Baling press, W. W. Seeley. 332,392; Ballot box, registering and canceling, S. J. Howell. 332,398; Band for strapping boxes, etc., G. Nicholson. 332,856; Banjo, C. J. Kelly. 332,538; Bar. See Composite bar. 332,407; Basket and skip, Milbourne & Humphreys. 332,471; Bed bottom, spring, J., Jr., & A. K. M. Ainslie. 332,442; Bed rail fastener, A. Schnell. 332,442

Table listing inventions with page numbers: Bed, sofa, C. A. Linder. 332,412; Bedstead, folding, G. H. Kamacher. 332,612; Beer cooling and drawing apparatus, P. F. Gardner. 332,508; Bell, magneto electric call, H. T. O. Fraser. 332,388; Belt, driving, Mellette & Harris. 332,672; Belt, electrical therapeutical, C. N. West. 332,467; Belt fastener, A. D. Sikes. 332,449; Belt waist, M. Rubin. 332,624; Bicycle, J. Laughlin. 332,263; Binder, temporary, H. Goodchild. 332,390; Bit. See Bridle bit. 332,561; Block. See Brake block. 332,338; Boiler. See Steam boiler. 332,561; Boiler heater and feeder, O. Rothrock. 332,338; Boiler sput, H. P. Folsom. 332,266; Boilers, device for cleaning water legs of, C. H. Manning. 332,396; Bolting reel, J. W. Hill. 332,327; Book mark, W. F. Clark. 332,627; Book shelf, C. B. Taylor. 332,238; Boot and shoe cabinet, W. Denton. 332,423; Boot or shoe, J. H. O'Donnell. 332,362; Boots or shoes, manufacturing, J. G. Ross. 332,659; Boots, shoes, etc., machine for hardening seamless felt, W. P. Hyatt. 332,281; Bottle covers from tulle, machine for the manufacture of, E. K. Cooley. 332,582; Bottle nozzle, S. B. Opdyke. 332,437; Bottle washing apparatus, A. L. Bernardin. 332,547; Bottle washing machine, A. E. Rich. 332,547; Bottle wiring machine attachment, F. Neumer. 332,638; Box. See Ballot box. Folding box. Paper box. Tape line box. 332,693; Box ventilator, W. T. Atterbury. 332,434; Brake. See Car brake. Vehicle brake. Wagon brake. 332,693; Brake block, R. S. C. Herrman. 332,434; Brake lever, T. Pinard. 332,300; Branding iron, A. Stollstorff. 332,474; Brick machine, J. Baillie. 332,571; Bridle bit, A. H. Trego. 332,558; Broiler for ranges, J. J. Richardson. 332,618; Brush holder, O. Ludwig. 332,392; Brush for lining brick houses, W. C. Green. 332,545; Brush, reservoir window washing, T. McCabe. 332,622; Buckle blanks, making, T. O. Potter. 332,425; Buckle, suspender, W. F. Osborne. 332,448; Burnishing machine, A. H. Bliss. 332,476; Bush for barrels, tap, I. Selgrath. 332,276; Button, L. Morse. 332,620; Button, cuff and collar, E. B. Nock. 332,560; Button fasteners from shoes, implement for detaching, H. Rose. 332,244; Callipers, spring, E. S. Field. 332,567; Call, individual, J. Stephen. 332,268; Can. See Oil can. 332,382; Capsule for bottles, W. R. Clough. 332,324; Car brake, W. M. Brisbane. 332,380; Car coupling, C. A. Chamberlain. 332,617; Car coupling, A. T. Lott. 332,353; Car coupling, C. S. Maynard. 332,544; Car coupling, S. F. McAllister. 332,430; Car coupling, G. D. Pearson. 332,316; Carrier. See Cash and parcel carrier. 332,589; Cash and parcel carrier, D. E. Kempster. 332,629; Caster, Van Valkenberg & Teal. 332,462; Casting gate, C. Truesdale. 332,508; Casting mould, J. R. Davies. 332,311; Chain, drive, J. H. Weaver. 332,269; Chair. See Convertible chair. Reclining chair. 332,528; Check hook, N. McGoldrick. 332,358; Chimney cowl and ventilator, W. G. Henis. 332,485; Chloriodine double combinations from pyridine and chinoline bases, producing, Ostermayer & Dittmar. 332,614; Churn, Brown & Bushnell. 332,349; Churn, J. W. Kernode. 332,680; Churn, H. R. Knox. 332,677; Churn dasher, J. B. Swaim. 332,420; Churn ventilator, J. G. Pritchard. 332,420; Circuit breaker and closer, automatic, M. J. Myers. 332,323; Clamp. See Wire clamp. 332,265; Clapboards, adjustable gauge for supporting, H. Brand. 332,588; Clock frame, R. W. Lucius. 332,575; Clothes cleansing machine, J. M. Chamberlain. 332,401; Coaster, O. A. Wheeler. 332,345; Cock box for water and gas pipes, stop, A. R. Ketcham. 332,613; Cock for ammonia gas, stop, Jungenfeld & Rassbach. 332,280; Coke, manufacture of, I. M. Kelley. 332,507; Collar for overcoats, storm, Brock & Wiener. 332,405; Collar, lady's, E. Fiske. 332,406; Composite bar, R. H. Libby. 332,484; Composite bars, making, R. H. Libby. 332,468; Compound engine, P. Brotherhood. 332,402; Condenser, surface, F. M. Wheeler. 332,676; Conductor pipe, J. Leadley. 332,285; Converter for the manufacture of iron and steel, E. M. Butz. 332,283; Convertible chair, J. K. Perley. 332,283; Cooker, steam, J. H. Parker. 332,235; Cooking vessels, etc., automatic heat regulator for, A. J. Simpson. 332,245; Corset, T. S. Gilbert. 332,543; Cotton drier, J. H. Lorimer. 332,296; Cotton gin rib, J. A. Smiley. 332,304; Cotton packing device, D. C. Summers. 332,308; Countersink, G. R. Valentine. 332,564; Coupling. See Car coupling. Lightning rod coupling. Pipe coupling. 332,376; Cradle, C. Streit. 332,684; Crate, E. F. Barton. 332,256; Cross-over switch, N. Cort. 332,375; Crutch, J. W. Tuttle. 332,355; Cube, aggregate, H. Keeler. 332,355; Culinary heater, E. Baltzley. 332,585; Cultivator, J. B. Morrison. 332,585; Cultivator tooth, J. T. Bond. 332,604; Curtain, window, F. H. Goodyer. 332,330; Cuspider and dust trap, Deis & Croxton. 332,256; Cut-off for bath boilers, anti-freezing non-exploding, W. C. Ellis. 332,387; Cut-off valve gear, J. J. Holland. 332,397; Cut-off valve gear, J. D. Cite. 332,381; Cutter. See Stalk and clod cutter. Straw cutter. 332,626; Dentists' chairs, lowering mechanism for, L. Stuck. 332,360; Desk, washstand, and other furniture, J. Penney. 332,678; Dials, transferring letters and designs to, F. Schmalz. 332,320; Digger. See Potato digger. 332,248; Distilling wood, apparatus for, T. H. Berry. 332,495; Doll body with corsets, P. Goldsmith. 332,495; Door or shutter fastener, P. J. Conroy. 332,495

Table listing inventions with page numbers: Doubling and twisting machines, thread breaking attachment for, F. Haggas. 332,512; Drawers, device for securing a series of, M. Fiset. 332,337; Drier. See Cotton drier. Fruit drier. Lumber drier. 332,342; Drill. See Well drill. 332,591; Drill press, W. Evans. 332,528; Dust pan, S. Cloud. 332,492; Dyestuff made from diazo-naphthaline, M. Hoffmann. 332,435; Earthenware, plated hollow, D. S. Plumb. 332,492; Elastic gore for wearing apparel, M. Cohn. 332,685; Electric machine, dynamo, F. G. Waterhouse. 332,399; Electric machines, commutator for dynamo, C. D. Jenney. 332,427; Electric machines, ventilating device for commutators of dynamo, C. Parham. 332,254; Electric mat, H. H. Hoffman. 332,668; Electric motor or dynamo-electric machine, W. Main. 332,319; Electrical conductors, conduit for subterranean, J. A. Barrett. 332,444; Elevator. See Hydraulic elevator. 332,454; Embossing plastic material, C. Schwartz. 332,227; Engine. See Air and gas engine. Compound engine. Gas engine. Rotary engine. Steam engine. 332,227; Envelope, S. H. Smith. 332,227; Excavator, M. F. Brainard. 332,227; Excavators, universal swivel and pipe connection for, M. F. Brainard. 332,228; Extension table, S. E. Claussen. 332,560; Extractor. See Stump extractor. 332,334; Eyeletting machine, L. C. Emerson. 332,689; Fabric. See Non-conducting fabric. 332,439; Fabric turning machine, M. F. Connitt, Jr. 332,470; Fan, columnar, J. M. Seymour. 332,470; Fanning mill, automatic, H. S. Zink. 332,555; Feed water by exhaust steam, heating, W. E. Pearson. 332,598; Felly, vehicle wheel, E. Danford. 332,582; Fence, barbed, J. Haish. 332,600; Fence building machine, J. T. Fairburn. 332,253; Fence wire, barb, J. Haish. 332,416; Fence, worm, D. A. McHenry. 332,514; Fiber for textiles, cordage, etc., treating animal and vegetable, W. W. Hamilton. 332,515; Fiber for upholstery, treatment of animal and vegetable, W. W. Hamilton. 332,663; File, paper, J. H. Laney. 332,664; File, transfer, J. H. Laney. 332,665; Filing case, J. H. Laney. 332,610; Filter, B. James. 332,600; Filter, W. L. Johnson. 332,422; Filter, W. Neracher. 332,638; Fire alarm, electric, S. A. Chase. 332,255; Fire escape, Keck & Schadt. 332,554; Fire escape, I. D. Pasco. 332,229; Fire extinguishing apparatus, chemical, J. Britto. 332,429; Fireplace, hot air, D. Pearson. 332,573; Fishing line float, W. H. Tufts. 332,491; Floors, device for preventing draughts beneath, W. W. Clay. 332,648; Fluxes, manufacturing, Taylor & Leyshon. 332,619; Fodder binder, C. E. Moles. 332,486; Folding box, Brumby & Clarke. 332,342; Folding chair, Horn & Gundlach. 332,594; Forging machine, hydraulic, C. Davy. 332,595; Frame. See Clock frame. 332,596; Fruit drier, S. Dean. 332,596; Fruit drier, J. R. Dew. 332,497; Fuel and making the same, artificial, W. H. Cory. 332,498; Fuel and making the same, carbonaceous, W. H. Cory. 332,223; Furnaces, device for burning gas in, J. Ashcroft. 332,286; Fuse, electric safety, G. Pfannkuche. 332,569; Gauge. See Sewing machine gauge. 332,648; Gas, apparatus for manufacturing, J. L. Stewart. 332,648; Gas burners, safety key for, J. & J. H. Dutton. 332,646; Gas compressor, Jungenfeld & Rassbach. 332,447; Gas engine, C. Shelburne. 332,315; Gas engine, S. Wilcox. 332,315; Gas flame, support for holding and adjusting incandescing bodies in a, O. B. Fahnehjelm. 332,568; Gas regulator, automatic, A. J. Stewart. 332,341; Gate, H. Green. 332,494; Glass and articles therefrom, manufacture of, F. S. Shirley. 332,411; Glass, making crystalline, E. A. Savary. 332,534; Grain binder, M. G. Hubbard, Jr. 332,233; Grinding mill, vertical disk, J. T. Case. 332,483; Hair crimper, E. J. Brooks. 332,271; Halter, E. R. Michaelis. 332,260; Hame, E. G. Latta. 332,270; Hame fastener, M. M. McKinnon. 332,409; Hame fastener, H. Nadorff. 332,536; Hammer for welding locomotive frames, J. R. James. 332,367; Hammock awning support, J. Hamilton. 332,369; Hammock support, J. A. Woodworth. 332,561; Harrow, Barnard & Geary. 332,582; Harrow, J. S. Rowell. 332,604; Harness crupper, F. K. Hickok. 332,634; Harness trimming, W. Boese. 332,565; Harvester, self-binding grain, P. A. Spicer. 332,411; Harvester, sugar cane, C. H. Lee. 332,599; Hat brims, setting the folded or curled edges of, R. Eickemeyer. 332,530; Hay and straw rack, W. G. Houk. 332,440; Hay rake, horse, G. Robinson. 332,487; Heater. See Boiler heater. 332,350; Hinge, M. Campbell. 332,275; Hoe, F. S. Kretsinger. 332,466; Holder. See Bag holder. Broom holder. 332,466; Hook. See Check hook. Snap hook. 332,275; Hop stripping machine, E. D. Mills. 332,367; Horse detacher, T. W. Lambert. 332,464; Horseshoe nail, B. Watkins. 332,589; Hose truck, H. P. Cope. 332,457; House. See Tobacco curing house. 332,457; House, tenement, W. Sturm. 332,418; Hydraulic elevator, P. F. Morey. 332,466; Ice cream freezer, J. G. Webb. 332,361; Ice machine, T. L. Rankin. 332,471; Ice plow, J. G. & H. Bodenstien. 332,541; Illuminating device, C. A. Leager et al. 332,511; Indicator. See Magneto-electric indicator. 332,559; Induction coil, J. A. Robinson. 332,386; Injector, steam, J. Desmond. 332,306; Inking pad, B. B. Hill. 332,475; Iron. See Branding iron. Soldering iron. 332,475; Iron and steel, apparatus for manufacturing, B. Bayliss, Jr. 332,404; Ironing table, F. A. Lerch. 332,548; Knife. See Pocket knife. 332,657; Knife blade holder, E. Nicholson. 332,677; Knife for cutting seed potatoes, D. S. Humphrey. 332,372; Knitting machine needle, Adgate & Kittle. 332,374; Knitting machine, welt thread, J. J. Adgate. 332,374

Knitting machines, cam cylinder for, J. J. Adgate 332,373
 Knob attachment, W. B. Smith 332,455
 Knob attachment, door, J. A. Paine 332,359
 Lamp, heating, A. F. Zimmerling 332,370
 Lamp, moderator, E. Bourdon 332,322
 Latch, mortise, W. E. Sparks 332,456
 Lath attachment, E. J. Bracken 332,481
 Lathe, R. C. Fay 332,335
 Lathe for turning spirals, A., Sr., & A. Gassinger, Jr. 332,510
 Lathe, many-spindle, A. & A. Gassinger, Jr. 332,509
 Lathes, taper and pulley turning attachment for, T. H. Worrall 332,578
 Leather splitting machine, E. Cummings 332,385
 Leggin, J. H. Way 332,630
 Lightning rod coupling, A. J. Munson 332,673
 Lightning rod standard, Cole & Knudsen 332,383
 Lock, W. H. Taylor 332,459
 Locomotive traction increaser, J. J. Steiger 332,288
 Loom shuttle driving mechanism, F. Kesselring 332,400
 Lubricator. See Pulley lubricator.
 Lubricator, J. Powell 332,623
 Lumber drier, O. A. Duke 332,241
 Magneto-electric indicator, J. C. Boyle 332,480
 Masts, with the band stay for, R. B. Chute 332,232
 Mat. See Electric mat.
 Mattress, G. D. Peters 332,432
 Measuring vessel, E. R. Stasch 332,297
 Meat chopping machine, A. Heusch 332,608
 Metal pressing apparatus, fluid, W. R. Hinsdale 332,656
 Meter. See Water meter.
 Middlings purifier, W. Klostermann 332,615, 332,616
 Mill. See Fanning mill. Sawmill.
 Mould. See Casting mould.
 Motion, transmitting, H. Wright 332,692
 Motive power, W. A. Brown 332,231
 Motor. See Electric motor.
 Motor, Graham & North 332,249
 Motor, A. F. Harrell 332,517
 Mowing machine finger bar and finger, D. C. Markham 332,671
 Music and book rack or holder, B. Dreher 332,647
 Music leaf turner, Andersen & Wilhelm 332,579
 Musician's exercising device, A. P. Scheurman 332,290
 Nail. See Horseshoe nail.
 Nail drawer, G. L. Donovan 332,598
 Nippers, cutting, G. N. Donovan 332,597
 Non-conducting fabric, W. P. Adams 332,371
 Nut lock, J. B. Law 332,540
 Nut lock, C. Maldner 332,669
 Nut lock, G. P. Rose 332,288
 Oil can, W. S. Denton 332,289
 Ore crushing machine, E. M. Carhart 332,488
 Oyster opening machine, C. Leduc 332,403
 Packing, metallic piston, N. Pfau 332,433
 Packing, steam pipe joint, J. B. Lyons 332,667
 Pad. See Inking pad.
 Pan. See Ash pan. Dust pan.
 Paper bag, J. P. Onderdonk 332,280
 Paper bag machine, D. Appel 332,631
 Paper box, G. L. Jaeger 332,535
 Paper folding machine, T. C. Dexter 332,331
 Paper folding machine, J. T. Hawkins 332,530
 Paper folding machines, sheet switching device for, T. C. Dexter 332,332
 Peanut roaster, T. Lee 332,351
 Perforating machine, J. E. Munson 332,419
 Photographs in permanent pigments, producing, W. W. Sherman 332,364
 Piano and organ music desk, S. G. Chickering 332,326
 Pill machine, E. A. Coles 332,493
 Pills, lozenges, etc., machine for making, E. A. Coles 332,494
 Pin stem, C. I. Loveren 332,264
 Pipe. See Conductor pipe.
 Pipe coupling, J. A. McCormick (r) 10,674
 Plane, floor, J. A. Traut 332,305
 Planter, corn, A. Glisson 332,602
 Planter, corn, E. M. South 332,679
 Planter, corn, A. Yount 332,469
 Platform dump and elevator, portable, A. L. Grinnell 332,654
 Plow, W. Strait 332,302
 Plow and pulverizer, cylinder, S. M. Neely 332,421
 Plow attachment, W. S. Felton 332,652
 Plow carriage, C. B. Spurr 332,566
 Plow, shovel, J. P. Scott 332,563
 Plow stock, T. W. Boyle 332,225
 Plow, sulky, W. Strait 332,301
 Pocket and protector, detachable, A. Warshoer 332,310
 Pocket knife, C. H. Kahler 332,537
 Post driver, A. Weeden 332,687
 Potato digger, C. J. Cummings 332,644
 Power. See Motive power.
 Press. See Baling press. Drill press.
 Pressure regulator, fluid, J. F. De Pew 332,645
 Printer's chase, L. W. Hardwicke 332,516
 Printer's galley, D. B. Watts 332,686
 Printing machine sliding bearer, S. Whitlock 332,577
 Printing machine, web perfecting, J. T. Hawkins, 332,518, 332,519, 332,521
 Printing press gearing, S. Whitlock 332,576
 Printing rollers or blocks, making, F. Beck 332,337
 Printing surfaces, machine for justifying matrices for producing, F. D. Maltby 332,352
 Propeller, screw, A. Vogelsanz 332,309
 Pulley lubricator, loose, W. J. Ormsby 332,552
 Pump, rotary, J. F. Breux 332,586
 Pumps, oil drip and separating tank for ammonia gas, Jungensfeld & Raasbach 332,344
 Pumping apparatus, device for transmitting motion in oil, G. Allen 332,318
 Punch, J. H. Janey 332,666
 Rack. See Hay and straw rack. Music and book rack.
 Rails to metal sleepers, fastening, J. Conley 332,384
 Railway heads, etc., stop motion for, A. Schaefer 332,289
 Railway signal, W. M. Pease 332,431
 Railway tie, L. M. Clark 332,490
 Railway time signal, electric, G. Cornell 332,496
 Rake. See Hay rake.
 Reclining chair, M. S. Curtiss 332,237
 Reclining chair, J. Gloekler 332,603
 Refrigerating vessel for cold storage, A. M. Blanchard 332,584
 Refrigerator, A. McKenzie 332,417
 Refrigerator safe for bread, cake, etc., H. D. Streator 332,367
 Regulator. See Gas regulator. Pressure regulator.
 Roaster. See Peanut roaster.
 Rock drill core lifter, G. F. Case 332,587
 Rock drilling and tunneling machine, R. Daltzell 332,592
 Roofing, W. H. Stewart 332,570
 Roofing anchor, sheet metal, W. A. List 332,413
 Roofing machine for edging and seaming tin, J. J. Cowell 332,643
 Rotary engine, J. Harrington 332,253
 Saddle, harness, A. Gilliam 332,340
 Safe and vault, fireproof, C. C. Gilman 332,246
 Safe, druggist's, T. Knoebel 332,661

Sails for vessels, rigging for, G. Bianchi 332,583
 Sash balance, J. A. Rogers 332,368
 Sash fastener, J. E. Alexander 332,472
 Sash fastener, S. N. Chapin 332,325
 Satchels, fastener for hand, M. Rubin 332,625
 Saw guide track, P. Miller 332,273
 Sawmill, band, S. Stephens 332,365
 Sawmill, circular, H. Wright 332,691
 Sawmill, portable, H. Wright 332,690
 Saw sharpening machine, D. W. Johns 332,611
 Sawing machine, scroll, A. D. Goodell 332,391
 Scalping machine, W. D. Gray 332,250
 Scraper, wheeled, F. W. Hubbard 332,531 to 332,533
 Screen. See Window screen.
 Screwdriver, self-holding, J. W. Richardson 332,438
 Seal, metallic, C. L. Pond 332,556
 Seeding machine, L. Eberhart 332,506
 Sewers, device for flushing, A. T. Elford 332,333
 Sewing machine, H. P. Aldrich 332,317
 Sewing machine, J. W. Tuttle 332,683
 Sewing machine buttonhole attachment, W. H. Gilbert 332,511
 Sewing machine buttonhole attachment, J. M. Griest 332,251
 Sewing machine buttonhole attachment, J. H. Palmer 332,426
 Sewing machine buttonhole attachment, E. S. Pratt 332,676
 Sewing machine for connecting soles and uppers of turned shoes, P. A. & J. Coupal 332,642
 Sewing machine gauge, H. Hitchcock 332,526
 Sewing machine thread waxing and heating device, B. F. Landis 332,259
 Shade roller, automatic, G. W. Stewart 332,299
 Sheet delivery apparatus, L. C. Crowell 332,236
 Shoe, plow, M. Walker 332,463
 Shutter, R. Hammill 332,655
 Shutter fastener and opener, combined, Horn & Leick 332,343
 Sifter, ash, F. Heimann 332,394
 Sign for railway cars, traveling, G. M. Traylor 332,306
 Signal. See Railway signal. Railway time signal.
 Signaling device, J. D. Fee 332,326
 Silk fabrics, machine for finishing, A. Crew 332,245
 Skate fastener, H. F. Osborne 332,424
 Skate, roller, T. Mulvin 332,277
 Skate, roller, Nelson & Donovan 332,278
 Skate, roller, H. Thomas 332,460
 Skate sharpener, E. F. Watson 332,465
 Sleeve, garment, C. H. Ostrander 332,553
 Snap hook, W. H. McGrew 332,415
 Snow plow flange, I. P. Kilgore 332,348
 Soap, manufacture of, W. A. Grant 332,606
 Soap manufacturing machine, W. A. Grant 332,605
 Soldering iron, J. A. Bostwick (r) 10,672
 Spark arrester, T. F. Landis 332,280
 Spark arrester, T. Thornton 332,628
 Speculums, electric light attachment for, C. Smith 332,453
 Spindle steps, setting, F. H. Colony 332,628
 Spring. See Velocipede seat spring.
 Sprinkling machine, J. Dahn 332,329
 Stalk and clod cutter, J. C. Farley 332,601
 Stamps, envelopes, etc., apparatus for moistening, W. H. H. Lintner 332,542
 Starch, treating buckram and other fibrous substances with, P. C. Ritchie 332,439
 Steam boiler, J. H. Mars 332,267
 Steam boiler, V. P. Orloff 332,357
 Steam engine, R. Creuzbauer 332,499 to 332,502
 Steam engine, R. M. Marchant 332,670
 Steam pipe covering, C. Lamkin 332,258
 Stenographer's use, line finder for, A. & W. Nimmo 332,410
 Stocking exhibitor, J. D. & G. W. Hibbs 332,524
 Store service apparatus, R. H. North 332,674
 Store service apparatus, switch for, E. L. Giles 332,339
 Store, oil burning, J. F. Trout 332,307
 Straw cutter, F. W. Miller 332,272
 Stuffing box for piston rod of ice machines, etc., G. F. Ott 332,675
 Stump extractor and stone lifter, W. O. White 332,368
 Suspenders, G. H. Boyd 332,479
 Switch. See Cross-over switch.
 Table. See Extension table. Ironing table.
 Tank. See Water tank.
 Tanning apparatus, L. Simpson 332,450, 332,451
 Tape line box, H. E. Dickhut 332,505
 Tapping device, J. H. Rathbun 332,436
 Telegraph, printing, R. N. Dyer 332,649
 Telegraph, quadruplex, H. C. Nicholson 332,549 to 332,551
 Thrashing machine and dust protector, W. W. Barber 332,224
 Tie. See Railway tie.
 Tile, encaustic, F. J. Frenzel, Jr. 332,389
 Tile machines, automatic cut-off and take-away for drain, Merrill & Viggers 332,546
 Tobacco curing house, J. Osborn 332,621
 Tobacco holder and shaver, S. R. Parks 332,284
 Tongue support, wagon, J. Smalley 332,452
 Toy gun, G. S. Tingley 332,461
 Truck, car, W. T. Browne 332,378
 Truck, car, J. Turner 332,682
 Truss and supporter, combined, H. A. Schulz 332,443
 Type matrices, machine for forming, O. Mergenthaler 332,354
 Vacuum brake apparatus, automatic, J. Gresham 332,653
 Valve, balanced slide, J. D. Olds 332,279
 Valve, piston, P. Armington 332,632
 Valve, steam engine, H. H. Westinghouse 332,689
 Vault, fireproof, C. C. Gilman 332,247
 Vehicle brake, T. Briggs 332,452
 Vehicle dash, A. S. Parker 332,282
 Vehicle seats, adjustable back for, Straubel & Hebel 332,303
 Vehicle top, K. W. Holmes 332,529
 Velocipede, C. S. Leddell (r) 10,673
 Velocipede seat spring, R. E. Humphreys 332,658
 Ventilator. See Box ventilator. Churn ventilator.
 Ventilator for cooking and other apartments, D. Burgess 332,379
 Vessel, screw propelled, C. W. Field, Jr. 332,243
 Vise, H. D. Booth 332,478
 Vulcanizing rubber and for other purposes, apparatus for, H. C. Miller 332,408
 Wagon brake, Swann & Adkins 332,681
 Wagon, dumping, J. McFarland 332,414
 Walls of buildings, preventing salt-peter exudations from forming on the faces of, J. C. Anderson 332,580
 Washing machine, G. G. Koschel 332,662
 Water closet, automatic flushing, W. B. Parsons, Jr. 332,423
 Water closet supply tanks, valve for, W. Bunting, Jr. 332,635
 Water meter, oscillating, J. W. Byrne 332,637
 Water tank, F. J. Carney 332,489
 Weaning calves, device for, Shank & Meek 332,293
 Well drill, self-pumping and expanding, W. C. Wells 332,688
 Windlass locking gear, C. A. Potter 332,287

DESIGNS.

Burial caskets, ornamentation of, Quint & Mowen 16,418
 Dish, E. Gerard 16,414
 Lamp globe or shade, J. Webb 16,419, 16,420
 Moulding, F. Mankey 16,416
 Ornamentation of walls, etc., surface, F. Mankey 16,415
 Scarf, etc., knot for, C. E. Page 16,417
 Stove, cooking, H. C. Bascom 16,421, 16,422
 Stove, parlor, H. C. Bascom 16,418

TRADE MARKS.

Abietine gum, and salves, ointments, and other compounds made therefrom, distillation from, Abietine Medical Company 12,854
 Ale and stout, Read Brothers 12,866
 Baking powder, G. B. Burlingame 12,839
 Baking powder, Thomson & Taylor Spice Company 12,870
 Blood purifier and cancer cure, R. G. Jones et al 12,860
 Boots and shoes, sectional metallic protectors for soles and heels of, J. Blakey 12,837
 Cards, Christmas, New Year, Easter, birthday, Scriptural, and other, J. & H. Castell 12,840
 Condiment, bottled, S. F. Beer Company 12,869
 Dental rubber, Boston Rubber Company 12,838
 Essences and toilet soap, Eastman & Brother 12,843
 Finger rings and thimbles, filed, H. Muhr's Sons 12,847
 Hose, canvas, J. McGregor 12,845
 Jewelry, imitation diamond, H. Muhr's Sons 12,846
 Lanterns, magic, J. Scheidig & Co 12,851
 Medicine, corn, E. E. Howard 12,858, 12,859
 Milk, condensed, Boden Condensed Milk Company 12,855
 Oil preparation for alleviating pain caused by nervous diseases, I. E. Porter 12,865
 Opera glasses, J. Scheidig & Co 12,852
 Paper, writing, East Hartford Manufacturing Company 12,842
 Salt, Phillips, Henry & Co 12,850
 Silverware for table use, watch cases, etc., imitation, Holmes & Edwards Silver Company 12,844
 Soap, laundry, Oberne, Hosick & Co 12,848
 Soap, glycerine, Mulhens & Kroppf 12,863
 Soap, laundry and toilet, N. K. Fairbank & Company 12,856, 12,857
 Stoves and ranges, cooking, Western Stove Manufacturing Company 12,853
 Thimbles, gold, silver, and other solid, H. Muhr's Sons 12,861
 Tobacco, cut smoking and cut chewing, B. Payne's Son's Tobacco Company 12,849
 Tobacco, plug, Perkins & Ernst 12,864
 Varnishes, japans, wood stains, etc., D. Rosenberg & Sons 12,868
 Watch cases, Crescent Watch Case Company 12,841
 Watch cases, filled, H. Muhr's Sons 12,862
 Wood stains, varnishes, etc., D. Rosenberg & Son 12,867

A Printed copy of the specifications and drawing of any patent in the foregoing list, also of any patent issued since 1866, will be furnished from this office for 25 cents. In ordering please state the number and date of the patent desired, and remit to Munn & Co., 361 Broadway, New York. We also furnish copies of patents granted prior to 1866; but at increased cost, as the specifications, not being printed, must be copied by hand.

Canadian Patents may now be obtained by the inventors for any of the inventions named in the foregoing list, at a cost of \$40 each. For full instructions address Munn & Co., 361 Broadway, New York. Other foreign patents may also be obtained.

Advertisements.

Inside Page, each insertion - - - 75 cents a line.
 Back Page, each insertion - - - \$1.00 a line.
 (About eight words to a line.)
 Engravings may head advertisements at the same rate per line, by measurement, as the letter press. Advertisements must be received at publication office as early as Thursday morning to appear in next issue.

THE PAYNE AUTOMATIC ENGINE
AND BOILERS
 of all sizes.
 Write for Circular and tell us what you want.
 B. W. PAYNE & SON, Drawer 1004, Elmira, N. Y.
 Or address our New York Office.
 Eastern Agents, HILL, CLARKE & CO., Boston, Mass.
 Our patented Vertical Boiler will not prime. No danger of burning flues.

THE GENUINE LIGHTNING SCREW PLATE
PERFECT SCREWS AT A SINGLE CUT
 Fine Taps and Dies, Bolt Cutters, and Lathe Saving Tools
Wiley & Russell Mfg. Co., Greenfield, Mass.

ADVERTISERS Can learn the cost of any proposed line of Advertising at GEO. P. ROWELL & CO.'S NEWSPAPER Advertising Bureau, 10 Spruce St., New York. Send 10 cents for a 100-page pamphlet.

WEST BRANCH BOILER WORKS
STEAM BOILERS OF ALL KINDS
 STACKS, TANKS, STEAM PIPE, PUMPS,
 ALL KINDS OF VALVES, & INSPIRATORS,
 AND ENGINE SUPPLIES, NO. 27
 Valuable Fertilizer Distributer Patent for Sale entire, or will license; already introduced in several counties; acknowledged the best. Address JOSEPH B. DENTON, Newtown, Long Island. Send for circular.

GET THE BEST AND CHEAPEST
 SILVER FINISH
J. A. FAY & CO.
 CINCINNATI, O.
 SOLE AGENTS UNITED STATES.
J. A. FAY & CO.,
 (Cincinnati, Ohio, U. S. A.)
 Exclusive Agents and Importers for the United States of the
CELEBRATED
PERIN BAND SAW BLADES,
 Warranted superior to all others in quality, finish, uniformity of temper, and general durability. One Perin Saw outwears three ordinary saws.
 Manufacturers of Planing Machines and other Patent Wood Working Machinery.

Every Man His Own Printer.
 Type setting, etc., easy by printed directions. For business or home use or money making. For old or young. Send 2 stamps for catalogue of presses, type, cards, paper, etc., to factory.
KELSEY & CO.,
 Meriden, Conn.

WATCHMAN'S IMPROVED TIME DETECTOR,
 WITH SAFETY LOCK ATTACHMENT.
 Patented 1875, 1876, 1877, 1880, 1881, 1882.
 This instrument is supplied with 12 keys. Invaluable for all concerns employing watchmen. It contains all modern improvements and is far superior to the old style. 1882 - At the National Exposition for Railway Appliances and Perfect Instrument. Send for circular to P. O. Box 2875.
E. IMHAUSER, 212 Broadway, New York.

POWEN'S MANUAL OF CHEMISTRY.
 Embracing WATTS' PHYSICAL and INORGANIC CHEMISTRY.
 A new American from the Twelfth English Edition. 1050 pp. Leather, \$3.50. Will be sent, postpaid, by MUNN & Co., on receipt of price.

Remington Standard Type-Writer
 Purchasers permitted to return by Express C. O. D. for full purchase price at any time within thirty days, thus giving an opportunity for comparison with other machines.
Wyckoff, Seamans & Benedict,
 339 Broadway New York.

NICKEL PLATING & POLISHING MATERIALS.
ZUCKER & LEVETT
 CHEMICAL CO. NEW YORK, U.S.A.
NICKEL & ELECTRO PLATING OUTFITS.

OUR ODOMETER attached to a wagon gives the miles traveled from 1-100 part to 1000, and repeats. The size of a dollar (2 1/2 oz.). Price \$2. Only one ever stood test of time. 3 wheels. No springs. A new principle in mechanism that would be well for every inventor to study, as there are hundreds of places in which it can be used. Right of use, reasonable. Will be mailed to inventors for \$2. If mention Sec. Act. Send for catalogue of our accurate instruments. A FEW GOOD MEN WANTED to handle our goods.
McDONNELL ODOMETER CO., 2nd & LaSalle Ave., Chicago, Ill.

ICE-HOUSE AND COLD ROOM.—BY R. G. Hatfield. With directions for construction. Four engravings. Contained in SCIENTIFIC AMERICAN SUPPLEMENT, 59. Price 10 cents. To be had at this office and of all newsdealers.

ROP HAMMERS
Punching Presses
 DIES AND OTHER TOOLS
 For the manufacture of all kinds of SHEET METAL GOODS, DROP FORGING, &c.
Stiles & Parker Press Co.,
 WILMINGTON, CONN.

Wanted—The right to manufacture some patent article or device in which light ironworking machinery can be used. Will purchase patents or manufacture on royalty. Address P. O. Box 23, Decatur, Ill.

VAN DUZEN'S Mechanical Boiler Cleaner.
 Takes out all mud and scale forming properties from the water of Steam Boilers, keeping it clean and free from all impurities. Send for circular. Manufactured by
IE. W. VAN DUZEN,
 CINCINNATI, O.

AMERICAN MECHANICAL DICTIONARY. A Descriptive Word Book of Tools, Instruments, Machines, Chemical and Mechanical Processes; Civil, Mechanical, Railway, Hydraulic, and Military Engineering; a History of Inventions; General Technological Vocabulary; and Digest of Mechanical Appliances in Science and Industrial and Fine Arts. Illustrated with upward of 7,000 engravings. By Edward H. Knight, A. M. Civil and Mechanical Engineer. In three octavo volumes. The set, cloth, \$24.00; sheep, \$27.00. For sale by MUNN & Co., 361 Broadway, New York City.

AMERICAN STEAM BOILER INSURANCE CO.,
 45 William Street, New York.
 Write for Special Blanket Form No. 99; gives complete protection to property, and pays \$5,000 for a life and \$50 weekly for six months for injury.

Edco System
 Of Arc and Incandescent Lighting.
 Electric Light and Power.
 Motors, Dynamos, Lamps, and Batteries in all varieties. Electro-Dynamic Co., 224 Carter St., Philadelphia.
W. W. Griscom, Consulting Electrical Engineer.

Important Practical and Scientific Books

LIST No. 2.

Amateur Mechanics' Workshop.—Containing Plain and Concise Directions for the Manipulation of Wood and Metals, including Casting, Forging, Brazing, Soldering, and Carpentery. By the Author of "Lathe and Its Uses." Illustrated, 8vo. \$3.00
Arlot.—Complete Guide for Coach Painters. 12mo. \$1.25
Armstrong.—The Construction and Management of Steam Boilers, with an Appendix. By R. Mallet. 7th edition, illustrated, 12mo. 75c.
Baker.—The Mathematical Theory of the Steam Engine. With Rules at length and Examples Worked Out for the Use of Practical Men. 6th edition. Revised by Prof. Young. Illustrated, 12mo. 75c.
Bauman.—A Treatise on the Metallurgy of Iron. 5th edition, revised and enlarged; illustrated, 12mo. \$2.00
Beans.—A Practical Treatise on Railway Curves and Location of Railroads. Illustrated, 12mo, tucks. \$1.50
Beckett.—A Rudimentary Treatise on Clocks, Watches, and Bells. Illustrated by Numerous Engravings. 7th edition, revised and enlarged, 12mo. \$2.25
Bell.—Carpentry Made Easy; or, the Science and Art of Framing on a New and Improved System. With Specific Instructions for Building Balloon Frames, Barn Frames, Mill Frames, Church Spires, etc. Also a System of Bridge Building, with Bills, Estimates of Cost, etc., and Tables. Illustrated, 44 plates, 8vo. \$5.00
The above or any of our Books sent by mail, free of postage, at the publication prices to any address in the world.
Our large Catalogue, 96 pages, 8vo, and our other Catalogues and Circulars, the whole covering every branch of Science applied to the Arts, sent free and free of postage to any one in any part of the world who will furnish his address.

HENRY CAREY BAIRD & CO., INDUSTRIAL PUBLISHERS, BOOKSELLERS & IMPORTERS, 810 Walnut Street, Philadelphia, Pa., U. S. A.

IT PAYS To sell our Rubber Stamps. Free Catalogue to agents. FOLJAMBE & Co., Cleveland, O.

DRAINAGE.—A SERIES OF VERY excellent directions for draining railways, roads, etc., by Mr. Charles Palmer. Contained in SCIENTIFIC AMERICAN SUPPLEMENT, No. 465. Price 10 cents. To be had at this office and from all newsdealers.

NOTICE to Users of Steam Pumps. We have received following letter in regard to one of our No. 5 "L" (\$16) Steam Jet Pumps elevating 1 1/2 inch pipe of water more than 50 feet high: "L'ANSE, MICH., Feb. 24, 1883. "VAN DUZEN & TIFT, Cincinnati, O.: "Money could not buy the Jet of us unless another could be had. We would not give your No. 5 "L" for a \$700 pump, equal distance to raise. "N. A. Litchfield, Supt. Mich. Slate Co." We make Ten Sizes of these Pumps. Prices \$7 to \$75. Capacities 100 to 20,000 gallons per hour. State for what purpose wanted and send for Catalogue of "Pumps." VAN DUZEN & TIFT, Cincinnati, O.

RAILWAY AND STEAM FITTERS' SUPPLIES Rue's Little Giant Injector. SCREW JACKS, STURTEVANT BLOWERS, &c. JOHN S. URQUHART, 46 Cortlandt St., N. Y.

THE DESIGNING OF ORDINARY IRON HIGHWAY BRIDGES. Illustrated by Numerous Engravings and 7 Folding Plates. Showing Bridges Actually Constructed, and Giving Their Dimensions; also containing 49 Tables. Price, \$4.00. By JOHN S. URQUHART, C. E., B. S. C. M. A. E. The very complete index will prove of great convenience to both students and engineers, using the work as a book of reference. Address, MUNN & CO., 361 Broadway, New York.

ROOFING for Buildings of every description. Durable, Light, Easily Applied, Inexpensive. BUILDING PAPER—Sackett's Waterproof Sheathing. Clean to Handle, Impervious to Moisture, Water, and Gases. NEW YORK COAL TAR CHEMICAL CO., 10 Warren St., N. Y.

Syracuse Malleable Iron Works

PROPOSITIONS FOR GAS AND ELECTRIC LIGHTING.

PROPOSITIONS are hereby invited and will be received by the undersigned committee for the purpose of lighting the city of Montgomery, Alabama, with Gas and Electricity. Population 25,000. W. S. REESE, Mayor, T. H. CARR, Alderman, J. W. ALLEN, " A. A. WILEY, " T. J. WILLIAMS, " Committee.

INJECTORS For all kinds of STEAM BOILERS. RUE MFG. CO., FILBERT ST., Philadelphia, Pa., U. S. A.

A BIG OFFER. To introduce them, we Self-Operating Washing Machines. If you want one send us your name, P. O. and express office at once. The National Co., 23 Ely St., N. Y.

Insoluble ELECTRIC ALARM MATTING. Few pieces under the carpets. Cheapest. Best. Protection from Burglars, Sneakers, etc. Single. Or Eight is your best. Wholesale and Retail. Best discounts to Electricians, Builders, etc. Ad. B. S. APPLING, Inventor and Patent Attorney, 152 CHESTNUT STREET, Philadelphia, Pa. (English Patent for Sale.)

TELEPHONES SOLD. Don't pay exorbitant rental fees to the Bell Telephone Monopoly to use their Telephones on lines less than two miles in length. A few months' rental buys a first-class Telephone that is no infringement, and works splendid on lines for private use on any kind of wire, and works good in stormy weather. It makes homes pleasant; annihilates time; prevents burglaries; saves many steps, and is just what every business man and farmer should have to connect stores, houses, depots, factories, colleges, etc., etc. The only practicable and reliable Telephone that is sold outright and warranted to work. Chance for agents. No previous experience required. Circulars free. W. M. L. NORTON, Buffalo, N. Y.

The New Catalogue of Valuable Papers contained in SCIENTIFIC AMERICAN SUPPLEMENT, sent free of charge to any address. MUNN & CO., 361 Broadway, N. Y.

PERFECT NEWSPAPER FILE

The Koch Patent File, for preserving newspapers, magazines, and pamphlets, has been recently improved and price reduced. Subscribers to the SCIENTIFIC AMERICAN and SCIENTIFIC AMERICAN SUPPLEMENT can be supplied for the low price of \$1.50 by mail, or \$1.25 at the office of this paper. Heavy board sides; inscription "SCIENTIFIC AMERICAN" in gilt. Necessary for every one who wishes to preserve the paper. Address MUNN & CO., Publishers SCIENTIFIC AMERICAN.

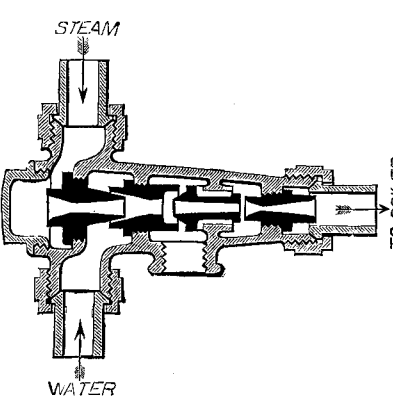

THE NEW "GRESHAM" PATENT Automatic Re-Starting Injector.

A most remarkable boiler feeder, which has just taken the first premium at the Inventors' Exhibition in England. May be used as a lifter or a non-lifter; restarts immediately without any manipulation whatsoever, after interruption of the feed from any cause. The most effective injector ever placed on the market for stationary or portable boilers. Reliable and cheap.

Sole Manufacturers in the United States and Canada, Nathan Manufacturing Co., 92 & 94 LIBERTY ST., NEW YORK.

PLAYS Dialogues, Tableaux, Speakers for School, Club & Parlor. Best out. Catalogue free. T. S. DENISON, Chicago, Ill.



The STANDARD SCREWDRIVER. A perfect tool that fits all screws. The four points are always in hand, quickly adjusted, and cannot be lost. Sold by dealers. Agents wanted. A prize for canvassers. Mailed for \$1.00 and postage 10 cents. STANDARD TOOL COMPANY, 230 State St., Hartford & Conn.

No More Slipping Belts. No Loss of Power. Use the new French Papier Maché to cover your pulleys. It is much cheaper, more durable, and positive than leather and secures the grip of the belt on the Pulley. ELMER E. HAWES, Sole Proprietor and Mfr., 17 S. 4th St., Phila.

\$000000000. NO CAPITAL REQUIRED.

To enable any person of ordinary intelligence to make from \$5 to \$20 a day. We will pay ONE DOLLAR cash on every subscription taken for the most popular \$2 Weekly Paper in America. Never was such a large commission offered before. In even the smallest towns agents can obtain several new subscribers every day of the year round, and thus make more money than they could in any other soliciting business. For descriptive pamphlet write HARDENBROOK & CO., 240 Broadway, N. Y.

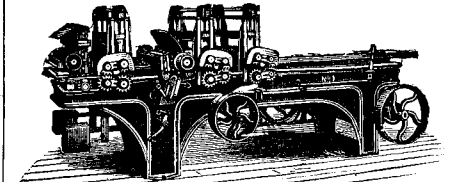

WITHERBY, RUGG & RICHARDSON, Manufacturers of Patent Wood Working Machinery of every description. Facilities unsurpassed. Shop formerly occupied by E. Ball & Co., Worcester, Mass. Send for Catalogue.

"THE ELECTRICAL REVIEW," An illustrated weekly journal, is the acknowledged leader in the world of electrical science. Edited with care. Its editorial opinion is reliable, its news columns bright and instructive. \$3.00 per year; single copies, 10 cents. 23 PARK ROW, NEW YORK. Best advertising medium in the electrical field.

Van Duzen's Pat. Loose Pulley Oiler HAS Highest Indorsements, Envyable Reputation, Scientific Pedigree. A two years' test by conservative manufacturers of national reputation has shown it to be the only perfect Lubricator for Loose Pulleys in use. Prices very reasonable. Send for our "Catalogue Number 55." VAN DUZEN & TIFT, Cincinnati, O.

STEAM ENGINES. Horizontal and Vertical. Dredging Machinery, Flour, Powder, Slate and Flint Mill Machinery, Turbine Water Wheels. York Mfg Co., York, Pa., U. S. A.

Moss Engraving Co. THE LARGEST ESTABLISHMENT IN THE WORLD. PHOTO ENGRAVING. ILLUSTRATIONS OF EVERY DESCRIPTION FOR BOOKS, MAGAZINES, NEWSPAPERS, CATALOGUES, CIRCULARS, &c. Moss' New Process Superior to Any Other Method. 535 PEARL ST. COR. ELM. NEW YORK. SEND GREEN STAMP FOR 24 PAGE CIRCULAR -- SEND PHOTOGRAPH, DRAWING OR PRINT FOR ESTIMATE.

ATNA INSURANCE CO. HARTFORD CONN. CASH CAPITAL \$4,000,000. LOSSES PAID IN 66 YEARS \$56,000,000. The Largest and Strongest Company. L. J. HENDEE, Pres't, J. GODDOW, Sec'y, W. B. CLARK, Asst. Sec'y.

THE POPULAR SCIENCE MONTHLY CONDUCTED BY E. L. & W. J. YOUMANS.

THE POPULAR SCIENCE MONTHLY for 1886 will continue, as heretofore, to supply its readers with the results of the latest investigation and the most valuable thought in the various departments of scientific inquiry. Leaving the dry and technical details of science, which are of chief concern to specialists, to the journals devoted to them, the Monthly deals with those more general and practical subjects which are of the greatest interest and importance to the public at large. In this work it has achieved a foremost position, and is now the acknowledged organ of progressive scientific ideas in this country.

TERMS: 5.00 per Annum; Single copy, 50 cents. D. APPLETON & CO., PUBLISHERS, 1, 3, and 5 Bond Street, New York.

EASY STAR LESSONS, By Richard A. Proctor. With 48 star maps and 45 other illustrations. Extra cloth, \$2.50. Will be sent postpaid by MUNN & CO., on receipt of price.

The Standard Rider (HOT AIR) PUMPING ENGINE For Gas or Coal. Is absolutely safe. Cannot explode. Simple and durable. Any one can run it. Has a record of eleven years. Send for catalogue "A." SAYER & CO., 34 Dey Street, N. Y. City.

2c. PULLEYS 4c. ORDER FROM OUR "SPECIAL LIST." THE ROUGH John T. Noye Mfg. Co. FINISHED BUFFALO, N. Y.

FREE TRIAL.—NERVITA speedily cures all effects of youthful errors. Nervous Debility, Involuntary Losses, Lost Manhood, and kindred affections. TRIAL package 12 cents postage. Free at office. Dr. A. G. OLIN CO., 180 E. Washington St., Chicago.

CUTLER'S POCKET INHALER AND CARBOLATE OF IODINE INHALANT.

A certain cure for Catarrh, Bronchitis, Asthma, and all diseases of the Throat and Lungs—even Consumption, if taken in season. It will break up a Cold at once. It is the KING of Cough Medicines. A few inhalations will correct the most offensive Breath. It may be carried as handily as a penknife, and is always ready. This is the only Inhaler approved by physicians or every school, and indorsed by the Standard Medical Journals of the world. Over 400,000 in use. Sold by all Druggists for \$1. By mail, \$1.25. W. H. SMITH & CO., Buffalo, N. Y.

DYKE'S BEARD ELIXIR Force Instantly Mustache, Whiskers, or hair on bald heads in 20 to 30 days. Extra Strength, Quick, Safe, Sure. No other remedy. 2 or 3 Pkgs. does the work. Will grow, or forfeit \$10.00. Price per Pkg. with directions sealed and post-paid 25 cts. 3 for 75 cts. 6 for \$1.00. Smith Mfg. Co., Fairbury, Ill.

FREE TO MEN Who suffer from Nervous Debility, Lost Vigor, Exhausted Vitality, etc. A FREE TRIAL PACKAGE OF the celebrated MARSTON BOLUS, together with Sealed Treatise and Testimonials, will be sent on receipt of 2 stamps. MARSTON REMEDY CO., 46 West 14th Street, New York.

PILES. Instant relief. Final cure in 10 days, and never returns. No purge, no salve, no suppository. Sufferers will learn of a simple remedy, free, by addressing C. J. MASON, 78 Nassau St., N. Y.

CURE FOR THE DEAF Peck's Patent Improved Cushioned Ear Drums PERFECTLY RESTORE THE HEARING, and perform the work of the Natural Drum. Always in position, but invisible to others and comfortable to wear. All Conversation and even whispers heard distinctly. We refer to those using them. Send for illustrated book with testimonials, free. Address, F. HISCOX, 853 Broadway, N. Y. Mention this paper.

DEAFNESS its CAUSES and CURE, by one who was deaf twenty-eight years. Treated by most of the noted specialists of the day with no benefit. Cured himself in three months, and since then hundreds of others by same process. A plain, simple, and successful home treatment. Address T. S. PAGE, 128 East 26th St., New York City.

TO WEAK MEN suffering from the effects of youthful errors, nervous debility, loss of manhood, etc. I will send you a valuable treatise upon the above diseases, also directions for self-cure, free of charge. Address Prof. F. O. FOWLER, Moodus, Conn. MEN ONLY. A Quick, Permanent Cure for Lost Manhood, Debility, Nervousness, Weakness, Noquackery, Indisputable Proofs. Book sent sealed free. ERIE MED. CO., BUFFALO, N. Y.

GOLD MEDAL, PARIS, 1878. BAKER'S Breakfast Cocoa. Warranted absolutely pure Cocoa, from which the excess of Oil has been removed. It has three times the strength of Cocoa mixed with Starch, Arrowroot or Sugar, and is therefore far more economical, costing less than one cent a cup. It is delicious, nourishing, strengthening, easily digested, and admirably adapted for invalids as well as for persons in health. Sold by Grocers everywhere. W. BAKER & CO., Dorchester, Mass.

DELAFIELD'S PATENT SAW CLAMP. Holds any blade up to 8 in. long, whether new or broken. Two or more hack-saw blades can be clamped together side by side so as to make a wide cut, such as a slot, ward, or small keyway, in one-tenth the time of filing. Patented April 28, 1885. Price, postpaid, 35 cents; with one 8 inch hack-saw blade, for cutting any metal, postpaid, 42 cents. A. F. DELAFIELD, Noroton, Ct.

SENT FREE. A Sample No. of the Phrenological Journal, A YEAR \$2.00, And list of books on Phrenology, Physiognomy, Health, Heredity, etc. THE JOURNAL and SCIENTIFIC AMERICAN a year for \$4.00. Address Fowler & Wells Co., 753 Broadway, N. Y.

WANTED An active Man or Woman in every county to sell our goods. Salary \$75 per Month and Expenses. Canvassing outfit and particulars FREE. STANDARD SILVERWARE CO., Boston, Mass.

SHIELDS & BROWN Manufacturers and Sole Proprietors of BRADLEY'S INSULATED COPPER TUBES. For BOILERS and STEAM PIPES. Reduces Condensation of Steam. FOR GAS AND WATER PIPES. Prevents Sweating and Freezing. The best Non-Conductor of Heat and Cold in the World. Send for illustrated descriptive Circular, and name this paper. 132 Cedar Street, New York. 78 and 80 Lake Street, Chicago.

COPPER TUBES SHEET BRASS BRASS WIRE. MENTION THIS PAPER.

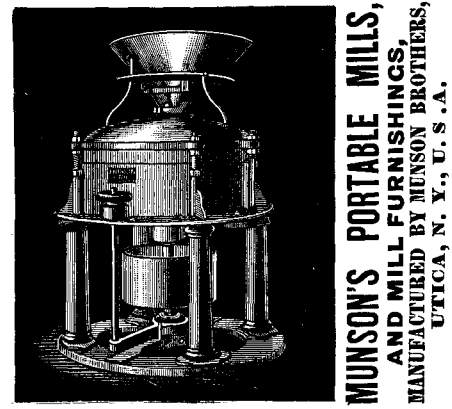

MUNSON'S PORTABLE MILLS, AND MILL FURNISHINGS, MANUFACTURED BY MUNSON BROTHERS, UTTICA, N. Y., U. S. A.

STATIONARY STEAM ENGINES ESPECIALLY adapted to Electric Lighting Purposes. Treating of the development of Steam Engines; the principles of Construction and Economy; with descriptions of Moderate Speed and High Speed Engines. By Robert H. Thurston A. M., C. E., with many handsomely executed illustrations. 12mo. cloth, \$1.50. Address, MUNN & CO., 361 Broadway New York.

ICE. REFRIGERATING and Ventilating Machines Jarmans Patent. YORK MFG. CO., York, Pa. THE CAMERON STEAM PUMP. STANDARD OF EXCELLENCE. 30,000 IN USE. ADAPTED TO EVERY POSSIBLE DUTY. The A. S. CAMERON STEAM PUMP WORKS, Foot East 23d St., New York.

Advertisements.

Inside Page, each insertion - - - 25cents a line. Back Page, each insertion - - - \$1.00 a line. (About eight words to a line.) Engravings may head advertisements at the same rate per line, by measurement, a letter press advertisement must be received at publication office as early as Thursday morning to appear in next issue.

H.W. JOHNS' ASBESTOS

Roofing, Building Felt, Steam Packings, Boiler Coverings, Fire Proof Paints, Cements, Etc. Samples and Descriptive Price Lists Free. H. W. JOHNS MFG CO., 87 MAIDEN LANE, N. Y. 175 Randolph St., Chicago; 170 N. 4th St., Philadelphia.

Especially for MILLER'S STEAM HAMMERS. Unequaled for wa... Packing material... none out—add a rou... MILLER PACKING WORKS, 1335 Buttonwood St., Philadelphia, Pa., U. S. A.

SANITARY EXAMINATION OF DRINKING Water.—By Prof. E. R. Angell. The odor of water, and how to detect it. Tests and their applications. Nitrates and Nitrites. Lead and iron. Test for lead. Tests for organic matter. A valuable paper. Contained in SCIENTIFIC AMERICAN SUPPLEMENT, No. 462. Price 10 cents. To be had at this office and from all newsdealers.

PIPE COVERING.

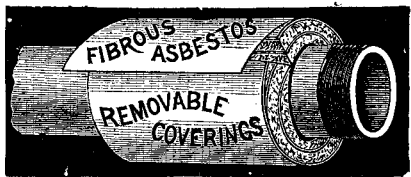

SPECIAL FELT FOR ICE HOUSES. Fireproof Non-conducting Coverings for Steam Pipes, Boilers, and all hot surfaces. Made in sections three feet long. Easy to apply. Asbestos Materials—Fiber, Millboard Packing, and Cement. CHALMERS-SPENCE CO., 419-421 Eighth St., New York.

NATURAL GAS.—A PAPER BY C. E. Hequebourg, discussing the illuminating power and calorific value of natural gas as compared with that made from coal. Contained in SCIENTIFIC AMERICAN SUPPLEMENT, No. 471. Price 10 cents. To be had at this office and from all newsdealers.

WESTON DYNAMO-ELECTRIC MACHINE

The undersigned, sole agents for the above machine for ELECTROPLATING AND ELECTROTYPING, refer to all the principal Stove Manufacturers, Nickel and Silver Platers in the country. Over 1,500 now in use. Are also manufacturers of Pure Nickel Anodes, Nickel Salts, Polishing Compositions of all kinds, and every variety of supplies for Nickel, Silver, and Gold Plating; also, Bronze and Brass Solutions. Complete outfit for plating. Estimates and catalogues furnished upon application.

HANSON VANWINKLE & Co. SOLE AGENTS NEWARK, N. J. New York Office, 92 and 94 Liberty St.

ARCHITECTURAL PERSPECTIVE for Beginners, with 11 plates of Practical Examples. Quarto, cloth. By F. A. Wright. This book will be sent to any address, postage prepaid, on receipt of price by MUNN & Co., New York. Price \$3.00.

DRAWING INSTRUMENTS. Illustrated catalogue sent on application to Wm. T. COMSTOCK, 6 Astor Place, New York.

MALLEABLE AND FINE GRAY IRON ALSO STEEL CASTINGS FROM SPECIAL PATTERNS. THOMAS DEVLIN & CO. FINE TUNING, JAPANNING AND FINISHING. LEHIGH AVE. & AMERICAN ST. PHILA.

ICE-HOUSE AND REFRIGERATOR. Directions and Dimensions for construction, with one illustration of cold house for preserving fruit from season to season. The air is kept dry and pure throughout the year at a temperature of from 34° to 38°. Contained in SCIENTIFIC AMERICAN SUPPLEMENT No. 116. Price 10 cents. To be had at this office and of all newsdealers.

WM. A. HARRIS, Providence, R. I. (Park St.) Six minutes' walk West from station. Original and Only Builder of the HARRIS-CORLISS ENGINE, With Harris' Pat. Improvements, from 10 to 1,000 H. P. Send for copy Engineer's and Steam User's Manual. By J. W. Hill, M.E. Price \$1.25. MENTION THIS PAPER.

PATENTS.

MESSRS. MUNN & CO., in connection with the publication of the SCIENTIFIC AMERICAN, continue to examine improvements, and to act as Solicitors of Patents for Inventors.

In this line of business they have had forty years' experience, and now have unequalled facilities for the preparation of Patent Drawings, Specifications, and the prosecution of Applications for Patents in the United States, Canada, and Foreign Countries. Messrs Munn & Co. also attend to the preparation of Caveats, Copyrights for Books, Labels, Reissues, Assignments, and Reports on Infringements of Patents. All business intrusted to them is done with special care and promptness, on very reasonable terms.

A pamphlet sent free of charge, on application, containing full information about Patents and how to procure them; directions concerning Labels, Copyrights, Designs, Patents, Appeals, Reissues, Infringements, Assignments, Rejected Cases, Hints on the Sale of Patents, etc.

We also send, free of charge, a Synopsis of Foreign Patent Laws, showing the cost and method of securing patents in all the principal countries of the world. MUNN & CO., Solicitors of Patents, 361 Broadway, New York. BRANCH OFFICES.—No. 622 and 624 F Street, Patent Building, near 7th Street, Washington, D. C.

THE BRIDGEPORT WOOD FINISHING CO. G. M. BREINIG, AGENT, PRINCIPAL OFFICE AT MANUFACTORY NEW MILFORD, CONN. NEW YORK BUSINESS OFFICE, 96-98 MAIDEN LANE. MANUFACTURERS OF WHEELERS PATENT WOOD FILLER. BREINIG'S LITHOGEN SILICATE PAINT. LITHOGEN PRIMER, WOOD STAINS. SILEX FLINT AND FELDSPAR. PAMPHLET GIVING DIRECTIONS FOR FINISHING HARD WOOD FREE TO ANY ADDRESS.

SAWS Wanted 50,000 Sawyers and SAW S Lumbermen to send us their full address for a copy of Emerson's Book of SAWS. We are first to introduce NATURAL GAS for heating and tempering SAWS with wonderful effect upon improving their quality and toughness, enabling us to reduce prices. Address EMERSON, SMITH & CO. (Ltd.), Beaver Falls, Pa.

THERAPEUTICAL EFFECT OF THE Internal Administration of Hot Water in the Treatment of Nervous Diseases.—By Ambrose L. Ranney, M.D. Rules for administration. The effects of the treatment. Theory of the action of hot water. Points in its favor. Conclusions. Contained in SCIENTIFIC AMERICAN SUPPLEMENT, No. 463. Price 10 cents. To be had at this office and from all newsdealers.

WIRE ROPE

Address JOHN A. ROEBLING'S SONS, Manufacturers, Trenton, N. J., or 177 Liberty Street, New York. Wires and Rope for conveying power long distances. Send for circular.

FIRE BRICK TILE AND CLAY RETORTS ALL SHAPES. BORGNER & O'BRIEN, 23 29 ST. ABOVE RACE, PHILADELPHIA.

HYPNOSCOPE.—A PAPER BY J. Ochovitz, M.D., describing a new apparatus for ascertaining to what degree persons are hypnotizable. With three figures. Contained in SCIENTIFIC AMERICAN SUPPLEMENT, No. 473. Price 10 cents. To be had at this office and from all newsdealers.

EPPS'S COCOA

THE BACKUS WATER MOTOR. SUPPLIES FROM HYDRANT PRESSURE the cheapest power known. Adaptable for Printing Presses, Sewing Machines, in Households, Turning Lathes, Scroll Saws, Grindingstones, Coffee Mills, Sawage Machines, Feed Cutters, Electric Lights, Elevators, etc. It needs little room, no firing up, fuel, ashes, repairs, engineer, explosion, or delay, no extra insurance, no coal bills. Is noiseless, neat, compact, steady; will work at any pressure of water above 15 lb.; at 40 lb. pressure has 4-horse power, and capacity up to 10-horse power. Prices from \$15 to \$300. Send for circular to THE BACKUS WATER MOTOR CO., Newark, N. J.

COILED WIRE BELTING. Cheap, Durable. Increases Power. Is not affected by Water, Oil, Steam, or Weather. Easily connected. Thousands of feet in use. Can refer to hundreds of large manufacturing concerns using it. COILED WIRE BELTING CO., 93 Cliff Street, New York.

BARREL, KEG, AND STAVE MACHINERY. Over 50 varieties manufactured by Truss Hoop Driving. E. & B. Holmes, BUFFALO, N. Y.

Telegraph and Electrical SUPPLIES. Medical Batteries, Inventors' Models, Experimental Work, and fine brass castings. Send for catalogue C. E. JONES & BRO., Cincinnati, O. It is important to us that you mention this paper.

DROP FORGINGS. FINISHED TOOLS. BILLINGS & SPENCER Co., HARTFORD, CONN.

SEBASTIAN, MAY & CO.'S IMPROVED \$60 Screw Cutting Lathe. Designed for actual work; no toy. Lathes for wood or metal. Drill Presses, Chucks, Drills, Dogs, and machinists' and amateurs' outfits. Lathes on trial. Catalogues mailed on application. 165 West 2d Street, Cincinnati, Ohio.

BLAKE'S IMPROVED PIPE HANGER. IT IS THE CHEAPEST AND BEST HANGER IN THE MARKET. It saves many expensive Blacksmiths' Jobs. Can be attached to pipe when in position. Expansion always provided for. Cheap because it is simple. Pitch lines of mains easily obtained. No troublesome screws to adjust. JENKINS BROS., SOLE AGENTS, 71 JOHN ST., NEW YORK, 13 SO. FOURTH ST., PHILA., 79 KILBY ST., BOSTON.

AUSTRALIA. American Manufacturers wishing to be represented in these colonies please communicate with Messrs. Imray & Co., Australian Agents 28a Basinghall St., London, E. C., and at Sydney and Melbourne.

HARTFORD STEAM BOILER INSPECTION AND INSURANCE CO. HARTFORD, CONN.

ERICSSON'S NEW CALORIC PUMPING ENGINE, FOR Dwellings & Country Seats. Simplest! Cheapest! Economical! Absolutely Safe! DELAMATER Iron Works, Foot of W. 13th St., NEW YORK, U. S. A.

STEAM CATAMARAN MAY BARRETT.—Plans and specifications of the catamaran May Barrett, a family cruising boat built for use on rivers and lakes. Construction of hulls, deck beams, main deck, upper works, engine and boiler, wheel. With 10 figures. Contained in SCIENTIFIC AMERICAN SUPPLEMENT, No. 472. Price 10 cents. To be had at this office and from all newsdealers.

BRIGHT, CLEAR WATER THE HYATT FILTER. guaranteed in all cases, at low cost, and in quantities from 5 galls. to 5,000 galls. per minute. Adapted for Private Houses, Hotels, Asylums, Hospitals, Factories, Mills, Boilers, Steam Boats, Water Works in Towns, and Cities. Our Filters are simple in construction and operation, will stand any pressure, the filtering material is imperishable, and can be cleaned in from five to twenty minutes, effectually removing all impurities from the filter bed. Plans and specifications ready for a 15,000-gallon plant. Send for Circular, stating paper you saw advertisement in, to THE NEWARK FILTERING COMPANY, 141 COMMERCE ST., NEWARK, N. J.

SHEPARD'S NEW \$60 Screw-Cutting Foot Lathe. Foot and Power Lathes, Drill Presses, Scroll-saw Attachments, Chucks, Mandrels, Twist Drills, Dogs, Calipers, etc. Lathes on trial. Lathes on payment. Send for catalogue of Outfits for Amateurs or Artisans. Address H. L. Shepard, Agent, 134 E. 2d St., Cincinnati O.

BOOKWALTER ENGINE. Compact. Substantial. Economical, and easily managed; guaranteed to work well and give full power claimed. Engine and Boiler complete, including Governor, Pump, etc., at the low price of HORSE POWER..... \$240 00 4 1/2 " " 280 00 6 " " 355 00 8 " " 440 00 Put on cars at Springfield, O. JAMES LEFFEL & CO., Springfield, Ohio, or 116 Liberty St., New York.

MARTIN BRICK MACHINE. LATEST AND IMPROVED BRICK MACHINERY FOR BOTH STEAM AND HORSE POWER. HENRY MARTIN, INVENTOR, PROPRIETOR AND MANUFACTURER, LANCASTER, PA., U.S.A.

PHILLIP SEMMER, AMERICAN PLATE and SHEET GLASS DEPOT. Headquarters for American Polished Plate, French and English Silvering Quality Plate Glass, Beveled and Plain Mirrors, Beveled, Ground, and Embossed Plate and Sheet Glass, Cathedral Colored, Single and Double Strength Window Glass, 1/4 in., 3/4 in., and 1 in. Polished Plate, etc. All thickness SkyLight and Floor Glass. 6, 8, and 10 Desbrosses Street, New York. ESTIMATES PROMPTLY FURNISHED.

THE AMERICAN BELL TELEPHONE CO. 95 MILK ST., BOSTON, MASS.

This Company owns the Letters Patent granted to Alexander Graham Bell, March 7th, 1876, No. 174,465, and January 30th, 1877, No. 186,787.

The transmission of Speech by all known forms of Electric Speaking Telephones infringes the right secured to this Company by the above patents, and renders each individual user of telephones not furnished by it or its licensees responsible for such unlawful use, and all the consequences thereof, and liable to suit therefor.

A NEW HYDRAULIC MOTOR.—FULL description, with nine illus. ative figures, of a novel hydromotor devised by Mr. Yagn for irrigating and other purposes. Contained in SCIENTIFIC AMERICAN SUPPLEMENT, No. 463. Price 10 cents. To be had at this office and from all newsdealers.

I.W. COLBURN & Co. FITCHBURG, MASS. 200 MAIN ST. ARC INCANDESCENT LOWEST LIVING PRICES LIGHTING AND PLATING MACHINES

HIGH EXPLOSIVES FOR WAR PURPOSES.—A paper by Prof. C. E. Munroe, U.S.N.A., discussing some recent experiments on the use of high explosives for war purposes. Contained in SCIENTIFIC AMERICAN SUPPLEMENT, No. 474. Price 10 cents. To be had at this office and from all newsdealers.

Barnes' Patent Foot and Hand Power MACHINERY, \$15. Contractors and Builders, Jobbers in Wood or Metal, who have no steam power, can, by using outfits of these machines, bid lower and save more money than by any other means for doing their work. Illustrated Catalogue FREE. W. F. & John Barnes Co., Address 192 Main St., Rockford, Ill.

The Scientific American. THE MOST POPULAR SCIENTIFIC PAPER IN THE WORLD.

Published Weekly, \$3.20 a Year; \$1.00 Six Months. This unrivaled periodical, now in its forty-first year, continues to maintain its high reputation for excellence, and enjoys the largest circulation ever attained by any scientific publication.

Every number contains sixteen large pages, beautifully printed, elegantly illustrated; it presents in popular style a descriptive record of the most novel, interesting, and important advances in Science, Arts, and Manufactures. It shows the progress of the World in respect to New Discoveries and Improvements, embracing Machinery, Mechanical Works, Engineering in all branches, Chemistry, Metallurgy, Electricity, Light, Heat, Architecture, Domestic Economy, Agriculture, Natural History, etc. It abounds with fresh and interesting subjects for discussion, thought, or experiment; furnishes hundreds of useful suggestions for business. It promotes Industry, Progress, Thrift, and Intelligence in every community where it circulates.

The SCIENTIFIC AMERICAN should have a place in every Dwelling, Shop, Office, School, or Library. Workmen, Foremen, Engineers, Superintendents, Directors, Presidents, Officials, Merchants, Farmers, Teachers, Lawyers, Physicians, Clergymen, people in every walk and profession in life, will derive benefit from a regular reading of THE SCIENTIFIC AMERICAN. Terms for the United States and Canada, \$3.20 a year; \$1.00 six months. Specimen copies free. Remit by Postal Order or Check.

MUNN & CO., Publishers, 361 Broadway, New York.

THE Scientific American Supplement.

THE SCIENTIFIC AMERICAN SUPPLEMENT is a separate and distinct publication from THE SCIENTIFIC AMERICAN, but is uniform therewith in size, every number containing sixteen large pages. THE SCIENTIFIC AMERICAN SUPPLEMENT is published weekly, and includes a very wide range of contents. It presents the most recent papers by eminent writers in all the principal departments of Science and the Useful Arts, embracing Biology, Geology, Mineralogy, Natural History, Geography, Archaeology, Astronomy, Chemistry, Electricity, Light, Heat, Mechanical Engineering, Steam and Railway Engineering, Mining, Ship Building, Marine Engineering, Photography, Technology, Manufacturing Industries, Sanitary Engineering, Agriculture, Horticulture, Domestic Economy, Biography, Medicine, etc. A vast amount of fresh and valuable information pertaining to these and allied subjects is given, the whole profusely illustrated with engravings.

The most important Engineering Works, Mechanisms, and Manufactures at home and abroad are represented and described in the SUPPLEMENT.

Price for the SUPPLEMENT for the United States and Canada, \$5.00 a year, or one copy of the SCIENTIFIC AMERICAN and one copy of the SUPPLEMENT, both mailed for one year for \$7.00. Address and remit by postal order or check, MUNN & Co., 361 Broadway, N. Y., Publishers SCIENTIFIC AMERICAN.

To Foreign Subscribers.—Under the facilities of the Postal Union, the SCIENTIFIC AMERICAN is now sent by post direct from New York, with regularity, to subscribers in Great Britain, India, Australia, and all other British colonies; to France, Austria, Belgium, Germany, Russia, and all other European States; Japan, Brazil, Mexico, and all States of Central and South America. Terms, when sent to foreign countries, Canada excepted, \$4. gold, for SCIENTIFIC AMERICAN, one year; \$9, gold, for both SCIENTIFIC AMERICAN and SUPPLEMENT for one year. This includes postage, which we pay. Remit by postal order or draft to order of MUNN & CO., 361 Broadway, New York.

PRINTING INKS. THE "Scientific American" is printed with CHAS. T. LENOX JOHNSON & CO.'S INK. Tenth and Lombard Sts., Phila., and 47 Rose St., opp. Duane St., N. Y.