

# SCIENTIFIC AMERICAN

[Entered at the Post Office of New York, N. Y., as Second Class Matter. Copyrighted, 1889, by Munn & Co.]

A WEEKLY JOURNAL OF PRACTICAL INFORMATION, ART, SCIENCE, MECHANICS, CHEMISTRY, AND MANUFACTURES.

Vol. LXI.—No. 18.  
ESTABLISHED 1845.

NEW YORK, NOVEMBER 2, 1889.

\$3.00 A YEAR.  
WEEKLY.

## THE NEW YORK SIGNAL SERVICE STATION.

The New York station of the United States signal service is situated in the topmost story of the Equitable building, at 120 Broadway, New York. A suite of rooms is devoted to its uses, clerical and observational. Upon the roof, at some distance from the offices, is placed the instrument tower. This contains some of the meteorological instruments of the station, and is visited twice a day by the observer, who secures direct readings. In addition to this some of the apparatus is in telegraphic communication with registering mechanism in the office. In the illustrations accompanying this article are shown the interior of the instrument room, with its apparatus, the weather tower, exterior and interior, and views of some of the instruments.

On the right of the instrument room, against the wall, is an apparatus known as the triple register. By it are recorded on a sheet of paper the direction of the wind, its velocity, and the rainfall. A sheet of paper, marked for six hours with spiral or inclined graduation lines, surrounds a drum rotated by clockwork. This revolves four times in twenty-four hours, advancing axially. At one end of the drum four arms are arranged that project over its surface, each arm being attached to the armature of a separate electro-magnet. When the circuit of any of these magnets is closed, the arm is drawn down and makes a mark upon the paper. The circuits are normally broken at the triple register, but, by a switch actuated by the clockwork of the register, the break is closed every five minutes. Each

magnet circuit is also connected to apparatus attached to the base of the spindle of the weather vane and rotating therewith. It carries four contact points, one for each of the cardinal points of the compass.

The whole is so arranged that, when the vane points to the north, the north point contact shall close. If the circuit is also closed at the register, this excites one of the magnets; it draws down its armature and depresses the marking arm, making a spot upon the paper whose position characterizes it as north. If the vane points west, then the west point contact closes, and the corresponding arm is drawn down upon the drum. This accounts for the four cardinal points. If the wind is intermediate between any two, then two contacts are closed and two marks are made side by side. Thus, if

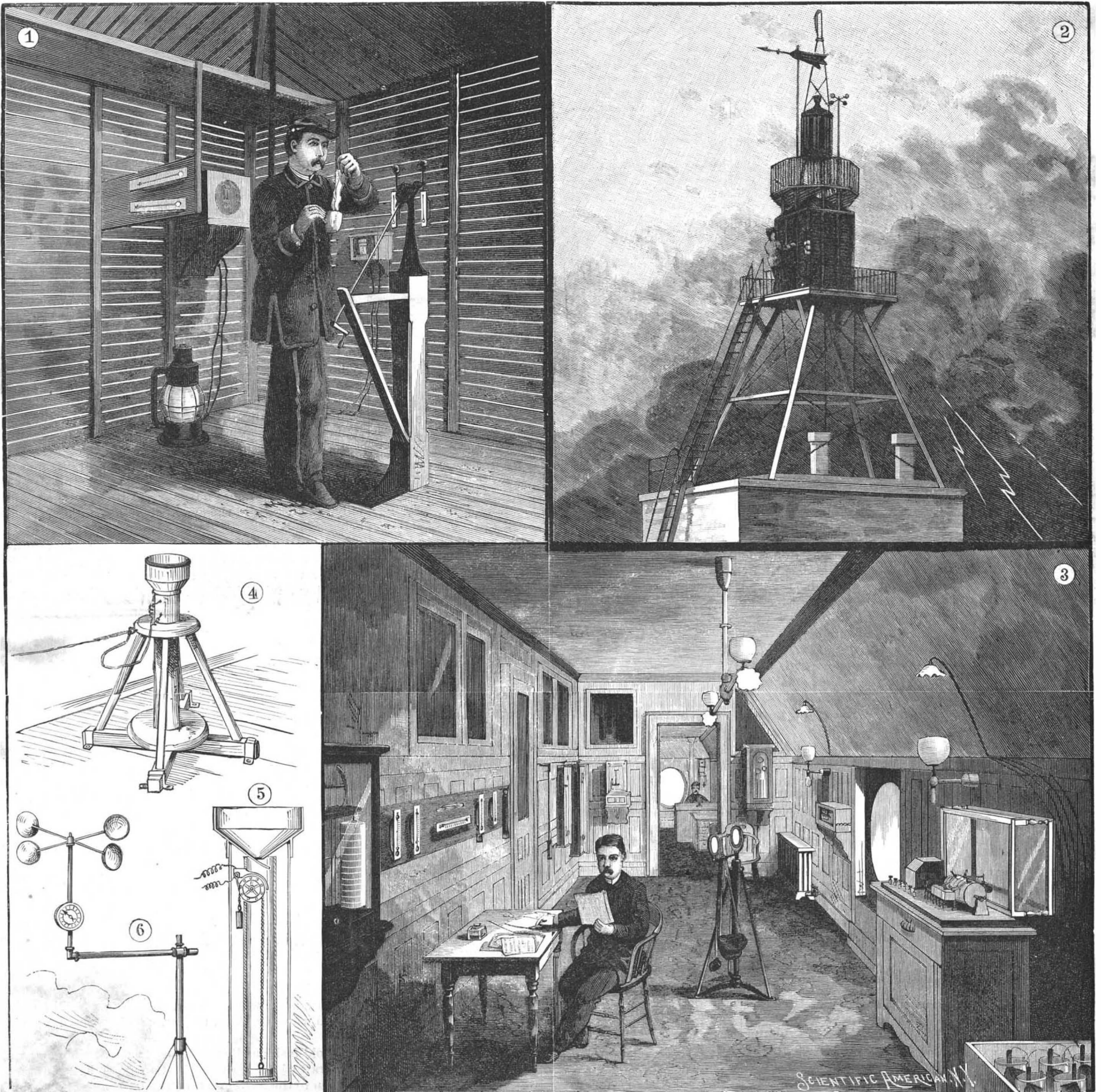

1. Weather tower, interior—making humidity observation. 2. Weather tower, exterior. 3. Instrument room, with apparatus. 4, 5, and 6. Some of the instruments used.

## THE NEW YORK SIGNAL SERVICE STATION.

the wind is northwest, both north and west marks are made upon the register. The magnet circuits, as just explained, are normally broken, but when closed by the clockwork every five minutes the marking is done, the wind vane contacts determining which circuits are complete and which magnet or magnets shall be actuated.

The register is also in connection with a cup anemometer mounted above the weather tower. Four hemispherical cups are attached to the extremities of two cross pieces carried on an axle at their intersection, forming a horizontal windmill. The hollows of the cups hold the wind better than the smooth convexities, so that in a breeze it rotates. The relation of the velocity of the wind to the number of the rotations of the little mill is determined; five hundred revolutions correspond to a wind travel of one mile. A fine pencil carried by an arm rests upon the paper on the drum of the register, making a spiral line thereon. On the completion of each five hundred revolutions of the anemometer a contact is closed, causing a current of electricity to go through a magnet which moves the pencil to one side, and at once releases it. Thus every such mark indicates a wind travel of one mile. If there are ten made while the drum goes one-sixth of the way around, then the wind is blowing at the rate of ten miles an hour. A spiral mark is registered for every ten miles traveled. The anemometer is tested for accuracy by comparison every two months.

The rainfall is indicated by another pencil which traces a spiral line upon the paper. As each five one-hundredths of an inch of precipitation occurs, the pencil is drawn out of its course by a magnet actuated as in the preceding case, so as to make a mark characteristic of such precipitation upon the same paper. The rain gauge is illustrated and is described further on.

The instruments whose registrations are thus kept are mounted upon or within the weather tower. Every month the sheets are sent to the headquarters of the Signal Service at Washington, D. C. The triple register was made by Queen & Co., of Philadelphia, and is the second of its kind.

Near it is a tele-thermograph by Richards Freres, of Paris. On the drum of this are inscribed the temperatures as determined by a thermometer in the weather tower. An aneroid registering barometer or barograph by the same makers is kept running, marking its indications also upon a cylinder wrapped with a graduated sheet of paper. A Saussure's hair hygrometer is near it, but is little used.

Three mercurial barometers hang against the wall of the observer's room. One large and elegantly mounted instrument is termed the sub-standard barometer. It was made by Adie. All three are of the Fontin type. The sub-standard is rated at Washington, and is not used for general readings. The others, made by Green, of this city, serve for the regular observations, and are compared with the standard at least once a month. The cisterns of the barometers are 185 feet above the level of the sea.

A self-registering siphon barometer by Eccard and a Gibbons self-registering rain gauge also find a place in the office.

The instrument tower on the roof has been recently completed, and forms one of the most perfect meteorological stations ever constructed. It is built of iron, and forms a small elevated chamber, closed on all sides by iron louver work. To cut off any heat that the iron might radiate, wooden louvers are arranged inside the iron ones. It contains the registering rain gauge, with 8 inch funnel and 2 1/2 inch barrel, multiplying the rise of the column so as to make it about ten times the depth of the rainfall. The gauge is shown in perspective and section. The rain that falls into the funnel runs down into the cylinder. A float contained therein rises, by means of a chain, causing a wheel at the top of the cylinder to rotate. By the rotation of this wheel the contacts are made affecting the triple register. Maximum and minimum thermometers and wet bulb thermometers for determining the hygrometric condition of the air are mounted in this chamber. The wet bulb thermometers have their bulbs wrapped with porous material that is wetted. To obtain a reading, they are rotated in a whirling apparatus in order to expose them to air currents.

Above the instrument chamber a framework rises carrying a red lantern, with a place above it for the display of a white light. The latter is hoisted into position from outside the chamber. These are used as night storm signals. The red light alone indicates easterly winds; the red and white together indicate westerly winds. The red lantern, at an elevation of 240 feet above the street, or 275 above high water, can be seen from the East and Hudson rivers, as well as from the whole inner bay of New York.

The station is in charge of Sergeant E. B. Dunn, of the United States Signal Service. In addition to the interesting meteorological apparatus, a phonograph is to be found in the office, into which the sergeant dictates the weather reports each day. These are then repeated to inquirers directly from the wax cylinder. Our thanks are due to Sergeant Dunn for courtesies received.

Scientific American.

ESTABLISHED 1845.

MUNN & CO., Editors and Proprietors.

PUBLISHED WEEKLY AT

No. 361 BROADWAY, NEW YORK.

O. D. MUNN.

A. E. BEACH.

TERMS FOR THE SCIENTIFIC AMERICAN. One copy, one year, for the U. S. or Canada, \$3 00. One copy, six months, for the U. S. or Canada, 1 50. One copy, one year, to any foreign country belonging to Postal Union, 4 00. Remit by postal or express money order.

Australia and New Zealand.—Those who desire to receive the SCIENTIFIC AMERICAN, for a little over one year, may remit £1 in current Colonial bank notes. Address MUNN & CO., 361 Broadway, corner of Franklin Street, New York.

The Scientific American Supplement

is a distinct paper from the SCIENTIFIC AMERICAN. THE SUPPLEMENT is issued weekly. Every number contains 16 octavo pages, uniform in size with SCIENTIFIC AMERICAN. Terms of subscription for SUPPLEMENT, \$5.00 a year, for U. S. and Canada. \$6.00 a year for foreign countries belonging to the Postal Union. Single copies, 10 cents. Sold by all newsdealers throughout the country.

Combined Rates.—The SCIENTIFIC AMERICAN and SUPPLEMENT will be sent for one year, to any address in U. S. or Canada, on receipt of seven dollars.

The safest way to remit is by draft, postal order, express money order, or registered letter.

Australia and New Zealand.—The SCIENTIFIC AMERICAN and SUPPLEMENT will be sent for a little over one year on receipt of £2 current Colonial bank notes. Address MUNN & CO., 361 Broadway, corner of Franklin Street, New York.

NEW YORK, SATURDAY, NOVEMBER 2, 1889.

Contents.

(Illustrated articles are marked with an asterisk.)

Alarm door, Streeper's\*..... 275
Alcoholism in Norway..... 277
Amber and ambergris..... 281
Apparatus, meat-carrying..... 275
O'Keefe's\*..... 275
Appliances, railway..... 282
Arm, clevis, for ice plows, Der-nell's\*..... 276
Awards at Paris exposition..... 273
Books and publications..... 282
Business and personal..... 282
Carcass, animal, all used..... 278
Conference, marine, internat..... 272
Cultivator, cotton, Runyon's\*..... 276
Diamond, the..... 276
Diamonds at Paris exhibition..... 277
Dog, lathe, Engert\*..... 275
Dynamo, Edison\*..... 274
Engine, condensing, Willard\*..... 280
Exhibition, Paris\*..... 279
Explorations in New Guinea..... 280
Exposition, floating, Germany's\*..... 278
Fish, iced, dangerous..... 280
Gas at five cents a thousand..... 281
Gear, vehicle, Lowe's\*..... 276
Incident, singular..... 276
Inventions, agricultural..... 282
Inventions, engineering..... 282
Inventions, index of..... 283
Inventions, mechanical..... 282
Inventions, miscellaneous..... 282
Jupiter, occultation of\*..... 277
Kiln, gas, for fire bricks..... 275
Lamp, Edison\*..... 274
Lamps, petroleum, management..... 278
Light, penetration, in water..... 274
Lighting, incandescent\*..... 274
Notes and queries..... 282
Objects, natural, preserving..... 273
Paint, flexible..... 277
Power, water and steam, cost..... 276
Power, water, high pressure..... 280
Progress, mechanical..... 281
Projectiles, steel, remarkable..... 280
Regulating, Edison's system\*..... 274
Science, experimental..... 273
Screwdriver and wrench, Stras-ser's\*..... 275
Signal Service station, New York..... 271
Success, methods of..... 280
System, three-wire, Edison\*..... 274
Telephones in Austria..... 276
Vermin from plants, removing..... 275
Wood, polishing, with charcoal..... 274

TABLE OF CONTENTS OF SCIENTIFIC AMERICAN SUPPLEMENT No. 722.

For the Week Ending November 2, 1889.

Price 10 cents. For sale by all newsdealers.

I. ANTHROPOLOGY.—Heredity.—By Sir WILLIAM TURNER.—The first installment of Sir William Turner's opening address before the British Association, at the last meeting, reviewing Weismann's and others' theory on the subject of transmission of character..... 11530
II. ARCHITECTURE.—The New Bourse or Commercial Exchange at Paris.—Interior and exterior views of the new Paris stock exchange, with a general description of the building and of the history of the organization.—2 illustrations..... 11527
The Pavilion of Nicaragua at the Paris Exposition.—A picturesque little structure illustrated and described.—Built of rosewood, mahogany, and other Nicaraguan woods.—1 illustration..... 11530
The Russian Izba, or Log House, at the Paris Exposition.—A sample of Russian folk architecture illustrated and described.—1 illustration..... 11530
III. BIOLOGY.—Days and Nights by the Sea.—By FRANCIS H. HER-RICK.—A very interesting lecture upon marine life and the study of biology at the sea shore.—An eminently practical paper, of interest to all..... 11528
IV. CHEMISTRY.—Ozone and Ethylene.—The solidification of ethylene.—An interesting note on the relation between the physical characteristics and critical points of ethylene and ozone..... 11538
V. CIVIL ENGINEERING.—The Channel Bridge—Preliminary Designs by Messrs. Schneider & Co.—A gigantic project for building a railroad bridge across the British Channel.—Its situation, estimates of its cost, material of construction, and other details.—5 illustrations..... 11582
The Paris Exhibition—Girard's Hydraulic Railway.—The frictionless wheelless railroad of the Paris exposition.—The history of Girard's great achievement and description of the railroad as now in operation in Paris.—24 illustrations..... 11530
VI. ELECTRICITY.—Contribution to the Chemistry of Storage Batteries.—By E. FRANKLAND.—A research into the production of anomalous sulphate of lead in the storage battery, with the reactions and analyses of products..... 11585
Lacombe Battery.—A variation on the Leclanche battery, in which the zinc occupies a central position and is surrounded by the carbon and depolarizer.—1 illustration..... 11535
Note of an electric launch recently built at Ansonia, Conn..... 11530
VII. HYGIENE AND SANITATION.—How to Remove Warts and Tattoo Marks.—An interesting extract describing how to attain these great desiderata..... 11540
Lactic Acid a Cause of Rheumatic Disease.—By Dr. B. W. RICH-ARDSON.—An abstract and search on the causation of rheumatic troubles, giving striking results attained in the research with lactic acid..... 11541
The Use of Disinfectants at Johnstown.—By GEORGE G. GROFF, M.D.—The Johnstown disaster and a list of the disinfectants employed to prevent the spread of disease..... 11541
VIII. MISCELLANEOUS.—The Inventor's Wife.—By T. E. CORBETT.—A poetical review of the tribulations of the inventor's family..... 11538
List of awards to American exhibitors at the Paris exhibition..... 11584
IX. TECHNOLOGY.—The Pictet Ice Machines.—The exhibit of the Pictet Company at the Paris exposition, with full description of their refrigerating apparatus for use in breweries, slaughter houses, and other places.—8 illustrations..... 11536

THE INTERNATIONAL MARINE CONFERENCE.

The International Marine Conference, now sitting in Washington, is composed of expert navigators from almost all the maritime powers, big and little. They are unanimous in the opinion that a better means of averting collision at sea than that now employed is desirable, but have not as yet been able to discover it. Nor is there any lack of suggestions. In one system presented, the look-out in the bows of a steamer has only to press upon a lever, and the steam whistle will indicate in long and short sounds the compass direction of the course that the ship is making. In another and less complex system the general course is indicated in sounds so simple that the untutored savage might readily get them by heart. In the same class of orders may be reckoned the system which Mr. Houghton of the New York Maritime Association suggested by letter to the conference, and which, if adopted, he thinks would clearly indicate to vessels invisible, the one from the other, the course each was pursuing. It is a system of musical sounds, "consisting of two or three notes, produced by whistles, vessels going north to indicate it by the rising scale; vessels going south, by the descending scale; vessels going east, by a single note followed by the other two sounding together; vessels going west, by all notes sounding together followed by a single low note." He would have small vessels carry a detonating bomb in addition to the regulation flash lights, the same to be tossed over the stern, thus to warn away the approaching stranger.

As to all these systems of sound signals, it was pointed out that a wind athwart the course that approaching ships might be traversing would puzzle rather than inform. If the first ship could signal that she was to windward or to leeward of the course the second was making, it would only be necessary for the latter to luff or keep off, as the case might be, and the thing would be done. But if the first ship was so well informed as that, she could readily get out of the way without any recourse to signaling at all. The feeling among British mariners anent sound signaling may be found in a communication presented by Mr. Hall, of the British deputation, in the shape of letters to the marine department of the English Board of Trade in reply to a request for opinions upon the question: "Is it practicable, and, if so, is it desirable, to introduce some system of course or route indicating sound signals, to be made by steamships under way in fog, mist, or falling snow, when neither can see the other?" To this replies were received from 119 masters and 10 owners and societies who oppose the introduction of any compulsory system of sound signals; from 48 masters and 2 owners who advocated the adoption of simple signals; and from 28 masters and 1 seamen's society who advocated the adoption of a more complete system. The chief reasons given by those who object to the introduction of any system of fog signals are the confusion they would cause in crowded waters, the difficulty of locating sounds in fogs, the false confidence they would give to officers in charge of the vessels using them, and the considerable degree of skill and experience necessary to prevent the possibility of mistake in the event of any complex system being adopted.

Article XIII of the present rules of the road requiring sail and steam to go at moderate speed in thick weather was opposed by the German delegation. Dr. Sieveking advised high speed under such conditions. He said the German courts, in some cases, had held "moderate" speed to be only a trifle less than high, and in others only just enough to keep steerage way on.

Mr. Goodrich (American) thought it would be safer to accept the interpretation of the term by the American and English courts, "such a rate as would enable the vessel to avoid doing damage after the discovery of a vessel approaching."

Captain Mensing (German) said there were many steamers that were expected to make fast time. He had never heard of orders being given to their masters to go very slow in thick weather. All masters were agreed that full speed was desirable at such times. High speed on a steamer was safer, he thought, because she could be got out of the way quicker, for minding her helm better. The following was carried unanimously:

"Resolved, That it is the sense of the conference that there shall be no change in the masthead and colored lights as at present used."

The following was proposed, and will come up again when the steering rules are reported back for amendment:

"The term 'starboard your helm' shall mean that the wheel or tiller, rudder, and bow shall go to the starboard, and the term 'port your helm' shall mean that the wheel or tiller, rudder, and bow shall go to port."

The old-fashioned system yet in vogue on many a noble craft of rigging the wheel to move in a counter direction to the movement of the bow must, there is reason to believe, disappear. As was shown in the conference, and, indeed, it has long been apparent, "port your helm" cannot imply two different things. All steamer wheels, and most of those on modern craft,

move in the same direction as the bow, that is to say, when the helm is ported, the bow follows in the same direction. It is obvious that no rules can be clear and safe until wheel ropes are wound in the same fashion, the wheel when hove over to starboard throwing the ship's head in the same direction, etc. This question of the definition of terms is occupying no little attention from the conference, and very reasonably, too.

"Under-way" has, it seems, been variously understood; the American courts holding that a vessel is under-way the moment her anchor is lifted and her moorings slipped; but when hove-to she is *not* under-way, while the English courts regard her as under-way when hove-to.

It is safe to say that, at least when rules of the sea are considered, the latter is the safest definition, because, when hove-to, a ship is drifting to leeward, sometimes very rapidly; and for those under sail or steam, and coming up from the leeward, it requires a sharper eye to avoid her than if she were running down the wind, because she is beyond the control of her master; while the position of a ship not under-way, *i. e.*, anchored, can be counted upon.

Capt. Silveson (Norway) wanted the word "carry," so often used in the rules, defined. Mr. Verbrughe (Belgium) called attention to the continued use of the word "feet"—so many feet—used in the rules. On the Continent the meter was the standard, in Belgium it being a misdemeanor to use the foot measure. He wanted distances referred to in meters.

Mr. Goodrich advised the use of powerful lights for swift ships. He said:

"Some years ago a steamer overtook a sailing vessel at the rate of a mile in three minutes; now the rate is reduced to a mile in a minute and a half. The power of the lights to be carried should be graded to the speed of the vessel upon which they are placed."

**MR. HOPKINS' NEW BOOK, "EXPERIMENTAL SCIENCE."**

"Experimental Science" is the title of a new book by Mr. George M. Hopkins, on "Experimental and Practical Physics," just published. The author is well known to our readers as the writer of numerous articles on various scientific subjects. In this work are described simple and practicable experiments in almost every branch of physics. The apparatus—most of which is of the simplest character—is fully illustrated, and the details of construction are given, to enable the reader to readily make whatever is needed for carrying on the experimental work. Every experiment described was tried at the time of writing to insure fullness of detail and accuracy in the description. The book is a magazine of material for class room illustration. It is an aid to the teacher and student in carrying forward practical work. All who desire to acquire a knowledge of physics by the experimental method without going into mathematics will find "Experimental Science" exactly suited to their needs.

We cannot, in the space at our command, give more than a hint of the contents of this book. It opens with a description of the properties of bodies, rest, motion, and force, in which are presented many new experiments. A chapter is devoted to the gyroscope. Falling bodies, the inclined plane, and the pendulum receive due attention. A chapter is given to molecular actions, and under this head are figured and described several new illustrations. Liquids and gases are fully described. A simple hydraulic press, which any intelligent person can make, is shown; also new apparatus for illustrating Pascal's law. An easily constructed and inexpensive air pump and other vacuum apparatus is described. The chapter on sound is very full. Much of the experimental apparatus described is of the simplest description, lately obtained or constructed. There are new illustrations of harmonic vibrations; also new forms of vibrating flame apparatus. A very complete description of the new phonograph is here found. The scientific top, which takes the place of the whirling table, and numerous interesting experiments connected with it form the topic for a chapter.

Under "Heat and Light" are described many novel experiments. A full chapter is devoted to polarized light and experiments connected therewith, which are very simple and of such a nature as to enable the reader to easily gain an insight into this difficult subject. A chapter is also devoted to the microscope and to microscopy, full of interest and instruction.

Under the head of the telescope an inexpensive and easily constructed instrument is described. The chapter on photography is in itself a complete manual of the art. A large number of experiments in magnetism form the subject of another chapter. Frictional electricity is very fully treated, and under the head of dynamic electricity, the principal batteries, including those of recent invention, are fully described. A practical form of secondary battery is also given. The Deprez-D'Arsonval galvanometer, the tangent galvanometer, and the Wheatstone bridge are described in detail. Electrical terms are clearly defined, and simple methods of electrical measurements are described in such a manner as to enable the reader to measure the current, electromotive force, resistance,

conductivity, etc. The principles of the dynamo and electric motor are fully explained, and directions are given for the construction of a simple motor and two forms of small dynamo for experimental uses.

In the chapter on electric lighting we find the arc and incandescent systems clearly set out, together with lighting by means of secondary batteries. This chapter and its accompanying experiments will give to the reader a very complete idea of the principles of the various systems of electric lighting. The chapter on induction by electric currents contains full information regarding induction coils, the induction balance, and how to make them, with numerous experiments in induced electricity. A chapter is devoted to the telephone and microphone, with instructions how to make them. Under the head of lantern projection the scientific use of the ordinary magic lantern is described. A new and very complete scientific lantern for projecting various apparatus and experiments upon the screen is illustrated. The book closes with a chapter on mechanical operations, which will be of great assistance to students and amateurs in the construction of apparatus.

The book contains 740 pages, superbly illustrated by 680 first-class engravings, and is withal a fine specimen of the printer's art.

We consider this work the best of its class, and believe it will prove invaluable to those interested in this branch of science.

**On the Preservation of Natural Objects in Alcoholic and Other Solutions.**

NICOLAS PIKE.

Collections of specimens of natural history are of comparatively little use to either student or scientist unless the greatest care is observed in their preparation and preservation. The naturalist Swainton said that "collections of natural objects in public and private museums are to the naturalist what a library is to the critic and scholar, yet with this remarkable difference, that one draws his knowledge from the works of man, and the other from those of God."

Now I go still further—museums are of the greatest utility not only to the naturalist, but when well managed to the people at large. Besides being places of resort for recreation and amusement, they are also an education in themselves to toiling men and women who have no time for study at home. Thousands of objects are brought together from all parts of the world, and when carefully prepared are invaluable in imparting a fund of knowledge no books could give. Every one knows the difference between seeing an object and reading of it, even when fairly described.

In some of the museums I have visited in the old world and in others of our own country I have noticed that many of the rarest and finest specimens were ruined from having been badly prepared in the first instance, and others from a lack of knowledge as to their keeping. This is especially true of objects preserved in alcoholic and other solutions.

When in Mauritius, I made a very large collection of the fish of the Indian Ocean and sent them to the museum of comparative zoology at Cambridge, Mass. When they reached their destination, though many of them had been in alcohol for over a year, they somewhat surprised the distinguished scientists there, for all were fine, and many had retained some of their colors and markings so well they were easily recognized. I have reptiles, batrachians, spiders, etc., now, that have been for years in bottles, and they are firm and fresh. So many friends and naturalists have asked and written to me about my methods of preservation that I give the following formulas, which I have proved to be the best I am acquainted with. They are simple and do not differ much from the ordinary ways naturalists have preserved for years—yet the slight differences mean success or failure.

Taking fish, for instance, and I proceed as follows: When first drawn from the water I kill it by severing the vertebra near the tail, as I have proved beyond a doubt that a fish dispatched as soon as caught keeps better than one left to die a natural death. All but very small fish should have an incision made near the vent to allow the gases to escape, and alcohol be injected through the vent and mouth. All extraneous matter is to be carefully washed from the fish with fresh water and then it must be placed in strong alcohol, the stronger the better. Four to six days are generally enough to render the flesh firm and all slimy matter exuded, but practice and judgment on this point are required. When ready, wipe the fish and place it in the following solution, and it will keep for years if good alcohol be used;

Alcohol (95 per cent).....8 parts.  
Distilled water.....2 "

\* If the fish are small, three or four days suffice to harden them, and the following is a better solution for them, *viz.*:

Alcohol.....6 parts.  
Distilled water.....2 "

Reptiles, rodentia, etc., can be also preserved in the same manner. The first alcoholic bath can be used over and over again for the same purpose if strained

and well corked, as alcohol is an expensive item in collections.

It is but too prevalent a custom to keep specimens of natural history in the strongest alcohol and place them on the shelves of a museum or cabinet exposed to a bright light. This is ruin to them, as every one knows it is impossible to expose any matter to the sun's rays without its being influenced by their action.

For the preservation of tadpoles, young frogs, salamanders and similar objects, take 1 pound sulphate of zinc, 2 drachms burnt alum, and mix well together.

When wanted for use, take one drachm by weight of the above and put it into forty-two ounces of pure spring water, and when all is dissolved, filter and let it stand five or six days, then filter again and decant, when it should be a bright and sparkling fluid. The above small animals are to be placed for a short time in alcohol to harden. When taken out they must be well washed in clean water and left to dry a little, so that all traces of the alcohol may be evaporated. When placed in the above solution, they must be corked immediately. Specimens thus prepared are really beautiful, more so than when put in any alcoholic mixture.

The following solution for larvæ of insects, spiders, and other small delicate objects will be found very valuable:

Glycerine.....1 oz.  
Common salt.....1 dr.  
Saltpeter.....1 dr.  
Distilled water.....8 oz.

Mix well together.

When wanted for use, take two ounces of pure alcohol and add one ounce of the mixture, shake well, and filter.

There is another solution I use for delicate objects I intend for dissection or anatomical specimens, as it keeps them fresh and flaccid without the least contraction. I have adopted the formula given below as the very best preservative for the above purposes, after years of patient experimenting. I have larvæ of insects, worms, spiders with soft bodies, etc., over ten years in this solution, and they are in excellent condition, and have never shown the least sign of decomposition. Take of chloral in crystals one ounce and dissolve it in five ounces of distilled water:

Alcohol (95 per cent).....1½ oz.  
Glycerine.....1½ dr.  
Rock salt.....15 grs.  
Saltpeter.....30 grs.

Dissolve the glycerine, salt, and saltpeter in the alcohol, and when well mixed add to the chloral solution, shake well till thoroughly incorporated, filter, and it is ready for use. Specimens intended to be preserved in this solution should be placed for a day or two in alcohol, but if wanted for dissection quickly, or only to be kept a few weeks, the alcoholic bath may be omitted. Do not crowd the specimens either with this or any other of the solutions, but see well to the corking and that they are quite covered with the fluid.

The tadpoles of frogs and salamanders can be preserved in this method by omitting the bath and placing them at once in the solution. This is invaluable for medical students, entomologists, and scientists, as it not only preserves objects, but in many instances the colors are retained if kept in a cool, dark place.

I tried the Wickersheimer process, but it failed in my hands completely. Goadby's solution I find after a time makes a white deposit on the specimens, thereby spoiling them.

I keep my reptiles in a cool place with a paper cap over each bottle, and can recommend this plan. The smaller objects are shut in closed cabinets. Where the paper cap cannot be used, I would suggest that a curtain be drawn in front of shelves containing alcoholic specimens when not required for exhibition. By following the above directions, success is pretty certain, though, as I said before, judgment and practice are requisite to insure it—simple as it appears.

I would say a word to those who collect with the intention of presenting their catch to some institution. Never forget that it is the first manipulation of the various objects that requires attention, as no after care can wholly undo the effects of negligence or ignorance in that stage. Especially be particular to place your name, date, and locality on your labels.

**Awards at the Paris Exhibition.**

A correspondent at Paris has sent us a copy of the official list of awards. It is a closely printed document of 127 pages, and occupies a space equal to seventy-five pages of the SCIENTIFIC AMERICAN. The total number of awards is said to be about 33,000. This is the French mode of dealing with her children—give them each a prize, so there will be no crying.

We have compiled as well as we could from this great list the names of the awards to American citizens, and present them in our SUPPLEMENT of this week. It is probable there are errors in the spelling of some of the names, but this has been unavoidable; we shall be pleased to make any corrections to which our attention is called. The awards to Americans are 941 in number, and include 52 grand prizes, 189 gold medals, 273 silver medals, 220 bronze medals, 207 honorable mention.

**INCANDESCENT LIGHTING.\***

The arc light is specially adapted to the illumination of streets and large open or closed areas; but it cannot be successfully applied to lighting in a small way like gas or oil. The incandescent system permits the subdivision of the current, and consequently of the light, to any degree.

While lighting by incandescence had been the subject of much thought and experiment by different inventors, undoubtedly Mr. Edison was the first to produce a commercially successful system of incandescent lighting. The success of the system depends upon two principal features, the vital one being the high resistance lamp, by means of which any degree of subdivision of the current is rendered possible; the other being the system of electric distribution by which the current is furnished as required to each lamp. The construction of the lamp is clearly shown in Fig. 1, in which parts are broken away to show the internal construction. The description of the several parts of the lamp appears in the illustration. The glass globe is exhausted so as to remove as nearly as possible all of the air, thus preventing the burning of the carbon. The filament which yields the light consists of a carbonized strip of bamboo of the size of a horse hair. The diameter and length of the filament varies with the candle power required and with the strength and voltage of current used to operate the lamp. The standard 16 candle power lamp when hot has a resistance of 168 ohms, and requires a current having an E. M. F. of 100 volts; and, according to Ohm's law ( $\frac{E}{R} = C$ ),  $\frac{100}{168} = 0.595$ , or about  $\frac{6}{10}$  ampere. In practice the circuit has a certain amount of resistance, which must be included in this calculation. Calling this 2 ohms, the total resistance will be 170 ohms, and the current will be  $\frac{100}{170} = \frac{10}{17}$  ampere. Now by introducing 500 lamps into the circuit the resistance will be reduced to  $\frac{1}{500}$  its former value, since the current has 500 paths instead of one;  $\frac{170}{500} = 0.34$  ohm. The E. M. F. divided by this resistance  $\frac{100}{0.34} = 294.1$  amperes. This amount divided among 500 lamps = 0.5882 ampere per lamp, equivalent to  $\frac{10}{17}$ , as in the case of the single lamp. It is thus seen that with a constant electro-motive and a current of varying strength any number of lamps within certain limits may be operated on the same circuit.

The Edison dynamo shown in Fig. 2 has a drum armature much like that of the Siemens machine. It differs, however, from that armature in having an odd number of commutator bars and in having an armature core built up of thin disks of soft iron insulated

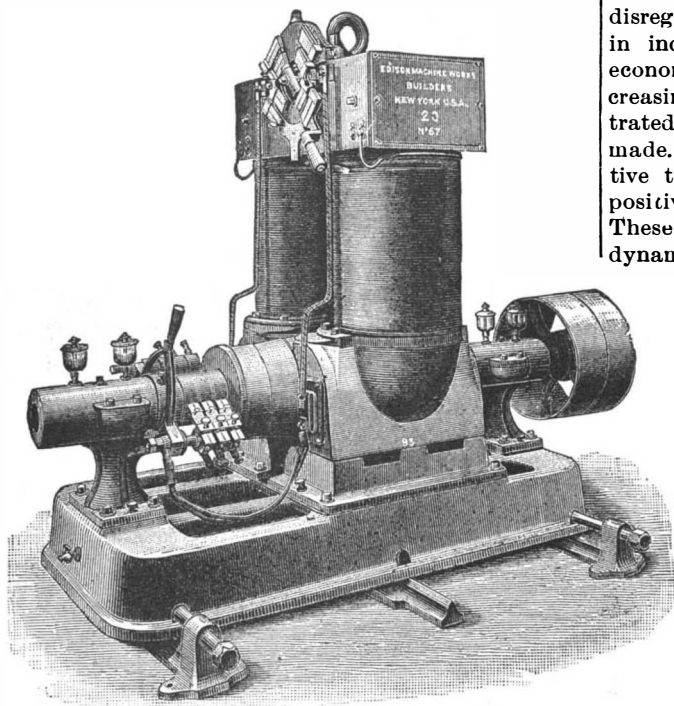

Fig. 2.—THE EDISON DYNAMO.

from the shaft and separated from each other by paper.

Fig. 3 illustrates the method of regulating the Edison dynamo. The machine is shunt wound, and a variable resistance, R, is introduced into the field magnet circuit. Whenever the current rises or falls below the

normal, the switch arm of the rheostat is moved by hand in one direction or the other, thus controlling the excitation of the field magnet.

In this diagram (Fig. 3) is shown the old method of connecting the lamps, L, in the external circuit. Each

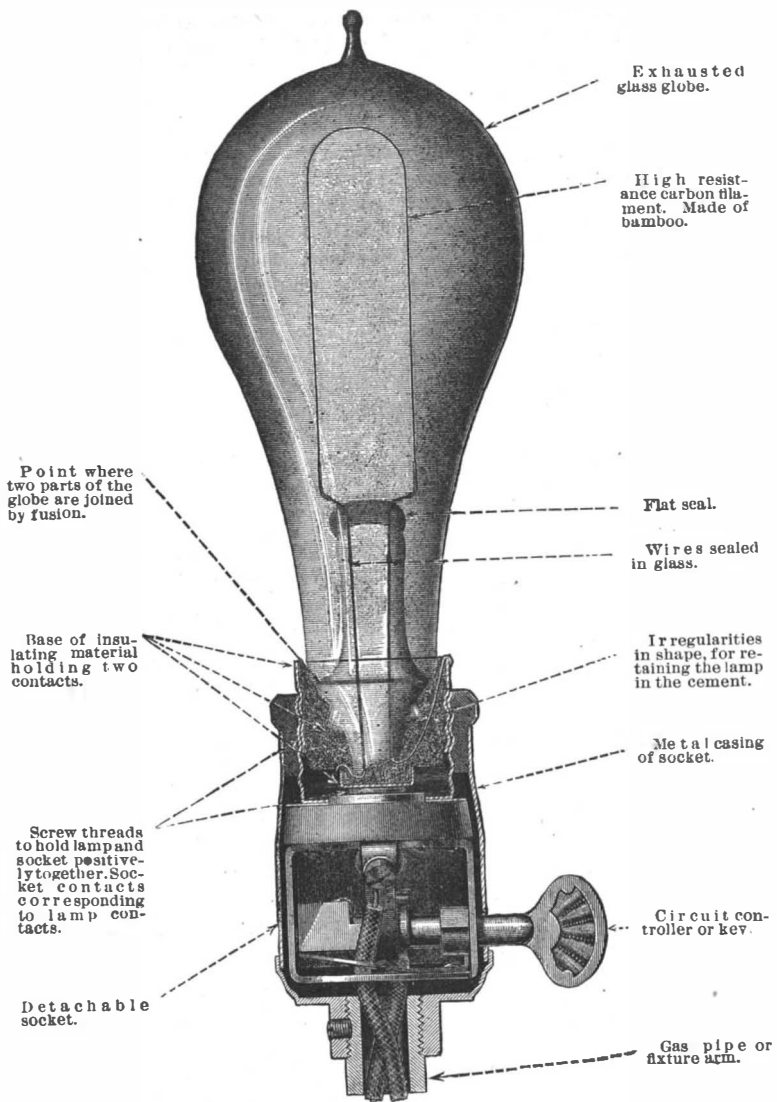

lamp is connected with both of the main conductors or with wires connected with the main conductors. When connected in this way they are in parallel circuit, and in this case when one lamp fails the others are not affected. Where several lamps are connected in series and the series are connected in parallel, if one lamp of a series should fail, the other lamps of the series would be useless without some device for automatically throwing into the circuit a resistance equivalent to that of a lamp, thus maintaining the same resistance in the circuit.

When the Edison electric circuit is arranged as shown in Fig. 3, the conductors to carry the current economically must necessarily be large, and there is a relation between the cost of copper in the circuit and the waste of energy in overcoming resistance which cannot be disregarded. The first cost of conductors is a large item in incandescent lighting. In some circuits there is economy in reducing the size of the conductor and increasing the current. In the three-wire system illustrated in Fig. 4 a saving of 25 per cent in copper is made. Two dynamos, D<sup>1</sup> D<sup>2</sup>, are required. The negative terminal of dynamo, D<sup>1</sup>, is connected with the positive terminal of the dynamo, D<sup>2</sup>, by the wire, a. These conductors are connected with the two dynamos as follows: Conductor, b, is connected

with the positive brush of dynamo, D<sup>1</sup>; conductor, c, is connected with the wire, a, and conductor, d, is connected with the negative brush of dynamo, D<sup>2</sup>; a number of lamps, L, are connected with the conductors, b, c, and lamps, L', are connected with the conductor, c, d. The central conductor, c, acts as a return for the first dynamo and a lead for the second dynamo. When the number of lamps between the conductors, b, c

and c, d, is equal, no current passes along the conductor, c, either from or toward the lamps or dynamos, and under these circumstances the conductor, c, might be disconnected from the dynamos without in any way affecting the results; but when the two groups of lamps differ in number, the difference of current will be carried by the central or compensating conductor. When two dynamos are combined on this

plan, these conductors take the place of four connected up according to the two-wire system.

**Polishing Wood with Charcoal.**

A method of polishing wood with charcoal, which is much used by French cabinet makers, is thus described in a Paris technical journal:

All the world knows of those articles of furniture of a beautiful dead black color, with sharp, clear-cut edges and a smooth surface, the wood of which seems to have the density of ebony. Viewing them side by side with furniture rendered black by paint and varnish, the difference is so sensible that the considerable margin of price separating the two kinds explains itself.

The operations are much longer and more minute in this mode of charcoal polishing, which respects every detail in carving, while paint and varnish would clog up the holes and widen the ridges. In the first process they employ carefully selected woods, of a close and compact grain, then cover them with a coat of camphor dissolved in water, and almost immediately afterward with another coat, composed chiefly of sulphate of iron and nut-gall. The two compositions, in blending, penetrate the wood and give it an indelible tinge and render it impervious to the attacks of insects. When these two coats are dry, they rub the surface of the wood at first with a very hard brush of couch-grass (chien dent), and then with charcoal of substances as light and friable as possible, because if a single hard grain remained in the charcoal, this alone would scratch the surface, which they wish to render perfectly smooth. The flat parts are rubbed with natural stick charcoal, and the indented portions and crevices with charcoal powder. Alternately with the charcoal, the workman also rubs his piece of furniture with flannel soaked in linseed oil and the essence of turpentine. These pouncings repeated several times cause the charcoal powder and the oil to penetrate the wood, giving the article of furniture a beautiful color and a perfect polish which has none of the flaws of ordinary varnish.

**Penetration of Light in Water.**

M. Hermann Fol reports to the Academie des Sciences the result of the researches that he has been making in the depths of the Mediterranean during the summer months, his object having been to certify how far daylight penetrates. His operations have been carried on in water of remarkable clearness between Corsica

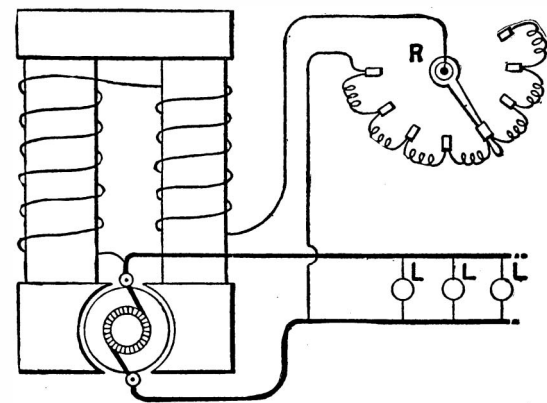

Fig. 3.—EDISON'S SYSTEM OF REGULATING.

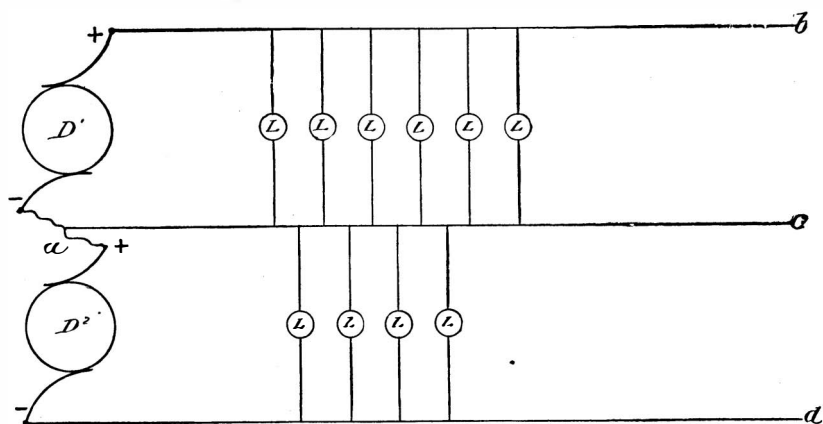

Fig. 4.—EDISON THREE-WIRE SYSTEM.

and the shores of the Alpes-Maritimes, at a distance of 18 geographical miles from the nearest land. M. Fol used gelatino-bromide plates exposed during ten minutes, whereby he has found the limit of daylight in those waters to be at a depth of 1,518 feet (465 meters). This is 327 feet short of the limit assigned to daylight in the Mediterranean by the Germans Chun and Petersen some years ago.

\* From "Experimental Science," by George M. Hopkins. Munn & Co. publishers, New York.

**AN IMPROVED SCREWDRIVER AND WRENCH.**

The accompanying illustration represents a tool designed especially for use by piano makers, cabinet makers, carpenters, and others, for turning screws in corners or other obstructed positions, one tool being designed to serve the purpose of numerous different-angled screwdrivers. It has been patented by Mr. Carl A. Strasser, of Baltimore, Md. The handle has at its outer end notches to receive pins, such as the key-guiding pins of a piano, or wires that may have to be straightened. At the other end of the handle is journaled a ratchet head, the teeth of which are adapt-

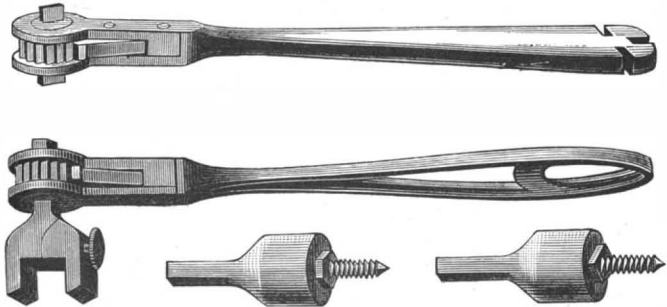

STRASSER'S SCREWDRIVER AND WRENCH.

ed to be engaged by a spring-controlled pawl in such way that, by turning the handle in one way, the pawl will turn the ratchet head, while by turning the handle in the opposite direction the pawl will slip back over the teeth of the ratchet. Through the axis of the ratchet head is formed a slot in which the screwdriver is fitted to project beyond both ends, or the opening in the ratchet head may be formed to also admit the shank of a wrench, adjustable for different-sized nuts, as shown in one of the views. A removable plate at the ratchet end of the device permits the ready taking apart and putting together of the parts.

For further information relative to this invention address Messrs. Strasser & Schroeder, No. 222 West Pratt Street, Baltimore, Md.

**AN IMPROVED LATHE DOG.**

The accompanying illustration represents a lathe dog of simple and durable construction, and designed to be very effective in operation, requiring no wrench or other tool for adjusting it in starting or stopping, and which is self-tightening when the lathe is started. This invention has been patented by Mr. George J. Engert, Dansville, N. Y. The dog has an aperture in which slides a die, to be pressed against the work by a set screw, and there is in the opposite end of the dog a slot extending to the aperture, the tail being pivoted in this slot, and having at its outer end the usual offset adapted to engage the face plate of the lathe. When the dog with the work is placed in position in the lathe, the tail swings to one side as the lathe is started, the work being more firmly gripped and clamped the harder the face plate turns, the tail assuming its natural position and releasing the tight grip when the lathe is stopped.

For further information relative to this invention address Mr. E. C. Schwengel, Dansville, N. Y.

**AN IMPROVED MEAT-CARRYING APPARATUS.**

A novel form of meat-carrying apparatus, whereby meat or other articles suspended may be moved to position as desired in storage sections, and almost any piece so stored may be run out upon receiving and delivery tracks without interfering with the position of

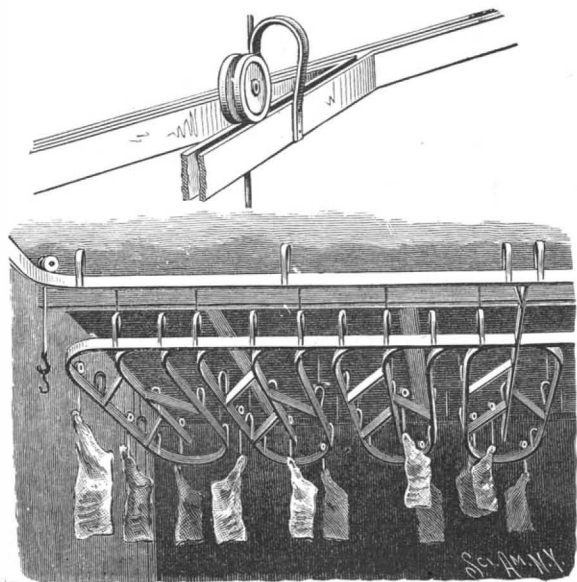

O'KEEFE'S MEAT-CARRYING APPARATUS.

the other pieces, is illustrated herewith, and has been patented by Mr. John O'Keefe, manager of the Omaha branch of the Armour-Cudahy Packing Company, 14th and Leavenworth Streets, South Omaha, Neb. The truck or carrier consists of two wheels upon a central shaft, a yoke being loosely arranged on the shaft, while from the yoke depends a rod, on the lower end of which is a swivel hook serving as a support for a meat hook. The track or way upon which the truck rides is formed of two rails united by arched hanger ties, as shown in the sectional view, the arms of the hanger ties being secured to the outer faces of the track in such manner that the truck is free to pass between the arches. Suspending rods are secured to a longitudinal bar or to the arched hanger ties. The rails forming the receiving and distributing track are connected with storage tracks made up of sections, the inner rails in the storage sections being separated to form auxiliary tracks connected by permanent switchways. Each of the tracks and switches is composed of two parallel flat rails placed vertically edgewise, all of the rails being rigidly connected together, and the upper faces of all of them lying in the same plane, so that the flangeless truck wheels may be readily turned to pass from track to track. This apparatus is designed to save largely in the labor, and facilitates the handling of meat by packers and provision dealers.

**Process of Removing Vermin or Scales from Plants.**

A novel process, by Edwin P. Fowler, of National City, California, consists in dislodging the vermin by means of a sand blast.

The object of the invention is to remove and eventually destroy vermin which are liable to cause injury to vines or other plants of a similar nature, and also to remove growths—such as those known by the term "scale"—which appear in the form of white protuberances formed of fibrous cotton-like matter and containing vermin, and which destroy yearly entire groves of lemon and orange trees in Florida, South California, and other tropical States.

In carrying out the invention, a fan blower of any suitable construction, or any other apparatus capable of creating an artificial current of air, is employed. The artificial current of air thus created is directed against the tree or other plant, and in its transit from the fan blower to the plant the current of air is charged with sand. Of course the force of the artificial air current must be carefully gauged, so that the sand which is projected by the same against the trees or plants will not destroy the plants together with the vermin or scale, and the sand must be sifted, so that no coarse particles or stones remain mixed with it. If the force of the air current is properly limited, according to the nature of the plants under treatment, the scale or vermin can be removed without injuring the trees or plants.

In some cases it is desirable that the artificial current of air shall be heated, and for this purpose there is combined with the fan blower or other apparatus a suitable heater. It may also be desirable in certain contingencies that the sand which is used for charging the artificial air current shall be hot, and for the purpose of heating the sand before introducing it into the air current, any suitable heating apparatus may be used.

**Continuous Regenerative Gas Kiln for Fire Bricks.**

In former years, the "Newcastle" kilns were the only ones employed in Scotland for the burning of fire bricks, but at the Glenboig and Cumbernauld works, near Glasgow, Scotland, a most important advance has been made in recent years by the introduction of the "Dunnachie continuous gas kiln." This kiln is constructed of two rows of fire chambers, all connected with each other by means of flues underneath the floors. By means of these flues the gaseous fuel is obtained from gas producers. A continuous firing is thus maintained, and the heat regenerative principle involved has resulted in the most efficient and economical system of burning fire brick yet known. As compared with the "Newcastle" kiln and the older method, the saving in fuel has been found to be from 50 to 75 per cent—at Glenboig the latter figure has been attained. Since the introduction of this system at Glenboig, in 1881, the Dunnachie kiln has been applied at various other establishments for the burning of other classes of bricks, pipes, tiles, pottery ware, etc., with much success.

**IMPROVED VEHICLE RUNNING GEAR.**

The accompanying illustration represents a vehicle running gear in which the king bolt is dispensed with, and the reach is attached to the head block and front axle by a ball and socket joint, the arrangement being such that the head block and axle may be quickly and conveniently disconnected, while a fifth wheel of economical and durable construction is provided. This invention has been patented by Mr. Wade H. Lowe, of Campti, La. A segmental plate, constituting the lower

section of the fifth wheel, is clipped on each side of the center of the axle, each plate having on its inner edge an upwardly extending flange. In the case of wood axles, a metal plate is secured to the upper face of the axle beneath the segmental plates, but this is not necessary when the axle is made of metal. In the center of the plate or of the metal axle is a circular concavity, a similar concavity being produced in alignment therewith upon the under face of the head block, or in a metal plate secured thereto. The upper sections of the fifth wheel are also rigidly secured to the under face of the head block, at each side of the center, and have flat under faces adapted for contact with the equivalent surfaces of the lower fifth wheel sections, being guided thereon by the upwardly extending flanges on the inner edge of the lower sections. The reach is provided at its forward extremity with a metal tip or ball, and has an enlarged portion near the

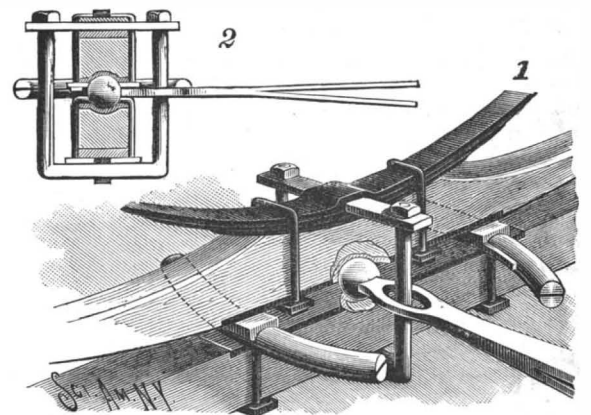

LOWE'S VEHICLE RUNNING GEAR.

ball in which there is an oval-shaped vertical opening. The ball is seated in the opposed cavities in the axle and head block, as shown in the sectional view, the two surfaces contacting upon the ball being held in position by a U-shaped yoke, the lower portion of which is pivoted upon a stud projected downward from the center of the axle, while its upper members are connected by a tie plate and jam nuts. This tie plate is preferably passed beneath the upper leaf of a spring attached to the head block, and one member of the yoke passes through the opening in the reach. The ball and the surfaces constituting its sockets and the bearings of the upper and lower sections of the fifth wheel are adapted to reduce the friction to a minimum, while the coupling may be readily taken apart and put together again, only two nuts having to be removed or applied to the yoke.

**AN IMPROVED ELECTRICAL DOOR ALARM.**

A simple and effective alarm, to give notice within when the door knob is turned from the outside of the door, is illustrated herewith, and has been patented by

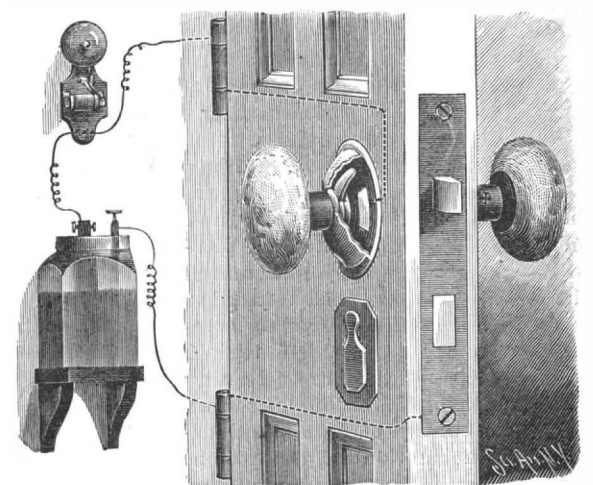

STREEPER'S ELECTRICAL DOOR ALARM.

Mr. Daniel H. Streeper, of Norristown, Pa. The door is fitted with a lock of ordinary construction, its two spindles axially in line with each other, and adapted to operate independently on the mechanism of the lock in the usual way, and to the knob socket on the outer spindle is attached a switch arm, just under the outer collar, there being inserted in the face of the door a contact plate, in the path of the switch arm when the latter is turned with the knob socket. The lock is connected through a wire and the hinges of the door with one pole of a battery, and the contact plate is connected through another wire and the door hinges with an electric bell, as shown in the illustration, the bell being in turn connected with the other pole of the battery. The bell has an electro-magnet capable of acting upon an armature connected with the bell hammer. When the door is opened by turning the inside knob, the electric circuit remains unchanged, but on turning the outer knob the switch arm on the knob socket is brought into contact with the contact plate, closing the

### Comparative Cost of Water Power and Steam Power.

A very thorough examination into the relative cost of water power and steam power has been made by Chas. H. Manning, of Manchester, N. H., in a paper recently read before the American Society of Mechanical Engineers. The author takes the water powers at Manchester, N. H., and at Lawrence and Lowell, Mass., as his standards for that side of the calculation, and for steam power he takes the steam engines used in the same towns for manufacturing purposes, where the cost of coal is \$4.50 per ton. The conditions greatly favor the water power side, although all these water power privileges are permanently capitalized, and under the original leases paid \$10.55 at Lawrence and \$10.42 at Manchester per horse power. Under recent leases their prices have been advanced at Lawrence to \$14.08 per horse power.

After making elaborate calculations as to the practical additions and abatements required in putting both to use, the author sums up the cost in each case, and says: "In the water power plant we paid \$14 for the cost of the water, simply, per horse power per annum; add to which \$8.62 for attendance and supplies, we have a total cost for water power of \$22.62 per horse power per annum." And taking for steam a low pressure plant of 1,100 horse power, with compound engines run on one and three-quarters pound of coal per horse power, with coal at \$4.50 per ton, the total cost for steam is given at \$21.16 per horse power per annum.

"On a 1,000 horse power plant the difference in cost saves an engineer's wages." We doubt not, says *Iron*, this decision in favor of the cheaper steam power will surprise many who have supposed that the cities on the Merrimack had a great advantage over our Pennsylvania towns in the cheapness of water power as compared with our coal. As coal is obtained for steam power much below \$4.50 per ton, it is evident that our advantages are much greater than those claimed for steam in Massachusetts.

### A Singular Incident from the Scrap Heap.

A curious phenomenon recently occurred at the Frankfort shops of the West Shore Railroad, which is vouched for by the superintendent of motive power, James M. Boon, few men being better known in railroad circles.

A cast iron piston, eighteen inches in diameter, having been worn out, was removed from an engine and thrown in the scrap pile. Some time afterward it was taken from the pile with other scrap, and being too large to use in the cupola, was carried to the breaker. On being struck it broke in two parts and immediately began to act in a remarkable manner. The iron turned to a red heat and from that to a sparkling white, while from the hollow parts a flame arose to the height of three or four feet, throwing out sparks as though it were filled with damp gunpowder.

The man who broke the piston became frightened and threw a pail of water on it, which deadened the flame somewhat, but it continued to glow and throw out sparks for some time, to the amazement of the twenty or more men who stood looking on.

J. R. Slack, the chief draughtsman of the West Shore, has referred the case to various scientific men, but has received few satisfactory replies.

One opinion is that cylinder oil worked into the hollow part of the piston around the plugs which filled the core holes, and under the high temperature and pressure to which it was subjected, united with some of the core sand remaining in the piston, formed a highly combustible compound, which ignited spontaneously on exposure to the air.

Another theory is that the loose core sand, being thrown backward and forward by the motion of the piston, wore off a considerable amount of iron in an exceedingly finely divided condition, which ignited on exposure.

It is well known that a great many substances, iron among others, may be so finely divided that, when thrown into the air, they will take fire spontaneously, but it does not seem possible there could have been enough atomized iron in this case to cause the excessive amount of heat shown.

Whatever the cause may have been, the facts are as stated above, and, as far as we know, it is the only case of the kind on record; and any solution of what has proved so far a complete mystery will be gladly received for publication by the editor of *The Safety Valve*, from which the above is copied.

Some time ago we heard of a case in which an old piston casting, thrown on the scrap heap, had suddenly burst with a loud report, but as far as we are aware no display of incandescent activity accompanied

### DERNELL'S CLEVIS ARM FOR ICE PLOWS.

Considerable inconvenience is often found to exist in ice plows, owing to the location of the clevis at the end of the plow beam. In case the draught is not applied in the proper way, the front or clearing tooth of the plow is apt to sink into the ice, especially when slush or water is in the grooves, and the latter will be tilted forward on its front tooth, its handles being jerked out of the hands of the driver. With direct connection of the clevis to the plow, when the cutting teeth of the plow are very sharp they tend to bury themselves in



DERNELL'S CLEVIS ARM FOR ICE PLOWS.

the ice when draught is applied, and when the teeth become dull they fail to cut to the proper depth. In order to avoid this, Mr. Herman F. Dernell, of Athens, N. Y., has patented an adjustable clevis which may be raised and lowered to any position so as to regulate the angle of draught to any degree that will secure an even and steady motion.

To the forward end of the beam of the plow is mounted a vertically swinging arm which carries the clevis at its outer extremity, and beyond the front teeth of the plow. This consists preferably of two parallel bars bolted to the end of the beam, and forms an opening for clips passing up in front of the clearing tooth. Each bar is provided with a depending lug which has a curved slot, through which is passed a bolt provided with a tightening nut, by means of which the arms may be locked at any desired angle to the plow beam.

### AN IMPROVED COTTON CULTIVATOR.

A machine designed to scrape, chop, and cultivate a row of cotton, in passing once over it, is illustrated herewith, and has been patented by Mr. Edwin E. Runyon, of Tioga, Tex. Upon the main frame of the machine there is adjustably mounted an interior frame carrying at its forward end scraping shovels, behind these a chopping wheel and driving wheels, and, at the rear, adjustable covering shovels. To the main axle is secured a block which serves as a footboard and a support for a standard upon which the seat is mounted, and from the lower ends of vertical standards rigidly connected to the main axle extend the horizontal timbers of the main frame. The front ends of this frame are joined by two arched connections, from the front one of which extends the tongue, while

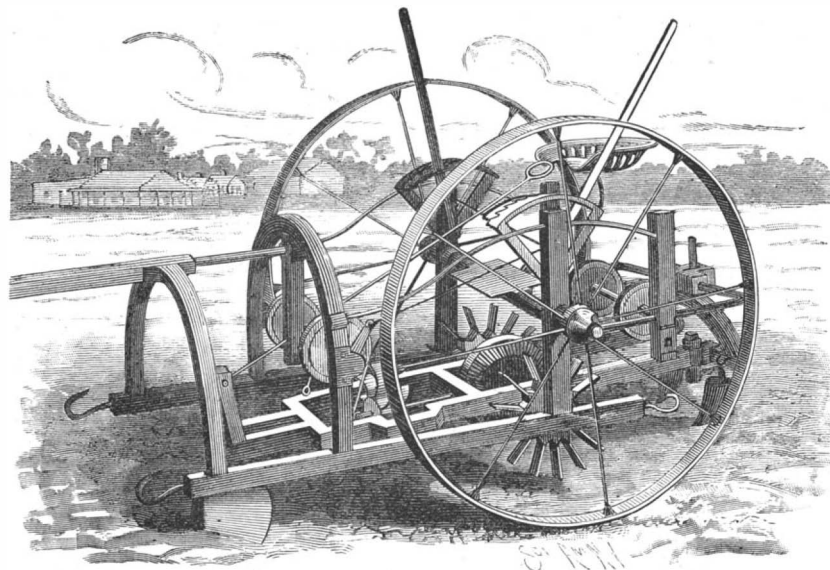

RUNYON'S COTTON CULTIVATING MACHINE.

in the other is journaled a shaft carrying two sheaves and a crank arm, ropes or chains from the sheaves being attached to the front end of the supplemental interior frame, whereby this end of the frame is supported, and may be raised or lowered by operating the crank arm on the shaft. A similar shaft, having sheaves and a crank arm, is journaled in a rearward extension of the main frame, whereby the rear end of the supplemental interior frame is supported. There

are toothed racks at each side upon the vertical standards on the main axle, and the crank arms on the front and rear shafts are connected by rods to levers pivoted upon the vertical standards, and adapted to engage the racks, whereby the forward and rear ends of the supplemental interior frame may be raised and held up from the ground when the machine is being moved from place to place, or to regulate the depth of cut of the scrapers or cultivator shovels. To the forward end of the supplemental interior frame are rigidly connected two scraper shovels, adapted to operate one upon each side of the row being cultivated, and to its rear end are adjustably connected cultivator shovels, while about centrally in the frame is journaled a horizontal shaft upon which are driving wheels with radially extending blades. Upon this shaft is a gear engaging a pinion carried by a longitudinal shaft upon which is mounted the chopper wheel. The gear is preferably so arranged as to secure four revolutions of the shaft of the chopper wheel to one revolution of the driving wheels, and the chopping hoes or blades are preferably so arranged that, as the wheel is revolved by the forward movement of the machine, the wheel will leave a space in the row that the blades will not operate on. A lever extends from the forward end of the supplemental interior frame to within convenient reach of the driver, whereby this end of the frame with the scraping shovels may be moved slightly to the right or left, to allow for any swaying motion as the machine advances, and hold the shovels in operative position on each side of the row.

### The Diamond.

The origin of the diamond has been a fruitful topic for speculation among scientists; hence many contradictory theories have been advanced and argued with some show of reason; but after all that has been said and written upon the subject, we are still left pretty much in the dark. Theories answer a good purpose, since they often lead the way to truth. But this is not all; they illustrate the ingenuity in the human mind in seeking to account for the methods Nature takes for the accomplishment of her secret operations.

Some of these theories about the origin of the diamond are very ingenious and interesting, though the amount of truth they embody remains to be proved. It has been suggested that the vapors of carbon during the coal period may have been condensed and crystallized into the diamond; and again, the itacolumite, generally regarded as the matrix, was saturated with petroleum, which, collecting in nodules, formed the gem by gradual crystallization. Newton believed it to have been a coagulated, unctuous substance, of vegetable origin, and was sustained in the theory by many eminent philosophers, including Sir David Brewster, who believed the diamond was once a mass of gum, derived from certain species of wood, and that it subsequently assumed a crystalline form. Dana and others advance the opinion that it may have been produced by the slow decomposition of vegetable material, and even from animal matter. Burton says it is younger than gold, and suggests the possibility that it may still be in process of formation, with capacity of growth. Specimens of the diamond have been found to inclose particles of gold, an evidence, he thinks, that its formation was more recent than that of the precious metal.

The theory that the diamond was formed immediately from carbon by the action of heat is opposed by another, maintaining that it could not have been produced in this way, otherwise would have been consumed. But the advocates of this view were not quite on their guard against a surprise, for some quick-witted opponent has found by experiments that the diamond will sustain great heat without combustion.—*Theodore Rothchild, in Bullion.*

### Telephones in Austria.

Long-distance telephonic communication was opened on October 1 in Austria between Vienna and Prague, a distance of 220 miles. Every subscriber in Vienna can now communicate with Prague, and every word can be perfectly understood and the voice recognized. In connection with this news the *London Star* gets rather a good joke on the *Daily News*, who first announced the opening. Their correspondent mentions as a curious fact that it has been observed that those

who listen at Prague hear more clearly than those who listen in Vienna, and remarks the reason has not been explained. The *Star* heads its paragraph, "They speak plainer in Vienna," and says the reason seems clear enough.

EIGHTEEN tons of steel disappear daily on the single system of the London and Northwestern Railway through wear and rust.

Correspondence.

THE OCCULTATION OF JUPITER.

To the Editor of the Scientific American:

The occultation of Jupiter by the moon on the evening of September 3, 1889, was successfully observed by me with the 10 inch equatorial and the 3 inch finder attached thereto. The latter instrument was used for eye observations after the photographic lens and plate holder had been attached to the larger telescope.

The first contact of the planet with the dark limb of the moon was noted at 20 h. 29 m. 21 s.; and the first appearance of Jupiter as it emerged from the bright limb of the moon was recorded at 21 h. 25 m. 30 s. local sidereal time.

Although the atmospheric conditions were not favorable for photographic work, the air being filled with smoke and haze, several good negatives were secured before the occultation, and one showing the disk of Jupiter half covered by the dark limb of the moon, an enlarged drawing of which is shown in Fig. 1. In the



Fig. 1.—DISK OF JUPITER HALF COVERED BY DARK LIMB OF MOON AT IMMERSION.

photographic views the relative apparent size, as seen upon the sky, of Jupiter and the moon is graphically shown. Also by a comparison of these two views, the motion of the moon toward Jupiter is impressively recorded, and a measurement with scale or dividers shows the space moved over by the moon in the inter-

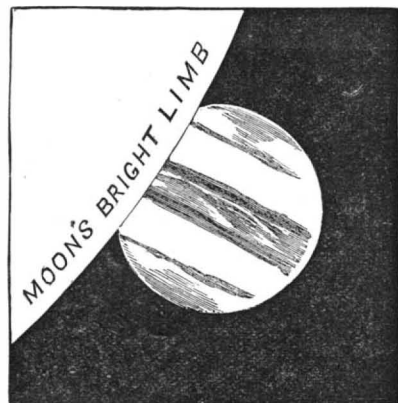

Fig. 2.—JUPITER AT EMERSION FROM BRIGHT LIMB OF MOON.

val between the two photographs, which was 5 minutes and 10 seconds. Although the image of Jupiter is so small, yet the belts can be easily seen in the original photographs with a magnifier.

WILLIAM R. BROOKS.

Smith Observatory, Geneva, N. Y.,  
September 20, 1889.

Alcoholism in Norway.

To the Editor of the Scientific American:

In a recent issue of the SCIENTIFIC AMERICAN I noticed some statistics, given by the *Medical Record*, in regard to the relations between alcoholism, crime, and insanity. In so doing the paper states that in Norway, contrary to other countries, there is a decrease in alcoholism as well as in crime, and that this is due, not to prohibition, but to lessening the number of licenses. Admitting the above to be a fact, let me add that the liquor business in most towns and cities in Norway is under the management of an association, which is again controlled by the municipal authorities, that the goods are analyzed and examined before sold, that minors or intoxicated persons cannot buy any liquors, and that one glass at a time is all each person can obtain. In the liquor shops there is no furniture, nor games of any kind allowed. The sale of liquors in bottles takes place in centrally located stations, and is run on the same principle as the retailing in glasses.

The dividend of the business goes to pay for public improvements, such as the building of parks and highways, homes for aged people, reform schools for strayed children, and the like. The scheme has been in practical use now for several years, and so far has been very successful in diminishing the alcoholism and crime of the country.

JACOB IRGENS.

Palisades, Oct. 16, 1889.

Diamonds at the Paris Exhibition.

Scarcely on any other occasion have so many diamonds been collected and exhibited as at the Paris exhibition; although there is always a fine show of diamond ornaments in the jewelers' shops on the boulevards, in the Palais Royal, and other quarters of Paris. But the exhibition has brought together a more than ordinary display from Paris, Belgium, and Holland, as well as the rich products of South Africa. In the French Jewelry Gallery, Class 37, there are more than two dozen exhibitors of diamond ornaments of every kind and shape, as coronets or diadems, necklets, bracelets, sprays, earrings, rings, pins and combs for the hair, brooches, medallions and miniature frames, bouquet holders and handles for fans, breast plates or bodices, epaulettes, and lacework for corsages, robes, etc.; as well diamonds in the rough, as polished and set in all sorts of forms.

In the French Jewelry Court is also exposed the grand prize of the *tombola*, or lottery, a parure of diamonds valued at £8,000. This consists of a coronet or diadem, bracelet, brooch, earrings, spray, fan, etc. The lottery, consisting of one franc tickets, is to be drawn on October 30.

The diamonds shown in the exhibition must be at least of the value of seven or eight millions sterling, or forty millions of dollars. There are many specialties and *tours de force*, such as a model of the Eiffel tower, made entirely of diamonds, 3¼ feet high, which is going off to America. The Imperial diamond, belonging to a syndicate of London merchants, which weighed in the rough 457 carats, and now, cut and polished, is 180 carats. This stone is believed to have been obtained surreptitiously from one of the South African mines, and is expected to sell for about £40,000. The Koh-i-noor only weighs 108½ carats, but there are brilliants shown more than double that size. To Bruges is attributed the credit, in the 15th century, of first polishing the diamond with its own dust. The troubles of the 16th century, however, drove most of the experienced workmen to Amsterdam; but Belgium has now regained its old prestige for diamond working. To Antwerp belongs the honor of improving the cleavage and polishing of these precious stones, which have increased considerably the brilliancy of the diamond by adding to its fire and luster from the regularity of the facets. In order not to waste any of the material, the lapidary now shapes the gem according to its natural form. Hence it is rounded gracefully, which adds considerably to its value. Since 1830 the cutting of rose diamonds has become a specialty of Antwerp. The fine jewels shown in the Belgian section are marvels of workmanship, and the admiration of all connoisseurs. Nearly all the Cape diamonds are now sent to Antwerp to be cut and polished. Since 1840, when the first steam diamond-cutting firm was established in Antwerp by Messrs. Bovie, the industry has made rapid progress, there being now about 50 workshops, employing 3,500 operatives, and a skilled workman, according to the work he turns out, can earn from £8 per week upward.

In the Belgian section there is in a showcase a fine display of large and beautifully cut Cape diamonds by two exhibitors, Messrs. Coetermans and Mr. Latinie. There are two jewel cases, one containing a very large brilliant, surrounded by six small stones; another with six large diamonds. There is a Cape diamond in the rough weighing 300 carats, a diamond cross out of a single stone, unique of its kind, two long drop diamond earrings, miniature portraits of the king and queen of the Belgians shown under large diamonds, and a small sword cut out of a diamond. The last named three objects have been presented to the King, as Sovereign of the Congo State.

In the exhibition grounds the public have two opportunities of seeing the rough diamonds cut and polished, an industry which has made enormous strides of late years, keeping pace with the increased supply of stones from the extraordinary discoveries in South Africa.

Messrs. Boas & Co., of Amsterdam, have a small pavilion situated near the British Commission offices, where there are diamonds in cases round the room, valued at more than a million sterling. Here will be found Dutch Jews cutting and polishing, for these men are very expert workmen, and have had long experience in the business. The rough stone is set in a kind of metal solder, and is submitted to the tedious grinding process to form tables and facets, the side of the stone being changed from time to time.

The General Diamond Mining Company, of South Africa, has a very large building in the grounds, devoted to showing all the operations of washing the blue diamondiferous earth imported, and shaping diamonds. There are also models exhibited of the Bultfontein mine, of the hauling gear of De Beer's mine, maps, photographs, and a large show of diamonds, worth at least a million sterling. One in the rough, an octohedron, weighs 306 carats; another polished, the largest brilliant in the world, weighing 228½ carats, is valued at £100,000. The Shah of Persia bought here three large diamonds. Here are to be seen French workpeople employed by M. Roullin, cutting and

polishing diamonds, and the tedious process of drilling diamonds, for it takes three weeks to pierce a hole the size of a pin in diameter, by a steel tool revolving 14,000 times in a minute.

There is little doubt that the earliest known diamonds came from India. Indeed, until quite modern times, no other source of supply was known. To-day, the only Indian mines regularly worked are the northern ones at Punnah, in Bundelcund, and those in the Madras Presidency. The total yield of these is of trifling importance to the world's traffic, the bulk of the production being disposed of in the local markets, the principal of which is Benares.

It is estimated that the annual weight of Indian diamonds exported to Europe does not exceed 100 carats. They are chiefly interesting through their historical associations, nearly all the celebrated crown jewels of Europe having been derived from India. The opening of the Brazilian mines at the beginning of the last century practically closed the mines of the Deccan. The value of a diamond depends on the purity of its color, its freedom from flaws and spots, and its relative size.

The discovery of the South African diamond mines about twenty years ago created a complete revolution in the trade. The finding of the famous "Star of South Africa," a stone weighing 83½ carats in the rough, caused a great rush to the district, and the banks of Vaal River were found rich in diamonds. This large brilliant when cut weighed 46½ carats, and now figures among the jewels of the Countess of Dudley; but this has been far exceeded by subsequent finds. The river diggings were soon abandoned for the farms of Du Toit's Pan, Bultfontein, and the locality where now stands the town of Kimberley. A circle of about 3½ miles in diameter indeed incloses the four principal diamond mines which have been worked to such advantage. The depth to which these principal mines have now been excavated is from 400 to 500 feet.

In an account published in the Cape Colony four years ago it was estimated that the yield of diamonds at the Kimberley mine, from the opening in 1871 to the end of 1885, was about 17½ million carats, equal to 3½ tons of precious stones, of the value of £26,000,000, and the total weight of reef and ground excavated exceeded 20,000,000 tons.

The gross value of the diamonds produced by the De Beers mine in the same period was about £9,000,000 sterling, representing about 1½ tons weight of precious stones.

The stringent police laws established have enabled a tolerably accurate idea to be formed lately of the production and sale price of the diamonds, and the following are official statistics of the yield of the four principal mines, from 1882 to the end of 1888:

|                    | Carats.     | Sale value. |
|--------------------|-------------|-------------|
| Kimberley.....     | 6,050,490½  | 5,960,898   |
| De Beers.....      | 4,444,421½  | 4,385,782   |
| Du Toit's Pan..... | 3,651,961½  | 5,060,341   |
| Bultfontein.....   | 3,771,981   | 3,765,074   |
| Total.....         | 17,918,854¼ | £19,172,095 |

These totals do not include the production of some of the secondary mines, as Jagersfontein, Coffeefontein, and the alluvial washings of the Vaal River, etc., which may be valued at 150,000 to 300,000 carats yearly; nor the diamonds stolen, which are estimated at one-fourth to one-fifth of all found. If we add to the above the quantity obtained previous to 1882, the entire production in the 18 years certainly exceeds 40,000,000 carats, or more than eight tons of diamonds, representing a value of at least £56,000,000 sterling, or \$280,000,000.

This large production of diamonds has necessarily had an effect in depreciating prices, and there have been considerable fluctuations from time to time, but by a combination of the several mining interests into the De Beers Consolidated Mining Company, Limited, with a capital of £12,000,000 sterling, the production will in future be limited to 2,000,000 or 2,500,000 carats per annum, a quantity sufficient to meet the current demand, and at which prices will be maintained.

The public have a general impression that the Cape diamonds are usually of a yellow tinge, but this is not so, and they may convince themselves to the contrary by inspecting the large collection of diamonds shown in the South African pavilion. There are stones, it is true, of various shades of yellow, and the deep orange tint is highly valued by collectors for its rarity. The Cape diamonds, as a rule, are indeed less colored on the average than those of India and Brazil. This erroneous opinion arises from the fact that the largest Cape diamonds found are somewhat yellow, while the large diamonds of India and Brazil are of a white and brilliant hue. The diamonds obtained from the mine of Jagersfontein, in the Orange Free State, are remarkable for their whiteness, verging to blue.—*Journal Society of Arts.*

Flexible Paint.

The following retains sufficient flexibility to enable the sheet to be rolled:

|                    |            |
|--------------------|------------|
| Soft soap.....     | 2 ounces.  |
| Boiling water..... | 12 ounces. |

Dissolve and work well into usual oil paint; 6 lb.

**GERMANY'S FLOATING EXPOSITION.**

From an economical point of view, the great international expositions have heretofore been considered the best means of disposing of the overproduction of different industries, because they extend the field of commerce. On the other hand, an ever-increasing number of voices has, of late years, been raised against modern expositions, naming as their chief disadvantage the great expense considering the short duration of the exhibitions and the doubtful results. In regard to exhibitions in their usual form, and the immense buildings erected for the reception of exported samples, experience has taught that the only true way to make foreign traders and consumers buy is by convincing them that they will find a demand in their own countries for German manufactures and to open business connections with the respective firms. Considerations of this kind long ago led to the idea of building a so-called floating storehouse for samples. The Deutschen Exportverein formulated a plan for a German national floating exposition, which should be continually supplied with novelties, and should visit all of the principal foreign ports in regular succession, open-

the most favorable effect on visitors. There will also be a sufficient number of motors to show the machinery in operation.

The plan of the exposition palace was drawn and will be carried out by Bernhard Schaede, of Berlin, an architect who is well known by his work in the line of decorative art. The management and control will be vested in a board of directors, whose duty it will be to attend to business transactions in the names of the exhibitors, unless they prefer to represent their own interests, or to send agents, in which latter case cheap passage tickets will be provided. This exhibition will be equivalent to a number of international exhibitions, and it will be less expensive for each exhibitor to send exhibits than it would be for him to participate in one ordinary exposition. Besides its special object, the new steamer will, in every respect, facilitate journeys around the world for study or pleasure. It is expected that a trip around the world will take two years, during which time the steamer will stop at each of the ports visited (about eighty in all) from three to fourteen days, according to the importance of the place. The starting point is Hamburg, where opportunity

glue stock, all of which is used by the bone men in various ways. A few of the tails are absorbed in cold weather in the manufacture of ox-tail soup, but usually "the tail goes with the hide," and becomes spoiled for domestic use while lying around the tannery. Every scrap of the skin of the animal, even the pate, as the skin of the head is called, is used in one way or another, and the refuse of the tanneries forms an important part of the income of the establishments.

**The Management of Petroleum Lamps.**

In view of the numerous fatal and other accidents caused by petroleum lamps, the following suggestions as to the construction and management of such lamps have been made by Sir Frederick Abel and Mr. Boverton Redwood, chemist of the Petroleum Association, after investigating the causes of lamp accidents:

1. That portion of the wick which is in the oil reservoir should be inclosed in a tube of thin sheet metal, open at the bottom; or in a cylinder of fine wire gauze, such as is used in miners' safety lamps (28 meshes to an inch).

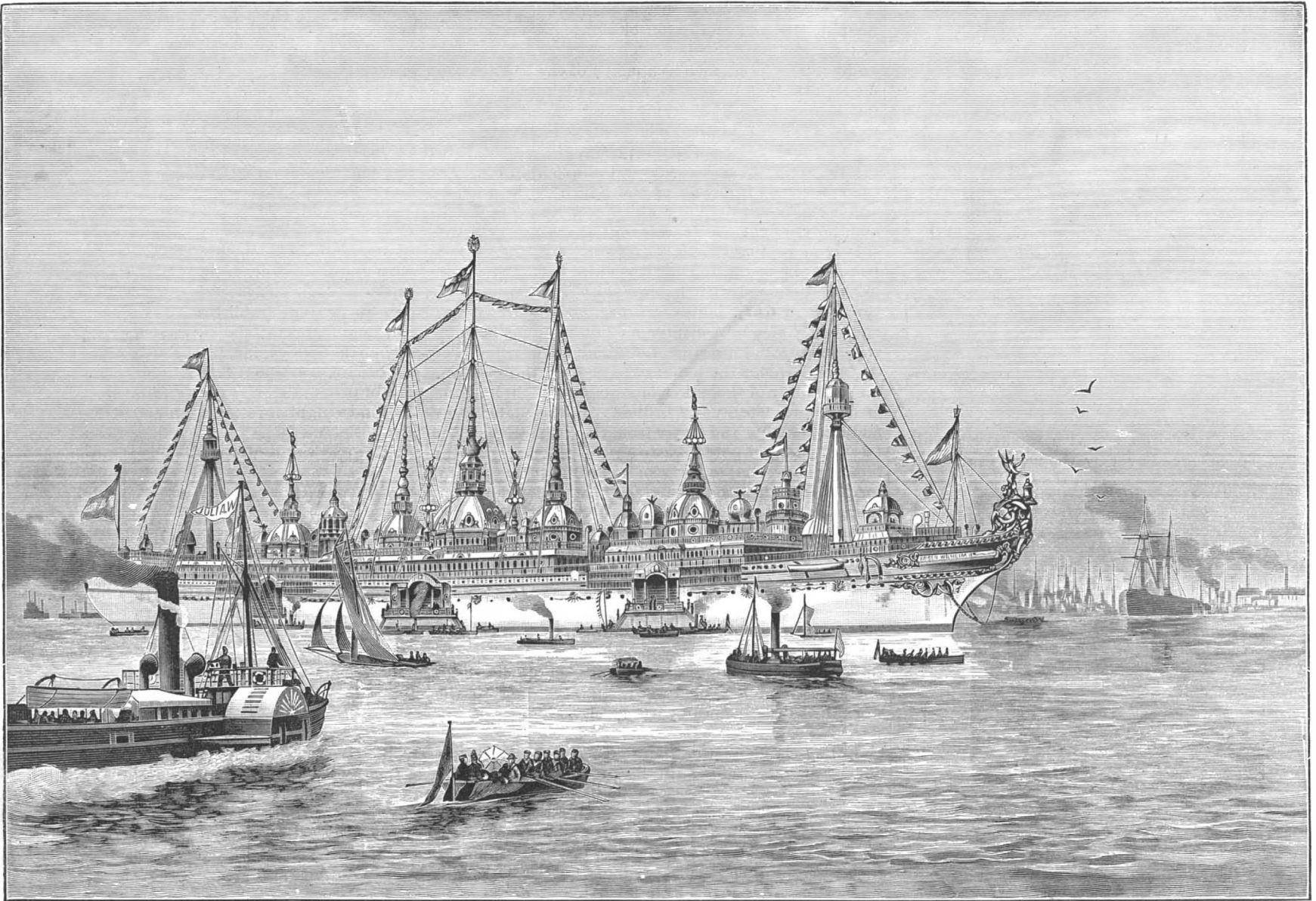
**GERMANY'S FLOATING EXPOSITION.**

ing its rooms, not only to business men, but, by the variety of its exhibits, attracting people of the town and also of the surrounding country. In order to carry out this plan, a committee was formed which included a number of well-known manufacturers, through whose efforts the completion of the exposition already seems assured.

As will be seen by the accompanying illustration, the floating exposition palace has taken the form of a gigantic steamer without masts and rigging, but covered with large and small structures with towers and cupolas. The enormous steamer, which is to bear the name of Kaiser Wilhelm, will have three decks, like the first-class German Lloyds ships, and will be provided with all the latest technical improvements, as well as with the best appointments for comfort, so that it, in itself, will bear witness to German industrial progress. It will be the largest seaworthy vessel, for its length will be about 560 ft., its breadth 69 ft., and its height 44 ft. The exposition rooms—eight large, high saloons, with galleries—are to be on the middle deck, the sleeping rooms for the crew and passengers on the main deck, the dining rooms and restaurants on the upper deck, while the ladies' saloon, reading, smoking, and music rooms, as well as the various booths, will be arranged on the promenade deck. All of the rooms are to be provided with proper ventilation, electric light, and steam heat. Special care will be taken of the exhibits, so as to protect them from atmospheric and other injurious influences, and they will be arranged in such a manner as to make

will be offered to those interested to investigate the great undertaking.—*Illustrirte Zeitung.*

**The Animal Carcass All Utilized.**

The *Sunday Call* editor has discovered that after a steer goes into a Newark slaughter house nowadays, the only thing that is wasted is his dying breath, and if it were possible to find some use for that, no doubt it would be caught and preserved. Nothing else is wasted, from the tip of the tongue to the brush on the end of the tail. The blood is caught and sold to make albumen for sugar refiners and other manufacturers, one use of it being the cheap substitute for hard rubber and other plastic material used in the manufacture of buttons and other materials. Next the hide is taken off, and after the meat is dressed, the contents of the stomach are removed and dried and baled for manure, and the stomach itself is prepared as tripe. The hide goes to the tanner, the head is skinned and denuded of flesh for the sausage maker, the horns are knocked off and go to the comb maker, who knocks out the pith and sells it to the glue manufacturer, who is ever ready to take all the refuse from any part of the steer. The horny coverings of the hoofs are almost as useful as the horns for making buttons, etc., and the feet make oil and glue. The shinbones make the finest of bone handles for various purposes, and all the remainder of the bony structure which the butcher is unable to sell with the meat finds its way eventually to the manufacturer of bone fertilizer and bone black. With the bones there is usually considerable marrow, grease, and

2. The oil reservoir should be of metal, rather than of china or glass.

3. The oil reservoir should have no feeding place nor opening other than the opening into which the upper part of the lamp is screwed.

4. Every lamp should have a proper extinguishing apparatus.

5. Every lamp should have a broad and heavy base.

6. Wicks should be soft and not tightly plaited.

7. Wicks should be dried at the fire before being put into lamps.

8. Wicks should be only just long enough to reach the bottom of the oil reservoir.

9. Wicks should be so wide that they quite fill the wick holder without having to be squeezed into it.

10. Wicks should be soaked with oil before being lit.

11. The reservoir should be quite filled with oil every time before using the lamp.

12. The lamp should be kept thoroughly clean, all oil should be carefully wiped off, and all charred wick and dirt removed before lighting.

13. When the lamp is lit, the wick should be at first turned down and then slowly raised.

14. Lamps which have no extinguishing apparatus should be put out as follows: The wick should be turned down until there is only a small flickering flame, and a sharp puff of breath should be sent across the top of the chimney, but not down it.

15. Cans or bottles used for oil should be free from water and dirt, and should be kept thoroughly closed.



[SPECIAL CORRESPONDENCE OF THE SCIENTIFIC AMERICAN.]  
THE PARIS EXHIBITION.

PARIS, October 8, 1889.

An emery grinding machine constructed by Messrs. Aut Fetu Defize & Co., of Liege, Belgium, and exhibited in the Palais des Machins, calls for particular notice as the first of its kind I have yet seen. It is designed for grinding out circular curves of a large radius, and is shown with the link of a locomotive running gear chucked ready to be ground.

The most important part of the construction is shown in Fig. 1, in which *a* is a slider on the slide-way, *b*, and capable of being locked in its adjusted position thereon. It carries a stud, *c*, which forms a pivot for the two arms, *d d*, which are hollow, so that

motion so as to cause it to remain parallel and not wear taper. This end motion is produced by a cylindrical cam placed on the back end of the emery arbor.

The operation of setting the work in the machine is as follows: The work being fastened by the before-mentioned set screws in *i* and *j*, the slide, *a*, is set to about the right height and the length of arms, *e h*, roughly adjusted. The exact adjustment is then made by operating the adjusting nuts, *g*, and the right length of vibratory stroke is obtained by adjusting the position of the pin, *o*, in the slot, *q*. It is obvious that in setting the work the old wearing marks may be taken as a guide, or with the work placed central, as in the figure, a spirit level may be used, setting it central in the length of the slot in the link, *k*. This is

Nor do I find any of the large lathes furnished with means to cut the keyways in the latter without unchucking them after they are turned, as is done in the Ames lathes in the United States, and which I have found an excellent arrangement.

I came across a keyway cutting bar, however, that is not a bad thing in its way, the construction being shown in Fig. 2, in which *A* is the body of the bar, *B* the tool, *D* feed spindle, having on it a pinion to operate bevel gear, *C*, and a milled head, *E*, to put on the feed by. The tool, *B*, is threaded into the bevel gear, *C*, but has its sides flattened, and fits into a square hole in the bar, *A*, so that it cannot turn therein. *P*. Hure, of Paris (the exhibitor), makes a special keyway cutting machine in which this bar is used, and also

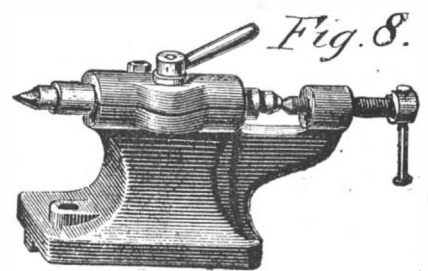
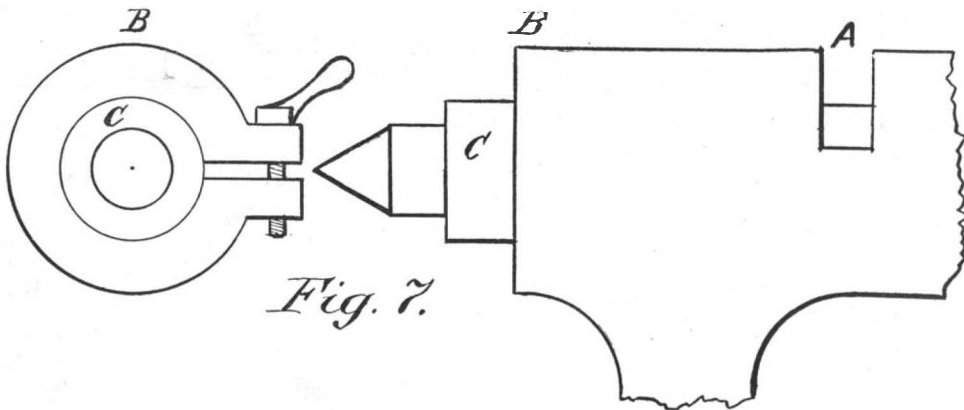
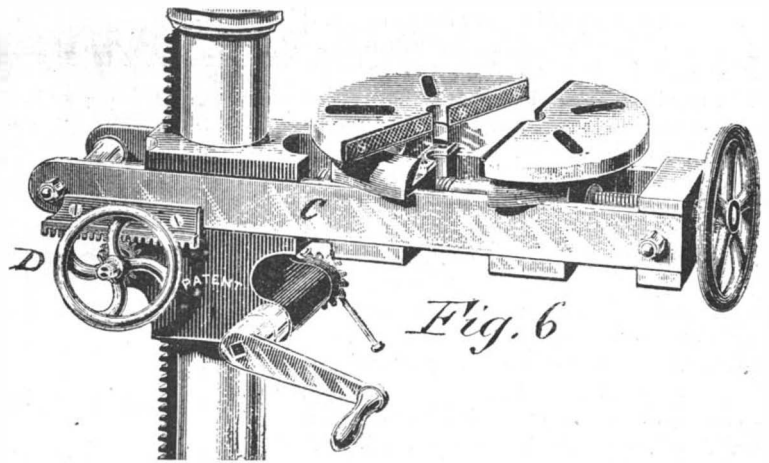
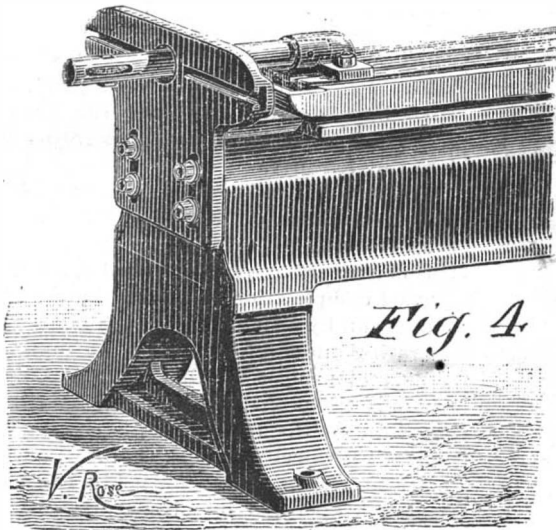
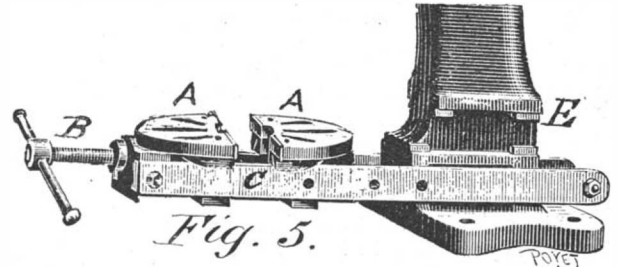
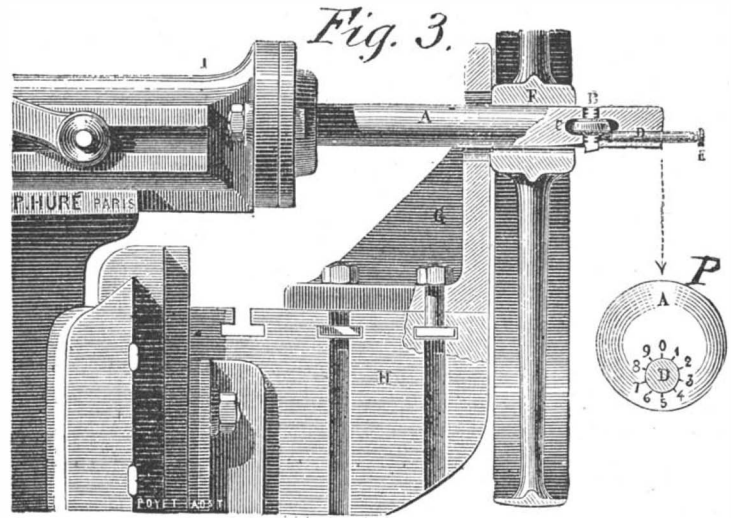
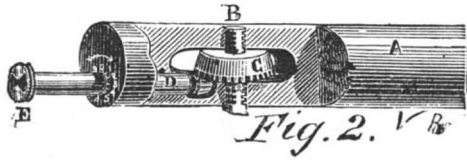
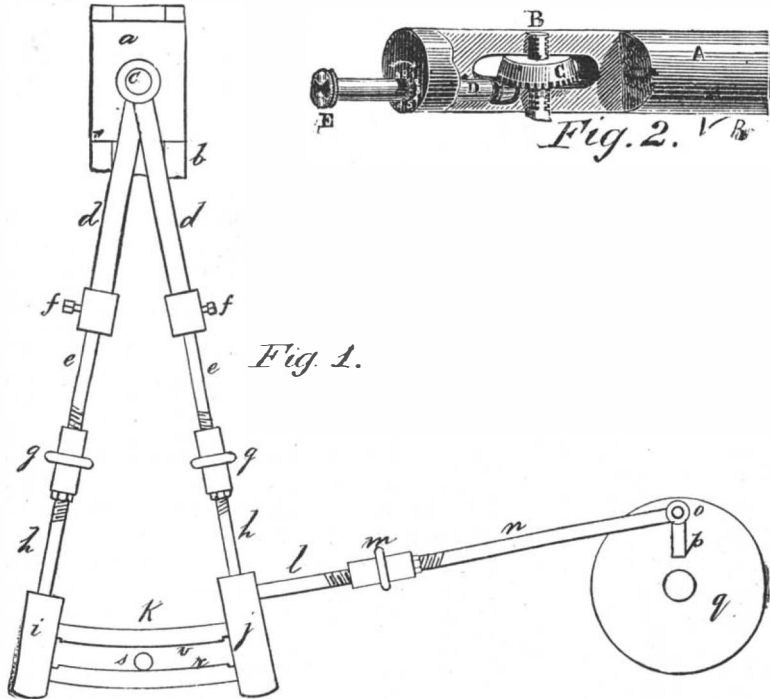

the arms, *e e*, may pass up them, the set screws, *f f*, locking *e e* in their adjusted positions in *d d*. The rods, *h h*, are simply continuations of rods, *e e*, with the adjusting nuts, *g g*, between them; *i* and *j* are boxes in which the work, *k*, is chucked by means of set screws placed at the backs of *i* and *j* respectively. These rods, it will be noted, form in connection with the work a frame which may be vibrated on the pivot, *c*. To effect this vibration a revolving plate, *g*, is employed, having a slot, *q*, for the stud, *o*, which drives the rods, *n l*, there being a length-adjusting nut, *m*, between them corresponding to those at *g g*. These nuts have in their ends a right and left hand thread respectively, the rod ends being threaded to correspond, so that by revolving the nut the rod length is altered. It is obvious that as the plate, *g*, revolves, the work is swung backward and forward in an arc of a circle of which *c* is the center. The emery wheel, or, more properly, perhaps, emery arbor, *s*, revolves at high speed, and is given at the same time an end

undoubtedly a simple and very useful machine, since it enables the links to be trued up without softening them, and thus not only saves the processes of softening and rehardening, but also avoids the warping that accompanies the rehardening, and, therefore, makes a more true and parallel job. It may finally be pointed out that the feed should be put on at such an end of the work that the emery wheel runs against the cut; or otherwise there will be a tendency for the wheel to run over the cut too fast or the work to run under the wheel, causing a jamming and unsteady motion. It follows from this that the feed for the top surface, *v*, must be in the opposite direction to that of the bottom surface, *r*. It is obvious that with the live spindle speed sufficiently reduced by means of a suitable arrangement of gearing, the machine could be used for milling purposes, also a milling cutter being used in place of the emery arbor.

The keyway cutting machines on exhibition are entirely different from those in use in the United States.

shows its application to a shaping, as in Fig. 3, and to a planing machine, as in Fig. 4. In Fig. 3 it is merely bolted to the ram, the wheel to be operated on being chucked on an angle plate. The end of the bar is shown (at *P*) to be graduated on a circle, from 0 to 9, to guide the operator in putting on the cut. It will be noted that the cutting action of the tool occurs during the back or return stroke of the ram of the machine. This, of course, stiffens the bar, as it is placed under tension while cutting. In Fig. 4 the bar is shown bolted to the table of a planing machine, a plate whereon to chuck the wheel to be keyseated being bolted on to the end of the planing machine bed. Small shops having no slotting machine or keyseating machine (and few small shops have) will find this device quite a boon.

In the exhibit of the Societe Daudoy-Maillard, Lucq & Co. there are some bench and pillar drilling machines with a novel work chucking table, shown in Figs. 5 and 6, the former showing it as applied to a

hand and the latter to a power drilling machine. The work table, A, is made in two halves, the joint faces having a steel gripping face. A right and left hand screw, B, operates the two halves to grip and release the work. Both halves of the table will swivel to grip taper work as shown in Fig. 6. As applied in Fig. 5, the frame, C, merely pulls in and out from the frame, E, of the machine; but in Fig. 6, which is for heavier work, a rack and pinion moves C, being operated by the hand wheel, D. It is obvious that when the two halves of the table are closed, they constitute an ordinary table whereon work may be chucked as usual.

On a 16 inch swing lathe I find the dead center gripping device shown in Fig. 7, there being a slot through the tail stock at A, so that the top piece from A to B shall grip the spindle, C, parallel, while on the smaller tail stock, shown in Fig. 8, the locking bolt is in front, and a split runs from end to end of the spindle casing or bearing, so that the spindle is gripped along the whole upper surface of the bearing, which is only practicable on very light tail stocks. I have not seen any lathes in which the dead spindle is locked at both ends, as it is in the Sellers lathe, but I have seen some whose bolt for locking the tail stock to the bed was made on the principle of that patented in the United States by S. W. Putnam, of Fitchburg, Mass. One cannot but notice the hold the gap lathe has in European practice, indeed, the great majority of small lathes are made on that principle. One such a lathe may be all very well in a shop, but looking to the fact that the greater part of the work done on a lathe is done at the head stock end of the bed, it is a good deal like spoiling a good lathe to break away the bed there.

JOSHUA ROSE.

#### The Methods of Success.

There is no modern notion that more completely strikes at the root of wholesome sentiment and of national and individual prosperity than the idea that many young persons are growing up with, that industry, especially manual industry, is not quite respectable.

Whether idleness takes the form of lounging and street gossip that begets all kinds of vices, or of dreamy sentimentalism that wastes life in vague fancies, or the busy idleness that occupies itself in attending to other people's business, all is pernicious in its effects as it is culpable in character.

The want of method and habit in early life is answerable for many evils to manhood. The youth accustomed to regular and industrious employment will seldom lose such habit in after life, while those who have been suffered to pass a desultory childhood will require extra fortitude and strength of character to become persevering, energetic, and industrious in after life. A determination of character, a firmness of principle, which tries to do that which is right instead of that which is temporarily agreeable is the great safeguard against evil. Impulsive exertions may sometimes produce magnificent deeds; but without methodical and steady resolutions, without system and habit and strength of will, but little permanent good or usefulness is ever accomplished. It is only in the cultivation and improvement of our faculties that we can properly enjoy any of them. The large number of instances show the vice of idleness to be the result of luxurious habits, which break down the native energy of character. The person who regards momentary gratification as the chief good will soon lose the vigor and enterprise necessary to undertake and the perseverance to carry through any scheme requiring industry and self-command. Some, from a paucity of ideas, lack enterprise and become torpid, being unable to see the utility of proper undertaking; while others, overwhelmed with a vast conception of what is to be done, sit down in the inaction of despair. Others begin with earnestness and hope, but, lacking perseverance, are intimidated by the first difficulty, and accomplish nothing because they have not the courage to face obstacles. Still others waste their energies in trying to keep others from succeeding, and have none left with which to secure their own success.—*St. Louis Miller.*

#### Iced Fish Dangerous.

According to Mr. J. Lawrence-Hamilton, M.R.C.S., in the *Lancet*, ice spoils the freshness, firmness, and flavor of fish by rendering it, prior to putrefaction, insipid, soft, and flabby. Experience seems to show that the gravest cases of fish poisoning arise more commonly from eating fish which has been kept on ice than from eating fish kept naturally cool. Where fish is preserved on ice it appears that the ice only favors putrefaction by furnishing a constant supply of moisture, carrying with it the putrefactive bacteria derived from its foul and filthy surroundings, so that this iced fish remains covered with fresh solutions of filth pregnant with putrefactive bacteria. Thus large quantities of those subtle, complex bodies, the animal alkaloids or ptomaines, are probably elaborated, and give rise to those marked symptoms of poisoning which sometimes occur from eating fish preserved on ice. On the other hand, keeping fish dry and cool can in no way favor putrefaction. And although here cases of poisoning

may happen, yet the symptoms are much less marked, and pass off sooner, the toxic effects being usually confined to a passing attack of vomiting and diarrhea, while in the case of fish preserved on ice the vomiting and diarrhea may be less marked, though the other symptoms may be much more profound and lasting, and even sometimes fatal. There are various poisons derivable from putrid fish, the detailed consideration of which requires much further elaboration, work, experiment, and research. Indeed, as upward of seventy different kinds of food fishes, within a few hours of their death, on being eaten, give rise to poisonous symptoms, the Russian government, in 1894, will award a prize of 5,000 rubles (say roughly £500) for the best essay upon the nature and cure of fish poisoning.

#### WILLARD CONDENSING ENGINE.

The extensive sale of gas engines and hot air engines, notwithstanding the high cost of the engines and of gas, reveals the very general demand for an engine of small power, say 2 to 4 horse power, for the use of small industries, which shall be perfectly safe, and the manufacturers of the Willard condensing engine (of which we give an illustration), who have been engaged in the manufacture of small engines of various types for the past ten years, believe that in this new engine, which they have now put on the market for the first time, they offer a motor which possesses all the advantages of other motors of this class, and is free from the structural faults that exist in some of the other machines. The manufacturers claim that the cost of fuel will not exceed one cent per horse power per hour, that it requires no watching, does not increase the rate of insurance, can be safely

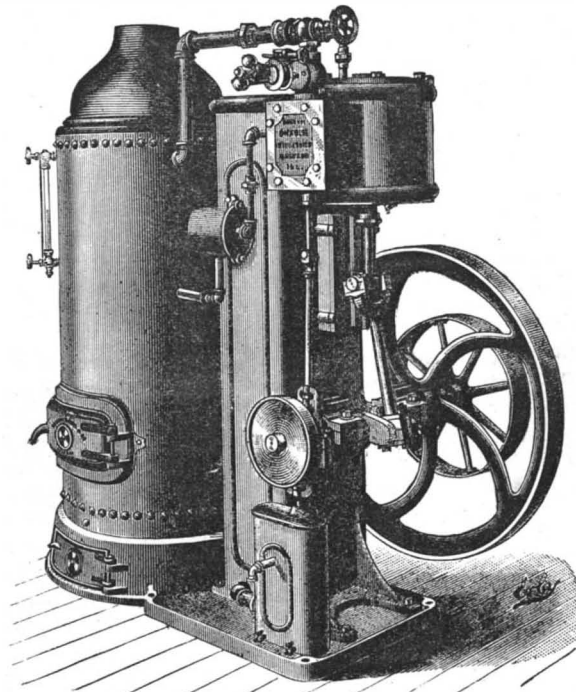

WILLARD CONDENSING ENGINE.

managed by a person having no knowledge of engines, and that it is absolutely safe and cannot be exploded, because there can be no steam pressure whatever.

The manufacturers, in putting this engine upon the market, desire to impress upon the public the fact that it is not a hot air engine or a kerosene oil engine or a gas engine, but it is a condensing engine using a small quantity of steam, at less than one pound pressure, burning wood or coal, and is perfectly simple and reliable, making no noise or objectionable smell.

Full information can be obtained by addressing Charles P. Willard & Co., 236 Randolph Street, Chicago.

#### New Explorations in New Guinea.

One of the most important of recent exploring expeditions has been that under Sir William Macgregor, the Administrator of British New Guinea, who has recently ascended and examined the Owen Stanley Range, over 13,000 feet above the sea. Several attempts have been made to reach the summit within the past few years. Sir William, therefore, deserves much credit; all the more that his natural history observations are very full and valuable. Sir William is an accomplished naturalist, so that any exploring work he may undertake is sure to be of scientific value. He left Port Moresby in May, accompanied by his secretary, and when the expedition was finally made up there were about forty natives. Only five, however, went up to the top with Sir William, who spent three or four days examining the ridge. The summit was reached on June 11.

The climate Sir William describes as foggy and unpleasant up to 8,000 feet; but above that clear blue sky and beautiful climate, "one of the finest in the world." The party were ten days over 10,000 feet, and never had a cloud above them. The sea coast was visible on both sides, that on the north being the most

distant. But the country is much smoother on that side, and the ascent of the mountain from the north apparently unobstructed and easy. From the point of Mount Victoria in the east to Mount Lilley in the west is a continuous, unbroken crest of thirty miles, which was traversed by Sir William, who spent three days and a half on the summit. His eyes were gladdened by the sight of daisies, buttercups, and forget-me-nots, and he brought away with him a quantity of white heath which reminded him of his native mountains. Big icicles amazed his native companions, who thought their mouths were burnt when they attempted to bite this, to them, novel product of nature. Larks were plentiful, similar in flight and song to those of the old country. Specimens of the flora were naturally collected by an enthusiastic naturalist like Sir William, and among them also probably several novelties will be found.

There are no trees within 1,000 feet of the top, which is bare rock or covered with grass. There are no snakes or other pests on the main range, but unfortunately game is very scarce also. The temperature ranged from freezing point to 70° in the sun. The southern aspect of the range is drained exclusively by the Vanapa River, the head of which was crossed at an elevation of 10,130 feet. No natives live on the mountains above 4,000 feet, although they hunt as high as 9,700 feet. All those met with at the base were extremely friendly. Nothing, however, would induce any of them to accompany the party up the mountain. They grow tobacco, peas, beans, many kinds of potatoes, yams, and bananas, and of these they gave Sir William as much as he wanted. They are certainly Papuan. The party returned to Port Moresby on June 25. Sir William was in perfect health the whole time, though, as usual, the natives had their little complaints. Another account states that Sir William found the top of the crest very uneven, consisting of immense masses of rock separated by deep chasms. The long-tailed bird of paradise was shot at from 5,000 to 9,000 feet altitude. On the top of one of the mountains what is believed to be a new bird of paradise was obtained, golden yellow on the back, with a black velvet breast and belly. As to the botany, the variety was very small, but what there was, was new.

#### High Pressure Water Power.

The Pelton Water Wheel Company, of San Francisco, have recently furnished the Treadwell Mill, of Alaska, a power equipment presenting many very interesting features.

The mill referred to is the largest quartz mill in the world, consisting of 240 stamps, 96 concentrators, 12 ore crushers, etc., requiring about 500 horse power. All of this machinery, covering several acres of ground, with its vast complication of countershafts and connections, is now run by a single Pelton wheel, 7 feet in diameter, operating under a head of 490 feet, making 235 revolutions, and using 630 cubic feet of water per minute, which is discharged through a nozzle three and thirty-one hundredths inches in diameter. With a 4 inch nozzle this wheel will work up to 735 horse power.

Perfect regulation is afforded by the use of a deflecting nozzle operated by a hydraulic governor. This is a nozzle about 4 feet long, with a ball joint at the butt end. To the discharge end is attached by lever connections an automatic hydraulic regulator, that varies the amount of water applied to the wheel as may be needed to adapt it to varying loads. This device has been adopted by the Pelton Co. as affording the most simple, sensitive, and satisfactory regulation, both for general machinery and electric light purposes.

Comparisons are often made at the East between the advantages of steam and water power. As applied on the Pacific coast, water has so much the better of steam that the latter is not to be thought of where water is available. A striking instance of this advantage is here afforded. The wheel above referred to weighs but 800 pounds, and the entire equipment, embracing shafts, boxes, driving pulley, etc., only about two tons. A steam machinery plant to give the maximum capacity of this wheel would not weigh less than 200 tons. The expense of operating such a plant would run well into the thousands every month, while the cost of running the Pelton wheel is merely the oil needed for the journal bearings.

Included in the above equipment was also an 8 foot Pelton wheel to drive a 15 drill compressor, requiring 175 horse power. Also two small 18 inch wheels to run dynamos, which light the entire works. Probably no such amount of power was ever before furnished at so small expense, both as to first cost and that of maintenance. This mammoth mill affords a fair illustration of the modern methods of mining and of how low-grade ores can be made to pay large dividends.—*Pacific Lumberman.*

#### Remarkable Steel Projectiles.

At the Paris exhibition the firm of Holtzer show a shell which pierced a steel plate 10 inches thick and landed entire without a flaw 800 yards, or nearly half a mile, distant from the target. Only the point of the shell was slightly distorted.

**Mechanical Progress—the Past and Present Contrasted.\***

BY GEORGE B. PRICE, M.E.

The purpose of this paper is to indicate something of the wonderful growth of our manufacturing industries in the last twenty years, and to call attention to the wide difference in systems, marking this from previous epochs; especially the introduction of the draughting room as one of, if not the chief factor in promoting this unparalleled growth of mechanic arts.

To show the invariable superiority of one method over all others for accomplishing a purpose, and to be able to prove by many notable examples the unquestionable value of such method, is to show, at once, the road by which the live men of to-day are winning a deserved success, and a very possible cause of partial failure to those who are yet unacquainted with the very radical change in the situation.

Nothing is truer to this century than the oft-heard phrase, "the world moves on."

Time was when men were satisfied with candle light.

The ship in which Columbus sailed was doubtless looked upon as a noble craft. Men, for centuries, plowed the earth with wooden plowshares, and the smith at his forge was the nobleman in mechanical skill.

Our century, with its myriad wheels of invention, looks back upon those times as upon a world in its infancy. It was in its infancy. Then men toiled as best they knew how; and with commendable zeal constructed the argosies that have floated humanity to the portals of a new age.

From those portals a new light is shining, with promise of untold wealth. The rapid accretion of knowledge in the scientific world has evolved principles that men knew nothing of, even a century ago; but which, being recognized and practically applied, are stimulating the great world of industries, abrogating the old and instituting revised methods, to such an extent that men have now grown perfectly familiar with the quotation that "things are not now done as they used to be." How very true! Instead of a small wooden hull, drifting uncertainly upon an almost impassable sea, we have now the advantage of swift and massive "ocean greyhounds," whose grace and perfection tell of a new world of mechanic arts. The smith at his forge, toiling with scarce-requited labor, to express in rude form the conceptions of his individual brain, has given place to our splendid machine shops and great foundries, equipped with "plant" that now makes easily possible what once had been more than a Utopian dream.

The secret of all this change, this wonderful accretion of the wealth of the world, is the genius of invention, controlled by scientific knowledge and wrought out by the subdivision of labor.

This means, when practically applied to our present subject: First, the conception, in one or more minds, of the elementary ideas of an invention. To embody this invention is the work, next, of the mechanical engineer, whose province it is to consider the various principles of construction that enter into the combination; to adjust the different parts to each other and to the whole, having regard to the required solidity, stability, flexibility, simplicity and economy, as well as the most approved or possible methods of casting, welding, finishing and joining those parts, considerations which may not only affect the ultimate practicability of the invention, but, according to the manner in which the subject is treated, will depend largely the grace, symmetry, and perfection of the machine.

The position of the mechanical engineer, in this early stage of the work, is as unique as it is important. He is like the doctor who is versed in the principles of medicine, but who, according to his appreciation of the conditions of the case, not less than the ingenuity of his resources, may often build up the patient speedily and lastingly, or only partially and imperfectly.

The physician of known ability is quite likely to be the cheapest in the end; so the timely employment of the engineer is almost certain to mean the best construction of the work proposed, in the shortest time, and with the most economy in ultimate cost.

From the hands of the engineer (who should follow up and superintend the subsequent construction) the plans and specifications go into those of the several workmen who are individually instructed, by the drawings, as to the proper way of working up their respective details. There is in this way no clashing or confusion, each man being responsible only for the correct production of his part.

Such seems to be the true explanation of the economic principles of the subdivision of labor.

Men have found out *principles*, and that the most progress is made and wealth more rapidly accumulated when the several stages of any piece of work are each guided and controlled by those who have made *that part* their special study.

We have a very limited idea of the subdivision of labor when we think of it only as of a number of men being divided into groups for the several manual operations in forming, say, a pin. This, indeed, is sub-

division of labor; but it should mean more than this. It presupposes antecedent skill and varied ability of a high order.

Before the finished product was possible, an intricate piece of machinery had to be built; which further presupposes not only skilled mechanics, but an inventive genius, and an ability, of somebody, to understand the requirements and correctly portray on paper the many parts, in detail, and as a whole. The designer was quite as necessary as the inventor or the workman.

Let it be remembered, then, that the workshop, though necessary for the practical embodiment of the invention, is yet distinct from the invention. The rule of true progress here is plain. The invention must first be clearly conceived and plainly drawn on paper, clearly and in detail, carefully and studiously designed according to the principles governing the particular construction; in short, it should be wholly created and visibly expressed in every detail, by one who is master of the subject, before it is put into the hands of a single workman.

How many ambitious, bright, but over-sanguine men have conceived a general notion of some invention, involving mechanical principles of which, most likely, they knew little or nothing, and have thrown away time and hundreds—perhaps thousands—of dollars in blundering along—time and money that might have been saved had they started aright. Most assuredly it can be said, with emphasis, no matter how great or how small the new work proposed, construct it first on paper!

Progressive manufacturers and machinists everywhere are every year recognizing more forcibly the value of this method, and recognizing it, are growing richer. Look into our best workshops of to-day; the great foundries and machine works that turn out our exact machinery, our fine locomotives, our floating palaces; in all you will find—not "a rule of thumb" and endless experiment, but a well-constituted, thoroughly superintended drawing room. Here the work is first really constructed, on paper, the varied problems carefully thought out, the many parts fitted and proportioned to their several functions; then the various artisans and workers are given their parts, and the whole structure grows uniformly, rapidly, to perfect completion. This is the new way. It has come to stay.

It might be interesting to some to have described the actual working routine of one of our largest and most successful manufacturing establishments—the great locomotive works, whose world-wide reputation has made the American locomotive famous as a competitor on almost every line of railroad in the civilized world. One might naturally conclude that the system preferred by such a firm, after years of fruitful experience—the system which turns out two completed locomotives a day—ought to have superior merit; and if any doubt of this should remain in any one's mind, it should be fully dispersed by the further announcement that the virtues of that same system are being appreciated, and as far as possible imitated, by competitive concerns, whose capacity and business are being rapidly enlarged in consequence.

Let us, then, take a swift glance through the said establishment, beginning with the draughting room, properly the starting place for our inspection. Here, in a well-lighted, ample apartment, are a number of draughtsmen, many of them brought up in the service. These are under the supervision and direction of a superintendent, who originally decides upon the plan of each locomotive to be built, estimating its capabilities and requirements. Instructions and a specification are then given to a draughtsman in charge, who carefully constructs on paper elevations and sections necessary to the complete locomotive. The detail drawings are then executed on stiff cardboards, or other materials suited to stand shop wear, and after passing satisfactory inspection of the examiner of drawings, are given out, carefully numbered and registered, to the respective shops. No work can be done in any of the shops until this is done, thus manifesting the high importance which this successful establishment attaches to correct drawings as the starting point for all construction.

In the shops, the many details are each carefully wrought out, in strict conformity to the drawing, and, as completed, sent to the erecting shop, where, under competent foremen, the various parts are rapidly adjusted, each falling into its proper place, and in an incredibly short time the completed locomotive is breathed into by the breath of its steam life, and starts upon its career, a giant of force and monument of engineering skill.

Time was when a complete preliminary drawing was hardly known in a machine shop. Then, men blundered, and blunders are always costly. Time will be soon, when a machine shop without its drawing room, its superintending engineer, will be but a lingering reminder of an experimental age before men had learned the true source of progress and wealth.

Those that still cling, like the smith of old, to the methods of a by-gone age, are falling behind in the race,

for while, in a sense, they may be laboriously building up a small trade, others, taking advantage of the proved better methods of success, will be forging ahead into enviable wealth.

The former has been left behind, not because of inferior ability, in his line, but because he has lost time in trying himself to do what another could have better done, at less expense to him.

There is another and concluding thought that should give hope to every man in the mechanic world.

As his craft grows into closer relationship with the great world of science about and above him, it will certainly lift him to a higher plane. Men are everywhere realizing, as never before, the everlasting truth of fixed principles and universal law governing all things. If a house falls, a bridge gives way, a dam bursts its confines, it is no longer an unaccountable event. Something was deficient. The capacity to detect the cause, the power to avert the evil by a scientific knowledge of the principles of construction, is, of all knowledge, the most useful, while its possession, in proportion to its completeness, should raise its possessor to the first ranks among men.

**Amber and Ambergris.**

Ambergris, which is used as a basis for nearly all standard perfumery, was first found an unattractive mass floating on the surface of the sea or lodged upon the shore. How so unlikely a substance ever suggested itself as a perfume is unknown, but it has been in use for centuries, and it is only in comparatively recent times that its origin has become known. It is nothing more than the morbid secretion of the liver of a sick spermaceti whale. It is described as a fatty, waxy substance, disagreeable to sight or touch, but even in its crude state exhaling a pleasant odor. The crude substance is subjected to chemical action to extract the active principle, called amberine. It was recently reported that a Maine fisherman picked up a mass of the substance which nearly filled a barrel and is worth \$25,000. This is probably an exaggeration both as to size and price, for the largest piece on record was found on the Windward Islands, weighing 130 pounds. This was sold for about \$2,600.

Amber was also first found on the shores of the sea after severe storms. For a time its origin was unknown, but it was early put to use and regarded with a superstitious awe by the ancient Greeks and Romans, its peculiar electrical qualities being noted by them. It is now thought to be the gum of forest trees which perished ages and ages ago, the lands upon which they flourished having become the ocean's bed. Amber has no fixed value, the price being regulated wholly by size, quality, and other considerations. Drops of amber in which are embedded insects of those ancient times command fancy prices, while the more common kinds are used for making a certain kind of varnish and even in medicine. The world's supply of the two, amber and ambergris, does not wholly depend upon what may be accidentally found. Dredging for amber is now systematically carried on by regularly organized companies, and all spermaceti whales killed by whalers are subjected to a pretty thorough post-mortem examination, the find of ambergris in the monster's interior often being vastly more valuable than the oil extracted from his blubber overcoat.—*Lewiston Jour.*

**Gas at Five Cents per Thousand.**

It is announced that a company already in operation at Litchfield, Ill., will pipe fuel and illuminating gas into East St. Louis. Mr. Henry O'Hara, a capitalist of St. Louis, who is prominent in the enterprise, says they have a process for manufacturing gas from Lima (O.) oil, which costs 1¼ cents a gallon. This amount of oil renders over 1,000 feet of gas. They have eight miles of pipe down, and are furnishing families at a rate which for lighting a large house and supplying three stoves with fuel takes but \$54 per annum from the proprietor's pocket. The plant they are putting into Litchfield will cost some \$60,000. From this they propose to lay an 8 inch gas main to East St. Louis, 37 miles, and deliver their product there at a price far below that which the company now in power there can do. They claim that they can give light and heat to the city at five cents per 1,000 feet of gas, or give it away for a long time and scarcely feel it, the production costs so little. In explaining the process Mr. O'Hara said: "A bench, that is, a plant with twelve retorts, will cost about \$5,000, and will supply a town of 6,000 inhabitants, it would produce 60,000 feet of illuminating gas daily and 13 times as much fuel gas; here are the figures—120 gallons of crude petroleum \$1.50, gas for operatives 30 cents, one workman one day \$2, total \$3.80—product 200,000 feet. The crude oil is introduced to the furnace direct from the tanks. Steam forces it into spray, and, mingling, both absorb the elements from the air and a chemical degeneration commences that winds up in non-condensable, non-explosive gas. For intensity of heat the fuel gas excels. I have seen Swedish iron, which requires 4,500°, made with it, and also crucible steel not only made, but melted and burned up in a few minutes."—*American Manufacturer.*

\* Read at a meeting of the Franklin Institute. From the *Journal*.

## RECENTLY PATENTED INVENTIONS.

## Engineering.

**STEAM BOILER.**—Harry A. R. Dietrich, South Bethlehem, Pa. This is a boiler with a water front arranged in connection with a generating section, pipes leading upward to a steam receiving chamber, and thence downward to a receiving chamber, in connection with which is arranged a superheating section, the invention, being an improvement on a former patented invention of the same inventor.

## Mechanical.

**TUBE CUTTER.**—Patrick H. Benade, Punxsutawney, Pa. In this machine expansion bars actuated by an adjustable wedge are used to throw a series of cutters radially outward, independently rotatable cutters being used, and their feed effected by a screw forming part of the rotatable tube, the cutters being peculiarly placed and having the power very effectually applied, whereby various sized tubes may be cut with the same tool.

**AUGER BIT DIE.**—Charles H. Irwin, Francis I. Hoeft, and James W. Simmons, Wilmington, Ohio. This invention provides dies to be operated successively for forging bits having a spiral blade or flange which surrounds a central stem, which has a spiral form between the convolutions of the blade and gradually merges into them, the dies for forging the cutting head of the bit also forming special features of the invention.

## Railway Appliances.

**BALL AND SOCKET PIPE COUPLING.**—Thomas Aldcorn, New Durham, N. J. This is a pipe coupling joint specially adapted for connections between cars, the joint being formed with a ball and socket and a spring, the ball and socket providing a joint adapted for the turning of cars in rounding curves, and the spring permitting of endwise movement as the ends of the cars move toward and from each other.

## Agricultural.

**SIDE HILL PLOW.**—John D. Burkhardt, Dayton, Washington Ter. This is a double-pointed plow having the standard formed in two pieces, a vertical pivot bolt passing through the beam, hinged locking stirrups and locking lever, whereby the plow can be readily reversed by means of the locking lever and the stirrups, and the reversing, shifting the handles, and moving the clevis are each quickly accomplished by one or two movements.

**WEED CUTTER.**—Erich Schmidt, Marysville, Cal. The body of this implement carries a vertically adjustable angled share comprising a series of cutting blades and tie plates or frogs secured to the under face of the blades, the implement being so adjustable that the heel of the share may be raised or lowered in a line parallel with the point, while the share may be so regulated as to cut any width of swath desired.

**HEN HOUSE.**—Solomon Harbaugh, Geneva, Neb. This invention covers novel features of construction in a hen house, whereby the roosts and also the floor can be readily removed, making it convenient of access in all its parts for cleaning and renovating, the house also having room for the storage of feed, etc., and being so arranged as to be readily kept well ventilated at all times.

## Miscellaneous.

**CORSET.**—Thomas S. Gilbert, New Haven, Conn. This corset is provided with a transverse gore at the waist line, which serves to preserve the proper shape at the hip and without the use of the numerous ribs ordinarily required.

**LEATHER STRIPPING MACHINE.**—William H. Hoople, Brooklyn, N. Y. A machine for cutting strips to be used in the manufacture of leather welting. The leather is passed beneath a roller against the blades, and all material cut from the edge is guided outward, while the strips of proper width are carried forward.

**LIFE BOAT.**—Peter F. Schenck, Highlands, N. J. This is an unsinkable car or boat adapted for use from the shore or to be carried by vessels, and has air inlet tubes opening without and within, the outer parts of the tubes having valve chambers with opposing perforate and imperforate seats, the interior of the craft being entirely inclosed when in use and air abundantly supplied to the occupants.

**SUBMARINE DIVING APPARATUS.**—Frank Vaughan, Elizabeth City, N. C. This invention consists mainly in a submerged lamp arranged to automatically create and sustain the circulation and supply of fresh air to the diver, in connection with other novel constructions and combinations of parts, to facilitate exploring shallow waters and the examination of sunken vessels.

**ELEVATOR.**—Seth K. Humphrey, Faribault, Minn. This is a passenger elevator more especially designed for the use of employes in mills and factories, the invention being an improvement on a former patented invention of the same inventor, and covering various novel details and combinations of parts designed to facilitate the operation of the elevator and prevent accidents.

**TRIPOD.**—Jonathan Warner, Sag Harbor, N. Y. This is a tripod especially adapted for use with photographic cameras, and the legs of which may be folded into small space, the legs being also adjustable laterally upon the head of the tripod and readily attached thereto and firmly locked in adjusted position.

**PROCESS OF TREATING CEREALS.**—Franklin Dorr, Baltimore, Md. This process consists in first cooking the grains, then partially drying and

cooling them, then crushing the grains by a prolonged frictional grinding and in the same operation drying the product and also stimulating chemical changes by the frictional heat generated by the prolonged grinding, thus better adapting the grains for use in brewing and distilling and also as a food product.

**TORCH AND GAS BURNER KEY.**—George W. Lindsay, Gainesville, Texas. This is a combination implement by means of which the gas may be lighted without the flame of the torch coming in contact with the globe, and the cock of the gas burner can be readily taken hold of and operated, the body portion of the implement having a forked upper end, below which is a reservoir from which a wick tube projects at one side.

**CONVEYER.**—William R. Crow, Buffalo, N. Y. This conveyer consists of a casing with discharge chute and upwardly inclined floor section, a wheel at each end of the section and wheels at opposite ends of the casing, in connection with shields and an endless chain provided with blades, the conveyer being especially designed for use in connection with drag chains wherever grain, coal, sawdust, etc., can be carried with one line of chain from a horizontal to an oblique position.

## SCIENTIFIC AMERICAN BUILDING EDITION.

OCTOBER NUMBER.—(No. 48.)

## TABLE OF CONTENTS.

- Elegant plate in colors of a residence at Montclair, N. J. Perspective elevation, floor plans, sheet of details, etc. Messrs. Munn & Co. architects, New York.
- Plate in colors showing a two story and attic frame dwelling at Montclair, New Jersey, at a cost of five thousand dollars. Messrs. Munn & Co. architects, New York. Perspective, floor plans, sheet of details, etc.
- Design for a memorial monument at the Langside battlefield. A. Skerring, L.A., architect.
- Engraving of the Winn memorial public library, Woburn, Mass. H. H. Richardson, architect.
- A cottage at Mt. Vernon, N. Y., costing four thousand five hundred dollars. Perspective view and floor plans.
- Residence erected at Mt. Vernon, N. Y., by the Hon. Chas. Cray, at a cost of eight thousand dollars. Plans and perspective elevation.
- Design for a three thousand dollar railway station. Drawn by Mr. W. Henderson, of the Chicago Architectural Sketch Club.
- A residence at Bridgeport, Conn., built for I. W. Birdsey, Esq., at a cost of eleven thousand seven hundred dollars. J. W. Northrup, architect.
- A residence at Chester Hill, Mt. Vernon, N. Y., recently erected for I. J. Smith, Esq., at a cost of twelve thousand dollars. Floor plans and perspective elevation.
- A stone house on Jersey City Heights, N. J., built in 1812, and recently remodeled by L. H. Broome, Esq. Perspective elevation and plans.
- A block of brick fronts at Bridgeport, Conn., W. H. Worsam, architect. Cost three thousand six hundred dollars each. Floor plans and perspective elevations.
- New court house and post office, New Bedford, Mass. Perspective and plans.
- The Mexican pavilion at the Paris exposition—half page engraving.
- A residence on Jersey City Heights, N. J., built for G. W. Patten, Esq. Plans and perspective.
- A colonial house at Englewood, N. J. Edward H. Kendall, architect, New York. Perspective and floor plans.
- Sketch of Florence Nightingale's home at Lea Hurst.
- House on Grayswood Hill, Haslemere. Perspective and plans.
- Sketch of the Fitzwilliam museum, Cambridge. Half page engraving.
- Entrance doorway to the ceramic and mosaic section, Paris exposition.
- Bedroom of the Shah of Persia, in the Hotel de la Rue Copernic, Paris.
- Miscellaneous Contents: An acoustic trouble.—Evils of large drain pipes.—The giant redwoods.—Use of dynamite in making foundations.—Cement for stone.—Ornament.—Cypress.—A talk with a quarryman.—Slate an unsafe roofing for mills.—Memorial pulpits, illustrated.—An ornamental chimney, illustrated.—Planting strawberries.—The camera as a witness in a suit for damages.—Extensive and successful trusts: the co-operative building system.—A model bedroom.—The painter and the architect.—Woods for finishing.—An improved wood finish for interiors, illustrated.—Decoration of interiors with "Lignomur," illustrated.—A substitute for glass.—Artistic surroundings enhance morals.—An improved woodworking machine, illustrated.—House heating.—The homes of the poor.

The Scientific American Architects and Builders Edition is issued monthly. \$2.50 a year. Single copies, 25 cents. Forty large quarto pages, equal to about two hundred ordinary book pages; forming, practically, a large and splendid MAGAZINE OF ARCHITECTURE, richly adorned with elegant plates in colors and with fine engravings, illustrating the most interesting examples of Modern Architectural Construction and allied subjects.

The Fullness, Richness, Cheapness, and Convenience of this work have won for it the LARGEST CIRCULATION of any Architectural publication in the world. Sold by all newsdealers.

MUNN & CO., PUBLISHERS,  
361 Broadway, New York.

## Business and Personal.

The charge for insertion under this head is One Dollar a line for each insertion; about eight words to a line. Advertisements must be received at publication office as early as Thursday morning to appear in next issue.

Agents wanted for the United States for sale of improved horizontal-acting cast steel ratchet wrench and screwdriver, patented March 5, 1889. See description, page 275. Caution: Beware of fraud. To protect the buyer against high prices and inferior goods, see that the name of Carl A. Strasser is stamped on the shank of screwdriver. Apply to Strasser & Schroeder, 222 West Pratt St., Baltimore, Md.

Wanted—Experienced mechanical draughtsmen. Apply at the Baltimore Sugar Refining Co., Curtis Bay, A. A. Co., Md.

Manufacturers in iron and wood desiring plain, broad insurance at moderate rate should address the General Fire Insurance Company (mutual), 96 Broadway, New York. Edward A. Swain, President.

The Eclipse hydraulic elevator is absolutely safe. No ropes or cables. Cannot fall or freeze. Tuerk Hydraulic Power Company, 12 Cortlandt St., New York.

Wire Rope Tramways for the economical transportation of ores and other materials. Quarry hoists. Wire rope of all kinds. The Trenton Iron Company, Trenton, N. J. New York office, Cooper, Hewitt & Co., 17 Burling Slip. Western agents, Fraser & Chalmers, Chicago, Ill.

For best hoisting engine. J. S. Mundy, Newark, N. J. Guild & Garrison, Brooklyn, N. Y., manufacture steam pumps, vacuum pumps, vacuum apparatus, air pumps, acid blowers, filter press pumps, etc.

For the latest improved diamond prospecting drills, address the M. C. Bullock Mfg. Co., Chicago, Ill.

Presses & Dies. Ferracute Mach. Co., Bridgeton, N. J.

The Holly Manufacturing Co., of Lockport, N. Y., will send their pamphlet, describing water works machinery, and containing reports of tests, on application.

Screw machines, milling machines, and drill presses. E. E. Garvin & Co., Light and Canal Streets, New York.

The Improved Hydraulic Jacks, Punches, and Tube Expanders. R. Dudgeon, 24 Columbia St., New York.

Safety Elevators, steam and belt power; quick and smooth. The D. Frisbie Co., 112 Liberty St., New York.

Tight and Slack Barrel Machinery a specialty. John Greenwood & Co., Rochester, N. Y. See illus. adv., p. 173.

Belting.—A good lot of second hand belting for sale cheap. Samuel Roberts, 369 Pearl St., New York.

Patent swing cut-off saw, with patent shield for saw. Rollstone Machine Co., Fitchburg, Mass.

Send for new and complete catalogue of Scientific and other Books for sale by Munn & Co., 361 Broadway, New York. Free on application.

## NEW BOOKS AND PUBLICATIONS.

**STEAM ENGINE DESIGN.** For the use of mechanical engineers, students, and draughtsmen. By J. M. Whitham. New York: John Wiley & Sons. 1889. Pp. ix, 391. Price \$5.

The titular subject of this book is well treated by the author. The design of the different portions of an engine is first treated, and then, proceeding from the parts of the engine, the next step is to the different types of engines themselves. Indicator diagrams and crank-effort diagrams are also treated, and a chapter is devoted to the friction of different moving portions. Toward the end of the work propelling instruments for vessels are spoken of. The definition of parts is carried to such detail that of the crank pin and connecting rod each receives a chapter to itself. The work is illustrated by numerous plates and cuts, and the mathematics of the subject receive proper consideration.

**DIE GASMASCHINE.** Ihre Entwicklung, ihre heutige Bauart und ihr Kreisprozess. Von R. Schottler, professor an der Herzogl. Technischen Hochschule zu Braunschweig. Braunschweig. 1890. Benno Goeritz. Pp. viii, 330.

Taking the leading gas engines of the world as a theme, the theory and practice of this subject is well treated in the book before us, and in view of the ever increasing importance of this branch, the book must be looked upon as a valuable contribution to science. The mathematics of the subject are well treated by differential calculus, and the Carnot engine, so well known to students of the sciences, is treated of in its proper place; 250 illustrations are included. Tabular plates are also given, showing different indicator curves and the theory of the mixture of gas and air.

**HYDRAULIC MOTORS: Turbines and Pressure Engines.** For the use of manufacturers and students. By G. R. Bodmer, A. M. Inst. C. E. London: Whittaker & Co.; New York: D. Van Nostrand Company. 1889. Pp. ix, 525. Price \$4.

In the preface of this work, it is stated that the author's attention was directed to the absence of any English work of adequate comprehensiveness on the subject of turbines, and this want he seems to have supplied most excellently, giving a very exhaustive treatment of the mathematics of the various types of hydraulic motors, with formulae and examples of the practical application of the same. The work is accompanied by an excellent index, but the table of contents seems hardly adequate for the very exhaustive text of the volume.

**COMMERCIAL ORGANIC ANALYSIS.** A treatise on the properties, proximate analytical examination, and modes of assaying the various organic chemicals and products employed in the arts, manufactures, medicine, etc. By Alfred H. Allen, F.I.C., F.C.S. Volume III. Philadelphia: P. Blakiston, Son & Co. 1889. Pp. vii, 431. Price \$4.50.

The third volume of this work, now become a classic in chemistry, is devoted to the acid derivatives of phenols, aromatic acids, tannins, dyes and coloring matters. Those who are familiar with the first volumes

of the work need only be informed that this one shares their excellence to appreciate its important character. Under dyes we find treated systematically the various organic products of synthetic chemistry, followed by the natural dyes, with full treatment of the chemistry of all.

**PRACTICAL BLACKSMITHING.** Compiled and edited by M. T. Richardson. Volume II. New York. 1889. Pp. xxxii, 224. Price \$1.

This work is properly characterized by the publishers as unique. It is believed that no work of this character, treating practically of its subject, exists in this language. In it we find the subject of anvil construction and anvil tools treated most interestingly. Hammers, ancient and modern, and other tools are considered, giving the archaeology of this subject, as well as its present practice. Numerous illustrations accompany the work, and we believe that in the present era of manual training it will have an especial value for many students of metal working.

## Notes &amp; Queries

## HINTS TO CORRESPONDENTS.

Names and Address must accompany all letters, or no attention will be paid thereto. This is for our information, and not for publication.

References to former articles or answers should give date of paper and page or number of question. Inquiries not answered in reasonable time should be repeated; correspondents will bear in mind that some answers require not a little research, and though we endeavor to reply to all, either by letter or in this department, each must take his turn.

Special Written Information on matters of personal rather than general interest cannot be expected without remuneration.

Scientific American Supplements referred to may be had at the office. Price 10 cents each.

Books referred to promptly supplied on receipt of price.

Minerals sent for examination should be distinctly marked or labeled.

(1439) F. J. K. asks: 1. For a formula for a metal polish (red colored paste)? A. For red polishing paste use following: Beef marrow 7 oz., pine colcothar 3 oz. Mix by heat and perfume with oil of almonds. Lard may be used instead of marrow. 2. A receipt for making silver soap polish? A. Various formulas for silver soap are given. We give three receipts. (a) The best colcothar is used. If commercial is to be employed, it must be washed 6 or 8 times and levigated. Dissolve 5½ lb. cocoanut oil soap cut in pieces in soft water. Mix thoroughly ½ lb. of the colcothar, which has previously been rubbed up with a little water, with 5½ oz. pure ammonium carbonate finely powdered. The latter is added to the cold soap solution. The soap may be boiled down and run into moulds. It should be wrapped in waxed paper. (b) Dissolve 14 ounces white castile soap in ½ gal. water and add 7 oz. of finely pulverized chalk. Keep in bottles. (c) To 100 parts cocoanut oil soap melted with sufficient water add 10 parts tripoli, 5 parts alum, 5 parts cream of tartar, 5 parts white lead (dry), all mixed and pulverized together. Cast in cakes.

(1440) C. S. C. asks if the speed of a vessel given as so many knots an hour is the same as so many miles of 5,280 ft. to the mile. A says a knot is 6,080 ft., B says a knot is 5,280 ft. A. Knots per hour indicate nautical miles, each equal to 1-60 of a degree measured on the equator, or 6,079 feet nearly.

(1441) J. H. K. writes: We inclose a sample of earth or soap filling. We would like you to tell us how to restore the color or make it white. A. We suggest treatment with nitric acid, followed by thorough washing. The trouble is that any chemical treatment will be apt to cost too much, or to involve too much trouble and complication.

(1442) G. R. writes: In SCIENTIFIC AMERICAN SUPPLEMENT, No. 709, August 3, 1889, you speak thus of Dr. Edward Jenner: "It was about 1776 that he began his researches upon cow pox," etc. Also, "It was on May 14, 1796, a memorable date, that Jenner, courageous from his observations, dared to perform the first vaccination." I also quote from James D. McCabe's "Centennial History," page 227: "And yet this man (Cotton Mather) was not to die without rendering to the country a genuine service. In 1721, having become satisfied that inoculation was a sure preventive of small pox, he advocated the introduction of it into the colony. He was opposed by the whole body of the clergy," etc. Are these statements correct as regards dates? A. Inoculation was introduced into England from Constantinople by Lady Mary Wortley Montagu. In 1718 she had her son and daughter thus treated, and soon after returned to England to wage war for the new treatment there. Jenner substituted vaccination for inoculation, and after great difficulty caused its extensive use. Inoculation is treatment with the virus of true small pox; vaccination is treatment with the virus of cow pox. The dates you refer to are undoubtedly correct.

(1443) S. E. K. asks: What is the largest bay in the world? A. Hudson Bay, measuring 850 miles north and south by 600 miles wide.

(1444) C. A. M. L. writes: I desire to get up some arrangement to set off two or three charges of powder or gun-cotton at the same instant; of course, an electric spark seems the only way. Can you describe a battery suitable for the purpose, and the arrangement of the same? A. A number of static electric machines, inductive and frictional, are on the market, constructed for this purpose. These ignite by a spark. A dynamo can be used to ignite by an incandescent wire. The gun-cotton must not be fired directly; a capsule containing gunpowder must be embedded in it and arranged to be ignited by the spark or incandescent wire. In our SUPPLEMENT, No. 161, you will find a dynamo described that will answer your purpose. Use a short piece of No. 30-36 platinum or iron wire to complete the circuit through the gunpowder.

(1445) C. W. J. writes: Will you please inform me how to make a good toning solution for albumen prints that will give a good rich tone pleas-

ing to the eye? A. Tone with gold and borax in the proportion of:

- Gold chloride..... 1 gr.
Borax pulverized..... 60 "

Water ..... 3 oz.

2. How can I make chloride of gold from a gold dollar?

A. Mix one ounce of nitric acid with two ounces of muriatic, in a six ounce porcelain dish, and apply a gentle heat until the gold is dissolved and the solvent is nearly evaporated, then allow it cool, and dissolve the contents in ten ounces of water. When required for use, add one ounce of the gold solution to six of water and neutralize with bicarbonate of soda. The soda precipitates the alloy in the coin and thus makes it harmless in the process of toning the prints. 3. How is brown chloride of gold made? A. By dissolving pure gold in c. p. nitric acid one ounce, c. p. muriatic acid three ounces and evaporate until this compound acid is entirely driven off by heat. 4. What causes frills or blisters in albumen prints, and what can I do to prevent them? A. This is often caused by the condition of the silvering solution and the manner in which the paper is manipulated. To avoid this perplexity, first purify water by dissolving five grains silver nitrate in each ounce of water required for use, and allow it to stand in sunlight for two days or more. Then filter, and add one ounce of silver to every ten ounces of water. When the silver is dissolved, add 2 drachms of fused nitrate of ammonia to each ounce of silver nitrate used. Before floating the paper on this solution, rub the surface with pad of absorbent cotton, and when taken from the bath, remove the surplus silver with thick blotting paper. Paper prepared in this way requires no fuming, but should be printed a trifle lighter than when subjected to ammonia. 5. Can I burnish albumen prints without a burnishing machine? A. A pressing iron, such as used by tailors, may be employed for this purpose, but there is probably nothing that will do the work as effectually as the burnisher. 6. Where can benzoic acid be procured? A. Of Charles Cooper & Co., 197 Worth Street, N. Y.

(1446) F. A. Y. asks: 1. Has an electromagnet with the core made of a bundle of iron wires much more strength than one with a solid core? A. It is not stronger, but it will receive and part with its charge more rapidly than a solid core. 2. Where could I procure vulcanite? A. From any dealer in electrical supplies in this city. 3. In a bichromate of potash battery composed of a plate of carbon 1 inch square and a plate of zinc same size, one inch distant, what is the resistance of the liquid? A. The resistance varies with the liquid. With a fresh solution, less than an ohm. 4. If they are two inches apart, is the resistance doubled? A. Yes. 5. If the plates are two inches square, is the resistance quadrupled? A. No; it is reduced to 1/4 the former value. 6. If there is a plate of carbon on each side of the zinc, is the resistance halved? A. It is much lessened, but not halved. 7. Is shellac acid proof? A. Yes. 8. In the condenser described in SUPPLEMENT, No. 160, by 40 square feet of tin foil surface does it mean 40 square feet of tin foil, or 20 square feet of foil, each piece having two surfaces? A. 20 square feet. 9. Would the effect be the same if the length and width of the condenser would be increased or diminished and still contain same number of square feet tin foil surface? A. Yes.

(1447) J. E. S. asks (1) why the discoloration of a plastered ceiling is heavier on that portion of the plaster that is not backed by a beam or a lath? In other words, why do we see so plainly marks on a sooty wall or ceiling that correspond to the beams and lathing that support the plaster? A. It is hard to assign any reason that will be certainly correct. The plaster is of course less permeable where the lath is, and may be slightly damper there. It is possible that this would assist its discoloration. 2. Is the platinum that is used in the manufacture of jewelry a comparatively pure production, or is it sufficiently alloyed with lead to make it practically fusible? A. Platinum as used by jewelers is of good degree of purity, and is not alloyed with lead. 3. Will you please name some work in which the reduction of the above metal from its ores is explained? A. Platinum is found in the metallic state in nature. In Brant's Metallic Alloys, \$2.50, you will find its preparation and uses discussed and described. Its reduction is very simple, consisting of little more than melting or welding the particles of metal together.

(1448) H. C. S. writes: 1. Can you tell me what quantity of air in feet is comprised in one pound of air? A. A cubic foot of air weighs 537 grains; 1 pound avoirdupois of air measures about 13 cubic feet. 2. Is there any way to burn alum in small quantities? A. Heat very gently on a tablespoon until all the water is expelled. Be careful not to heat so as to expel the sulphuric acid. 3. Please give me a formula for a simple sirup. A. Place sugar in a funnel or percolator and pour water through it. If not packed in, the water should be allowed to act upon the sugar for some time before being drawn off. Or simply keep an excess of sugar in a vessel of water, and stir from time to time, drawing off the clear sirup. 4. What proportion of glucose is usually used in manufacturing sirups? A. It should contain none. No fixed quantity can be assigned.

(1449) R. A. S. asks: 1. Is the induced 50 volt current in a Westinghouse system continuous or alternating? A. It is alternating. 2. If alternating, how can I make a motor to run on that circuit? I should want it about 1/2 horse power. Have you ever described such a motor in your columns? If so, in what number? A. You will find a description of an alternating current motor in SUPPLEMENT, No. 601. 3. I want to make a magneto generator with permanent magnets and a Gramme armature. I should like to get about 40 or 50 volts out of it. What size wire am I to wind the armature with? Armature to be about same size as simple electric motor, March 7, 1887. Will 40 volts form an arc between 1/2 inch carbons? A. The armature of the simple motor would be too small to generate a 50 volt current. You will need about 3 feet of effective wire surface per volt, in a strong magnetic field. A current of 3 or 4 amperes with a voltage of 40 volts will run an arc lamp. 4. Can I get a secondary current by forming a coil of say 18 wire, passing a current from four Samson cells through it, and putting soft iron bar into it, and next to the primary slide over the same core a secondary

coil of say 4 ounces No. 30 wire? If so, could I make use of it as a medical coil? A. With an interrupted current it would produce a secondary one, but would not be effective.

(1450) P. D. asks: 1. Does gasoline evaporate if exposed to the air? A. Yes. 2. Is there any danger of explosion in using it as fuel for a cooking stove? A. It would be exceedingly dangerous, and almost certain to cause a conflagration, unless burned from proper gasoline burners and fittings. 3. Which book of electricity do you recommend for the use of a beginner? A. Thompson's Elementary Electricity, which we can supply for \$1.25. 4. Could you give me a good receipt to can tomatoes? A. Scald the tomatoes and remove the skins. Put them in a porcelain-lined kettle and simmer 30 minutes. Put boiling hot into jars and seal. Warm jars previously very slowly to avoid cracking. 5. Which is the simplest rule to find out the tonnage of a ship? A. There are a number of rules, most of them arbitrary, such as the old rule, new rule, builder's rule, etc. The true tonnage or displacement is a matter of elaborate calculation from the shape of the ship. 6. Is window glass cut on the convex or concave side? A. It is cut on either side.

(1451) G. M. writes: 1. Has carbonic acid gas either in a liquid or gas ever been tried as a motive power to run machinery? A. Never successfully, on account of the expense of its application. 2. Is there any liquid that is explosive by a spark of fire coming in contact with it? I mean the liquid, not its vapor. A. Yes; but such liquids are exceedingly dangerous to experiment with. 3. Is there any reason why a gunpowder could not be made that would be several seconds (5 or 6) in exploding, and how long does it take to explode the so-called slow-burning powders of the present time? A. Such can be made by reducing the proportion of sulphur generally used. A charge of slow-burning powder explodes in a fraction of a second. 4. Assuming that the boilers of an ocean steamship deliver twenty thousand horse power at the throttle, how much is delivered at the propeller, or how much is absorbed by the best engine? A. About ninety per cent is a fair allowance.

(1452) F. M. W. asks for the ingredient which added to glue will make it impervious to water after it has dried? A. Add bichromate of potash representing one tenth the weight of the dry glue. Do the mixing and heating in a dark or obscure room or cover the glue pot.

(1453) I. E. B. asks for the composition of a good sizing to be used in embossing silk or leather with gold leaf by means of a hot die. The sizing must not stain. A. Very finely powdered dried white of egg, resin, or gum mastic is used. It is dusted over the surface, the gold leaf placed upon it, and the hot iron tool is pressed down upon the leaf, causing it to adhere where the tool touched it. The rest of the gold leaf may be rubbed off with a greasy cloth.

TO INVENTORS.

An experience of forty years, and the preparation of more than one hundred thousand applications for patents at home and abroad, enable us to understand the laws and practice on both continents, and to possess unequalled facilities for procuring patents everywhere. A synopsis of the patent laws of the United States and all foreign countries may be had on application, and persons contemplating the securing of patents, either at home or abroad, are invited to write to this office for prices, which are low, in accordance with the times and our extensive facilities for conducting the business. Address MUNN & CO., office SCIENTIFIC AMERICAN, 361 Broadway, New York.

INDEX OF INVENTIONS

For which Letters Patent of the United States were Granted

October 15, 1889,

AND EACH BEARING THAT DATE.

[See note at end of list about copies of these patents.]

Table listing inventions such as Agricultural boiler or heater, Air heating and circulating device, Alarm, Album, leaf and flower, Alcohol, purifying, Animals, machine for dipping, Auger bit die, Auger handle, Auger, post hole, Axle box and lubricator, Bag and twine or sample holder, Bag holder, Barrel, Basket handles, apparatus for shaping and drying, Battery, Bearing, lubricant, Bed covers, device for securing, Bed pan, Bed sofa, Bedstead crib attachment, Binder, temporary, Board, Boat, Boiler, Boiler furnace, steam, Bolt, Schoen & Friedenstein, Boom standard, spinnaker, Boot or shoe, spring heel, Boots, hip attachment for, Rexer & Sidesinger, Bottles, dropping stopper for medicine, Bouquet pin, Box, Brake, Brick, composition for basic, E. Bertrand, Brush machine, scrub, Buckle, J. Gump, Bung bushing or faucet socket, Burglar alarm, S. W. Wilt, Button, W. J. Leckie, 2d.

Table listing inventions such as Buttoner, T. W. G. Cook, Cables, making lateral connections in underground, S. P. Denison, Can, See Force can, Cane reeds for weaving, preparing, A. A. Ehrlich, Cane shaver, plant, R. Maurin, Cannon and supply system, pneumatic, W. A. Bartlett, Car brake, R. Hawes, Car brake, F. M. Smiley, Car card clip, railway, F. Robinson, Car coupling, Deyo & Schroeder, Car coupling, F. A. Fox, Car coupling, A. L. Stover, Car coupling, C. C. Warren, Car door retainer and seal, A. Roelofs, Car doors, tightening and fastening device for, J. C. Wands, Car, electric railway, F. J. Sprague, Car journal box, railway, P. Brownley, Car mover, E. Dederick, Car, railway freight, C. Mackall, Car ventilation, E. P. Brown, Cars, drawbar stop for railway, G. W. Cushing, Cars, fender guard attached to, R. M. Edwards, Cars, hand power motor for street, J. N. Johnson, Cars, steam heater for railway, S. F. Gold, Card, sample, J. Samuels, Carpet stretcher, C. F. Cooper, Carriage and sled, combined, E. B. Whitney, Carrying apparatus, J. O'Keefe, Case, See Shot case. Toilet case, Casting ingots, device for, T. Brady, Cattle guard, surface, P. Merrill, Cereals, treating, F. Dorr, Chain, trace, M. H. Kinsley, Chair, See Dental chair. Rocking chair, Check receiving apparatus, J. R. Ward, Cheese, machine for cutting, shaving and grinding, Vercelli & Graziani, Chess board, pocket, F. Catlin, Chopper, See Cotton chopper, Churn, W. H. Shoup, Clamp, See Clothes line clamp, Clasp, I. L. Weiskopf, Clip, See Car card clip, Clothes folding machine, W. F. Brook, Clothes line clamp, M. F. Hayes, Coal bin or coal cabinet, J. J. Kuykendall, Coal, tower for the elevation and storage of, E. L. Clark, Cock, gauge, D. G. Noack, Coffee pot, Florer & Moyer, Collar fastener, horse, W. T. Summers, Coloring matter, blue, Gnehm & Schmid, Coloring matter, gray, Gnehm & Schmid, Coloring matter, violet, Gnehm & Schmid, Coloring matters, production of yellow, J. Rosenle, Condenser, E. Dederick, Converter, J. W. Bookwalter, Converter, R. F. Ludlow, Converter bottoms, machine for manufacturing, W. L. Groff, Conveyer, W. R. Crow, Cooking utensil, C. C. Davis, Copying pad, T. Robson, Corn conveyer, J. & G. G. Heales, Cornet, B. H. Hite, Cotton chopper and cultivator, G. W. Hutto, Cotton cultivating machine, E. E. Runyon, Cotton press, W. W. McAlpine, Cotton press, J. W. Turnpaugh, Coupling, See Car coupling. Pipe coupling. Pole coupling. Thill coupling. Vehicle reach coupling, Coupling for permanent ways, Cardwell & Watson, Crane, hydraulic, Kennedy & Aiken, Crystalline calcic tetraphosphate and making the same, J. Reese, Curling iron heater, Mattes & Burkhardt, Current machine, alternating, C. Zipernowsky, Curtain pole, H. J. Schrader, Cutter, See Tube cutter. Weed cutter, Dental chair, B. M. Wilkerson, Dental engine, Hood & Reynolds, Dental matrix, G. M. Weirich, Die, See Auger bit die. Screw die, Digestive compound, J. Carnrick, Digestive compound, liquid, J. Carnrick, Digestive compounds, preparing, J. Carnrick, Digger, See Post hole digger, Diving apparatus, submarine, F. Vaughan, Dock, floating, J. Standfield, Door, D. W. Howard, Draught equalizer, J. Butler, Draught equalizer, I. E. Lucas, Drag rake, Harryman & Cooksey, Drawheads, manufacturing, E. N. Colwell, Drawer guide for bureaus, etc., D. C. Clapp, Drawer lock, F. Brabson, Dredge, pneumatic, C. L. Riker, Dress form, J. B. Stone, Drier, See Fruit drier, Drill, See Grain drill, Driving wheel, C. E. Swinerton, Drum, heating, A. W. Brock, Dynamos, discharge device for, O. B. Shallenberger, Dyestuffs, production of yellow, J. Rosenhek, Dyeing machine, W. A. Lorimer, Electric circuit closing device, W. C. Johnston, Jr., Electric currents, system of distribution by alternating, O. B. Shallenberger, Electric machine, dynamo, J. A. Kingdon, Electric machine, dynamo, G. Pfannkuche, Electric meter, W. H. Douglass, Electric motor, F. J. Patten, Electric motors, governor or regulator for, R. Maerac, Electric terminal, C. McIntire, Electrical conduits, coupling box for, S. P. Denison, Electrical switch board, J. J. Wood, Electrode, secondary battery, H. Tudor, Elevator, S. K. Humphrey, Elevator bucket, L. D. Howard, Elevator bucket, A. Miller, Enameler's apparatus, S. D. Keene, End board fastening for wagons, R. Allen, Engine, See Dental engine. Pulping engine, Eraser, blackboard, T. H. Costello, Explosives, manufacture of, E. Liebert, Extractor, See Stump extractor, Fabrics, forming a border on the edges of, J. M. Merrow, Feed water heater, F. D. Langenheim, Feed water heater and purifier, J. J. Hoppes, Feed water heating and purifying apparatus, J. H. Blessing, Feed water purifier, G. B. Field

Table listing inventions such as Feeder, automatic, J. H. Blessing, Feeder, coagulant, J. H. Blessing, Fence, D. N. Ralstead, Fence post, R. S. Case, Fence post, E. Gilbert, Fence post, J. Lounsbury, Fence post, J. S. Payne, Fertilizer distributing machine, Schmidt & Spiegel, Fertilizing machine, Brandenburg & Wogaman, Files, cleaning, J. E. Mathewson, Filter, C. J. Buhring, Filtering, J. McNab, Fire alarm box, G. F. Milliken, Firearm, K. R. Milovanovitch-Koka, Firearm, magazine, K. R. Milovanovitch-Koka, Fire escape ladder, W. Hewitt, Fireplace, C. A. Wellington, Flag staff holder, F. J. D. Chappell, Flash light ignitor, H. G. Ramsperger, Flooring, T. Cantwell, Food for infants and invalids, prepared, J. Carnrick, Force can, E. E. Ertzman, Founding apparatus, metal, G. W. Van Tine, Founding machine, metal, H. Tabor, Frame, See Necktie frame, Frog, spring, A. W. Paige, Fruit drier, J. H. Bard, Fuel, artificial, D. C. Fischel, Furnace, See Boiler furnace. Heating furnace. Hot air furnace, Furnace door, J. Heatley, Furnace for calcining boneblack, J. McNab, Gauge, See Water gauge, Gauges, instrument for testing and graduating vacuum, C. B. Bosworth, Gas, apparatus for manufacturing, J. E. Mendenhall, Gas engines, operating, S. Griffin, Gate, C. P. Lancaster, Gate, H. Friday, Gate, I. M. Thompson, Gearing for high speed motors, P. Hockett, Glue melting apparatus, M. F. Bingham, Grain binder, J. W. Blood, Grain binders, band securing mechanism for, J. S. Davis, Grain drill, W. A. Van Brunt, Grain troller, T. M. Nesbitt, Grillages, platforms, or foundations of structures to piles or other materials, fastening, R. Hunt, Guard, See Cattle guard. Keyhole guard, Guard finger, R. W. Walker, Gun carriage, J. B. G. A. Canet, Gymnasiums, parallel bars for, F. Medart, Hammer, power, C. A. Vaughn, Hammock, I. E. Palmer, Handle, See Auger handle, Handle for metallic vessels, W. C. Leavitt, Handles, making hollow metallic, I. E. Moody, Harness back band attachment, C. E. Ward, Harrow, B. M. Barber, Harrow, W. Wilkes, Harrow and roller, combined, J. A. Dawson, Harrow tooth, spring, F. Var Patten, Harvester, G. G. Hunt, Harvester and shock bundler, corn, E. Houtz, Header and thrasher, G. W. Haines, Heater, See Curling iron heater. Feed water heater. Water heater, Heating furnace, H. Swindell, Heel trimming machine, J. W. Plummer, Hoisting mechanism, T. A. Weston, Holdback, vehicle, Kooiger & Slonecker, Holder, See Bag holder. Bag and twine or sample holder. Flag staff holder. Opera glass holder. Pillow sham holder, Hook, See Shoe hook. Shoe lacing hook. Snap hook, Horse detaching device, C. L. Rice, Horses from cribbing, device for preventing, A. J. Avery, Horseshoe nail and calk combined, A. Carstens, Hot air furnace, D. S. Richardson, Hub or pulley, divided, O. L. Dunton, Ice cutting machine, electrically operated, F. E. Kinsman, Inhaler, G. W. Bence, Inhaler, W. J. Fairfield, Inhaler, W. W. Smith, Insulator, L. McCarthy, Jack, See Lasting jack. Window jack, Jacquard apparatus, S. Holdsworth, Joint, See Rail joint, Joist crowning machine, C. B. Woodruff, Journal bearing, J. T. Murray, Journal, vehicle, T. N. Subers, Keyhole guard, C. D. Williams, Knife, See Pocket knife, Knitted undergarment, M. Orr, Knitting machine, circular, Huse & Carr, Knitting machine, circular, W. H. Stewart, Lamp, central draught, J. Jauch, Lamp extinguisher, automatic, L. B. Mellus, Lamp extinguishing apparatus, J. Miller, Lamp shade, W. S. Berg, Lamp socket, incandescent, O. P. Loomis, Lamps, globe protector for arc, G. C. Asmus, Lantern signal, A. F. Prahm, Lasting jack and support, S. Clark, Lath, metal, G. M. Edwards, Lathes, adjustable cone center for, J. Knight, Lead chloride, making, W. Shapleigh, Leather splitting machine, J. A. Safford, Leveling instrument, C. T. Straus, Life boat, P. F. Schenck, Lock, See Drawer lock. Nut lock. Permutation lock, Lock, W. H. Taylor, Loom take up mechanism, Warner & Skinner, Loom tug strap holder, A. E. Bray, Malt machine, Free & Barber, Malt stirring machine, Free & Barber, Maltsting machine, J. & H. Noth, Mash tub mechanism, J. H. Eickershoff, Mashing machine, M. Gottfried, Match safe and ticket holder, combined, S. Wolstein, Matching machine, B. G. Luther, Measurements, instrument for taking and transferring, J. H. W. Schmidt, Mechanical movement, J. I. Conklin, Medical compound, J. Carnrick, Metal detector, electrical, J. F. Kester, Meter, See Electric meter. Proportional meter, Microphone, E. F. Heydler, Mill, See Ore mill. Rolling mill, Mining cage counterbalance, R. H. Arthur, Mixer, P. A. Oliver, Mop and wringer, combined, Sangster & Ormsby, Motor, See Electric motor. Thermic motor.

Mower, lawn, H. G. Miller..... 412,970  
 Nail. See Shoe nail.  
 Necktie frame, J. Kaiser..... 412,923  
 Net, fish, A. F. & W. Meisselbach..... 412,773  
 Nut lock, F. Post..... 412,786  
 Obstetrical appliance, J. P. Turney..... 412,969  
 Opera glass holder, E. B. Meyrowitz..... 412,774  
 Ore mill, W. Bainbridge..... 413,014  
 Ore separator, W. Bainbridge..... 413,013  
 Ore separator, J. B. Freeman..... 412,741  
 Oven, bake, J. D. Bandholz..... 412,943  
 Packing, rod, D. H. Chaddack..... 412,874  
 Packing stuffing boxes, tool for, P. J. Smith (r)..... 11,035  
 Pad. See Copying pad.  
 Pan. See Bed pan.  
 Paper box, angular, D. S. Clark..... 413,029  
 Paper cutting machine, Pavyer & Burns..... 413,086  
 Papermaking machines, water marker for, F. H. Richards..... 412,794  
 Patterns, making, W. J. Keep..... 412,759  
 Pen holders, elastic socket for, M. I. Rodrigue..... 413,092  
 Pen, ruling, J. S. Soderin..... 412,991  
 Permutation lock, W. F. Peters..... 412,977  
 Petroleum burning apparatus, Collings & Weatherhead..... 412,875  
 Phosphates, making, J. Reese..... 412,793  
 Photograph mount, H. N. Gale..... 412,953  
 Photographic developing bath, C. Spiro (r)..... 11,034  
 Photographic pictures, making, W. H. Stauffer..... 413,106  
 Pillow sham holder, T. R. Weyant..... 413,119  
 Pin. See Bouquet pin.  
 Pipe coupling, ball and socket, T. Aldcorn..... 412,940  
 Pipe stems, absorbent cartridge for, W. Demuth..... 413,036  
 Planter, cotton, J. R. Cook..... 413,043  
 Planter, cotton seed, L. E. Secrest..... 413,105  
 Planter, seed, J. E. Atkins..... 412,907  
 Planter, seed, T. H. Taber..... 412,806  
 Plow, side hill, J. D. Burkhardt..... 412,915  
 Plow, cultivator, etc., garden, C. Collins..... 412,840  
 Plow, sulky, E. C. Westervelt..... 413,157  
 Pneumatic conveyer, C. H. Schmitzler..... 412,985  
 Pocket knife, J. C. F. Schenck..... 412,739  
 Pocket fastener, B. Woodsford..... 412,906  
 Pole coupling, H. M. Hanson..... 413,056  
 Post. See Fence post.  
 Post hole digger, Taylor & Lightfoot..... 413,108  
 Post or pile driving machine, M. L. & G. W. Mowers..... 412,974  
 Pot. See Coffee pot.  
 Press. See Cotton press.  
 Press attachment, job, D. W. & F. W. Glendinning..... 412,816  
 Pressing fabrics, machine for, G. W. Miller..... 412,776  
 Printing machine, chromatic, C. B. Cottrell..... 412,878  
 Printing machine, cylinder, C. B. Cottrell..... 412,877  
 Printing, producing from a copy a plate or type for, F. X. Ritter..... 412,760  
 Proportional meter, F. E. Youngs..... 412,824  
 Pulley, W. H. Dodge..... 412,916  
 Pulley lubricating device, loose, Almond & Groshen..... 412,876  
 Pulp engine, J. H. Annandale..... 412,871  
 Pulverizer, rotary, R. Yates..... 412,823  
 Pump, E. S. Babcock..... 412,942  
 Punching and cutting machines and cutting out generally, blocks used as beds in, P. J. Simoulin..... 412,802  
 Punching machine receiving box, W. W. Russell..... 413,150  
 Push button, G. E. Ely..... 412,844  
 Rail joint, Killinger & Wolfe..... 413,067  
 Railway crossings, signal device for cable, G. H. Wright..... 413,120  
 Railway rail, J. R. Haldeman..... 413,053  
 Railway rail fastening, W. Salisbury..... 412,797  
 Railway switch, street, H. W. Libbey..... 413,145  
 Rake. See Drag rake.  
 Razor strip, L. C. Tower..... 412,918  
 Reeling machine, yarn, H. Hardwick et al..... 413,055  
 Reflecting apparatus, solar, W. Calver..... 412,734  
 Refrigeration, electric, M. W. Dewey..... 413,136  
 Rifles, cartridge magazine attachment for, A. Coley..... 413,052  
 Rocking chair, G. F. Hall..... 413,140  
 Rolling mill, P. F. Hanley..... 413,141  
 Rolling mill, Kennedy & Aiken..... 412,852  
 Rolling mill, rod, Day & Roberts..... 412,915  
 Rowing machine, T. J. Bigger..... 413,015  
 Ruler, flexible, B. H. Toquet..... 412,904  
 Sash cord guide, J. A. Burchard..... 413,022  
 Sash fastener, F. F. Schumann..... 412,987  
 Sashes, manufacturing metallic cross bars and rails for window, W. Henderson..... 412,751  
 Saw, crosscut, E. C. Atkins..... 413,012  
 Sawmill carriages, mechanism for reciprocating, G. R. Ray..... 412,791  
 Sawset, H. Peter..... 413,089  
 Scaffold standard, T. Sixsmith..... 412,989  
 Scows, shifting deck for dumping, Clark & Howard..... 413,030  
 Scraper and grader, road, J. C. Gordon..... 413,047  
 Scraper, road, G. Fry..... 412,712  
 Screen. See Window screen.  
 Screw die, C. Leach..... 412,855  
 Secondary battery, H. H. Carpenter..... 412,727  
 Separator. See Ore separator.  
 Sewer flushing tank, automatic, E. B. Mastick..... 412,965  
 Sewing machine presser feet, gauge attachment for, J. Fasser..... 413,043  
 Sewing machine ruffing attachment, E. Seitz..... 413,096  
 Sewing machine shuttle-actuating mechanism, J. Tripp..... 413,111  
 Shaft attachment, carriage, C. C. Graham..... 413,051  
 Shell, J. J. Moore..... 412,856  
 Shirt, etc., A. E. Lehman..... 412,764  
 Shoe hook, W. H. Smidt..... 413,098  
 Shoe lacing hook, W. H. Smidt..... 413,099  
 Shoe nail, H. A. Sanford..... 412,981  
 Shoe upper, S. P. Carrick..... 412,873  
 Shot case, I. H. Willis..... 412,817  
 Shuttle planer, J. M. Newton..... 412,930  
 Sign, F. Mitchell..... 412,972  
 Skylights, glazing bar for, T. W. Helliwell..... 412,750  
 Sled, J. I. Hancock..... 413,054  
 Snap hook, A. J. Dennis..... 413,135  
 Soap, making, A. L. Crane..... 413,035  
 Spike, L. A. Bower..... 412,831  
 Spinning frame spindle support, Taft & Woodmanancy..... 412,996  
 Spring. See Vehicle spring.  
 Stairway, P. Rieseck..... 412,898  
 Stamp, hand, E. D. Chamberlain..... 413,027  
 Stamp, time, E. H. Rogers, Jr..... 412,900  
 Stamp, time, C. H. Shaw..... 412,902  
 Stanchion, portable, Morris & Cool..... 413,080  
 Steam boiler, J. Barnhart..... 412,718  
 Steam boiler, H. A. R. Dietrich..... 412,950  
 Steam boiler, sectional, A. Worthington..... 412,820  
 Steam controlling device, R. Smith..... 412,804  
 Steam trap, B. Thoenes..... 413,109  
 Steam trap, W. P. & R. P. Thompson..... 412,903  
 Steel bodies having layers of different carbons, manufacturing, J. Pedder..... 412,893  
 Steel, making, R. F. Lullow..... 412,768

Stirrup strap loop, W. P. Young..... 412,825  
 Stove, solar, W. Calver..... 412,725  
 Stump extractor, J. A. Woodworth..... 412,819  
 Switch. See Railway switch.  
 Switch board, J. F. McLaughlin..... 413,083  
 Tablet, black, C. E. Perry..... 413,147  
 Tacking tool, R. C. Lambert..... 412,762  
 Tank. See Sewer flushing tank.  
 Tap and holder therefor, C. Elterich..... 412,952  
 Telescope bag, J. W. Beyer..... 412,909  
 Thermic motor, C. F. L. Gardie..... 412,882  
 Thill coupling, A. St. John..... 412,863  
 Thrashing machine band cutting feeder, Anspach & Wilhelm..... 412,715  
 Thrashing machine grain elevating attachment, R. S. Gabbey..... 413,045  
 Tires for carriage wheels, machine for grooving, J. Shaw..... 412,801  
 Toilet case, L. B. Martin..... 413,075  
 Tonic, alterative, W. E. Lyons..... 412,769  
 Tooth cleaning implement, J. A. Walsh..... 413,001  
 Torch and gas burner key, combined, G. W. Lindsay..... 412,765  
 Torpedo, auto-mobile, A. G. Von Buonaccorsi di Pistoja..... 413,113  
 Torpedo, self-propelling, A. G. Von Buonaccorsi di Pistoja..... 413,114  
 Torpedoes, automatic sinking valve for submarine, A. G. Von Buonaccorsi di Pistoja..... 413,115  
 Toy, electrical, L. Hirsch..... 413,058  
 Trap. Steam trap.  
 Tripod, J. Warner..... 413,118  
 Truck transferring device, L. D. Howard..... 413,063  
 Trunk, J. M. Wolbrecht..... 412,870  
 Trunk and wardrobe, convertible, F. J. Lytle..... 412,770  
 Truss, Streeter & Schlesinger..... 413,152  
 Tube cutter, P. H. Benade..... 412,944  
 Twine for binding grain, G. A. Lowry..... 412,963  
 Type bars, machine for making, A. J. Engelen..... 413,042  
 Type making machine, J. G. Pavyer..... 413,087  
 Umbrella or parasol, Peters & Green..... 412,894  
 Valve mechanism, hydraulic, H. F. Probert..... 412,789  
 Valve, steam-actuated, J. A. Wiggs, Jr..... 413,005  
 Vehicle body, C. M. Blydenburgh..... 413,017  
 Vehicle body, Morrill & Eddy..... 412,779  
 Vehicle gear, D. W. Camp..... 412,726  
 Vehicle gearing, S. S. Fax..... 412,740  
 Vehicle reach coupling, C. C. Bradley..... 412,872  
 Vehicle spring, A. J. Barrett..... 413,126  
 Vehicle spring gear, C. C. Hayes..... 413,057  
 Vehicle top prop rest, W. L. Hawes..... 412,748  
 Velocipede, D. W. Saxton..... 413,104  
 Vending apparatus, B. Adriance..... 413,009  
 Vending machine, automatic, J. C. Stevens..... 412,993  
 Ventilator. See Car ventilator.  
 Ventilator, C. Mohlmeyer..... 412,973  
 Violin bow, C. L. Landas..... 413,069  
 Voting, apparatus for use in secret, L. Kutscher..... 412,761  
 Wagon body, Morrell & Eddy..... 412,778  
 Wagon box, R. A. Hart..... 412,746  
 Wagon brake, J. S. Brown..... 413,020  
 Wall brick, J. McMurtry..... 412,858  
 Warmer, body, T. C. Green..... 412,744  
 Washing machine, G. M. Beck..... 412,719  
 Watch bow fastener, East & Turner..... 412,844  
 Watch, calendar, B. Rosenburg..... 412,796  
 Water closet, F. A. Wells..... 412,814  
 Water gauge, N. W. Pratt..... 412,787  
 Water heater, J. C. Eaton..... 413,039  
 Water purifier, rain, W. R. Scott..... 412,862  
 Weed cutter, E. Schmidt..... 412,983  
 Wheel. See Driving wheel.  
 Wheel, W. J. Holland..... 412,848  
 Whisky tester, K. Taylor..... 413,154  
 Wick, lamp, J. Ehls..... 412,736  
 Window jack, C. Parker..... 412,785  
 Window screen, S. J. Anderson..... 413,010  
 Wire tightener, E. Z. Mack..... 413,074  
 Wood grinding machine, Carter & Pertz..... 413,024  
 Yarn machine, tie, C. H. Everson..... 412,880  
 Yeast, making compressed, C. Mildenberger..... 412,968

TRADE MARKS.

Basin lifts for wash basins and bath tubs, W. H. Ward..... 17,103  
 Brandy, cognac, Gautier Freres..... 17,108, 17,109  
 Cachemires for dresses, Hilton, Hughes & Dering..... 17,111  
 Cards, playing, Russell & Morgan Printing Company..... 17,117  
 Cigarette paper, straw, C. E. Wackerhagen..... 17,106  
 Cigars, P. Moreda..... 17,102  
 Confections, chocolate, Fobes, Hayward & Company..... 17,098  
 Elastic, shoe, Herbert & Rapp Company..... 17,100  
 Emmeragogue, Chichester Chemical Company..... 17,114  
 Games, R. G. Barnes..... 17,113  
 Gloves, A. C. Hartman..... 17,116  
 Hose, linen hydraulic, Eureka Fire Hose Company..... 17,107  
 Lozenges, Fobes, Hayward & Company..... 17,099  
 Metallic rings for the cure of rheumatism and the like, L. G. Abbott..... 17,101  
 Preparations entitled Liq. Santal Flav. c Buchu et Cubeba and Mist. Pepsinae Co. c Bismutho, C. J. Hewlett & Son..... 17,110  
 Puzzles, J. C. Collin..... 17,115  
 Salt, table, W. C. Baird..... 17,096  
 Shoes, E. Dalsimer..... 17,097  
 Tonics, febrifuges, and the like, C. Wright & Company..... 17,119  
 Valves for water closet tanks and cisterns, W. H. Ward..... 17,104  
 Wagons, side spring, H. A. Moyer..... 17,118  
 Watch cases, Roy Watch Case Company..... 17,112  
 Watch movements, American Waltham Watch Company..... 17,105

DESIGNS.

Belt, L. Sanders..... 19,360  
 Bottle, W. G. Walter..... 19,357  
 Brougham body, W. R. Connor..... 19,352  
 Buckle, belt, L. Sanders..... 19,358, 19,359  
 Cap, J. M. Frank..... 19,354  
 Stove, heating, J. Dwyer..... 19,353  
 Tea and coffee pot handle, Shepard & Adams..... 19,361  
 Teeth, gum for artificial, E. T. Starr..... 19,362  
 Toy savings bank, Shepard & Adams..... 19,356  
 Type, font of printing, W. W. Jackson..... 19,355

A Printed copy of the specification and drawing of any patent in the foregoing list will be furnished from this office for 25 cents. In ordering please state the name and number of the patent desired, and remit to Munn & Co., 361 Broadway, New York.

Canadian Patents may now be obtained by the inventors for any of the inventions named in the foregoing list, provided they are simple, at a cost of \$40 each. If complicated, the cost will be a little more. For full instructions address Munn & Co., 361 Broadway, New York. Other foreign patents may also be obtained.

**Advertisements.**  
 Inside Page, each insertion --- 75 cents a line.  
 Back Page, each insertion --- \$1.00 a line.  
 The above are charges per agate line—about eight words per line. This notice shows the width of the line, and is set in agate type. Engravings may head advertisements at the same rate per agate line, by measurement, as the letter press. Advertisements must be received at publication office as early as Thursday morning to appear in next issue.

**USE ADAMANT WALL PLASTER**  
 It is Hard, Dense, and Adhesive. Does not crack or peel. It is impervious to wind, water, and disease germs. It dries in a few hours. It can be applied in any kind of weather. It is in general use. Licenses granted for the mixing, using, and selling. Address  
**ADAMANT MFG. CO.**  
 71 E. Genesee Street, Syracuse, N. Y.



**THE PHONOGRAPH.—A DETAILED**  
 description of the new and improved form of the phonograph just brought out by Edison. With 8 engravings. Contained in SCIENTIFIC AMERICAN SUPPLEMENT, No. 632. Price 10 cents. To be had at this office and from all newsdealers.

**“Star”** Foot Lathe Swings 9x25 in. \$75  
 Lathe with Automatic Cross Feed, etc.  
 Catalogue Free of all our Machinery.  
**Seneca Falls Mfg. Co.,** 695 Water St., Seneca Falls, N. Y.

**CATALOGUES FREE TO ANY ADDRESS**  
**TOOLS OF ALL KINDS**  
 GODDARD & NIGHTMAN BOSTON

**CABINET WOODS and VENEERS,**  
 FRET SAW or BRACKET WOODS,  
 PLANED READY FOR USE  
 Send stamp for catalogue.  
**HENRY T. BARTLETT, 200 LEWIS STREET, NEW YORK.**

**\$3 PRINTING PRESS**  
 For cards, labels, etc. Circular press, \$3 Size for small newspapers, \$4. Rotary jobber, 9x13, \$100. Do all your own printing and advertising. Full printed rules for type-setting, etc. Send 2 stamps for catalogue of presses, type, cards, etc., to factory. **KELSEY & CO., Meriden, Conn.**

**PAGET'S NEW WARP WEAVING AND**  
 Knitting Machine.—Description of one of the most ingenious and extraordinary weaving and knitting machines ever produced, with an account of its operation, and of the results obtained with it. With 3 figures. Contained in SCIENTIFIC AMERICAN SUPPLEMENT, No. 709. Price 10 cents. To be had at this office and from all newsdealers.

**ROP HAMMERS**  
 Punching Presses  
 Dies and other tools  
 SHEET METAL GOODS,  
 DROP FORGING, &c.  
 Stiles & Parker Press Co.  
 203-205 & 207 Center St., N. Y.

**Fine Taps, Dies, Reamers, Etc.**  
 Lightning and Green River Screw Plates.  
 Bolt Cutters, Hand and Power Drilling Machines, Punching Presses, Tire Benders, Tire Upsetters, and other Labor Saving Tools. Send for Price List.  
**WILEY & RUSSELL MFG. CO., Greenfield, Mass.**

**ASBESTOS**  
 MINERS & MANUFACTURERS.  
 The ASBESTOS PACKING CO.  
 169 CONGRESS ST BOSTON

**USEFUL BOOKS.**  
 Manufacturers, Agriculturists, Chemists, Engineers, Mechanics, Builders, men of leisure, and professional men, of all classes, need good books in the line of their respective callings. Our post office department permits the transmission of books through the mails at very small cost. A comprehensive catalogue of useful books by different authors, on more than fifty different subjects, has recently been published for free circulation at the office of this paper. Subjects classified with names of author. Persons desiring a copy, have only to ask for it, and it will be mailed to them. Address,  
**MUNN & CO., 361 Broadway, New York.**

**PRESSES** KNUCKLE JOINT SCREW OR HYDRAULIC FOR CIDER-LARD-TALLOW-OILS-LEATHER-GLUE STOCK OR ANY OTHER PURPOSE REQUIRING PRESSURE BOOMER & BOSCHERT PRESS CO. 136 WATER ST SYRACUSE NY USA

**SEBASTIAN, MAY & CO'S**  
 Improved Screw Cutting  
**Foot & Power LATHES \$60**  
 Drill Presses, Chucks, Drills, Dogs, and machinists' and amateurs' outfits. Lathes on trial. Catalogues mailed on application. 165 W. 2d St., Cincinnati, O.

**BIT**  
 Square, Oval, or Round Smooth Holes. For Carpenter, Cabinet, and Pattern work. 1/2 inch, 50 cents, set \$4.00, made free. Bridgeport Gun Implement Co., 17 Maiden Lane, New York.

**INGERSOLL-SERGEANT ROCK DRILL CO.**  
 10 Park Place, N. Y.  
 Rock Drills, Air Compressors, Stone Channeling Machines, Coal Cutters, Diamond Core Drills, Boilers, Hoists, Electric Blasting Batteries, Fuse, Wire, etc., Complete Plants of Mining, Tunneling, and Quarrying Machinery.

**ROCK DRILLS**  
 AIR COMPRESSORS & GENERAL MACHINERY FOR MINING, TUNNELING, QUARRY & RAILROAD WORK.  
**RAND DRILL CO 23 PARK PLACE NEW YORK**

**ICE-HOUSE AND COLD ROOM.—BY R. G. Hatfield.** With directions for construction. Four engravings. Contained in SCIENTIFIC AMERICAN SUPPLEMENT, 59. Price 10 cents. To be had at this office and of all newsdealers.

**Lightning Well-Sinking Machinery.**  
 Makers of Hydraulic, Jetting, Revolving, Artesian, Mining, Diamond Tools, Wells & Prospecting, Engines, Boilers, Wind Mills, Pumps, etc. TRIAL. An ENCYCLOPEDIA of 1,000 Engravings, Earth Stratification, Determination of Minerals and Quality of Water. Gives Light, Gold, Mailed for 25 cts. Gas Book 25 cts. The American Water Works, AURORA, ILLS

**OIL WELL SUPPLY CO. Ltd.**  
 91 & 92 WATER STREET, Pittsburgh, Pa.,  
 Manufacturers of everything needed for ARTESIAN WELLS for either Gas, Oil, Water, or Mineral Tests, Boilers, Engines, Pipe, Cordage, Drilling Tools, etc. Illustrated catalogue, price lists and discount sheets on request.

**ARTESIAN**  
 Wells, Oil and Gas Wells, drilled by contract to any depth, from 50 to 300 feet. We also manufacture and furnish everything required to drill and complete same. Portable Horse Power and Mounted Steam Drilling Machines for 100 to 600 ft. Send 6 cents for illustrated catalogue. **Pierce Artesian and Oil Well Supply Co., 80 Beaver Street, New York.**

**Perforated Electric Belting**  
 FOR SWIFT RUNNING MACHINERY.  
 Write for Descriptive Catalogue to  
**CHAS. A. SCHIEREN & CO.**  
 45-51 FERRY ST., NEW YORK.

The most successful Lubricator for Loose Pulleys in use. **VAN DUZEN'S PATENT LOOSE PULLEY OILER.** Highly recommended by those who have used them for the past two years. Prices very reasonable. Every user of machinery should have our "Catalogue No. 55," sent free. **VAN DUZEN & TIFT, Cincinnati O**

**Steam! Steam!**  
 Quality Higher, Price Lower.  
 For Strictly Cash, Complete Fixtures except Stack.  
**2-Horse Eureka Boiler and Engine, - \$135**  
 4. " " " " " " " " - 210  
 Other sizes at low prices. Before you buy get our prices.  
**B. W. PAYNE & SONS,**  
 Drawer 56. ELMIRA, N. Y.

**ASK-FOR-THE-LUNKENHEIMER RE-GRINDING-VALVE**  
 COSTS LESS & OUTLASTS ANY COMPOSITION DISK VALVE FOR ALL PURPOSES. SIGHT FEED LUBRICATORS OIL & GREASE CUT. THE LUNKENHEIMER BRASS MFG CO. CINT. I.

**MAGIC LANTERNS** and STEREOPTICONS for Public Exhibitions and for Home Amusement. Views illustrating every subject. A very profitable business for a man with small capital. Best apparatus, new views, largest stock. 26 years practical experience. 170-p. catalogue free. **GEO. H. PIERCE, 140 S. 11th St., Philadelphia, Pa.**

**2 to 40 H. P. The MOTOR of 19th CENTURY.**  
 Can be used Any Place, to do Any Work, and by Any One. No Boiler! No Fire! No Steam! No Ashes! No Gauges! No Engineer! A perfectly safe Motor for all places and purposes. Cost of operation about one cent an hour to each indicated horse power. For circulars, etc., address **Charter Gas Engine Co., Economy, Reliability, Simplicity, Safety. P. O. Box 148, Sterling, Ill.**

A New and Splendid Technical Treatise. The Manufacture of VINEGAR AND ACETATES, CIDER, AND FRUIT-WINES; Preservation of Fruits & Vegetables.

JUST READY. A Practical Treatise on the Manufacture of Vinegar and Acetates, Cider and Fruit-Wines; Preservation of Fruits and Vegetables by Canning and Evaporation; Preparation of Fruit Butters, Jellies, Marmalades, Catchups, Pickles, Mustards, etc. Edited from various sources by Wm. T. Brant, one of the Editors of 'The Techno-Chemical Receipt Book.' Illustrated by 79 engravings. In one volume, 8vo., 4:9 pages.

Price \$5.00, by mail, free of postage to any address in the World. CONTENTS.—PART I. The Manufacture of Vinegar. CHAPTER I. Introduction. II. Theory of the Formation of Vinegar. III. The Vinegar Ferment and its Conditions of Life. IV. Products of Acetous Fermentation. V. Methods of Fabrication of Vinegar. VI. Quick Process of Fabrication of Vinegar. VII. Arrangement of a Vinegar Factory. VIII. Artificial Ventilation of the Vinegar Generators. IX. Automatic Vinegar Apparatus. X. Operations in a Vinegar Factory. XI. Preparation of the Alcoholic Liquid. XII. Execution of the Work in a Vinegar Factory. XIII. Disturbing Influences in the Fabrication of Vinegar. XIV. Method of the Fabrication of Vinegar in Apparatus of Special Construction. XV. Further Treatment of Freshly Prepared Vinegar. XVI. Preparation of Vinegar from Various Materials. XVII. Preparation of Vinegar Specialties. XVIII. Fabrication of Wine Vinegar. XIX. Chemical Examination of the Raw Materials and Control of the Operation in a Vinegar Factory. XX. Examination of Vinegar as to the Presence of Foreign Acids and of Metals, as well as to its Derivation. XXI. Manufacture of Wood Vinegar. XXII. Preparation of Pure Concentrated Acetic Acid. XXIII. Acetates and their Manufacture.

PART II. Manufacture of Ciders, Fruit-Wines, etc. CHAPTER XXIV. Introduction. XXV. Fruits and their Composition. XXVI. Practice of the Preparation of Cider and Fruit-Wines. XXVII. Cider from Apples and Pears. XXVIII. Fruit-Wines; a. from Small Fruits; b. from Stone Fruits.

PART III. Canning and Evaporating of Fruit, Manufacture of Catchups, Fruit-Butters, Marmalades, Jellies, Pickles, and Mustards. CHAPTER XXIX. Preservation of Fruit. XXX. Evaporation of Fruit. XXXI. Preparation of Pickles and Mustards. Appendix of XVI Tables, Index.

An illustrated circular, 6 pages, 4to, giving the full Table of Contents of this volume, will be sent free of postage to any one in any part of the world who will reply by letter.

Our new and Revised Descriptive Catalogue of Practical and Scientific Books, 86 pages, 8vo., A list of Books on Distillation and Rectification of Liquors, Brewing and Fermentation, Wines, Sugar, Starch, etc., as well as a circular showing the full Table of Contents of 'The Techno-Chemical Receipt Book,' sent free of postage to any one in any part of the world who will furnish his address.

HENRY CAREY BAIRD & CO., INDUSTRIAL PUBLISHERS, BOOKSELLERS & IMPORTERS, 810 Walnut St., Philadelphia, Pa., U. S. A.

RARE BUSINESS OPPORTUNITY For Individuals or Corporations. FOR SALE—to close the estate, as a whole, the Architectural Iron Foundry

as most successfully run for over 15 years by the late SAMUEL J. CRESWELL, 23d and Cherry Sts., Philadelphia, Pa.

Location—Freight yards of Baltimore and Ohio and Philadelphia and Reading Railroads within one block, and Penna. Railroad within four blocks. Buildings—Specially erected for this business, and of most substantial character. Real Estate—Owing to location, of great intrinsic value, apart from present occupation.

Equipment—The finest of its kind in this country. Pattern tools, and machinery, complete, and requiring no further outlay. Possibilities of production unlimited. Business—Running as in lifetime of late owner, with full force of employees, large contracts on hand, in midst of great activity.

Possession—Immediate. Apply to or address JOSEPH K. KIN, Executor of Estate of Samuel J. Creswell, S. E. cor. 6th & Walnut Sts., Philadelphia, Pa.

After Being on the Market Four Years The 'ACME' Still Leads. Sizes One, Two, Three, and Four Horse Power. Arranged for either NATURAL GAS or Kerosene Oil fire, as ordered. No extra insurance required on account of the oil fire. Send for catalogue giving full particulars and prices. Rochester Machine Tool Works, Rochester, N. Y.

INVENTORS and others desiring new articles manufactured and introduced, address P. O. Box 86, Cleveland, O.

TO MANUFACTURERS

Manufacturers of the United States contemplating starting branch establishments in Canada, are invited to communicate with the 'Town of Simcoe,' which is prepared to offer special inducements to secure factories that will employ skilled labor. Address 'Secretary Board of Trade,' Simcoe, Canada.

COMPLETE STEAM PUMP ONLY SEVEN DOLLARS DEMAND THIS PUMP OF YOUR DEALER OR WRITE TO US FOR PRICES. VAN DUZEN'S PATENT VAN DUZEN & TIFT, SOLE MAKERS CINCINNATI, O.

ASBESTOS Fire Felt Coverings, Packings, Sheathings, &c. The CHALMERS-SPENCE CO., Mfrs., 419-425 5th Street, East River, N. Y.

PERFECT NEWSPAPER FILE The Koch Patent File, for preserving newspapers, Magazines, and pamphlets, has been recently improved and price reduced. Subscribers to the SCIENTIFIC AMERICAN and SCIENTIFIC AMERICAN SUPPLEMENT can be supplied for the low price of \$1.50 by mail, or \$1.25 at the office of this paper. Heavy board sides; inscription 'SCIENTIFIC AMERICAN' in gilt. Necessary for every one who wishes to preserve the paper. Address MUNN & CO., Publishers SCIENTIFIC AMERICAN.

DEAFNESS and Noises in HEAD Entirely Cured by Tubular Ear Cushions. Whispers heard distinctly. Unseen, comfortable, self-adjusting. Successful when all remedies fail. Sold only by F. H. COX, 853 Broadway, cor. 14th St., N. Y. Write or call for illustrated book of proofs FREE.

48c. RAZOR STEEL SPECIAL SAMPLE OFFER! This cut is exact size of our 65c. razor steel, 2 blade, warranted Knife. Our production, 300 doz. monthly. Price to new customers, for a while, postpaid, 48c., 5 for \$2. Blades made on honor; file tested; replaced free if soft. Send for 64 page free illustrated list, and 'How to Use a Razor.' MAHER & GROSCH, 40 S Street, TOLEDO, OHIO.

THE BOOKWALTER CASTING CO. Are now fully prepared to furnish Steel Castings on short notice, of any size and pattern, made under the BOOKWALTER AND ROBERT PATENTS. These castings are guaranteed to be sound and true to the pattern, and of unequalled tensile strength and ductility. Address THE BOOKWALTER CASTING CO., Springfield, Ohio.

CUTLER DESK. BEST IN THE WORLD. A CUTLER & SON, BUFFALO, N. Y., U. S. A.

REMINGTON

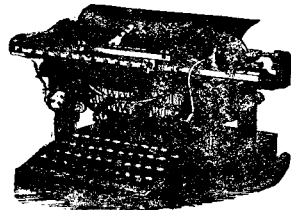

STANDARD TYPEWRITER. Gold Medal—Paris Exposition, 1889.

Wyckoff, Seamans & Benedict 327 BROADWAY, NEW YORK.

STEEL ALPHABETS. Brands, Seals, Steel Stencil Cutting Dies, Soap Moulds, and Brass Stamps. J. M. STUTZMAN, 181 William St., N. Y.

The Paris Exposition—Illustrated.

The SCIENTIFIC AMERICAN SUPPLEMENT will for some months to come contain illustrations of the buildings and the most interesting objects to be seen at the great French Exposition opened at Paris a few days ago. The illustrations which will embellish the SCIENTIFIC AMERICAN SUPPLEMENT will add an interesting and useful feature to the publication, and subscribers to the regular edition of the SCIENTIFIC AMERICAN, who are not patrons of the SCIENTIFIC AMERICAN SUPPLEMENT, are advised to have their name enrolled on the SUPPLEMENT subscription list at once, so as to secure all the illustrated exposition numbers for preservation. Price, \$5 a year, \$2.50 for six months. News agents everywhere receive subscriptions, or remit to the publishers, MUNN & CO., 361 Broadway, New York.

CELEBRATED SUTTON RING PACKING. PIONEER RUBBER PACKING. POSITIVELY ANTI-FRICTION. SPECIALLY ENDORSED FOR HIGH SPEED ENGINES. SEND FOR SAMPLE PACKAGE AND PARTICULARS TO ERIE RUBBER CO. ERIE PA. U. S. A.

HARRISON CONVEYOR! For Handling Grain, Coal, Sand, Clay, Tan B.rk, Cinders, Ores, Seeds, &c. Send for Circulars. BORDEN, SELLECK & CO., Sole Manufacturers, Chicago, Ill.

PULLEYS, HANGERS, FRICTION CLUTCHES. PROGRESS MACHINE WORKS, A. & F. BROWN, 44 Park Place, N. Y.

BARREL, KEG, Hogshead, AND STAVE MACHINERY. Over 50 varieties manufactured by E. & B. HOLMES, BUFFALO, N. Y. Chamfering, Howeling, and Crozing.

MINERAL WOOL AS A LINING in WALLS and FLOORS for preventing escape of warmth and the condensing of same. Sample FREE. Western Mineral Wool Co., Cleveland, Ohio.

RAILWAY AND STEAM FITTERS' SUPPLIES Rue's Little Giant Injector. SCREW JACKS, STURTEVANT BLOWERS, &c. JOHN S. URQUHART, 46 Cortlandt St., N. Y.

TOOL AGENTS WANTED in every SHOP in the United States. Send for catalogue Stationery &c. THE FINEST OF MECHANICAL TOOLS A SPECIALTY. C. E. JAMES, 98 LAKE ST. CHICAGO.

THE KODAK Embodies the only system of continuous film photography. World-wide success. 'You press the button. We do the rest.' Or you can do it yourself. THE EASTMAN DRY PLATE AND FILM CO. Price \$25, loaded for 100 pictures. Reloading \$2. Send for Kodak Primer, free. ROCHESTER, N. Y.

MAGIC LANTERNS SCIOPTICONS STEREOPTICONS FIRST CLASS PROJECTING APPARATUS FOR SCHOOLS COLLEGES AND PUBLIC ENTERTAINMENTS. QUEEN & CO. MANUFACTURERS AND IMPORTERS 924 CHESTNUT ST. PHILADELPHIA PENNA.

PLAYS Dialogues, Tableaux, Speaker for School, Club & Parlor. Best out. Catalogue free. T. S. DENISON, Chicago, Ill.

YOU WANT A WHEREWITHAL? WHY GO TO SCHOOL? Education in 7 minutes, against 1 year by old method. See ads, Sept. 28 and Oct. 5, '89, in this paper

NOW READY!

Experimental Science

—BY— GEO. M. HOPKINS. 740 Pages. 680 Illustrations. Price, by mail, postpaid, - \$4.00

MUNN & CO., Publishers. Office of The Scientific American, 361 Broadway, New York.

This book treats on the various topics of Physics in a popular and practical way.

It describes the apparatus in detail, and explains the experiments in full, so that teachers, students, and others interested in physics may personally make the apparatus and perform the experiments without difficulty. It is a book full of interest and value for teachers, students, and others who desire to impart or obtain a practical knowledge of physics.

HEADS OF THE CHAPTERS. I. Properties of Bodies. II. Rest, Motion, and Force. III. The Gyroscope. IV. Falling Bodies, Inclined Plane, The Pendulum. V. Molecular Actions. VI. Liquids. VII. Gases. VIII. Sound. IX. Experiments with the Scientific Top. X. Heat. XI. Light. XII. Polarized Light. XIII. Microscopy. XIV. The Telescope. XV. Photography. XVI. Magnetism. XVII. Frictional Electricity. XVIII. Dynamic Electricity. XIX. Electric Lighting. XX. Induction by Electric Currents. XXI. Telephone, Microphone, and Electrical Magic. XXII. Lantern Projection. XXIII. Mechanical Operations.

Each chapter is full and complete. Under the head of Sound, an extended description of the new Phonograph is given, with directions for construction. The chapter on Polarized Light is superbly illustrated and contains many simple experiments explanatory of this difficult subject. The chapter on Photography is a manual of heart. Electricity in all branches is fully treated. The performance of the experiments in the chapter on Dynamic Electricity will give the reader a practical knowledge of electricity in its modern applications. The part devoted to Electric Lighting gives a clear understanding of all the principal systems. The chapter on Projection contains a large number of new experiments. The book closes with a chapter on Mechanical Operations, containing information of great value to the experimenter.

Send for Free Illustrated Circular and Table of Contents.

MUNN & CO., Publishers, Office of THE SCIENTIFIC AMERICAN, 361 Broadway, New York.

Proposals for Supplies.—OFFICE OF LIGHTHOUSE INSPECTOR, Third District, Tompkinsville, N. Y., October 24, 1889. (Post Office Box 2,128, New York City.)—Sealed proposals will be received at this office until one o'clock P. M. on Tuesday, the 5th day of November, 1889, for furnishing supplies for the Lighthouse establishment. The supplies needed consist of eighteen lots, embracing, respectively, blocks, brushes, chimneys, dry goods, engineers' stores, flags and bunting, hardware and tools, lamps and lanterns, lumber, paints, oils, etc., ship chandlery, soap, tin ware, wicks, window glass, wood and willow ware, and miscellaneous articles. All of which are enumerated in the specifications attached to the form of bid, which may be obtained on application to this office. Contracts will be awarded on entire numbered lots, and on each item in the miscellaneous lot. The right is reserved to reject any or all bids, to strike out any item or items in the specifications, and to waive any defects. FREDERICK BODEN, Commander U. S. N., Lighthouse Inspector.

Proposals for Material for Steel Boilers for U. S. S. Galena, at Navy Yard, New York. October 17, 1889.—Sealed proposals, endorsed 'Proposals for Material for Boilers, etc., to be opened November 12, 1889,' will be received at the Bureau of Provisions and Clothing, Navy Department, Washington, D. C., until 12 o'clock noon, November 12, 1889, and publicly opened immediately thereafter, to furnish and deliver, at the Navy Yard, New York, all the material necessary for the construction of 3 steel boilers for the U. S. S. Galena, consisting of 3 pop safety-valves, 6 steel corrugated furnaces, 70 bars of flat, round, and square iron and steel, 69 steel plates, 72 stay-bars, 368 steel tubes, about 3,211 pounds steel rivets, 4,800 iron grate-bar washers, and 750 wrought iron shapes. The steel plates and bars to be made by the open-hearth process, and to conform to the requirements and tests as prescribed for the inspection of steel for hulls and machinery of cruisers, etc. Blank proposals, together with blue-prints, will be furnished upon application to the Commandant of the Navy Yard or to the Bureau. The bids decided by lot. The Department reserves the right to reject any or all bids not deemed advantageous to the Government. JAMES FULTON, Paymaster General, U. S. Navy.

WANTED.—Patented article in manufacture of which small pieces of Russia sheet iron are used. Address Box 787, Waukegan, Wis.

WANTED.—Mechanical Engineer with experience; must be thoroughly posted on hydraulic elevator work for buildings and competent to do (and to take charge of) designing, estimating, etc., in connection with same. Give references, age, experience, salary required, etc. Address 'T. W. H.,' P. O. Box 606, Chicago, Ill.

The Scientific American PUBLICATIONS FOR 1889.

The prices of the different publications in the United States, Canada, and Mexico are as follows: RATES BY MAIL. The Scientific American (weekly), one year \$3.00 The Scientific American Supplement (weekly), one year 5.00 The Scientific American, Export Edition (monthly) one year 5.00 The Scientific American, Architects and Builders Edition (monthly), one year 2.50 COMBINED RATES. The Scientific American and Supplement, \$7.00 The Scientific American and Architects and Builders Edition, 5.00 The Scientific American, Supplement, and Architects and Builders Edition, 9.00 Proportionate Rates for Six Months. This includes postage, which we pay. Remit by postal or express money order, or draft to order of MUNN & CO., 361 Broadway, New York.

WORKING MODELS & LIGHT MACHINERY. INVENTIONS DEVELOPED. Send for Model Circular. Jones Bros. E. Co., Cincinnati, O.

Advertisements.

Inside Page, each insertion - - - 75 cents a line. Back Page, each insertion - - - \$1.00 a line.

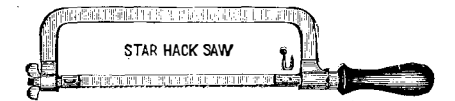

One Star Hack Saw will cut off a half inch bar of iron in forty seconds and will cut 100 times without sharpening.

For sale by most Hardware and Supply Dealers, or we will send one 3 1/2 inch Steel Frame and 15 Saws, by mail prepaid, on receipt of \$1.50.

Millers Falls Co. 93 Reade Street, New York.

STEEL TYPE for TYPEWRITERS, Stencils, Steel Stamps, Rubber and Metal Type Wheels.

GRAPHOPHONE AND PHONOGRAPH. An interesting account of the Edison, Bell, and Taintor apparatus for the mechanical reproduction of speech.

Wheeling is Better than Walking. Victor Bicycles Are Better than Any Others. Catalogue Free.

THE COPYING PAD.—HOW TO MAKE and how to use; with an engraving. Practical directions how to prepare the gelatine pad, and also the aniline ink by which the copies are made.

CLARK'S ALL TRUCK WHEELS AND CASTERS. Noiseless Rubber-Tired Truck Wheels and Casters.

CLARK'S ALL TRUCK WHEELS AND CASTERS. Noiseless Rubber-Tired Truck Wheels and Casters.

Scientific Book Catalogue. RECENTLY PUBLISHED. Our new catalogue containing over 100 pages, including works on more than fifty different subjects.

BARNES' PAT. FOOT POWER MACHINERY. I feel so highly pleased with your Velocipede Foot Power with seat, that I wish to add my testimony to its superiority.

CONTRACTORS MAKE THE LARGEST LINE OF ROAD GRADERS, SCRAPERS, PLOWS, & RR. CONSTRUCTION TOOLS IN THE WORLD.

PATENTS!

MESSRS. MUNN & CO., in connection with the publication of the SCIENTIFIC AMERICAN, continue to examine improvements, and to act as Solicitors of Patents for Inventors.

THE BRIDGEPORT WOOD FINISHING CO. G. M. BREINIG, AGENT, PRINCIPAL OFFICE AT MANUFACTORY NEW MILFORD, CONN.

SAWS Wanted 50,000 Sawyers and Lumbermen to send us their full address for a copy of Emerson's Book of SAWS.

THE ONLY PRACTICAL LOW-PRICED TYPEWRITER. Catalogue free. Address Typewriter Department, POPE MFG. CO., Makers of Columbia Cycles, Boston, New York, Chicago.

CASTINGS SOFT AND STRONG, ROUGH OR FINISHED. PATTERNS FOR ORDER, ALLENTOWN FOUNDRY & MACHINE CO.

ARTIFICIAL SILK.—DESCRIPTION of Mr. De Chardonnet's recently discovered method of manufacturing artificial silk from pure cellulose as a base.

A NEW INVENTION! Sure Grip Steel Tackle Block. The only lifting device which has Double Brake.

POP SAFETY VALVE WATER RELIEF VALVE IMPROVED STEAM GAGE STEAM ENGINE INDICATOR

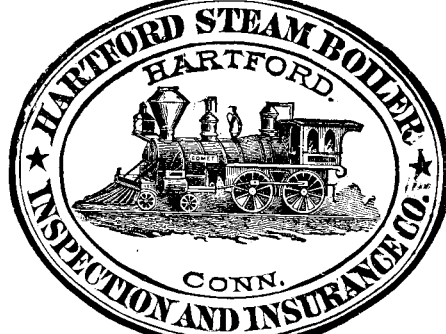

ELECTRO MOTOR, SIMPLE, HOW TO MAKE. By G. M. Hopkins.—Description of a small electro motor devised and constructed with a view to assisting amateurs to make a motor which might be driven with advantage by a current derived from a battery.

THE STANDARD ASBESTOS CEMENT FELTING, FOR LAGGING LOCOMOTIVES, ETC. SECTIONAL PIPE COVERING. ASBESTO-SPONGE NON-CONDUCTING COVERINGS.

THE AMERICAN BELL TELEPHONE CO. 95 MILK ST., BOSTON, MASS.

This Company owns the Letters Patent granted to Alexander Graham Bell, March 7th, 1876, No. 174,465, and January 30th, 1877, No. 186,787.

NICKEL AND ELECTRO-PLATING APPARATUS AND MATERIAL. HANSON, VAN WINKLE & CO. NEWARK, N. J. 92 LIBERTY ST. N. Y.

JAMES B. EADS.—AN ACCOUNT OF the life and labors of this eminent engineer. With a portrait. Contained in SCIENTIFIC AMERICAN SUPPLEMENT, No. 592.

WELTMAYER PATENT FURNACE. BOILERS OF EVERY DESCRIPTION. IDE AUTOMATIC ENGINES. Traction and Portable Engines. STEAM ROAD ROLLERS.

JENKINS STANDARD PACKING. THE ORIGINAL UNVULCANIZED PACKING CALLED THE STANDARD.

THERMOMETERS.—A VALUABLE PAPER upon the history, manufacture, uses, calibration, and various forms of Thermometers.

TO BUSINESS MEN.

The value of the SCIENTIFIC AMERICAN as an advertising medium cannot be overestimated. Its circulation is many times greater than that of any similar journal now published.

MALLEABLE AND FINE GRAY IRON ALSO STEEL CASTINGS FROM SPECIAL PATTERNS.

JENKINS BROS. 11 John Street, N. Y. 105 Milk Street, Boston. 21 North 5th St., Phila. 54 Dearborn St., Chicago.

RUBBER ROOFING. UNEQUALED For House, Barn, and all out-buildings. Anybody can put it on. PRICE LOW.

WORKING MODELS and Experimental Machinery, metal or wood, made to order by MASON & RAUCH, successors to J. F. Werner, 62 Centre Street, New York.

SYRACUSE MALLEABLE IRON WORKS. W. B. BURNS PROPRIETOR.

OTIS ELEVATORS. With late improvements for Factories. The Largest Elevator Works in the World.

The Stevens Portable Mills For CORN and FEED Grinding. Genuine French BUHR STONES. POWER CORN SHELLER.

THE Scientific American

ESTABLISHED 1846. The Most Popular Scientific Paper in the World. Only \$3.00 a Year, including Postage. Weekly. 52 Numbers a Year.

This widely circulated and splendidly illustrated paper is published weekly. Every number contains sixteen pages of useful information and a large number of original engravings of new inventions and discoveries.

MUNN & CO., 361 Broadway, New York.

THE Scientific American Supplement.

This is a separate and distinct publication from THE SCIENTIFIC AMERICAN, but is uniform therewith in size, every number containing sixteen large pages full of engravings.

Price for the SUPPLEMENT for the United States and Canada, \$5.00 a year, or one copy of the SCIENTIFIC AMERICAN and one copy of the SUPPLEMENT, both mailed for one year for \$7.00.

Buildings Edition.

THE SCIENTIFIC AMERICAN ARCHITECTS' AND BUILDERS' EDITION is issued monthly. \$2.50 a year. Single copies, 25 cents.

MUNN & CO., Publishers, 361 Broadway, New York.

PRINTING INKS. THE "Scientific American" is printed with CHATELAIN'S INK.