

SCIENTIFIC AMERICAN

[Entered at the Post Office of New York, N. Y., as Second Class Matter. Copyrighted, 1890, by Munn & Co.]

A WEEKLY JOURNAL OF PRACTICAL INFORMATION, ART, SCIENCE, MECHANICS, CHEMISTRY, AND MANUFACTURES.

Vol. LXII.—No. 14.
ESTABLISHED 1845.

NEW YORK, APRIL 5, 1890.

\$3.00 A YEAR.
WEEKLY.

ELECTRO-PNEUMATIC BLOCK SIGNAL SYSTEM.

The block system of running railroad trains has been generally adopted in England. In this country it has not yet come into very extensive use. As hitherto installed, it requires the presence of an operative at the termination of each block. The theory of its operation is simple. It consists in the use of danger signals at the beginning of specified lengths or blocks of track, each of which signals is to be kept at danger when a train is on the block protected by it until the block in question is free. In practice a block may be from 1,000 feet to three miles in length. To facilitate traffic to the highest degree, the length should not exceed one-half mile. To introduce the block system, therefore, upon a line of road under the old system is very expensive, owing to the number of men required to run it. To reduce this expense there is a constant temptation to increase the length of the blocks, thus making it less efficient. A system which depends upon human vigilance can never be considered a perfect one. In a recent issue we illustrated a mechanically worked interlocking system of switches in use at the Grand Central Depot, New York, which was constructed and installed by the Union Switch and Signal Co., of Pittsburg, Pa. This system represents the most advanced type of mechanical appliance for railroad safety. In our present issue we illustrate a plant recently erected by the same company for the blocking of a track, in which the work is done by electricity and pneumatic pressure combined, and in which all the operations are automatic, human agency having no part whatever in the work. The system illustrated has recently been introduced upon the Central Railroad of New Jersey, between Jersey City and Bergen Point. It is a four-track road, and is traversed by a very large number of trains daily. It has been found advisable to protect all classes of traffic, and accordingly the system has been put in operation on the four tracks.

As a very large number of trains, running at high speed, pass over this line, the blocks have been made short, ranging

from 1,000 to 2,500 feet in length. At the commencement of each block signal posts are erected, one for each of the tracks. Each post carries two signals and protects the tracks over which it stands.

The signals are semaphores, and are arranged one above the other for a single line of track. The upper semaphore has a square end; the lower semaphore is fish tailed in shape. When the upper one projects at right angles from the post, it indicates that a train is on the next block. Whenever it projects in this way, the lower one is also set at danger or caution. As the train leaves the block thus protected the upper signal falls, but the fish-tail signal remains at caution until the next block is passed and the train is two blocks distant. The upper signal is called the "Home" signal, the lower one the "Distant" signal.

The semaphores, whose construction is seen in the cut upon this page, are connected with a counterpoise, so that when left to themselves the counterpoise drops and sets them in the "Danger" position, or at right angles to the sustaining post. Directly below each semaphore a pneumatic cylinder, with single-acting piston, Fig. 2, is mounted, which is connected, by means of a balance lever and connecting rod, to the semaphore arm. As arranged, the piston, which works within the cylinder, is pressed upward to its highest position when the semaphore is at "Danger;" this, therefore, being the natural position of the whole apparatus. At the top of the cylinder a valve is arranged which can be opened electrically, and which closes automatically by a spring. To this valve a pipe is connected which communicates with a supply of compressed air. Above the valve is an electro-magnet, whose armature is connected to the valve stem. From what has been said it will be easily understood that, if a current of electricity is sent through the magnet, the valve will be opened. Compressed air will be admitted above the piston, which will be depressed, and as it goes down will force the semaphore in opposition to

(Continued on page 216.)

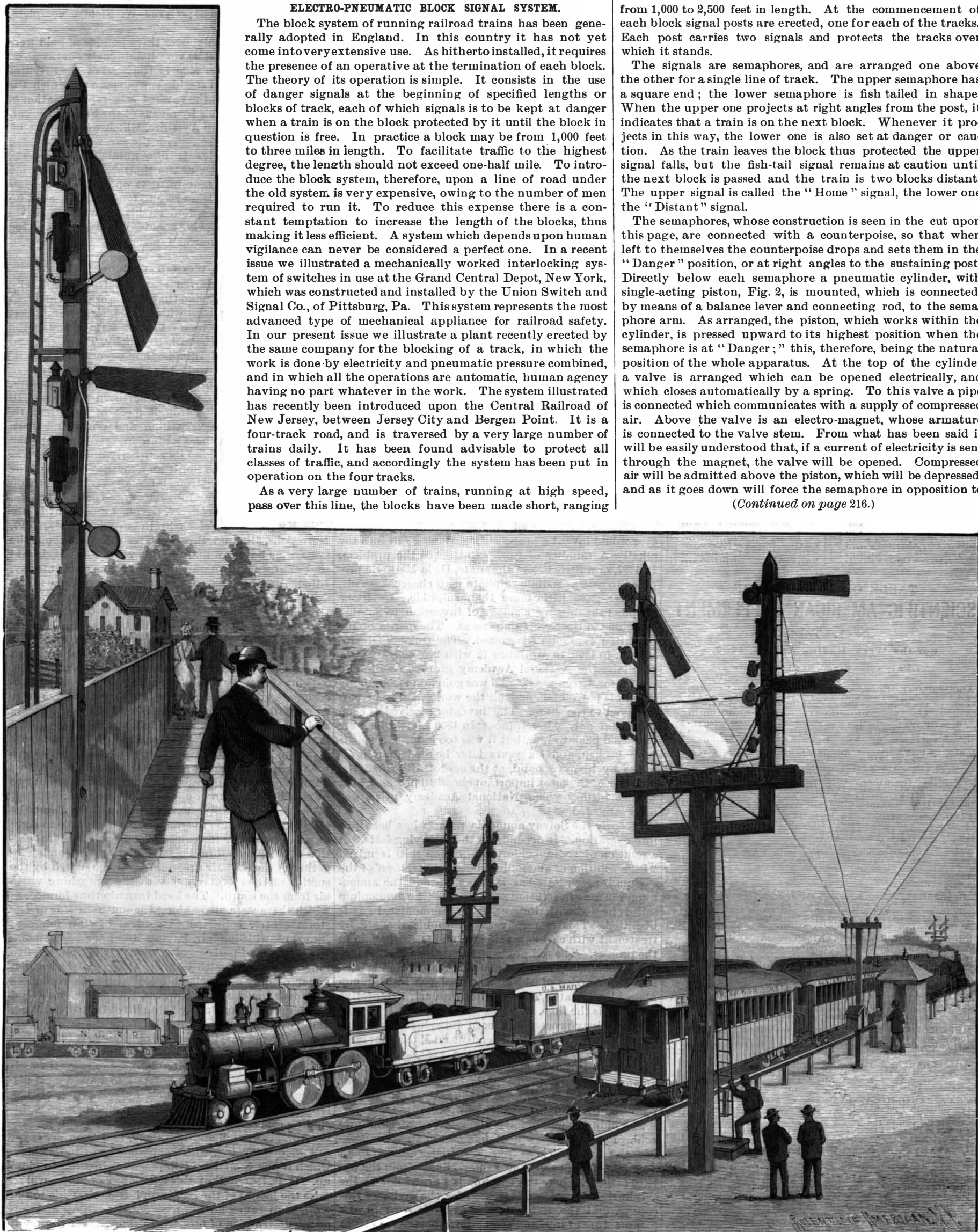

WESTINGHOUSE AUTOMATIC BLOCK SYSTEM RECENTLY INTRODUCED ON THE CENTRAL RAILROAD OF NEW JERSEY.

Scientific American.

ESTABLISHED 1845.

MUNN & CO., Editors and Proprietors.

PUBLISHED WEEKLY AT

No. 361 BROADWAY, NEW YORK.

O. D. MUNN.

A. E. BEACH.

TERMS FOR THE SCIENTIFIC AMERICAN.

One copy, one year, for the U. S., Canada or Mexico.....\$3 00
 One copy, six months, for the U. S., Canada or Mexico..... 1 50
 One copy, one year, to any foreign country belonging to Postal Union, 4 00
 Remit by postal or express money order, or by bank draft or check.
 MUNN & CO., 361 Broadway, corner of Franklin Street, New York.

The Scientific American Supplement

Is a distinct paper from the SCIENTIFIC AMERICAN. THE SUPPLEMENT is issued weekly. Every number contains 16 octavo pages, uniform in size with SCIENTIFIC AMERICAN. Terms of subscription for SUPPLEMENT, \$5.00 a year, for U. S., Canada or Mexico. \$6.00 a year to foreign countries belonging to the Postal Union. Single copies, 10 cents. Sold by all newsdealers throughout the country. See prospectus last page.
 Combined Rates.—The SCIENTIFIC AMERICAN and SUPPLEMENT will be sent for one year, to any address in U. S., Canada or Mexico, on receipt of seven dollars. To foreign countries within Postal Union, nine dollars a year.

Building Edition.

THE ARCHITECTS AND BUILDERS EDITION OF THE SCIENTIFIC AMERICAN is a large and splendid illustrated periodical, issued monthly, containing floor plans, perspective views, and sheets of constructive details, pertaining to modern architecture. Each number is illustrated with beautiful plates, showing desirable dwellings, public buildings and architectural work in great variety. To builders and all who contemplate building this work is invaluable. Has the largest circulation of any architectural publication in the world.
 Single copies 25 cents. By mail, to any part of the United States, Canada or Mexico, \$2.50 a year. To foreign Postal Union countries, \$3.00 a year. Combined rate for BUILDING EDITION with SCIENTIFIC AMERICAN, \$5.00 a year; combined rate for BUILDING EDITION, SCIENTIFIC AMERICAN and SUPPLEMENT, \$9.00 a year. To foreign countries, \$11.50 a year.

Spanish Edition of the Scientific American.

LA AMERICA CIENTIFICA E INDUSTRIAL (Spanish trade edition of the SCIENTIFIC AMERICAN) is published monthly, uniform in size and typography with the SCIENTIFIC AMERICAN. Every number of *La America* is profusely illustrated. It is the finest scientific, industrial trade paper printed in the Spanish language. It circulates throughout Cuba, the West Indies, Mexico, Central and South America, Spain and Spanish possessions—wherever the Spanish language is spoken. \$3.00 a year, post paid to any part of the world. Single copies 25 cents. See prospectus.
 MUNN & CO., Publishers, 361 Broadway, New York.

The safest way to remit is by postal order, express money order, draft or bank check. Make all remittances payable to order of MUNN & CO.

NEW YORK, SATURDAY, APRIL 5, 1890.

Contents.

(Illustrated articles are marked with an asterisk.)

Alloy, new.....	211	Gate, end, wagon*.....	213
Aristol, new antiseptic.....	215	Holder, lemonade, Wilkins*.....	213
Articles found in cotton bales.....	212	India, the masses in.....	214
Artists, great, contributions to astronomy.....	216	Inventor, honoring.....	210
Ash, soda.....	210	Lock, alarm, De Basto's*.....	212
Atomizer, Windolph's*.....	213	Machine, Toepler Holtz, new*.....	219
Bicycle, safety, Victor*.....	212	Mercury, planet, news of.....	211
Boilers, improvements in, Cronin's*.....	212	Notes and queries.....	220
Borax, California.....	219	Mountains of the moon*.....	217
Bridge, Forth.....	219	Nut and washer, Sullivan's*.....	213
Camera, Hale's*.....	218	Protector, channel, Mauermann's*.....	212
Camphor, Japanese.....	213	Roads, country, good.....	213
Cars, compressed air.....	218	Rot, potato, preventing.....	217
Chemistry, lectures on.....	214	Signal, railroad, Ivey's*.....	219
Comet, discovery of.....	214	Signal system, block*.....	203, 216
Cowboys in Rome.....	214	Sulphur not effective in fumigation.....	216
Cyclone, western.....	210	Those who follow us.....	213
Fastener, key, Armstead's*.....	213	Tin, history of.....	215
Fiber, pineapple.....	211	Vesuvius, trouble explained.....	218
Flooring, bridge, Carman's*.....	218	Warship, accident to.....	215
		Well, gas, large.....	212

TABLE OF CONTENTS OF SCIENTIFIC AMERICAN SUPPLEMENT No. 744.

For the Week Ending April 5, 1890.

Price 10 cents. For sale by all newsdealers.

I. ARCHÆOLOGY.—Palenque, the American Pompeii.—A wonderful buried city, one well worthy of further exploration.—An account of the discoveries already made there, and the rich probabilities for future ones.....	11890
II. ARMS OF WAR.—The New Magazine Rifle.—An interesting abstract of a lecture on modern military rifles, comparing the arms of different countries, with tabulated statement of results.....	11879
III. BIOGRAPHY.—James Watt.—By ARCHIBALD BARR.—A very interesting and graphic review of the life-work of the great engineer, with lessons to be drawn from his trials and success.....	11880
IV. CHEMISTRY.—On the Genesis of Elements.—By H. M. VERNON.—An abstract of the present view of the all-important subject of the origin of the different forms of matter, with very interesting data and theories.....	11889
V. CIVIL ENGINEERING.—An East Indian "Jhula," or Rope Bridge, made of Bamboo and Twisted Grass.—Illustration of a primitive bridge, affording a good contrast to the triumphs of engineering of the present day.—1 illustration.....	11884
Machine for Cleaning Gratings.—A machine for use with turbine water wheels, cleaning the gratings through which the water supply passes.—2 illustrations.....	11884
The Souleuvre Viaduct.—Description with illustrations of the operations of erecting a viaduct in Normandy.—A valuable example of French railway bridge construction.—8 illustrations.....	11882
VI. ELECTRICITY.—Some Effects of Heavy Electric Currents.—By G. M. HOPKINS.—A paper recently read before the Brooklyn Institute, giving new experiments on contact action between the surfaces of electric conductors and the result attained in electric welding.....	11885
VII. HORTICULTURE.—Diseases of the Cranberry.—Notes of diseases of this important plant.....	11886
VIII. HYGIENE.—The Physiological Treatment of Obesity.—By WALTER MENDELSON, M.D.—A widely interesting topic practically treated.—The causes of obesity and its treatment.....	11892
IX. MENSURATION.—The Refinements of Modern Measurements and Manipulations.—By J. A. BRASHEAR.—An exceedingly striking and graphic account from the popular standpoint of the refinements introduced into the measurements of modern science.—A lecture by one of the exponents of its finest work.....	11887
X. METEOROLOGY.—Eight Rainbows seen at the Same Time.—The formation of rainbows from the image of the sun in water, an illustration of a very remarkable effect produced by the extraordinary and the ordinary rainbows.—1 illustration.....	11893
XI. MISCELLANEOUS.—Curious Process of Cutting an Orange Skin.—A very striking amusement, the elaborate figures which can be obtained from an orangeskin, with many examples of the patterns obtained.—4 illustrations.....	11890
XII. NATURAL HISTORY.—A Cattle Bone.—A popular account of the cuttlefish bone, used to supply carbonate of lime to caged birds.....	11891
Titanotherium in the British Museum.—An extinct group of animals allied to the rhinoceros, with an illustration of the complete skeleton of the animal.—1 illustration.....	11891
XIII. NAVAL ENGINEERING.—H. M. S. Trafalgar.—Data of a great warship, a recent accession to the British navy, one of the most powerful ironclads afloat.—1 illustration.....	11879
XIV. PHOTOGRAPHY.—Composite Photography.—New results in composite photography examined by geometric figures and applied to faces.—3 illustrations.....	11886
XV. PHYSICS.—Constitution of Celestial Space.—By Prof. DE VOSSE WOOD.—The interstellar medium discussed, its necessary properties as evolved from a consideration of its rate of transmitting wave motion.—A very interesting investigation.....	11893
XVI. TECHNOLOGY.—New Electrical Process for the Manufacture of White Lead.—By TURNER D. BOTTS.—An application of electrolysis for producing the well known pigment.....	11886

SODA ASH.

Recent trade agitation in England threatens to interfere with the supply of soda ash for this country. Some clew to what this means may be derived from the fact that the annual importation of these products exceeds three hundred millions of pounds. Glass makers and soap manufacturers are most affected, but the soda salts are used in so many industries that any difficulty in procuring them is felt by all chemical manufacturers.

Soda ash is a crude carbonate of soda, and is the alkaline basis of all hard soaps. It also supplies a constituent of a great proportion of glass, sodium oxide forming from ten to thirty per cent of some varieties. The glass and soap industries are both dependent on it. It is the central figure in the most important group of allied chemical industries of the world. It has been aptly said that the civilization of a country could be judged of from its soap manufacture; not from the standpoint of cleanliness, but because the manufacture of soap involves so many chemical processes, the chief among them being the soda ash industry.

Formerly soap was largely made with the lye produced by boiling wood ashes, a solution of crude potassium carbonate. The salt produced by evaporation of this lye was originally called pot ashes, from its mode of preparation. This gives a soft soap. As a basis for hard soaps, the ashes of certain seaweeds and seashore plants were used which contained sodium carbonate. The chemical advance of the last century has changed this, and now the majority of the soda ash is made from salt by the Le Blanc process. Salt is treated in an open hearth furnace with sulphuric acid. This converts it into sodium sulphate, or salt cake, a crude Glauber's salt. The salt cake is withdrawn from the furnace and pulverized. It is mixed with an equal weight of limestone or chalk (calcium carbonate) and half as much coal, all ground or crushed. This material is subjected to fusion in another furnace, also of the open hearth type, and is constantly stirred. The general reaction that takes place consists in the reduction of the sodium sulphate to sodium sulphide, followed by an interchange with the calcium carbonate, the resulting mass containing calcium sulphide and sodium carbonate. The latter is removed by lixiviating with cold or tepid water. It is evaporated to dryness, and calcined with a little sawdust in a furnace.

The history of the Le Blanc invention is one of the saddest romances of science. The chemist Duhamel, in 1736, established the fact that the base of salt and of soda alkali was the same. In 1775 the French Academy of Sciences offered a prize of 2,400 livres to whoever would invent a process of converting salt into the alkali. A number of workers attacked the problem. In 1787, or a little before that date, De la Metherie proposed to calcine sodium sulphate with charcoal. This, however, gave little more than sulphide. Le Blanc supplied the missing element of invention by adding limestone in the reduction process. The merits of the invention were soon recognized. The Duke of Orleans agreed, in 1790, to capitalize it with 200,000 francs. A year later the National Academy granted Le Blanc a patent for fifteen years. All was going on swimmingly when his patron fell, and all the works had to be surrendered to the state. The inventor received as compensation only 4,000 francs. In 1800 his works were conveyed back to him, but it was too late. His spirits were broken, and six years later he died in a madhouse by his own hand, at the age of fifty-three, the inventor of the most important chemical process of the world's history. The National Academy prize was never awarded.

Recently the Solvay ammonia process has been put into operation. It depends on the following facts. If a solution of sodium chloride (common salt) is mixed with a solution of ammonium bicarbonate, most of the sodium is precipitated as bicarbonate and the ammonium remains in solution as chloride. The ammonium salt is heated with lime, whereby ammoniacal gas is liberated. This is reconverted into bicarbonate by treatment with carbonic acid gas, and is used again in the process. The sodium bicarbonate is converted into the carbonate by heating, and the gas evolved is used in the conversion of the ammoniacal gas into ammonium bicarbonate. Thus the lost product, irrespective of waste, is the lime.

The Solvay process has been introduced into this country, but still we are dependent on Europe for most of our soda. The imports for the year ending June, 1889, were 308,990,773 lb. About one-half of this amount was used in the glass houses alone. Great Britain remains the largest producer, her output representing probably over half the world's product.

The industry uses immense quantities of sulphuric acid. Pyrites are now used to a great extent for making the acid. These pyrites often contain small amounts of copper. The ash or clinker from the pyrites furnace, where the sulphur is burned out in the sulphuric acid process, is treated for the saving of this copper, and the residual iron oxide is used in the manufacture of iron and steel. So important are these side products that the soda ash process is often run without direct profit, it is said, the copper and iron

being depended on to make it pay. The absence of any side products tells heavily against the Solvay process.

Honoring an Inventor.

Captain Joseph Francis, the veteran life-saving appliance inventor of this city, is the recipient of the largest and most expensive gold medal ever presented to any citizen of this country by Congress in recognition of valuable services rendered.

The actual cost of the medal is several thousand dollars, some of the items of which areas follows: Cost of dies, \$1,500; model, \$700; gold used, \$760; striking medal, \$30; cost of case, \$18. Other medals of value that have been presented by Congress are as follows: U. S. Grant's, complete, cost \$594.79; Capt. Ingram's, complete, cost \$546.50; Cyrus W. Field's, complete, cost \$562.88.

In the Francis medal over three pounds of gold were used, and the medal is very handsomely engraved on both sides. On one side is the head of the inventor and the inscription stating the purpose for which the medal is given. On the reverse is a representation of the saving of 360 souls by means of the Francis life-car, from the British ship *Ayrshire*, which went ashore off the New Jersey coast. The life-car which rendered this valuable service is now numbered among the most interesting relics at the Smithsonian Institution in Washington. A movement is on foot by members of the Chamber of Commerce to tender to the aged inventor a rousing reception on his return from Washington with his newly acquired and well deserved trophy of the government's esteem.

The Western Cyclone.

A storm which started eastward from the Rocky Mountains, March 29, and that had its origin near Great Salt Lake, Utah, caused wide devastation over a great tract of country. It took a violent form through the States of Kansas, Missouri, Kentucky, Tennessee, and the southern part of Illinois, Indiana, and Ohio, on its southern boundary, while the storm drew its northern limit through the States of Nebraska, Iowa, Minnesota, Wisconsin, Michigan, and the northern portions of Illinois and Indiana. Through most of this great region the winds were very high, and on the northern boundary there was heavy snow in sections, while the rain fell copiously along its southerly line. There was also, however, on the south and southwest edge of the storm, a series of disastrous tornadoes on the afternoon and evening of March 27, the most destructive of these, both as to life and property, having occurred at Louisville, Ky., about 8 o'clock in the evening of March 27, Metropolis, Ill., and Bowling Green, Ky., at about the same time having a like terrible visitation. It is said that scarcely a town on the border line of Kentucky, Illinois, and Indiana escaped the ravages of these tornadoes. At Louisville the storm entered the southwestern portion of the city, and swept a path through it in a northeasterly direction about five blocks wide, leveling every building, tree, and telegraph pole in its course. The district thus laid waste comprises an area about three miles long and nearly half a mile wide. The inhabitants were all attending to their usual avocations, although warning of an exceptionally severe storm had been given by the Signal Service Bureau, and in one large building a ball was in progress and two or three meetings. The collapse of this structure is said to have buried two or three hundred persons in the ruins. The total loss of life in the city cannot be known for several days, but it is estimated at about two hundred, while many hundreds are wounded.

The reports indicate that the wind throughout the storm-visited section averaged from forty-five to sixty miles an hour, the tornadoes along the southern portion of the great storm being caused by the coming together of the cold air drawn in from the north by the suction of the storm center with the uprushing warm air from the south. The local tornado thus formed, of which there were many along the southern side of the storm center, consisted in general of "an immense funnel of whirling air, having its upper base among the clouds, and perhaps of a diameter of four or five miles, while its mouth or lower sharp end had a diameter of only a few city blocks." As such tornadoes rush over the country, however, this lower sharp end of the funnel is constantly being lifted from the ground, and withdrawing itself into the storm cloud, which accounts for the varying degrees of intensity of the storm at different places along the line of its course.

This cyclone, with the attendant heavy rains through the Mississippi Valley, cannot fail to have a most disastrous effect along the whole lower portion of that river. Already great districts have been flooded, including some of the largest and finest cotton plantations of Mississippi and Louisiana, and the river is yet full to overflowing, with many crevasses in its banks which it has been found impossible thus far to close up. It is feared that this new influx of water will so raise the height of the Mississippi, from the Ohio to the Gulf, as to cause an unprecedented overflow and immense destruction of property, although such thorough warning has been given that there should not be any accompanying great loss of life.

Pineapple Fiber.

The Calcutta *Statesman*, of December 14, in the course of a long article on the uses of the pineapple fiber, says: "It is almost a truism to say that no new or untried natural product, however useful, or even valuable, in an economic point of view, can ever stand a chance of becoming an article of commerce, unless it is put into the market in a form that admits of an easy test of its fitness and capabilities for practical purposes. The rapid popularity attained by jute as a textile material was owing largely to the care with which the finest qualities of the fiber were developed in the samples shipped for trial in Dundee and Glasgow.

"That the undoubtedly superior fiber of the pineapple plant is not in such general request as it ought to be, and might be, is, we fear, due entirely to a neglect of the conditions which would have adapted it for ready experiment. In a note in the last issue of the Calcutta Agricultural Society's *Journal*, Mr. R. Blechynden has collected and set out such information as he has been able to gather from books and other publications regarding the uses to which the leaves of the pineapple plant are known to have been applied in India and in other countries.

"As this knowledge is calculated to open out a new and remunerative industry, we think, says the *Journal of Fabrics*, it is very desirable that a systematic effort should be made for the development and utilization of what Mr. Blechynden describes as 'one of the most interesting, promising, and valuable fibers of India.' In order to awaken public interest to the economic value of this fiber, we shall draw upon Mr. Blechynden's note for such information as may give some idea whether its preparation for textile purposes is likely to be a source of profit to the agricultural classes of this country. The industry would appear to be not altogether new.

"The pineapple has long been cultivated for its fiber in India, having been introduced into Hindostan from Malacca, during the reign of the Emperor Akbar. Indeed, it is still an article of trade in the Eastern Islands, and in the Philippines it is manufactured into a cloth (pina), 'well known to be of great strength, durability, and beauty.' The fiber is also largely exported to China, where it is woven into linen. As regards India, we find that it was in 1834 that Col. C. T. Watson brought to the notice of the Asiatic Society of Bengal that the people of the Khasya Hills utilized the pineapple fiber for the net pouches or bags which generally formed a part of their equipment. Two years later Dr. Wallich saw it applied to the same purpose, and in writing to the Agricultural and Horticultural Society, said: 'Considering the enormous quantity of pines grown in that range (Khasya Hills), the plant appearing as if it were quite a natural production, the fiber of it is worthy of attention.' No action, however, was taken on Dr. Wallich's hint. As a fact, the pineapple plant grows, and can be made to grow, in almost every part of India. It has hitherto, without much trouble, been raised exclusively for its fruit, but its cultivation for the fiber will be no less simple. The production of fruit and of leaves, it is generally admitted, 'in no manner interferes with each other, the leaves being fittest for fiber after the fruit has ripened.'

"The largest and most mature leaves are said to yield the finest fiber. The cheapest and most thorough process of extracting it in a way to exhibit its best qualities is, therefore, all that is wanted to place it in its proper position among the most valuable fibers suited for textile fabrics of the higher class. In the Khasya Hills, we are told, the leaves are gathered before the rains set in, and, after they have been soaked in water for some time (not specified), they are beaten out in order to separate the fiber. The Chinese process, as followed in Singapore, is as follows:

"The leaves, recently gathered, are laid upon a board, and the epidermis is removed by a broad knife, not unlike in form to a shoemaker's paring knife. Upon its removal from the upper surface of the leaf, the long and beautiful fibers were seen lying upon the lower and denser epidermis running in a longitudinal direction. The fascicle of fibers were then readily detached, either by hand or by being raised by the broad knife. . . . The first appearance of the pineapple fibers would not cause one to suppose it to be so remarkably fine as it really is; but, by taking one coarse fiber, it is found capable of being subdivided into threads of such delicacy as to be barely perceptible, and yet sufficiently strong for any purpose.'

"Experiments recently made with the leaf in the Seebpore Engineering College showed that steeping destroyed the fiber. The Agri-Horticultural Society, however, have since made up a sample of fiber prepared by hand and heckled, and it is believed that this fiber, if properly prepared, could be mixed with cotton or wool as a substitute for silk. Indeed, we are told that some thread was made out of it by a Miss Davy so far back as 1839, and, under her direction, it was subsequently manufactured into cloth, which might, with more experience of the fiber, have been made equal to the fine fabric of Manila. Mr. Blechynden notes that a Mr. Zinke has taken out a patent for the manufacture of thread from this fiber, as he is satisfied that, by sub-

jecting it to the process of bleaching, it becomes pliant enough to be spun in the manner now adopted with flax, and by the same machinery. Here, surely, is a fit opportunity for the Agricultural Department of the Government of India to step in and direct experiments to be prosecuted on some prescribed system, in districts where the pineapple plant is found already growing in abundance. When the most suitable methods and conditions for the extraction and preparation of the fiber have been thoroughly ascertained and made known, we have no doubt that private enterprise will take up the new industry with the same vigor as was manifested in the manufacture of jute, especially as, like jute, the pineapple plant can be raised at little cost and trouble, and, still better, as a subsidiary cultivation."

Wonderful News about Mercury.

The Italian astronomer Schiaparelli, who has become famous in recent years for his discoveries on the planet Mars, has lately surprised his fellow savants by the announcement of equally remarkable discoveries about the planet Mercury. The reader will remember that Mercury is the planet nearest to the sun, so that, on account of its proximity to the solar orb, it can never be seen except low down in the evening or morning sky. On this account comparatively few persons ever see it. It is, however, a very brilliant object when well situated for observation, and glows so brightly that the Greeks named it the "Sparkling One." Mercury is very much smaller than the earth, being only 3,000 miles in diameter, but it is composed of far heavier materials, and, according to recent investigations, it weighs almost as much as a globe of real mercury of the same size would weigh. In fact, it is not improbable that the planet is very largely, if not chiefly, composed of metallic matter.

It has long been known to astronomers that there are permanent markings visible on the surface of Mercury, but it requires a sharp eye, a fine telescope, and exceptional conditions of atmospheric purity and steadiness to enable one to detect these delicate shadings on the planet's disk, and so not much has heretofore been known about them. As Mercury is nearer to the sun than the earth is, it presents to us in the course of its revolution around the sun all the phases that we see in the moon.

Schiaparelli, after studying Mercury for seven years, makes the surprising assertion that Mercury, instead of turning on its axis once in twenty-four hours, turns only once in the course of a revolution around the sun. In other words, it always presents the same face toward the sun, behaving in this respect just as the moon does toward the earth. Moreover, Schiaparelli has discovered many marks upon the disk of the planet which had not been noticed before, and he has made a little map or diagram which shows that these marks strikingly resemble some of the features discovered in recent years on Mars. They are elongated streaks running in various directions, and frequently presenting at their points of junction the appearance of an enlargement or knot. Similar streaks on Mars have been assumed to belong narrow seas or water courses. The geometrical figures formed by the intersection of these streaks on Mercury strikingly resemble those on Mars. In one place there is a shape of this kind that roughly resembles a huge figure 5, covering a quarter of one hemisphere of the planet.

It has long been known that evidences of an atmosphere are perceptible on Mercury, and the spectroscopic has shown that watery vapor probably exists in this atmosphere. But if some of the phenomena observed by Schiaparelli are correctly interpreted, he has actually beheld clouds floating in the planet's air, and the indistinctness of the spots on the disk, when seen near its edge, is ascribed to the effects of the atmosphere absorbing the light. These supposed clouds, which, reflecting the sunlight from their upper surfaces, appear as white patches, are more numerous, according to Schiaparelli, in the northern than in the southern hemisphere of the planet. In fact, they are so numerous near the north pole that they produce an apparent elongation of the northern horn of the crescent when Mercury appears in that form, and Schröter's supposed shortening of the southern horn has accordingly been ascribed, not to the shadow of great mountains, but to the effect of contrast with the extraordinary lengthening of the northern horn caused by Schiaparelli's clouds.

There is really nothing to cause astonishment in Schiaparelli's announcement that Mercury makes only one rotation on its axis in going once around the sun, for it is so near the sun that the tidal influence of the latter might readily have reduced its rotational velocity to coincidence with its period of revolution, just as has occurred in the case of the earth and the moon. Nevertheless the fact is exceedingly interesting and it becomes much more so when considered in connection with the question whether Mercury is habitable. It has generally been regarded as highly improbable that Mercury is an inhabited globe, yet so long as it presents evidences of the presence of air and water on its surface, it is impossible to deny the possibility of the existence of some forms of life there. Suppose we imagine our-

selves in the position of an inhabitant of Mercury. If we dwelt on the sunward side of the globe, we should have perpetual day, and, of course, on the other side we should be plunged in perpetual night, since the sun can never shine on that side. Still, owing to the great eccentricity of Mercury's orbit, the planet undergoes a large libration in longitude as it journeys around the sun, and the result of this is to produce the same effect as if it rocked to and fro on its axis to the extent of nearly 24° on each side of a median line, making one complete swing in the course of a single revolution around the sun. Consequently there are regions along the eastern and western edges of the sunward side of the planet which are alternately brought into the sunshine and plunged back again into darkness. The dwellers within these lune-shaped regions, each of which attains a width of 24° at the equator and diminishes to nothing at the poles, would therefore be the only inhabitants of Mercury who could enjoy the alternation of day and night. Those living at the inner edge of one of the lunes would see the sun slowly rise to a height of 24° above the horizon, and then sink again in a period of six weeks; those living at its outer edge would catch only a brief glimpse of the sun just peeping above the hill tops once in every year, or 88 days, that being the time required by the planet to complete a revolution in its orbit.

An inhabitant dwelling near the center of the sunward side of the planet would have the sun directly over his head twice in a year, and from that position it would appear to oscillate 24° on each side of the zenith, moving first to one side and then to the other. As Mercury has also a small libration in latitude, this apparent swinging of the sun to and fro in the sky would not be performed in a straight line, but in a very long and narrow ellipse.

The inhabitants of Mercury, if any there are, have something besides these curious oscillations to make them take a particular interest in the sun. We have already referred to the great eccentricity of the planet's orbit. This, in fact, is sufficient to cause the distance of Mercury from the sun to vary to the extent of some fourteen million miles in the course of a revolution, its greatest distance being about 43,000,000 miles, and its least distance in the neighborhood of 29,000,000 miles. At its perihelion, under the tremendous impulse of solar attraction, the planet darts ahead in its orbit at the rate of 3,000,000 miles a day; in aphelion this daily motion is reduced to 2,000,000 miles. This variation of orbital velocity however is simply interesting in itself, and probably has no bearing upon the question of life on Mercury. But the change in the amount of radiation received from the sun has a most decided bearing upon that question. When Mercury is at perihelion, the sun pours down upon the surface of that devoted planet more than twice as much light and heat as it does at the time of aphelion. Making a comparison with the earth, we find that the amount of solar light and heat received upon the sunward side of Mercury varies from four times the amount that the earth gets to nine times that amount. Such alternations as these would certainly prove fatal to any of the higher forms of life that exist upon our globe, but it would be presumptuous to attempt to set bounds to the power of the Creator to fit His creatures to the varying circumstances of their environment. Even the comparatively narrow limits of life upon the earth supply us with many astonishing instances of adaptation.

If we cannot accept as a proper residence for intelligent beings either the sunward hemisphere of Mercury, smitten with so fierce a gust of solar heat and subjected to such violent alterations of temperature, or its unilluminated hemisphere plunged in perpetual darkness and frozen with a cold more than Arctic, perhaps we can turn with better success to those lune-shaped regions that we have described, in the search for some spot on this strange planet where creatures not utterly unlike ourselves might dwell. In those regions, as we have seen, there are alternations of light and darkness. In them, too, the sun cannot smite so cruelly, for its rays must there fall robbed of their worst effects on account of the great inclination at which they meet the surface. The effect is the same as that produced upon the earth by the difference in the inclination of the sun's rays in winter and in summer.

How strange and wonderful is the globe that is thus presented to the imagination, with a desert of heat on the one side and a wilderness of cold on the other, but possessing between these two frightful expanses narrow regions in which it is possible to live! Truly the wonders of the universe are beginning to be opened before our eyes!—*N. Y. Sun.*

A NEW alloy has been discovered by Herr Reith, of Bockenheim, Germany, which is said to practically resist the attack of most acid and alkaline solutions. Its composition is as follows: Copper, 15 parts; tin, 234 parts; lead, 182 parts; antimony, 1 part. This alloy is, therefore, a bronze, with the addition of lead and antimony. The inventor claims that it can be very advantageously used in the laboratory to replace vessels or fittings of ebonite, vulcanite, or porcelain.

AN IMPROVED ALARM LOCK.

The accompanying illustrations represent an alarm lock patented by Mr. Carlos A. De A. Basto (address in care of Jules Geraud, No 43 Rua do Rozario), of Rio Janeiro, Brazil. Fig. 1 presents face and sectional views, and in Fig. 2 is shown the inner face of the lock,

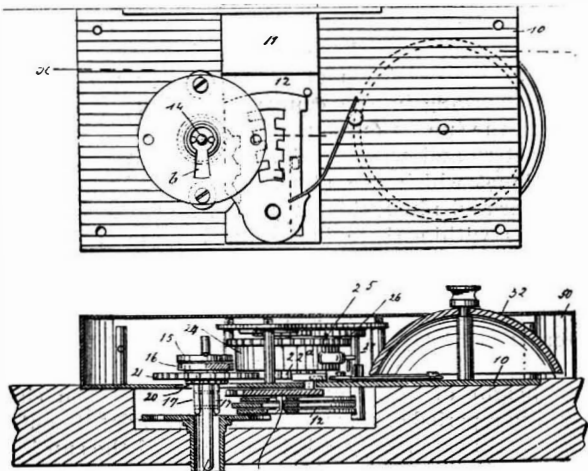

Fig. 1.—DE BASTO'S ALARM LOCK.

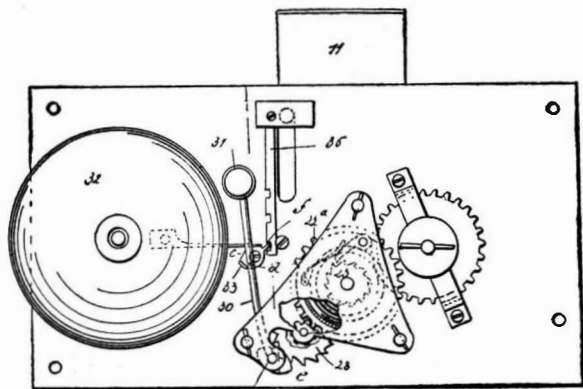

Fig. 2.—DE BASTO'S ALARM LOCK.

the guard or shield plate being removed and the parts represented as they appear when the locking bolt is thrown to the locking position. On the lock plate, 10, is mounted a locking bolt, 11, in connection with which is arranged a series of tumblers, 12, the key engaging a post, 14, which is in position to bear against the tumblers. The post carries a ratchet, 20, and on the post is loosely mounted a gear, 21, carrying pawls arranged to engage the ratchets, so that when the key is turned in one direction the gear will be advanced, and when turned in the other direction the gear will remain stationary. The gear, 21, engages a gear, 22a, carried by a shaft, on which is mounted a spring barrel, 24, carrying a gear, 25, that engages a pinion, 26, carried by a shaft, on which there is a ratchet or scape wheel, 28. In connection with the latter wheel is arranged an escapement lever, e, carried by a shaft, which also carries a hammer arm, with a hammer, 31, arranged to strike against a gong, 32, as the ratchet operates the escapement lever. There is also a special arrangement by which the ratchet will be held from vibration at all times except when the bolt is moved partially downward. In the construction shown, the alarm mechanism is inclosed in a case, 50, and it requires three turns of the key to carry the bolt home.

THE VICTOR SAFETY BICYCLE.

In the Victor safety bicycle, illustrated herewith, is shown a very perfect machine in respect to strength



THE VICTOR SAFETY BICYCLE.

and lightness, as well as in ease of running. It is manufactured by the Overman Wheel Co., Chicopee Falls, Mass. Two prominent features of construction especially characterize the machine, namely, the diamond frame and spring fork for the front wheel, the former possessing some of the elements of the bridge truss.

The spring forks are composed of four curved steel rods, made of the finest spring steel, of the same grade used in swords. These serve as a spring that has seven

ral inches of play, that is of even flexibility throughout its entire length, that permits up and down as well as front and rear motion, and that avoids the disagreeable vibration of the front wheel. In its construction eight and one-half feet of rod are used.

The wheels are built with tangent spokes and are practically everlasting. The spokes at the points of intersection are wound with wire, so that the whole wheel is a unit, and a single spoke never has more than its own share of work to do. The rims of the wheels are hollow, and are rolled from weldless steel tubing. They are of great strength, and the spokes are secured by threaded nipples to the rim. Counterboring is used to prevent wear upon the screw threads. The India rubber tires are compressed into the wheel by a chemical process without cement. If the tire is cut by a stone or other substance, the cut tends to close instead of open.

The sprocket wheel on the driving axle comes between the bearings, saving the rear forks and bearing from injurious and destructive side strains.

Dustproof ball bearings are used throughout. The machine contains the surprisingly large number of 176 balls. They are the Æolus balls, and are the best known.

The above is a resume of some only of the salient points of the Victor.

Articles Found in Cotton Bales.

According to the Providence (R. I.) Journal, at the Wampanoag Mills, Fall River, Mass., not long ago, the workmen in the picker room stopped a package of matches just as the bundle was disappearing into the picker. It had come out of a cotton bale the men had just opened. Had they gone into the machine, there would have been a lively blaze. Speaking of this incident, a man who has tended a picker for several years said that the things which come out of a cotton bale, and evidently grow on bushes, would astonish one. One day he heard something grind inside the picker, and, stopping the machine, found a silver spoon. Lizards and small snakes were common. A set of false teeth, small coins, knives, tobacco, and occasionally articles of more value have been found. These things undoubtedly get inside the bales accidentally, but there are other things which evidently get inside in accordance with a fixed purpose, and by strange coincidences they are found to weigh more than cotton, and not to be worth as much per pound on the market. Sand, scraps of iron, and dirt are often found wrapped inside a cotton bale for ballast.

LOW WATER ALARM AND FLUE CLEANING DEVICE FOR STEAM BOILERS.

The accompanying illustrations represent three patented improvements in steam boilers made by Mr. Cornelius J. Cronin, of Findlay, Ohio. Fig. 1 is a view from the rear of a portion of a locomotive type of boiler, so constructed that the flues may be expeditiously freed from scale, and having a low water alarm designed also to extinguish the fire before the crown sheet of the firebox is exposed. Fig. 3 is a sectional view of the alarm device, and Fig. 4 represents a different form of construction for facilitating the cleaning of the flues. The low water alarm is made by producing centrally in the crown sheet of the firebox an upwardly extending inverted cup-shaped offset, in the center of which is a threaded aperture for a hollow plug or carrier, from the bottom of which is an opening into the firebox, this plug or carrier to be filled with lead or an equivalent soft material capable of melting at a low temperature. When the water falls sufficiently to expose the upper surface of the plug, the lead is melted and runs down into the firebox, followed by the steam, which gives an alarm and extinguishes the fire. The device not only gives timely warning, but is preferably so arranged as to always leave a reserve of an inch of water upon the top of the crown sheet.

To facilitate the cleaning of the flues, the boiler shell has a transverse slot in its top at the rear of the tube sheet of the firebox. The walls of this opening are preferably strengthened by re-enforcing strips, and the cover, shown in section in Fig. 2, is bolted to the outer face of the shell with a washer or packing of asbestos or equivalent material. Near the bottom of the casing or shell, at each side, is a hand hole, closed by a steam-tight plate, through which the scale may be removed after it has dropped to the bottom of the casing. In the construction shown in Fig. 4, the boiler shell has a series of holes near the sides of the front wall, so arranged that the scraper may be introduced to the inside of the side wall at any height up to the water level, whereby the side walls and stay bolts may be readily cleaned. These holes are closed by tightly fitting screw plugs and at the bottom are the customary hand holes through which the sediment is removed.

NOTE.—The lister and drill illustrated and described on page 181, issue of March 22, was patented by William A. Loughry, of Odessa, Nebraska.

AN IMPROVED MEANS OF CHANNEL PROTECTION.

The accompanying illustration represents a means of permanently maintaining a navigable channel across a bar or bank, patented by Mr. Albert J. Mauermann, of Houston, Texas, and especially adapted for localities not favored by swift-running rivers or streams, wherein jetties may be used to advantage. Fig. 1 is a plan view of water courses having such a channel protector, Figs. 2 and 3 being vertical sectional views, and Fig. 4 a plan view at one end. The ocean, or deep water, being at B, and the adjacent harbor at C, the sand bar between is represented by A A, transversely across which the channel protector ranges, D D representing islands at each side which naturally promote accumulations tending to close the channel to the harbor. Two parallel walls or dams, E E, are built at suitable distances apart across the bar, to provide a permanent channel, and at their seaward end is constructed a submarine barrier, G, having two relatively inclined faces or wings meeting at the center and front of the channel. This barrier may be constructed of piles driven into the bottom,

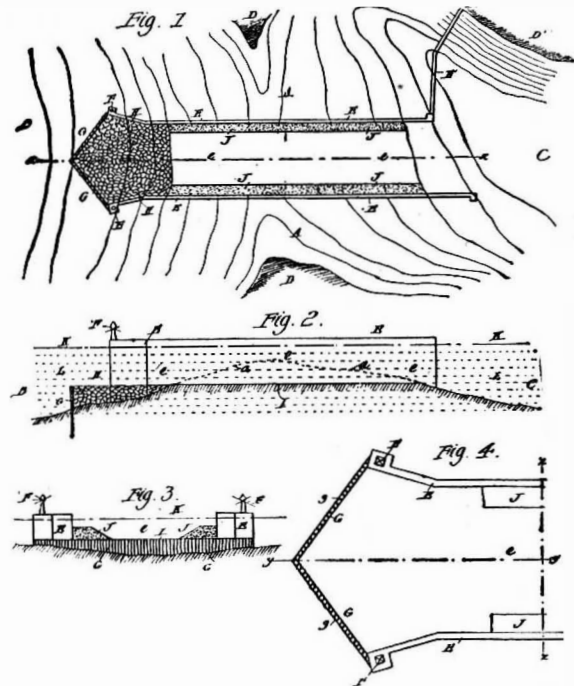

MAUERMANN'S PROTECTOR FOR SUBMARINE CHANNELS.

or of other material, backed with a filling or otherwise; but the top of the barrier must never be so high as to prevent the passage of a vessel through the channel at low water, and it must be built out sufficiently far into deep water to have its top range from ten to fifteen feet above the bottom, as shown in Figs. 2 and 3, to prevent the sand from outside washing over its top and facilitate its rolling down its natural slope. When desirable, a lateral extension, E', of the dam wall may be built to an adjacent piece of land, to prevent sand being washed into the harbor by water currents from the wall, E. The outline of the bar or bank cut away to make the channel is indicated by the dotted line, a a, in Fig. 2, the sand excavated being most conveniently dumped over the side walls.

Thirty-seven Millions of Cubic Feet of Gas per Day from a Single Gas Well.

A dispatch from Fostoria, O., January 10, says an attempt was made to pack the Northwestern Ohio Natural Gas Company's gas well on the Huston farm, but the packers were immediately blown out. Another attempt will be made to pack this monster well. It has increased 2,000,000 feet since it was drilled, and is now a 37,000,000 feet per day well, the largest and best well ever drilled.

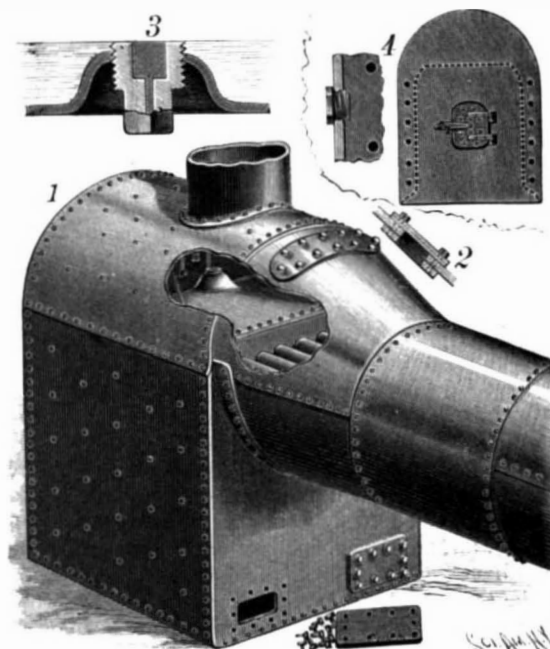

CRONIN'S IMPROVEMENTS IN STEAM BOILERS.

AN IMPROVED ATOMIZER.

A convenient spraying device, designed to force a continuous stream, has been patented by Mr. J. Fred Windolph, of No. 128 Flatbush Avenue, Brooklyn, N. Y., and is represented in the accompanying illustration,



WINDOLPH'S ATOMIZER.

a portion being broken out to show the interior. The flexible receptacle has a stopper, from which leads an air pipe bent in the usual manner, and having an outlet opening at its outer contracted end. The liquid pipe is within the air pipe and extends from near its outer end through the stopper and into the liquid. A valve is arranged in one side of the receptacle to close outward and open inward, there being also a similar valve opening inward on a cup-shaped bulb depending from the stopper, and through the bottom of which the liquid pipe extends. As the operator presses upon the outer receptacle, air is forced into the interior bulb at the same time that the liquid is being sprayed in consequence of such pressure. With the release of the pressure on the outer receptacle its valve opens to admit air, while the valve of the interior bulb closes, and the compressed air in the bulb continues to flow out through the discharge pipe, whereby the spray is made continuous.

AN IMPROVED KEY FASTENER.

A guard to prevent a key from being turned from the outside, and also to keep a key from falling out of the door when the latter is unlocked, is shown below, and has been patented by Mr. Taswill B. Armstead, of No. 345 East Forty-third Street, Chicago, Ill. The guard consists of a shank with spring metal

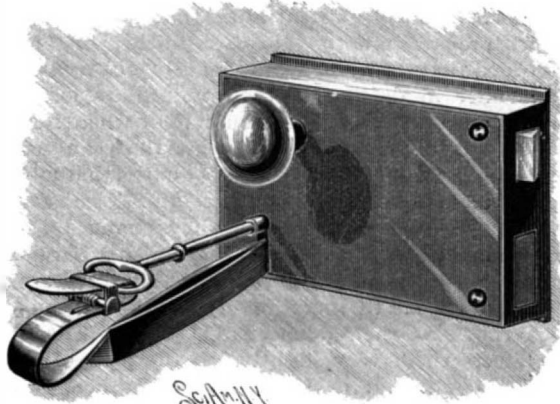

ARMSTEAD'S KEY FASTENER.

members bulged in the middle, its straight ends being adapted for insertion in the key hole, and having one of its members bent at the opposite end and returned on itself, terminating in one arm of a spring clasp lying at a right angle toward the key hole, in position to embrace the ring of the key. The other arm of the clasp is attached to the first arm by lugs and a pivot pin, around which is a coiled spring to hold the jaws normally closed, although they may be readily opened for the insertion of the key ring. In using the device, the key in the lock is turned to move its bit away from the key hole, when the ends of the shank are inserted, and the jaws of the clasp are caused to grasp the ring of the key, thus preventing the turning of the key or the picking of the lock from the outside.

"We have enough gas to burn up the world," said Harvey Hardy, of the Midland Investment Company. "In drilling for water we struck it at from 150 feet to 200 feet from the surface, and the wells roar like an engine blowing off steam. The driller, not knowing much about natural gas, struck a match, when it shot up 35 feet and made a flame as big as this building, nearly scaring the life out of the poor fellow. An expert familiar with the gas fields of Pennsylvania on seeing it pronounced it the right thing and to exist in sufficient abundance to pipe for fuel."—*Salt Lake City Herald.*

Those Who Will Follow Us.

I imagine that, when we look back from our home in the unseen universe ages hence, we shall see, without much doubt, a race of men differing from those of to-day as much as the man of to-day differs from his simious, perhaps simian, ancestors, writes Professor Thurston in the *North American Review*. The brain will be developed to meet the more complex and serious taxation of a more complex and trying civilization, the vital powers will be intensified, the man, reducing the powers of nature still more completely to his service, and they will be correspondingly and comparatively less powerful, though they will probably nevertheless, I imagine, continue to grow somewhat in size, as they unquestionably have grown since the middle ages; the lungs must supply aeration to a larger and more rapidly circulated volume of blood richer in the phosphatic elements especially needed for the building up of brain and nerve, the digestion must supply its nutriment in similarly increased amount and altered character and composition, the whole system must be capable of more rapid, more thorough, and more manageable conversion of the energies of the natural forces to the uses of the intellect and the soul which inhabits it.

The Need of Good Country Roads.

College professors, civil engineers, and magazine writers are directing public attention to the subject of country highways, and the Vanderbilt University, Tennessee, has gone so far as to provide for the free instruction in road engineering of one person from each county in that State. The *Baltimore Sun*, which is agitating the question in Maryland, points out that the power required to draw a wagon weighing, with its load, one ton on a level, macadamized road of broken stone is sixty-five pounds, which is increased to two hundred pounds on a common dirt road. Prof. Ely, of Johns Hopkins University, estimates that poor roads cost the farmer, on an average, \$15 per horse, and Prof. Jenks, of Knox College, Illinois, argues that with good permanent roads freight could often be hauled ten miles on wagons cheaper than it could be taken one mile on a dirt road to a railroad station, unloaded, put on the cars, and carried to its destination. Of the social influences of good roads, he says that "a large part of the mental inspiration of the farmers depends on their ability to attend church lectures, concerts, and social gatherings at a distance; and really good roads, by enabling them to go so much more easily would doubtless raise the whole intellectual tone of the farming community, besides keeping within the healthful influence of the farm many who are now forced into the towns."

AN IMPROVED END GATE FOR WAGONS.

An end gate especially designed for farm wagons, and adapted to be easily converted into a chute or shoveling board, has been patented by Messrs. Philip Steuerwald and Albert Cording, of Saunemin, Ill., the illustrations herewith showing different positions of the gate applied to a wagon box. The upper and lower parts of the gate are so hinged together as to be readily unhinged, and each part has a wide flange at each end to overlap the sides of the wagon body. The lower side of the end gate is held closed by two pivoted buttons, each having an inwardly extending hook on its upper end engaging a recessed plate in the lower edge of the gate, the lower ends of the buttons being connected by a rod, so that both may be turned at once. On each side of the upper portion of the wagon box is a plate to which is pivoted one end of an extensible lever, in the other end of which is an eye, each such lever engaging a hook on each side of the upper flange of the end gate. The parts of this lever are so pivoted together that they may be folded one upon the other and locked closely to the wagon box, as shown in one of the views, or the lever may readily be entirely removed from the wagon. The lower flange of the lower end gate has on its inner side a slotted adjustable slide having an eye adapted to engage a pin on the wagon box, whereby the lower part of the end gate may be fastened to the wagon box when the upper part is removed. One of the views represents the end gate in position as a chute or shoveling board, and the dotted lines in the other view show how, by swinging outwardly the lower portion of the gate, grain or other material may be easily unloaded. If the lower part only of the gate is to be used, its upper portion may be readily removed, or the whole may be swung bodily to the top of the wagon box for a seat.

A PORTABLE LEMONADE HOLDER AND GLASS WASHER.

A compact, convenient, and cleanly portable receptacle for lemonade, with glass washer attached, is represented herewith, and has been patented by Mr. Stillman Wilkins, of Albia, Iowa. The two vessels are united by a vertical web, and each have depending concentric flanges around the edges of their partially closed upper ends as splash guards. The beverage compartment is a smaller cylindrical chamber in one

vessel, the dead air space thus provided being designed to retain the properly prepared lemonade in a cold condition. Within the other vessel is a bracket plate to retain glasses or drinking cups in upright position, there being sufficient rinsing water in this vessel to keep the glasses cool, as well as to clean them, while

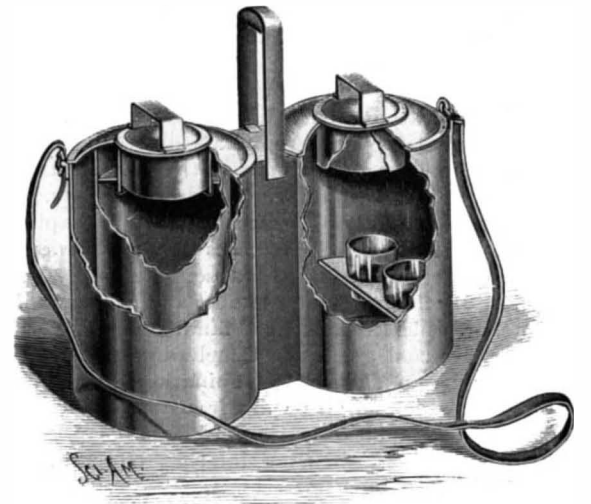

WILKINS' LEMONADE HOLDER AND GLASS WASHER.

dust and flies or other insects are excluded. The lid is preferably made of sheet metal in plug form.

A NUT AND WASHER FOR VEHICLE AXLES.

A device designed to prevent the unscrewing of nuts on vehicle axles when the wheels are moved rearwardly, and also applicable to other mechanism where nuts are liable to be loosened by frictional contact, is represented herewith, and has been patented by Mr. Jonathan L. Sullivan, of No. 1209 Canterbury Street, Austin, Texas. Fig. 1 shows the application of the nut, with its loosely attached washer bearing against the wheel hub, and Fig. 2 is sectional view. The threaded end of the axle spindle has two opposite longitudinal shallow grooves, and the nut has an integral radial flange on its inner end, a cap ring being adapted to be secured on this flange by rivets. In the side of the cap ring next the flange is produced an annular recess, adapted to engage inturned ears of a cylindrical shell washer, loosely fitting around the cap ring and nut flange. The ears are bent to place in the cap ring after the latter is seated in the shell, and these ears are adapted to engage the longitudinal

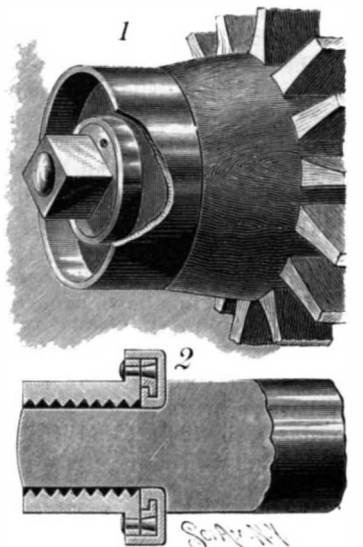

SULLIVAN'S NUT AND WASHER FOR VEHICLE AXLES.

axle spindle, whereby the shell and attached ring will slide inwardly until the threads of the nut engage the mating threads of the spindle end, when the nut may be revolved to screw it to place and the compound washer will slide before it, held from rotation. When the washer shell is in contact with the shoulder of the spindle, it receives the frictional action of the hub and permits the nut to remain as it was adjusted.

By orders issued by both the Minister of War and the Minister of the Navy, army and navy physicians have been forbidden to use hypnotism in the French services.

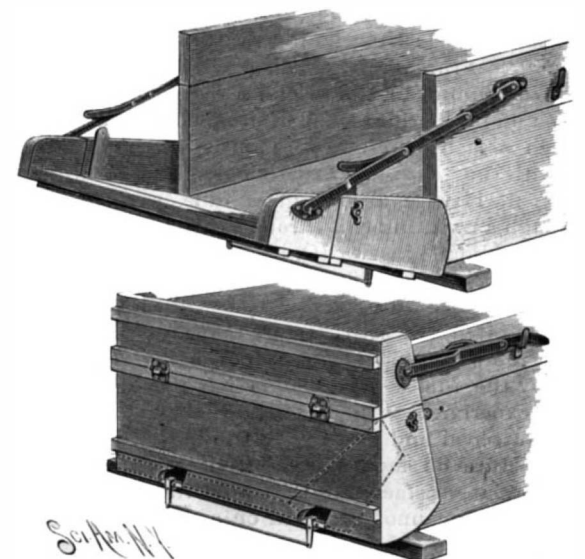

STEUERWALD & CORDING'S END GATE FOR WAGONS.

Experimental Lectures on Chemistry.

The Four So-called Elements of the Ancients: Fire, Air, Water, and Earth.—Introductory remarks. Contrast limited knowledge of ancients, who knew only these four elements, with chemical science of present date. 1. Fire.—The heat given off when bodies burn or combine chemically. Explain chemical union of parts of burning body with O of the air, such as coals in a fire being converted into C and O. Burn taper in bottle; pour in lime water; explain result. Show H₂O produced by holding glass over flame. 2. Air.—Composition of atmosphere; use of N in the air. Explain what goes on when we inhale and exhale air; also action of plants and animals on the air. Remarks on density of atmosphere, winds, explosions, etc. 3. Water.—Its composition, which show, and explain properties of H and O. Short notes on various waters—spring, salt, rain, distilled, hard, soft, etc. 4. Earth.—A solid. Its composition; metallic and non-metallic elements, of which name a few familiar ones. Coal, its properties; coal gas, etc. Concluding remarks.—A few remarks on chemical combinations in definite proportions, which might be illustrated by one or two simple chemical equations.—*Samuel Lawrence.*

Something about Elements.—Materials required: Fe, C, Pt, glass, brass, bone, gold, O, H, N, S, P, aq. calcis. Define element, atom, molecule. Show Fe, C, Pt, and contrast with glass, brass, bone. Gaseous elements: Show O, H, Cl, N, just as much elements (though invisible) as S, Au, Fe. Describe their wonderful power. C and O would suffocate; H and O fired together would shatter this room; Cl would stop our breath. Bullet: Pb fired from rifle by gaseous element, or by compressed air, how fatal. Explain mining accidents, earthquakes, thunder. Explain composition of air we breathe, with use of each element. O keeps us alive. Show supporter of combustion, O, and the lime light. S in O on spiral wire; Fe in combination with O; put P in O=PO₂. Say how this is all constantly going on silently and unnoticed around and within us. The process going on in our lungs; N, very inert, does not support respiration; does not burn. Aq. vapor CO₂; make some. In our breath; blow in aq. calcis. Need of ventilation.—*Charles Wilson.*

Glimpses in Chemistry.—1. Explain uses of sympathetic inks. Have a drawing (landscape) in CoN₂O, and heat it, and letter written in same. Milk, lime juice, and H₂SO₄; similar, except latter being permanent. 2. Show action of HCl on bone, and explain use of lime salts in food, lime water, etc., for children, for rigidity of bone material, etc. 3. Bismuth (and lead carbonate in common). Face powders: show action of H₂S on face mask covered with PbCO₃ face powder. Relate experience of Professor Black lecturing to a fashionable audience on "Harrogate Water;" it being handed round in a bowl, came to a lady, who, smelling it, went black in the face. 4. Bleach a red cabbage (moist with H₂O) with SO₂. State use of SO₂ in bleaching feathers, straw, etc. 5. Exhibit De la Rue's floating battery, with an explanation. 6. Show action of mordants in dyeing, and dye several pieces of cloth various colors. 7. Show how primitive torpedoes were made by action of 1 or 2 drops strong H₂SO₄ on dried mixture pot. chlor. and sacch. alb. (in fume cupboard)—flash, bang, and a smell—experiment; exhibit drawing of torpedo. 8. Show how to produce a white solid from two liquids (strong sol. alum. + strong sol. sod. phos.), vel. MgSO₄ + sod. phos. 9. Show effect of light on Ag salts (AgI or AgCl), previously exposed for time, or use rough negative; hence use of Ag salts in photography. 10. Show action of H₂O₂ in arts as bleaching agent, for hair, picture cleaning, etc., and show its difference from water by collecting evolved oxygen when heated (by incandescent taper).—*Cotopaxi.*

Chemical Chats.—First, show the burning qualities of alcohol by igniting some in a saucer. Now saturate some with NaCl, boracic acid, stront. nit., in separate dishes; apply a light; result, three differently colored flames. Show the carbon in sugar by mixing with it some pot. chlor., place in dish, add few drops H₂SO₄ on glass rod; result, takes fire; carbon left. Make hydrogen, apply a light to it; also from another apparatus collect some H₂O; ignite; result, explosion. Oxygen: collect three bottles full, place in one a piece of lighted sulphur, in the second a piece of glowing carbon, and in the third a coil of iron wire with a lighted match attached; result, wire burns in the O. Wind up with the following experiment: Take an ordinary flask, fit it with a long glass tube, say 18 inches, through a cork, insert it through the mouth, expel the air by adding 3j. AmHO, heat over spirit lamp for a few seconds, place finger over the mouth of the tube; now turn it upside down, the tube into a glass of water tinted red with litmus, take away the finger, then the water will ascend into the inverted bottle, and by the fumes of ammonia left it will turn blue. This experiment will show how alcohol alters the color of blood and destroys its vitality. I have given this lecture on more than one occasion, and it has given great satisfaction. Of course there is a lot of detail which cannot be given on a post card.—*R. H. Richards.*

Chemical Curiosities.—Experiment 1.—Lighting

candle by touch.—Candle, chlor. potass. powdered, sugar powdered, aa. Spread out candle wick, dress with a few grains of powder, have small pot containing acid. sulph. behind the candle. After introducing the subject, make the remark that a chemist is nothing at all if he cannot at all times get a light. Dip the point of finger into the acid, bring it down on the chlor. potass. and sugar. Flame will at once light candle. Have a wet rag ready to wipe finger. Experiment 2. Illustrating the power of oxygen in supporting flame and animal life.—Have a 30 oz. or 40 oz. stoppered bottle filled with oxygen. Take a splinter of wood, light it at the candle, plunge it into the bottle of oxygen, remove, blow out the flame, and repeat this till the oxygen is exhausted. Experiment 3.—Follow up by showing that, although the oxygen has been removed, it has been replaced by carbonic acid. Pour an ounce or two of lime water into the oxygen bottle, and shake. Result: Lime, carbonate, chalk. Show that oxygen forms $\frac{1}{5}$ of our atmosphere. Experiment 4.—Take a soup plate, fill with colored water, also a wide-mouthed bottle; have a piece of sponge fixed to a piece of bent wire, dip the sponge in spirit, light it, invert the bottle over the flame into the plate; as the oxygen burns, the water fills its space. Follow up the hint on atmospheric pressure given in the last experiment with a few remarks about its power—15 lb. to every square inch. Explain that it caused the water to rise in last experiment. Experiment 5.—Have a hard-boiled egg, with the shell off, placed on top of a W. M. bottle (not wide enough to let the egg in) in full view of the audience; light a piece of paper, put it into the bottle, and replace the egg on the mouth of bottle. The egg at once elongates itself, and drops into the bottle. Experiment 6.—Take a small tumbler, goblet shape (with foot), so small that the naked hand can easily cover it; light a piece of paper, place it in the tumbler, and immediately cover with the right hand. The tumbler becomes fixed to the hand, and requires considerable force to remove it. This experiment may be repeated several times, by allowing the chairman, a lady, or child to pull it off, which they are always very pleased to do. Experiment 7.—Select a large seidlitz tumbler, place it on an empty soup plate, fill it with water; place a piece of ordinary writing paper over it, so as to cover without a large margin; place the left hand on the paper, lift and invert the tumbler with right hand, the water remains suspended in tumbler. Draw attention to the fact that the paper is pressed into the tumbler instead of out, which we would expect the water would do. A few nice effects may now be shown with chemical reactions. Experiment 8.—Make iodide of lead, red iodide of mercury, etc. Mix infus. galls and sol. sulph. iron—ink; mix sol. yellow pruss., potash, and iron—Prussian blue. Make saturated solutions of carbonate of potash and muriate of lime, half fill a tumbler with each, pour one solution into the other; keep pouring them backward and forward from tumbler to tumbler—it gradually gets thicker and thicker, until it becomes solid and will not pour. Mix sol. nit., baryta, and acid. sulph. Mix acid mur. solution with a few drops of solution nit. silver. Mix sol. of sulphate iron with sulphocyanide of potassium. Produces a red. Make a few general remarks on metals, their weight, etc.; show a metal that is so soft that it can be moulded between the finger and the thumb, so light that it floats on water, and has the wonderful property of going on fire when it touches water. Experiment 9.—Burn potassium. Draw attention to the beautiful purple flame. Make a few remarks on colored flames and their use in analysis, fireworks, etc. Show copper, soda, strontium, baryta, in flame of burning spirit. Experiment 10.—Burn a piece of magnesium wire. Experiment 11.—Have a small kettle or flask of water boiling, $\frac{1}{2}$ lb. of lump sugar, a soup plate, a glass rod, and a $\frac{1}{2}$ pint tumbler. Place the tumbler on the plate, fill it with sugar, throwing a few lumps among the juvenile part of the audience to show that there is no deception; now pour the hot water over the sugar, stirring till a thick sirup is formed; pour sulphuric acid steadily into the sirup; it will first get brown, and then become black, will then foam up and overflow the tumbler, and fill the plate with charcoal, because the sulphuric acid takes the water from the charcoal; a splinter of clean wood shows the same result if put for a moment in the acid. The lecturer's watch will now inform him that time is up; but to make sure of a grand finish, let the gas be lowered and a 2 oz. box of red flame burned on a shovel. When the gas is turned up again, let him remark that he had commenced by lighting the candle by chemistry; he would now extinguish it by another experiment. Let him pour a quantity of carbonic acid over the flame, which will at once put it out. Finis.—*Archd. Paterson.*

Chemistry of a Candle.—(1) Early history of candle manufacture and materials used. (2) Materials used at the present time, their chemical composition, and their relation to one another. (3) The mechanical formation of a candle, the structure of the flame, and the natural laws involved. (4) The theory of combustion, the products of combustion, and the similitude of this combustion with our own respiration. (5) The laws which preserve the equilibrium of the atmosphere through

the action of the vegetable kingdom, in the presence of sunlight. (6) A general summary of the foregoing outline, and a caution in the matter of ventilation in shops and factories, and the value of green leaves in the preservation of our lives. (7) Experiments with lime water, proving the above, both from the candle and the lungs, and also an experiment on the balance, showing from these data the indestructibility of matter.—*Walter E. Martin.*

Chemical Affinity.—Introduction: Elementary substances held together by a force—chemical affinity—of which nothing is known. Contact of certain substances with each other. New substances appear which differ more or less in properties from original substances. Composition of elements. Difference between molecules and atoms. Disposition of atoms to form substances which go to compose universe, controlled by forces such as gravity, cohesion, heat, light, electricity, chemical affinity, pressure, violent concussion. Chemical affinity the foundation of the whole science of chemistry. Mutual affinity of substances differs very greatly. Experiment.—Chlorine and turps: Explain action by simple chemical equation. Description of carbon—various forms, diamond, coal, etc. Carbonaceous materials used as fuel derived from organic structures. Power of sunbeam one of the great mysteries of nature. CO₂ decomposed in a leaf—carbon retained and oxygen given off. Relation of carbon to organic structures. Oxygen, H, and N; briefly describe, etc. Series of changes in which CO₂ plays an important part. Experiment with marble, HCl, and gasogene. Soda water. Hard water "killing" soap. Properties of CO₂. Experiment.—Pour gas upon lighted candle. Example of chemical affinity—Iodine and phosphorus. Ferri sulph., acid tannic, oxalic acid. Water and wine trick. Potassium thrown upon water. Influence of cohesion on chemical affinity. Experiment with antimony in lump and powder upon chlorine gas—terchloride of antimony result. No mechanical process of subdivision will break up a chemical compound. Experiment.—Triturate lump sugar. Experiment.—Action of H₂SO₄ upon sugar solution. Power of adhesion in chemical affinity. Experiment.—Seidlitz powder. Difference between a chemical compound and mechanical mixture. Gunpowder a mechanical mixture, etc. Affinity of one substance for another under adverse circumstances. Experiment.—Phosphorus, chlorate of potash; under-water addition of H₂SO₄ per funnel tube. Appropriate quotation from Huxley.—*F. Jardine.—Chemist and Druggist.*

The Masses in India.

The Indian peasantry has changed in no characteristic features from what it was in the early periods of the Aryan age. In those days the tillage of the soil went on in the presence of contending armies. It was understood that the cultivators were not to be molested by either party, and thus they were at liberty to cultivate relations of benevolent neutrality, that is, of indifference with regard to both. Nowhere in their history is it recorded that they ever spontaneously took up sword and buckler in defense of their immediate lord, or more distant overlord. They could fight when forced to do so, but it had to be in a cause that concerned themselves, without reference to any quarrel that might be going on between their own chief and those of any outsider. In what respect have they changed since those remote times? So long as they are not harassed or plundered in the cultivation of their Lilliputian farms, they little care as to the form of government under which they lead their laborious existence. The salt duty affects them very slightly. If the price of that universal condiment be low, they may indulge in its use a little more freely; if it be high, they deny themselves, or pay their money with grumbling. It is simply a bazar commodity, and is liable to fluctuations like any other form of seasoning. They buy it from day to day with the other materials of their simple meal, and scarcely know if the pinch they receive be a little greater or a little less than usual. They do not trouble themselves to inquire into the causes of the variation of its amount. Cheap salt means health for their children and cattle, and a larger preservation of fish, but they never pause to ask if it would be more plentiful under Home Rule.—*Madras Mail.*

Buffalo Bill's Cowboys in Rome.

Since the closing of the French exposition, Buffalo Bill has gone to the Eternal City, and is astonishing the old and young Romans by his exploits.

The Duke di Sermoneta had assured Buffalo Bill that he had horses on the Campagna at his estate of Cisterna which he defied the cowboys to ride. It was impossible even to put a halter on them, and they had to be left wild, although they were valuable animals. The challenge being accepted, three horses were, with much difficulty, driven into the city, and after a most exciting struggle, two of the most powerful were lassoed, saddled, bridled, and ridden by the cowboys, in the presence of about fifteen thousand people. Prince Napoleon was among the audience. The excitement ran so high because the famous herdsmen of the Campagna are supposed to be able to ride anything.

Correspondence.

Discovery of Comet Brooks a of 1890.

To the Editor of the Scientific American:

I have the pleasure to announce my discovery of a new comet—the first one of the present year—on March 19, 16 hours. It is situated in the eastern morning sky, right ascension at discovery 21 hours 9 minutes; declination north, 5 degrees 35 minutes. Clouds prevented any observations of the new object until this morning, when I found it less than one and one-half degrees to the north of the place of discovery. Its daily motion is therefore quite slow, amounting to only 22 seconds of time east and 25 minutes of arc north.

The comet is rather bright telescopic, and has a stellar nucleus and a short, broad tail.

From its apparently slow motion it is probably at a great distance from the earth, and is either receding or approaching quite rapidly.

Further observations will be needed to definitely settle these points, and hence the future developments of the comet.

WILLIAM R. BROOKS.

Smith Observatory, Geneva, N. Y., March 24, 1890.

The Trouble with the Vesuvius Explained.

To the Editor of the Scientific American:

In your valuable journal of March 22, 1890, you say under the heading of "Trying the Air Guns on the Vesuvius," "Can anybody tell us what is the real trouble?" The facts are that the dynamite gun has been tried with wooden pegs, and on March 13 with gun cotton, but not with dynamite. The gun is made in sections, and that section nearest the breech is opened and lowered to receive the charge, and when it is shut and fastened in position, it does not come up true and make a perfect fit with the balance of the barrel, the consequence being that the charge, when fired, tears through the balance of the barrel; and if dynamite were fired, the gun would be exploded, and the person firing it, together with the Vesuvius, in all probability would not be heard from, but with a wooden peg nothing happens other than the tearing out of the barrel, which has taken place on more than one occasion.

A SUBSCRIBER.

New York, March 26, 1890.

Aristol—A New Antiseptic.

The combinations of iodine with phenols led to the production of a series of new compounds, many of which possessed striking antiseptic properties. The above-named "aristol" is one of these, which is the product of reaction between thymol and iodine. More than one of such combinations can be formed, which were tried against skin diseases, and in a large number of cases produced extraordinarily beneficial effects. Of these new bodies it has been said that they ought to replace iodoform on account of the absence of toxic properties and of all odor, while it is not improbable that even iodol and soziodol salts will also have to give way before them. Monoiodthymol has the iodine substituted in the "ring," while in aristol it substitutes the hydrogen of hydroxyl. From this circumstance it derives its greater instability and probably also its greater activity.

Aristol is a reddish-brown amorphous body, which may be obtained by precipitating a solution of thymol in aqueous soda-lye by a solution of iodine in iodide of potassium. The reaction may be expressed by the following equation:

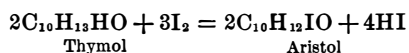

though there seems to be some doubt about the real constitution of the body. By distillation with chalk, dithymol is obtained. The proportion of iodine present is stated as 45.8 per cent, but it is added that care has to be taken in the process of manufacture, or else a product of inconstant composition is formed. According to Messinger and Vortmann, by the reaction of iodine and thymol in alkaline solution, first monoiodthymol is formed, which then condenses to a dithymol, in each thymol molecule of which the hydrogen of the hydroxyl group is displaced by iodine.

Aristol is insoluble in water and glycerine, slightly soluble in alcohol, and freely in ether. It also dissolves when rubbed with fatty oils (if warmed together, decomposition occurs), a property which facilitates its medical application; it adheres lightly to the skin, and can be with equal benefit used as a dusting powder on the surface of wounds. In cases of mycosis it produced the most favorable results, and for lupus is believed to be the best remedy hitherto tried.

The only really active agent at present known as useful in psoriasis is chrysarobin, which colors the skin and induces conjunctivitis; aristol was therefore tried also in this direction, and was found to be equally effective as chrysarobin, and quite free from its irritating and staining properties. On the whole, considering the activity, the non-poisonousness, and the freedom from odor of the new compound, there seems to be reason to believe that we have in aristol a most valuable antiseptic.—*Monthly Mag.*

Tin in Ancient and Modern Times.

Among metals, tin is no doubt one of the earliest that has been in use, as we learn from a highly interesting, if somewhat discursive, article which appears in the *Revue Scientifique*, from the pen of M. Brau de St. Pol Lias, of which we give an abstract. It is one of the most precious and interesting of metals. It ranks next to gold and silver for intrinsic value among ordinary metals. It has the color and nearly the brilliancy of silver when pure, but it is less resisting and more malleable. Tin heated by rubbing has a very pungent odor and taste. When bent, the disaggregation of the crystals forming its mass, without any breakage being produced, makes a peculiar noise which metallurgists call the crackling of tin, and which enables a practiced ear to form a fairly accurate idea of its degree of purity. Tin is not found in many places, being thinly sprinkled over the surface of the globe. It is not found everywhere, like gold for example, and it lies hidden under the form of a blackish mineral, which, to a profane eye, has not the least appearance of being the receptacle of a metal.

The Malay Peninsula, the Golden Chersoneses of the ancients, may be considered its natal land, and it still remains the true country of tin. It is contiguous to the equator, at the southeast extremity of Asia, separated from Sumatra by the Straits of Malacca. It is reached from Europe by the well known route across the Mediterranean, Suez Canal, Red Sea, and the Indian Ocean—about one month by steamer—disembarking either at Penang or Singapore. Penang at the entrance, and Singapore at the head of the Straits of Malacca, are two islands and two English towns. The Peninsula of Malacca at the present day, moreover, is English from one end to the other, or tends to become so. Perak, in Malay, signifies silver. It is the name of the tin district *par excellence*. The manner in which a tin mine is attacked and worked at Perak is of the greatest simplicity. After having cleared the land of the brushwood, the vegetable soil and the unproductive layers, ranging from 3 to 10 feet in depth, are taken away, in order to lay bare the ore, the stanniferous stratum, which has sometimes a thickness of 10 feet. The washing of stanniferous soils is done by coolies provided with rakes, who take away the pebbles, and mix the materials so as to eliminate the light sands, mingled with oxide of tin, until at last there does not remain more than from 25 to 35 per cent of foreign substances. The ore thus selected is smelted in small brick furnaces from 5 feet to 6 feet 6 inches high, blast being supplied by a bamboo bellows, a coolie moving a horizontal piston backward and forward. A bright white metal is obtained, cast in moulds which give it the well known form of the cubic ingots called block tin, with an elongated face and projecting on both sides so as to form ears, which enable the ingots to be more easily handled. The ore is very rich, the metal pure, but the way in which the Chinese work it is ridiculous, and the quantity of metal wasted great. A fresh washing of what is thrown away would still be very remunerative. The Chinese and Malays call that "tima monda," young tin, and they restore it to the earth, doubtless in order that it may ripen, the metal being considered by them not old enough to remain in their primitive machines. It is only now that a beginning has been made to work these Perak mines in a rational way, yet for many centuries tin has been known and worked in the Malay Peninsula.

The use of tin goes back to the highest antiquity. Homer mentions tin, "kassiteros," in describing the arms of his heroes. Herodotus, the father of historians, calls the British Isles "Kassiterides." The Phœnicians in effect found it in these isles, a little also in Gaul and the Iberian Peninsula, the tin which they spread through the ancient European world. But before the Phœnicians and the Greeks, the Chaldeans were acquainted with tin under the name of "kastira." Tin 5,000 years ago was designated by the word "anaku." The text of the Bible where Moses mentions tin is in the Book of Numbers. In ancient Egypt bronze statuettes of a tin alloy have been found which date from the epoch of the Pyramids, 3600 B.C.

In a recent work (*La Néerlande Industrielle*, Brussels, 1887), M. De Ramaix gives these statistics:

	Tons.
Dutch Indies, islands of Bangka and Billiton, etc.	10,000
Cornwall	8,000
Australia	7,000
Total	25,000

The Malay states of the isthmus of Malacca exported to Penang in 1877, in round numbers, 2,500 tons of tin, and the Siamese states of the same country 7,000 tons, being over 9,000 tons. Personal information permits us to establish that the exports from Perak in 1881 amounted to 6,139 tons. At the present day the total production of the world may be estimated annually at nearly 45,000 tons.

There is scarcely a household, however humble, in which some article in the manufacture of which tin enters is not met with. The amalgam of tin applied to glass is so common that there is hardly any uncivilized country into which mirrors have not found their way with European glassware. Soldering, which

is employed in innumerable ways, requires tin chiefly. Tin foil makes good wrappers for food. Type metal, used by type founders, has tin in its composition.

In the middle ages tin passed from the Gauls to the Merovingians. Even the roofs of basilicas were formed of it, according to Gregory of Tours, and coverings for tombs. It was much used in convents, where it was wrought for a long time, and in churches, where it was made into religious objects of all kinds—crosses, candlesticks, holy water founts, basins, jugs, cruets, organ pipes, ampullæ, pilgrims' badges, etc. It has been used in the tenth century with gold and silver for the making of sacred vessels, when wood, lead, copper, and bronze were interdicted as common or insalubrious, and glass on account of its fragility. Bishops and priests were buried with their emblems, crosiers, and chalices represented in tin.

It is chiefly in the fourteenth and fifteenth centuries that the use of tin became popular in Europe. Tinplate became common in every-day use, even with the peasant and the workman, extending even to the animals.

The most wonderful works of art which have remained from that age were produced in France and Germany, chiefly at Nuremberg. Tin has had all the honors of the precious metals. It shares with them yet another advantage, that of perfect salubrity. On that account, medicaments which might be spoiled by contact with other metals were preserved in tin boxes.

Tin is a wholesome metal *par excellence*, and it owes to this quality, besides the numerous uses already mentioned, an application of a most important kind—tinning, which was invented, as Pliny attests, by the Gauls. If the Auvergnois were the first tinkers, it is consoling to meet at length, what is so rare, inventors who have not allowed themselves to be robbed of the benefit of their invention, and have enjoyed it for a long time.

Again, to-day, after twenty centuries, traveling workmen who traverse all the villages of France, and perhaps those beyond her frontiers, making the well-known cry heard, "Spoons, forks, saucepans to tin," and working in the open air, to the infinite glee of children, are the tinkers of Auvergne. It is by tinning that tinplate is obtained, which is merely sheet iron tinned.

We shall have passed in review all the chief uses to which tin is devoted when we recall to mind the casting of bells, statues, and all the bronze or brass objects in the alloy of which we find tin at every age, and even with the ancient Egyptians, the date of which has already been fixed at the thirty-sixth century before our era. But from where could the tin come at so remote an epoch?

Which was the country, producing tin, sufficiently advanced in civilization more than fifty centuries ago for its inhabitants to have had sufficient knowledge to enable them to recognize the metal in this oxide, with blackish grains of sand, which is its ore, and a social organization such as to enable them to undertake and successfully conduct the long operations of extraction, washing, and metallurgic treatment demanded in the exploitation?

In one of the most remarkable and most interesting works written on this subject ("L'Étain," by Germain Bapst; Paris, E. Masson, 1884), the author is inclined to think that it was the Malay Peninsula. A curious comparison has been made between the names which the Malays of the Peninsula give to tin and lead, "tima pouté," white tima (tin) "tima itam," black tima (lead), and the names given to them by Pliny, "plumbum candidum," white lead (tin), "plumbum nigrum," black lead (lead), and also between this Malay name "tima" and the English, Dutch, Danish "tin," German "Zinn," Swedish "tinn."

Etymologists, doubtless, ask themselves whether this Malay appellation of tin—at a time when the Kassiterides, yet nameless, lay in the solitude of their dense forests, like Gaul and Iberia, in the pre-historic epoch of our countries, when the primitive populations of Switzerland, who also used tin for ornamenting their earthen vases, had not yet built their lake dwellings—did not leave Malacca, and arrive, much later no doubt, borne through slow migrations, but directly, and over the heads of the Assyrians and Greeks, as far as the extremities of Europe. Thus it would be the Malay Peninsula, covered at the present day with virgin forests, which at that time was at the head of the civilized world, possessing everything which constitutes the last expression of progress, without doubt, under very different forms.

Preserve for Binding.

The publishers of the SCIENTIFIC AMERICAN would advise all subscribers to preserve their numbers for binding. One year's issue (52 numbers) contains over 800 pages of illustrations and reading matter. The practical receipts and information contained in the Notes and Queries column alone make the numbers worth preserving. Persons who have subscribed since the commencement of this year can have the back numbers sent them on signifying such wish. Their subscription will then expire with the year.

ELECTRO-PNEUMATIC BLOCK SIGNAL SYSTEM.

(Continued from first page.)

the counterpoise weight into the "Safety" position. The object to be attained, therefore, is this: When the train is on the block in advance of a set of signals, it must automatically cut off the current of electricity from both, so that they will both be drawn into "Danger" position. When the train is on the next block, the current of electricity must be again permitted to pass through the upper semaphore magnet, forcing it into "Safety" position; but no current must be admitted to the lower semaphore magnet until the second block has been passed.

Assuming, therefore, a supply of compressed air with battery to be given, the connections are carried out on the following basis: The rails for one block are insulated from the rails of the preceding and following blocks. At one end the right and left hand rails are connected by a wire containing in its circuit two cells of gravity battery. At the other end the same rails are connected through an ordinary relay. The battery is placed upon the end of the block first touched by the train. As long as no train is on the block, a current will pass through the relay, whose armature will be attracted, making a constant contact for the current of a local battery. When a train enters upon the track, its wheels and axles short-circuit the battery, so that the relay is thrown out of action and the circuit of the local battery is broken. To simplify the matter we will assume, first, that only one set of signals, the "Home" semaphores, are to be worked. The arrangements for this are shown in the diagram, Fig. 5. A local battery of eight cells is arranged in circuit with the magnet of the semaphore and with the relay, so that when the latter is excited a current passes through the semaphore magnet, the local battery circuit being closed by the relay.

When no train is on the block, it will be seen that the relay is in action; it closes the local battery circuit. The current from the local battery going to the semaphore magnet forces open the valve, compressed air is admitted into the semaphore cylinder, and the piston is driven down and the semaphore is forced into the "Safety" position. When a train enters on the block, the relay being thrown out of action as described, the local battery ceases to act upon the semaphore magnet, and the semaphore is drawn by the weight into "Danger" position.

Where the "Home" and "Distant" signals have both to be operated under the conditions described as in use upon the railroad we are describing, a somewhat more complicated arrangement of circuits is required, which is shown in the diagram, Fig. 6. The line battery and relay are identical with what has been described. The local battery circuit includes, as shown in the diagram, within its circuit a "Distant" signal at the commencement of one block, and the "Home" signal at the commencement of the next block in advance. To save wire a ground circuit is used as the return. Thus, when a block is occupied by a train, it sets, by the action just described, the "Distant" signal one block behind it at "Caution," and the "Home" signal directly behind it at "Danger" by short-circuiting the single relay. The lower end of the piston rod of the "Home" semaphore is provided with a circuit-closing switch, indicated conventionally in Fig. 6, under each upper signal. One terminal of this switch is connected to ground, the other terminal is connected to the wire leading to the magnet of the "Distant" signal below it. The circuit closer closes the circuit when the piston is in the upward position or when the "Home" semaphore is at "Danger." This establishes a ground connection for the line leading to the "Distant" semaphore magnet below it, which connection is of zero resistance. This operates as a shunt to the "Distant" semaphore magnet, so as to throw it out of action. It will be remembered that when a magnet is out of action its semaphore is set at "Danger." Therefore when a "Home" signal is set at "Danger" by the passage of a train, the "Distant" signal below it is set at "Caution" by this action of the circuit-closing switch, and the "Distant" signal one block in its rear is also set at "Caution," because it is in circuit with the "Home" signal magnet in question.

It is obvious that where electricity and compressed air are depended on as the agents for the working of an automatic system, failures in their action are to be anticipated. In the present system, should electricity or pneumatic action fail, the signals affected would at once rise into the "Danger" position. It is here that its peculiar safety ap-

pears. The signals are only maintained at safety by the perfect working of the apparatus. The instant anything happens, the semaphores disclose it to the runner of the first train passing, by the signals assuming the "Danger" position.

As regards the details of its installation, the batteries

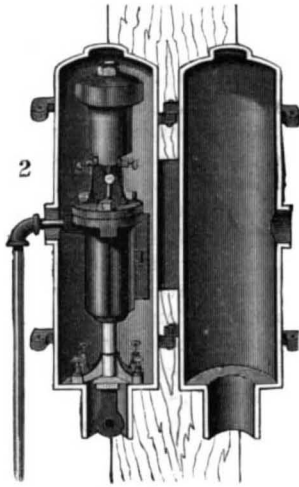

MECHANISM FOR MOVING SEMAPHORE, ETC.

are established in underground structures, a sectional view of one of which we show in the cut, Fig. 3. The same cut shows the relay pole, upon which the relay boxes are placed. In order to supply compressed air, a plant of compressors is established which communicates by pipes with a series of reservoirs placed along the line at the foot of the signal poles, and pipes are carried from these to the semaphore signals. The ordinary sleepers are found to give sufficient insulation to the rails; the fish plates, however, do not form adequate

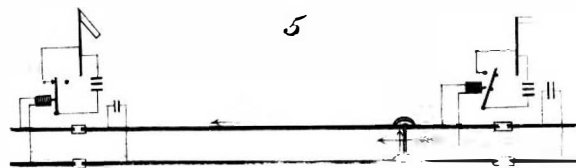

SINGLE SIGNAL BLOCKING.

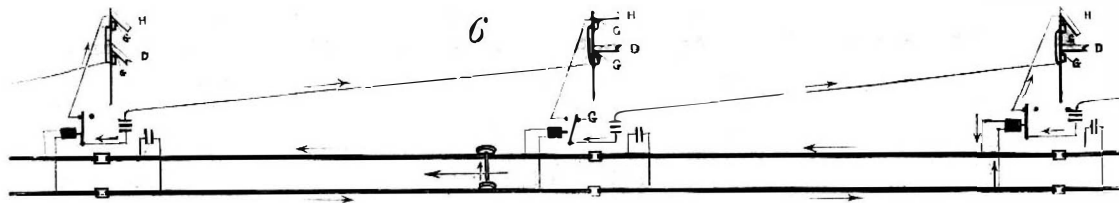

DOUBLE SIGNAL BLOCKING.

connection between the rails, so that iron wire is fastened by iron pins driven into the foot of the rails across each joint of a block. Between the blocks the rail ends are insulated as shown in Fig. 4. For ground or return circuit, the pneumatic air pipes are used. For night work powerful white lanterns are arranged on the uprights, which, in the danger position of the sig-

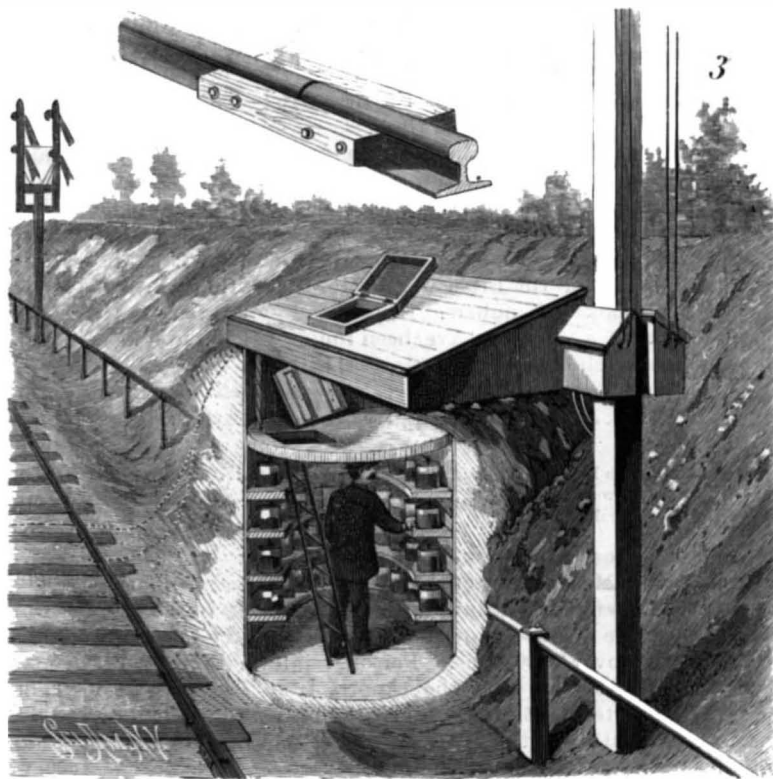

3. RELAY POLE AND BATTERY. 4. INSULATION OF RAIL ENDS.

nals, are masked by colored glass carried by the rear end of the semaphore. For the "Home" signal the glass is red, for the "Distant" signal it is green. The same colors are used to paint the sides of the sema-

phore board nearest the advancing engine. The other sides are painted white.

Enough has been shown to indicate the possibilities of the pneumatic system. It is applied also to moving switches, and a full interlocking switch and signal system utilizing electricity, hydraulic and pneumatic pressure, is now in use in track yards, which plant is installed by the same company. This system we shall probably illustrate in our next issue.

Contributions of Raphael and of Albrecht Durer to Astronomy.

It may not be known to all that Raphael's Madonna di Foligno has a special interest to astronomers. It is, I believe, the only painting of any note which commemorates an astronomical event. This picture was painted by Raphael in 1511, and placed in the Church of Ara-Cœli, as a votive offering from Sigismund Conti, secretary to Pope Julius II., for his miraculous escape from death by an aerolite. The picture was removed to the Convent of Foligno in 1565 by a niece of Conti's, and was carried off by the French in 1792. It was returned in 1815 and is now in the Vatican. Such is a brief sketch of the wanderings of this exquisite painting. Its purely astronomical interest is in the portrayal of the fall of the aerolite itself, which occupies the center of the picture. The drawing must have been made by Raphael from the personal account of Conti (who was living in 1512), and, therefore, it has even a certain scientific value.

It does not seem to be superfluous to call attention to this item of history, which lends a slight additional interest to one of the world's great pictures. I have presented a good photograph of this painting to the Astronomical Society's library.

The contribution of Albrecht Durer to astronomy is even more pronounced and permanent, though it is unknown, I believe, to all of his biographers.

Hipparchus (B. C. 127) and Ptolemy (A. D. 136) fixed the positions of stars by celestial latitudes and longitudes, and named the stars so fixed, by describing their situation in some constellation figure. The celestial globes of that day have all disappeared, and we have only a few Arabian copies of them, not more ancient than the XIIIth century, so that we may say that the original constellation figures are entirely lost. The situations of the principal stars in each one of the

forty-eight classic constellations are verbally described by Ptolemy. In Lalande's *Bibliographie Astronomique* we find that in A. D. 1515 Albrecht Durer published two star maps, one of each hemisphere, engraved on wood; in which the stars of Ptolemy were laid down by Heinfogel, a mathematician of Nuremberg. The stars

themselves were connected by constellation figures, drawn by Durer. These constellation figures of Durer, with but few changes, have been copied by Bayer in his *Uranometria* (A. D. 1603); by Flamsteed in *Atlas Cœlestis* (1729); by Argelander in *Uranometria Nova* (1843), and by Heis in *Atlas Cœlestis Novus* (1872), and have thus become classic. It is a matter of congratulation that designs which are destined to be so permanent should have come down to us from the hands of so consummate a master. —E. S. H., in *Astronomical Society of the Pacific*.

Sulphur not Effective for Fumigation.

It appears that the prevailing method of disinfection by means of burning sulphur is considered by some of the leading bacteriologists as of less value than it has heretofore been considered, though Dr. Edson strenuously maintains the contrary. Dr. J. G. Johnson, on the other hand, read a paper before the Kings County Medical Society recently in which he stated that he had proved the present system of fumigation as worthless for the destruction of disease germs; that the fumes of burning sulphur do not penetrate woollens as disease germs do. He also stated that he had propagated diphtheria from the clippings of blankets after they had undergone a thorough process of fumigation by burning sulphur. Dr. Prudden, of the New York City Board of Health, appears to have come to the same conclusion, and in both New York and Brooklyn currents of steam are to be recommended for disinfecting purposes instead of burning sulphur. —*Medical Record*.

THE large mortars now being made for the government, the details as to which were given in the *SCIENTIFIC AMERICAN* of March 15, are cast at the Builders' Iron Foundry, of Providence, R. I., and not of Boston, as stated in our number of March 15 last.

MOUNTAINS OF THE MOON.

The geographical discoveries made by Mr. H. M. Stanley's expedition in its route, accompanied by Emin Pasha, to the south of Lake Albert Nyanza and west of Victoria Nyanza, through a region previously unexplored, are the latest additions to our knowledge of the wonderful interior of what has been called the "Dark Continent." They are of much scientific interest, apparently solving the question of the true source of the Upper White Nile, or rather of its western branch flowing through the Albert Nyanza—the eastern branch coming from the Victoria Nyanza—while they reveal also the position of the southern lake hitherto vaguely spoken of as the "Muta Nzige," but henceforth named Lake Albert Edward Nyanza, in honor of the Prince of Wales. The land between the Albert Edward Nyanza and the Victoria Nyanza, with a central line from north to south about the 31st degree of east longitude, rises into lofty mountain ranges. A few of their high summits, which had been only seen at a distance by Mr. Stanley in December, 1887, and May, 1888, were then named Mount Gordon Bennett, Mount Edwin Arnold, and Mount Lawson; and these are marked in the map of Central Africa published by Messrs. W. &

ing comment or description is written by Lieutenant Stairs:

"For centuries the sources of the Nile have been wrapped in mystery. Many attempts to reach the southernmost fountains have failed. We have been able to add a great deal to our knowledge of the Nile sources, and have discovered a range of mountains to the S. S. E. of the Albert Nyanza Lake stretching away to the southward and westward, and then east again in a decidedly crescent-like form. The name given to the highest points of the range is Ruwenzori, though by different tribes it goes by different names.

"The scenery afforded by these mountains, as one passes by their feet, is most splendid. Deep valleys of an intense darkness run up from the forest beneath. A distinguishing feature of the range is the clear and well defined character of the hill tops. Almost invariably on the southern side these are of a conical shape, with extremely steep slopes, some of them being quite 45 deg. in steepness. The lower spurs and gullies are covered with ordinary forest growth up to a height of some 6,000 or 7,000 feet; above this there is generally a forest of bamboo going up to 9,500 or 10,000 feet; above this, again, for another 1,500 feet of altitude, the hill-

An Experiment in Preventing the Injuries of Potato Rot (*Phytophthora infestans*).

BY CLARENCE M. WEED.

The experiment was undertaken to determine what effect the application of a solution of sulphate of copper and lime (known as the Bordeaux mixture) to the foliage of potatoes would have in preventing the injuries of the potato rot, and was conducted on the grounds of the Ohio Agricultural Experiment Station.

Fifteen feet at the end of each of twenty rows of potatoes were sprayed with the Bordeaux mixture four times, viz., May 28, June 6, June 29, and July 16. Four varieties were included in the experiment, viz., Early Ohio, Early Oxford, Puritan, and Lee's Favorite.

The season proved favorable for the development of the blight, which appeared in the experimental field about the middle of June, and did serious damage for the next six weeks.

The sprayed vines showed much less injury than their unsprayed companions, remaining green after the others were dead.

The crop was harvested August 22, and the product of 12½ feet of the sprayed part of each row was compared with the product of an equal distance of the un-

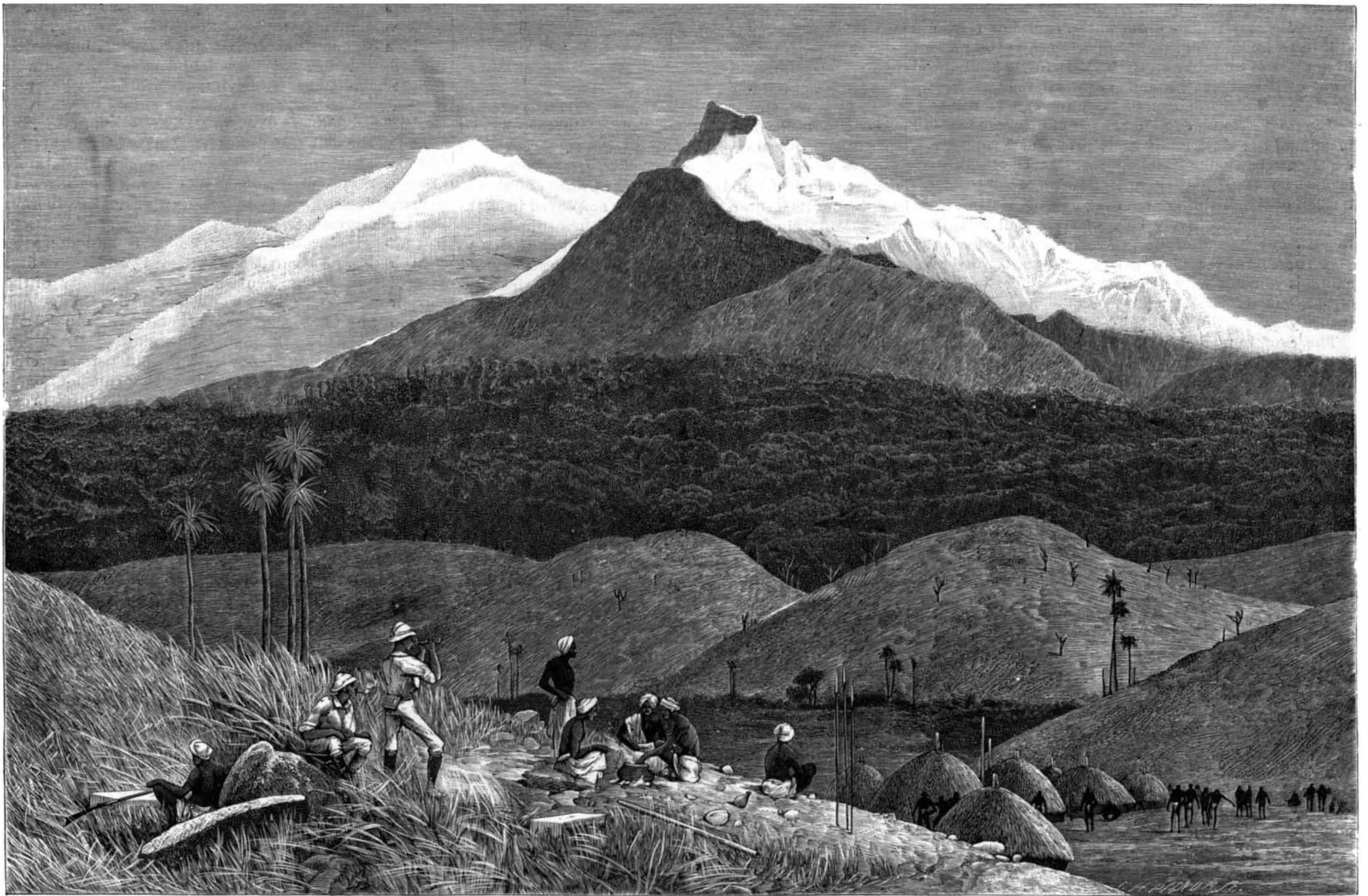

"THE MOUNTAINS OF THE MOON," DISCOVERED BY MR. STANLEY.

A. K. Johnston in 1888. In June last year, many months after his distant sight of those mountains from the southern extremity of Lake Albert Nyanza, Mr. Stanley, with his second in command, Lieutenant Stairs, R. E., the expedition having traveled southward through the Unyoro country, crossing the Semliki River, and approaching the mountains through the valley of Awamba, were enabled to gain nearer acquaintance with this remarkable feature of a region hitherto unknown.

Mr. Stanley's letter of August 17, 1889, to the Royal Geographical Society clearly describes the physical conformation of the vast trough, or subsidence of the earth's surface, 230 miles long, containing the Albert Edward Nyanza, with the plains on its shores, the Semliki River valley, and the Albert Nyanza; he also describes the Ruwenzori range of mountains, rising above the Semliki valley; and he considers them identical with what the ancients called "The Mountains of the Moon." This name is mentioned by Scheabed-din, an Arab geographer of the fifteenth century, who says that the Nile takes its rise from those mountains, a little south of the equator; which is now proved to be the fact, so far as the western branch of the Upper White Nile is concerned.

Lieutenant Stairs, the only member of the Emin Pasha Relief Expedition who actually ascended Ruwenzori to the height of 10,677 feet, on June 6, 1889, has favored us with the sketch of "The Mountains of the Moon," represented in the engraving. The follow-

sides are covered with tree heath, and all above this is bare rock and earth to the summits. A peculiarity to be observed in this range is the intense depth of the ravines or gullies between the spurs of the hills. Though the streams start from almost the summit, still they have very little fall, comparatively, as their channels appear to be cut right into the heart of the mountains. In some places the ravines down which these streams flow are quite 6,000 or 7,000 feet deep. The height of the highest point of the range is about 17,000 feet, with about 2,000 feet above the snow line.

"The country at the foot of the range is among the most fertile passed through by us. Bananas, Indian corn, beans, and matama are the chief products of the natives."

The position of Ruwenzori, as shown in Mr. E. G. Ravenstein's new map, "Stanley in Africa," published by Messrs. G. Phillip & Son, is within less than one degree north of the equator, and in the thirtieth degree of east longitude. The mountain range to which it belongs, parallel with the Semliki River, which is the outlet of Lake Albert Edward Nyanza and the most southerly feeder of the Nile, extends in a southwest direction from a point of the Unyoro table land opposite the south end of Lake Albert Nyanza, and is about ninety miles in length. It is remarkable that these mountains, nearly 18,000 ft. high, with snow-covered peaks, were not visible to Sir Samuel Baker, who supposed the Albert Nyanza to extend hundreds of miles farther south.—*Illustrated London News*.

sprayed portion of the same row. The results have been summarized as follows:

The treated portions of the twenty rows yielded a grand total of 2,471 potatoes, weighing 320 pounds 7 ounces, and 1,128 of these were of marketable size, and weighed 244 pounds 2 ounces, while the untreated portions of the same rows yielded a grand total of 2,771 potatoes, weighing 274 pounds 4 ounces, of which 948 were of marketable size, and weighed 180 pounds 1 ounce. There was, consequently, a grand total increase in favor of the treated hills of 46 pounds 3 ounces total product, and 64 pounds 1 ounce marketable product; or an increase from the treatment of 62.2 bushels to the acre.

There was in nearly every case a marked difference in the amount of scab on the treated and untreated tubers, the former being much more free from the disease.

So far as a single experiment can be relied upon, the results here reported seem to indicate the correctness of the following provisional conclusions:

1. That a large proportion of the injury done by the potato rot can be prevented by spraying the vines with the Bordeaux mixture.

2. That this treatment apparently diminishes the amount of scab affecting the tubers.

3. That by adding London purple to the mixture the same treatment may be made effective in preventing the injuries of both the rot and Colorado potato beetle.—*Jour. of Mycology*.

Japanese Camphor.

The following particulars regarding the preparation of Japan camphor are furnished by a firm of exporters of Japanese products at Hiogo:

The camphor forests in Southern Japan are divided into two categories, which furnish the bulk of the world's camphor supplies.

In the first category are the forests which are the property of the government, and kept under the strict supervision of the forest department. They contain a considerable number of trees, but as far as the supply of camphor is concerned, these forests can only be counted upon to a limited extent. At the discretion of the authorities, permits are given at irregular intervals to cut down old trees in certain districts, and the production of the government forests depends on the relative liberality with which permits are issued. On the average, the government forests furnish about one-fifth of the total quantity exported, and cannot be depended on as a regular source of supplies. On the other hand, the forests or trees belonging to private individuals are the base of the supply of the trade. That a considerable decrease of these camphor trees has taken place is beyond doubt. The provinces of Tosa and Satsuma, in former years the only source of supply, are very nearly exhausted; but in distant parts, beyond the mountains and remote from water, camphor trees are still to be found. This is of importance, as the present high price of camphor on the spot is further enhanced by transportation through pathless regions before water, for the distillation of the gum, can be reached.

The production has, under these circumstances, and in spite of the abnormally high prices now ruling, not experienced any material increase. At the same time it must be stated that there is now proceeding an extension of the distilling area over new districts, *i. e.*, in provinces comparatively bare of trees, and which up to now gave no camphor. These facts confirm the view that, however high prices may go, the average supplies will not only not experience any essential increase, but, on the contrary, become less and less in future years.

The camphor tree, like the oak, grows very slowly, and it takes several hundred years before the full size has been attained; there is, therefore, no chance for the present generation to derive any benefit from the trees now in course of being planted. The present prices stimulate the production to the utmost, and the fresh gum is being hurried upon the market. The opinion that native speculators store the camphor in order to raise prices is totally wrong.

The largest yield of gum from the trees is obtained during the cold season; first on account of the sap or essential oil contained in the tree then being concentrated in the big roots and the lower part of the stem, and secondly, as the distillation can be done more efficiently by using cold water. This process is performed in a most primitive way on the banks of the nearest brook, as follows:

A hearth or circular wall of stones is constructed, 5 to 7 feet high; on this is placed an iron pan, and thereon a tub about 3 feet high, the perforated bottom of which rests on the pan. Then the tub is wrapped up in a layer of clay, into which the roots and stem wood, cut into small chips, are placed. Water is now poured into the pan, the cover of the tub closed airtight by clay, and fire kindled on the hearth. The steam rising from the pan pervades the chips and extracts from them the essential oil, leading it through a bamboo tube into the refrigerator, which consists of two wooden boxes, through the larger one of which, having no cover, a continuous stream of water is flowing, while the smaller one, being without a bottom, is placed on the water in the larger box, and serves as an air-tight receptacle for the steam saturated with the essential oil, which after the lapse of twelve hours is thoroughly extracted from the chips. In the meanwhile camphor and camphor oil have deposited on the inside of the smaller box above the water; they are scraped off, and, by pressing them, the camphor crystals and oil are separated. The camphor thus obtained is in a very wet condition, and loses up to 30 per cent more of oil and water until it is put on board a vessel. The camphor oil is valuable, and carefully collected to be refined, thus yielding more camphor, while the refined oil is sold for exportation as camphor oil.

Hiogo is by far the most important place in Japan for the exportation of camphor, but the gum is extensively dealt in at Nagasaki also, chiefly for the wants of Hong Kong. There are no available returns for this latter port, and it is probable that its trade is gradually more or less being absorbed by Hiogo. The apparent scarcity of camphor in Satsuma and the southern provinces generally accounts for this fact, while the distilling area has extended further north, *i. e.*, into closer proximity to Hiogo. It should also be borne in mind that the camphor which is now shipped loses about 5 per cent more weight during the voyage than formerly, when the cargo was delivered by the natives in a drier condition.

ALL of the bank note currency of the Italian government is engraved and printed in the United States.

AN IMPROVED BRIDGE FLOORING.

A bridge flooring especially adapted to be laid as an auxiliary flooring on the main floor of a bridge or similar structure when the original flooring has become decayed or injured, and also adapted to be laid when a bridge is first constructed, is represented in the accompanying illustration, and has been patented by Mr. Charles W. Carman, of Hamburg, Iowa. Upon the main flooring two spaced side strips are securely attached at each side of the road bed to be laid, the in-

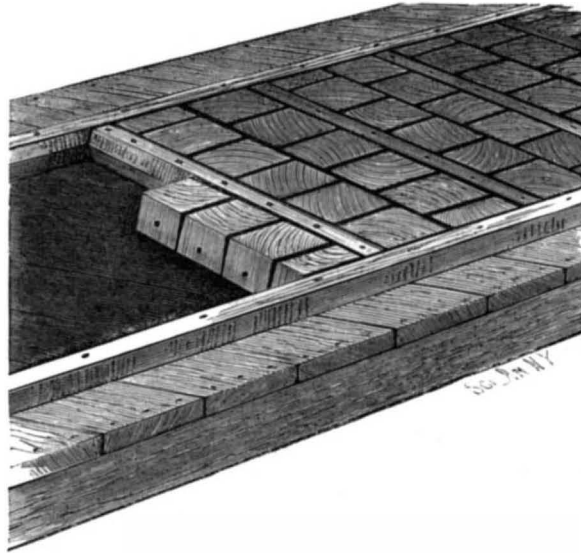
**CARMAN'S BRIDGE FLOORING.**

ner face of each strip being beveled upward and downward from its center. The blocks employed in making the flooring are square upon their upper and lower faces, the upper faces being smaller than the lower faces, and the four sides of the block beveled downward. In connection with the side strips and blocks, cross strips are used, having a double bevel on both longitudinal faces, while their ends are recessed to receive the beveled surfaces of the side strips, whereby both may be effectually wedged to place. The main floor is first preferably coated with pitch, and the blocks are laid to break joints and nailed in position, when the cavities between the opposed edges of the blocks, and also those along the side and cross strips, are filled with pitch or any desirable form of cement, the whole being effectually tied in position and forming an even upper surface.

AN IMPROVED CAMERA.

The accompanying illustration represents a camera, patented by Mr. Henry W. Hales, designed to render the lens movable in every direction, and obviate all danger of sticking in bad weather. The lens tube is attached to an apertured plate made universally adjustable by a rotating connection or coupling with the camera front, in which connection it is also adapted to slide. The connection shown consists of a circular metallic rim fitted in a circular opening in the camera front, and having side cleats or holders for the plate, the rim being held and made tight in the opening to exclude light by clinching its inner edge. The holding cleats are preferably made integral with the rim, and

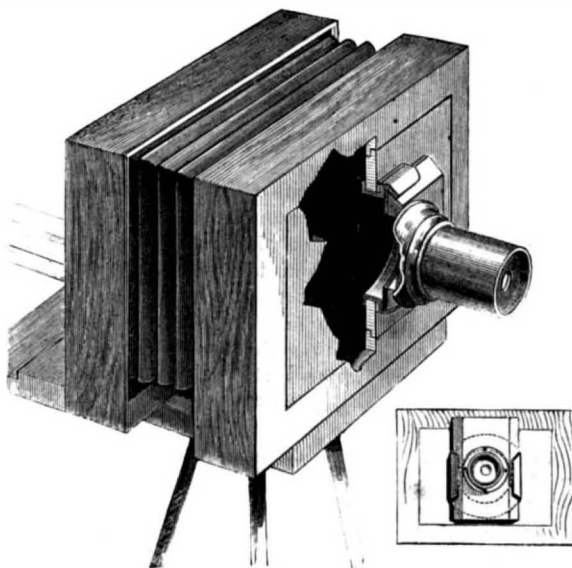
**HALES' CAMERA.**

shaped to grasp the beveled side edges of the lens plate. The small figure shows the invention applied to the permanent front of the camera.

For further information relative to this invention apply to Mr. E. I. Horsman, Nos. 80 and 82 William Street, New York City.

THE open winter in the vicinity of New York has prevented the gathering of the usual quantity of ice, consequently there is an unusual demand for artificial ice machinery. One day's mail last week brought to this office sixteen letters of inquiry about machinery for the manufacture of ice.

Compressed Air Cars.

Messrs. Hughes & Lancaster, whose works are at Chester, England, have been for some time steadily working to improve the low pressure compressed air system which they have introduced. *Engineering* says they have taken one of the ordinary Chester horse cars, and by means of a certain amount of cutting and contriving have managed to produce a fair example of their invention, at any rate sufficient to give a working example of the device. Underneath the car cylindrical reservoirs have been placed and a motor has been introduced. In other respects the vehicle has not been altered to any noticeable extent—in fact, it is only on close inspection that one realizes that the car carries its own motive power. The reservoirs contained air compressed to a tension of about 170 pounds to the square inch, at least that is the initial pressure when the car is first started after having been charged; but as the total storage capacity of the car in question is but 50 cubic feet, it will be easily understood that the pressure falls with considerable rapidity as the journey is made, more especially if the car has to climb a fairly steep gradient, as was the case during some runs we recently made. It may be as well to state at once that there is ample space under seats and elsewhere to place other cylinders, so as to very greatly increase the storage capacity.

The motor on this car is a Rigg engine, but unfortunately this has not been found so far very suitable for the conditions of driving tramcars. At any rate the leakage is very great, as was shown by the way the pressure gauge fell when the car was standing.

As the car will travel but a short distance—we believe about two miles on the level—upon its initial store of energy, special arrangements have to be made to recharge the storage cylinders. To effect this there is an air-compressing plant erected at a central station, and this supplies an air main which is laid along the entire route. At convenient intervals, greater or less according to the gradient and storage capacity of the car—probably two miles would be the maximum distance of any two from each other—there are special valves attached to the main. These are placed in pits close to the outside of one rail, the pits being covered by iron lids level with the roadway and causing no obstruction to traffic. The car has to lift this lid in order that connection may be made between the air reservoirs of the car and the supply pipes. In order to perform this opening operation, there is a bent lever on the lower part of the car.

When it is required to recharge the reservoirs, the lever is lowered by the attendant and the lid is raised; there is a stud on the end of each arm of the car valve. As the car passes on, it causes the car valve to make a quarter turn on its center, that center being the end of the air pipe in connection with the reservoirs. The valves are brought into their open positions, and air flows freely from the street main to the car reservoirs. When the latter are charged the car is started, both valves make a part of a revolution, until they are brought to the closed position, and the operation is completed by the lid of the pit closing by its own weight.

The attendant having gone through the extremely simple operations of lowering the lever, the rest of the operations are purely automatic, and the practical success of the device naturally greatly depends on the rapidity with which the reservoirs are charged. In the car we have described, to raise the reservoir pressure from 60 pounds to 165 pounds per square inch took ten seconds, or about one-sixth the time generally required to get an elderly lady or stout gentleman off the pavement on the footboard.

We had recently an opportunity of inspecting at Chester this car and the air main connections, through the courtesy of Professor Henry Robinson, M. Inst. C.E., who is consulting engineer to the promoters of the system. The short runs we made were conducted without a hitch, and enough was shown to prove that this system is quite practicable in its working, and that many of the objections to a steam motor are entirely absent.

The total weight of the car and machinery is 3 tons 14 cwt., and the resistance has been estimated at not less than 27 pounds per ton by Professor W. C. Unwir who made some trials with this car.

A New Warship Hurts Herself.

The *Army and Navy Register*, of Washington, states that information has been received at the Navy Department that the *Chicago* was recently considerably injured by reason of the command to start the vessel having been given before the anchor was hoisted. The plates are said to have been torn down almost to the water line. When the fleet was sailing out of the port of Toulon, signals were hoisted on the flagship ordering the commanding officer of the *Atlanta* under arrest and directing the executive officer, Lieutenant-Commander Couden, to take command. It seems that for some reason or other the *Atlanta* had gone out of her course and broken up the sailing formation. It is understood that Captain Howell has asked for a court martial.

AUTOMATIC RECORDING SIGNAL FOR RAILROADS.

A signal for automatically recording the time of passage of a train past a station, and delivering any desired message or orders for station agents or employees, is illustrated herewith, and forms the subject of a patent issued to Mr. James B. Ivey, of Macon, Ga. A carrier is connected to the engine, caboose, or one of the cars, and a receiver located on the road bed at the side of the track, into which signal balls are automatically dropped by the carrier, the balls being marked with or containing the instructions or messages to be delivered. A face plate carried by the truck frame, or by a frame carried by the axle boxes of the engine, is provided with lugs having vertical grooves in which the side flanges or wings of a barrel may slide up and down, and into the top of this barrel is fitted an upper pipe or tube passing through a cap or head plate. The upper end of the carrier barrel projects a little above the floor of the car to permit signal balls to be conveniently dropped into it by a conductor or trainman, and the arrangement is such that the barrel may be held at various heights to keep a swinging striker and valve device on its lower end at any required distance above the trip plate of the signal ball receiver. This striker and valve device is designed to operate by the striker being moved either forward or backward, but in any case drops only the lowest ball from the carrier barrel into the receiver. The latter has a ball-catching trough of considerable length, and a shorter and deeper box into which the balls pass from the trough, there being in this box a clockwork mechanism by means of which the exact time of the dropping of each ball is marked by a prick, punch, or stamp on a ribbon or band. The signal ball may be made hollow, with one or more holes communicating with its interior, or in two detachable parts, to contain reports, orders, etc., or it may be made solid and marked on its exterior with the desired information, but the ball receiver is designed to be locked, so that only authorized persons having a key shall have access thereto.

QUEEN'S NEW TRIPLE PLATE TOEPLER-HOLTZ MACHINE.

On this page we print a cut showing some of the details of the new Toepler-Holtz machine which has just been patented by Jas. W. Queen & Co., the well known manufacturers of philosophical apparatus and electrical test instruments, of Philadelphia, Pa. This machine, unlike very many that have appeared from time to time, is not simply a modification of the orthodox model, embodying certain conveniences, but is an entirely new thing, owing its efficiency to novel and, we feel assured, valuable ideas of construction and action.

This machine, as its name indicates, is a three-plate machine; it is not, however, the same thing as the machine usually spoken of as the "double revolving plate machine," although it does have two revolving plates. The latter machine is simply an ordinary Toepler-Holtz machine doubled, *i. e.*, with a revolving plate behind the fixed plate, exactly like the front one and acting in exactly the same manner. In this new form the additional plate is not like the front revolving plate, nor does it act in the same way. The third and additional plate is here a perfectly plain glass plate, mounted upon the same axis as the usual revolving plate and placed behind the fixed plate. Its *modus operandi* is, like many other points in the theory of the Holtz machines, not entirely understood, although there is no doubt but that much of the increased efficiency obtained by its use is due to the screening effect it has upon the other plates, *i. e.*, to the leakage that is prevented by its presence; there is also supposed to be a considerable generation of electricity by friction of the plain plate and the air. Undoubtedly, many other causes also tend to increased effects of, possibly, even greater importance than those just mentioned. The advantage of this new form of machine becomes especially marked during moist weather. At such times ordinary frictional machines will not work at all, and all older text books direct that electrical experiments must be performed during January and February, when the weather is clear and dry. With the Toepler-Holtz machine as now known this requirement has not been so rigid, although such machines are not to be always trusted during damp seasons, as lecturers have found out to their sorrow. This difficulty it has been desired

to do away with in this new form, and that it does it very effectually will be evident from the following letter sent to Queen & Co. by Prof. Wm. A. Anthony, the well known electrician and late Professor of Physics at Cornell University. Says he:

"Below is a report of the small Holtz machine you sent us a few days ago. First, in order to determine

These new machines are being sold by Messrs. Queen & Co. at the same price as the ordinary form heretofore used, and are gotten up in the finest possible manner. It may be mentioned also that the plates used in Messrs. Queen & Co.'s machines are manufactured and prepared by Voss himself, the inventor of what is usually known as the Toepler-Holtz machine, and are guaranteed to give much finer and more reliable results than any plate made in the American market. There are certain little tricks of the manufacturer and application of the insulating shellac which Americans have not yet mastered, pursued by the Germans to perfection, and which add greatly to the efficiency of the machine.

It may not be generally known that Messrs. Queen & Co. were the first to introduce the Toepler-Holtz machine into this country.

In 1880, the manager of their physical department, Joseph J. Walton, while on a business trip abroad, accidentally learned of the existence of this machine, examined it, and was so favorably impressed by it that he purchased a number for introduction into this country. This was the first appearance of the now well known Toepler-Holtz machine in the United States. It was exhibited soon afterward by the before mentioned gentleman before the meeting of the American Association for the Advancement of Science, and attracted much attention. It immediately became popular, and had such a large sale that it was straightway copied by various American makers, and patents secured upon modified forms.

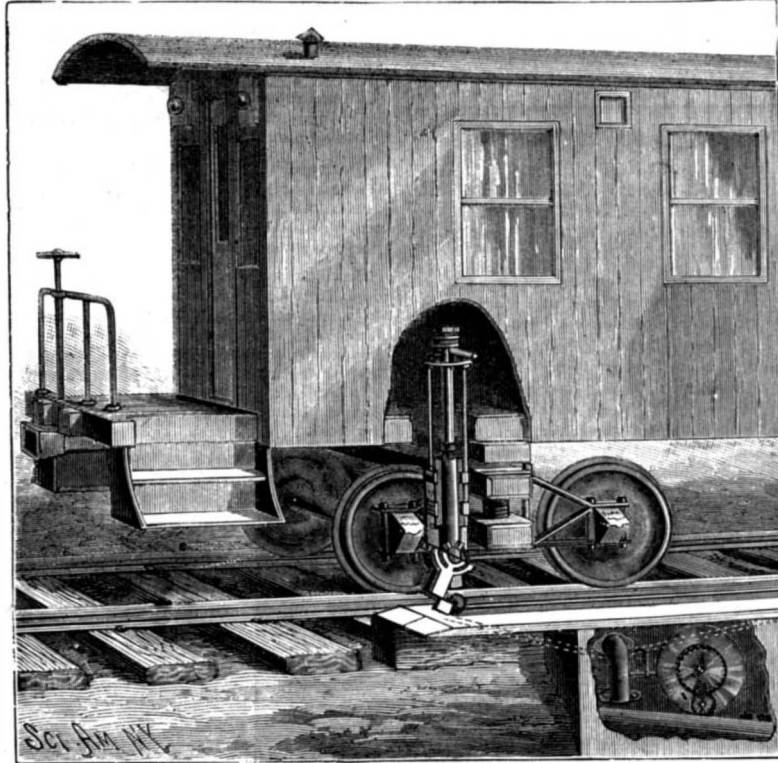

IVEY'S AUTOMATIC RECORDING SIGNAL FOR RAILROADS.

whether the extra plate gave any increased effect to the machine, I set up both machines and arranged them so that they both could be revolved by means of one crank, and so that they would both run at the same speed, and then adjusted the terminals until the sparks occurred with about the same frequency in both. Then I removed the combs from one of them, so that the third plate would have no effect in the development of electricity, and found that the frequency of sparks on that machine was very much less than on the other. I repeated this several times with the same result, and tried the same experiment on the other machine; that is, leaving the combs on the first machine, I removed them from the second, when that one was found to give considerably less electricity than the first. I can say unhesitatingly, therefore, that the addition of the third plate does very much increase the rate of discharge, and, as nearly as I could tell by this rough experiment, about double the rate." Prof. Anthony also speaks of the slight effects produced by dampness upon this machine.

Another great improvement that is made in this machine is the form of the electrode which is used. This is made of a metallic disk two inches or more in diameter, and hollow, so as to have very gradually rounded edges, this preventing any leakage at the

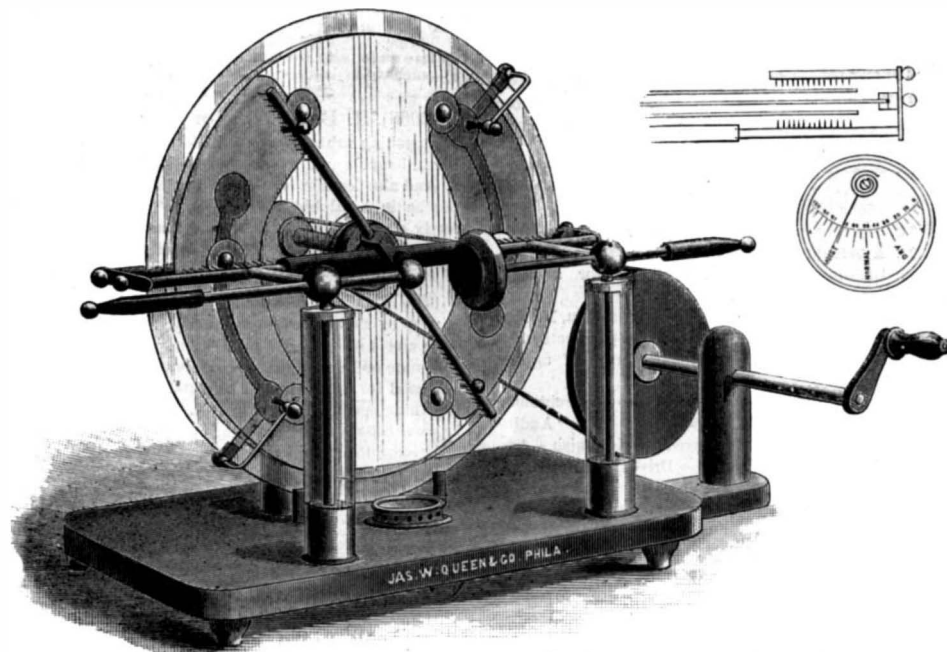

QUEEN'S NEW TRIPLE PLATE TOEPLER-HOLTZ MACHINE.

edges. Over this disk, separated from it by about an eighth of an inch, and nearer the other electrode, is fastened a thin disk of vulcanized rubber about one-half an inch less in diameter. This rubber disk plays the part of the rubber sheet sometimes held between the electrodes and compels a much higher potential to be established between the two electrodes before a spark can pass. It can be used upon either one or both electrodes, as desired.

The Forth Bridge Again.

All classes of English newspapers and periodicals, since the completion the other day of the wonderful Forth bridge, which has been so fully illustrated in the SCIENTIFIC AMERICAN SUPPLEMENT, have published descriptions, and in most cases engravings, of this remarkable engineering structure.

Still, persons have got it in their heads, says the *Building News*, that the Forth bridge is on the cantilever principle, and if they proudly proclaim to us the fact, and we strive to point out that the cantilever has nothing to do with the integral calculus, but is twin brother to the hat peg behind the door, they smile blandly, as though to say, "We know all about that." This, the editor adds, is exasperating to a degree. But it is a state of things that may be expected to continue for some time in spite of sentences such as that in the *London Times*, explaining that "in architecture the cantilever is merely a bracket," and all the information which the engineers of the bridge have been at some pains to convey to the popular mind through the medium of magazines, etc. A cantilever bridge it is, and a cantilever bridge it will remain, and there is no reason why things should not be known by their right names, but it seems a pity that ignorance should be so rife as to the meaning of a simple word, and that a principle old as the hills should be believed by the public to be some new patent automatic compound, double-acting, triple-expanding system of construction.

As for the Forth bridge itself, the world should be pretty familiar with its general appearance. It is evidently a structure that will give no small pleasure to the engineer and architect to behold. "For my own part, I am anxious to see it in the flesh—or rather the steel—believing it to be the most creditable piece of engineering of its kind ever brought to a successful issue." That it will greatly influence the future of bridge building there can be no doubt. It will probably lead to a still further abandonment of close web iron construction in favor of open steel work.

Irrespective of the employment of the cantilever principle, which will be a factor to influence future bridge designing, the Forth bridge should induce engineers to still further throw off the bonds of traditional construction and make further progress in a knowledge of the true principles to be observed in the use of steel and iron for constructive purposes.

THE Inyo (Cal.) *Independent* says: There are five teams engaged in hauling borax from the works in Saline Valley to the railroad. In this newly discovered borax field lies the greatest natural deposit of borax now known to exist in any part of the world. It is only necessary to dig up the mineral and shovel it into wagons.

RECENTLY PATENTED INVENTIONS.
Engineering.

STEAM BOILER.—William J. Kennedy, Jersey City, N. J. This boiler is made with hemispherical ends and exposes a large surface to the products of combustion, which are retained or held for a considerable time in contact with the heating surfaces of the boiler, the products of combustion also passing in contact with the pipes leading to the steam drum, to superheat and dry the steam as it rises from the boiler.

Electrical.

DENTISTS' ELECTRICAL APPLIANCES.

—Charles W. Manker, Nebraska City, Neb., and George F. Manker, Bedford, Iowa. This invention covers a combination of a battery, an induction coil, a vibrator adapted to rapidly interrupt the primary circuit of the coil, and a finger piece to be worn by the operator and adapted to close the secondary circuit, for sending a current through the tooth of a patient while the tooth is being extracted, to lessen the pain. Another patent has been issued to the same inventors, consisting of a battery and induction coil, combined with an interrupter operated by two electro-magnets and provided with two sets of contact points, the arrangement being such that the secondary current passes through the hands of the patient, through rings on the hand of the operator, and the forceps in contact with the rings, to the patient's teeth.

Miscellaneous.

TYPE WRITING MACHINE.—James A. Wallace, Alexis, Ill. This invention covers a novel combination and arrangement of parts for a machine designed to be simple and inexpensive in its construction and easily operated, while producing writing having perfect alignment.

RECORD SHEET.—James J. Barnard, deceased, Passaic, N. J. (John Adams, administrator). This is a sheet supplementary to the usual books of record on which the sales are entered in brief to economize the time and labor usually required in recording and journalizing, to insure the completion of the entire course of the same at the close of each business day.

HARMONICA.—John F. Stratton, Brooklyn, N. Y. This is a mouth instrument in which a reed board having cells and reeds held thereon is combined with a covering plate arranged over the reeds and forming at its rear end an enlarged deflecting and resonating chamber, to produce very rich and full tones when the instrument is played.

CATCH FOR CHATELAIN BAGS, ETC.—Louis B. Prahar Brooklyn, N. Y. Combined with the frame of the bag is a stud mounted to turn in one member of the frame, and having a latch head adapted to engage the other member of the frame, with a spring for controlling the movement of the stud, so that the latch cannot be accidentally manipulated and the bag opened when such action is not intended.

ACID BOTTLE.—Edward Hart, Easton, Pa. This bottle is made entirely of wax, paraffine, or ceresine, sometimes called ozokerite or mineral wax, or mixtures of these substances, the stopper being made of like material with the body.

FILTER.—William Mailer, St. Joseph, Mo. This is a filter capable of being attached to a faucet, and consists of a tubular body having a screen or sieve secured near one end, upon which a body of sand is placed, combined with a series of screens or sieves and an interposed apertured corked disk placed in the opposite end of the body, a screw being arranged in connection with the bail to bear upon the upper disk and compress the sand.

CAP FOR CRUETS.—Simon B. Simon, New York City. This cap consists of an attaching ring having a transverse round bar across its upper edge, a cover plate with a circular flange, and a transverse guide plate, whereby the mouth of a cruet or similar vessel may be uncovered without removing the cap, and quickly closed.

EGG TESTER.—Frank Herrick, Rhinebeck, N. Y. This is a device with a box-like body having an opening in one side and means for supporting a lamp, a strip of pliable material with apertures covering the body opening, and a sliding damper adapted to close one or more of the apertures, whereby eggs may be tested accurately and conveniently in a lighted room.

AUTOMATIC GILL NET PULLER.—Robert O'Neill, Charlevoix, Mich. The entire mechanism of this machine is operated by a single continuously rotating driving shaft, which may be driven by a small engine, being an efficient and labor-saving apparatus for pulling or hauling gill nets or set lines from the water, and intended more especially for use on shipboard.

WATER LEVEL INDICATOR AND ALARM.—Ira A. Fuller, Pepin, Wis. This is a peculiar construction and arrangement of a float with indicator gauge and an electric circuit with contact closer, battery, and bell, all worked by the float, for automatically giving notice of the amount of water that may have leaked into the hold of a vessel.

WAGON SEAT LOCK.—David W. Glidden, Montrose, Pa. A bed plate is arranged for engagement with the seat riser and to extend below the seat rail, in connection with a slide held to the base plate, and carrying a hinged catch with a locking device, the lock being easily manipulated and the parts so arranged that the seat may be readily moved from place to place upon the seat rail.

TRUCK.—William A. Clark, Crisp, Ga. This is a truck with centrally arranged wheels adapted to run on a single rail, and mainly carry the weight, but with lateral supporting wheels running on the ground, a bent axle being employed which will turn in its bearings in the truck to accommodate itself to the unevenness of the ground the end wheels pass over.

FENCE POST.—Silas J. Saxon and William H. James, Colfax, Washington. This post has an iron foot piece with a tubular extension, combined with a wooden part driven down upon the extension, so that no water can settle in any portion of the post to freeze or cause the decay of the wood or the corrosion of the iron.

HORSE COLLAR FASTENER.—John H. Emerson, St. Joseph, Mo. This is an improvement in fastenings to be applied to horse collars which open at their lower ends, and consists in the novel construction and arrangement of two metal plates adapted to be applied to collars of any size, to form an easily operated and efficient locking device.

NEW BOOKS AND PUBLICATIONS.

HENDERSON'S HANDBOOK OF PLANTS AND GENERAL HORTICULTURE. By Peter Henderson. New edition. New York: Peter Henderson & Company. 1890. Pp. 526. Price \$3.

The writer of this work is equally well known as a highly successful horticulturist and as an author. His ability in both lines of work has contributed largely to the value of the present book. It is in the form of a dictionary, and almost every item of horticulture and plant information is given, each word being followed by a definition and, where required, by a short treatise. The different plants are given very full notes, and illustrations are used profusely throughout the book. It forms an admirable addition to the general library, and is one which, by its authoritative position and wide scope, should be in every one's hands. The principal text is followed by a glossary of botanical nomenclature, giving the meaning of all the Latin words in general use by horticulturists, and at the end some practical information, with tables of work for the different months in the garden, etc., is given.

CHICKEN FIXINGS.—This is the title of a curious specimen of periodical literature, published by Richard H. Young, Westboro, Mass. He seems to deal in every species of poultry, and everything pertaining to the rearing, feeding, cooping, etc. In the copy before us the editor says: "I present you my Thirtieth Annual Catalogue, 'Chicken Fixings' for 1890, fearlessly and without apology. I do not present it as a work of art, science, literature, religion, or anything of that sort. It is simply a trade circular of my poultry and supplies. Catalogue and price list of the articles on which I am simply and humbly endeavoring to float a sufficient margin to keep the wolf away from the hedge."

SCIENTIFIC AMERICAN BUILDING EDITION.

MARCH NUMBER.—(No. 53.)

TABLE OF CONTENTS.

1. Elegant plate in colors of a dwelling for \$3,200. Perspective elevation, floor plans and details.
2. Plate in colors of a residence lately erected at Newark, N. J., from plans and specifications by Munn & Co. Elevation, floor plans, and details.
3. Perspective view of the Carteret Club House, Jersey City, N. J.
4. Residence of Mr. Woodruffe, Tompkinsville, N. Y. Perspective and floor plans.
5. A cottage at Stuyvesant Place, Staten Island. Cost \$11,000. Plans and perspective elevation.
6. Views showing the burning of the Palace of the King of the Belgians at Laeken, near Brussels—The Conservatory—The Royal Palace of Laeken.
7. Views of Beethoven's birthplace—Bonn and room in which Beethoven was born.
8. A residence at South Bend, Ind., built at a cost of \$7,500. Perspective elevation and floor plans.
9. A residence at Elm Hill, Boston, Mass. Perspective view.
10. A cottage at Ludlow, N. Y., erected at a cost of \$5,400 complete. Plans and perspective.
11. A residence at Binghamton, N. Y., erected at a cost of \$7,800. Plans and perspective.
12. Cottage at Binghamton, N. Y., erected at a cost of \$1,100 complete. Floor plans and perspective elevation.
13. A Binghamton, N. Y., cottage recently erected at a cost of \$2,600 complete. Perspective elevation and floor plans.
14. Drawing of a porch at Zutphen.
15. A model farm house.
16. Illustration of climbing plants for a covered avenue or pergola.
17. A \$2,500 cottage erected at Binghamton, N. Y., for Mr. W. A. Sanford. Plans and perspective.
18. Design for a Congregational church of moderate cost.
19. Miscellaneous Contents: Errors in architectural design.—Sandy foundations.—The "Auditorium," Chicago.—Improved interior finish.—Adobe houses in Louisiana.—Drives and walks.—To take grease from marble.—Hydraulic passenger elevators, illustrated.—Slow burning buildings.—Hill's solid steel anvil, illustrated.—Sliding door blinds.—Improved wood working machinery, illustrated.—Barlow's shipping tags.—To estimate brick work.—An automatic pump operated by water pressure, illustrated.—Increased use of water filtering appliances.

The Scientific American Architects and Builders Edition is issued monthly. \$2.50 a year. Single copies, 25 cents. Forty large quarto pages, equal to about two hundred ordinary book pages; forming, practically, a large and splendid MAGAZINE OF ARCHITECTURE, richly adorned with elegant plates in colors and with fine engravings, illustrating the most interesting examples of Modern Architectural Construction and allied subjects.

The Fullness, Richness, Cheapness, and Convenience of this work have won for it the LARGEST CIRCULATION of any Architectural publication in the world. Sold by all newsdealers.

MUNN & CO., PUBLISHERS,
361 Broadway, New York.

Business and Personal.

The charge for insertion under this head is One Dollar a line for each insertion; about eight words to a line. Advertisements must be received at publication office as early as Thursday morning to appear in next issue.

English tanned walrus, hippopotamus, giraffe, elephant and buffalo leather for polishing metals. All kinds mfrs.' supplies. Greene, Tweed & Co., 83 Chambers St., N. Y.

For Sale—A recent patent for an excellent straw cutter. Address Hirsh & Raquin, 16 Court St., Brooklyn, N. Y.

Wanted Immediately—Two Fox lathe hands at Farnan's Brass Works, 23 Center St., Cleveland, O. None but first-class men need apply.

The locomotive "Onward," illustrated in Scientific American of March 8, is drawing the Philadelphia express on the Central R.R. of N. J., daily. For full information respecting this locomotive address C. E. Swinerton, president, at Fifth Avenue Hotel, New York.

Chain Factory for Sale.—Owing to the death of the proprietor, the Star Chain Works at Trenton, New Jersey, are offered at private sale. This is an old established concern now in full operation, it has good trade connections, and is located on a branch of the Philadelphia & Reading R.R., so that there are no cartage expenses. With a moderate outlay the capacity of the work can be doubled. Inquire of H. L. Shippy, No. 117 Liberty St., New York.

The best book for electricians and beginners in electricity is "Experimental Science," by Geo. M. Hopkins. By mail, \$4; Munn & Co., publishers, 361 Broadway, N. Y.

Wanted—A thoroughly competent designer of wood-working machinery by a well established house. To the right party a first-class opening. Address P. O. box 1001, New York, N. Y.

Best Ice and Refrigerating Machines made by David Boyle, Chicago, Ill. 140 machines in satisfactory use.

Guild & Garrison, Brooklyn, N. Y., manufacture steam pumps, vacuum pumps, vacuum apparatus, air pumps, acid blowers, filter press pumps, etc.

Presses & Dies. Ferracute Mach. Co. Bridgeton, N. J.

The Holly Manufacturing Co., of Lockport, N. Y., will send their pamphlet, describing water works machinery, and containing reports of tests, on application.

Tuerk water motors at 12 Cortland St., New York.

Screw machines, milling machines, and drill presses. The Garvin Mach. Co., Laight and Canal Sts., New York.

The Improved Hydraulic Jacks, Punches, and Tube Expanders. R. Dudgeon, 24 Columbia St., New York.

Hoisting Engines. The D. Frisbie Co., New York City.

Tight and Slack Barrel Machinery a specialty. John Greenwood & Co., Rochester, N. Y. See illus. adv., p. 173.

For steel castings of best quality, write the Buffalo Steel Foundry, Buffalo, N. Y.

Acme engine, 1 to 5 H. P. See adv. next issue.

Send for new and complete catalogue of Scientific and other Books for sale by Munn & Co., 361 Broadway, New York. Free on application.

Notes & Queries

HINTS TO CORRESPONDENTS.

Names and Address must accompany all letters, or no attention will be paid thereto. This is for our information, and not for publication. **References** to former articles or answers should give date of paper and page or number of question. **Inquiries** not answered in reasonable time should be repeated; correspondents will bear in mind that some answers require not a little research, and though we endeavor to reply to all, either by letter or in this department, each must take his turn. **Special Written Information** on matters of personal rather than general interest cannot be expected without remuneration. **Scientific American Supplements** referred to may be had at the office. Price 10 cents each. **Books** referred to promptly supplied on receipt of price. **Minerals** sent for examination should be distinctly marked or labeled.

(2066) R. B. C. asks for the best cement for patching rubber boots. A. Soften pure India rubber in benzole and knead or masticate it thoroughly. 2. And also leather boots. A. Use a solution of gutta percha in bisulphide of carbon. Pour upon the perfectly clean leather, and after it has dried apply the patch with a burnisher. The sides of the patch should be pared down to a feather edge all around.

(2067) H. F. asks (1) the best kind of a battery to use for an incandescent light requiring 20 volts and 1-80 amperes to light it. A. Large size bichromate or Bunsen battery. 2. Is the Edison-Lalande cell good for lighting electric lights? A. Not as a general thing, as it is of too low E. M. F. 3. How many Lalande cells would light the light stated above; each cell giving 15 amperes and seven tenths of a volt? A. Thirty cells. 4. Please state whether a converter will light when the current from an induction coil is sent through it. A. No.

(2068) N. A. D. asks for the size of carbon used in electric light described and illustrated in SUPPLEMENT, No. 149. A. Use carbons proportioned to your current, 1/4 to 3/4 inches in diameter.

(2069) T. D. B. asks: Can you recommend anything that will remove a dark stain from mother of pearl knife handles? The knives were stored in boxes for some months, and the stain is probably the result of dampness. A. Expose to strong sunlight. Try washing with a solution of binocide of hydrogen and ammonia.

(2070) P. J. N. asks how to get silver from plated ware. A. Immerse in dilute nitric acid. This will remove some. Then apply the acid to the spots where silver is left, with a sponge, to remove the last traces. It should be done with a battery by stripping. This gives a solution of nitrate of silver. Add excess of zinc, to separate silver, and purify by washing with sulphuric acid.

(2071) H. F. K. asks how to make a preparation to apply to wooden frames to make them glossy white, that is to make white frames and also have an enameled effect. A. Cover your frames with two coats of white lead paint, each coat being allowed to dry hard, and rendered smooth by the application of fine sandpaper. As a final coat to give it a glossy finish, apply zinc white with dammar varnish as a vehicle. Use a flat camel's hair brush for laying on this coat.

(2072) R. C. H. asks if the simple electric motor that you tell how to make in SCIENTIFIC AMERICAN SUPPLEMENT, No. 641, will be large enough run a screw propeller boat 16 feet long, 4 feet beam, and 14 inches draught. Or if it can be made strong enough, and how many cell battery it will take to run it, and how large a screw it will take? A. We think the motor referred to will be large enough to run your boat at a fair speed, provided you gear back so as to allow the motor to run very fast. You can operate it with six cells of a large plunging bichromate battery. The screw should be about 8 inches in diameter.

(2073) Old Reader asks for a method of preparing a waterproofing composition for a folding canvas canoe. It requires to dry without becoming stiff or hard, at the same time must not be sticky. A. We generally recommend painting or treatment with melted paraffin. To carry out your requirements, send the cloth to a rubber factory and have it coated with rubber, like a gossamer cloak.

(2074) X. Y. Z. writes: Given an ordinary solution in good order: 1. What is the proper voltage of the electric current to produce the best results in plating? A. Too rapid deposition gives a granular deposit that does not adhere. The rapidity of deposition may be made to vary by changing the voltage of the battery or by working at a constant voltage with varying resistance. Hence no fixed rule for voltage can be given; eight or ten volts are ample. A counter-electromotive force is sometimes to be overcome in the bath, but this is rarely more than one volt. 2. To caseharden wrought iron, we are told to use prussiate of potash; which is the proper kind to use, the red or the yellow? A. Yellow prussiate (potassium ferrocyanide). 3. With an average quality of illuminating gas, about how many candle power of light does a four-foot burner yield? A. Twelve to fifteen candles, if burning four feet per hour.

(2075) R. R. M. asks: Will you kindly give me the best formula for dissolving pure rubber to make a fine light cast, and how to prevent its adhering to the mould? A. In our SUPPLEMENT, Nos. 249, 251, 252, you will find the whole subject of the treatment of India rubber fully described. You should use pure rubber mixed with sulphur. It should be pressed into the mould while warm, and while so pressed should be heated for some hours, in order to vulcanize it. You will not succeed in working with a solution, except for thin articles like gloves.

(2076) H. T. U. asks (1) some tests by which I can detect the presence of alum in baking powders. A. Dissolve in water and add some muriatic acid and chloride of barium. A precipitate indicates sulphuric acid, and probably alum. 2. The presence of ammonia in baking powders. A. Heat in tube, and a white sublimate will indicate ammonia. 3. The presence of aniline coloring matter in tomato catsup. A. Shake with alcohol, and the coloration will give a clew. A full test should be made by a chemist.

(2077) J. E. P. writes: We notice in your SCIENTIFIC AMERICAN edition of the 8th instant a remark on Japanese lacquer. Can you advise us how this article is made, and whether the materials for it can be had in this country? A. Japanese lacquer is prepared from a Japanese gum. We hope soon to publish an article on the subject.

(2078) A. L. E. asks: 1. How does the graphophone differ from the phonograph? A. The graphophone is described in the SCIENTIFIC AMERICAN, vol. 59, No. 2; the phonograph in vol. 57, No. 27. Also in our SUPPLEMENTS, 632-669. The latter describes both. 2. What is the meaning of a magnifying power of so many diameters, as applied to the microscope? A. That the object forms an image so much wider and longer than if seen with the naked eye at the distance of the eye piece from the slide. 3. Please give a receipt for a nickel-plating solution, for use with battery. A. Use double sulphate of nickel and ammonium, 1 part to 25 or 30 of water, with one-tenth part sulphate of ammonium.

(2079) W. D. H. asks: Can a spring with proper gearing, fly wheel, etc., be successfully used to form a motive power to operate the phonograph? If not, why? A. As a rule, spring motors are too heavy and bulky for application to work requiring the expenditure of much energy.

(2080) O. R. writes: 1. I have about 300 flints or Indian darts. Will you give some hints how to arrange them or what to use? A. Arrange in a tasteful design on a plush or cloth covered board, securing them with fine wire. 2. How to construct a small turning lathe for foot power. A. We recommend "A Manual of Turning Lathes for Technical Schools and Apprentices," by James Lukin, \$1.

(2081) I. C. B. writes: Can you give me an application to remove an ink stain from a linen shirt bosom? A. The best rule in these cases is to apply the mildest remedy first. Try soaking in very dilute solution of oxalic acid with a little muriatic acid added. This in the course of a day will probably bleach it. If not, add more oxalic acid. Wash afterward, first with water without soap.

(2082) H. J. A. asks whether or not he can copper-plate a piece of lead, by means of, or without, an electric current. A. You can by means of a battery; without a battery you can get a thin coating, by simple immersion in nitrate of copper in solution in water.

(2083) M. S., La Grange, asks: Will you kindly answer me what makes the electricity in the dynamo? A. We refer you to Thompson's "Dynamo Machinery," \$5, and Hering's "Principles of Dynamo Machines," \$2.50. It is the conversion of mechanical energy into electrical energy.

(2084) N. W. W.—We recommend and can supply you with Byrnes, "Hand Book for the Artisan, Mechanic, and Engineer," price \$5, which contains information on polishing stones, agates, etc.

(2085) S. S. D. asks: Could the simple storage battery described in the SCIENTIFIC AMERICAN of March 8 be charged by the hand power electric machine described in SUPPLEMENT, No. 161? How many of these cells would it require to run one Edison 16 candle lamp? A. This machine may be used for charging a storage battery, but it will be impracticable to run it by hand. One or ten Edison 16 candle low voltage lamps can be run by ten cells of storage battery. It requires this number to produce the E. M. F. necessary for a single 20 volt lamp.

TO INVENTORS.

An experience of forty years, and the preparation of more than one hundred thousand applications for patents at home and abroad, enable us to understand the laws and practice on both continents, and to possess unequalled facilities for procuring patents everywhere. A synopsis of the patent laws of the United States and all foreign countries may be had on application, and persons contemplating the securing of patents, either at home or abroad, are invited to write to this office for prices, which are low, in accordance with the times and our extensive facilities for conducting the business. Address MUNN & CO., office SCIENTIFIC AMERICAN, 361 Broadway, New York.

INDEX OF INVENTIONS

For which Letters Patent of the United States were Granted

March 18, 1890.

AND EACH BEARING THAT DATE.

[See note at end of list about copies of these patents.]

Table listing inventions such as 'Account and record holding case and correlative sheet, card, or ticket, C. M. Wilson', 'Alarm, See Burglar and fire alarm. Low water alarm.', 'Ampere meter, G. A. Frei', 'Annunciator, C. E. Scribner', etc.

Table listing inventions such as 'Cash recording and indicating machine, C. H. L. Pillsbury', 'Casks or barrels, machine for making, A. Dunbar', 'Cement into forms to be tested, device for moulding, L. Girdler', etc.

Table listing inventions such as 'Glass beveling machine, R. R. Newton', 'Glass polisher, C. G. Flick', 'Glove fastener, C. A. Bryant', 'Governor for steam engines, centrifugal, J. W. Brown', etc.

Table listing inventions such as 'Photo-chemical printing, W. Willis', 'Photographers, timing apparatus for, H. Ford', 'Photographic cameras, magazine for, T. S. Wiles', etc.

Advertisements.

Inside Page, each insertion 75 cents a line. Back Page, each insertion \$1.00 a line.

The above charges per agate line—about eight words per line. This notice shows the width of the line, and is set in agate type. Engravings may be advertised at the same rate per agate line, by measurement, as the letter press. Advertisements must be received at publication office as early as Thursday morning to appear in next issue.

Tap, adjustable, H. C. Bradford	428,409
Tapping sheet metal vessels, devices for, C. H. James	428,429
Telegraph, fire or police, G. C. McCullough	428,487
Telephone call, individual, J. Sack	428,575
Thermometer, J. Wach	428,842
Thill coupling, W. M. Edelin	428,675
Thill coupling, P. V. Egbert	428,420
Thill coupling, M. G. Hawke	428,763
Thill coupling, A. W. Hollingsworth	428,765
Thill coupling, E. M. Howenstein	428,892
Thill coupling, M. L. Schoch	428,634
Threshing machine, Wemple & Smith	428,581
Threshing machines, band cutter and feeder for, A. A. Naylor	428,624
Tie. See Railway tie. Railway cross tie.	
Tobacco conveyer, L. J. Wright	428,505
Tool, combination, A. & J. F. Clarke	428,513
Tooth crown, artificial, E. P. Murray	428,467
Toy, puzzle, S. P. Baldwin	428,407
Toy savings bank or safe, registering, A. S. & L. A. Munger	428,528
Transom lifter, O. H. Taylor	428,835
Transplanter, F. A. Bemis	428,723
Transplanting trees, apparatus for, W. A. Estes	428,746
Trough. See Feed trough.	
Truck, W. A. Clark	428,672
Truck, barrel, L. Rawdon	428,442
Truck catch, H. C. Hunt	428,607
Tube or case for holding drawings, B. Arnold	428,712
Tufted fabric, A. Bollenin	428,659
Type impressions, apparatus for producing indented, W. J. Howell	428,688
Type transferring case, E. E. Baker	428,715
Typewriting machine, D. A. Murray	428,622
Typewriting machine, J. W. Schuckers	428,576
Typewriting machine, J. A. Wallace	428,644
Umbrella or parasol, H. A. Fleuss	428,422
Universal joint, W. L. Judson	428,562
Valve mechanism slide, C. Schmid	428,492
Valve, straight-way, J. Giles	428,755
Vapor burner, P. J. Fitzgerald	428,747
Vehicle, two-wheeled, W. N. Sterner	428,830
Velopede, A. Easthope	428,471
Velopede saddle, Nodder & Petford	428,800
Vertical anti friction engine, O. Colborne	428,315
Violins, tuning peg for, S. W. Wilcox	428,648
Vise, adjustable, G. H. Cole	428,737
Vise, door supporting, W. Bateson	428,719
Voting booth, portable, J. Payne	428,571
Wagon, W. W. Haupt	428,475
Wagon bed raiser, H. E. Jackson	428,771
Wagon brake, F. W. Oeburg	428,695
Wagon brake, W. E. Stevens	428,454
Wagon seat lock, D. W. Glidden	428,681
Wagon skain, G. J. Larson	428,438
Walls and chimney, flashing for, J. White	428,888
Warp beaming machine, E. H. Taylor	428,643
Water level indicator and alarm, I. A. Fuller	428,680
Water purifier and cooler, G. Simpson	428,824
Weatherboarding machine, Dunn & Paschal	428,419
Weather strip for windows, Fowler & Ulmer	428,752
Welding metals by electricity, C. L. Coffin	428,732, 428,734, 428,735
Welding metals electrically, C. L. Coffin	428,736
Welding, method of and apparatus for electric, C. L. Coffin	428,733
Wheel. See Door hanger wheel. Fifth wheel.	
Whiffletree, A. S. Johnston	428,519
Whip, C. J. Bradley	428,726
Whip socket attachment, D. D. Fraser	428,679
Windmill, J. J. Gardner	428,602
Window chair, H. D. Pilmsoll	428,698
Wire rope grip, A. H. Mathesius	428,694
Wrench, F. F. Asmus	428,509
Wrench, E. H. G. Brinser	428,492
Wrench, J. Lepley	428,488

TRADE MARKS.

Baseballs, J. C. Richard	17,683
Boots, shoes, slippers, hosiery, and insoles, Smith, Waters & Havens	17,686
Candles, F. Baumer	17,667
Chocolates and candies, C. Gousset	17,673
Cocoa, E. Galer	17,672
Exercising machines, D. L. Dowd	17,670
Face bleach or wash, M. Meyberg	17,678
Fishing tackle, A. G. Spalding & Bros.	17,685
Flour, C. C. Washburn's Flouring Mills Company	17,689 to 17,691
Flour and other products from wheat, C. C. Washburn's Flouring Mills Company	17,692
Flour, C. C. Washburn's Flouring Mills Company	17,693, 17,694
Flour, wheat, Sweet Water Mill Company	17,687, 17,688
Hats and caps, Young Brothers	17,695
Lager beer, Long Island Brewery	17,676
Leather and leather worked up into footwear, uncut, Pfister & Vogel Leather Company	17,681
Oil, illuminating, Cleveland Refining Company	17,688
Oil, medicinal quality of castor, Red Seal Castor Oil Company	17,682
Oils, lubricating, W. T. O'Mara	17,679
Perfumes, toilet soaps, and preparations for the hair, skin, and teeth, S. Palmer	17,680
Pickled meats, L. G. Davalos & Co.	17,669
Salve for the cure of skin diseases, Schneider & Bisdorf	17,684
Saws, E. C. Atkins & Company	17,686
Snuff, catarrh, F. C. Keith	17,675
Stoves and ranges, ventilating, H. Howe	17,674
Toilet essences and toilet soap, Eastman & Bro.	17,671
Typewriting machines, Merritt Manufacturing Company	17,677

DESIGNS.

Brushes, mirrors, etc., back for, H. Berry	19,702, 19,708
Cigar, M. Boremsky	19,705
Com receptacle, W. Monteith	19,708
Combs, brushes, etc., handle for, H. Berry	19,704
Glass, ornamentation of, E. F. Chauce	19,707
Silver or other tableware, ornamentation of, S. W. Babbitt	19,701
Spoon or similar article, Myrick & Roller	19,709
Stove, gas, Adams & Rivett	19,700
Toilet stand for babies, C. M. Burnett	19,706
Tray, wash, F. J. Torrance	19,711
Type, font of printing, E. C. Ruthven	19,710

A Printed copy of the specification and drawing of any patent in the foregoing list will be furnished from this office for 25 cents. In ordering please state the name and number of the patent desired, and remit to Munn & Co., 361 Broadway, New York.

Canadian Patents may now be obtained by the inventors for any of the inventions named in the foregoing list, provided they are simple, at a cost of \$40 each. If complicated, the cost will be a little more. For full instructions address Munn & Co., 361 Broadway, New York. Other foreign patents may also be obtained.

USE ADAMANT WALL PLASTER



It is Hard, Dense, and Adhesive. Does not check or crack. It is impervious to wind, water, and disease germs. It dries in a few hours. It can be applied in any kind of weather. It is in general use. Licenses granted for the mixing, using, and selling.

Address ADAMANT MFG. CO.
309 E. Genesee St.,
Syracuse, N. Y.

THE PHONOGRAPH.—A DETAILED description of the new and improved form of the phonograph just brought out by Edison. With 8 engravings. Contained in SCIENTIFIC AMERICAN SUPPLEMENT, No. 632. Price 10 cents. To be had at this office and from all newsdealers.

LATHE



"Star" Foot Lathe Swings 24x25 in.

Screw Cutting Automatic Cross Feed, etc.

Seneca Falls Mfg. Co., 695 Water St., Seneca Falls, N. Y.

SEBASTIAN, MAY & CO'S

Improved Screw Cutting Foot & Power LATHES \$60



Drill Presses, Chucks, Drills, Dogs, and machinists' and amateurs' outfits. Lathes on trial. Catalogue mailed on application.
165 W. 2d St., Cincinnati, O.

BEST SHORT LINE TELEPHONES



Unexcelled in Tone and Quality. Thousands in Daily Use. Satisfaction guaranteed. Prices Low. Send two 2-cent stamps for illustrated catalogue and circulars.
T. G. ELLSWORTH,
177 West St., N. Y. City.

THE FRED K CRANE CHEMICAL CO.
SHORT HILLS, N. J. - BOX 91A -

ZAPONS, BRUSH & DIP LACQUERS, VARNISH, SHELLACS, BLACKS, BRILLIANT & DEAD, JAPANS AIR DRYING, ENAMELS, TRANSPARENT, FOR METAL AND WOOD. PROOF AGAINST ACIDS AND ALKALIES.

— WRITE FOR CATALOGUE —

PULLEYS HANGERS, FRICTION CLUTCHES.

PROGRESS MACHINE WORKS, A. & F. BROWN, 44 Park Place, N. Y.

CELEBRATED SUTTON RING PACKING.

POSITIVELY AN ANTI-FRICTION, SPECIALLY ENDORSED FOR HIGH SPEED ENGINES. SEND FOR SAMPLE PACKING PARTICULARS TO ERIE RUBBER CO. ERIE PA U S A

SPECIAL NOTICE!

We have recently issued a priced Catalogue of MINING, TUNNELING & QUARRYING MACHINERY. This is a large volume, profusely illustrated and compiled with the view of placing intelligently before the public Facts and Figures relating to Equipment, Cost, and Operation of Mining, Tunneling, and Quarrying Plants. It will be mailed free to any one interested or engaged in **ROCK EXCAVATION or COMPRESSED AIR.** To others it will be sent on receipt of 50 cents in stamps.
INGERSOLL-SERGEANT ROCK DRILL CO.
No. 10 Park Place, New York, U. S. A.

ROCK DRILLS AIR COMPRESSORS & GENERAL MACHINERY FOR MINING, TUNNELING, QUARRY & RAILROAD WORK.



RAND DRILL CO. 23 PARK PLACE NEW YORK

DRY AIR REFRIGERATING MACHINE.

Description of Hall's improved horizontal dry air refrigerator, designed to deliver about 1000 cubic feet of cold air per hour, when running at a speed of 100 revolutions per minute, and capable of reducing the temperature of 90° above to 50° below zero. With five figures, showing plan and side elevation of the apparatus, and diagrams illustrative of its performance. Contained in SCIENTIFIC AMERICAN SUPPLEMENT, No. 458. Price 10 cents. To be had at this office and from all newsdealers.

BARNES' PAT. FOOT POWER MACHINERY.

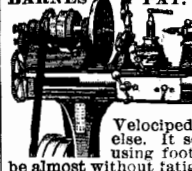

I feel so highly pleased with your Velopede Foot Power with seat, that I wish to add my testimony to its superiority. I did not expect to like it, but having used the Velopede Power, I would have nothing else. It so greatly lessens the fatigue of using foot power, in fact, it may be said to be almost without fatigue, and is a steady motion. I only wish I had known of it sooner. Send for catalogue.
W. F. & J. BARNES CO., 399 Ruby St., Rockford, Ill.

COMPLETE STEAM PUMP

10 SIZES FROM \$7 TO \$75

FOR WATER SUPPLY TANKS, FIRE PUMPS & ETC.



WRITE FOR PRICES AND DESCRIPTIVE CATALOGUES.

SOLE MAKERS - CINCINNATI, O.

PRESSSES. 50 TO 500 TONS, By Hand or Power.

For almost every purpose requiring pressure.

BOOMER & BOSCHERT PRESS CO.

155 West Water Street, Syracuse, N. Y., U. S. A.

TOOL AGENTS WANTED in every SHOP in the United States. Send 10c for catalogue. Stationery & the FINEST OF MECHANICAL TOOLS A SPECIALTY. C. E. JAMES, 98 LAKE ST. CHICAGO.

ICE-HOUSE AND COLD ROOM.—BY R. G. Hatfield. With directions for construction. Four engravings. Contained in SCIENTIFIC AMERICAN SUPPLEMENT, 59. Price 10 cents. To be had at this office and of all newsdealers.

ROP HAMMERS

Punching Presses DIES AND OTHER TOOLS



Branch Office and Factory, 203, 205 & 207 Center St., N. Y.

\$3 PRINTING PRESS. Do all your own printing. Save money. Catalogue for two stamps. Kelsey & Co., Meriden, Conn.

CATALOGUES FREE TO ANY ADDRESS

TOOLS OF ALL KINDS



GOODNOW & NIGHTMAN BOSTON

Scientific Book Catalogue

RECENTLY PUBLISHED.

Our new catalogue containing over 100 pages, including works on more than fifty different subjects. Will be mailed free to any address on application.
MUNN & CO., Publishers Scientific American,
361 Broadway, New York.

DROP FORGINGS



FINISHED TOOLS

BILLINGS & SPENCER CO.
HARTFORD CONN.

Fine Taps, Dies, Reamers, Etc.

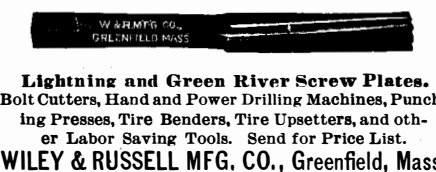

Lightning and Green River Screw Plates. Bolt Cutters, Hand and Power Drilling Machines, Punching Presses, Tire Benders, Tire Upsetters, and other Labor Saving Tools. Send for Price List.
WILEY & RUSSELL MFG. CO., Greenfield, Mass.

THE FRED K CRANE CHEMICAL CO.
SHORT HILLS, N. J. - BOX 91A -

ZAPONS, BRUSH & DIP LACQUERS, VARNISH, SHELLACS, BLACKS, BRILLIANT & DEAD, JAPANS AIR DRYING, ENAMELS, TRANSPARENT, FOR METAL AND WOOD. PROOF AGAINST ACIDS AND ALKALIES.

— WRITE FOR CATALOGUE —

PULLEYS HANGERS, FRICTION CLUTCHES.

PROGRESS MACHINE WORKS, A. & F. BROWN, 44 Park Place, N. Y.

CELEBRATED SUTTON RING PACKING.

POSITIVELY AN ANTI-FRICTION, SPECIALLY ENDORSED FOR HIGH SPEED ENGINES. SEND FOR SAMPLE PACKING PARTICULARS TO ERIE RUBBER CO. ERIE PA U S A

VELOCITY OF ICE BOATS. A COLLECTION of interesting letters to the editor of the SCIENTIFIC AMERICAN on the question of the speed of ice boats, demonstrating how and why it is that these craft sail faster than the wind which propels them. Illustrated with 10 explanatory diagrams. Contained in SCIENTIFIC AMERICAN SUPPLEMENT, No. 214. Price 10 cents. To be had at this office and from all newsdealers.

OUR MOTOR. PERFECT POWER

For Any Purpose. OUR FAN. Send for Catalogue.

CHICAGO WATER MOTOR CO.
88 Lake Street, Chicago, Ill.

Patent Pocket Oiler and Sheath



Handiest Oiler in the market. Releases one drop of oil, no waste or leakage. For guns, bicycles, typewriters, fine machines, etc. Send 25c for sample. Bridgeport Gun Implement Co., 17 Maiden Lane, N. Y.

CHICAGO NICKEL WORKS.

MANUFACTURERS OF **Sohn's Patent Foot Rest, And Other Metal Specialties.**

We make a specialty of manufacturing on contract all kinds of metal articles, small machinery, etc. Have the largest nickel-plating works in the west. Obtain our estimate on work and submit meritorious patents for manufacture and sale.

CHICAGO NICKEL WORKS, 93 & 95 E. Ohio St. Chicago

ICE-BOATS — THEIR CONSTRUCTION and management. With working drawings, details, and directions in full. Four engravings, showing mode of construction. Views of the two fastest ice-sailing boats used on the Hudson river in winter. By H. A. Horsfall, M. E. Contained in SCIENTIFIC AMERICAN SUPPLEMENT, 1. The same number also contains the rules and regulations for the formation of ice-boat clubs, the sailing and management of ice-boats. Price 10 cents.

2nd MACHINERY

N. Y. Mach'y Depot, Bridge Store 16, Frankfort St., N. Y.

STEEL TYPE FOR TYPEWRITERS, Stencils, Steel Stamps, Rubber and Metal Type Wheels.

New York Stencil Works, Mfrs. 100 Nassau Street, New York.

FOR LINING WALLS, FLOORS TO PREVENT WARMTH ESCAPING AND DEADENING SOUND.

USE MINERAL WOOL. FREE SAMPLES AND CATALOGUES.

WARMTH ESCAPING AND DEADENING SOUND. USE MINERAL WOOL. FREE SAMPLES AND CATALOGUES. U. S. MINERAL WOOL CO., 200 CORTLANDT ST., NEW-YORK CITY, U. S. A.

Steam! Steam!

Quality Higher, Price Lower. For Strictly Cash, Complete Fixtures except Stack. 2-Horse Eureka Boiler and Engine, - \$135
4- " " " " - 210

Other sizes at low prices. Before you buy get our prices.

B. W. PAYNE & SONS,
Drawer 56. ELMIRA, N. Y.

OUR MAGIC LANTERNS



WITH OIL LAMPS HAVE NO EQUAL.

VIEWS OF ALL SUBJECTS

EASTERN PRICES GUARANTEED

L. MANASSE
88 MADISON ST. CHICAGO ILL.

ICE-HOUSE AND REFRIGERATOR. Directions and Dimensions for construction, with one illustration of cold house for preserving fruit from season to season. The air is kept dry and pure throughout the year at a temperature of from 34° to 36°. Contained in SCIENTIFIC AMERICAN SUPPLEMENT No. 116. Price 10 cents. To be had at this office and of all newsdealers.

Lightning Well-Sinking Machinery. Makers of Hydraulic, Jetting, Revolving Artesian Mining, Diamond Tools, Wells & Prospecting Engines, Boilers, Wind Mills, Pumps, etc. SOLD ON TRIAL. An ENCYCLOPEDIA of 1,000 Engravings, Earth Stratification, Determination of Minerals and Quality of Water. Gives Light, Finds Gold. Mailed for 25 cts. Gas Book 25 cts. The American Well Works, AURORA, ILLS.



OIL WELL SUPPLY CO. Ltd.

91 & 92 WATER STREET, Pittsburgh, Pa.

Manufacturers of everything needed for **ARTESIAN WELLS** for either Gas, Oil, Water, or Mineral Tests, Boilers, Engines, Pipe, Cordage, Drilling Tools, etc. Illustrated catalogue, price lists and discount sheets on request.

ARTESIAN



Wells, Oil and Gas Wells, drilled by contract to any depth, from 50 to 3000 feet. We also manufacture and furnish everything required to drill and complete same. Portable Horse Power and Mounted Steam Drilling Machines for 100 to 600 ft. Send cents for illustrated catalogue. Pierce Artesian and Oil Well Supply Co., 80 Beaver Street, New York.

Perforated Electric Belting

FOR SWIFT RUNNING MACHINERY.

Write for Descriptive Catalogue to **CHAS. A. SCHIEREN & CO.**
45-51 FERRY ST., NEW YORK.

MUNSON'S PORTABLE MILLS, AND MILL FURNISHINGS, MANUFACTURED BY MUNSON BROTHERS, UTICA, N. Y., U. S. A.



EVERY USER OF MACHINERY SHOULD LEARN How to Use Loose Pulleys.

Useful information on this subject is given in our "Catalogue No. 55," sent free to any address.
VAN DUZEN & TRFT, Cincinnati, O.

THE PENNA. DIAMOND DRILL & MFG. CO.

BIRDSBORO, PA., Builders of High Class Steam Engines, Diamond Drilling and General Machinery. Flour Mill Rolls Ground and Grooved.

MAGIC LANTERNS

SANDS STEREOPTICONS SCHOOLS & PUBLIC ENTERTAINMENTS FOR LANTERN SLIDES COLORED & UNCOLORED

SEND FOR CATALOGUE **QUEEN & CO.** PHILA. PA.

TO BUSINESS MEN

The value of the SCIENTIFIC AMERICAN as an advertising medium cannot be overestimated. Its circulation is many times greater than that of any similar journal now published. It goes into all the States and Territories, and is read in all the principal libraries and reading rooms of the world. A business man wants something more than to see his advertisement in a printed newspaper. He wants circulation. This he has when he advertises in the SCIENTIFIC AMERICAN. And do not let the advertising agent influence you to substitute some other paper for the SCIENTIFIC AMERICAN, when selecting a list of publications in which you decide it is for your interest to advertise. This is frequently done, for the reason that the agent gets a larger commission from the papers having a small circulation than is allowed on the SCIENTIFIC AMERICAN. For rates see top of first column of this page, or address **MUNN & CO., Publishers,**
361 Broadway, New York.

SOME CHOICE Technical & Treatises!

ANDRES.—A Practical Treatise on the Fabrication of Volatile and Fat Varnishes, Lacquers, Siccatives, and Sealing Waxes. With additions on the application of Varnishes, Stains for Wood, Horn, Ivory, Bone, and Leather. Edited from the German by W. T. Brant.

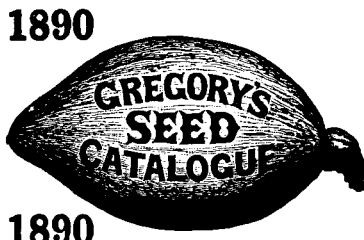

1890

THE PUBLIC WANT their seed fresh and true. Would they not be most likely to obtain such by buying directly from the grower?

FLORIDA STEAM AND HOT WATER HEATERS. FOR WARMING RESIDENCES STORES HOTELS BUSINESS BLOCKS, SCHOOLS AND PUBLIC BUILDINGS BY STEAM OR HOT WATER CIRCULATION.

IS YOUR LIFE SAFE AT HOME?

SHERMAN 'KING' VAPORIZER CO. THE SHERMAN 'KING' VAPORIZER CO. KING VAPORIZER CO. CHICOPEE FALLS, MASS.

CLARK'S NOISELESS RUBBER WHEELS. Absolutely prevents splintering and wearing of floors caused by use of iron wheels.

EXCELLENT BLACK COPIES, only equaled by Lithography, of anything written or drawn with any Pen by the Patent AUTOCOPYIST.

"ELECTRIC" SPIRAL SCREW DRIVER

THE ALFORD & BERKELEY CO., 77 Chambers St., Sample, by mail, \$1. P. O. Box 2002, New York City.

NUT TAPPING MACHINE. DURRELL'S PATENT. No. 1 Machine, 900 lb., 7 spindles.

POP SAFETY VALVE WATER RELIEF VALVE IMPROVED STEAM GAGE STEAM ENGINE INDICATOR.

MULTIPLICATION AND DIVISION TABLE for all numbers between 1 and 100. Chart 12 in. by 15 in.

Do Your Trousers Bag at the Knees?

DO YOUR SUSPENDERS pull them so tight as to draw them into creases from the knee to the body? Scientific Suspenders carry the trousers from the pivotal point over the side seam.

PROPOSALS.

Proposals for Material for Steel Tops for the U. S. S. "San Francisco," at the U. S. Navy Yard, Mare Island, California.

Proposals for Monitor Screw Machine for the New York Navy Yard.—March 14, 1890.—Sealed proposals, endorsed "Proposals for Material for Steel Tops of the U. S. S. 'San Francisco,' at the Mare Island Navy Yard, to be opened April 13, 1890," will be received at the Bureau of Provisions and Clothing, Navy Department, Washington, D. C., until 12 o'clock noon, April 15, 1890, and publicly opened immediately thereafter.

Department of the Interior, WASHINGTON, March 13, 1890.—Sealed proposals for erecting an engine house and impounding reservoir, furnishing pumping engines and boilers, cast and wrought iron piping, special castings, fittings, valves, lead pipe, and for excavation and performing the work necessary to complete the pumping station on the Hot Springs Reservation, at Hot Springs, Ark., will be received at this Department until 12 o'clock M., Wednesday, April 30, 1890, when they will be opened.

Proposals for Installing an Electric Lighting Plant at U. S. Navy Yard, Norfolk, Va.—BUREAU OF YARDS AND DOCKS, Department of the Interior, D. C., March 25, 1890.—Sealed proposals, in duplicate, endorsed "Proposals for Electric Lighting Plant for Norfolk Navy Yard," will be received at this Bureau until 11 o'clock A. M. on Friday, April 25, 1890, and publicly opened immediately thereafter.

WESTERN MINERAL WOOL. MINERAL WOOL. SAMPLE FREE. FAMILY ICE MACHINE. Ice in few minutes. Price, \$10 to \$185 Circular. L. Dermigny, 126 West 25th Street, New York.

WORKING MODELS & LIGHT MACHINERY. INVENTIONS DEVELOPED. Send for Model Circular. Jones Bros. E. Co., Cir. 11, O.

INVALUABLE BOOKS

Mechanic, Engineer, and Scientist. NYSTROM'S POCKET-BOOK OF MECHANICS AND ENGINEERING. Nineteenth Edition, Revised and Greatly Enlarged, with Original Matter. By WM. DENNIS MARKS, Ph.B., C.E. (Yale S.S.). Illustrated. 16mo. \$3.50.

THE AMERICAN RAILWAY. With 225 Illustrations Bound in half leather. 8vo. \$6.00 net. *Send to publishers for full descriptive circular.

THE EAGLE THE EASIEST RUNNING BICYCLE IN THE WORLD. Speed, Comfort and Safety. AGENTS WANTED. Large Illustrated Catalogue sent Free to any Address.

FORGING AND WELDING BY PETROLEUM AIR BLAST FIRES.

Wm. Pickett, Son & Co., 170 Lake St., Chicago; and St. Louis. W. S. Collins, 171 B'way, New York; Chilton Jones, Gananoque, Can.; G. M. Smith, Los Angeles, Cal.; Alden Speare's Sons & Co., 3 Central Wharf, Boston; Kalamazoo Spring & Axle Co., Kalamazoo, Mich.

SEATTLE The "Queen City" and Metropolitan of the New State of Washington. For Illustrated Descriptive Matter write to the Lead.

RAILWAY AND STEAM FITTERS' SUPPLIES Rue's Little Giant Injector. SCREW JACKS, STURTEVANT BLOWERS, &c. JOHN S. URQUHART, 46 Cortland St., N. Y.

Excursion to Chattanooga to Chattanooga Land Co., at Chattanooga, Tenn., arrangements have been made with Messrs. RAYMOND & WHITCOMB, the popular excursion managers, to conduct personally, at an early day, excursions from Boston, Chicago, New York, Philadelphia, and Cleveland to Chattanooga.

PLAYS Dialogues, Tableaux, Speakers, for School, Club & Parlor. Best out. Catalogue free. T. S. DENISON, Chicago, Ill.

AGENTS WANTED by an old reliable firm; large profits quick sales. SAMPLE FREE. A rare opportunity. Geo. A. Scott, 842 Broadway, N. Y.

WEITMYER PATENT FURNACE. BOILERS OF EVERY DESCRIPTION. IDE AUTOMATIC ENGINES. Traction and Portable Engines. STEAM ROAD ROLLERS. Manufactured by FOUNDRY & MACHINE DEPT., Harrisburg, Pa., U. S. A.

Cheap Printing. Do it yourself. Circular press \$8. Size for small newspapers, \$44. Every thing easy, printed in the factory. KELSEY & CO., Meriden, Conn.

THE BEST LIME KILN KNOWN or no pay. C. D. PAGE, Rochester, N. Y.

THE HAMMOND TYPEWRITER CO. 447, 449 East 52d Street, NEW YORK, U. S. A.

INVENTORS We make a specialty of manufacturing and selling advertising novelties. We buy patents in this line, or manufacture and sell on royalty. We employ a large number of bright agents. Correspondence solicited. WILBUR PUBLISHING CO., 541 The Hookery, Chicago.

TO INVENTORS!—PATENTS, Trade and Copyrights. Agency Office for ITALY—Rome E. via Cavour 194. L. GATTA. Highest references. English correspondence. Commissions and representations.

INVENTORS!—We make anything you want from a Screw to Complete Working Model. Inventions perfected, details worked out, drawings made. Repairs. Circulars sent. A. J. WEED & Co., 112 Fulton St., N. Y.

A VALUABLE PATENT FOR SALE. Walden's Automatic Force Delivery Elevator Bucket. Designed especially for ditching, dredging, or well digging machines, or handling wet and sticky material. Address T. J. WALDEN, Lebanon, Boone Co., Indiana.

The Scientific American PUBLICATIONS FOR 1890. The prices of the different publications in the United States, Canada, and Mexico are as follows: RATES BY MAIL. The Scientific American (weekly) one year \$3.00

THE BACKUS WATER MOTOR. THE BACKUS EXHAUST FAN. With or without Governor. Supplies from hydrant pressure the cheapest power known. Invaluable for blowing church organs, running printing presses, sewing machines, lathes, saws, coffee mills, fans, sausage cutters, elevators, and all machinery requiring light power.

Advertisements.

Inside Page, each insertion --- 75 cents a line.
 Back Page, each insertion --- \$1.00 a line.
 The above are charges per agate line—about eight words per line. This notice shows the width of the line, and is set in agate type. Engravings may head advertisements at the same rate per agate line, by measurement, as the letter press. Advertisements must be received at publication office as early as Thursday morning to appear in next issue.

Wheeling is Better than Walking.



Victor Bicycles
 Are Better than Any Others.
 Catalogue Free.
 Overman Wheel Co., Makers,
 Chicopee Falls, Mass.

THE COPYING PAD.—HOW TO MAKE
 and how to use; with an engraving. Practical directions how to prepare the gelatine pad, and also the aniline ink by which the copies are made; how to apply the written letter to the pad; how to take off copies of the letter. Contained in SCIENTIFIC AMERICAN SUPPLEMENT, No. 438. Price 10 cents. For sale at this office and by all newsdealers in all parts of the country.

NEW KODAKS
 "You press the button,
 we do the rest."
 Seven New Styles and Sizes
 ALL LOADED WITH **Transparent Films.**



For sale by all Photo. Stock Dealers.
THE EASTMAN COMPANY,
 Send for Catalogue. ROCHESTER, N. Y.

MODELS!
 Experimental Work, Light and Special Machinery to order. N. ERLANDSEN, 107 Rivington St., New York.

Hoskins' Patent Hydro-Carbon
BLOW-PIPE AND ASSAY FURNACES.
 No dust. No ashes. Cheap, effective, economical, portable, and automatic.
 Send for Price List. W. Hoskins, 81 S. Clark St., Room 50, Chicago, Ill.



THE AMERICAN BELL TELEPHONE CO.
 95 MILK ST., BOSTON, MASS.

This Company owns the Letters Patent granted to Alexander Graham Bell, March 7th, 1876, No. 174,465, and January 30th, 1877, No. 186,787.

The transmission of Speech by all known forms of Electric Speaking Telephones infringes the right secured to this Company by the above patents, and renders each individual user of telephones not furnished by it or its licensees responsible for such unlawful use, and all the consequences thereof, and liable to suit therefor.

REMINGTON

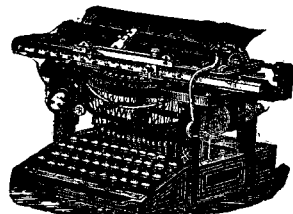

STANDARD TYPEWRITER.
 Gold Medal—Paris Exposition, 1889.
Wyckoff, Seamans & Benedict
 327 BROADWAY, NEW YORK.

NICKEL AND ELECTRO-PLATING APPARATUS AND MATERIAL
 HANSON, VAN WINKLE & CO.
 NEWARK, N. J.
 92 LIBERTY ST. N. Y.



PATENTS!

MESSRS. MUNN & CO., in connection with the publication of the SCIENTIFIC AMERICAN, continue to examine inventions, and to act as Solicitors of Patents for Inventors.
 In this line of business they have had forty-one years' experience, and now have unequalled facilities for the preparation of Patent Drawings, Specifications, and the prosecution of Applications for Patents in the United States, Canada, and Foreign Countries. Messrs. Munn & Co. also attend to the preparation of Caveats, Copyrights for Books, Labels, Reissues, Assignments, and Reports on Infringements of Patents. All business entrusted to them is done with special care and promptness, on very reasonable terms.
 A pamphlet sent free of charge, on application, containing full information about Patents and how to procure them; directions concerning Labels, Copyrights, Designs, Patents, Appeals, Reissues, Infringements, Assignments, Rejected Cases. Hints on the Sale of Patents, etc.
 We also send, free of charge, a Synopsis of Foreign Patent Laws, showing the cost and method of securing patents in all the principal countries of the world.
MUNN & CO., Solicitors of Patents,
 361 Broadway, New York.
 BRANCH OFFICES.—No. 622 and 624 F Street, Pacific Building, near 7th Street, Washington, D. C.

THE BRIDGEPORT WOOD FINISHING CO
 G. M. BREINIG, AGENT, PRINCIPAL OFFICE AT MANUFACTORY NEW MILFORD, CONN.
 NEW YORK OFFICE, 240 PEARL ST.
 CHICAGO OFFICE & WAREHOUSE 211 EAST RANDOLPH. MANUFACTURERS OF
WHEELERS PATENT WOOD FILLER.
BREINIG'S LITHOGEN SILICATE PAINT
 LITHOGEN PRIMER, WOOD STAINS
SILEX FLINT AND FELDSPAR.
 PAMPHLET GIVING DIRECTIONS FOR FINISHING HARD WOOD FREE TO ANY ADDRESS.

Printing Presses.
 MILWAUKEE, WIS., 387 B'way, Feb. 18, 1890.
 CHARTER GAS ENGINE CO., Sterling, Ill.
 In answer to your inquiry how we like our engine, will say we have used your No. 4 Gasoline Engine about one year and are much pleased with it. It furnishes a stronger and steadier power than the Gas Engine we formerly used, at a cost of about \$15.00 less per month to run it, which we consider quite an item. The average is 12 gallons of gasoline for 10 hours work. Our insurance has not been raised on account of it. The Chief of our Fire Department recommended it as a better insurance risk than an engine using manufactured gas, and we are in the heart of the city. The printer in the interior of Wisconsin to whom I recommended the "Charter," says it is working splendid. You can refer any one to us for further particulars.
 Yours,
 SWAIN & TATE.
 For circulars, etc., address CHARTER GAS ENGINE CO., P. O. Box 148, STERLING, ILL.

GATES ROCK & ORE BREAKER
 Capacity up to 150 yards per hour.
 Has produced more ballast, road metal, and broken more ore than all other Breakers combined.
 Send for Catalogues.
GATES IRON WORKS
 50 C So. Clinton St., CHICAGO.
 215 Franklin St., Boston, Mass.

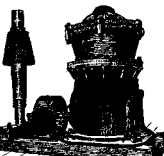

VAN DUZEN GAS & GASOLINE ENGINE
 OPERATED with COAL and OTHER MANUFACTURED GASES AND GASOLINE.
RELIABLE AND ECONOMICAL.
 Fully Warranted
 VAN DUZEN Gas & Gasoline Engine Co.
 53 E. 2d St., Cincinnati, O.

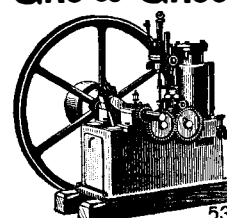

HOME-MADE INCUBATOR.—PRACTICAL
 directions for the manufacture of an effective incubator that has been carefully tested and found to perform all that may be reasonably expected; with directions for operating. With 4 figures. Contained in SCIENTIFIC AMERICAN SUPPLEMENT, No. 630. Price 10 cents. To be had at this office and from all newsdealers.

Shipman Automatic Steam Engine
 KEROSENE OIL FUEL.
STATIONARY and MARINE.
 1, 2, 4, 6, and 8 Horse Power Single, and 8, 12, and 16 Horse Power Compound.
THE SHIPMAN STEAM LAUNCHES
 From 22 to 50 feet in Length.
SAFE, ROOMY, DESIRABLE.
 Send for Catalogue. Mention SCI. AM.
SHIPMAN ENGINE CO., 200 SUMMER STREET, BOSTON, MASS.



THE GREAT IMPROVEMENT IN ROOFING

We are now ready to supply the product of entirely new machinery and processes just completed, by aid of which we not only have greatly improved the strength and durability of our well-known **ASBESTOS ROOFING**, but have also secured a degree of uniformity never before attained in any similar fabric. We offer this as the PERFECTED form of the portable Roofing which we have manufactured with continued improvements during the past thirty years, and as the most desirable Roofing for general purposes.

The important features of our recent improvements, for which patents have been allowed and others applied for in this Country and in Europe, are described in our new circular, which, with samples, will be sent free by mail.

Our Asbestos Roofing is now in use upon Factories, Foundries, Cotton Gins, Chemical Works, Railroad Bridges, Cars, Steamboat Decks, etc., in all parts of the world.

It is supplied ready for use, in rolls containing 200 square feet, and weighs, with Asbestos Roof Coating, ready for shipment, about 85 pounds to 100 square feet.

It is adapted for steep or flat roofs in all climates, and can be readily applied by unskilled workmen.

There are inferior imitations of our Asbestos Roofing. Purchasers are cautioned.

Exclusive sale of our IMPROVED ASBESTOS ROOFING will be given to reliable dealers in important towns where we have not already made arrangements.

H. W. JOHNS MANUFACTURING CO.
 SOLE MANUFACTURERS OF
 H. W. Johns' Fire and Water Proof Asbestos Sheathing, Building Felt, etc. Asbestos Boiler Coverings, Steam Packings, Fire-Proof Paints, etc.
 Samples and Descriptive Price List Free by Mail.
87 Maiden Lane, New York.
 CHICAGO. PHILADELPHIA. BOSTON.

COPPER TUBES SHEET BRASS WIRE
 SEND FOR CATALOGUE
 175 177 LAKE ST. CHICAGO

INVENTORS and others desiring new articles manufactured and introduced, address P. O. Box 86, Cleveland, O.

Moss Engraving Co 535 PEARL ST. NEW YORK.
 cor. Elm St.
ENGRAVINGS for BOOKS, NEWSPAPERS and CIRCULARS
 SEND GREEN STAMP for CIRCULAR—SEND PHOTOGRAPH, DRAWING or PRINT for ESTIMATE.
 When writing to us please mention SCIENTIFIC AMERICAN.

CUTLER DESK BEST IN THE WORLD.
 A. CUTLER & SON, BUFFALO, N. Y., U. S. A.

BASE BALL.—A DESCRIPTION OF
 the great national game of the United States, by an English writer, Jno. Newton Crane, with diagram of the field and 7 illustrations of players. Contained in SCIENTIFIC AMERICAN SUPPLEMENT, No. 693. Price 10 cents. To be had at this office and from all newsdealers.

"COLUMBIAS"
 HIGHEST GRADE ONLY.
 Catalogue Free.
POPE MFG. CO. BRANCH HOUSES:
 77 Franklin St., BOSTON. 12 Warren St., NEW YORK.
 291 Wabash Ave., CHICAGO.

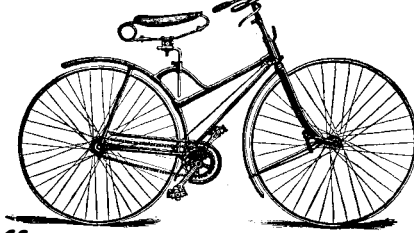

THE ONLY PRACTICAL LOW-PRICED \$15 TYPEWRITER
 Catalogue free. Address Typewriter Department, POPE MFG. CO., Makers of Columbia Cycles, Boston, New York, Chicago.

BARREL, KEG, Hogshead, AND STAVE MACHINERY.
 Over 50 varieties manufactured by
E. & B. HOLMES,
 Chamfering, Howeling, and Crozing. **BUFFALO, N. Y.**



SYRACUSE MALLEABLE IRON WORKS
 W. B. BURNS, PROPRIETOR.

THREE ELEVATORS

A Day is the output of
OTIS BROTHERS & CO.'S
 Passenger and Freight Elevator Works,
 General Office, 38 Park Row, New York.

THE OTIS ELEVATOR

THE GRAVES ELEVATORS.
 PASSENGER & FREIGHT L. S. GRAVES & SON ROCHESTER N. Y.
 NEW YORK, BOSTON, ST. LOUIS, DETROIT.

ELECTRO MOTOR. SIMPLE. HOW TO
 make. By G. M. Hopkins.—Description of a small electro motor devised and constructed with a view to assisting amateurs to make a motor which might be driven with advantage by a current derived from a battery, and which would have sufficient power to operate a foot lathe or any machine requiring not over one man power, with 11 figures. Contained in SCIENTIFIC AMERICAN SUPPLEMENT, No. 641. Price 10 cents. To be had at this office and from all newsdealers.

COMPTOMETER
 ALL ARITHMETICAL PROBLEMS
 Solved rapidly and accurately by using the Comptometer. Saves 40 per cent. of time. Entire relief from mental strain. Adapted to all commercial and scientific computations. Send for circular.
FELT & TARRANT MFG. CO., 52-56 Illinois St., Chicago.



THE Scientific American
 ESTABLISHED 1846.

The Most Popular Scientific Paper in the World.

Only \$3.00 a Year, including Postage. Weekly. 52 Numbers a Year.

This widely circulated and splendidly illustrated paper is published weekly. Every number contains sixteen pages of useful information and a large number of original engravings of new inventions and discoveries, representing Engineering Works, Steam Machinery, New Inventions, Novelties in Mechanics, Manufactures, Chemistry, Electricity, Telegraphy, Photography, Architecture, Agriculture, Horticulture, Natural History, etc. Complete List of Patents each week.

Terms of Subscription.—One copy of the SCIENTIFIC AMERICAN will be sent for one year—52 numbers—postage prepaid, to any subscriber in the United States, Canada or Mexico, on receipt of three dollars by the publishers; six months, \$1.50; three months, \$1.00.

Clubs.—Special rates for several names, and to Post Master s. Write for particulars.

The safest way to remit is by Postal Order, Draft, or Express Money Order. Money carefully placed inside of envelopes, securely sealed, and correctly addressed, seldom goes astray, but is at the sender's risk. Address all letters and make all orders, drafts, etc., payable to

MUNN & CO.,
 361 Broadway, New York.

THE Scientific American Supplement.

This is a separate and distinct publication from THE SCIENTIFIC AMERICAN, but is uniform therewith in size, every number containing sixteen large pages full of engravings, many of which are taken from foreign papers, and accompanied with translated descriptions. THE SCIENTIFIC AMERICAN SUPPLEMENT is published weekly, and includes a very wide range of contents. It presents the most recent papers by eminent writers in all the principal departments of Science and the Useful Arts, embracing Biology, Geology, Mineralogy, Natural History, Geography, Archeology, Astronomy, Chemistry, Electricity, Light, Heat, Mechanical Engineering, Steam and Railway Engineering, Mining, Ship Building, Marine Engineering, Photography, Technology, Manufacturing Industries, Sanitary Engineering, Agriculture, Horticulture, Domestic Economy, Biography, Medicine, etc. A vast amount of fresh and valuable information obtainable in no other publication.

The most important Engineering Works, Mechanisms, and Manufactures at home and abroad are illustrated and described in the SUPPLEMENT.

Price for the SUPPLEMENT for the United States and Canada, \$5.00 a year, or one copy of the SCIENTIFIC AMERICAN and one copy of the SUPPLEMENT, both mailed for one year for \$7.00. Single copies 10 cents. Address and remit by postal order, express money order, or check.

MUNN & Co., 361 Broadway, N. Y.,
 Publishers SCIENTIFIC AMERICAN.

Building Edition.

THE SCIENTIFIC AMERICAN ARCHITECTS' AND BUILDERS' EDITION is issued monthly. \$2.50 a year. Single copies, 25 cents. Forty large quarto pages, equal to about two hundred ordinary book pages; forming a large and splendid Magazine of Architecture, richly adorned with elegant plates in colors, and with other fine engravings; illustrating the most interesting examples of modern Architectural Construction and allied subjects.

A special feature is the presentation in each number of a variety of the latest and best plans for private residences, city and country, including those of very moderate cost as well as the more expensive. Drawings in perspective and in color are given, together with full Plans, Specifications, Sheets of Details, Estimates, etc.

The elegance and cheapness of this magnificent work have won for it the Largest Circulation of any Architectural publication in the world. Sold by all newsdealers. \$2.50 a year. Remit to

MUNN & CO., Publishers,
 361 Broadway, New York.

PRINTING INKS.

THE "Scientific American" is printed with CHAS. T. JENNEJOHN & CO.'S INK. Tenth and Lombard Sts., Phila. and 47 Rose St., opp. Duane St., N. Y.